

RADIO NEWS

NOVEMBER
1941
25c
In Canada 30c



Television Antennae
Atop Empire State Bldg.

STAGING A
TELEVISION
PROGRAM

CONSTRUCTING A WEARABLE HEARING AID
★ PORTABLE SEMI-PRO RECORDER ★

Enjoy **FM** at its Best!



Frequency Modulation and Amplitude Modulation in One Receiver

A FREQUENCY MODULATION communications receiver covering three bands: 28 to 46 mc; 45 to 84 mc; 81 to 145 mc. Switch changing from FM to AM reception. Acorn tubes in RF and converter system. High gain 1852 tubes in Iron Core IF stages. Beam power tubes in AF amplifier. Controls are: RF gain control, Band Switch. Antenna trimmer. IF selectivity control and power switch. Volume control, Pitch control, Tone control, S-Meter adjustment, AVC on-off switch, Send-receive switch, 15 tubes. Operates on 110 volts 50-60 cycle AC. Cabinet dimensions 19" long, 9" high, 14" deep. Model S-27 FM/AM Receiver complete with tubes. \$195. Model S-27B (Covers from 36 to 165 mc.) \$195.

*Jensen Model CRJ-52 Reproducer delivers
outstanding performance with FM/AM
Model S-27 and S-27B*

the hallicrafters co.
CHICAGO, U. S. A.

USED BY 33 GOVERNMENTS ★ SOLD IN 89 COUNTRIES

**Men NOW in Radio
who Don't Think
they know it All
Read This**

You don't want to see younger, better trained men push ahead of you, I know. You don't want Radio's new technical developments to baffle you either, I am sure. You want to be ready to "cash in" on Television, Frequency Modulation, too. I have helped many already in Radio to win promotions, to make more money. Read my message below.

J. E. SMITH, President
NATIONAL RADIO INSTITUTE
Established 25 years

He has directed the training of more men for Radio than anyone else—has helped men already in Radio to get ahead, and men not in Radio to get into Radio and win success.



**If You're NOT
Working in Radio Now
Read This**

Do you want to make more money? Do you want to cash in on your present interest in Radio, Television, Frequency Modulation? Do you want a full-time job with good pay in one of Radio's many fascinating branches? Or do you want to make extra money in your spare time to boost your present income, or to get better rank and pay if called into military service? If you want to do any of these things—you owe it to yourself to find out how I have trained hundreds of men for jobs in Radio. MAIL THE COUPON BELOW—TODAY.

Make Me Prove I Can Train You at Home for RADIO and TELEVISION

Clip the coupon and mail it. I'm certain I can train you at home in your spare time to be a Radio Technician. I want to send you a sample lesson free; to examine, read. See how clear my Course is to understand. See how my Course is planned to help you get a good job in Radio, a young growing field with a future. You don't have to give up your present job, or spend a lot of money to become a Radio Technician. I train you at home nights in your spare time.
Charles F. Helmuth, 419 N. Mass. Ave., Atlantic City, N. J., writes, "I started Radio in the Marines. Later I took the N. R. I. Course. Now I am my own boss and get jobs over others who thought they had them. I owe plenty to N. R. I. Training." James E. Ryan, 119 Peble St., Fall River, Mass., writes, "I was working in a garage when I enrolled with N. R. I. I am now Radio Service Manager for the M. Furniture Co. for their four stores."

**Many Radio Technicians I Trained at Home
Make \$30, \$40, \$50 a Week**

Many N. R. I.-trained Radio Technicians have taken advantage of opportunities to open a full-time or spare-time Radio business selling, servicing, installing, repairing home and auto Radio sets. Many others hold good jobs doing this kind of work for Radio manufacturers, dealers, jobbers, service organizations. Radio Operators I trained have good jobs in Broadcasting, Commercial Aviation, Police, Ship, Radio Stations. Some make good money in Public Address work and other branches of the Radio industry. My Course is thorough and practical. I give you basic training in Radio Theory and Practice which enables you to understand the operation and design of practically every type of Radio apparatus. You understand your work—know just what to do—instead of merely relying on your mechanical ability to fix a few common faults and make a few simple adjustments. That's why many men who have been in Radio before enrolling report that my Course helped them make more money, win success. I train you too, for Television, a promising field of future opportunity.

**Beginners Quickly Learn to Earn \$5 to \$10
a Week Extra in Spare Time**

Nearly every neighborhood offers opportunities for a good part-time Radio Technician to make extra money fixing Radio sets. I give you special training to show you how to start cashing in on these opportunities early. You get Radio parts and instructions for building test equipment, for conducting experiments that give you valuable practical experience. My 50-50 method of training—half with Radio parts I send you, half studying my Lessons—makes learning Radio at home interesting, fascinating, practical.



**You Also Get This
Professional Servicing
Instrument**

as part of my Course to help you make more money, do better Radio work. For full details mail the Coupon.

**EXTRA PAY IN ARMY,
NAVY, TOO**

Every man likely to go into military service, every soldier, sailor, marine, should mail the Coupon Now! Learning Radio helps men get extra rank, extra prestige, more interesting duty at pay up to 6 times a private's base pay. Also prepares for good Radio jobs after service ends. IT'S SMART TO TRAIN FOR RADIO NOW!

MAIL THE COUPON—get my FREE Lesson and 64-page book "Rich Rewards in Radio" at once. See what Radio offers you as a skilled Radio Technician. Learn how practical my Course really is. Read letters from more than 100 men I have trained telling what they are doing and earning. Mail the Coupon NOW—in an envelope or paste it on a penny postal.

J. E. SMITH, President, Dept. IMR
National Radio Institute
Washington, D. C.

SAMPLE LESSON FREE

I want to prove our Course gives practical, money-making information—that it is easy to understand. My text, that you need to master Radio. What you need to know. "Radio Retention" Sample Lesson Text, "Radio Retention" Troubles—Their Cause and Remedy. Covers a long list of Radio receiver troubles in A.C., D.C., battery, universal, auto, T. R. F., super-heterodyne, all-wave and other types of sets. And a cross reference cause and effect system to locate and remedy these set troubles. A special section is devoted to receiver check-up, alignment, balancing, neutralizing, testing.

**GOOD FOR BOTH 64 PAGE BOOK FREE
SAMPLE LESSON FREE**

J. E. SMITH, President, Dept. IMR
National Radio Institute
Washington, D. C.

Dear Mr. Smith: Mail me FREE, without obligation, your Sample Lesson and 64-page book, "Rich Rewards in Radio," which tells about Radio's spare-time and full-time opportunities and explains your 50-50 method of training men at home to be Radio Technicians. (No salesman will call. Write plainly.) (Please check)

I AM doing Radio work. I am NOT doing Radio work.

Name Age

Address

City State



by **THE EDITOR**

THE attitude of Washington has been consistently pro-ham since the emergency began. A demonstration of this is the formation by the Defense Communication Board of a Priorities Liaison Committee, on which there is an amateur representative.

The function of this committee will be to learn from the operators of our communications system what their needs are, to evaluate these demands and then to present the information to the priorities board in the Office of Production Management. The OPM has already granted a high priority rating to manufacturers who are making replacement parts for radio.

There is a feeling that in addition to replacement parts, there may be a genuine need for many pieces of new equipment. There is also the fear that in the rush, the communications industries may get trampled on. Therefore, they are to have an official body in Washington which will plead for their needs. Indicative of the fact that the Defense Communications Board considers the amateurs an essential part of the communications system which must be kept going is the fact that they are to be represented on the priorities committees. Their pleas for priorities ratings on material they need to keep going will be presented to the proper officials.

The FCC Listening Posts, which are intercepting and analyzing German Propaganda broadcasts, found themselves in a difficult spot when the Nazis started bombarding Iceland with radio propaganda in the difficult tongue of that island. There aren't many people in this country who understand Icelandic and the Listening Post directors anticipated some trouble in finding the proper linguist.

The officials were just about to send an SOS to the State Department when up stepped one of their own employees to volunteer. Miss Dema Westman mentioned that her parents lived in Iceland and that she spoke the language with them often. Result: Miss Westman was chosen to thaw out the Nazi nastiness directed to our Atlantic outpost.

The Navy Department's request to Congress for funds for establishment of an experimental censorship of the radio and cables which go overseas was turned down, amidst great shouts of indignation. The Navy asked for funds to train censors.

Of course, radio operators know
(Continued on page 62)



Trade-Mark Registered

Including Articles on **POPULAR TELEVISION**

*The Magazine for the radio amateur
experimenter, serviceman and dealer*

Vol. 26, No. 5

Contents for November, 1941

FEATURES

- How a Television Program Is Staged** **6**
A step-by-step illustrated story shows present technique.
- Portable Semi-Pro Recorder** Oliver Read **10**
Here is a flexible unit for recording "on location."
- Portability Plus** . . . Herbert Schor, W2EMN & Frank Canning, W2GCB **13**
A 3-band midget transmitter. Inexpensive to build.
- A Wearable Hearing Aid** Edwin Ewing **16**
Increased earnings possible by building "on-order."
- 112 MC. Mobile Xmtr-Revr.** Raymond B. Frank, W9JU **18**
A highly efficient 2 1/2 meter mobile installation.
- Build This Signal Generator** Clarence Zornes, W9TAL **20**
An easily-built instrument for the serviceman.
- Ft. Monmouth Radio School** **24**
One of Uncle Sam's outstanding radio centers.
- A Challenge and a Reward** Samuel C. Milbourne **27**
An opportunity now exists for all radio servicemen to make more money.
- Measuring Small Capacitances** Rufus P. Turner, W1AY **28**
Condenser and circuit capacities can be readily found.
- Theory and Practice of Disc Recording, Part 3** Oliver Read **31**
A discussion of various feed-mechanisms.
- Enclosing the Transmitter** Nicholas Lefor, W2BIQ **33**
An ordinary steel cabinet adapted for the Ham.
- Add a Tweeter for FM** Willard Moody **37**
How to increase the high-frequency audio reproduction range.

Cover Picture: *Television Antenna Atop Empire State Building.*

DEPARTMENTS

What's New in Radio	38	Washington Communication	14
Hamchatter	35	Police Radio	22
QRD?	34	Serviceman's Experiences	32
Bench Notes	23	Service Case Histories	36
Manufacturer's Literature	40		

Copyright 1941
ZIFF-DAVIS PUBLISHING COMPANY
Member of the Audit Bureau of Circulations

RADIO NEWS is published monthly by the Ziff-Davis Publishing Company at 608 S. Dearborn St., Chicago, Ill., William B. Ziff, Publisher; B. G. Davis, Editor; Oliver Read, W5ETI, Managing Editor; Raymond Frank, W9JU, Technical Editor; Herman R. Bollin, Art Director; H. G. Strong, Circulation Manager; S. L. Cahn, Advertising Manager, New York Office, 270 Madison Ave. Washington Bureau, Occidental Hotel, Lt. Col. Harold E. Hartney, Mgr. Subscription \$2.50 per year; single copies, 25 cents; foreign postage \$1.00 per year additional, Canada 50c additional. Subscribers should allow at least 2 weeks for change of address. All communications about subscriptions should be addressed to: Director of Circulation, 608 S. Dearborn St., Chicago, Ill. Entered as second class matter March 9, 1938, at the Post Office, Chicago, Illinois, under the Act of March 3, 1879. Entered as second class matter at the Post Office Department, Ottawa, Canada. Contributors should retain a copy of contributions. All submitted material must contain return postage. Contributions will be handled with reasonable care, but this magazine assumes no responsibility for their safety. Accepted material is subject to whatever adaptations, and revisions, including "by-line" changes, necessary to meet requirements. Payment will be made at our current rates upon acceptance and, unless otherwise specified by contributor, all photographs and drawings will be considered as constituting a part of the manuscript in making payment.

DAVEGA

AMATEUR DIVISION, 63 Cortlandt St., N. Y., N. Y.
World's Largest Radio Dealer

The New 1942 SUPER SKYRIDER SX-28

The new 1942 Super Skyrider Model SX-28 sets a new high in quality performance. 15 tubes, two stages pre-selection, calibrated bandspread inertia controlled, micrometer scale tuning inertia controlled, Tone and AC on-off, beat frequency oscillator, AF gain, RF gain, crystal phasing, adjustable noise limiter, send-receive switch, AVC-BFO switch, bass boost switch, phono jack, 80/40/20/10 meter amateur bands calibrated, band pass audio filter, push-pull high fidelity audio output, 6-step wide range variable selectivity. \$179.50



Echophone Model EC-3

Now you can buy all these communications features at moderate prices. Echophone, Model EC-3: Crystal filter (four position variable selectivity). Calibrated bandspread, automatic noise limiter. Preselection on all bands. Two stage IF amplifier. Fly-wheel tuning. Separate 6" PM speaker housed in matching cabinet. CW monitor. 10 tubes. 3 bands. Covers from 550 to 2100 kc. —2.1 to 8.1 mc.—7.9 to 30 mc. Electrical bandspread. Operates on 115 volts AC/DC. Echophone (Model EC-3) \$59.50.

HALLICRAFTERS S-29

The Sky Traveler—Take it with you or use it at home. A Hallicrafters designed to communications tolerances—Frequency coverage from 550 kc. to 30.6 mc. (545 to 9.8 meters) on four bands. Self-contained antenna with high gain coupling circuit provides truly remarkable reception throughout its tuning range. 9 tubes. Operates on either 110 volt AC or DC or from its self-contained batteries. 18 lbs. Price



\$69⁵⁰

HALLICRAFTERS S-19R

Continuous coverage 550 kc. to 44 mc., four bands, electrical band-spread, built-in 5" Dynamic Speaker, six tubes, built-in line filter.

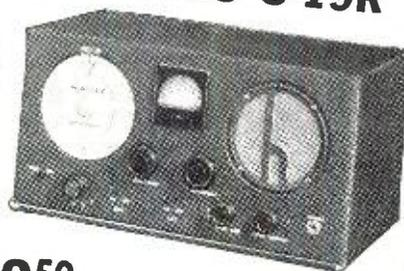

\$32⁵⁰

AMATEUR DIVISION
63 CORTLANDT STREET
NEW YORK, N. Y.

DAVEGA

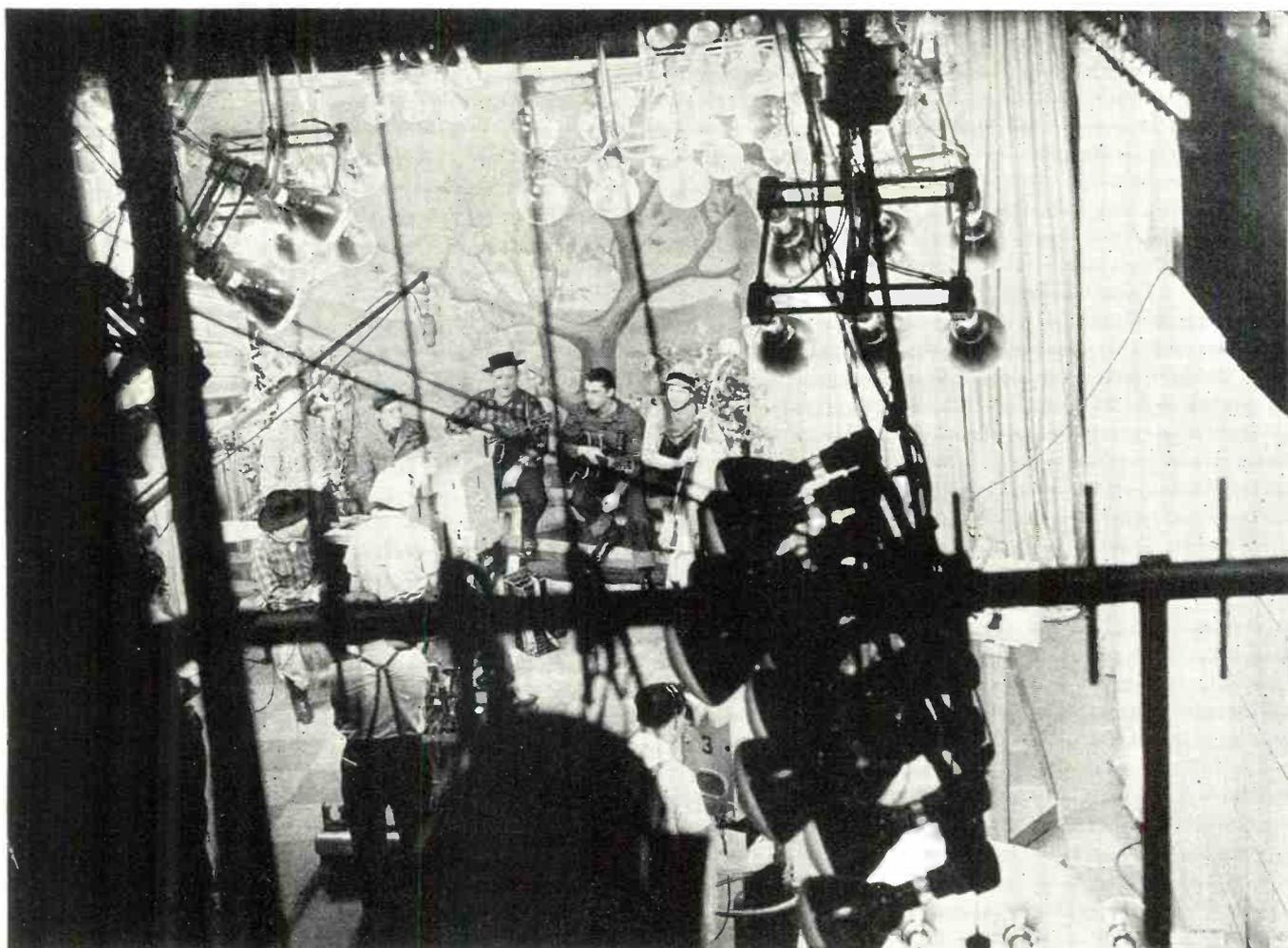

View of the television studio from the production manager's control room from over the light bridge. The 17 foot high studio is lighted by 156 bulbs of 300 and 500 watt sizes connected in groups of 6 and 12. These are rigged so that the light men can direct the monster banks to illuminate any part of the studio.

Staging a TELEVISION PROGRAM

Television Broadcasting is set, technically, for full-time production. It must compete with moving picture studio technique.

“**C**OME in one. Stick to the faces. That's it. Get those gestures in the picture. Get ready three. Dolly one. Keep the heads in. That's enough. Now nice long shot. Take those legs. Come in three. Nice close-up. Light man get that floor board out of range. Ready for two. Check focus. Boom Man—You have to make a quick switch. Fade out three and come in two on the American Flag . . .”

That jargon comes from the program director during the fever of

shooting and broadcasting commercial television. He talks continuously just like old time movie directors. But in television the director uses a telephone instead of a megaphone. His orders are heard and carried out by the cameramen and stage technicians while the video and audio control men get their commands direct because they are seated below the director in the million dollar control room perched over the studio.

Broadcasting television is technically set for full time production. But

the production is still limited to 15 hours a week of simple staging. Hollywood absorbed and climbed ahead of legitimate staging. Television must vie with the talking pictures and radio of 1941. It needs must take time.

Nevertheless the moment the *Federal Communications Commission* gave Television the go ahead, three sponsors bought time and programs on NBC. They are a watch outfit, a yarn company and an advertising agency now signed up for telecasting.

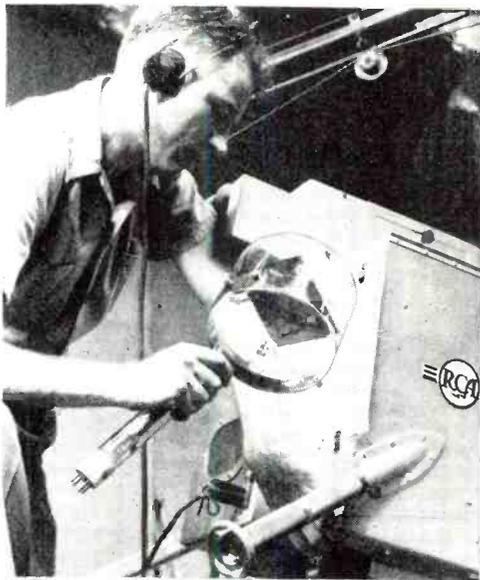

The heart of the television camera is called the "Ike." The square plate inside the tube acts as a photograph negative. Cameraman is installing tube into unit.



The camera is focused on the test pattern designed to serve the purpose of stand-ins. This is more accurate, serves special television needs and saves wear and tear on the cast. The various technicians: cameramen, light men, technical director, video man, etc., line up their controls and the camera for deflection with a peculiar chart. Sharpness is still not perfected.

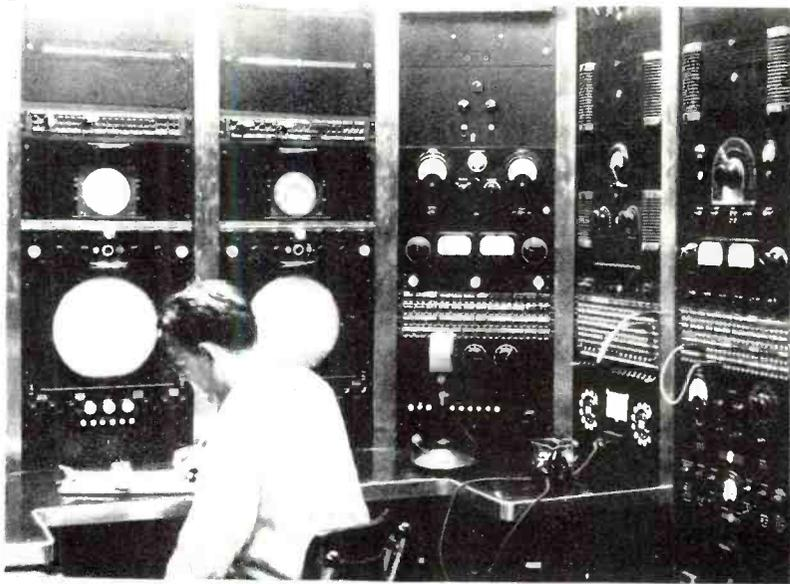

Television transmitting room on the 85th floor of the Empire State Building in New York. Here, at WNBT, the sync-generator makes electronic television possible. The test pattern is broadcast half an hour before show time to give the control men and listeners an opportunity to focus their television receivers in proper manner.



The stage manager uses red crayon to mark the places for the actors to stand. This is most important in closeups, such as this one of the model exhibiting the hidden pocket, a new gimmick for milady's new wardrobe.

Finished acts demand so much work to stage that television is forced to avoid creating new ones. Hence old vaudevillians, night club performers, single features and circus acts hold the television stage of today. There is practically no television drama being produced. The entertainment value of the offerings rate poorly as a steady diet. As soon as more sponsors buy time and produce their own shows the quality will improve. The situation is similar to the pioneer days of radio. It wasn't until the sponsors

competed for the greater audience that production costs and entertainment valued advanced.

They shoot with three cameras, each designed to take a different angle so that the pictures may be varied. Unlike the ear, the eye demands much more variety. Besides which the quality of television pictures is constantly being compared with talkies. The three cameras are bossed from a panel in the control room from where the director may switch from one to another to liven production. Of course,

showings from the film studio and the mobile unit invite different problems. It's the mobile unit jobs covering prize fights and ball games that make television unique by permitting an almost unlimited audience to witness popular events the moment they occur.

At the moment, the audiences are small. Television Broadcasting stations are few and set owners in the New York area, for instance, only number 4,800. The cost of sets and their limited manufacture due to defense are holding it up. Nevertheless



This picture allows us to see the "business end" of one of the \$3,000 television cameras. The upper lens is the cameraman's direct view-finder: the lower image lens opens onto the iconoscope tube. The lights below the lens mount are for cue signals.



The camera shown is fixed on a hand-operated dolly that performs gymnastics which make a wide range of camera angles possible. A dolly man drives the cameraman around the studio and hoists him up and down. Other lifts are electrically operated.

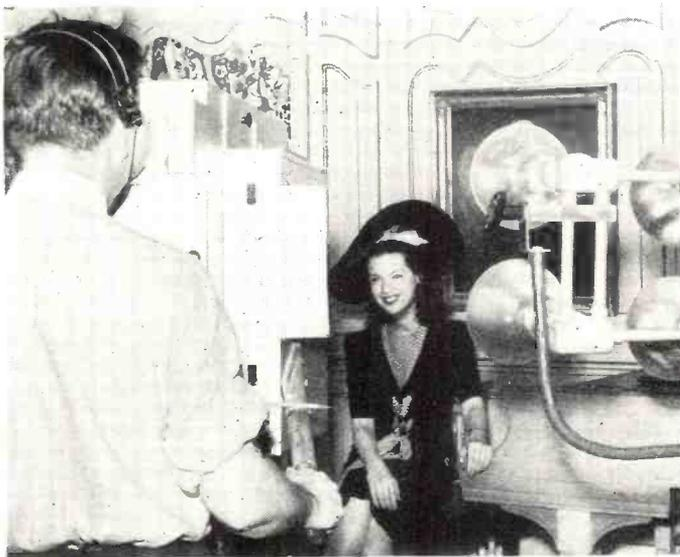

Hat model, Nina McLoughlin, watches the television birdie. Augmenting the ceiling wattage is the floor light broad, and we don't mean Nina! Here's the focusing handle at work. Headphone permits cameraman to receive his cues and orders from the director.

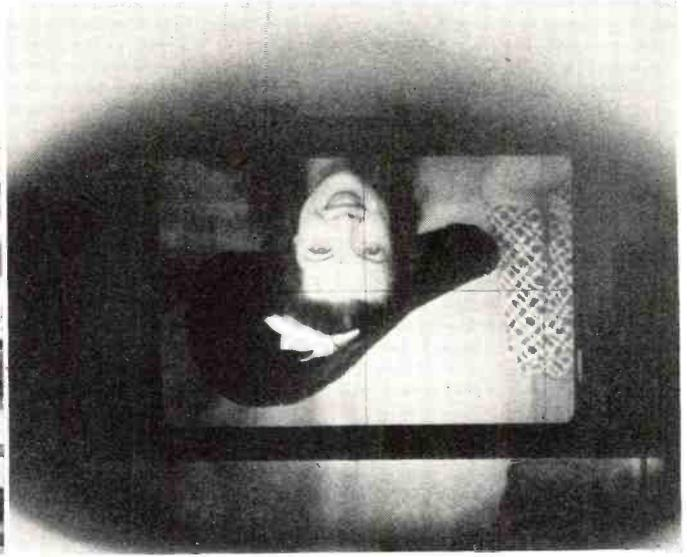

Upside-down television image as seen by the cameraman through the view-finder. Nina is bottom-side-up and in reverse. A light inside the camera tells the cameraman when he is on the air. The crossed hairline is identical in all standard cameras.

the Government is doing all it can to help because they believe that advancement of television may eventually prove valuable for defense.

The staff behind the scenes make the television studios look like sound stages. Sixteen technicians are used to operate cameras, booms, the Video, Audio, turntables and lights. Up at NBC, they are all men who have been with television at least nine years. Most are Amateur Photographers, one of the requisites for video jobs.

Though certain basic patents were

taken out in 1884, the science of Television took until July of this year to get Government okay for commercial showings. It was not until then that equipment standards won the nod. NBC has invested \$15,000,000 in experiments to date.

Though the public has seen but few showings in the ten years of actual television, myths have mushroomed. Actors engaged for their first television jobs expect blue, purple and yellow makeup. They ask about black lipstick. This rainbow makeup was

tried out during the scanning-disk days. The electronic system employs straight panchromatic makeup, sun-tan powder and no eye shadow. Men use no makeup except when they have extra heavy beards.

Just as radio stations broadcast sound, so television stations broadcast light. The heart of the new science is the Iconoscope, or Cathode ray tube. In the camera the Iconoscope converts light into electrical impulse. These impulses are broadcast and received by a similar Cathode ray tube in your

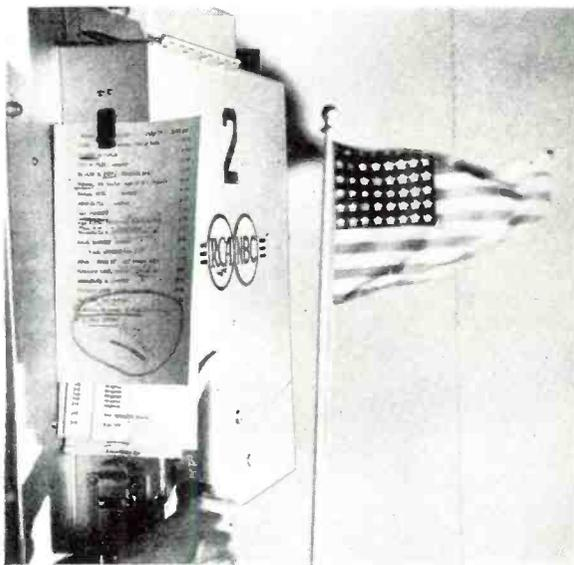

Every television program ends with a waving American Flag and a recording of the Star Spangled Banner. Attached to every camera is a cue sheet and a copy of the program routine. The backdrop is painted light grey.



Here is the control room during a nervous moment taken during air time. Al Protzman, left, with his trained fingers on the camera switches, and program director Ernest Colling, right, watching the action on the three kinescopes and the studio through the plicofilm. Control room is almost completely dark.

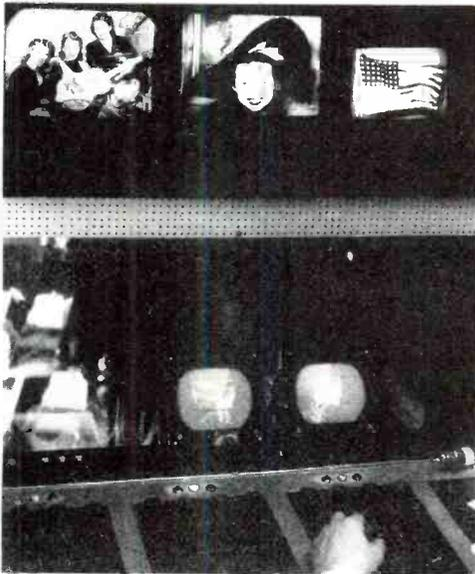

The top three images appear on the kinescopes in the control room. At Colling's orders any one may be put on the air. Number two is being previewed and the flag is being corrected.



Miss Listener tunes in the Radio City Matinee on her home television set. The image appears on a milky glass covering the Cathode ray tube. This is reflected by a slanting mirror on the back of the set. Miss Listener's left hand is on the "Brightening Dial." Note the reflection of her hand in the mirror above. She appears to be enjoying the show.

home set which reverses the process. That is, converting the electrical impulses back into light and forming images. The subject is shot by 525 lines of light, forming 30 frames per second as against motion pictures which is only 24 frames per second. The 525-30 are standard today.

Television studios are working intensively on developing formulas for future programs. What some of the participants may have up their sleeves is still secret. There has been nothing spectacularly creative—nothing to re-

flect that a great entertainment technique will be developed within the field of television itself. Rather, the program lads have been content to borrow methods of procedure from the movies, the stage and radio.

The easiest way to solve the program problem is to give television fans a little bit of everything, the video directors seem to believe. And they borrow a bit of talent and technique from here and a little bit from there and then they stir it all up with the result of obtaining a none too palat-

able hash for the video customers.

The potentialities of television programming are so enormous that the directors of experimental shows seem scared of their shadows. Television can be an original entertainment medium right from the start. The video art can develop its own technique—and it can be a polished, acceptable medium at the very start. The only requirement is that the holders of commercial television licenses will have to open their purse-strings for creative

(Continued on page 64)

PORTABLE SEMI-PRO RECORDER

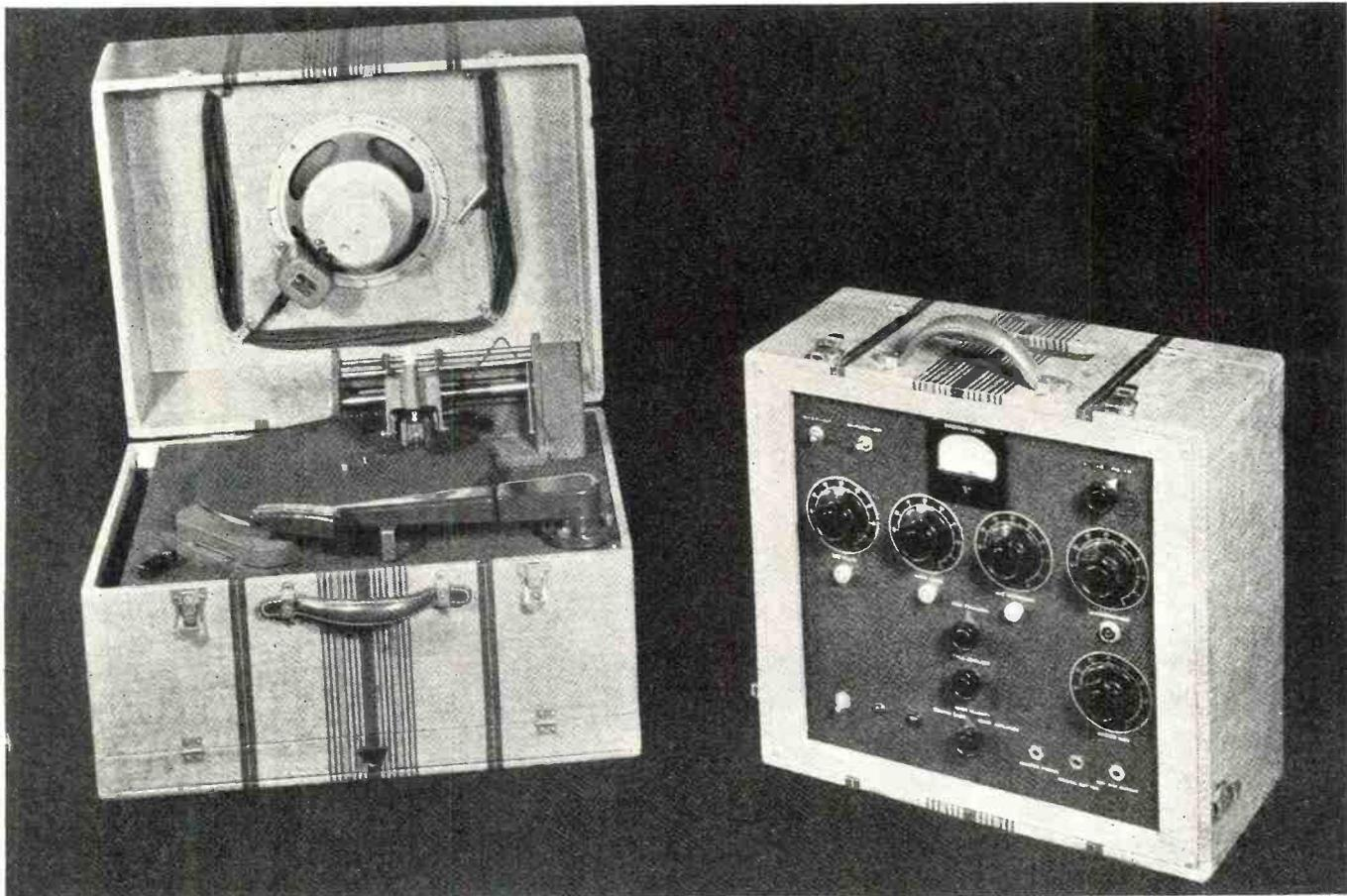

Two portable cases contain all equipment and accessories for recording wherever line power is available.

THERE are many uses for recording equipment whether it is used in the home, studio, or out in the field. In an attempt to design a complete assembly that could fulfill a host of applications, we decided that the best method of attack would be to build a two-unit affair which would be extremely flexible in operation and would include many features not found in ordinary commercially available equipment.

Our main desire was to have a workable combination that could be set up at any point where 60 cycle source was available so as to be able to make recordings of actual sound effects and events of outstanding interest. Of course, it is essential that plenty of space be provided so that the necessary accessories may be transported with ease. These include extension cords, two microphones, collapsible mike stands, spare cutting styli, headphones, stroboscope and compartment for blank and cut disks. Other "musts" include a turn-table assembly of the dual-speed type, and a feed mechanism which is capable of performing a wide range of cutting pitches as well as including other fea-

by **OLIVER READ**
Managing Editor

Maximum economy and versatility are had if a recorder is designed to include features not found in most commercially made units.

tures found necessary for high quality work. The particular one used is made by the *Regal Recorder Company* and may be seen in the illustrations. The amplifier is "home-built."

We decided to construct the high fidelity amplifier so that it could be housed in a separate portable carrying case. This unit is capable of cutting and reproducing all frequencies between 30 and 12,000 cycles. A small compartment was built into the cover of the amplifier carrying case and this contains the accessories mentioned above. The line cord and extensions fit nicely into the shallow compartment which is built into the case and is located directly back of the amplifier chassis assembly.

The amplifier includes all features which we have found from experience

to be necessary for complete recording procedure. First of all, it is necessary to determine the number of inputs which will be needed. Our final choice was as follows: a microphone input for a low-impedance type unit, which is used where it is necessary to extend the microphone cable in excess of twenty-five feet. A second microphone input (high impedance) that is used with a *Shure Uni-dyne Dynamic* microphone for studio work, a high impedance phono input with associated filters and switch to match properly the *Brush PL-20* pickup used on the recorder assembly, and another medium-impedance input for a compact radio tuner so that "off the air" recordings may be made when necessary.

Separate high gain pentodes are

used, one for each input stage, as voltage amplifiers. A considerable number of parts may be saved by connecting all cathodes, screens and plates in parallel, as shown on the wiring diagram. The circuit works extremely well and hum is completely absent from this important channel. Either the 6J7 or 6SJ7 tubes may be used for the amplifier. We have found from experience that the former are best suited to an amplifier where a.c. fields are present below the chassis.

A "dialog filter" is used between the first and second stages of the amplifier to gain a "telephone effect" when recording sound effects and in other applications. The coupling condenser, C5, remains in the circuit at all times. This limits the audio frequencies to those in the vicinity of from 300 to 2000 cycles. When the switch, SW2, is closed, it places C4 in parallel with C5 and the audio range of the amplifier is thus extended to include the full frequency range.

It is imperative that efficient equalizers be used to control the treble and bass frequencies and we feel that no recording amplifier is complete without this feature. This circuit is based on a degenerative action taking place in the 6J7 (triode connected) stage. Normal response is had when R13 and R14 are set to the midpoint on the dial scale. An increase or "boost" is had when the controls are advanced in a counter-clockwise direction. The opposite effect is had when they are turned in a clockwise direction—that is, the treble and bass frequencies are reduced (attenuated) as the rotation nears the maximum position.

Several precautions are needed in wiring if hum is to be kept to a mini-

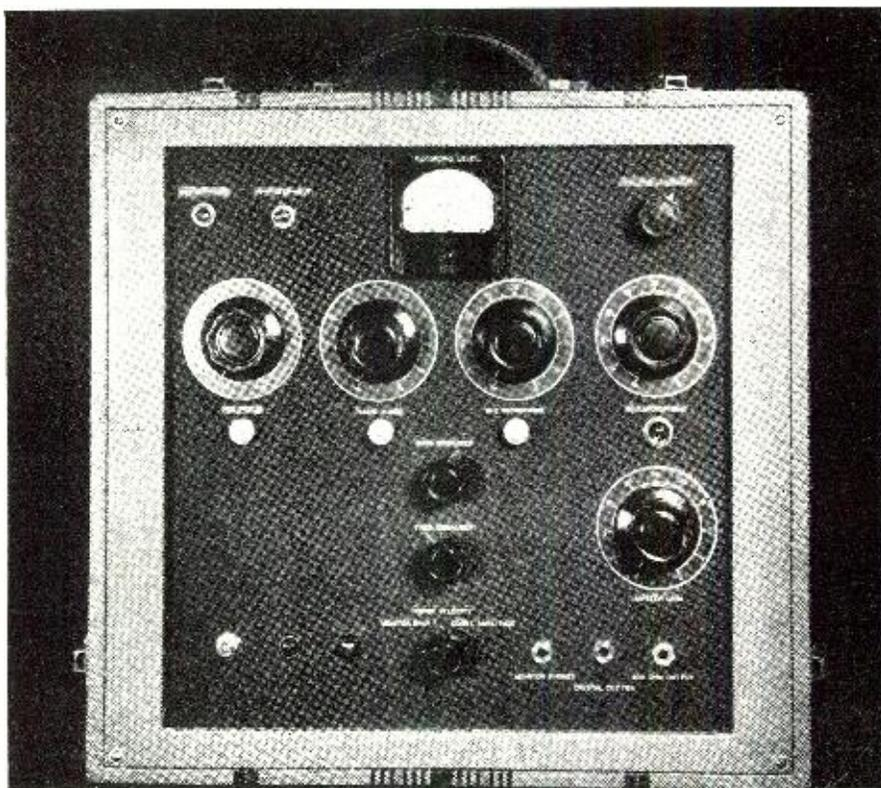

The amplifier is able to reproduce all usable frequencies at low distortion.

imum. All of the plate leads from the 4 6J7's must be shielded as well as the resistor, R10, the lead coming from the junction of R14 and R15, and including condensers, C6, and the complete lead extending up to C5. Failure to observe this precaution will result in a greatly increased hum level, especially when the bass control, R14, is advanced to the "boost" position.

The following stage uses a 6C5 triode as a normal resistance coupled amplifier. A master gain control, R22, is a refinement which we have found to be most useful. The grid lead from this control should be shielded right up to the grid socket pin of the 6V6G. The screen is tied to the plate on this tube so that it may be used as a triode driver-amplifier.

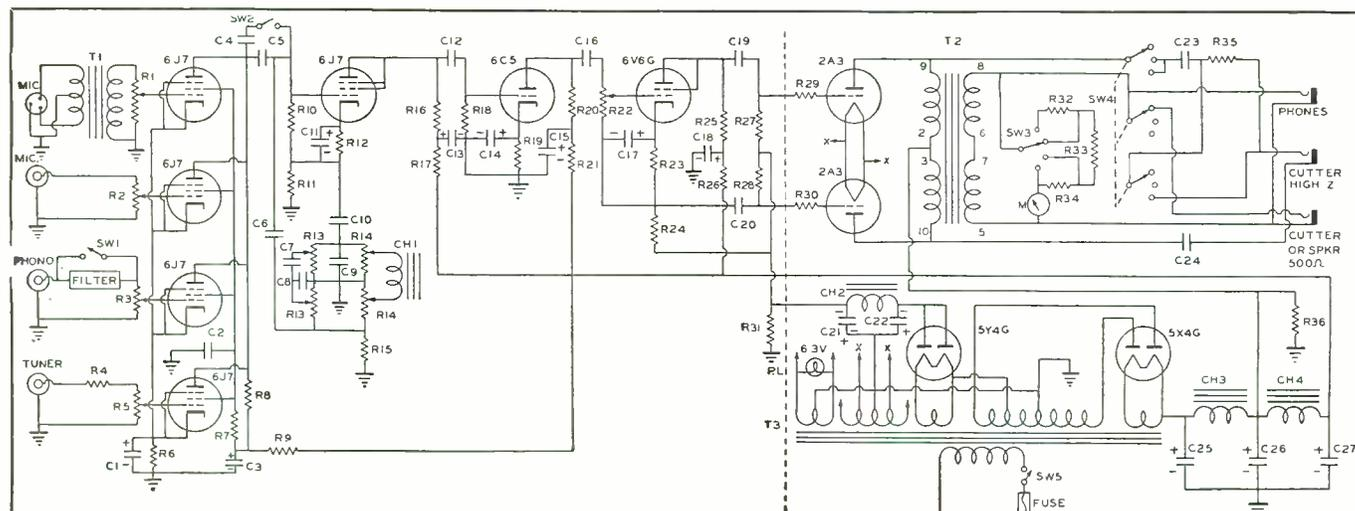

- C₁, C₁₁, C₁₄—10 mfd., 50 v. electro, Mallory
- C₂, C₄, C₁₂, C₁₃—1 mfd., 400 v. paper, Mallory
- C₃, C₁₂, C₁₅, C₁₆—20 mfd., 250 v. electro, Mallory
- C₅—0.01 mfd., 400 v. paper, Mallory
- C₆, C₁₀, C₁₉, C₂₀, C₂₃, C₂₄—5 mfd., 400 v. paper, Mallory
- C₇, C₈—0.1 mfd., 400 v. paper, Mallory
- C₉—0.02 mfd. postage stamp mica, Mallory
- C₁₇—25 mfd., 50 v. electro, Mallory
- C₂₁, C₂₂—16 mfd., 150 v. electro, Mallory
- C₂₃, C₂₆—20 mfd., 450 v. electro, Mallory
- C₂₇—40 mfd., 450 v. electro, Mallory
- R₁, R₂—1 meg. pot., Mallory
- R₃, R₄—500,000 ohms pot., Mallory
- R₅, R₁₅, R₁₈—500,000 ohms, 1/2 w., Mallory
- R₆—25,000 ohms pot., Mallory

- R₁₀—250 ohms, 1 w., Aerovox
- R₇—750,000 ohms, 1 w., Aerovox
- R₈—100,000 ohms, 1 w., Aerovox
- R₉—25,000 ohms, 1 w., Aerovox
- R₁₀—25,000 ohms, 1/2 w., Aerovox
- R₁₁, R₁₂—20,000 ohms, 1/2 w., Aerovox
- R₁₃, R₁₄—1000 ohms, 1/2 w., Aerovox
- R₁₅, R₁₆—Twin tone control pots., Thordarson R1068
- R₁₇, R₁₈, R₂₁, R₂₅, R₂₆—10,000 ohms, 1/2 w., Aero.
- R₁₉, R₂₀, R₂₇, R₂₈—50,000 ohms, 1/2 w., Aerovox
- R₂₃—2000 ohms, 1/2 w., Aerovox
- R₂₄—3000 ohms, 10 w., Ohmite
- R₂₅, R₂₆—5000 ohms, 1/2 w., Aerovox
- R₂₇, R₂₈—5000 ohms, 10 w., Ohmite
- R₂₉—20,000 ohms, 10 w.

- R₃₀—10,000 ohms, 50 w.
- T₁—mike-to-grid, Thordarson T1A71
- T₂—PP 2A3's to line, Thordarson T3S20
- T₃—Plate & filament trans. with bias tap, Thordarson T15R05
- CH₁—Tone choke, Thordarson T1C69
- CH₂, CH₄—35 MA filter choke, Thor. T18C92
- CH₃—150 MA filter choke, Thordarson T13C30
- SW₁, SW₂, SW₃—SPST toggle, Arrow
- SW₄—Single pole 4 pos. wafer sw., Yaxley
- SW₅—3-pole, 3 pos., wafer sw., Yaxley
- Speaker—8" PM Utah FP820
- M—+6 -10 D.B. meter, Simpson slow speed Case—Knight
- Input jacks & sockets, Amphenol
- Inter-connecting cable plugs & sockets, Jones

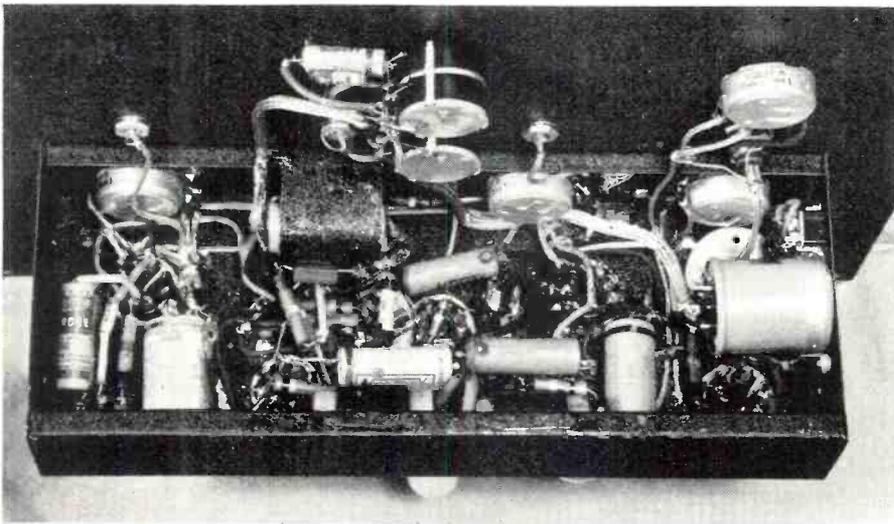

Underside view of amplifier chassis shows where the parts are located.

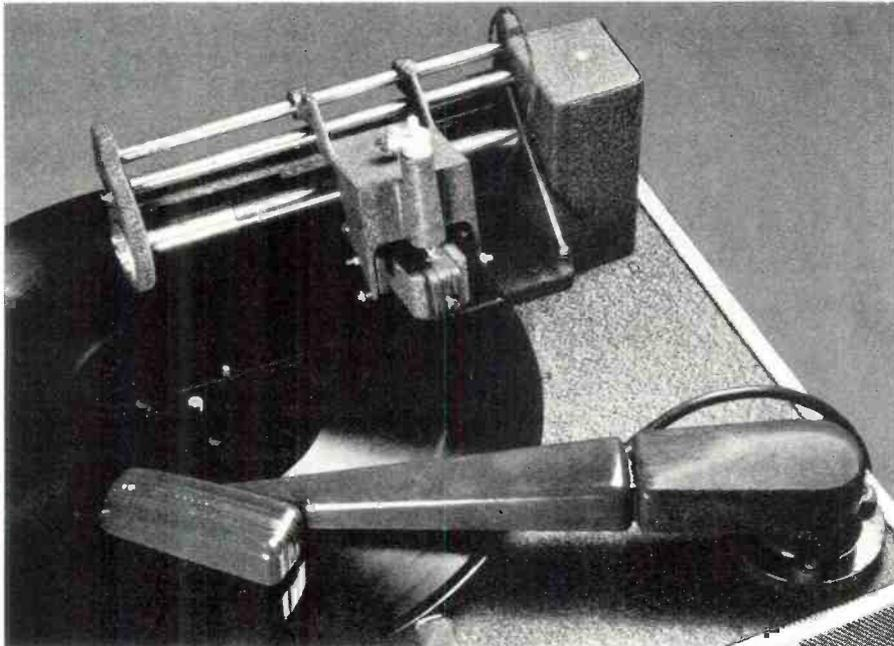

Fifteen minutes of recording are had on each side of a 13½" disc.



Both chassis are mounted on the panel and held together by straps.

One of the unusual features of the amplifier is this driver stage. Note that fixed bias is used, not only for the output tubes, but for the 6V6G as well. This permits excellent voltage regulation to be attained and stabilizes the entire amplifier to a marked degree. It is necessary that the ground return of R22 be connected as shown. Otherwise, it will not be possible to use the tube as a single-ended inverter. Thus we combined several features in one stage and reduced the number of components that might otherwise be required.

All of the parts and tubes discussed so far are mounted on a separate chassis which is placed above the power supply and amplifier assembly. The grid leads to the 2A3's should be shielded right down to the resistors, R29 and R30. The heavy components are all mounted on the lower chassis

and care will be needed in locating them in order that they may all fit into one compact assembly. The dimensions of the chassis will depend upon the cabinet space available. We were able to obtain those which measured 12x4½x3".

The output transformer, T2, was designed to operate from a pair of 2A3's into a 500 ohm line. This is a *Thor-darson Tru-Fidelity* unit and is capable of passing all frequencies within the range of the amplifier. A *Simpson db* meter with associated multiplier resistors is used to indicate the recording level. This instrument, designed for placement across a 500 ohm line, is kept permanently in the circuit at all times and will not be affected when SW4 is placed in any of the three positions as proper loading will be had as long as the cutter and speaker are connected to their respective jacks. The db meter reads +6, +12, +18, +24, db, depending upon the position of SW3.

A *Brush RC-20* cutter is used and a choice of either "constant amplitude" or "constant velocity" recording may be had by placing SW4 to the proper position. Referring to the diagram, when the switch is placed in the top position, a 500 ohm speaker or cutter may be supplied with audio from the circuit. In the mid-position, this 500 ohm output is disconnected automatically and the output will be fed through C23 and C24 directly to the crystal cutter for constant velocity recording. While in the third position, the resistor, R35, will be shorted out and then the cutter will operate properly for constant amplitude recording. Note that the value of R35 determines the turn-over frequency used in commercial constant velocity recording technique.

A pair of headphones connects across the 500 ohm line and these may be left in circuit at all times providing they are of the high impedance type. The mis-match resulting will not affect the quality to any marked degree but is, on the other hand, desirable as it will reduce the volume at the phones. If the level is too high, a 1 megohm resistor may be connected in series with one side of the phones.

The power supply consists of a plate and filament transformer together with two filter chokes and associated filter condensers. Two rectifier tubes are used, a 5X4G for supplying the B voltage and a 5Y4G to supply the fixed C bias voltage. A tap is provided on the high voltage winding of T3 for that purpose, and filtering is done by means of CH2 and the condensers C21 and C22. It is important that a fairly low resistance bleeder be used, R31, so that a fixed load may be kept on the bias rectifier at all times. This improves the regulation and keeps the voltage constant. Condenser C21-C22 is a dial unit in an aluminum can. Inasmuch as this can or shell is negative, it will be necessary to use the insulating wafer so that the positive terminals may be grounded.

(Continued on page 61)

Portability Plus

by HERBERT SCHOR, W2EMN,
and FRANK CANNING, W2GCB

This 3-band midget transmitter has worked many states. Operates from ac and dc lines. Is inexpensive, efficient and easily built.

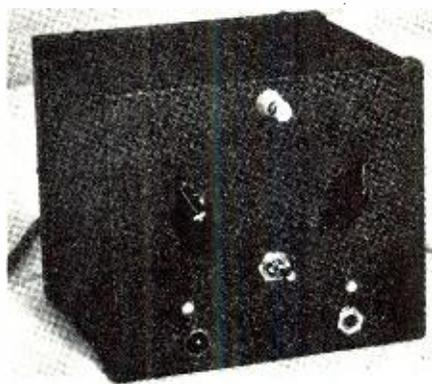

The completed midget transmitter.

THIS transmitter was born one cold night last winter during a QSO with W8TZG, an old school friend of ours now living in Rochester, New York. When he first moved up there we had built him a 250-watt rack-and-panel transmitter with which to keep in touch with the old home town. He soon discovered that, while it worked beautifully, the darned thing was just too much transmitter for his one room.

So all our discussion and planning that night boiled down to the little gadget you see illustrated. That small black box, measuring just four by five by five and a half inches, houses a complete transmitter and power supply that will deliver four husky, man-sized watts on any predetermined frequency in three bands with the flip of a switch.

Some of the brethren will scoff loudly and long at the rather meager power output, and I will admit we were a little dubious ourselves as to the usefulness of such low power. But in the few months this rig has been on the air from W8TZG it has more than proved its usefulness. Using only a 90-foot stretch of wire for an antenna, and an indifferent urban location, W8TZG puts in S8 signals all over the east, with fair reports from the middle west, and one memorable contact with Puerto Rico on 80 meters, with a report of RST559. And that's good work for a powerful transmitter. His signal down here in New Jersey is not noticeably weaker than when he used the quarter kilowatt into the same antenna.

As can be seen from the circuit diagram, the rig uses the new 117N7GT tube as a beam tetrode crystal oscillator and half-wave rectifier. A ganged tap switch selects any one of three crystals, shorts out an appropriate section of the tank coil, and connects the antenna to the proper tap. The crystals used may be either all in one band, or, as used in this rig, one on each band, 160, 80, and 40.

In the original bread-board model we used straight cathode bias, and secured a very low power output. Upon substituting the present combination of grid-leak and cathode bias the out-

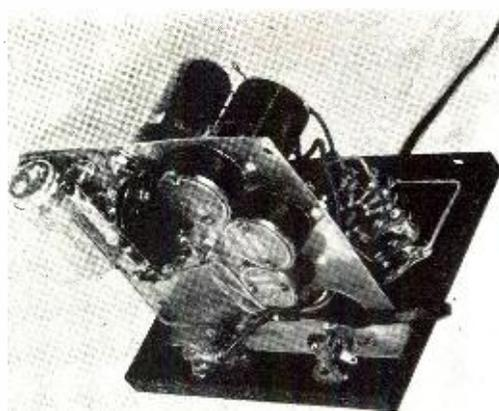
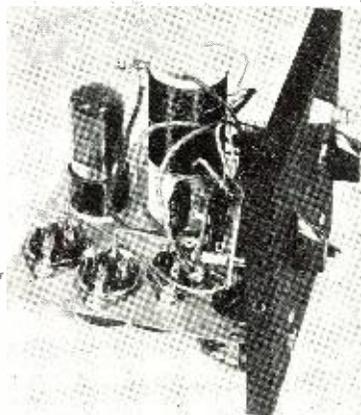

Left: Top view of chassis. Right: Three crystals mount on the underside.

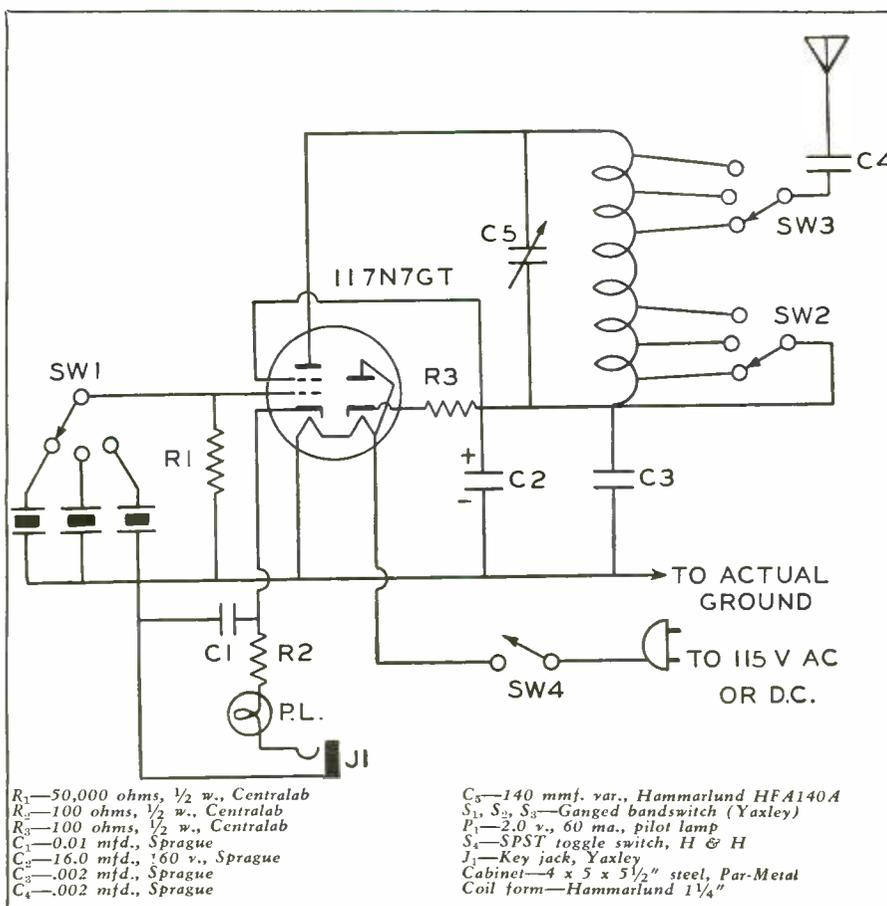

put promptly went up considerably.

The usual plate millimeter is dispensed with in the interests of economy and space, and the 2-volt, 60-mil. pilot lamp serves very well in its stead. A millimeter is employed in the preliminary tuning-up by the simple expedient of plugging it into the key jack. In this way the pilot lamp may be roughly calibrated, and the brightness of its glow serve as a useful indication of conditions in the circuit.

Now let's take a look at the panel. The left-hand knob is the band-change switch, and the right-hand one the plate tuning condenser. The toggle switch just below is the main on-off power switch, with the key-jack to its left and the "plate meter" to the right. The antenna feed-through at the top completes the panel. Some may wish to dress it up a little by using larger, transmitter-type knobs, but the smaller ones work just as well, and do not crowd the panel so much.

When assembling the transmitter, be sure to insulate the plate condenser, C-5, from the panel with a bit of bakelite, as it is at the full plate potential above ground. Also, when wiring the power supply section, be sure to connect R-3 between the tube cathode and filter condenser C-2, as this resistor serves to prevent the usual high surge in a condenser-input filter system. Failure to observe this precaution burned up two brand-new tubes in our experimental set-up.

Now a few words about the a.c. supply. In the original model, we found that an actual ground was not necessary for proper operation, hence we used the regular two-wire line with a fused plug. In the event that an actual ground became necessary later, this fused plug would protect the rig in case the line plug was inserted the wrong way.

Some time later we discovered, by involuntary personal experiment, that the chassis was a bit hot with respect to grounded objects (a radiator, in our case). Purely as a safety measure, it is wise to use the single-wire a.c. connection and ground the chassis, the a.c. circuit then being completed through the ground. Then in the event that the plug is inserted wrong side to, nothing will happen, and the transmitter will simply refuse to work. If you decide to use this system, ground the side connecting to the number two pin on the tube socket. Then the single wire should connect to number seven pin, and the fuses may be dispensed with. Remember, though, that with this connection an actual, physical ground is needed, and it must be a good one. Just be sure you ground the number two prong, as the number seven filament prong is connected to the rectifier plate inside the tube.

Now back to the oscillator. The tap switch is a *Yaxley* job having two decks and four circuits, only three of which are used. The plate coil here was wound on an old pregrooved *Isolantite* form we happened to have

(Continued on page 49)

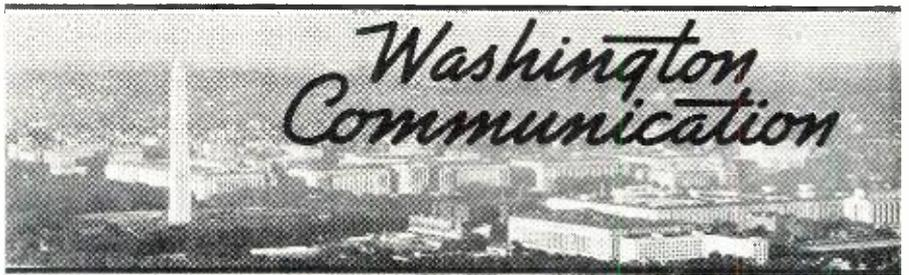

by ALFRED TOOMBS

THIS autumn, more than two years after the start of the fighting in Europe, the United States is at last getting around to taking the offensive in the violent radio war which has been swirling through the air above us. And thereby hangs an appalling tale of bungling and indifference—told here for the first time—which has cost our cause heaven alone knows how much advantage.

When the war started in September, 1939, it was apparent that radio would be one of the important weapons. Nazi propaganda, sent out over the air, seeped into countries about to be conquered and undermined the foundations upon which Governments rested. All this was known to even the most casual newspaper reader and it therefore must have been known to Government officials and the high moguls of the broadcasting industry.

Our Government had no official station and the job of representing the United States on the air was left to private broadcasters. As a result, this country—alone of all the great powers—was virtually unrepresented on the short-wave. Against the powerful and well-planned propaganda of Hitler, Stalin and Mussolini, we were sending out apologetic, weak programs consisting of phonograph records, news and a little second-rate talent to supply entertainment.

Prominent Men in Radio World Meet



Publisher William B. Ziff (right) with Charles I. Stanton, Assistant Administrator of the C.A.A., during the recent presentation to Mr. Wm. Ziff of the *Diplome d'Honneur* by the International League of Aviators in Washington, D. C.

About a year ago, the FCC took a look at the stations which were broadcasting on the short-wave bands and found they were in a very poor condition. Their equipment was in sorry shape and they weren't using enough power to hit Peoria. So an order was issued, requiring that the 11 international short-wave stations in this country step up to 50 kw minimum and make a number of technical improvements. With this, the matter was dismissed.

The American stations were doing this broadcasting purely as a public service. It was costing them money and they weren't much interested in it, with one or two exceptions. There was some agitation in Washington to have the State Department take over direction of their programs, but the State Department hemmed and hawed—and did nothing. Meanwhile, the Axis powers with their well-planned, well-executed programs were ranging the airways 24 hours a day. Their programs were going to South America, to Asia, to Europe, always presenting the United States in the wrong light.

When it was suggested that this country should do something about this situation, Washington countered with the assertion that everything possible was being done and pointed to our eleven 50 kw stations. The general assumption was that these stations were doing the job.

When Brig. Gen. William J. "Wild Bill" Donovan was appointed Coordinator of Information for the U. S., one of his first acts was to order a confidential survey made of our international broadcasts. The results of that survey caused a stir in Washington.

Our diplomatic outposts in all parts of the world were asked to listen to American broadcasts on stated nights. The Legation in Bern, Switzerland, reported that it could hardly hear the program at all. Other embassies and legations likewise said that the reception was poor, or couldn't be heard at all. It was discovered that not a single program was being broadcast in Arabic to North Africa—a place which Washington considers vital. Almost nothing was being sent to our Good Neighbor Brazil in the language of that country, Portuguese.

Surveying the private stations which were making these broadcasts, it was discovered that they were complying technically with the FCC order requiring a minimum 50 kw output but that most of the stations weren't getting as much out of their broadcasts as they should. It was further discovered that most of the stations were putting on very poor shows—some just tossing on records, canned speeches, etc. There was no effort at coordinating the time nor the direction of these broadcasts. All the stations might be beaming programs to South America for three or four hours—at the same time—leaving the rest of the day completely blank.

So the short wave broadcasters were summoned to Washington. The officials of the Coordinator of Information's office explained that they didn't think much of the job that was being done and said they wanted the broadcasters' cooperation in improving it.

(Continued on page 58)

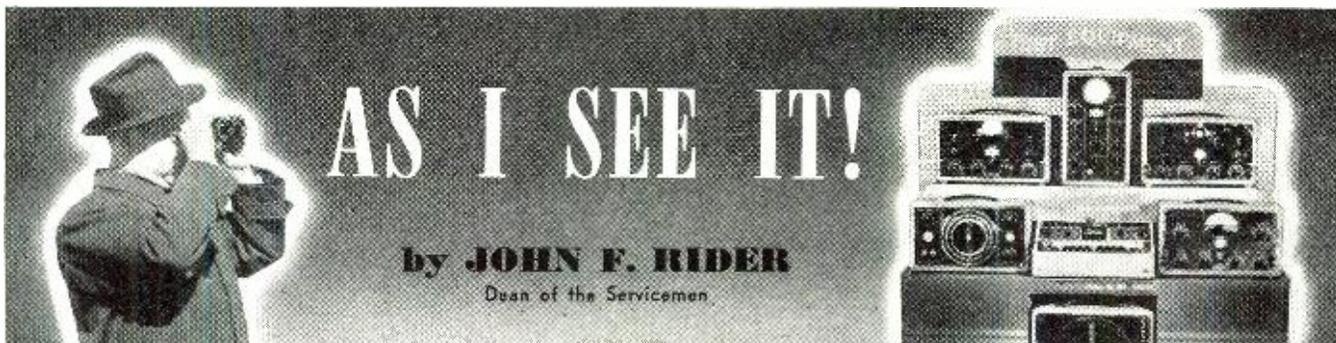

WE have before us as we type these lines a recent issue of the SAT EVE POST, to be exact, that of September 20. On pages 94 and 95 appears a doublespread ad dedicated by that publication to the automotive repair mechanic. It is a message to the public, and in simple yet brilliant language tells the public about the part the automotive mechanic, the guy with the greasy hands, plays in the life of the average man who owns an automobile. To quote the last three lines of this endorsement: "Without faith in him, how many of us would enjoy the endless driving we now do with complete peace of mind."

Maybe you don't know it, but in the July issue of the READER'S DIGEST the automotive repair man was taken apart just like they did the radio serviceman in August.—Well, it is indeed gratifying to see an institution like the SAT EVE POST, with a circulation of better than 3,500,000 copies per issue, go to bat for the man with the greasy hands who never gets rich. From what we know about automotive mechanics, there is no solid organization or association of them big enough to bring pressure to bear upon an institution to print an ad such as this. In other words, this ad cannot be anything else but recognition of the problems which confront the backbone of the automotive industry—the people who see to it that cars stay sold—in other words, the repairman.

Of course we don't know, but we like to think that perhaps the SAT EVE POST does not agree with the READER'S DIGEST. We most certainly hope that such is the case.

Whether or not such an ad will ever appear in the defense of the radio serviceman is not known, although we do know that certain manufacturers are making plans for national consumer magazine advertising wherein they defend the radio serviceman. More than likely such ads will have already made their appearance by the time this column gets into print.

We believe that all of those people in the radio business who have felt that any attempt to fight the presently existing blanket indictment of the radio industry is hopeless, can take heart from this SAT EVE POST ad about the automotive mechanic. No doubt the automotive man felt that things were pretty tough after the READER'S DIGEST test—only to

witness something almost two months later which comes to his defense without qualification or reservation.

To us this means much, for ever since publication of the August issue of RD we have had conversations with servicemen and some really felt that the servicing situation as a whole was hopeless. No one can deny that many cards are already stacked against the independent serviceman, and if whatever information we have at hand is true, and we have no reason to doubt it, many more cards will be added to the pile. Yet the case is not hopeless, and it does not mean that the independent is licked. There are many independent servicemen who are tempted to give up the fight as independents, simply because they feel that they will find employment with those who take over—perhaps at even a higher weekly income than they are getting today.

If that is considered as justification for quitting the fight, then give heed to just one thought. If a set dealer can hire an independent service shop owner and pay the employee more than he is getting now as a one-man shop owner, then it proves that the servicing industry as independents is capable of earning the increased income, but it just hasn't made the proper efforts to do so.

We realize fully well that this has been said before, but we repeat it and will continue repeating it because it is a proven fact in many shops—very successful shops. As we have said once



"I'll be d—! It's working!"

before in this column quite a long time ago, a dollar seems to go much further when a man is in business for himself than when he is working for someone else, and it is our recommendation that every serviceman, if it is in any way possible, remain an independent and continue his own shop. For then, whatever effort, whatever work, whatever sleepless nights he may spend, he is doing it for his own financial advancement.

As we expected, we have received quite a few letters concerning our September column. These letters were very interesting and contained many different ideas concerning service procedure from the business viewpoint, as well as suggestions concerning means of combatting the accusations recently made. One of these is, in our estimation, suitable for practice in every shop, and we present it for whatever it may be worth. Invariably suspicion is cast upon a serviceman when he tells a customer that he cannot diagnose a fault in the home, but must take the set into the shop. From information gleaned from various sources, at least 6 out of every 10 people refer to the magazine which took it upon itself to blacken the name of radio servicing. The answer which the serviceman gives to the customer is the suggestion that the customer come to the shop with the set and actually watch the serviceman make the diagnosis.

In one particular case which came to our attention, the serviceman not only drove the customer and the chassis to the shop, but in addition took the customer inside the shop and sat him down before the workbench. He then identified for the customer the model number of his receiver. Then he took from his files all of the information he had relating to that set. He showed him the schematic and even the manufacturer's instructions relating to alignment, voltages, etc. He explained to the customer which part of the set was equivalent to the various parts of the schematic.

It so happened that this individual employed signal tracing. He explained to the customer what he was doing when he fed the signal into the receiver and then probed for the defect. Within twenty minutes the defect was located. He then recounted to the individual the total time lapse since the start of the entire procedure, that is, the call in the home, the return to the

(Continued on page 44)

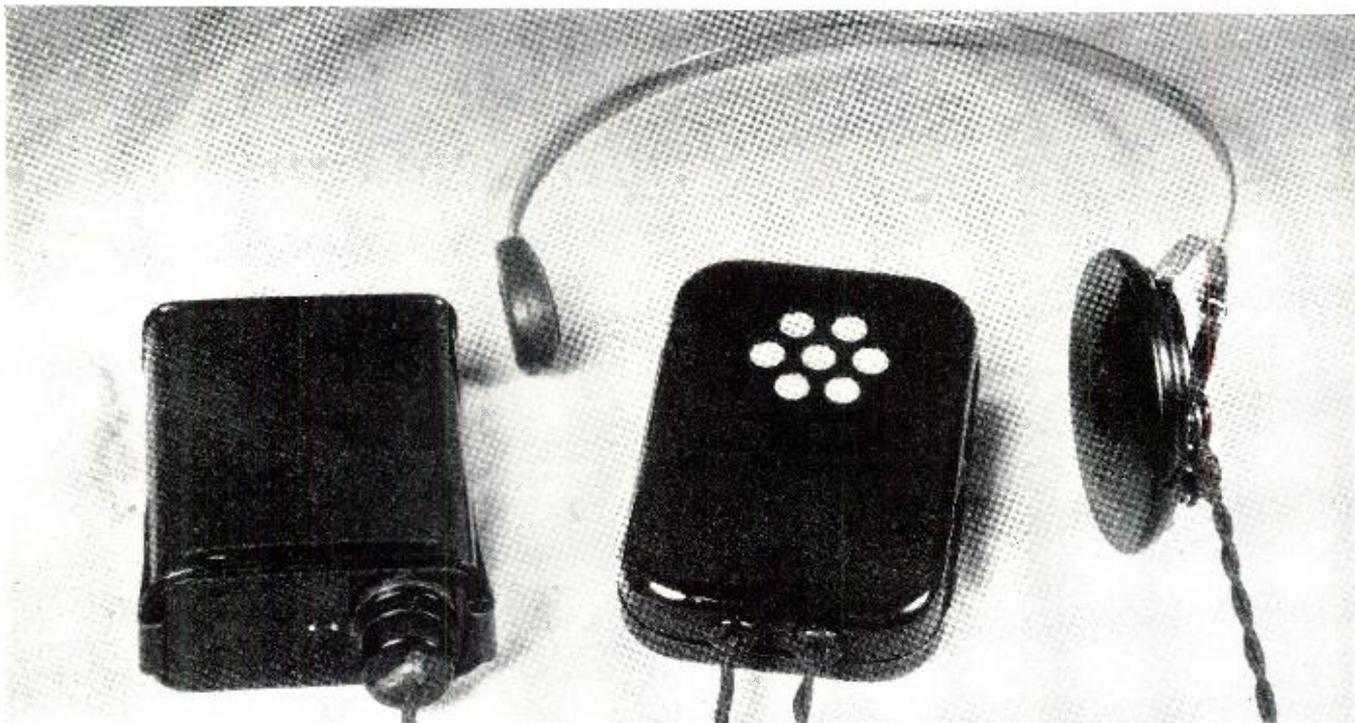

The complete hearing aid consists of battery box, amplifier unit, and special light-weight headphone.

A Wearable Hearing Aid

by EDWIN EWING

Microtube Labs.

Any radioman with soldering proficiency can build this compact, wearable hearing aid. Specially-designed components make construction simple.

MANY circuits have been published in various magazines built around standard tubes which were originally designed for use in compact hearing aid assemblies, amplifiers, and other miniature type instruments. In spite of the small size of the tubes used, there has been a great demand for ultra compact parts and accessories which were not, ordinarily, available on the open market. Since the introduction of the *Microtube* work has progressed on the design of a modern *wearable* type hearing aid which could be constructed by any radio man skillful in the handling of a small soldering iron, long nosed pliers, and wire cutters. Such a unit will be described in the following paragraphs.

The hearing aid may be used with one of several types of crystal headphones or bone conduction units, depending upon the recommendation of the physician prescribing for his patient. Essentially, the amplifier consists of three stages of resistance coupled amplification and uses specially made tetrodes which are no larger in diameter than a cigarette. In fact, the overall dimensions of the am-

plifier itself are not much bigger than a pack of cigarettes and this includes the microphone as well as all component parts with the exception of the headphones and batteries. The three units consisting of the amplifier, battery case and headphones, may be seen in the illustration.

Before going into the construction of the hearing aid, it might be well to state some pertinent facts regarding the nature of hearing. A human ear which is *normal* responds to frequencies of from about 40 to 15,000 cycles per second. A few of us are able to hear even higher frequencies. Hearing loss may be found in one of the following classifications: Nerve deafness (perceptive); conductive (impairment of the middle ear); and mixed, when both the inner and middle ear is impaired. We do not recommend that the radioman attempt to diagnose hearing loss. This can best be done by a physician who is equipped with a device known as an "Audiometer."

This instrument shows the increase in intensity above normal hearing, which is needed to make sounds of various frequencies perceptible. These

are measured on a chart which indicates the actual loss of hearing. Normal speech has a range from about 100 to 8000 cycles and consists of the *fundamental* range consisting mostly of voice frequencies of 100 to 400 cycles. The *middle*, or *vowel* range, from 300 to 2500 cycles and the *treble*, or *consonant* spectrum, which includes those frequencies from 2000 to 8500 cycles per second.

Inasmuch as the low bass frequencies contain the most power, which give an apparent loudness, we must not forget the higher frequencies which furnish the intelligibility of sound. If we are to eliminate those frequencies below approximately 1000 cycles, we will have a very unnatural tone in the headphones. At any rate, sound is very complex in character and we can touch only upon the constructional angle of a hearing aid to offset hearing loss rather than to diagnose those losses which might be present to the individual.

The performance of this compact hearing aid leaves little to be desired for the hard-of-hearing. It includes features found only in expensive instruments and yet may be built for a

fraction of the cost. We were fortunate, when searching for a suitable container, to run across a small metal box containing an assortment of household nails at one of the ten-cent store counters. This was exactly the size and shape needed to house the complete amplifier component. Likewise, the container for the batteries was made from a birdseed can which we first saw in a local drug-store. It is not much larger than the hearing aid and is small enough to be slipped into the pocket or in a lady's purse with ease as it takes up little room.

Many crystal microphones were tried in order to find the one most suitable for application. This one is especially designed for this particular instrument. It is extremely compact and requires but very little space in the assembly. The chassis, or mounting board for the components consists of a very thin piece of bakelite to which small eyelets have been attached.

Construction

Reference to the illustration will show where the three tubes are mounted. No sockets are used as they would require considerable more space and space is at a premium in any hearing aid. The tubes are laid flat against the bakelite and the stiff wire leads from the base of the tube are soldered directly to the eyelets provided. Ample support is provided and no trouble will be experienced from broken leads as there is very little weight encountered from the tubes themselves to cause bending of those wires.

The microphone unit is cemented to a piece of cloth to offer some shock absorbing effect to prevent noise from being picked up by any vibration at the microphone. The cloth is cemented around the cutout back of the microphone element. A special ultra-

Actual size of the Hearing Aid.

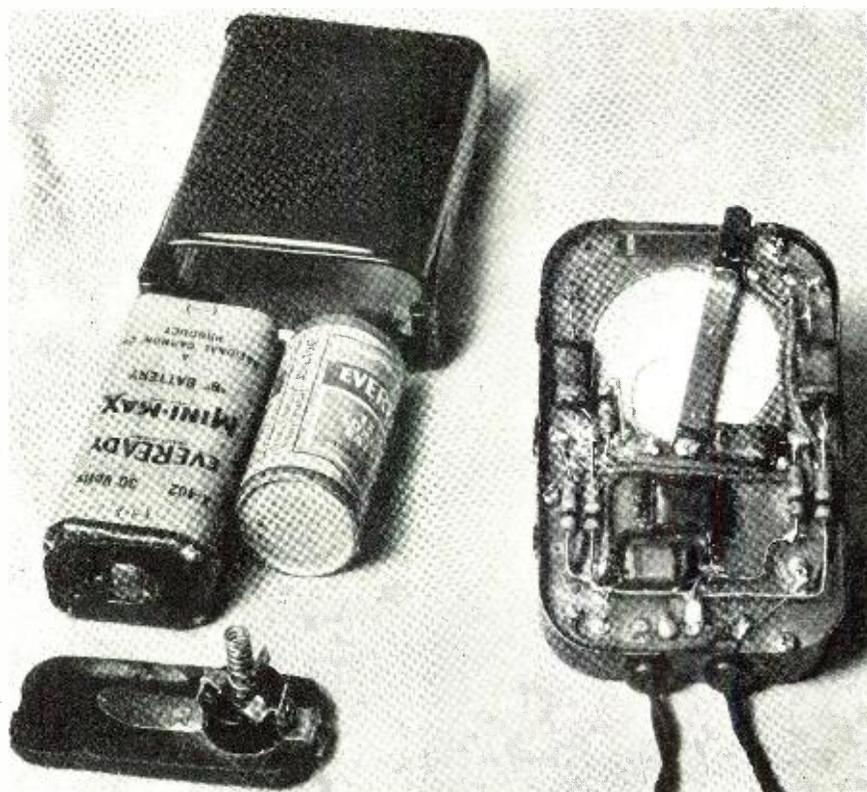
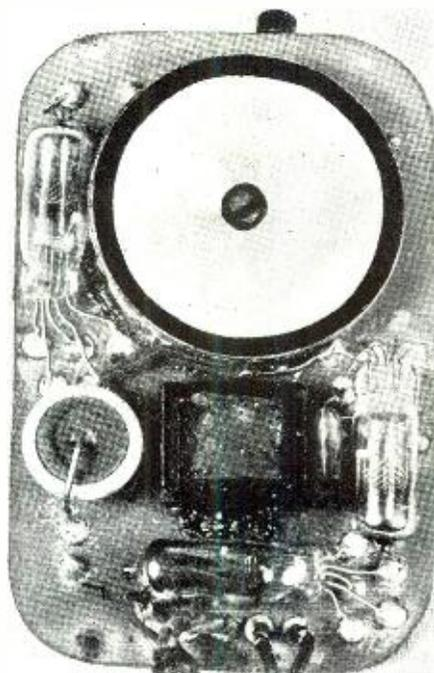

Left: Battery case showing socket. Right: Rear of amplifier with cover off.

midget audio choke is cemented to the bakelite and this is mounted directly underneath the microphone, as shown. A Mallory bias cell may be seen to the left of the audio choke. This furnishes the necessary bias voltage to the tubes and was used in place of the resistor-dropping method as a general improvement in performance. The cell is actually smaller than a by-pass condenser if one had been used.

All of the resistors have a 1/8 watt rating, and these are mounted on the back side of the chassis together with the special compact paper condensers and the volume control assembly. This consists of a long bakelite lever type arm, which passes through a cut-out slot in the top edge of the can. The other end is held in place with an eyelet so that it may be swung back and forth within the slot to regulate the amount of volume coming from the amplifier. A novel switching arrangement was introduced so that when the bakelite lever is placed in the position shown, a small length of

stiff bronze wire is lifted up off of the contacts, thereby breaking the filament connection.

The volume control itself consists of a flat piece of fibre on which a coating of special granulated carbon has been applied and the two outside connections are made to the leads at either end of this strip. The grid connection goes through the small piece of pigtail to the lever and this is seen on the illustration in front of the cloth on which the microphone is mounted.

All wiring is done with No. 20 tinned, or pushback wire, and we have found that the best soldering tool is one of the very lightweight pencil-type soldering irons, or, as an alternative, to file the end of a regular 100 watt iron to a pencil point and to adjust the copper tip so that an excessive amount of heat will not be applied.

There is nothing tricky or unusual about the wiring. Each stage may be wired in proper sequence and all of

(Continued on page 46)

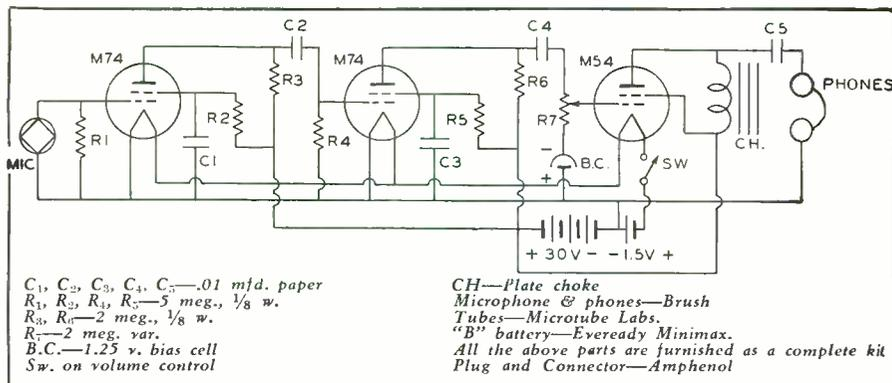

112-MC. Mobile Xmtr-Recv

by **RAYMOND B. FRANK, W9JU**

Technical Editor

Separate tuned circuits in this mobile transmitter and receiver step up the performance and simplify operation.

THE next time you whip out the old chamois and begin to give the dashboard and instrument panel of your car the long deferred polish that will bring back the gleam of respect to the old boat, take a few seconds time out and figure out how much of that panel isn't being used for anything.

If, for instance, you happen to own a *Chevrolet*, you might find a dandy vacant space (vacant, that is, of anything but a rather fancy grille) right in the middle of the dash. Very pretty looking, but not very utilitarian, because there's nothing behind it but space.

Well, right there is where you ought to install that transmitter-receiver.

There's something mighty convenient and adaptable about some of these grilles, and dashboards. They lend themselves not only to a fine, efficient panel-mount, but a very artistic and beautiful looking layout in the bargain.

Elsewhere in this article you'll find a picture of just such an installation job done on a 1941 *Chevrolet*. You'll see very readily that it looks like a 1943 model out ahead of time. Neat, balanced, serviceable, handy; and

looking as though it had been built in by the manufacturers right on the assembly line. That particular grille forms the basis for an installation that doesn't detract from the beauty and serviceability of either the dashboard or the instruments normally mounted on it.

Almost every car, new or a few years old, has a similar dashboard setup; one that will allow for the installation of the transmitter-receiver. Some have a handy glove department that isn't a glove department at all, but just a dummy panel. Others simply have blank spaces on the panel.

Mobile operation offers a thrill to those of us who are rather tired of the conventional lower frequency operation. For those of you who are contemplating construction of a rig for your car we suggest the one described.

Circuit

After trying many circuits as *transmitters* with little success, due to the critical antenna coupling, dead spots, cranky regeneration control plus the necessity for working the transmitter and receiver on the same frequency, it was decided to separate the func-

tions of the transmitter and receiver in order to eliminate the interlocking between the two. In this manner we automatically eliminated many of the faults of a "tranceiver" as it then became possible to design each unit for optimum performance.

It was possible to use the audio section of a modulator in the "transmit" position and as the audio amplifier in "receive" position. In this way the number of tubes used is considerably reduced, thereby cutting down the drain on the A battery and also on the Vibrapak.

The transmitter gives a healthy 6 to 8 watt carrier, while the receiver gives plenty of gain to drive a small P.M. dynamic speaker. An HY75 was chosen as the oscillator for the transmitter due to its large power capabilities which permit it to "loaf" in this particular application and to gain much greater stability than could be obtained by a receiving-type tube.

For the receiver section, an HY615 is used as the regenerative detector with a 6J5GT as a quench oscillator. In this manner it is possible to obtain a much smoother control of super-regenerative action than can be had with a self-quenching detector.

Most automobiles have plenty of space on the dash that can be utilized to mount the complete unit.

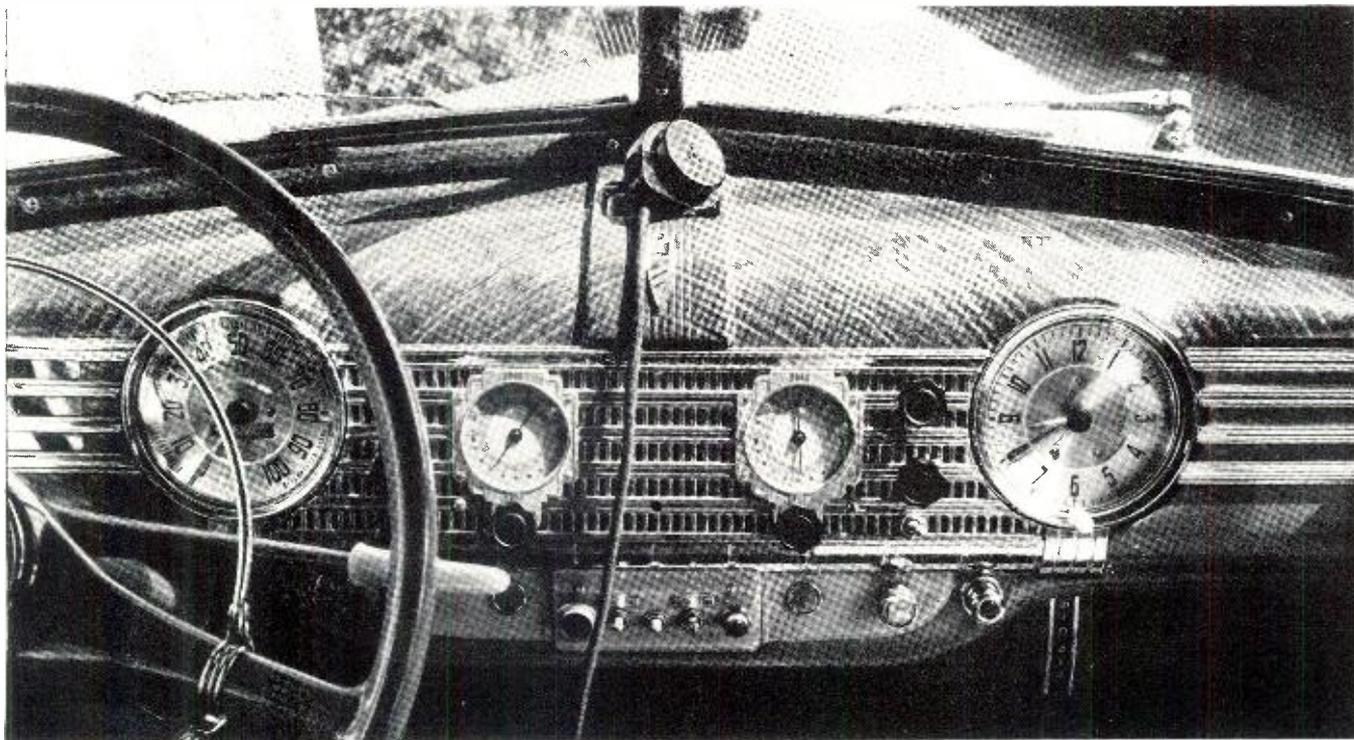

The Receiver dial is on the left-hand side and the Transmitter dial on the right.

For the audio section a 6J5GT is coupled to a 6V6, feeding into a center-tap transformer, one half of which serves to feed the oscillator and in this manner apply modulation to the carrier. The separate mike battery is used for mike current and audio bias to eliminate hash that might be induced in the filament leads by the *Vibrapak*, as the mike current is quite low and the battery in this application has a long operating life.

Construction

Because of space requirements in this particular installation, a 5"x9½" x1½" chassis is used. The size to fit your particular application will, of course, depend on the space available. It is rather difficult to give an exact layout as this is best dictated by the particular conditions encountered. In our case, the speaker and dials are mounted first on the grill and the chassis fastened to the grill by means of long bolts and spacers.

The receiver section is located on the left-hand side with the transmitter on the right. The "send-receive" switch is mounted on the left-hand side directly on the grill as it is the most used control. The switch used was the only one available at the time but in its stead a single section four pole two position switch can be used. However, the switch should be of Isolantite construction in order to reduce losses in the antenna section.

An Amphenol co-ax connector is mounted on the rear drop of the chassis
(Continued on page 50)

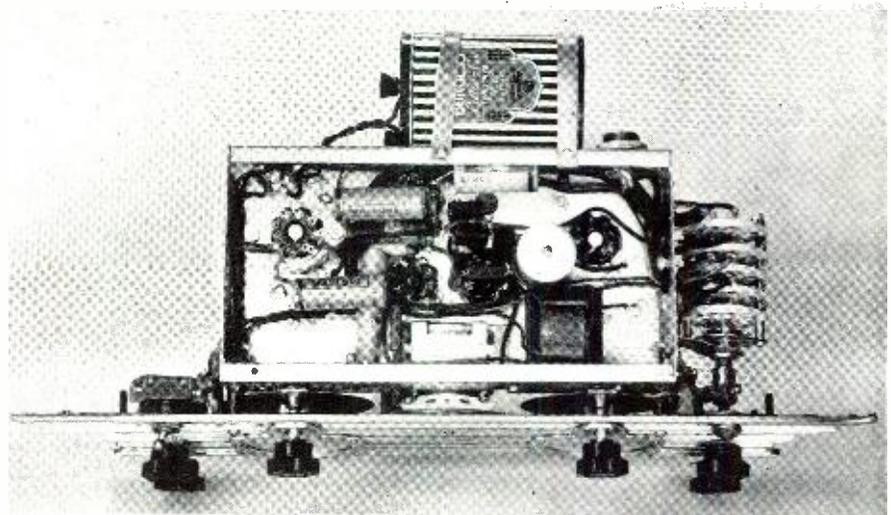
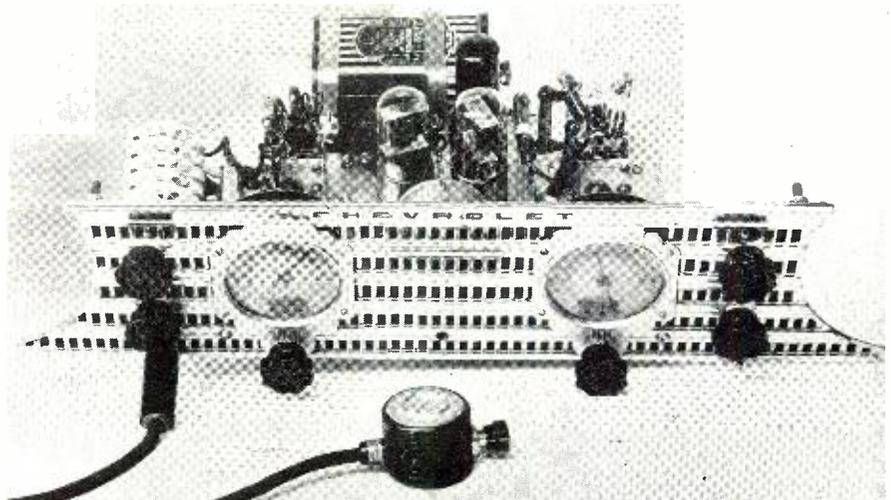

The small can under the chassis is the quench-oscillator. Note battery.

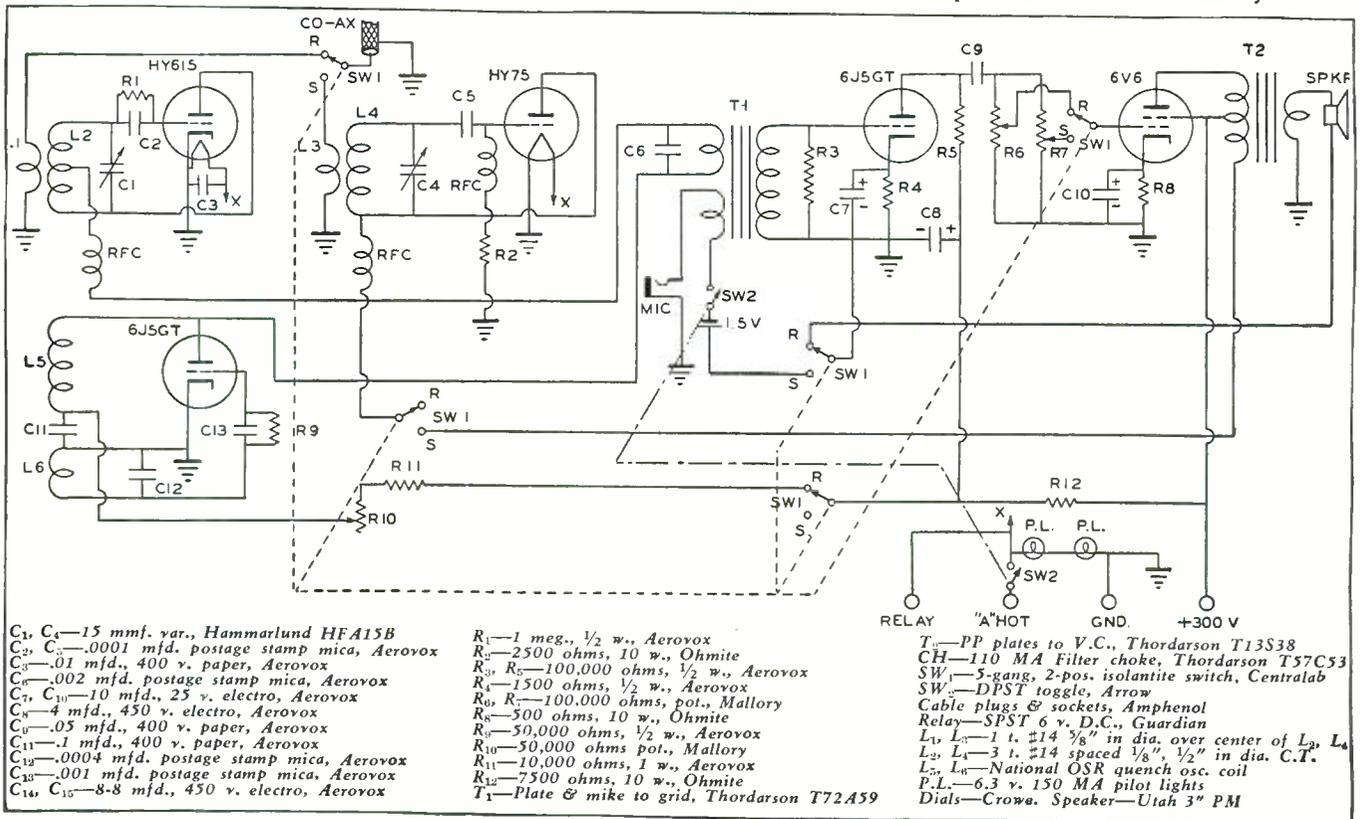

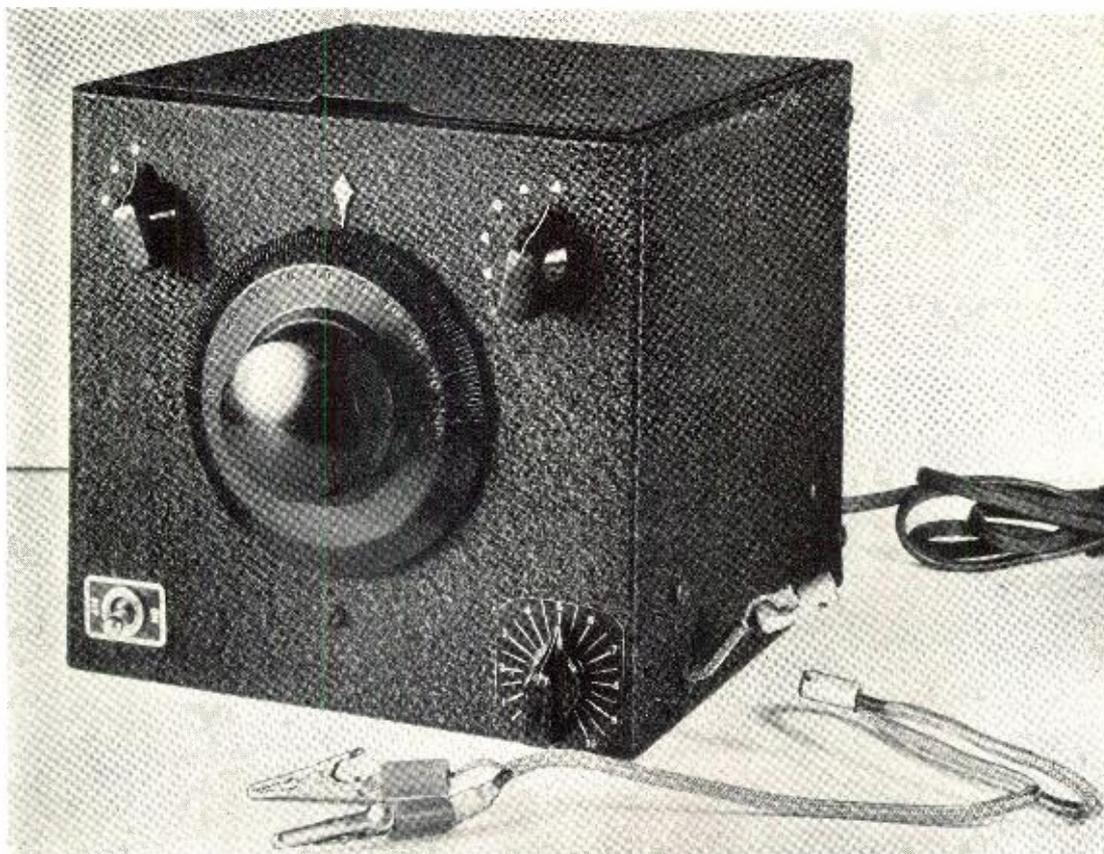

The completed signal generator is housed in a National steel cabinet. Note test leads.

Build This SIGNAL GENERATOR

by CLARENCE ZORNES, W9TAL

Most experimenters have parts needed to construct this efficient generator. It has many radio applications.

A GOOD all-wave signal generator is very essential to the radio-serviceman of today. Many of us, however, haven't the necessary cash with which to buy a generator, so the next best thing to do is to build our own. After some consideration the following requirements were decided upon: First, the generator must be stable in operation; second, it should be simple to construct; third low in cost for good operation; fourth, it should cover a comparatively wide range of frequencies.

The next step towards the completion of this generator was to see just how many of the parts needed could be salvaged from the age-old junk box, and it was surprising to find that many of these parts were there. It was necessary to buy a commercially

built cabinet because of the difficulty of home construction of enclosures. The cabinet, in this case, is a *National* Type *SRR* and is just exactly the right size for housing a compact, yet efficient generator.

Let us take a look into the circuit of this generator. This proved beyond a doubt, after much experimenting, that it was the most stable of them all. So, as a result, it was used in the final version.

Although specifications are given, it will still be necessary to "prune" the coils slightly to conform with the individual variations, as it is practically impossible to construct two sets of coils alike.

A very handy piece of equipment to aid in determining when the correct amount of modulation is being applied

to the final output tube grid is an A.C. voltmeter. The meter need not be highly sensitive, although it should be capable of showing a five volt reading rather closely. More about the voltmeter later.

The tubes selected were in keeping with low cost, availability, and stable operation.

Let us start with the power supply section. As will be observed there are a pair of line chokes in series with the A.C. line to keep the generated r.f. out of the line and thus being radiated that way. This condition would result in the attenuator control having little effect on the higher frequencies. These r.f. chokes were constructed in the workshop although they may be purchased commercially and possibly slightly better performance may result.

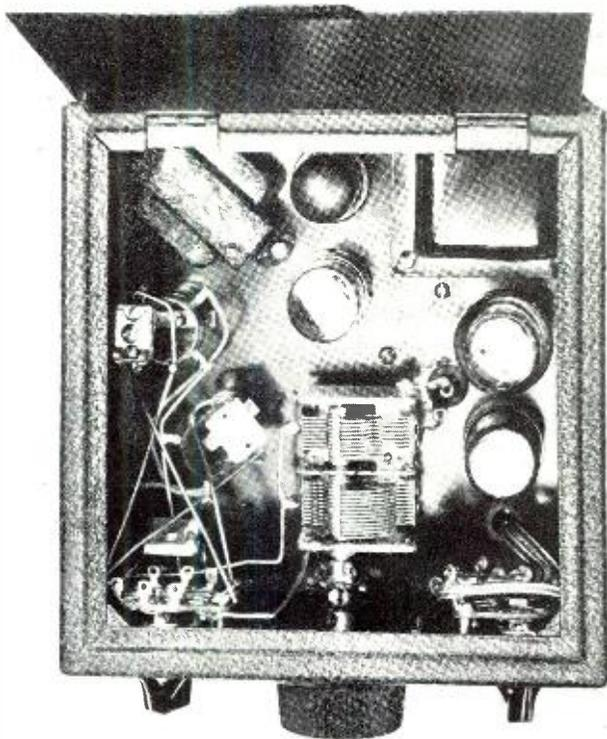

Coil assembly is mounted back of band switch.

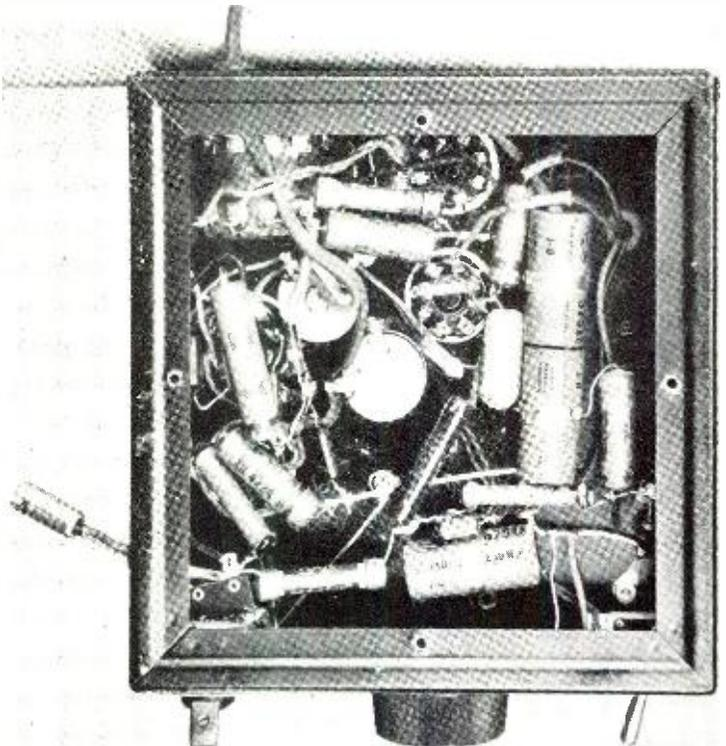

Bottom plate is removable. It protects parts from dust.

The Chokes may be wound with No. 24 D.S.C. wire and about 100 turns close wound on a form 1/4 inch in diameter and about 1 inch in length. The power transformer should be of the midget type as there is no necessity for a high voltage or a high current. Fixed bias is obtained through the use of a dropping resistor in series with the center tap of the high voltage winding.

In order to have a note that closely approaches a sine wave this fixed bias must be used to keep a constant bias on the tube at all times. In order to keep the cost low, the filter condensers are all of the low voltage variety. These condensers also help to conserve space. The r.f. section itself is wired with heavy bus bar to help keep the signal as stable as possible in case of vibration to the cabinet.

The gang condenser was used because of the fact that it was available at the time. It is of the midget superhet type with a tracking section, although this isn't necessary if another condenser of single gang variety is available it is mounted slightly above the chassis to prevent shock, such as jarring of the cabinet. Ceramic pillars with fiber washers under them are used for this job.

The parts for the r.f. section were mounted as far away from the power supply as possible so that the transformer vibration would have little effect. Little trouble will be had with coil interaction as only one coil is in the circuit at a time. Small 30 mmfd. trimmers are mounted on top of each coil to adjust the high frequency ends of each of the three bands. With this

particular generator the frequencies that are covered are as follows:

Band 1—420-1520 Kilocycles.

Band 2—1450-5000 Kilocycles.

Band 3—4800-15000 Kilocycles.

The trimmers help to overlap each

band so that continuous coverage is obtained.

The transformer for the audio-modulator is one designed for a pair of 6F6 tubes into a 500 ohm load. Circuit values are given for the capacity

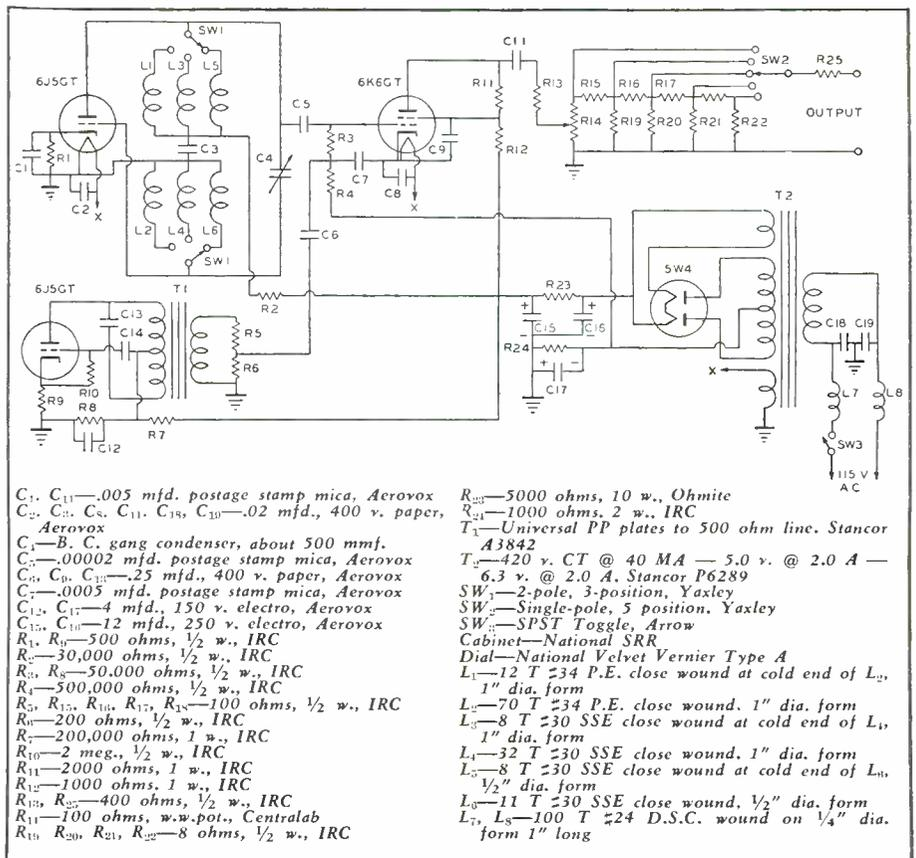

across the primary winding, but this may have to be adjusted to suit the individual as tastes vary as to the type of note wanted.

The A.C. voltmeter mentioned previously will now come into use to tell if there is too much, or not enough, audio exciting voltage being applied to the grid of the 6K6GT tube. Connect the voltmeter from the junction of the two 50,000 ohm resistors in the grid circuit of the 6K6GT tube to ground for measurement of this exciting voltage.

After the voltmeter is connected, adjust the value of resistance across the secondary of the audio transformer to read 4 volts with all tubes in operation. This is the correct value for this tube for about 30% modulation. Any greater modulation than this will result in the signal creeping and losing its sine characteristics.

As is shown in the accompanying diagram, the resistors across the secondary are fixed as this is the correct value for this generator. However, a variable resistor may be used to make it slightly easier to adjust. It will also be observed that the audio modulator differs from the usual types shown in handbooks in that a slight degenerative effect is induced by the use of an unbypassed cathode resistor. The purpose of this is to create a better note and to help in keeping the note of a sine variety.

The bandswitches used have extra contacts available but the automatic stops may be adjusted so that only the needed portions are used. If the builder has other switches on hand there is no reason why they cannot be used so long as they correspond electrically to the particular switch listed.

It will be noted that the attenuator switch and bandswitch are unshielded. The connecting leads should be shielded, however. This was to keep expenses down in the construction. However, if one wishes to do so he may put extra shield cans around these switches. This will add to the effectiveness of the attenuator controls. Also the 100 ohm vernier potentiometer for attenuation can be shielded with slightly better results in attenuation.

This extra shielding is left up to the good judgment of the constructor himself. In the case of this generator the shielding seemed to be quite adequate for all practical purposes.

The lead coming from the generator carrying the r.f. has the 400 ohm resistor in series with the live prod right at the termination of the clip. This system seems to be more effective than if the resistor were mounted in the generator itself. Some receivers have high-impedance, high-gain primaries in the antenna coils and it may be necessary to substitute a very low capacity condenser in place of the resistor because of the heavy loading effect of the resistor. This small condenser is about 20 mmfd.

All resistors connecting to the at-

(Continued on page 47)

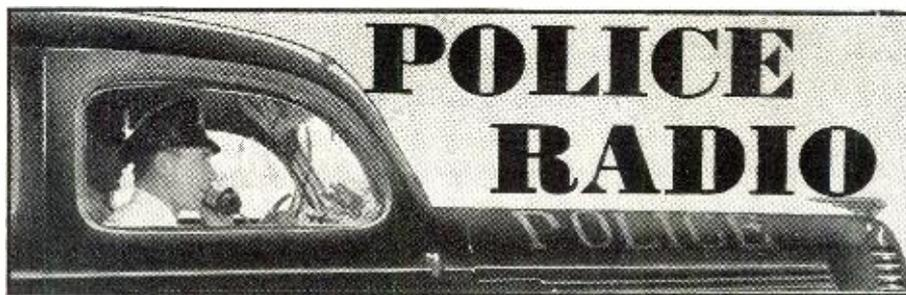

by **WILBERT T. PETERSON**
Illinois State Police Dept.

State-Wide Two-Way

PROBABLY the most interesting bit of news on the Police Radio front this month is the addition of the states of California and Michigan into the ranks of state-wide two-way frequency modulation communication.

The initial installation for the state of California will be one 500 watt headquarters transmitter, 70 patrol cars, 70 receiving stations and five mountain top automatic relay stations. Additional appropriations are expected to be made to greatly increase this number.

Since California is a long and narrow state with very rugged terrain, it is a rather difficult problem to design a two-way state-wide system, however, with the aid of the automatic relay stations on the mountain tops the problem is simplified. These automatic stations consist of a receiver tuned to the car frequency with a squelch circuit that opens when a signal is received and applied to the modulator of a 117 mc. transmitter. The output of the receiver is fed into the transmitter. A beam antenna then directs the signal to the receiving position down in the valley.

The swing to FM by the state of Michigan is very unusual due to the fact that they are discarding their old one-way low frequency system for the new state-wide two-way.

Under the new set-up the original order calls for seven *Motorola* 250 watt central station transmitters and 38 mobile units. This, of course, is only the initial installation and the system will be enlarged later.

Resembling the system used in Connecticut, Michigan will also utilize the modern three-way circuit in which the cars may be operated on one or the other of two frequencies. Since these two frequencies are only separated by 120 kc. no retuning is necessary when changing from one to the other; the operator in the car

merely pushes a change-over switch to change the frequency.

The central stations will be equipped with two receivers tuned at 37.5 mc. and 37.380 mc., the cars, however, use only one receiver. All of the station house transmitters send on the same frequency, with the cars normally transmitting back on the other frequency. If, however, in case of a blockade or other emergency where a car to car communication is necessary, the two cars may merely turn their switches and operate on the central station frequency to which their receivers are tuned, and communicate with each other.

The three-way system is also very advantageous in solving the interference problem which often occurs in the ordinary two way system. In the latter case when both the central station and cars are on the same frequency, communication between the cars and post of one district may interfere or delay communication between the cars and post of another district. In the three-way system this is impossible as the mobile units and central stations operate on different frequencies. In this way a message can always be sent to a certain car from a central station without any interference from other cars nearby.

We believe this is an ideal arrangement and is a great step toward providing more reliable communication in a police radio system. Michigan therefore is the second state to adopt this modern communication system for their state police department. Frank Walker is the chief radio engineer for the department, with Captain Scavarda in charge of communications.

Louisiana Network

WILBUR T. GOLSON, chief radio engineer of the *Louisiana State Police Radio System* reports he now

(Continued on page 48)

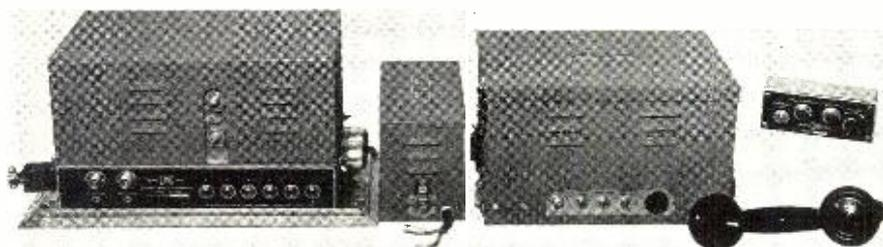

Complete Link police FM two-way mobile assembly.

BENCH NOTES

by **ROBERT KENDALL**
Service Manager, Indianapolis, Indiana

Checking Up

ONE night as we waited in a theatre projection booth for the end of the last show, with a view to investigating the misdemeanors of the sound system, the bored projectionist proceeded to speed up the approach of closing time by tossing aside every other one of the remaining reels of film with the remark that "Nothing much happens in that one." As shown on the screen, results were rather erratic to say the least, and such as to move one anguished spectator to shout "Oh, that so-and-so didn't cut out MUCH." Any writer will recognize the projectionist's action as a somewhat drastic form of editing, an operation performed in the literary world by individuals known as editors, who (in movie versions at least) loll around in air-conditioned offices, surrounded by beautiful secretaries, cutting out the most cherished thoughts of the writer who has labored all day over a hot typewriter, gathering up stray commas, and stitching together the split infinitives.

However, in all fairness, we must admit that the blue pencil has fallen but lightly on the *Bench Notes* copy in the *RADIO NEWS* sanctum, hence we were all the more disturbed at the bob-tailed state of a paragraph printed in the middle of page 46 in the August issue, which must have mystified those readers that got that far. We do not know who is to blame for the disappearance of the last two or three lines—but if it was the editor he can read them again for his pains, while if the compositor was guilty he can just run them off this time. The original paragraph read as follows:

"It would seem that radio broadcasting already had an ample number of qualified experts in the tub-thumping end of the business, and as for the average serviceman harassed by the necessity of keeping up with the field technically, while turning out a sufficient number of jobs per day to keep the bean-pot boiling, such a proposition is not likely to produce any more favorable response than a coarse sound known as the razzberry."

And now that is cleared up, we will proceed about our business.

Home Vs. Shop Service

THERE are times when we do not know why we bother to be civil to Sam Milbourne, and this is one of

them, as we have just finished the September installment of "Ringing the Bell" and find to our disgust that he has taken a whack at one of our pet themes: Service in the Home or Shop? To make matters worse, he has covered practically every angle of the subject that we had in mind, with an almost identical point of view, leaving us with little to say except that we agree with the old *Bell Ringer* 100%.

There have been a few attempts now and again to present a case in favor of radio service in the home, but to the average full-time service man, whose trade lies within a four or five mile radius of his shop, the few theoretical advantages of home service are negligible or non-existent in actual practice. Milbourne has enumerated decisively the many good reasons in favor of shop service, and there is one major reason that confronts the shop owner every time he looks around his place of business, and mentally inventories the array of instruments, tools, manuals, tubes and parts that have been found essential for the conduct of an up-to-date service business.

Few service men handling more than a job or two per day are likely to contemplate with any favor the problem of lugging around anything like the stock of tubes and miscellaneous parts that would be required to meet all contingencies arising in the course of an ordinary day's business. A considerable investment is required to maintain the tools and equipment that the modern shop finds convenient and

profitable to have at hand, and it is scarcely good business to leave most of this behind and attempt to do first-class repair work with the limited amount of equipment and stock that can be carried around in one or two carrying cases. Under these conditions the promised saving in time fails to materialize, as more time is usually taken up in running back and forth between the job and the shop to pick up odd tubes, parts or tools which were not available from the travelling stock.

Summing up, there is little or nothing in favor of doing service work at the customer's house in urban communities; and to this department at least, such methods of doing business bear too strong a resemblance to those of the scissors-grinder and umbrella repairman familiar to our childhood days. It may be significant that these itinerant service men have long since vanished from the scene.

Policy

IT may be indicative of the hazardous condition of the radio service business, that in recent years a few efforts have been made to lend radio service some dignity as a trade or profession. Some manufacturers have addressed their advertising to the service men as "service engineers," while in some cases a few men have adopted such weird titles as "Radiioneer," "Radiotrician" and others more amusing than useful. While these harmless applications of a little oil may be agreeable to the radio man's eye and ear, in the final analysis they are of little more practical benefit than an echo, as radio service, in its present state, is far from being a trade or profession, nor in many cases can it even be considered as a business. This statement is made on the basis of our own observations of a number of years, and that much-discussed article in "You-know-what" magazine.

To most people, as well as this writer, a bonafide business provides a fair amount of service at a fair price, and from the recent investigation it is apparent that a considerable percentage of men in the radio business make little or no effort to tie up these two factors in any logical manner. Many men felt entitled to collect "two or three dollars" on every receiver that got in their shop, while

(Continued on page 56)



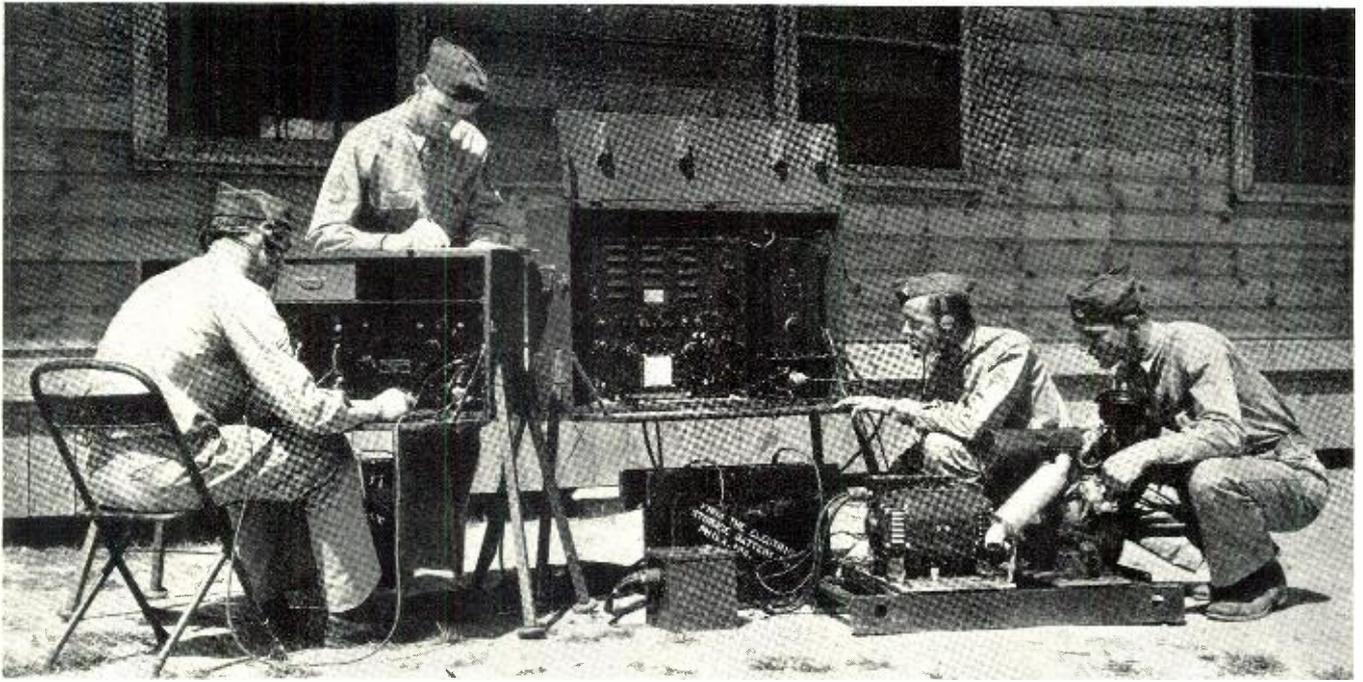

Once the students have learned the fundamentals of radio operation and maintenance, they start on their field practice. Here a crew operates one of the larger sets which requires four men and a truck for transportation.

Ft. Monmouth Radio School

Many men from private industry with specialized technical training are given speedy instruction at this famed school.

FORT MONMOUTH, New Jersey, located about fifty miles south of New York, is the only Army post occupied exclusively by Signal Corps troops, and is the home of the famous Signal Corps School. Here officers as well as enlisted men receive training, including the highest 15% of selective service soldiers from the Corps' Replacement Training Center. This school was established as a Communication Training Center during World War I and was then known as Camp Alfred Vail. Renamed in 1925, the post became Fort Monmouth, taking its name from the Revolutionary War Battle of Monmouth.

The U. S. Signal Corps, which began as an experiment during the Civil War, has progressed to a point where it is now an indispensable factor in the modern-day defense of our country. Unlike most other branches of the Army, it operates at full efficiency both in peacetime and in war. Its multiplicity of duties form an all-important network that literally keeps the Army together. Now, during the present Emergency, more than ever before, the need for a well trained Signal

Corps organization is imperative. Fort Monmouth is the answer to this need—at least, in part.

Everywhere within the boundaries of the Fort, signs of expansion are visible. In the Fall of 1940, many new buildings were erected for use as classrooms, laboratories and barracks for the men in the Service. Early in 1941, the Signal Corps Replacement Training Center was established at the Fort. The purpose of this unit is to train selectees who have been inducted into the service as Signal Corps personnel. These well-trained men are then sent to Signal Corps organizations in all parts of the United States. This Training Center is not a part of the Signal Corps School itself, however, about half the student body of the Enlisted Men's Department of the Signal School is drawn from this source.

Rookies arriving at Fort Monmouth in lots of approximately five hundred, are given I. Q. tests and the Signal Corps Code Aptitude Test. From the results of these tests, they are classified in accordance with their ability to receive and absorb special types of training. Because this branch of the

Army is self-sufficient, its personnel includes clerks, cooks, mechanics and, of course, communications experts of all kinds. The term length of this course of training is three months. Six thousand men are trained at the Replacement Center every three months, and approximately one thousand men are picked from the group and enrolled in the Enlisted Men's Department.

The Enlisted Men's Department of the Signal School, under the command of Maj. Paul L. Neal, is operated as two divisions: the Wire Division and the Radio Division. In the former, the trained men become telephone specialists: in the latter, the men become radio repairmen, the telegraph printer operators, field radio operators, or fixed station radio operators.

Men in the Wire Division of the Enlisted Men's Department receive training in telephone communications similar to that course of instruction pursued by commercial telephone companies in training their employees. Major R. G. Swift is in charge of the division.

Under the able guidance of Major



Students of the Signal Corps School at Fort Monmouth start the day by marching from barracks to classrooms.

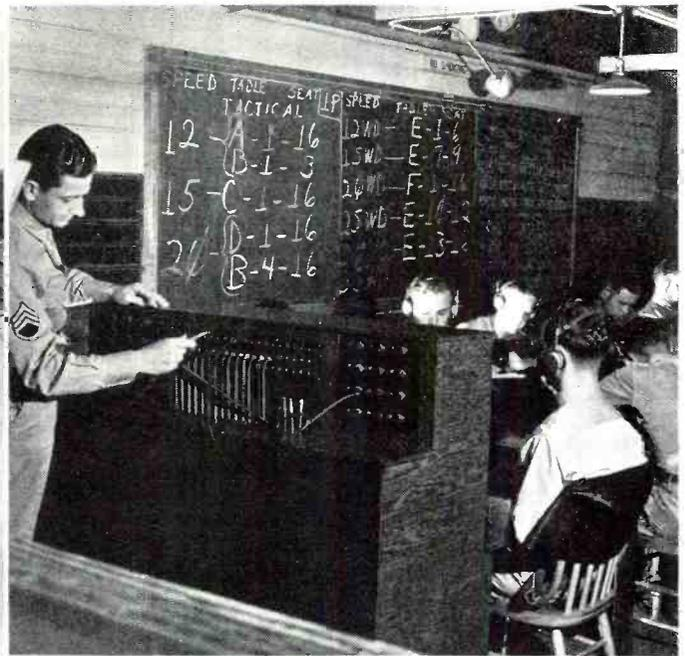

One of the first subjects taught the students is the reception of code. Plugs select various code speeds.



A group of automatic keying machines which are used to feed code to the lines selected for the students.



Practice in reading messages off the tape and typing them on paper is another activity for the students.

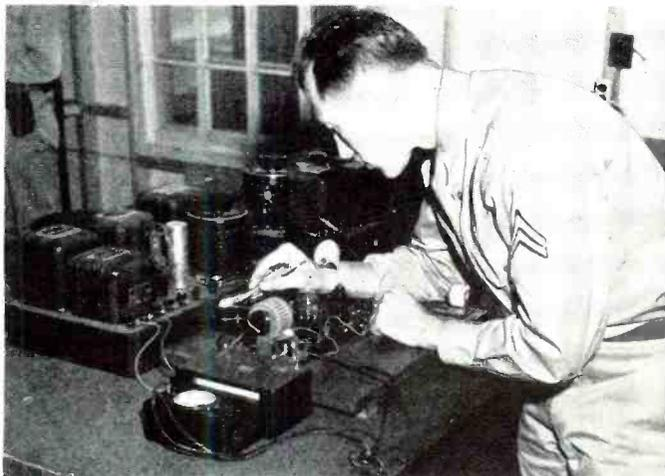

Maintaining the radio equipment of the Army is just as important as operation. Test equipment is modern.



Maintenance students are given a complete course in radio theory and maintenance. Laboratory in action.



Two soldiers carry a portable radio set of the type used for communication between tactical Army units.



The same set after being set up for operation. One turns the generator while the other takes the key.



Left: The Army "Walkie-Talkie" has 6-8 mile range.

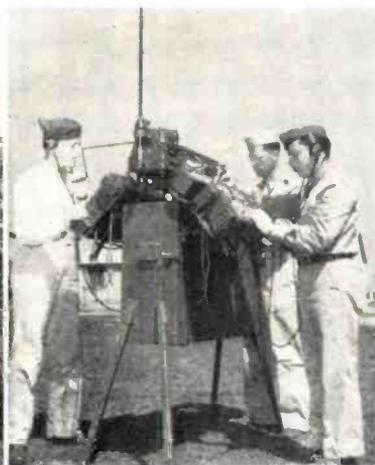

Right: Mobile unit designed for pack animal's back.



Graduation finds students on their way to various tactical units, in the famous Army Signal Corps.

M. G. Wallington, the Radio Division offers courses in both operating and radio theory. It is said that the most difficult course given to enlisted men in any branch of Army service is the course in radio theory given to students taking the radio repairmen's course. When they have completed this course, they are thoroughly familiar with that subject. Only these repairmen are given this course, and they have a tremendous job ahead of them in keeping radio equipment, belonging to the Army, in order. It must be remembered that all of the branches in the Army service use radio communications in one form or another.

About forty per cent of those in the Enlisted Men's Department are given the radio repairmen's course. These men need have no background in radio and little electrical knowledge. They are given a complete course in electricity and magnetism. And these subjects are further subdivided into other Principles and Phases of Electricity and in a.c. and d.c. theory. Inasmuch as this course is rather simple for the average student, he is expected to complete it in about four weeks' time.

Upon finishing this portion of the training, he may proceed to the course in Radio Elements. This is essentially a course in shop work and he is able to brush up on what he has previously learned in other departments.

One of the most important topics and one which is well liked by the students is that dealing with the testing and repairing of radio equipment which is used in Signal Corps operation. There is no time for taking it easy, and the student who is lax in his studies soon finds himself behind the 8-ball. Efficiency is the keynote in the Army Signal Corps and every effort is made to see that the student is neither rushed nor allowed to fall behind by keeping a close tabulation upon his progress. The Radio Elements course consists of a group of twenty-nine lessons and most of them include actual laboratory experiments. A large reference library is maintained which includes up-to-the-minute radio technical information and the student is urged to make use of this source of information.

The Signal Corps School possesses up-to-date equipment. Everyone has

a chance to make tests and diagnose troubles with a host of testers, etc. The progress of some of the students is rather amazing and the school recognizes this fact by offering instructorships to students who can qualify. All of the latest methods of testing are used, including dynamic testing and a complete study of the oscilloscope.

Later, each student receives actual instruction in the field on portable and mobile units. Some of these stations are built as complete mobile units while others consist of transceivers and other portable type gear. The student has already learned how to operate and maintain this field equipment during his course in testing and repair.

Other classes teach the Continental Code to the students and they are required to print rather than to write the characters as they are received. A fixed spacing rate is maintained and this is held to close limits whether the student is copying at a five word rate or at a 20 word rate. This offsets the tendency on the part of the student to count the characters and enables him

(Continued on page 66)

BY the time you read these lines, the world will either be a great deal better off, or a great deal worse off, than at the time of their writing. Events move with lightning rapidity these days, but they continue to cast their shadows before them. Thus, without trying to compete with any of the long-range prophets, I wish to predict that we will continue along the road to war, and that very soon there will be started an underground swell of public opinion to "get it over with now."

This is merely as a background for the more specific prediction that Government officials will soon begin to appreciate the true worth of radio broadcasting as a morale "builder-upper" and will move officially to see that the maximum number of radio receivers are kept in proper operation.

There is no doubt about it. Sooner or later we are going to roll up our sleeves and jump right into the thick of the battle. This is our opinion and, while it may differ radically from the opinions of some of our readers, we know that they will grant the writer the liberty of expression. However, once more we stress the point that this is merely a back-drop against which we ask the question, "If war comes, how will it affect you, and what are you going to do about it?"

A "shooting" war would result in many of our fellow servicemen closing up shop and joining in the fight. However, there are many thousands of us who, for one reason or another, can't go to war and it will be our job to keep the home fires burning and the radios playing.

Mr. Rider has covered the problem of replacement parts very well in a recent "As I See It" article in RADIO NEWS, so we shan't go into that phase of the resulting problem. Recent government rulings have resulted in moving materials, destined for radio receiver repair, up the priorities ladder and it is hoped that this will minimize any shortage of radio parts or tubes.

The phase of the problem about which we desire to "hold forth" at this time may be titled "A Challenge and a Reward."

The Challenge? The challenge to every radio serviceman will be his duty to his country to see that every possible radio receiver in his trade territory is in working condition and that it is kept in working condition.

The Reward? The reward will be the satisfaction of knowing that he is "doing his part" to help us stay a free peoples, plus the very definite personal monetary reward of increased profits through more radio repairs.

This business of keeping all sets in the radio serviceman's territory in operating condition is not nearly as simple a task as it is to make the suggestion. Any serviceman who has wrestled with the public knows it for a rather tough hombre with which to deal. Someday, a scribbler who is familiar with the often bitter experiences which are a part of a service-

A Challenge and a Reward

by SAMUEL C. MILBOURNE

man's daily life in dealing with the public, will get a chance to write an article entitled, "The Public Will Gyp You If You Don't Watch Out." However, that is beside the point. Let us see what *constructive* measures can be taken to keep a maximum of radio receivers in operation.

First, for any national success to be attained, there should be a national appeal to radio owners to keep their sets in operating condition. This appeal should come from the White House, or a responsible government official. Then, the drive can be carried forward by radio stations, radio manufacturers, radio servicemen, and all others interested in National Defense as it pertains to radio.

It must be explained to the public that radio broadcasting is the most likely form of mass communication. Through radio broadcasts, large percentages of our population can be warned instantly of any impending danger. Through radio, all Americans can keep in close touch with the news of the world and the progress of the war. Radio can be used as an excellent means of promulgating announcements, orders, etc.

This plan is no reflection upon the value of the newspaper, the telegraph or the telephone. They all are powerful aids in war as well as peace time, but paper may be scarce, and the idea of ringing several hundred thousand phones to warn of an approaching air raid is a rather startling undertaking.

Then, there is the lighter side of radio broadcasting. Its entertainment value as a powerful aid to keeping up

the morale of the nation can not be overlooked. The movies, the dance hall, the recreational center, the night club, etc., all help in this regard, but none enter the home as does radio broadcasting.

We proposed, a moment ago, a *drive* to get and keep radios operating. The theme of the drive would be, of course, a patriotic one. "Your radio is your closest link between you and your government." "Be a good American. Listen to your radio and keep informed." "Uncle Sam is broadcasting. Keep your radio turned on." "Be prepared to listen-in. Keep your radio fixed."

We never were much at coining slogans, but the above, though clumsy, probably will give you the idea which we wish to convey.

Next, there should be a national registration of radio receivers, or something of the like. Before you throw up your hands in horror at the idea, please be assured that with the aid of local civic organizations such as the Junior Chambers of Commerce, the Boy Scouts, and the local radio servicemen's organizations, the job *can be done*.

The registration need not be complicated. A card (postal size) could be used. On this need only appear the address, possibly the name of the party owning the radio or radios, how many radios are at the address and how many of these are in operating condition. Operating condition should be considered as a condition in which the radio can pick up at least one local station with volume and clarity sufficient to be heard over a portion of the house. Also, a space could be left for the party to indicate whether a radio serviceman could call regarding the fixing up of any faulty radio receivers.

If the party was not at home at the time the volunteer worker called, the card could be left for the set owner to fill out and return by mail under government frank.

The filled-out cards could be turned in to each local headquarters where they would be sorted and filed according to blocks. Local servicemen would then be furnished leads for radio repairs from these cards and they, in turn, would be required to furnish some report on the outcome of each lead.

Radio owners who had at least one radio in operating condition and who pledged to keep it turned on for a period of at least one hour a day, would receive a sticker for their window. Stickers could also be furnished

(Continued on page 59)



"Frankly, Ma'am, do I look like I am getting rich on \$2.00 calls?"

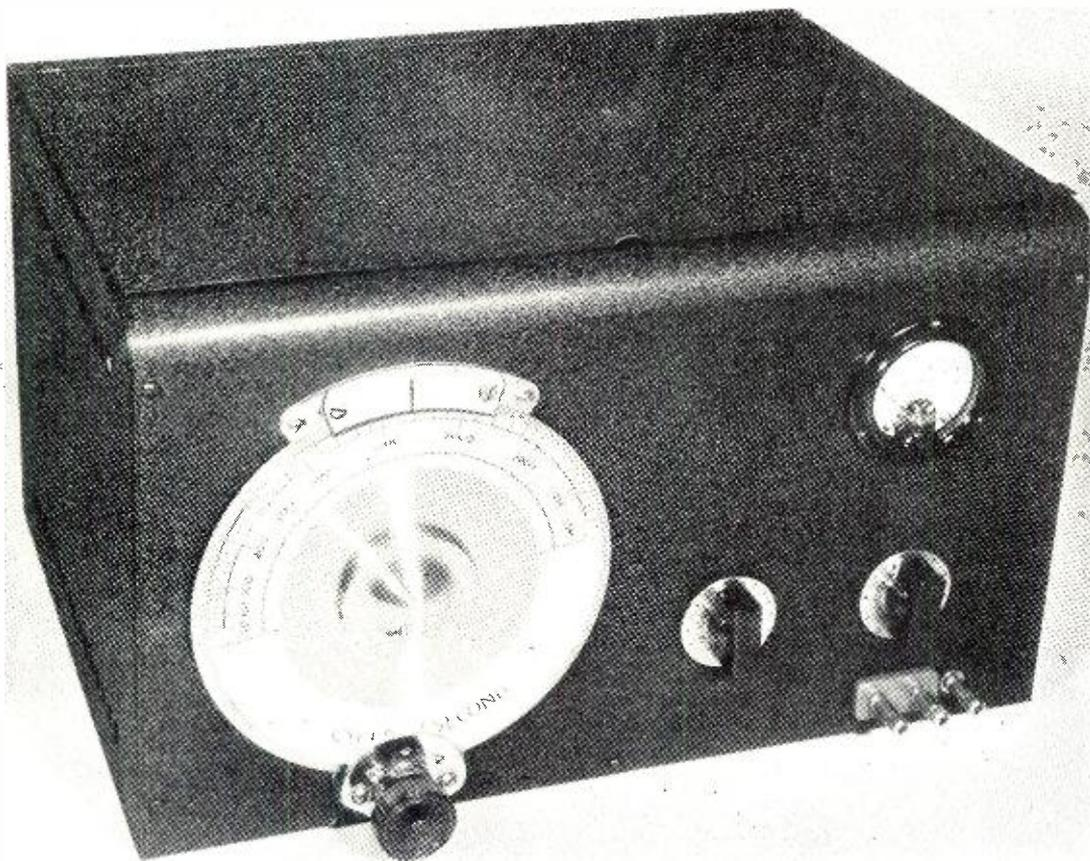

The design of the capacity meter can be similar to that of an audio oscillator.

Measuring Small Capacitances

RUFUS P. TURNER, W1AY

The author tells how to measure small capacitances between 1 and 50 mmfd. in the radio service shop or laboratories.

A CAPACITOR or *capacitive effect* of only a few micromicrofarads is generally of little consequence in circuits operated at the power-line frequency or at low audio frequencies. But, when the frequency is increased into the higher portion of the r. f. spectrum, small capacitances assume a more important aspect. This is almost entirely because the largely reduced reactance at those frequencies enables the small capacitor to transmit appreciable amounts of energy between circuit points.

Very often this transmission takes place between unintended points, giving rise to faulty circuit operation and reduced efficiency. Examples are the useless "charging current" which flows into the grid-cathode capacitance of a high-frequency vacuum tube and imposes heavy requirements upon the driver stage of a transmitter; stray-

capacity coupling in transmitters, receivers, and instrument circuits; and undesired feedback through the grid-plate capacitance of receiver and transmitter tubes.

It is seen, then, that small capacitances occur in the circuit not only in the *lumped* form of actual capacitors, but likewise as a circuit property in unavoidable condenser effects. It is very nearly impossible to eliminate all capacitance from a circuit of even great simplicity. Capacitative effects appear between adjacent conductors, adjacent turns in a coil, the electrodes of a vacuum tube, conductors and their shields, adjacent terminal posts, transformer windings, and between apparatus and the metal chassis and panels upon which it is mounted. Critical circuit design must contemplate these capacitances and take their *magnitude* into account. They are of vital con-

cern to all the high-frequency workers.

Turning our attention momentarily away from stray capacitances, we observe that the capacitance of capacitors associated with ultra-high-frequency tuned circuits is generally quite small, intentionally so. Here it is desired to have an actual capacitive component, fixed or variable, with small electrical dimensions.

The need to measure values between 1 and 50 mmfd. is a frequent requirement in the active laboratory. There are sufficient methods of measurement to embrace all practical cases, the particular method selected depending upon the instruments available to the engineer, individual preference with regard to indications and manual dexterity, and sometimes upon the nature of the capacitance being studied. A selected number of the most representative methods are discussed herein.

A few of the more refined capacitance test bridges designed for exacting engineering and physics laboratory use enable direct measurements as low as 5 mmfd., in some cases with an accuracy of plus or minus 1%. The tediousness of the actual manipulations in direct bridge measurements, as well as the necessity for calculations of the true value, are largely dependent upon the bridge characteristics and the ratio of stray capacitances to the condenser capacitance.

When measuring small capacitances directly with a bridge, the procedure

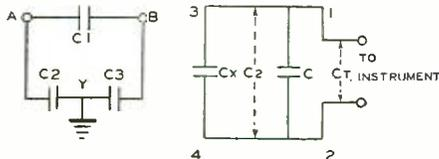

Fig. 1

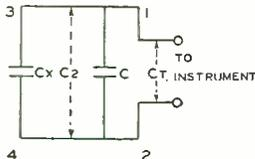

Fig. 2

is substantially the same as when using the instrument to check larger condensers, except that extraordinary care must be exercised in keeping the small condenser as close as physically possible to the "X" terminals of the bridge and well away from the fingers and any extraneous conducting bodies. But with even the greatest care, the actual capacitance presented to the bridge is a three-sided quantity, as will be shown in the following discussion, and particular procedure together with calculation may be unavoidable.

As viewed by the measuring instrument, the capacitance of the condenser is an aggregate of the actual direct capacitance in which the operator is interested and the stray capacitances set up between the condenser terminals and ground. Ground is assumed to be the metallic instrument panel or an actual ground terminal.

Figure 1 illustrates this condition. C1, the direct capacitance of the condenser, appears between the condenser terminals A and B, while C2 and C3 represent the stray capacitances between ground and condenser terminals A and B, respectively. In a two-conductor shielded cable, C1 would be the capacitance between the conductors; C2 and C3 capacitances between individual conductors and the outer sheath. A shielded transformer would present the capacitance C1 between windings, and C2 and C3 between corresponding windings and the shield. These stray capacitances often exceed the direct capacitance value, giving rise to a considerable error. They must, therefore, be taken into consideration in the measurement.

A standard method comprises three separate measurements and associated calculations. For each measurement, one of the capacitances is short circuited by jumper connection between A and Ground, B and ground, or from A to B, as follows:

C1 is first measured with C3 short circuited; and the value obtained, designated C'1, is equal to C1+C2.

C2 is then measured with C1 short circuited; and this result, designated C'2, is equal to C2+C3.

Next, C3 is measured with C2 short circuited; and the value obtained, designated C'3, is equal to C1+C3.

From these relationships:

$$(1) C1 = \frac{C'1 - C'2 + C'3}{2}$$

$$(2) C2 = \frac{C'1 - C'3 + C'2}{2}$$

And

$$(3) C3 = \frac{C'2 - C'1 + C'3}{2}$$

For the direct measurement of the correct values of capacitance and power factor without the foregoing calculations, the General Radio Co. recommends that the third condenser terminal (Y, in Figure 1) be connected to the Wagner ground junction.

Incremental Method

The stray capacitances present in a number of bridge circuits and other condenser test instruments limit the low-capacitance level which may ordinarily be reached by them. Such in-

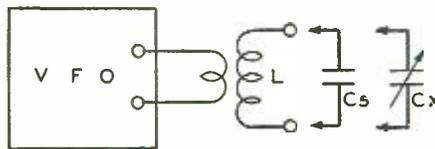

Fig. 3

struments may still be employed to measure small capacitances by the *incremental method*. In substance, the smaller condenser is connected in parallel with a larger one so chosen that the capacitance of the latter is within the reliable range of the instrument. The indication thus obtained being the capacitance of the simple

parallel combination, the smaller capacitance may be determined by subtracting the known value of the larger condenser from the total capacitance. The accuracy of the incremental method is greatly enhanced by previously determining the larger condenser's capacitance with great precision.

In Figure 2, Cx is the small capacitance of unknown value. C is the standard parallel condenser whose ca-

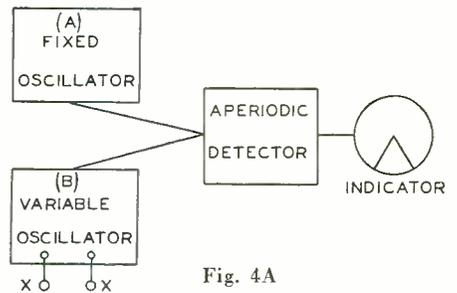

Fig. 4A

pacitance is known very closely. The bridge or other instrument is connected directly to the terminals of the parallel circuit.

The instrument indication will be a value Ct which is equal to C+Cx; and from this, Cx=Ct-C. The value of the standard condenser C must so be chosen that the addition of Cx will cause a readable difference in the reading of the instrument.

The length and spacing of the leads, 1 and 2, to the standard condenser are kept the same as when C was initially measured, in order that the amount of inductance and stray capacitance introduced will be kept at a minimum.

Cx is connected as closely as physically possible to C to avoid long leads at 3 and 4. If 3 and 4 must necessarily be long, a pair of identical leads (with-

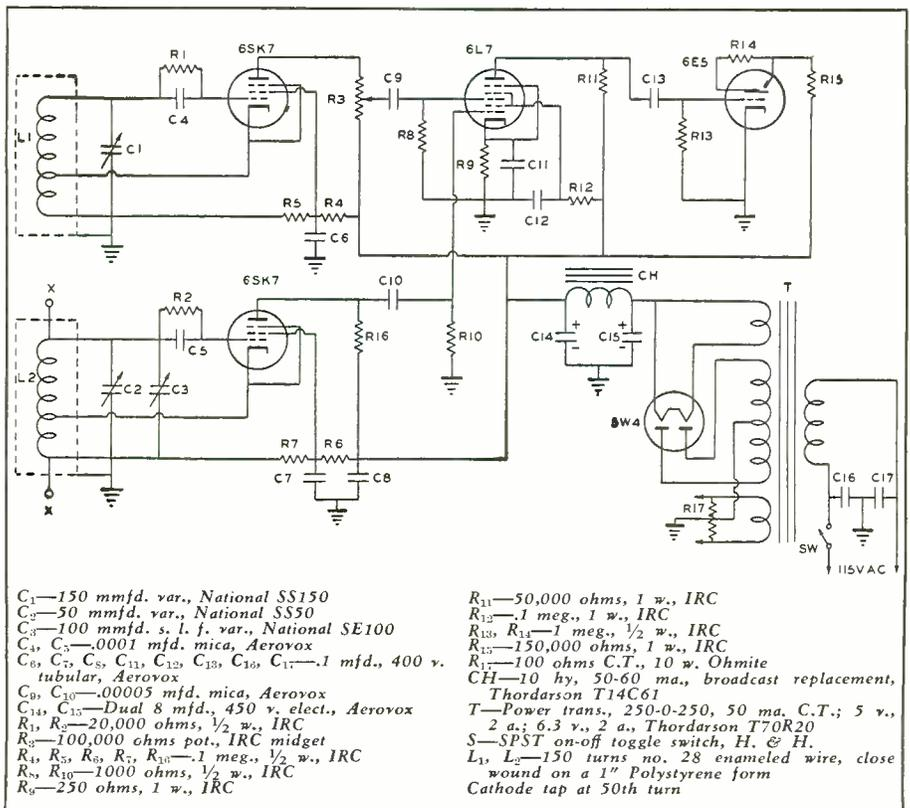

- C₁—150 mmfd. var., National SS150
- C₂—50 mmfd. var., National SS50
- C₃—100 mmfd. s. l. f. var., National SE100
- C₄, C₅—0.0001 mfd. mica, Aerovox
- C₆, C₇, C₈, C₁₁, C₁₂, C₁₃, C₁₄, C₁₅, C₁₆, C₁₇—1 mfd., 400 v. tubular, Aerovox
- C₉, C₁₀—0.0005 mfd. mica, Aerovox
- C₁₃, C₁₅—Dual 8 mfd., 450 v. elect., Aerovox
- R₁, R₂—20,000 ohms, 1/2 w., IRC
- R₃—100,000 ohms pot., IRC midget
- R₄, R₅, R₆, R₇, R₁₀—1 meg., 1/2 w., IRC
- R₈, R₉, R₁₀—1000 ohms, 1/2 w., IRC
- R₁₁—250 ohms, 1 w., IRC
- R₁₂—50,000 ohms, 1 w., IRC
- R₁₃—1 meg., 1 w., IRC
- R₁₄, R₁₅—1 meg., 1/2 w., IRC
- R₁₆—150,000 ohms, 1 w., IRC
- R₁₇—100 ohms C.T., 10 w. Ohmite
- CH—10 hy, 50-60 ma., broadcast replacement, Thordarson T14C61
- T—Power trans., 250-0-250, 50 ma. C.T.; 5 v., 2 a.; 6.3 v., 2 a., Thordarson T70R20
- S—SPST on-off toggle switch, H. & H.
- L₁, L₂—150 turns no. 28 enameled wire, close wound on a 1" Polystyrene form
- Cathode tap at 50th turn

out condenser) should be connected to C in the same position (spacing and direction) that will be taken by the Cx leads. The bridge is then balanced to obtain the value of C plus the lead capacitance C2. Cx is then connected with its leads, 3 and 4 in the same position and direction taken by the "stand-in" wires, and the aforementioned parallel measurement made.

Substitution Method

Figure 3 illustrates a popular substitution method for measuring small capacitances as well as larger capacitances over a wide range. A multi-band variable-frequency oscillator provided with a grid-circuit milliammeter is coupled to a suitable coil, L, the inductance of which need not be known. Cs is a laboratory standard variable condenser of range appropriate to the capacitances to be measured. The calibration of Cs must show the capacitance of this condenser at any setting of its dial.

The procedure followed in the measurement consists of first connecting the unknown small capacitance, Cx closely across coil L and, starting with the lowest frequency of the oscillator, varying the supplied frequency upward until a sharp deflection of the milliammeter indicates that the resonant frequency of the L-Cx parallel combination has been reached. This indication may be sharpened consid-

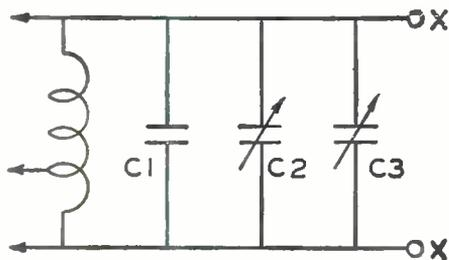

Fig. 4B

erably and the accuracy of the method greatly improved by decreasing the coupling between the oscillator and the coil L in discreet steps.

Then, without disturbing the setting of the oscillator, the unknown capacitance Cx is removed from the circuit and the standard condenser Cs connected in its place, taking care to keep the leads to Cs as short as is possible.

The standard condenser is then "tuned" carefully until a sharp deflection of the oscillator milliammeter announces that the resonant circuit has been restored to its original value. And at this point, the capacitance of the standard condenser, corresponding to the capacitance of Cx may be read, directly from the standard-condenser calibration.

The success of the substitution method rests to a great degree upon the stability of the oscillator and the ability of the operator to substitute Cx and Cs without introducing appreciable amounts of stray capacitance and inductance. Considerable pains are necessary in the measurement of small capacitances by this method, since the resonant frequency will be

very high. Stray capacitance, stray inductance, and oscillator stability will accordingly be of considerable moment.

The use of a switch for the alternate connection of the two condensers into the circuit is not recommended, as the switch and its leads will introduce a considerable amount of inductance and stray capacitance and influence the accuracy of the measurements proportionately.

Capacity in Terms of f and L

If the value of the inductance L is known precisely, the standard condenser shown in Figure 3 may be dispensed with and the capacitance of Cx determined from calculations involving the resonant frequency, f and the inductance, L.

Cx is connected closely to L and the frequency of the oscillator varied, starting with its lowest frequency, until a sharp deflection of the oscillator milliammeter indicates that the resonant frequency of the combination L-Cx has been reached. At this point, which may be determined very sharply by loosening the coupling between the coil and the oscillator, Cx is calculated from the equation for resonance:

$$(4) \quad C_x = \frac{1}{4\pi^2 f^2 L}$$

Meter for Small Capacitances

The arrangement shown in Figure 4A has been employed successfully for the measurement of small capacitances in a number of radio and electronic laboratories. It may be operated with unusual facility, may be made direct reading in micromicrofarads, and is reasonably fool-proof.

The apparatus line-up will be seen to consist of fixed oscillator (A), variable oscillator (B), aperiodic detector, and indicator. The two oscillator circuits, which are generally electron-coupled in configuration, are made identical and their components mounted intimately on the chassis in order that the two may experience approximately the same temperature changes and have the same electrical characteristics. If the circuits are identical in every respect and undergo the same temperature changes, their resultant frequency drifts will be practically the same and a constant frequency difference may be maintained between them. This is very essential to the operation of the instrument, as will be seen later.

When oscillator B is adjusted to operate on the fixed frequency of oscillator A, the condition of zero beat obtains, the aperiodic detector receives no signal voltage, and the indicator is not actuated. As the frequency of B is tuned away from that of A by a certain number of cycles or kilocycles, however, a heterodyne beat note equal to the frequency difference is set up and delivered as a signal voltage to the detector. The indicator, which is usually a magic-eye tube, is then deflected.

The tuned circuit of the variable oscillator is arranged as shown in Figure 4B. In addition to the main tuning condenser, C3, there are connected in

parallel with the coil a fixed "loading" condenser, C1 and the trimmer, C2. The terminals, X-X are connected directly to the tuning condenser.

C3 is accurately calibrated in order that its capacitance may be known for any setting of its dial. For added convenience, the latter may be made direct reading in micromicrofarads.

Before originally adjusting the instrument, it is allowed to heat for approximately one hour in order that tubes and other circuit components may arrive at their stable operating temperature. At the end of this period, C3 is advanced to a point in the vicinity of its maximum capacitance (a good point is the nearest integral capacitance setting at about 7/8 full capacitance) and the trimmer, C2, set at a point slightly less than its maximum value.

The fixed oscillator, A, is then set to the frequency at which the variable oscillator is operating by making appropriate adjustments to the semi-fixed tuned circuit of A. When the two oscillators are set to the same frequency, the indicator will show zero beat. This corresponding setting of the main dial attached to C3, to be known hereafter as "initial zero," is very important and must be recorded or identified directly on the dial face.

When the instrument is placed into operation on subsequent occasions and frequency drift has taken place, initial zero may be restored simply by adjustment of the trimmer, C2.

Now it is readily seen that if an unknown capacitance is connected to the terminals X-X across oscillator B's tuned circuit (Figures 4A and 4B), the frequency of the variable oscillator will be lowered and the instrument detuned from initial zero. Zero beat is then restored by decreasing the capacitance of the main tuning condenser, C3. We will call this new dial setting at which zero beat is restored "second zero."

It was pointed out earlier that C3 has been calibrated so that its capacitance at any dial setting may be known readily. So, we can read the capacitance values at initial zero and second zero. And the difference between these two capacitances will be the value of the unknown capacitance connected to terminals X-X.

Thus, with the meter just described small capacitances may be measured quickly and without having to perform any calculations save perhaps the simple mental subtraction of the initial zero and second zero capacitances of C3.

C1 is set to maximum. C3 is then set at maximum and C2 adjusted for zero beat between the two oscillators as indicated by maximum opening of the 6E5 tube. The ratio of voltages supplied to the 6L7 demodulator by the two oscillators may be adjusted by setting the potentiometer, R3, to prevent overload and "backlash" in the 6E5 indication. The unknown condenser is clipped at the contact marked "X." C3 is the condenser to

(Continued on page 66)

PART 3

ONE of the most important parts of the recorder assembly is the "drive mechanism" that is used to guide the cutter across the surface of the disc. If this part is not precision-made, trouble will be encountered and the final results will be disappointing to the recordist. Like other commodities the purchase price will be the determining factor as far as the quality of the mechanism is concerned. The higher priced units will have the better grade of components, while the low cost units will have production-made feed mechanisms that lack in the ability to guide the cutter accurately over the table.

Most all of the so called "home recorders" use an *underdrive* arrangement. The assembly is located under the motorboard and is on a plane with the cutter arm. When this arm is lifted from the surface of the record it will also disengage the knifelike end of the underdrive from the worm gear that turns when the table is revolving. The accuracy of the entire assembly will depend upon the worm gear and the amount of play that might be present in the hub assembly of the tone arm.

Many of the semi-professional recorders use a similar arrangement, but certain refinements have been added that eliminate the excess play in the driving arm. The knife is replaced with a special fan-shaped piece of metal. This piece is carefully machined and many small teeth are fashioned on the engaging edge so that they will all fit into the worm at the same time. The chance for play at this point is thus eliminated. The worm is driven by means of another fibre worm which, in turn, is driven from the shaft of the turntable.

One of the principal advantages of this drive is that a greater number of lines (grooves) per inch is possible as the spacing between them is more accurate and it is not necessary to allow for excessive play of the cutter assembly. Another feature found in this type of drive, is that the direction of cutting may be reversed simply by replacing the worm gear. A choice of outside-in, or inside-out cutting may then be had.

Another type of drive mechanism is shown in the article "Semi-Pro Recorder" in this issue of RADIO NEWS. This type is known as an overhead stationary feed-screw assembly. Two different arrangements are used on these. The one illustrated is driven by means of pulleys, which are driven from the turntable shaft by a flexible belt. There is an important advantage to be found in the *overhead* type of feed mechanism that cannot be overlooked by the more serious-minded recordist; the ability of the cutter to travel in a straight line across the disc. The swinging-arm type travels in an arc, and will not maintain the proper cutting angle for quality work at all positions of travel.

The overhead cutter mechanism

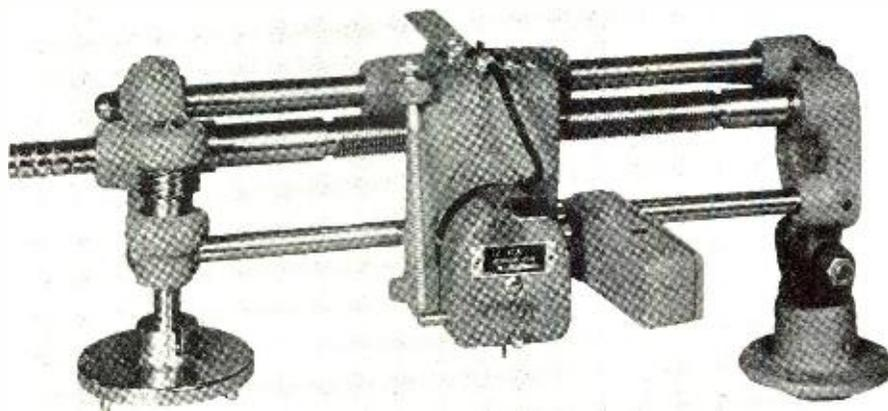

Typical overhead feed mechanism assembly.

Theory and Practice of DISC RECORDING

by Oliver Read

The recorder feed mechanism is a very important part of the assembly. Several types are described in this article.

rests on one or two horizontal guide rails. The cutter mechanism is equipped with a half-round threaded nut which engages the feed screw when it is lowered into the cutting position. The feedscrew itself is carefully machined on a lathe and the threads are spaced very accurately so as to maintain an even number of lines-per-inch when driving the cutter. These feedscrews are quite expensive, as they require precision labor. The cost of units employing such systems are, therefore, more expensive than the under-drive types.

Still another overhead mechanism is illustrated above. This is one of the most popular and accurate of all assemblies. The mechanism is placed directly onto the turntable and rotates in perfect synchronism with the revolving disc. A special worm gear is located within this hub assembly and drives a fine-toothed gear on a plate which is attached to the end of the feedscrew.

The cutting pitch (number of lines or grooves-per-inch) will be determined by the number of thread per inch on the feedscrew and by the speed at which it revolves. The tension offered by the cutting assembly will always be in one direction. It is therefore possible to use a feed which is capable of cutting many more lines-per-inch than on the underdrive units. Some of the overheads are designed to

cut up to as high as 180 lines-per-inch.

While on the subject of drive mechanisms, it might be well to discuss the various methods used to drive the turntable from the motor. Some of these are satisfactory while others are not. The first is known as a "direct drive" and the motor shaft extends up through the turntable. This is not very satisfactory and this type is rarely used. The second type is called a "rim drive." This may consist of either one or two rubber wheels that rest against the inside rim of the turntable. The dual-speed types use at least two of these rubber wheels or pulleys that are equipped with rubber tires. The last is the "belt-driven" type. This is very efficient and offers some shock absorbing characteristics not found in others unless they use live rubber wheels.

There are a few variations in the above drive methods. Some use a series of gears, but generally they will not be found in everyday application as they require a high degree of perfection if they are to operate in an efficient manner. Their cost is high and the adjusting of the equipment is rather ticklish.

Motors play an important part in the operation of the recorder. They must possess sufficient driving power to be able to rotate the weighted turntable at an even speed under varying loads offered by the cutter and other

(Continued on page 64)



SERVICEMAN'S EXPERIENCES

by LEE SHELDON

MY partner seldom comes in late, but when he does, it signifies something important. I'm the "outside" man in the partnership, but when Al isn't there, I stay in the store. By 11 a.m., I was pretty nervous, because I had Philips' Bosch to deliver. Just as I went to the rear of the store to call up Al's home, he came in.

"Surprise!" he said, jingling a key-ring. "Look out front—see our new truck!"

It was an Ajax—one of those midget cars! On the door was a sign: *Salutary Sales & Service*.

"What's the idea?" I asked. "I thought I had something to say in this business!"

"You have," Al admitted. "And because of that, I'm going to let you drive it." He seemed to think the whole thing was a joke, so naturally I was annoyed. We walked out to the curb together.

"What made you buy it without asking me?" I demanded. "Tires will be hard to get, and we'll have to send to Helengone for parts. Besides, it's much too small!"

"You can get three *Majestic 70's* in here with no trouble," he said, opening the door. "You never pick up three a trip, anyway."

"What about a console?" I persisted. "You can't get a piece of furniture in there!"

"When we have to, we'll strap it on top," he answered, raising the hood. "Look at that motor—isn't it a honey?"

"A sewing machine!" I snorted. "And it saves gas, too," he countered.

"Where's the old one?" I asked. "This is the old one," Al laughed. "I had it washed, and it shrank."

"Look here, fellow," I said indignantly, "this whole thing is outlandish. Do you expect me to make a fool of myself 10 hours a day, six days a week, in this thing?"

"I hope you do," he said. "It'll be good advertising for us. You know—the attention these little jobs attract is a feature a lot of small shop-owners overlook."

Well, I had to deliver the *Bosch*, so put the chassis on the front seat and climbed in beside it. There was plenty of leg-room, but I had the strange feeling, after being used to the old bus, that the seat of my pants were only about 4 inches above the road-bed. It was easy to handle, but I noticed people stopping to watch me as I drove by, just as I said they would, and it was very embarrassing.

When I stopped at Joe's gas station, he burst out laughing as soon as I came up to the pump, and dropped to his hands and knees and looked in at me.

"How many?" he asked, grinning wide.

"That's not funny," I told him. "Three, if you please."

I was so slow I couldn't see the meter on the pump, but I heard *ping!* three times. When he gave me my change, he handed a folded paper to me.

"What's this?" I asked.

"Road map of Texas," he roared. I went off in second, just to show how mad I was, but I guess it wasn't very impressive.

I arrived at the Philips house late, and they were both dressed to go out. They asked me to come back with the set the next day, but I told them if they'd let me install it then, I'd drive them to the station in time for the 12:15.

They waited as I worked, and when we got on the sidewalk, I remembered I didn't have the old bus any more.

"Can three people get into that thing?" Philips asked incredulously. We stood there, looking at each other, and estimating the sum of our wheel-bases.

"We've got to get into town," Mrs. Philips said. "Come on—let's try."

We exhaled together and squeezed in—but it would have been terrible if any of us got the hiccoughs.

At the last traffic light, as I started across the street, the motor quit! I looked down for the starter, but there were so many feet and legs, I couldn't see the floor. A crowd was beginning to collect, and I saw a cop coming toward us, so I decided to make a poke at the starter, no matter whose legs were in the way. I shoved hard with my foot.

"Ouch!" I shouted, for I had kicked myself.

The cop rapped on the roof. "Pull over to the curb," he said.

I turned and saw a row of brass

buttons on a convex coat. "I can't get it started," I shouted at his stomach.

The buttons went to the rear of the car, and we began to move. As we rolled to the curb, he came alongside and ordered me to get out.

"Can't reach the door handle," I yelled. He reached down and turned it, and I fell out with my hands on the street. Mr. Philips got out, and then Mrs. Philips, and they bent their knees. The cop burst out laughing.

"The last time I saw that gag," he said, "was in a *Keystone Comedy*." Even he laughed at me! "Run along now—but hereafter, keep your *Meccano* set at home!"

"Want me to take you the rest of the way?" I asked my passengers.

"No, thanks," Mrs. Philips said. "I'm shaped like a steering wheel on one side, and like my husband on the other. We'll walk!" She smiled like she was about to snap at me, and they limped away.

When I told Al what had happened, he shrugged his shoulders.

"You're no taxi-driver," he said, "and that car isn't made for three passengers. If you'd had your old car, you'd have got a ticket, sure."

"If I'd been in the old bus—" I began.

"Sure—I know," he interrupted, "but the Ajax is good show business. Think of its advertising value!"

"Perhaps I should dress like Charlie Chaplin," I said, sarcastically. "It's not going to take me long to get fed up with that bus. Don't be surprised if I chloroform it!"

For a while, I sort of got used to the thing. It was easy to park, and once in a while, although I knew it wasn't cricket, I managed to sneak between the rows of cars waiting at traffic lights. The drivers yelled and honked as I passed, but no one got sore, like they would if a regular car tried it. Once, while I was attempting a left turn a little after the light turned red, a big truck started up slowly and blocked the way. I knew then how a grasshopper feels when a 10-ton army tank rolls over him. I honked in panic, and felt the heat from his radiator before he stopped with his crank-handle about 6 inches from my window. I stuck my head out and yelled:

"Where the hell—?"

The teameo looked down and saw me for the first time. He was a bruiser, but instead of getting out to fight, he put one hand on his hip, waved the other to the people on the

(Continued on page 63)

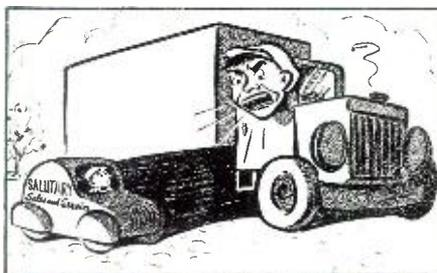

"Where the hell—?—Merciful heavens!—Bertha has pups!"



Looks very much like a commercial transmitter cabinet, doesn't it?

Enclosing the Transmitter

by
NICHOLAS LEFOR, W2BIQ

Neat appearance and low cost give this cabinet much appeal to Hams.

THERE is no doubt that modern practice in amateur transmitter design has definitely thrown out bread-board and open rack type of construction. It is possible that our transmitter being located in the living room has something to do with this trend in modern design.

A commercially enclosed rack was first considered, but money being an important factor, this was eliminated. Metal utility cabinets (kitchen cabinets) were next thought of, but here the drawback was the lack of proper size. These cabinets, although available in all heights and widths, lacked depth for our requirements. A wood cabinet was the third consideration, but here the drawback was one of inadequate shielding and grounding, an important factor in modern design.

In casting about for ideas, a *Sears Roebuck* mail order catalogue was thumbed, and lo and behold—our answer—a steel wardrobe cabinet, with plenty of room, size 60" x 24" x 20" deep, and the prices reasonable. There are two grades available, one at about seven dollars, and the other at twelve. These prices are not extreme considering the size. The cabinet selected was the latter model, the actual difference being in the rounded corners and finish.

In adapting this cabinet to an amateur transmitter, appearance was the prime consideration. The photographs show the simplicity of design and modern appearance of the transmitter. A

word about the meter panels. The panels contain only the Class C plate meter, modulation meter, pilot for filaments, pilot for transmit, main AC switch, and test button.

These panels can be extended and more meters added as required by the individual amateur. It is advisable to use bakelite panels to mount the instruments, pilot lights and so forth, and then fit these to the doors. These panels measure 14½" x 4", the cutout on the doors being ½" smaller—13½" x 3". In cutting the holes on the doors, drill a ⅜" hole in each corner and use either a keyhole saw or a pair of small tin snips. When using shears, care should be used to see that the edges when cut should not be turned or burred.

As the cabinet had no shelves, it was necessary to construct four shelves 24" x 18", one of these being used as false shelf on the bottom, raised and supported by two 2" x 3", eighteen inches long. These shelves were constructed of ¼" plywood laid on a 1" x 2" lapped and braced frame of the same size. This construction was cheaper by one half over the price of ¾" plywood shelves which of course would not require bracing. By all means, 1½" x 1½" x ⅛" steel angle should be used for shelf brackets.

These brackets are used not only to support the shelves, but to brace the cabinet as well. Six brackets 18" long were required in our case and cost approximately seventy cents. For addi-



Everything within easy reach for service or transmitter adjustment.

tional bracing, the welded steel hanger rod across the top of the cabinet should be left intact. For ventilation, six holes of about 1½" diameter at both top and bottom of the cabinet in the rear are cut, with a *Greenlee* punch or shears. Since the shelves are only 18" wide, they leave clearance both in front and back to allow the air to circulate through the cabinet.

All wiring for antenna feeders, 110 volt input, relay leads, etc., should be cut through on the back of the cabinet.

(Continued on page 66)

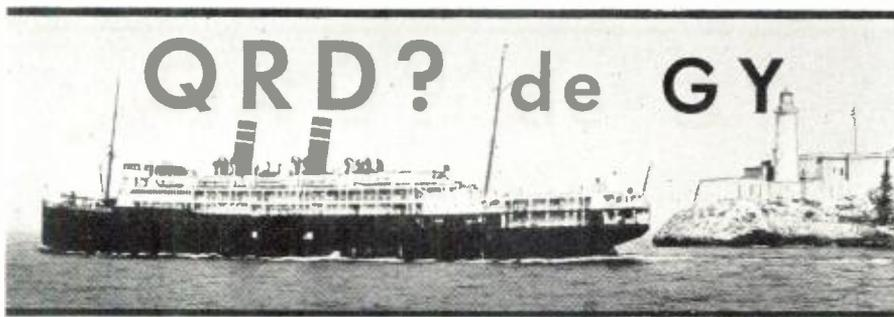

by JERRY COLBY

CONTINUING the "Six Months Law" by Fred Howe, ROU official. Quote . . . In hundreds of little things which get "under the Radio Officer's skin," life aboard a merchant vessel is made unpleasant for the Radio Officer. If thermos bottles are purchased for the Officers, it invariably occurs that there is none for the Radio Officer. If he makes a request for one, he is informed that there is none left, and he customarily finds that he is unable to obtain one by requisition through the proper channels. He must take this petty matter up with his union in order to get satisfaction.

He frequently finds that he is deprived of suitable towels, soap, linen for the bed, curtains, and other little things which are necessary aboard ship. If he wants them, he must fight for them.

Despite the Union agreement which prohibits the performance of clerical work, we find Skippers, Mates, Engineers, and Stewards bringing papers to him to type. He is often asked to run errands. If the Radio Officer refuses to do this work, he will find that when he wants some oil for his motor-generator, some rags for shining the brass, some sandpaper, or some kind of a job done, all of which he is entitled to under the Company's rules, that no one has time to bother with him.

In the "good old days" before we had a union, the Captains, Mates, Engineers, and Stewards looked upon the Radio Officer as some one whom they could ignore at their pleasure. If any protest was made, the Radio Officer was discharged. If he performed the little work which at first was asked of him, he soon found that he was loaded down with it, with more than he could do. He became ship's clerk, and frequently worked all day and half the night, without compensation, performing work for which others were paid. This has occurred on almost every ship of the merchant marine.

These little matters do get "under the Radio Officer's skin," and they have made him embittered at steamship companies and all those in charge on board ship. He always felt like quitting, and in most cases, he did. Conditions such as those here so briefly and inadequately described have been the breeding ground of "one-trippers." No one wants to work where life is unpleasant and men will not work under such conditions unless forced to do so by economic law.

Today that economic law is working in the Radio Officer's favor. He doesn't have to work on a ship today. He is finally free to tell the steamship company to go where the temperature is hottest. The Radio Officer today is getting his revenge after thirty years of abuse. It is a silent revolution on his part. It makes him happy to see the steamship companies beg him to remain on the job, beg him to return when he has quit, pay his transportation by plane a thousand miles, and meet him at the station with a taxi.

A number of steamship companies have been forced to bring Radio Officers by plane two thousand miles at great expense in order to sail their ships. As I write these lines, I have beside me a list of twenty experienced unemployed Radio Officers who have worked at their profession on ships for many, many years. They will not accept an assignment, not even to help their union. They are looking for something good ashore, and they will get that for which they are searching. They will be able to sleep

in a decent bed where cockroaches are not maneuvering like Hitler's armies up and down the walls. They will have the use of a clean and convenient bath room. They will be able to choose the kind of food they wish to eat. They will not be obliged to work in a room where the temperature is 120 degrees Fahrenheit. If they work overtime, it will be paid for. They won't have to work on Sundays and Holidays.

Many steamship companies, especially those under CTU agreement, have increased the wages of their Radio Officers to \$150.00 base pay. One line has raised them to \$160.00. Two small lines are paying \$175.00, base pay, for radio duties only. These rates to which may be added a war bonus makes the wages of the Radio Officer appear large. The wages are large compared to what was paid in 1932 and in other years, but they are not large compared with what the steamship companies are paying the Mates, Engineers, and Stewards. It might be well to explain at this point that it is not the amount of wages which greatly concerns the Radio Officer. *It is the discrimination to which he is subject in the matter of wages as in everything else aboard ship that aggravates.*

The Radio Officer feels that he is just as important aboard ship as any other officer of the vessel. In wartime, he is probably more important, more valuable than most of the officers; yet, his wages do not compare even remotely with the wages of the lowest paid officer of the vessel, namely, the Third Mate. They are even below those paid to the Steward. At least this is true in most cases.

They are usually on a par with those paid to the Filipino cook who in most cases is not a cook in any legitimate sense of the word. Most marine cooks know less about cooking than any one on board. A cook has never taken a costly course in cooking such as a Radio Officer has in learning his profession. It requires no education to be a cook on a merchant vessel. They have never attended a school where the art of cooking was taught. In many cases they are unable to read and write. They consist largely of West Indian negroes, Filipinos, Portuguese, Greeks, or what have you, who



"Clawson picks up 5 yards off—!"

were picked up in some foreign port by the steamship company in the "good old days" solely because they would work longer hours, at lower wages than would others.

The Radio Officer of the *American Merchant Marine* wants to be taken out of the cook category. He wants to be recognized as an officer of the vessel. He wants to be paid an officer's wage. He wants the same wage as that paid to the Second Officer of the Deck Department. This is the category in which nine of the principal maritime nations of the world have placed their Radio Officers. If it is good enough for foreign nations, it ought to be good enough for the U.S.A. If foreign nations, which are not so blessed with wealth as we, can afford to classify their Radio Officers in the Second Mate category, surely the United States ought to be able to afford it.

As a direct result of the constant and universal discrimination against the Radio Officer, the shipping industry finds itself confronted with a crisis. It wants the Six Months' Law repealed. It wants an opportunity to hire men for still less than they are now paying. But in reality, no shipping executive really desires a repeal of the Six Months' Law. The enlightened shipping executives know by previous experience that inexperienced Radio Officers should not be placed in full charge of the radio equipment on a one-man ship.

The intelligent shipping executive wants to know that when one of his ships sails, it will safely return. This is assured by the employment of competent, experienced navigators, engineers, and other personnel. While the vessel is away from the home port, the intelligent shipping executive wants to know the position of the vessel, when it will arrive, what accidents, if any, have occurred. In time of war, our government wants this same assurance. To make this a certainty, an experienced, competent and reliable American-minded Radio Officer must be employed.

A merchant vessel is no place for incompetency during a war, or at any other time.

Despite the mass exodus from the ships, the merchant marine still has hundreds of experienced, competent, reliable American-minded Radio Officers in its employ. This Union wants them to remain on their ships. The steamship companies want them to remain on them. The government wants them to remain on them. They, themselves, want to remain on them, and they WILL, if they are adequately compensated for their work, for their technical knowledge, ability, and experience, and if the many petty discriminations to which they have been subjected for so many years are removed.

If they work overtime, they want overtime for it, and they deserve it just as much as the Mates or the Engineers. Why should there be any discrimination? Eliminate the disparity and discrimination in wages, working and living conditions aboard ship, and the experienced Radio Officer will remain, and those who have left will return. The shipping industry should recognize this and raise the wages of the Radio Officer equal to those paid to the Second Officer of the Deck Department. This should be done immediately.

We are not only in the midst of a crisis, but a world revolution. As these lines are being written, the United States has not entered the conflict, but it may at any moment. Neither the government nor the shipping industry wants our merchant vessels manned by members of the Fifth Column, but the wages, working and living conditions on American Merchant vessels have been the breeding ground for discontent, the Fifth Column.

There is no better antidote for Communism, Nazism, Fascism, or any kind of discontent, than a decent living wage, pleasant and agreeable working and living conditions. These are a part of life and they must be provided. This applies to ships as well as to factories, mines, shops, shipyards, railroads, offices, and the farm. It applies to every industry. The Radio Officer wants to be recognized as an officer of the vessel, and he wants to receive the treatment accorded to an officer. He wants to receive the compensation of an officer. This must be done. It is to the interest of the shipping industry and the government that this be put into

(Continued on page 66)

Ham Chatter



W3HOV calls CQ 2½.

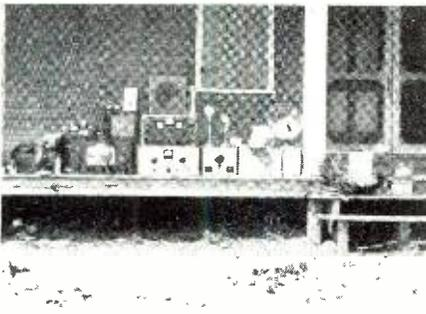

FD equipment of W3CDY gang.



Layout of W5JFF.

W1LZV and W1KPX.



NOW that cool weather is again with us the urge to operate once more surges to the surface, and we once again begin thumbing through catalogs of ham gear and planning that dream rig. However, some of us find it difficult when we attempt to purchase certain parts for said dream rig, as we find that National Defense has taken a great portion of the output of the Radio industry and left many dealers shelves rather low on some items. The situation is not as gloomy as it seems however as there are many parts gathering dust in junkboxes that can be used. A little ingenuity is needed in adapting some of this equipment to its new application but we believe that this is for the ultimate good of the amateur as it will in many cases serve to increase his technical knowledge and versatility to his own ultimate advantage. Far too many hams ceased to learn anything about the technical side of radio the day they passed their ham exam. This is an ideal time to show your versatility in coping with unusual conditions. You'll get more pleasure out of radio and be of greater value to your country if you have the proper technical knowledge.

ALEX, W5BFI, at Alvin, Texas has recently put up a 66 ft. vertical made of 3 inch tin gutter pipe. It really works fb from 160 to 10 meters. His sigs are up several R's above those of his old 80 meter zepp.

Bob, W5HNF, is back on the air agn after a long absence. Gld to see u back on Bob.

"Sugar" (W5IGS), Bob (W5INZ), and Ted (W5JOC) have been giving the old 2½ meter bands fits here in Houston.

On June, Friday the thirteenth, Allen's (W5ISC) xyl presented him wid a seven pound boy. Who said Friday the 13th is unlucky?

Bud, (W5HSX), Houston's 160 dx man, hasn't been wrking dx lately; he has been too busy building himself a new house. (Between u and a 204-A—it is just a front to get more room for antennas).

Homer, W5AEA, over in Richmond, Texas, is back on 160 meter fone wid a pair of 812's in the final, and 809 modulators. Gld to see u back after ur year es a half absence, Homer.

Leo, W5HKW, showed up shortly before the Gulf Phone Net (AARS) was to go on cw wid his keying arm broken. That was two months ago, and he says he still can't use the arm. The Houston gang are still anzius to know if Leo can copy cw!

Ben, W5INV, is back on the air at La Grange, Texas wid a pair of 812's and 811's class B modulator. He is really putting a sig into Houston.

Louis, W5IHY, and Don, W5JPD, (Junk

pile Donald) spent several weeks in June down at La Port on beautiful Galveston Bay as the guest of Bob, W5IIE, and Jimmy Palmer.

Eric, W5FCD, of Port Arthur spent his vacation by going to New Mexico and Arizona on a 3,500 mile trip.

Dick, and Mrs. Hall (W5EIB, and W5EUG) spent part of their vacation at the National Parts Show.

Dave Calk, W5BHO, is doing all the gud hr in Houston on 5 meters. But is still heard occasionally on 160 meter fone.

George, W5EEX, is conspicuous by his absence on 5 meters, say the 5 meter bugs. Its been many a moon since George was not at the mike when the band opened up. But Uncle Sam beckoned and George enlisted—another d.c.i. generator is off the air!

Tom, W5HPJ, and Charles, W5ERS, are vy active in the Texas Defense Net.

"Sam the Ham," W5HVN, hasn't been heard on 20 lately.—Could it be the yl's?

The Houston Amateur Radio Club held a fb Ham fest at Sylvan Beach near Houston. There were lots of gud prizes es food. Henry, W5FWC, walked off wid the top prize, a D-104, wid a push to talk stand.

YOUR first district reporter, W1JOM reports:

W1KQJ has put an RK-34 on the 2½ meter band with abt 20 watts input. Puts out a vy fb sig.

W1NIC of Chelsea, whose handle is Babe, and he is definitely not a yl, and doesn't want to be called "Hya Babe," has a new Hallicrafter HT-9 xmtr. He runs 100 watts to a vertical antenna and the rcvr is an S-20R.

A mobile emergency net has been organized on 2½ meters. There are at present fifteen active stations who meet every Tuesday night. W1AKD & W1KSA the originators of the net have the first numbers, as all cars are numbered. Each station is assigned to one of the many hills located in this vicinity. It's a fb idea and more such nets should be encouraged. Last week while W1KSA was driving through Avon, Mass., with some friends, his car caught fire. Before Joe could extinguish the flames, the wiring system was completely burned. Joe was really in a bad spot, since there was no garages for miles around and no telephones. Joe connected the spare battery and sent out a call for help. He immediately recvd a call from W1JQA (Smokey Joe) who is a fireman asking if the apparatus was needed. JQA was mobile and is a member of the net. In answer to KSA's call Smokey sent out a tow car and had Joe towed into town. While this was going on another ham had heard the call and being mobile rushed over to lend a hand.

W1GDY of ten and twenty fone has finally gone up to 2½. I'll bet Herb misses the DX. W1HX of Everett is also on 2½.

W1LBH who operates 80 fone is gg up to Me. for the summer.

The OM at W1KKJ called CQ one day and getting no response, he had the XYL call CQ. Presto—he got a contact. Now the OM calls Lou his decoy.

W1CRN, long waves and all.

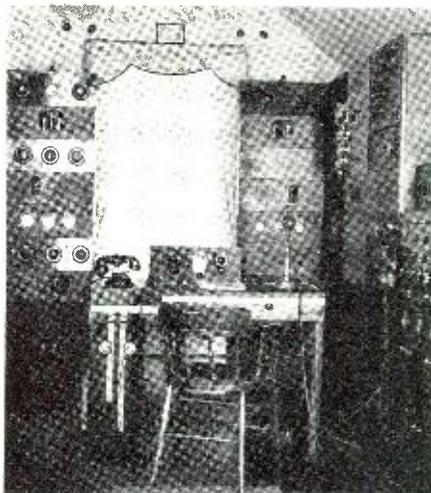

W5HPJ is really portable.

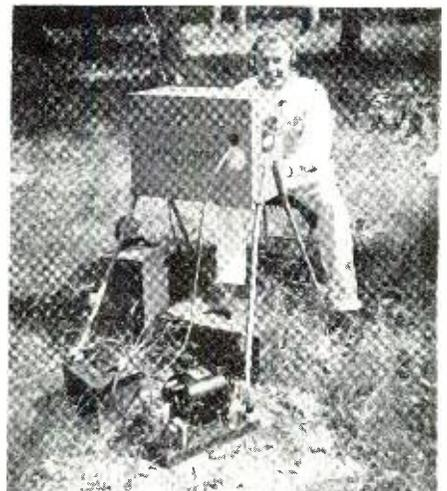

W5IRB is another YL on ten fone.
 W5IRO really keeps the QRM down during the La. 160 A.A.R.S.
 W5BN is an ardent TFC handler.
 W5KC is knocking them off on ten fone.
 W5DGF is doing same. They really keep Plaquemine on the map.
 W5JKW is doing an awful lot of rag chewing on 40 cw.

FROM W5KBZ the following:
 W5DNE works his son, W5HBN, every morning around 9 o'clock.
 W5JOU is the new instructor at the NYA School and station, W5JGE.
 W5FPY is working with the CAA now.
 W5JFF has a very FB rig on 160 meter fone, and is net control station for the AARS.
 W5JSU at Sanger, Texas, is going on 10 meter fone.
 W5IPC was heard by W5KBZ in Fort Worth, Texas, and W5IPC was only running 2½ watts input on 160 fone.
 W5IFL has a swell rig on 160 fone.
 W5GZI is an officer at Texas A&M.
 W5HBK is back on 40 again after trying 10 fone.
 W5GGK is in the Army at Camp Bowie.
 W5JOZ is the Tech. High School 160 fone station.
 W5FAB moved to San Antonio, Texas.

FROM Joe W9BZT:
 W9LBP (Little Bo Peep) Jerry, is still experimenting with low power and built in ECO from Des Plaines, Ill. Works out, too.
 W9LXD, Dutch, Winnetka, Ill., is receiving congrats on his promotion to Lieutenant of Police in his home town while W9MFP, Wally, has climbed to a sergeantcy with the Radio force in Chicago.
 W9JIL, Red, of the Waukegan Police Force, finally seems to have everything under control at home. Hi! Member when his neighbors were receiving him on Gas Stoves, Beds "everything"? Whatcha do for it, Red?
 W9KMH, Gordon, North Chicago, Ill., is now on 160 with a Stancor 10-p and runs from one and one-half to five watts. A very nice sig. too.
 W9IDK, Les, Lake Forest, Ill., entered Uncle Sam's employ last month and will be getting in touch with us from some Signal Corps, we hope. How about it, Les?
 W9EJZ, Harold, Aurora, Ill., is emulating Marshall, W9BSP of Olathe, Kans., with his code lessons from the Aurora Club Station and is doing a perfect job of it. Keep it up "Nephew."
 W9PQH (Pints, Quarts es Half-gallons) Jim, of Batavia, Ill., is back on 160 with us and has a peach of a sig.
 W9RTV, Gene, Ravinia, Ill., has rebuilt and is using an HY-40 in the final with a 268 foot antenna. Gonna work a K7, Gene?
 W9YSSV, Joe, Chicago, is certainly an interesting rag-chewer and its more fun to listen than to talk. F. B. Joe.
 W9ES, George, Niles, Ill., and family were vacationing out among the W6's. Betcha they had a swell time. Hi!



WIJLK goes to a picnic.

W4FXV, John of Rocky Mount, N C has a xv fb QSL. Rig runs 380 watts to PP T-55s. Rcvr is a SX 9. He also has another rig; 41 xtal osc., 41 final, modulated w/ a 41 es 6 watts output. Antenna is a 33' ft antenna.
 W4RJL, Reg. Boulder City Nev is active occasionally on 7199 kcs. He runs 50 watts to a T 40 final. Rcvr is a S-19-R Sky Buddy.

(Continued on page 65)

SERVICEMEN'S CASE HISTORIES

by
ALFRED A. GHIRARDI

Reprinted from new 2nd revised edition of the **RADIO Trouble Shooters Handbook**. Copyright, 1941. Radio & Technical Publishing Co. Copyright in Canada and Great Britain, and all countries subscribing to the Berne Convention, by Radio & Technical Publishing Co. All rights reserved.

(Continued from last month)

GENERAL ELECTRIC G-97

Push-buttons . . . 1) loosen tension spring fastened to latch bar at end of the switch

GENERAL ELECTRIC G-106

Intermittent reception . . . 1) check for faulty volume control tube
 2) check for leakage in 6F5 tube
 Volume varies slowly . . . 1) check plate resistor of 6F5 tube for change in value
 Push-button tuning inoperative . . . 1) check for "open" 60 mfd. 40-volt dry a-c electrolytic condenser (C-51) connected across tuning motor
 Dial pointer moves only in one direction (tuning motor operation O.K.) . . . 1) loosen set-screws of rubber friction bushing on motor shaft and push it forward so it presses more firmly against drive wheel associated with tuning condenser. Tighten set-screws
 2) clean selector rim and contacts at rear of tuning condenser with carbon tetrachloride

GENERAL ELECTRIC HB-504, HB-505

Inoperative (all voltages O.K.) . . . 1) oscillator inoperative due to "shorting" of one or more turns of grid winding of oscillator coil. Try squeezing coil with hand to see if this clears "short" and permits reception. Replace coil

MOTOROLA 9-19 Auto Radio

Cam does not release properly from condenser shaft . . . 1) replace latch release spring located beneath electric tuning assembly on the condenser shaft

PHILCO RECEIVERS

Intermittent reception in some models . . . 1) the critical reactions to signal and voltage surges which result when attempts are made to check Philco bakelite-encased type condensers for the faulty one producing an "intermittent" condition, makes the replacement of all condensers of this type (used either as coupling or bypass condensers, as the case may be) the most practical means of correcting the trouble. As a rule, condensers of this type used in an audio-coupling capacity are the most troublesome, but their intermittent operation is also troublesome when they are used for other purposes in the circuit
 Troubles in models employing "unit" construction . . . 1) recurrently broken wires are found between the coil and the waveband switch, especially the fine wires from the primaries. Inspection is the quickest way to locate them.

Broken leads also occur where the lead from the tuning condenser stators runs through the chassis to connect to the frequency switch. By visual inspection, or pulling on these leads with a hook, the broken one may be located. Ofttimes the waveband switch "shorts" between segments of the moving contact either because of small particles of metallic matter "shorting" between the segments, or because of metallic matter present in the fibre insulating section. This condition can be detected by disconnecting the coil, and testing for a "short" with an ohmmeter. To correct the condition, impress a high voltage across the switch terminals (with the coil disconnected), thus burning out the short

Electric dial troubles in models employing automatic tuning . . . 1) the "audio shorting" switch, which is operated by the indexing handle, sometimes "shorts" resulting in an inoperative receiver. This "short" may "make" and "break" by moving the index handle or the dial and thus become evident, or it may be revealed by removing the wire to the lug directly under the pilot lamp bracket and testing for a "short" with an ohmmeter. This short may develop from the fibre plunger on the index handle assembly breaking and allowing the rotating contact to "short," or it may result from wear or break on the insulating sleeve or the spaghetti which covers the fixed contact. By removing the retaining springs and the dial assembly, thus exposing these insulators to view, the break may be found

PHILCO 18 (Codes 122, 123)

Inoperative . . . 1) check for "shorted" 0.05-mfd. condenser No. 12 connected from tuning indicator

to ground (wide shadow)
 2) check for "shorted" electrolytic filter condenser No. 10 (capacities 2-1 mfd., 1-2 mfd.) (narrow shadow)
 3) check for "open" tuning meter No. 63 (narrow shadow)
 4) check for "shorted" 0.05 mfd. condenser No. 20 connected from 6A7 tube space-filter resistor to ground
 charge grid supply . . . 1) check for "shorted" 0.006-mfd. condenser No. 42 connected from plate of 42 first i-f tube to ground
 5) replace 0.015-mfd. coupling condenser No. 37 connected from plate of second detector to grid of 42 first audio ammeter O.K., but still may be "intermittent"
 plifier tube. May be "intermittent"
 2) check i-f transformer No. 23. Inspect for bad connection where coil wires are soldered O.K., but resolder
 to leads. May test

PHILCO 19 (Code 128)

Inoperative tuning meter shadow . . . 1) check for "shorted" condensers No. 29 and No. 38 breakdown (indicated by narrow shadow)
 2) check for "shorted" condenser No. 59 (indicated by wide tuning meter shadow)

PHILCO 89 (Code 128)

Distortion at resonance peak of station . . . 1) "partial open" resistor No. 32
 Distortion at low volume . . . 1) "shorted" condenser No. 41

PHILCO 116-B (Code 121) and 116-X (Code 122)

Inoperative . . . 1) "shorted" condenser No. 60 (indicated by resistor No. 61 overheating)
 2) "shorted" section in condenser No. 47 (indicated by narrow tuning meter shadow)
 3) "shorted" section in condensers No. 47 and No. 23 (indicated by wide tuning meter shadow)

PHILCO 201

Distortion at high volume . . . 1) "shorted" condenser No. 73, 77 or 78
 Weak, "tinny" signal . . . 2) "shorted" primary in input transformer No. 79 (some times indicated by "frying" noise)

PHILCO 511, 512, 513, 514, 515, 521, 531

Distortion at Hum (loud) . . . 1) "shorted" condenser No. 30
 2) "grounded" hum potentiometer No. 31 or No. 32
 3) "grounded" filament bus lines

PHILCO 655

Inoperative . . . 1) "shorted" section in condenser No. 58 (indicated by overheated rectifier tube)
 2) "shorted" condenser No. 8 (indicated by wide tuning meter shadow)
 3) "inter-winding short" in r-f transformer No. 10 (indicated by wide tuning meter shadow)
 4) "open" tuning meter No. 73 (indicated by narrow tuning meter shadow)
 5) "grounded" resistor No. 56
 Distortion at resonance peak of station . . . 1) check i-f transformer No. 30 for "shorted" secondary
 Hum . . . 1) realign second i-f stage
 2) "open" section in condenser No. 58
 2) "shorted" condenser No. 59

RCA 1941 Receivers

Excessive noise pickup between stations . . . 1) it may be found necessary in certain localities to reduce the sensitivity of these receivers. This can be done by adding larger resistors in the (connected between the existing 100-ohms and ground) with a 1/10-mfd condenser shunting the added resistor. On the receivers which do not use a 100-ohm resistor in the i-f cathode the resistor and capacity combination should be added between the cathode and ground. The value of the resistor could be anything between 500 and 3,000-ohms, depending upon the reduction in sensitivity required
 (Continued on page 60)

THE tweeter loudspeaker is necessary for satisfactory results when using an f-m tuner, in order to reproduce the higher frequencies from 7,500 to 15,000 cycles.

A good dynamic speaker, such as the *Rola G-12*, which the writer tried out in the laboratory, will have a range from about 35 cycles to 7,500 cycles per second. This range will be practically flat except at 120 cycles—the hum frequency of most power supplies—at which point it will suddenly dip in power output. Most speakers are purposely designed to have such a characteristic, using a hum bucking coil for cutting out the 120 cycle note.

As f-m extends upwards to 15,000 cycles, and by the way in a test the writer could hear nothing above 14,000, the tweeter is called on to do the job where the regular *woofer* speaker leaves off. But unless some sort of filtering device is employed, the tweeter will not cut in at the right frequency, may in fact absorb power from the circuit at the low frequency of 120 cycles, in the case of the *Rola K-5* and at 35 cycles in the case of a *Jensen* tweeter using a large series condenser.

If a condenser is used to make the tweeter cut in on the higher frequencies and exclude the lows, a small capacity should be used if the tweeter voice coil has a low resistance and the woofer voice coil also is low. If the woofer is high in resistance, either a much smaller condenser should be used or the tweeter resistance should be higher.

The important point is that tweeter resistance should be high compared to the woofer at low frequencies and its resistance, compared to tweeter, should be low at high frequencies. In measurements using a *Hickok* Vacuum Tube Voltmeter and a *Clough-Brengle* Audio Oscillator, it was found that for all practical purposes the voice coil d.c. resistance is enough for power calculations. The power in the coil is given by using the equation of Fig. 1. In Fig. 2 is shown a series condenser setup which has been used by *Pilot* in their f-m receiver. The complete circuit, including the woofer, is shown in Fig. 3.

The diagram of Fig. 7 shows how the woofer power decreases as the frequency increases, due to the fact that the speaker cone in many speakers of the heavy dynamic type is soft. Some speakers have a special cone, using a stiff conical section near the voice coil with the remainder of the cone soft. This results in reproduction of both highs and lows. A *Rola J-12* is typical and had a response in certain circuits to as high as 10 and 15 kc. with fair

ADD A TWEETER FOR F-M

by **WILLARD MOODY**

Commercial Operator

A considerable increase in the overall range of reproduction is had by adding a tweeter speaker and specially designed filter units.

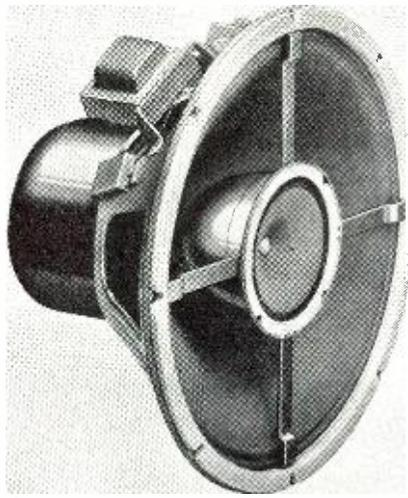

The Jensen Co-Ax speaker makes use of the woofer-tweeter combination.

range, employing a double transformer to isolate the tweeter from the woofer. This circuit has the advantage that the series condenser voltage drop need not affect the voltage supplied to the tweeter, since the turns-ratio of the transformer, acting as a controlling factor, may be made to step up the voltage and consequently the power to the tweeter. Further, the shunting effect of the capacitor across the woofer Z1 does not affect the tweeter impedance.

In checking speaker frequency response and power, in Fig. 4 connect a vacuum tube voltmeter across Z1 and read the voltage at the several audio frequencies. Disregard the condenser drop and simply check the voltage across Z2. The results should be tabulated for a given series condenser and speaker set-up. Power can then be calculated using the equation in Fig. 1. The speaker d.c. resistance is regarded as the impedance, which is close

power. Also shown by Fig. 7 is the decrease in tweeter power at low frequencies and the increase at high. The exact point of the tweeter cut-in action will depend on the circuit and the ratio of tweeter to woofer resistance.

A filter system used by *Stromberg-Carlson* is shown in Fig. 5. Here the woofer, Z1, receives energy from a separate winding. The highs are shunted out by C1 and, as inductive reactance increases with frequency L1 becomes progressively higher and higher. This reduces the power in the woofer as the frequency increases. In the case of the tweeter, Z2, the series condenser has a high reactance at low frequencies and L2 has a low shunt reactance. This reduces the power in the tweeter at low frequencies and the coil L2 shunts out the lows.

In Fig. 6 is shown still another ar-

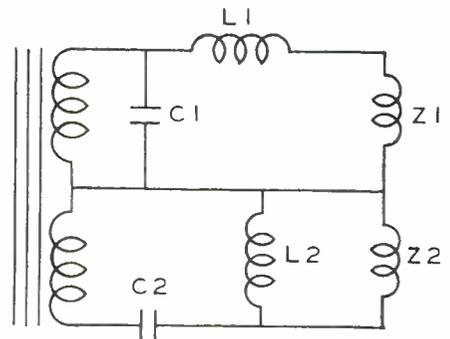

Fig. 5

enough for practical work. In making the test the signal generator should be set at a low frequency voltage and the voltage should not be ad-

(Continued on page 57)

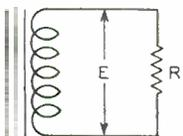
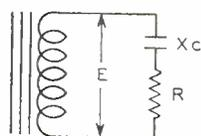

Fig. 1

$$P = \frac{E^2}{R}$$



$$Z = \sqrt{R^2 + X_c^2}$$

$$P.F. = \frac{R}{Z} = \cos \theta = \frac{P}{E I}$$

$$I = \frac{E}{Z} \quad P = E I \cos \theta$$

Fig. 2

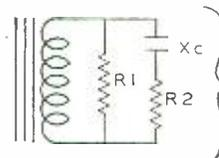

Fig. 3

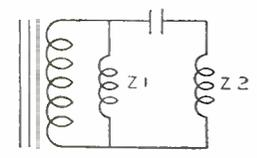

Fig. 4

WHAT'S NEW IN RADIO

Presenting the latest equipment now available on the market.

Knigh 6 Tube Phono-Radio

In answer to the ever-growing demand for phonograph-radio combinations, *Allied Radio Corporation* presents the highlight of their new 1942 line, the *Knigh 6-Tube Automatic Phono Radio*. This instrument is featured on the back cover of the *Allied 1942 catalog* which has just come off the press.

The *Knigh 6-Tube Phono-Radio* (including rectifier) combines three-band radio re-



ception with automatic record reproduction to give complete home entertainment. Some of the outstanding features of the receiver are: Three full wave bands for world-wide coverage (5.25 to 10.25 mc., 11.5 to 16 mc., and 540 to 1650 kc.); New spread-band feature for easier tuning of foreign bands; Superhet circuit with noise-reducing RF stage incorporating the following tubes: 2—6SK7, 1—6SA7, 1—6SQ7, 1—25L6, 1—25Z6; Automatic volume control; 5½-inch dynamic speaker; Built-in loop aerial; Tone control.

Features of the phonograph are: Automatic record changer which plays up to twelve 10-inch or ten 12-inch records at one loading; Featherweight crystal pickup; Life-time needle.

This instrument is housed in a gracefully styled walnut table-model cabinet. For 110-120 volts, 60 cycles a.c.

A product of *Allied Radio Corporation*, 833 West Jackson Boulevard, Chicago, Ill.

New Resistor Power Cords

Despite the general and growing shortage of resistor power cords required as replace-



ments for a.c.-d.c. radio set repairs, a dependable and adequate supply of such items is still claimed by *Clarostat Mfg. Co.*, 285-7 N. 6th St., Brooklyn, N. Y., through its job-

bing outlets. A choice of *Clarostat* power cords for certain sets is offered, as well as several universal types serving a wide variety of sets. These *Clarostat* power cords have three conductors enclosed in heavy braided covering, with a tie cord at the chassis end and a molded rubber plug at the other. The three conductors furnish the necessary plate voltages for rectifier tube and the reduced voltages for the tube filaments.

RCA Has New All-Way Baffle

A loudspeaker baffle of entirely new design, projecting sound uniformly over a 360° area through five evenly spaced apertures arranged in a horizontal plane, has been announced by George Ewald, Manager of the Commercial Sound Division of the *RCA Manufacturing Company, Inc.* for use in paging and announcing in industrial plants.

One of the most unique features of this new baffle, which operates from a single loudspeaker mechanism, is its construction of non-metallic non-vibratory acoustic material especially developed for this purpose. Its use releases a large quantity of aluminum, originally specified for the unit, for National Defense.

The new baffle distributes sound pressure uniformly throughout a radius of 50 feet, and the directive effect concentrates projected sound over the entire floor area. Exhaustive tests made under many types of abnormal operating conditions conclusively demonstrated its ability to effectively over-

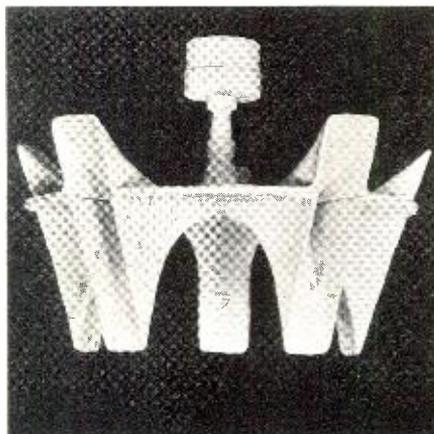

ride high noise levels up to 95 db, approaching the threshold of pain level.

"This remarkable baffle is RCA's answer to the demand for a time saving internal communication and paging system for routing of men and materials in industry with greater efficiency," Mr. Ewald explained. "It is now possible for the first time to cover efficiently the huge new factories, such as are being erected for national defense production."

New IRC Control Cabinet

No better evidence of the ability of the popular IRC Master Radiotrician's Volume Control Cabinet to handle from 60% to 75% of all control replacements is obtainable than in the fact that a total of 10,859 set models listed in the new IRC Volume Control Re-

placement Manual (Edition No. 3) specify controls included in this Cabinet. For convenience of Cabinet owners, all such replacements are indicated by an asterisk in the Manual. Thus, they can tell at a glance that the replacement is one immediately available from the stock of only 18 Type D Universal



Controls, 6 switches and 5 extra Tap-in shafts of special design contained in the Cabinet.

The IRC Cabinet is of sturdy, all-metal construction. It has individual, marked compartments for the controls so that the user can tell immediately just what he has in stock, and what should be re-ordered. Three handy drawers accommodate switches, special shafts and other spare parts. The hinged front cover snaps securely shut for carrying, or may be removed entirely for shop use. The cabinet is 14½" long, 7¾" high and 4½" wide. It is supplied at no extra cost.

Airline Phono Oscillator

The need for a low cost, compact phono oscillator prompted the development of the *Airline* unit shown in the photo. As is well known, home recording phono-radio combinations have been reaching new peaks of popularity. After the practice of stamp collectors, many home recording enthusiasts are now trading copies of their favorite recordings for mutual enjoyment. While sets today are equipped with push buttons for prac-



tically every conceivable function, no provisions are made for copying of records; i.e., for plugging in an external record player which can be played through the amplifier and cutting head. Some, of course, are technically informed, enough so that they can delve into the chassis wiring and bring out the proper terminal connections. But for the

greater number, this is too comprehensive a task to undertake.

With this in mind, *Airline* Engineers have designed a new, efficient phono oscillator which, when used with a modern record player, is capable of extremely faithful reproduction, played through the radio receiver. Using such a combination, it is only necessary for the owner to press the "Record Radio" button and copy any record whether of the home or regular type.

This *Airline* phono oscillator requires no metallic connection to the receiver for normal operation. It is housed in a small, attractive steel case finished in gray crackle lacquer. Measuring only 3¾ by 4¼ inches, it can be easily concealed in the console when not in use. Practical freedom from frequency draft is obtained by using a 70L7GT in a stabilized "High C" oscillator circuit. This is a feature much appreciated by those who have had experience with earlier types.—*Montgomery Ward & Co.*, Chicago, Ill.

Six Radiola Models Announced

A new series of 1942 *Radiolas* consisting of four a.c.-d.c. table models, a phonograph-radio *Electrola*, and a battery-powered farm



radio, has been announced by John C. Marden, *Radiola* Sales Manager of the *RCA Manufacturing Company, Inc.*

"These new instruments are in addition to a number of *Radiola* models recently announced to *RCA* Tube and Equipment Distributors," Mr. Marden said. "The *Radiola* line now extends across a wider price range to cover effectively the merchandising opportunities of the radio serviceman.

The four new a.c.-d.c. table models, two of which are 2-band instruments, have powerful 5-tube superheterodyne chassis, and have outstanding performance features. They are housed in smartly styled cabinets, two of plastics and two of matched woods.

Approved by *Fire Underwriters*, the new instruments employ a 5-inch dynamic loudspeaker, magnetite-core I-F transformers for improved sensitivity, plug-in connection for record player attachment, built-in antennas, and many other features. Newly-styled clear vision dials, make tuning unusually easy for such compact table models.

Model 527 (illustrated) is similar to Model 526 in operating features and the station-spreader dial, but is housed in a two-tone wood cabinet of selected veneers.

The new *Electrola*, Model R-560P, provides both first class radio entertainment and the world of enjoyment to be found in recorded music. The phonograph-radio provides excellent quality by the use of a specially designed audio circuit and a highly efficient dynamic loudspeaker. Either 10- or 12-inch records may be played with the lid closed. Five tubes are employed. The cabinet is of selected walnut and birch veneers, blended into a simplified, attractive styling.

The new farm model *Radiola* is designated as Model B-50. Low drain tubes assure low operating costs, while the superheterodyne

circuit is highly selective and sensitive. An automatic volume control reduces blasting and fading. The cabinet, of walnut veneer, is styled to blend with practically any type of surroundings, and is designed to contain the batteries.

Sonora "All-American" Model

Sonora Radio & Television Corporation, Chicago, appropriately calls this new 5 Tube a.c.-d.c. Superhet its "All-American." It is

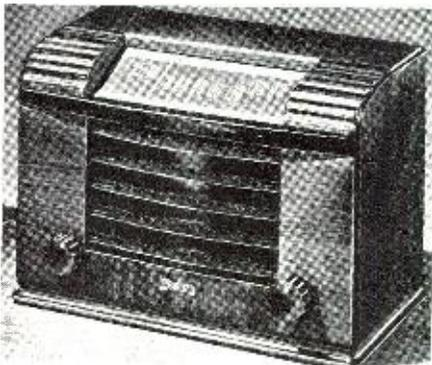

a model notable for vitality and stamina, honesty of tonal performance and attractive appearance. This 10½"x6"x7¾" table model radio features a 2¾"x6½" Slide-Rule Dial which is visible from any tuning angle; has latest Dynamic Speaker and Automatic Volume Control; includes built-in "Sonorscope" loop, no aerial or ground wires required—just plug in and play! The "All-American" cabinet is styled of contrasting-tone walnut veneers with beaded roll top effect and louvered-type speaker grille. Tunes 535-1720 kc., covering standard Broadcast band and 1712 kc. police channel.

New Howard 3 Band Table Radio

A new 10-tube 3 band a.c. table radio, Model 868T, is the latest addition to the 1942 *Howard* line, it is announced by Joseph M. Muniz, General Sales Manager, of the *Howard Radio Company*, Chicago.

This powerful receiver tunes 540 kc. to 22 mc. (555 to 13 meters). Tube lineup in-

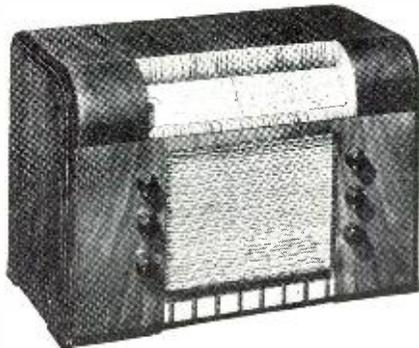

cludes new high Mu 6FG7 for more r.f. gain, and better signal to noise ratio. Two dual purpose tubes provide twelve tube performance. Features *Howard* band expander for fast and accurate logging of short wave stations, flywheel dial controls, "eye-angle dial," tuned r.f. stage on all bands for improved selectivity and increased sensitivity. Has inverse feed-back push-pull audio system, 8 inch speaker, and phonograph, television, recorder and external speaker connections. Set is housed in handsomely finished cabinet.

100 Watt Bell Amplifier

Announcement has just been made by *Bell Sound Systems, Inc.* of Columbus, Ohio, of a new Model 700-100-watt amplifier. Powered

by twin amplifier units of 50-watt output, either of which will operate the system alone when desired, this Model 700 *Bell* Amplifier is one of the most flexible, multi-purpose, large-capacity systems in the field. Its modern appearance and compact design are matched by wide-range tone fidelity and superb sound reproduction, yet its cost is surprisingly low. Rugged, durable construction enables this system to withstand long, hard use.

Each of the amplifiers has an individual, transformer-coupled driver and features maximum distortion of 2% at 50-watt output, and not more than 5% distortion at 58-watt output. The amplifiers have separate master gain controls and separate power switches. A third power switch is provided for converting the B supply of the preamplifier section to either one of the power units when the system is operated with a single power amplifier. A tap impedance switch for matching speaker load is also provided on each of the power output units.

Each amplifier unit has provision for two speakers, although additional speakers may be used if desired. Five input channels with separate volume controls permit electronic



mixing of four microphone and one phono pickup.

An automatic expessor switch and an automatic expessor level control maintain the correct degree of expansion or compression of the phono and microphone circuits. Electronic treble and bass boost controls of the latest type give exceptional tone control and, when properly adjusted, overcome the feedback difficulties encountered in large auditoriums.

This unit's smart, modern beauty of line is emphasized by its rich, gray finish and sharply contrasting dark red trim. A distinctive feature is the easy readability of the new angle-set dials, which are controlled by remote knobs. Sturdy handles at the sides of the unit make handling extremely easy.

Emerson Announces New Combination

Just announced by the *Emerson Radio and Phonograph Corporation*, New York City, is a new combination radio-and-phonograph, designated as Model 452. Smartly styled, the cabinet, finished in shark-skin-grained simulated leather, fully encloses a highly efficient chassis. The tuning dial is mounted on the front of the cabinet, as are the four knob controls, permitting tuning of the radio without the necessity of raising the cover.

The tone control operates on both radio and phonograph. Equipped with the new light-weight tone arm, this model plays all size records up to and including 12-inch with the lid closed. The large electro-dynamic speaker and specially constructed

acoustic chamber combine to give this model exceptionally fine tone.

Size: 8" high, 13 $\frac{3}{4}$ " wide, 16" deep.

Long-Playing Needle

A new long-playing needle, capable of playing 4,000 phonograph records without changing, has been developed in the *Philco Research Laboratories*, it was announced today. It is the only long-playing needle that can be used on the old, heavy electric phonograph arms without increasing record wear, claim the manufacturers.

The outstanding characteristic of the new needle is its hard point made of a highly polished precious metal.

The new needles are individually packed.

New Sprague Koolohms

Type VD *Koolohm* Resistors provide a handy, economical answer to the problem of making up tapped resistors with any num-

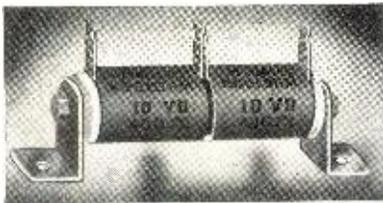

ber of 10- or 15-watt sections of any required resistance values.

The *Koolohms* are supplied in compact 10- or 15-watt sections equipped with ball and recess interlock feature. This prevents turning and automatically connects the units electrically in series when mounted on a threaded steel rod which is provided and which can be cut to desired length. Mounting feet and ceramic end-spacers are also supplied. Several resistor sections can be connected in series and be mounted on the same tie rod and mounting feet with a similar assembly insulated from it electrically by means of the ceramic spacers.

Overall length of the 10-watt Type VD *Koolohm* is 1 $\frac{1}{8}$ " and diameter is $\frac{5}{8}$ ". The 15-watt sections are 1 9/16" long by 11/16" diameter.

Sections have the exclusive *Koolohm* construction feature wherein they are wound with a 1,000° C. heat-proof moisture-proof material permitting layer-wound construction for higher resistance in less space; faster heat dissipation; unsurpassed stability and accuracy; greater humidity protection and the use of larger, more durable wire sizes.

The complete *Koolohm* catalog will gladly be sent upon request to The *Sprague Specialties Company*, Resistor Division, North Adams, Mass.

Multicoupler Antenna System

The inclusion of FM reception along with the already well-known features of all-wave reception and minimized noise, marks the



latest development in the multicoupler antenna system for apartment houses and other multi-radio buildings, according to *Amy*,
(Continued on page 52)

MANUFACTURER'S LITERATURE

Our readers are asked to write directly to the manufacturer for this literature. By mentioning *RADIO NEWS* and the issue and page, we are sure the reader will get fine service. Enclose the proper sum requested when it is indicated.

New Bulletin on Panel Instruments

Miniature a.c. and d.c. voltmeters and ammeters in the two inch classification for general use are described in a new 12-page bulletin announced by *Westinghouse Electric and Manufacturing Company*. Full scale readings on the d.c. ammeter series are from 20 microamperes to 100 amperes and on the a.c. units, from 5 milli-amperes to 50 amperes. Voltmeter calibrations are from 5 millivolts to 1000 volts full scale on both a.c. and d.c. lines.

Permanent white dials, interchangeability of parts, and high overload capacity are among the features discussed. Operation and construction are described with a note on repulsion vane types for a.c. circuits.

Typical instruments are illustrated and cutaway views show construction details. A complete tabulation lists ratings, scale divisions, style numbers and list prices.

A copy of catalog section 43-330 may be secured from department 7-N-20, *Westinghouse Electric and Manufacturing Company*, East Pittsburgh, Pennsylvania.

Kato Bulletin No. 511

The *Kato Engineering Company*, Mankato, Minnesota, has announced a new line of light and power plants. This series of lighting plants includes the Models 14A, 600 watts; 26A, 1,000 watts; 28A, 1,500 watts and Model 30A, 2,000 watts.

Generators are of the self-excited, single phase type, generating 110-volts, 60-cycle a.c. 1,800 r.p.m. Double sealed ball bearings. Bolted directly to engine crankcase. A source of d.c. may be drawn from the d.c. terminals when plant isn't carrying full a.c. load. This source of d.c. is furnished at a desirable and usable voltage, 12-volts or 32-volts. A.c. and d.c. brushes are easily accessible. Filtered and shielded for radio operation. Good motor starting capacity. Voltage regulation 8%.

Powered with the *Briggs & Stratton*, 4-cycle, single cylinder, air-cooled engines. Specially designed float-feed type, adjustable carburetor. Adjustable mechanical type, fully enclosed, running in oil, governor. Efficient oil-bath type aircleaner. One gallon overhead fuel tank. Gasoline filter. Pump and splash system lubrication. Sufficient oil capacity.

Really combination a.c./d.c. plants, two-plants-in-one, furnishing standard 110-volt, 60-cycle a.c. or a good source of d.c. at a usable voltage.

Economical in operation, fuel consumption being in approximate proportion to amount of load being run.

Prices have been kept down to a minimum without sacrificing any of the sturdiness and efficiency.

Very popular, all-around service models for continuous or stand-by service in case of power line failure for running oil burner, stoker, refrigerator motors, etc. Ideal for farms, summer homes, trailers, resorts, cabin camps, sound trucks, radio stations, and innumerable other purposes.

Available with Remote Control or Full Automatic Control if desired. New literature available. Write manufacturer. *Kato Engineering Company*, Mankato, Minnesota.

New Jensen Literature Available

Condensed Catalog No. 125 describes new *Hypex* Projectors, coaxial speakers and reproducers with High Frequency Control. Form No. 126 a treatise on "Hypex Horns" by Dr. Vincent Salmon. Form No. 127 "Loudspeakers for Speech and Music Reproduction" by Ralph P. Glover, Analyzes the requirements for speech and music reproduction. Data Sheet No. 123 completely describes *Hypex* Projectors employing the improved new formula non-exponential "Hypex" Horn and "Annular" Driver Unit. *Jensen Radio Mfg. Co.*, 6601 South Laramie Ave., Chicago, Illinois.

G-E Issues Booklet on Mycalex

The plastics department of the *General Electric Company*, Pittsfield, Mass., has issued a 10-page booklet, illustrated with photographs and charts, explaining the nature, properties, advantages and applications of G-E *Mycalex*. It was announced recently that G-E had perfected a technique for the molding of *Mycalex* by the injection process, thereby broadening the field of its usefulness by permitting the production of more intricate shapes. A stone-like product, made from mineral ingredients to meet exacting insulation requirements, *Mycalex* has been used extensively in various types of electrical apparatus, particularly in radio, industrial control and heating equipment.

New Howard Amateur Folder

The *Howard Radio Company* of Chicago announces the new edition of their amateur Folder No. 109, containing the complete line of *Howard* Communication receivers and showing latest prices. Accessories and recording discs especially suitable for amateur requirements are also included. The booklet is available without charge from distributors or direct from *Howard Radio Company*, 1735 Belmont Ave., Chicago, Illinois.

(Continued on page 64)

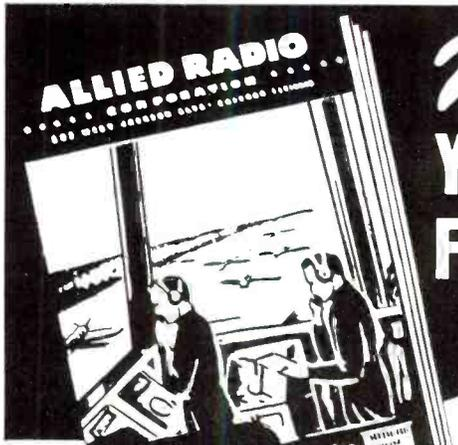

Now as Always.. YOU CAN DEPEND ON "ALLIED" FOR EVERYTHING IN RADIO AT LOWEST PRICES!

**Free
RADIO'S
GREATEST
CATALOG**

**212 PAGES!
BIGGEST
EVER!**

FOR SERVICEMEN • DEALERS • SOUND MEN • AMATEURS • BUILDERS

Today, more than ever, ALLIED is the one name that means Everything in Radio. Today, more than ever, you can always depend on ALLIED for vast, complete stocks of the leading makes of diversified equipment in every field of radio and electronics. You can always depend on ALLIED for quality merchandise that's "tops," for rush-service direct to you on all orders, for those extra values you'll not find equalled anywhere in radio today. There's never been so complete, so value-packed a catalog as the new 1942 ALLIED book—the FREE 212-page Catalog you'll need to keep up with radio. Servicemen, Dealers, Amateurs, Sound Men, Experimenters—send for your copy of Radio's Greatest Catalog with the lowest prices in the entire field.

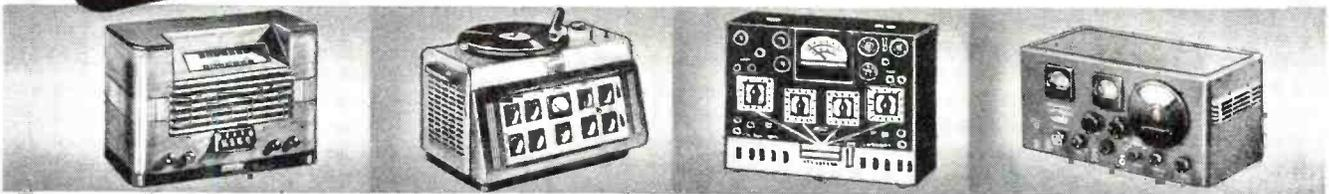

50 New Set Models

You'll want to see the 1942 KNIGHT "Radio Hit" models—more than 50 of them—featuring the newest styling, latest developments, low prices that can't be challenged. There's a radio for every room—New FM-AM models; Luxurious Phono-Radio Period Models; new continental-style plastics; Table Models; portables, recorder-radios; farm sets; auto radios—radios for every purse and purpose!

Knight Sets PA Pace

There's a big new section devoted 100% to PA. New Systems—7 to 60 watts; new biased-power amplifiers; new-type "Bantam" Portable Systems. Everything in microphone, speaker and phono accessories; valuable data and charts on how to select the right sound system. Get the facts about our 15-Day Trial Offer and the Easiest Time Payment Plan in PA! Write for FREE competent advice regarding your PA problems.

Big Service Section

The most complete catalog in all radio's history—nothing like it ever before. Page after page of the very latest quality Test Equipment—all the leading makes—all the newest gadgets, tools, books, to make service work easier, faster, and far more profitable. And more than 50 pages devoted exclusively to replacement parts for repairing any make and model radio. It's the Serviceman's Buying Guide!

Book Hams Like Best

And there's a reason, because the 1942 ALLIED Catalog is packed with the most complete Amateur listings in our long history. All the new communications receivers; new x-mitter kits; tubes; keys; accessories; replacement parts; specialized electronics equipment—everything in radio for the amateur is combined in one exclusive and clearly tabulated section. Amateurs may use our liberal time payment plan.

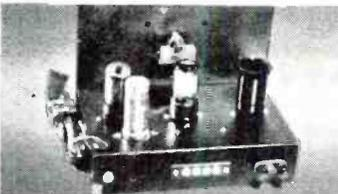

Builders' Guide

Nothing like it for the Builder and Experimenter has been published before. There's pages of new build-your-own kits; the popular "DX-ers" in new versions; new FM kits; "Popular Mechanics" Kits; dozens of new diagrams, circuits; everything for the Radio Builder and Experimenter! We'll supply FREE parts lists for any circuit described in magazine construction articles. You'll want this great 1942 Catalog—send the coupon for it now!



More Than 15,000 Parts

Today, more than ever, you can count on ALLIED'S vast stocks for everything you need in radio. Our experienced staff of merchandising specialists have spent months in combing the market to maintain and build up the most complete stock in radio's history. All the famous makes are offered; complete listings in every field are available—and all at lowest prices. Don't miss the big special Bargain Section that sets new value records for 1942!



Fluorescent Lighting

For those extra profits, and extra savings, see our completely new Fluorescent Lighting rotogravure section. Here's a wide variety of low priced easy-to-install new fixtures and accessories for commercial, industrial and home lighting applications—at new low prices that will amaze you. It will pay you large dividends to investigate this profitable new field! Clip the coupon below for the most reliable fluorescent guide to complete stocks available now.

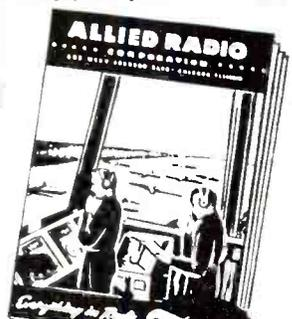

**Free
SEND
COUPON**

ALLIED RADIO CORP.
833 W. Jackson Blvd., Dept. 1-L-1
Chicago, Ill.

Rush me a copy of your FREE 212 page Complete Radio Catalog for 1942.

Name

Address

City State

ALLIED RADIO
833 W. JACKSON BLVD. • CHICAGO

RECORD CHANGER

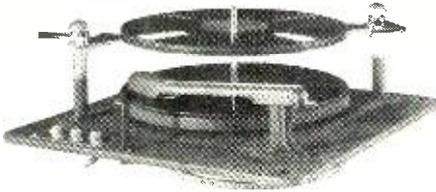

Plays 10 12" or 12 10" records. 14" by 14" by 5" high. Crystal pickup. Handles warped records. Will not chip or crack records. Reject switch—automatic or manual change—2 point record suspension. 115 V. 60 cycles. Only 7 seconds to change records.

\$13⁹⁵

Complete with Ratchet Trip to change old style records - \$14.95

PORTABLE CABINET

for record changer shown above. Compartment for wireless chassis. Beautiful brown alligator covering. Size: 17"x9½"x15". Records may be played with top closed. When purchased with changer.... \$4.95 When purchased alone..... 5.95

CHANGER-RECORDER

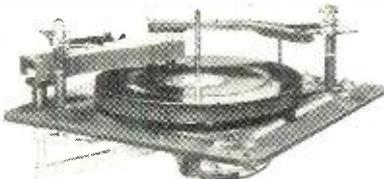

Records up to 12-in. record. Webster cutting head. 4 ohms at 400 cycles—cuts 112 lines per inch—cuts blank discs—under panel feed screw—powerful 110-volt 60-cycle motor. Changer features are the same as in the unit above. Simple to install.

\$26⁹⁵



CONSOLE CABINET

\$19⁵⁰

OXFORD TYPE PD. A beautiful hand-rubbed, piano-finished cabinet. Made of five-eighths stock. A real piece of furniture 33" high, 32" long, 17" deep. Phono compartment 31 x 15 x 6. Rose mahogany.

Other combination console cabinets from \$12.50

New folder lists uncut console, table, phono, and combination cabinets, as well as all radio parts.

Send for this folder TODAY!

LAKE RADIO SALES CO.

615 W. Randolph St.

Chicago

Making Dynamic Tests

by HAROLD DAVIS

WITH the many new-fangled and glorified pieces of testing equipment on the market today, the poor befuddled radioman is prone to forget just what can be done with the equipment he has on hand.

Take the old, battered signal generator, for instance. Who would ever think that it could be used very successfully in the new field of dynamic testing.

Of course, the signal generator is not nearly so convenient or efficient as the new testers, but to the serviceman who wants to gain some experience with the new system it will afford a means.

Lots of servicemen have used their oscillators for locating and isolating various types of radio troubles, and to these this system will not be new. The procedure is exactly opposite the one used with the new dynamic testers. The latter enables the servicemen to pick up, listen to, and measure the signal at any point in the radio from the antenna to the voice coil. He can observe the quality, the frequency, and the strength of the signal at any point in the r.f. system. He can check misalignment without turning the trimmers. He can check the condition of tubes without putting them in a tube checker. He can tell exactly what stage has a loss in signal strength, is developing hum or distortion, or is going into oscillation.

Keeping these things in mind, let us see how many of them we can duplicate with the signal generator.

Set up the radio in the same manner as though it is to be aligned. Attach output meter, either across the voice coil or to the plate of the output tube as is the custom. Switch the signal generator to the audio or plug the test leads into this position, as the case may be, and feed the audio signal into the grid of the output tube. On most oscillators, the signal will not be very strong at this point, because it has only the output tube to amplify it before reaching the speaker. Observe the reading on the output meter.

Now jump the signal to the plate of the first audio. In most of the superhets now encountered this will be the audio section of a duo-diode, such as a 75, 6Q7, 1B5, etc. The variation in signal strength between the grid of the output tube and the plate of the first audio will indicate the condition of the coupling between these two stages.

If the stage is resistance coupled and is working properly, there will be practically no difference in the reading. If it is transformer coupled, a slight increase should be indicated by the meter, the amount depending on the step-up ratio of the transformer. If the stage is a Class B driver, such as a

30 to 19, or 1J6, there will be a decrease, because driver transformers are step-down in ratio. This is necessary, because a Class B stage draws grid current during the positive half-cycles, and with a high impedance coupling the signal would be dissipated across the transformer windings.

By feeding the signal into the grid of the first audio, the gain through the tube can be recorded. This is very substantial if the tube is normal. A gain of five or six volts should be recorded.

From this point it is necessary to start testing with the r.f. signal from the generator, and for this reason it will not be possible to compare the meter reading at the grid of the 1st audio to that at the diode or grid of the second detector.

Using the r.f. lead from the oscillator set up in the same manner as for alignment, tune to the i.f. frequency of the radio and feed the signal into the grid or the diode as the case may be. The meter reading will depend on the strength of the oscillator. If a reading can be obtained, note it carefully and jump the r.f. lead to the plate of the last i.f. This step will check the condition of the last i.f. transformer. If the latter is in alignment and normal there should be a slight gain, although a slight loss is not uncommon. To check for alignment, merely shift the signal frequency back and forth and watch the meter for any increase. An increase in either direction indicates the coil is not aligned to the proper frequency, and can be corrected by adjusting the trimmers.

Gain through the i.f. tube can be checked by feeding the signal into the grid of this tube. It should be substantial if the tube is normal, five or six volts increase. A little experience will soon teach the operator what to expect from his particular setup.

Checking the first or interstage i.f. transformer is accomplished by following the same procedure as outlined above, and the signal remains set on the i.f. frequency up to the grid of the converter tube.

The converter tube or first detector as it is sometimes known, performs two functions. It detects or rectifies the incoming signal. It also generates an independent signal, the frequency of which is the frequency of the incoming signal plus the i.f. frequency. For example, if the signal being received is 600 kc. and the i.f. frequency is 460, the signal generated by the oscillator section of the converter tube will be 1060 kc. If this signal is not this frequency, the oscillator is said to be out of alignment, and the set will not track.

Occasionally the serviceman runs
(Continued on page 44)

AN IMPORTANT MESSAGE TO ALL SERVICEMEN

We have received many letters from servicemen who wanted to know why our ads have not appeared in the various Radio Publications during the past few months, and whether we intended to continue manufacturing Test Equipment on the same "direct-to-serviceman" sales policy as in the past.

We discontinued advertising temporarily because the increased business we received as a result of the Defense Program overtaxed our production facilities unexpectedly, and because of the increasing difficulty we have experienced in obtaining the various parts we require to complete our instruments. At the present time, however, we are in complete production at our new plant

(see our new address below) and the increased space in our new quarters will enable us to continue supplying Test Equipment at the same relatively low prices as in the past. Inasmuch as our prices because of our "direct" sales policy have always reflected our actual material cost, plus labor cost plus profit, we have been compelled to revise our prices due to the increased material cost. Please note these prices are based on our present cost and in the event that the price of parts continues to rise, we will be compelled to again revise our prices. We will, however, guarantee to fill all orders at the prices quoted below providing your order is sent in before December 31, 1941.



The New Model 1220 POCKET LABORATORY

- ★ WEIGHS ONLY 28 OUNCES!!
- ★ USES a 2% ACCURATE 0-200 MICROAMMETER—ENABLING MEASUREMENTS AT

5000 OHMS PER VOLT SPECIFICATIONS

- ★ 6 D.C. Voltage Ranges: 0-3-10-50-250-500-5,000 volts.
- ★ 3 A.C. Voltage Ranges: 0-15-150-1500 volts.
- ★ 4 Resistance Ranges: 0-3000 ohms, with 15 ohm center, direct reading to 0.2 ohm; foregoing base range multiplied by 10, by 100 and by 1,000, to read up to 3 Meg. with self-contained 3 V. flashlight battery.
- ★ D.C. Current Ranges: 0-200 microamperes; 0-2-20-200 Milliampere, using wire-wound shunts.
- ★ 3 Output Meter Ranges: Same as A.C. Voltage Ranges.
- ★ 3 Decibel Ranges: From -2 to +58 D.B., based on .005 watt in 500 ohms.

Model 1220 comes complete with cover, self-contained battery, test leads and instructions. ONLY **\$11.50**

THE NEW CHANNEL-ANALYZER

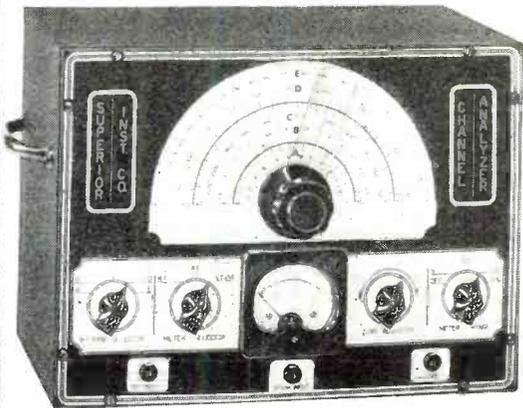

FOLLOWS THE SIGNAL

FROM ANTENNA TO SPEAKER OF ANY SET

The well-established and authentic SIGNAL TRACING METHOD of locating the very circuit in which there is trouble, and the very component that causes the trouble, is now for the first time available at a price any radio serviceman can afford.

THE CHANNEL-ANALYZER WILL

- ★ Follow the signal from antenna to speaker through all stages of any receiver ever made.
- ★ Instantly track down exact cause of intermittent operation.
- ★ Measure both Automatic-Volume-Control and Automatic-Frequency-Control, voltages and circuits without appreciably loading the circuit, using built-in highly sensitive Vacuum-Tube Voltmeter.
- ★ Check exact gain of every individual stage in receiver.
- ★ Track down and locate cause of distortion in R.F., I.F., and A.F. amplifier.
- ★ Check exact operating voltage of each tube.
- ★ Locate leaky condensers and all high-resistance shorts, also show opens.
- ★ Measure exact frequencies, amount of drift and comparative output of oscillators in superhets.
- ★ Track down exact cause of noise.

The Superior Channel-Analyzer comes housed in shielded cabinet and features an attractive etched aluminum panel. Supplied complete with tubes, three specially engineered shielded input cables, each identified as to its purpose. Also full operating instructions. Size 13" x 10" x 6". Shipping weight 19 pounds. Only... **\$21.75**

The New Model 1240 TUBE TESTER

Instantaneous snap switches reduce actual testing time to absolute minimum. Tests all tubes 1.4 to 117 volts.

Sockets for all tubes—

No adapters.

SPECIFICATIONS:

- ★ Tests all tubes, 1.4 to 117 volts, including 4, 5, 6, 7, 7L, octals, octals, Bantam, Jr., Peanut, single ended, floating filament, Mercury Vapour Rectifiers, the new S series, in fact every tube designed to date.
 - ★ Spare socket included on front panel for any future tubes.
 - ★ Tests by the well-established emission method for tube quality, directly read on the GOOD ? BAD scale of the meter.
 - ★ Jewel protected neon.
 - ★ Tests shorts and leakages up to 2 megohms in all tubes.
 - ★ Tests leakages and shorts in all elements AGAINST all elements in all tubes.
 - ★ Tests BOTH plates in rectifiers.
 - ★ Tests individual sections such as diodes, triodes, pentodes, etc., in multi-purpose tubes.
 - ★ Latest type voltage regulator.
 - ★ Features an attractive etched aluminum panel.
 - ★ Works on 90 to 125 volts 60 cycles A.C.
- Model 1240 comes complete with instructions and tabular data for every known type of receiving tube. Shipping weight 12 pounds. Size 6" x 7 1/2" x 10 3/4". Our Net Price. **\$14.85**



MODEL 1230 SIGNAL GENERATOR

WITH FIVE STEPS OF SINE-WAVE AUDIO

SPECIFICATIONS:

1. Combination R.F. and A.F. Signal Generator, R.F.—100 K.C. to 90 Megacycles, A.F.—200 to 7500 cycles; Sine-Wave—WITH OUTPUT OF OVER 1 VOLT. All direct reading, all by front panel switch manipulation.
2. R.F. and A.F. output independently obtainable at one or with A.F. (any frequency) modulating R.F.

3. Latest design full-range attenuator used for controlling either the pure or modulated R.F.
4. Accuracy is within 1% on I.F. and broadcast bands; 2% on higher frequencies.
5. Giant dial etched directly on front panel, using a new mechanically perfected drive for perfect vernier control.
6. Operates on 90 to 130 V. A.C. or D.C. (any frequency).

The Model 1230 comes complete with tubes, shielded cables, molded carrying handle and instructions. Size 14" x 6" x 11". Shipping weight 15 pounds. Only... **\$14.85**



SUPERIOR INSTRUMENTS CO.

227 Fulton St., Dept. RN11
New York, N. Y.

Making Dynamic Tests

(Continued from page 42)

into sets that have a separate tube for the oscillator, but the principle is the same. To check the operation of this oscillator section with the new dynamic testers it is only necessary to tune the tester to the estimated frequency of the oscillator and note the frequency on which the signal peaks, as indicated by the meter or magic eye indicator.

To check it with the service oscillator, it is necessary to substitute a signal from this instrument in place of the one generated within the set. This is done by tuning the service oscillator to the estimated frequency of the set oscillator as explained, and feeding it into the converter tube at the oscillator plate. The modulation can now be cut off, and the set should play if there is no other trouble. To tune in various signals, the service oscillator must be retuned to a frequency which is higher by the amount of the i.f. frequency of the set.

For maximum performance and to insure tracking, the oscillator high and low frequency trimmers should be adjusted to frequencies specified by the manufacturer. (Usually 1400 kc. for the high and 600 for the low.)

Gain through the converter tube or 1st detector may be measured by comparing the meter reading when a signal at i.f. frequency is fed into the plate to that obtained by feeding an r.f. signal into the grid. A slight error may occur here due to the service oscillator not having a constant output on both frequencies, but this is usually negligible.

Using the same r.f. frequency and volume setting, the signal may be fed

into the antenna connection to determine the condition of this circuit. On sets of good design, a slight increase is obtained in antenna circuits. No increase or a loss indicates faulty design, mis-alignment or defective circuit.

On auto radios, the gain in the antenna circuit is usually very substantial.

Intermittents

The first step in localizing an intermittent condition is to find out whether the trouble is in the r.f. or audio end. This can be done by feeding the signal from the service oscillator into the set and moving it back one stage at the time as the intermittent occurs, as explained in the foregoing signal tracing procedure. As the steady note from the oscillator becomes monotonous after a short period of time, it is suggested that the signal generator be modulated by connecting the external modulation jack to the voice coil of a small receiver and tuning in a signal from a broadcasting station. This arrangement is also good when checking for distortion, as it is easier to detect distortion in music than in a 400 or 1,000 cycle note.

We will consider a typical simple superheterodyne. Any variations from this are usually elaborations, such as adding an r.f. stage, using a separate tube for oscillator or detector, or both, and using push-pull output. Regardless of these variations, the method of testing will be the same, and with a little experience, excellent results can be obtained.

Test Procedure

1. Feed audio note to output tube grid. Adjust volume so that meter reads about $\frac{1}{2}$ volt on 5- or 6-volt scale.

2. Feed audio note to 1st audio plate. A slight gain or loss may be noticed, depending on coupling. (See text.)

3. Feed audio note to 1st audio grid. A gain of 5 or 6 volts.

4. Feed r.f. signal at i.f. frequency to diode. Re-adjust meter reading as in (1).

5. Feed i.f. signal to i.f. tube plate. A slight loss or gain. Check loss for mis-alignment.

6. Feed i.f. signal to i.f. tube grid. A gain of 5 or 6 volts.

7. Feed i.f. signal to converter (1st detector) plate. Results same as (5).

8. Feed r.f. signal (1400 kc.) to converter grid. A gain of 5 or 6 volts.

9. Feed r.f. signal to antenna post. A slight gain.

10. Tune in a station, feed an unmodulated signal whose frequency is the sum of the station plus the i.f. If no other trouble, radio will play, using this external oscillator signal.

-30-

As I See It!

(Continued from page 15)

shop, the time of diagnosis. He then explained what he had to do in order to make the repair. He showed the customer that the actual time required for removing the defective part and replacing it with a new one was but a few minutes. The set was then in an operative state.

The customer felt that the service job was finished, but the serviceman took it upon himself to explain that the job was not yet finished. He explained that a final overall check, accompanied by alignment operation, was necessary. He proved to the customer the importance of this final check, for it was very evident during the operation, that the various alignment adjustments definitely improved the performance of the receiver. This time was then added to all of the previous allotments of time for different operations. It did not take much effort to show the customer that of a total elapsed time of about 2½ hours, only a few minutes was required to correct the defect, yet the charge made covered much more time than that.

Not only was the customer convinced of the honesty of the serviceman, but for the first time in all the years that he owned a radio receiver did he gather any impressions whatsoever concerning what radio repair really means. That man left the shop a thoroughly satisfied customer, who had no complaint whatsoever to make concerning either the charge or the manner in which the entire procedure was handled. In fact he expressed himself as saying that such procedure was not in conformity with the impressions he had gathered after reading that famous (?) article which has become the subject of so many discussions.

We realize, of course, that all servicemen would not be willing to go to all this trouble, but we suggest that if at all possible, some such thing should be done each and every time a cus-

HOWARD Sets a New Standard For AC-DC Performance—

This gem of a receiver besides providing a full measure of sensitivity and selectivity performs equally well on AC or DC current—105-240 volts. Ideally suited for use in DC districts, aboard ships and for operation by the traveler encountering various voltages and currents. Model "445" operates at top efficiency on any available power supply.

Tuned R.F. on All Bands!

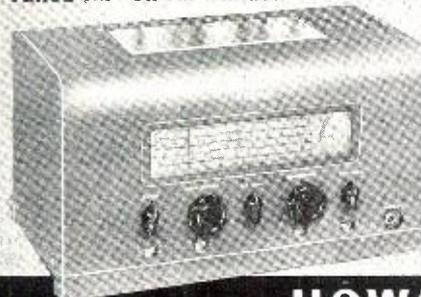

MODEL "445" UNIVERSAL 105-240 Volts Communication Receiver

Tunes 540 KC to 43 MC (556 to 7 meters) in four bands. Six latest type tubes provide nine tube performance! Has tuned R.F. stage on all bands, iron core I.F. transformer, B.F.O., electrical band spread, A.V.C., 6½ Jensen speaker, headphone jack and every desirable feature of a professional communication receiver. May be used on broadcast band for entertainment. Sturdy steel cabinet attractively finished in gray wrinkle enamel.

\$36⁷⁵ Export and Pacific Coast Prices Slightly Higher

Sold By All Leading Distributors

HOWARD RADIO CO.
1731-35 Belmont Ave., Chicago, Ill., Cable Address: HOWARDCO, U. S. A.
America's Oldest Radio Manufacturer

tomer expresses any suspicious attitude of the sincerity of the serviceman.

THE various power utilities in the United States have long been interested in the sale and servicing of radio receivers. Nevertheless, the plan now being broached by the *Consolidated Edison Company* in New York is one which should be of interest to every radio serviceman. Not that any activity in New York will have a direct effect upon a serviceman in Milwaukee or Dallas, but there is nothing which says that if the plan proves successful in New York, that a similar arrangement will not be tried or put into effect in other large centers.

Essentially, the reason for bringing this item before the servicemen is that it is aimed directly at servicemen. As you can readily appreciate, the shortage of materials in the United States is going to result in curtailment in the production of all kinds of electrical devices with the exception of those used or required for national defense. Under the circumstances, these organizations, like the power and light companies, who have in the years past sold various kinds of electrical appliances which use power, will be materially affected by the inability of their suppliers to secure the basic materials for the production of such appliances. At the same time, various dealer organizations associated with such power and light companies, selling the products for which these power and light companies may be distributors, will likewise undergo a reduction in sales revenue.

Logically, any reduction in sales revenue must be made up in whatever way possible. One such way is an increase in servicing activity. Here in New York the plan being broached by *Consoli-*

dated Edison is to sell appliances like refrigerators, electric ranges, home laundries, radio sets, toasters, irons and the like. That such a plan is a threat to the independent radio serviceman is easy to see. Whether or not they would be able to render better service than the independent shop is problematical, for after

all, a service job done well is the same no matter who does it, whether a serviceman is in the employ of a large concern or is working for himself independently. The fact that a man is working for a large concern does not necessarily make him better equipped technically. In this connection, if this plan is put into effect, the

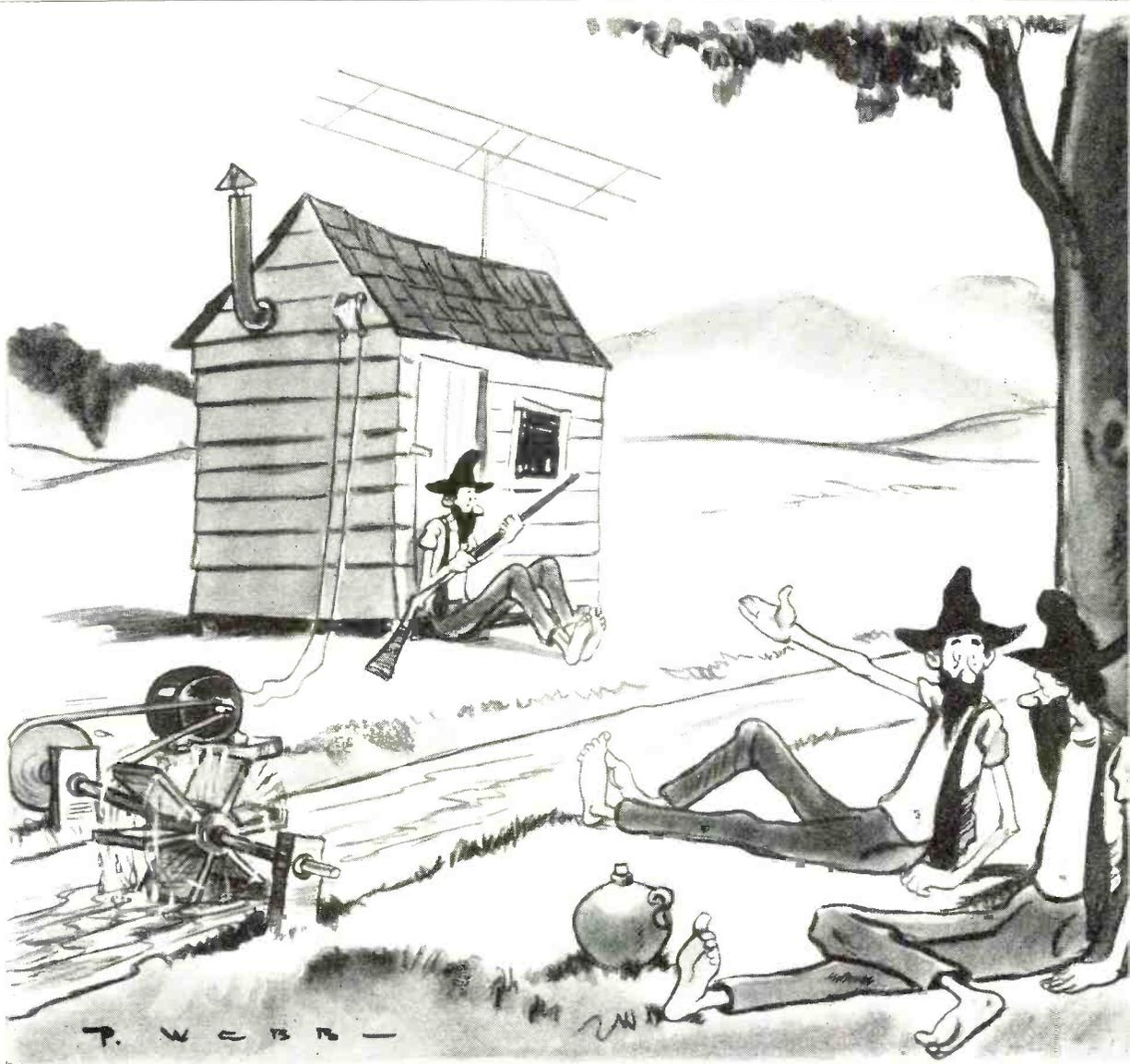

"EVER SINCE HE GOT THEM NEW G-E CAPACITORS HE WON'T LET NOBODY NEAR THE SHACK."

Filter troubles take a beating when you install Pyranol* capacitors—a beating that lasts for years and years.

And here's some more good dope on Pyranols:

- ★ Continuous operation at 10% above rating
- ★ Long life, for low cost per service-year
- ★ Small size—means easy portability
- ★ Upright or inverted mounting
- ★ Round or rectangular cases
- ★ More than 50 ratings to choose from
- ★ More than a million units in service
- ★ Hermetically sealed for permanence

*Reg. U.S. Pat. Off.

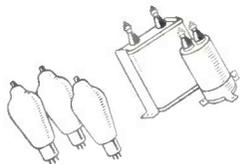

NEXT TIME YOU NEED TUBES— GET G.E.'S AND MEASURE THE IMPROVEMENT

FREE for your shack wall!

ENLARGEMENT OF THIS CARTOON, drawn by Paul Webb of *ESQUIRE* fame, reproduced on tapestry-finish paper.

Also
 GEA-3315B on G-E Transmitting Tubes
 GEA-2021B on G-E Pyranol Capacitors
 General Electric, Section N407-10, Schenectady, N.Y.
 Please send me free the items checked.

Name
 Address
 City State

only place where the organization would be able to procure its men would be from the ranks of existing independents. Consequently, whatever may be the technical level of the present-day independent, that would more than likely be the technical level of the man working for the utility.

However, we cannot overlook the fact that a utility, such as this company, comes in monthly contact with their public in the form of bills that they render for power, light, etc., and are in a position to maintain closer relationship and, disregarding actual amounts, offer the public a more attractive proposition with respect to payment for services rendered. In other words, the set owner who has his receiver serviced under a plan such as this is given the opportunity of paying the service charge on a monthly basis, in other words on the installment plan, so much per month as a part of the bill. That this will prove attractive to the public goes without saying. However, anyone in business does not give something away for nothing, which means that this plan of financing must bear some kind of an extra charge. Naturally, we cannot officially say concerning this charge but it only seems reasonable to assume that such would be the case.

The company feels pretty well fortified by the READER'S DIGEST article in their approach to the public and it is impossible to deny that it is an excellent wedge. So much for the items which are favorable to the plan.

Now, let's look at some of the things which would tend to work against the plan, at least as far as radio sets are concerned. Just what will happen with respect to home laundries, refrigerators and the like, we don't know and frankly don't care. As far as radio equipment is concerned, it seems to us that the distributors and set dealers would not view a plan such as this with great favor, for after all if they are going to suffer from the reduction of sales of new sets, why should servicing revenue be taken away from them. If servicing is an avenue of increased income, why should not the set dealer or set distributor install service departments? And if by chance, as is the case in many places, the service department already exists, we doubt very much if the anticipated cooperation between set distributors or set dealers and this contemplated organization would be obtained.

Then again, the problem exists of where such organization would secure its servicemen. After all it is true that a shortage of radio men, that is good radio men, exists in all towns and while it is possible that an offer of higher pay by this contemplated organization would attract some men, it is doubtful if many independent radio servicemen operating around metropolitan New York would close up shop and accept these jobs. Frankly, as we have stated elsewhere in this column, it wouldn't make much sense

to do so for if the formation of such an organization can be accepted as evidence that money can be made in the radio servicing field, the chance of making money is much greater when a man is an independent shop owner than when he is a mere employee.

As we said, this plan is in the process of discussion and we have seen a copy of the prospectus. More than likely it will go into effect, for after all the organization itself possesses the wherewithal to put the plan into operation even though it may not succeed. Be that as it may, the fact remains that any such plan would take business away from the independent man and it is necessary for servicemen, particularly in large communities where such plans could go into effect, to make an effort to organize themselves more solidly in order to protect their income. The fact that there exists certain reasons why this type of utility service program may not succeed is not justification for ignoring its threat aspects. It merits, as we said, consideration not in the future but right now. This topic among others will be discussed at a mass meeting to be held in New York City, September 29th which unfortunately will be held before the appearance of this column so that it is impossible for us, at this time, to make any statements concerning the conclusions arrived at at the meeting.

-30-

Wearable Hearing Aid

(Continued from page 17)

the small parts may be laid out as shown in the various illustrations. The amplifier chassis should not be placed into its metal container until it has been tested thoroughly.

First, connect the battery cable and apply only the filament voltage. The B battery should be left out of the can during this procedure. Check the filament switch to see that it is operating properly and observe the tube filaments, preferably in a dark room, to see that they are all lighted properly. The next step, of course, is to install the 30 volt B battery in its container and to see that proper contact is made.

Note that the negative side of the B battery connects to the metal can and that the center connector of the A cell also connects to the same point. Small indentations should be made in the bottom of the can with a nail so that a better contact will be provided when the batteries are shoved down into position. A three-wire cable extends from the amplifier chassis to the battery box and terminates in a three-prong *Amphenol* connector. This connector has been altered to include the special spring shown in the illustration to make proper contact to the A cell. A small strap on the side of the bakelite top piece makes contact with the can proper, while the spring for connection to the positive of the B battery may be seen mounted in the center of this bakelite top. Of course,

the original metal can cover is discarded.

The special tubes used in this hearing aid have a life expectancy of 7000 hours or more, and they are capable of giving daily service with a minimum of need for replacement. All tubes exhibit moderately low amplification factors, yet the actual overall gain of the amplifier is adequate. Very low tube noise was noted with a minimum of coupling and capacitive effects.

An overall voltage gain of nearly 10,000 should be obtained. Two different types of tubes are used. The first two are designated as M-74, while the power tube is known as M-54. The actual gain of the M-74 voltage tubes is approximately 25, while the M-54 power tube is about 15. The Mu of the M-74 is 63 and that of the M-54 is 26.

For certain services requiring extreme sensitivity, such as noise level indicators, portable radios, or transceivers, four tubes are recommended for a suitable amplifier. However, as stated previously, more than enough gain is provided with only three tubes for use in the hearing aid described.

In normal service the A cell should be replaced every two or three days. These are available at 10c store counters, drug stores, etc., in practically any community in the country. The tiny B battery need only be replaced after several weeks of operation as a total current gain is very low. This hearing aid has been actually tested on several persons who are afflicted, and the results are most gratifying. It is capable of giving a high degree of performance together with good stability.

It requires but a few hours' time for its construction and inasmuch as all parts are clearly in view it may be serviced with a minimum amount of effort. We feel that a new market is available for the serviceman who is proficient in the use of soldering irons as it will be possible for him to construct units "on order" for patients sent to him by physicians who are in a position to prescribe such an instrument. There is another tremendous advantage in this plan as it eliminates the necessity for returning the hearing aid to an out-of-town factory, depriving the wearer of its use. Fortunately, there is very little that can possibly go wrong and the chances are that an efficient radio serviceman can detect and remedy any trouble that may be encountered in a few moments' time. In conclusion, we would like to repeat that *in no case should the serviceman attempt to enter into the diagnosis* but should confine his efforts solely to the *construction* of the instrument itself. Remember that special ear moulds are required in many cases and other types of compact crystal phones must be used. It will be necessary for the radioman to receive proper information from the physician on construction of a hearing aid for a patient.

-30-

Signal Generator

(Continued from page 22)

tenuator control should be mounted as closely as possible to this control.

Otherwise radiation may occur other than through the live lead itself. This, very often, leads to the trimmers on the set being aligned to a very broad peak on the trimmer or perhaps a false peak all because of this spurious radiation.

The constructor of this generator should take great care to keep leads as short as possible and very direct. Because the more care that is taken, in this respect, the more stable will be its operation.

After the generator is put together and wired, a good quality receiver should be used for testing purposes. By a good receiver it is meant one that has at least one stage of pre-selection on all bands.

In such a receiver the image response is low and will help materially when the generator signal is tuned in. For example, if a receiver is used with no pre-selection and the generator signal is being tuned in, there is quite a likelihood that the constructor will find what seems to be spurious signals mixed in with the true signals, all of which will be very confusing. The r.f. stage ahead of the mixer will greatly reduce this difficulty.

For final calibration the generator is turned on the first band and, if you are fortunate enough to have a broadcast station in your town on 1000 kc., the dial is turned until the signal from the generator is dead zero beat with this particular station. From then on you may use the harmonics of 1000 kc. to pick up the other frequencies. You should hear a local or dx station on 1000 kc.

Now we want to calibrate the third band. The table lists the coverage as 4300-15000 kc. Now, start with 1000 kc. which was set on this broadcast station. Next tune up to 5000 kc. and pick up the fifth harmonic of 1000 kc. Leave the receiver exactly in tune.

Tune the generator dial until a signal is again picked up on the receiver.

It may be possible to pick up a "ghost" signal or the incorrect one if the attenuator is turned up too strong. Check to see that only one signal is being emitted from the gen-

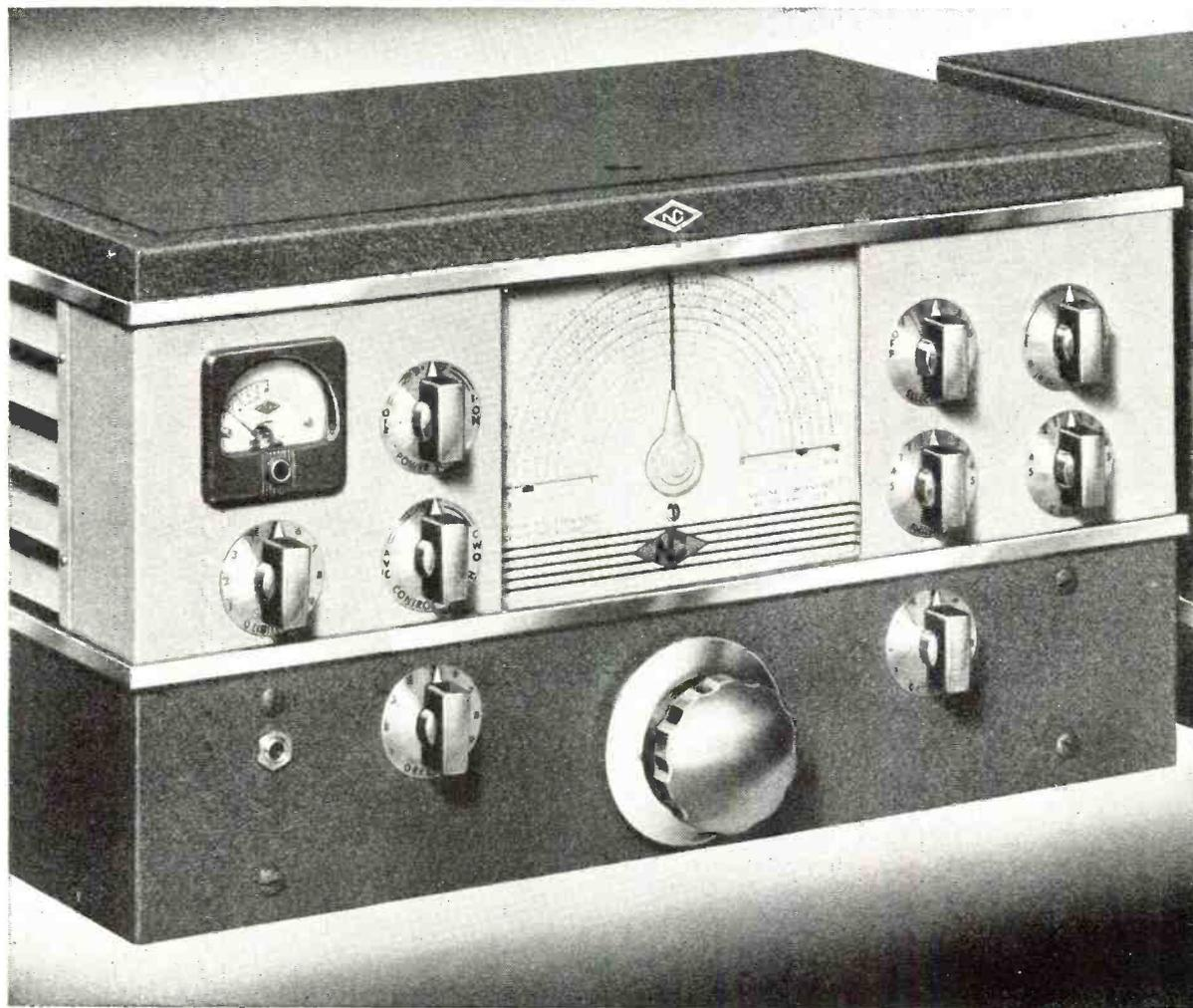

The Outstanding Amateur Receiver

The NC-200 Receiver is outstanding for Amateur use. For example, four amateur bandspread ranges are provided in addition to the six general coverage ranges. These bandspread ranges are entirely independent of the other ranges, their calibration is fixed, and their setting is read from the big sweep pointer on the dial. And it is real bandspread, too — for the 10, 20, 40 and 80 meter bands are each spread out over the major part of the dial scale.

FEATURES: Sensitivity better than one microvolt • Series valve noise limiter • Improved crystal filter with rejection ratios as high as 10,000 to 1 • Stability 3 parts in 100,000 for 20 volt line fluctuation • AC line or portable operation • Speaker in matching cabinet.

NATIONAL COMPANY, INC., MALDEN, MASS.



TEN
CALIBRATED
COIL RANGES

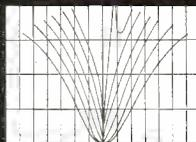

WIDE RANGE
CRYSTAL FILTER

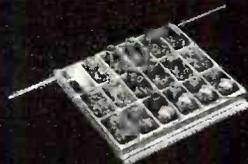

MOVABLE COIL
TUNING UNIT



PORTABLE OR
AC OPERATION

November, 1941

erator by turning the generator dial from one end to the other. If more than one signal is picked up turn down the attenuator until the "ghost" signal has disappeared. Alignment on other frequencies may be handled in the same manner as the example given with a fair degree of accuracy.

The author has had excellent results with this little generator and has aligned sets of all descriptions thus far and has never had any trouble in alignment. Just a little care is needed in the construction and alignment of the bands on the generator.

-30-

Don't miss the first in a new series of articles by Rufus P. Turner in the Dec. issue. This outstanding author has put forth a great deal of effort in preparing accurate information on the substitution of homemade parts for the construction of radio transmitters, receivers and test equipment.

**SAVE UP TO 50%
FACTORY-TO-YOU**



9 BANDS
(ON 6 DIAL SCALES)

PUT THIS CHASSIS IN YOUR PRESENT CABINET

20 TIMES BETTER FOREIGN TUNING with SUPER BAND SPREAD RADIO!

\$19.75

SPEAKER, TUBES, PUSH-BUTTON TUNING, MAGNA TENNA LOOP AERIAL... READY TO PLAY

COMPLETE

UP TO \$50.00 TRADE-IN

30 DAYS TRIAL

EASY TERMS



THINK of it... 20 times easier to tune... 10 times more sensitive than ordinary radios! Crystal-Clear High Fidelity Tone. Famous 30-day trial plan fully protects you and enables you to prove Midwest's amazing new 1942 Super Spread Band performance in your own home, without obligation.



Write today. Your name on a 1¢ postal card will do. Send for big FREE 1942 Catalog, showing Radios, Radio-Phonos, Home Recorders—from \$12.95 to \$212.50.



UP TO **16 TUBES**

USER AGENTS WANTED

MIDWEST RADIO CORPORATION
DEPT. 11E CINCINNATI, OHIO

Police Radio (Continued from page 22)

has the following state police stations in operation: Key station WLSP with 1000 watts at Baton Rouge; KRAD with 500 watts at Alexandria; KSPC, KSPB, KSPF with 250 watts located in Monroe, Lake Charles and Franklin respectively, and KSPL with 100 watts located in Leesville.

Golson also has two portable mobile units, one in the Superintendent's car, Brig. Gen. Steve Allord, and the other in his own car. He also has a 25 watt portable transmitter with a gasoline plant for power installed in a station wagon for emergency use.

Two transmitters are waiting to be installed at New Orleans and Shreveport as soon as the new buildings are completed.

All the stations are operated by a sergeant and two troopers and maintain a 24-hour schedule. The control station at Baton Rouge also continuously monitors the Texas, Mississippi and Arkansas state police systems.

The two stations at Leesville and Alexandria are in the heart of the U. S. Army maneuver area of Louisiana and gave excellent service in cooperation with the army maneuvers.

Captain Louis Heard is the radio communications supervisor of the system.

Personalities

TWO more old timers in the police communication field have been called to the colors in the Inspection service department of the U. S. Army.

John Pegg, who assisted in laying and installing equipment and supervising the method of operation of the *Indiana State Police* at the central station in Indianapolis, and at its various posts, has been called by the army to assist in inspecting some of the equipment now being purchased. Mr. Pegg is well known in Indiana police circles.

This same branch of service also called Irvin Chapel, a veteran operator and announcer of the Indianapolis city police station WMDZ. Chapel had been with WMDZ for more than ten years which dates back to the time before the present building in Willard Park had been installed. During his stay with WMDZ, experimental and complete installation of two way police cars was made, methods of operation improved, and the intercity CW net of police stations was organized.

Link FM

THE widespread popularity of *Fred Link's* new FM equipment throughout the entire eastern section of the country has caused us much concern as to the reason why this equipment has been so widely adopted by the armed forces and various government groups. The following description with the accompanying photos may serve to point out the outstanding characteristics in the *Link FM* system. Many new features are incor-

porated. The main station unit illustrated contains within a single welded steel cabinet, all the apparatus necessary for moderate power, fully crystal controlled main station for frequency modulation transmission and reception. It contains a transmitter and power supply, receiver and power supply, speaker and control equipment. The unit requires no special mounting and is small enough to be placed conveniently on the operating desk.

All tuning controls and adjustments are accessible only after unlocking the rear cabinet door. The front panels are readily removed for under-chassis inspection, test and maintenance. External controls include off-on transmitter and receiver switches, volume control and receiver squelch control.

The transmitter is designed for operation at any frequency between 30 and 40 mc. and output rating being 25 watts. It is designed to work into

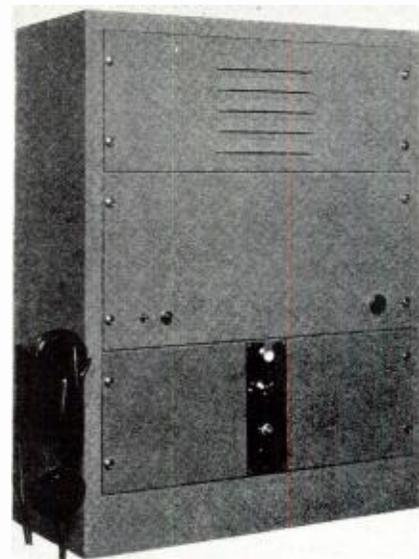

Latest Link FM transmitter unit.

a 70 ohm coaxial cable. A phase-shift system of modulation is employed to permit a frequency deviation of at least 15 kc. at a modulating frequency of 500 cycles and with a signal input of 6 milliwatts. High frequency pre-emphasis is inherent so that with constant amplitude audio input the frequency deviation increases linearly to 3,000 cycles, representing an increase of 15 db. over the frequency deviation at 500 cycles. The modulator is designed to provide an inherent peak limiting action at levels corresponding to the rated deviation of the transmitter.

The receiver is an extremely sensitive multiple superheterodyne. Both local oscillators are crystal controlled. Satisfactory signals can be utilized of the order of .1 to .2 microvolts.

The mobile two way assembly illustrated consists of the basic 25 watt transmitter and receiver described with a genemotor installed on the transmitter chassis, and a 6 volt input power supply for the receiver. The hand set and dash control unit is also included in the assembly.

-30-

Portability Plus
(Continued from page 14)

kicking around, and consisted of fifty turns of No. 26 enameled, close-wound, with taps taken off every five turns. This type of coil form is not, of course, essential. An ordinary one and a quarter inch diameter plug-in form is satisfactory, using the same winding data. The wire size may seem a bit small, but it really is necessary if the completed coil is to fit in the cabinet and still leave room for other parts.

The three crystal sockets are mounted upside down on the chassis, in which position the wires to the switch may be made short and direct.

The somewhat sloppy leads between the switch and the plate coil shown in the pictures were temporary ones used to determine the proper taps. They were later replaced with Number 14 bare solid bus in the interests of rigidity. This is a good plan to follow, incidentally, as the usual run of solid buswire is far from flexible. When setting the taps, it is possible, with the exertion of a little patience, to so place them that retuning is unnecessary when going from band to band. Set them so that the circuit resonates near the low-capacity end of the condenser.

The antenna taps are fairly easy to set. First plug an 0-100 millimeter into the key jack and tune for the dip in the usual manner. The plate current, unloaded, should be near 35 ma. Now, starting at the top of the coil, tap on the antenna and retune.

The circuit will probably go out of oscillation, as this coupling is very tight. Now bring the antenna down the coil, tap by tap, until one is found where the plate current is between 50 and 55 ma. This is the maximum plate current for this tube, and the antenna tap may then be soldered. Repeat the procedure for all three frequencies, and then replace the flexible leads with stiff busbar.

Well, that's it. A few hours pleasant work, some well-chosen swear words, and you have a really portable transmitter, one that you can stow in a corner of your suitcase or toss into the glove compartment in the old jalopy, ready to perk at a moment's notice. W8TZG likes his so well that he shipped us the quarter-kilowatt job for keeps and works his skeds with the peanut whistle in fine style.

Comes cooler weather and some inspiration, and we'll evolve a compan-

ion unit in the form of a modulator in the same style, probably using our favorite bottle, the 117N7GT. That line of thought opens vistas of receivers, too. Perhaps one day the complete ham station for the coat pocket. Who knows? Even that seems possible with the advent of the new hearing-aid tubes such as the 1S4, etc., little bottles not much bigger than a peanut, designed to work off a 45-volt plate battery of conventional type.

-30-



Photo by U. S. Army Signal Corps.

SERVICE PLUS... "SUPER-PRO"

THE "Super-Pro" has always been popular because of its great versatility. You'll find "Super-Pro" Receivers in just about every branch of the communications field from mobile units to fixed observation posts and international press installations. The "Super-Pro" has found wide application in the diplomatic service of many foreign governments on every continent, and in many branches of the United

States Government. Models are available to cover frequencies as low as 100 kc. and up to 40 megacycles.

MAIL COUPON TODAY!

HAMMARLUND MFG. CO., INC. RN-11
424 W. 33 Street, New York City
Please send "Super-Pro" booklet

Name

Address

City State



Canadian Office,
41 West Ave. No., Hamilton

HAMMARLUND

EXPORT DEPARTMENT, 100 VARICK ST., NEW YORK CITY

U-H-F
HYTRON
 RADIO TUBES
Excel

1-1/4 M. RECORD
HY615—led the pack in August, 1940. Using this little magician in simple transceivers, W6IOJ and W6LFN established a record of 135 miles, which still stands unchallenged!



BOTH the HY615 and HY75 U-H-F tubes used by the editors of RADIO NEWS in their mobile transmitter-receiver.

2-1/2 M. RECORD
HY75—outshone the rest in August, 1941. This miniature powerhouse hurled its energy across 335 miles, from W2MPY/1 to W1JFF, to prove once again—HYTRON U-H-F tubes EXCEL!

When you want the BEST, demand HYTRON

HYTRONIC LABORATORIES
 Salem, Mass.

Manufacturers of Radio Tubes Since 1922

112 Mc. Mobile
 (Continued from page 19)

sis for antenna connection. Tuning condensers are mounted on standoffs and the shaft is sawed off close to the bearing. Flexible ceramic couplings are used with bakelite shafts to connect to the dials.

The audio and the quench tubes are

overall height of the tube, and afford short grid and plate leads.

Coils are soldered directly to the terminals of the tuning condensers and the HY75 and the HY615 tubes inserted in their sockets, the plate and grid caps placed on the tubes, and connections made to the coils by means of solid bus bar. Although this prevents the tubes from being removed from their sockets without unsoldering, it does reduce the length of the

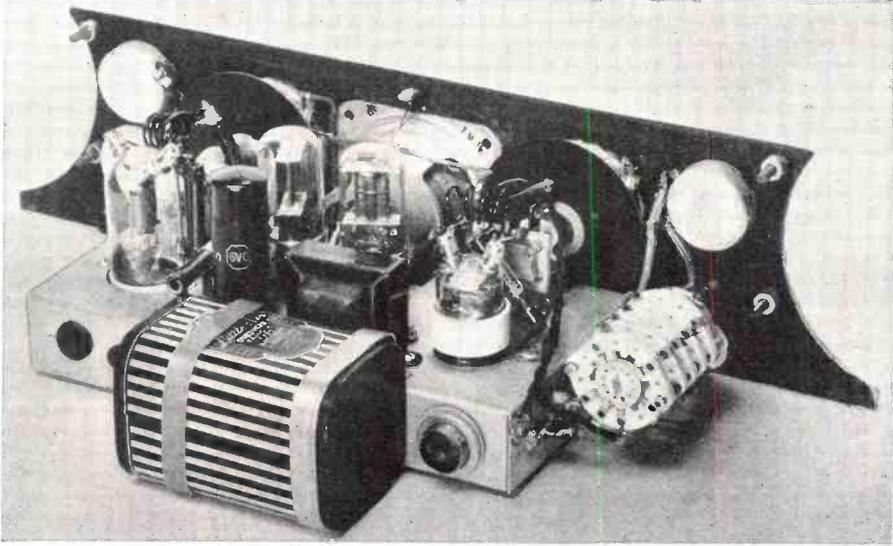

Rear view showing mounting position for the change-over switch and connectors.

mounted in a square in the center of the chassis, the other corner of the square being formed by the output transformer. It will probably be necessary to fasten a brace from the grill to the rear edge of the chassis in order to prevent undue vibration. The socket for the HY75 is mounted below the chassis by means of long bolts and spacers in order to reduce the

tuned circuit leads. The "gain control" is on the left side of the grill while the transmitter gain control is mounted on the right. The "regeneration" control for the receiver is in the lower right-hand corner of the grill with the on-off switch mounted just below. The mike jack is mounted just below the "send-receive" switch. Pilot lights are connected in series to keep the light down and eliminate bulb burnout. Power connections from the unit are brought out through a midget Amphenol plug and socket mounted on the right rear drop of the chassis. A four-wire cable should be made up to supply power to the unit.

The Vibrapak is mounted in a 5 1/2" x 5 1/2" x 6" Parmetal can together with its associated filter section, voltage regulators and control relay. This relay is an ordinary Guardian single-pole-single-throw 6 volt d.c. type, and is used to eliminate the voltage drop caused by long leads and also any hash that might be induced in the receiver due to the proximity of these leads to those of the audio circuit.

If it is desired to eliminate this relay, a heavy-duty type switch may be mounted directly on the Vibrapak box and used to control it directly. The on-off switch controls the filaments, Vibrapak and mike battery so that there is no danger of leaving the mike on when operation is completed. The mike battery is also fed through the send-receive switch so that the battery is disconnected in the receive position. The coil for the quench oscillator is mounted underneath the chas-

PACKED WITH POWER!

CONSERVATIVELY rated at 55 Watts Output, Thordarson Model T-30W55 amplifiers have an exceptional overload characteristic. This assures a peak reserve for quality reproduction at high sound levels.

Four microphone circuits are provided with independent gain controls for mixing. Optional low impedance input transformers are multiple shielded for absolute elimination of hum. Two phono input circuits operate into a fader gain control and may be mixed with one or all of the microphones. Bass or treble frequencies can be accentuated or

attenuated independently of each other. Model T-30W55 is the ideal amplifier for installation in theatres, schools, institutions, dance halls, parks, flying fields, stadiums, race tracks, sound trucks, etc. Ask your Thordarson Distributor for Amplifier Catalog 600F.

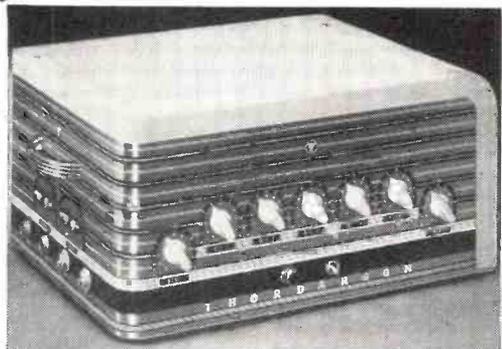

AMPLIFIER DIVISION
THORDARSON
 ELECTRIC MFG. CO.
 500 WEST HURON STREET, CHICAGO
TRANSFORMER SPECIALISTS SINCE 1895

sis to conserve space. When mounted in this manner it will be necessary to cut small slots in the can to permit the leads to pass under the edge of the can. Leads to the volume controls should be shielded as well as the lead to the grid of the 6V6. *Amphenol* flexible co-ax cable should be used for the lead from the antenna connector to the switch and from the switch to the oscillator and detector tank coils. Other wiring is simple and straightforward, parts being placed wherever convenient.

Testing

After wiring is completed the power supply should be connected and the on-off switch thrown to the "on" position. If the units have been wired properly both filament and plate power should now come on and the send-receive switch should be thrown to "receive" position and the usual super-regenerative hiss should be heard.

An antenna should be coupled to the receiver and the tank coil adjusted by stretching or squeezing the turn until the 2½ meter band is covered. The signal used for this checking may be from a local transmitter or from an outside signal. Regeneration should be smooth and easily controlled over the entire band. After the receiver has been adjusted properly the send-receive switch should be thrown to "transmit" and the frequency of the transmitter checked either by Lecher wires or on a calibrated receiver.

Antennae

Probably the best antenna for use with this unit is the quarter-wave type insulated from the car body and fed at the bottom end by means of co-ax cable. The antenna should be mounted on the car as high as possible and preferably near the center. An excellent place to mount an antenna of this type is above the center of the windshield by means of a feed-through insulator with another stand-off insulator a few inches up from the bottom to give mechanical rigidity. It is essential that the antenna be rigid if the transmitter is to be used while the car is in motion. If it is not practical to use an antenna of this type, a one-half or three-quarter wave rod can be mounted on the cowl and fed by any convenient means.

Installation

Installation, of course, will vary with the car. The *Mullory Vibrapak* should be mounted on the engine fire

wall. Short, heavy leads of at least number twelve wire should run direct to the battery in order to minimize the voltage drop. Filament leads from the transceiver unit should preferably run to a different point than the *Vibrapak* to eliminate hash. After installation is completed, the antenna length should be adjusted to that which will cause a dead spot to appear in the center of the band on the receiver when excessive antenna coupling is used.

The couplings should now be backed-off, either by enlarging the size of the coupling link, or by moving the link closer to the grid end of the coil. In the average case a one turn link slightly larger than a tank

coil will usually suffice. Switching to "transmit" position, the coupling coil should be adjusted to a point which will load the transmitter to approximately 40 ma. Maximum coupling will be had with the link at the center.

Any good single-button mike of high gain will serve to modulate the transmitter to its full capabilities.

With a rigid antenna, frequency stability is excellent for a modulated oscillator due to the light loading of the oscillator. Driving in city streets, the range varies with the surrounding terrain. However, even under the worst conditions encountered it is possible to work up to 5 miles consistently and up to 35 miles with optimum conditions. -30-

Once **QUALITY** alone recommended
RCP TEST EQUIPMENT
 Now there's another reason!

The rising cost of everything leaves fewer dollars for the things you need. Today, more than ever, you need dependable test equipment that's engineered ahead. RCP quality and advanced engineering at lower test equipment prices have always been good economy. Now, there's another reason why RCP is the buy: your net income today. RCP test equipment in this line for '42, with each instrument in this complete line designed to do more work STILL costs you less! Look at these RCP values:

RCP-446 AC-DC MULTITESTER

Quality in appearance, performance, materials and construction put this RCP general test instrument in a class with testers costing twice as much. Look at the specifications: DC Voltmeter 0/5/50/250/500/2500; DC Milliammeter 0/1/10/100/1000; DC Ammeter 0/10; AC Voltmeter 0/10/100/500/1000; Ohmmeter 0/500/100,000/1 Meg. 3-inch square D'Arsonval meter, accurate within 2%. The equivalent of 25 instruments in a single Bakelite case, complete with batteries—only..... **\$995**



RCP-309 DYNOPTIMUM TUBE TESTER

Tests all new miniature and Bantam, Jr. tubes, as well as all ballast tubes. Provides for tubes up to full line voltage. Tests at RMA specified plate voltages and loads. Hot interelement short and leakage test between all individual elements. Hot cathode leakage test. Noise test—indicates noisy tubes that would otherwise test "good." Spare socket for future tubes with new base arrangements. Adjustable for all line voltages 105-135, direct reading. Net..... **\$1795**



RCP-702 SIGNAL GENERATOR

Latest circuit and mechanical design. Continuously variable 95KC to 100MC, direct reading. Unmodulated or modulated 30% at 400 cycles. Five-step calibrated attenuator, 1 to 500,000. No dead spots, ripple or feedback through line. Net..... **\$2595**
 Price, complete.....

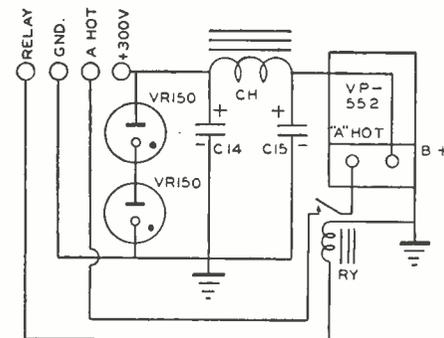

Wiring diagram of the mobile power supply.

BETTER SEND NOW for the new free RCP catalog. Get the low-down on the test equipment more users are buying than ever before. Write for your free copy today.



RADIO CITY
 PRODUCTS COMPANY, INC.
 88 PARK PLACE • NEW YORK, N. Y.

What's New in Radio

(Continued from page 40)

Acves & King, Inc., 11 West 42nd St., New York City, its patentees and licensors.

The new type system usually employs for its aerial a doublet of two wires, one 45 feet long and the other 15, supported by neat angle-iron masts mounted on coping or superstructure. Lightning arrestor and antenna transformer mount on mast, coping or wall, close to the aerial, so that no superfluous strain is placed on the wires. Where space is limited, vertical rod aerials are used.

The transmission line from the aerial connects with the outlet couplers. Up to 20 couplers can be served with a single aerial and transmission line. The patented coupler unit is provided with a built-in polarized outlet, fitting a standard box with face plate, which in turn takes a special polarized attachment plug connecting with antenna and ground terminals of the radio set. No

switching or other changes are required in making the outlet instantly available for satisfactory broadcast, short-wave or FM reception. Despite the addition of the FM feature, there is no increase in the cost of the new multicoupler antenna system.

Latest G-E Consoles

Frequency modulation is included in a variety of new radio receivers announced by the *General Electric* radio and television department, Bridgeport, Conn., as part of its 1941-42 line.

The new models include six radio-phonograph combinations, of which three have the

ANSWERS BY TRIPLETT



The need for controlled processes and uniform quality in parts has been answered by Triplett in setting up manufacturing facilities that make the company practically self-sustaining in the fabrication of instrument and tester components.

Shown here is a view of one section of the automatic screw machine department in the modern Triplett plant where essential parts—some as minute as the smallest used in watches—are turned out 24 hours a day. More and more, Triplett has turned to wholly automatic fabrication of materials to speed up production and to eliminate any possibility of human error. To assure parts best suited for Triplett needs, company engineers have pioneered in the design and manufacture of countless fabricated materials including switches, bar knobs, resistors, jacks, special adapters, etc.—a complete service intended to give each user the fullest measure of satisfaction.

**THE TRIPLETT ELECTRICAL
INSTRUMENT CO.**
Bluffton, Ohio

**BIG
FREE
CATALOG**

EVERYTHING IN RADIO

Sets, parts, supplies, public address systems, amateur equipment, testers, kits and fluorescent lighting at lowest prices. Huge stocks, bought months ago . . . ready for shipment the same day your order is received. The Defense Program is making big demands on our industry but because of our advance buying we are able to fill your orders promptly and efficiently.

**BURSTEIN-APPLEBEE
COMPANY**

1012-14 McGEE, KANSAS CITY, MO.

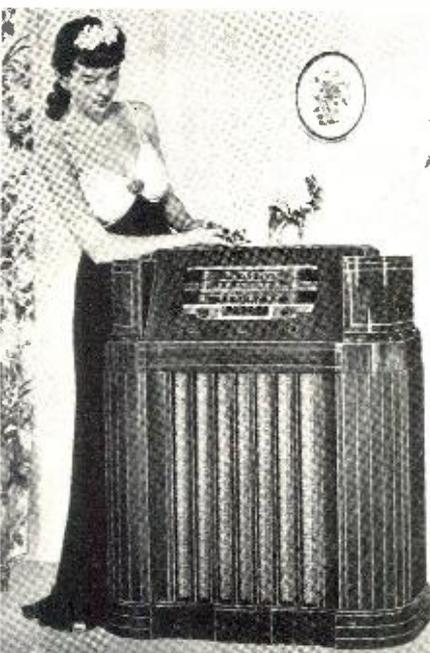

frequency modulation band, and two new consoles, both equipped with FM. One new console, also with FM, was announced earlier. At the same time, G-E announces seven new table models to be added to the table models, table-type radio-phonographs, and battery-portables announced previously.

One of the outstanding features of the new models, according to A. A. Brandt, G-E radio sales manager, is that frequency modulation is being offered at approximately the same cost as previous models not so equipped.

Another noteworthy feature of the new radio-phonograph combinations is the period styling which characterizes their distinguished cabinets.

Heading the group of radio-phonographs is model LFC-1228, equipped with 12 tubes including rectifier. This model has three receiving bands, for frequency modulation, standard broadcast, and short-wave, and three built-in Beamoscope antennas, each specially designed for the three receiving bands. The phonograph has an automatic record changer to play a series of twelve 10-inch or ten 12-inch records.

Its cabinet is styled in the tradition of the 18th century period. An unbroken top permits ornaments to remain undisturbed while playing the radio or phonograph. Top and side panels are in figured stripe mahogany veneers. In matching four-piece swirl mahogany are the twin front panels, one a roll-out drawer for the phonograph and the other the radio control door. The lower part of the front is a pierced dual grille treatment. The left-hand grille is a door for the record storage compartment. Gadroon carved mouldings on the front of the cabinet mark its period styling.

New Shipping Cartons

As a result of extensive research, *Audio Devices, Inc.*, 1600 Broadway, New York, N. Y., announces a new shipping carton for from one to three recorded glass base instantaneous blanks. Many thousands of these cartons have already given 100% satisfactory results. Each carton consists of a double corrugated container and a sufficient supply of shredded lint-proof wax paper and they are available in 12" and 16" sizes. They are primarily to be used for the re-shipment of recordings from station to station or from recording studio to processing plant.

Audio Devices and its distributors throughout the United States are handling these shipping cartons on a no profit basis in order to promote the wider use of the substitute glass base discs which have become necessary due to the shortage of aluminum so urgently required by the national defense program.

New Monitor Speaker for FM Stations

A new high-fidelity loudspeaker and high-fidelity amplifier for use in FM broadcast stations has been announced by the radio and television department of the *General Electric Company*, Schenectady, N. Y. The speaker, of single-unit construction, provides high-quality reproduction for the station operating staff and for parts of the station where true high-fidelity reproduction is desirable, such as in audience and sponsor rooms.

A special design, evolved by radio engineers of the *General Electric Company* at Bridgeport, Conn., made it possible to achieve high audio fidelity with only one speaker. It was previously necessary to use a base or "woofer" speaker and a high-pitched or "tweeter" speaker to cover the entire range.

The speaker is mounted in a cabinet of matched walnut veneer, and may be used on either a table or desk top. It is recommended, however, that it be used on a spe-

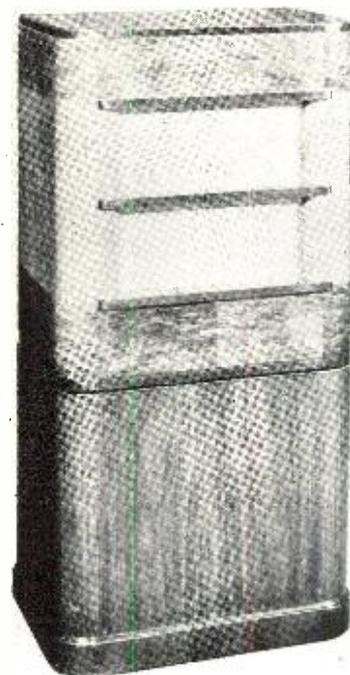

cial base designed as a companion unit. This base, about 18 inches high, provides ample space for mounting the high-fidelity amplifier.

The amplifier and speaker may be coupled directly to the new G-E FM station monitor for monitoring the programs and audio quality of an FM station.

Shure Voice-Type Unidyne

Shure Brothers, "Microphone Headquarters," Chicago, announce that the well-known Shure Unidyne Dynamic Cardioid Microphone is now available in a series of "voice" models for Police and Commercial Radio, as well as for Public Address, Paging, Broadcasting and Recording.

The new "Voice" Unidyne, employing the Shure patented Uniphase principle, combines the advantages of true cardioid uni-directional performance with emphasis on "voice" response. It is dead at the rear—provides clear reproduction of speech or singing without interference from feedback, background noise or reverberation. The extra-rugged, single-unit Uniphase construction makes it especially suitable for severe outdoor and indoor use. Uses a specially suspended double-wind screened moving coil system—and is not affected by heat or humidity. Low impedance models permit practically unlimited cable length.

The modern case design and satin chrome finish, same as the regular Unidyne, gives it distinctive appearance and "eye" appeal. Swivel head, with standard $\frac{3}{8}$ "-27 thread for stand mounting. Built in cable connector. Furnished complete with 25 ft. shielded cable and connector plug. Three Models: Model 55A1, low impedance, for 25-50 ohm circuits, Model 55B1, low impedance, for 200-250 ohm circuits with internal transformer, Model 55C1, high impedance, with internal transformer. For further information, write to Shure Brothers, 225 West Huron Street, Chicago, Illinois.

New String Instrument Amplifier

A "Singing Strings" amplifier for providing resonant power for string instruments is now offered by John Meck Industries, 1313

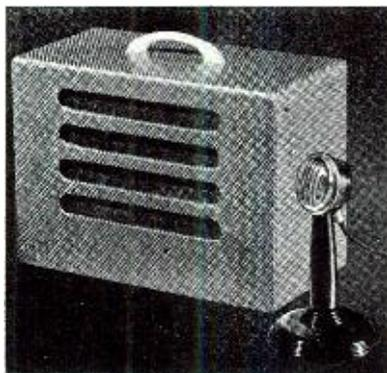

W. Randolph St., Chicago, Ill. It may be used with any string instrument for providing increased volume, either for solo or orchestral work, without the harshness of "heavy playing."

The Model M-1 Amplifier System is made up of matched units, employing a specially designed amplifier, loud speaker, and acoustic carrying case, so that tonal qualities are faithfully reproduced and rich overtones not ordinarily audible may be heard. Two input jacks are provided, allowing two instruments to be played at one time through the amplifier system. If desired, a crystal or dynamic microphone can be used with one electrified instrument for accompaniment. The unit may be used with any modern electric instrument or in conjunction with a contact pick-up for electrifying any string instrument. It is completely self-contained in a lacquered, record carrying case with ivory plaskon handle.

Speaker Field Supply

With defense priorities on special metals, production of P-M speakers is being abandoned in favor of the electro-dynamic type. Thordarson laboratories now have designed

a speaker field supply to meet the need of these electro-dynamic speakers.

The flexibility of this field supply makes it adaptable to practically any loud speaker that is equipped with a 2,500 ohm field. The switching mechanism permits operation of two 2,500 ohm fields requiring approximately 14 watts field excitation; four 2,500 ohm fields requiring approximately 8 watts field power; or, eight 2,500 ohm fields requiring about 4 watts field power. Efficiently operates on 110-120 volts 50-60 cycle current, and measures approximately 9" long by 5" wide by 7" high.

Information on the speaker field supply and the entire Thordarson line of quality amplifiers is contained in Catalog No. 600-F available free from your distributor or direct from the factory, Thordarson Electric Mfg. Company, 500 West Huron Street, Chicago, Illinois.

New Molded-In-Bakelite Capacitors

A new midget or so-called "postage stamp" molded-in-bakelite receiving circuit mica capacitor, Type 1478, is announced by Aerocon Corporation of New Bedford, Mass. This capacitor is an elongated version of the types heretofore offered in the "postage-stamp" series—its body measurements are 1-1/16" long by 7/16" wide by 3/16" thick. Hot-tinned brass wire leads provide the connections. The same molded casing is used for Type 1479 with silvered mica section. Both types, because of the longer casing, provide for higher capacity values at the given 1000 v. d.c. Test (500 v. d.c.w.) rating. The standard mica Type 1478 is available in from .0001 to .002 mfd., while the silvered mica Type 1479 comes in .0001 to .001 mfd. capacity.

Solves any Ohm's Law Problem with One Setting of the Slide

YOU'LL use this remarkable Calculator every day—it's so simple, easy and complete! Does not require any slide rule knowledge. All values are direct reading on the Calculator. Figures amperes, volts, watts, ohms—quickly, accurately.

Scales on two sides cover the range of resistances from .1 ohm to 10 megohms, also the range of currents, wattages and voltages commonly used in radio and commercial work. A setting of the slide also tells you the stock number of the resistor or rheostat you may need. Size of Calculator only $4\frac{1}{8}$ in. x 9 in.

Send for Calculator—Today! At Your Jobber or Use Coupon!

There's nothing like it. It was designed for you by Ohmite Engineers—and made available for only 10c to cover cost of handling! Why be without it! Get your Calculator at your Jobber or clip the Coupon and mail it today!

ONLY 10c to cover handling cost

OHMITE MANUFACTURING CO.
4884 Flournoy Street, Chicago, U. S. A.
10c in coin enclosed. Send Ohm's Law Calculator.

Name.....
Address.....
City..... State.....
R-11 News—Nov. 41

Be Right with **OHMITE**
RHEOSTATS • RESISTORS • TAP SWITCHES

LEARN CODE
the easy way...



with a Bud Code
Practice Oscillator

BUD CPO-124 Code Practice Oscillator has a clear, pleasant note. Variable volume and pitch controls. Use the built-in magnetic speaker or connect up to 20 ear-phones for group practice. Any number of keys may be used. 110 volts A.C. or D.C. Complete with tube and code card.



Write for your
copy of the No. 241
BUD Catalog.

BUD RADIO, Inc.
CLEVELAND, OHIO



**CHECK
HERE**

... if you want a
BETTER radio job!

Technical ability is the
only thing that stands be-
tween you and a better
job... CREI can pre-
pare you NOW with just
the training you need!

Yes, YOUR opportunity is here NOW! Our home study courses are "made to order" for this opportunity. CREI trained men are in demand throughout the radio industry... and the demand will increase as the months go by. If the lack of technical training is your stumbling block... you can do something about it now—if you will. Your radio experience backed by CREI modern training will equip you to share in the better, good-paying jobs that await trained men. 5000 radiomen can't be wrong! They're the men who have already turned to CREI for the advanced training they realize is necessary for success. Can't we help YOU?

**Write for Details
and Free Book Now**

*If you are a professional radio-
man and want to make more
money—let us prove to you we
have something you need to
qualify for the BETTER job
opportunities that can be
yours. To help us intelligently
answer your inquiry—please
state briefly your education,
radio experience and present
position.*



Free Booklet
Sent

**CAPITOL RADIO
ENGINEERING INSTITUTE**

Dept. RN-11, 3224-16TH ST. N. W., WASH., D. C.

In the Control Room

by T. R. WISEMAN

THE control room is the heart—the real romance and drama—of radio. An engineer is not only a mechanical genius who understands electricity, but he must be an artist and critic as well. He must have an ear for good tone, in order to graduate the volume of sound which reaches the public. He advises and rehearses all local programs, in collaboration with the announcer, the director and the cast, whether singing or speaking. He helps adjust programs to the time allotted for each one.

Singers or actors or speakers, looking for success in a radio career, do well to heed the nod of the man who guides the controls. His check on the program is more important than "art"—for he can hear the program as it is rehearsed, as it will appear to the public, and he can frequently suggest a tone change or a harmony balance which will make all the difference between the performer's "click" or failure.

The engineer is used to listening for separate themes in a chorus, and if his nod indicates that the tenor needs strengthening, or the bass is too heavy, then bass and tenor will do well to heed. He must study the balance of the voices and adjust the different levels by changing the volume of sound on the control board for the variations of pitch which are unavoidable in microphone work.

One control room engineer speaks with fervor of the gracious way in which Fritz Hoff (violinist-director), in rehearsing his programs for local broadcast, allowed his musicians to play only a short phrase of the music, and then turned to the control engineer for assistance in direction, so that the high notes and the low, deep notes would register properly on the microphone.

A control room engineer can bring out a tone which is too soft, and he can lower a tone which is too loud, by use of his volume controls, but he has no way to sweeten a sour note. Fifty percent of radio success is due to microphone technique.

The microphone or mike as it is commonly called, cannot pick up notes above a certain range. If a soprano is singing a very high, rather sharp, brilliant note, she should be taught to fade that note slightly away from the mike so that it will not sound shrill to the listeners. Very low bass tones are also outside the range of the average mike pick-up. Violin players especially, take note of this! Occasionally a singer will lose a note, caused frequently by faulty breath technique. The mike will portray these frantic gasps as well as the gap caused by the lost note.

During odd moments it is part of control room work to test and cut transcription records to be used at another time. The material for most of these transcriptions comes in on the network, although records are also made from studio programs. Other transcriptions are kept on file by the stations for use in case of diffi-

culties with a scheduled studio program or if the network is cut off unexpectedly because of wire trouble.

Records on certain network transcription programs must be used and returned to the American Federation of Musicians within seven days. This is because the musicians' unions agitate against the use of transcribed programs, lest the over-use of such records might deprive musicians of work. There are two sides to this question. Musicians who are employed in making these transcriptions are paid for their work, as are musicians who play on network programs direct, or on local programs. All three phases are a benefit to musicians in general.

These transcription records are used for sound effects, as well as for short program announcements. An embarrassing moment for an engineer occurred once, when a bugle was required for sound effect. There were at that time two transcription record machines in use. One which spun the record at a rate of thirty-three and a third revolutions per minute and the other at seventy-eight revolutions per minute. The operator, by mistake, used the thirty-three and a third when he should have used the faster machine. As a result, the bugle sounded like a rheumatic trombone.

Another amusing instance of a control room engineer's troubles, is illustrated by a local program's effort to give extra service to its listeners. A famous national figure, a stormy petrel, was on the verge of death. A news bulletin of his passing was expected momentarily and when the station signed off at midnight, the announcer was authorized to tell his listeners that if they wished to listen in, the station would broadcast news of the public man's death, during the night.

In the wee small hours, the newsman was notified of the message, and called the control room, located on the edge of town, instructing the engineer to start up his transmitter. So the engineer "warmed" things up. When the announcer had finished giving the news-cast, he concluded with the words,

"We will finish with a short transcribed program."

The engineer out on the hill was caught off guard. No one had mentioned the transcription and he had only an instant to get the record and start the machine. Reaching quickly behind him into the case where transcribed records for emergency use were kept, he took one out without glancing at the title and started it off. He was horrified to hear a male quartet singing. "I'll be glad when you're dead, you rascal, you!"

Another reason for the fascination of control room work is the intimacy between the control room engineer and his audience. There is nothing between the control room and the private life of the world, except the click of a switch. He is responsible for his audiences' enjoyment, even more than an actor upon a stage. Even the

most marvelous song by John Charles Thomas or Rosa Ponselle, cannot reach radio listeners, in perfection of loveliness, unless the control engineer is on the job. And like the stage, the control room has the motto, "The show must go on!"

Most stations design and install their own control boards, to suit the space in which the control engineer must work and to make the co-ordination of announcer, control room engineer and studio program as flexible and as efficient as possible.

KLZ (Columbia) of Denver utilized a small space at the back of the control room very cleverly to install an extra announcer's booth. In this the control engineer can watch the studio program and by means of a mirror, the announcer behind him, while the announcer can see his signals, as well as the studio program.

Since the duties of the control room are multiple, and sometimes an emergency is a matter of split seconds, every part of his equipment must be directly under the engineer's hand. It is frequently necessary to change a connection from one board to another without loss of time. Occasionally one man will hold the controls for four programs under his hand at the same time: the network, through the leased wires, the announcer for network "breaks" in studio A, a rehearsal in studio B, and a transcription which he is taking through the leased wire, for use later in the day.

Many of us do not realize that the network programs come through the station on a telephone company service leased wire. These are put through the radio station control board and released on the local radio station hook-up. In installing a board for this station work, a wire trouble called "cross talk" is one of the most difficult problems to be overcome by the radio station.

Cross talk is caused when a high level line and a low level line are too closely connected on the control board. If sufficient air space separates these wires, the air will act as a further insulation to the current. But if they are too closely connected on the board, the voice current carried by one pair of wires will be inducted into adjacent pairs. Standard equipment is very carefully insulated. These copper wires, carrying low voltage, are first insulated with ordinary thread insulation. After this another ordinary insulation is used and the heavy tarred covering used to protect all telephone wires covers the outside. In spite of this heavy shielding, cross talk is a very serious problem.

Breaking the connection in another way, by crossing the line with a test set, is also called "cross talk." Many funny and (to the transgressor) tragic instances have occurred in this way. A crew of linemen were working between Kansas City and St. Joseph, looking for trouble on a service line. One of the men was ordered up a pole to test lines numbered 1197 and 1198. He hooked his clips over the two wires. His head phone was right in front of his mouth and without thinking, he bawled down to the foreman, on the ground, with a usual lineman's profanity:

"Guess this ain't the one, Joe. The _____ thing's got a lot of _____ music coming through." The profane em-

broidery was clearly audible to listeners who were tuned in on the Philharmonic Symphony Orchestra! And they say the lineman's last pay-check was made out in the office before he could climb down the pole.

Another telephone employee who had worked for the company for over thirty years wanted to hear one of the Dempsey fights. He picked himself a quiet corner behind the board, borrowed a head-set, and clipped in on the wire. He enjoyed the fight for about half an hour, cutting off the station listeners completely, while the rest of the staff went crazy trying to answer telephone complaints and nearly taking the telephone building apart, trying to find the short which he was causing. He

also found his pay-check ready for him.

Among other duties the engineer is responsible for checking the log. Each station is required to keep a log of programs, timed to the second, including all announcer's words, station breaks, the number of words used, length of individual programs, names of sponsors and any changes made from the detailed program planned for the time, as well as the reason for the change. This log is filed and must be sent to the Federal Communications Commission in Washington, if demanded. Loss of license may follow any offense against the Commission's rulings.

Stations must stay on the air unless given permission by the Federal Communications Commission to cease operating. While run-

10,859 SET MODELS USE CONTROL TYPES INCLUDED IN THIS CABINET

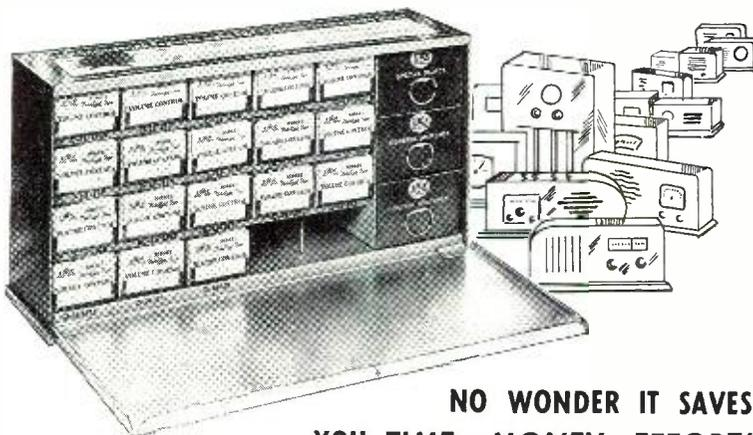

NO WONDER IT SAVES YOU TIME..MONEY..EFFORT!

By ACTUAL COUNT, 10,859 of the radio receiver models listed in the new IRC Volume Control Replacement Manual (Edition No. 3) call for one or more replacements that can be supplied from the 18 Type D Universal Controls, 6 switches and 5 extra Tap-in Shafts included in the IRC Control Cabinet. In other words, Cabinet owners are equipped for fast, accurate control replacement service on as high as 75% of all radio sets they are likely to be called upon to repair—and that isn't all!

Thanks to Tap-in Shafts, you can often use standard controls instead of more costly special replacements. What's more, Tap-in Shafts simplify installations, especially in crowded chasses where they avoid removing other parts in order to insert the control. And remember! Type D Universal Controls themselves are small enough to fit in anywhere—large enough for utmost dependability.

ASK YOUR JOBBER FOR THIS MANUAL!

If you haven't already received your copy of the new IRC Volume Control Replacement Manual (Edition No. 3) ask your IRC jobber today. It's a "must" for every serviceman who makes volume control replacements. Larger—more accurate—easier to use—contains more information and 35% more listings than ever before.



INTERNATIONAL RESISTANCE CO.

401 N. Broad Street, Philadelphia, Pa.



Great News! For RADIO and ELECTRICAL SERVICEMEN

The New Utility Tester

The UTILITY TESTER is a new kind of instrument for testing all electrical appliances—WASHERS, IRONERS, REFRIGERATORS, RANGES, VACUUM-CLEANERS, TOASTERS, PERCOLATORS, HEATERS, SUN LAMPS, AIR-CONDITIONING, MOTORS, ETC. The UTILITY TESTER enables every possible measurement necessary to service any electrical appliance.

SPECIFICATIONS:

3 Wattage Ranges: 0 to 5000 Watts A.C. and D.C. The UTILITY TESTER reads the actual consumption of any appliance, motor, etc., while it is in operation thus you can actually prove to the layman the actual cost per hour of operation.
6 Voltage Ranges: 0 to 1000 Volts A.C. and D.C.,
4 Current Ranges: 0 to 100 Amperes A.C. and D.C.,
2 Resistance Ranges: 0 to 3000 Ohms. The UTILITY TESTER reads all resistances commonly used in electrical appliances, and in addition reads extremely low resistances. For instance 1½ ohms appears on the center of the low ohms scale and resistances as low as 1/50th of an ohm are easily read.

The UTILITY TESTER comes complete with portable cover, self-contained battery, test leads and all necessary instructions. Shipping Weight 11 pounds. **\$12-85**
Only

NOTHING ELSE TO BUY

SUPERIOR INSTRUMENTS CO.

227 Fulton St., Dept. RN11, New York, N. Y.

ANNOUNCING A NEW MASTER TELEPLEX To Teach You the Code

The Master Teleplex Code Teacher has been streamlined to make it easier for you to learn the code. Yes, the same engineers who developed the original TELEPLEX have worked out an entirely new principle. This new machine records your sending visibly by a brand new method on a specially prepared tape and also sends back your own key work at any speed you wish. Thus you learn by hearing as well as seeing. There are NO PERFORATIONS—NO INK. Far superior to anything ever developed... A marvel of simplicity.

Teleplex machines are used by practically every school teaching the code. Regardless of whether you wish to learn code as a hobby, a vocation, or to teach, you will surely want to see this new Master Teleplex. We furnish you a complete course, including practice messages, the new Master Teleplex plus a personal service on a money back guarantee. Low Cost. Easy terms. Special trial offer to any responsible defense unit. Write for complete information.



TELEPLEX COMPANY 107 HUDSON ST.
DEPT. RN 11
JERSEY CITY, N. J.

ning a small station in Kansas, back in the early days of radio, an operator found his crystal had gone bad and he could not continue to transmit programs. The crystal is used to keep a station on its proper frequency. Any attempt to broadcast would be ruinous. But he could not go on the air until he got a new crystal and he could not stop until he had Federal Communications Commission permission. Although he was already stopped, he wired the Commission in Washington for permission to cease operation until he could get a new crystal.

Control room engineers are nearly all young men. Perfect co-ordination is an essential, they must be on their toes, every moment on duty. Only the young men can keep going, constantly, smoothly, during eight hours' duty every day. A second's delay in timing "station breaks" on the network program is very awkward. A man's mind must be free from all outside worry, such as the air-line pilots call "homework" or "human cargo." Such worries prevent precision of mental effort and are responsible for most mistakes. Mistakes on the radio, particularly carelessness, are costly. The engineer frequently pays for a bad mistake by loss of his job. The station pays in loss of prestige and sponsors. Some control engineers become announcers and a great many of them become continuity writers, when they find themselves "slowing up."

In the kindergarten days of commercial broadcasting a certain small station in Kansas had sold a commercial program to a music firm of long established name in the vicinity. The firm was conservative and stood for the best in music, in taste, and in clientele and business practice.

They had recently stocked a new line of phonograph records of especial value and wished to advertise them by having them played on the program.

At that time it was difficult to reproduce the transcribed programs, because of the lack of expensive equipment. This station had built their own turn-tables for this work, and the result was pretty bad. Sustained musical notes would strike an uneven place and slide up and down in a very unpleasant sound.

After the program had gone on for two or three nights the proprietor called up one night and asked, with tears in his voice, "How much will you take to stop my program?"

Good-will, as in any advertising business, is the most valuable asset a station can have. Naturally, stations have different codes of action in this matter. However, every station does try to maintain an attitude of courteous treatment and co-operation for the benefit of the public. There are all sorts of cranks, who call up and complain, sometimes with justice and sometimes in an absurd belief that it is the fault of the station if their own radio does not work.

One particularly amusing incident occurred when a lady called the control room one evening about ten o'clock to beg the engineer to shut off his program (a national network broadcast) for an hour. Her son was to sing in a program to be broadcast from the Mark Hopkins Hotel and she was sure the station would be willing to cease operation for a short time

so she could listen to her son. It seems that when the station was on the air her set would not pick up San Francisco because of conflicting programs! All explanations of Federal Communications rulings were over her head.

She asked the engineer plaintively, "How would you like to have your mother listening for your voice—and unable to hear a word because a selfish and completely mercenary local station insisted on broadcasting—"

The best stations, in spite of such incidents, continue to operate on the theory that their first duty is to serve the public. The motive force—the heart of the entire service—originates in the control room, where every split second is alive and crackling with the spirit of that same devotion.

—30—

Bench Notes

(Continued from page 23)

others made little or no charge for what was considered a small service. From the cases reported we are inclined to believe that a considerable number of radio shops are operating with no definite price policy, and charges are made with no known system that would bear close inspection. For such reasons as these we feel that radio service as a whole is hardly even a business.

There was a time when the radio service man, arriving at the side of an ailing receiver, was hailed with a fervor somewhat similar to that accorded to a rescue party by marooned Arctic explorers; but as the novelty of radio reception diminished, and the prices of receivers declined, the set-owner's enthusiasm likewise waned, and many of them developed an annoying habit of wanting to know what they were being charged for. Therefore over a period of years, a definite price policy was more or less automatically developed at Super-Snappy Sales, designed to prevent misunderstanding or suspicion on the part of the customer, and at the same time keep the shop rent paid. Since this policy has been reasonably effective for some time, and no customer has as yet bounded in our door shouting "Thief—Robber," we will present a rough outline for any who may be interested.

In general, our policy is an attempt to set up a system of minimum prices, and to arrive at a definite understanding with the customer before any repair work whatever is done. This is by no means the customary flat estimate method, which is seldom satisfactory, as such estimates are often too low to permit a first-class service job at a profit. However, certain prices can be fixed, and made known as minimum charges.

For example a minimum shop charge of 50c is fixed for all midget table model receivers if the chassis is removed from the cabinet, which is usually necessary, even if only to check tubes. For console model re-

ceivers, up to 10 tubes, the minimum shop charge is \$1.00, while for larger sets a proportionately higher charge is made. As a rule the owners of fine receivers, employing fifteen or twenty tubes, or more, are not given to quibbling over small service charges, and a price of \$1.50 to \$3.00 for such service will usually be obtained without difficulty. When auto radios are removed from the car, the handling charge is \$1.00 which includes, of course, re-installation. In many models it is necessary to remove the glove compartment as well, and an additional charge of 50c is added for this labor. It should be borne in mind that these are not total charges, but simply the minimums in case no repair is made, or recommended replacements are not purchased.

Usually, however, the customer wants his set repaired, and whether he asks for an estimate or not, a tentative price should be given, and no work done until the customer has agreed to the proposal. As a rule the major defect responsible for the receiver's trip to the repair shop is readily detected, but more often than not smaller defects will be uncovered when the principal trouble is cleared, and the service man must have some margin for such cases if a mutually satisfactory job is to be done.

A typical case might be as follows: An average seven-tube receiver is brought to the bench with complaint of strong hum and mediocre reception. Since the receiver is three years old the service man may rightly suspect the filter condensers of being worn out, which is verified by application of a test condenser. Using the method described some months ago, a quick estimate of the minimum repair charge may be made as follows:

2—8 mf. Condensers....\$1.80
Labor 1.80

Total\$3.60

This amount should not be quoted to the customer but instead an estimate made as "somewhere around four to five dollars," with the proviso that the customer must be consulted if the total cost exceeds five dollars. As a rule the customer will agree to this (if he can afford it) and the work may be begun.

After the new condensers are installed, it may be found by further checking that a couple of carbon resistors have changed in value sufficiently to require replacement, and new ones are installed at 25c each, plus a similar charge for labor, adding \$1.00 to the first estimate, making a total of \$4.60, which is well within the limits of the original agreement with the customer, hence there will be no lifting of eyebrows when the bill is presented. In actual practice it will be found that few customers will insist on an exact estimate of the repair costs, but it is important that a limit be set which must not be exceeded without the customer's permission.

This method is quite flexible, and may be applied to almost any job,

large or small—but don't ask, "How about intermittents?" We have been rasslin' radios for quite a few years, but don't know the answer to that one yet.

-50-

Add a Tweeter for FM

(Continued from page 37)

justed thereafter but rather held constant, so far as amplitude is concerned, the frequency of course being varied.

From a study of Fig. 4 it is evident that if Z1 has a low value and Z2 has

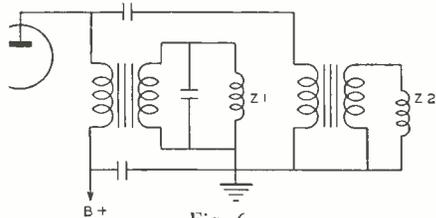

Fig. 6.

a high value relatively, that C may be fairly large. As a practical case, Z1 would be 2 ohms, C would be 6 microfarads, and Z2 would be 12 ohms. The Jensen tweeter in a test had 12 ohms voice coil resistance and did not take power of appreciable magnitude at 120 cycles. A Rola K-5, with 3 ohm coil, using 6 mfd. and 2 ohm woofer, took power at 120 which made the tweeter rattle.

A Utah speaker having an 8 ohm

resistance voice coil, using a 2 mfd. series condenser and Jensen tweeter, took all the lows and the tweeter took no power at 120 cycles. However, with the 6 mfd. condenser the tweeter did start to rattle at 120. The smaller size condenser made the tweeter circuit impedance high at low frequencies and no power was taken.

From all the experimental data derived, the conclusion reached is that for low woofer resistance and a large

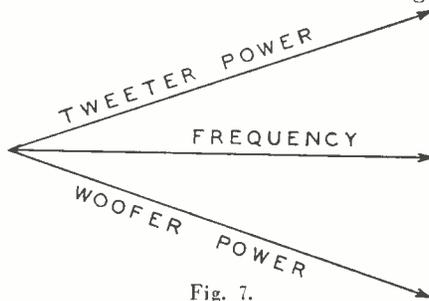
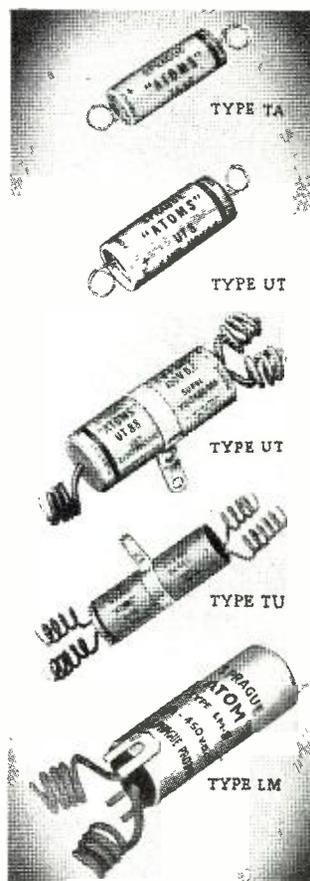

Fig. 7.

series capacity the tweeter resistance should be high. Stated another way, the capacity in the series circuit should be small if the tweeter resistance is small compared to the woofer resistance.

The series condenser method has the great advantage of low cost and simplicity. While the response may not be as smooth and as definite as speakers used with low pass and high pass filters, it is quite smooth enough and satisfactory.

-50-



5 SPRAGUE ATOM TYPES

FOR BETTER, SMALLER, MORE ECONOMICAL REPLACEMENTS

● Of course you know Sprague Atoms—the "blow-proof" midget dry electrolytic condensers that have literally made larger, old-style condensers obsolete. But did you know there are five different Atom types—types that make these popular midgets practically universal for any replacement job whether it be single-section, multi-capacity, lug-mounting, or calls for separate positive and negative leads? Did you know leading manufacturers specify Atoms for equipment to be shipped overseas—because Atoms are so uniformly dependable under bad atmospheric conditions? And did you know that Atoms are so rugged, they'll even stand up in many jobs where old style large dry and wet electrolytics were formerly specified?

Play safe. Use Sprague Atoms in every job.

YOU SAVE THREE WAYS

Make up hard-to-get replacements by strapping individual Atoms together with ST Mounting Straps—supplied free! You'll find the combined Atoms actually smaller, often cheaper, and fully as reliable. You save time—money—space

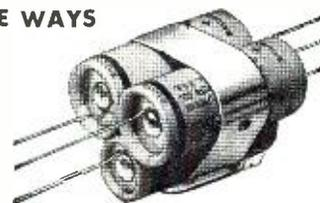

SPRAGUE CONDENSERS

Sprague Products Company,
North Adams, Mass.



QUICK, EASY WAY TO TRAIN FOR RADIO in 8 WEEKS

H. C. Lewis

I'LL FINANCE YOUR TRAINING
Mail the Coupon TODAY and I'll not only tell you about my quick, easy way to train for a good pay job in Radio, Television and Sound, BUT, I'll also tell you how you can get it and pay for it, in Easy monthly payments starting 60 days after 8 weeks' training period.

LEARN BY DOING
On Real Equipment in Coyne Shops
Simple, easy method of Practical Training. You don't need previous experience or a lot of book learning. You work on real equipment in the Coyne Shops at Chicago. This 8 weeks training prepares you for a job in service and repair work—we also offer radio operating training. Full details of this training will also be sent you when you send coupon.

EARN WHILE LEARNING, Job Help After Graduation
We help you get part time work to help with living expenses and then give you employment service after graduation.

H. C. LEWIS, President,
Radio Division, Coyne Electrical School,
500 S. Paulina St., Dept. 81-3k, Chicago, Ill.
Dear Mr. Lewis:
Please send me your Big FREE Book, and details of your PAY-AFTER-GRADUATION-PLAN.

NAME _____
ADDRESS _____
CITY _____ STATE _____

SEND COUPON TODAY

NEW! HEARING AID IN KIT FORM

EXTRA PROFIT OPPORTUNITIES FOR ALL WIDE-AWAKE RADIO SERVICEMEN!

Opening up a big new volume market for servicemen, this sensational new midset hearing aid—the first on the market in kit form—will appeal to men and women alike! Look at these facts: 1. Outperforms 2-tube instruments and has less battery drain. 2. Easily built and serviced. 3. No larger than a pack of cigarettes. 4. Weighs less than most aids. 5. High degree of sensitivity. 6. Small batteries give long service. 7. All components guaranteed. Complete kit only.

\$37.50 LIST

Servicemen and Dealers! Write for Discounts Today!

MICROTUBE LABORATORIES
2414 W. Lawrence Ave. — Chicago, Ill.

Duotone

Take a tip from leading broadcast and sound studios, which use these **QUALITY styli** because it's proven that they sound **BETTER** and last longer. Sold at better stores everywhere . . . or write us direct. **DUOTONE CO., 799 Broadway, N. Y. City.**

CUTTING and PLAYBACK

NEEDLES

SOLAR RED-CAPS
Smaller Diameter Dry Electrolytics

SPEED Servicing
Write for Catalog

SOLAR MFG. CORP. Bayonne, New Jersey



Washington Communication
(Continued from page 14)

When it was suggested that the broadcasters spend some money to put their equipment in better shape, they balked.

"We are losing all kinds of money on these shows now," they wailed. "We don't think we should be called upon to put more money into our equipment."

It was suggested that the Government might bear the expense of the improvements.

"Very well," said a Government spokesman. "But if we put up the money, it will be understood that the Government will have to maintain close supervision over the operations."

This stopped the broadcasters cold, because if there's anything the industry wants it is less Government not more. So they agreed to draw up a plan for stepping up the strength of their broadcasts and to follow the suggestions of a coordinator from the Donovan office.

Hobart C. Montee, formerly with WRUL—a station which has been doing a good job—will take over the task of directing the private stations in their efforts. Through the Donovan office move the daily reports of the FCC listening posts, which intercept and analyze foreign propaganda broadcasts. When it is felt necessary to reply to these broadcasts, the Donovan office will see that our short-wave stations carry the replies.

Furthermore, the power of our stations is to be increased and the quality of the programs is to be improved. Programs will be directed to places like French North Africa and Brazil, where they will do some good, and the broadcasts are to be better timed.

After two years of kicking this vital job around, it appears that we are going into action.

WE told you in this column months ago that the trial of the Nazi spies in New York would bring out some sensations involving the use of radio. That forecast was accurate and we advise you to watch for more of the same in the near future. In recent months, South American countries have been discovering that there was Nazi radio espionage being carried on within their borders. In Mexico, Panama, Bolivia, Argentina, Chile and other nations, the discovery of German radio equipment has created sensations. Many of these discoveries have been made with the help of the FCC air patrol. And we'll predict that there will be more before long.

The testimony at the New York trial revealed the accuracy and effectiveness of the work done by George Sterling's Defense Operations Section. One of the FCC men was called to the stand to testify against the Nazi agents. His testimony revealed that the FCC had picked up the signals of the station which the Nazis had ordered set up here on the first day it was in operation. The FBI, of course, was manning the station and so the FCC did not molest it.

But the radio detectives did make a complete recording of all messages sent from the station. This record was introduced in evidence and confirmed the FBI testimony that such messages had been directed to Germany. Furthermore, the FCC had been able to triangulate and locate the station with which the spies were corresponding in Germany. The station used the letters AOR and was in Hamburg—which clinched the case. The investigators got a laugh out of the naivete of one of the spies. He had spent \$400 building a transmitter which any ham could have thrown together for \$40—and then he couldn't ever quite learn how to operate it.

THE fingerprinting of hams undertaken by the FCC has led to the solution of one mystery. Recently, a vandal broke into a broadcast station and smashed up a quantity of valuable equipment, including the crystal control. Fingerprints were found at the scene, but police could not find any to match in their files. The prints were forwarded to the FCC, where it was discovered that the owner was an amateur operator. Investigation showed that the operator had been working for the station, had been fired and had turned vandal to revenge himself.

THE Office of Civilian Defense—run by Mayor LaGuardia—has stirred up a hornet's nest in Government circles. The OCD sent a letter to Government agencies announcing that it was going to set up a central agency for handling all domestic radio broadcasts by Federal agencies. The other Government units began to kick.

This was the first inkling of the ambitious program which OCD is dreaming up to establish itself as the great morale agency and nerve center of domestic broadcasting. The plan is to give OCD the power to form on short notice a super-network to carry "urgent" messages to the nation. Further, the OCD has been working on plans to direct the broadcast of more morale-building programs. Whether this scheme will ever work is doubtful. The other Federal agencies and the broadcasters are certain to fight it.

IT is a foregone conclusion in Washington that this country will declare war on the Axis as soon as it is deemed wise and expedient—and that may be before long. All dreams of aid-short-of-war have gone glimmering and there is no longer any doubt that the administration means to bring about a defeat of the Axis by any means at our command.

And so, being realistic about this thing and understanding that war is inevitable, we want to discuss the status of the amateur operator under the emergency conditions. On the basis of conversations we have had with officials closely in touch with the situation, we think it is safe to assure the hams that, even after the shooting starts, they are going to be allowed to operate to some extent. This does not mean that all hams will be allowed to continue on the air as they have in the past—for in war time, all superfluous or frivolous activities will be curbed. But the amateurs will be allowed to operate to the extent that they show themselves to be useful to the war effort.

There is some sentiment in Washington to repeat, in this war, the drastic action of the last war, when the hams were chased off the air entirely. But, luckily for the amateurs, there are those in high places who have sense enough to see beyond the end of their noses and who insist, therefore, that the hams be utilized—not suppressed.

These friends are trying—and with some success—to show the Defense Communications Board that the amateurs can perform real service. The Army has collected full particulars on all amateur operators in this country and, partly on the basis of this information, the decision is being made on the future status of the hams.

Confidential plans are being worked on now by the Office of Civilian Defense and the Army, which contemplate the utilization of amateurs in the Air Raid Warning Service, in home defense units and in other ways. Some 21,500 amateurs have signified their willingness to work in the Air Raid Warning Service. What particularly interests those in charge of this organization is that nearly 7,000 of these operators have their own power sources, independent of central station service. Under present plans for the Air Raid Warning Service, radio would be an

auxiliary means of communication—to be used where telephone or electric service is knocked out or in areas where there is no telephone service.

It is highly likely that amateurs will be included in organizations set up by city and state defense councils, who need emergency radio channels for civilian communication. The War Department, further, contemplates using amateur operators in Army fixed stations and possibly in the operation of the new aircraft detectors. Dr. Lawrence J. Dunn, W2CLA/WLMD, the recently appointed War Department advisor on amateur radio, has been chosen to assist ARRL Prexy George W. Bailey in drawing up plans for use of amateurs in war time.

It is possible that some amateurs may be taken into the Army as instructors, operators and for special duties. But officials, analyzing the returns on the 40,000 questionnaires which have come in, have discovered that a vast majority of the amateurs are not eligible for induction in the Army. The average age of hams, it was learned, is about 30. About 60 per cent of the operators are married and most are ineligible for Army service because of dependents or physical condition.

The most interesting thing, to some observers, about the returns on the questionnaires was that out of 40,000 operators who filled out the form—about 37,000 of them volunteered to serve their country, either as operators of their own stations or as operators of Government fixed stations. No more impressive demonstration of patriotism and unselfishness could come from any group.

And because Washington knows how faithfully the hams serve in times of stress, it is likely that when the war comes they will be saved from banishment. The war may bring an end to pleasant hours of ham chatter, but it will probably see most of America's amateurs still on the air, doing serious work for their country and writing another glorious chapter in the history of their band.

LITTLE noted nor talked of has been the valuable service rendered by members of the *Army Amateur Radio System*, in handling hundreds of personal messages from the boys in Army camps to the folks back home. But the traffic over the AARS nets has become so heavy that the Army has decided to emulate the big companies with "form messages."

These messages will be transmitted by number. For instance, form message No. 5 is "All well here. Love to folks;" form message 71 is "Have not heard from you in some time. Please write at once or answer by amateur radio."

This method of transmitting messages to and from the men in camps will be almost mandatory at Christmas time. Members of the AARS are getting invaluable training in handling these messages and are performing a great service.

Note: The heavy pressure of Army duties may soon force regular Army officers, including Major David Talley, Liaison Officer of the AARS, to turn their work over to civilian aides. In each of the corps areas, civilian aides are taking more and more active part in the work, relieving the radio officers of the Army for other duties.

Tabulation of the results of the quiz contest on Army radio procedure, staged during the summer by AARS, shows that the crack Ninth Corps Area operators walked off with top honors. They won the quiz with an 83 point score, based upon an average of 83.3 per cent correct answers and a 99.7 per cent average participation. The Second Corps Area placed second, with a score of 50, and the Third Corps was third with 49.

Corps Area	a Average Drill Attendance During Summer	b Participa- tion in Contest	c Correct Answers Submitted	SCORE (b x c)
Ninth CA	342	99.7%	83.3%	83
Second CA	142	57.0%	87.6%	50
Third CA	40	52.5%	94.7%	49
Puerto Rican Dept.	6	50.0%	90.4%	45
Sixth CA	235	36.2%	84.0%	30
Seventh CA	111	29.8%	96.3%	29
Eighth CA	105	21.9%	77.3%	17
Fourth CA	324	15.0%	100.0%	15
First CA	98	14.2%	100.0%	14
Fifth CA	45	2.2%	83.3%	2
TOTAL	1448	45.0%	86.5%	

Complete tabulation shows Ninth CA on top.

Challenge & Reward

(Continued from page 27)

for auto radios. After working down the list of "hot" prospects, lists of names of people with inoperative radios could be furnished the local servicemen for a cold-turkey canvas intensification of the drive to get every radio playing. Lists of addresses without radios could be furnished local radio dealers and they could concentrate on selling radios to "radio-less" homes.

Now, no drive can keep up its initial movement without continued "prodding," and no undertaking of this nature can be a sustained success unless the value of an operative receiver can be brought home to each and every man, woman and child. Thus, there must be a steady stream of publicity in newspapers, magazines and over the air. These sources can continue to remind the public of the vital need to keep their radios playing.

One way to keep up the public interest in the project and furnish valuable pre-war training, would be to let the listeners join in a mock alarm program. It could be well publicized that during a certain evening, at an unknown time, there would be a mock alarm called. It would be in the nature of a *black-out in reverse*. That is, at the time of the mock alarm, all stations (chains and independents) will be interrupted and an announcement made that each listener *turn on one more light for a period of three minutes*.

By doing this, they would be answering an invisible "roll call" and their answer would be received at the power houses of the local power companies. The amount of the increase in the load at each locality could be computed easily, and this amount sent in to a national center (such as Army Intelligence). From these amounts, it is fairly easy to judge the number of people listening, and the efficiency of the trial warning. Results can be announced in the Press and suggestions made for improving the number of future participants.

Then, the formation of volunteer local agencies such as fire-fighters, air-raid wardens, first-aid helpers, etc., could be tied in with radio and with these mock alarms. Also, special programs could be broadcast which would be educational to the general public

SPECIAL NOTE

To wide-awake
**Dealer-
Servicemen**

Your Golden Opportunity
is **RIGHT NOW!**



Push the Meissner
F-M CONVERTER
For **EXTRA Profits!**

Now is the time to cash in on Converter sales—before the sale of new set models with built-in F-M has a telling effect! The Meissner F-M Converter, conveniently connected to ANY radio set, gives the same performance at a third of the cost. Take one under your arm when you call on a service customer—demonstrate the amazing quality of this new system—leave it on trial if you can't walk away with a check! The radio public is rapidly becoming F-M minded—new stations are going up at a rapidly increasing rate—and they're going to demand F-M in a hurry! The best, simplest and most economical way is by using the Meissner F-M Converter with the present radio set. But **PUSH IT NOW!**

F-M CONVERTER, Complete with tubes,
Model 9-1047A. List Price . . . \$44.95

INSTRUCTION MANUAL

1941 EDITION



Get your copy of this big new manual at once! 168 pages, 8½ by 11 inches, full of all the latest in receiver circuits, complete instructions on all Meissner kits and wired sets. Many pages of data on F-M; coil design, charts and tables.

Only 50 cents Net

Write for Free Complete Catalog!

Dept. N-11

Meissner HT. CARMEL, ILLINOIS
"PRECISION-BUILT PRODUCTS"

★ ★ ★ ★ ★ ★ ★

NATIONAL DEFENSE NEEDS

RADIO OPERATORS!

★ ★ ★ ★ ★ ★ ★

PREPARE NOW!

★ ★ ★ ★ ★ ★ ★

Specialized training right in your own home will quickly prepare you for a promising career in the Army, Navy or commercial communications work. It is easy to learn RADIO CODE with the Candler System, the system selected by the ninth district U. S. Naval Reserve for training radio operators. The Candler System is a specialized training backed by over a quarter of a century of success in training radio telegraph operators. Why not start now! find out today how easy it is to develop speed right in your own home.

Get the FREE Book Now!
It tells you the inside facts of how you can train easily and quickly for an interesting career. It's FREE—Send for this book today—a postcard is all you need, and there's no obligation—Mail the postcard NOW!

CANDLER SYSTEM CO.
Box 928, Dept. N-11
DENVER, COLO., U.S.A.



★ ★ ★ ★ ★ ★ ★

RADIO ENGINEERING

DEGREE IN 2 1/2 YEARS

• Complete Radio Engineering Course in 2 1/2 years. Bachelor of Science Degree. Radio (television, talking pictures and the vast electronic field) offers unusual opportunities for trained radio engineers. Courses also in Civil, Electrical, Mechanical, Chemical, Aeronautical Engineering; Business Administration and Accounting. Tuition, living costs low. World famous for technical 2 1/2 year courses. Special preparatory department for those who lack required high school work. Students from all parts of the world. Enter January, March, June, September. 58th year. Write for catalog. 1611-1 COLLEGE AVE., ANGOLA, IND.



★ ★ ★ ★ ★ ★ ★

TRI-STATE COLLEGE

★ ★ ★ ★ ★ ★ ★

RADIO TECHNOLOGY

RCA Institutes offer an intensive course of high standard embracing all phases of Radio and Television. Practical training with modern equipment at New York and Chicago schools. Also specialized courses in Aviation Communications, Radio Writing and Commercial Operating. For Free Catalog Write Dept. RN-41.

RCA INSTITUTES, Inc.
A Radio Corporation of America Service
75 Varick St., New York 1154 Merchandise Mart, Chicago

★ ★ ★ ★ ★ ★ ★

RADIO-TELEVISION

Oldest, largest Radio-Television school in West training you for good pay job. Complete instruction, advanced Radio Theory and Design. Modern laboratory. Low tuition. Self-help opportunities. Also 2-year courses in Aeronautical, Chemical, Civil, Electrical and Mechanical Engineering. Participation in Civilian Pilot Training Program. Enter December, March, June, September. Catalog.

NATIONAL SCHOOLS Dept. 11-RN
Los Angeles

★ ★ ★ ★ ★ ★ ★

RADIO ENGINEERING

DEGREE IN 2 YEARS

Intensive, specialized course, including strong basis in mathematics and electrical engineering, advanced Radio Theory and Design. Modern laboratory. Low tuition. Self-help opportunities. Also 2-year courses in Aeronautical, Chemical, Civil, Electrical and Mechanical Engineering. Participation in Civilian Pilot Training Program. Enter December, March, June, September. Catalog.

INDIANA TECHNICAL COLLEGE
7111 E. Washington Blvd. Fort Wayne, Ind.

★ ★ ★ ★ ★ ★ ★

GOOD JOBS in RADIO

for young men age 17 to 20

As older men leave for the army, Radio calls for high school graduates. So don't snap up just any temporary job! Train for \$150 to \$250 per month positions at school where the army has sent many men the past year. Next class starts Jan. 5. Write for free catalog now!

THE DODGE TELEGRAPH & RADIO INSTITUTE
403 Monroe St., Valparaiso, Ind.

and would also be helpful to the volunteer workers.

The main thing is to *get started*, on a national scale, a powerful drive to repair all radios.

This is one drive where everyone will gain. The government will gain an all-important means of keeping up civilian morale. The public will gain immeasurably by the increased use of radio receivers and the reception of radio programs in many more homes. The broadcasters will benefit because the audiences will be larger and the reception will be better (because more sets will be operating correctly).

The advertisers will gain because of the added number of people listening to all programs. The parts and set manufacturers will be interested because of the increased business obtained *where it will do the country the most good*. Finally, the radio serviceman—backbone of our industry—will gain by the increased repair business.

Now, this plan, or one similar to it, can be made to work. It needs men of vision—men who are willing to do the necessary ground work and men who are willing to be recruited into a national radio repair corps. It needs the co-operation of leaders in manufacturing, distribution, and repair branches of this industry. It means longer hours at the bench, and on the street. It also means that when the emergency arises, we, as a united people, will have a virile, vital means of communication at the disposition of our national leaders.

The writer asks for expressions of opinion from radio servicemen and from others in the industry. We ask every reader of RADIO NEWS who is a member of a local radio servicemen's organization, a Junior or Senior Chamber of Commerce, or any other organization which is founded on American principles, to call this article to the attention of their fellow-members, or their organization officers.

It is also suggested that such organizations can call the matter to the attention of their state and national representatives for any action which they might desire to take.

This plan is *not* primarily a business-getting scheme for the radio serviceman. *It is one method of working out a defense problem which will become more and more acute as the months roll by.* If it is important to train an efficient fighting force and equip them with weapons, it is as vital to see that the "morale" equipment of our civilian population is at fighting peak. When the emergency arises, it will be too late. Now is the time to act!

Watch for a special constructional article in next month's issue of RADIO NEWS. It shows how to construct an inexpensive FM receiver. Don't miss it!

Case Histories
(Continued from page 36)

- RCA 95X6**
Distortion when 1) reverse power line plug large antenna is used
2) shunt two 1-mfd. condensers (in series with each other) across power line, and connect their common junction to ground
- RCA 97Y, 98EY**
Hum 1) locate shield of cable which Audio whistling interconnects 6J7 grid to the or howling volume control. Change it from the tone control terminal to terminal No. 3 (one nearest end of chassis) of the volume control
- RCA K-105**
High-frequency 1) inspect to see if "diffuser" mechanical buzz mounted across front of the loudspeaker is striking the cone of the cabinet baffle. If so, remove diffuser entirely. It is not used on later production receivers
Hum 1) check for broken lead to A (tunable) and B primary loop
- RCA U-125**
Phono play- . . . 1) if it is desirable to com- through on radio pletely void the phono-cross- in Early U-125 talk on a particular instru- instruments ment it may be done at a slight loss of high frequency response by removing capacitor C-15 and resistor R-11 from the circuit. Resistor R-11 has a gray body, red end, and yellow band; and is attached between the volume control tap and a terminal strip located adjacent to the tandem control assembly. Its removal effects the necessary change.
Reducing low- . 1) connect a 500,000-ohm 1/4- frequency re- watt resistor directly across sponse on phono the pickup circuit. This resistor may be installed at the terminals of the crystal cartridge under the pickup head
- RCA U-132, U-134**
Needle scratch 1) 0.025-mfd. condenser C-102 in RCA U-134 associated with the high-frequency tone control switch may be of the wrong value in some cases. Check its capacity and substitute a 0.025-mfd. condenser if necessary
- RCA V-405**
Radio break- . . 1) caused by capacity coupling between 1-f 6SK7 plate lead and 6F6G grid leads. Dress 6F6G grid leads down against chassis well away from 6SK7 1-f plate lead
To increase . . . 1) untuned r-f stage is resist- sensitivity ance-coupled to 1st det. Change r-f plate load resistor to a higher value between 6,000 and 10,000 ohms
- SENTINEL 11-A**
Weak reception 1) check for change in value of 1) at low-frequency 50,000-ohm resistor connected from 540-1,730 kc band end of broadcast oscillator coil to ground. Replace
- SILVERTONE 4701 Power Shifter (for 4 1/2-volt Battery Receivers)**
No. "B" volt- . 1) check the 25Z8GT tube age output
2) the transformer should be tested by measuring the a-c voltage developed across each half of the plate winding with the red leads disconnected
3) check all carbon-resistors for correct resistance values
- SILVERTONE 6109**
Hum 1) connect a 10-mfd. electro- lytic condenser (Part No. 101209141) across the 0.025-mfd. condenser (C-9) now connected in detector cathode circuit. Positive lead of new condenser should be connected to 6J7 detector tube cathode and negative lead to chassis
- SILVERTONE 6551**
Hum 1) check filter condenser nearest rectifier in circuit
2) "ground" filter condenser can securely to chassis
To improve . . . 1) change 0.00005-mfd. con- oscillator per- denser C-6 to a 0.0001-mfd. mica condenser formance in re- ceivers bearing Chassis No. 101.620
- STROMBERG-CARLSON 505, 515**
Inoperative . . . 1) in receivers manufactured prior to Oct. 1, 1940, check for overheating and change in value of 22,000-ohm resistor R-8 connected between

ground and second i-f trans. In most cases, this condition can be rectified by simply removing the resistor from the circuit. If regeneration or oscillation occurs after this resistor has been removed, connect a 22,000-ohm resistor between ground and the secondary of the second i-f trans. terminals No. 4 and No. 5

TRUETONE 667

Strong "hiss" . . . 1) "broken" lead in r-f stage—on local station usually between 6K7 r-f tube reception grid cap and tuning condenser

WELLS GARDNER 6A13-1

Circuit changes 1) add a 1.5-meg. resistor in series with No. 2 terminal on band switch (Section No. 1) and the ungrounded terminal of the phono socket. Also connect a 0.5-meg. resistor between the ungrounded terminal of photo socket and ground

WELLS-GARDNER 01WG732

"Needle scratch" . . . 1) connect a 100,000-ohm resistor between ungrounded side of phono socket and the phono switch to reduce needle scratch on high-impedance pickups

ZENITH "Radiorgan"

No control of tone . . . 1) insulation on 33,000-ohm resistor cut through, "shorting" to cathode lug
Too much tone 1) "shorted" tone condenser or control on some switch leads buttons, none on others

ZENITH 6-8-527 (Chassis 6A02)

Whistling or squealing on short-waves . . . 1) dress black lead of automatic away from automatic adjustments. Dress white-and-green leads of automatic away from 7L7-7H7 socket

ZENITH 9-8-365 (Chassis 5906)

Weak reception, 1) "open" 8-mfd. condenser C-21 squealing in block No. 22-571
Fading . . . 1) "shorted" i-f stage trimmer condenser
Howling . . . 1) faulty 0.05-mfd. condenser in a-v-c circuit. Replace with 400-volt unit

(To be Continued)

Portable Semi-Pro Recorder

(Continued from page 12)

Filter chokes are mounted below the chassis as shown on the illustration. Other parts included on this assembly are: the on-off switch, pilot light, fuse receptacle, selector switch, SW4, and the three output phone jacks.

When completed, the two chassis are held together by means of metal straps as indicated. The panel used on this amplifier is made of tempered masonite *Preswood* and finished in black crackle. The completed assembly fits nicely into the case, after which a frame work is attached in picture frame fashion to enhance the appearance of the unit. The case used was obtained from the *Allied Radio Corporation* and is normally used for housing an automatic record-player and changer. Many sizes and types of cabinets are available from many sources and the builder should have no trouble in obtaining one to his liking.

The Recorder Assembly

This unit consists of the recording turn-table, high fidelity *Utah* FM speaker, and a suitable leatherette covered carrying case, and the *Brush* PL-20 crystal pickup. Note that a space is left at one side of the motor-board and this is used as a compartment for the 110 volt line cord and plug so that it may be stored where it will be out of the way when not in

use. The hinged cover on which the speaker is mounted is removable so that it will serve as a baffle for the speaker when the unit is set up for play-back. 50 feet of siamese cord may be seen wrapped around four brackets screwed onto the inside of the case cover. We found from experience that plenty of cord should always be available to meet peculiar set-ups.

The basic recorder assembly consists of the dual-speed turn-table and a rather novel cutter-drive assembly. It is possible to adjust the cutting from approximately 96 to 150 lines (grooves) per inch. This is done by shifting the position of the rubber tired drive wheel which extends up into the enclosed metal housing, seen in the upper right-hand corner of the illustration. It is also possible to change the direction of cut—that is, from outside-in to inside-out—by shifting the pulley to a position either above or below the axis or hub of the feed-screw.

Another very important refinement in this assembly is the inclusion of a mechanical device so that the vertical position of the cutter may be altered even during the process of recording, to get the exact angle for the stylus which will produce the least amount of surface noise. This feature is usually found only on professional models.

The depth of cut is governed by the tension of the spring contained under the threaded rod and thumb screw seen directly over the cutter itself. This, too, may be changed during the process of recording. The long, narrow lever located next to the enclosed pulley box serves to guide the cutting carriage in the up-and-down direction.

When cutting "constant amplitude" it is possible to obtain maximum playing time on a 12 or 13½" disc by setting the pulley for 150 lines per inch. The recorded disc shown on the illustration in the close-up view was cut at 150 lines per inch and the playing time is 17¼ minutes for one side. We will not go into the theory and application of constant amplitude recording as we have covered this subject thoroughly in past issues of *RADIO NEWS* in the articles entitled, "How to Build a Recording Studio," as well as in other feature articles.

Now in order to take full advantage of both classifications of cutting, it is necessary to use a crystal pickup as this is the only type which is capable of reproducing with constant amplitude characteristics. In this connection, we might point out that when used for the reproduction of "constant amplitude" that no filter network is necessary. In order that the pickup may be adapted for either type of reproduction, we have incorporated a switch on the amplifier panel, designated as SW1, which is used to short out the filter for that class of service. On the other hand, commercial constant velocity records require the use of such a filter for correct characteristics. This unit is



TED

BOB

Henry Goes Hollywood!

BETTER SERVICE FOR OUR WESTERN FRIENDS

IN order to give better service to my ever increasing list of western customers, I have opened a completely stocked branch in Los Angeles. My brother Ted is in charge—drop him a line, or stop in and see him.

There are many good reasons for our increasing sales of Amateur Receivers. Each order receives our personal attention, a service you cannot get elsewhere. You get IMMEDIATE SHIPMENTS from the WORLD'S LARGEST STOCK of all makes and models of Amateur Communication Receivers. We finance our own time payment sales—no red tape—and less cost to you, easy 6% terms. We can afford to give you better trade-in—send us a description of your old receiver.

Remember, you don't buy unless you are satisfied and you get a 10 DAY FREE TRIAL!

● **New Branch Address:**
HENRY RADIO SHOP
2335 Westwood Blvd.
West Los Angeles, Calif.

"World's Largest Distributor of Amateur Receivers"



1st

FOR DEPENDABLE CRYSTAL CONTROL

Plus performance is deliberately built into every Bliley Crystal Unit. Ask your Distributor for descriptive Circular A-8.

BLILEY ELECTRIC COMPANY
UNION STATION BUILDING ERIE, PA.



MODERN PARTS for MODERN CIRCUITS

THAT HAVE BEEN

*"Designed for
Application"*

CATALOG UPON REQUEST

JAMES MILLEN MFG. CO. INC.
150 EXCHANGE ST. MALDEN, MASS.



- Yes, the Aerovox Research Worker can be mailed to you month after month, absolutely free! Chuckful of latest radio and electronic data, charts, formulae, diagrams, suggestions. Simply indispensable in your work.
- Ask local jobber about a free subscription. • Or write Aerovox Corporation, Dept. RN, New Bedford, Mass.

EASY TO LEARN CODE

It is easy to learn or increase speed with an Instructograph Code Teacher. Affords the quickest and most practical method yet developed. Available tapes from beginner's alphabet to typical messages on all subjects. Speed range 5 to 40 WPM. Always ready—no QRM.

MACHINES FOR RENT OR SALE

The Instructograph Code Teacher literally takes the place of an operator-instructor and enables anyone to learn and master code without further assistance. Thousands have used and endorse the Instructograph System. Write today for full particulars and convenient payment and rental plans.



INSTRUCTOGRAPH COMPANY

Dept. RN, 4711 Sheridan Rd., Chicago, Illinois
Representatives for Canada: Radio College of Canada, 54 Bloor St. West, Toronto.

supplied with the PL-20 pickup and is available for other pickups by the manufacturer of the unit. Some of you may wonder why we used a pickup which has been designed for 16" transcription tables. The selection was based on the necessity for using a long tone arm as we intended to use discs with a diameter of 13½ inches, known as masters, and the shorter pickup arm did not permit discs of such large diameter to be used. Remember that greatest economy is had by using the larger discs. Finally, holes were drilled in the motor board so that the two cables, one from the pickup, the other from the cutter, could be pushed down into the bottom of the case and the unit was out of service. In this way we prevented a mess of cord from being entangled with the delicate equipment.

Conclusion

The two units may be set up for operation in a period of approximately five minutes. This includes the connecting of the two microphones, crystal pickup, cutter, phones and speaker. The overall fidelity of the combined combination permits practically any type of recording and reproduction from the finest symphonies down to the tooting of automobile horns. The recordist who is an ardent fan will enjoy the possibilities of making his own sound effects records "on the spot." We have made many ourselves and have found many applications for the finished discs, particularly if they are properly identified and kept in a library where they will be available for use at a moment's notice. Engineers concede the fact that practically all sound effects can best be handled by means of recorded sounds unless they be of the simple types commonly used in the various broadcast studios. In other words, we do not have to rely upon a "reasonable facsimile" and may have the real "McCoy" whenever we need a certain sound or effect.

Other uses for such a recorder assembly are well-known to our readers. They include the educational slant as well as the entertainment angle. The amplifier is capable of enough output to fill a medium sized auditorium, either as a P.A. system or for demonstrating the reproduction of either radio programs by means of tuner, or by direct playback of all types of records with the exception of "hill and dale."

We feel that the amplifier will be of particular interest to those who have already purchased a recording turn-table assembly, or to those who want to start from scratch and build something that is really worthwhile. We have received many requests for an amplifier such as the one described and we feel that it falls within the price range of those who desire high quality equipment at a reasonable figure. Inasmuch as reproduction of the entire system leaves little to be desired from the musical standpoint, it will satisfy the most critical music lover.

For the Record

(Continued from page 4)

that the Government has been maintaining a sort of censorship on the quiet on overseas messages for a long time. That this may become more rigid has been hinted in Washington. For while the Navy was turned down on the appropriation which was sought specifically to establish the "school for censors," Congress did pass a bill making available to the Navy a large sum for confidential purposes. No loyal American citizen need be at all concerned about official interest in their cable and radio communications, but subversive elements should have much to worry about.

THE radio industry continues to move at such a fast pace that by the time this issue of RADIO NEWS reaches the newsstands there will, quite likely, be some further outstanding news from the OPM in Washington. We have every reason to believe that Uncle Sam will not neglect one of his first lines of defense, "having the public be informed of what is transpiring in this good old country of ours." Radio sets must be serviced and for that reason a substantial amount of material must be allocated to the replacement parts manufacturers, and this of course includes the manufacturers of radio tubes. Let's hope that this curtailment of material will in some way, stabilize the tube industry to a point where engineers will finally get together and select a group of tubes which may be used for any radio set now on the production line.

It is true that the ingenuity of the radio engineer is being taxed to the limit, but out of the present mess will come forth a greatly improved radio receiver and one which will be far less complicated than most of the existing models. At any rate, there is a good chance that receivers will be simplified and improved in general overall quality.

FREQUENCY modulation is receiving a tremendous reception by the American public and construction permits for new FM transmitters are being requested at an ever increasing volume. Yes, Major Armstrong really started radio, as far as FM is concerned, in the right direction.

OUR Washington correspondent Mr. Alfred Toombs, in his column this month, throws some encouraging light upon the status of the amateur radio operators. Apparently Uncle Sam is fully aware of the importance that amateur radio will play during the present emergency. Service men as well as amateurs will be interested in reading the latest information regarding a new setup of the OPM which will relieve, at least in part, some of the pressure now being felt regarding priorities on radio parts and accessories.

OUR good friend John Rider discusses a timely and important topic for the service man. This monthly column is a "must" for those who serve the public in keeping radio sets in top notch condition. Mr. Rider's viewpoints are well founded and this feature should be read by every radio man.

WE present this month, an outstanding article on the construction of a wearable hearing-aid, written by a new contributor to this fast moving field. We believe this to be the first time that a specially designed instrument, which is no larger than a package of cigarettes, has been presented from the constructional angle. Competent service men should welcome the new source of revenue which can be had by constructing such units for the hard-of-hearing under the guidance of a competent physician. Mr. Ewing has spent many years as a tube engineer. Without specially-designed tubes, it would not be possible to obtain such a compact assembly.

MOBILE operation on the ultra-high frequencies is on the increase. The hams are becoming more and more enthused about the results they are obtaining. Our Technical Editor, Ray Frank W9JU, has designed a custom-built unit which may be adapted to fit most existing automobiles. It differs from conventional design as it utilizes separate circuits for both transmitter and receiver, with a general step-up in efficiency resulting. It features an efficient tube lay-out and a separate quench-oscillator to insure a high degree of performance.

AN up-to-date, low cost, signal generator is described for the benefit of the service man. It may be constructed from inexpensive parts, most of which can be found in a radio service shop or junk box. It is capable of generating a very stable signal and

its range includes all frequencies necessary for up-to-date service technique.

OUR monthly defense section illustrates and describes the activities at the *Fort Monmouth Army Radio School*. Thousands of students receive a complete course of instruction in the maintenance and operation of Uncle Sam's radio equipment. This school enjoys an enviable reputation as being one of Uncle Sam's outstanding institutions.

MR. SAMUEL MILBOURNE has written a very excellent article entitled: "A Challenge and a Reward." No up-to-date serviceman can afford to miss this special feature.

AN outstanding contributor to **RADIO NEWS**, Mr. Rufus P. Turner, tells how to measure small capacitances. His wide experience in the commercial engineering field has made possible the preparation of this authentic material. The equipment used is either from parts on hand in most service shops or may be constructed from standard items. Its versatility cannot be questioned as there is a host of application for such tests on modern radio circuits.

THE editorial offices of **RADIO NEWS** in which "yours truly" hangs his hat, received a miniature "blitzkrieg" during the process of getting this issue to bed. We were summoned from our deep sleep one Saturday morning to learn that a goodly amount of our office ceiling had let go as a result of a 3" hot water main's inability to withhold its contents. We arrived at the office to find things in a general mess. We couldn't help but feel that this would be a good time to play a particular recording which we had that was made in London recently, which gives the actual sounds picked up by the microphone during an air-raid. However, after viewing the damage fur-

ther, our sense of humor was quieted and we looked about for some dry area in which to conduct our editing. Oh well, it won't be long and we'll be moving to new and more spacious quarters, so until next month, 73, OR.

-30-

Serviceman's Experiences

(Continued from page 32)

sidewalk, and said:

"Merciful heavens!--Bertha has a pups!"

The incident that finally set me against a small car was one that occurred as I delivered a repair job to a big uptown apartment hotel. I pulled up at the end of the awning, and the doorman sniffed, but wouldn't come to the curb. Twenty minutes later, when I came down, the car was gone! I raised my eyebrows at the doorman.

"Down that-away," he said, pointing and grinning. "Why don't you keep it on a leash?"

I ran to Foster Avenue. Two blocks to the north was a crowd. I hurried toward it. A mob of kids were around the Ajax, jumping and shouting. Some were pushing, some were inside, steering, and about ten were sitting on the roof and fenders. There must have been 50 altogether. Traffic going their way passed slowly, and the drivers looked out and laughed. As I was running, I saw they would pass an intersection before I could get to them, and was scared, but the traffic cop, with great ceremony, held up cross traffic to let the parade by.

I came up shouting, and the kids ran away. Boy, oh boy--did I think of some things to tell Al as I drove back to the shop! It was late when I got there, and the shop was closed, so I went home and prepared a blast to use against him the next morning.

I came in early. Al was in the lunchroom next door, eating breakfast and reading the morning paper.

Greater Production per Man Hour!

WITH THESE New RIDER BOOKS

EVERY one of these Rider Books, released during the past ten months, is on a "live" subject. Every one is designed to increase your efficiency--enable you to handle more jobs in

less time--make more money. If you need additional help to turn out the work you are getting--you need these books. Order them **Now!**

METER AT WORK

Get the most from your present meters, and make a more intelligent selection of new ones you buy, by reading this book. 152 pages. \$1.25.

Abridged Rider Manual—Vol. I to V

Doesn't contain all the information in the individual volumes I to V, but does cover the most widely sold sets made between 1930 and 1935. 2000 pages. \$12.50.

RIDER MANUAL—VOLUME XII

Released this past Spring, and containing "Clarified Schematics," this volume covers sets now coming to your bench. 1643 pages. \$10.00.

ALIGNING PHILCOS, VOL. II

Covers Philcos from 1937 to 1941 inclusive. Includes remote control and tone sets. 200 pages. \$1.60.

FREQUENCY MODULATION

Explains F-M transmission, as well as discussing the new F-M sets. 136 pages. \$1.00.

OSCILLATOR AT WORK

Protect your investment in your present or future oscillator equipment by reading this book. 243 pages. \$1.50.

VACUUM TUBE VOLTMETER

Covers practical aspects and underlying principles of various types of v. t. voltmeters. 179 pages. \$1.50.



JOHN F. RIDER, Publisher, Inc.

404 FOURTH AVE., NEW YORK CITY

Export Division: Roca-International Elec. Corp.
100 Varick St. New York City. Cable: ARLAB

"That damned little bus is ridiculous," I said. "Everyone—"

Al looked up. "Good morning," he said.

"Good morning," I answered. "Everyone laughs at me, and I can't stand it. We've got to keep some dignity in our profession, and it's a cinch we won't if we ride around in a car that's as conspicuous as a grapefruit on a billiard table. Get another bus—get our old one back—get a wheelbarrow—get anything—"

"Good work, Lee," Al said, handing his paper to me.

I looked at it, and sat down heavily. There was a big picture of a crowd of kids, rolling the Ajax down Foster Avenue! *The city needs playgrounds,*

COMMERCIAL RADIO INSTITUTE

A radio training center for over twenty years. Well equipped. Excellent faculty. Practical RESIDENT COURSES in Radio Telegraphy, Broadcast, Servicing, Industrial, Television, Aeronautical, Drafting, Mathematics and Studio Technique. Placement Bureau. Fall classes now forming. Catalog upon request. Dept. C, 33 West Biddle St., Baltimore, Md.

RADIO COURSES

Start November

RADIO OPERATING—BROADCASTING
● RADIO SERVICING—a practical course
● RADIO AMATEUR CODE ● TELEVISION
● ELECTRONICS—1 yr. day course, 2 yrs. eve.
Day and Evening Classes. Booklet Upon Request

New York Y. M. C. A. Schools
7 W. 63rd St. New York City

Classified

Rate 15c per word. Minimum, 10 words

CORRESPONDENCE COURSES

AMATEUR Radio licenses, training in code and theory. Resident and home study courses. Hundreds of licensed students. American Radio Institute, 1123 Broadway, New York.

USED Correspondence Courses and Educational Books sold or rented. Inexpensive. Money-back guarantee. Write for Free Catalog listing 4000 bargains. (Courses Bought.) Lee Mountain, Pisgah, Alabama.

CORRESPONDENCE courses and educational books, slightly used. Sold. Rented. Exchanged. All subjects. Satisfaction guaranteed. Cash paid for used courses. Complete details and bargain catalog free. Nelson Company, 500 Sherman, Dept. L-237, Chicago.

MISCELLANEOUS

RADIO Questions answered, 25 cents each. Research extra. Willard Moody, 403 W. 205 St., New York City.

FOR SALE. Radio repair shop, complete. Drafted. Taylors Radio Shop, Main St., Coshocton, Ohio.

PATENT ATTORNEYS

PATENTS—Advice and booklet free. Highest references. Best results. Promptness assured. Watson E. Coleman, Patent Lawyer, 724 9th Street, Washington, D. C.

INVENTORS—Before disclosing your invention to any one send for Form "Evidence of Conception"; "Schedule of Government and Attorneys' Fees" and instructions. Sent free. Lancaster, Allwine & Rommel, 414 Bowen Building, Washington, D. C.

RADIO ENGINEERING

RADIO Engineering, broadcasting, aviation and police radio, servicing, marine and Morse telegraphy taught thoroughly. All expenses low. Catalog free. Dodge Institute, Elm St., Valparaiso, Ind.

RADIO SUPPLIES

FOR SALE: Rider's Guide 1-8, Superior Oscillator 1230, P. Mengel, 70 Park Ave., Bloomfield, N. J.

the caption said. *Things have come to a pretty pass when our children have to take their toys out on the city streets. What are you going to do about it, Mr. Mayor?*—and so on, with a couple of columns of the delicious whimsy newspapermen like to lay on thick when they're given a chance.

"A quarter page," Al pointed out, "and our name on the side of the car, where lots of readers will see it and be amused. An ad like that would have cost us plenty. Subtract it from the cost of the car, and you'll see we got a bargain. But you'll have to stop being so thin-skinned!"

I looked at the picture again. The cop the *SS&S sign*—the people laughing—the kids having fun—and me, running excitedly into the left side of the photograph. It wasn't a bad shot of me, really.

"Coffee and!" I shouted to the counterman, to cover up a smile. I knew Al was looking at me and grinning, but I sort of hated to give in.

I ate one doughnut before I said anything. "You know," I said, "perhaps people do get a kick out of that bus!"

Al stood up, and started for the cashier's desk. "Atta boy," he said, slapping me on the back as he passed. "See you in the shop!"

-30-

Disc Recording Series

(Continued from page 31)

parts of the complete assembly. Most of the better recorders include a 1/20th horsepower motor, while some use a 1/4 hp. In any case, the motor must maintain an even speed and not work under an overload. Proper ventilation must be provided to prevent overheating of the motor.

Next month's article will be devoted to the subject of cutting and playback needles or, correctly, (cutting and playback styli). This is an important topic and should be understood by all who do recording, either for pleasure or for profit.

-30-

Mfrs. Literature

(Continued from page 40)

IRC Replacement Manual

Copies of the new, up-to-the-minute IRC Volume Control Replacement Manual (Edition No. 3) are available to servicemen, through IRC Jobbers. Fully revised, printed in larger, easier-to-read style and containing a wealth of new listings and material, this Manual gives complete control replacement information in addition to including full details on the cabinet, handy resistor charts and information, and a complete catalog of all IRC standard control and resistor types.

-30-

Staging a Television Program

(Continued from page 9)

writers, imaginative directors and top-notch talent.

In matters relative to writing, directing and casting programs, broadcasting has been playing up to the stage and screen for many years. And radio has developed a program inferiority complex as a result. So, at the start, television should realize that it is potentially a more powerful and far-reaching medium than plays and movies and should, right from the start, relegate Broadway and Hollywood to a contributory rather than dominating spot. True, stage and screen personalities will be in television demand—but their iconoscope ability is more important than marquee prominence.

We are bound to hear from Hollywood to the effect that the cinema city is the logical contender for talent leadership of the nation when, as, and if nation-wide video networks are placed in operation.

True, Hollywood has a load of movie names which may register as well over the kinescope as they do over the theatre screen. But movie names won't be enough to support a bid for leadership. New York has "on call" the cream of the crop in the way of radio, stage, concert and, yes, even movie names. It may seem odd to suggest that New York can compete with Hollywood in the television availability of movie personalities. But it's true! Mind you, we said *availability* and not *quantity*. And what good is quantity if just a very small percentage can be signed when needed for a television show?

Broadcasting experience of many years has shown that there are great difficulties in obtaining talkie stars for Hollywood broadcasts when they were seasonally engaged before the cameras; it's often hard for a star to find time away from the klieg lights for the countless rehearsals as well as the actual broadcasts. But, when they're in New York, there's barely a hitch in taking on the mike assignment that won't clash with other activities.

We've even known of movie stars who preferred a special flight to New York (all expenses paid by the sponsor, of course!) to appear on a radio program. And the same will hold true of television.

The video industry has already demonstrated its operating independence of the movie industry. While the movies may not exactly take a back seat in television rating, they apparently will have to be content with one off the center aisle. And it is very likely that a batch of broadcasters who have their eye on television allocations will be a bit disappointed, too, in discovering that telecasting won't be dominated by the present broadcasting fraternity.

-30-

Ham Chatter

(Continued from page 36)

W6RJR, Rol, of Prescott, Ariz belongs to ARRL, ORS, es EC. Xmtr runs 150 watts input. Ant is a Zepp. Rcvr is a RME 69.

W9LEM got his duplicate ticket back in record time. Has been devoting a little of his spare time to amateur photography. Trying to get some pictures of the rig and stuff. Should have a pair of T 40's on the air very shortly.

W9HIG, Jerry, of Flaxton, N. Dak., was in town the other eve to see DAO. LEM had a FB QSO with her from his place by auto horn.

DAO & LEM were down to see W9OKM (CCC WUFD) Kenmare, N. Dak., but always seems to be on leave to Minot, N. D., his old home QRA. We guess that it must be a YL.

W9DAO, Judd alias "Jughead," left for a vacation in the western parts of the USA. Going to be gone for a month or so and will spend most of his time in Los Angeles, Calif. Maybe he'll contact one of us up here with the help of some obliging W6 out there. Judd was going to work on a new rig but I guess that's postponed indefinitely.

W9ABQ, Dude says "Dollar for dollar and watt for watt your money is best invested in antennas." I think he speaks as a voice of experience for he's worked Hawaii, Alaska, Virgin Islands, and nearly all the States with from 20 watts to 1/2 watt. Rig and thirteen tube rcvr all homebuilt from obsolete junk, powered with vibrapacks, he experiments extensively with antennas.

HERE are a few of the old timers around to 20 meter fone band: CO7VP, CO2KL, CO2KP, CO2KO, CO2HH, CO2JJ, CO2RA, CO2LY, CE1AK, CE1AC, CE3DW, CE2AO, CE1AM, HH2HB, HH2B, HH2D, H10Q, H13N, YV5AB, YV5AC, YV5AE, YV1AK, XE2KG, XE2IK, XE1JW, EA5A, EA4AI of Spanish Morocco, HP2HC, HP2HP, PY1EM, PY2AC, PY7AI, AC4YN 14,292 on cw, CR4AF, 14,040, PY7AD, TG9AV, EK1AF, K4EGR, K5AP, ZP2AA, YN1P, OA4R, LU7BH, LU2AF, YS10I, TG9BA, YS1MS, T15JRS, HC2HC, YP1MS, YN2M, KAIHR, CE1BC, LY1AA, and AC4JS.

CR6AF Angola, Portuguese, S. Africa, is now active on 20 meter fone after some technical advice from WPH of Boston, Mass., who passed along the necessary info that allowed the CR to take a few bugs from the fone equip. This CR is the 1st phone station from that country on 20 meters.

H13N recently paid a visit to H16Q with XYL. CE3CZ is at the present time on both 10 and 20 fone. He is running abt 250 wts to a Lazy H ant, 65 ft off the grid. At present he is experimenting with an ECO t: really is stable.

He is nw using an SX-24 his old stand-by the Nat HRO is being aligned. His frq for a SWL's is 28,252 kc.

Frank CE1AC needs Vt. and N.H. for WAS. (Guess u'll have to wait a little while Frank, but we'll be real glad to wrk u agn in the yr nr future.) By the way Frank is running 100 watts to a Zepp ant. Rcvr is a SX17.

A little more on CR6AF. U cn hr him daily in the late afternoons frn 1400 to 1600 GMT. CR5JR is another gd catch for the many nw SWL's. His signals reach a peak at 5 p.m. EST. Rpt is 5-7 to 9 plus.

Here is a little info on the Far East. No stations frn any country other than Japan were hrd or reported hrd on this Coast on any bnd. Most of their sigs were frn abt Q-3 R-3 to 8 with a rapid flutter that made the signals yr hrd to follow. Here are a few of the J's: JSCL, J2XA, J2NF, J5CW, J2KC, J2NQ and J2NJ.

FIVE meter activity has been increasing rapidly in this section of the country. Among the local hams who expect to have rigs on soon are W5FGT, W5KBE, and W5JPC.

One of the most constant five meter sigs reported here comes from W5AJG of Dallas. There is also some activity reported in Shreveport, La., and Tyler, Texas.

One of the newest calls in Kilgore is W5KEB. Frank made his appearance on 40 mtrs recently with a 6L6GT xtal osc with about 15 watts input. The rcvr is a new Sky Buddy.

After overcoming his fear of RCLs, W5JPC has finally decided to give 160 mtr fone a tryout. He has erected a sky wire es will be on very shortly.

THE following news items from Missouri's 160 meter fone gang come via W9FYM, Brunswick, Mo.

W9OFD, Marion, is back at his home in Bosworth, working fone and CW with a single 6L6 in the final. He has a yen to work fone on 40 and is grinding his crystals down to meet the new regs.

W5JPG, "Doc," from way down in Minden, La., spent his vacation in Marceline working at his old job of fireman on the railroad. He brought his xmtr to Missouri with him.

W9AEE, Larry, has joined the Naval Reserves and is now stationed at USNR aviation base in Kansas City, Kans. He hopes to have his rig on 160 and 10 before he posts.

W9KSA, Harryette, Kansas City's vl op with the mike-organic voice now has a Stancor 110-C on 160 and they stand in line when she gives a CQ.

W9OYS, Jerry, at Brookfield, is still calling CQ with his powerful little 5 watter, but has a 250 watt rig coming up.

W9FYM, Charley, of Brunswick, has a new Stancor 110-C on 160 and is all set to work on 10 as soon as he gets an antenna up.

W9VIN, George, former commerce instructor at Brunswick High School, is now on the faculty of the Chillicothe Business College. YL qrm and a coupe, recently acquired, keep his mind off radio.

W9WSH, "Hersh," of California, Mo., is radio operator on a Mississippi river tow-boat working between New Orleans and St. Louis.

W9QCG, "Dick," late of Kansas City, is now running 300 watts to two 812s on fone in Chillicothe.

FROM W9BDO the following:
Tis the vacation season as I write and our ham brethren R no exception (if they ain't already spent the travel wherewith for xmtr parts). W9MJY is off for a course towards Minnesota and fishing, from whence W9PDI has just returned and finds the weeds as tall in his back yard as his antennae—mte be Les's ant is low rather than the weeds being tall enuf for ant supports.

W9QYL visited W9HAF a few days ago before W9HAF himself took off for a spell of galavantin' around amongst the hams and fishes in Colo. and parts adjacent.

W9FPG was home on a furlough and Tarz had to get the o' rig on ham hands to go some of the other boys besides brother Larry W9HCP.

W3ASQ Capt. "Luther" of Sewell, N. J., told me on 20 F when we had FB ragchew t: he felt one needed his vacation worse after-getting-home from vacation so he could rest up from the vacation. Hi. Affects most of us the same way, Luther.

W9AMY took an impromptu vacation when he autoed his aviation inclined brother Elmer down Missouri way where Elmer now works. "Aimee" stopped a few points along the route and visited hams and BC ops.

Understand "Doc" W9UHT has bn called for duty wid Unk Samuel. "Doc" is a nacheral CW-man tho he did get "civilized" enuf to acquire an "A" es work us jawmen then es nw on 75. He was NCS for AARS and bit up sum CW speed thereby as t: is way AARS set up works in giving "bosses" plenty practice and members vy little, so besides a "molar man" Uncle is setting a 45 WPM CW enthusiast. "Doc"

SPRAYBERRY TRAINS YOU for GOOD PAY! STEADY WORK! ADVANCEMENT! in RADIO and TELEVISION



DON'T WAIT! START NOW!

You Can Make Money Almost At Once
You'll be quickly shown how to get and do neighborhood Radio Service jobs - for practice and profits. You easily learn Television, Frequency Modulation, Signal Tracing, Mobile Radio (Auto-Tank), Aviation Radio, Electronics, Facsimile Radio, Radio Set Repair and Installation Work. I'll Prepare You Quickly In Spare Time

At Home Or At Camp
SPRAYBERRY Training does not interfere with your present work. You will receive personal coaching service all the way. You'll be fitted to hold down a good paying job in Radio or to have a Radio business of your own.

You Get Professional Test Equipment
Plus Experimental Outfits
Includes 146 RADIO PARTS (to build complete Radio Receiver), RADIO TOOLS and a TESTER-ANALYZER. MY EXPERIMENTAL OUTFITS enable you to conduct actual experiments with your own hands.

NO EXPERIENCE NEEDED
It makes no difference what your education has been. I can fit you to become a real RADIO TECHNICIAN. Your success is my full responsibility.

THE SPRAYBERRY COURSE IS SOLD UNDER MONEY-BACK AGREEMENT

RUSH COUPON for BIG FREE BOOK

SPRAYBERRY ACADEMY OF RADIO
F. L. Sprayberry, President
225-L University Place, N. W.
Washington, D. C.

Please rush my FREE copy of "HOW TO MAKE MONEY IN RADIO."

Name..... Age.....

Address.....

City..... State.....

(Mail in envelope or paste coupon on penny postcard)

PUBLIC ADDRESS HEADQUARTERS

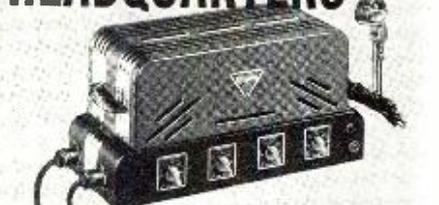

RADOLEK De Luxe Public Address Systems
Offer the most for your money in Styling—Hi-Fidelity Performance—Reserve Power—fast, convenient, easy installation. Offered in 15, 30, 50 and 100 watt sizes—for permanent, portable or mobile use. They feature from 2 to 6 input channels, built-in input and mixing controls, AVC, and the newly developed "feedback" tone control circuit. Wide choice of microphones and speakers. Mail coupon for complete information.

RADOLEK'S NEW 1941 RADIO PROFIT GUIDE

FREE! Indispensable to every serviceman, dealer and sound engineer. Send for big FREE Radolek Profit Guide now!

SEND TODAY! FASTE ON A PENNY POST CARD

RADOLEK CO., Dept. B-60
601 W. Randolph St., Chicago, Ill.

Please send information on Radolek Public Address equipment—also the Big Radio Profit Guide.

Name.....

Address.....

DEALER SERVICEMAN EXPERIMENTER

FOP DEFENSE



BUY UNITED STATES SAVINGS BONDS AND STAMPS

ON SALE AT YOUR POST OFFICE OR BANK

AMERICA ON GUARD!

Above is a reproduction of the Treasury Department's Defense Savings Poster, showing an exact duplication of the original "Minute Man" statue by famed sculptor Daniel Chester French. Defense Bonds and Stamps, on sale at your bank or post office, are a vital part of America's defense preparations.



In 25, 75, 150, 250, 450 and 600 v. D.C.W. Single, dual and triple sections. Popular capacities. Unit illustrated actually measures $1\frac{1}{16} \times 1\frac{1}{16} \times \frac{3}{16}$ in., barely 10% larger than pictured.

ALWAYS a good bet...

Yes, Aerovox PBS cardboard-case dry electrolytics always rate "tops" with successful servicemen when it comes to low-cost jobs. The compact dimensions; adjustable metal mounting flanges; polarity-indicating leads; generous voltage ratings; full capacity—these and other features brand them as ideal replacements—or original components, for that matter—when pennies count.

Type PBS600—600 v. D.C.W.	
Single Section: 4 and 8 mfd., \$1.05 and \$1.47, your net cost.	
Type PBS450—450 v. D.C.W.	
Single Section: 2 to 16 mfd., \$0.87, your net cost.	
Double Section: 4-4 to 8-16 mfd., \$0.72 to \$1.14, your net cost.	
Triple Section: 8-8-8 mfd., \$1.32, your net cost.	
Type PBS250—250 v. D.C.W.	
Single Section: 2 to 30 mfd., \$0.33 to \$0.84, your net cost.	
Double Section: 4-4 to 16-16 mfd., \$0.54 to \$0.99, your net cost.	
Triple Section: 8-8-8 and 8-8-16 mfd., \$1.14 and \$1.26, your net cost.	
Type PBS100—100 v. D.C.W.	
Single Section: 3 and 10 mfd., \$0.33 and \$0.42, your net cost.	
Type PBS50—50 v. D.C.W.	
Single Section: 5, 10 and 25 mfd., \$0.30, \$0.39 and \$0.48, your net cost.	
Double Section: 2-5, 5-5 and 2-10, \$0.30, \$0.39 and \$0.48, your net cost.	

Ask Your Jobber...

He'll gladly supply you with these Aerovox money-saving PBS electrolytics. Ask for latest Aerovox catalog. Or write us direct.



is a good co-operating leader and bilt up a good CW AARS in the White Spot. Too bad, for good of country, AARS didn't hv more such as "Doc" with a somewhat modernized outlook—he got more accomplished than the adamant attitude the CSO takes, gets done.

W7FLO "Wild Bill" on our Sun morn cross band gabfests tells me he is co-operating with some of the Colorado rocky mountain gang in their plan to try and "break the record" for 112 mc on Labor Day from his highest peak around there to the tallest rock pile the Coloradons have. Luck to U guyz Bill—hpe U break-it!

W2DYR—darn your radio—heard on 20F hollering "CQ Omaha" but as I am 300 mi west of our metropolis I didn't QRT W2KWH "Pres" on same freq to try assisting his Nebr. desire. Sig mover, 80 W inp at W2KWH's.

Think it was W1JFG who was tellin' abt one of the KC4USC op's he had wrkd just having visited him and left a QSL—deliverin' 'em in person shud B FB for both ends of previous qosos. QSB still is bad on 20 and I also missed call of stn who sd he used wrk Swan Island back in spark gap daz of previous World War. due to abrupt fadeout b4 he signed over to ham he was gassing wid.

Enclosing the Transmitter

(Continued from page 34)

This is for appearance sake.

The bracing channels on the inside of the doors form excellent conduits for the wiring of the external meter panels. It is recommended that ample use be made of five and dime receptacles and plugs for power supply input, relay circuits, control circuits, etc. It is suggested that all relays be mounted on strips of rubber cut from kneeling pads to insure quiet operation.

Although this cabinet houses but a 150 watt phone transmitter at present, sufficient space is available to house a future 500 watts. Since amateur transmitter design varies greatly in detail, much is left to the ingenuity of the individual in adapting this idea for his particular purpose. With care and judicious layout a cabinet closely resembling a commercial transmitter will be obtained.

A word of caution—make sure your wife does not use this cabinet for the purpose it was originally intended, as was the case here, where a few pairs of shoes were found on the bottom shelf.

Measurement of Small Capacitances

(Continued from page 30)

which the dial is attached, and if this dial has 100 divisions, each graduation will be approximately 1 mmfd.

If care is taken to keep the coupling between the two oscillators and the detector loose, there will be little tendency of the oscillators to "lock" into step near the region of zero beat. The action of the indicator is clean and positive, and the entire instrument reasonably "selective."

The initial zero setting automatically takes into account the stray capacitance between the X-X terminals and the leads extending to them. If it is necessary to make the leads to the unknown condenser long, a pair

of identical "stand-in" leads may be connected previously to the X-X terminals and initial zero obtained with them in place. Thus, compensation will be obtained even for the stray capacitance between condenser leads.

At the same time, very precise measurements may be made by using the calculations described in the first part of this article together with measurements made with the meter.

QRD? de Gy

(Continued from page 34)

effect immediately.

When this is done, there will be no necessity to modify or repeal the Six Months' Law. When this is done, there will be no shortage of Marine Radio Officers. When this is done, the American Merchant Marine will be proud once again that it leads the world in efficient radio communication. Let us not debase the art which has done so much for mankind on the troublous seas. It is a noble art and Radio Officers must learn to be proud of their profession. Unquote. With which we heartily agree. And with best 73 de GY.

Fort Monmouth

(Continued from page 26)

to form in his mind a fixed oral sound for each letter. He must learn to copy at a rate of 20 words per minute over a period of three months of instruction if he is to qualify as an apprentice radio field operator and furthermore must be able to send accurately at the rate of 15 words per minute in addition to passing certain tests on procedure on network operation.

The student is taught to print because most Army transmissions are sent in cipher or in code groups and it is necessary that they be copied accurately. Those who can qualify or those with previous experience may take a further course in fixed station operation. Here the student becomes proficient in touch typing and he finally obtains a maximum speed in the neighborhood of 35 words per minute. He also receives instruction in operation of automatic keys (bugs). Other instruction includes practice in handling various types of traffic. This follows the general line used in commercial applications.

Fort Monmouth is one of the most active of all instruction centers operated by Uncle Sam and the quality of their personnel leaves little to be desired for they are masters in the art of radio instruction. Until recently, this Fort was under the command of Brig. General Dawson Olmstead. The Signal Corps School is under the command of Lieut. Colonel W. O. Reeder.

Any amateur who is inducted into the Service may well give deep thought to entering into the Signal Corps and, subsequently, of training at Fort Monmouth. Here is a golden opportunity for the young man who is interested in radio as a life's work.

PARTIAL LIST OF CONTENTS

How to align Superheterodynes
 Condenser replacement chart
 All RMA color codes
 I-F "peaks" of 20,173 superhets
 Trouble "case histories" for 4,607
 receivers and record changers
 Portable receiver replacement
 battery charts
 Socket connect. diagrams of 970
 tubes
 Operating characteristics of 970
 tubes
 Grid-bias resistors for 297 tubes
 Power transformer design chart
 Volume & tone control circuits
 Vibrator buffer condenser chart
 Decibel tables
 How to modernize old receivers
 Home and auto-radio trouble-
 shooting charts
 Reactance charts & servic-
 ing formulae
 Important radio & servic-
 ing formulae
 Radio trade directories
 Radio & physical con-
 version units, etc.,
 etc.

**THE GREAT NEW BOOK THAT WILL BRING
 MORE PROFIT!
 TO YOU!**

**GHIRARDI'S
 REVISED AND ENLARGED RADIO
 Troubleshooter's
 HANDBOOK**

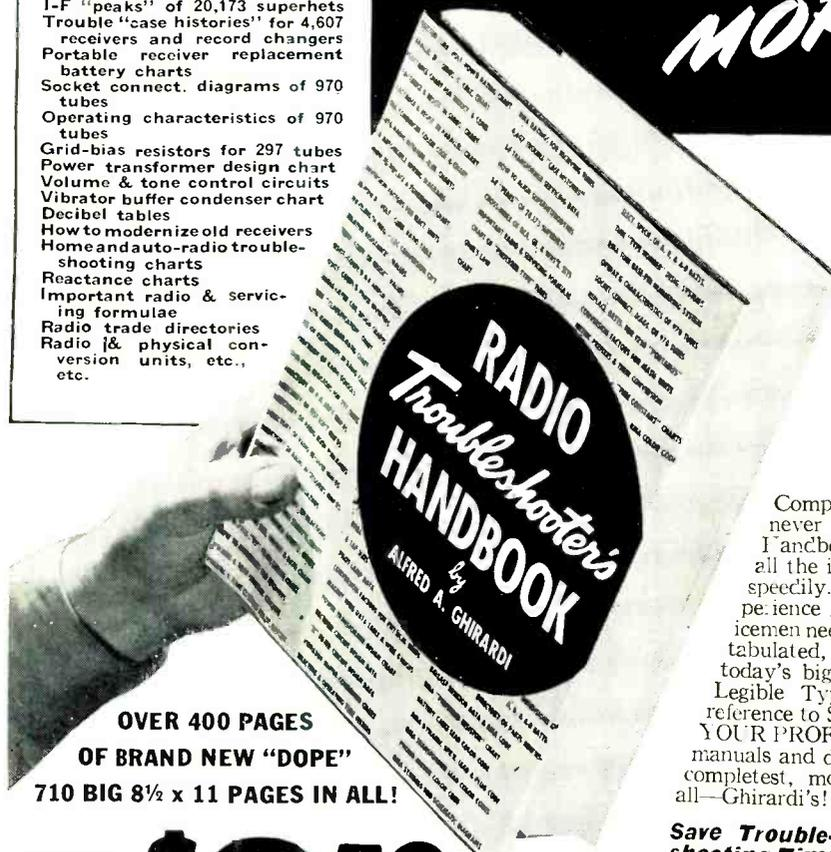

Completely revised, with 400 pages of brand new data, never before published, this big NEW Troubleshooter's Handbook covers the entire field of radio servicing. Here is all the information you need to do your service work more speedily. Reference is easy and fast . . . from years of experience A. A. Ghirardi knows exactly what data you servicemen need in your work today. And here, skillfully assembled, tabulated, charted, indexed and boiled down to essentials is today's biggest store of working service information in Large Legible Type, with bold subject captions—for split-second reference to **SAVE YOU SERVICING TIME AND TO ADD TO YOUR PROFIT!** It's all new and different! No matter how many manuals and data books you now own, you will want the fastest, complete, most practical servicing reference handbook of them all—Ghirardi's!

**OVER 400 PAGES
 OF BRAND NEW "DOPE"
 710 BIG 8½ x 11 PAGES IN ALL!**

NOW ONLY \$3.50
 Use Our 5-Day Trial Plan
 YOU MUST BE SATISFIED!

Save Trouble-shooting Time
 Cut down your trouble-shooting time with the greatest compilation of case histories ever published. Common trouble symptoms and remedies for over 4,600 models of home and auto sets and record changers—all carefully indexed and arranged for instant reference.

Save Repair Time
 I-F alignment peaks of 20,173 superhets, I-F transformer troubles, servicing and replacement. "Plug-in" and "ballast" resistor replacement and RMA color code charts, 20-page tube chart. Modernizing old receivers. Loads of other tables, charts, etc.

Save Labor
 Do you spend precious hours hunting up data required for servicing that gosh-darned complicated job in the shop? You can't but help save valuable time all-around with this new, revised, up-to-the-minute encyclopedia of important, necessary data. Order a copy now.

MORE GHIRARDI VOLUMES!

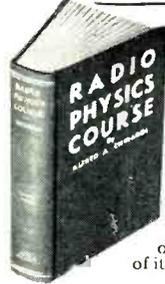

RADIO PHYSICS COURSE

Selected as a training text for the U.S. Army and Navy, this Ghirardi book can help fit you . . . at home . . . in spare time for big-pay radio jobs. Between the covers of this 972-page volume is one of the most intensive technical training courses in radio, sound, electricity and television. Designed for study at home—it is so simple and easy to understand that you need no previous radio background, not even a knowledge of math. The course complete, think of it, only \$4.00.

MODERN RADIO SERVICING



A. A. Ghirardi has packed years of servicing experience into the 1300 pages of this training book. Starting with a complete 420 page treatment of servicing instruments, he takes you step by step through the actual procedure of profitable trouble-shooting, testing and repairing of all makes of radio sets. More than a practical "how to" book, it's so easy to understand that you can study servicing at home. (Check your progress with the 720 review questions.) A gold mine for you, and the price is just \$4.00.

FREE!! UP-TO-THE-MINUTE COLOR CODE WALL CHART

Send for your FREE copy of Ghirardi's new, easy-to-read Capacitor and Resistor color code chart. It's original . . . the only one of its kind we know of . . . gives all the RMA coding arrangements at a glance.



**RADIO & TECHNICAL PUBLISHING CO., Dept. RN-111,
 45 ASTOR PLACE, NEW YORK, N. Y.**

- Enclosed find payment for books I have checked (on 5-day trial)
- Revised Radio Troubleshooter's Handbook \$3.50 (\$4 foreign)
- Modern Radio Servicing \$4. (\$4.50 foreign)
- The above two combined in your SPECIAL OFFER \$7. (\$8 foreign)
- Radio Physics Course \$4. (\$4.50 foreign)
- Rush my FREE COLOR CODE CHART Rush FREE literature.

NAME _____
 ADDRESS _____
 CITY _____
 STATE _____

**5 DAYS
 AT OUR RISK**

SAVE MONEY! Here is your opportunity to get two great Ghirardi servicing books—Modern Radio Servicing and the famous just-off-the-press Troubleshooter's Handbook—at the money-saving price of \$7.00. Not only do you pocket real money, but you get the complete serviceman's library . . . the two books that give you everything in profitable servicing from A to Z—over 2,000 pages of practical servicing information!
MODERN RADIO SERVICING \$4.00 plus RADIO TROUBLE-SHOOTER'S HANDBOOK \$3.50 . . . now only \$7.00. Rush the coupon this minute!

**Go to Your Dealer
 or Mail This Coupon Now**

P.R. MALLORY & CO. Inc.

MALLORY

Replacement VOLUME CONTROLS

The Greatest Advance Ever Made in Tapped Controls

THE PERFECT SIZE FOR EVERY APPLICATION!



Completely New ...And All-Mallory

PRECISION-BUILT LIKE A FINE WATCH!



MORE RUGGEDNESS THAN YOU'VE EVER SEEN BEFORE!



AN A-C SWITCH THAT SNAPS ON AND STAYS ON!

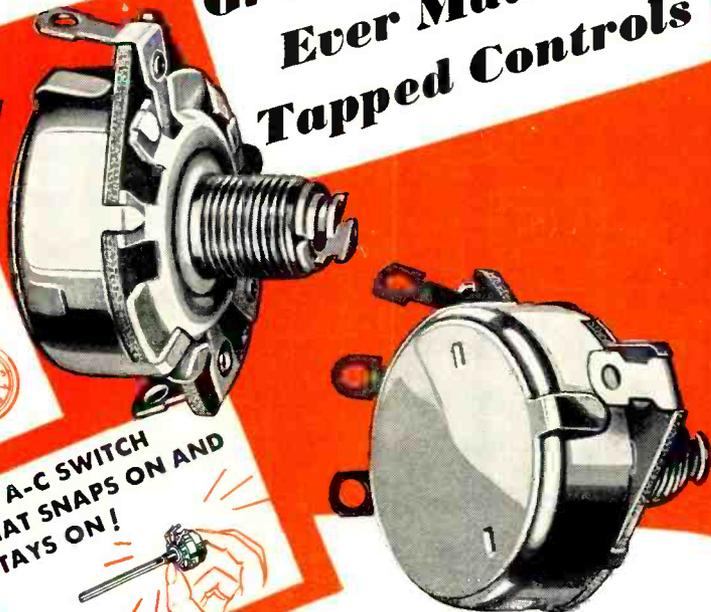

You've probably been up a tree over this matter of tapped controls.

But this new Mallory Tapped Replacement Volume Control has put an end to confusion and worries!

Entirely new mechanically and electrically, this control gives you everything you've looked for! Installation is easy and foolproof. The shafts can't pull or twist loose. The A-C switch *snaps on*. There's no assembly work required!

What's more—Mallory controls mean quiet operation... smooth attenuation... gradual increase or decrease of volume. 16 controls fill 85% of your replacement needs. See them at your Mallory distributor's today—and they will be *your* controls from now on!

Save your old Aluminum parts. It is patriotic to give them to National Defense.

P. R. MALLORY & CO., Inc., INDIANAPOLIS, INDIANA

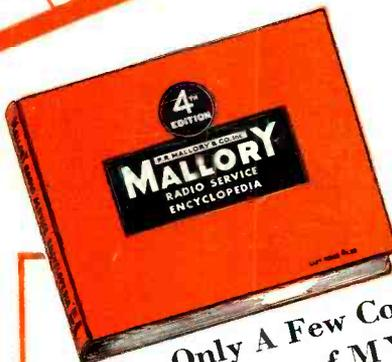

Only A Few Copies of MYE Left!

Don't Miss Out! Order Yours Today!

Phone Your Distributor Now!

There's A Growing Swing To Mallory Replacement Condensers!

Complete coverage... color-coding for instant voltage-identification of paper tubular condensers... mounting features that others have tried to copy... long-life construction... all help account for this swing to Mallory. No other line of replacement condensers gives you such complete and dependable coverage!



More than ever
—INSIST ON

P.R. MALLORY & CO. Inc.

MALLORY

APPROVED
PRECISION PRODUCTS

VIBRATORS • VIBRAPACKS • CONDENSERS •
VOLUME CONTROLS • ROTARY SWITCHES •
SINGLE AND MULTIPLE PUSH BUTTON SWITCHES
• RESISTORS • RADIO HARDWARE