

RADIO NEWS

radio
Trade
news
EDITION

JULY
1941
25c
In Canada 30c

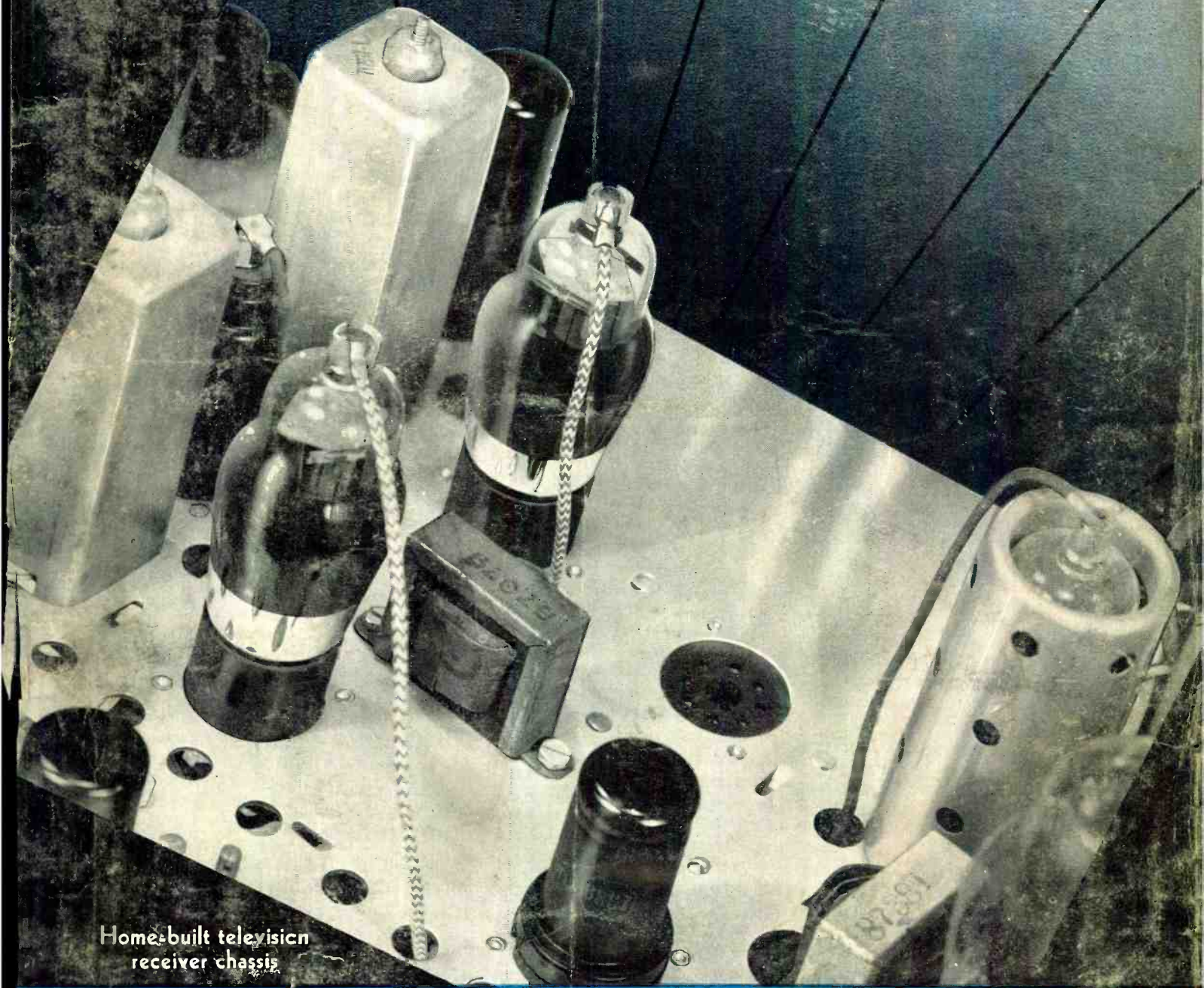

Home-built television
receiver chassis

BUILDING A De LUXE RECORDER AMPLIFIER

THE PROGRESS OF MILITARY RADIO 1905-1941

Serviceman's Chart to Track Down Hum ★ 75-watt Transmitter, 1941 Version

BEGINNER'S ECONOMY 5-TUBE SUPERHET

It's Here!

The New

P. R. MALLORY & CO., Inc.

MALLORY

**Replacement
VOLUME CONTROL**



**THE PERFECT SIZE
FOR EVERY
APPLICATION!**



**PRECISION-BUILT
LIKE A
FINE WATCH!**



**MORE RUGGEDNESS
THAN YOU'VE
EVER SEEN BEFORE!**



**AN A-C SWITCH
THAT SNAPS ON AND
STAYS ON!**

Completely New... And All-Mallory

A Masterpiece of Fine Engineering!



**SEE IT...
TRY IT...
TODAY!**



Coming Next Month!
The New MYE (4th Edition)
**Bigger and Better
Than Ever!**
Order Now!

**Get In Touch With Your
Distributor Today!**

**Mallory
Replacement Condensers
... More Popular Than Ever!**



More and more service engineers are recognizing the value of Mallory's long-life construction... the mounting features which others have tried to copy... and, in the case of paper tubular condensers, Mallory's color-coding for instant voltage-identification. Here are the *only* replacement condensers you need. They save you time — save you money — do a job you can back up!

P. R. MALLORY & CO., Inc., INDIANAPOLIS, INDIANA • Cable Address—PELMALLO

**More
than ever
—INSIST ON**

P. R. MALLORY & CO., Inc.
MALLORY
**APPROVED
PRECISION PRODUCTS**

**VIBRATORS • VIBRAPACKS • CONDENSERS •
VOLUME CONTROLS • ROTARY SWITCHES •
SINGLE AND MULTIPLE PUSH BUTTON SWITCHES
• RESISTORS • RADIO HARDWARE**

DAVEGA

AMATEUR DIVISION, 63 Cortlandt St., N. Y., N. Y.
World's Largest Radio Dealer

READY FOR IMMEDIATE DELIVERY!



- Crystal filter (four-position variable selectivity).
- Calibrated bandspread.
- Automatic noise limiter.
- Preselection all bands.
- Two stage IF amplifier.
- Fly-wheel tuning
- Separate 6-inch PM \$49.95 speaker.
- CW Monitor.

ECHOPHONE Commercial

- Preselection on all bands
- Calibrated bandspread
- Automatic noise limiter

8 Tubes, 3 bands, covers 545 to 2100 kc.—2.1 to 8.1 mc.—7.9 to 30.5 mc. 5" PM dynamic speaker mounted in cabinet. Calibrated bandspread scale on 80/40/20/10 meter amateur bands. Electrical bandspread at all frequencies in the tuning range. Operates on 115 volts alternate current or direct current. Available also for operation on higher voltages with resistance cord.

SENSATIONAL PRICE REDUCTIONS on RECORDERS

Largest Recorder Stock in United States

Federal Symphonic 16" Recorders

Federal Little Pro 12" Recorders

Federal Portable 10" Recorders

Leach Recorders

PRESTO PROFESSIONAL AND SEMI-PROFESSIONAL RECORDERS

We lead the field! Come in and choose from the largest stock of recording machines and recording accessories. Marvelous values. Write today for our list of recorder bargains.

Largest stock of aluminum recording discs in U. S.

RECORDING PANELS LEACH MODEL L

Wide range magnetic cutting head. Special G.E. split phase recording motor. Quadrant worm gear drive. 12 1/2" aluminum die cast turntable.

REGULAR PRICE ... \$59.50

OUR PRICE

\$29.50

Easy to connect to radio or amplifier

HALLICRAFTER S.X.23

8 bandswitch positions
Six step selectivity
Completely shielded
Improved crystal circuit

Regular \$115.00

Special **\$74.50**



SMASHING LOW PRICE!

McMURDO SILVER 15-17

New r.f. amplifier equalizes gain at all wave lengths and provides in single stage, selectivity and gain heretofore available only in best two stage r.f. amplifiers. Four bands. Special Jensen-Silver 15" Giant electro-dynamic speaker. 30 to 8000 cycles. Heavy welded one piece chassis, 20" by 12 3/4".

Regular Price, \$205.00

SALE PRICE **\$89.50**

You Save \$115.50

Demonstrator Models, good as new



AMATEUR DIVISION
63 CORTLANDT STREET
NEW YORK, N. Y.

DAVEGA



by THE EDITOR

ONE of the most difficult things to understand, is why there are some hams who think that the FCC Rules & Regulations are such a "big joke." Here they are in a country which is almost the last place on this globe where they are permitted to operate, if they will only behave themselves, and keep "within bounds," and yet some are so foolish as to think that they can get away with anything! We were more than distressed to find that hams have been contacting foreigners, even German stations, night after night, believing that they would not be heard by the Monitors, and that Uncle Sam would not step in.

Well, the FCC did step in . . . and how!!! Wholesale revocations are taking place, quietly, yet effectively. Not only that, but those who are convicted of contacting foreigners are under every kind of suspicion and are being carefully investigated by the FBI.

Once and for all, let us not be asses! This war is no tea party. There are vital issues at stake, and our Government is certainly more than a mere bystander. The Government will brook no monkey-business, no dereliction from the ranks, no violation of the FCC Rules. Radio is at once the most dangerous of weapons in the hands of a prospective enemy, as it is a joy to the hams!

And to those hams who are violating the Rules and thereby jeopardizing the hobby of the rank and file of the rest of us, we give this honest and sincere warning. We, the hams who want our hobby, who value our licenses, who are patriotic, and who respect the FCC and its Rules, whatever they may be, will cooperate with the FCC in cleaning out our own ranks. You few who are making our hobby totter by your failure to obey the law will find that you are up against us, 50,000 strong.

* * *

THERE is always an amusing angle to almost every vexatious situation. From the lab which adjoins our editorial office we have just had a complaint from Ray W9JU Frank. He is working on a transmitter and the dang-dang unit just wouldn't modulate upwards. Ray got out the books, and finally announced triumphantly, "According to every book in our library, this thing works perfectly!"

Haw!

* * *

YOU can well imagine the kidding that Technical Editor Ollie Read went through when he built up his DeLuxe amplifier which is described elsewhere in this issue. Seems as if the boys here did not appreciate the use of 845 tubes and their associated 1000-volt power supply which Ollie claimed was needed to use with a 3-watt magnetic cutter. Actually Ollie

(Continued on page 52)



Trade-Mark Registered



Including Articles on POPULAR TELEVISION

The Magazine for the radio amateur
experimenter, serviceman & dealer

Vol. 26, No. 1

Contents for July, 1941

FEATURES

- Progress of Military Radio** Charles R. Leutz **8**
A pictorial review of the progress of Military radio from 1905 to 1941.
- Building a Deluxe Recording Amplifier** Oliver Read, W9ETI **10**
A unit which no serious recordist can afford to be without.
- A New Load-Divoreed Oscillator** McMurdo Silver **14**
A purely technical article of a novel circuit for the engineer.
- As I See It!** John F. Rider **15**
A monthly review of problems facing the serviceman.
- 75-Watt Transmitter, 1941 Version** Karl A. Kopetzky, W9QEA **16**
Building all the latest improvements into a low-powered rig.
- An Economical 5-Tube Superhet** L. M. Dezettel, W9SFW **21**
A good receiver with which the experimenter can start his radio career.
- Serviceman's Chart to Cure Hum** Walter Kenworth **23**
How to locate and cure hum in receivers; 44 causes and remedies.
- Communication & Electronic Maintenance** W. H. Bohlke **26**
Conclusion to this interesting series.
- United Air Lines 5000 Watt Transmitter** Peter C. Sandretto **33**
Describing the latest and most powerful aviation transmitter in the U. S.

Cover Picture: A chassis of a home built television receiver.

DEPARTMENTS

- | | | |
|----------------------------------|--|--|
| What's New in Radio 36 | Manufacturer's Literature 40 | Serviceman's Cases 58 |
| Hamchatte 28 | Aviation Radio 42 | The Video Reporter 39 |
| QRD? 35 | Washington Communi-
cation 32 | Ringin the Bell 34 |
| Bench Notes 20 | Police Radio 38 | Serviceman's Experi-
ences 27 |

Copyright 1941,
ZIFF-DAVIS PUBLISHING COMPANY
Member of the Audit Bureau of Circulation

RADIO NEWS is published monthly by the Ziff-Davis Publishing Company at 608 S. Dearborn St., Chicago, Ill., William B. Ziff, Publisher; B. G. Davis, Editor; Karl A. Kopetzky, W9QEA, Managing Editor; Oliver Redd, W9ETI, Technical Editor; Raymond Frank, W9JU, Laboratory Technician; A. H. Erickson, W9TDT, Draftsman; Herman R. Bollin, Art Director; S. L. Cahn, Advertising Manager. New York Office, 270 Madison Ave. Subscription \$2.50 per year; single copies, 25 cents; foreign postage \$1.00 per year additional, Canada 50c additional. Subscribers should allow at least 2 weeks for change of address. All communications about subscriptions should be addressed to: Director of Circulation, 608 S. Dearborn St., Chicago, Ill. Entered as second class matter March 9, 1938, at the Post Office, Chicago, Illinois, under the Act of March 3, 1879. Contributors should retain a copy of contributions. All submitted material must contain return postage. Contributions will be handled with reasonable care, but this magazine assumes no responsibility for their safety. Accepted material is subject to whatever adaptations, and revisions, including "by-line" changes, necessary to meet requirements. Payment will be made at our current rates upon acceptance and, unless otherwise specified by contributor, all photographs and drawings will be considered as constituting a part of the manuscript in making payment.

New FM/AM RADIO RECEIVING STATION



**... with 25 Watt
High Fidelity Amplifier**

The No. 1 band covers all frequencies used by amplitude modulated broadcast stations. No. 2 band covers frequencies used by high fidelity frequency modulated broadcast stations. Changes from FM to AM with band switch. Self-contained monitoring speaker. The use of additional high

fidelity speakers makes this an ideal unit for installation in hotels, schools, churches, lodge halls, etc. Complete unit is extremely flexible in operation and will provide reproduction of sparkling depth and brilliance. Model RSC-2 complete with tubes and monitoring speaker \$140.

hallicrafters

Used by 33 Governments. Sold in 89 Countries

*Super Skyrider SX-28
Tunes from 550 KC to 42 MC*



*Sky Traveler
Model S-29
Tunes from 550
KC to 30.5 MC*



Hallicrafters ... *USED BY*

DISTRIBUTED BY

ALBANY, N. Y.
Uncle Dave's Radio Shack
356 Broadway
ANN ARBOR, MICH.
Wedemeyer Radio Co.
221 East Liberty
ATLANTA, GA.
Lafayette Radio
265 Peachtree St.
ATLANTIC CITY, N. J.
M & H Sporting Goods Co.
1709 Atlantic Ave.
BATTLE CREEK, MICH.
Wedemeyer Radio Co.
183 W. Michigan Ave.
BOSTON, MASS.
Lafayette Radio
110 Federal St.
The Radio Shack Corp.
167 Washington St.

BRIDGEPORT, CONN.
Hatry and Young, Inc.
BUFFALO, N. Y.
Radio Equipment Corp.
326 Elm St.
BUTLER, MO.
Henry Radio Shop
Bob Henry, W9ARA
CHICAGO, ILL.
Allied Radio Corp.
833 W. Jackson Blvd.
Chicago Radio Apparatus
Co., Inc.
415 S. Dearborn St.
Lafayette Radio
901 W. Jackson Blvd.
Newark Electric Co.
323 W. Madison St.
The Radolek Company
601 W. Randolph

CINCINNATI, OHIO
Steinberg's, Inc.
633 Walnut St.
CLEVELAND, OHIO
Radio Servicemen's Supply
Co.
519 Huron Rd.
628 Prospect Ave.
COLUMBUS, OHIO
The Hughes Peters Electric
Corp.
111-117 East Long St.
COUNCIL BLUFFS, IOWA
Wholesale Radiolaboratories
744 West Broadway
DALLAS, TEXAS
Wilkinson Brothers
2406 Ross Avenue
(Mailing Address P.O. Box
1169)

HARRISBURG, PA.
Radio Distributing Co.
1124-26 Market Street
HARTFORD, CONN.
Hatry and Young, Inc.
Radio Inspection Service Co.
227 Asylum St.
HOUSTON, TEXAS
R. C. & L. F. Hall
1021 Caroline
INDIANAPOLIS, IND.
Van Sickle Radio Supply Co.
34 West Ohio St.
JAMAICA, N. Y.
Lafayette Radio
90-01 166th St.
KANSAS CITY, MO.
Burstein-Applebee Co.
1012-14 McGee St.
LANCASTER, PA.
George D. Barbey Co.
29 E. Vine St.



Model SX-25
Tunes from 550 KC to 42 MC

FM/AM Model S-27
Tunes from 28 MC to 142 MC

33 GOVERNMENTS • SOLD IN 89 COUNTRIES

DISTRIBUTED BY

LIMA, OHIO
The Northwestern Radio Co.
116 W. Spring St.
LONG BEACH, CALIF.
Scott Radio Supply
266 Alamitos Avenue
MILWAUKEE, WIS.
Central Radio Parts Co.
1723 W. Fond du Lac Ave.
Radio Parts Co., Inc.
538 W. State St.
NEWARK, N. J.
Lafayette Radio
24 Central Ave.
NEW HAVEN, CONN.
Hatry and Young, Inc.
NEW ORLEANS, LA.
Shuler Supply Company
902 Poydras Street

NEW YORK, N. Y.
Davega-City Radio
63 Cortlandt St.
Harrison Radio Co.
12 West Broadway
Harvey Radio Company
103 W. 43rd St.
Lafayette Radio
100 Sixth Ave.
542 E. Fordham Road, Bronx.
Sun Radio Co.
212 Fulton Street
Terminal Radio Corp.
68 W. 45th St.
80 Cortlandt St.
NORFOLK, VA.
Radio Parts Distributing Co.
523 Boush Street

OAKLAND, CALIF.
W. D. Brill Co.
198 Tenth St.
E. C. Wenger Co.
15th and Harrison Sts.
PHILADELPHIA, PA.
Consolidated Radio Corp.
612 Arch St.
M & H Sporting Goods Co.
113 S. 16th St.
512 Market St.
Radio Electric Service Co.
N. W. Cor. 7th and Arch Sts.
PITTSBURGH, PA.
Cameradio Co.
963 Liberty Ave.
READING, PA.
George D. Barbey Co.
432 Walnut St.

ST. PETERSBURG, FLA.
Cooper Radio Co.
648 Second Avenue So.
SAN FRANCISCO, CALIF.
Offenbach's
1452 Market St.
Zack Radio Supply Co.
1426 Market St.
SCRANTON, PA.
Scranton Radio & Television
Supply Co.
519-521 Mulberry St.
SHREVEPORT, LA.
Interstate Electric Company
616 Spring St.
SPOKANE, WASH.
Spokane Radio Co., Inc.
611 First Ave.
WASHINGTON, D. C.
Sun Radio
938 F St. N. W.

PROGRESS OF

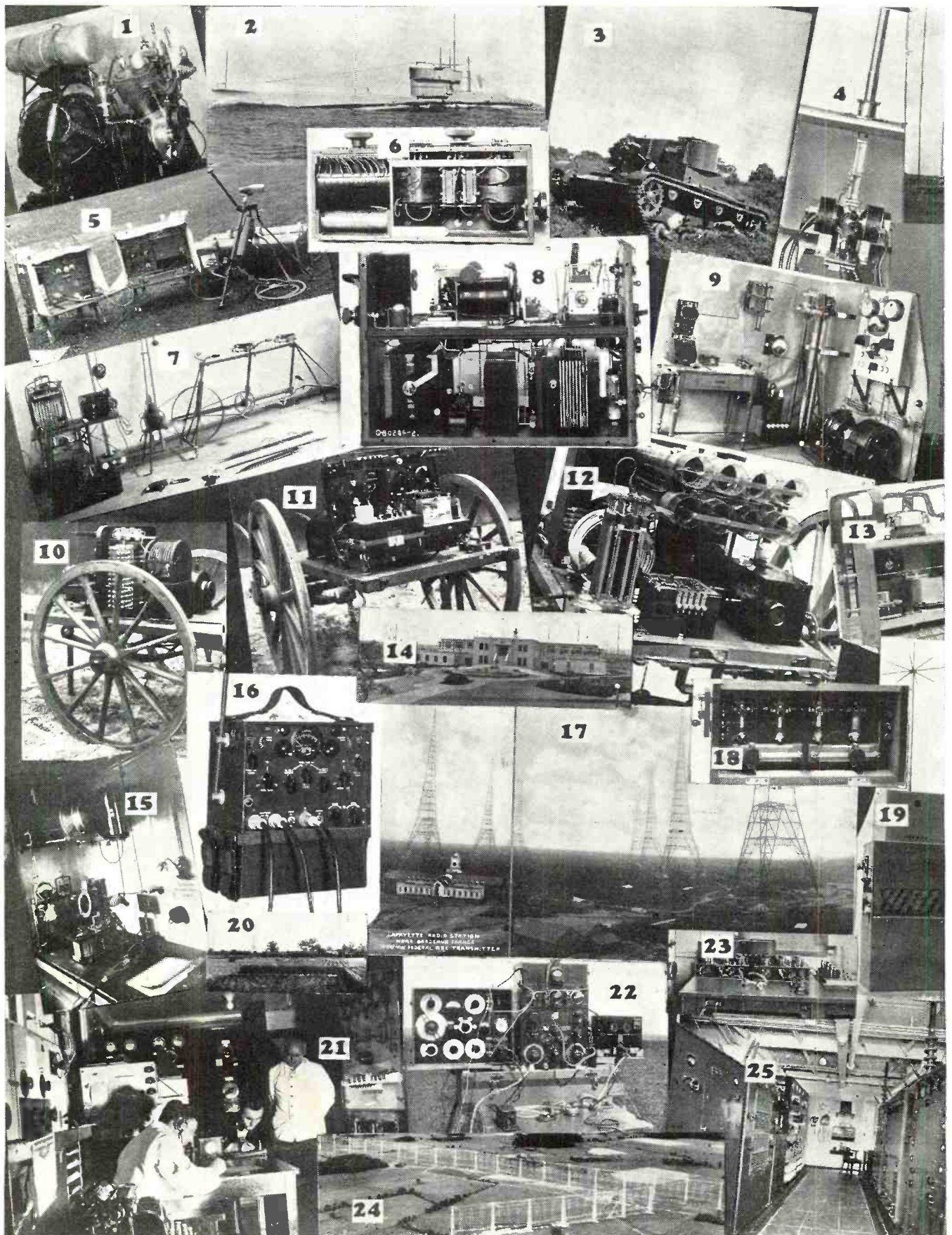

This group of pictures, some of them very rare, shows the gradual progress of Military Radio. Key is on next page.

MILITARY RADIO

1905-1941

Pictures Assembled by CHARLES R. LEUTZ

Glendale, L. I., N. Y.

THE progress which has been made in Military Radio has only lately come to exceed in pace, that which was set by non-Government radio. Originally, the militia was loth to try out anything but the most reliable circuits and equipment, and had little or no incentive either to do any developing on its own, or to subsidize much research work by others. Notable exception to this state of affairs has been the German Government which even in 1905, as today, was ever willing to try the most "outlandish" scheme, and to spend many tedious hours and much money in perfecting some unit which would serve a particular function.

Consequently, a great deal of advance in military radio in general must be laid to the door of the German scientists.

Next in line of endeavor has been the *Marconi Company*, (both British and American Branches). Working along more conservative lines, this concern, with the blessing of the British Government, has also been signally successful in much research and development.

Here in the United States the *Western Electric Company*, a name which has been said in the past to have been synonymous with "Signal Corps" has done vast and varied research. In the latter years, since about 1930, it has been joined by the giants, *RCA* and *General Electric*. Using typical American ingenuity and cunning, these radio firms' technical staffs have succeeded in turning out what is admitted as the World's Best radio equipment. Not only have the American military radio units surpassed those of any

other nation, but the continuing research bids fair to promise that the U. S. will never again be headed off as the leader in the field. Certainly, in one respect it surpasses all others, and that is in the ruggedness which it builds into every unit. Much of American research can properly be accredited to the great body of American Hams whose number now exceeds 50,000. It was this group which first experimented with the ultra high frequencies, thought by the professionals to be worthless. These experiments were the foundation on which all radio, military or otherwise, in the ultra high frequency spectrum is founded. For an outstanding U. S. example of military radio, see picture No. 16 of the series.

Censorship has more or less prevented any respectable showing of 1941 radio sets.

Key to pictures on adjoining page.

1. Field Gasoline Engine Driven Power Plant, 1917. (*Marconi Photo*)
2. English Submarine, 1940, showing the Marconi collapsible Loop Aerial directly behind the Conning Tower. (*Marconi Photo*)
3. British, Armstrong-Vickers Tank, 1940, radio equipped. Note the vertical aerial. (*Marconi Photo*)
4. Ultra Short Wave Generator, part of the assembly, 1920; note tube elements are placed within a magnetic field. (*TFS-Paris Photo*)
5. Advanced British Field Radio Station (one-man power) driving a Vacuum Tube Transmitter and Receiver, 1934. (*Marconi Photo*)
6. Early Marconi Tuned Receiver, one of the first applications of Sir Oliver Lodge's coupled circuit invention, 1906. (*British P. O. Photo*)
7. Early German Field Radio Transmitter (2-man power); the Spark Coil, Leyden Jars and Quenched Spark Gap appear to the left; the Receiver and Reel Antenna appear on the right-hand side of the table, 1905. (*Telefunken Photo*)
8. American Trench Transmitter and Receiver, 1918, Vibrator Power Unit, Quenched Spark Gap, Wavechange Switch, Flash Light resonance indicator and Crystal Detector. (*Marconi Photo*)
9. German Torpedo Boat Transmitter and Receiver, 1914. (*Telefunken Photo*)
10. Field set, Spark Transmitter, 1905. (*Telefunken Photo*)
11. Field set, Receiver, 1908 Model, including an automatic tape recorder. (*Telefunken Photo*)
12. Field set, High Power Spark Transmitter, 1908. (*Telefunken Photo*)
13. Field set, Receiver, 1905. (*Telefunken Photo*)
14. Oyama Transmitting Station, Wireless Telegraph Bureau of Tokyo, 1938. (*Japanese Gov't. Photo*)
15. Typical German Ship Station, 1914. (*Telefunken Photo*)
16. Portable American transmitter of 75 calibrated frequencies, 28 to 65 MC. Weighs 30 lbs. complete. Contains complete receiver. Can be placed in operation in less than 30 seconds, 1941. (*Western Electric Photo*)
17. Lafayette Radio Station, near Bordeaux, France, built by U. S. Navy, 1918-1920. (*U. S. Navy Photo*)
18. Early British Marconi Multi-staged Vacuum Tube Amplifier, 1918. (*Marconi Photo*)
19. Ultra Short Wave Transmitters of the type used in the Maginot Line, 1939. Aerial shown projects above fortification wall and can be replaced from inside the fort. (*TFS-Paris Photo*)
20. Receiving Aerials, Iwatsuki, Wireless Telegraph Bureau of Tokyo. (*Japanese Gov't. Photo*)
21. Radio Room on S.S. "Bremen," 1938. (*North German Lloyd Photo*)
22. Vacuum Tube Field Transmitter and Receiver used during the World War, 1917. Instant change to 8 different frequencies was provided. (*Telefunken Photo*)
23. Coastal Radio Receiving Station, Stonehaven, England, 1915. (*British P. O. Photo*)
24. Directional Antenna Arrays at Lawrenceville, N. J., a former U. S. Navy Station, 1918. (*A. T. & T. Photo*)
25. All wave radio telegraph and direction finding equipment on board a British Naval auxiliary, S.S. "Empress of Britain," 1935. (*Marconi Photo*)

Building a deluxe RECORDING AMPLIFIER

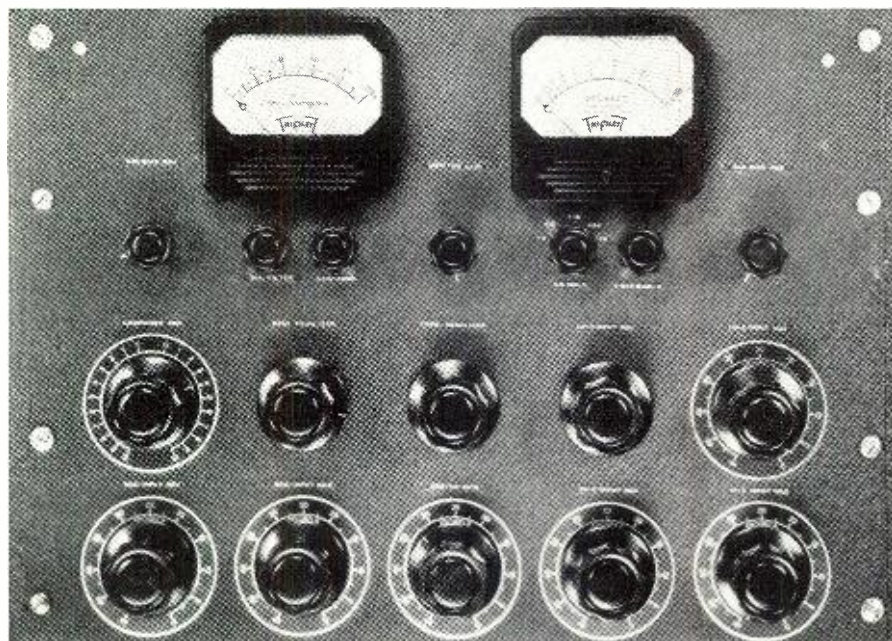

Front panel of the amplifier. This layout applies to either set.

by

OLIVER READ

Technical Editor, RADIO NEWS.

In creating these novel recording amplifiers, the author has designed two units which should give the superlative results that recordists demand.

TO do a special job, special equipment, more often than not is required. As a general rule, this will also apply to recording amplifiers. While it is true that the market has been flooded with very excellent portable recorders, these must of necessity have limitations which are engendered by the very fact that the units are portable. Between the fully portable units, and the heavy, set-in-concrete turn-tables fed from ceiling-high rack and panel amplifiers, lies a vast and somewhat uncharted space wherein the measure of the amplifier's efficiency and fidelity of response is the number of dollars the buyer wishes to invest.

Now a recording amplifier can have as much or as little distortion as the builder or buyer can afford. The peculiarity of that statement can be explained by the fact that while distortion is usually present in most of the cheaper grade of amplifiers, the money spent in removing the distortion can be considerable. The picture is further complicated by the fact that the higher we extend the response curve—and for the moment the flatness of that curve is not in question—the finer the component parts incorporated in the amplifier must be. This, too, represents an increase in cost.

If one adds to these conditions the flatness of response, and the flexibility with which one would have the amplifier equipped, then the final unit becomes, not the simple one-control unit which was the portable, but a rather bulky, somewhat unwieldy and heavy amplifier.

Why, then should all these things be included in a *de luxe* amplifier? Aside from the fact that the very name "de-luxe" connotes that the unit is something very special, there are very cogent reasons for refining and again refining the amplifier until all the conditions above set down are met.

Let us consider them one at a time. Distortion is introduced into the amplifier when all component parts do not function perfectly as they can easily upset the entire characteristics by the effect and mismatch presented to the amplifying tubes. For example: a resistance-coupled phase-inverter stage can ruin fidelity unless the voltage is set, by means of a vacuum tube voltmeter, so that each grid receives exactly the same amount of drive from the preceding plate circuits, or in other cases, from plate and cathode. Furthermore—many resistance-coupled audio stages do not use the proper relationship between resistance and coupling capacity to afford a flat response characteristic and this condition is most prevalent in home constructed units.

In addition to the above, is the matter of bias, plate, screen, and other potentials applied to the tubes. It is not enough to tell the constructor to use a 250 volt plate supply and let it go at that. Why is 250 v. recommended? Well, in the first place the tube charts, if followed accurately, show that in order for a given tube to function as a class A amplifier, for example, a certain potential must be applied through a certain resistance in order that the tube operate under *ideal* conditions. This condition can only be

met if the resistor values are held to close tolerance, or the plate voltage changed to offset error present when the resistors are considerably off in indicated resistance.

The engineer in the Laboratory is equipped to compensate for the variations as he has the proper instruments to do the job. The home constructor, on the other hand, must rely entirely upon his ear to tell him when the distortion has exceeded the minimum permitted for good reproduction. Transformer coupling offsets this and is used.

Another example, and one which can cause considerable distortion, is the use of pentodes as power amplifiers. These tubes have a very high plate resistance and do not have the lo-mu characteristic so desirable for recording or for high quality reproduction for sound systems. Some of the newer beam-tetrodes are almost as bad and we have not even considered their use for an amplifier of the type illustrated. The regulation afforded by the lo-mu triodes, plus the fact that they are designed for class A operation (2A3 and 845) led to the adoption of this class of tube for use in our two laboratory models.

It may seem a bit unusual to build an amplifier around the 845 which is a 50 watt tube generally associated with broadcast equipment, but our choice is brought about from several considerations. Tube charts show that a pair of 845's operating strictly class A are capable of power outputs up to 30 watts at a very low percentage of distortion. The plate resistance is very low and the overall characteristics

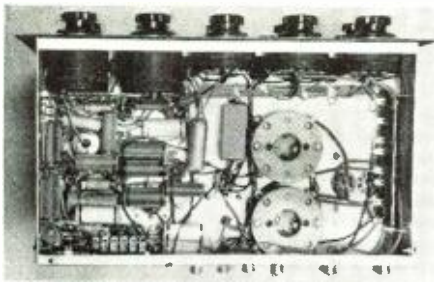

Underchassis view of the amplifier.

show that it is ideally suited for use in a recording-playback amplifier of the de luxe type.

All magnetic cutters present a *variable impedance* load to the output of the amplifier. When they follow an audio stage using pentodes, etc., this condition is aggravated and the regulation and response wanders around with a consequent loss in general efficiency. The crystal cutter presents a capacitive load to the amplifier and the effect is somewhat the same. This, then, is another point in favor of the triode amplifier stage over those employing pentodes and tetrodes and this choice has been well founded, as indicated on the response and distortion curves taken from the amplifier described.

A discussion on the subject of frequency response is now in order. This subject has been covered many times in publications and claims have been made, in some cases, that a certain unit is "flat to 15,000 cycles," or another claims that his amplifier is of the "High-fidelity" type. Another statement often used, and many times exaggerated, is that so-and-so's unit includes an "equalizer control" when, in reality, it includes nothing more than the old time tone control to cut off the high notes. An "equalizer" is much more than that and should not be confused with a "tone control." Ask a recording engineer what is meant by an "equalizer." He will tell you that it is a device which may be used in conjunction with an audio amplifier to shift the response in many directions in order to produce certain effects or to compensate for the loss, or excess, of certain frequencies in the system and to balance the sounds so that they are most pleasing to hear. Such a device is included in our model.

The audio response curves, using the 845's or 2A3's are shown. They speak for themselves. We find, from actual examination, that we have an amplifier which can be truly classified as a "high-fidelity" unit as it meets the specifications required for excellent tonal quality, good plate regulation, low distortion, plenty of reserve power, 30-15,000 cycle response, flexibility, ample input channels, accurate volume indication, low hum content, and general overall characteristics which make it an ideal unit for the professional recordist or for the layman who really appreciates the finest of quality in reproduction.

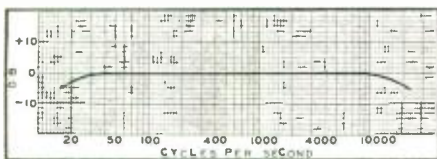

Response curve.

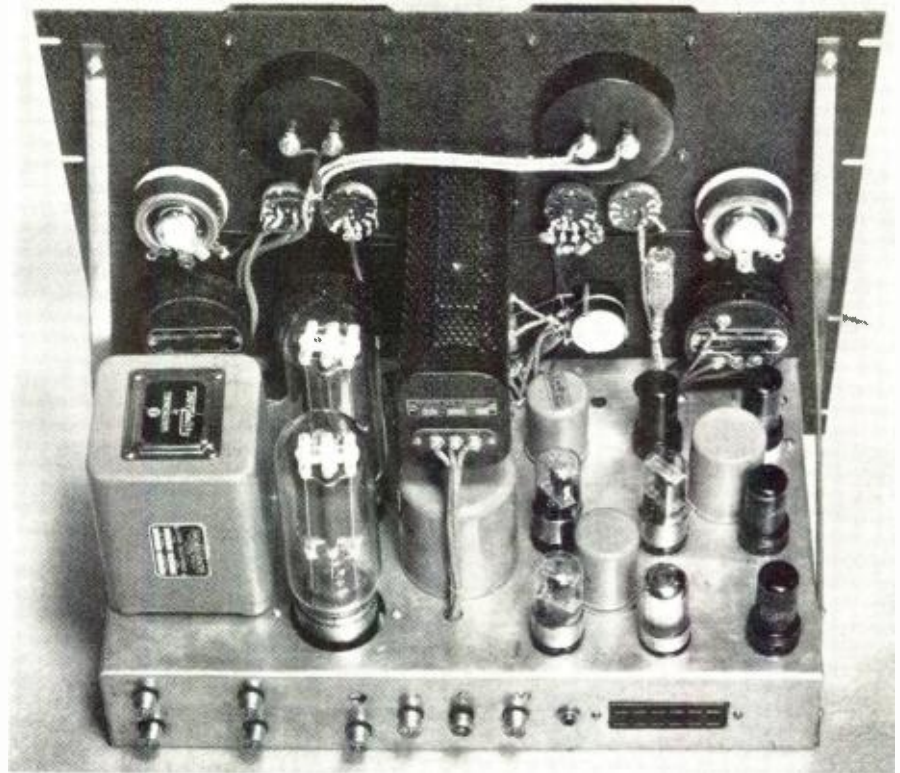

Top chassis view of amplifier using 845's. The chassis and transformers would be exactly the same for 2A3 tubes but the cost is less.

Work was begun around a circuit in which either the 2A3 or the 845 could be used to equal advantage and the models built leave little to be desired for the most discriminating listener. The first, using push-pull, class A 2A3's can be built for about half the expenditure of the larger model using the 845's. Many cutters require but 1 watt power for average modulation, others require up to 3 watts. The 2A3 version is best for the former, and the larger 845 unit should be used for the latter. There is an important point that must be considered if the serious-minded recordist is to get superior results from his cutting of quality discs—to build an amplifier that has 10 times the power required to drive and modulate the cutter over *normal* cutting level in order to take care of the instantaneous peaks. Few recordists realize that there are many of these short peaks that do not show on the level indicator, and they are completely disregarded in many cases. Even a high-speed meter fails to indicate them.

This is foolish and its practice should be discouraged. The use of push-pull 845's operating class A in the larger amplifier is an ideal arrangement for use in the recording studio. It is capable of some 35 watts output, undistorted, which is just about right for the better magnetic cutter requirements (10 times 3 watts). We recom-

mend the less expensive model for those who cannot afford the larger unit. This one is capable of furnishing 10 watts class A output, undistorted, or 15 watts maximum at low distortion.

Now for other features which should be included in order to have maximum flexibility and include everything required by the recordist or music lover. Examination of the diagram will reveal that there are a total of 6 inputs—four of them in the high gain channel for crystal and dynamic mikes, etc., two inputs for phono pickup or radio tuner or possibly two pickups and no tuner. The overall gain of the amplifier when using 2A3's is 114 db. with the expander off and 125 db. when it is "full-on." This is sufficient for any conventional microphone or phono pickup. The gain of the low channel is 72 db. Two of the high-gain inputs are shown connected for 50 ohm mikes. The reader may substitute two high-impedance channels if wanted in their stead by eliminating R1, R2, T1 and by substituting the same arrangement as that shown for the other two inputs which connect directly to the *Centralab* 1-010-851 pots. The two 50 ohm T pads are used in preference to other

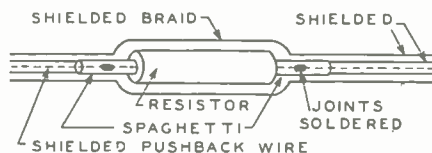

How to shield resistors.

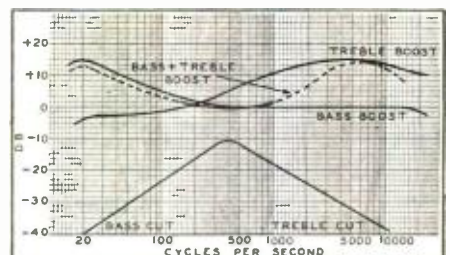

Tone control curves.

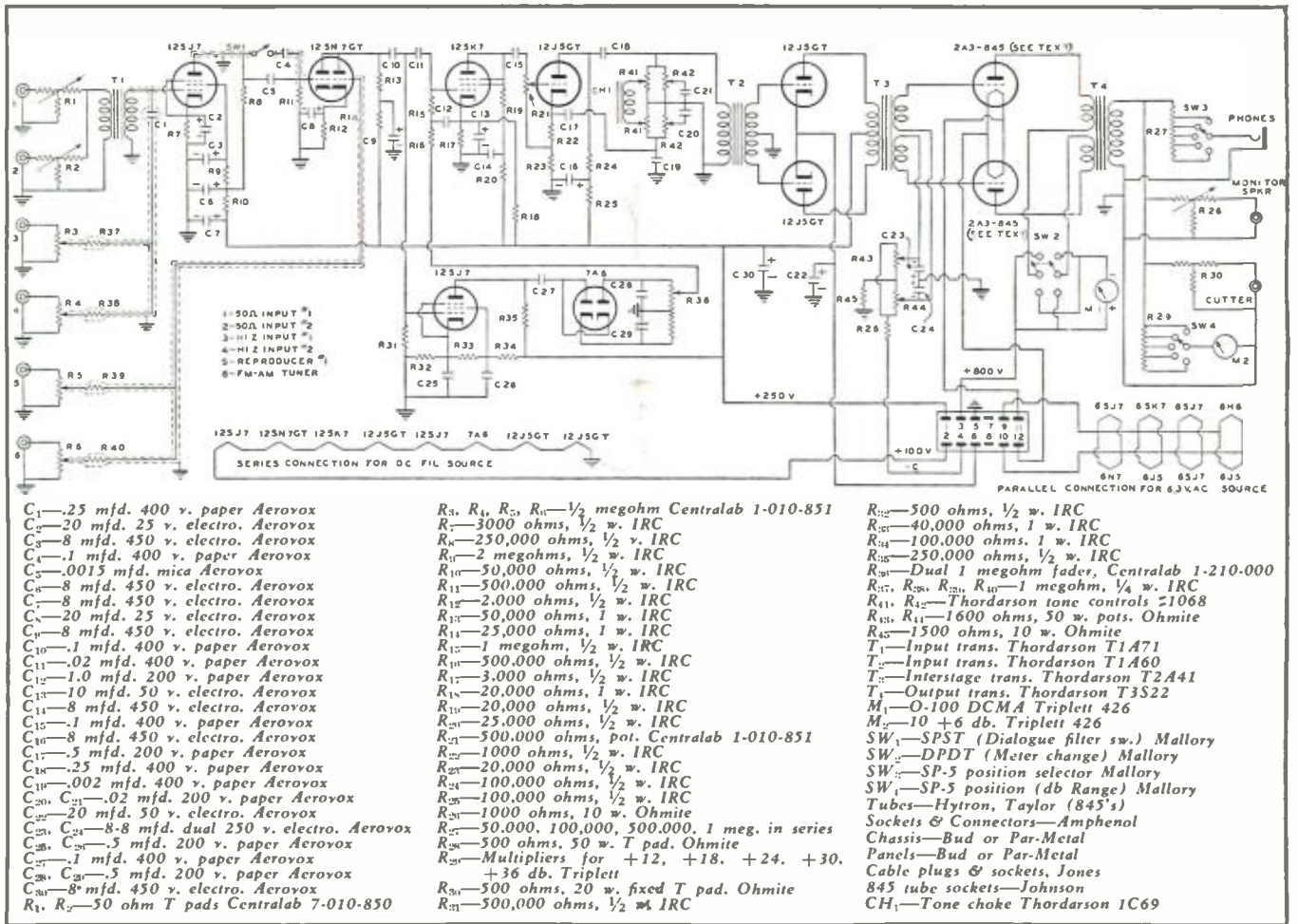

methods of mixing, as they must feed into a common transformer primary and maintain a constant impedance to the input as well as to the output of the pad. The gain is such that only the best shielded transformer can be used successfully in this position. Such a unit is the Thordarson T1A71 used in the model.

Another feature of the circuit is the addition of a "Dialogue filter" in the

form of two condensers in the coupling circuit that are arranged so that the capacity can be reduced, by switching, to limit this to .0015 mfd. This passes only the higher frequencies and gives a "telephone" effect. It is used in recording plays that call for such an effect or for public speakers if the amplifier is used on a p.a. job.

Many various tone control circuits have been publicized and their advan-

tages stressed. The one selected for use in this unit is known as a "degenerative" feedback arrangement. It is unusually flexible in operation and has a very wide range of control in order to equalize the response of the amplifier to meet all conditions in operation. It is possible to introduce considerable treble or bass, (or both), boost to the circuit and to take full advantage of this for recording. When the controls

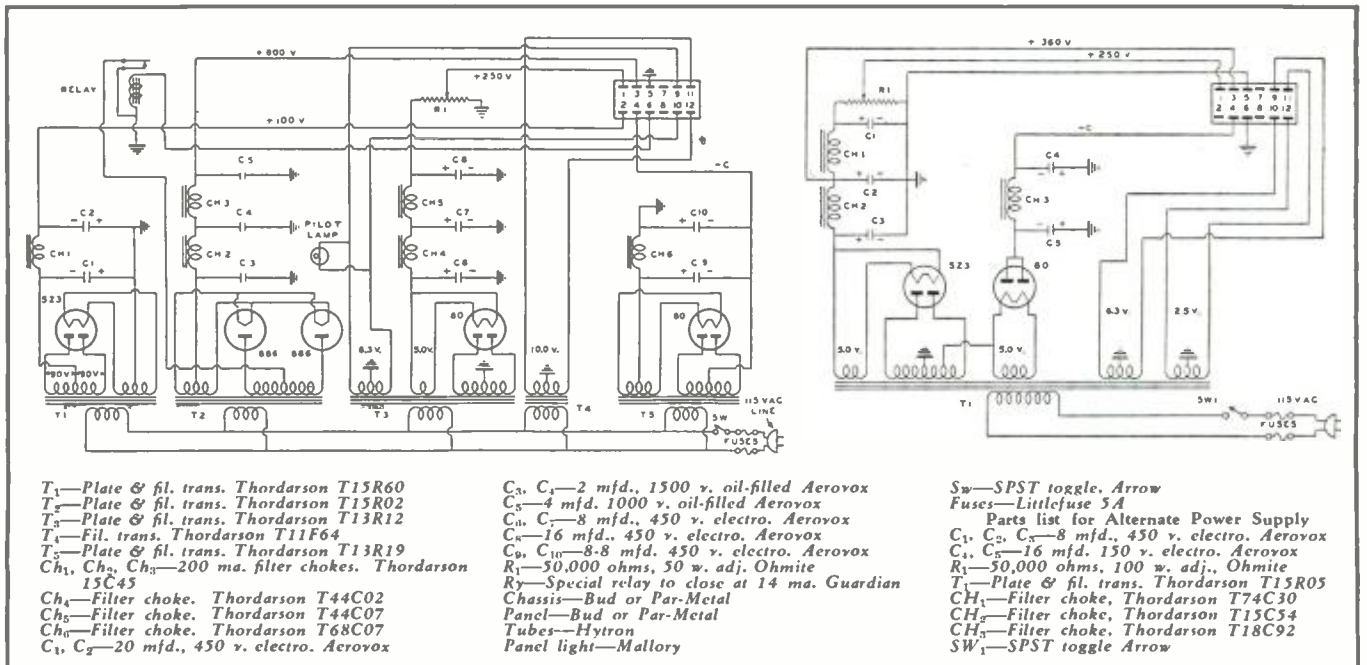

are set in this position, we may simulate the response used by one of the broadcast chains known as *Ortho-coustic*. This method uses a boosted low and high frequency curve so as to afford some advantage in reducing the background and surface noise present on the disc.

The equalizers can also be used to introduce attenuation (loss), to the amplifier to meet other conditions; are very effective in reducing unwanted feedback between speakers and microphones in sound installations. Equalizers are set to a mid-position when the normal flat response characteristic of the amplifier is wanted. The correct manner in which to use these controls will be apparent to the reader in actual service and so much will be left to his own taste.

A highly efficient "Expander-Compressor" circuit has been included. This design follows a circuit recently published in *Electronics* which features a 6K7 as the control tube, connected as a triode. This method was adopted after several conventional arrangements were tried. A smooth control of either expansion or compression is had with the dual 1 megohm potentiometer connected as shown.

The 12SJ7 amplifies part of the signal passing through the amplifier and feeds this signal into the rectifier tube, which is connected as shown. The output of the tube is connected to the outside contacts of the control, R21. One end of the network has a positive potential, while the other is negative. A choice of either, in any amount up to maximum is had by rotating the slider across this resistance. Expansion of the signal is had on one side, while compression takes place on the other. The contact is set at midpoint on the scale for taking the action out altogether. The values of the condensers must be selected for proper action of this network. The ones shown will be found to offer a good average delay action to the circuit.

The overall performance of the amplifier is excellent with either tubes used in the power stage. In fact, the power has been kept high so that the output could be halved in order to handle two channels, one for a cutter (500 ohms) and another for a monitor and playback speaker (500 ohms). The output transformer is used to feed both channels from a single secondary. This must be connected as a 200 ohm load on the transformer used as there is no combination to match 250 ohms (two 500 ohm loads in parallel). The slight mismatch cannot be detected.

Two T pads are introduced unto the circuit, one to serve as a gain control to the speaker, and another to introduce a fixed 10 db. loss ahead of the magnetic cutter. This reduces the output of the channel to the cutter by an amount of 10 db. Any tube noise or other noise of low amplitude is taken out and the regulation to the cutter is greatly improved. Any magnetic type cutter presents a variable impedance load to the output of an amplifier. This can be somewhat offset by using a series resistor in the cutter channel, or by adding a loss pad as indicated. In some cases it is desirable to incorporate a combination of both.

A common loudspeaker is used, both for playback and as a monitor when inputs other than microphones are used—unless they are in another room. It is necessary to use a T pad which will handle the power in the circuit.



The 800-volt power supply chassis. The layout is smaller for 2A3's.

Such a unit is shown and may be seen mounted in the center of the panel between the two meters. The dialplate for the pad is calibrated in db. loss, so it may be used for other applications where it is desirable to know the insertion loss at any particular marking on the dial.

The use of an accurate volume indicator is a necessity for good recording technique. The decibel meter is recognized as the standard for most applications and is used in the better grade of equipment. Multiplier resistors, ordered from the manufacturer, are selected by means of the multiplier switch.

This meter is invaluable for many applications where a reading of the cutting level must be indicated. One must consider the fixed 10 db. loss from the pad when the meter is connected

at the cutter side of the line as shown. For example—if the normal recording level is 14 db., the meter will show 14 db., while the actual power output into the pad will be 24 db. It is also used when making frequency measurements of the amplifier system as it is capable of indicating the actual level of the line at the various frequencies that are fed into the amplifier at constant voltage. If the amplifier is flat in overall characteristics, the voltage, as read on the meter, will be constant over the range of the equipment.

The headphones are used when microphones are being used in close proximity to the amplifier. Volume may be reduced by adding resistance in series with the phones. High-impedance phones should be connected at some

(Continued on page 48)

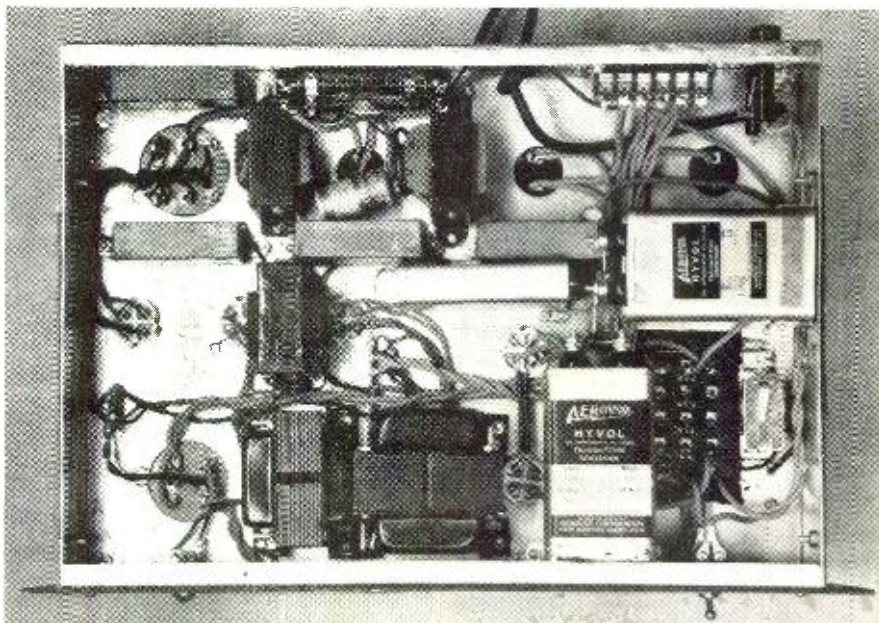

Under the chassis of the 800-volt power supply.

A New Load-Divorced Oscillator

by **McMURDO SILVER**
Radio Engineer, Philadelphia, Pa.

A new department for the outright technician,
featuring this month a novel oscillator circuit.

Editor's Note. Mr. Silver is one of the country's outstanding radio engineers, whose knowledge of pure radio technique is extensive. He claims to have discovered a new type of oscillator circuit which, being independent of the load, is thereby that much more stable.

SEVERAL years ago, in searching for an oscillator circuit which would exhibit a minimum of shift or change in frequency as a function of loading, the writer devised what he believed to be a substantially new circuit. While it had always been his intention to bring its merits to the attention of the radio public, many things intervened and this article was postponed. He is spurred to this effort now only by the work of an apparently more recent investigator having paralleled what the author believes to be the author's own earlier discovery.

Upon the assumption that the average reader is familiar with the desirability of absolutely constant frequency in any oscillator circuit intended as a source of radio frequency power, as in a radio transmitter, consideration of some of the factors involved may proceed. It is not, however, the purpose of this paper to treat of the more conventional requirements for high frequency stability such as mechanical rigidity, stabilization of temperatures and voltages, high-C tuned circuits, or high-Q tuned circuits, for it is assumed that the reader is fully familiar with

the oscillating source so obtained via the plate circuit, coupled to the oscillating circuit primarily through the electron stream proceeding from the cathode through control grid through screen grid, and thence to plate. He observed, however, that that portion of the tuned oscillating circuit located between cathode and ground presented an impedance common to both the oscillating circuit and to the plate or load circuit. This common coupling, in conjunction with interelectrode capacity in the tube itself even though the screen grid was operated at ground potential for r.f., frequently not only failed to divorce oscillator and load circuits in the desired manner, but often necessitated operation of the plate load circuit at a harmonic of the oscillator frequency.

When James Lamb, of *QST*, came along with the scheme of substitution of a quartz crystal for the cathode-to-grid impedance of the Dow oscillating circuit, creating the well-known *Tritet* oscillator, exactly the same difficulty was observed with not too well screened tubes.

While the problem responsible for the writer's development of the circuit herein described was primarily one of discovering a means of minimizing the reaction upon oscillation frequency of variable loading upon the oscillator, the additional benefits of good harmonic operation were also desired—a meritorious feature of the basic Dow circuit.

The *Pierce* crystal oscillator has some advantages in terms of the sought-for result due to the absence of a tuned circuit in its output. Fundamentally, it is the old DeForrest *Ultra-audion* oscillator, in which a two-terminal tuned circuit to determine frequency of oscillation is connected from grid to plate of a triode tube, except that *Pierce* substituted a quartz crystal for the tuned inductance-capacity circuit to determine frequency of oscillation. This is depicted in Fig. 1. The plate circuit load is indicated as "Z" since it is not the usual tuned LC circuit, but usually a resistance or r.f. choke whose natural period is lower in frequency than that of the oscillating circuit, to prevent short-circuiting the plate to ground for r.f.

This use of an untuned load circuit operates to reduce the power which may be usefully taken from the plate circuit, but it likewise eliminates one of the variables affecting oscillator frequency, since the *Pierce* oscillator plate circuit is usually coupled directly to the grid of a following r.f. amplifier. An additional benefit lies in the fact that, in practical operation, the power

output on harmonics of the oscillator frequency is relatively high in relation to power output on fundamental oscillator frequency.

It required no master mind to contemplate the combination of the merits of the Dow and *Pierce* circuits, as in Fig. 2, and this is exactly what the writer arrived at. A comparison of Fig. 1 with Fig. 2 indicates that the cathode, grid and screen of the tetrode of Fig. 2 are functionally equivalent to the cathode, grid and plate of the triode tube of Fig. 1. The change appears comparable to the change Lamb wrought in developing his *Tritet* circuit out of Dow's original "electron coupled" oscillator, for the result may be simply regarded as an "electron coupled *Pierce*," or an "electron coupled *Ultra-audion*" oscillator; it might be named the "*Pierce-Silver*," or maybe the "*Ultra-Silver*" circuit. But we are not here concerned with names, rather with the question of merit sufficient even to deserve a differentiating name.

Merit would appear to be present simply in the combination of the two basically meritorious systems of Dow and *Pierce*. In practice such proves

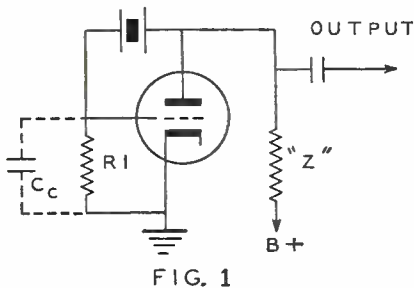

FIG. 1

the literature of the art upon such subjects. Possessed of the most stable oscillator which might be built, such as one employing a quartz crystal resonator having microscopically low frequency change with temperature, and assuming a desirable constancy and stabilization of all factors contributing to oscillation, it still remains a problem to draw energy from such a stable source in appreciable magnitude without reaction upon the frequency of the supposedly perfect oscillator.

The invention by Commander Jennings B. Dow, U.S.N., of the "electron-coupled" or *Dow* oscillator was a tremendous step in the desired direction. Dow proposed to employ the grid, screen and cathode of a multi-element vacuum tube as a triode oscillator with a suitable tuned circuit, and to withdraw radio frequency energy from

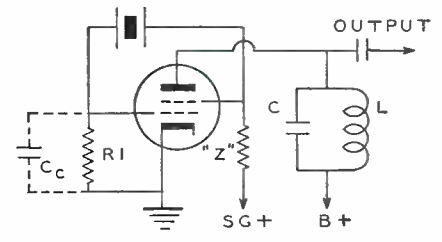
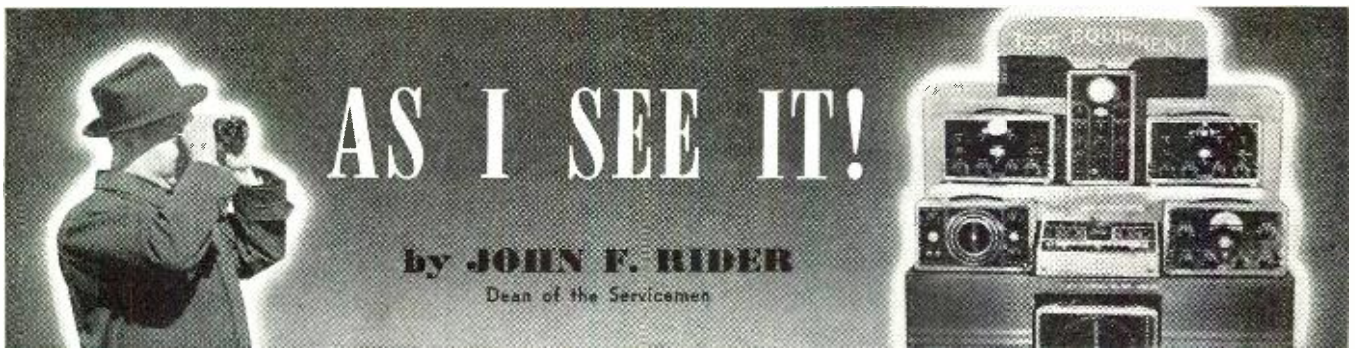

FIG. 2

to be the case. In effect, the application of electron coupling to the basic *Pierce* oscillator, *à la* Dow, permits the retention of the untuned plate circuit of *Pierce* with resultant freedom from reaction on oscillator frequency due to the tuning of what is, in effect, the plate circuit of a separate following amplifier tube. No such separate following amplifier tube is diagrammed in Fig. 2, but it has its equivalent in the electron stream from oscillator screen to plate—exactly as the tuned plate circuit of a following r.f. amplifier is divorced from reaction upon the oscillator itself by the electron stream of the intervening amplifier tube.

While the writer's quantitative notes of his original investigations were not momentarily available, he can state,

(Continued on page 51)



Push-Button Receiver Readjustments

WE hear from various quarters that the efforts made by various radio organizations to stimulate interest among radio servicemen in connection with the frequency reallocation program have not proved very fruitful. That is to say, the push-button receivers which were readjusted by servicemen after "radio moving day" were not as plentiful as expected.

Rather than go on the limb blindly, we decided to ascertain some figures concerning how many of these receivers were readjusted by servicemen in the period between March 29th and May 25th, approximately 60 days. In order to get this information, we made a mailing of questionnaires on a postage prepaid card to approximately 26,000 servicemen. The number of responses received were ample to enable the formation of definite conclusions.

We segregated these replies into six groups; those who indicated that they had readjusted from 1 to 25 receivers, 25 to 50, 50 to 100, 100 to 150 and those who did over 150. Those men who indicated that they had readjusted none, we did not consider because we felt that those answers were either not accurate, or the man who replied just did not take the pains to answer this question. The distribution of the number of replies show that the general comments to the effect that this campaign was not successful and that it did not provide the remuneration which servicemen expected, is correct. At the same time, however, one very significant point comes to light, namely, that the total number of men who readjusted more than 100 receivers were equal to about 30% of the number who serviced between 1 to 100 receivers and of this group 60% readjusted between 1 and 50 receivers.

Recognizing that the location of the service shop, that is to say the city where it is operating, is a dominant factor in determining how many such receivers would be available for service, we checked the city as well as the number of receivers and it was indeed

surprising to note that many of the men who reported having readjusted less than 50 receivers were located in centers with a population in excess of a million, in fact several million. At the same time, in these same cities were found replies which indicated that a man had readjusted several hundred receivers, with quite a few being in excess of 500.

Trying to give every benefit of doubt, there seems to be something wrong, not with the campaign, but with the individuals who were supposed to do this readjustment work when five men in a town will handle about 1800 receivers and another five men likewise picked at random, in the same town, will handle only 130 receivers.

It is of course possible to find an explanation for such discrepancy in operations in the resultant operating revenue. It is far fetched to imagine that the five men who handled approximately 15 times as many receivers as the other five, got this business because of cut prices. By and large, the average price in a community of the type about which we are talking, was \$1.00 and while we do not know definitely that these five men who handled a respectable amount of those readjustment jobs did charge \$1.00, we would be willing to bet a \$5 bill that the volume was not due to price; rather it was due to the effort to go out and get the business. It is of course possible that by the same good fortune these five men possessed greater knowledge concerning the commercial viewpoint than the other five with whom we compared them. More than likely this is so, and if it is, it behooves the servicing industry to realize the fact that it is just as much to their interest to gather facts relating to the commercial side of radio as to the technical side of radio.

Accepting the general opinion, which is pretty much verified by this survey we have made, that this reallocation program campaign was not as successful as it could be to radio servicemen, we feel that if there is any one condition that can be blamed for it, it is nothing more than the lack of the commercial slant on the part of the majority of servicemen in America. This is no new argument we are presenting, for we have hollered about the commercial slant for many years. A few years ago there developed some agitation concerning the commercialization of the servicing industry and all effort was focused upon the determination of operating expenses, costs and servicing charges. If our memory does not fail us, information concerning means whereby servicemen could get business and what tactics to employ were disseminated by various agencies seven,

eight, nine and ten years ago but for some reason this kind of effort has been dropped during recent years. It is our sincere opinion that if anything is done by anyone to help the servicing industry, at least 50% of that effort should be along lines which would educate the serviceman relative to how to get new business.

We appreciate that in these hectic times when practically all business has become a seller's market, few men have any inclination to study sales methods and sales psychology. Maybe that applies to those organizations who are providing the vital necessities of the nation. As I see it, the serviceman too, is providing vital facilities. It may be of a different character than the manufacture of tanks and guns and planes—but it is equally important to the welfare of the nation as well as the government, for radio receivers in the hands of the public to be in good repair. Unfortunately, however, radio repair has been considered a necessary evil for twenty years and so little education has been done to make the public see the value of radio service work that even with the present state of affairs—when radio receivers are getting more use than ever before—it is still necessary for the servicemen to convince the public that receivers which are not in perfect condition should be serviced. In other words, the serviceman is still in that position where he must solicit his business. To depend upon word-of-mouth advertising—the recommendation of one man to another—is not sufficiently reliable to enable a man to earn a respectable living and to support himself in these days of inevitable rising taxes and expenses. Just how high taxes and expenses will go we don't know but there is no doubt about the fact that every man in the servicing industry is going to shoulder a portion of the financial burden. To provide the wherewithal, he must go out and get the business—it will *not* come to him who waits.

Everyone in the radio industry is convinced that there will be a major upswing in radio servicing if only because of the shortage in production of new receivers. But it is still necessary to overcome the inertia of the public to call the serviceman. The industry might just as well realize that from the public's viewpoint, it is labor to hunt up the address of the local service shop and to use the telephone to call the serviceman. The radio industry feels that many servicemen missed the boat in the frequency relocation program. It is hoped that the same thing will not happen during the next two years of increased demand for radio service work.

(Continued on page 50)



Runt: "I'm looking for trouble!"

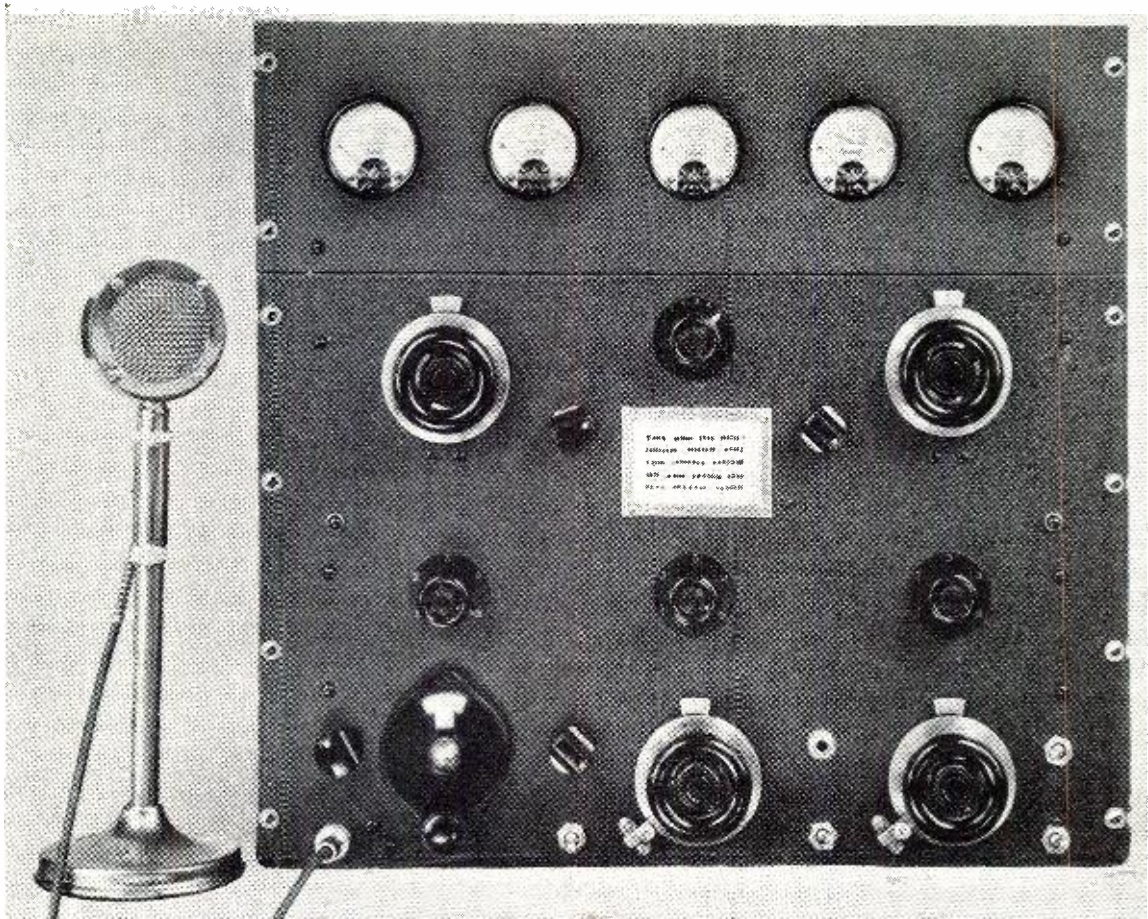

A complete, ECO-excited, five-band, phone or CW, 75-watt transmitter in 1941 dress.

75-watt TRANSMITTER

1941 VERSION

by **KARL A. KOPETZKY, W9QEA**
 Managing Editor, RADIO NEWS.

Why not build up a low-powered transmitter which will have all the gadgets which you were going to put into that kilowatt rig?

WITH the scare that the National Emergency threw into the ham ranks, there has been a marked decline in the building of kilowatt rigs. When the decline in this type of construction set in, the average ham was loath to include any of the latest gadgets, or quirks in anything less than a half kilowatt rig. That is where the original mistake was made, for if a gadget will improve a half kilowatt rig, think what it would do for a smaller powered one.

It was with this thought in mind that we decided to design a low-powered rig which would at the same time take every advantage of the latest features and developments. If we could include means to keep our modulation close to (but not exceeding) 100%,—if we could cut down side-bands,—if we could stabilize an included eco oscillator and cover all bands without

lifting the lid to change coils, we would indeed have something which would be an advantage even if we stayed on the fair side of 100 watts input to the final amplifier.

Since we were determined to make the transmitter outstanding, except for low power, and if we were including these features, there was not any reason why the small rig should not in its fashion look as good as a "broadcast station transmitter." This made us more sure than ever that we would have sufficient meters for every circuit that needed metering, that we would have all controls brought out to the panel, and that everything would be in tip-top shape.

Starting then at the power input stage, since the entire rig is more or less determined by this factor alone, we fixed on a power of 75 watts. This, 100% modulated, would give us a peak

power of 300 watts allowing for a conversion factor of unity (which is, of course, impossible). However, if we were successful in designing a rig which was, say 75% efficient, input vs. output, we would be able to put out approximately 225 watts on peaks, which is quite good. Adding to that some form of antenna which had in itself a multiplication factor, our peak power would seem to rise as high as 22.5 kw., which is quite respectable. Naturally this would only be possible on 10 or 20 meters with a 5-element beam. But then that was where we wanted the power, while on the other bands a gain of 4 or 6 times could be expected with other antennae. Thus it can be seen that the original 75 watts, if kept close to 100% modulation, for phone, presented a very highly respected power output which can be stepped up to something to give the

kilowatt boys a bit of competition provided they have not the antennae to give them the advantage of the power gain there.

This should prove to the most skeptical that there is good sense in designing a good low-powered rig and coupling it to a fine, power-gaining antenna. That situation is old stuff to the British, who have been doing it for years.

Having, then, decided on 75 watts input, next thing was to find out what tubes to use. Books can be written on the choice of tubes, and how to arrive at a good tube for a given function, but we used the old ham method, pocket-book versus "specs." The cheapest screen grid tube (and therefore easiest to band-switch and not neutralize), was the new RCA 815. Having an RCA 815 in the final, and we were going to run in with its elements in parallel, at an input of 75 watts, the next step was to decide on a modulator. We needed 37.5 watts output. At 400 volts plate potential, the RCA 815, again, was the logical choice for a modulator, Class AB2. Under these circumstances it develops 42 watts. Allowing for some losses in the transformer, we would have enough to modulate our carrier 100%.

The choice of the proper tubes in each case was resolved in the favor of tubes which would be loafing, and not driven. The eco tube chosen was the RCA 802 running at reduced voltage (300 volts) and the speech tubes, a 6SK7 input and a 6V6 driver. Voltage regulators in the plate circuit of the RCA 802, in the form of two VR-150's would keep the eco stable, and the addition of a 6H6 AMC tube in the speech stage would act to keep the modulation up to, but not exceeding 100%. That was the final line-up: 802 eco, 815 (parallel connection) final, modulated by an 815 Class AB2, with a 6V6 driver, a 6SK7 speech input, and a 6H6 AMC tube. For good regulation two power supplies were decided on, and each was rectified through an 83.

Having fixed the tube lineup, the next problem presented was to get the most from the setup.

Since the rig was to be used for communications only, there was not any reason why high-fidelity, the delight of every ham, should not be dispensed with. We know that it will be difficult for the average ham to find space in his mind for the thought that high-fidelity is not necessary. In fact, it is so unnecessary as to be bothersome, because of the increased space in the spectrum which the broad-band rig takes up, and adds nothing except to the quality of the voice of the operator. We were little interested in sounding like Bing Crosby, but we were mighty anxious to get the most from the transmitter, and at the same time be as intelligible as possible. It was intelligence we wanted to transmit, not musical sounds. Hence we included a cut-off device which attenuated the audio frequencies above 2500 cps. The drop off is sharp, and at 10,000 cps. the response was down over 20 db. below that at 2200 cps. We could therefore treat our carrier as having only 2500 cps. side bands. The device, an .02 mfd. condenser in the grid-ground circuit of the 6V6.

The fact that speech is lopsided, especially that of the male, has been expounded before, notably in *QST*

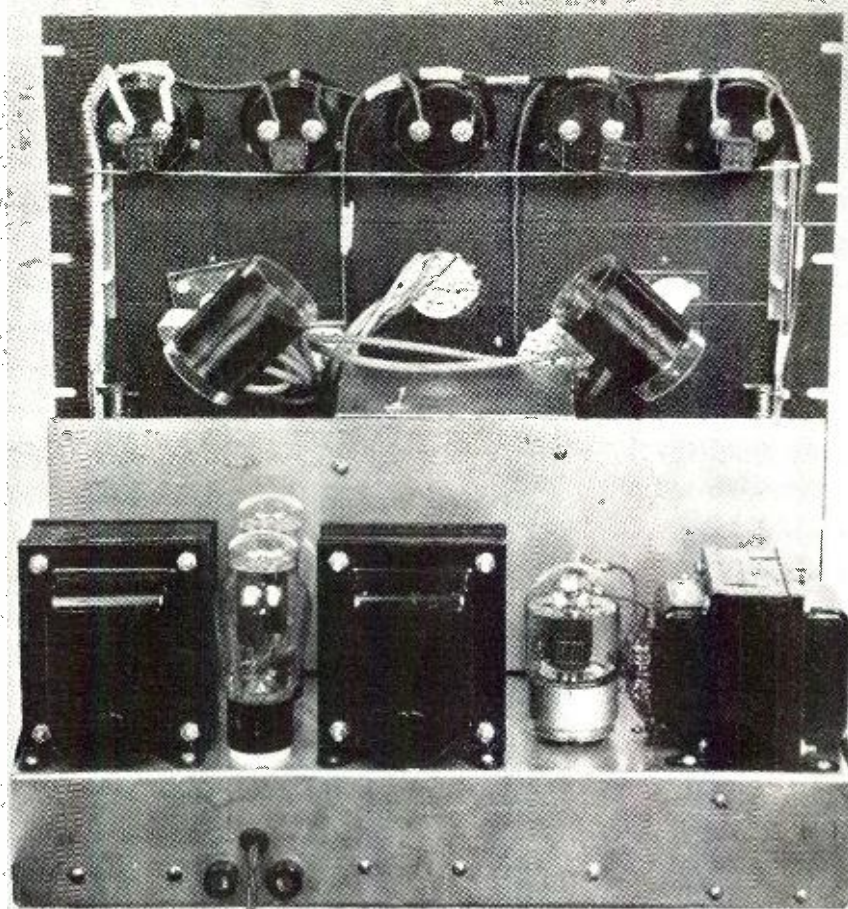

The two Collins pi network coils, visible above the shield, were later replaced with a single coil which worked well tapped in eleven places.

(*Grammer*, page 14, February 1940 issue) and also in *Radio* (December 1939 issue). To take advantage of this phenomenon, a speech reversing switch such as was advocated by both articles was installed. It was now possible to keep the modulation up to 100% positive, while not clipping the negative peaks. Such clipping as took

place on the positive peaks caused no change in receptive characteristics, while the elimination of the clipping of the peaks on the negative side eliminated splatter in adjacent channels, and in adjoining ham's receivers. This gadget, if only a simple DPDT switch was therefore more than worth while. Incidentally, with the inclusion

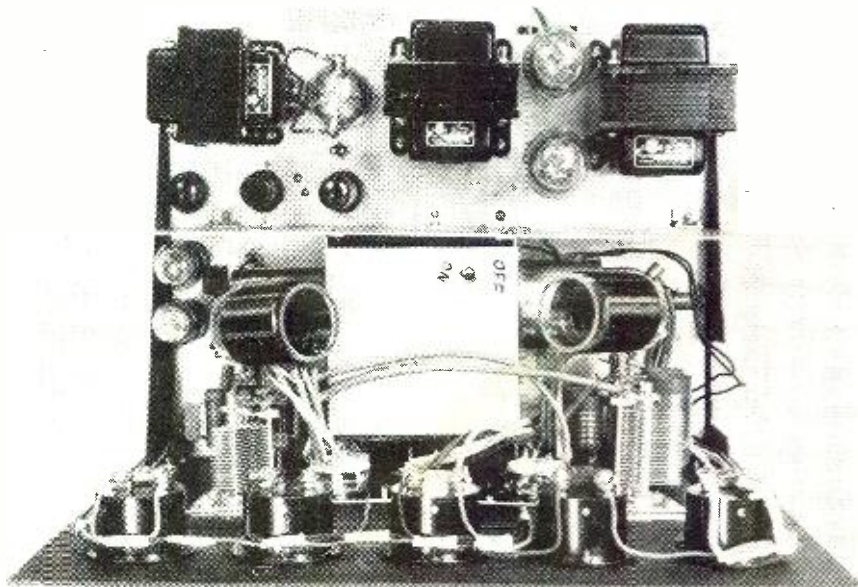

The on-off switch on top of shield is to cut 815 screen while tuning up.

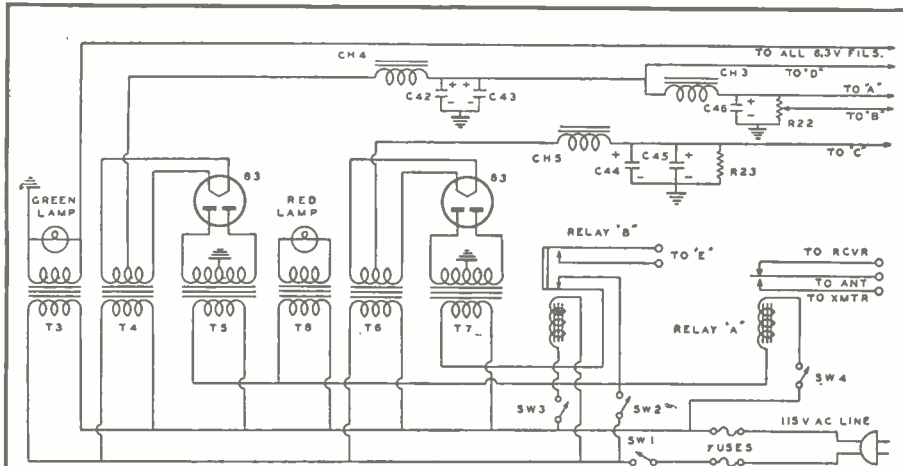

- SW₁, SW₂, SW₃, SW₄, SW₅—SPST toggle switches, Arrow
 Relay B—Make one, break one, 115 AC coil, Guardian
 Relay A—Antenna change over, 115 AC coil, Guardian
 CH₁, CH₂, CH₃, CH₄, CH₅—8 mfd. electro. 600 v. Mallory
 R₂₂, R₂₃—50,000 ohms, 25 w. Ohmite
 T₁—Filament transformer, Stancor P-4089
 T₃, T₄—Filament transformers, Stancor P-4088
 T₅—(500 v. DC @ 200 MA from filter) transformer, Stancor P-6321
 T₇—(400 v. DC @ 200 MA from filter) transformer, Stancor P-6337
 T_K—Midget filament transformer, Stancor P-6134
 CH₁, CH₂—50 MA filter choke, Stancor C1003
 CH₃, CH₄, CH₅—250 MA filter choke, Stancor C1412
 Sockets—Millen throughout
 Feed-throughs—Millen
 Cabinet, Panels, Chassis—Bud
 Tubes—RCA

be changing dangerously. Thus, with the five meters included, we can read respectively the plate of the eco, the grid of the 815 r.f. amplifier, the plate of the 815 r.f. amplifier, the screen of the 815 modulator.

While *Browning* turrets were used throughout since they presented a compact and neat appearance and worked well, some pruning of the 10 meter coils had to be done. Coils L5, L10 and L15 were trimmed by taking off one turn each to hit the highest frequency of 30 mc. If the constructor finds he has to take off more, he should not be alarmed, since the specifications of these coils will vary with each layout.

The modulation transformer impedances which worked for us were 6200 ohms plate to plate for the modulators (taken from the instruction sheet) and 3333 ohms for the final r.f. amplifier. If the input voltage to the 815 modulators is kept at 400 volts under load, the 6000 ohms modulation transformer tap should be used and if the final is run at 150 ma at 500 volts, use the 3450 or 3200 modulation transformer secondary taps.

A full and simple *Collins pi* network has been included in the upper half of the rig, and that, too, is bandswitching. Leave one "blank" space in the connecting switch for tuning the final.

Also a cut-off switch, not shown in the circuit diagram, was inserted in the 815 final screen lead. By using this at "off" the 802 eco could be tuned to maximum efficiency without having the final wander all over the lot.

Construction

The entire r.f., speech, and power supplies are built on a chassis which measures 13"x17"x3" which is a standard size. There are no important precautions needed in laying out the parts. The correct position is determined by referring to the illustrations. Note that considerable space is saved by mounting as many of the transformers and parts under the chassis as we

of the *AMC* circuit cutting off the carrier at 100% modulation, the legal question presented in using the lopsided speech in the "positive" position was entirely avoided. Since the carrier was not being modulated in excess of 100%, there could be no *FCC* criticism.

The matter of feeding the screen of the 815's properly next engaged our attention. We have discovered, in common with many other hams, that the screen grid tube is prone to "creep" if the excitation was too high, if the screen voltage was high. But for any given set of conditions, if the tube instructions were followed the tube settled down to operation according to "Hoyle." Since we could easily control the excitation by detuning the plate circuit of the eco, and still keep it "in

the band" the problem of holding the screen "nailed down" was what bothered us. *Roberts*, in *QST*, October 1940 issue at pages 38-40 explains how to figure resistors which, if used in the screen feeding circuit tube will prevent the screen's dissipation from being exceeded no matter what the condition of the power supply. This was the system followed, and was more than worth all the paper work needed to come to the results shown in the parts lists. The screen of either 815 was seen not to draw more than its rated input in watts no matter what the tuning adjustments.

Meters, mentioned before, were used in every circuit. We have a horror of changing a switch every time we want to read a meter for fear that while we are reading one circuit, another might

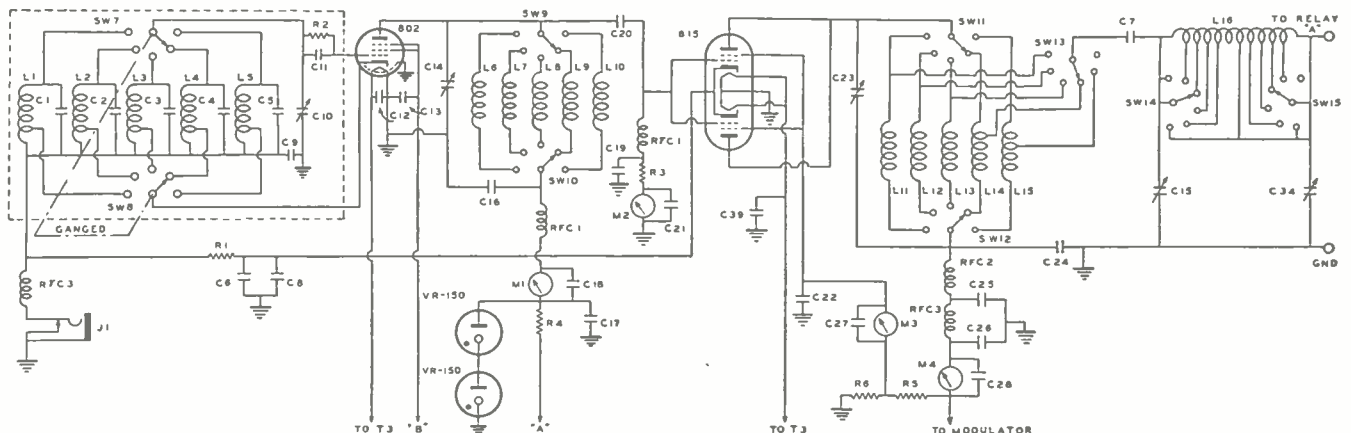

- L₁, L₂, L₃, L₄, L₅ } *Browning* 5G tuner
 C₁, C₂, C₃, C₄, C₅ }
 SW₇, SW₈ }
 L₆, L₇, L₈, L₉, L₁₀ } See text
 L₁₁, L₁₂, L₁₃, L₁₄, L₁₅ } *Browning* 5 P Tuner
 SW₉, SW₁₀, SW₁₁ }
 L₁, L₂, L₃, L₄, L₅ } *Browning* 5 PL Tuner
 SW₁₂, SW₁₃, SW₁₄, SW₁₅ }
 C₁—0.005 mfd. mica Mallory
 C₂—0.1 mfd. paper 400 v. Mallory
 RFC—2.5 mh, 250 MA, choke, Millen
 C₃—0.005 mfd. mica Mallory
 C₄—100 mmfd. Millen midget 20100
 C₁₁—0.001 mfd. silver-mica Mallory (or *Browning*)

- C₁₂, C₁₃, C₁₇, C₁₈, C₁₉, C₂₁, C₂₂, C₂₇, C₂₈—0.002 mfd. mica Mallory
 C₁₆—0.06 mfd. mica Mallory
 C₁₀—50 mmfd., Included with *Browning* 5 P
 C₂₀—0.0015 mfd. silver-mica, Mallory
 C₂₃—75 mmfd. Bud MC967
 C₂₄—0.005 mfd. mica Mallory
 C₂₅—0.01 mfd. mica Mallory
 R₁—100 ohms, 20 w. Ohmite
 R₂—50,000 ohms, 1 w. IRC
 R₃—5,000 ohms, 20 w. Ohmite
 R₄—15,000 ohms, 20 w. Ohmite
 R₅—15,000 ohms, 20 w. Ohmite
 R₆—100 ohms, 1 w. each, to total 62,500 ohms, IRC
 RFC₁—Ohmite Z-10 RF choke

- M₁—0.75 MA DC meter Triplett No. 221
 M₂—0.25 MA DC meter Triplett No. 221
 M₃—0.50 MA DC meter Triplett No. 221
 M₄—0.250 MA DC meter Triplett No. 221
 J₁—closed circuit jack, Carter
 RFC₂—2.5 mhy, 250 MA, Millen
 R₇—20,000 ohms, 2w, IRC
 C₂₆—0.1 mfd. paper, Mallory
 C₇—0.06 mfd. mica, 1000 v. Mallory
 C₁₅—200 mmfd. Hammarlund
 C₃₁—325 mmfd. Hammarlund
 SW₁₃, SW₁₄, SW₁₅—6 pos. 1 Pole Switch, Centralab, each
 L₁₆—Bud, 150-w, 160M coil tapped in 11 places

can find room for. This includes chokes and audio components.

The panel assembly is divided into two parts—one measuring 12¼"x19" and the other 5¼"x19". The latter is available already cut to accommodate five meters. The *Triplet 2"* meters are mounted in back of the panel as shown in order to relieve some of the crowding effect when they are placed close together. The appearance of the unit is improved by using this method of mounting. The larger panel is also of standard dimensions and is easily obtained.

All of the tuning condensers for the r.f. stages are mounted beneath the chassis. Standard coil assemblies are used as they provide the most efficient design. A bit of pruning is required in order that they be adapted to the particular layout used in this transmitter. Remove the tie-bracket that holds the coil switch and condenser. Mount the condenser below the chassis—through the panel as shown. Mount the coil assemblies above the chassis, directly on the panel so that the common lug will be in the "down" position. This is necessary in order that a short connection can be made to the tuning condenser.

Baffle shields are cut from *evaydo* or aluminum and formed so that they fit around the coil assembly. A cover is provided for the center section. This fits snugly in place over that coil assembly. The 802 eco oscillator tube is mounted in a horizontal position. There is an advantage in using this position, as it places the base of the tube near the grid coils, and isolates the input from the output circuit. The plate cap is then close to its associated coil assembly and a very short length of wire may be used for connection. An aluminum can is fitted around the tube as further shielding is desirable in an efficient eco.

The complete speech and modulator components are laid out along the rear of the chassis. It is well to keep these parts as far away from the r.f. section as possible in order to cut down on any reactive circuits. The use of single-ended tubes will reduce the danger of hum pickup to a great extent and their use is recommended over the older types. A *Millen* tube base shield is used at the 6SJ7 socket to prevent coupling between the grid and plate circuits. All leads should be carefully shielded where they are indicated on the diagram.

We have already covered the theory for the peak-limiter circuit. The gain control for this circuit is mounted on one side of the chassis where it will be out of the way. Once this is set, it can be left in place and will not require any further adjustment. The shaft is cut off close to the bushing and a slot is cut into the end so that adjustment can be made with a screwdriver.

Another aluminum can is placed over the 815 r.f. tube as shown. This tube is also mounted in a horizontal position in order that the r.f. leads may be kept as short as possible. In fact—the shielding of the unit is most complete, and we have spared no material in isolating the circuits as much as possible. The use of an eco oscillator requires that certain fundamental laws be adhered to if the finished unit is to function properly and if we are to attain maximum efficiency—hence all the shielding.

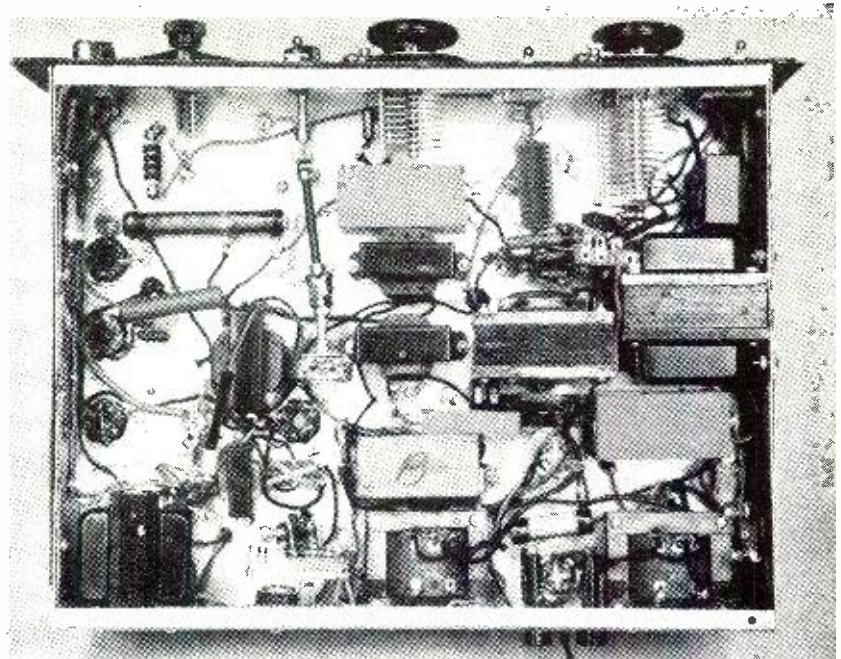

Under chassis view, with the speech yet unwired.

The complete *Collins* network components may be seen on the illustration. These mount so that the tapped leads from the coils may be run to the switch in a convenient manner and where they can be kept short in length.

Note that a vernier dial is used on the eco grid condenser. This was added as a refinement after the unit was completed. It affords a more accurate logging of the various frequency settings and space is provided on the card-

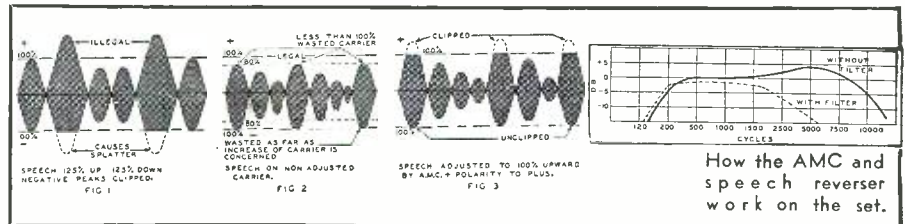

How the AMC and speech reverser work on the set.

The two coils must be placed in position so that the r.f. field will not be in proximity to those from the coil circuits in the other stages. This is important if trouble is to be avoided. The two antenna feed-through insulators are mounted at the rear top corner on the cabinet so that the antenna lead-in will be away from the operator.

board scale so that spot frequencies may be indicated. Calibration is made with a standard signal generator and by checks with WWV.

If desired, the links with which the final tank turret comes equipped may be left intact and used to feed any balanced line. The links will be best usable on 20 and 10 meters.

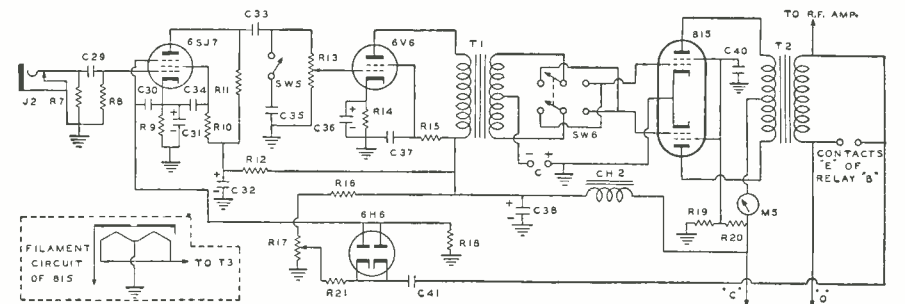

- R₁—5 megohms, ½ w. IRC
- R₂—300,000 ohms, ½ w. IRC
- R₃—1500 ohms, 1 w. IRC
- R₄—1 megohm, 1 w. IRC
- R₅—250,000 ohms, 1 w. IRC
- R₆—60,000 ohms, 20 w. Ohmite
- R₇—500,000 ohms potentiometer, Mallory
- R₈—350 ohms, 10 w. Ohmite
- R₉—5000 ohms, 10 w. Ohmite
- R₁₀—50,000 ohms, 10 w. Ohmite
- R₁₁—50,000 ohms, potentiometer Mallory
- R₁₂—100,000 ohms, 1 w. IRC
- R₁₃—60,000 ohms, 1 w. IRC
- R₁₄—15,000 ohms, 20 w. Ohmite
- R₁₅—Filter choke, Stancor C-1003
- T₁—Driver transformer, Stancor A-4752

- T₂—Modulation transformer, Stancor A-3892
- M₁—0.200 MA DC meter Triplet
- SW₁—SPST toggle switch, Arrow
- C₂₀—.05 mfd. paper, 200 v. Mallory
- C₂₁—.25 mfd. paper, 200 v. Mallory
- C₂₂—.25 mfd. electro., 25 v. Mallory
- C₂₃—.8 mfd. electro. Mallory
- C₂₄—.02 mfd. paper, Mallory
- C₂₅—.05 mfd. paper, 200 v. Mallory
- C₂₆—.006 mfd. mica Mallory
- C₂₇—.25 mfd. electro. Mallory
- C₂₈—.1 mfd. paper, 600 v. Mallory
- C₂₉—.8 mfd. electro., 600 v. Mallory
- C₃₀—.10 mfd. electro., 50 v. Mallory
- C₃₁—.5 mfd. paper, 400 v. Mallory
- C₃₂—.5 mfd. paper, 600 v. Mallory

BENCH NOTES

by **ROBERT KENDALL**

Service Manager, Indianapolis, Indiana

Spring Cleaning and Fever

THE May issue of RADIO NEWS has just come on to our desk, and no doubt you noticed as we did, that the boss in Chicago has been doing a little spring cleaning of his own, by giving the departments new decorations in the way of photographic headings. It is also noted that the by-lines for the various departments have not been changed, as yet, so we will grab our typewriter and tear off this month's assignment, and rush it in to Chicago before the thought occurs to K.A.K. to extend his spring cleaning along that line as well.

It is not thought that we are betraying any family secrets when we inform our readers that the earnest-looking prod-pusher in the *Bench Notes* head is not the present conductor of this department, nor is the rather stern-looking gent "ringing the bell" our genial friend Sam Milbourne. From the expression on the face of the illustrated bell-ringer, we are inclined to suspect that he is ringing up "No Sale," or is getting ready to cut into the day's profits by shelling out for his wife's new spring hat. [A. P., please note! Ed.]

The exhortation against dawdling and piddling, is written with Sam's customary right and right and left hand counter-punching, and was well-timed to appear when the average fellow is beginning to be afflicted with *leadius pantsus*, or the Vernal Droops, but was so full of the old pepper that we were slightly worn-out when we had finished it—and whether on account of the weather, the article, or plain contrariness we defiantly ambled over to the corner drug-store and imbibed a couple of "cokes" before tackling that tough job that has been setting in the corner for three days. And tomorrow, no fooling, we are going to get out our mailing list, and send out something to the trade, even if it is nothing more than "Love and Kisses."

After considering Milbourne's anti-piddling campaign, we begin to suspect that there is some doubt about the exactness of the general assumption that our brethren below the *Mason-Dixon* line do not have quite the zing of those inhabiting the cooler climes, especially since our communications from residents in Dixie indicate that the boys in that locality are about as up-and-at-'em as elsewhere. For instance, we might mention Quincy Gibbon again. Mr. Gibbon, you may remember, is the originator of that unique tabulation, published some months ago, that purported to show the customer why it cost \$4.33 to repair his set. We have word from Mr. Gibbon that he is considering a change

in this schedule, and append his comments:

"That form is about three years old now, and I think it is about time I was bringing out a new model. Owing to changing conditions—especially the prevalence of 9, 19 and 29 dollar so-called radios, I think the same form could be set up with only one change, i.e., and assumption of five jobs per day, which would reduce the cost per job to exactly \$3.00. Since there is no allowance in that cost schedule for any help whatever, it stands to reason that one man would have to keep his shirttail in the wind to fix five radios every day, including Xmas, the 4th of July, and his Aunt Susie's birthday."

And we should say that Mr. Gibbon is just the fellow to do it.

Garrard Record Changers

SUPER-SNAPPY Sales & Service is rather fortunate in possessing and catering to a rather select clientele, that go in for radio in its more elaborate and expensive forms, and quite a number of these desirable customers have high-priced radio-phono combinations that include the Garrard record-changer, an English-made mechanism of better than average construction. These record-changers rank among the best, and seldom give serious trouble, as most of the adjustments ordinarily required are precise and easily made. However, on occasion we have encountered a trouble in their mixer-changer models, such as the *RC30*, that is not covered in the manufacturer's service manual, and as the correction is not at all difficult will pass it on for the benefit of others who may run across the same trouble.

In the later models of the inter-mix changers, the edges of the records rest on a single shield-shaped part, known as the record platform. When the changer operates it will be noted that this platform moves with a double-thrust, one stroke nudging the 10" records off the spindle, and the shorter stroke designed to shift the 12" records. At times it may be found that the stroke is either too long or too short, and the small nib in the center of the platform will fail to engage the edge of the record sufficiently for proper changing. Usually this trouble occurs only with one size of record, seldom for both.

When this condition is met, the repair man should not attempt to change any of the adjustments under the motor board, but look for the small L-shaped bracket located directly under the record platform. After loosening the lock-screw a half-turn the bracket should be shifted slightly and locked in place again. The direction of the shift will depend upon the correction of the

stroke necessary. If the stroke of the record-platform is too short the bracket should be moved away from the turntable. Conversely, if the stroke is too long, the bracket is moved toward the turntable. This adjustment is rather critical, and the bracket should be moved only about 1/16" at a time. If the bracket is slid too far away from the turntable, the mechanism will jam and stall the motor, and care should be taken to avoid this.

Antennae

THERE was a well-remembered time in the earlier days, when radio was just becoming popular, and the installation of antennae constituted a large part of the service man's business; and what old-timer does not remember those three-wire, 150-foot contraptions that took two men and a boy a half a day's time to get in the air, and the rest of the month in making explanations to the customer as to why he couldn't get California every time he tuned in? Old-timers will also remember, but few can explain, those customers that chose the worst day of the winter, when there was six inches of snow on the roofs, to insist that their antennae be put up that very day. We finally got around that one rather neatly by agreeing to put up the antenna—if the customer would help us! Since that time the antenna has declined in size and importance, and with the advent of more powerful transmitters, and more efficient tubes and receivers, the rank and file of the radio listeners find that the built-in loop of present receivers, or

(Continued on page 53)



"Don't worry Ma'm, Jones is our best man. He goes in there and fights!"

Beginner's Economy 5-tube Superhet

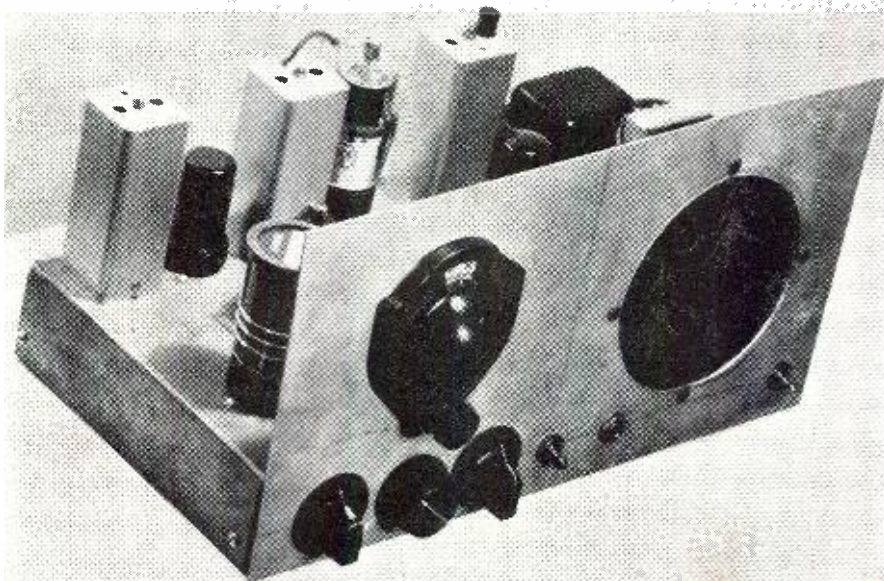

Note the extreme simplicity of this beginner's receiver.

by **L. M. DEZETTEL, W9SFW**

Engineer, Allied Radio Corp., Chicago, Illinois.

This is an extremely economical, yet easy-to-build superheterodyne receiver with which the beginner may well start his experimental work.

IN building the model of this ham super, we attempted first of all to provide the constructor with an amateur type communication superhet receiver that would be low in cost and easy to construct. It is possible to accomplish this end without in the least sacrificing efficiency of operation.

Ease of construction is made possible by the fact that the chassis and panel can be purchased already formed and drilled. If you prefer, however, you may make your own chassis and panel following the layout shown in the diagram. The tedious job of making the plug-in coils is eliminated by purchasing factory wound coils especially designed for this receiver.

Where no r.f. pre-selection is used, modern practice dictates the use of a 1,500 kc. intermediate frequency. Careful design permits us to maintain plenty of wallop in the i.f. channel.

Two 140 mmf. midget variable condensers are used for "band-setting." One is in the r.f. circuit and one in the oscillator circuit. A single 30 mmfd. midget variable condenser in the oscillator circuit is used for tuning in the stations once the band is set. The 30 mmfd. condenser is driven by a vernier dial, adding further to the bandspread.

The front-of-panel controls are all shown in the sketch. The phone jack includes a switch for cutting out the power stage on speaker when head-

phones are inserted. The beat frequency oscillator pitch control is located on the B.F.O. coil. Once adjusted, this control need not be touched again.

Let us take a look into the tube lineup and see why the tubes used in this circuit were chosen. The 6K8 H.F. converter is actually two tubes in one. Its operation is equivalent to a separate converter tube and a separate H.F. oscillator tube. Very little pulling effect was noticed, even at the highest frequency, when rotating the r.f. condenser. The i.f. amplifier tube is a 6SK7. The new single ended tubes have higher gain and better circuit adaptability than their older counterparts. The function of second detector and B.F.O. are taken care of by a 6C8G dual triode. One triode section of the 6C8G tube is used as a biased detector. This type of detector not only adds to the amplification of the signal but does not load the i.f. transformer preceding it. It is this point together with the use of the higher gain single ended i.f. amplifier tube and iron core transformers that gives this receiver plenty of gain in the i.f. channels, even at 1,500 kc.

The B.F.O. comprises the second triode section of the 6C8G tube. The capacity between the two sections of the tube was found to provide sufficient coupling for the B.F.O. circuit.

The old reliable 6F6 provides the power for driving a 5" speaker. Inverse feedback is introduced in this circuit in a simple and novel manner. The usual high capacity cathode bypass condenser is eliminated and instead a .01 mfd. feeds some out of phase signal back to the cathode of the tube. Although we lose a little gain here, there are many other benefits which justify our use of inverse feedback in this stage.

In laying out the parts for the constructions of this receiver, we suggest that you follow the diagram shown here as closely as possible. Every part should be mounted securely. The diagram should be followed and checked against your work so that no connections will be overlooked. Make all connections as short as possible—directly from one point to another. Fixed condensers and resistors are supported by their own pigtail leads, but where the distance is short, cut off the excess lead.

Well-soldered connections are essential to noise-free operation. Touch the hot soldering iron to the connection and apply a good grade of resin-core solder to the *heated connection*, not to the soldering iron. Allow only a small amount of solder to flow into the connection—only enough to make a good bond. When soldering socket terminals, be careful that solder does not

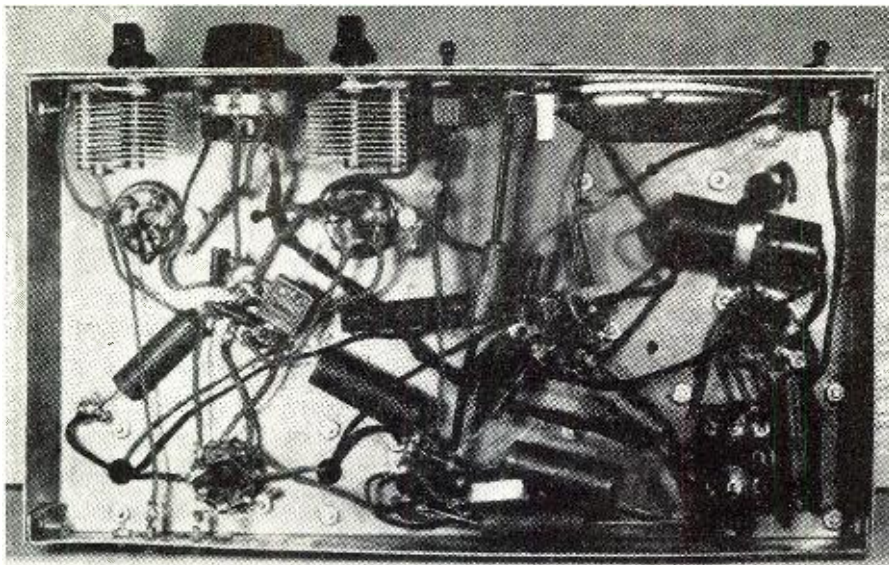

Note the direct point-to-point wiring under the chassis.

flow over to the next terminal and cause a short.

The i.f. coils are pre-tuned to approximately 1,500 kc., but a little additional peaking will increase the sensitivity of the receiver. This is a very easy thing to do in circuits such as this having a B.F.O. With the coils in but with the antenna disconnected, throw on the B.F.O. The B.F.O. acts as a signal generator, radiating a weak signal in the vicinity of 1,500 kc. Adjust the B.F.O. until a soft rushing sound is heard in the speaker. Now, adjust each of the i.f. trimmers until this rushing sound is loudest. That's all there is to it.

An essential to good reception, as you already know, is a well designed antenna. The antenna you are using

for your transmitter makes the best antenna for the receiver. The input to the receiver is low impedance and will match nicely the average 400 or 500 ohm line. If a straight wire antenna is contemplated, try to cut it to a length equal to an odd multiple of a quarter-wave length for the band you wish to operate most. For instance, a single wire antenna for the 40 meter band should be either 10 meters, 30 meters, 50 meters, etc., long. This is equal to 66 feet, 99 feet, 175 feet, etc. An antenna about 100 feet long is a good average antenna length for the 40 meter band. It goes without saying, that a good ground, to a cold water pipe or a rod driven into moist ground outdoors, is essential.

Now let's try out the set. There are

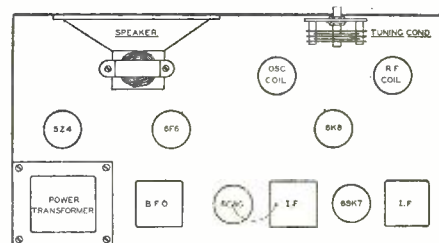

Chassis layout diagram.

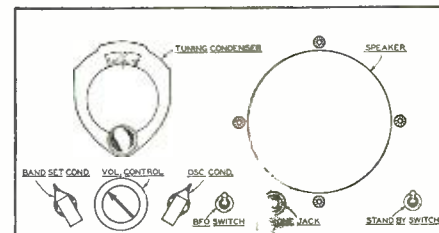

Front panel layout.

eight coils altogether, 1 r.f. and 4 oscillator, giving you general coverage from 1,700 kc. to 32 mc. Try out your set with the lowest frequency coils first. Set the volume control at maximum position (all the way to the right). Locate a group of stations by rotating the oscillator band setting condenser until the station signals are brought to maximum volume. Now pick out a station and tune it in carefully with the vernier dial. You will soon be acquainted with the location of the amateur bands on the band setting condensers. It is a good idea to put a pencil mark on the panels indicating the position of the band setting condensers for the various bands, so that they can be quickly re-set when changing coils. Just keep in mind that the band setting oscillator condenser *locates* the band and the band setting r.f. condenser tunes the antenna coil to maximum sensitivity.

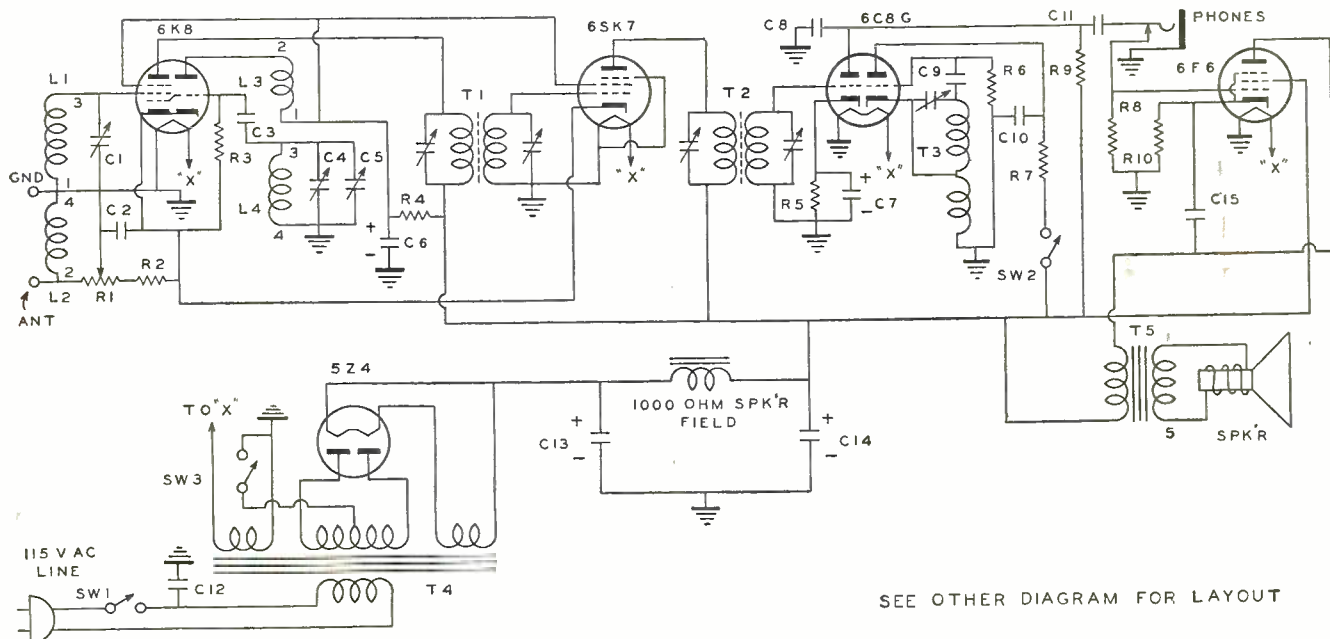

SEE OTHER DIAGRAM FOR LAYOUT

- C₁, C₅—140 mmf. var. Millen 22140
- C₂, C₁₀, C₁₂—1 mfd., 200 v. paper, Sprague
- C₃—0.001 mfd. midget mica, Sprague
- C₄—35 mmf. var. Millen 22935
- C₆—4 mfd., 150 v. elect., Aerovox
- C₇—10 mfd., 25 v. elect., Aerovox
- C₈—0.0025 mfd. midget mica, Sprague
- C₉—0.0025 mfd., silver mica, Sprague
- C₁₁, C₁₅—0.1 mfd., 600 v. paper, Sprague
- C₁₃, C₁₄—8 mfd., 450 v. elect., Aerovox

- R₁—10,000 ohms pot., IRC
- R₂—150 ohms, 1/2 w., IRC
- R₃, R₄, R₅, R₆—50,000 ohms, 1/2 w. IRC
- R₇—10,000 ohms, 3 w., IRC
- R₈—100,000 ohms, 1/2 w. IRC
- R₉—250,000 ohms, 1/2 w. IRC
- R₁₀—500 ohms, 1 w., IRC
- L₁, L₂, L₃, L₄—Kit of 8 antenna & osc. coils—1.7 MC to 32 MC Knight N1007
- T₁, T₂—1500 Kc. Iron core input IF Transformers,

- T₃—1500 Kc. BFO Transformer, Knight
- T₄—650 v. CT @ 45 MA 5.0 v. @ 2.0 A, 6.3 v. @ 1.8 A, Knight B11611
- T₅—To match 6F6 to speaker voice coil Spkr.—Knight 5" 1000 ohms field coil Panel—Drilled 7" x 13" Knight N1004 Chassis—Drilled & formed 7" x 13" Knight N1005
- SW₁—SPST on volume control
- SW₂, SW₃—SPST toggle, H & H

Serviceman's Chart to Locate Hum

by **WALTER KENWORTH**

Radio Service Instructor, RCA Institutes, Chicago, Illinois.

The author's chart will greatly assist in the location and removal of AC hum from radio receivers.

ONE of the things a serviceman must know if he has to make profits is to run down a fault as fast as possible. He must get a *blitz-krieg* under way on each fault he meets in a receiver. He must make attacks up and down the line roughly at first until he discovers the weak point; then concentrate on this with his equipment until its threat to good reception is removed. If he can attack with a systematic plan and with proper equipment used effectively to bring immediate results, the booty is bigger—in his case bigger profits. To ensnare more profits, he must be ready to outflank, make frontal attacks or cut the opposing line in two—in his case be master of many methods.

While there are many types of lines he has to crack—like many types of receivers with their faults—his experience, linked with a definite plan will carry him farther than drifting, than deciding what he will do only when he reaches the line. A definite plan means to advance with a proven routine common to all situations, then call upon his experience to go farther. Such a definite plan in servicing means first, keen observation of symptoms, then

he can make many of the tests quicker by following the directions which accompany such equipment. By listing the following methods with the use of *simple equipment*, both classes of service men, the "haves" and the "have nots" can use the directions, each doing them in the way he knows best.

Repetition of checks has been made purposely rather than to make a back reference, for it is often necessary to make similar checks in different circuits. For example, an instance is to connect a good condenser across a suspected one to check it in different circuits throughout the receiver.

Symptoms

The procedure of tracing the hum to the defective area will be given for the two cases:

(a) Where the hum heard is steady

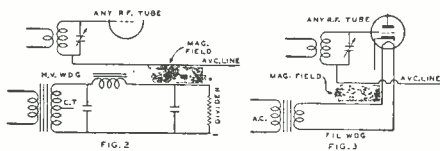

Two examples of how hum can be produced. Fig. 2 at left, fig. 3 at right. See Cause #41 (left), Cause #43 (right).

isolation of the fault. This much is common to all service problems and should be followed in all cases. Then the service man must use his experience to decide for the particular fault he meets which specific checks he should make.

To take the problem of 'hum' as an example, the service man needs a systematic procedure in servicing it which he can memorize as a routine. It should be useful enough to apply in the vast majority of cases. Although there are thousands of models and makes of receivers, we can still use the plan of procedure successfully if we make the exceptions few.

These directions apply to an a.c. operated superheterodyne since these are in the majority. The service man is assumed to have the minimum of testing equipment in making these checks. If he has the most modern equipment,

and present at all frequencies.

(b) Where it is modulated, i.e., is heard only when a station is tuned in.

Procedure in Localizing the Area of Trouble

Steady Hum

1. To find whether the Hum is before or after the Second Detector.

Short circuit the input of the audio frequency circuit just after the second detector. If the hum persists the cause is probably in the circuits "shorted." On the other hand, if no longer heard, the hum must be ahead of this point.

2. If Hum is after the Second Detector.

"Short" the grid circuit of each stage following the a.f. input until the output and then loud speaker circuit is reached. If the hum is found in either the a.f. stages or the loud speaker, ap-

ply the detailed checks listed under *audio frequency* and *loud speaker* following until the cause is found and its correction noted.

3. If the Hum is Ahead of the Second Detector.

With one end of a wire connected to the chassis, successively touch the grids of the r.f., mixer, i.f. and oscillator tubes while noting the hum. If the cause is in any one of these circuits, look under "Miscellaneous" for more detailed checks. In most cases if the hum stops on that check, the cause is in or ahead of that stage. If it continues, the cause is usually after it.

4. If the Hum is Ahead of the First R.F. Circuit.

Make the detailed checks listed under Antenna-Ground circuit.

5. When Hum cannot be Located in

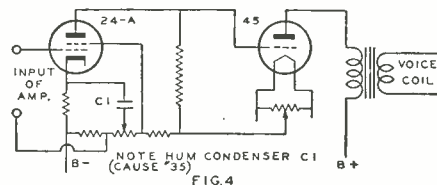

Showing condenser C1 causing hum.

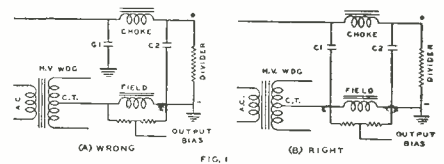

Right and wrong way to connect power unit to decrease hum. See Cause #10. Note condenser C1 connection.

any one of the Areas previously noted.

Check for hum arriving over the a.c. line by operating another receiver without an antenna from the same a.c. receptacle. The hum must be external if heard in both receivers. Then proceed as directed under "External to Receiver" checks.

Procedure in Localizing the Area of Trouble

Modulated Hum

Hum cannot pass through the r.f. or i.f. stages of itself because these stages are tuned only to radio frequencies. When superimposed on an r.f. signal passing through, hum will get through along with it just as the dog slips through the door when we open it to enter.

To detect this type, turn the receiver (Chart starts on next page; explanation of Causes continued on page 56)

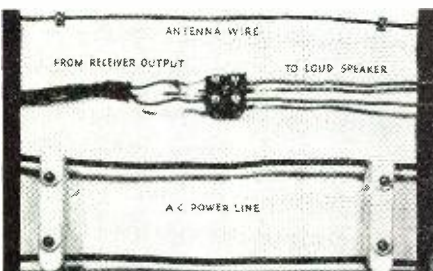

Keep radio lines away from AC lines.



Loose condenser nut causes AC hum.

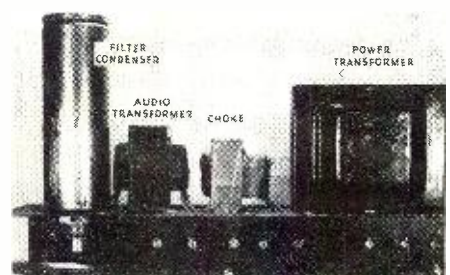

Incorrectly placed parts cause hum.

**Detailed Checks in Each
Trouble Area**

POWER SUPPLY Cause	Check	Correction	EXTERNAL TO RECEIVER
1. Open filter condenser	(a) Temporarily connect good condenser across suspected condenser and observe hum level. (b) Disconnect one terminal of condenser and check with ohmmeter.	(a) Replace faulty condenser or add new one. (b) Replace faulty condenser or add new one.	14. Power line voltage low. (a) Measure voltage at terminals of rectifier socket and compare with rated voltage. (b) Measure voltage at a.c. receptacle and compare with rated voltage if this is known.
2. Low emission from rectifier tube or gassy tube.	(a) Replace tube with good one. (b) Note whether filament coating has peeled. (c) Note by color whether gassy.	(a) Replace tube. (b) Replace tube. (c) Replace tube.	(c) See whether lamp plugged in shows less brilliancy.
3. "Shorted" filter choke.	(a) Short choke with set operating and note effect on hum. (b) Measure resistance of choke and compare with rated value. (c) If condenser across choke, disconnect it and test. (d) See whether a voltage drop exists across it.	(a) Repair or replace choke. (b) Repair or replace choke. (c) Replace condenser. (d) Replace condenser.	(d) If receiver is equipped to work at different line voltages, set tap at lowest value. Also try separate line voltage regulator. (e) If receiver is equipped to work at different line voltages, set tap at lowest value. Also try separate line voltage regulator. (f) If receiver is equipped to work at different line voltages, set tap at lowest value. Also try separate line voltage regulator.
4. Electrolytic filter condenser drying up.	(a) Disconnect condenser terminal and measure leakage. (b) Take plate voltage on any tube. This will be low if excessive leakage or cracking is taking place.	(a) Replace condenser. (b) Replace condenser.	(d) See whether tap on power transformer is at its highest point.
5. Field from pwr. transf. or choke cutting across wiring in a.f. circuit.	(a) Use shielded power transformer or choke. (b) Put double sheet iron around power section. (c) See that a good ground exists. (d) Try wire connection from case of power transformer. (e) Raise a.f. transformer off chassis or turn at angle to interfering field. (f) Replace a.f. transformer with resistance coupling. (g) Shield grid leads in a.f. circuit with grounded metal braid, also power transformer leads near grid. (h) Determine extent of field with head phones in series with electromagnet as detector.	(a) Replace with shielded pwr. transformer or choke. (b) Shield. (c) Ensure good ground. (d) Make solid connection to chassis. (e) Fix in proper position. (f) Install resistance coupling stage. (g) Shield leads. (h) Re-locate.	15. Electrical machinery feeding in hum over a.c. line. (a) Operate another receiver with different antenna from same outlet. (If hum present in both, it is definitely located in a.c. line.) (b) Connect two 0.1 mfg. condensers in series across the a.c. line and ground their center connection to receiver. (c) Locate interfering machinery and follow (b) directly at machine. (d) Reverse a.c. line plug.
6. Condenser across field.	(a) Touch terminals of a good condenser of proper size across suspected one meanwhile noting hum. (b) Disconnect condenser and check for short or leakage. (c) Compare voltage or resistance of choke with values given. If correct, condenser is not "shorted."	(a) Repair or replace condenser. (b) Repair or replace condenser. (c) Repair or replace condenser.	16. Hum bucking coil turns "shorted," its ends reversed or "shorted" to speaker frame. (a) Short hum bucking coil, operate off station so as to hear hum but not signal and compare hum level before and after "shorting." (b) Disconnect one terminal of voice coil from transformer secondary. Then connect secondary winding terminals to a permanent magnet dynamic speaker and compare hum with that of original speaker. (c) Use low reading ohmmeter to read resistance of bucking coil. (d) Disconnect voice coil as in (b). (e) Connect output secondary through a transformer to a magnetic speaker. (This transformer can be another output transformer with normal primary connected to magnetic speaker.) (f) If bucking coil connections are reversed, check by reversing voice coil connections.
7. A.C. Line voltage filter by-pass condenser open.	(a) Connect good condenser of proper size across suspected one. (b) Disconnect and check for "open."	(a) Repair or replace condenser. (b) Repair or replace condenser.	17. Hum field induced into the windings of the output transformer mounted on speaker frame. (a) Slip thick shield around transformer or around field coil if it is unshielded and note difference in hum. (b) Connect head phones in series with electro-magnet and use around the transformer as an exploring coil. (c) Unbolt transformer, remove it, splice on longer leads and operate as before, observing any change in hum level.
8. Loose laminations in power transf. or choke.	Check by pressing laminations together	Screw down or tighten holding bolts.	18. Audio transformer windings grounded. (a) Remove tube in circuit suspected, measure resistance from plate terminal of tube to chassis and compare with rated resistance if available. (b) Measure resistance from tube grid terminal of transformer to ground and compare with rated resistance. (c) Check by replacing with another transformer. (d) Replace transformer with resistance capacity coupling between plate and grid of suspected stage. (e) Disconnect B+ end of transformer and check with ohmmeter from end to core.
9. Loose nut holding inverted condenser can to chassis.	Wiggle can to see whether it is loose. Try tightening nut.	Tighten nut or ensure firm contact to chassis.	19. Secondary winding of transformer open. (a) Check continuity from grid of suspected stage to other end of coil. Resistance is normally several thousand ohms.
10. In case of using field in negative leg of power supply for bias, both filter condensers grounded instead of one. Refer to sketch No. 1 for this.	Connect good filter condenser to rectifier filament to c.t. of high voltage wdg. (Be sure condenser will stand full potential.)	Connect condenser correctly as in sketch No. 1.	20. Loud speaker hum balancer not set properly. (a) Adjust balancer for best position with hum in speaker. If no difference noted, check electrical circuit of balancer.
ANTENNA—GROUND CIRCUIT			
11. Missing ground or poor ground connection.	(a) Connect wire to good ground and compare hum level. (b) See that connections of ground lead to source ground are tight and clean. (c) Compare hum level with and without ground. (d) See that all joints in ground lead are tight. (e) See that ground wire is not on antenna post by mistake.	(a) Use good ground. (b) See that all connections are firm. (c) See that all connections are firm. (d) See that all connections are firm. (e) Connect correctly.	21. Hum field induced into the windings of the output transformer mounted on speaker frame. (a) Slip thick shield around transformer or around field coil if it is unshielded and note difference in hum. (b) Connect head phones in series with electro-magnet and use around the transformer as an exploring coil. (c) Unbolt transformer, remove it, splice on longer leads and operate as before, observing any change in hum level.
12. Ground lead picking up hum.	(a) Note whether ground lead passes too near a.c. line or electrical machinery. (b) Try operation with doublet or other ungrounded system. (c) Leave off ground and note hum level.	(a) Re-locate. (b) Install proper antenna. (c) Re-locate, shield or use shorter ground	22. Loud speaker hum balancer not set properly. (a) Adjust balancer for best position with hum in speaker. If no difference noted, check electrical circuit of balancer.
13. Antenna pick-up from adjacent pwr. lines or equipment. (May have been blown down.)	(a) Connect and disconnect antenna lead, noting hum level. (b) Change direction or type of antenna. (c) Move it away from power lines. (d) Shorten antenna if signal is loud enough. (e) Connect antenna and ground posts together to cut off all pick-up. Inspect over whole length of lead-in and flat top span.	(a) Re-locate. (b) Change direction, type or height. (c) Change direction, type or height. (d) Change direction, type or height. (e) Change direction, type or height.	23. Loud speaker hum balancer not set properly. (a) Adjust balancer for best position with hum in speaker. If no difference noted, check electrical circuit of balancer.

21. Too high a grid leak in resistance coupled stage.	(a) Read resistance and compare with rated value. (b) Connect resistors of increasing-ly lower values than specified across grid leak temporarily to lower its resistance while noting hum. Note particularly that gain has not appreciably decreased nor distortion increased after doing this.	(a) Replace resistor with proper size. (b) Replace resistor with proper size.	(b) Take voltage drop across it. Connect another resistor of same size across it which should halve the drop, otherwise the original resistor is shorted. (c) Try larger resistance.	(b) If resistor too small and value unknown, insert rheostat and adjust for least value of hum without decreasing the signal output. (c) Replace with larger resistance.
22. Push pull input transformer secondary unbalanced.	(a) Measure impedance on each side of tap if equipment is available. (b) Temporarily connect a replacing transformer into the circuit. (c) Note with ohmmeter whether the values of two halves are too far apart.	(a) Repair or replace transformer. (b) Repair or replace transformer. (c) Repair or replace transformer.	(a) Check tube in tester for this defect. (b) Replace with another tube. (c) Take cathode to heater voltage and check with that specified if given. (d) Reduce cathode circuit impedance with larger condenser across cathode bias resistor. (Do this by temporarily connecting a n o t h e r condenser across it.) (e) Change bias from cathode leg to grid circuit. Use rheostat in its place to find correct value. Note carefully that signal does not suffer while doing this.	(a) Replace tube if defective. (b) Replace tube if defective. (c) Replace tube if defective. (d) Use higher capacity condenser across cathode grid biasing resistor. (e) Replace bias resistor with correct value determined.
23. Unbalanced power tubes in push pull output circuit.	Replace either tube or both tubes with those known as definitely good.	Replace tube or tubes whichever is necessary.		
24. Amplifier or parts poorly grounded or no ground.	(a) Connect wire from amplifier chassis to ground and compare hum levels. (b) With hum in, short metal case of each part to chassis thus ensuring firm contact.	(a) Attach good ground to amplifier chassis. (b) Ensure good contact of parts cases with chassis where this is needed.		
25. Grid element in tube itself picking up hum.	(a) Shield tube with a shield making good contact with chassis. (b) Check hum level using another tube.	(a) Install tube shield and ensure good contact with chassis. (b) Replace tube.		
26. No shielding, imperfect shielding or ungrounded shielding of output leads to speaker where speaker is distant from set. (Common in P. A. systems.)	(a) Try use of shielded leads. (b) Examine entire length of leads to see that the shielding shields completely. (c) Connect known good ground to chassis.	(a) Install braided shielded leads. (b) Shield output leads completely. (c) Ground shield thoroughly.		
27. Grid wiring, including all grid leads of a.f. circuit picking up hum from other wiring or parts.	(a) Try shielded leads on grid wiring. (b) See that shielding is complete over entire length of grid leads. (c) See that shielding is thoroughly grounded.	(a) Use shielded leads on grid wiring. (b) Shield completely from terminal to terminal. (c) Thoroughly ground shield.		
28. Hum present in a cathode bias resistor.	Increase size of by-pass condenser.	Use by-pass condenser value by check.		
MISCELLANEOUS				
"Shorted" resistor in resistance capacity filter in grid circuit of any tube or resistance too low.	(a) Measure resistance from grid to chassis. Compare this with sum of all resistances in the circuit which should lead to the one suspected. (b) Disconnect one end of resistor and check its resistance. (c) Check directly across resistor with ohmmeter and compare with rated value.	(a) If resistance too low, increase value and compare hum levels not, however, at expense of signal volume. Replace with correct size resistor. (b) If resistance too low, increase value and compare hum levels not, however, at expense of signal volume. Replace with correct size resistor. (c) If resistance too low, increase value and compare hum levels not, however, at expense of signal volume. Replace with correct size resistor.		
30. Open "shorted" half or uncentered center tapped resistor across heater circuit.	(a) Measure resistance or continuity reading from center tap to each end. (b) Check a.c. voltage from center tap to each end of resistor. (c) Temporarily replace with good c.t. resistor.	(a) Replace with good center tap resistor. (b) Replace with good center tap resistor. (c) Replace with good center tap resistor.		
31. "Shorted" resistor in decoupling (plate) filter.	Measure resistance and compare with rated value. (The resistor should be disconnected and measured again if "short" indicated, to distinguish between "shorted" condenser across it.)	Repair or replace resistor.		
32. Condenser open in plate decoupling filter.	Touch a good condenser of proper size across suspected condenser and compare hum levels.	Replace condenser.		
33. Resistor of plate decoupling filter too small or short-circuited.	(a) Measure resistance by ohmmeter across it without disconnecting and check with rated value.	(a) If resistor "shorted," replace it.		
34. Cathode to heater leakage.				
35. Open screen grid by-pass condenser.				
36. Leaky hum bucking condenser in Loftin-White direct coupled circuit.				
37. Secondary coil winding of r.f. or i.f. circuits "open."				
38. Open in an r.f. grid circuit due to poor contacts at tube socket or open elsewhere in grid lead.				
39. Pilot lamp wiring inducing hum in grid or plate wire or pilot lamp shorting to chassis.				
40. Electric clock or lamp on radio.				
41. Wiring of power supply or filament circuit inducing hum into one or more r.f. grid circuits.				
42. Magnetic field from power transformer.				
38. Test for continuity between socket spring and tube pin. If possible, note tension of against spring from bottom of chassis. For open grid lead at any point, check continuity between grid terminal and chassis. Note: This may be very high due to AVC filter resistors in the line.	(a) Add tension to spring. (b) Add tension to spring. (c) Repair "open."	(a) Add tension to spring. (b) Add tension to spring. (c) Repair "open."	(a) Test for continuity from grid to chassis. (b) Test for control grid voltage. (If any present, coil is not open.)	(a) Replace coil. (b) Replace coil.
39. Examine pilot lamp wiring with reference to adjacent grid or plate wires. Try another pilot lamp. Note carefully whether lamp is "shorting" to socket hence chassis.	(a) Re-locate wires. (b) Replace lamp. (c) Repair or replace socket.	(a) Re-locate wires. (b) Replace lamp. (c) Repair or replace socket.		
40. Shut off the suspected part and compare hum.	If induced hum is from radiation, fasten metal foil or plate on inside of radio cabinet top between part and set. If hum is conveyed over a.c. line, try filter condenser of .1 mfd from side of line to frame of lamp or clock or re-locate the part.			
41. Trace each of the r.f. and detector leads and re-locate if near wires of power supply. Try shielding r.f. grid leads or if shielded see that shield is properly grounded. Operate filaments of tubes one at a time with batteries or d.c. supply. Replace r.f. tubes one at a time.	(a) Make permanent improvements found in the checks. (b) If filaments at fault, replace with twisted pair, re-locate, shorten or shield with grounded metal braid. (c) Re-locate improper wiring. (d) Replace with satisfactory tube.	(a) Make permanent improvements found in the checks. (b) If filaments at fault, replace with twisted pair, re-locate, shorten or shield with grounded metal braid. (c) Re-locate improper wiring. (d) Replace with satisfactory tube.		
42. Connect a pair of sensitive head phones in series with a suitable electro magnet and coil. Locate source and extent of hum by passing the coil near the part suspected so that pick up will be heard in phones. With longer leads, use another choke farther away to check against choke field in power supply. If unshielded transformer or shielded transformer is used, use fairly thick sheet iron as shielding and shield closely. Shield should be at least 1/4 inch thick. Use shielded transformer or choke with air gap smaller and spaced farther.	(a) Use suitable choke or transformer or properly shield those being used. (b) Re-locate choke. (c) Install shielding. (d) Replace with shielded transformer or choke.	(a) Use suitable choke or transformer or properly shield those being used. (b) Re-locate choke. (c) Install shielding. (d) Replace with shielded transformer or choke.		

Explanation and Chart concluded on page 56.

Communication & Electronic MAINTENANCE

by **W. H. BOHLKE**

Director of Test Equipment Merchandising, R.C.A. Mfg. Co., Camden, N. J.

How to use various components of the Communication & Electronic Service Bench.

Conclusion.

THE concluding lines in the previous article discussing the equipment used in this Communication Electronic Maintenance Shop, stated that we would speak about the Crystal Calibrator, and Signal Generator. This we shall do in this article and towards the end make some general comments concerning a subject which has been brought to the fore in the form of letters.

Concerning the *Crystal Calibrator* which has been mentioned as an essential item in this shop, its primary purpose, as can be readily understood, is described by its name. By this we mean that it serves admirably as a handy and easy-to-use calibrating device whereby locally generated signals can be checked for frequency, as well as the frequency of received signals definitely established by means of the zero-beat method.

As to the specific device shown in previous installments, its design is such that it provides two fundamental frequencies namely, 250 kc. and 2000 kc. However, it should be known that while these are the two fundamental frequencies, the operation of the crystal is such that it is extremely rich in harmonics and with suitable detecting equipment, it is not a difficult task to pick up the 50th harmonic. With ordi-

nary simple apparatus, the 250-kc. setting of this crystal calibrator should be suitable as a calibrating signal source for frequencies up to at least 5000 kc., in steps of 250 kc. The 2000-kc. setting in turn should provide with all ease calibrating frequencies up to the 20th harmonic or 40,000 kc. in steps of 2000 kc. If the calibrator is used in conjunction with the *Signalyst*, where-in a sensitive detecting circuit is incorporated, it has been our experience

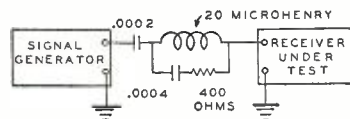

FIG 1

that frequencies up to the 50th harmonic are useable. In other words, a 250-kc. setting will provide calibrating frequencies up to 12,500 kc. in steps of 250 kc. and the 2000 kc. setting will provide checking frequencies up to 100,000 kc. or 100 megacycles in steps of two megacycles.

The *Crystal Calibrator* is intended for use with either 110 or 120-volt 50 or 60 cycle a.c. supply or 90-volt d.c. supply, provisions for such supply being contained in the device. When

used with a d.c. supply the output of the crystal of course is, unmodulated or to put it differently, is pure c.w. However, when an a.c. supply is used, the carrier, which is generated by the crystal, bears a 60-cycle component as the result of 60-cycle supply being applied to the plate of the tube connected to the crystal. Thus it can be said that with 60-cycle supply the output of the crystal is modulated at 60 cycles.

As we said before, the crystal is rich

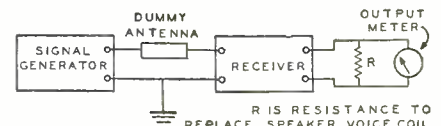

FIG 2

in harmonics but it is possible to select any single frequency of these harmonics as well as the fundamental for each of the settings, by means of a straight-forward resonant circuit in which, the signal voltage built up across this resonant circuit will be of but one frequency, consequently of undistorted character. With the d.c. supply this single frequency is a pure wave, unmodulated, whereas with a.c. supply this single frequency carries the 60-cycle ripple as a modulating frequency.

As to its use for calibrating receivers, 60-cycle supply to the crystal is most convenient, for then the signal is picked up with greatest of ease. In the specific crystal unit we have mentioned in this series, an output jack is provided whereby the signal from the crystal can be fed wherever it is supposed to be applied. As a rule such a connection is not necessary unless there is need for an appreciable output, since the circuits within the device are not contained in shields and because of the customary design of such units, a sufficiently strong signal will be radiated from the device itself without requiring a direct connection. That is to say, the signal field of such devices is ample so that any receiver can pick up the signal without a direct connection. However, if the signal from the calibrator is to be fed into the *Signalyst*, the link between this output jack and input jack of the other device is necessary.

With respect to the normal use of such crystal calibrators, a previous type which supplied two frequencies, namely, 1000 kc. and 100 kc., was not provided with an output jack because of the very strong field surrounding the device during its operation.

As a general rule, the only means of

(Continued on page 44)

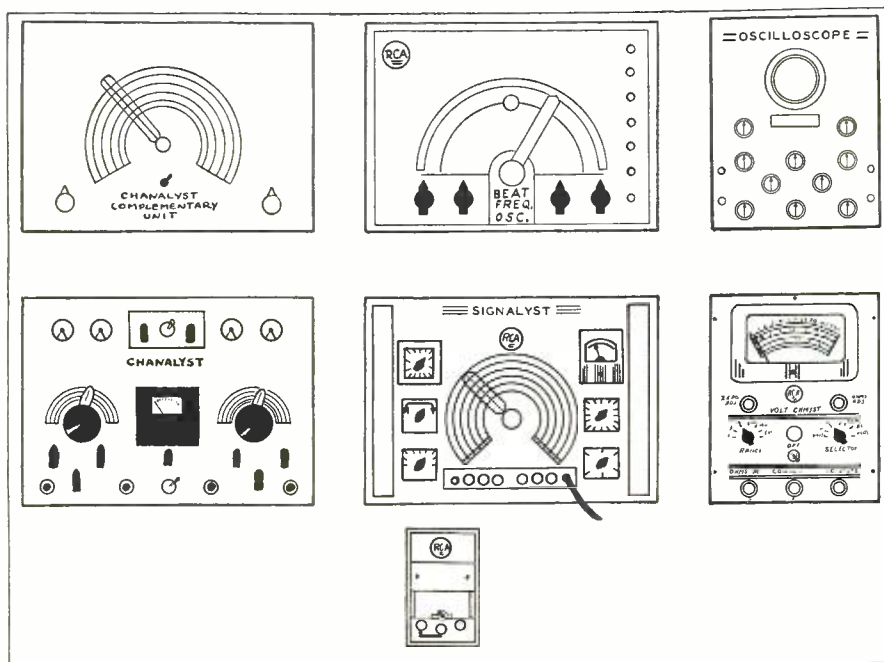

What the complete communication and electronic service bench should contain.



SERVICEMAN'S EXPERIENCES

by LEE SHELDON

INE afternoon last week I delivered an *Atwater Kent* we had just converted, and I collected about five times the amount we get for an average repair job. I left the customer's house at five-thirty; and, on the strength of the windfall, I stopped off for an early dinner at Rousseau's. The place is sort of expensive, and I don't ordinarily eat there; but you know how it is after you net more than a day's pay for a single delivery. A luxurious reaction sets in, and you want to sit down somewhere to enjoy it.

After a long, gentlemanly dinner, I bought an expensive cigar and rolled a few games of "26" with the nifty little blonde at the cashier's desk. If you've played the game, you know I seen her smile, you'd forgive me. It was wasting my time; but if you'd ever was a pleasure to lose, and I forgot about the clock. I pulled into the shop at eight, and my partner was furious.

"Where ya been?" he snarled.

"Delivering that A-K," I told him. "Then I ate supper. Anything wrong with that?"

"I 'phoned the customer," Al declared accusingly, "and he told me you left his house three hours ago."

"Listen, mister," I told him. "I'd rather install a time-clock in this joint rather than argue with you. Since when do you have to check up on me?"

"Two new customers called while you were out," Al said, "and they both wanted a serviceman immediately."

"What of it?" I demanded. "You used to blame me when business was bad—now you blame me because it's

good. Why didn't you stall them off?"

"Stall them off?" Al yelled. "What do you think we're in business for? Perhaps I should have told them to write in for an appointment, and that you'd attend to their letters when you returned from your West Indies cruise!"

He began to walk up and down, making animal noises. When my partner gets like that, there's no use arguing with him. I kept quiet, but I was plenty sore, too. Who did he think he was, anyway? We were supposed to be partners, weren't we? Wasn't my time my own? I'd show him! I jumped up and strode to the door.

"See you tomorrow," I announced gaily. "I'm going to the movies!"

Al stopped walking and stared at me. I admit I felt a bit guilty about running out early; but, after all—

"Wait a minute, Lee," he said, suddenly calming down. "I just thought of a story. Mind listening for a while?"

Funny thing. He wasn't mad any more, but he tried, in his coarse way, to pretend he was discouraged. He didn't fool me, though; I sighed patiently, to show him how I felt, and sat down again.

"I'm not trying to bawl you out," Al said, offering me a cigarette, which I refused so I could take one of the same brand from my own pack, "but sometimes you act like a disinterested employee on the payroll of a giant corporation. Lately, when business runs good, you seem to think that stalling is a legitimate way of passing time. Even in good times, we shouldn't forget that there is a direct connection between income and effort in a store like ours."

"Get on with that story," I interrupted. "The last show starts in fifteen minutes!"

Al lighted his own cigarette, and resumed:

Once the president of a railroad, while looking over an attendance record of his employees, came across a mechanic named Brown who had been in the company for thirty-five years. Brown hadn't been late once, hadn't been out a day because of sickness, and had never taken a vacation.

"It's astounding!" the president exclaimed. "I want to meet this man!"

He was taken down to the shop, and the two were introduced.

"Mr. Brown," the president said, "I want to congratulate you. Never before have I come across a man so attentive to his work. What work did you do before you came here?"

"This was my first job, sir," Brown replied. "I liked it so well I stayed and stayed."

"Remarkable!" the president said. "Tell me—what makes your work so interesting?"

"Well, sir—it's mostly the responsibility. At exactly seven-thirty every morning, a big, long train backs into the yards. The locomotive is uncoupled, and I wave good-bye to the engineer (I've known him for twenty years, sir) and start to work. I take my hammer—this one, my number seven—and reach under each car by the truck, and hit every bearing three times: one! two! three! Then I come back along the other side, doing the same thing. It may sound like boasting, sir—but it's tradition among the rest of the boys that I've never missed a bearing in all these years. 'Brown sure biffs those bearings,' the boys say."

"Good for you," the executive said, thinking of raising Brown's salary. "By the way—what do you listen for when you hit those bearings?"

Brown scratched his head. "Damned if I know," he said.

"You remind me of Brown," Al added. "Sometimes you work like you were only going through meaningless motions until the whistle blows. That sort of thing is poison in radio repairing!"

"Al," I replied, "I see your point—don't rub it in. I don't blame you for going up in the air when I use three hours for a call, but I do hate to be ridden for it. Now—about those new

(Continued on page 52)



"There'll be a slight delay, Madam—I got awful mad at your radio today."



"To have good reception, it's very important to put the plug in a socket!"



Marconi Memorial Award presented to W. B. (W5FDR-WLJR) Hollis by the AARS.

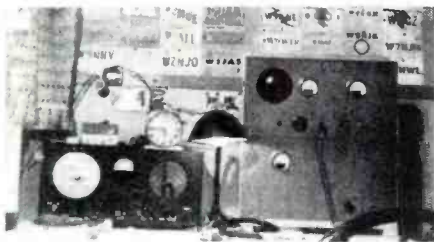

Hamstation of w9nnv.

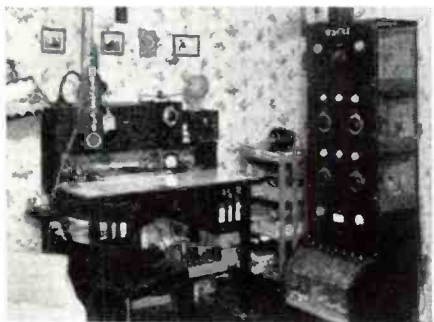

Former layout of w1cxe (See page 29).



Hamop & station of w9wgl.



w1ndi & xyl.



w1iby.



w1ico, w1etr.



w1msv, w1lo, w1m?



w1fcz, w1luv.



Courtesy W9LIX

SOMEONE once said that "you can't figure out a woman." Said same applies to the hams! Yowsah! We said in the June issue, quote Come one come all! The dough is waiting! unquote. Well, did youse guys and youse gals come across wid a few of the chere articles for the dough? You sure did! Perhaps we are too impatient, but then again we need a lot more ham articles! . . . This is true; we will gladly read any MSS. you might have written lately, and wondered how to turn into money!

Anyway, the offer to buy the manuscripts describing your favorite transmitter, receiver, antenna or gadget still holds good. Write anything up to 3500 words and send pencil diagrams and photos (we'd prefer professional pix, but will accept snaps if they are good). Payment will go forth at once at rates up to 2c a word (and in no event lower than 1/2c a word) on acceptance. If we don't accept your stuff, we'll return it within 30 days after we receive it. But include postage for the manuscript's return.

Want to take that vacation 'way out West or East . . . want to take your gal to that special "social" . . . want to buy some of those expensive parts . . . or a new transmitter . . . or a receiver? Well, then get busy at the mill, and typing on one side of the page only, double spaced, write us that article, draw a pencil diagram, include the parts lists just as the Editors of RN do, have the local shutter-bug snap a coupla pix, and shoot it to the Hamchatter Editor at RADIO NEWS, 608 S. Dearborn Street, Chicago, Illinois. Won't take long to do, and the Dough is waiting!! Wat sa om es og?

HAD ourselves a nice QSO wid the Managing Ed of the rag last week. Seems as if he got hisself a pee-wee transmitter and receiver and put them on the air. Got an earful, too. All about how the hams, we mean some of them, are violating Uncle Sam's Orders for them to stay away from QSO'ing the foreigners. The M.E. told us that a few of the hams had even been caught "talking" to the Germans!

Wow! Can't done you fellers out nohow! Don't you want your licenses? Don't you want to stay on the air? Are you anxious to have the Great Amateur Blackout? The President has said in no uncertain words that an un-Americanism will not be tolerated. Well, to our addle-pated mind it's as unAmerican to violate the FCC Rules & Regs as anything else that would be illegal in these tough days!

And ferheavensakes, whats the matter with you guys who hear these hams QSO'ing the foreigners? Why don't you turn the violators in? 'Fruidy cats? 'Fraid that someone will pernt the finger of scorn at youse and say, "He's a tattler!"

Would you let someone steal your hobby, your money, your liberty? Of course you

wouldn't! Well, those rotters who violate the FCC Regs are just thieves of our hobby. They are stealing your ham radio right out from under your noses. If they continue their rotten practices, all of us hams will have to shut down on account of the fact that Uncle Sammy will feel that the monitoring is "just too much trouble" fer a whole class because a few cannot abide by his rules.

Nossir! Fer my part, I'd turn in each and every one who violates the Rule. You'd better do it too, if you want to stay on the air.

If you're afraid to do, mail us the dope and we'll do it fer you. But by all means, let us rid ourselves of the Guy Who Won't Be Good By Obeying The Rules.

Yrs, The HC Editor.

MARSHALL H. ENSOR, W9BSP 41-year old radio amateur of Olathe, Kansas, was chosen by a board of five distinguished judges for the William S. Paley Amateur Radio Award of 1940. Ensor flew to New York for a presentation luncheon at the Waldorf-Astoria, June 2, where Mr. Paley, president of the Columbia Broadcasting System, made the award of the trophy, a symbolic sculpture in silver.

Ensor was chosen by the judges because of his service to the nation in voluntarily conducting courses in the fundamentals of radio over his own radio station, W9BSP, over a period of 10 years. During that time he has given code practice lessons on the air to thousands of young men on regular schedule, enabling them to pass their examinations for amateur radio licenses.

From the Mail Bag:

DEAR Old Hamchatter Ed. Dunno if the phone boys are jest too lazy to learn code at more than 13 wpm, or whether they jest cant take the mikes outta their respective mouths. All this twaddle abt phone versus cw fer the AARS! Any dope knows that cw is used fer recorded msgs like field orders, lists, and the stuff which makes up the greatest part of our Army's paper work, while phone is used fer commands, like go into action, etc. Imagine sending lists of how much ammunition, how many soldiers, etc., etc. by phone, even if coded!!! Can't be done, fellers. Jest sit down and get into the AARS. Any dogface can operate phone.

Respy' yrs.

The Sergeant.

Dear Hamchatter Editor: This controversy of phone vs cw for the AARS has gotten under way due to the desire of the 'phone boys to participate in the AARS activities. There can be no question that 'phone can be used for the same work for which cw is reserved now. I feel that the AARS should be "modernized" by opening the System to 'phone men. If that means changing the regulations, then they should be changed. There will always be more 'phone men than there will be men proficient at 25 wpm-per-minute code. Why not take advantage of those who want to serve, even if it is in their own way? I believe that "coded" 'phone communications are just as "secret" as "coded" cw, and that orders, and supply lists can be encoded in 'phone as well as they can in cw. I was told that in the last (or should I say, World War No. 1) war the enemy had little or no difficulty in tapping our field telephone lines. Yet by means of encoding the messages sent over the wire, very little if anything ever leaked out. If it can be done over a tapped wire, it can be done over the air. I'm for 'phone in the AARS as being the most up-to-date, the most modern, and the fastest means of communicating.

A Good 'Phone Man Who Wants to Join the AARS.

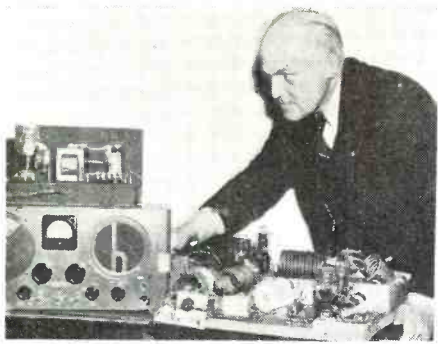

U. S. Marshal and the illegal equipment seized from Peoria "Nazi spy."

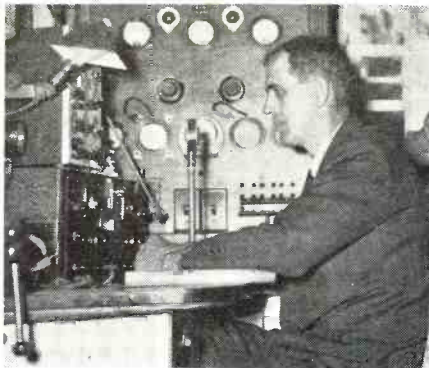

w9bsp, winner of the Paley Award.

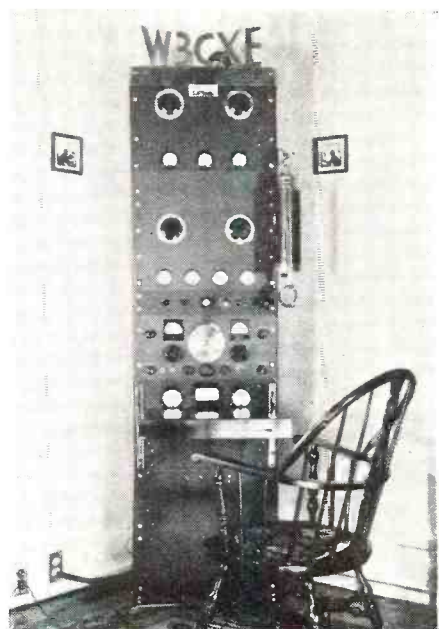

1941 version of hamstation w3cxe.

MR. WILLIAM B. HOLLIS, of 8010 Grafton Street, Houston, Texas, veteran of the National Guard, the Navy and the Marine Corps, has won the annual *Marconi Memorial Award* for code proficiency in a contest held by the Army Amateur Radio System, the War Department announced today.

The award, which is a gilded American eagle mounted on a wooden base, is sponsored by the *Veteran Wireless Operators Association*. To win it Mr. Hollis recorded radio telegraph signals at the rate of 65 words a minute, besting more than 800 other Army amateur radio operators in the contest held last February 10. The proficiency of the average amateur radio operators with the International Morse Code is about 15 to 20 words a minute. Mr. Hollis is operator of Army amateur station W5FDR—WLJL.

WSUOF writes in as follows:
W8STJ has finally gotten around to putting his two element twenty rotary up. U 20 fone boys better watch out now.

8JHG also has one up—a three el.
8UFG, 8VAG, 8UNW all putting on PP812's SUOF and 8DCE also putting on hi pwr if DCE can break away from his servicing long enuff to finish his rig.

8ANL got his ole call back after several yrs. 8VNG is a new ham on 160 and 10 fone.

8UFE is getting around the country pretty well wid 10 watts on 40 c.w. He is 8STJ's brudder and they have their rigs about 20 feet apart in the basement, and their antennas in the same yard. However, they can operate certain bands without messing each other up too much.

8TDR, 8STQ, 8UFF, 8STJ, and 8SUK playing with 2½ transceivers. They have a lot of fun on Sunday afternoons.

8SUK just bought a big rig wid 50T's. 8SMA has it temporarily until John can change QRA. He wud have too much BCL trouble at his present location.

The rig formerly belonged to 8NCU. Gess Doc has left the air fer gud.

8SMA, 8STQ, and yours truly SUOF waiting to hear bad news on class A tkts.

The 160 fone boys are all excited abt hearing a K7 the other morning. None of the locals cud wrk him, but they're laying fer him. (Gud luck boys.)

Several of the fellows have received their *ARRL Code Proficiency Certifs.* Why don't sum more of you fellas try it, it ain't gonna hurt ya.

8SEM has a steady job wid Uncle Sam now. Condx on 40 and 20 been lukin' a little better. We might get sum "dx" after all, even if it is the wrong period of the sun spot cycle.

8YX at U. of Cincinnati was on 5 mtrs fer a while, but altho the band was full of locals, as soon as they wud get on, not a sig wud be heard, hi hi.

8STQ been waiting fer quite a while to find out abt an *ORS* appointment.

8UFG also a tfc man hr in town. He's in *AARS*.

A couple of the fellas including myself have had sum "BCL" trouble, which turned out to be line noises and selective fade. Sum people hear a noise on their 5 buck revr, luk out the window and see a nice tall pole and blame the poor innocent ham fer their poor reception. But I guess that's part of being a ham, hi hi.

W9UFU, Doc, formerly of Chicago is now filling cavities (no not post holes) for Uncle Sam's Boys somewhere in the deep south.

Claims to have swell time eating those "Little Bittie" cakes and things that go with afternoon teas. How would you like a real Hamburger about now, Doc?

W9NMJ, Ed, Buffalo, N. Y., started to send a message thru on 160 the other a.m. and darned if the band didn't close up tight. Persistent cuss, that he is tho, got it thru a coupla days later.

Apologies to Frank W7FWC of Malin, Oregon, for getting his call and QTH all balled up, in last month's issue. Darned old typewriter just won't co-operate, Frank, Honest!!

W9NOO, Gene, Oglesby, Ill., is now class "A" but not doing much due to lack of antenna space. Hope you get a wire up soon, fella.

W9PRZ, Al, Colman, So. Dak., just needs Vermont for was on this band and as luck would have it just missed W1LW, Hassal, of Ryegate, Vermont, by about five minutes the other a.m. That was tough, Al, but watch for him on about 1890, he's on fairly regular.

W2MVT, Henry, New York City, comes in much stronger than when he was in Demarest, N. J., found him QRming a W9 the other a.m. Is it because you are nearer, Henry?

Those W5's are sure rolling in here. They could cut their power in half and still be too darn strong. W5ZS with "T" at the Mike helped prove that. He's in Shreveport. W5HHT of New Orleans is still being heard regularly. This W5BUZ (famous because he's the Husband of W5DEW, The Texas Dew Drop, Mary) should have someone steal half his rig, the way he rolls in and talk about razzing. Whooooooo. Mary is going to town on 20 but drops in on 160 for short spells but Buzz is here all the time.

W6AEP, Bud, North Hollywood, California, has been coming thru consistently on 1896 (but is ECO) in fact so much so that he holds schedules with W9RUJ, Floyd, Auburn, Neb., who calls Bud's folks up and a regular family rag chew ensues.

W9IDL (Gypsie) Frank of K. C., Mo., suddenly became afflicted with the wanderlust, picked up his wife Mary and another couple, Slim and his wife Lucille, takes a run out to Lincoln, Neb., one week end visiting all the hams in between home and there then bundles the same group up the next week end and lands. Kerplunk in Chicago and the suburbs of same. They are a swell bunch at that, folks. It was a treat to have them drop in. Of course the old rig wouldn't work while they were here. Hi.

PAUL M. CORNELL, W8EFW, says:
W8DGP is now in Washington working for *National Defense Research Committee*. He has an appointment as Asst. Physicist with the *Carnegie Institution* of Washington, Dept. of Terrestrial Magnetism.

W8KC works 20 phone, but on the side is quite an amateur movie fan.

W8FFK has himself a job at *Hickok* making big meters. This will explain his occasional absences from the air of late.

W8IRM, after six years of construction work has finally finished the rig and is on the air with it. Looks nice, but the tube lineup can be considered a little out of date. Out of date or not, those tubes we used six years ago will still put out a healthy signal.

W8FZN will be operator of the Cleveland R. R. Co experimental station, W8XXN.

W8FS is one of the ops at WAKR, Akron, under Chief Op. W8VO.

W8DS was again drafted as President of the *Cuyahoga Radio Association*. The Club operates W8URA at *Red Cross Headquarters*. There will be a hamfest for Club members and all amateurs on April 19th. (Pse. turn the page)



Portable gear & hamop w9evu.



w1lyl es wlksa.



w1aun es gang.



w1dpw, w1l1l.



w1mth, w1aja.



w1nhn es yls.



w1ndr es gang.



w8pak pretends to break a "bottle."

W8KO hams and RI's at the same time. He has done a nice job of eliminating Bootleg stations on the 2 1/2 meter band, in the Cleveland area.

W8TMA thinks people kid him when his quality is bad, but he'll find out!

W8TMI now happily married for more than a year, likes his new job, and the nice new auto that goes with it. We haven't heard him on the air for ages, however.

W8VRC new ham in Cleveland Heights. Is on with 6L6 PA on 160 c.w.

W8RHZ has been telling 'em that he's bought a farm in Twinsburg, Ohio, and will be moving there in the Spring. Several BCLs were heard expressing relms of joy over this declaration. All in fun, Harry!

W8QLN's vertical still has that funny twist in the top, the result of one of last season's heavy storms.

W8EBJ darn near became a Navy Radioman, but his eyes kept him out. Doc keeps up on his radio however, working 160 meter phone.

W8BBB is in the Navy now. Last we heard, he was out at San Diego training school.

W8GD expects to be called for Navy service soon. Bob recently got his old call back after losing W8GKG for a number of years; between losing W8GD, and obtaining it again.

W8KOL has been playing with 75 phone. Says he gets out nicely with low power. This winter's heavy weather has kept Bill busy replacing traffic lights and keeping streets clear. He works for local Traffic Division of Cleveland Heights.

FROM Bud Crawford, W9BDO. Picnic talk seems to predominate the lower freq ham bands at this time. Western Nebraska Radio Club are planning theirs probably near



w1ph (sitting) es w1he.

Lake Minatare on field day with a hidden transmitter hunt again. Intend to quarter in the Boy Scouts shack—Mrs. W9SDL opined that "hams are boy scouts that never grew up."

Northeast Nebraska Radio Club gathered at Norfolk first Sunday in June, with W9's ANZ and GFO doing their bit of "telling 'em how" it is, was, etc., in ham raydeowe! Harlan, W9DHO compiled the mailing list for invitations.

Razzberry Gang chose Hidden Paradise near Long Line, Nebr., as place to have been June 15th for a visiting nice-pic of all hams around thr.

Incidentally, W9QWD formerly of Long Pine, who has been working for Lockheed, Calif., past yr. recently amakamated wid a YL out thr so as to take advantage of Orange Blossoms, or sumpin'. FB!

Tt dawgone stormiest day in April was what the bunch at Denver drew for their hidden xmtr hunt so W9IVT got all wet with W9LLP as partner, while sumone else located source of RF.

Same storm marooned lots of skool-kids at various musical contests in Nebraska, and W9OGS was "enjoying" nature's QRN while trying get names of kids sought from W9WZB, but W9WBX was able to help relay when QRN was too tuff for OGS whr storm was still bad. As usual cw was nsg during nature's QRN, es voice best.

W9IDO was given a cw test wen he got out of hospital after a stay for throat infection, and suprised himself by puttin' dwn 18 wpm of coded stuff—sed was plumb rested es seemed cum easy—so, since he has bn teaching cw to rest of his bunch at McChord Field, seven teaches the officers. Hi!! Is being given op practice in plane, too, es finds his mental facilities slow-dwn 6-8 WPM even wid oxyzen above 10,000 ft up.

W9DFI is call of Ray Schulte near Elgin, Nebr., drew. Working batt rig on 160f es 80 cw. Raising a sud ant at the moment.

W9QDC is being hrd fm Denver on 75f wid nice sig.

W9DZB, Keensburg, Colo., is nw on 75f gabbing a bit wid the boys.

W9OTG on one-sixth-nuthin' fm Lafayette, Colo., hrd trying make W9ISJ hear him answer his cq last nite—say, lil ol' Sweet Willyum, seems as how the ow is g' hafta wash ur auditory organs a bit if u ain't able hear as nice a sig as OTG had hr. Lil Willie is nw feeding 425w to pr 357's to get his W9ISJ call out.

W9CSE same town as ISJ visited W9IDR and daughter W9ZQZ one Sunday recently. Betcha had a fh time Connie. We always do when we ston thr.

In fact, last month when tuk W9JRZ and ERW home fm their visit wid me, W9ZQZ invited us over for supper to disprove our scoffing abt her cooking ability and did prove she was her mother's daughter when it cum to dishing up a palatable mess to modulate ur midsection wid. That is, for sumner anyway. One mite hv wait for breakfast til noon if tt "sleeping beauty" ran true for horses. Hi!

W9RFB is here this aft on 75f seekin-u W9HIC henry ida chicago at Independence near KC, Mo. on 75f.

W9EYB—eight young babies—like Ole cudn't wait, so he jined up wid northern nieghburs es is wid Royal Canadian Air Force and stationed at Toronto now. Luck to u, Dana.

W9MCK, Dick of Des Moines, is active morns on 75 wid gang.

W9LGR, Paul Daniels, is another of Unk nephews but he is riding on the aqua saline much nuss—a "gob" u kno.



Spring means Love: w9nnv es xyl.

W7FHM for happy marriages of Eugene, Oregon, heard on voice.

K6BHL, Big Hawaiian Lover is a cop near Schofield Barracks and a darned good booster for his native land. Hrd him qso wid our own W9BBS and apparently Clyde was "as-usual" asking about fishing. Sounded like "opu" was native parlance for an over-modulated midsection on humans. K6BHL on 20f.

K6PAH is a new one to my ears on 14 mc gab. K6OJI wid the "it" qsl, sed he had trans trub wid plate suppli the very-time an opportunity came up to hv a qso wid his folks in KC, Mo. but luckily managed to snar a loose end and get circuit continuity in time to still achieve a fb qso.

W9QNX, "Roscoe" of Chase, Kan., uses 250 w inp on 160f.

W9CHE coffee ham eggs remains consistent fnt St. Joe on 75f; also member of tt vy-fb Missouri "emergency" fone net on 75 tt really leaves a cloud of dust on their rapid drill sessions at noon. Iowa, too, has a similar fone net tt perks during midday tt will show ant but the very most obstinate "old head" tt fone is superior for emergency t/c handling when properly done. Just no use trying keep an AARS net gg with hdsq-opposition to fone, in either of those states which went ahead on their own initiative and showed it cud b done. FB!! Only fly in the ointment is: Army, thus is deprived of their exceptional radio ability by their not being trained in Z sigs; otherwise by discarding wasteful red-tape, they can still wait for Army-net to catch up in another decade or two.

W9WED of DuQuoin, Ill., is still being hrd on 160f with usual nice sig, the same as for many yrs in past.

W7FLO, Bill has bitt himself a 112 mc transceiver but has no neighbors close enuf to qsc on tt band—isolation has it's dis-advantages, too, eh Bill? W7GOH, W7FLO and W7ACG enjoy nice ragchews on 160f in morns. Betty W7IDO supplements her 40cw by op-ing the OM's W7ACG call on 160f to kid the radio romeos.

W5EAK eggs apples kraut Milo is still teaching radio at Spartan Aviation School. Gaw-gone! Milo I tho't one had to kno more'n the scholars b4 u cud teach? May be all u hafta do is "ask questions" is it how u get by, Milo? Hi!

W7AOX, "the ol' ox" can be hrd most morn abt bikfast time gassing wid chief polecat Christy W9FLZ in fact, FLZ sez his log wid show 300 or more qso's a yr past two yrs wid W5AOX. These boys ought-to get acquainted, give 'em time em!!

I had a nice long qso for first time in yrs wid W9BWX Lewis of Weston, Mo., and Lewis informed me tt Mrs. Ida P. Rogers the well known old dxer who used to be an Official Listening Post Observer in bc band for this mag several yrs ago had "signed off" abt cuppla yrs ago. Mrs. Rogers was around 85 yrs old es used radio dxing as a pastime and hobby to while away her last years pleasantly. Lewis was on 160cw and so was I most of qso tho did change to gaw sum.

Got quite a kick outa bearing ol' W5LZ Leo

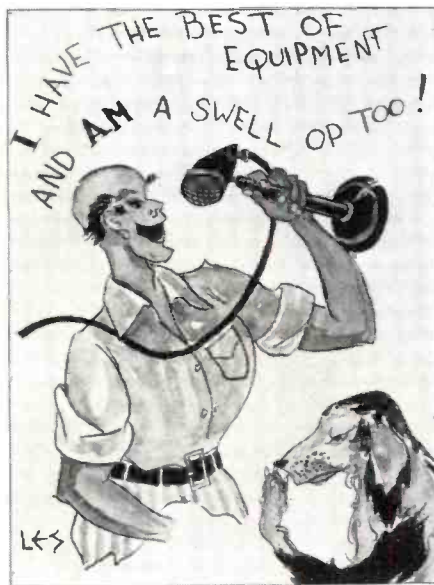

There's one on every band!



Hamshack w5icz.



Hamopess & rig of w7ido.



w1bql, w1iha, w1dnl,
w1brb, w1kxu, es w1dpl.

of Lone Wolf, Okla., with another W5 wrking our W9EKP on 75f other eve. Hadn't hrd Leo since Jan. 16th, '32, when we hiked up on 160' fm"—shuda bn "freq mod" as he had mopa es I a *Hartley*, both of us wid 112A type tube tied to ant. Hi! Hi! Betcha, we had as much or more "fun" back "in the good ol' daze" wid those means to an end of a lone qso as we nw do wid gud xtal controlled rigs! Tt, initial thrill! W5HL is one of the few Louisiana stns I hv hrd hr on 20f.

W3EWN's east west north ant. really has long extremities. 400-es-sum ft on each "laig" Jerry sed wen we jawed on 20.

Hving known personally and also qso'd W9JAJ one of Unk's wx bureau men. I was quite psd contact "Al" W3JAJ on 20 cw es get two numerically mis-matched qsl's. Wud like wrk the rest of the BDO's but so far nvr did sew, tho hv hrd W8BDO on 20f long ago.

Got a call off 20cw fm Berlin, N. H. Other recent 20 cw victims for me are W9HGT Indianapolis; W1AJJ; W8QKN Daxton; W1AW; W1GRK Taunton, Mass.; and W6ONQ was first qso wid mi new doublet ant. Qsb wid Qsc has bn quite prevalent on 20 lately for me es hear other's cussin abt it also. Yep, Miss Fadeaway is vy active wid 14 "maggie sickles."

W9ZFC jawin' along rite nicely on 4 mc band. W9HVV Marshall, Mo., "showin' em" how tlc shud b did on 75f but he to found fastest method was in sum other net than AARS which he belongs. To much internal resistance fm hds—dissipates to much energy uselessly.

W5DEN on 3.9 mc cw wid a sig tt shud net qso's a plenty.

W9WCC of Annandale, Minn., on seven-five articulations as in past.

W9HSL of Wichita, hving fb qso wid W9WRS on 75 one morn.

Abt 15 hams widin "shouting distance" wrkd W9EYN's ow outa two fb meals, while Joe was wrking em to be "the yeast" to raise his new 105 ft "stick"—is ben said Joe found a worm and was vy, vy qrl feeding said fishbait to Donna his Duck whilst the hoys were actually in process of raising the ramrod. Joe used his old ant to top of new pole temporarily and tried using new as vertical for receiving and burned out primary on rec'r so measured and found had amp'n half current at bottom of vertical receiving ant ttway—still he contends he wasn't "usin' n" new ant, despite all this rfi in the "wrong-end" whr voltage shud hv bn. So, W9LVT (after two days since the big feeds at Joe's) proposed the gang again assemble at Joe's and "turn the 105 ft pole up-side down" so as to put the current at top whr it shud b, or sumpin'; anyway "catch" was tt Warren stated three-meals for bunch, matter of factly pointing out to Mrs. EYN it they wud hv take dwn ant es re-raise it—darned if don't seem as tho those bums don't know but what three of their feeds are worth the trub! Em hr, I note Joe's sig is as loud at noons as similar powered xmt's half as far, es his beats best sigs fm his neighbors for me nw, so guess the "ant's the thing" when it cums to gettin' out!

W9AHO a hot oyster is another old timer who is heard spasmodically fm near Gridley, Kan. Like wrk ya Homer.



Portable w1ksa.



w2mqd visits w2lnt.

W7CT Les expects to be on the ocean blue sn in Navy. W7DAQ "Al" is wrking W9HNG "Rose" across abt 450 mi of space this noon on 75f—"Al" realli keeps gud receivers up thr in Mont. W9LLP has nw jined 'em in a 3-weigh, es we hear abt W9EYN, his worm and his duck. Hi, Joe nvr will hear the last wrd on tt!

W9FPG fresh pork gravy Tarz is nw at Camp Bureauquard but expects b qsyd sn to Camp Pope, es accordin to big-bro W9HCP Tarz is upholding ham traditions es not proving the dumbest in class.

W3FUN es that wuz wat we were hving on 20 CW til he had to QRT es "take" his YF to town b4 she got riled es "tuk" him. Hi, Ellsworth, U shud b "not tuk"—an old indepent bach like me! Hi.

W9RYV Roy tells me he has bn transferred to Windsor, Colo., to wrk under his original "boss" thr in the sugar factory. Roy is a chemist for same company at Minature, Nebr., at present. Sorry to lose U out of "White Spot" Roy but gang all psd at ur "rise."

W9YYV Jawm has popped up agn on 75 to try es take ur place Roy. Jawm is runnin' 25 w nw but gettin' lined out to boost the lite wilyum wid his usual 200 w.

The hams widin walkin' ridin' es flyin' es may-beso Thumbin' dx of Concordia, Kan., gathered thr to give each-other the look-adt during hamfest thr May 18th.

Rumor has it tt W9PGA is being given a medical discharge fm Navy es will b home sn. He was called abt six mo ago on acct of his naval reserve radio affiliation.

W6TAN gy W8OUD dope on his rig as bein' 300 w inp to an "un-married" 100th during their qso on 20 cw. W8OUD's "bug" must b like mine in it it won't "slow-dwn" decently. Sluggish if enuf weights r used to slow it dwn below 20 wpm.

A yr ago I reported W9KQX as raising 500 lil chix 4 preacher es ham cumpanee! Jist nw hear story is dif this yr in tt the "ol' feathered bird" left him a 4th son. No handle as yet, so gang promises to dew tt cum next Sun morn's round-table es no moniker!

W9IRZ has bn wrking on his 2 1/2 m transceivers. Lawrence is of-the-type who gets more kick outa experimenting than op'ing.

W9JLS, Bill of Keokuk, recently went dwn to KC, Mo., but not after a class "A" or "B" as he already had an "A"—hope the kinda "ticket" he sought and got was one puttin' him'n'a—YL on xtal control for rest of their unmaturl lifetime. Willyum es may the pink-tickets 4 "harmonics" em fm the sawbones insted of RL.

W9FMW for (or, four) more winners "O.K." is ok at it slogan as his fourth-YL recently came via feathered bird. "O.K." is well known in this mag hving copped a fifth and btr a "first" prize in past technical quizzes in R.N. "O.K." belonged to 160f AARS past winter es nvr mist a report period, but gave up the ghost es tended his resignation when hds tried to "force us" into using cw also—he has had class "B" ticket since 1928 es can "take cw." Most of us feel, had we wanted wrk cw net, it is net we wud hv jined originally.

W8DBC do be careful "Grant" of Cleveland told me nu call semed familiar to him but didn't recall ever hving qso'd him b4. Found out he had bn readin' *Hanchatter* in RADIO NEWS not once but often es it is whr mi call had registered in his mind. Well, "Grant" the Editor prints



w1bio, w1mey es xyl's.



Hamop & station w9zlv.

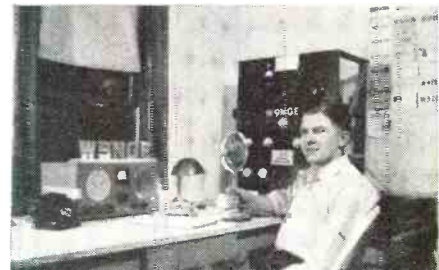

Hamop w9nge es rig.

this whooev for you readers to read and he'll b psd to kno u do! T200's at W8DBC's on 20f. Nice ragchew on 20f wid W9TGB—those good blondes—of Bellwood, Ill. "Walt" uses abt 120 w inp es W8JK ants.

I'm "threatened with dire vengeance" by the gal, if, I expose her engarement to one of Unk's nephews, but as their amalgamation isn't due to take place til August, I may give u a hint in next issue as to which pages, pix es past issues to look at to "get a gud idea" of what these two fool things that are in love look like. Hi! Apparently sum of the rest of us set such a bad example in our old age tt these two decided they didn't want to grow-up to be old crabby bachelors and maids like us. Hi! Hi!

One aft on 20f W4OC es W6LS were hving the vy-nicest chat abt their beam-ants, "movin' pitcher peepul" the ham xmt's es calls in movie "Men of Boy's Town," and a certain VO-1 YL back in the gud old daze.

W9CCS bumping in hr vy fb on 40cw eq but didn't cum back to W4EUO-9 who called him this noon.

W9DWD was cq'ing—"east" same band a cuppla min later.

Got a snigger outa hearing a W6 telling the W5 he was qso wid abt "sum guy hving recorded a eq at slow speed es then put it on air at high speed" one aft on 20f when I had just previously rattled off my "usual" 350 wpm eq strait-fm-the-tongue—he shud hear me when I'm hving sum fun es doin' abt 500 wpm. Boys also seem get

(Pse QSY to page 64)

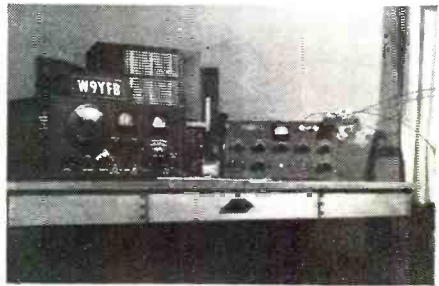

Hamrig of w9yfb.



Hamop w3hzk.



by ALFRED TOOMBS

Special Washington Correspondent for RADIO NEWS

The National Emergency

ON the day that President Roosevelt issued his proclamation of an *Unlimited National Emergency*, he assumed the power to take over the facilities of, or to shut down completely, any radio station in the United States—commercial or amateur. On the following day, he made it plain that he had given no thought to using this power. All that is necessary now to put Section 606(c) of the *Federal Communications Act* into operation is the issuance of an *Executive Order* from the White House. This section provides that upon declaration of a national emergency "the President may suspend or amend, for such time as he may see fit, the rules and regulations applicable to any or all stations within the jurisdiction of the United States as prescribed by the Commission and may cause the closing of any station for radio communication and may cause the removal therefrom of apparatus and equipment or he may authorize the use or control of any such station and/or its apparatus and equipment by any department of the Government under such regulations as he may prescribe upon just compensation to the owners."

This was one of the many powers the Chief Executive assumed to meet the crisis. At a special press conference the next day, Mr. Roosevelt was asked whether he had any plans to take over broadcasting. He replied with a suggestion that the reporters ask Harry Butcher (CBS Washington man) or Mark Ethridge or Fly or some of those fellows about that. He indicated he had no immediate plans for any such action.

At present, there is nothing to be gained by the Government taking over control of standard commercial broadcasting. The networks are giving the Government everything it asks for now. Insiders know that plans have been made for establishment of a central "clearing agency" to direct Government broadcasting. Through this agency will clear all programs written and planned by any Federal agency. The clearing house will make arrangements with broadcasters on time and coverage. This is as far as the White House has any intention of going at this time.

There is considerable sentiment inside the Administration, however, to have the State Department take over control of all international broadcasting emanating from the United States. The ten big international stations are doing the work at present as a labor of love. Those who want to take them over argue that the Government could finance the operations in order to produce better programs and that Government operation would give the stations greater prestige with foreign listeners. This step will likely be taken.

The Government already has quietly put the *RCAC* and *Mackay* and other international radio telegraph agencies firmly under its control. Nothing more is necessary here at present.

As for the hams and the others who share the air, they will not feel the weight of the White House emergency power as long as they behave themselves and as long as the country is out of the shooting part of this war.

The order placing all U.S. industry under the Government may have little effect in the radio trade where the civilian orders have been side-tracked for Uncle Sam's Military Effort for some time past. The ra-

dio industry has needed the boom which the Preparation Program brought it, and is not intent "on biting the hand that feeds it." The *RMA* in conjunction with the executives of many leading factories have been in close collaboration with the *OPM* and the radio parts have been turning out as fast as is reasonably possible.

The problems of radio in the war effort have been brought increasingly to the attention of the White House recently. There are three main problems which will be before the President persistently in coming weeks—the war on the short wave, the production of military radio and the resumption of the bloody feud between the Federal Communications Commission and the broadcasters.

Propaganda Broadcasts

THE tempo of the war on the short wave has stepped up in recent weeks, both on the international and domestic front. In this column last month was printed the first true story of the real function and purpose of the *FCC* short wave listening post organization, which story *FCC* Chairman Fly confirmed recently in a speech. The organization of this new branch of U. S. defense is proceeding rapidly, and within a short time, those directing our national strategy will be receiving regular reports on the Axis short wave activity. These reports will analyze all broadcasts emanating from abroad and will furnish the basis for understanding the dictators' tactics. The English, we told you last month, have been able to call most of the Axis moves by a similar analysis of their propaganda.

Washington is not worried over the effect of short-wave propaganda on the United States. Harold N. Graves, the *FCC* expert on this subject, said in a recent report that Axis broadcasts to the United States were water off the duck's back. Mr. Graves said "there is as yet no evidence that Germany has won more than a small audience for her radio broadcasts to this country, and no evidence that even those who listen are much influenced by what they hear."

This country is receiving more radio attention than any other at the present time—being bombarded with short waves "29 hours a day." The German radio is beamed at the U. S. for eleven hours, the Rome radio for six, London for six and a half, Russia for one hour and Japan for four and a half.

The nature of the programs has changed considerably recently. In other days, there was a carefree quality—jokes, music and sugar coated propaganda. The announcers were Germans who spoke with an Oxford accent and the tone of the broadcasts was chummy.

But lately the Germans have become more serious and more threatening. They spend most of their time in bombast directed at the President, the Cabinet and the American "war-mongers." They've even hired a staff of ex-Americans to do their dirty-work. The chief of these turncoats has been identified by *FCC* experts as Fred W. Kaltenbach, a native of Iowa and son of a German immigrant to this country. He has two stooges, and Edward Delaney, alias E. D. Ward, who used to be a theatrical press agent, and a Dr. Otto Koischwitz, formerly an instructor in New York according to *FCC* sources.

The Italians have managed to come up

with an American, too, and a fairly eminent deserter. He is identified as Ezra Pound, the poet, who has lived in Italy for many years and has taken his stand in front of the Rome radio recently to describe the beauties of fascism and the foolishness of Americans in opposing it.

But nobody in this country is paying attention to these broadcasts. Washington is convinced. In fact, there is some doubt in official circles as to whether short wave propaganda is worth the trouble that it is putting Europe to. British efforts, for instance, to stir up revolution in Germany by radio haven't been outstandingly successful. They may be some day, and it is to be noted that the Germans have gone to the trouble in recent weeks to jam with artificial static the British broadcasts to Nazi-conquered countries.

By analyzing the foreign broadcasts and finding clues to Axis plans—and answering the dictators' propaganda where necessary—Washington believes it will be doing all that is needed at this time. But on the domestic short wave, the situation is not so well in hand. There are storm clouds on the horizon.

Hams in Trouble Again

THERE is a certain group of hams that seems determined to give the whole group a bad name. These are the amateurs who have been engaged recently in wholesale violation of *Order 72*, forbidding contact by American amateurs with stations outside of the United States. The violations are continuing at the rate of about six a day—and there is a whole batch of license suspensions coming out of the *FCC* as a result.

The first suspension resulted from a contact with a South American station, which was bad enough, but some whose tickets are in the process of being taken up were talking to Germany—and knew they were. The Germans, all hams should be warned, have been making persistent efforts to establish contacts in this country. The *FCC* can't quite understand their new technique. At the start of the war, the Germans would try to get U. S. hams into political discussions. But now they seem content merely to make routine contacts. Hams had better take care, because there is no surer way to bring down an amateur radio blackout than to continue this sort of thing.

Aside from the violation of the order against foreign communications, which we mentioned earlier, the hams have been conducting themselves like model citizens. The *FCC* denies there is any plan to "censor" ham chats in order to eliminate political discussions or other material which might interest the Nazis who listen in. In fact, it is suggested, the ham's "political" discussions might do the Germans some good.

Hot tip: Watch for action against some 7 hams within 2 weeks, maybe sooner, for violation of *Order 72*. More will follow!

It is this sort of thing—and there are some others who are going to get a rude awakening before long when they find out that they haven't gotten away with it, after all—that is causing some real worry around Washington.

Of one thing the hams may be certain—as certain as death and taxes. If the wholesale violations of *Order 72* continue, and there seems to be no letup in sight at this writing, the *FCC* will finally have to crack down on the entire group of 50,000 for the misdeeds of a mere bagatelle of "dopes" whose main pleasure seems to be to get Uncle Sam riled. The situation is this. It requires so much time and so many man-hours of monitoring to do a good job on the airwaves. Even with 350 additional monitors working, there is not too much time which can be devoted to hams. So, in order to release men for other work, what could be simpler than to take the hams off the air entirely then only a very few monitors would be needed in those bands where any signal at all would stand out like a sore thumb in the void created by the entire absence of any legal ham signals. Since the other work of the monitors is far more important than the running down of "twerps"

(Continued on page 46)

UNITED AIR LINES

NEW 5-KW TRANSMITTER

by **PETER C. SANDRETTO**

Radio Engineer, United Air Lines.

In order to have 100% communication over the 750 miles between airports, the most powerful, yet versatile transmitters had to be installed.

As is well known, a small amount of power at medium high frequencies is all that is required during certain occasions for transmission over extremely long distances. However, the necessity for communicating on these frequencies at all times over all distances up to 750 miles has caused *United Air Lines* to install 5000 watt transmitters. These transmitters, designed to overcome static and skipping, were recently installed at New York, Cleveland, Chicago, Salt Lake City and Portland, and installations at Denver, San Francisco and Los Angeles will soon be made. Designed to the specifications issued by the *United Air Lines' Communications Laboratory* to fulfill a definite requirement, they are the most powerful company owned aeronautical A-3 transmitters in the country. The transmitter consists of a power unit, a modulator unit, a cooling unit and a number of radio frequency units. The number of these radio frequency units employed has a direct relation to the number of frequencies used at a given station. An individual unit is used for each frequency. The radio frequency units operate at any one pre-set frequency from 3 to 15 megacycles.

Aeronautical ground station equipment is visited by servicemen every three weeks for the purpose of determining possible causes of failure and to take steps for their prevention. During this time it is usually necessary that the transmitter be completely off the air for only a very short period. Consequently, much thought has gone into the mechanical design of the transmitter to permit rapid inspection. The entire transmitter pulls out of the front of the cabin (in a manner similar to a drawer) and it is unnecessary to go to the back of the transmitter in order to make inspections. All of the construction is made *vertically*, so every connection is visible when the transmitter is withdrawn. The conventional upside-down dishpan chassis, skillfully hiding the resistor and bypass condensers underneath it, making it necessary that the serviceman lie on the floor and hold the soldering iron above his face has not been tolerated.

When the transmitter is pulled out of its rack, all power to it is automatically disconnected. However, by using both hands, thereby *making necessary a deliberate motion*, the power may be again returned to the equipment for checking purposes. When the high voltage is on, a latch closes the fuse door, so that fuses may not be changed unless the power is off.



Top: Mr. Sandretto, right, inspects new unit. Below: Each man works a transmitter.

The rectifier unit contains a number of separate power supplies as follows:

1. A full wave rectifier using 6 Federal type 353 (872A) Mercury vapor rectifier tubes supplying 4000 volts and also 2000 volts.
2. A rectifier using 2 866A tubes for supplying 650 volts.
3. A rectifier employing two 866A tubes for supplying 400 volts D.C.
4. A rectifier employing a single type 83 tube for supplying 300 volts D.C.
5. A rectifier employing type 83 tubes for supplying 48 volts D.C.
6. A rectifier employing two type 83 tubes in parallel for supplying minus 120 volts.
7. A rectifier employing two type 83 tubes in parallel for supplying minus 200 volts.

An auto transformer is employed in the power unit for adjusting the voltages to their proper values. Three voltmeters are supplied for reading the high voltage d.c. Filament voltage for the various units is not supplied from the power unit, but is incorporated in each r.f. unit, as will be described later.

The modulator unit is novel in that it includes two separate amplifiers with their output circuits in parallel. With this arrangement it is possible, in case of failure of one-half of the modulator unit, to cut the defective portion free from the circuit and con-

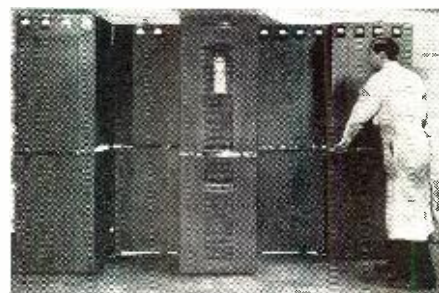

Only one Transmitter is shown here!

tinue to modulate 5 kw. at 50%, or by removing two of the tubes in the output unit, modulate 2500 watts at 100%. The modulator unit for each half of the radio amplifier consists of a 6N7 tube in push-pull, resistance-coupled to two 6C5 tubes in push-pull. This stage in turn drives four 6L6 tubes in push-pull parallel and these in turn drive two 450TH tubes in Class B.

The second audio amplifier is exactly the same as the one described and none of its parts are common to the first amplifier. The output of these two amplifiers is connected in parallel through a 4000 cycle low-pass filter which serves to eliminate cross modulation to adjacent radio frequency channels. This audio power

(Continued on page 54)



RINGING THE BELL

by

SAMUEL C. MILBOURNE

Station Logs

NOW, more than at any time within the past few years, station logs are proving to be a good advertising means for the radio serviceman. This is, of course, due to the shift in broadcast frequencies of last March 29th.

People have become "frequency conscious" and before the new allocations become a matter of habit with the radio listening public, you can gain attention for your sales message by combining it with a log of the radio stations most often listened to in your locality.

You should tie in this log with a message to the effect that now that radio's "moving day" is over, radio reception will be better than ever and radio entertainment a real treat. Stress the importance of a radio check-over and a re-alignment of the receiver so that the radio owner can enjoy fully the new benefits.

If you live in a small town, you can often make arrangements with a local radio set dealer to mail these logs with his monthly invoices. Another possibility is to sell some local dealer on sharing the expense of the log by adding his advertising on the back of the log. A third arrangement is to pay for the set-up cost and a small number of logs for your own distribution. Then, find out what additional logs will cost with an imprint on the back such as "compliments of John Doe's Drug Store." Then, offer to supply John Doe's Drug Store with these logs at this additional cost which will be very small. The main thing is to get circulation of the log which carries your sales message. If you try this, limit the logs to one dealer in each classification, such as one drug store, one grocery, one gas station, etc. A fourth arrangement is to make up the log with a notation at the top, "This radio log compiled by PDQ Radio Service. Phone 1234 for fast, reliable radio service." Leave space at the bottom for an ad and give your local printer permission to sell this space on the log to local merchants. In this way, you should be able to get your logs at a much cheaper price (due to the quantity) and be assured that on every other log your advertising will also appear. By all means, speak to your local printer and see what arrangements can be made to fit your locality. The added business you will receive from this type advertising will help pay for some of those much-needed pieces of test equipment, that new sign, or a shop redecoration.

Shop Redecoration

THAT brings us to one of our pet subjects—shop redecoration. Have you redecorated your shop lately? We mean other than with a few more old

chassis. When we first started writing "Ringing the Bell," we devoted a good deal of space to this subject and thus, we shan't go over the whole subject again at this time. Sufficient it is to say that invariably a shop *always* needs a "sprucing up" and often it is merely a matter of getting started.

Hence, we once more ask that you look at your shop through the eyes of an outsider and see where a little paint or a little soap and water would make a big improvement. Consider whether the placement of your bench and other shop fixtures is as good as it would be if you would rearrange it somewhat. Do you need additional shelves? How about the bench panel, does it need a modernization? Is your stock placed with relation to your bench so that you make a minimum number of steps between the two? Are you accumulating a fine collection of old radios, or are you keeping the shop clean of such space-clutterers? Do you have a good-sized circular (round) "file" and do you use it instead of the floor or shelves for all waste paper, old tubes, parts and other "junk"? Do you have a certain place for the dustpan, dust rag and broom, and do you use them *daily*?

Yes, it's time to clean up, paint up and redecorate the shop. There are few better ways to increase business, believe it or not.

Discounts on Test Equipment

EVERY serviceman is vitally interested in the cost of the test equipment, manuals, etc., that he must use in the conduct of his business. However, there is still some misunderstanding by servicemen regarding net prices on such items. Some servicemen believe that, inasmuch as they are in the radio business, they should get a discount on the test instruments, manuals, etc., that they buy from time to time.

This is, of course, erroneous. The reason is quite simple. The serviceman is the "ultimate consumer" in these cases.

A legitimate discount on an article of merchandise is offered a person or firm so that they, in turn, may re-sell the article at a profit.

Thus, when you, as a service man, buy an i.f. transformer from your jobber, that transformer may carry a list price of \$1.00. You pay less than \$1.00, by a certain percentage discount, so that you, in turn can re-sell the item for \$1.00 and make a profit (you hope). However, when you buy a test instrument or a tube manual, or any other item which you intend to use (making you the *ultimate consumer* in this case) you pay the *final list price* for the item. However, here is where you actually *do* get a *hidden* discount as

compared to the average person who trades with you. (The following percentages are merely taken as *examples* and are not intended to be construed as *actual* percentages now in use.)

Let us suppose that a parts manufacturer has an item to merchandise and he finds that (to make a legitimate profit) his net billing on the item should be three times the cost of the bill of material. Let us assume that the bill of material cost is 15 cents. Three times 15 cents is 45 cents, the net amount of money the manufacturer must receive for each similar part he sells. Now, he knows that the jobber, through whom he sells, requires a mark-up of 33 1/3% (which is equal to 25% of the *jobber's* net price to the serviceman). A mark-up of 33 1/3% on 45 cents would be 15 cents. This added to the original 45 cents equals 60 cents, the net billing to the serviceman. The manufacturer also knows that on this particular item, the serviceman requires a 66 2/3% mark-up (which is equal to 40% of the *serviceman's* list price to the customer). A mark-up of 66 2/3% on 60 cents would be 40 cents. This added to the original 45 cents and the jobber's 15 cents makes a list price of \$1.00 to the public.

Thus, we have:

\$0.15—Original bill of materials cost.

\$0.30—Manufacturer's share to cover labor of manufacture, advertising, representatives percentage, overhead and profit.

\$0.15—Jobber's share to cover his overhead, salaries, commissions, and profit.

\$0.40—Serviceman's share to cover his overhead, salary and profit.

\$1.00—List price to public.

Now, let us take the same set-up from the test instrument, manual, etc., angle. Let us assume that the bill of materials on a test instrument would run \$15. Let us further assume that



"Awright, awright! So what if you have to hold the wire; it plays, don't it?"

the manufacturer's mark-up is the same (3 times), making the net amount of money the manufacturer must receive \$45. Again, we will assume the same mark-up by the jobber (33 1/3%), making the net amount of money the jobber must receive from the serviceman \$60. If the serviceman had to re-sell this item, he might be entitled to another 66 2/3% mark-up, making the final list price of the article \$100. However, inasmuch as the serviceman is the "ultimate consumer," there is no point in listing the test instrument at \$100 and then offering a 40% discount to the serviceman. The test instrument is normally listed at \$60 net to the serviceman.

However, let us get this one point across. That \$60 test instrument actually represents a 40% saving to the serviceman as compared to the cost to the serviceman's customers of the parts he sells. This is possible because the item requires one less distributing agency and, in effect, the serviceman is his own retailer.

Trade-Ins on Test Equipment

ANOTHER question which continues to bother some servicemen is why their obsolete test instruments do not have some trade-in value against the purchase of modern testing equipment.

A legitimate trade-in is one in which the object being traded in has some actual resale value, or some salvage value.

There are a number of reasons why most test equipment can not qualify under a legitimate trade-in arrangement.

First, if the equipment is obsolete to you, it is probably of little value to anyone else and thus has practically no resale value.

Second, if the equipment is in need of repair (and almost all old test equipment is in that condition) a certain amount of money must be spent on putting it in resale shape. This amount usually is more than can be obtained on the resale.

Third, if you have owned and used the equipment for several years, you can afford to write off the complete original purchase price and simply "junk" the instrument. For instance, let us assume that you own a multimeter which is five years old, and for which you originally paid \$36.00. Over a five-year period, this instrument has actually cost you about two cents per day. That's cheap enough to allow you to forget trying to resell it.

Fourth, the test equipment has no salvage value to a test instrument manufacturer, because no test instrument manufacturer would consider putting salvaged parts into new equipment.

Thus, under the above conditions, old test equipment has no trade-in value as far as the test instrument manufacturer is concerned. However, if the equipment is in fairly good operating condition, or can be reconditioned at a reasonable cost, the serviceman may be able to dispose of it by selling it himself. A few jobbers have some setup whereby they can help servicemen dispose of their old instruments, but this is not looked on with much favor by most jobbers. They prefer, and rightly, not to have any hand in this type transaction because should the second-hand test instrument prove unsatisfactory, the buyer might blame

(Continued on page 54)



by JERRY COLBY

THE following memo comes to us from Ray Hutchens, former radiop who pounded brass on the seven seas, and now the very esteemed editor of RELAY, the house magazine of RCA Communications, in New York.

"The cut at the top of the 'QRD?' column is either the SS Orizaba or the SS Siboney leaving Havana harbor. I don't know where the Orizaba is, but the Siboney is running to Portugal for the Export Line. Remember how the skipper got mad a couple of months ago when the British gunboat threw a few shells across her bow? ... I sailed with the first mate of the Orizaba 16 years ago. First thing he said when he met me last month was, 'Hutch, the last time I saw you, you broke a mandolin over my head.' ... The Siboney was used as a transport during the last war, and its bases for gun mounting may still be seen fore and aft. ... The Orizaba (KMEI) and the Siboney (WRN) were sister ships running 180° out of phase with each other on the Havana run. ... I served on both ships. ... Thought you'd like to know."

The Editor.

PUBLIC cognizance was taken of radiops when Walter Winchell, the one man newspaper, in a Sunday nite broadcast asked what was being done about Admiral Hooper's revelations to Congress of the subversive radiops in our Merchant Marine. This would be great publicity if it weren't for the fact that 100% American radiops are being classed with a type of rat whose background, education and intelligence are the lowest of the low. For years American radiops have been trying to gain the recognition of the sailing public so that safety would be synonymous with the radiop's ability. The average ticket-buyer never inquired what kind of radiops were on the vessel, or even if a radiop was aboard ... just in case. They took it for granted that the vessel was safe and would reach its destination right on the nose. So radiop organizations tried their utmost to let Mr. and Mrs. Tourist and Pleasurehound know that without capable radiops aboard their lives weren't worth a plugged dime. We can remember when ARTA picketed shipping offices on lower Broadway, N'Yoik, so that potential travellers would see their slogan-painted placards. But today there is no need for placards. Mr. and Mrs. Tourist and the millions of fireside listeners know all about the radiops, know all about the terrible menace some of these radiops are to the safety of American democracy; feel that unless a radiop can prove himself to be a 100% American, he should not be permitted to handle a watch on an outgoing vessel.

These are trying times. The whole nation is in the throes of an industrial upheaval. Good business which would never permit expansion in consideration of what the future might hold, is now expanding and disregarding what lies ahead. They have but one thought in mind "produce war products for all-out aid." There is no dilly-dallying. A suggestion is put into immediate execution without any whys or wherefores to redtape the work. Everyone is doing his best to put over in one year what it has taken the dic-

tators to do in ten years. And you radiops can do your share by unearthing those misguided inhuman souls who will sell our heritage for a less than the proverbial mess of pottage.

The time has come when we must realize that we can't stick our heads into a mud-hole and pretend that we can't see what is going on about us. We must understand that the very future life of democracy and the freedom that we hold so dear is in jeopardy unless each and every man Jack does his share towards the fulfillment of our country's pledge to the democratic nations of the World ... the pledge of aid against their tyrannical aggressors. And we will be found wanting if we do not inform the proper authorities as soon as we suspect someone to be a Communist or Nazi sympathizer. Don't kid yourselves, gentlemen, we're all in this boat, and if we all don't help bale out it's just gonna be too, too bad.

ANENT the above we received a communication from Congressman Ed. V. Izac, sponsor of H. R. 10446, a bill which if passed "will deny or nullify the license of any radiop who could be proven to be or have been a member of any subversive organization." He sez quote ... I reintroduced the bill regarding radio operators and believe action is likely to be taken in the near future regarding it. I talked over your suggestion with several and they thought it might be biting off more than we could chew to include the Western Union and Postal operators. All seemed to agree that there might be the necessity of including them but also that after we are successful with this bill would be the proper time to tackle the other problem ... I am in receipt of a communication from Karl Baarslag and others who are interested in the passage of legislation which will give our country, at least in times of emergency, the protection that was so absolutely lacking in several of the countries Hitler has already overrun ... I trust if you feel you can aid in any way the passage of this bill that you will make your views known to the Chairman of the Committee at the time the hearings are held. Unquote. We believe it is the duty of every American radiop to make sure that bill H. R. 10446 does become law. Don't fail to write to the Chairman of the Merchant Marine Committee requesting that he do his utmost to ensure the passage of Congressman Izac's proposed bill.

WE are able conclusively to report that Brother Charlie Luck, CTU-Mardiv's aggressive New Orleans representative engineered a contract which was signed by the Waterman SS Company, and that it was accomplished in a business-like manner. There are many firsts in this contract which calls for closed shop, union hall hiring without quibbling, fifteen days' vacation with full pay, full establishment of officer status (the radiop shall have a room assigned for his sole occupancy and use), establishment of full recognition of the eight-hour day principle without deviously written jokers. Sez Luck, quote, even the most obtuse skipper cannot apply his own private in-

(Pse QSY to page 54)

WHAT'S NEW IN RADIO



NEW RCA MICROPHONE CONTROL ANNOUNCED. A new "pushmike" adaptor and stand, making a valuable addition to the current line of RCA microphone stands and accessories, has been announced by George Ewald, Manager of the RCA Commercial Sound Division.



The new unit is ideal for mobile or portable operation of public address systems, or for other uses where it is desirable to cut the microphone in and out of the amplifier circuit at will. Sturdy in construction, the unit is finished in polished chromium and is available with or without a chromium-finished base. Without the base it may be used as a hand grip or in conjunction with a floor stand.

The switch adaptor is fitted with a heavy duty double-pole-double throw low-capacity leaf switch, with a "push-to-talk" button that can be locked in the "talk" position with ease. As an adaptor it may be fitted to any stand with 5/8"-27 thread. By use of the proper thread changing adaptor, any RCA microphone can be attached to the switch and case, which is shipped unassembled. RCA Manufacturing Co., Inc., Camden, N. J.

EMERSON ADDS 11 TYPES TO TUBE LINE. In line with its policy of including in the Emerson tube line new types as they become factors in replacement sales, the Emerson Radio and Phonograph Corporation, New York City, announces the addition of eleven types. Among these are several types, which although recently introduced, are already enjoying extensive usage as initial equipment and will resultantly be in wide demand.

Added to the line are the following types: 1LA4, 1LA6, 1LB4, 1LH4, 1LN5, 3S4, 5W4GT, 6A3, 6SG7, 7B4 and 117P7GT.

Type 3S4 an improved output tube in the miniature series, is being employed in new "personal" battery sets. The 117P7GT, a combination beam power output and rectifier tube, has a higher output than its predecessor and is used in the new Emerson 3-way, 3-gang condenser portable sets. Emerson Radio and Phonograph Corp., 111 Eighth Ave., N. Y. C.

ANNOUNCING NEW Z-225 UNITED MERCURY RECTIFIER TUBE. One of the most interesting mercury rectifier developments in recent years is expressed in the new United Z-225.

The new United tube has the same ratings as types 866-866A, yet, including overall clearance occupies less than one-half of the cubic space in an installation.

Many who have discovered the superior operating capabilities of types 966 and 966A will be eager to set their mental yardsticks to work on the Z-225.

Mercury in a high voltage rectifier is something like food or drink for human beings. Too much—bad; Too little—bad; The right amount (and the right kind)—fine. The Z-225 has the right amount and the right kind.

The Z-225 not only provides great space saving advantages, twice the efficiency per cubic inch of your power supply, but it gives all out proof of what can be done the way United makes rectifier tubes. Bulb Type T-14, overall height 5 1/2 inches, overall diameter 1 1/4 inches. United Electronic Co., Newark, New Jersey.

NEW GTC PORTA-POWER. General Transformer Corporation announces the new Model "C" Porta-Power which supplies 1 1/2 volts "A" and 90 volts "B" to battery radios when connected with a 6 volt d.c. source. This unit, which should be of special interest to jobbers and dealers serving rural districts away from the high lines, was shown for the first time at the Radio Parts Show at the Hotel Stevens, June 10th to 13th.

In addition, they displayed the complete line of GTC Porta-Power which enables owners of 1 1/2, 2, or 6 volt farm or portable battery radios to operate from the high lines.

General Transformer Corp., 1250 W. Van Buren St., Chicago.

LINE-VOLTAGE REGULATOR ALSO PROVIDES LIGHTNING PROTECTION. The automatic line-voltage regulator—a handy plug-in unit in-

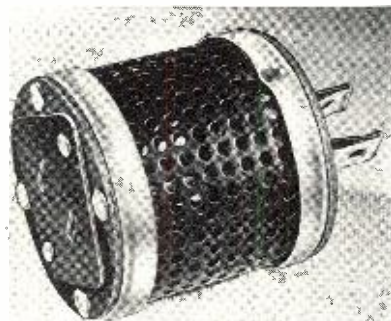

serted between power cord and electric outlet, costing but a dollar list—is being used more and more as a lightning protection fuse in the Middle West and other localities subject to severe electrical storms, so reports Clarostat Mfg. Co., Inc., of Brooklyn, N. Y.

It seems that the main lightning threat is

over long, overhead and therefore exposed power lines, in severe electrical storm localities. The heavy induced charge travels over the line and gets into the radio set, causing serious damage. By inserting an automatic line-voltage regulator between set and outlet, however, the heavy induced charge is stopped short of the set, sometimes at the cost of a melted regulator serving as a fuse, but even so that is a lot cheaper than having a wrecked radio set. Meanwhile, of course, the usual lightning arrestor is used to protect the set against any lightning bolt in the immediate vicinity of the aerial. The regulator also serves to maintain the set voltages within satisfactory and safe limits for good reception.

NEW RECORDING AID. "Slik" has been put on the market by National Recording Supply Co., Hollywood, in 2 oz bottles for distribution thru the usual channels. The preparation is a scientific concoction to help preserve recording discs. It is said to minimize surface noise on acetate of micro cellulose blanks by lessening the cutting point friction and lengthens the needle life, while also disposing of accumulated static charges. The liquid is applied with soft brush or cloth before recording. National Recording Supply Co., Hollywood, Calif.

RCA DEVELOPS NEW DELUXE PORTABLE DISC RECORDER. A portable disc recording equipment for cutting high quality instantaneous recordings both in the radio studio and on remote locations, has been announced by

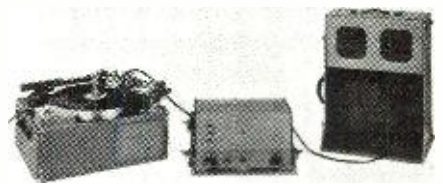

the Engineering Products Section of the RCA Manufacturing Company. Although a quality instrument in all respects, the device is compact enough to be enclosed in two handy carrying cases when ready for moving. It is designated as Type OR-1.

Designed for years of service and built to the same standards set for RCA's radio studio equipment, the portable unit is a complete recording channel, with the exception of a microphone. It consists of a turntable, a record cutting attachment, and an amplifier and loudspeaker unit. The turntable and the amplifier-speaker unit may be used together as a high-quality record player.

The turntable unit consists of a 16-inch aluminum turntable, rim-driven by a high quality synchronous motor. A unique feature is the use of two rubber-tired driver wheels (instead of the usual one) between the motor shaft and the turntable rim, thus virtually eliminating slippage. The off-on switch disconnects the power and, at the same time, releases both driver wheels to

prevent "flats" from developing in the rubber.

The turntable operates at 78 and 33½ r.p.m., the speed change being made by turning a single knob. The unit is equipped with an RCA high-fidelity combination pickup and tone arm with permanent diamond point stylus and a uniform frequency response between 30 and 10,000 cycles. This pickup reproduces with laterally- and vertically-cut records and several filters are provided for properly reproducing the particular kind of record being used. A convenient switch permits selection of the filter desired.

The driving motor is rubber shock mounted from the motor board, reducing "rumble" below audibility. The recording attachment is equipped with a spiralling handwheel, a 6000-cycle cutting head and a unique cutter-dropping mechanism which is designed to prevent stylus or record damage.

The amplifier and loudspeaker unit contains a 12 watt amplifier which has a gain of 105 db., and includes a built-in a.c. power supply. It has a frequency response of plus or minus 2 db. from 30 to 15,000 cycles, a noise level which is minus 60 db. below signal, and a distortion content of less than 3% r.m.s. at full output when measured at any frequency between 50 and 7000 cycles. A complete signal stage preamplifier with input and output transformers is included as a part of the amplifier.

Mounted in the removable lid are two RCA "accordion edge" loudspeakers enclosed in a sealed compartment for proper cone loading and low frequency response.

A cut-out is provided in the front panel for the installation of a meter for monitoring the recording level, if desired. A monitoring headphone jack, a power switch and a fuse are also located on the front panel for ready accessibility. The unit is furnished with an AC power cord and interconnecting cable.

Available accessories are a 10,000 cycle cutter-head, an automatic equalizer, and outside-in feed screw.

KNIGHT DE LUXE RECORDER WITH AUTOMATIC RECORD CHANGER. One of the latest products of *Allied Radio Corporation*, Chicago, is this combination recorder, playback system with record changer and portable PA system, housed in a single airplane-type luggage case. An ideal combination for home



use and entertainment, it is well suited for use by schools, churches, and similar groups, also. Plays manually at 78 r.p.m. all acetate home recordings or commercial records up to 12" diameter. Automatically plays without interruption twelve 10" or ten 12" records. Will record at 78 r.p.m. on composition and acetate blanks up to 10" diameter. Built-in amplifier delivers 3 watts output. Uses the following tubes: 1-6J7GT, 1-6Q7GT, 1-6K6GT, 1-5W4 and 1-6U5 Electric Eye Volume Indicator. Speaker is 6½" PM dynamic type. Crystal recording head is adjustable for depth of cut. Crystal pickup is latest true-tracking type. Turntable operates at 78 r.p.m. from constant-speed self-starting a.c. motor. Has volume and tone controls; selector switch for "Record,"

"Playback," or "PA" functions. Accessories include tubes, crystal mike, desk stand, six 6" recording blanks, cutting needle and package of playback needles. Operates on 110 volts, 60 cycles.

NEW KATO MODEL 23A, 500 WATT. PLANT. The *Kato Engineering Company*, Mankato, Minn., has added a new, compact, light weight, portable unit to their line of light and power plants, namely, the Model 23A which generates 500 watts standard 110-volt, 60-cycle, a.c. or 200 watts at 6-volts d.c. suitable for battery charging if desired.

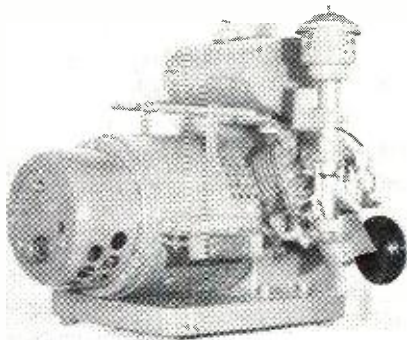

Because of its portability, compactness and rugged construction, it is an ideal model for sound trucks, trailers, cottages or any other place where 500 watts capacity is all that is desired and it will deliver the service economically and dependably. Ideal for operating lights, radio and small appliances.

Comes complete with Johnson 1 h.p. "Iron Horse" single cylinder, air-cooled, four cycle engine, 2¼" bore; 1¾" stroke; a.c. generator; push button starter; carrying handle; aircleaner; rope crank pulley; charge control resistor; d.c. ammeter; cutout; battery cables; filtered and shielded for radio operation.

21" long; 16½" wide; 17½" high; net weight 135 lbs.; shipping weight, 170 lbs. Will run approximately nine hours on a gallon of gasoline.

Can be equipped with remote control or automatic starting upon specification at slight additional charge.

Other sizes available from 300 watts through 10,000 watts capacity. Write for new literature now available.

AM/FM PHONO-RADIO COMBINATION. New *Howard Radio Company's* 14-tube, 4 band phono-radio combination, housed in a mod-



ern version of a period Chippendale cabinet. Receiver tunes three a.m. bands from 540 kc. to 22 mc. (555 to 13 meters) and the f.m. band from 41 to 50 mc. Record player

changes twelve intermixed 10 and 12" records. Has special 12" Jensen speaker to handle high fidelity of f.m. All bands have dual tone control for boosting bass or accentuating treble.

HYTRON ENLARGES BALLAST TUBE LINE AND ANNOUNCES NEW LISTING. *Hytron Corporation*, Salem, Massachusetts, manufacturers of radio tubes since 1921, announce the addition of many hundreds of exact-duplicate ballast tube types to its already extensive line.

The new price list includes more than one thousand stock type, exact-duplicate ballasts. *Hytron* plug-in ballasts are available with both ballast and non-ballast action windings.

The *Hytron* line of ballasts includes both the metal series and the glass series. In view of the unusually large number of types available, it is not necessary to refer to interchangeability charts but rather order the required type direct from the *Hytron* list.

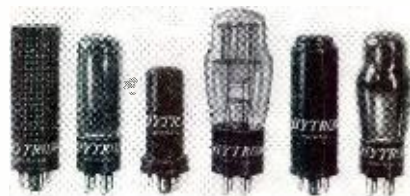

Hytron exact-duplicate ballasts packed in individual scaled cartons list at \$.60, \$.75, \$.95 and \$1.20, and these prices are subject to usual trade discount. Special types not available in the line can be supplied on a special order basis for \$1.50 list when complete information concerning the tube is supplied.

POCKET SIZE TESTER FOR ELECTRICAL APPLIANCES. Servicemen and salesmen of electrical appliances, as well as electrical contractors, will find special interest in an inexpensive, pocket-size appliance tester just introduced by *Radio City Products Co.*, 88 Park Place, New York City, specialists in radio and electrical test equipment.



The Model 417 appliance tester speeds up testing, trouble diagnosis and power-consumption demonstrations by elimination of the usual connection terminals. It is only necessary to plug the tester into the line and the appliance, in turn, into a receptacle provided on the face of the tester. Two 2-position toggle switches and a 3-position rotary switch then permit instant selection of the type of measurement and the meter range desired, with all measurements of voltage, current and power consumption provided by the multi-scale, a.c.-d.c. meter. Heavy duty terminals are provided for current values in excess of appliance ratings.

Eighteen measurement ranges are provided. These include a.c. and d.c. line voltage up to 250; four d.c. ampere ranges to 25 amps. and the same for a.c.; four d.c. watts ranges to 3000 watts and duplicate a.c. ranges.

Watt ranges are direct reading where the line supply is 120 volts and power factor of

the appliance unity. Curves and data supplied with the instrument permit rapid conversion for different values of voltage and power factor. The Model 417 permits direct comparison of power consumed by various appliances.

This is also an excellent instrument for making power measurements of motors up to several horsepower.

Contained in a neat hardwood case with etched metal panel, the overall dimensions of this instrument are 5 $\frac{1}{8}$ " long, 3 $\frac{1}{4}$ " wide and 2" deep.

NEW HOWARD RECORDING DISC. The *Howard Radio Co.*, 1735 Belmont Ave., Chicago, announces a new Economy Recording Disc in the 6 $\frac{1}{2}$ " size. Has the same superior Type C Black Coating used on this firm's



metal-base discs which features low surface noise and good reproduction of both high and low frequencies. Has a list price of 10c each.

A new counter display is available 11x 14 $\frac{3}{4}$ ", with easel for easy placement. Cream color card with glossy maroon color printing with sample disc attached.

NEW RCA TUBES 6SS7, 12SN7GT, 931 AND 8001. The 6SS7 is a remote cut-off, r.f. amplifier pentode of the single-ended metal type having a 6.3-volt, 0.15-ampere heater. This new tube provides for a further degree of flexibility in the design of a.c.-d.c. receivers utilizing single-ended metal types, where the total heater voltage of a complement of 0.15-ampere types heretofore available would exceed 117 volts.

The 12SN7-GT is a single-ended, twin-triode amplifier having separate cathode terminals for each triode unit. It is recommended for use in resistance-coupled circuits as a voltage amplifier or phase inverter.



Since this tube has separate cathodes which are brought out to terminals in the base, this tube offers much greater flexibility from the circuit designer's standpoint than do other twin triodes having only a single cathode connection.

The RCA-931 is a new type of phototube in which the photocurrent produced at a light-sensitive cathode is multiplied many times by secondary emission occurring between nine successive dynodes within the tube. It is capable of multiplying feeble currents produced by weak illumination as much as 230,000 times. Focusing of the electron stream is accomplished electrostatically within the tube.

The 931 employs the S4 photosurface which has higher sensitivity to blue-rich light than to blue-deficient light.

Because of its small size, rugged construction
(Continued on page 57)



by **WILBERT T. PETERSON**
Illinois State Police Dept.

Dial Operated Receivers

A NOVEL method of remotely controlling a police c. w. receiving system has been developed by *Doolittle Radio Company* of Chicago. This system employs a relay rack consisting of 9 separate c. w. receivers set on each of the 9 c. w. frequencies allocated for police use, a local control panel, relay panel, and 48 volt d.c. power panel.

Remote control of this equipment is obtained over a single telephone line, which may be a maximum of 15 miles in length. Selection of the desired frequency or combination of frequencies is obtained by dialing. The dialing is so arranged that all three calling frequencies may be obtained in one position, or each of the calling frequencies may be obtained alone, or each of the working frequencies may be obtained with all of the calling frequencies sustained in the background. The dialing operation sends a 60 cycle pulse down the telephone line to operate the selector switch.

Sensitivity is controlled remotely in three steps by carrying the 48 volt d.c. supply down one side of the line returning by way of ground. By means of relays various values of resistances are inserted in the r.f. circuits of the receiver thus varying the gain. In exactly the same manner, the b.f.o.'s are tuned, using the other side of the line and ground. The b.f.o. condenser on each receiver is motor driven, and by utilizing two push buttons on the remote control allowing two different values of current to pass through the line, the direction of the motor is changed by means of relays. The beat can be set to any desired frequency in this manner.

The receivers are crystal controlled fixed tuned with a limiter circuit in the audio amplifier limiting the output to about 50 or 60 milliwatts.

Remote control of phone receivers is quite common, however we believe this is the first

attempt to remote a group of c. w. receivers and control the beat note and sensitivity of each individual receiver over one single pair of telephone wires! The boys in the police field can well take off their hats to Doolittle for this accomplishment.

New Ordnance Radio

SEVERAL new government ordnance departments are equipping themselves with 2-way police radio installations. These include the ordnances at Wolf Creek in Milan, Tennessee; Elwood, Kankakee, Rock Island, and Savannah, Illinois, and the Kingsbury ordnance in LaPorte, Indiana.

These ordnance departments are composed of guards who patrol the grounds, both on foot and in cars. At various places around the grounds, small dog-houses are placed containing complete 2-way mobile equipment including the storage battery. These little 2-way shacks, which, incidentally, are featured by Motorola, can be carried any place and set up instantly. They also contain a trickle charger for keeping the storage battery charged, providing 110 a.c. is available. An ordinary fishpole antenna is mounted on back of the shack.

The ordnance at Savannah, Illinois, now has two-way communication with the *Illinois State Police*, having set up a transmitter on the Illinois net frequency. Reliable communication is always maintained with the state station at Sterling.

New FM Experiments

IN line with emergency radio equipment we understand the *St. Louis Public Service Company* are well satisfied with their 2-way f.m. equipment. They are using a 250 watt headquarters transmitter with several 2-way equipped cars. They experience reliable 2-way communication from car to car between distances up to 10 miles across the city.

(Continued on page 54)

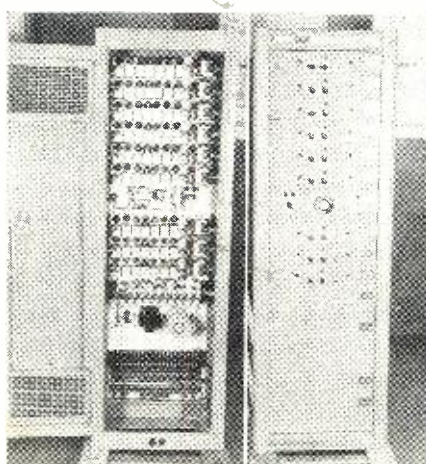

Two views of the new Doolittle Radio Company's remote controlled receiver.



Where telephone lines are not available, police use radio equipment.

THE VIDEO REPORTER

by Samuel Kaufman

DESPITE the shortage of materials radio manufacturers are being forced to cope with during the extensive national defense program, there is every reason to believe that television will be off to a full commercial start at an early date—probably by the time you read these lines.

The *Federal Communications Commission*, impatient aplenty over the way in which certain holders of experimental video licenses weakened at the thought of early commercialization after earlier enthusiasm, is about to let the television industry (if it can be called that as yet) cut loose with full commercial privileges. This action would embody permission to sell television time to advertisers.

Such *FCC* action is presaged largely by the manner in which even the reluctant video participants have been coming to the fore with public statements to prove that they are not asleep on television progress, even though they may, at present, favor a delay in full commercialization.

After tremendous investments in early television experiments and equipment—and very extensive promotional and ballyhoo expenditures—it may seem odd to see the video lads pull in their horns. But, now, it seems that even if they're pulling in their trumpets, they're still sounding the call to advance.

What surprises us no end is the apparent action of some television participants to drag red herrings across their announcements of video plans and progress. It seems that such actions are bids for time, time and more time before commercialization is sanctioned. The radio public can't be kidded, however. There is no reason why the plans of many television companies—as well as the desires of potential look-and-listeners—cannot be carried out. If the technically-informed listener is willing to gamble on investment in home equipment, the desires of a few companies to hold up the whole works pending acceptance of their standards should be dealt with fairly and squarely—but just as fairly and squarely in respect to the views of others.

In the *Video Reporter's* mind, commercialization now should be given full release, but there should be no attempt to misinform the set-buying public on the myth that television has reached the height of perfection and that standards will remain unchanged.

No one can be certain that standards will remain unaltered in years to come. Regardless of any ruling or conditions to the contrary, a major technical advancement in the future will knock the stilts out of any set of standards accepted now.

Does this uncertainty then imply that television should remain shelved in the laboratory until standards can be guaranteed? Of course not! No other industry we can recall was ever hampered by such reasoning. Radio itself had its standards changed and re-changed and yet it grew to a mighty and powerful trade.

Just let the trade and public get a crack at commercial television and watch the new art leap forward!

WE'VE spoken before of the manner in which the New York *RCA-NBC* television station leaned towards sports programs. And it was our deduction that the reason such outside pickups were favored over studio presentations was that the production cost was more favorable. And if you want to know why the production cost was less, it's because there were no talent charges at all. The only expense was for the technical and directional crew on the scene of the ball game, prize fight, wrestling match or other form of athletic competition.

Ah! But now we find there's another angle. We hear the *RCA-NBC* lads, enterprising fellows that they are, feel that it will be a long, long time before profits can be realized on the business of telecasting. And they're probably right! But they now seem to be flirting with the idea of sending "wired" television programs to theatres. With *RCA*-equipped auditoriums in the metropolitan area having exclusive video reception facilities for Madison Square Garden prize fights, for example, an immediate flow of dollars into the *Radio City* till may be assured.

Now everyone knows that the idea of theatre television isn't new. Before the war, *Baird* was using the idea on a widespread basis in England and undoubtedly was on the way to good-sized revenue when the service ceased. And *U. A. Sanabria*, a young Chicago experimenter, startled New York in 1930 with theatre-sized images. *Scophony*, like *Baird's*, a British enterprise, has shown its theatre television in New York. And, we mustn't forget that the *Baird* firm itself, through its affiliate *British Gaumont* pictures, went to town (New York, too, of course!) with its auditorium-sized television system.

However, it took *RCA*, through the reason of its size, importance and weight to open industry eyes as to the potentialities of "paid-admission" television.

RCA, you know, is no newcomer to the show business. It had loads to do with the formation of *R-K-O* theatres and pictures



Exhibition base-ball game being televised from Ebbets Field, Brooklyn, N.Y. Televising at top; tele-trailer below.

and its present investments in sound movie production are tremendous.

Hence, it must know what it's doing in theatre television promotion. But any implication that home television must be shelved until after the commercialization of theatre television is silly.

The *Video Reporter* believes that there is a future for both types of television but that they should be separate and distinct things and neither one should be permitted to advance at the expense of the other. Or, if one *must* come out on the short end, public service would be best catered to if the long end went to home television.

THE *National Television Systems Committee* has gone its way. Having served its usefulness in an effort to demonstrate to the *Federal Communications Commission* just how advanced—or retarded—television really is, the *NTSC* is now out of existence and, according to an announcement by the *Radio Manufacturers Association*, original sponsor of the *NTSC*, "commercialization and future engineering work in connection with television standardization has been transferred and will be continued by the *R.M.A. Engineering Department*."

It must be noted that the *NTSC* did a re-
(Continued on page 55)

Cut your Operating Costs per hour

YOU must increase the volume of your production to maintain profits in the face of increasing labor costs. These Rider Books will show you how. Order Today.

CHECK THIS LIST ALSO

- Serviceing Superheterodynes, 308 pgs., 106 illustrations \$1.00
- The Cathode Ray Tube at Work, 338 pgs., 460 illustrations \$2.50
- Automatic Frequency Control Systems, 143 pgs., hard covers \$1.00

Hour-A-Day-With-Rider Books on Resonance and Alignment—on Automatic Volume Control—on D.C. Voltage Distribution in Radio Receivers—on Alternating Currents in Radio Receivers. Stiff covers—only 60c.

SERVICING BY SIGNAL TRACING

Book explains this fundamental method of servicing that is free from every limiting factor or hazardous encounter. 360 pages, 188 illus., \$2.00.

FREQUENCY MODULATION

Frequency Modulation is here! This book explains transmission of F-M signals as well as discussing the new F-M sets, 136 pages, 76 illustrations, \$1.00.

OSCILLATOR AT WORK

Protect your investment in oscillator equipment. Make any future investment in the light of the knowledge this book gives you. 256 pages, 167 ill., \$1.50.

VACUUM TUBE VOLTMETERS

Explains practical aspects as well as principles underlying functioning of various classifications of v-t voltmeters. 180 pages, \$1.50.

METER AT WORK

If you want to get the most from your present meter or want to buy the proper one for your needs, you should have this informative book. Only \$1.25.



JOHN F. RIDER Publisher, Inc., 404 Fourth Ave., New York City

Export Division: Rocke—International Elec. Corp., 100 Varick St., N.Y.C. - Cable: ARLAB

RECORD CHANGER



Plays 10 12" or 12 10" records. 14" by 14" by 5" high. Crystal pickup. Handles warped records. Will not chip or crack records. Reject switch—automatic or manual change—2 point record suspension. 115 V. 60 cycles. Only 7 seconds to change records.

\$12⁹⁵ F.O.B.

CHANGER-RECORDER



Records up to 12-in. record. Webster cutting head, 4 ohms at 400 cycles—cuts 112 lines per inch—cuts blank discs—under panel feed screw—powerful 110-volt 60-cycle motor. Changer features are the same as in the unit above. Simple to install.

EASY TO OPERATE!

\$25⁰⁰



OXFORD TYPE PD. A beautiful hand-rubbed, piano-finished cabinet. Made of five-eighths stock. Rose mahogany or walnut, \$19.50. Blonde maple, \$25.50. A real piece of furniture 33" high, 32" long, 17" deep. Phono compartment 31x15x6.

UNCUT CONSOLE CABINETS

Send for latest folder

LAKE RADIO SALES CO.

618 W. RANDOLPH ST. CHICAGO

MANUFACTURERS' LITERATURE

Our readers are asked to write *directly* to the manufacturer for this literature. By mentioning **RADIO NEWS** and the issue and page, we are sure the reader will get fine service. Enclose the proper sum requested when it is indicated.

NEW LAFAYETTE PA CATALOG PRESENTS 1941-2 LINE. A new 48-page catalog devoted exclusively to sound equipment and including the brand-new Lafayette line for 1941-2 has been issued by the *Lafayette Radio Corp.*, 100 Sixth Avenue, New York City. Illustrated listings of some 25 amplifier models and approximately 75 completely coordinated sound systems, plus expanded lines of accessories, recorders, intercommunication equipment and custom-built systems for school, industrial and other specialized applications, make this catalog literally "the sound man's bible."

The new *Lafayette* amplifiers include separate standard and economy lines, the former available in ratings from 6 to 100 watts, the latter from 5 to 50 watts. In the standard line of "Super Stylined" amplifiers extreme flexibility of application is provided through incorporation of more input channels, greater equalization, optional built-in record-player equipment and optional built-in sound level meters.

A feature of the new catalog which makes it especially useful to the busy serviceman or sound specialist is the entirely new method of listing and describing equipment, with all salient facts presented in tabular form for quick reference. Technical specifications of all amplifiers are also presented in this form.

Copies of the new catalog may be obtained by writing to the above address, or from *Lafayette* branches in the Bronx, Jamaica, Newark, Boston, Chicago and Atlanta.

HOW TO SELECT A SOUND SYSTEM FOR ANY INSTALLATION. *Allied Radio Corporation*, Chicago, through the medium of their new 1941 Spring and Summer Catalog, has eliminated the mystery usually associated with selecting the proper public address equipment for efficient results.

An easy-to-understand chart covers all applications, including Churches, Schools, Auditoriums, Carnivals, Night Clubs, Taverns, Skating Rinks, Athletic Fields, Outdoor Meetings, Armories, Stadiums, etc. Complete information is specified for computing the area to be covered in square feet, wattage required in amplifier, size and make of speakers needed, and type of baffle to use.

A simplified explanation of the necessary public address components, such as microphones, amplifiers, and speakers, is provided with each type of equipment being summarized for the most effective usage. The *Allied Sound Engineering Division* will provide competent advice, based on a careful study of individual problems, where necessary.

A catalog including the complete chart and instructions is available from *Allied Radio Corporation*, 833 West Jackson Boulevard, Chicago, Illinois.

NEW R.C.P. 1941-1942 CATALOG READY. Combining to an unprecedented degree the features of dependability, wide utility and economy, the 1941-1942 line of test equipment offered by *Radio City Products Co.*, 88 Park Place, New York City, made its bow at the Chicago trade show. Immediately after the show complete details of some fifty models which comprise this line will be presented to the public in a

brand new R.C.P. catalog (No. 125), which is now ready for distribution.

Recognizing the specialized equipment needs of service men whose activities extend into fields other than radio, the new line includes several models for electrical service-testing all types of appliances, refrigerators, coin machines, etc.

The main emphasis is, however, on radio test equipment. Perhaps outstanding in this field is the inexpensive Model 661 electronic multimeter (illustrated) which combines in one instrument the functions of a vacuum-tube voltmeter for a.c. and d.c., vacuum-tube ohmmeter and vacuum-tube capacity meter. This instrument provides a total of 26 ranges for measurements of voltages, both a.c. and d.c., to 6000; resistance from 1/10 ohm to 1000 megohms; capacity from 30 microfarads to 1000 microfarads. It is an ideal unit for testing during actual operation, signal tracing, etc., and insures negligible circuit loading because of its input resistance of 160 megohms on the higher ranges and 16 megohms on lower ranges.

Copies of this new catalog are available through R.C.P. distributors everywhere, or may be obtained upon written request to *Radio City Products Co.*, 88 Park Place, N. Y. C.

NEW LITERATURE DESCRIBES WESTINGHOUSE RECORDING INSTRUMENTS. Improved a.c. and d.c. ammeters and voltmeters for general use are described in a new 12-page bulletin announced by *Westinghouse Electric and Manufacturing Company*. The ammeters are available in ranges from 5 to 125 amperes, and the voltmeters are made in ranges from 90-140 to 450-700 volts.

Switchboard, portable, wall, and socket types are described, special attention being given to application. Operation and construction details are explained.

List prices are quoted for all meter ratings and styles. Physical dimensions are given on outline sketches which show mounting details. Typical 1 and 6 day charts are illustrated.

A copy of Catalog Section 43-414 may be secured from department 7-N-20, *Westinghouse Electric and Manufacturing Company*, East Pittsburgh, Pennsylvania.

NEW PENNSYLVANIA TUBE COMPLEMENT BOOK, 1941 EDITION. A new *Pennsylvania Radio Tube Complement Book*, 1941 Edition, containing tube and panel lamp information for 16,730 radio models with 100,380 sockets is now being released by the *Pennsylvania Radio Tube Division of the Hygrade Pennsylvania Corporation*, Emporium, Penna. The price is 35c. Radio servicemen and dealers can buy copies from their local jobber, or direct from *Hygrade Pennsylvania Corporation*, Emporium, Penna., by sending 35c in stamps or coin.

The book has an attractive two tone blue cover, contains 272 pages of tube replacement data, 586 trade names of receivers, including all current makes as well as those no longer being manufactured, and the names and business addresses of 190 Receiver manufacturers. It is bound with

(Continued on page 51)

radio *Trade* news

FOR THE DEALER, JOBBER & SERVICEMAN

The Trade Month in Review

The Lend-Lease Law has just begun to make itself felt in the matter of radio, as predicted here two months ago, and orders for the British are beginning to find their ways into our factories. U. S. orders meanwhile have been kept up, and for one, the radio industry is not behind in its deliveries.

As reported here last month, General Electric has frozen its radio sets for the year 1941-1942; and there is some talk that the other big manufacturers may do likewise. This will be a godsend to the serviceman and enable him to do a bumper business of repairing the older types which will not have been "orphaned."

The further effect of such "freezing" will be to prevent inflation in the prices of radio sets.

Priorities have the industry in a dither, much concerned with what will be the outcome after the National Defense Situation clears away, which eventually it must. Meanwhile prosperity, and a terrific back-log of orders are creating a boom. Civilian radio is suffering somewhat from non-delivery of parts, but not enough to make any real difference; and some factories are reporting that for the first time in years they have been able to increase their prices with ready absorption by the trade.

Home recording is at the present at its lowest ebb due to a scarcity of material to record from the air. By the end of August, and the return of cooler weather, this seasonal decline will be more than made up. Glass and paper are the substitutes for aluminum used in manufacture of discs, the prices of which will go down sharply and thereby attract thousands of dollars to be spent in this new hobby.

Some radio factories are in the field looking for good men to replace those who have been called up in the draft, but the movement is not likely to become general. Also, some of the servicemen-owners of shops have been around seeking to replace men called.

The usual summer increase in PA business is expected with sales for out-of-doors work predominating. Adding to the dollar value of such sales is the equipping of the Recreational Centers for the Military. PA is very definitely to be able to chalk up a better summer season for this year than ever before.

Ham business remains about the same. Quite some sales in portable gear were reported as a result of the National ARRL Field Day in which several thousands participated. Sales of high-powered apparatus has all but stopped.

August should show further increases in factory salaries, deliveries of units to the British, and a slow, but general upswing in list prices of parts and receivers, with the ceiling nowhere in sight.

All in all, the month just passed was a good one for the industry, with fewer strikes, more money being paid out as salaries, and larger contracts being signed.



THE Capital buzzes with price-control talk. Whether it will be applied to radio receivers or not is a question in the minds of many manufacturers. So far, there has been a marked preference for the "freezing" technique, rather than the fixing of any price ceiling. This concerns only receivers. In the matter of parts, the Government has indicated that it will be quick to step into the picture with price-ceilings should the situation get out of control; in fact, has already stepped in in the matter of aluminum and nickel. This may cause a fixed selling price in electrolytics and permo-magnets for speakers. So far, there has been a gradual increase in the prices in these units as well as others, such as metal cabinets and meters. Some firms have increased their prices 10% and some higher. If this continues, there is every chance that the Government will step in to hold prices at some definite level.

The acquiring of radio transmitters and receivers from the 50-odd thousand "hams" also has the attention of the Government, and plans are being made which will be carried out should the emergency warrant. Some method of payment for the equipment will be put into effect, though there will be literally thousands who will "give" the Government their transmitters or receivers for \$1 just as many a boatsman "gave" his field glasses for the same sum during the World War I when a shortage developed.

At present, the hottest thing in the Capital is the *FCC-Broadcasters'* fight, with the "wiseys" refusing to predict the winner. Next is the continuous monitoring going on in all bands, which is hitting "pay dirt" and resulting in the wholesale discovery of those who are opposed to our form of Government.

Shortages in operators and technicians are still being felt, even though there seems to be enough of these operators, if there can be some way found for the Government to get together with those who are more than anxious to serve. The trouble lies not in the shortage, but in "red tape." This will soon be dispelled.

Meanwhile production goes ahead at an unprecedented scale with radio conspicuous as an industry which is making deliveries on schedule. The increased prosperity reflected in the buyers pocket-book bids fair to make for a boom in civilian as well as military radio. Servicing is on the upswing, and a generally better season, even in the "off-season" is being freely predicted.

SELECTIVE CALLING DEVICE FOR MOBILE RADIO SYSTEMS

A new control device for mobile radio systems, by means of which any one car or group of cars can be called without disturbing the other receivers in the same system, has been developed by the *Emergency Communication Section* of the *RCA Manufacturing Company*.

Given its first showing at the Seventh Annual Conference and Exhibit of the *Associated Police Communication Officers*, at Orlando, Fla., it created a sensation among the several hundred delegates. Known as the *RCA Selective Calling Equipment*, it may be applied to any new or existing radio system.

It is ideally suited for use by utility companies with fleets of radio equipped service and maintenance cars. Heretofore, all workmen in the field have found it necessary to stop work and return to their cars during radio transmission to ascertain for whom the message was intended. Now it is possible to call the one receiver or selected group of receivers desired. All other receivers remain inoperative while the crews of those cars remain on active duty.

The equipment consists of a transmitter coding unit assembled on a standard speech input rack, and receiver decoding units similar in size and appearance to ordinary mobile receivers. The control panel of the transmitter coding unit has two rows of eight buttons, from which as many as 200 different combinations of numbers can be used.

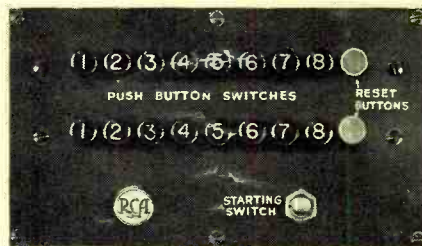

The transmitter coding unit consists of four panels—power supply, coding unit, tone generator, and control panel. The power supply is conventional, supplying AC filament power and DC plate power from a voltage regulated rectifier and filter. The tone generator produces the proper audio tone at the desired level, which is in turn sent out in the correct sequence by the coding unit.

The mobile decoding unit is housed in a metal case measuring approximately 11" by 7" by 7" and weighs approximately 15 pounds. It operates from six volts DC and requires about 15 milliamps at 200 volts from the receiver power supply during times of signal transmission, and two milliamps on stand-by. The decoding unit will operate from signal inputs of from 100 milliwatts to 3 watts, and requires an audio signal only.

SERVICE HINT

It is far better to break "even" on a disputed matter with a customer, than to make a profit and lose him forever!

BOOST YOUR BUSINESS

— AN EDITORIAL —

WE will always have some alarmists with us no matter how reassuring those "in the know" may be. These persons, prefacing their remarks with, "I'm only telling you this for your own good . . ." will mostly be repeating just what any Fifth Columnist would want them to, and undermining the morale of the industry.

This is not the time to be scared from keeping on with your business. This is not the time to listen to those who would have you believe that the end of all radio servicing business is just around the corner, and that that corner has just been reached.

There are more signs that point to a boom in the servicing business than there are signs which point away from it. Take, for instance, the "freezing" of the models by one of the leading radio factories. This will mean that the inducement to purchase new sets will not be as strong as it was before. Add to that the fact that the radio is more than ever now the means for the rapid dissemination of information, plus the fact that the pay envelope of the worker is fuller than ever before, and you have a first-rate set-up for a serviceman's boom.

There will always be some who will say, "Well, and good, but I haven't seen anything of this so-called boom." But then there are always some who have not seen the handwriting on the wall for years and years.

There will definitely be a boom in servicing. The radio sets in the people's hands must be kept up, and John Q. Public will want to have his radio working perfectly. All this means money in the pocket of that serviceman who is ready to take advantage of the unusual situation.

Be one of those who believes in himself, in his business, in the inherent opportunities of radio which first attracted him.

Be a radio service booster, and it will follow, as night does the day, that you will be among those whose business will improve, yes, beyond your fondest imagination.

URGES PLANNING FOR DEFENSE

Non-defense industries must plan for "a period not of months but of years" to get along with much less than their requirements in a long list of strategic materials, Philip D. Reed, chairman of the board of the *General Electric Company*, said at the 25th annual meeting of the National Industrial Conference Board at the Waldorf-Astoria Hotel.

Mr. Reed, who for three months has been Senior Consultant to the Director of Priorities of the Office of Production Management in Washington, said he was expressing "a few personal observations on several points that must be considered in charting the course of any business."

Prime emphasis will be placed on military products for five or more years, he said, and added that "the sooner we accept the fact, for purposes of planning, that we face a long period of enormous production for defense, with a consequent shortage, rationing and allocation of strategic materials, the more quickly will non-defense industries adjust themselves to the new conditions and undertake the great task of maintaining maximum production for civilian needs without interference with defense output."

PARTS JOBBERS GLIMPSED FUTURE

A glimpse into the future of the electronic arts, together with a realistic view of a steadily expanding business in fields other than radio, was unfolded before more than 200 RCA Tube and Equipment Distributors from all parts of the country gathered at the Hotel Morrison.

Indicative of the unusual program was the "Electronics on Parade" feature, which presented to the distributor guests the famous RCA Electron Microscope, the latest types of television equipment, and other modern miracles of the RCA Research Laboratories. Announcement of the addition of a line of RCA sound equipment for the service field available to tube and equipment jobbers, was made at the same time.

A delegation of RCA executives from Camden, including Robert Shannon, Executive Vice-President, came to Chicago to meet with the wholesalers.

NEW S-W RECEIVERS

Three new self-charging portable radios, forerunners of 20 streamlined *Stewart-Warner* radio receiving sets which appeared early in June, were announced by L. L. Kelsey, manager, Stewart-Warner radio division.

Outstanding feature of the Stewart-Warner portable radios is a new self-charging circuit which charges any standard dry battery commonly used in this type of set. The manufacturers emphasize the fact that no special batteries are required for charging purposes or to operate the sets. Besides battery operation the sets function on both AC and DC voltages. The charging rate makes the cost very low.



It is not enough to furnish good merchandise, in the opinion of Crosley. one must also furnish attractive aids, which have eye-appeal and do sell.

RECORDIO'S OFFER WIDE CHOICE

One of the outstanding radio values of 1941 is the *Recordio Jr.* A combination radio, phonograph and recorder, retailing for \$39.95, makes quality home recording possible for all. *Wilcox-Gay* helped to pioneer home recording in 1939.

The *Recordio Jr.* is convenient in size (12" x 12" x 9"), smartly covered in airplane luggage style fabric and truly portable. The phonograph plays 10" or 12" records, recordings may be made direct from the radio or with the mike. The snap-on cover protects the turntable and microphone, included with each set.

The striking modern design of the A-93 *Recordio*, dual-speed recording (33½ r.p.m. and 78 r.p.m.) and an automatic record changer are combined into a beautiful and highly enjoyable set. Automatically equalized for slow speed recording, 12 minutes of continuous recording is possible on one side of a 10" home recording disc. Recordings may be made of radio programs through the 10 tube receiver; simultaneous recordings may be made with the radio and mike or with the microphone alone. The record changer plays 10-12" records or 12-10" records. A 12" heavy duty dynamic speaker, three gang condenser, and a special wave-trap insure high fidelity radio performance.

NEW "PICK-ME-UP"

Featuring nearly a score of performance and convenience features, and a smart, modern luggage-type construction characterized by lightness in weight, a new "Pick-Me-Up" portable radio re-



ceiver has been announced by Edward W. Butler, Manager of the RCA Victor Radio, Television and Phonograph Division. The instrument, designated as model 25BP, is complete with batteries.

P. I. BUSINESS GOOD

Despite war threats and the menace of invasion, business in the Philippines is expected to be especially good in the radio line, according to the Philco distributor in Manila. The Philippines looks forward to a record year in 1941 and revealed the fact that their average unit price is above \$75, a significant figure considering general market conditions.

DRIVE-IN RADIO REPAIR WORKS OUT

(Special to RADIO TRADE NEWS.) Drive in, cash and carry, no telephone, and a store painted in orange with white trim, open on three sides, that is the set up of *Van's Radio Service* in Miami, Fla. His business is principally service, catering mostly to the auto radio owner and the small set business. "We let the other fellows handle the large sets," explained Chas. Vredenburg, the owner.

"The main thing in car radio service is our location, being out where people can see you, with plenty of parking space. We feature drive in service. The main trouble with our previous location was that we did not have any parking space whatever and it is hard to get business today without it."

"By featuring up to date equipment, being out in the open, and catering to the traffic that daily passes your store, you can do better. Being out here on the Avenue my drawing area is much greater. I have drawn jobs as far up as Palm Beach. People visiting Miami learn about this place and leave their sets and when they go back up they take them along. We also do business as far south as Homestead. We pick up a lot of radio sets out of boats, because people have passed by and seen the shop."

"Having a place to drive in is the main factor in getting business. And you get to meet the customer personally. But people want service. They will drive up here and want you to walk out to meet them, even though he has nothing but a portable battery radio to be repaired, so we have a man here who tends to nothing but the front. All of our boys are in uniform."

"Of course with this set-up you cannot get into the sales angle on house sets, but *Sears Roebuck* or *Montgomery Ward* will attend to that anyhow. Most of our business is done in the evening hours, when people are not working. They have time to talk about things."

"We are open from 8 a.m. to midnight. By having 24 hour service we can take care of things at night. And we have radio sets on display so that when they stop and chat we can make sales."

"We are building up a tube stock with a tube cabinet. There isn't a bulb that we don't have. When people come in it is due to tube trouble generally. We don't push the sale of a tube, however, because in that way you make better customers."

"Fixing up your place builds confidence. For instance, we have a work bench in blue and fluorescent lighting, with chromium stools. We haven't had a kick on price since we fixed up. People appreciate having good equipment in handling their work."

"In pricing our work we figure on \$1.25 an hour minimum on a job. Then we add the cost of the parts of the job, plus \$1 to cover overhead. We invoice material out on the job because there was a time that the many little things used were not charged to the job."

RCA SPECIAL MAILING

Carrying the responsibility of the manufacturer for the most efficient use of the product past the salesman's counter and into the shop of the purchaser, the *RCA Manufacturing Company* has made the first of a scheduled series of mailings of supplementary information to owners of *RCA Test Equipment*.

The mailing comprises five pieces: an announcement letter from W. H. Bohlke, Director of Test Equipment Merchandising; a reprinted article on the development of the *Chanalyst*—the original and tremendously popular signal-tracing instrument—by John F. Rider; 8-page booklet of special application information on the *RCA Rider Chanalyst*; a 4-page gain data instruction bulletin for *RCA Victor* receivers, and a sheet describing the "Electronic Eye" indicators and associated circuits used in the *Chanalyst*.

JENSEN TESTS ACOUSTIC THEORY

The odd looking horns with their abrupt steps are not quite as freakish as they appear at first glance. Actually they are merely steel forms into which Dr. Vincent Salmon, mathematical physicist of the *Jensen Radio Manufacturing Company*, Chicago, cast plaster paris internal



contours to test his new mathematically developed "Hypex" horn formula.

As far as is known, this is the first time that experimental horns have been cast in this manner. Experimental tests proved what the mathematics predicted—that the new formula is a definite improvement over the older exponential rate of flare which dates back to 1919 because the horn impedance provides a better "impedance watch" with the driver unit. The new formula is employed in Jensen's new "Hypex" Projectors.

NEW SONORA MODELS

A new modestly-priced, smart-looking Portable Phono-Radio is announced by the *Sonora Radio & Television Corp.* of Chicago. This popular new instrument has a 5-Tube Superhet Radio portion which tunes 535-1720 KC, covering the standard Broadcast band and police band.

CUSTOM-BUILDING PAYS

(Special to RADIO TRADE NEWS.) We are indebted to Harry Burnor, serviceman of *Commodore Music Shop*, 144 E. 42nd St., New York City, for the many practical and valuable hints in this article.

As the business of this particular concern is largely record selling and custom-built phonograph installations, it is natural that Burnor should have encountered a great many perplexing problems in his daily work. How he has solved those "tough ones" is a tribute to his ingenuity and technical skill.

But ten years with the *Commodore Music Shop* has certainly brought its share of varied experiences. He has designed audio amplifiers of all kinds and

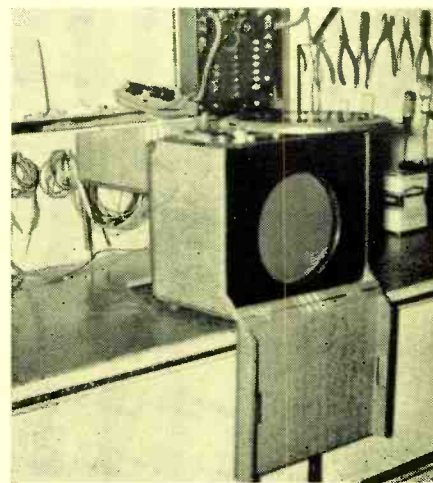

One of Harry's custom built jobs.

recently built a portable, 8 tube phonograph that beats anything on the market. It uses four 25L6 tubes, one 25Z5, and 12Z3, one 6C5 and one 6SF5. The chassis, made of aluminum, is neatly laid out. The circuit, which incorporates negative feed-back and bass compensation, was designed to please the highly critical musicians who are the patrons of *Commodore Music Shop*. These people are willing to pay and pay very well for truly great quality. Their discerning ear is the criterion by which all final results must be judged. That they think well of this circuit, this radio tube and crystal pick-up combination, is proof that it does the job.

SENTINEL '42 LINE

From Evanston, Illinois, comes the announcement of *Sentinel's* new 1942 line of radios, reported by company officials to be more outstanding and value-packed than ever before in *Sentinel* history.

In the belief that this year, increased employment, growing payrolls and excellent prospects for unusual farm income will be important factors in radio merchandising, *Sentinel* is providing a line equal to the big sales opportunity. Sets are already rolling off the production line and deliveries well under way.

Headlining the dynamic merchandising plan on the new *Sentinel* models is "Studio-Tone"—symbolic of radio reception with studio-like realism—symbolic of *Sentinel's* achievement of high quality, acoustically and mechanically correct.

NEW RECORDING DISCS

Many tons of aluminum have been freed for use in the National Defense Program by the success of the RCA Research Laboratories in perfecting a new 16-inch fire-resistant, paper-core recording blank for use in radio studios, airline terminals, and other locations where sound is recorded for "reference" purposes.

W. W. Early, RCA-Victor Manager of Recording and Record Sales, announced the new disc, at the same time pointing to the fact that it is thinner and lighter than the aluminum-core blank, and is being sold at one-half the price of the old type.

"The new blank provides a quality of reproduction that is unsurpassed by any other paper-core blank, no matter of what size," Mr. Early said. "Many months of research preceded the perfection of the special type of paper used in the core. The result is an amazing flexibility which prevents warping and allows the disc to flatten out at the mere pressure of the cutting head."

The disc itself is slow-burning because of the paper core, and the shavings will not support combustion. With no fire hazard involved, the shavings can be thrown into any rubbish can. Its cutting surface permanency is assured, since the secret formula lacquer will not harden with age.

Presto Recording Corporation started deliveries about June 15th on a new high quality sound recording blank using a plate glass base. Engineers who have used the new glass disc report that its performance is even better than the aluminum base discs which were generally used in the past. The new disc is .104" in thickness making it as durable as the ordinary commercial phonograph record. The coating compound which serves as the recording medium adds to the durability of the disc and the breakage problem is expected to be negligible.

Presto will also manufacture a new steel base disc for school and home use which will be available in 7", 8", 10", and 12" sizes only. Made on a specially treated grade of sheet steel, the disc compares favorably in appearance and performance to the aluminum base disc and will be available in unlimited quantities.

FUTURE RCA PLANS REVEALED

RCA-Victor dealers have been so enthusiastic in their acceptance of present table models in the "under \$20 bracket" that no change is planned at present in instruments of that type. The new table models to be announced offer improved performance due to improvements in the RF stage, tuning band, and in loudspeakers.

In all cases, he said, RCA-Victor engineers have recognized the increased interest in short-wave reception and, in addition to providing improved radio performance, are incorporating the convenience of bandspread tuning on important short-wave overseas bands, first brought to the low price field by Model 14X, the "Foreign Correspondent."



The Silent Salesman which GE has originated for the self-charging radios.

USES P.A. IN CAR TO BUILD BUSINESS

(Special to RADIO TRADE NEWS.) Too often, the use of P.A. systems by radio shops has been seasonal, but Ernest B. Dolfer, Madison Radio Shop, Madison, Wis., has built an all-year-round program which produces 25% of his annual income.

Like so many others, he started the easy way by building up a summer business. Through watching the newspaper, and consulting with state-wide agencies,



The first car used with a P.A. system to bring business to a radio store. Later it was replaced with a new one.

he built a mailing list of dates for county fairs, community celebrations, and similar events. A postal card, describing his services, was sent to each agency. He didn't just sit down and wait for results but rather on occasions, telephoned various persons when he had a "live" lead.

In this manner, he built a reputation, with the result that organizations began to telephone him. For a radius of fifty miles around Madison, when groups need

P. A. systems, they call Ernest Dolfer. Sometimes he has two and three jobs on a single day, such as, Fourth of July.

With this beginning he began looking



The latest car equipped with a P.A. which is more than paying for itself.

for Fall and Winter work. This suggested, naturally, political campaigns, ski jumps, musical festivals, orchestras and other mass events. He makes more money in a political campaign when he can use his own truck, rather than equipping an auto for the organization to use. They prepare the bally-hoo, script, etc., and he charges \$5.00 an hour for his services. In addition, he sets up the amplifying system in the hall for the political meeting in the evening.

Big events produce the most money, however. He handled the inauguration of the Governor at the State Capital, using twenty to thirty amplifiers. They don't quibble over the price, but pay the bill.

SERVICE HINTS

It is only a foolish serviceman who believes that he will make the most out of a law suit. Of course, sometimes one must "put the law on a customer," but usually the only one to profit from any law suit, is the lawyer—that's HIS business!

MAKING POLITICS PAY THE P.A. MAN

At the age of 12, Harold Davis of Mississippi was office boy for a candidate for governor of his state. In those days, the candidate who could display the most placards up and down the highways, had a pretty good chance of winning. Davis thinks sometimes that he still has a couple of dark spots left from the many black-eyes he received attempting to prevent his man's placard from being torn off the trees and posts on his town's main street.

We've come a long ways since then, so long, in fact, that next year will mark the 12th anniversary of his political debut with a P.A. system. It was the first ever used in the state, and the price he got would astound even a member of our Congressional Finance Committee.

However, the prices didn't hold for long, and soon there was so much competition in the field that his system was worth more sitting in his own doorway spilling World Series results, than could be obtained in rental.

But that situation went as quickly as it came and once again there was a field for a good P.A. system.

However, there is and always will be



The method used to mount the speakers is clearly shown in these two illustrations. Note all the bracing.

one big drawback to P.A. work—everybody wants one at the same time. This condition is due to the natural consequences of people all doing the same thing at the same time. On holidays, everybody has a dance, on the fourth of July and Labor Day they have speeches, and during political campaigns, some 5,000 candidates in each state clamor for the use of P.A. systems.

During the last campaign, much was done to cope with this situation. Past experience had taught that the fellow running for a minor office needed a sound system as much as the man running for

governor, but he couldn't afford an expensive sound truck or the salary of a man to operate it. Yet, this fellow was prepared to invest up to \$150 in something simple that he could carry in his own car, and operate himself. Some of the candidates made as many as seven and eight speeches a day, traveling 300 or more miles.

The first step was to devise a means of mounting the speakers on his personal car so that they would be ready to go at the flick of a switch, and that without disfiguring the car. This Davis did with some one-half inch pipe and some standard pipe flanges and connectors, as is off a 6-volt vibrapack mounted on the running boards and the uprights braced with pipe curved to follow the lines of the car and fastened under the bumper bolts. If additional bracing were needed, a wooden block wrapped in a piece of inner tube was used between the pipe and body.

For amplifiers, Davis furnished a small 14-watt job with 6V6's in the output. These were built up to operate off AC or off a 6 volt vibrapack mounted on the chassis. Fool-proof switching was used, no two plugs alike, and only a single mike and tone control incorporated.

Davis incorporated two 8-watt speakers in aluminum baffles and the cheapest crystal mike available. The whole outfit cost us less than \$50 apiece to complete, and candidates stood in line to rent them at \$35 per week, C.I.A. (Cash in advance). Davis also sold a few outright for \$125 installed, which price included upkeep on the outfit until the campaign was over.

When there was a breakdown, which was seldom, Davis analyzed the trouble over the phone and then shipped out a replacement mike, amplifier or speaker as the case may have been. Having all systems alike, this was simple. Candidates even borrowed parts from each other.

In all, Davis sold or rented 25 systems. A number of them were re-purchased and later resold at a neat profit. They then were sold to traveling preachers and show men, which in itself was a good business.

Davis has not been where we couldn't set up at least three systems at one time for years, and at present he is covering two state conventions being held in his city simultaneously. With the proceeds from this he can pay our entire weekly overhead.

As for the placards that caused so many black-eyes, they are taboo. Our women's clubs have cooperated beautifully by asking candidates not to use placards on our beautiful highways.

And, if you've ever been in politics, you know that a women's club can get more out of a politician than Hitler can get from the British.

SERVICE HINTS

Remember that a smart salesman agrees with his customer,—if he wants to make a sale. So it is in P.A. work. Even if you don't like a high, squeaky P.A., if your customer does, sell him what he wants.

SW SERVICE AND REPAIR SHOP PAYS

(Special to RADIO TRADE NEWS.) The Zeigler Radio Company in Charleston, S. C., is known as short wave headquarters, specializing in servicing and selling radios with short wave reception.

"We push short wave reception of all kinds in all of our sales," says T. W. Zeigler, "and teach our customers how to work the short wave radio properly to get the best results. Lack of proper instruction frequently is the cause of discouragement and makes people disgusted with the reception they get on short wave, and so they start knocking it to their friends, relatives and acquaintances. And it is all due to the fact that they are not properly instructed in the first place as to what time and where to find it on their dial.

"We feel that most of the present day sales are ruined by telling people what they can get on short wave and not showing them where to find those stations and how to pick them up any time of day or night, considering atmospheric conditions, etc. We do not suggest any particular log book to keep them straight as to what short wave stations they can get their best programs on because it is not dependable in our judgment. You have to pick and hunt but we can steer them right in what they can find and make it easy for them.

"This has been the biggest part of our radio sales and has been directly due to the reception we have given people on short wave by teaching them how to get the best reception. So they do not cuss it out and say, 'I cannot get this or that.' We show them how to get the best results on short wave."

PHILCO REPORTS INCREASED SALES

Gross sales of radios, refrigerators, and other products by Philco Corporation totaled \$16,497,065 (exclusive of sales by its Canadian subsidiary) in the first three months of 1941, as compared with \$11,154,129 in the corresponding period a year ago, it was announced today by James T. Buckley, president, at the Company's distributor convention in Atlantic City to introduce the new 1942 radio line.

Earnings of Philco Corporation before taxes amounted to \$910,272 in the first quarter of 1941, as compared with \$593,320 last year, Mr. Buckley said.

NEW "FLU" LAMP PLANT

Contract for building a new fluorescent lamp plant in Danvers, Massachusetts, for the Hygrade Sylvania Corporation at an estimated cost of \$500,000 has been awarded to the Austin Company of Cleveland, Ohio, nationally known engineers and contractors, according to an announcement made by Mr. F. J. Healy, Vice President and General Manager of the Hygrade Sylvania Corporation. Construction is expected to be completed in six months.

NEW TEXAS RETAIL RADIO TAX IMPOSED

Very recently a new retail sales tax of 2 per cent on new radios sold and also cosmetics became effective in Texas. The new state tax was opposed by RMA and Texas retail and radio trade organizations, and also by Texas broadcast stations whose assistance was secured by RMA through the cooperation of the National Association of Broadcasters. Despite the opposition, the new 2 per cent retail sales tax was retained by the Texas Legislature in its new general revenue law. The question of the constitutionality of the new Texas law on new receiving set sales is being considered by the legal department of RMA and its Legislative Committee.

The Texas radio tax was enacted hurriedly, with little time for effective opposition. The RMA Legislative Committee, in opposing the Texas legislation, secured assistance from manufacturers and Texas distributors. In addition a brief was filed with the Texas Legislature by Bond Geddes, executive vice-president of RMA, and included the following excerpt:

"Radio is not a 'luxury' or even a 'semi-luxury.' Its wide public service and functions make a comparison with cosmetics utterly absurd. Radio receiving sets are part of a vast and important agency, particularly in the present emergency, of public communication. Over 50,000,000 radio sets are now in use and radio has become an established and general agency of education, information, religion and culture, in addition to entertainment, and it is comparable to the press in its public use and important functions. President Roosevelt has formally stated that radio should receive the same consideration as the press in its service to the public, and special taxation of radio would directly conflict with this announced policy of President Roosevelt. Special taxation of radio, as proposed in the amendment to the House Revenue Bill, would work great injury not only to the national radio industry but especially to thousands of Texas distributors, dealers and other retail outlets, as well as to the broadcasting industry of Texas. It would be a discriminatory tax and a burden upon the radio trade in Texas."

SENATE RADIO INQUIRY STARTS

Opening of the Senate Interstate Commerce Committee's investigation of radio network operations, a sequel of the FCC network "monopoly" decision on May 3 and Chairman Fly's controversy with the National Association of Broadcasters at its recent St. Louis convention, was scheduled for Monday, June 2. Sweeping investigation of radio affairs, including the Commission's action, is in prospect under the resolution of Senator White of Maine. The hearings will be public, the chairman of the Senate Committee presiding.

CURB ON INSTALLMENT SALES CONSIDERED

Reduction of installment purchases of consumer goods, including automobiles, radios, refrigerators and other articles is under consideration by the Government, according to a recent announcement of the Federal Reserve Board. Congressional legislation would be required and is being studied by the Board, the Office of Price Administration and Civilian Supply, of which Mr. Leon Henderson is Administrator, and other government agencies. Definite recommendations have not been completed. It was announced that the objectives are to conserve industrial material needed for national defense and to prevent inflation.

NEW ATLAS SPEAKER

Atlas Sound, 1449 39th Street, Brooklyn, N. Y., has just released a new illuminated "Organette" Speaker, Model OR-12LT, for night club, cafe and restaurant p. a. installations where glamour is needed to sell the sound system. The "Organette" is constructed of carefully selected walnut veneers and colored plas-

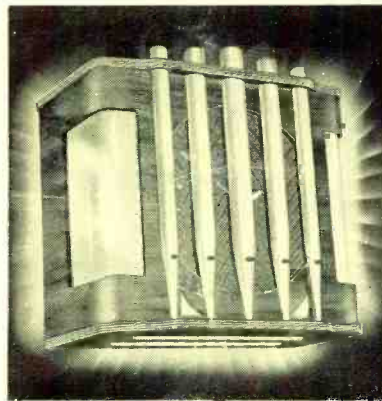

tic, offering illumination on the front, sides and bottom of the cabinet. The "pipes" are finished in distinctive gold lacquer. High fidelity 12" cone unit, 16 watts peak, for high quality reproduction of music and voice. 17" wide, 13½" high, 8" deep. Recommended for use as an extension unit in connection with coin-operated phonographs.

RADIO EXCISE TAXES

Treasury and Internal Revenue Bureau officials are continuing their studies relative to the radio, automotive and other excise taxes, in view of recent official recommendations for increases even beyond the original high rates proposed by the Treasury Department. Under consideration but still undetermined is the question of whether the increased radio tax may be assessed on the basis of the present law on components or changed to a basic tax on receiving sets.

Among various tax proposals submitted to the House Committee during its present hearings was a \$10,685,000 defense tax on the gross income of broadcasting stations.

RADIO MOSTLY EXEMPT FROM WAGE DECISION

RMA recommendations for general exemption of manufacturers of "home radio sets; their component parts and tubes," were incorporated in the final minimum wage decision of the Walsh-Healey Administration, in charge of wage rates for government contracts of \$10,000 or more. The wage decision, pending for four years, was transmitted recently to Secretary of Labor Perkins for final approval for the "Electrical Radio Transmitter and Related Products Manufacturing Industry." A minimum wage of 45c per hour, or \$18 per week of 40 hours, was recommended by the Public Contracts Division, with the exemption of manufacturers of "home radio sets; their component parts and tubes." This generally exempts the radio industry and the wage determination will apply only to manufacturers of "commercial" radio, such as police, aircraft and similar receivers, transmitters and public address systems. The 45c rate applies to both male and female workers (on government contracts of \$10,000 or more), without any geographical differential and with a provision for a lower wage scale for learners.

Proceedings leading up to the final decision began four years ago, the last public hearing being held a year ago. Labor unions urged a minimum rate of 75c per hour instead of the 45c minimum finally recommended. All interests have until June 7 to criticize or appeal from the decision, which is more applicable to the electrical than the radio industry.

KNIGHT MOBILE SOUND SYSTEM

The Allied Radio Corporation is currently featuring a new Knight 30 Watt De Luxe Mobile Sound System, designed to operate from either 6-volt storage battery or 110-volt 60 cycle AC power, thus making it ideal for all-purpose indoor-outdoor use. Comes housed in two compact portable cases which include, in addition to the Knight 30 Watt Mobile Amplifier with phono top for playing records: 2 Knight 12" PM Dynamic Speakers with 30-foot cable and plug on each; 1—Knight Electro-Voice 631 Dynamic Microphone with 25-foot cable and plug; 1—take-down floor stand and all tubes. Features include: Illuminated sloping control panel; stand-by switch to conserve power; jack for headphone monitoring; speaker selector switch to permit adding or dropping speakers without affecting tone quality. Circuit is of latest type with inverse feedback. Speakers are fused as a protection against overload.

The amplifier, whether operating from 6-volt battery or 110-volt AC line source, delivers full 30 watts usable power (37 watts peak); hum is inaudible (60 db. below rated output); output impedance, 2, 4, 6, 8, 250 and 500 ohms on selector switch (designed for PM speakers); four input channels, two for high-impedance mikes with individual volume controls and two for phono on single fader control.



DISC and THAT

by Bill Adams

TEN TOP TUNES WITH WHICH TO STOCK YOUR SHELVES

NAME	ORCHESTRA	NUMBER
"The Hut-Sut Song"	Freddy Martin	Bluebird-B-11147
"Aurora"	Andrew Sisters	Decca-3732
"Good Bye Now"	Horace Heidt	Columbia-36026
"Two Hearts That Pass in the Night"	Orrin Tucker	Columbia-36071
"Keep Cool, Fool"	Ella Fitzgerald	Decca-3751
"Music Makers"	Harry James	Columbia-35932
"I Understand"	Four King Sisters	Bluebird-B-11122
"I Only Want a Buddy Not a Sweetheart"	Bing Crosby	Decca-3736
"Jezebel"	The Golden Gate Quartette	Okeh-6204
"Do I Worry"	Tommy Dorsey	Victor-27338

ALBUM HITS

The White Cliffs of Dover (Lynn Fontanne)	Victor-M-775
Ambrose (England's Greatest Dance Band)	Decca-A-189
Rhumba with Cugat	Columbia-C-54
Let's Polka	Columbia-C-56
I Hear America Singing (John Charles Thomas)	Victor-M-777

FIVE OUTSTANDING CLASSICAL ALBUMS

Fourteen Songs of Moussorsky—Seven Twelve-Inch Discs	Decca No. 1
Sung in the original language with copious translation notes. Flawless recording. Album will be worth a hundred-fold in value within a short time.	
Festival of Brazilian Music—Five Twelve-Inch Discs	Victor-M-773
An unusual and violently brilliant interpretation of the outstanding music of Brazil with Elsie Houston, soprano and The Brazilian Festival Quartette.	
Tchaikovsky: Symphonic Poem—Francesca da Rimini (Op. 32)	Columbia-M-447
Sir Thomas Beecham conducts a poignantly beautiful work of one of Tchaikovsky's greatest tone poems paraphrasing an episode from Dante's Inferno. This rendition makes use of the entire original score.	
Rimsky-Korsakov: Symphonic Suite "Scheherazade"	Decca-162
Victor Kolar's rendition (eight sides—twelve-inch discs) of "The Arabian Nights" music.	
Beethoven Concerto No. 5, in E Flat Major ("Emperor") (Op. 73)	Victor-M-761
Benno Moiseivitch, pianist and the London Symphony Orchestra conducted by Georg Szell record the seventh work of Beethoven.	

Box Score for June, 1941

"Intermezzo"	10 points
"Marie Elena"	10 points
"My Sister and I"	10 points
"The Band Played On"	10 points
"The Princess of Pure Delight"	No score
"Friendly Tavern Polka"	10 points
"Dolores" (Bing Crosby)	10 points
"Was You Ever in Cincinnati"	No score
"Alexander the Swoose"	No score
"The Wise Old Owl"	10 points
Total 70 points	

Out of a total possible 100 points the box score rates last month's predictions 70% correct. The following basis of scoring is used and only actual record sales in total, as closely as can be ascertained through reliable sources, are used: the first ten top selling tunes in record sales are given 10 points each. The next five tunes, that is sales listings from eleventh leading to 15th, are allowed 5 points each. All other tunes from 15th position on down are not counted.

NEW CHROMIUM RECORD NEEDLE

A new Chromium Needle good for at least 50 playings, has just been placed on the market by the Duotone Co., Inc., 799 Broadway, New York City. The needle is issued in handy folding packages of five, each needle good for a full evening of record entertainment. Highly polished for smooth, even tone and minimum rec-

ord wear, the chromium needles are individually shadowgraphed for flaw detection, only the perfect specimens being retained. The long-distance performance of Duotone Chromium Needles make them ideal for record changers.

RECORD HINTS

Youngsters make the best customers of swing music. Even if you, personally, don't like "jazz," encourage them to hear it at your store! Then they'll buy there.



Firemen broke all kinds of records when they went to work on a \$250,000 fire which destroyed a quarter of a million phono records in the RCA Mfg. warehouse in Hollywood, Cal. Was the fire started by hot music?

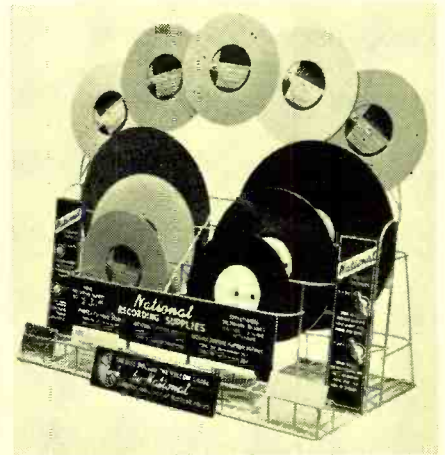

This disc display sells for National.

CLARION HAS TWO NEW P.A. UNITS

Clarion introduced two new sound equipment lines—the "Streamliner" and "Superliner"—designed to meet not only the requirements of sound purchasers desiring high quality equipment at low initial cost, but also filling the needs of those buyers of sound equipment demanding only the finest in appearance, quality reproduction, workmanship and life-long dependability.

The 25 watt Clarion "Streamliner" is an economically priced amplifier offering all the facilities of much higher priced units of its kind. Three mike input channels, one phono channel, separate bass and treble controls, inverse feedback, extra high gain and low hum level, make the Clarion Model A-11-R an outstanding amplifier buy.

The Model A-54-K 30 watt "Superliner" provides four microphone inputs, a low gain input, individual equalizer controls and an output meter calibrated in both watts and decibels.

CANADIAN SALES UP

Canadian sales last March were 25,516 receiving sets compared with 23,481 in March 1940, in spite of the War.



Coming Next Month...

**A Special All-Star
SOUND ISSUE!**

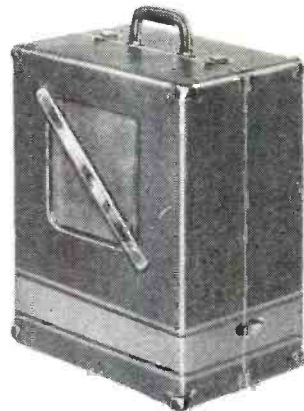

**WHERE AND HOW TO
SELL SOUND**

**NEW SOUND AND P. A.
EQUIPMENT**

**MERCHANDISING
PLANS**

**HOW TO BUILD A
UNIVERSAL
SOUND UNIT**

**SELECTING THE
PROPER UNIT**

Now—RADIO NEWS brings its readers a *special* issue on SOUND! This banner August issue will be brimming with reliable, dependable information on various phases of SOUND and P. A.! It will be authoritative, up-to-the-minute, illustrated with brilliant pictures and instructive diagrams. New SOUND and P. A. equipment; valuable merchandising plans; where and how to sell SOUND; how to select the proper unit; how to build a portable-universal sound unit . . . these are just a few of the bang-up features you'll find in the *special* SOUND number of RADIO NEWS! No sound engineer, dealer or serviceman can afford to miss this great August issue.

SPECIAL AUGUST SOUND ISSUE



ON SALE JULY 25!



A QUARTER-CENTURY OF SERVICE TO THE RADIO INDUSTRY





by CHARLES J. SCHAUERS

Airport Radio Traffic Control

HOW is air-traffic handled at the many crowded airports throughout the Nation; especially at those fields where Uncle Sam's Flying Cadets are undergoing intensive training? Is radio the sole means of contact with an aircraft flying around or near the average airport? What should the airport traffic control or tower operator know in order to perform his duties efficiently; and what are his duties? These questions and many more have been literally "pouring in." Therefore, we will answer them and consider the airport radio traffic control problem.

At each airport throughout the United States where military and/or scheduled aircraft used for transportation land, dispatch or receive passengers and service, control tower facilities are usually provided for; either by the airport administration center or by the Government if the airport is Government owned and supervised. These control tower facilities involve the use of radio, signal lights, teletype; station to station interphone; and in some cases, station to station radio.

Trained radio operators are usually chosen to operate the facilities mentioned, who have graduated from a course in aviation radio

operation at any one of a number of schools located throughout the country. Those having knowledge of flight operations are invaluable and are preferable to those operators who do not have flight operations training. Before the control tower operator is rated as "proficient" and before he is usually given the very responsible job of directing aircraft, he must learn the following: Weather observation; aircraft radio-telephone contact procedure; to decipher teletyped weather sequences and information; CAA "flight plan" operations; CAA flight regulations; how beam flying is accomplished; and be familiar with general conditions affecting flights within his allocated territory.

Today, more than ever before, the air traffic problem is one of major concern due to National Defense air training measures; increased student pilot (civilian) flying; and because there are so many fields under construction, necessitating use of those already established and in operation prior to all this increased air activity. The airplanes must be continually "policed" and the greater part of this flight supervision is accomplished by direct radio contact with aircraft in flight, and prior to take-offs and landings.

Many cases have been cited wherein the vigilance of both the trained tower and the CAA station operator has averted many accidents; especially collisions.

Airport traffic control stations at civilian airports usually employ the frequency of 278 kilocycles for transmitting intelligence to aircraft in flight. Military airfields utilize various frequencies depending upon the amount of aircraft; 396 kilocycles being the general contact frequency most used. At fields where Flying Cadets are based, as many as three frequencies are used; with one frequency being used for the "general" contact frequency and the other two being used to contact one or more specific groups of students.

Aircraft employ either 3105 kc., 6210 kc., or a special frequency between 2500 and 8000 kilocycles for their contact frequency. The Army Air Corps occasionally uses 3105 kilocycles, but they usually use specifically assigned frequencies not employed by other aviation services.

When an aircraft not employing radio, or due to station breakdown, either ground or aircraft, the control tower operator must employ "the light" to guide air traffic. It is quite possible to signal a pilot of an aircraft with either one of three beams, i.e., red, green and white. When the pilot is given the "white light" it is clear for him to taxi his aircraft to the take-off strip or from his "ground turn" position to the ramp. The "green light" is the signal for, "Okel to land or take-off"; and the "red light" gives the signal to, "Taxi back to the ramp" or to "Stop in present position." If an aircraft flying on its "final approach" for a landing is in danger, then the "red light" flashes its message, "Circle again and wait for the green light." This means of communication from ground to aircraft is worthy of consideration when radio facilities are not available, but planes flying 20 or more miles from the airport cannot be given instructions by this method when poor visibility prevails due to weather conditions.

Prior to a flight, a pilot usually "checks in" to the control tower by radio and informs the tower operator where he will fly. A pilot who is making a long cross-country trip usually prepares a flight plan and submits it to the local CAA station for approval and recommendations; obtains advance



The new Lear portable receiver.

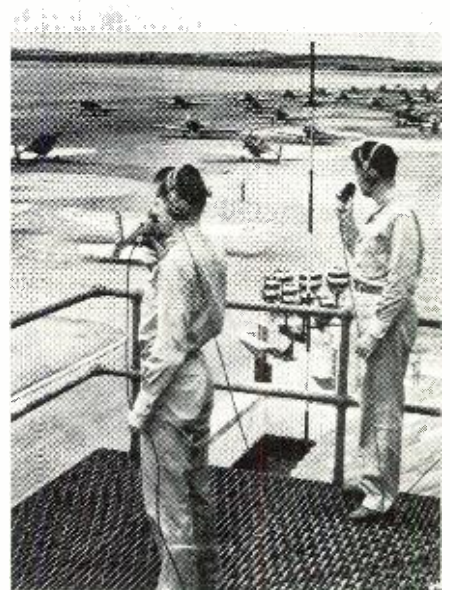

Traffic Control at Randolph Field.

weather information; checks in to the control tower and then takes off.

The airport radio traffic control operator must be constantly on the alert and he must "use his ears as well as his eyes." When it is necessary that he listen to two or more receivers constantly, over an eight hour period; and when the static is so bad that it makes reception sometimes seem impossible, he must "stick it out" and not lose patience. This writer dropped in at a military airfield in Southern California not so long ago. He was amazed at the efficiency of the two operators on duty. At one time, there were over twenty aircraft in the air circling in turn for landings, and about half as many waiting for tower instructions to take-off. With coolness and precision, those planes circling the airport were brought in, one by one; and those waiting for their turn to take-off were dispatched in "rhythmic" order. These operators were trained by the Air Corps for this work and are now training other operators who will either relieve them or be sent to other airfields.

The reason for constant weather checking by the tower operator and the ground communications operator (CAA) is obvious. Examining an airport, one will see a number of runways running in various directions. One or more of these may be used for both landing and take-off, but if the pilot or pilots aloft do not know in which direction the wind is blowing and the approximate velocity

MAKE YOUR PRESENT SET an F-M RECEIVER with the BROWNING F-M TRANSCRYPTOR

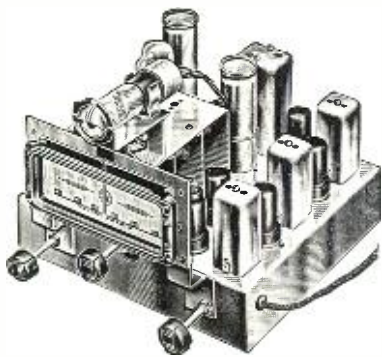

AFTER months of painstaking research the Browning Laboratories were among the first to present a transcryptor which allows F-M reception with your present receiver. Simply plug the output of the transcryptor into the phonograph jack of your receiver or connect transcryptor to separate audio amplifier and speaker system. Tunes 42-50 M.C.

BROWNING F-M PARTS FOR SET BUILDERS

Write for Details and Prices on
F-M Parts

- Wired IF and Detector System.
- High Frequency Tuner.
- Complete F-M Adapter.

Write for Full Details and Prices

BROWNING LABORATORIES, Inc.

753 MAIN STREET WINCHESTER, MASS.

of that wind, accidents could easily happen. Even though "smoke direction" from various smoke stacks in the vicinity may indicate general wind direction, wind shifts do take place that are detrimental, especially when an aircraft is just "letting down." The control tower operator, then, must keep his eyes on the wind direction indicator and the meter which gives him the approximate wind velocity. Too, if weather conditions change after the pilot has left the airport, he is usually advised of this by the tower operator.

A constant check must be made on various flight plans of various pilots flying within a certain area; this is where coordination of traffic control station to station facilities, comes in. An operator having no knowledge of flight plan operations may be more of a nuisance than an asset to safe flying. It is essential, then, that the control tower operator familiarize himself with flight plan operations as used by the various aviation services such as the Airlines, Army, etc.

Pilots usually attempt to contact the control tower 15 minutes "out." This gives the tower operator ample time to look over his operating log to make certain no aircraft in that vicinity will fly in conflict with fixed flight plans controlling the flight of the "first" contact aircraft. The minimum "call in" rule (usually 20 miles) should be followed because at some airports the traffic is so heavy that it necessitates "appointment" for landing and take-off instructions. That is, a certain period of time must elapse between take-offs and landings, with "first" contact aircraft being given first instructions.

As each day passes, air traffic control facilities are being added to the new airports; but eventually these low frequency facilities will be superseded by ultra high frequency equipment which offers greater freedom from static, general interference, etc.

For those who would like to enter aviation radio operating, proper training as one can readily see, is a dire necessity. Tower operators are needed at all airports both civil and military, and it would pay those who now have the proper qualifications to investigate; and who knows, you may, if you try, be an airport traffic control radio operator!!?

About the Market

LAZARE GELIN, export manager of *Lear Avia. Inc.*, manufacturers of aircraft and general aviation radio equipment, returned from a six months tour of South America and reports an unparalleled demand for "made in U.S.A. aviation equipment." Radio equipment aboard aircraft, now being somewhat standard equipment on most modern aircraft, would naturally fall in with the demand. With imports of this type of equipment from Europe, cut off by the war, the U.S. industry now is in an unusually favorable position to establish close commercial relations with the democracies of Latin America.

"Thorough understanding of the special problems confronting the various Latin American republics is vitally necessary to successful commerce," Mr. Gelin said.

A trip through any American aviation radio factory will convince anyone of America's National Defense policy. With added orders of civilian concerns, National Defense Agencies, plus orders from Latin America, those factories now working on a 24 hour basis will have to find ways and means of adding a few hours to labor efforts in order to keep up with the boom not yet experienced.

Air Associates, Inc., of Bendix, New Jersey are now manufacturing a new line of receivers and transmitters for the light plane for heavier planes with payloads overtaxed by extra equipment. Their BR-3 receiver is a four tube superhet with an approximate receiving range of 150 miles and covers the frequencies of 180 to 410 kilocycles. Its total weight is 5 pounds and because low-drain tubes are used, up to 100 hours or more useful battery life is assured. Their BR-3-T Receiver-Transmitter weighs 10½ pounds, has a power output of 2 watts, and a 35 to 50 mile transmitting range; four tubes are used. A crystal maintains the frequency of 3105 kilocycles constant within very narrow tolerance limits.

(Continued on page 56)

TECHNICAL BOOK & BULLETIN REVIEW

PREMAX ANTENNA MANUAL, published by *Premar Products Division, Chisholm-Ryder Co.*, Niagara Falls, N. Y. This new booklet contains much valuable information for the radio amateur that is interested in giving his antenna system the attention which it deserves. Contains 32 pages of charts, data, and diagrams so that practically any modern type of beam antenna may be easily calculated from the tables supplied. All types of verticals are illustrated. These have proved to be very popular during recent years and plenty of DX has been worked with this type of antenna. Directive antennas have long been used by communications companies. Most of them are rhombics or fixed multi-element arrays requiring great acreage on one hand or high, expensive towers on the other.

In nearly every commercial application the arrays are fixed so as to "aim" at a similar array at the receiving point. For point-to-point service it is general to provide two such arrays at each terminus; one for transmitting to and one for receiving from the opposite end of the "line."

Radio amateurs have spent considerable time in working-out various arrays that were compact and flexible. Having a low power limit placed on their transmitters, to start with, and, as a rule, but little space for their aeriels, they have made their transmitting power many times more effective by forgetting about rhombics and other acreage-covering devices and have resorted to multi-element, close-spaced arrays. Furthermore they overcome the difficulty of "beaming" in a single direction by making their antennas rotatable.

Premar engineers have desired to assist amateurs in their work and have made many products, originally applied commercially, available to the amateur. In this new booklet, *Premar* is presenting some entirely new ideas which, though they have not yet appeared elsewhere, have proved their work over long periods of operations; sometimes under most adverse conditions. The vast amount of experience gained from actual use of these antennas in service has made possible the design of units that are fool-proof and which will stand up in operating schedules. Copies are available for 25 cents each from *Premar Products*, Niagara Falls, N. Y.

SIMPLIFIED RADIO SERVICING BY COMPARISON METHOD, published by *Supreme Publications*, 3727 West 13th Street, Chicago, Ill. Written by M. N. Beitman. The contents of this manual have been used for lectures in a number of practical radio shop classes and has proved very successful in application. Only practical and required data for actual radio work is included. Theory is kept to a minimum. Sufficient inductory material has been included to acquaint the reader or student with essential radio facts. This same information will serve as an excellent review for all others. You need only to be mechanically inclined to be able to follow the simplified instructions and to repair any radio set.

The comparison method of radio servicing tells what simple tests may be made to obtain electrical, visual, and other reactions from radio parts and circuits, and how to determine if the indications secured are to be expected from a properly functioning circuit, or what parts or circuits to suspect. This method is a great simplification of serv-

(Continued on page 52)

Will Send My FIRST LESSON FREE



It Shows How I Train You at Home for GOOD RADIO JOBS

J. E. SMITH, Pres. National Radio Institute

Salary Increased \$1,800 Year in Radio



"I have been employed in radio since my graduation. I have been Chief Engineer of three broadcast stations, and at present time am Chief Engineer of WDDO. My salary has increased \$1,800 per year since entering radio and credit is given you for your excellent training."

\$15 a Week Extra in Spare Time



"I am doing spare time radio work, and I am averaging from \$700 to \$850 a year. Those extra dollars mean so much the difference between barely getting by and living comfortably."

\$3,500 a Year in Own Business



"After completing the N. E. I. Course I became Radio Editor of the Buffalo Courier. Later I started a Radio service business of my own, and have averaged over \$3,500 a year."

Get my sample lesson Free. Examine it, read it—see how clear it is, how easy to understand. Find out how I train you at home in spare time to be a Radio Technician. Do it now. Mail the coupon.

Many Radio Technicians Make \$30, \$40, \$50 a Week

Radio Broadcasting stations employ operators, technicians. Radio manufacturers employ testers, inspectors, servicemen in good-pay jobs. Radio jobbers and dealers employ installation and servicemen. Many Radio Technicians open their own Radio sales and repair businesses and make \$30, \$40, \$50 a week. Others hold their regular jobs and make \$5 to \$10 a week fixing Radios in spare time. Automobile, Police, Aviation, Commercial Radio; Loudspeaker systems, Electronic Devices are other fields offering opportunities for which N. R. I. gives the required knowledge of Radio. Television promises to open good jobs soon.

Many Make \$5 to \$10 a Week Extra in Spare Time While Learning

The day you enroll I start sending Extra Money Job Sheets, showing you how to do Radio repair jobs. Throughout your Course, I send plans and directions that have helped many make \$5 to \$10 a week in spare time while learning. I send you special Radio equipment to conduct experiments and build circuits. This 50-60 method of training makes learning at home interesting, fascinating, practical. YOU ALSO GET A MODERN, PROFESSIONAL ALL-WAVE SERVICING INSTRUMENT to help you make money fixing Radios while learning, and equip you for full time work after you become a Radio Technician.

Find Out What Radio and Television Offer you

Act Today. Mail the coupon now for sample lesson and 64-page book. They point out Radio's spare time and full time opportunities and those coming in Television; tell about my training in Radio and Television; show more than 100 letters from men I trained, telling what they are doing and earning. Find out what Radio, Television offer YOU! MAIL COUPON in an envelope, or paste on a postcard—NOW!

J. E. SMITH, President Dept. 1GR, National Radio Institute Washington, D. C.

Good for Both 64 PAGE BOOK *Free* SAMPLE LESSON

RICH REWARDS IN RADIO

Mr. J. E. SMITH, President
Dept. 1GR
National Radio Institute
Washington, D. C.

Mail me FREE, without obligation, your Sample Lesson and 64-page book, "Rich Rewards in Radio" (No Salesman will call. Please write plainly.)

Age.....

Name.....

Address.....

City..... State..... 2FR

Electronic Maintenance

(Continued from page 26)

attenuating the signal from such a crystal calibrator is by varying the location and the distance between the signal source and that circuit to which the signal voltage produced by the calibrator is fed. In the event that a direct link is used between the calibrator and some other unit and attenuation is necessary, it is suggested that this link be in the form of capacity coupling, obtained by using a piece of wire connected to the output jack of the calibrator and another piece of wire connected to the input jack of the pick-up device. By changing the separation between these two leads, the capacity and consequently coupling, can be varied until the proper level of signal is available.

It is of course unlikely, but possible, that an occasion may arise when this crystal calibrator must serve as a source of a signal, which is stronger than that available from the unit itself. If such becomes necessary, it must be obtained by means of a separate r.f. power amplifier.

With respect to accuracy of calibration it is generally conceded that such crystals are more accurate than the general run of signal generators unless they too employ a crystal in the basic oscillating circuit. However, it is necessary to remember that even the crystal may bear some tolerance rating and while it is true in some instances a crystal which may be rated at 250 kc. is "right on the nose," it is

also possible that some deviation exists. Whatever these deviations or the tolerance, it is as a rule, specified on the device. In most cases you will find that this deviation is extremely small and for normal routine service work is entirely negligible even when the 40th or 50th harmonic is used.

A circuit diagram of the *Crystal Calibrator* we have spoken about appeared as Fig. 3 of December 1940 issue of RADIO NEWS.

As strictly a servicing tool, the *Crystal Calibrator* serves best as a source of certain specified fixed frequencies which are the harmonics of the two basic fundamentals provided by the device. However, the acquisition of such a unit for such use when compared with the normal oscillator would not be worthwhile, even though the calibrator does provide greater accuracy. But the purchase of such a device is justified as a calibrating device if for nothing else than a means of regularly checking the accuracy of whatever basic signal source is used in the shop. We appreciate that the broadcast station can also serve in this manner but since the varied present-day signal sources cover quite a range of frequencies, the limitations presented by the use of a broadcast station for the purpose of calibration are entirely too great. It is our frank opinion that a crystal calibrator is an essential part of every service shop, even though the scope of operation of the shop may not be as great as that which we have presented in this series.

Concerning maintenance upon such crystals, they are virtually fool-proof and with reasonable handling will remain operative for a very long time. This however does not mean that it can be subject to unnecessary physical shocks, particularly during operation. After a period of use and this may be several years, depending upon how and where it is used, it may be necessary to clean the crystal. This can be done by immersing it in carbon tetrachloride. When replacing the crystal in its holder, it should be borne in mind that the spacing of the plates between which the crystal is mounted has an effect upon the frequency. Because of this, it is best when such cleaning operation becomes essential, that an indicating circuit be set up which is tuned to the frequency of the crystal so that the proper adjustment of the plate be made after the crystal has been cleaned and reinserted.

The Signalyst

Concerning signal sources it is only natural for us, inasmuch as the signal source suggested for this specialized shop is the *Signalyst*, to speak about that device. We have upon a number of occasions in this series mentioned the general fact that the device serves as a source of a test signal within certain maximum limits for whatever application requires a signal of from 100 kc. to 120 mc. with and without modulation. That, however, is not a sufficient explanation of what can be done with this device.

There are certain general routine operations associated with the application of a signal generator to radio receivers. They may be classified as laboratory methods of testing, but one can readily realize that similar technique can be applied during service work, the basic difference being that of accuracy of the readings and settings, and also the basic accuracy of

the signal source. But if a signal source of proper accuracy is available, it can just as readily be used for service operations as for laboratory checking. Therefore we will describe a few simple checks, that can serve as basic information to be used as shown, or with those modifications which would constitute the difference between laboratory checking and service checking. As far as we are concerned, we feel that the amount of additional detail involved in making a laboratory check rather than a less accurate service check is not so great as to justify the less accurate check, because of time saved. It has been our experience that the information gathered by making the so-called laboratory type of test, can prove so valuable as to make the additional time spent really negligible.

Basically there are three primary tests upon radio receivers. These are sensitivity, selectivity, and what is best described as fidelity. Since the *IRE* has standardized upon the procedures for making the various tests to establish these fundamental characteristics, it seems most logical to present these tests.

In normal laboratory work a dummy antenna is usually used between the signal generator and the receiver under test. This dummy antenna comprising inductance, capacity and resistance of such order as would normally be experienced in actual practice when a receiver is connected to an aerial. However, it is also true that in some service literature the manufacturer makes specification of some other type of link between the signal source and the receiver. Which of these is used by the serviceman depends upon how well he can interpret operation of the regular dummy antenna in terms of the simpler method which the set manufacturer recommends in his service notes. Thus the man who makes the tests can decide for himself which he is going to use. For normal broadcast operation a system like that shown in Fig. 1 with the constants, would serve as a satisfactory dummy antenna.

For the measurement of receiver sensitivity it is necessary to take cognizance of certain conditions. Speaking in generalities, the commonplace method would be to place the receiver in operation, check all of the tubes, see that all have average characteristics, then proceed to feed a known test signal into the input and to check the output across either a dummy load which is used in place of the voice coil, or across the voice coil, depending entirely upon the manner in which the comparison data is presented by the manufacturer of the receiver.

Simple though work of this type may be under proper conditions, several very significant details must be mentioned because they can lead to misleading results. The first of these relates to the signal source itself with respect to leakage, and the second with respect to the accuracy of the attenuator setting upon the signal source. In making these statements we are speaking in terms of the general run of signal sources rather than any one specific device. It is because of the desire to avoid excessive leakage from the signal source and the consequent error which may accrue in deciding whether or not the receiver sensitivity is what it should be, that we have suggested the use of a high-grade signal generator rather than conven-

★ Now, though faced with the most urgent demands industry has seen in years, GUARDIAN has set aside, as "sacred ground," a Special Production Department devoted to the requirements of RADIO AMATEURS and the jobbers who supply your relay needs. You've looked to Guardian for RADIO RELAYS for many a year... so, today we will not let you down. Prices? Right! Deliveries? Now!



Standard A-100 and A-100-C Antenna Relays AlSimag insulated operate on 110 V. 60 cycle A.C.

Amateur Net Prices:

A-100 Double Pole Double Throw Relay	\$4.11
A-100-C Single Pole Double Throw Relay	\$2.28
	\$3.45

R-100-G Triple X insulated

Write for New Bulletin "N" and Free Circuit Diagrams. Order Today!



GUARDIAN ELECTRIC

1630 W. WALNUT ST. CHICAGO, ILL.

tional test oscillators to serve as the source of the test signal. When making sensitivity tests one fact must be definitely established, and that is that the signal being fed into the receiver under test is that which passes into the receiver through the proper channel, namely, the connecting circuit between the output of the signal source and the input of the receiver. If signal leakage exists between the signal source and the receiver under test, the receiver will appear far more sensitive than it really is, because the signal actually indicated upon the output is not representative of the true signal being fed from the signal source to the receiver via the proper channel. The second consideration relating to the accuracy of the attenuator setting is of equal importance, for if the signal is greater than that shown by the attenuator, the degree of sensitivity possessed by the receiver will be much less than that indicated by the measurement.

It is of course necessary in such operations to appreciate the amount of accuracy that can be expected in devices of the character which are available within certain price limitations. When people speak about a signal source, it has become customary to talk in terms of 1% and 1/2% accuracy in frequency. Such accuracy in attenuators, however, is impossible, and should not be expected. For that matter, it is not necessary. To set a limit is likewise difficult, although it would appear as if such were necessary. Over the broadcast band 10% output voltage accuracy seems entirely reasonable, and as the frequency increases the tolerance likewise increases. The setup for such measurement is show in Fig. 2, and operation should be started with the signal generator attenuator set at zero output, then gradually increased until the output meter reading indicates the correct amount of audio power across the voice coil or dummy load (whichever is used in accordance with the comparison data), indicates the proper value.

Generally receivers are rated for test purposes at approximately 0.5 watt, but this should not be taken for granted, as we have seen a number of service notes where the power rating during such sensitivity tests is a different value. The input signal in microvolts is the amount indicated by the setting of the signal source attenuators when the output indicator shows the required audio power.

In the operation of the *Signalyst* as a signal source for receiver sensitivity checking, accuracy of the signal output depends first of all upon correct setting of the reference level control, and the associated indication upon the reference level meter. It is only when this indicator is properly adjusted that the calibrations upon the output attenuators are indicative of the signal output. With respect to receiver sensitivity checking, it is necessary to recognize one limitation which is associated with the location of the test in addition to the operating characteristics of the apparatus used. There are many instances when servicemen attempt to check sensitivity as low as a microvolt, when the existing noise level may be from 20 to 100 times as great. To attempt to check sensitivity in such localities without recourse to special precautions is impossible. This

means that receiver sensitivity tests of serious character require either a shielded room so as to minimize trouble from such noise, or location of the shop in such a place where there is minimum noise. As a matter of fact, sensitivity checking even if not of a serious character as previously mentioned, still requires freedom from noise if reasonable conclusions concerning the condition of the receiver are to be arrived at.

Selectivity Tests

We have mentioned the subject of selectivity tests earlier in this series, and we feel that this characteristic of a receiver has been greatly neglected in service operations. In our estimation it is not a fair check to determine selectivity by simply tuning in a number of local broadcast stations because, while it may indicate correct performance, it is not definite indication of such a condition. And bearing in mind that it does not take a long time to make a selectivity test, we think it would be good practice if servicemen made such tests. As far as receivers of specialized nature are concerned, selectivity is an important characteristic, and definite comparison data is given which must be lived up to if the receiver in question is to be considered as being normal.

The selectivity of a radio receiver is determined by comparing the level of a signal which is required to produce the *normal* test output at a frequency which is different from that to which the receiver is tuned, and the signal strength which is required to produce the same output at the frequency to which the receiver is tuned. The ratio between these two is the factor of selectivity. To make such a selectivity curve the setup is the same as for a normal selectivity test. The receiver is adjusted for maximum sensitivity, and both the receiver and the signal generator are tuned to whatever the frequency specified for such tests may be. This usually is 1000 kc. in the standard broadcast band. The signal from the signal generator is modulated. The output of the signal source is adjusted until the output indicator connected to the receiver indicates the normal test output used for making the test. This may be 0.5 watt, or whatever else the manufacturer may specify in his comparison data.

The next step is to detune the signal source by 5 or 10 kc., again the exact amount depending upon the manufacturer's specifications, from the frequency to which the receiver is tuned. The signal output from the signal source is now increased until the indication upon the output meter equals that previously obtained. The ratio of the signal from the generator off resonance to the signal from the generator at resonance for equal receiver output is equal to the selectivity factor of the receiver. This is repeated above and below resonance until the required signal input off resonance is 10,000 times as great as the signal level at resonance. As a general rule this work is carried out in steps of 10 kc.

Such selectivity curves provide valuable data, but the closest approach to actual conditions prevailing during normal operation of a receiver would be that when two signals were present. In other words, the use of two signals for checking receiver selectivity is, in a way preferred to one signal used as previously described. However, two-signal testing requires two

MODERN PARTS for MODERN CIRCUITS
 THAT HAVE BEEN
"Designed for Application"
 CATALOG UPON REQUEST

JAMES MILLEN MFG. CO INC.
 150 EXCHANGE ST. MALDEN, MASS.

3 Things to Look for When You Buy a Mike

To be good a Microphone must have equally good response for voice or music; it must be dependable under all climatic conditions; it must have an attractive professional appearance.

TURNER MICROPHONES

Are BETTER, because they offer extra octaves in the high frequency end of the audio band as well as smooth response in the bass register. Accurate tests show a maximum of 1% harmonic distortion in Turner mikes. They're dependable at all times and under all conditions. They have that distinctive style and finish that gives you pride in ownership.



TURNER HAN-D

Ideal for 1" A. men. recorders and dictators. Engineered for voice AND MUSIC. Can be held, hung or mounted on desk or floor stand. Positive contact switch for off-on operation. 50 dynamic, 80, 100 cycles. Level - 50dB with 7 ft. removable cable set, List \$25.00. Write for FREE Catalog. The Turner Co., 908 17th St., N.E., Cedar Rapids, Ia.



FREE! TURNER PUSH PULL VIBRATOR MANUAL

16-page Manual brings you a wealth of technical information. Explains Turner Push Pull action. Lists Standard as well as Push Pull Turner Vibrators.



USE COUPON

The Turner Co.
 908 17th St. NE., Cedar Rapids, Iowa
 Please send me FREE Turner Vibrator Manual for Radio Service Engineers.

Name

Address

City..... State.....

signal sources. It is possible to make these two-signal tests with one well-calibrated signal generator, and another signal source which is not so accurately calibrated, by first establishing the magnitude of the signal at resonance by using the accurately calibrated signal generator and replacing that generator with the other one adjusted to provide the required signal at resonance. The interfering signal then is supplied from the well-calibrated generator.

The two generators are connected in parallel to the antenna and ground terminals of the receiver, each with its own dummy antenna between the generator and the receiver input terminals. In this case the various impedance values of the dummy antenna must be doubled. This makes possible grounding both signal generators, which is not possible with series connection. It is assumed that the percentage of modulation of both signals is the same. As to the test, the receiver is tuned to the standard test frequency, for example 1000 kc. and in accordance with the suggestion previously made, the cheaper generator supplies the standard signal at a known level previously identified by comparison with the better generator. After the standard signal level has been established, the modulation is switched off the signal source which is supplying the standard signal. "The interference signal," source is now tuned off resonance by say 10 kc. either above or below, it being assumed that tests will be made both sides of the resonant frequency. Signal output from this source is now increased, starting at zero until the indication upon the output meter shows .001 of the normal test output. The ratio between the original signal input at the standard frequency and the signal input at "off resonance" is the selectivity factor for the receiver at the frequency at which the test is made. This operation is carried out over a range of 30 to 50 kc. in steps of 10 kc. each side of the standard frequency or is made in accordance with the manufacturer's specifications of selectivity. This test is based upon standardization reports of the *Institute of Radio Engineers*.

In connection with the tests described so far, all have been upon the broadcast band. This should not be

construed as meaning that all such tests are made upon the broadcasting band. The same procedure is suitable upon higher frequency bands.

Image Response

The measurement of image attenuation is made in exactly the same way except the off resonance frequency is the image frequency. The image frequency differs from the resonant frequency to which the receiver is tuned by an amount equal to twice the intermediate frequency. In other words, if the i.f. of a set is 455 kc., the image is 910 kc. away from the frequency to which the receiver is tuned. Whether the image frequency is above or below the frequency to which the receiver is tuned depends upon the relationship between the receiver oscillator frequency and the frequency to which the receiver is tuned. If the receiver oscillator adjustment is such that its frequency is higher than that to which the receiver is tuned, the image frequency is likewise higher than the frequency to which the receiver is tuned. On the other hand if the receiver oscillator is tuned below the frequency to which the set is tuned, the image frequency then is below the frequency to which the receiver is tuned.

Referring again to selectivity at a high frequency an idea of check of the overall performance of the receiver can be had from the information that in many cases a 2 to 1 ratio is acceptable at 10 kc. off resonance in a frequency range between about 2000 and 20,000 kc. This of course is not a figure which should be accepted as applying to all receivers, for as we have said before, the manufacturer usually furnishes the specific data. In many instances the attenuation is given in form of decibel values rather than voltage values but this can be interpreted without much trouble by reference to any number of text books and charts which are easily to be had.

Measurement of Fidelity

The fidelity test indicates the manner in which the audio output varies at different audio frequencies. This test is made by supplying various modulating frequencies to a signal source, covering a range from about 30 cycles to approximately 5000 cycles with 7500 cycles as the upper limit in so called high fidelity receivers. The test is made in a manner similar to the sensitivity test. The audio source used as the modulating frequency is an audio oscillator which is connected as the external modulating frequency source to the r.f. signal generator. In view of the fact that this test is somewhat more tedious than the others mentioned and we do not think many people will apply them to the entire receiver, we do not feel it justifies more extended comment. We say this with due recognition of the fact that we already mentioned previously the use of the audio-oscillator to check the frequency response of the audio system. This will in all probability be the more frequent test than the over-all fidelity. With respect to such fidelity tests, the *Signalyst* is entirely suitable because its design is such as to permit the use of an external modulating source covering a range of from 60 cycles to 5 megacycles. As such a source of modulation, the audio-oscillator mentioned

in previous articles is to be found very useful.

In view of all that has been said in previous installments concerning application of this equipment, we do not deem it necessary to go into further detail in this, the concluding article of the series. However, as we mentioned at the beginning of this installment, it may be well to clarify one or two problems which have perplexed some of the readers.

With respect to adjustment of transmitters which have been referred to herein, it is true that a license is required by the person who is to do the work. This is not an obstacle that cannot be overcome by anyone who is sufficiently interested in this type of work. As a matter of fact, it is possible because of the nature of the emergency existing in the United States and because of what need may exist for people who can perform servicing operations upon various devices of oscillator systems, special classifications of licenses may be established by the *F.C.C.* This is entirely our own belief and in no way reflects even remotely, any suggestion made by authoritative sources. It is only what we believe may happen because of the important part the servicing industry will play in the future of radio communication.

-30-

Washington Communication

(Continued from page 32)

who violate the *Order 72* just "for fun," it stands to reason that the hams are right now walking on eggs. If they do not *at once* knuckle down to brass tacks, and keep their respective noses clean, there just won't be any hams for the duration. Worse than that, having been put off the air for interfering with Uncle Sam's more serious business, there is a very good chance that, if, and when, they get back after the Mess is over, they will be circumscribed to a state where they will be kept at 2½ meters or worse, and with power not to exceed 20 watts to the final amplifier. Mind you, we *don't* say that this *will* happen, it's just one of those things being *thought* about down in the Capitol.

Pseudo-German Radio Agent Seized

THE Defense Operations Section of the *FCC*, cooperating with the Army Amateur system, succeeded in making one spectacular seizure in May. The sleuths of the airways arrested Charles W. Johnson in Peoria, Ill., who had been signing himself "Fritz" and whose "Heil Hitlers" and other tactics had been causing a lot of trouble.

The Government first got on the trail of this youngster when certain Federal stations began to get mysterious communications from an operator who refused to give his call letters.

For a time, the Federal agents thought perhaps they were on the trail of something. Bearings were taken on the station by the *FCC* monitoring units and these placed it near Peoria. From all directions, the mobile units of the *FCC* began to move on Peoria. By triangulation, they located the block from which the broadcast was coming. Then they located the house. The *F.B.I.* was notified and made an investigation, which determined that the offender was not a foreign spy but a boy who had a "superiority complex." They moved in to arrest him.

The youth tried to destroy his equipment, but was prevented. He expressed surprise that the *FCC* had been able to track him down and displayed a knowledge of the Government's direction finding equipment which amazed the *FCC* sleuths. He had

ASSURED STABILITY

WITH
BLILEY CRYSTAL UNITS

10-20-40-80-160
METER BANDS



TYPE B5 —This highly active crystal unit for the 40 meter band has less than 4 cycles/mc/°C drift. Price \$4.80.

TYPE LD2 —An efficient and powerful low drift crystal unit for the 80 or 160 meter band. Price \$4.80.

TYPE HF2 —Simplifies the construction of 5-10- and 20-meter transmitters. Drift, 20 mc/°C; 10 meters, 43 C/mc/°C. Price, 10 or 20 meters, \$5.75.

TYPE BC3 —A moderately priced mounted crystal with unusual activity and power output. Drift 23 C/mc/°C. Price, 40, 80 or 160 meters, \$3.35.

BLILEY ELECTRIC CO. • ERIE, PA.

studied codes in the Peoria public library and knew a lot about them. But the Government hasn't been able to find out yet where he got one code he was using. *It is alleged that it belonged to the U. S. military!*

Production on Schedule

THE second radio defense problem which is engaging close attention is production. As has been stated here before, production of radio equipment for the armed services has been on schedule. But there is a tight squeeze yet to come. For one thing, the shortage of certain materials is going to be felt. And for another thing, the research facilities of the industry are going to be concentrated increasingly on defense.

General Electric made a sensational announcement when it revealed that it was "freezing" its models of commercial equipment so as to concentrate on military radio. This move had the blessing of OPM which has been trying to get others to follow suit. Inside reason for this action was to free the General Electric laboratories—which were engaged in research on radio and television commercial receivers and electronic tubes—so that these facilities could be concentrated on defense radio research.

The preoccupation of the radio manufacturing industry with defense orders is threatening the development of commercial television. The FCC has given television the green light, by allowing it to start commercial programs on July 1. But this is largely an empty gesture, it appears. The shortage of qualified engineering personnel and of manufacturing facilities is going to put the damper on video development for a long time.

Bland Bill to Senate

THE passage by the Senate of the *Bland Bill*, which relaxes experience requirements for radio operators in the *Merchant Marine*, is expected soon. The House has already passed the measure. This will mark the opening of the Navy's effort to replace with men it can trust some merchant marine radio ops whose political convictions the Government isn't quite sure about. The day when the Navy will take over the merchant marine radio rooms is drawing closer, and it won't be long now.

AARS Continues Through Summer

FOR the first time since the organization of the *Army Amateur Radio System* in 1926, its members will continue operations through the summer months. Usually, the AARS goes silent on the last Monday in May until the first Monday in September. But the pressure of the emergency has meant that this vacation period will be a work period.

The AARS is handling thousands of messages for boys who are in camps. On Mother's Day, for instance, the system handled more than 500 messages. There is no charge for this service and any soldier can send or receive messages by contacting the AARS liaison man at his camp. The service, in addition to saving soldiers' money, is a valuable form of training for the operators.

All sorts of messages travel over this net, even into the most inaccessible spots. There was an officer in the deep South, for instance, who was ordered to duty at Kodiak, Alaska, in January. From WJ.R, the Atlanta net control station, he dispatched a message to Alaska, asking whether there was a place in Kodiak where he and his family could live. He was told that no houses were for rent, but that there was plenty of room to build—and that in the meantime, neighbors had promised the family lodging. The message was handled by H. T. Riipa, of Astoria, Ore., net operator of WJ.GY/W7EBQ.

A lieutenant stationed in Schofield Barracks, Honolulu, radioed to a florist in Baton Rouge, La., ordering a dozen red carnations for his mother on Mother's Day. A buck private at the same station kept sending messages back home to his sweetheart every time he got a promotion. When he reached the rank of sergeant, he added a note, promising that he would send for the girl when he became a lieutenant. An Army couple

at Fort Sill, Okla., announced over the net to their friends "It's a nine-pound boy."

During the summer, members of the AARS will participate in several code speed contests. The latest was held June 2 and results will appear here when they are available.

There was so much interest in the annual AARS speed contest earlier in the spring, that the *Ninth Corps Area Signal Officer* decided to hold another competition later. The automatic tape transmissions were from WLV/W6NLL, located in the Presidio of San Francisco. Speeds were from 15 wpm to 60 wpm in increments of 5 wpm. The 3497.5 kilocycle frequency was used and 222 ops in the Ninth Corps Area and 14 in the Seventh Corps Area (these are on the West Coast) participated. Arland N. Page, W6FWJ walked off with top honors, qualifying at 60 wpm. A check of the results showed that 18 qualified at 15 wpm; 48 at 20; 46 at 25; 53 at 30; 31 at 35; 21 at 40; 10 at 45; 1 at 50, and 1 at 60 wpm.

The new schedules for WAR have been announced for the summer months. More than 1,400 hams have contacted this War Department station since contacts were inaugurated on December 3, 1940. Approximately 750 of these were on the 80 meter band (WAR on 4020 kc.) and 650 were on the 40 meter band (WAR on 6990 kc.). In June, the new schedules were begun with the 4020 WAR broadcast on the 3500-4000 kc. ham band maintained only on Saturdays from 7 to 8 p.m. EST. The present daily 9 to 10 p.m. EST. 6990 kc. WAR schedules will be continued during the summer as long as the hams want these contacts.

Military Radiomen Wanted

THERE are some opportunities for those who are looking for radio berths in the armed services. The Signal Corps of the Army is in need of immediate service of a number of unmarried men between the ages of 21 and 36 who have special training as radio engineers or in electronic physics. Those accepted will be commissioned second lieutenants in the Reserve Corps and will be given active duty for one year.

The Navy has placed so many members of its reserve system on active duty, that plans are under way to organize a second reserve net. This has not been decided on definitely, but meantime, the Navy is again accepting enlistments in Class V-3 of the Naval Reserve, which was described in an article in RADIO NEWS last winter. For some years, the Navy has been accepting

applications for commissions from qualified radio engineers. Men between 21 and 30 can be commissioned as ensigns and put on active duty now. Applications for or information about these enlistments or commissions may be obtained from the Commandant of your Naval District.

There are spots open also in the Maritime School, run by the Coast Guard to train operators for the Merchant Marine, and in the Air Corps signal unit, for both officers and enlisted men. Information is available on these from the Coast Guard, Treasury Department, Washington, or from the Air Corps station nearest you or in the War Department, Washington.

Questionnaires Being Studied

STUDY of the questionnaires filled out by hams recently at the request of the War Department has been begun. This is the best file of American hams yet compiled and will be used, should the occasion demand, to find men for air raid warning nets, training of radio recruits, and other emergency duties.

Intelligence reports to Army headquarters in Washington revealed that dozens of Nazi Fifth Columnists were landed in Crete, with compact equipment for radio transmitting and receiving. They did their treacherous job with unusual precision, guiding the air borne invaders to safe spots.

More on Class D Licenses

THE proposal of the ARRL, at its recent board meeting, to establish a new class of license—a proposal which was forecast here many weeks ago—is being considered by the FCC. The license which the ARRL recommended would be a one-year, non-renewable "feeder" type, which would require a code speed of only seven words per minute. The objective would be to train more radio ops.

Some at the FCC have advanced arguments against the proposal. For one thing, the Amateur Section at FCC is still snowed under by the questionnaires which came in last year in the citizenship proof drive. It is contended that establishment of the new license would heap additional work on this unit—since new questionnaires would be necessary for the new applicants. It is further argued that in these times, ham broadcasts should be curtailed, not expanded. Watch the FCC decision on this closely, for it will give a clue to the whole future of ham broadcasting. If the proposal is adopted, that will mean that the Government is intent on continuing amateurs

... SQUARE DANCE goes MODERN

with

• THORDARSON • AMPLIFIERS!

• An unsolicited letter from a user of Thordarson Amplifiers outlining a unique performance . . . "For many years my business has been conducting square and old fashioned dances at schools, colleges, and recreation centers . . . the amplification used at these gatherings must be perfect to hear every word spoken by the caller over the crowd noise . . . I consider it quite a feat that a Thordarson 20 Watt Amplifier has enabled me to call square dances with as many as 1200 people dancing . . . when I buy another amplifier it will be a Thordarson."

Mr. Clossin is one of the nation's best known authorities on the square dance. Ask your Thordarson distributor to assist with your sound installations.

(Signed) Jimmie Clossin,
El Paso, Texas.

THORDARSON
ELEC. MFG. CO.
500 W. Huron St.,
Chicago, Ill.

TRANSFORMER SPECIALISTS SINCE 1895

on the air indefinitely. Which will be good news.

A second *ARRL* proposal will meet little opposition. This was the recommendation that the radiotelephone sub-band in the 10-meter frequency be extended down to 28.1 megacycles, instead of the present 28.5 megacycles and to open the upper section of this band from 29.25 to 30 megacycles to FM experimentation.

FCC vs. Broadcasters

THE last serious radio problem engaging Washington's attention is not strictly of a defense nature. It is something that Washington wishes hadn't come up at this time—but it can't be ignored any longer. It is the battle to the death between the *FCC* and the big broadcasting chains. This is a domestic row, but the importance of the radio chains in war makes it essential that the quarrel be settled quickly.

The Government regulatory agency and the broadcasters have been on bad terms for some time, of course. In recent months, however, all had been sweetness and light. That was before the *FCC* issued its "monopoly report" in May, ordering *NBC* to divest itself entirely of control of one of its two networks and imposing other rules which would break up both *NBC* and *CBS*, as they are now constituted.

As a result of the order, the *FCC* and the broadcasters are on the worst terms that could be imagined. To the *FCC's* demand that the networks be abolished, the broadcasters replied with a demand that the *FCC* be done away with. Chairman Fly appeared at the convention of the *National Association of Broadcasters* a short time after the monopoly report was adopted. He sat on the platform while Mark Ethridge, Louisville newspaper and radio man, denounced the *FCC* bitterly.

It was Mr. Ethridge who got the White House earlier this year to conduct a survey of the newspaper ownership of radio stations, after the *FCC* had announced it was going to make an inquiry. He has been a friend of the New Deal, but the things he said about Mr. Fly's Commission were anything but friendly. He said that the *FCC* had a "psychosis" against certain persons in the broadcasting industry. Mr. Fly sat by, reddening as the attack developed. When Mr. Ethridge had finished, *NAB* President

Neville Miller promptly closed the session.

Mr. Fly stalked out of the hall, white with rage. He protested that he had been promised a chance to reply. He had not received it.

This gives an idea of the bitterness which has been engendered. The name calling has been going on since. Mr. Ethridge has gone to the White House to get help, but found little support. The President indicated that there were more important things on his mind. At the Capitol, however, the *NAB* found a friend. He is Senator White, Republican, of Maine, who for some time had been preparing a resolution calling for an investigation of the *FCC* and the radio industry.

The monopoly report resulted in the introduction by Senator White of a resolution calling for an investigation. This will undoubtedly result eventually into a thorough investigation of the whole set-up. There will be plenty of fireworks before this is over.

In the meantime, the big legal guns were being wheeled into position. The broadcasting chains prepared material for injunction suits to restrain the *FCC* from putting its order into effect on July 1. The *FCC* quietly moved in Thomas E. Harris as Assistant General Counsel. He came from the Justice Department, with a reputation as one of the ablest litigation lawyers in the Federal service. His assignment will be to enforce the *FCC* order in the courts.

And sitting back, saying nothing, were Attorney General Robert Jackson and Trust-busting Assistant Attorney General Thurman Arnold. Mr. Fly had quietly slipped them copies of the *FCC* report and they have indicated their willingness to step in with anti-trust proceedings if necessary.

Although the President expressed his unwillingness to get mixed up in the fight, observers don't see how he can avoid it long. It's a battle to the death—and the *FCC* or the broadcaster's chains may in the end perish. In times like these, observers point out, the country can't do without either. So they look for the White House to find a compromise.

Defense Orders

NOW that airplanes are beginning to roll out of the factories in quantity, the demand for radio equipment for them is going to increase sharply. Within the next few months, the Government will sign at least \$100,000,000 worth of contracts for radio equipment. (*R.C.A.* recently borrowed ten million dollars to construct new manufacturing facilities to handle anticipated Government work.)

At the same time, the quantity of radio equipment being exported is increasing greatly. Most of this is going to Great Britain under the Lease-Lend program. For instance, there was an increase of 42 per cent in the value of equipment exported in March of this year over that exported in February. The radio apparatus which we sent abroad in February was valued at \$1,705,597—and in March we exported \$2,431,183 worth. Later figures have not become available, but it is known that the figure is still rising.

The radio industry is confident that it can do the job. During the next few months, there will be more sub-contracting of radio defense orders. The smaller plants will get their share of the work. The *OPM* is determined on this.

Note: Labor in the radio manufacturing industry is driving hard for a share in the increased profits. *GE* Vice President Burrows announced that his company's new contract with the *CIO* gave 75,000 workers a raise of ten cents an hour.

The following contracts for defense radio have been signed recently: Western Electric, Kearny, N. J., radio telegraph sets (for Coast Guard), \$89,910; Fred M. Link, New York City, radio receivers, \$588,760; John Wood Manufacturing Co., Muskegon, Mich., radio parts, \$29,497; Collins Radio Co., Cedar Rapids, Ia., coils and transmitters, \$20,628; William J. Murdock, Chelsea, Mass., headsets, \$30,322; Bendix Aviation Corp., Pioneer Instrument Div., Bendix, N. J., indicators and tube assemblies, \$601,515; Radio Receptor Co., New York City, rectifiers and radio transmitters, \$5,166; H.

O. Hoehme, Inc., New York City, panels, \$1,305; Barlow Engineering Co., oscillators, \$2,079; General Electric Co., Radio and Television Department, equipment, \$31,000, and J. H. Bunnell & Co., Brooklyn, keys, \$640.

WU-PT Merger

THE Senate Commerce sub-committee which was appointed to hear testimony on the proposal to allow *Western Union* and *Postal Telegraph* to merge heard a lot about the effects of the merger on the domestic wire system, but not much about the international radio-telegraph picture. The plan to permit the merger, by the way, appears to be certain of eventual enactment.

In the current international unpleasantness, the Government has found the radio-telegraph to be an invaluable help. Both *Mackay* and *RCAC* have performed valuable service in maintaining communications with out-of-the-way "trouble spots," such as Greenland, Martinique, etc. Somewhat mysterious, then, was the failure of the State Department to take any interest in the hearings, which might decide the fate of one or both of these radio-telegraph systems.

Chairman Fly, in his testimony, indicated that if the merger went through, the domestic radio-telegraph circuits would be maintained merely as "standby" service. These circuits wouldn't handle traffic except in emergency. He said that last year the two companies handled \$10,843,000 worth of business, of which only 15 per cent was domestic traffic. Mackay handled a larger percentage of business than *RCAC* in domestic traffic. Apparently, the *FCC* plans to do away with regular domestic radio-telegraph business, to merge the international systems eventually and concentrate on building up their revenue.

Note: The *FCC* granted to *RCAC* a temporary license to establish contact with Brazzaville, French Equatorial Africa, recently. This is in Free French territory, a short distance from Dakar—the nearest African point to South America. The U. S. suspects Nazi military activity in Dakar and has established the radio contact with Brazzaville to assure quick, direct communications for reports from U. S. observers.

-30-

Deluxe Amplifier

(Continued from page 13)

point in the circuit where a better match may be had such as from one of the driver plates, through a series condenser, to ground.

Frequency response curves are shown in the illustrations. Note that the overall range is essentially flat from 30 to 15,000 cycles. This is far in excess of the capabilities of most recording heads or speaker systems used today and the available range is desirable if, and when the range of such systems can be extended.

Other curves have been plotted to show what can be accomplished when the two equalizer controls are used. Note that a boost of approximately 15 db. is possible for either circuit. Applications have been covered and will not be repeated. The curve shown for a combination of both treble and bass boost is the one previously mentioned as being suitable for the "Orthocoustic" type of recordings. Other combinations are possible, or any degree of attenuate-accentuate may be employed.

The complete amplifier consists of two separate units, one for the amplifier, and another for the power supply. This is necessary for two reasons—first, the isolation between units to prevent hum pickup, and second, to allow more space for the large components used for the 845 combination. The power supply for use with 2A3

★ ★ **SOLAR** ★ ★

SERVES THE SERVICES

Solar is proud of . . . and is zealously guarding . . . the reliability which its Capacitors add to radio and electrical control equipment for the Armed Service Branches of our Government. Solar reliability is built into all types of electrical condensers for industrial, radio and service applications.

SOLAR Mfg. Corp. Bayonne, N. J.

RADIO **EVERYTHING IN RADIO**

This one big book serves your entire radio needs. It includes sets, parts and supplies, public address systems, amateur equipment, testers, kits and fluorescent lighting. You'll find the nationally known favorites at the lowest possible prices. Get your copy of this big FREE CATALOG today.

BURSTEIN-APPLEBEE COMPANY

1012-14 MCGEE STREET, KANSAS CITY, MISSOURI

tubes can be considerably smaller in physical size and may be placed on a chassis measuring 10 x 17 x 2". Standard relay rack panels are used so that the equipment may be mounted on either a rack, or on a recording console.

The amplifier proper is built on a chassis which measures 12 x 17 x 3", supported to the front panel by means of brackets made from strap iron 1/2" wide and 1/8" thick. The control dials are first laid out so that they present a neat arrangement, besides being convenient for the operator. The bottom row includes the two 50 ohm inputs, the master gain, and the two hi-impedance mike channels. The center row includes the two lo-gain inputs, the treble and bass controls, and the expander-compressor control. The top row includes the two bias rheostats, and the monitor pad. The remaining small knobs are for the dialogue filter, db. multiplier, phone series resistor switch, and the changeover switch for reading the individual plate currents of the 845's or 2A3's. The bias is adjusted by means of the two rheostats so that the current in each tube is the same. In this manner, any mismatch in tubes may be compensated for and the distortion in that stage kept to a minimum.

The transformers are laid out in the positions indicated on the illustrations. Each unit comes from the manufacturer with a template for drilling and cutting of the mounting holes and this should be followed for accurate fitting. Likewise, a chart is included in the package showing proper terminal connections for the transformers. The input (T1A71) is connected for a primary impedance of 30 ohms as being the closest available match to the parallel 50 ohm pads.

All leads indicated on the diagram as being shielded are made with shielded push-back wire and the braid is soldered to the chassis at several points. These leads are in the high-gain portions of the circuit and it is important that all extraneous noises be kept out of these parts if the amplifier is to be free from hum pickup. This includes the 1 megohm series resistors from the sliders of the gain controls and the .25 mfd. paper condenser which feeds the audio to the 12SJ7 grid.

A choice of tubes will indicate whether series or parallel connections will be made to the sockets. The tubes shown on the diagram are chosen from the 150 ma. series and all take the same current for operation. There is an advantage in using rectified d.c. on the filaments as it keeps the tubes free from the cathode-leakage hum troubles, especially the 12SJ7 hi-gain amplifier. This requires a power supply that will deliver the total voltage required by all of the tubes when their filaments are wired in series. A *Thorndarson* bias-supply transformer is ideally suited to this application and the taps are set so that the d.c. output from the filter is 100 volts d.c.

The other choice is to substitute the usual 6.3 v. tubes. These would be—6SJ7, 6N7, 6SK7, 6J5, 6J5, 6J5, 6SJ7, 6H6. The power supply should be constructed and wired according to the alternate diagram shown. This supply costs considerably less than the one for the arrangement using the series filaments and is recommended to those who cannot afford the larger unit.

Only one transformer will be needed for furnishing all of the voltages. The C supply voltage is had by utilizing a tap on the high-voltage secondary of the plate transformer and by using a separate rectifier tube and filter system.

Be sure to observe the polarity of the filter condensers when they are connected. Note that the units must either be of the cardboard type or be insulated from the chassis if they are of the can type. The output voltage is fed to the two bias rheostats in the same manner as that of the separate supply used for the 845's. The voltage is lower, however, and it will be necessary to increase the value of R45 to 5,000 ohms, and to eliminate R26. This will permit accurate settings for the 56 volts required for the two 2A3's.

A single 0-100 d.c. milliammeter is used to read the plate current of each individual output tube. This is made possible by the split-primary of the transformer and by the use of a double-pole-double-throw switch connected as shown. The correct setting will be when the plate current for each 2A3 is approximately 42 ma.

The wiring of the input circuits must be done with considerable care. Shielding is complete right up to the input connector. These connectors are *Amphenol* CL-PC1M and are of the closed-circuit type so that the unused input will be shorted to prevent any unwanted grid pickup. The shielded push-back wire is extended into the connector or so that no uncovered part of the wire will be exposed. Allow enough slack in back of the connectors so that about a quarter inch movement may be had for the lead.

The shielded leads are connected to the *Centralab* controls and the output run through more shielding to the grids. The 1 meg. resistor is of the insulated type. The stiff wire leads are cut close to the resistor and shielding is done as indicated on the small drawing. Small lengths of spaghetti tubing are slipped over the exposed wire and also over the soldered connection to the resistor from the long lead. This same procedure is followed in shielding condenser C1.

All by-pass condensers should be located as close to the socket connections as possible, and each stage should be wired point-to-point in every case. No attempt has been made to keep the wiring fancy—efficiency being the main consideration. Most tubular condensers are marked to show which end connects to the outside foil. This is important. The outside foil must always connect to the ground circuit, in the case of the by-pass condenser, and to the plate, or input side when it is used as a coupling condenser. In other words—keep the outside foil at low pickup potential in all applications.

If the reader is to build the larger unit, designed around the 845 triodes, he must use the 50 watt type of socket. Note that these are underslung beneath the chassis so as to bring all of the terminals out on the underside. Holes are cut in the chassis which will allow a bit of clearance between the socket shells and the chassis. Long 8-32 machine screws and nuts are used as mounting pillars and provide satisfactory support.

A series of 1/2" holes are drilled in the chassis before the panel is attached to allow sufficient outlets for the leads that connect to the various controls

and switches on the panel. They are centered between the gain controls that mount under the chassis so that the leads will not interfere with the connections to the latter.

Of great importance is the shielding of the connecting wires between the parts which make up the tone equalizer circuits. This is carried out, largely, above chassis and the two tone controls R41 and R42 are placed in position so that the soldering terminals will be facing each other. Complete instructions accompany each control and will show the proper terminal arrangement for wiring. The bass choke, Ch1 on the diagram of the amplifier, is mounted close to the two controls in order to make the connecting leads as short as possible. The unit is provided with a special static shield to prevent any hum pickup and feed this into the amplifier when the bass control is set to the boost position.

Another important feature included in the design of this amplifier is the guardian relay which is wired in series with the two driver tube cathodes-to-ground. This serves as a time-delay relay and is used as a protection to the rectifiers for the 845's. By choosing the correct resistance—the same as would normally be used for a fixed resistor, we can take advantage of the warmup period of the two drivers before they draw normal cathode current and effect some 20 or 30 seconds delay before the contacts on the relay will close. The contacts of the relay are normally open, and close when full cathode current is drawn. This completes the center-tapped return circuit

Change Bands in a Hurry...

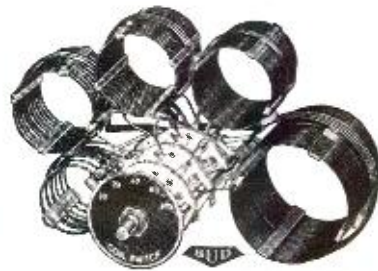

... with BUD BAND SWITCH UNITS

Band switching is simple and economical when you use BUD Band Switch Assemblies. They are made in 50 watt and 100 watt sizes for operation in single-ended and push-pull stages.

A new type of shorting-out switch removes all unused coils from the circuit and permits unusual efficiency of operation. And best of all, band switching need no longer be a costly feature—prices on all units are surprisingly low.

BUD Coils are also made in fixed and adjustable link types for all bands, in sizes from 50 watts to 1 kilowatt.



Write for Catalog
No. 241, just off
the press.

BUD RADIO, Inc.
CLEVELAND, OHIO

of the high voltage winding and puts the two 866 jr. tubes into operation. One precaution should be observed. When testing, allow a few moments after the amplifier has been shut off for the two 12J5GT tubes to cool before re-applying the line voltage. This will restore the action of the delay circuit and protect the rectifiers from receiving plate voltage before the filaments have reached operating temperature.

Testing of the amplifier should reveal no audible hum or tube noises. Be sure to use only the noise-tested type of tubes in the high-gain stages. Each input should be tested for proper continuity with microphone or other sound source. A complete frequency response curve may be made to indicate whether or not any of the sub-circuits, like the expander-compressor, are introducing any distortion. This test should be made with a calibrated audio oscillator, VTVM across the input terminals of the oscillator, equalizers set to mid-point on the dials, and with the expander-compressor in the "off" position. The monitor T pad should be wide-open.

A 500 ohm vitreous resistor should be connected in place of the cutter, so as to reflect a pure resistive load to the output transformer. The db. meter may be used to read the volume level when sounds of various frequencies are fed to the amplifier from the audio oscillator. Set the input voltage (level) so that 0 db. is indicated on this meter. Use a frequency of either 400 or 1000 cycles as a reference point. Begin at the lowest frequency, say 30 cycles, and note the level on the meter. The reading will remain close to 0 db. throughout the range from 30-14,000 cycles, and drop but slightly when set to 15,000 cycles. If it does not show this flat response, the circuits must be checked to find the cause of trouble.

The curves illustrated were taken by the above procedure under the con-

ditions indicated. They apply to the parts used which include very high-grade transformers. If the reader attempts to substitute other transformers, they must be capable of the same characteristics in order to attain the same results. The curves made with a pair of 2A3's are equally as satisfactory, and the same transformers can be used for either arrangement. If care is exercised in the construction of the amplifier, the reader will possess equipment that compares favorably with that found in the better broadcast studios.

-30-

As I See It!

(Continued from page 15)

As to business acumen possessed by servicemen, there is a great lack but it is not an insurmountable obstacle. We have said before and we say again that there exists in these United States a large number of manufacturing organizations of various kinds who derive their income from the servicing field who have at various times made contributions of various kinds for the betterment of the servicing industry. Taking the broadest viewpoint, it is possible to come to but one conclusion and this is, that from a selfish viewpoint as well as an altruistic viewpoint, the responsibility of making this servicing industry commercial minded rests in their lack. In this respect, if we may inject our own commercial associations, we too feel a sense of obligation. We know that magazines are on the hunt for articles of various kinds. May we suggest that these magazines secure articles which would acquaint the servicemen with the commercial side of servicing—the sales side. At the same time it is also imperative that the servicemen realize his part in the bargain and appreciate that it is important for him to read articles other than those which are strictly technical and not to consider those few suggestions which at times appear in different publications as simply so much bunk and superfluous material printed solely for the purpose of filling space. More than one sales idea which appeared utterly ridiculous at first glance, proved tremendously successful because it contained that which the public liked even though the sales manager personally would never respond to the same appeal.

Speaking about sales ideas, the following has nothing to do with the servicing industry but it does illustrate to what lengths organizations who make a study of how to get business can go. For example, we doff our hat to *Tom Powell* of the Hotel Plaza in San Antonio who thinks enough of his out-of-town guests, even though he has never met them, to call them on the 'phone when he visits their town. We have stopped at the Plaza when last we were in San Antonio and having no complaints against the Hotel, it would be almost instinctive to direct the cab driver to take us there the next time we land there. We don't know, but it seems to us that when this sales idea was first broached to the people who run that hotel, they must have laughed at it for it is unique to say the least but upon second thought, they must have realized the reaction of the man who gets the call. As far as we are

concerned, it builds up a spirit of friendship that requires a great deal to undermine.

Then again there is the jobber, a radio jobber, who is selling fluorescent lamps—not fixtures just lamps. Do you know how he sells these lamps? In his town there is a young boy about 14 who has a burning desire to learn about radio. This boy is permitted to come into the shop run by this jobber and to watch the men working on radio receivers and he is given permission to ask questions. In turn for this education and for the fact that they permit him to buy radio parts to play with by saving pennies, this boy bicycles around town in the evening for several hours and notices where fluorescent lamps are not burning properly or at all. He makes a record of the location—the name of the store owner if it is a store—and the light. The next day he reports back to the jobber with his information. The result is the sale of fluorescent lamps, and an easy sale at that. The first time I heard about this, I actually laughed as did others, but upon second thought, it made a great deal of sense.

We know of a certainty as a result of actual conversation, that servicemen have pooh-poohed sales ideas which have in the past appeared in magazines. They considered the ideas childish and silly despite the fact that the man who made the suggestion stated that they were founded upon experience and had proved successful. These disbelievers would not hesitate to try some ridiculous technical idea and will spend time trying to make something work which is based upon the contradiction of every known electrical law. The answer is found in that one is commercial and one is technical. We can understand the lure of romance in things technical, but it's the commercial side of radio which enables a man to capitalize upon his technical knowledge and in that way feed the cavity in the human anatomy known as the stomach.

Priority for Replacement Parts

There is talk about an attempt to place radio replacement parts in the same priority classification. At the present time the entire radio business is pretty well down on the list and there have already been brought to light instances where difficulty was found in the manufacture of replacement parts because of the difficulty of obtaining the necessary basic materials. Whether or not it will be possible to shift the replacement parts manufacturing field into one of the prime classifications, it is difficult to say but those who decide this classification should take cognizance of the fact that definite benefits can accrue to the government if all of the people who have radio receivers are in a position to have those receivers serviced.

Many hundreds of announcements are made each day through various radio broadcasting channels which are intended to acquaint the eligible youth of the land with facts relating to various government services. In other words, recruiting effort is carried on by various governmental agencies through spot announcements. Every home where a receiver through which people could listen to these announcements is inoperative, represents the loss of a listener and perhaps a potential recruit. In each of those experimental black-outs taking place in dif-



COMPLETE Radio Engineering Course in 2 1/4 years. Bachelor of Science Degree. Radio (television, talking pictures and the vast electronic field) offers unusual opportunities for trained radio engineers. Courses also in Civil, Electrical, Mechanical, Chemical, Aeronautical Engineering, Business Administration and Accounting. Tuition, living costs low. World famous for technical 2 1/4 year courses. Special preparatory department for those who lack required high school work. Students from all parts of the world. 58th year. Enter Sept., Jan., March, June.

Write for catalog.

1671 College Ave. Angola, Ind.

TRI-STATE COLLEGE

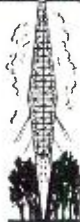

operated heater, is operated above ground potential for r.f., as when the cathode is tapped on to a tuned circuit, or connected between crystal and tuned cathode circuit.

To secure maximum isolation of oscillator frequency from plate circuit tuning, neutralization of the capacity between screen and plate in the vacuum tube may be employed. This can be accomplished by a center tap upon L of Fig. 2, to which B is then connected, while the bottom end of the tuned plate circuit, LC, connects to the screen through a neutralizing condenser. For the amateur, this is an ordinarily unnecessary refinement, for in a well screened tetrode effective stray couplings are not of sufficient magnitude to be bothersome.

The advantages of relatively high harmonic frequency power output in terms of fundamental frequency power of the Pierce and Dow circuits appear to be realized with this new circuit, while in original investigation r.f. crystal current was found to be pleasingly low. Exact figures are not today available, for complete examination of circuit behavior was cut short by government demands upon the writer's time, but it is recalled that measured crystal currents were surprisingly low. Power output, using an RK23 tube, possessed of the shielding advantage of an r.f.-grounded suppressor grid between screen and plate, as compared to some other tubes tried experimentally primarily in terms of absence of plate circuit loading reaction, was on the order of eight to ten watts when operated at 400 volts plate potential.

Those who have used the Pierce circuit are familiar, particularly with low frequency crystals with which the impedance of inter-electrode capacities appears high, of the occasional need of a feedback capacity between grid and cathode or ground. Such feedback condenser is usually on the order of 50 mmfd., or less. This same need was originally found to apply to the new circuit, although in somewhat lesser degree than with the regular Pierce circuit using a triode. The amplifica-

tion constant of the tube employed will have bearing upon the need, or value, of the grid-to-cathode condenser. It has been noted by a recent investigator that such feed-back capacity appeared unneeded using a 6AG7 pentode as oscillator. In any case, such capacity should be kept as small as possible to minimize crystal current.

For amateur use, *only fundamentally-cut crystals may be employed*, as the customary harmonic-cut 10 and 20 meter crystals will oscillate at their fundamental, not at their indicated operating frequencies, just as in the regular Pierce oscillator circuit. Such harmonic crystals may be used if a tuned screen circuit is substituted for Z in Fig. 2, when the oscillator becomes a straight crystal-grid, tuned-plate triode oscillator coupled to the plate load circuit by electron coupling. This seems a not worthwhile complication, particularly as without neutralization spurious plate-screen oscillation can develop, and because with generally available tubes the harmonic output of 40 meter crystals on 20 and even on 10 meters is adequate to drive a following beam-tetrode power amplifier—though a frequency doubler may usually prove desirable to obtain 10 meter output from a 40 meter crystal; but not necessarily. Second harmonic power output compares favorably with fundamental output—enough for all practical purposes in any case.

For the user desiring a stable-frequency oscillator exhibiting the always-sought freedom from frequency shift due to load circuit tuning, this new circuit appears to be meritorious, and will probably find wide-spread use in amateur and commercial circles. As described above, its frequency is determined by a quartz crystal, which means that the number of output frequencies obtainable from a typical circuit will be only as many as crystals may be afforded for, plus their harmonics. One out of a group of crystals may be selected by suitable switching circuits, which may be on grid or plate side of the crystals, or on both. The preferred switching circuit is one which will select the desired crystal and short-circuit the unused ones, one side of which, however, may "hang" on grid or plate circuit. A d.c. isolating condenser, about .01 mfd., mica, not paper, should be connected between "hot" vacuum tube plate and crystal or crystals to keep high voltage d.c. off the crystals. Constants and operating voltages should be in accord with specific tube data sheet recommendations.

The substitution of a good LC tuned circuit for the diagrammed crystal, in the same circuit position, provides a very satisfactory variable frequency oscillator, the frequency stability of which is a function of the mechanical and temperature excellence of the tuned circuit, plus operating voltages which are easily stabilized by VR-type gaseous voltage regulator tubes. However, both ends of the two-terminal tuned circuit are "hot" for r.f., must be ungrounded, and the tuning dial *must be insulated from the condenser shaft to eliminate hand-capacity effect.*

Serviceman's Experiences

(Continued from page 27)

calls that came in—what say I answer them?"

"Too late," Al replied. "I answered them myself."

"You did?" I said. "Great—then you go to the movies, and I'll stay and repair them."

"I already fixed 'em," Al informed me.

"Then I'll deliver them," I offered.

"They're already delivered," Al laughed. "Just goes to show what a person can do if he's willing to occupy his time properly."

"If the work is finished," I asked, "why did you shoot off all those fireworks?"

"I wanted to impress you," Al replied, slapping my shoulder, "that a serviceman in his own store is on no one's payroll but his own. After this, don't forget—a salaried man has time to spend, but a store owner has time to sell!"

-30-

Book Review

(Continued from page 43)

icing and calls for less knowledge, less time spent, and less instruments, claims the writer.

While the technique of Comparison servicing is easy to learn and employ, the information must be read with care if best results are to be obtained. There are no meaningless words in the manual and every sentence tells important facts. Copies and price may be obtained from the *Supreme Publications*, 3727 West 13th St., Chicago, Ill.

For the Record

(Continued from page 4)

lie developed over 30 watts from the 845's and then "lost" it down to 3 watts by means of pads, resistors, etc.

He turned tables on us too, because when we attended a recent *Institute of Radio Engineers* meeting, the speaker, Fredendall, eminent sound engineer for RCA-NBC blithely announced, "In order to make perfect recordings with a magnetic cutter, approximately ten times the power needed for the cutter must be available from the amplifier."

For those who are interested in making the discs, and in doing an outstanding job at it, we heartily recommend Ollie Read's article on the DeLux Amplifier.

* * *

THE NCR is no more. Organized to enlist the hams in naval communication work, the NCR made an enviable record during the times directly preceding the National Emergency. Now probably 80% or more, are actually in the Navy serving their country, and not enough are left outside of those on active duty to carry on the work of the NCR. So having realized the goal for which it was formed the

HOW TO LEARN CODE

Whether you wish to enter radio as a career or merely add another valuable and fascinating accomplishment to your achievements, the All Electric Master Telex Code Teaching Machine will show you how. Telex records your sending in visible dots and dashes on a specially prepared waxed paper tape and then sends back to you at any speed you desire. It does not merely show you code. It is code. No experience needed. While not designated as standard equipment, Telex is used at many U.S. Army Posts, Naval Training Stations as well as by the American Tel. & Tel. Co. Also by practically every private school in the U.S. teaching code; and many foreign governments. We furnish you complete course, including practice messages, the All Electric Master Telex, plus a personal service on a



MONEY BACK GUARANTEE. Low cost. Easy terms. Without obligation write for booklet "RNT."

107 HUDSON ST.
TELEPLEX CO., JERSEY CITY, N. J.

FLUORESCENT

Buy Direct—All Types—Factory Prices
Save up to 50% on Fluorescent Lighting. Using 100% G-E parts. Dealers write for FREE catalog.

M c GEE RADIO
KANSAS CITY, MO.
F-2073

-30-

NCR, as such, respectfully bowed out.

We were sorry to see it go, but we were also very proud that the hams who worked so hard on the many drill nights, who made the NCR what it was, were able to come to the aid of our country in such great numbers and to "take over" so well.

So long, NCR! We will look for you again after this shindig is over!

* * *

THE serviceman is being importuned by numerous manufacturers to enter into that field. By this we do not mean that all, or even any great number of them are being approached. But we have had reports from several places that the manufacturers are going around trying to pick up a good man here and there.

What bothers us most, though, is that some of these servicemen have written us, "Shall I go into the manufacturer's field, or shall I stay here at servicing?"

On top of that we have it on good authority from two very well-informed servicemen that (a) the independent servicing field will expand and that there will be more money spent in servicing, and (b) the independent field is declining and will continue to do so until eventually all servicing will be done by the factories. Both these opinions are from men who are supposed to "know their stuff."

What should we advise the men who want our opinion about leaving the servicing field? Well, frankly, we don't know. We suspect that it is a problem that each man will have to solve for himself. The best thing we know how to do, is to revive a statement attributed to the late President Coolidge, when asked if he thought it would rain that day.

"Yes, and again, no," is what he said. And so do we.

* * *

WATCH for the super sound issue next month. We will have a lot of new information all about sound, its installation, how to sell it, where to sell it, and how to build a portable-universal sound unit. We couldn't possibly cover all phases of sound—that would take a volume many times the size of RADIO NEWS—but we will try to cover various conditions and technicalities which are of interest to the sound technician. Don't miss the August issue for sound sound advice.

* * *

AN unusual letter from England came to our attention the other day. It is from a London serviceman. Below we quote from it, and let it speak for itself.

"... We are getting on very well with servicing considering the tremendous demand upon our labour and material but things are rapidly approaching the state where we may have to give up servicing domestic radios in order to concentrate on more important work.

"Of course, a great number of us are engaged in very similar work in His Majesty's Forces where radio is of a tremendous value, especially where we make such rapid advances as we have done in Libya. The chaps in the front must let the fellows behind know just how far they have got! ...

"... we have been bombed a great deal, as you will have seen from your newspapers and we have quite a number of radio receivers and radio-gramophones in for repair which have

been damaged in air raids. One of the more common faults is loudspeakers with the cone sucked out through the grille (or fret) in front of the instrument, due to the suction created by a High Explosive bomb bursting nearby.

"On the other hand, I have seen television receivers in which bombs fragments have gone clean through the thick cabinet and the chassis and yet the cathode ray tube has been perfectly intact, which shows how strong these components are. . . ."

* * *

THE chart to track down hum which is in this issue is one of the first that we have ever seen on the subject. We didn't know there would be that many reasons why the annoying A.C. would get into places where we would not want it. Mr. Kenworth, an instructor of the RCA Institutes has performed a task in listing the hum causes and their remedies which should endear him to every serviceman and sound engineer. If you are having hum troubles, the answer will very probably be listed in "A Serviceman's Chart to Track Down Hum."

* * *

HAVEN'T anything more on our minds. Too hot to work at the typewriter anyway. We can expect some outstanding changes in the radio situation with the proclamation of the "Unlimited Emergency" by the President, they may be slow or they may be sudden, but we wouldn't be so foolish as to stick our editorial necks 'way out to there in trying to predict what they will be. You will just have to wait and see.

We're doing it, too! KAK

-50-

Bench Notes

(Continued from page 20)

a few feet of wire hung out the window provides adequate pick-up for their listening requirements.

However, there are still a considerable number of customers, with all-wave receivers in the higher price brackets, that want, and will pay for, a better signal accumulator than two-bits' worth of wire tacked under the eaves of the house. For this class of trade a number of special antenna systems have been developed of widely varying degrees of efficiency, and to many a service man their installation has often resulted in nothing but grief and the loss of a good customer. When the customer that has invested ten to twenty-five dollars in a fancy antenna system finds that results from his loudspeaker are nothing like the delightful condition he pictured from the Serviceman's recommendation, his opinion of that service man is going to suffer a sharp slump, which may or may not be permanent. Super-Snappy S & S has acquired just enough clients from other service shops for this reason to know that this is not pure theory.

While a good many of these special antennae are not worth a tinker's dam, from the standpoint of final results in the owner's living room, this is by no means the whole story. Assuming that an antenna system of reasonable efficiency has been chosen and installed, it will generally be found that the ensuing cat-calls and boos from the huffy customer are largely due to the manner in which the antenna was sold to

the customer. Practically all manufacturers and most service men have been too careless of their claims in this respect, and the system is often sold to the customer as a noise eliminator, instead of a noise reducer. There is more than a little difference between these two terms, and the set-owner that has been led to believe, intentionally or unintentionally, that his new antenna will eliminate noise, is going to be hard to handle when the familiar buzzes and pops again assail his ear, no matter how much their intensity is reduced.

Here at S-S. S & S. we have always been most conservative in our statements when discussing such antenna with prospective buyers, and have made it a point to stress the fact that noise will be reduced rather than eliminated, and any benefits to be had will be due to an improved noise-signal ratio. We may not sell as many antennae as we might, but at this writing we have yet to receive a complaint from a buyer that his new antenna failed to equal his expectations.

As we have hinted many of these antennae fail to even remotely approach the ideal, but there are several that do give the set-owner a reasonable return for his money. One of the best we have yet installed is a new antenna system just recently put on the market, and so far the reports on installations just made are very gratifying, and indicate that better than average results are being obtained. The antenna is of the vertical rod type, with an efficient coupling system, and has the desirable feature of being quickly mounted in a small space without the necessity for guy wires or



Better Performance with HQ-120-X

THE "HQ-120-X" is widely used in amateur stations owned and operated by men, who during their work day, are designing and developing commercial equipment. These engineers are real critics when they are buying a receiver for their own use. With them its performance above all else. Craftsmanship and engineering have been combined to make the "HQ-120-X" a receiver which anyone would be proud to own. No corners were cut in its design. Inductive and capacitive trimming are employed in the R.F. circuits to assure perfect alignment, maximum image rejection—low noise level. Go over the "HQ-120-X" carefully—try it in your own shack—you will agree it's a fine performer.

WRITE FOR "HQ" BOOKLET!

HAMMARLUND MFG. CO., Inc. RN-7
424 W. 33 St., N. Y. City
Please send 16-page "HQ" booklet

Name

Address

City

State

HAMMARLUND

Canadian Office: 41 West Av. No., Hamilton, Ont.

masts, which results in a decided cut in installation costs, often an important factor in making such sales.

No matter how good this antenna or any other proves to be, no prospect will be urged to buy it. We will make every effort to contact those set-owners that might be interested in improved reception, and tell them frankly what the system will do, and what it will *not* do. Then when the prospect buys the system he should have a fairly accurate conception of what he may expect for his outlay. While we like to hear the rich rustle of the customer's folding money as well as the next fellow, at the same time we want to hear those words of appreciation that mean the customer will be seeing us again—with another radio job, not a complaint.

-30-

United Air Lines Xmtr.

(Continued from page 33)

then plate modulates the radio frequency channels.

The radio frequency units operate independent of each other. They consist of a crystal oscillator operating at twice the crystal frequency. The crystal oscillator uses an 807 tube and drives an additional 807 used as a buffer. This tube drives two 813 tubes in push-pull which in turn drive 450TH tubes in parallel push-pull Class C. The radio frequency unit to be used is selected by a dial system over a telephone line. This dial system turns on the filaments of the radio frequency unit desired. No radio frequency is generated, however, because the oscillator, buffer and intermediate amplifier stages are biased far beyond cut-off. When a transmission is to be made a button is pressed at the microphone which removes this bias, thereby placing the transmitter in operation.

EASY TO LEARN CODE

It is easy to learn or increase speed with an Instructograph Code Teacher. Affords the quickest and most practical method yet developed. Available tapes from begin-ner's alphabet to typical messages on all subjects. Speed range 5 to 40 WPM. Always ready—no QRM.

MACHINES FOR RENT OR SALE

The Instructograph Code Teacher literally takes the place of an operator-instructor and enables anyone to learn and master code without further assistance. Thousands have used and endorse the Instructograph System. Write today for full particulars and convenient payment and rental plans.



INSTRUCTOGRAPH COMPANY

Dept. NR, 4701 Sheridan Rd., Chicago, Ill.

Representatives for Canada

Radio College of Canada, 54 Bloor St. West., Toronto.

CHEST MICROPHONE

Breastplate "Dispatcher" type. Leaves hands free. Handsome dielectric black finish. Fabric neck-band. Choice of single or double headset, high or low impedance. Available total of 12 dif-ferent types and imp. Incl. 7 1/2 ft. flex. cord. Wt. 8 oz. Most attractive, lightweight rugged practical chest mike yet de-vised. At your dealer or jobber.

UNIVERSAL MICROPHONE CO., LTD.
INGLEWOOD, CAL., U. S. A.

COMMERCIAL RADIO INSTITUTE

A radio training center for over twenty years. Well equipped. Excellent faculty. Practical resident courses in Radio Telegraphy. Broad-cast, Servicing, Industrial, Television, Aero-nautical, Drafting, Mathematics and Studio Technique. Positions Guaranteed. Fall term October 6. Catalog upon request.

Dept. C, 38 West Biddle St., Baltimore, Md.

Arrangements are made for greatly reducing the power of the transmitter when transmissions are made to planes located in its immediate vicinity. All units are supplied with a forced draft from the cooling unit. This cooling unit contains a blower, an air filter and a half horsepower motor. When the temperature in any unit rises above 60° C. (140° F.) the blower is turned on by thermostats located in all units. A door is located in each air duct so that when any unit is pulled from the rack, the air is shut off. The filter consists of a number of cloth bags and serves to keep dust out of the various units. These bags are removable and can be washed in a pail of cleaner in order to remove the dust.

-30-

Police Radio

(Continued from page 38)

Several state systems are realizing the advantages of an f.m. system in providing more reliable coverage across the greater distances which state systems must cover, and are experimenting with the commercial f.m. units now available. We have reports that Iowa, Indiana, Maryland, Virginia, Delaware, New Hampshire, North Carolina, and New Jersey have already purchased f.m. equipment. Michigan is also experimenting with 2-way f.m.

The various departments experimenting with f.m. have reported very reliable reception at distances ranging between 40 and 70 miles from car to station. One of the peculiarities of an f.m. signal noted in this type of work is that the signal remains good until it suddenly drops out when the distance becomes too great. This differs from an a.m. signal which gradually disappears into the background as the car proceeds out of range.

Traffic Control

THE radio-ops at WMDZ, Indianapolis, are confronted with a huge task on Memorial Day each year during the running of the 500 mile speed classic.

On this grand day, when about 40,000 to 60,000 cars roll in and out of Indianapolis, a major traffic problem is made lighter by the co-operation of the radio division of the Indianapolis police.

Several cars equipped with receivers and manned by new home guard organization of Indiana and one airplane equipped with 2-way radio transmitting on the state net frequency aid in routing traffic.

Inspector Robert L. Batts, assisted by Curt Springer and Irvin C. Chapel, worked in the judges' stand relaying the incoming telephone messages from the outlying observation towers and posts to the radio dispatcher at WMDZ who in turn sent the calls to the various cars. Russell E. Nicewanger operated the rig in the plane, dispatching directly to the cars below. However, the dispatches were repeated by the op at WMDZ.

The receivers used in the cars driven by the home guard are only temporary installations, being mounted on the front seat next to the driver, and removed after the event is over. These cars are used both in and out of the field as a safety measure, handling accidents, removing debris from track, etc.

The boys have done a swell job, this being the eighth year they have assisted at the track.

Chatter

DON MURPHY, radio engineer for the Peru, Indiana, Police, is looking up textbooks these days getting ideas lined up

for remoting his transmitter and receivers at WASC. Don believes his 100 watts should get out a lot better, and he is planning on setting up the rig and antenna out of the heart of the city.

Paul Mishler, veteran radiop at Kokomo, Indiana, manages to elude some of the dia-thermy and other man made interference by the use of home made loop antennas on his receivers. He would also welcome any ideas pertaining to the insertion of a squelch circuit in his station house receivers.

The Indiana State Police have recently acquired four new men. James Vokorokos at the Dunes Park post, William More and Glenn Peebles at Indianapolis, and Bill Ives at the Seymour post. We are sure glad to hear of a little hiring for a change instead of receiving reports of men leaving the field.

Ero Erickson, W9HPJ, commonly known as Highway Police Joe to the QPO boys, has made a very interesting survey of the average qualifications of the boys in the Illinois Net. His report shows the average code speed ability of the system as 34 w.p.m. The average typing speed 51 w.p.m. The average years of experience as 8.4 years.

Arnet Curry, communications chief of the Indiana State Police, reports they are in the process of building new phone rigs for the other stations in the state net of the same type used at Indianapolis. Curry is also using the new Doolittle c. w. dial receiving system described in this issue. He will not comment on its performance until he has seen it in service for a few months.

-30-

Ringing the Bell

(Continued from page 35)

the jobber-intermediary.

Nevertheless, this is not to underestimate the pioneering efforts of those jobbers who do a brisk trade in second-hand instruments and apparently find a ready market for certain types. We merely desire to bring home the point that a "trade in" plan by the test instrument manufacturer would be a very difficult undertaking because of the conditions previously stated, and we desired to clear up the question in the minds of some servicemen who profess difficulty in understanding why such a plan could not be used.

-30-

QRD? de Gy

(Continued from page 35)

interpretation of what does or does not constitute a violation of this agreement. If a radiop has been compelled to work more than eight hours out of twenty-four, or to perform duties other than in connection with licensed radio station, the radiop collects at the end of each voyage to the tune of \$1.00 per hour, and the skipper does the explaining to the company. . . .

There is also a first, quote, a radiop's port time is his own except for duties directly connected with the job he is hired for, such as inspections, repairs, etc. Unquote. There are a few other firsts but as space is limited we end this agreement with the substantial wage of \$150.00 per month. And after four years of these clean, concise and courteous contracts between shippers and the CTU-Mardiv officials we repeat "these have been accomplished

without strikes, lockouts, loss of wages or bloodshed."

BROTHER LOUIS J. KLEINKLAUS, *GST-CTU-Mardic*, advises us that a bill, *H. R. 2662*, fathered by Congressman Dirksen proposes sweeping changes in the method of hiring of seamen, the outlawing of strikes, the "control" of subversive literature on shipboard, and many other departures hard to envision. . . Radiops come into the bill in the last paragraph which would amend the *Communications Act of 1934* as amended, providing that licenses of radiops shall be revoked for various minor offenses, instead of the suspension that now prevails. In addition, the proposal states that all outstanding licenses "when the bill is enacted" shall be cancelled within 180 days. The bill does not go on to say what takes place from there on. We are left to the conclusion that the *Communications Commission* can either renew those they wish, refuse to renew others, or require the re-examination of all license holders, or the production of certain specified evidences.

But in spite of these sharp proposals it is believed that the bill is aimed primarily at the ridding of the marine industry of subversive activity. There is the indication that a showdown is near between the totalitarian groups (disguised as unions and the government. Since the party line changed prior to the last Presidential election, all opposition possible has been placed in front of every government project, no matter what its scope or object. And now that Washington has embarked on a definite course of action, it is believed that a real fight is soon to be witnessed. . . the government coming out on top, you betcha. And so another bill against subversive activity in the American Merchant Marine. . . seems like it all can't be but scuttle-butt. We hope one of these bills go thru. P.D.Q.

IT'S a lie, a dastardly unwarranted lie to even think that Brother Walter Broomall had joined a stevedore union. Although he was seen toting fifty-pound sacks of sugar along a dock, he has an explanation. It seems that Broomy met up with a couple of British ship officers and after a few sociable Zombies he learned, to his horror, that along with torpedoes, mines, bombs and other missiles tossed by the playful Nazis, his British friends had to put up with a shortage of sugar for their tea. Another tea party, sez you, but this was vicky verky, as the saying goes.

Since Broomy's boat was docked at a sugar refinery, literally surrounded with mountains of sugar, the irony of this situation bit deep into his sensitive soul, and after a few more Zombies he decided that something should be done about it. A "Bundles for Britain" movement was inaugurated on the spot. The refinery manager entered enthusiastically into the scheme after Broomy, the bartender, the oiler of a Latvian ship, a barge captain, two small boys and somebody's dog visited him in his office and talked quietly but firmly to him for a couple of hours. Not content with inaugurating the movement, Broomy saw it thru by personally carrying the sugar aboard the Britisher in spite of a heavy rain. She sailed next day on her weary, dangerous way with supplies for her fighting people. And we are happy to think that no matter what happens to her, Broomy saw to it that there would be a good cup of tea waiting for her men when the fight was finished.

FRED FISH, ex-radiop Nyvy, now editor *Navy News*, is in the dumps. All of his old shipmates are back in the service, drawing down plenty of what-it-takes, base pay, rent allowance, ration allowance, etc., with plenty of time off, and he is chained to his desk working like a Trojan. Fred doesn't like it, thinks there is no justice and will rectify matters as soon as he can tear himself away from his work. Which we doubt. Because an editor, as a general rule, grins, growls and groans after every dead-line but loves the work, just the same. So as even you and me. . . So keep the home fires banked, your flintlock dry and the bore-sight clean 'cause we may be goin' places and ringin' door bells. And with a cheerio. . . 73. . . ge. . . GY.

Video Reporter (Continued from page 39)

markable job of "boiling down" the technical video situation. What seemed a hopeless task emerged as a job well done. True, not all the wrinkles were ironed out and matters between television competitors have not quite passed the *solito voce* name-calling stage. But, at least, there isn't as much fist-shaking in the industry as once existed.

More than 160 technical experts participated in the studies and discussions of the various *NTSC* panels. No single firm could possibly have employed this array of radio engineering talent.

It is obvious that many of these experts were bound to the policies of the companies they represented and couldn't come around to accepting competitors' views even when they may have been more logical. And, perhaps, they can hardly be criticized for that.

Even though *NTSC* is a thing of the past, it is gratifying to know that at least part of its scope will remain alive under the *RMA* engineering banner.

THE New Deal's promotional facilities embrace, in some observers' minds, crackerjack examples of showmanship. And the *Federal Communications Commission* gets its full share of ballyhoo spotlighting.

In an effort to let enquirers know what makes radio tick, the *FCC*, via the *U. S. Government Printing Office*, is distributing a booklet entitled "Radio—A Public Primer." And it is apparent that the thing that interested the *Video Reporter* most in this industrial "ABC" was the chapter on television.

Here, in simple outline, is an elementary outline of television in the U.S.A. and, for capsule education, it is an interesting job. Technical experts may find some fault with such a rationalizing description of television transmission as the following quoted example:

"The scene in the television studio or elsewhere is photographed by a camera and the accompanying sound is recorded by a microphone. The camera is equipped with a special vacuum tube which changes the image into a series of electrical impulses."

But it must be agreed that, in a nutshell, it tells the story satisfactorily for the lay mind.

WHAT has happened to all the video receivers that were proudly displayed and demonstrated in prominent New York department, radio and furniture stores not so long ago?

Everyone concerned doesn't seem eager to talk about the topic. One thing is certain: the sets weren't all sold. Undoubtedly the bulk of them went back to manufacturers' warehouses. In all, due to the short-lived "regular" television program schedule, retailers are not too keen about this thing called television. And it's all due to their past experience.

Dealers like to handle lines that move. Display space is at a premium in busy shops and it is important to cash in on every inch. True, television demonstrations attracted some persons into the stores and getting a potential buyer into the shop—even if he doesn't buy anything immediately—is not to be sneezed at.

But, when television programs suddenly ceased and then resumed on a schedule that was only a ghost of its former self, those curiosity seekers—and certainly the dealers, too—can't be too keen about the whole thing.

As a result, even when the *FCC* sanctions commercial television—and when the manufacturing industry wholeheartedly supports it, there's a tremendous job ahead in arousing the interest of the prospective purchaser and the dealer who both feel that television once let them down.

Hence, it is essential that a unified industry campaign be put behind video receivers when they hit the market in volume.

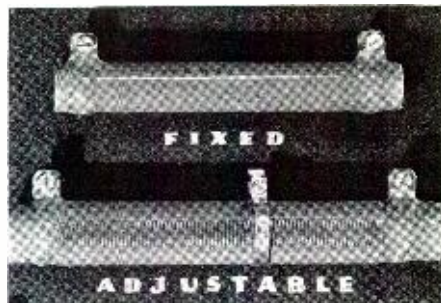

RESISTORS WITHSTAND MOISTURE

The elimination of minute cracks due to its crazeless structure, enables Ward Leonard enamel to withstand humidity, moisture and immersion better than any other known enamel or protective coating.

Send for circular 507. It not only gives Resistor data and prices but other valuable information for hams.



WARD LEONARD ELECTRIC COMPANY

47 South Street, Mount Vernon, N. Y.



Don't confuse this big book with any catalog you've seen before! When you get your free copy, you'll see why—it's complete. Whatever the wiring diagram or service job calls for, you'll reach for your Lafayette catalog—and find it! You'll be surprised at the low prices, too, 'till you remember that Lafayette is the largest radio supply house in the world today!

you'll be glad we suggested
MAIL THE COUPON TODAY!

Lafayette
FOR RADIO VALUE

NEW YORK, N. Y.
100 Sixth Ave.
CHICAGO, ILL.
901 W. Jackson Blvd.
ATLANTA, GA.
245 Peachtree Street
BOSTON, MASS.
BRONX, N. Y.
NEWARK, N. J.
JAMAICA, L. I.

Lafayette Radio Corp., Dept. 2G1
901 W. Jackson Blvd., Chicago, Ill.
or 100 Sixth Avenue, New York, N. Y.

Please Rush FREE Catalog.

NAME _____
ADDRESS _____
CITY _____ STATE _____

Serviceman's Chart to Cure Hum

(Continued from page 25)

- | | | |
|--|--|--|
| <p>43. Field of filament inducing hum volt-in grid or plate circuit.</p> | <p>43. (a) Replace tubes one at a time and compare hum level.
(b) Note whether filament wiring passes near grid or plate circuits of any tubes.
(c) Note whether filament wiring is twisted.</p> | <p>43. (a) Replace tube.

(b) Re-locate filament or grid wiring.
(c) Twist filament wiring or shield grid and filament wires.</p> |
| <p>44. Hum in oscillator plate supply circuit.</p> | <p>44. (a) Disconnect mixer tube.

(b) Remove oscillator tube.

(c) Disconnect mixer-osc. tube plate lead.

(d) Insert plate filter (resistor and condenser) in osc. plate lead.</p> | <p>44. (a) Insert choke condenser or resistor condenser filter in plate circuit of oscillator to obtain better filtering.
(b) Insert choke condenser or resistor condenser filter in plate circuit of oscillator to obtain better filtering.
(c) Insert choke condenser or resistor condenser filter in plate circuit of oscillator to obtain better filtering.
(d) Insert choke condenser or resistor condenser filter in plate circuit of oscillator to obtain better filtering.</p> |

rough checks, first to localize it in one area and then to check specifically in this area until the cause is accurately found.

Then it shows what correction to make to obtain hum-free operation again.

If a service man will follow these instructions long enough to make them habitual, he can become an expert on detecting hum intelligently and quickly.

-30-

Aviation Radio

(Continued from page 43)

A trend toward the manufacture and general acceptance of "portable" a.c.-d.c. sets has been noticed during the last two months. RCA announces a new three-way aviation portable receiver. It's a 110 volt a.c.-d.c. battery operated set and uses 6 tubes in a superhet circuit; and covers the weather-beacon-broadcast bands. It may be used either in the office or in the plane for flying the beam and is known as *RCA Model AVR-102*, for those who would like to obtain service information about it.

Lear Avia, Inc. is also manufacturing a new portable which incorporates a new interphone circuit which may be used for communicating with the passengers in an aircraft or for student instruction purposes. The receiver provides frequency coverage in three bands: the regular weather-beacon-broadcast bands, and an additional band which covers those frequencies used by the airlines, private flyers, Army and Navy, etc., i.e., 2200-6300 kcs. It's an a.c.-d.c.-battery operated set and either a loudspeaker or headphones may be used.

Servicing

ON the receivers just mentioned, in all cases, follow the alignment procedure given in the instructions packed in the carrying case. There are separate adjustments that must be accomplished in turn. Always place the loop antenna in the same position it will be in when the set is in the cabinet; and when adjusting oscillator, r.f. and loop trimmers, do not connect test oscillator to loop, but make a loop of five to ten turns of No. 20 or 30 size wire on a three-inch form and attach across output of test oscillator. Place the test oscillator near the set loop and be certain that neither moves while aligning. If the set does not operate when the headphone plug is removed from the jack, check the contacts of the plug to make certain that they make correct contact. Because of the "heavy duty construction" of these receivers, very little trouble will be experienced with them; other than making periodical checks on the batteries and tubes.

From the Mail Box

FROM the many letters received from our readers, we have gathered that many of them are wholly qualified to work as aviation radio operators, servicemen, etc., but it seems they do not know where to apply for these jobs. A letter, stating your qualifications, directed to the attention of "The Personnel Manager" of any one of a number of aviation radio factories, Airlines, etc., should bring a prompt reply in the form of a request to appear for an interview. In some cases, the reply will be in part, a notice to report for work. Aviation Radiomen are needed; if you can qualify, apply NOW! On the other hand, if you are in doubt as to who you should write to (concerns) a stamped self-addressed envelope will bring you the information you desire; a personal answer is always given.

Facsimile

TODAY, aviation is making ready use of all available radio aids, both to navigation and air to ground communication. Due to the emergency now existing, many developments have made their preliminary "bows." A word from a reliable source indi-



40,000 Civilian Flyers for Home Defense?

Do you know that there are 17,000 light planes and 40,000 private pilots in America? Could this potent "air militia" be used as a weapon in an emergency? Is the United States government overlooking one of the greatest defense organizations in world history? Read "Private Warplanes" . . . one of the many timely and authoritative articles on flying you'll want to read in this month's fact-filled, picture-packed FLYING and POPULAR AVIATION.

JULY ISSUE



NOW ON SALE AT ALL NEWSSTANDS!



(Explanation continued from page 23)

dial thus cutting out the station and the hum should stop. Upon tuning in a station again, the hum will come in along with it. For modulated hum, look under that heading for detailed checks.

List of Trouble Areas

The foregoing simple and rapid checks should by now have placed the cause of the hum in one of the areas listed below. The checks to locate the defective part in the area will now be listed by sections. Here is where the judgment of the service man will come in for he is to choose which one of the checks listed is the better to apply for each case.

The areas in which the faults are to be localized are:

- (a) Power Supply.
- (b) Antenna—Ground.
- (c) Audio Frequency.
- (d) Loud Speaker.
- (e) Miscellaneous, i.e., in one of several places.
- (f) External to foregoing circuits.

Summary

The forty-four causes of hum listed constitute by far, the most common of all those responsible. They have been classified, with the means of tracing them, for the first time so far as known and in such order that they can be easily referred to for practical use.

In "running down" the hum, the chart gives directions how to make

cates that facsimile equipment as designed for aircraft use is being considered for installation in observation type aircraft. For sometime now, facsimile equipment for aircraft has been on the market. Notable is the equipment of *Finch Tele-communications, Inc.*

Nomenclature

HAVE you ever been around an Army airport and heard the radio operators and mechanics conversing? If you have, you no doubt have wondered during the course of their conversation what they were talking about. Here is a little bit of Army radio slang.

"Fish," trailing antenna weight; "coffee grinder," antenna reel; "antenna blues," bad reception—no contacts made; "static bender," aircraft radio operator; "AACs," Army Airways Communications System; "bum flipper," poor radio telegrapher (poor fist); "denatured gin," distilled water; "dit-happy," talkative radio operator; "batting 'um out," sending fast; and "weak kitten," radio operator susceptible to air sickness.

Kinks of the Month

THOSE of you who operate in aircraft using a trailing wire antenna sometimes encounter icing conditions which soon snap the antenna if it isn't reeled in. By attaching a small can with a small spout arranged for drip purposes, near the antenna fairlead, filled with glycerin; and allowing a slow drip while the antenna is being reeled out, icing is held to a minimum. But it is to be remembered that twisted, cotton core wire, should be used for the antenna in this case, because if a single strand wire was used, the glycerin would be blown off by the "slip-stream." By using twisted wire, a certain amount of the liquid is retained which acts somewhat as a "deicer." [Our apologies to "Smilin' Jack!"] Ed.]

A well known make of receiver recently became inoperative due to "hermetically" sealed transformers leaking compound, tightening the shell retaining nuts cured this defect.

Due to the limited space found at most airports for the installation of receiving antennae, it has been found that a compromise must be made between over-all length and height for a particular location.

At some airports it has been necessary to run transmission lines to the receivers in the operating room for quite some distance; and the problem of installation has become a major one at most modern airports due to hangar construction, etc. However, by employing balanced line feeders, maximum signal with minimum background noise has been obtained.

For receivers operating at high frequencies, vertical antennae have been employed; and it has been found that these antennae work very well if in the clear away from metal hangars, steel beams, etc.

The problem of coping with metal obstacles that inevitably "absorb" signals that must be received, especially signals of high frequency, has been solved by suspending a horizontal antenna some distance away from obstructing material and tuning the receiver feeders. Of course, one antenna being used for one frequency, and it is usually cut to that frequency.

Where distant communication is necessary, a spaced antennae array, composed of four antennae spaced 90° apart, cut to frequency, has been tried by the writer with much success.

A rotary switch which connects any one of the four antennae to a receiver is installed on the operating panel.

When bad fading occurs, the operator manually operates the rotary switch and "cuts" in one of the four antennae. The shift in phase difference is accomplished by the switch and fading is usually reduced greatly.

Relay switching has been tried, utilizing the output of two tubes 180° out of phase on input audio, and as the plate current is reduced due to minimum signal input, the relays switch their respective antenna into the receiver. This system works after a fashion, but "phase difference balance" is hard to obtain.

When time becomes available, further experiments will be conducted with this "brain child system." However, it isn't impracticable.

Odds 'n Ends

RADIO receivers for ground radio station use vary in design because of different service requirements. Not so many years ago, station operators had to contend with frequency drift, man-made static at high frequencies, "standby static," and other undesirable features that are now non-existent or greatly reduced.

With the installation of voltage stabilizing elements in modern day receivers, oscillator drift at both high and low frequencies has been minimized to a large degree. Continuous operation of receivers does not change the frequency characteristics noticeably, and noise limiting circuits have been perfected which cuts the man-made static that made high frequency communication somewhat impossible a few years ago to a minimum.

New "standby static" eliminating circuits have been perfected to the point where no noise of any kind is heard during standby periods. This is appreciated by those operators who have to listen to more than one receiver tuned to different standby frequencies for lengthy periods.

At a typical aviation radio ground station, various receivers might be tuned to 3105, 6210, 4495, and 5170 kilocycles. If these receivers were continually on, and the radio operator had to listen for calls from an aircraft whose transmitter is tuned to any one of those frequencies, for any length of time at high noise levels; it wouldn't be long until a "straight-jacket" would have to be provided for the said operator!

Crystal circuits in modern day "standby" aviation radio receivers provide a means whereby the control of any one frequency is held within a very narrow "kilocycle margin," and it can be said here that there will be very few receivers manufactured during the next few years that are to be used in aviation radio ground stations that do not incorporate at least one crystal "filter" circuit.

When engineers design the ground station receiver a "saturation temperature" point is usually calculated within limits and with the addition of voltage ballasts, part deterioration due to temperature rises are minimized. However, it has been found that certain parts, such as condensers, etc., that are wax filled sometimes do "drip"; and this causes high resistance connections especially if the wax drips around tube socket connections, etc. A small piece of asbestos placed between the chassis and the offending part, or between the offending part and a heated transformer, etc., will minimize dripping.

"Dripping" is quite prevalent in receivers that are used continuously without a certain amount of "let-up," and a periodic inspection should be made of parts that employ wax "filler," in order to prevent complete "dripping."

-30-

What's New in Radio

(Continued from page 38)

tion, enormous sensitivity, low noise level, low dark current, freedom from distortion, and relatively low cost, the 931 has practical application in light-operated relays, in sound reproduction from films, in facsimile transmission, and in other operations involving high quality optical signals.

The 8001 is a transmitting beam pentode suitable for power amplifier, modulator, and oscillator service. Because its driving power requirements are low, and because neutralization is generally not required, the 8001 is particularly useful in all hand transmitter designs. In class C telegraph service, the 8001 will provide a power output of approximately 230 watts at frequencies as high as 75 megacycles. Its plate dissipation is 75 watts.

(Continued on next page)

Pocket Tester FOR THE AMATEUR

TRIPLET
Model 666-H



\$15.95
Net Price

Size:
3-1/16"
x 5 5/8"
x 2 1/2"

5000 VOLTS SELF-CONTAINED

Model 666-H Volt-Ohm-Milliammeter is a complete pocket size tester—with AC and DC Voltage ranges to 5000 Volts (self-contained), AC and DC Voltage at 1000 ohms per volt 0-10-50-250-1000-5000; DC Milliamperes 0-10-100-500; Resistance 0-300 ohms; shunt type circuit, 10 ohms reading at center scale; 0-250,000 ohms, series type circuit, 3700 ohms at center scale. Higher resistance measurements available by using external batteries. Selector switch for all instrument readings. The Ideal Pocket Volt-Ohm-Milliammeter for amateurs, radio technicians, industrial engineers, research. Black Molded Case and Panel, Completely Insulated . . . With RED • DOT Lifetime Guaranteed Measuring Instrument. . . Dealer Net Price . . . \$15.95

"See Triplet's 1941-42 Line of Test Equipment—Booths 720-722—Chicago Radio Parts Show."

WRITE FOR CATALOG!
Section 157 Harmon Avenue

THE TRIPLET ELECTRICAL INSTRUMENT CO.
Bluffton, Ohio

Do You Want
A BETTER
RADIO JOB?

• CREI Technical Training Is Enabling More Than 5000 Professional Radiomen to Prepare for Good-Paying Radio Jobs—

Stop fooling yourself! The good jobs—the permanent jobs in radio don't come easy. The sure way to success is to build your future on a sound foundation of knowledge and ability. The ability you develop is your assurance of a steady, sure income. Ability can be developed now by combining your own radio experience with modern CREI advanced technical training.

THINK THIS OVER:—

Actual Records Show—
• CREI graduates, as a group, are among the highest paid in radio! • CREI men are in more than 400 broadcasting stations! • More than 5,000 radiomen have taken this course of training! • Employers are increasingly calling upon CREI for graduates for personnel replacements and additions!

WRITE FOR FACTS TODAY!
Our free booklet and personal recommendations may hold the answer to your future success. In your inquiry, please state briefly your background, education, present position—and whether you are interested in Home Study or Residence training.



CAPITOL RADIO
ENGINEERING INSTITUTE

Dept. RN-7, 3224 16th St., N. W., Wash., D. C.

Allied Radio Corporation, Chicago, presents a new 6-tube 3-way portable radio, Model B17115. This new lightweight receiver is easily portable and offers reception from either a long-life battery of any 110-125 volt, 40-60 cycle a.c. or d.c. source. The modern RCA and Hazeltine licensed circuit uses the latest low-drain tubes as follows: 2—1N5GT, 1A7GT, 1H5GT, 3Q5GT, 35Z3GT.



Advanced features include: special r.f. stage for extra sensitivity; big full-vision clock-type dial; A.V.C.; built-in "Magna-Beam" loop aerial; heavy duty 3-gang tuning condenser; PM Dynamic Speaker, etc. The battery pack provides 200-250 hours of service. Tuning range is from 540 to 1650 kc. The modern case is styled in two-tone Brown and Ivory leatherette. A drop-front disappearing lid can be locked for protection. Has sturdy carrying handle and leather name tag. Size: 12 3/4" x 9 1/2" x 6 1/2".

NEW KNIGHT STATION LOCATOR. Allied meets the heavy demand for re-setting radio set push-buttons by placing on the market a new low-priced Knight Station Locator, No. B10060. Approximately 784 American stations have made a ten to forty kilocycle shift on March 29th, bringing an avalanche of calls for servicemen everywhere to re-set receivers in accordance with these frequency changes. The especially designed Knight Station Locator easily solves the serviceman's problem even if the station should be off the air at the period of adjustment. No direct connection to the radio is necessary. A drift-free oscillator generates either a modulated or unmodulated signal at the flip of a switch. An easily read and simply cali-

brated dial identifies all stations; covers the entire broadcast band. This versatile unit



may also be used to service auto radios. Operated from self-contained standard batteries, the Station Locator measures 3"x4"x5" and is housed in a portable black crackle-finished case.

TERMINAL SLIP-THROUGH MOUNTING OF X-MITTING CONDENSERS. Simply drill two holes large enough to slip through the pillar terminals, and properly spaced apart. Drill two smaller holes to take the bolts that hold the mounting ring. Now slip the pillar terminals through the holes, fasten the mounting ring or bracket, slip through the bolts and tighten up. That's all there is to a mighty neat job. Incidentally, this arrangement keeps that "live" stuff beneath the chassis platform where you can't come in contact with it. *Aerocox Corporation, New Bedford, Mass.*

ALUMINUM SUBSTITUTE AIDS DEFENSE. *Audio Devices, Inc.*, announces a new glass base recording blank. More than a million pounds of aluminum used each year by manufacturers of instantaneous recording discs can now be used in the production of bombers, pursuit planes, ships, and other means of defense without affecting radio broadcasting. *Audio Devices*, of New York, leading producer of professional instantaneous recording discs, announces the successful production of glass base recording blanks.

Instantaneous recording discs are blank records on which sound can be recorded and played back immediately or at any future time without further processing. Formerly, due to the particular adaptability of aluminum for this purpose, discs were all made with a base of this metal, covered with an acetate coating. In this coating the sound track is cut.

These discs are extensively used in radio broadcasting, motion picture production, educational institutions and as master discs in the production of phonograph records. Various branches of the government, such as the FBI, Army and Navy are also large consumers.

Due to the expanding defense program and resulting priorities, manufacturers of instantaneous recording discs found their aluminum supplies completely cut off. As in many other industries, an intensive search for an adequate substitute resulted.

The solution to this problem was not so simple. An adequate base for these recording discs must be thin, completely flat, flawlessly smooth, free from any tendency to spring or warp and have a surface to which the acetate coating will properly adhere.

Audio Devices, finally, by new technique in cutting and drilling the glass, has produced a disc on which recorded sound is reproduced as perfectly as modern science can achieve—as well as, if not better than, on the standard aluminum base discs. Recording engineers of leading networks and studios have acclaimed its excellent tone

SERVICEMAN'S CASE HISTORIES

Reprinted with permission, from **RADIO Trouble Shooters Handbook**, Copyright, 1939. Radio & Technical Publishing Co. Copyright in Canada and Great Britain, and all countries subscribing to the Berne Convention, by Radio & Technical Publishing Co. All rights reserved.

GRAYBAR GB-310

(Uses same chassis as RCA Radiola 62 receiver.) See the Case Histories listed for the RCA Radiola 62 receiver

GRAYBAR GB-500

(Uses same chassis as RCA Radiola 44 receiver.) See the Case Histories listed for the RCA Radiola 44 receiver

GRAYBAR GB-550

(Uses same chassis as RCA Radiola 46 receiver.) See the Case Histories listed for the RCA Radiola 46 receiver

GRAYBAR GB-600

(Uses same chassis as RCA Radiola 66 receiver.) See the Case Histories listed for the RCA Radiola 66 receiver

GRUNOW 4B

Distortion 1) replace 0.02-mfd. coupling condenser (Part No. 29567)

GRUNOW CHASSIS 5A

Inoperative 1) flashing occurring between (no plate voltages) the hum-bucking coil and the speaker winding, destroying the field coil leads. (Although factory diagrams do not show a hum-bucking coil in the speaker, some of these sets have them)

GRUNOW CHASSIS 5B

Motorboating, . . 1) open-circuited 20-mfd. filter Weak reception on local stations only condenser. Replace with new unit across the terminals of the old unit on condenser bank

2) open-circuited 8-mfd. filter condenser. Repair similar to above

60-cycle Hum. . . 1)

flashing occurring between the hum-bucking coil and the speaker winding, destroying the field coil leads. (Although factory diagrams do not show a hum-bucking coil in the speaker, some of these sets have them)

2) loose laminations in filter choke

3) faulty filter choke coil. Replace

Set draws 1) due to large capacity of the current after condenser jammed in behind being turned off. (dial-light glows dimly)

leads from output transformer touch the cone. Move them further back and fasten them to prevent them from returning to the cone

Rattle in 1) loudspeaker

GRUNOW CHASSIS 5E

Motorboating, . . 1) check the 0.1-mfd. 400-volt plate filtering condenser (No. 38726)

GRUNOW CHASSIS 5G

Distortion 1) replace "coupling" condenser between '75 tube and '42 tube. Use a good quality high-voltage condenser for replacement

GRUNOW CHASSIS 6A, 6C

"Mushy" recep- . . 1) suspect high-resistance leakage in the 0.01-mfd. audio coupling condenser between the plate of the '75 tube and the grid of the '42. Leakage toward "maximum." Poor tone resistance even as high as 5 to 10 megohms is sufficient to impair reception. A neon condenser tester will reveal this trouble, but an ohmmeter will frequently fail to show it unless it has a sufficiently high range. Replace with a 600-volt type unit

Inoperative. . . . 1) Weak

check 0.02-mfd. condenser by-passing plate supply of 6D6 r-f stage for a "short." The 2,000-ohm 1/4-watt resistor in plate circuit of same tube will also likely be damaged if this condenser "shorts"

GRUNOW CHASSIS 6D

See also Case History listed for Grunow Chassis 6F
Set dead 1) short-circuited lead in con-

LEARN RADIO SERVICING-8 WEEKS OPERATING-5 MONTHS

"LEARN BY DOING"

Actual shop training on real equipment. You don't need previous experience. Prepare for Radio operator's Government license and for good jobs in Broadcast, Police Radio, Aircraft stations, ships, commercial radio stations, or for good jobs in Service Shops, Radio manufacturers and many other branches of Radio. Greater opportunities in Radio today than ever before.

EARN WHILE LEARNING

If you need part time work to help out with living expenses we will help you get it. Employment service after graduation.

FULL FINANCE YOUR TRAINING

You don't need to lay out a lot of money for Coyne training for on my "pay after graduation" plan you can get your training first and pay for it in easy monthly payments after your training period is over. Mail the coupon today and I'll send you my big free book and tell you all about my plans to help you—even if you don't have much money to lay out. Don't delay. Send the coupon today and get all the facts with no obligation on your part.

H. C. Lewis Pres.

COYNE ELECTRICAL SCHOOL, Radio Division
500 S. Paulina St., Dept. B1-3K, Chicago, Ill.

Send me all details of "Pay-After-Graduation" Plan and BIG FREE Illustrated Book on RADIO.

NAME _____
ADDRESS _____
CITY _____ STATE _____

block, as negative Intermittent reception Hum Motorboating when vol. control is turned to reduce volume Distortion (especially on low vol.)

denser block. This necessitates replacement of entire lead is tied inside it faulty type 75 tube (even though it may test O.K.). Replace with new tube install a low-voltage type 12- to 20-mfd. electrolytic by-pass condenser across the 6,000-ohm bias resistor connected to the cathode across this resistor

Motorboating when vol. control is turned to reduce volume Distortion (especially on low vol.)

GRUNOW CHASSIS 6F

Inoperative, Weak (early models) (receiver voltages low)

or reduced by connecting resistor in parallel with the condenser. A 40,000-ohm 5-watt carbon resistor (Part No. 31421) can be used for this purpose. Connect it across the black and white leads of the 8-mfd. filter condenser which connects directly across the output of the '80 rectifier

GRUNOW CHASSIS 7A

Inoperative, Intermittent reception

replace the 14,700-ohm section of the Candohm resistor with a 15,000 ohm, 10-watt wire-wound unit

faulty 0.1-mfd. condenser in block behind tuning gang. Identify it by a green lead which is connected together with two red leads to a common terminal at the left rear of the short-wave switch. Replace with a 600-volt unit.

GRUNOW CHASSIS 7B

Inoperative at high-frequency end of dial, (trouble corrected by shifting band switch from broadcast to short-wave band and back again)

Intermittent reception

check the two 0.1-mfd. condensers connected between the lower end of the r-f coils and ground. They are enclosed in a small can fastened to the bottom of the coil shields. The connections are made by wire leads inside the shield—the lugs on the can are "blanks"

GRUNOW CHASSIS 7C

Intermittent reception

too much delay in AVC circuit. Replace all the 0.1-mfd. by-pass condensers in the grid circuits of the type 600-volt units

leaky electrolytic filter condensers. Replace with new 8-mfd. units, leaving the shield off

voice coil rubbing. Recenter "leaky" 0.25-mfd. condenser in 2nd-detector plate resistance network. This is one of 6 condensers in a block and is identified by a black and connects to the junction of the two 0.1-megohm resistors. The other end of this condenser "grounds" inside the can

faulty type 6B7 tube (even though it may test O.K.). Replace with new tube

GRUNOW CHASSIS 7D

Motorboating and "blocking"

due to the two large square coil shield cans mounted to large under the condenser gang working loose. Ground each can to the chassis with "bonding braid"

GRUNOW CHASSIS 7E

Loss of volume, Noisy reception, Inoperative, Dual-ratio drive, does not stay in low ratio position, Microphonic noises

faulty volume control. Replace dirty or corroded grounding arms which hold the variable condensers in place. Clean them with fine sandpaper

loosen the two small bolts on the drive-sleeve assembly; push the drive sleeve back slightly, re-tightening the screws as tightly as possible chassis bolts too tight. Loosen bolts

shafts on chassis touching the wood of the cabinet

GRUNOW CHASSIS 7F

Inoperative

leakage in r-f coil between primary and secondary windings. If this condition exists, there will be about 50 volts in the AVC circuit

GRUNOW CHASSIS 8A

Weak

"leakage" in filter condensers (through the fibre protective covering to the close-fitting can) causes a low-resistance short condition of the output tube's bias resistor. Check the condensers

2) make sure that all filter condensers are insulated from the chassis—remember this also when replacing condensers

Inoperative, Intermittent reception

check the by-pass condenser block and voltage divider. The "high" side of the latter should be 17,500 ohms, and the next section from there to ground should be 14,700 ohms. Use 10-watt wire-wound units for replacement

GRUNOW CHASSIS 8B

Volume cannot be reduced on local stations

"open," or short-circuited second-detector cathode by-pass condenser. Replace, if necessary, with an 8-mfd, 25-v. unit

Fading

check first detector plate by-pass condenser No. 39, i-f plate by-pass condenser No. 38, and AVC condenser No. 36 for leakage. Replace if necessary

try reducing the value of coupling condenser No. 29 and 0.01-mfd.

"leaky" coupling condenser No. 27 (between plate of 37 tube and grid of 42 tube). Replace the grid resistor with a 0.05- or 0.1-meg. unit. Also replace coupling condenser No. 27

GRUNOW CHASSIS 9A

See also Case Histories listed for Grunow Chassis 7A

Fading

if fading occurs when volume control is touched, check the 0.04-mfd. condenser which connects from center tap to ground. Use 0.05-mfd. for replacement

GRUNOW CHASSIS 9C, 9G

Inoperative after being switched from "broadcast band" to "S. W."

faulty 6A7 detector-oscillator tube (trouble will not usually show up in a tube checker). It may be necessary to try several new 6A7's before a suitable one is found.

align the receiver carefully

GRUNOW CHASSIS 11A

See also Case Histories listed for Grunow Chassis 7B

Oscillation

high-resistance connection between shield and socket of type 6C6 tube. Drill out mounting rivet, replacing it with a 3/32 brass machine screw and nut. Place a soldering lug under this screw on the underside of the chassis, and ground this lug to the chassis

Very short tube filament voltage runs too high even when line voltage is normal. Install a line-voltage regulator to reduce the line voltage slightly

GRUNOW CHASSIS 11G

Inoperative

check for screen voltage on 6K7 1 tubes. If no voltage—0 or low voltage—check 0.1-mfd. 200-volt tubular screen by-pass condenser (Part No. 29,135) (connected from screen of the first i-f tube to ground) for "shorted" or "leaky" condition. Replace with 0.1-mfd. 600-volt unit

GRUNOW CHASSIS 12A

Low volume, Distortion

speakers out of phase—polarity of their terminals reversed. Test by shorting out voice coil in large speaker and reversing the polarity of one of the small speakers. Connect leads of one of the small speakers in the position which give best response. Then do the same with large speaker, connecting leads in position which gives best output

GRUNOW 60

Distortion

a-f coupling condenser "leaky." Replace this condenser regardless of how it checks

GRUNOW CHASSIS 65B, 65C

Same Case Histories as those listed for Grunow Chassis 5B

GRUNOW MODELS 150, 160, 170

Inoperative (no voltages on any tubes)

faulty dual 8-mfd. electrolytic condenser. For replacement use a high-grade unit having low leakage

GRUNOW MODEL 500

See Case Histories listed for Grunow Chassis 5A

GRUNOW MODEL 501

See Case Histories listed for Grunow Chassis 5B

GRUNOW MODELS 520, 530

Same Case Histories as listed for Grunow Chassis 5B

GRUNOW 512

Inoperative (on short-wave bands only)

set switch to short-wave position. If no signal is obtained when control-grid of 6Q7 tube is touched with finger, replace 0.02-mfd. by-

WANTED!

Radio Operators

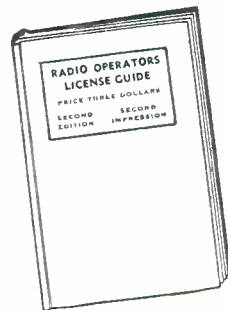

National Defense Program Creating Many Openings for Radio Operators...

- ★ NOW is the time to capitalize on your radio training and experience by obtaining a commercial operator's license and taking advantage of the many opportunities presented!
- ★ The "RADIO OPERATORS' LICENSE GUIDE" has been especially prepared as a study and reference manual for those radiomen having considerable training and experience who are unfamiliar with the exact requirements for a commercial radio operator's license.
- ★ Containing over 1,250 questions and answers to the new type examinations, it will aid you to pass the tests. Purchase from your local parts distributor or order direct. Postpaid only..... \$3.00

WAYNE MILLER

The ENGINEERING Bldg. • • • Chicago, Ill.

RADIO made EASY

LEARN AT HOME - IN SPARE TIME!

36 VOLUMES in 1 Big Book!

- Broadcasting system
- Sound Music
- Electric Current
- Elec. Units; Ohm's Law; Batteries
- Magnetism
- Electromagnetism
- Electromagnetic Induction
- Inductance
- Capacitance; Condensers
- A.C. Circuits
- Filters
- Measuring Instruments
- Radio Waves
- Broadcasting
- Receiving
- Vacuum Tube Principles
- V.T. Characteristics
- Vacuum Tube Construction
- V.T. Detector and Amplifier Action
- Radio Frequency Amplification
- "Superhets," R.F. Amplifiers; Tuning Coils
- Audio Amplifiers
- Loudspeakers
- Battery Receivers
- Power-Supply Units
- Electric Receivers
- Auto and Aircraft Radio
- Phono Pick-ups; Public Address
- Short-Waves
- Photoelectric Cells; Cathode-Ray
- Television
- Antennas and Grounds
- Sound Pictures

Ghirardi's COMPLETE Course will train you QUICKLY

Here's your BIG CHANCE to get a thorough training in basic RADIO FUNDAMENTALS—quickly, easily. There are BIG OPPORTUNITIES and lots more jobs for men with radio training—in radio factories, in radio service shops—and in all branches of the Army and Navy.

RADIO, SOUND, TELEVISION —MADE EASY AS A. B. C.

Ghirardi's famous RADIO PHYSICS COURSE is the cheapest, quickest radio training you can find. The whole science of Radio, Sound, & Television in a form completely intelligible even to beginners without any previous radio experience. Clear explanations and 856 self-testing Review Questions make it as easy to understand as a primer. Thousands of successful radio men got their start with this book, and it's used by more radio schools and students than any other radio text in the world! Get this whole 972-page course today for only \$4—and get started on your own radio career!

Use it 5 Days —OUR RISK! Your money back if not fully satisfied. Don't delay—get started now! mail this coupon at once!

972 Pages
508 Illus.
\$4
Only \$4

CLIP OUT—AND MAIL!

Radio & Tech. Publ. Co. Dept. RM-71, 45 Astor Pl., N. Y.

Enclosed \$4 (\$4.50 foreign) for my copy of "RADIO PHYSICS COURSE" with your 5-day Money-Back Guarantee.

Name _____
Address _____
City _____ State _____

Send me free literature.

pass cond. from one leg of switch to ground. Use a 600-v. cond.

GRUNOW MODEL 650

See Case Histories listed for Grunow Chassis 6A, 6C

GRUNOW MODELS 660, 661, 662

See Case Histories listed for Grunow Chassis 6A, 6C

GRUNOW MODELS 670, 671

See Case Histories listed for Grunow Chassis 6D

GRUNOW MODELS 690, 691

Same Case Histories as listed for Grunow Chassis 6F

GRUNOW MODEL 700-800 SERIES

"Frying" noises 1) faulty resistors or condensers
2) slight leakage between the windings of the power transformer

GRUNOW MODEL 700

See Case Histories listed for Grunow Chassis 7A, 8A, 9A

GRUNOW MODEL 701

See also Case Histories listed for Grunow Chassis 7A, 8A, 9A

Interference . . . 1) insert the primary or secondary winding (shunted by its trimmer) of a 262 kc. i-f transformer in series with the antenna circuit. Adjust the trimmer until the interfering signal is trapped out

2) another method is to realign the i-f amplifier at a new frequency (say 255 or 270 kc.). This calls for complete realignment of the r-f and oscillator systems

GRUNOW MODEL 720

Inoperative . . . 1) partially "open" secondary (all tubes and voltages O.K.)
Weak, . . . 1) replace "leaky" screen by-pass condenser on the audio amplifier tube

GRUNOW MODELS 750, 751

Same Case Histories as those listed for Grunow Chassis 7B

Classified
Rate 15c per word. Minimum, 10 words.

CORRESPONDENCE COURSES

AMATEUR Radio licenses, training in code and theory. Resident and home study courses. Hundreds of licensed students. American Radio Institute, 1123 Broadway, New York.

USED Correspondence Courses and Educational Books sold or rented. Inexpensive. Money-back guarantee. Write for Free Catalog listing 4000 bargains. (Courses Bought.) Lee Mountain, Pisgah, Alabama.

CORRESPONDENCE courses and educational books, slightly used. Sold. Rented. Exchanged. All subjects. Satisfaction guaranteed. Cash paid for used courses. Complete details and bargain catalog free. Nelson Company, 500 Sherman, Dept. G-237, Chicago.

PATENT ATTORNEYS

PATENTS—Advice and booklet free. Highest references. Best results. Promptness assured. Watson E. Coleman, Patent Lawyer, 724 9th Street, Washington, D. C.

INVENTORS—Before disclosing your invention to any one send for Form "Evidence of Conception"; "Schedule of Government and Attorneys' Fees" and instructions. Sent free. Lancaster, Allwine & Rommel, 414 Bowen Building, Washington, D. C.

PHOTO FINISHING

ROLLS DEVELOPED, two prints each and two free enlargement coupons, 25c, reprints, 2c each; 100 or more, 1c. Summers Studio, Unionville, Mo.

RADIO ENGINEERING

RADIO Engineering, broadcasting, aviation and police radio, servicing, marine and Morse telegraphy taught thoroughly. All expenses low. Catalog free. Dodge's Institute, Elm St., Valparaiso, Ind.

RADIO SUPPLIES

BARGAINS in Radio Supplies. J. C. Thimijan, Lake City, Minn.

Don't Let Your Old Equipment Gather Dust!
The Classified Columns of RADIO NEWS with 42,000 Readers offer the least expensive way to make a quick sale. The rate is only 15c per word, prepaid.

GRUNOW MODEL 801

Same Case Histories as those listed for Grunow Chassis 7A, 8A, 9A, and for Grunow Model 701

GRUNOW MODEL 821

Same Case Histories as those listed for Grunow Chassis 8B

GRUNOW MODEL 901

Same Case Histories as those listed for Grunow Chassis 7A, 8A, 9A, and for Grunow Models 701 and 902

GRUNOW MODEL 902

See also Case Histories listed for Grunow Chassis 7A, 8A, and 9A
Aligning the . . . 1) this receiver employs a 6B7 tube in an unorthodox AVC circuit. Special manufacturer's instructions must be followed in order to correctly align the set. In adjusting the AVC trimmer on the underside of the chassis, located between the two pairs of i-f trimmers, the correct adjustment is between the two peaks obtained on the output meter when the AVC trimmer is turned counter-clockwise from the maximum

GRUNOW MODEL 1101

No control of . . . 1) replace remote control cable volume 2) short-circuit between blue wire and metallic shield over black wire

GRUNOW MODELS 1151, 1152

Same Case Histories as those listed for Grunow Chassis 11A

GRUNOW MODEL 1191

Inoperative, . . . 1) check the 205-ohm bias resistor for the 6F6 tube for intermittent "opens." Replace with a 10-watt unit
2) check the 68,000-ohm plate resistor of the 6C5 audio tube for "opens"
Weak . . . 1) oil from the shaft has probably leaked on to the resistance element, causing a high resistance "leak" in the control
High-pitched . . . 1) check speaker terminal strip for break in lead from output transformer
Tuning indicator tube has short life . . . 1) connect a 50,000-ohm, 0.5-watt resistor in series with the plate circuit of this tube

GRUNOW MODEL 1241

Same Case Histories as those listed for Grunow Chassis 12A

GRUNOW MODEL 1291

Low volume, . . . 1) oil from the shaft has probably leaked on to the resistance element, causing a high resistance "leak" in the control
Inoperative . . . 1) check the 205-ohm cathode bias resistor for the 6F6 tube for intermittent "opens." Replace with 10-watt unit
High-pitched . . . 1) check speaker terminal strip for break in lead from output transformer
Oscillation, . . . 1) intermittent trouble of this kind may be due to an "open" 6J7 tube screen by-pass condenser. Replace with a 0.1-mfd., 400-volt unit
Inoperative over 1) one lug of volume control a part of the being "shorted" by dial
Microphonic . . . 1) rubber cushion support for condenser gang loose. Drill out rivets and replace by machine screws

GRUNOW 1541

Inoperative . . . 1) check acoustic filter choke (only strong local calls come in) for "open"

GULBRANSEN RECEIVERS

See also Case History listings under Wells-Gardner

GULBRANSEN "CHAMPION JUNIOR"

Set dead . . . 1) double open-circuit caused by the corrosion of the primary leads of the first audio transformer, inside the case. Remove the transformer from the case and after removing tape, etc., from the connected joints, clean off the corrosion and solder a new section of the wire to the leads. Re-tape and insulate the newly soldered joints carefully
"Sluggish," . . . 1) voltage-dropping resistors off Poor tone, check their resistance, replacing with new units if they are found to be above or below tolerance value
Lack of sensitivity

GULBRANSEN 8 TUBE A-C CHASSIS

Noisy reception, 1) defective type '24 r-f tubes (even though they may test O.K.). Replace with new tubes
Intermittent reception 2) intermittently short-circuiting 0.3-mfd. r-f plate supply by-pass condenser (one of 3 units in a common can). Replace with a new unit.

GULBRANSEN 9

Fading . . . 1) faulty "local - distance" switch. While receiver is operating O.K., jerk the wires leading to this switch. If this causes fading to occur, replace the switch.
Oscillation . . . 1) clean the contacts between the rotor of the tuning condenser and the metal chassis

GULBRANSEN 23

Weak reception 1) check 40,000-ohm yellow carbon resistor mounted on one end of Candohm and wired between plate of '27 first a-f tube and grid of '47's. Replace with 5-watt unit. Also replace 0.5-mfd. by-pass unit in the condenser block (red wire) with an external 0.5-mfd. 600-volt unit
Intermittent . . . 1) check 0.1-mfd. (600-volt) reception and 0.05-mfd. by-pass condensers
"Fuzzy" tone

GULBRANSEN 40, 40A

Erratic tuning 1) try new '35 first r-f and i-f tubes
"Plopping" on . . . 1) check value of AVC plate resistor. Replace if value has increased appreciably

GULBRANSEN 75

Noisy, sounding 1) if all tubes and voltages check O.K., check the choke coil in the plate circuit of the '24 detector tube

GULBRANSEN 92, 93

Tubes burn out 1) note the position of the B-limiting resistor connected for no apparent reason from the socket of the '33 tube to the filament prong of the second detector. Arcing often occurs between this resistor and a nearby filament wire (easily visible in dark room)

GULBRANSEN 161

Weak, . . . 1) 0.006-mfd. coupling condenser from plate of '27 detector tube "leaky." Replace with high-quality 0.01-mfd. unit

GULBRANSEN 200, 291, 292, 295

Fading, . . . 1) poor contacts at the power transformer coil lead lugs which are riveted to posts on terminal plate. Solder each lug to its post.

GULBRANSEN 322

Weak . . . 1) leads to tuning meter coil snapped, thus cutting off the voltage from the associated tube. Replace tuning meter with one of same type (full-scale deflection at 5 mls)
'82 rectifier . . . 1) replace the wet 8-mfd. 500-volt electrolytic condenser in the inverted can. Also replace the 0.25-mfd. tubular condenser connected from the positive terminal of the wet condenser. Replace the '82 rectifier tube if a tube tester shows it to have been damaged in any way

HALLICRAFTERS H-8 (EC8), H8PA

Inoperative . . . 1) check tubes
2) check coils and i-f transformers for voltages and "grounds"
Weak . . . 1) check antenna check i-f stages
(all bands) 2) check tubes
3) check voltages
4) check contact points of wave-band switch
Weak . . . 1) check wiring to coils, and the coils, for continuity
Weak audio . . . 1) check AVC circuit
2) check '42 tube
3) check output transformer
4) check loudspeaker
Hum . . . 1) check for grounded filament
2) check filter condensers
3) check tubes

HALSON AC-DC

Receiver stops playing if pilot lights burn out . . . 1) shunt a 25-ohm resistor across the pilot light socket and replace the bulb with a 6-8 volt pilot. The receiver will now continue to play even though the pilots burn out

HALSON L-10

Hum . . . 1) faulty volume control. Replace it

HALSON N. S. 40

25Z5 tube . . . 1) replace the 25Z5 socket which has fused to "ground" burned out 2) replace the 25Z5 tube and socket 3) replace 2.5-volt pilot light fused

HALSON 5LR, 50R, 60M

Inoperative, . . . 1) faulty filter condenser at input to filter
Hum

HALSON 515 SW

Poor reception . . . 1) increase in values of bleeder resistors

- 2) faulty 900-ohm bias resistor for the '45 tube. Replace with a 10-watt unit
- Intermittent hum ... 1) replace the filter condensers

HAMMARLUND "PRO", "COMET"

- Failure of the i-f oscillator ... 1) high-resistance connection to one of the secondary lugs on the i-f oscillator coil. Resolder the connection
- Insufficient gain ... 1) reduce the first-detector cathode resistor to about 2500 ohms. Take the screen voltage directly off the high-voltage B-line, with a 1-megohm resistor in series. Replace the cathode resistor in the second-detector circuit with a 5000-ohm fixed resistor and a 10,000-ohm volume control. Mount the latter on the front panel. The screen voltage for the second detector tube should be obtained from the high-voltage line through a 2-megohm resistor in series

HOWARD 1936 A.C.-D.C. MODELS

- Hum ... 1) interaction between the pilot light leads (running from sockets to the resistor) and other nearby wires. Isolate these leads from all the rest of the receiver circuits

HOWARD E-14

- Hum ... 1) insert a 30-henry choke between the speaker cable and the field coil terminal, adding a 16-mfd. condenser to the input of this choke. Note: since there is no room on the chassis for this installation, it will be necessary to install a little shelf in the cabinet above the power transformer, for mounting the units

HOWARD HA-6 (Series 1) Auto Radio (Serial Numbers Below 2000)

- Inoperative ... 1) fuse blown. Check it
2) "off-on" switch "faulty". Check it
3) vibrator "faulty". Test by checking "B" voltage
4) condenser in power unit "shorted". Test by checking "B" voltage
5) choke or speaker field coil winding "open". Test by checking "B" voltage
6) voice coil or speaker transformer "open"
- Weak reception, Insensitive ... 1) antenna system poor. Check it
2) receiver needs aligning. Check alignment (465 kc i-f)
3) speaker field coil "shorted". Check it
4) 2nd i-f transformer No. 8532 has lost its gain due to softening of the wax and the shifting of the iron-core coupling. If this transformer does not respond to alignment, replace it with new type i-f transf. No. 8512. When replacing this unit, readjust the trimmers to 465 kc. When making the adjustment on this unit, and likewise when re-trimming the 1st i-f stage, be sure not to screw the plates down together too tightly as this may bend them permanently out of shape, and they will not spring back when the screw is turned in the other direction. In this event, "peaking" of the trimmers would not be obtained, and the unit would have to be replaced

- Insufficient selectivity ... 1) check alignment, especially that of the i-f stages
- Excessive ignition interference ... 1) in Ford 1936 V-8, and other automobiles where an excessive amount of ignition noise is present, the shield bracket should be used with the new type of tuning cable shield plate No. 3132. This shield plate is supplied by the set manufacturer together with a screw used to fasten it over the tuning cable opening in the receiver cabinet. This bracket and shield need not be ordered for Serial numbers above 5000 (Series 2)

- Vibrator "hash" ... 1) see that cover on power unit makes good contact to the box. Tighten the cover by bending the flanges inward slightly
2) check the 0.005-mfd., 1600-volt condenser across the vibrator for "open"

- Tone quality poor ... 1) check all receiver voltages
2) check tubes
3) check vibrator
4) check 0.02-mfd. condenser in the plate circuit of the '75 tube for "open" circuit
5) speaker cone "off-center". Adjust cone, or change speaker if necessary

- Radio-frequency oscillation ... 1) "open" 0.006-mfd. condenser in plate circuit of '42 tube
2) variable tuning condenser not floating freely in its rubber mountings. "Free" the condenser

- Tuning dial "off" calibration ... 1) receiver not properly aligned. Check the alignment
2) dial hand not set to maximum line when tuning condenser is at full-capacity

- position. Reset the screw on the back of the drive head
- Volume control shaft slips ... 1) cable may not be meshed with slot in control shaft due to cable not being far enough in the coupling
2) volume control bracket may be bending back at an angle which does not allow the control to meet the shaft slot

HOWARD HA-6 (Series 2) Auto Radio (Serial Numbers Above 5000)

- Inoperative ... 1) fuse blown. Check it
2) "off-on" switch "faulty". Check it
3) vibrator "faulty". Test by checking "B" voltage
4) condenser in power unit "shorted." Test by checking "B" voltage
5) choke or speaker field coil winding "open". Test by checking "B" voltage
6) voice coil or speaker transformer "open"

- Weak reception, Insensitive ... 1) antenna system poor. Check it
2) receiver needs aligning. Check alignment (465 kc i-f). Inability to peak an i-f transformer may be due to absence of trimmer capacity variation, even though the trimmer screw turns. This occurs when the i-f trimmer is turned too tight, causing the plate to become permanently "sprung"

- Insufficient selectivity ... 1) check alignment, especially that of the i-f stages
2) make sure that the cover on the power unit makes good contact to the box. Tighten the cover by bending the flanges inward slightly

- Vibrator "hash," Noisy ... 1) check the 0.005-mfd., 1600-volt condenser across the vibrator for "open"
2) make sure that the chassis and power unit make good contact to the inside of the receiver case
3) make sure that the paint has been removed from under the heads of the various bolts on the outside of the case—bolts that hold the power unit

- bolts on the outside of the receiver case. This is a normal condition and will not be present when the receiver is in actual use
- 5) harmonics of the i-f may be noticed when the chassis is being serviced outside of the receiver case. This is a normal condition and will not be present when the receiver is in actual use

- 6) make sure to bond all the flexible control cables
- Tone quality poor ... 1) check all receiver voltages
2) check tubes
3) check vibrator
4) check 0.02-mfd. condenser in the plate circuit of the '75 tube for "open"

- Radio-frequency oscillation ... 1) "open" 0.006-mfd. condenser in plate circuit of 6B5 tube
2) grid lead between the 6L6 mixer tube and the variable tuning condenser may be too close to the Ant. section (top section). Push this lead away

- Audio oscillation or "howl" ... 1) "open" 0.006-mfd. condenser in plate circuit of 6B5 tube
2) variable tuning condenser not floating freely in its rubber mountings

- Tuning dial "off" calibration ... 1) receiver not properly aligned. Check the alignment
2) dial hand not set to maximum line when tuning condenser is at full-capacity

- position. Reset the screw on the back of the drive head
- Volume control cannot be adjusted to minimum vol. ... 1) wrong assembly of the drive cable. Before connecting the drive cable, turn the volume control shaft in the receiver all the way to the left, and the control knob on the head all the way to the right

HOWARD "Highwayman" Auto Radio

- Fuse blows frequently ... 1) see that insulating sleeve is in proper position over fuse
2) if sleeve is O.K., replace the vibrator. Do not attempt to adjust the old vibrator points

HOWARD SG-B

- Oscillation ... 1) dirty or corroded contact springs on the tuning condenser rotors. Solder flexible pigtails from the rotors to the ground, and also clean the contacts

HOWARD W

- 83V rectifier tubes blow (set plays O.K.) ... 1) due to causes which would result in the "B" current drain of the tubes in the receiver to exceed the rating of the 83V
2) check 2A5 tube for leakage
3) if '56 rectifier tube is "slow-heating" replace it with a faster heating tube
4) faulty units in bias circuits

to obtain

Superior Performance
WITHOUT ADDITIONAL COST
ALWAYS USE
Meissner
PRECISION-BUILT PRODUCTS
Progressively Engineered
for the
Serviceman
Radio Amateur
Sound Engineer
and Experimenter
Write for Free 48-page Catalog

DEPT. N-7

Meissner ME. CAR. MEL. ILLINOIS
"PRECISION-BUILT PRODUCTS"

GL-807



ONLY \$3.50

UP TO 75 WATTS

60-MC FM INPUT

with
1/4-WATT DRIVING POWER
NO NEUTRALIZING
QUICK BAND CHANGE

Free

Complete Ratings of GL-807 (GET-756)
 A Tribute to the Radio Amateur (GEA-3052A)

General Electric, Section 161-13A, Schenectady, N.Y.

GENERAL ELECTRIC
161-13

HOWARD X-2, X-3, Y-3
Noise suppres-...1) reduce length of the antenna
sor system does
not function

HOWARD 67
Weak,1) high-resistance leakage in the
Tone quality 0.25-mfd. condenser by-pass-
poor ing the 6F5G plate resistor
to ground

GENERAL ELECTRIC S-22 Duo
(Uses same chassis as RCA R-7A receiver.) See
the Case Histories listed for the RCA R-7A
receiver

GENERAL ELECTRIC S-42
(Uses same chassis as RCA R-9 receiver.) See
the Case Histories listed for the RCA R-9
receiver

GENERAL ELECTRIC S-12-B
(Uses same chassis as RCA R-43 receiver.) See
the Case Histories listed for the RCA R-43
receiver

GENERAL ELECTRIC S-132
(Uses same chassis as RCA R-10 receiver.) See
the Case Histories listed for the RCA R-10
receiver

GENERAL ELECTRIC SZ-42-P
(Uses same chassis as RCA RE-16 receiver.)
See the Case Histories listed for the RCA RE-16
receiver

GENERAL ELECTRIC T-12
(Uses same chassis as RCA R-5 receiver.) See
the Case Histories listed for the RCA R-5
receiver

GENERAL ELECTRIC T-41
(Uses same chassis as RCA Radiola 48.) See
the Case Histories listed for RCA Radiola
48 receiver

Distortion at res-
onance
Noisy tuning, . . .1) corroded condenser-gang ro-
tor
Oscillation, . . . contacts. Bond rotor to
chassis with flexible pigtails
Motorboating be-
tween stations, ch
Mechanical hum 1) loose laminations of filter
choke—heat in oven, press

Noisy reception 1) together, allow to cool
noisy volume control

GENERAL ELECTRIC 155
Motorboating, . . .1) poor welded ground connec-
tion of the triple-section
condenser in the corner close
to the 6L8 tubes. This con-
nection is under a group of
thump, followed by poor tone
by poor tone

GENERAL ELECTRIC 700
Same Case Histories as those listed for RCA
Radiola 80 receiver

**GENERAL ELECTRIC (CANADIAN)
RECEIVERS**

**GENERAL ELECTRIC (CANADIAN)
ALL-WAVE RECEIVERS**

Inoperative on . . .1) warped 7 inch shaft on the
"C" or "X" wave-change switch. This
band, prevents the rear switch arm
(set may operate if switch is
snapped hard against the
stop).
Cleaning or tightening con-
tacts does not improve the
switch

GENERAL ELECTRIC (CANADIAN) B-10
(Uses same chassis as RCA M-34 receiver.) See
the Case Histories listed for the
RCA M-34 receiver

GENERAL ELECTRIC (CANADIAN) H-31
(Uses same chassis as RCA Radiola 80 receiver.)
See the Case Histories listed for the
RCA Radiola 80 receiver

GENERAL ELECTRIC (CANADIAN) H-32
(Uses same chassis as RCA R-50 and RCA R-55
receivers.) See the Case Histories listed for
the RCA R-50 and RCA R-55 receivers

GENERAL ELECTRIC (CANADIAN) H-51
(Uses same chassis as RCA Radiola 82 receiver.)
See the Case Histories listed for the
RCA Radiola 82 receiver
junction forms the bias po-
tential tap. Replace the
100,000 ohm unit

2) unmatched '45 output tubes
3) check the output transformer
4) faulty variable resistor in the
tone control. Replace with
500,000-ohm unit
Intermittent . . .1) faulty type '23 first detector
buzz, (even though it may
test O.K.). Replace by sub-
stitution tests with a new
tube
(stops when aerial and
ground are disconnected,
but when it is not of an
external nature)

Excessive hum..1) faulty power transformer in-
put by-pass condensers, hav-
ing the center tap grounded.
Replace with a pair of 0.003-mfd. units

GENERAL MOTORS A5003, A5010, 5091
Distortion, . . .1) unmatched '45 output tubes
Poor tone 2) check the output transformer
quality 3) faulty variable resistor in the
tone control. Replace with
new 500,000-ohm unit

GLORITONE "Aircell" Models
Speaker1) magnetic speaker on these
trouble sets has dual-coil driving unit
designed to operate directly
in the plate circuit of the
'33 output tubes. These windings develop faults
if moisture penetrates into them. Secure a re-
placement coil, and before installing it, coat it
with thin high-grade shellac or insulating var-
nish and allow to dry thoroughly

GLORITONE 24 (Early)
Hum1) check speaker field for
"shorted" turns (a continui-
ity test between yellow and
red speaker field leads should
show a resistance of 2,500-
ohms)
2) in the very early models a
0.006-mfd. condenser was
connected from the power
transformer primary to ground. If this con-
denser is "open" a hum will result

GLORITONE 26, 26P
Inoperative, . . .1) "open" 2,460-ohm tap on the
Very low vol- 5,500-ohm speaker field
ume winding. Can repair by sim-
(model 26) ply connecting a 25,000-ohm
resistor from the screen-grid
circuit to the field coil. Then
it is unnecessary to re-wind the field coil

-50-

\$6,000 PICTURE CONTEST

AN EQUAL OPPORTUNITY FOR ALL IN POPULAR PHOTOGRAPHY'S GIANT 1941 CONTEST!

Here it is, camera fans—the 1941 POPULAR PHOTOGRAPHY \$6,000 Prize Picture Contest! *Bigger and better than ever!* Think of it! \$6,000 in prizes; 228 separate awards! You *don't* have to be a "professional" nor own expensive photographic equipment to be eligible. You've got just as good an opportunity to win as anyone.

CONTEST OPEN TO ALL! COSTS NOTHING TO ENTER

Your best picture, black-and-white or color, may win one of the 228 cash or valuable merchandise awards. So get in this *big, new* picture contest *now* and make your camera pay dividends. For official contest rules, entry blank and complete list of prizes, see page 54 of the July POPULAR PHOTOGRAPHY. Get your copy *today*, or tomorrow *sure*.



**WIN A 1942 PACKARD \$1,200 TOURING SEDAN
OR ONE OF THE OTHER 227 BIG AWARDS!
COMPLETE DETAILS IN THE JULY**

Popular Photography

NOW ON SALE AT ALL NEWSSTANDS AND CAMERA STORES!

Recording Pointers by "Recordist"

G. B. S., Atlanta, Ga., asks: What is meant when one talks about "using fresh discs"?

ANSWER: Home recording discs consist of a cardboard or paper base that is coated with various types of material such as: lacquer, cellulose nitrate, rubber, etc. Some of these materials have a tendency to dry out after they have stood around for several weeks, while others have characteristics which makes the coating remain pliant or soft and actually never dry out. These discs are best suited to home recording. A recording disc, in order to be well cut, must have a coating that never becomes hard or dry either before or after cutting. A dry disc will have considerable "surface noise" and is not capable of as good a response as one which is soft and flexible. The finest professional recording discs are manufactured under most perfect conditions in air-conditioned plants so that no dust or any particles floating about the room will be deposited in the lacquer coating as it is applied to the base of the disc. The coating is of a formulae that prevents the disc from ever becoming hard and much care is used to ship these blanks in metal containers which are sealed to keep out dust. Speaking of dust—this is the worst enemy of the home recordist and he should always see that a disc is clean on the surface before proceeding with a cutting.

A. T. M., Brooklyn, N. Y., requests information on the photo-cell type of phonograph pickup when used in conjunction with home recording blanks.

ANSWER: This is one of the latest pickups to make its appearance on the market and features a built-in mirror mechanism used in conjunction with a photo-electric cell so that the vibrations set up by the modulated grooves will cause the mirror to swing from side-to-side and interrupt the light beam actuating the cell. It should be mentioned that any device used in phonograph playback will exert some pressure in the grooves. The older pickups used several ounces of pressure on the needle so that the pickup would stay in the grooves. A properly cut record requires only about 1 or 2 ounces pressure for good response and tracking, and under this condition record wear will be reduced to a minimum. Several crystal pickups, equipped with permanent sapphire points, feature this and they cause a minimum wear to the recording. They are just as capable of high-fidelity as the photo-cell type and are less expensive. Remember that all needles will cause some wear to the record, depending upon the amount of pressure used on the needle. For that reason it doesn't matter what type we use just as long as it is capable of reproducing all frequencies with minimum record wear.

Discussion

In many cases where commercial crystal pickups employing steel needles are used, it may be desirable to cut records with a "turnover" at some higher frequency than for commercial "constant velocity" recording. Since many of these pickups have resonant peaks between 4,000 and 5,000 c.p.s., a "turnover" at from 1,000 to 3,000 c.p.s. may produce a more uniform frequency response. It

will be necessary to experiment with the "turnover" frequency to obtain best results. When records with a high "turnover" are reproduced with the Brush Pickups above, this will result in a uniform response up to the "turnover" frequency with attenuation of 6 db. per octave above this frequency.

In cutting "constant amplitude" the actual impedance from which the cutter operates should not exceed about 4,000 ohms. This may be obtained from an output transformer or by connecting directly to the plates of the output tubes. In the latter case the plate resistance (Rp) of the vacuum tube (plate resistance of two tubes for push-pull) should not exceed about 4,000 ohms. When a uniform frequency range up to 9,000 c.p.s. is required, "constant amplitude" recording requires approximately 50 volts (maximum swing on R.M.S. meter) for average modulation of the record.

In cutting commercial "constant velocity" the impedance from which the cutter operates will depend on the "turnover" frequency selected. This may be obtained from an output transformer and a series resistor or by connecting to the plates of the output tubes through a series resistor. For example, where a turnover frequency of 500 c.p.s. is required, the cutter should operate from an impedance of approximately 44,000 ohms (this being the cutter impedance at this frequency). Referring to Figure 3, this impedance should be divided between the series resistance and the secondary impedance of the output transformer. Generally these two may be made equal, viz. 22,000 ohms each for a "turnover" of 500 c.p.s. In the event that the plate resistance (Rp) for two vacuum tubes in push-pull is 1,600 ohms, the output transformer would then have an impedance ratio of 1,600:22,000 ohms. This corresponds to an impedance ratio of approximately 1:13.8, or a turns ratio of 1:3.7. Since such an odd ratio transformer may not be easily obtainable, one having a turns ratio of 1.35 or 1:4 will be found suitable, without shifting the turnover frequency too seriously.

In selecting the output transformer make sure it is of sufficient power handling capacity and has uniform frequency characteristic throughout its range.

Where the "turnover" frequency is between 250 and 800 c.p.s. commercial "constant velocity" recording requires approximately 150 volts (maximum swing on R.M.S. meter) for average modulation of the record.

It will be noted that in commercial "constant velocity" recording, the lower frequencies are cut approximately 10 db. higher than "constant amplitude" recording, and that the frequencies above "turnover" in the case of the former, fall off at the rate of 6 db. per octave. "Constant amplitude" can be cut at a higher level for higher record modulation; however, it will be necessary to reduce the frequency range during recording. This can be accomplished by providing a "turnover" below 9,000 c.p.s., much in the same manner as is done at 250 to 800 c.p.s. in the case of commercial "constant velocity" recording. For example, if a "turnover" is selected at 4,000 c.p.s. so that only those frequencies below this point are cut "constant amplitude," then the voltage applied to the cutter may be increased to approximately 80 volts (maximum swing on R.M.S. meter). Lower "turnover" frequencies will permit higher voltages to be applied to the cutter for higher record modulation.

The cutting stylus is not normally supplied as part of the RC-20 Cutter. This stylus consists of finely polished sapphire, mounted in a protective metal shank. The total cutting angle is 88°, which is standard for commercial lateral type records.

For normal recordings in wax, the depth of cut is usually .0025" and in recording materials such as nitrocellulose, is usually .0015" to .002".

It is important, if best quality results are to be obtained, especially in the recording of music, that no groove containing sound modulations be closer to the center of the record than 2½" for 78 r.p.m. recording, or 4" for 33½ r.p.m. recording.

Care should also be taken that recording materials should be as smooth and homogeneous as possible, and that the cutting edge of the stylus be always sharp.

It is very important that the turntables

★ ★ ★ WANTED

5400 Trained Operators

NATIONAL DEFENSE has caused the UNITED STATES NAVY Communication Reserve to issue the call for 5400 expert radio operators.

You can easily qualify for positions requiring expert radio operators if you are properly trained. The Candler System of training shows you the easy, interesting way to Speed, Skill and that Amateur or Commercial License right in your own home!

52-PAGE BOOK FREE!

Read how the Naval Reserve speeds up its operators. Read how to get the license you want. Read how you can become a high speed expert! A penny post card brings you the most fascinating book you have ever read. Write today for your free copy of the new BOOK OF FACTS. No obligation, of course.

Candler System Company
Dept. N-7
Asheville, N. C., U. S. A.

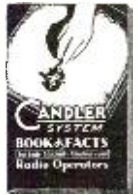

RADIO ENGINEERING DEGREE IN 2 YEARS

Intensive, specialized course, including strong basis in mathematics and electrical engineering, advanced Radio Theory and Design. Modern laboratory. Low tuition. Self-help opportunities. Also 2-year courses in Aeronautical, Chemical, Civil, Electrical and Mechanical Engineering. Participation in Civilian Pilot Training Program. Enter September 2, December, March, June. Catalog.

INDIANA TECHNICAL COLLEGE
771 E. Washington Blvd., Fort Wayne, Ind.

RADIO TECHNOLOGY



RCA Institutes offer an intensive course of high standard embracing all phases of Radio and Television. Practical training with modern equipment at New York and Chicago schools. Also specialized courses in Aviation Communications, Radio Servicing and Commercial Operations. For Free Catalog Write Dept. RC-41.

RCA INSTITUTES, INC.

A Radio Corporation of America Service
75 Varick St., New York 1154 Merchandise Mart, Chicago

LES Correspondence Courses in RADIO and ELECTRICAL ENGINEERING

ELECTRICAL ENGINEERING Get good grasp of wide practical field. Prepare yourself at Low Cost, for secure future. Modern course. So simplified anyone can understand quickly. RADIO ENGINEERING Extra fine course in radio, public address, photo-electric work. Trains you to be super-serious man, real vacuum-tube technician. Experimental kits furnished. Diploma on completion. Either course, only \$25. Deferred payment plan available. Write for free copies of school catalogs, students' magazines, full details. SEND NOW!

LOW AS \$25
LINCOLN ENGINEERING SCHOOL, Box 932-R 32, LINCOLN, Neb.

RADIO ENGINEERING,

broadcasting, aviation and police radio, servicing, marine radio telegraphy and telephony, Morse telegraphy and railway accounting taught thoroughly. 48 weeks' Engineering course equivalent to 3 years of college radio work. All expenses low. Catalog free. School established 1874. Dodge's Institute, Oak St., Valparaiso, Ind.

RADIO-TELEVISION

Oldest, largest Radio-Television school in West trains you for good pay job. Complete instruction including Radio Construction and Service, Broadcast Operating, Sound, Talking Pictures, Television, Public Address, etc. Flexible plan to meet specific needs of those with or without jobs. Transportation allowed to L. A. Earn room and board while learning. Request Free Catalog.

NATIONAL SCHOOLS Dept. 7-RN
Los Angeles

RADIO COURSES

Start September

- RADIO OPERATING—BROADCASTING
- RADIO SERVICING—a practical course
- RADIO AMATEUR CODE & TELEVISION
- ELECTRONICS—1 yr. day course, 2 yrs. eve. Day and Evening Classes. Booklet Upon Request.

New York Y. M. C. A. Schools
7 W. 63rd St. New York City

selected for recording purposes be as free from "flutter" (periodic changes in speed), "wobble" and "rumble" as possible. Any one of these turntable defects will affect the quality of the recording. It should be noted that ordinary reproducing turntables have insufficient mass and torque for recording purposes.

-30-

Ham Chatter (Continued from page 31)

quite a kick outa hearing me do mi sign-off abt 500 wpm of "W9BD of Seneca, in the heart of the famous Nebraska Sandhills where millionaires he bn made and millions he went broke, saying 'Nk 73 es all the rest of the cw whooey to W9—'." So tht it is, boys es gals, in case u didn't get it the 9th time u hrd me say it. Hi!
Nw for sum final serious-thoughts to finish up on. I hv no particular kick on those of u who wish to use it using cw—ur own biz. I myself

taking cognizance of rapid strides of radio art since abt 1927, the advance of teletype, facsimile and other ultra-modern trends which will eventually largely displace strait cw in communication; that, coupled with poor cw ability, causes me to feel personally cw ain't worth the chips tht I have spent more time trying to master cw than many of you verbest op's ever will. Hv a rating in cw, es can copy in my head enuf to get-by with all but best ops. cw for me is "slow." For all of you, it too is subject to error. It possess some advantages and should be used to its fullest possibilities by all of us. Yet, why should pet-peeve and teacher's pet, be permitted to jeopardize "safety" of American citizens in their unknowingly having to rely on cw in Signal Corps? Why, not supplement by fone, where voice is "best." Hitler is reputed to have thrown all the old theories and completely and thoroly modernized his equipment including the use of voice in his radio mechanized units and we know he has ben "going to and thru the other fellow's towns."

I'm not advocating replacement of cw by voice—merely a more liberal un-biased view and ermination is in order. Bluntly, seems a thoro modernization is in order.
Am not asking for info on what equipment is in hands of Signal Corps as that is none of our biz. Seems to be a "public secret" abt those

old *Hartleys* and transceivers, etc., which we hams were compelled to cease using 5-10 years ago and which any self respecting ham wud be ashamed to be heard operating, is typical army equipment. Doubtless, sum more modern radio gear is in hands of trusted few—for sake of people whom they wul protect, we sincerely hope so.

However, knowing the mind of the *Chief Signal Officer* as expressed to us *AARN* men, one can't "hope" for much actual "hope" in any degree of thoro renovation has or will take place to replace this old phobia tht "cw's the one and only" for communication.

A fair-trial of voice would have shown a passable degree of utility in certain things for defense purposes; the same as voice has bn adopted for R.R.; aviation; trans-oceanic; some police; as well as the American people when they wish to get in contact by land wire with someone, and don't hv need for a "printed record" of a business deal such as they use telegraph for.

Lindbergh's row with the president several years ago over airmail contracts showed up one thing and that was "mess army was in" for planes and good flyers then—that "expose" came in time and has bn largely remedied. Will radio's "expose" come "in time?"

W9QWN, Pontiac, Ill., sez:

W9QLZ, George of Utica, Ill., is recuperating and catching up on his sleep after receiving a new Jr. on March 20.

W9LHK, Cliff, has now settled in Pontiac, Illinois, and has just put a new HT9 Xmtr. on 160 m. It seems that he has an awful time settling down as he is a newspaper traveling district mgr.

There sure is a big mob on 160 m in Bloomington, Ill. Bloomington also is a net center and an active club center. Those boys include W9SKL, Al; W9MNR, Helen; W9ODX, Bill; W9JLK, Clarence; W9VPD, Floyd; W9CFV, Jim; W9CEV, Bill; W9LML, Everett; W9VQT, Doc; W9BPU, Del; W9PRV, Floyd.
W9YBY, of Streator, is working with some model airplane fans and hopes to get the plane flying soon.

CORDELE, GA's, pride, W4GFF reports:

W4GEX of Greenville, S. C., did a fine job of getting the news from her part of the country to W4GFF at Cordele, Ga. The 4th dist. ed.

We have already given our thanks to her by mail, but looking at the envelope containing the news from the YL operator at Greenville, S. C., we find that she lives in the U. S. Antarctic Message Center, which consist of W4GEX-W4ABC-WLWX-W4B-WLWC-W4NG-W4AA.

W4CSP Lunn has quit exercising his lungs on 160 fone and is trying cw for a while.

W4GBY, Tom has changed his qth to Moultrie, Ga. We sure miss him on 28.4mc. W4DAM cw now has 1st Telephone and 2nd Telegraph license.

W4CUU—Joe is on 160 phone wid 500 watt rig, which works fb too.

W4AIS, George is chief engineer at whoop and hollow joint in Greenville, S. C. The glorified cord player.

W4HIA is now at Greenville Working Fixed portable at NYC camp.

W4FW, Doc really slayes em each month wid his 160 rig.

We regret to learn that W4FCW has to store the rig for and endefinite period. Army maneuvers, are the cause.

W4HAB Georges XYL had very bad accident but is doing fine now, also his little YL op JoAnn can carry on a qso as good as his pop.

W4EMT, Everett was finally caught by Uncle Sam and is now at Spartanburg, S. C., making the boys keep in good health. He is an M.D.

W4HEY, Posey, is really mopping up 40cw wid his 3 watt blooper, also his job fits his name—he is a commercial photographer. Hi! Hi!

W4ETC, Larrie is finishing new rig and will soon be on 28 mc looking for dx. Hi!

W4FYL, Perry and XYL just got back from a trip to the Blue Grass State. He said they had fun meeting the W9 boys, casually mentioned the fact that he was a ham and will be on soon wid low power. Well ob fwe welcome you.

W4EZF, Gene, took off for Seneca, S. C., and is now on the air from there. We also hear he has job pushing film for the local theatre.

W4NG, Ed, is in Toccoa, Ga. To get the new BC Station on the air at the scheduled time.

W4EDQ, Bob, left us and is now headed for Cleveland, Ohio.

W4GWC is inactive at the present time.

W4GEX is the first and only licensed YL operator in S. C., so far as is known and she is also waiting for that long hoped for Class A ticket.

W4GFF, your reporter, was a visitor to W4FOO at Fender, Ga., and was suppressed to find that Alvin had bought a Meissner Deluxe signal shifter. We wanted it but it was impossible to get away with it. Hi!

We also went on down to Valdosta, Ga., and visited the local Hams there. To our surprise we found W4AZK from Jacksonville, Fla., and W4GTJ from Panama City, Fla. We almost had a ham fest then and there.

The gang at Panama City, Fla., promised big things at there Ham Fest June 22 and the gang at Rome, Ga., also promised a big affair, your reporter is going to do his best to be at one or the other and regret we can't be at both the same day.

W4GRP is thinking of moving to Columbus, Ga.

W4HFK is going to Jacksonville, Fla.

W4HLH, Mr. Eugene Bowers, is a new ham in Cordely, Ga. It is reported that he will begin his activities with a portable job—a 315 in. fm.

W4GKQ, formerly of Ft. Bragg and Lexington, Ga., has finally settled down in Tignill, Ga.

W4FCW, Cap't McArthur, at Ft. Jackson, S. C.,

Now! 30 Complete Authoritative Pocket-Size PHOTOGRAPHIC TEXT BOOKS

AGAIN the Little Technical Library makes photographic history! Meeting the demands of "L.T.L." readers and amateur photographers everywhere, Little Technical Library has added 10 important new titles to the ever-popular PHOTOGRAPHIC SERIES. Yes, camera fans, those 10 authoritative new volumes, text books to help you further improve your photographic technique, are now ready! They're complete, authoritative, profusely illustrated! Like volumes 1-20, these 10 brand new additions to the PHOTOGRAPHIC SERIES are bulging with reliable photographic information . . . up-to-the-minute counsel from the masters to help you get the most out of your hobby—to help you make better pictures all year 'round!

The PHOTOGRAPHIC SERIES, now a big, instructive library of 30 informative volumes, brings you hundreds of valuable picture-taking ideas—yes, brings you the answers to every photographic problem with unprecedented thoroughness and accuracy.

Why not get acquainted with these gems of photographic information today—and collect on fun, new thrills, and better pictures with your camera. The Little Technical Library PHOTOGRAPHIC SERIES, quickly identified by those colorful new jackets, is now on display at your favorite book, camera or department store.

PLAN ALL YOUR PICTURES WITH THESE 30 INFORMATIVE VOLUMES AT YOUR FINGERTIPS

- No. 1—YOUR CAMERA AND HOW IT WORKS by W. E. Dobbs and Charles A. Savage. Selection, use, focusing, composing, lenses, shutters, filters, problems, etc.
- No. 2—DEVELOPING, PRINTING AND ENLARGING by Al and De Vera Bernsohn. Elementary and advanced developing, chemicals, types of printing, elements and advanced enlarging, enlarging equipment, etc.
- No. 3—FILTERS AND THEIR USES by W. E. Dobbs. Light, film sensitivity, types of filters, polarizing screens, color separation, lens shade, problems, etc.
- No. 4—COMPOSITION FOR THE AMATEUR by Kenneth Helbronn. Joining subject and picture, the picture as a whole, tone, lines, rhythm, etc.
- No. 5—MOVIE MAKING FOR THE BEGINNER by H. C. McKay, F.R.P.S. Modern movies and cameras, using the camera, procedure, titling, projection, etc.
- No. 6—COLOR IN PHOTOGRAPHY by Ivan Dmitri. Types of colors, separating, color density scales, wash-off relief printing, chromotone printing, etc.
- No. 7—CHILD PHOTOGRAPHY by Harold Lambert. Cameras and equipment, taking the shot, posing, finishing and processing, etc.
- No. 8—HOME PORTRAITURE AND MAKE-UP by Maurice Seymour and Syd Symons. Part I: Toning, lighting, background, etc. Part II: Restyling, contour, eyes, eyebrows, lips, etc.
- No. 9—TRICKS FOR CAMERA OWNERS. An outstanding collection of the latest and most valuable kinks and hints on every phase of a amateur photography.
- No. 10—A GLOSSARY FOR PHOTOGRAPHY. Compiled by Frank Fenner, Jr. Over 3,000 words having photographic significance are defined. They cover still and motion-picture photography in black-and-white and color.
- No. 11—OUTDOOR PHOTOGRAPHY by Samuel Grierson. A comprehensive coverage of the picture possibilities found outdoors: landscape, pictorial, etc.
- No. 12—INDOOR PHOTOGRAPHY by Hilary G. Bailey, F.R.P.S. Posing, lighting, and exposure for portraiture, table-top, etc.
- No. 13—FLASH PHOTOGRAPHY by Rus Arnold. Flash equipment, synchronization, exposure, indoor and outdoor work at night or in daylight, etc.
- No. 14—PHOTOGRAPHIC ACTION by Victor De Palma. Selecting shutter speed for motion. Special discussion of action photography outdoors and indoors.
- No. 15—MANUAL OF ENLARGING by Stephen White, A.R.P.S. Complete guide to projection printing, printing technique, paper, etc.
- No. 16—MINIATURE CAMERA TECHNIQUE by Fenwick G. Small. Discusses miniature camera, special technique in shooting, finegrain developing, printing, etc.
- No. 17—PHOTOGRAPHIC LENSES AND SHUTTERS by Richard W. St. Clair, A.R.P.S. Photographic optics; camera lenses; auxiliary lenses and shutters; etc.
- No. 18—PHOTO TRICKS AND EFFECTS by Jacob Deschin, A.R.P.S. Montage, double exposure, saturation, and other effects obtained by photography.
- No. 19—SELLING YOUR PICTURES by Kurt S. Szafranski. Markets, saleable material, local aspects, and numerous hints on making money with your photos.
- No. 20—DARKROOM HANDBOOK—AND FORMULARY by Morris Germain, A.R.P.S. Formulas for film and paper developers, fixing baths, intensifiers, reducers, toners, and other plans, equipment technique, etc.
- No. 21—BEGINNER'S BOOK OF PHOTOGRAPHY by Walter E. Dobbs. Designed for beginning camera fan; discusses approach to independent action shots, interior pictures, portraits, etc., explaining use and operation of camera.
- No. 22—MANUAL OF CORRECT EXPOSURE by H. F. Rockwell, Jr. Comprehensive information on exposure—and use of an exposure meter, obtaining high-contrast film speed, improving negative characteristics, and many other helpful suggestions.
- No. 23—TAKING PICTURES AT NIGHT by Robert W. Brown. Contains instructions for making pictures after dark by moonlight, making effective silhouettes, how to record reflections of lights on water, fireworks displays, and stage performances.
- No. 24—TABLETOP PHOTOGRAPHY by Jacob Deschin, A.R.P.S. Describes methods and materials to use for table-top photography. Contains interesting information on perspective, lighting, and selection of subject.
- No. 25—PORTRAITURE SIMPLIFIED by A. L. Schafer. Authoritative, Hollywood's best-known portrait photographers give simple instructions for lighting, posing with helpful diagrams, discuss equipment, and offers tips on composition.
- No. 26—MIXING COLOR PRINTS by Dr. M. K. Ing. Leadley and Werner Stoeneweyer. Simplified explanation of color printing for amateur who have hesitated to attempt this work; includes the popular processes; includes making of separation negatives, describing variations in density and contrast.
- No. 27—PRESSPHOTOGRAPHY FOR THE FREELANCE by Kip Ross, A.R.P.S. Covers all types of news pictures; gives advice on suitable equipment, flash technique, and markets. Contains valuable hints for both amateur and advanced photographer in field.
- No. 28—COLOR MOVIES FOR THE BEGINNER by Harris B. Tuttle, A.R.P.S., with a Foreword by Dr. Walter Clark, F.R.P.S. Deals with equipment, exposure of natural color movie film, control of color, editing, tinting, color temperature, and use of various lenses.
- No. 29—NEGATIVE RETOUCHING AND PRINT FINISHING by Ernest E. Drap r and Norris Harkness. Shows ways of improving photographs after negatives have been developed; print-spotting, staining, coloring, mounting, titling; making greeting cards, and newly effective.
- No. 30—PHOTOGRAPHIC QUESTIONS AND ANSWERS. An instructive course in the principles of photography with over 400 questions accompanied by complete answers. Includes information on cameras, lenses, shutters, focusing, types of film, making prints, slide-shooting, assembling albums, etc.

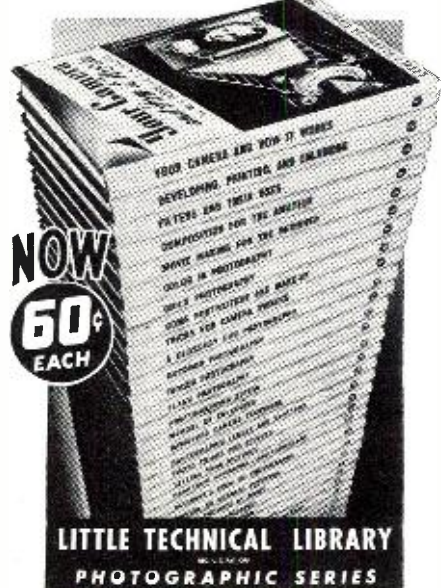

ON SALE AT ALL LEADING BOOK, CAMERA AND DEPARTMENT STORES

has been ill with an infected foot. His XYL was a visitor in Georgia this past week end.

W4HFK has moved to a new location, already has his skivvie up and is reported doing a fb job with a new rig, on 160 meters.

W4AZK has changed his qth to Jacksonville, Fla. He is getting back on the air there.

W4GPC, Weslie Gordon, of Montezuma, Ga., was a visitor this week end to W4GFF. Wes says he has joined the Navy and at this writing he should be in Norfolk, Va. He said that Radio was still his chief interest.

W4EQB is reported to have built himself and cw that works all the way from 160 to 10 meters, and according to the dope we got on it the calibration is down to gnats heel.

We notice there is some good boys in HAM gear in the past months RADIO NEWS. The guy with the money is winner again. (To the Editor, some of the boys want to know if it is true that RADIO NEWS is not sold on the news stand any more? *Yep! T'aint true. You can get it any newsstand!* Ed.)

W4GOA, Mr. Clayton Williams from Jacksonville, Fla., was a visitor in Cordele, Ga., this week end.

W4DIA of Augusta, Ga., is active on 75 meters. His rig is portable.

W4FNC still puts on a whale of a signal, regardless of what band or of what time of the year he is on. J. C. might tell us how he does it. So does his right hand buddy, W4BPD.

The voice of the air from Ft. Jackson, S. C., is visiting in Cordele this week end, and we hope that he has lots of news for this department. As it is getting time for the annual hamfest over this part of the country. All parties knowing the exact dates and places if you will kindly drop us a card to Cordele, Ga. We will be more than glad to put every one interested in attending on the right track.

As you fellows know, it is impossible to get all the news (the best) off the air. And we want this column to be as interesting as can be to all that read it every month. So please, let's have your cooperation by sending those bits of news you have from time to time to W4GFF. So '73 till next month.

DOPEY Dope done darginly but recently by that dizzy and daffy (dope) W51KP:

Things that I would like to see:

W5HZP's 160 meter half wave rotary beam.

W5MO's new harmonic.

W5HHT with a suitable antenna to match his high power.

W51XL working the 15625 meter band only. If there were time.

W5FDN back on the air.

W5IRO with 100% modulation.

W51KP's storm net with 100% attendance.

W4FVN back on the air or some news from him.

W5LLW's face when he finds out that that ham whose handle is "Winnie" or "Windy" is not a YL like he thinks.

W5JEV's also.

W5HJJ.

K6OJ's qsl again.

W5HMV's taxi-cab number 5.

W5HRD's little 10 meter rig.

W5ADJ's transmitter, and antenna.

W5EB's powerful 50 watter.

W5HCY on the air oftener.

W5GDU off the air oftener.

W51ZX dancing to the tune "Beat me daddy eight to the bar."

W5HQE's Tchuncta river.

W51MT any old time.

W51ZC and the rest of the Pole Cat club together for a hamfest.

W8QDA-5 on leave so that he could come to New Orleans.

W5JGO on the air in his new location of New Iberia.

W5GXO personally and on the 160 hand again.

Less qrm; less qrm; more tfc; more rag chews; Walter Winchell a ham; Pres. Roosevelt a ham; Young xl hams; another convention; Yehudi.

The following is a true story and if you see any similarity to any person (a Mississippi ham) you have probably guessed right. W51ZC says that he sold a power transformer to W5? who bought it on time with one dollar down payment. Well W5? used the transformer for a time but still didn't pay anything on it. About this time W5? decided to add another 35T to his final. This naturally overloaded the Xformer and in time it blew out. W5? now wants another transformer even after it was agreed upon at the time of sale that it was not guaranteed due to the fact that the company was not making this type of Xformer anymore. This transformer nets at 14 dollars but thru the kindness of W51ZC it was sold for about 7 dollars. Still W5? refuses to pay what he owes. You cannot say his name because he would probably be embarrassed and would not like that.

That's all the news for this time being ya next month.

SARASOTA, Fla., through W4CFP reports: Amateur radio activity has hit a new high in these parts.

Main stimulus has come from Sarasota's first organized ham club, now hitting on all four cylinders. Officers are: W4CFP, president; W9GXG 4, vice president, and W4DUI, secretary-treasurer. The club has been given quarters on the second floor of the county court house with the privilege of stringing antennas from a 100-foot tower in the courtyard. W4DUI donated the use of an 80 watt cw rig and the club hopes to be on 20 and 40 cw soon. The club's station license application has gone to the FCC. W4CUZ will be the trustee. A special desk with code practice equipment was constructed by members and a dozen or more would-be hams are

busy boning up for their tickets. Members also are planning to build portable equipment for service with the Red Cross, civilian defense force or other groups during any emergency.

W4CCR (Dave Johnson) and W4HDO (Chick Sills) are the first Sarasota hams to report for duty with Uncle Sam's armed services. Johnson resigned his job with the local telephone company and enlisted in a signal corps maintenance unit attached to MacDill field, the army's air base at Tampa, Fla. Sills, who had served for five months as radio operator at a nearby CCC camp, enrolled in a *Naval Reserve* training group at Charleston, S. C.

Another old timer will be back on the air by the time this reaches print. C. A. Service, jr., a pre First World War amateur in Connecticut who signed W4IE here about 10 years ago, recently took the exam and came up with a new ticket. And he got that old call W4IE. Charly also has an HQ120X receiver on order and is building up a cw rig.

W4DUI and W4CFP have enlisted in the Sarasota company of the Florida Defense force, a home guard unit formed to replace the National Guard unit while the latter is in training at Camp Bladensburg, Fla.

Recent Sarasota visitors included John Cripps, W4GHU, a 160 fone man from Albany, Ga., and Irving Vosbrink, W1MDO, of Bridgeport, Conn. Vosbrink combines flying with radio and worked in this area with an aerial crop dusting outfit.

W3HGN'4, Sarasota's only 20 meter fone man, and W9GXG/4 who manages to draw a few cartoons for Collier's, Saturday Evening Post and other magazines when the 10 meter band goes dead, are still waiting for W4 calls. Incidentally, a sketch of Banded W9GXG/4 Linn recently appeared in Collier's, along with a self-executed caricature. He's now staying awake nights trying to develop an idea featuring ham radio for a cartoon to be offered one of the big mags. (Note to RADIO NEWS editors—You might manage to shake one loose for Ham Chatter. Make him an offer, hi.) [O.K. we hereby do! Ed.]

Add quasi-silent keys—Lindsay Wolfe, W4EPV, of Tampa, Fla. Bedridden for two years as the result of an injury, Wolfe was one of the well known members of the Florida west coast gang.

W3CDY blasts in wild:

W3HOV formerly on 40 cw es 160 fone, now rev'd his class A ticket es then moved to 20 fone, moved to a new QRA es is pioneering 2 1/2 hr. Sure qrl, Wayne.

W3GJK is a member of the AARS fone net es handling tfe for *Indiantown Gap Military Reservation*.

W3GXX has been on 75 the past while making new friends, but don't peddle ur wares there Jim, the FCC doesn't approve. Hi!

W3HPZ got his ticket back from the FCC following a long delay after making application for renewal.

W3HZK got caught in the draft es instead of saying "Inx fr the dope O M" he now sez "Here's the dope on the tanks O M." Here r the best regards from the gang Lynn.

W3GJA made a fb showing for himself es is now a Sgt. in the *Air Corps* es instructing in Radio.

W3CXE didn't give up ham radio-fellows. Just because u don't hear him on don't think so but model airplanes do consume much of his spare time. Do u think maybe Chet is building planes for National Defense?

K6TEBexW3FYG is a new on at WILM es will be on 5 with the gang sn.

CAMDEN, N. J., via W3IWF, reports:

The *Greater Camden Amateur Radio Assoc.* in the near future will establish an 80 mtr es also a 20 mtr net.

W3JFD wrks at the *Phila. Radio Electric Service Co.*

W31NU got married in June es has a new qth. Jim is interested in becoming AARS.

SWL's Smith, Franchetta es Higgins will sn go to visit the RI.

SWL Higgins fm Portland, Me., has sum vy interesting stories abt the Me. snow strm es the wrk done by the Pine Tree Net.

W3ENB has at long last rec'd his duplicate for the license he lost. Joe will also be on the air fm a new qth sn.

Wonder hw mani of u had t K6 wrking a K4 who told him to qsl direct to a CM?? Tt aint funny, it's lousny! Unless itsa gag!

K4GXV has been on quite frequently around 7235 Kcs wrking a lot of W2's es others.

Chet, W1MKN, has a new antenna, the wind blew down his dbtl last month es he just put up this 13' ft. matched impedance type.

BILL of W2KPB is now running some real

sonn to an 813 on two and a "Hawf."

W2ADW has bought himself a new qth in Quoetz, Long Island, N. Y. "Nick" says that he wishes that some one would move one of his old Flanders hills over in his new back yard for u.h.f. work.

W21NQ says that the only thing that he gets when he goes out surf casting over there on Fire Island, is back lashes.

As the xyl was hanging out his wet clothes she is alleged to have been heard to say "That aint the way I heard it!"

W2KOA zets out well on 160 with his "how-erful little five watter." "Havent heard "Bill" on 2 1/2 lately.

Several of the boys have received cards from "Chik" of W2LNU postmarked "CURACAO."

The "Fishermens net" seems to have split up into two nets, now. The u.h.f. addies have gone down to 2 1/2 while the regular noon rag chewing gang are back on their usual frequency.

Overheard Marion, the xyl of W2BFA giving

SPRAYBERRY TRAINS YOU for GOOD PAY! STEADY WORK! ADVANCEMENT! in RADIO and TELEVISION



DON'T WAIT! START NOW!

You Can Make Money Almost At Once! You'll be quickly shown how to get and do neighborhood Radio Service Jobs... for practice and profit. You easily learn Television, Frequency Modulation, Signal Tracing, Mobile Radio (Auto-Tank), Aviation Radio, Electronics, Facsimile Radio, Radio Set Repair and Installation Work. I'll Prepare You Quickly In Spare Time

At Home Or At Camp SPRAYBERRY Training does not interfere with your present work. You will receive personal coaching service all the way. You'll be fitted to hold down a good paying job in Radio or to have a Radio business of your own.

You Get Professional Test Equipment... Plus Experimental Outfits... Includes 146 RADIO PARTS (to build complete Radio Receiver), RADIO TOOLS and a TESTER-ANALYZER. MY EXPERIMENTAL OUTFITS enable you to conduct actual experiments with your own hands.

NO EXPERIENCE NEEDED It makes no difference what your education has been, I can fit you to become a real RADIO TECHNICIAN. Your success is my full responsibility.

THE SPRAYBERRY COURSE IS SOLD UNDER MONEY-BACK AGREEMENT

RUSH COUPON for BIG FREE BOOK

SPRAYBERRY ACADEMY OF RADIO
F. L. Sprayberry, President
425-G University Place, N. W.
Washington, D. C.

Please rush my FREE copy of "HOW TO MAKE MONEY IN RADIO."

Name..... Age.....

Address.....

City..... State.....

(Mail in envelope or paste coupon on penny postcard)

PUBLIC ADDRESS HEADQUARTERS



RADOLEK De Luxe Public Address Systems offer the most for your money in Styling—Hi-Fidelity Performance—Reserve Power—fast, convenient, easy installation. Offered in 15, 30, 50 and 100 watt sizes— for permanent, portable or mobile use. They feature from 2 to 6 input channels, built-in input and mixing controls, AVC, and the newly developed "feedback" tone control circuit. Wide choice of microphones and speakers. Mail coupon for complete information.

RADOLEK'S NEW 1941 RADIO PROFIT GUIDE

FREE! Indispensable to every serviceman, dealer and sound engineer. Send for big FREE Radolek Profit Guide, now!

SEND TODAY! PASTE ON A PENNY POST CARD

RADOLEK CO., Dept. B-56
601 W. Randolph St., Chicago, Ill.

Please send information on Radolek Public Address equipment— also new 1941 Radio Profit Guide.

Name.....
Address.....
 DEALER SERVICEMAN EXPERIMENTER

Better AUTO-RADIO



Today's highly sensitive, full-volume, quality-reception auto-radio receivers require a first-class suppressor job. And that's where these latest Aerovox Auto-Radio Condensers come in.

First and foremost, they have more-than-generous capacity ratings for the intended function. Then they are electrically and mechanically rugged to withstand vibration, heat, humidity and other service conditions. Lastly, they are designed for simple, satisfactory installation. Note these typical items . . .

For generator-noise suppressor, a choice of several types to fit standard generators, including a general "hash" condenser.

For gas-gauge and oil-gauge filtering purposes, choice of Types 1120-O and 1143-G.

For dome-light clicks, Type 1180.

For vibrator noise suppression, the widest choice of mica and oil condensers.

For shunting ammeters, Types 1160 and 1170.



Ask for Copy...

New 1941 catalog lists wide choice of auto-radio condensers. Ask jobber for copy — or write us direct.

AEROVOX

CORPORATION
NEW BEDFORD, MASS.
IN CANADA: AEROVOX CANADA, Limited, Hamilton, Ont.

Don, Wldwk, "the business" for trying to interest Milt in model airplanes. She says "Milt" has enough hobbies already!

With Nick of W2ADW settled down at the new location, it would seem that one of his famous "Pole raisings" should come any week end now.

W1IJ of Madison, Conn., is heard consistently on Long Island on 2 1/2. His sigs have a real wallop.

W2LUD claims that one of the frogs in his swamp keeps calling "CQ."

HERE is sum local news of the hams in Bkln. W2NUC youngest ham in Bkln., 13 yrs 10 mo. on 40 m c.w. 7160 Kcs. Hws abt sum shouts o.b.

W2MQA quiting local police es will hve to keep off 1930 Kcs.

W2MRB finally putting up his hearts desire. 160 m. doublet.

W2MQA swishing all over 160 m. fone band wid fb eco.

W2MXM in Army wrking portable W3 frm Camp Hamlopan. Del., wid 60 watts output to 21IE.

W2MFR joined Coast Guard es sure miss Sy on 40 c.w.

W2NNL, George wrks W5IYW wid ten watts input to a 6L6 es 40 m. doublet wid RST 569X.

W2MVX on twenty wid nw Meissner deluxe sig. shifter.

W2MOQ drafted in Army es wrking portable. W2KPE, the voice of Canarsie, alternation between 20 m. fone es 160 fone.

W2NAG off 160 fone es back to old hobby "Bridge."

W2MBP isn't active anymore due to position in Navy Yard.

W2MPT finally back on 160 fone after short vacation. Irv got hooked es can hear the xyl whenever Irv is on.

W2LXU Major is dwn in Ft. McLellan, Ala., wid Army es wrking portable W4 wid fb sigs up hr. in Bkln RST 579X.

W2BOK/2 on 40 c.w. wid push push 6L6's es 60 watts wrking everything under the sun. QRM does not bother him becu he has 6N7 sig shifter.

W2LZX off the air becu has job wid government dwn in Washington. Sure miss u, "Jack."

W2JVT "Hank" Mayor of Pigtown on 2 1/2 m. es wrking rig frm car.

FROM W1JOM your 1st District reporter we hear the following:

Last Saturday we (5yd the 2nd op. myself & a bunch of the local color) took a run dwn to Framingham to attend the 9th Annual Hamfest sponsored by the Framingham Radio Club. We got there just in time to see the 2 1/2 & 5 meter treasure hunt start off. Then after meeting the gg we sat in on an interesting FM demonstration by G.E. A traffic test was carried on by several prt. and prt. mobile stas all using FM. It was a complete success & went off without a hitch. Later Col. Boyden, W1SL in the main lounge talked on "Amateur Radio & the State Guard," followed by Percy Noble of the ARRL. Then came the main event, the eats. If u hwn't hrd by nw, the Frgm Hamfest always has the best food within 500 miles. Then Ed Leahy W1IYL, Pres. of the P.R.C., welcomed the gathering. After dinner speakers were W1KH, Pres. of ARRL, Lt. Dumas of the USA & Lt. Cummings of the USNR. The Radio Shack of Boston set up 10 nw revrs so th the hams cud try them out side by side. This was the only exhibit at the fest & we r looking forward to many more exhibitors taking part next yr. We had a fb time & frm the sound of things so did everyone else. PS, look above or in the next issue or so for pictures th urs truly snapped at the Hamfest. of the gg.

While in Frgm we found th many of the members of the FRC r nw in the service. Sum of them r: KAG, USN; JAQ, USN; PZX, USA; HQU, USN; GLA, USA; LXO, US Coast Guard. W1LLP & WINGS of Milford r also sporting bright nw Army togs.

Well Spring is hre, the season when all ham's fancy turn to prt mobile wrk (unquote). Most of the mobile wrk is being done in coordination with the local Amateur Defense Emergency Units. Sum of the gg ur liable to run into on sum hi hill (wrking prt mobile, of course) r: W1MZF, AKD, KSA, KWD, IS, MME, LWQ, LYL, MPT, LDG, MNC of R. I., 2MIW bt W1. BZT, JLL, & many more.

W1MYO of Lynn claims th he's the best checker player arnd tw.

W1KSA ditto. They will sn get together with none other than myself as go between. Just in case things go tuff for our Boston boys weve got a full pocket of extra red checkers (not th we'l nd them). Hi, Herman.

W1MQO is Emergency Coordinator for Somerville. AR sez th he's got so many certificates th he hasn't room on the wall for his code performance sheepskin.

Here's a nw one: over Rosindale way an elderly deaf lady was entreating sum friends one nite when she hrd someone's voice coming frm her hearing aid when no one in the room was talking. What she hrd was "W1KDF calling cq 5 meter fone." All she nds nw is a ticket & a transmitter. Hi.

W1LZB when last hrd had wrked 15 Providence sta & had crds frm six. All contacts were on 2 1/2 fone.

W1HDS a regular RN reader, is doing color photography with his Arjus.

When u say th W1CIB is "all wet" u may be true. U see his ant. mast most of the yr is in several feet of water. (We got out of that one pretty easy, didn't we George.) Say George, tell Ernie W1GOU th short skip came thru on 10

the other nite, so he better cum dwn frm "one sissie."

W1AZV is wrking port frm Brattleboro, Vt., these days.

W1KNM is with G.E. He is a sailboat enthusiast.

W1IIM is pounding brass on 80. U shud hear his lingo, it sounds like pig-Latin mixed with a little salt & pepper. It's really original.

Hrd W1ZZC on 10 fone the other nite. No, we're not up to the Z's yet, all it is, is one of those port calls issued way back that hasn't bn recalled.

W1ON of Conn. recently pd W1BKE of Lynn a visit.

W1AJA speaking: "Ham radio is alright, at least it stops depressions." George is gg to put up a 33 ft pole in the back yard of his nw home for a beam. Mary, xyl is cooperating by planting a climbing rose bush at the base. I betcha the neighbors still find out th George has a ham sta. Mary.

W1DNL is spending much time of late bowling. His average last week was (hold ur hats) 300. Bob u remember is the fella th was on the "Nox-zema Radio Quiz" program. And cu u imagine with all the help th W1AJA gave him the day before, helping him memorize the first 12 volumes of the Encyclopedia, he didn't know th "The Charleston" was a dance. Don't u remember book 3, page 1237? Tsk, Tsk. This will go down in the annals of radio. Bob, since the broadcast has left ham radio and gave W1AJA his 300 watt rig & revr.

W1BB usta be a ships op. W1MB gg dwn on 2 1/2. W1CWB & HXE r both putting in gd sigs to Hampton Beach on 10 fone. W1LKP is dwn at Wells Beach, active on 73 fone.

W1COO wrks W1XOY daily on 5 meters. XOY is a weather sta atop Mt. Wash., licensed to wrk hams.

With all the nets nw gg. on hams shud remember th when calling the net according to regulations u must call "CQ —Net." Don't forget the "CQ."

W1MSS of these parts, pulled up stakes on the East Coast for "sunny" Calif. Wayne w1 drop his W1 call & use a nw W6 wven he gets set. Best of luck on ur nw venture Wayne, we'll see u on 10 fone in the winter.

It's cheaper than a e.o.o. W1NBM en change freq by putting a piece of paper between his xtal. Try it, I cudn't get it to wrk, hi.

W1MZF is quite an acroplane enthusiast. In the past he's done quite a bit of flying & also sum air photography. At present he is attending Mass. Radio School.

W1AKN is a teacher by profession. W1LZA is at present a ship's op. When he left most of his equip was donated by him to MWO. W1KGR is an osteopathic physician.

W1NFZ is a nw ham & is located in Brookline. Hank is a freshman at Northeastern University. He is active on 160 & 80 & w1 sn be dwn on 2 1/2 meters using short lines.

W1MSW is a marine electrician. W1MJK visited the Hammarlund plant on the last tour of the season while with the Boston Symphony Orchestra.

W1JDO of Dorchester is on 112 mc. W1JDO of Adams, Mass., is still using in his rig the same 204A's th he got way back in 1925. The tubes were previously used in a bc station. Harry is a real old timer who got in the game in the 20's. He is a cw man at heart & only came on fone last yr. Harry, by the way, is in the insurance business.

W1MMT has a nw Sky Buddy. He just got his class A, & nw all he nds is a rig to get on the air.

W1QJT is attending Worcester Tech. W1APQ is back at Hampstead Beach. The Army Net nds members in Me. Wat say fellas.

W1KYT is looking arnd frm sum dope on over-load relays to keep his 809's frm popping off. Hve u noticed the similarity in W1KYT's & W1LKP's voice. The reason is they r brothers.

W2AWJ is an amateur photography fan. He lacks a print dryer. (So do we.) While on the subject, W1KKG is a movie fan. He's looking for a gd 35mm camera.

Nw ham doing arnd tw: W1JPM started up a story telling contest. It meet Sat nites & is held on 2 1/2 fone. It all started when JPM picked up a qst frm W1LJT. He answered the call & found out th a gas sta a few doors away frm LJT was just heldup & the cops were wanted in a hurry. Later when things quieted dwn they got together talked over their experience. Later W1LKT was called in the qso & they had such a fb time th they decided to meet every Sat & swap stories. Listen in sum nite they're real gd. You'll find W1AYO dwn Dennisport on the Cape these nice summer days. He usually spends most of his time dwn there. W1JLI & NHN w1 he his neighbors. They also vacation on the Cape. N. Turo to be exact.

W1IIM is Pres. of the N. E. Radio Club Council.

W9WKW is wrking prt frm Ft. Mead. Hws the dust dwn there. Al, hi.

W1LO is thinking seriously of gg dwn on 20 fone. W1MSK gg up frm his class A sn. W1MSW of Roxbury recently changed qth. W1MNK is a nw sta on 10 fone. Howdy fella.

W1MME recently took a trip with his xyl to N. Y. by auto. W1MNY of Roxbury is being hrd up in Pawtucket, R. I. r-8. Clarence uses several beams on his 2 1/2 meter rig to poke his sig arnd tw.

W1KSA w1 sn be on 2 1/2 with a xtal rig. The rig w1 be the same one Joe's bn using on 5 fone & cw. The rig starts off with a Meissner sig shifter. He will be on fone & cw. Revr he is using is a nw S-27, a Hallicrafter uhf AM & FM job.

We'll hve to run nw, becu the Emergency Power drill starts in a cupla seconds. 73.

BUY DIRECT FROM THE MANUFACTURER AND SAVE

WE KNOW OUR PRICES ARE VERY LOW and expect a certain amount of skepticism from servicemen who have never purchased the SUPERIOR way, but five years of sticking to our way of doing business has convinced us and many thousands of servicemen who have purchased from us that it is a practical and mutually profitable way of doing business. We know that the average income of the Radio Serviceman prohibits his purchasing high-priced equipment, and yet the very nature of his work makes it necessary for him to use accurate, dependable and up-to-date equipment. We know we have solved the problem for him and our continually expanding business proves that servicemen recognize this claim to be true.

BESIDES THE THOUSANDS OF SERVICEMEN AND TECHNICIANS, THE FOLLOWING WELL-KNOWN NAMES ARE LISTED AMONG SUPERIOR INSTRUMENT PURCHASERS: Standard Oil Company of New Jersey; U. S. Dept. of Agriculture; U. S. Dept. of Commerce; U. S. War Department; C.C.C. Camps; National Youth Administration; Goodyear Tire and Rubber Co.; E. I. duPont de Nemours & Co.; University of Nebraska; Leland Stanford Junior University; Westminster College; Oberlin College; University of Michigan; Boston College; Pomona College; Board of Education, Remus, Michigan; Board of Education, City of New York; Board of Vocational Education, State of Illinois; City of Bartow, Florida; Florida State Dept. of Education; Educational Dept., Custer, North Dakota.



The New Model 1220 POCKET LABORATORY

★ WEIGHS ONLY 28 OUNCES!!
★ USES a 2% ACCURATE 0-200 MICROAMMETER—ENABLING MEASUREMENTS AT

5000 OHMS PER VOLT SPECIFICATIONS

- ★ 6 D.C. Voltage Ranges: 0-3-10-50-250-500-5,000 volts.
- ★ 3 A.C. Voltage Ranges: 0-15-150-1500 volts.
- ★ 1 Resistance Ranges: 0-3000 ohms, with 15 ohm center, direct reading to 0.2 ohm; foregoing base range multiplied by 10, by 100 and by 1,000, to read up to 3 Meg. with self-contained 3 V. flashlight battery.
- ★ D.C. Current Ranges: 0-200 microamperes; 0-2-20-200 Milliampères, using wire-wound shunts.
- ★ 3 Output Meter Ranges: Same as A.C. Voltage Ranges.
- ★ 3 Decibel Ranges: From -2 to +58 D.B., based on .006 watt in 500 ohms.

Model 1220 comes complete with cover, self-contained battery, test leads and instructions. ONLY **\$10⁴⁵**

THE NEW CHANNEL-ANALYZER

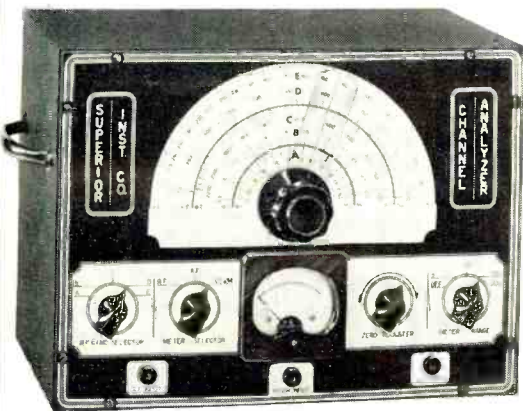

FOLLOWS THE SIGNAL

FROM ANTENNA TO SPEAKER OF ANY SET

The well-established and authentic SIGNAL TRACING METHOD of locating the very circuit in which there is trouble, and the very component that causes the trouble, is now for the first time available at a price any radio serviceman can afford.

THE CHANNEL-ANALYZER WILL

- ★ Follow the signal from antenna to speaker through all stages of any receiver ever made.
- ★ Instantly track down exact cause of intermittent operation.
- ★ Measure both Automatic-Voltage-Control and Automatic-Frequency-Control, voltages and circuits without appreciably loading the circuit, using built-in highly sensitive Vacuum-Tube Voltmeter.
- ★ Check exact gain of every individual stage in receiver.
- ★ Track down and locate cause of distortion in R.F., I.F., and A.F. amplifier.
- ★ Check exact operating voltage of each tube.
- ★ Locate leaky condensers and all high-resistance shorts, also show opens.
- ★ Measure exact frequencies, amount of drift and comparative output of oscillators in superhets.
- ★ Track down exact cause of noise.

The Superior Channel-Analyzer comes housed in shielded cabinet and features an attractive etched aluminum panel. Supplied complete with tubes, three specially engineered shielded input cables, each identified as to its purpose. Also full operating instructions. Size 13" x 10" x 6". Shipping weight 16 pounds. Only **\$19⁷⁵**

Canadian Distributors; Radio Parts Supply Company, 962 Bleury St., Montreal, Canada

The New Model 1240 TUBE TESTER

Instantaneous snap switches reduce actual testing time to absolute minimum. Tests all tubes 1.4 to 117 volts.

Sockets for all tubes—

No adapters.

SPECIFICATIONS:

- ★ Tests all tubes, 1.4 to 117 volts, including 4, 5, 6, 7, 7L, octals, octals, Bantam, Jr., Peanut, single ended, floating filament, Mercury Vapor Rectifiers, the new S series, in fact every tube designed to date.
- ★ Spare socket included on front panel for any future tubes.
- ★ Tests by the well-established emission method for tube quality, directly read on the GOOD ? BAD scale of the meter.
- ★ Jewel protected neon.
- ★ Tests shorts and leakages up to 2 megohms in all tubes.
- ★ Tests leakages and shorts in all elements AGAINST all elements in all tubes.
- ★ Tests BOTH plates in rectifiers.
- ★ Tests individual sections such as diodes, triodes, pentodes, etc., in multi-purpose tubes.
- ★ Latest type voltage regulator.
- ★ Features an attractive etched aluminum panel.
- ★ Works on 90 to 125 volts 60 cycles A.C.
- Model 1240 comes complete with instructions and tabular data for every known type of receiving tube. Shipping weight 12 pounds. Size 6" x 7 1/2" x 10 1/2". Our Net Price **\$11⁸⁵**

PORTABLE COVER \$1.00 ADDITIONAL

MODEL 1230 SIGNAL GENERATOR

WITH FIVE STEPS OF SINE-WAVE AUDIO



SPECIFICATIONS:

1. Combination R.F. and A.F. Signal Generator. R.F.—100 K.C. to 90 Mcgacycles, A.F.—200 to 7500 cycles; Sine-Wave—WITH OUTPUT OF OVER 1 VOLT. All direct reading, all by front panel switch manipulation.
 2. R.F. and A.F. output independently obtainable, alone or with A.F. (any frequency) modulating R.F.
 3. Latest design full-range attenuator used for controlling either the pure or modulated R.F.
 4. Accuracy is within 1% on I.F. and broadcast bands; 2% on higher frequencies.
 5. Giant dial etched directly on front panel, using a new mechanically perfected drive for perfect vernier control.
 6. Operates on 90 to 130 V. A.C. or D.C. (any frequency).
- The Model 1230 comes complete with tubes, shielded cables, molded carrying handle and instructions. Size 14" x 6" x 11". Shipping weight 15 pounds. Only **\$12⁸⁵**

SUPERIOR INSTRUMENTS CO. 136 Liberty St., Dept. RN7
New York, N. Y.

RCA Rider Chanalyst

\$107.50

**Net Price Complete
Stock No. 162**

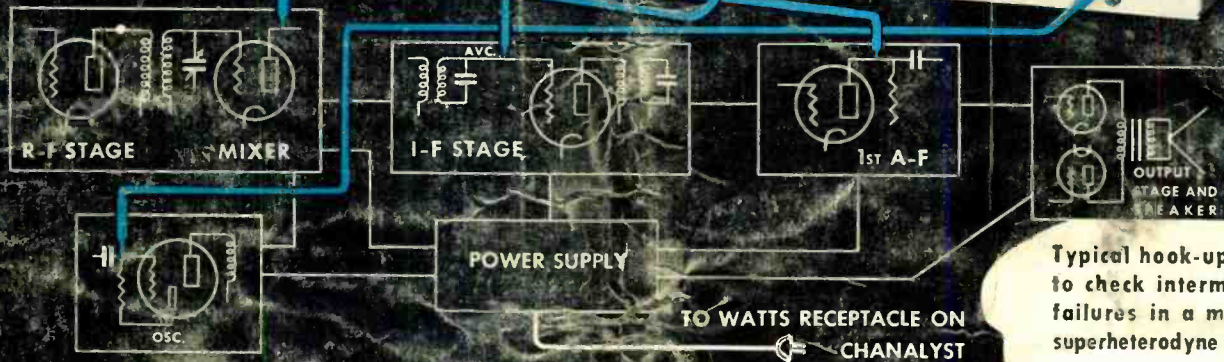
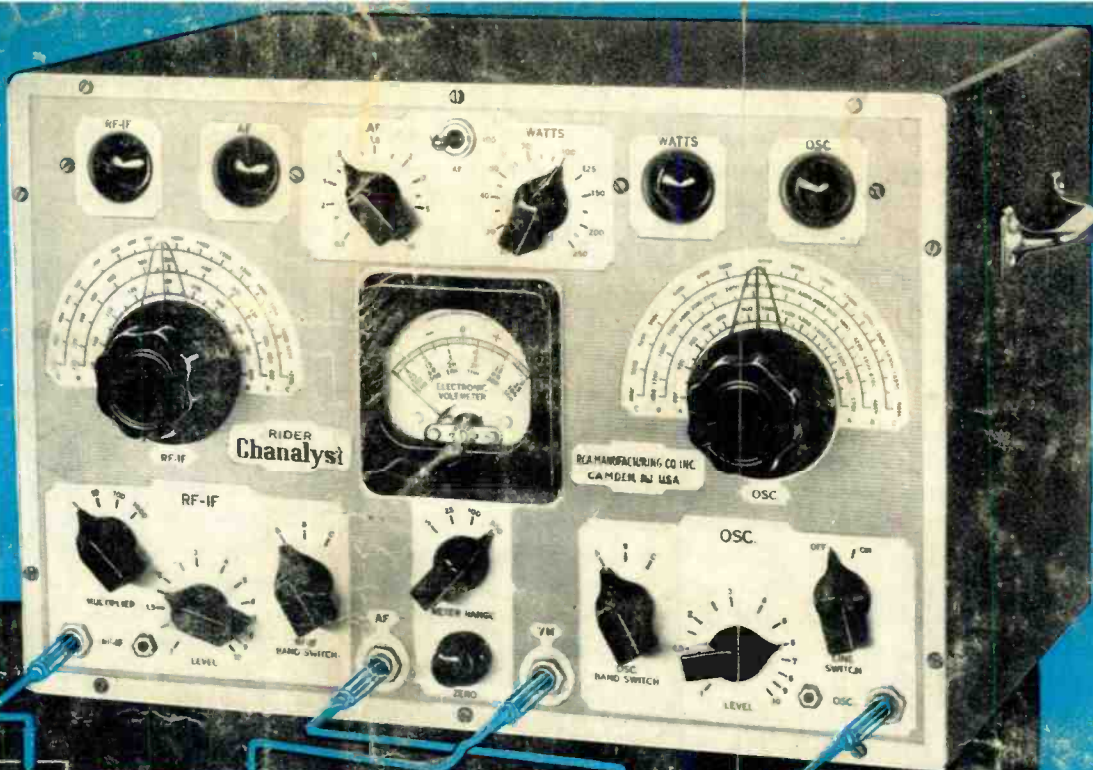

Typical hook-up used to check intermittent failures in a modern superheterodyne circuit.

PAYS FOR ITSELF BY TIME SAVED

Just a glance at the schematics here discloses how easy it is to use the RCA-Rider Chanalyst, and how reliably it will quickly disclose the source of the most baffling intermittent trouble. But forget technicalities for a moment and look at the RCA-Rider Chanalyst from a strictly dollars-and-cents business standpoint. Let's compare what you pay for it against what it stands to pay back to you.

At a recent meeting, a group of servicemen (who did not use the Chanalyst) admitted that they averaged somewhere between 3 and 5 "tough" repair jobs a week—sets that took them two hours or more to repair. Let's take the low figure, and do our calculating on the basis of only 3 of these "2 hour" jobs a week.

Careful tests with the Chanalyst show that an experienced operator can handle even the most difficult intermittent "short" or "open" jobs in 30 minutes. Again to be conservative, however, let's make it an hour—although,

actually, not one tough job in ten would take this long, once you had familiarized yourself with the tremendous time-saving possibilities of the Chanalyst.

Thus, a Chanalyst in your shop can mean a saving of at least a full hour on every one of those difficult "2 hour" jobs—or a total saving of 3 hours a week. That's 156 hours per year! At your normal rate for service . . . just figure how quickly the Chanalyst will pay for itself.

And remember, this only counts in the savings on difficult jobs. All that it saves you on the less complicated jobs is pure "gravy".

Small wonder, then, that more than 4,000 Chanalysts have been sold. Small wonder that it has proved the one absolutely indispensable piece of test equipment to so many leading service dealers. The Chanalyst not only helps them do better, more accurate work. It actually "puts more hours into their day"—hours for which a profitable service charge can be made!



Test Equipment

RCA MANUFACTURING CO., Inc., Camden, N. J. • A Service of the Radio Corporation of America
In Canada: RCA Victor Company Limited, Montreal

