

Build the Junk Box "Hurdy-Gurdy"

SEE PAGE 6

RADIO NEWS

APRIL
1940
25c

**Make Money
REVAMPING
Old Receivers**

★

**HAM RADIO
in the
Georgia Tornado**

★

**Full Floating
1940
Tub Tester**

★

**GENERAL
HAMMETER**

★

**Home Remote
CONTROLLER**

★

**Ham Deviation
METER**



THE POWERFUL FINAL

2075 KNX

DAVEGA

"World's Largest Retail Radio Dealer"

AMATEUR RADIO

Distributors For:

- Hallicrafter
- Hammarlund
- Howard
- National
- R.M.E.
- Sargent
- R.C.A.
- Abbott
- Garrard
- Peterson
- Astatic
- Btush
- Presto
- Federal
- Bogen
- Wilcox Gay
- Meissner
- Guthman
- Premax
- Amperite
- American
- Shure

HALLICRAFTER

SUPER DEFIANT

Two stages R.F. variable crystal; real value; with spkr. \$99.50.

\$20⁰⁰ DOWN
12 payments \$7.61

SUPER SKYRIDER

Famous no drift I.F.'s custom construction. \$115.00.

\$23¹⁰ DOWN
12 payments \$8.85



HALLICRAFTER

DUAL DIVERSITY

25 tubes; most famous set built; two eight-gang condensers; fading minimized; finest tone; best D.X.; regular \$750.00; special \$450.00.

\$90⁰⁰ DOWN
12 payments \$34.50

DEFIANT

Calibrated band spread; variable crystal; complete coverage 8 to 550 meters; superior workmanship. \$69.50.

\$13⁹⁰ DOWN
12 payments \$6.25

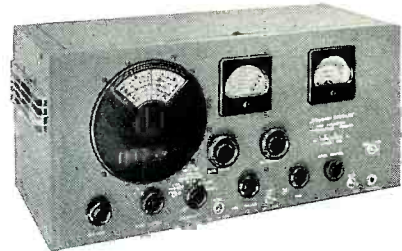

HALLICRAFTER

SKYBUDDY

Most popular priced radio made with 6 tubes, four bands. Electrical band spread. \$29.50.

\$5⁹⁰ DOWN
12 payments \$2.26

SKY CHAMPION

Sensational value; 9 tubes band spread; noise silencer; real value. \$49.50.

\$9⁹⁰ DOWN
12 payments \$3.79

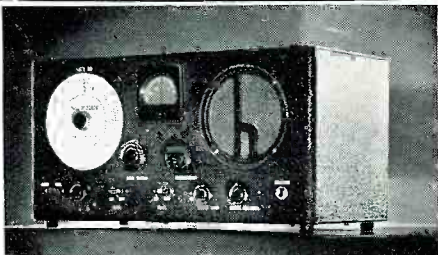

McMURDO SILVER 15-17 High Fidelity & D. X. Champion

25 Watt Hi-Fi Audio system. Grant Jensen Silver 15" spkr. Solid welded chassis 20 x 12 3/4. Reg. \$205.00.

\$109.50
McMurdo Masterpiece VI. Giant 18" Silver Jensen spkr. Volume Expansion, 40 Watt undistorted output. Reg. \$355.00.
\$199.50

GARRARD Record Changers R.C.1A

Regular list \$102.50. Mixes 10 and 12" records; limited quantity.

\$41.50

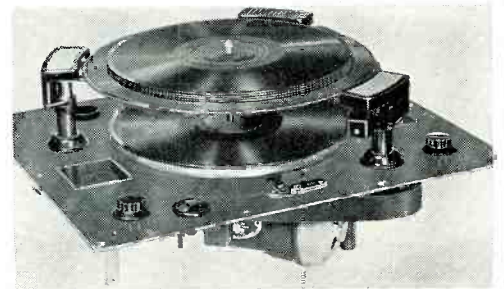
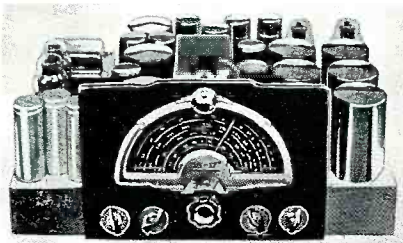

PRESTO RECORDERS

list \$149.00

SPECIAL \$89.00

USED RECEIVER VALUES

National F.B.7. with tubes.....\$15.00
Hallicrafter S.11 with tubes..... 39.50
Hallicrafter Skychief with tubes..... 17.00

Federal Recorders P.R.12. List \$249.00 **SPECIAL \$110.00**

DAVEGA

AMATEUR DIVISION 63 CORTLANDT ST., NEW YORK, N. Y.

"World's Largest Retail Radio Dealer"

EVERYTHING YOU WANT TO KNOW ABOUT PHOTOGRAPHY



TEN POCKET-SIZE TEXT BOOKS

- COMPLETE
- ILLUSTRATED
- AUTHORITATIVE

50¢ EACH

- NO. 1—YOUR CAMERA AND HOW IT WORKS by W. E. Dobbs and Charles A. Savage, with a Foreword by C. B. Neblette, F.R.P.S. Selection, use, focusing, composing, lens, shutters, roll film translators, cut film and film packs, accessories, etc. 132 pages.
- NO. 2—DEVELOPING, PRINTING, and ENLARGING by A. and DeVera Bernsohn. Elementary and advanced developing, chemicals, types of printing, enlarging equipment, elementary and advanced enlarging, care of prints, etc. 96 pages.
- NO. 3—FILTERS AND THEIR USES by W. Bradford Shank. Types, selection, use, requirements, advantages, problems, suggestions, the care of, etc. Informative and up-to-the-minute. 96 pages.
- NO. 4—COMPOSITION FOR THE AMATEUR by Kenneth Heilbron. This book is complete and workable. It covers the joining of subject and picture, tones, lines, rhythm, problems, suggestions, etc. 96 pages.
- NO. 5—MOVIE MAKING FOR THE BEGINNER by Herbert C. McKay, F.R.P.S. Modern movies and cameras, use, movies versus photography, producing, editing, processing, projection, etc. 100 pages.
- NO. 6—COLOR IN PHOTOGRAPHY by Ivan Dmitri. Types of subjects, natural color film, mounting, projection, color separation, density scales, printing, etc.
- NO. 7—CHILD PHOTOGRAPHY by Harold Lambert. Cameras and equipment, posing, types of pictures, finishing and processing, in natural color, problems, etc. 96 pages.
- NO. 8—HOME PORTRAITURE AND MAKE-UP by Maurice Seymour and Syd Symons. Part I: Lighting, camera, model, posing, background, and suggestions. Part II: He-styling contour, eyes, eyebrows, lips. Powdering, equipment, etc. 112 pages.
- NO. 9—TRICKS FOR CAMERA OWNERS. An outstanding collection of the latest and most valuable kinks and hints, covering every phase of amateur photography. 160 pages.
- NO. 10—A GLOSSARY FOR PHOTOGRAPHY. Compiled by Frank Fenner, Jr. Over 3000 words having photographic significance are defined. They cover still and motion-picture photography in black-and-white and color. 132 pages.

**ATTENTION DEALERS!
ORDER FROM YOUR PHOTO
SUPPLY JOBBER TODAY!**

The PHOTOGRAPHIC SERIES of the Little Technical Library is MORE than just another set of photographic books . . . MORE than an accumulation of mere facts or questions-and-answers . . . MORE than a collection of pictures and data through which one gropes casually. Rather, it is a complete, authoritative, brilliantly illustrated library of ten handy, pocket-size text books covering every phase of amateur photography with unprecedented thoroughness and accuracy!

Nowhere else will you find such a well-rounded photographic education for so little money! The entire PHOTOGRAPHIC SERIES of the Little Technical Library, containing everything you want to know about photography, is yours at only 50c per volume, a price so low that you need no longer deny yourself the real enjoyment of amateur photography. Yes, this instructive photographic library is a "must" for every camera fan in America!

Little Technical Library PHOTOGRAPHIC SERIES

AT ALL LEADING BOOK DEALERS & CAMERA STORES—Or, Use Convenient Coupon

ZIFF-DAVIS PUBLISHING CO. Book Dept. C4, 608 South Dearborn St., Chicago, Illinois

Please send me at once the books of the Little Technical Library PHOTOGRAPHIC SERIES whose numbers I have checked below. I understand that if I am not in every way delighted with the books, I have the privilege of returning them within five days for complete refund.

1 2 3 4 5 6 7 8 9 10

Please send me the complete set (10 volumes) attractively boxed in special library case. Amount enclosed \$..... or Send C.O.D. postage added (C.O.D. in U.S.A. only).

NAME ADDRESS

CITY STATE

(60c Each outside of U. S. A. — Payment with order)

WITHIN

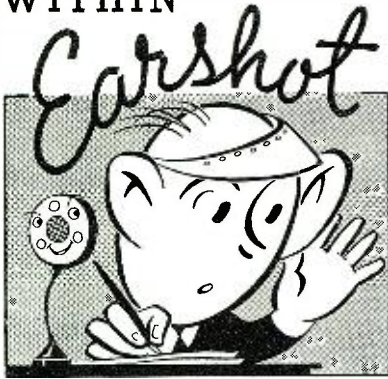

OF THE EDITOR

ANDOM thoughts of an editor of a radio mag: Wonder how it is that the police boys thought of Frequency Modulation about the same time that we did, and yet the airplane boys are still hanging back. . . . Nice attendance at the First Annual Dance of the Greater Chicago Area Club Council on Feb. 2, 1940. Seems like everybody had themselves a perfectly grand time. Al Knodell, W9TLQ, who impersonated a big mammy, was surely a hit. . . . Guess we'll have to think up a new contest for our readers. Since that last big Receiver Contest we haven't had anything "super-colossal" for the men to use their radio eye-teeth on. . . . That contest, in this month's issue, of Lee Ward's is clever. We had our favorite serviceman try, and as far as we know he's holed up for the rest of the winter. Swears he'll solve the puzzle,—or else. Guess it'll be, "or else." . . . Our new "Super-Streamliner" Superhet is coming along nicely, too. So far the only thing that it does *not* do, is to throw the *other* fellow's carrier for him. Ought to go over very well with those who want the very latest and the most complete *analytical* receiver which can be had. . . . Wish that we were where Johnny Rider is. Down in Florida. Sure would be nice to forget the deadlines for a while and just bake yourself in the sun. . . . Too bad about our Technical Editor, Ollie W9ETI Read. Got himself bedded with Scarlet Fever. The fellows in the shop keep calling him "Scarlet O'Read," which is laying it on rather thick. . . . Hear that WBBM is rebuilding their 50 KW xmtr. Even the broadcasters are not immune from the bite of the "rebuild-it" bug it seems. . . .

* * *

HEARDED of an interesting thing the other day. A representative of one of the medical short-wave therapy machines said he couldn't understand how it was possible to build a machine which would maintain its frequency no matter at what distance from the patient the electrodes were placed. Of course, what he meant, was that he did not understand how the frequency could be kept steady while varying the
(Continued on page 54)



Including Articles on POPULAR TELEVISION

The Magazine for the radio amateur experimenter, serviceman & dealer

VOL. 23, NO. 4

Contents for April, 1940

FEATURES

Junk Box Hurdy-Gurdy S. H. Giffin **6**
An old receiver, a few packing cases, some good records—the life of the party!

As I See It! John F. Rider **8**
Are there too many tube types?

General Hammeter R. L. Miller, W5AMU **9**
A meter for the amateur, with five separate uses.

200 Watt Stylized Phone Transmitter
. Wm. A. Woehr, W9WOP, with A. S. Kirk **10**
Fine engineering and construction combined to make a superb transmitter.

Ham Deviation Meter Edward Lovick, Jr. **13**
Check your frequency visually with this meter.

Full-Floating 1940 Tube Tester R. K. Wheeler **14**
Build this all-tube tester for emission testing now.

Home Remote Controller Wm. E. Barbour, Jr. **18**
A valuable gadget for the sick room or general household purpose.

Unicontrol 5-Band Transmitter **Part 2**
. Karl A. Kopetzky, W9QEA & Oliver Read, W9ETI **20**
Building the R.F. section of the 200 watt output transmitter.

Modernizing Old Receivers, Part 2 Charles R. Leutz **26**
Further advice on turning old receivers into servicemen's cash.

DEPARTMENTS

Book Review 24	QRD? 24	Serviceman's Experiences 19
What's New in Radio . . . 30	Bench Notes 25	Serviceman's Cases 34
Radio Physics Course . . . 60	Manufacturer's Literature 40	Hamchatting 35
The Video Reporter 39		

Copyright, 1940
ZIFF-DAVIS PUBLISHING COMPANY
Member of the Audit Bureau of Circulations

RADIO NEWS is published monthly by the Ziff-Davis Publishing Company at 608 S. Dearborn St., Chicago, Ill., William B. Ziff, Publisher; B. G. Davis, Editor; J. Fred Henry, Vice-president; Karl A. Kopetzky, W9QEA, Managing Editor; Oliver Read, W9ETI, Technical Editor; Raymond B. Frank, W9JU, Laboratory Technician; Eugene O. Gleeson, W9FXK, Engineering Draftsman; Herman R. Bollin, Art Director; John H. Reardon, Circulation Director; S. L. Cahn, Advertising Manager. New York Office, 381 Fourth Ave. Subscription \$1.50 per year; single copies, 25 cents; foreign postage \$1.00 per year additional except Canada. Entered as second class matter March 9, 1938, at the Post Office, Chicago, Illinois, under the Act of March 3, 1879. Contributors should retain a copy of contributions. All submitted material must contain return postage. Contributions will be handled with reasonable care, but this magazine assumes no responsibility for their safety. Accepted material is subject to whatever adaptations, and revisions, including "by-line" changes, necessary to meet requirements. Payment will be made at our current rates upon acceptance and, unless otherwise specified by contributor, all photographs and drawings will be considered as constituting a part of the manuscript in making payment.

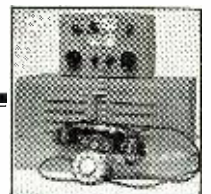
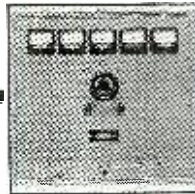
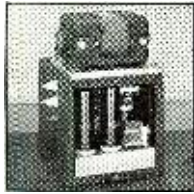

WHAT HAPPENS TO THE ELECTRONIC UNITS DESIGNED BY RADIO NEWS ENGINEERS?

The custom-built electronic units designed by our engineers are produced solely for editorial presentation in RADIO NEWS. After display in the pages of RADIO NEWS they are offered for sale at a reasonable price. This is one way you can obtain these RADIO NEWS electronic units, representing the crowning achievement in custom-built radio design, craftsmanship, and performance for your own use.

Attention manufacturers, dealers, jobbers and readers! We are prepared to quote prices on any of the custom-built units, receivers, transmitters, gadgets, amplifiers and testers designed by, or for, the staff of RADIO NEWS. Adjustments in design to meet specific needs will be made where so requested. A card of inquiry will bring complete information.

**ZIFF-DAVIS ELECTRONIC LABORATORIES
608 SOUTH DEARBORN ST., CHICAGO, ILL.**

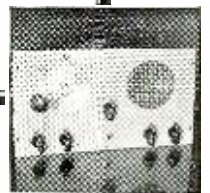
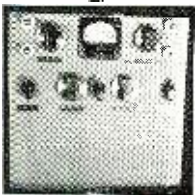
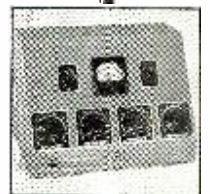
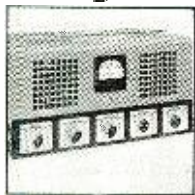

ADVERTISEMENT

JUNK BOX HURDY-GURDY

by **S. H. GIFFIN**

Radio Engineer, Baltimore, Md.

An expensive P. A. system is not needed to be the life of the party,—try this junk special



NO suh, Gempmum! You do not have to tote a saxophone along to furnish the "Life of a Party." Neither do they laugh when you sit down to play a record. With the utmost confidence of being able to adjust the volume control to the desired output, you, too, can then join the dance, and the tempo of these private parties depends to a large extent on the type and volume of the music available.

The radio seems to have gradually fizzled out as a source of home dance music. The Radio Chains have raised the standard of programs to such a high plane that the dance music can't squeeze in between the commercial announcements. The broadcasting people have some very nice literature illustrating what percentage of time is given over to Education, News, Entertainment, etc., on the basis of 100% per chain. With ten chains available we have our choice of 10,000% which should be wholly adequate to put it mildly, but when the guests collect in the club room for an evening's fun, and the Radio turned on for a bit of the light fantastic, the speaker emits 1% dance music, 10% stale dialogue, 15% news, 2,000% Dead Eye Dick serials and 7,974% long winded Commercial Insults to your belittled intelligence to a point where you shut off the Radio and get down to a little serious this 'n that and story telling—and the party just drags through.

However, if the host or one of the guests breaks out the old *Junk Box Special*—quite another story may be told. The records are good, the tone quite superior to some of the "minute" radio receivers and you have what you want as you want it with no breaks. Above all, the talking and laughing of a gathering of fifteen or twenty couples requires more than the average little radio set can produce in the way of umph!

In the July, 1939, issue of *RADIO NEWS* you published an article by Seymour Berkoff on the production of a Pure-Tone 12-watt P.A. system that so intrigued me that I set out to build myself one for occasional friendly gathering needs. I even filled out the order blank for the parts, but when totalling up the cost of the parts, my pocket book immediately questioned the investment. Considering the fact that it

This young lady was surprised to find that in spite of the system being "junk," it was really heavy.

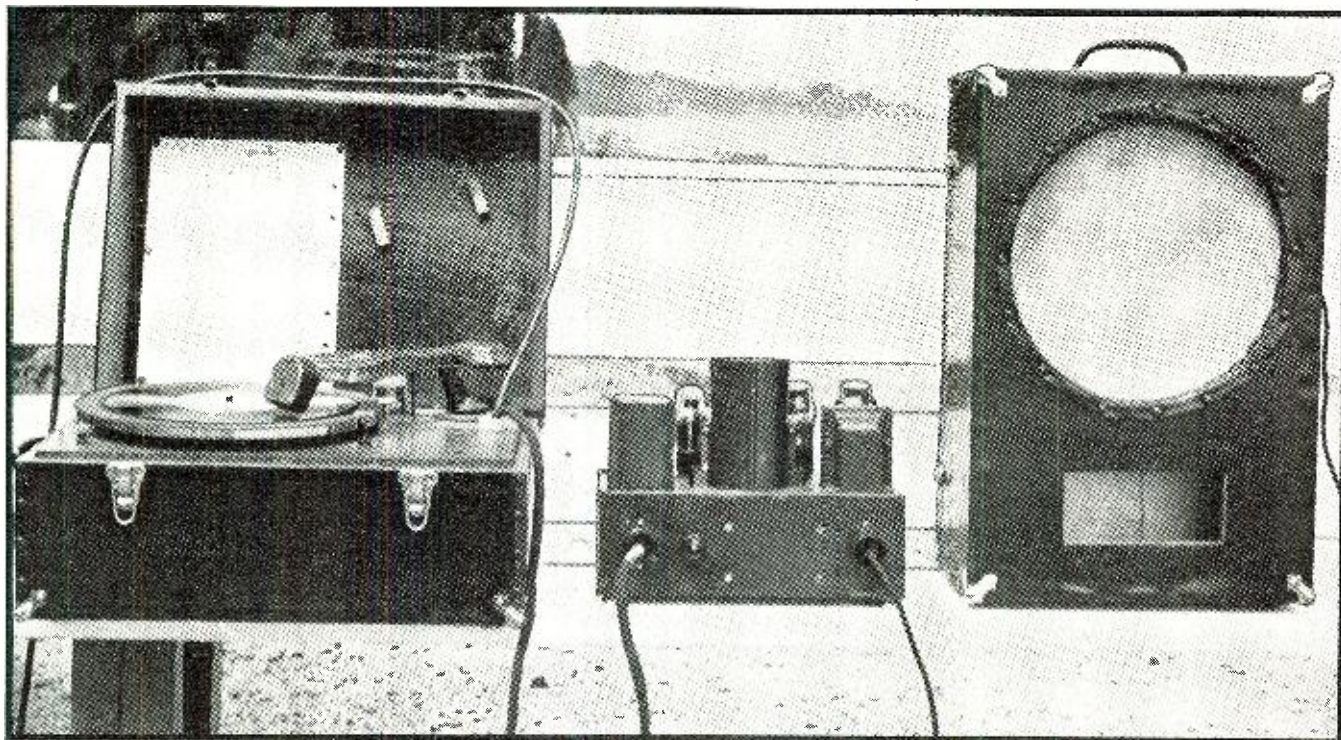

When set up, the Hurdy-Gurdy looks so respectable that one would hardly expect that it had been assembled from the junk-box and a few "mouldy" receiver parts.

would hardly be used over 30 times a year, and was not for commercial rental business, but just for one of a crowd who likes dance music for the group well enough to tote along the makins, I realized that this investment wasn't so sound.

Thinking about the thing further, and not readily giving up the idea of some sort of a set, I began to opine that while the best is none too good for the most of us, yet how far back can we go from the ideal and still have something that is commercial and good enough for the most of us. You know that the works of these nickelodeons in the drink mills are far from being gold-plated, yet the result is, on the whole, quite pleasing.

In checking over my junk box, and that of some second hand Radio stores, I looked first for a motor driven pickup unit, then a power pack, and amplifier, and finally a loud speaker. Well the home supply produced a fifteen year old magnetic pickup that might do. The second hand dealer sold me a complete "Zenith 50" series radio receiver which was, of course, of ancient vintage for a price of Five Dollars—Roosevelt money—and thus completed the inventory in one operation. The

diagram of this set, as purchased complete, with tubes is shown.

I believe that ordinarily, the ethics of the trade forbid the actual listing of the manufacturer's name on equipment such as this, but then on the other hand, this is a case where nothing less than a good three stage amplifier will do. Every old timer knows that Zenith, way back in the 201A tube days, always made a feature of three stage amplifiers, so it is not at all unusual that Zenith's in the junk store came in for special investigation. This particular audio amplifier is just about fifteen years ahead of its time. It has one stage of shunt fed audio of a bass booster type, followed by two well designed stages of pushpull amplification ending in a very well made 12" dynamic speaker. During the era of its introduction I believe that this set was advertised as having a 20 watt output. Testing through it with an audio oscillator, found that from 30 cycles to 4,500 cycles, the ear could detect no variation in output, then it sloped off until complete cut off was reached at 5,000 cycles. Now for ordinary

phonograph use, this came too close to the ideal to be passed up. The output tubes as will be noticed in the circuit diagram are 245s. These deliver less output than the 6L6 tube would, but on the other hand you can kick this amplifier around in your car and still have it play when set up. For home use with a party of fifteen couples, the volume control is never run up over three quarters of the way, so better use it as is, than try to work in 6L6's for a 3db increase in output.

The local Grocery Store presented me with a couple boxes that looked rather promising as embryo traveling cases, while the amplifier base presents no problem. The speaker box
(Play back further on page 50)

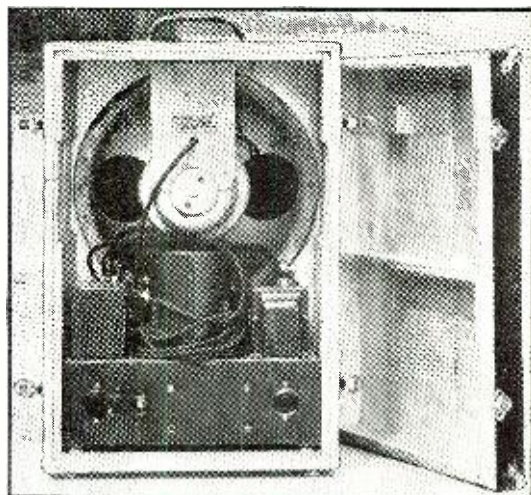
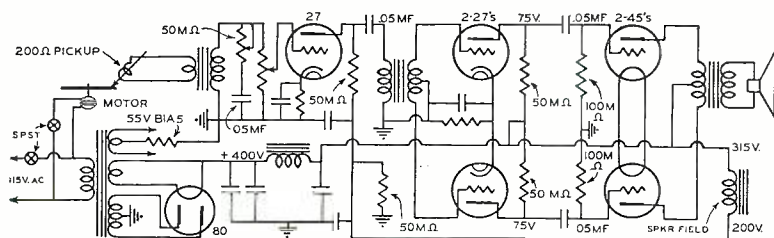

The amplifier fits into the speaker cabinet when the H-G is "put to bed."

A S . . . S E E . . .

by JOHN F. RIDER

Dean of the Servicemen

Are there too many tube types? Read what an old-time serviceman says.

Fewer Tube Types

WE note agitation in the direction of a reduction of the number of tube types to be placed into use during the year 1940. With full recognition that some will accuse us of favoritism, we cannot help but say that as we see it from the servicemen's viewpoint, such a program cannot be of help. As a matter of fact, it might even be possible that such a program will be of help to the tube companies as well as the set manufacturers. However, these two slants are somewhat beyond our ken, so we'll stick to our last.

Without delving into the exact tube types in question, but considering the subject solely from the viewpoint of reduction of tube types, certain conclusions appear incontrovertible. It stands to reason that if the number of tube types is reduced, servicemen will become more familiar with those in use and will more readily comprehend the operation of these tubes in receivers. Today with five or six different types of tubes being used for similar service it is not strange that many men find it difficult to appreciate that many receiver circuit structures have the same basis or foundation.

Furthermore with the many tube types intended for similar service in like receivers, but with these tubes op-

erating under different voltage conditions but like in appearance, there cannot help but be confusion in the actual physical replacement.

Most certainly tube type reduction will simplify the tube sales and inventory problem. Granted, that the reduction of tube types used in the receivers produced during 1940, will have no effect on the types used in the past, it nevertheless is a stride forward in the right direction. If continued, it will in time to come reduce the number of types a man must carry in stock and thereby will make his shop inventory more liquid, which is a definite requirement in the average service shop. Servicemen on the whole cannot afford to tie up money in slow moving inventory, even if the number of tubes involved is comparatively few.

It definitely will help the serviceman who sells tubes in the customer's home and carries a stock in his car. Just as today the type 80 rectifier is a prime mover because it is used in so many receivers, just so will other tubes become staple readily movable items when the number of tubes used in receivers is reduced to a minimum.

Today only a certain number of types are carried. Naturally the types which were used in the majority of receivers were carried; but now and then and some times even more often, a repeat call is required because certain tubes which are needed are not carried in the car. This is to be expected and it seems unlikely that it will be completely solved even when the number of tube types are reduced, but every tube type removed from the list is one less type to carry, hence is a help.

From the viewpoint of tube checking, both on the counter and in the home it will be a gift from heaven, not only to the serviceman, but to the test equipment manufacturer as well. Today, with all the tube types available, it is really a job properly to check the tubes removed from a receiver, what with the different filament or heater voltages, plate voltages, screen voltages,

etc., a multiplicity of knobs must be set. Reduce the number of tube types, and you minimize obsolescence; the number of switches or knobs to set, the number of sockets required; in fact, if you can conceive of such, keep the tube checker offered for sale today up to date a year from today, and last but by far not the least, enable a rapid test of tubes in tube checkers when such checks have to be made.

Inasmuch as all tube manufacturers do not make all types of tubes today, it is going to simplify the purchasing problem . . . One source, with which the serviceman likes to do business, will be able to supply the types needed. Today, men are oftentimes called upon to secure tubes from several sources so as to fill a replacement requirement.

Now, wherever we find advantages, there must be some disadvantages and they exist. Reduction of such tube types will naturally lead to increased production of those types which are in use, hence it might lead to a reduced list price. We said it might. We don't know. At any rate, it is not as black as it appears for if in the distant future, such list price reduction does take place, there no doubt will be a reduction in the net price. It is, of course, far fetched to imagine a revision in discount so as to provide the same dollar income to the serviceman, but maybe it will happen. Even if it does not, maybe steps will be taken to cause more extensive replacement of tubes than takes place today. The low list price might cause more frequent replacement.

It is also possible, that a reduction in tube types might create a condition such that the customer finding a great similarity in the tubes used in his receiver, might become more courageous and carry the tubes to the set dealer for checking, thus taking business away from the serviceman. Again we want to remind you that we are speaking about possibilities, not, necessarily, probabilities.

Recognizing all of these conclusions and possibilities, we still feel that the step is in the right direction and we most certainly hope that such a policy will be adopted by the industry. Of course, the set manufacturers must be heard from. Maybe they have reasons of their own, just as sound as those being advocated in the tube business, why they find it necessary to introduce new tube types so as to continue with receiver development.

Flat Rate Charges

THE discussion of service charges will not cease until such time as all servicemen say that they find the servicing industry to be a lucrative source of income.

The questionnaire we mentioned elsewhere in this column also asked a question about service charges—that is, whether hourly charges or flat rate charges were being used. Frankly, we were extremely surprised to note the

(Continued on page 52)



"Be thet a still? We got too many now. Don't pay!"

MOST of us amateurs build fairly decent transmitters, - quite a number have regular haywire outfits while a still smaller group really get that *commercial touch* so many would like to have. The rig illustrated and described in this article has that professional air about it.

When first planning this outfit several prerequisites were set up. First, it must be strictly commercial looking. Second, it must be compact and yet have a medium power input rating—in this case 200 to 250 watts. Third, it must use well proven, yet simple circuits easily constructed on not too large chassis. Fourth, each unit must be easily removable so that the whole rig would not have to be torn down to replace a by-pass condenser. And last and perhaps the most important, maximum safety must be provided—1000 volts still being considered lethal. And so with these thoughts in mind we'll show you how W9FQL, Andy Kirk, solved the problem when he built this phone transmitter.

The cabinet shown is 52" high 16" wide and 11" deep, finished with the new wrinkle gray seen recently on the new broadcast transmitters. This particular cabinet was hand made out of sheet car metal; however, for those desiring, they may purchase a ready made cabinet of suitable size. Two removable doors are fitted to the front so that after all tuning adjustments are made, the whole rig may be entirely closed up. The outstanding safety provided by this type of housing is a major point not to be overlooked, especially in view of the current safety campaigns. In mounting the various units a sheet metal shelf is arranged for each to slide in and rest on, while two *Amphenol* male connectors are mounted on the rear of the chassis so as to engage with two corresponding female connectors, for quick, easy plug-in connections. Two shallow U-shaped channels about 1½" wide formed out of sheet metal and running up and down each inside corner at the rear of the cabinet has been found to be a handy way of keeping the connecting wires in place. If one does not care to use this channel method, the wires may be cabled together in the conventional manner.

Looking now at the individual chassis, the first one at the top is the r.f. final amplifier using two *TZ40's* in a push-pull arrangement. These tubes were selected for the final because they need no extra bias supply, and can handle a decent amount of power input. Other tubes of a similar type may be used, too. The coil on the left is the grid coil while that on the right is the plate tank, a self supporting air-wound type with an adjustable link for varying the coupling to the antenna circuit. Those round disks about the size of a half dollar are the neutralizing condensers while the two tuning condensers are located below deck. Two openings are made in the front of the chassis so that a small insulated

screw driver may be inserted to tune up this stage. Incidentally, all the variable condensers have the shaft ends slotted for screwdriver adjustment and this explains the lack of any dials or knobs. In mounting the *TZ40's* be sure that the plates are in a vertical plane to allow for any filament sag.

Just below this unit is found the exciter chassis. The crystal oscillator is in the front right hand corner and utilizes the reliable high output *RCA 6L6* beam tube. This unit was not entirely finished at the time the picture was taken as a switch for selecting any one of three crystals had not yet been installed. By using two or three crystals with frequencies somewhere near each other the rig may be shifted around in a band so as to avoid QRM, without retuning any of the circuits. The oscillator tuning condenser is a small midget mounted right in the coil form and adjustable from the top. The larger glass tube is the *RCA 807* buffer, its tank circuit being at the extreme left hand side of the chassis. The use of this beam tube for the buffer stage results in relatively high output, for exciting the final, with the oscillator operating either on the fundamental, second or fourth harmonic. By properly shielding the lower half of this tube as shown, no neutralization is required. This exciter incorporates its own power supply, being positioned along the rear.

As the rig is shown it is set up for 10 meter fone operation using a twenty meter crystal, doubling in the oscillator to 10 meters, amplifying straight through the buffer on 10 so as to provide plenty of grid drive for the final r.f. In this manner an input of 200 to 250 watts for 10 meter fone operation, may easily be attained without pushing any stage too hard. As shown, all the tank coils are of the plug-in type, thus the rig may be quickly changed over to another band at any time.

On the lowest deck is the speech amplifier and modulator chassis. Separating it in this manner from the r.f. sections eliminates a lot of feedback that might otherwise be encountered if this unit were directly under the r.f. circuits. The first a.f. stage is located in the lower right hand corner with the *RCA 6N7* directly in line behind it. Metal tubes are used in the speech section due to their inherent shielding, so desirable in high gain circuits. The four *RCA 6L6G* modulators are grouped in the left rear corner. Immediately in front of these is the modulation transformer chosen to have sufficient rating so that distortion will not be present when modulating 100%. This means at times a peak audio power of 125 watts and the *RCA 6L6G's* do it very nicely. The gain control is mounted on the chassis in such a manner that it may be adjusted by means of a screwdriver. In actual operation this is usually set so that overmodulation will not occur, yet a good gain is realized through the am-

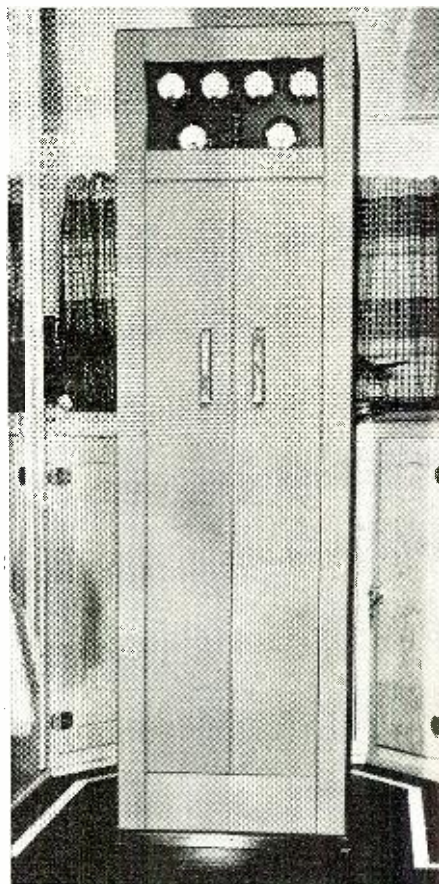

When closed up, the rig will not annoy the XYL; but stands serenely and austere ready for that elusive dx.

★



A very smart bridge-rectifier layout. No overheating troubles here.

★

Note the simplicity in the wiring of the bridge-rectifier power chassis.

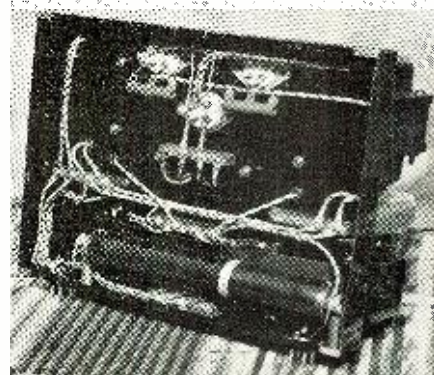

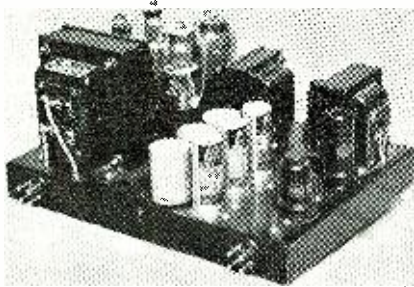

The modulator-speech supply deck.

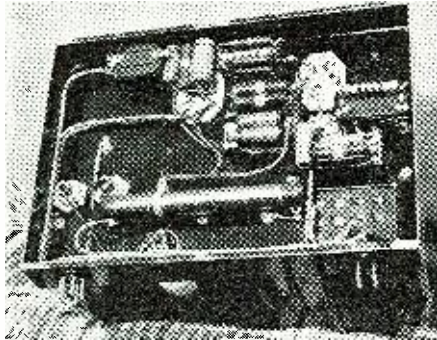

Underside the modulator speech deck.

plifier. The input to the speech circuit is designed for the conventional crystal type microphone.

On the third deck from the top is the power supply for the *TZ40*'s. This utilizes three mercury vapor rectifiers, type *RCA 83*, bridge connected to give a d.c. output of 1000 volts at 250 ma. A glance at the photos will give an idea of how the parts are arranged. In this case nothing is very critical as regards placement so the various components are positioned in a pleasing symmetrical layout. The bottom view shows how the wiring is arranged and the placement of the bleeder resistor. The two centertapped plate load balancing resistors are mounted directly to the socket terminals while several fiber strips are used to anchor terminal connection, merely for neatness in wiring. The customary swinging-smoothing choke type of filter is used to insure a hum free and well regulated power supply.

The next chassis down carries the modulator-speech amplifier power supply. This follows somewhat the same design as the 1000-volt unit except that only two *RCA 83*'s are used in a full wave circuit to give an output of 400 volts. It will be noticed that the primary connections of the transformers are so connected that the filaments may be turned on first for proper warm-up, after which the plate transformers may have the line voltage applied to them whenever the transmitter is to go on the air.

One of the most noticeable commercial touches is the recessed meter panel. This tells the operator at a glance if everything is behaving normally even though the whole rig is totally enclosed. A Masonite panel carrying five 2" *Triplet* meters is mounted behind a pane of glass, set into the cabinet front.

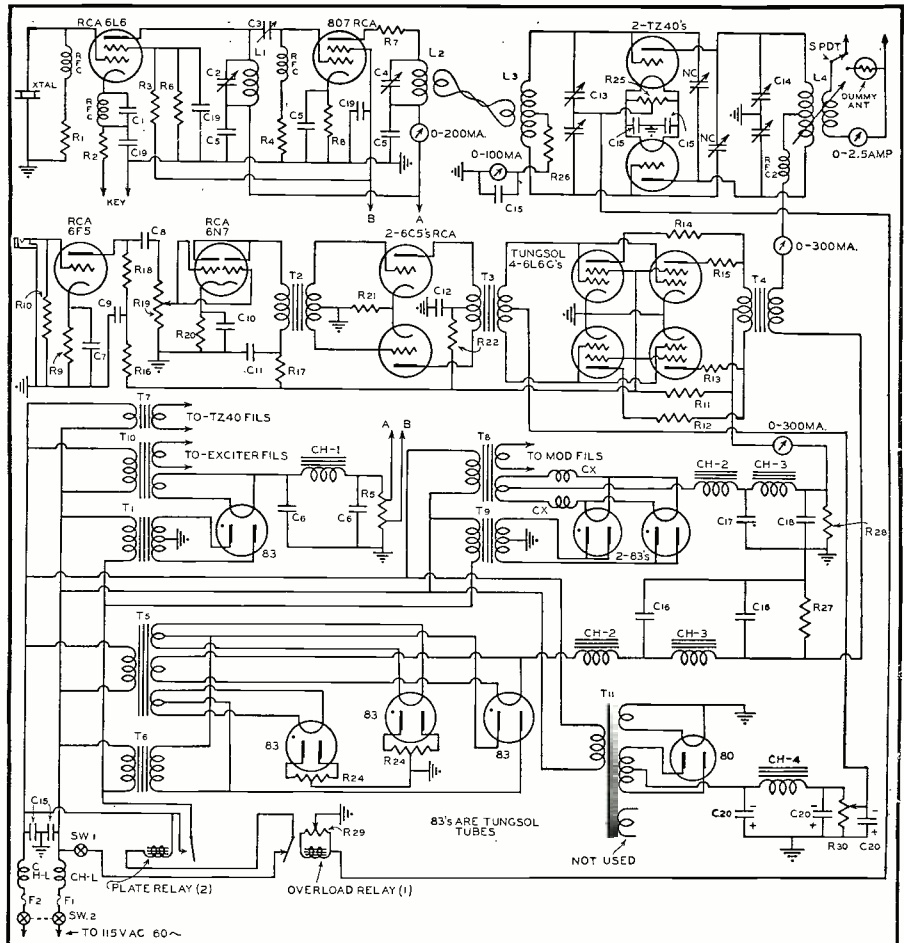

Circuit diagram of the 200-watt stylized 'phone transmitter.

- R₁—100,000 ohms, 1 w, carbon
- R₂—400 ohms, 2 w carbon
- R₃—15,000 ohms, 10 w, Ohmite
- R₄—50,000 ohms, 2 w, carbon
- R₅—25,000 ohms, Ohmite #1168
- R₆—50,000 ohms, 10 w, Ohmite
- R₇—25 ohms, 5 w, carbon
- R₈—600 ohms, 10 w, Ohmite
- R₉—1 000 ohms, Ohmite, wirewatt
- R₁₀—1 megohm, carbon
- R₁₁—5,000 ohms, 20 w, Ohmite
- R₁₂, R₁₃, R₁₄, R₁₅—50 ohms, 1 w, carbon
- R₁₆—50,000 ohms, 1 w, carbon
- R₁₇—6,000 ohms, Ohmite wirewatt
- R₁₈—250,000 ohms, 1 w, carbon
- R₁₉—250,000 ohm Pot. Yaxley
- R₂₀—1 000 ohms, Ohmite, wirewatt
- R₂₁—500 ohms, Ohmite, wirewatt
- R₂₂—100 ohms, 20 w, Ohmite
- R₂₃—100 ohms, c.t., Ohmite
- R₂₄—25 ohms, c.t., Ohmite
- R₂₅—750 ohms, 20 w, Ohmite
- R₂₆—25,000 ohms, Ohmite #0919
- R₂₇—50,000 ohms, Ohmite #0619
- R₂₈—25 ohms, Ohmite #0365
- R₂₉—5,000 ohms Ohmite #0578
- RFC₁—National R100
- RFC₂—National R154
- NC—Johnson N125
- Cx—18 turns #18 1" dia.
- Crystals, Bliley B5 and LD2
- L₁—Hammarlund XP-53 form
 - 1.7—3.5 mc 60 turns #22 enameled
 - 3.5—7 mc 30 turns #18 enameled
 - 7—14 mc 8 turns #18 enameled
 - 28 mc 4 turns #18 enameled
- L₂—National UR13 form & socket
 - 1.7—3.5 mc 45 turns #18 enameled
 - 3.5—7 mc 20 turns #18 enameled
 - 7—14 mc 8 turns #14 enameled
 - 28 mc 4 turns #14 enameled
- L₃—Johnson Hi-Q inductor, all bands

- L₄—B & W type TVL with swinging link, all bands
- Meters 0.50 0-100 0-200 0-300 M.A. type 221.
- 0-2½ RF type 241 Triplet
- Relays—Overload Guardian series 35
- Off-On Guardian series 40
- Dummy Antenna—Ohmite D250-73
- ChL—Ohmite Z-21
- C₁—.0001 mfd. Sangamo A10
- C₂—100 mmfd. Hammarlund APC-100 mounted in L1
- C₃—100 mmfd. Hammarlund APC-100
- C₄—150 mmfd. Cardwell MR150BS
- C₅—.01 mfd. Sangamo A10
- C₆—2 mfd. Aerovox Type 1010
- C₇ & C₁₀—10 mfd. 50 volt electro Aerovox
- C₈—.01 mfd. 600 volt paper Aerovox
- C₉, C₁₁, C₁₂—4 mfd. Aerovox type GLS
- C₁₃—.00005 mfd. Cardwell ER50AD
- C₁₄—.000035 mfd. Cardwell NP35ND
- C₁₅—.006 Sangamo A10
- C₁₆—2 mfd. Aerovox 1509
- C₁₇—4 mfd. Aerovox 610
- C₁₈—4 mfd. Aerovox 610
- C₁₉—.01 mfd. Aerovox type 684
- C₂₀—8MF 450 v. Aerovox
- T₁—Stancor P-3010
- T₂—Stancor A-4206
- T₃—Stancor A-4703
- T₄—Stancor A-3807
- T₅—Stancor special, 3-5 volt secondaries
- T₆—Stancor P-4016
- T₇—Stancor P-3022
- T₈—Stancor P-4022
- T₉—Stancor P-4024
- T₁₀—Stancor P-5008
- T₁₁—Stancor P-2751
- Ch₁—Stancor C-1410
- Ch₂—Stancor C-1403
- Ch₃—Stancor C-1413
- Ch₄—Stancor C-1003

Next, is an 0-100 d.c. milliammeter for registering excitation to the final, i.e., the d.c. grid current. Two 0-300 d.c. milliammeters are connected respectively in the modulators B plus lead

and in the *TZ40*'s plate lead. These meters give a constant check on the plate currents of the a.f. and r.f. output stages. For the buffer plate circuit an 0-200 milliammeter is used while the oscillator stage is taken care of by an 0-50 ma. meter. While not shown in the diagrams, two small pilot

(Pse Qsy to page 58)

FAITHFUL FREQUENCY

by **EDWARD LOVICK, Jr.**
Falls City, Nebraska



A neat instrument to visualize if your transmitter remains on frequency or not. Cheap but efficient.

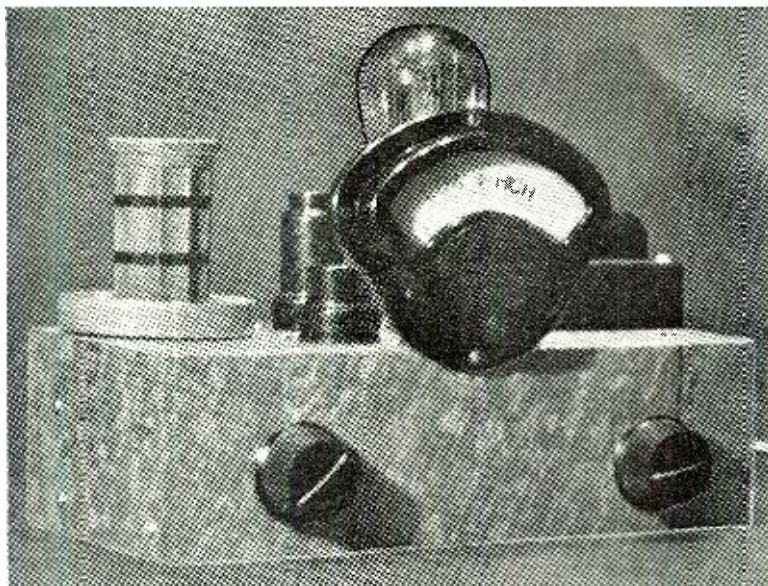

The meter will tell whether the frequency is low or high.

DESIGNED primarily to provide sensitive and dependable indication of frequency deviation, this meter also shows the shift to be either higher or lower in frequency than resonance. Four tubes are used to attain the desired results. A pair of 6C5's are used as blocking and indicator tubes. The 6H6 provides the "discriminator" action to actuate the indicator tube and a type 80 is used in an entirely conventional power supply circuit.

The basic principles of the "discriminator" commonly used in automatic frequency control systems are used to achieve deviation indication. The discriminator is as simple as possible and is a common circuit adapted to high frequency operation. Actual operation of this circuit has been discussed before* and hence needs no explanation.

Isolation of the tuned circuits is accomplished by utilizing one of the 6C5's as an untuned amplifier. If more gain is needed, by pass the cathode of this tube with an .05 mfd. condenser. A short wire serves as an antenna.

A 10 ma. meter was originally used in the plate circuit of the other 6C5 to

provide the actual indication. Some other meter using less current is to be preferred. In operation the plate current is adjusted to mid-scale, the reference point, by means of R5. Make a new scale for the meter reading *Low-O-High*. The high current end should read *high*.

Both tuning condensers must be insulated from ground and from each

other. Mount the two, ganged by means of a flexible coupler, on a strip of bakelite and space it away from the chassis. Drill the hole in the front apron large enough so that the tuning shaft will be clear of the chassis.

Two coils will cover the 20, 40, 80 and 160 meter bands.

With no signal input adjust the meter (Pse check further on page 63)

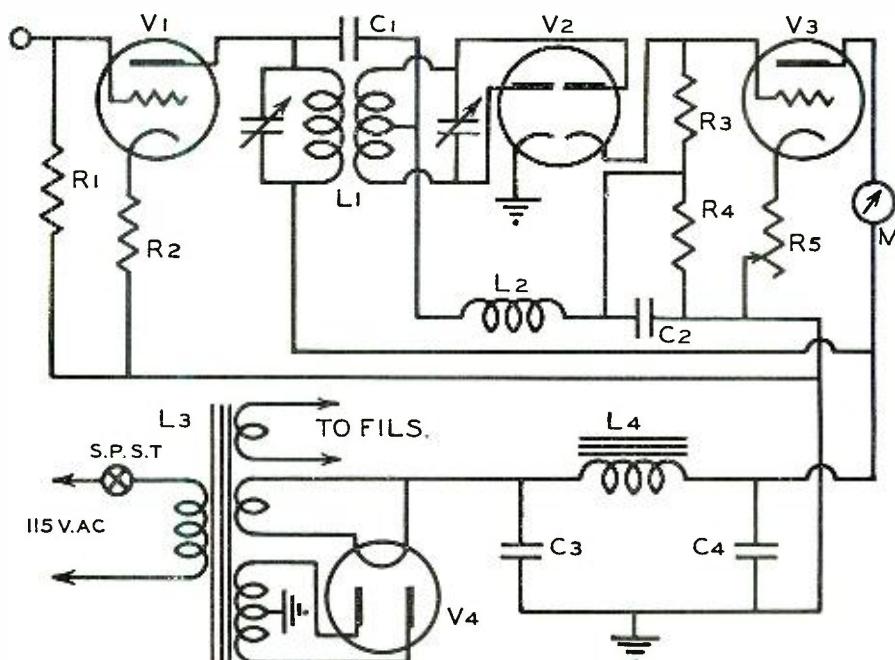

- C₁—100 mmfd. mica Solar.
- C₂—.001 mfd. mica Solar.
- C₃—8-8 mfd. electro. Solar.
- R₁—10,000 ohms 1/4 w. IRC.
- R₂—10,000 ohms 1/2 w. IRC.
- R₃—100,000 to 500,000 ohms 1/4 w. IRC.
- R₄—5000 ohms wire wound Yaxley type E with s.p.s.t. switch.
- L₁—See text.
- L₂—R.f. choke, 2.1 mhy Hammarlund.
- L₃—Stancor P-2751.
- L₄—30 hy Stancor C-1003.

- V₁—6C5 Sylvania.
- V₂—6H6 Sylvania.
- V₃—6C5 Sylvania.
- V₄—80 Sylvania.
- M—10 ma. meter (original was Supreme).
- Tuning condensers—140 mmfd. Hammarlund SM-140.

COIL DATA

	Primary	Secondary	Spacing
High Frequency	12t	12t	3/4"
	Use No. 24 enameled wire.		
Low Frequency	30t	30t	1"
	Use No. 32 enameled wire.		

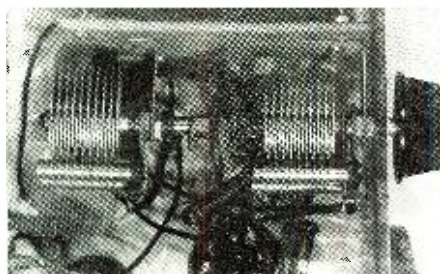

How condensers are coupled together.

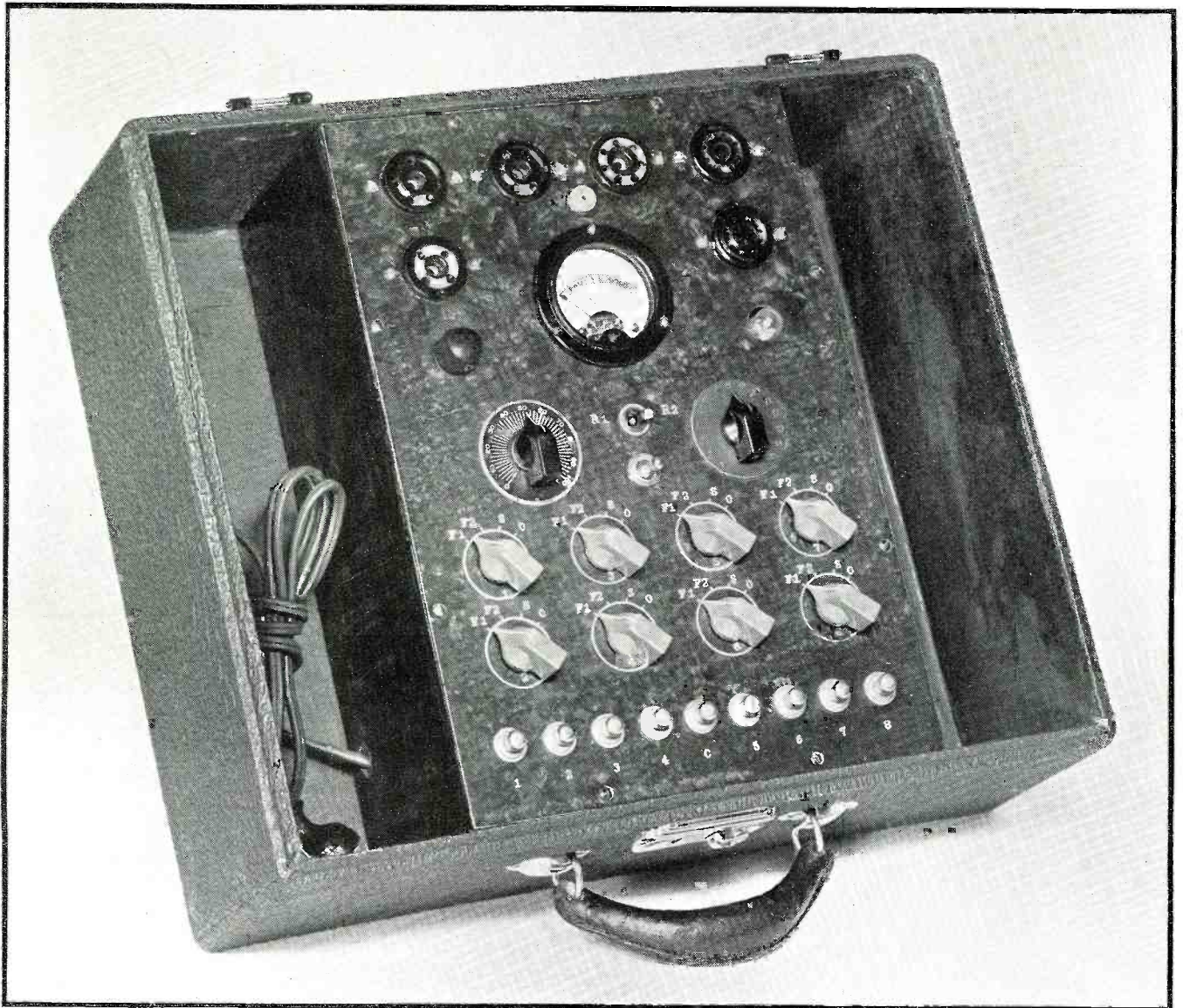

While designed for 115v AC line operation, still the tester is wholly portable.

THE low rumbling sound that has been heard throughout the country the past few weeks, has not been, as many thought, due to unseasonable thunderstorms; but has been found to be created by the groans of the radio men, as they contemplate the newest crop of radio tubes, and foresee the early necessity of re-vamping their present tube tester, or buying a new one.

The latest tubes are indeed nothing to cause the service men to burst out with hearty cheers, as those who have studied the specifications and base arrangements will realize. New filament voltages of 35, 45, 50, 70 and 115 volts are required, and the heater leads are often brought out to different pins than heretofore used, and in some instances a third lead is brought out for a pilot light tap. Cathodes are not always brought out to pin No. 8, and other elements are also found to "wander," especially in the case of single ended tubes, such as the 6SA7, 6SC7 and others. The service man can no

FULL FLOATING 1940 TUBE TESTER

by **R. K. WHEELER**

Indianapolis, Indiana

Need a tube tester? Build yourself this emission tube tester which will not become obsolete the very next day. It will be reasonably accurate, too.

longer apply a test prod to terminal No. 3 of an octal socket, with the assurance that it is the plate of the tube, as it may be a cathode, grid or heater terminal; therefore it seems that the tube manual or base chart will be the service man's daily companion.

It is also apparent that the day of the comparatively simple tube tester, with only a few controls, is past. The installation of additional sockets, each wired to fit the requirements of a specific tube, can only be regarded as a makeshift. Such sockets will only take care of a few tubes, and from present indications there is no reason to believe that still more will not be needed as later tubes are released. The use of a single switch to set up the checker for different base arrangements also suffers from the same disadvantage, as the number of combinations possible are almost endless. The use of "floating filament" switches has for some time been recognized as essential, and after consideration of the newest tubes, it seems inevitable that all other lines must be "floated" too, in order to anticipate future contingencies.

In the tube tester presented herewith, this is accomplished by installing a single pole-four throw switch for each socket terminal, which allows the tester to be set up for any combination of elements likely to be met, at the present writing. The first two positions are marked F1 and F2 respectively, and permit any pair of terminals to be connected properly across the filament voltage supply. The third position, marked "S," connects to the single pole double throw testing switches, and a fourth position "Off" is provided to disconnect any socket terminal from the testing circuit. This is essential when testing the tubes with tapped heaters, to avoid short-circuiting a portion of the filament; and is also useful as one method of testing separate sections of dual tubes. These switches will hereafter be referred to as circuit switches as that is their sole purpose.

In view of the multiple requirements in the way of circuit arrangement and switching, the constructor is almost of necessity limited to the use of the emission test method, if a practical tester with any flexibility and speed of operation is to be produced. As most men know, emission testing consists of checking the current flow of all tubes, operated as rectifiers. In practice, the correct filament voltage is applied to the heater, the cathode is connected to one side of a low voltage supply, usually about 30 volts A.C.; all other elements being strapped together and connected to the other side of the 30-volt supply. Since the tube will only pass current one way, the plates or anodes may be considered as positive, and the line to the cathode designated as the negative bus. There is a tendency on the part of some men, usually uninformed, to deride emission testing as an inefficient test method. The truth is that emission testers

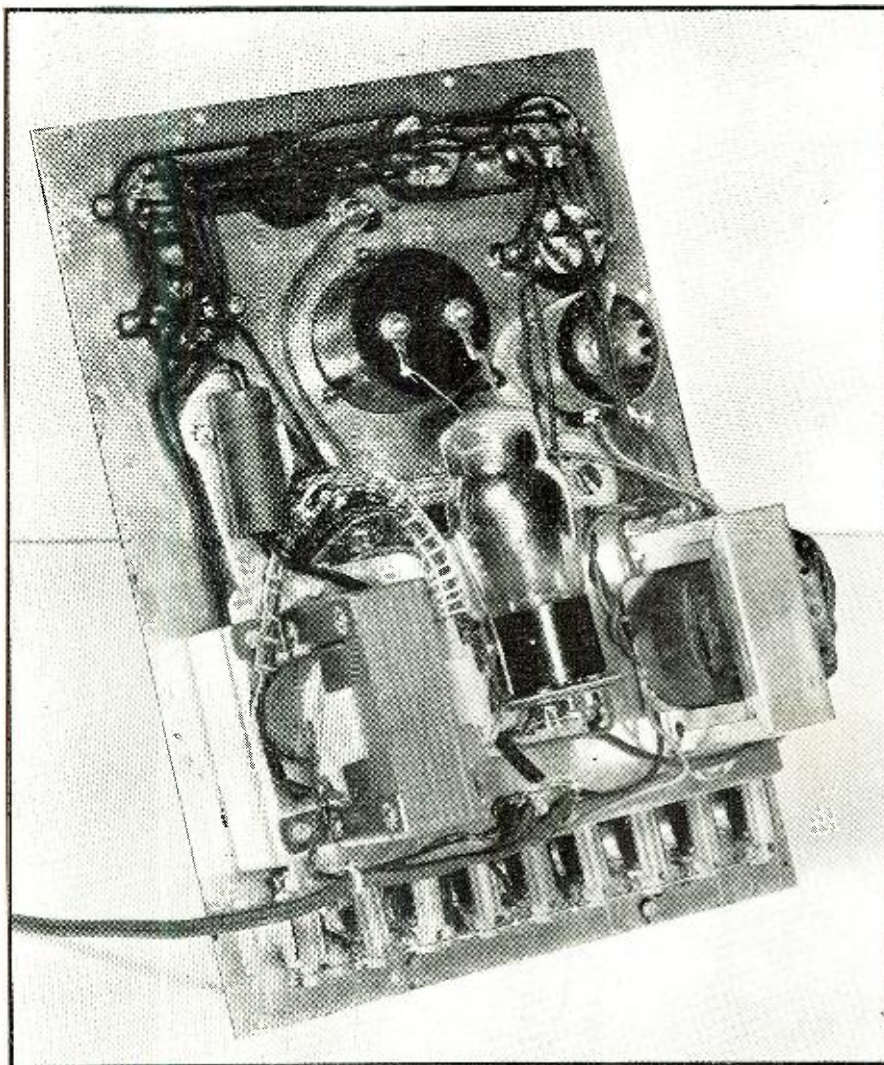

Note the extreme cleanliness of wiring in the back of the tube tester.

are considerably better than most suspect—such an authoritative source as *Weston* recently stated that true mutual conductance testing was only 3% better. Tubes that pass the reliable manufacturer's inspection, and have been in service a year or more are not likely to develop any defects other than reduced cathode emission, internal shorts, or burnt-out heaters, which constitute about 99% of the tube failures to be encountered in service work.

A meter to read the emission current is of course essential, and some method must be provided to adjust the meter so that the same reading may be had for all good tubes, with currents varying from 5 to 125 milliamperes. A Triplet 0-1 mil meter (available with "GOOD-?-BAD" scale) was used with a 5,000 ohm resistor in series, shunted by a 1,000 ohm variable wire wound potentiometer. The potentiometer must be at least 4 watts rating to carry currents around 100 milliamperes with any safety or stability. While a linear control may be used, it will be seen that as the shunt resistance is decreased, the lower settings will become rather critical, as the range from 50 to 100 mils will be confined to only 5 degrees of the dial.

If a graphic curve of the shunt current is plotted against the dial settings (or percent of rotation) it will be found that the curve approaches the logarithmic in shape. The *Yaxley* type B control with a No. 1 taper approximates this curve, and will carry 125 milliamperes safely at low settings, for the short periods necessary for tube testing.

This control also affords a variable load for each type of tube tested, and is of such value that practically all tubes are tested with safe amounts of emission current drawn. One exception noted, is the diode detectors, such as the 6H6, 6H4 and 7A6. On account of the low voltage drop in these tubes an injurious amount of current may be drawn, and an additional load resistor (R2) of 400 ohms must be added to limit this current. The diodes ordinarily used in dual tubes (the 55, 75, etc.), do not draw excessive current; and the extra load resistor is not required, being shorted out by the load switch when thrown in the R1 position.

According to tube manufacturers' recommendations the low drain 1.4-volt battery type tubes should also be tested at fairly low emission currents,

Type	Fil.	F 1	F 2	K	Test
01a	5	1	4	0	72
10	7	1	4	0	70
12a	5	1	4	0	59
15	2	1	5	4	75
18	8	1	6	5	57
19	2	1	6	0	59
20	4	1	4	0	77
22	4	1	4	0	62
24a	3	1	5	4	70
26	1	1	4	0	67
27	3	1	5	4	62
30	2	1	4	0	70
31	2	1	4	0	69
32	2	1	4	0	72
33	2	1	5	0	62
35/51	3	1	5	4	60
36	6	1	5	4	56
37	6	1	5	4	59
38	6	1	5	4	61
39/44	6	1	5	4	60
40	5	1	4	0	70
41	6	1	6	5	58
42	6	1	6	5	57
43	9	1	6	5	55
45	3	1	4	0	65
46	3	1	5	0	58
47	3	1	5	0	59
48	10	1	6	5	30
49	2	1	5	0	67
50	7	1	4	0	67
53	3	1	4	4	40
55	3	1	6	5	54
56	3	1	6	5	51
57	3	1	6	5	57
58	3	1	6	5	57
59	3	1	6	5	56
71A	5	1	4	0	61
75	6	1	6	5	58
76	6	1	6	5	58
77	6	1	6	5	59
78	6	1	6	5	42
79	6	1	6	5	58
85	6	1	6	5	58
89	6	1	6	5	58
V99	4	2	4	0	67
X99	4	1	4	0	76
950	2	1	5	0	65
1221	6	1	6	5	57
1223	6	2	7	8	57
1602 (10s)	7	1	4	0	71
1612	6	2	7	8	50
7000	6	2	7	8	58
1A4p	2	1	1	0	74
1A4t	2	1	4	0	74
1A5	1	2	7	0	84-R2
1A6	2	1	6	0	72
1A7	1	2	7	0	85-R2
1B4	2	1	4	0	73
951	2	1	4	0	71
1B5	2	1	6	0	71
1B7	1	2	7	0	74-R2
1C5	1	2	7	0	72-R2
1C6	2	1	6	0	66
1C7	2	2	7	0	68
1D5p	2	2	7	0	72
1D5t	2	2	7	0	72
1D7	2	2	7	0	74
1D8	1	2	7	0	69-R2
1E4	1	2	7	0	72-R2
1E5	2	2	7	0	75
1E7	2	2	7	0	54
1F4	2	1	5	0	62
1F5	2	2	7	0	61
1F6	2	1	6	0	72
1F7	2	2	7	0	75
1G4	1	2	7	0	77-R2
1G5	2	2	7	0	67
1G6	1	2	7	0	66-R2
1H4	2	2	7	0	71
1H5	1	2	7	0	85-R2
1H6	2	2	7	0	72
1J5	2	2	7	0	68
1J6	2	2	7	0	58
1N5	1	2	7	0	80-R2
1N6	1	2	7	0	69-R2
1P5	1	2	7	0	85-R2
1Q5	1	2	7	0	66-R2
1T5	1	2	7	0	78-R2
1LA4	1	1	8	0	83-R2
1LA6	1	1	8	0	85-R2
1LH4	1	1	8	0	85-R2
1LN5	1	1	8	0	82-R2
Wund. A.	3	1	6	5	62
Wund. B.	3	1	6	5	62
2A3	3	1	4	0	48
2A5	3	1	6	5	58
2A6	3	1	6	5	58
2A7	3	1	7	6	58
2B6	3	1	7	6	62
2B7	3	1	7	6	61
6A3	6	1	4	0	49
6A4/LA	6	1	5	0	60
6A5	4	2-7	8	8	46
6A6	6	1	7	4	40
6A7	6	1	7	6	58
6A8	6	2	7	8	58
6AC5	6	2	7	8	56
6AE5	6	2	7	8	65
6AE6	6	2	7	8	58
6AF5	6	2	7	8	68
6B4	6	2	7	0	47
6B5	6	1	6	5	64
6B6	6	2	7	8	59
6B7	6	1	7	6	62
6B8	6	2	7	8	60

RECTIFIERS

Type	Fil.	F 1	F 2	K	Test
6X5	6	2	7	8	36
6Zy5	6	2	7	8	52
7Y4	6	1	8	7	36
12Z3	8	1	4	3	33
25Y5	9	1	6	3-4	30
25Z4	9	2	7	8	30
25Z5	9	1	6	3-4	23
25Z6	9	2	7	4-8	25
35Z3	11	1	8	7	27
35Z4	11	2	7	8	32
35Z5	11	2	7	8	25
45Z5	12	No. 3	off	7	32
50Z7	12	No. 3	off	7	22
117Z6	15	No. 6	off	7	30
		No. 2	off	7	30
		No. 1	off	8	30

MAJESTIC TYPES

Type	Fil.	F 1	F 2	K	Test
58S	3	1	6	5	56
58AS	6	1	6	5	56
75S	6	1	6	5	58
85AS	6	1	6	5	58

SPARTON TYPES

Type	Fil.	F 1	F 2	K	Test
182b	5	1	4	0	62
482b	5	1	4	0	61
483	5	1	4	0	61
484	4	1	5	4	60
485	4	1	5	4	60

**TUNING INDICATORS
6R BASE**

Type	Fil.	F 1	F 2	K	Test
2E5	3	1	6	5	
2G5	3	1	6	5	
6AB5	3	1	6	5	
6E5	6	1	6	5	
6G5	6	1	6	5	
6H5	6	1	6	5	
6N5	6	1	6	5	
6T5	6	1	6	5	

MAJESTIC TYPES

Type	Fil.	F 1	F 2	K	Test
2A7s	3	1	7	6	58
2B7s	3	1	7	6	62
2s/4s	3	1	5	4	73
2Z2	3	1	4	0	72
6A7s	6	1	7	6	58
6B7s	6	1	7	6	62
6C7	6	1	7	6	57
6D7	6	1	7	6	57
6E7	6	1	7	6	58
6F7s	6	1	7	6	59
6Y5	6	1	6	4	44
6Z5	8	2	6	4	36
56s	3	No. 1	off	5	57
56AS	6	1	6	4	57
57S	3	1	6	5	57
57As	6	1	6	5	57

7 AG BASE

Type	Fil.	F 1	F 2	K	Test
6AD6	6	2	7	8	
6AF6	6	2	7	8	

Switch setting given to allow short checking.

therefore these tubes should be tested with R2 in the circuit as noted in the tube list. Unless otherwise noted, all other tubes are tested with R2 out of the circuit. *It might be well to point out that emission current should only be drawn long enough to take a meter reading, when testing any tube by the emission method.*

The double-pole double-throw switch connects the meter to the positive bus line for the emission test, in one position, while in the other position tubes are connected to the short indicator, which consists of a neon lamp with 115 volts applied through a .5 mfd. condenser. This condenser is used to prevent the flow of rectified current through the tube, but passes any a.c. due to shorts or leakages. As the element test switches are operated, a single flash may be noted, which is not due to leakage, but the charging current of the condenser. Leakages or shorts will be evidenced by *both* plates of the neon lamp glowing. It will be necessary to place a limit on the sensitivity of the neon lamp, to avoid rejecting tubes that are actually serviceable. The RMA recommendation of this limit is .2 megohm, but in actual service a shunt of 1 megohm provides a practical compromise. Dual sensitivity can be easily obtained, by shunting two different values of resistance in series across the lamp, with a shorting switch to take one out of the circuit when desired. When the DP-DT switch is in the leakage testing position the filament of the 201a rectifier is also switched on, and the meter will give an indication of the line voltage, which is only important with respect to the anode voltage. As shown the meter reads .9 scale when the shunt control is at the setting for a 201a tube, i.e., 72, and the anode voltage is adjusted to 30 volts.

It has been often mentioned that emission checkers do not test rectifier tubes at their maximum capacity. This is true in most cases, and some consideration was given to the application of higher anode voltages, to produce greater emission currents up to 150 milliamperes. An experiment set-up was made, using 115 volts with a load resistor of a few hundred ohms, and a large number of rectifiers of different types and varying degrees of condition were tested. Each tube was labeled, with the amount of current noted; and then tested by the usual method at 30 volts. The percentage of difference in meter readings was practically the same at either voltage, and in no case was a weak tube passed as good. In general, a rectifier may be regarded as approaching the end of serviceable use when emission current drops 25% or more from normal value. From the foregoing experiment it was

RECTIFIERS

Type	Fil.	F 1	F 2	K	Test
1v	6	1	4	3	44
80	5	1	4	0	58
81	7	1	4	0	76
82	3	1	4	0	10
83	5	1	4	0	10
83v	5	1	4	0	32
81	6	1	5	4	35
6-4	6	1	5	4	35
2W3	3	2	8	0	70
5T4	5	2	8	0	34
5U4	5	2	8	0	46
5V4	5	2	8	0	28
5W4	5	2	8	0	57
5X4	5	7	8	0	49
5Y3	5	2	8	0	58
5Y4	5	7	8	0	58
5Z3	5	1	4	0	51
5Z4	5	2	8	0	28
6W5	6	2	7	8	36

Rect. Section
Amp. Section

SOCKETS ARE NUMBERED ACCORDING TO R.M.A. SYSTEM

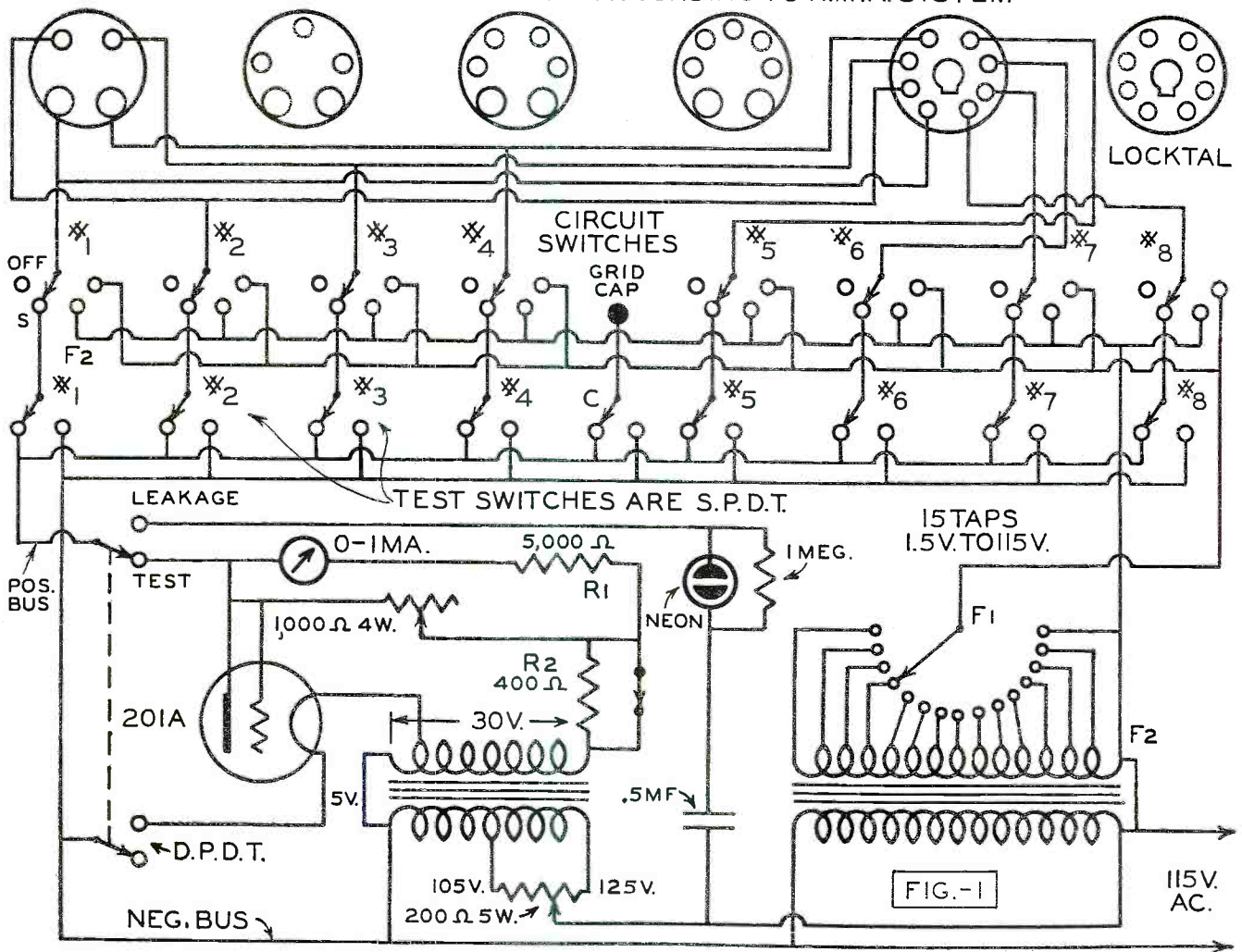

The circuit diagram of the full-floating 1940 emission tube tester.

concluded that the standard emission check was accurate enough for practical purposes, and a test at 115 volts was not included; in order to eliminate the extra switching this would entail, and the possibility of damage to other tubes if accidentally tested at this voltage.

As shown in the diagram, each terminal of the 4-pin and octal sockets is connected to the corresponding 4-circuit switch, and then connected from the "S" position to the correct single-pole double-throw test switch. In order to reduce confusion, wiring from the other sockets is not shown, but it should be understood that the terminals of each socket are likewise connected to the proper circuit switch. The test switches may be the toggle type, but push-button switches are much to be preferred. Push-button switches may be obtained which have a spring-return, closing one circuit, and wiring should be done so that the common terminal is closed to the positive bus when not depressed.

In addition to a tapped filament transformer, a second transformer was used to supply the 30 volts for the anodes. The principal reason for the use of this extra transformer was the

fact that the primary was tapped, thus affording regulation of the secondary output by means of a 200-ohm potentiometer across the tapped portion of the primary. This transformer need not represent additional expense as the filament transformer from an old tester may be used. It was also considered desirable to segregate the anode supply from the filament voltage, to avoid any possible conflicts.

Filament voltage variations, due to normal line fluctuations, were found to have little effect on results, but it was found desirable to provide an adjustment to maintain the 30-volt anode supply fairly constant. Without such adjustment the meter readings will vary with the line voltage.

Alden "tuning fork" sockets were used throughout as they have much to recommend them. The sockets afford a positive contact, and at the same time permit easy insertion and removal of tubes. The design is such that tubes with irregular pin spacing are accommodated without trouble, and the sockets will give perfect service over long periods.

All rotary switches should be non-shorting, and the Yaxley 3200 J switches were selected as suitable for

this service on account of improved contacts, and positive indexing action. The Yaxley method of plating the lugs does much to speed up the work of soldering, as only a touch with a hot iron is needed to make a perfect joint. The eight circuit switches are No. 3215J, and the filament voltage selector is a No. 32117J—a 17-point switch of which 15 points are used. Switching under load should be avoided as much as possible to prolong the life of these, or any other, rotary switches.

Normally all circuit switches are set in the "S" position, and the lower test switches connected to the positive bus. To test tubes, circuit switches are set according to the chart, and the filament selector set at the correct voltage. The DPDT switch should be in (Build further on page 51)

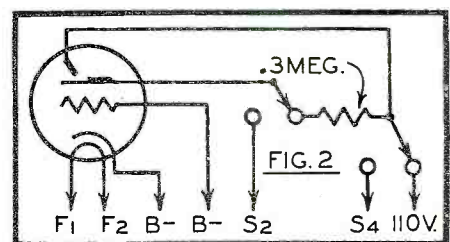

Home Electronics

by **WILLIAM E. BARBOUR, Jr.**
Electrical Engineer, Cambridge, Mass.

Conduct your household duties from a Morris chair. With this intriguing device, control runs through the wires with the greatest of ease.



Buzzer transmitter and receiver; signal for children or invalids.

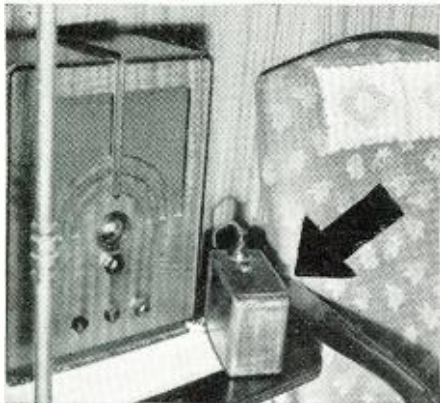

Ratchet relay receiver connected to control radio from remote point.



Oscillator left, receiver right. Simplicity indicates good design.



Inside detail of the OA4G receiver. Note the very rugged construction.

THE OA4G tube, which became commercially available little more than a year ago, has opened up a new field for the amateur experimenter. This tube is classified as a three element cold cathode or filamentless glow discharge tube. It has the unique characteristic of requiring sensibly no stand-by power when connected in a circuit which is ready to operate on a minute impulse from some external source. Neither is there a filament to deteriorate or to burn out.

The OA4G consists of an anode, a cathode, and a starting anode, which acts as a trigger to start conduction. With a positive voltage of 110 volts on the anode no conduction will take place. Conduction will start, however, as soon as the starting anode is brought up to a critical value of 50 or 60 volts. Using resistors or a potentiometer a voltage not quite sufficient to start conduction may be applied to the starting anode. Then a very small impulse such as a weak radio frequency current added to the voltage on the starting anode will make the tube conduct sufficient current to operate a mechanical relay or a buzzer.

A series resonant circuit will increase a small radio frequency voltage sent through the home lighting circuit sufficiently to instantly start conduction. To produce this radio frequency voltage the simplest kind of an oscillator may be used. In the models shown a 1C5G tube was used with raw 110 volts of A.C. on the plate. In several models two 1C5G's were used to provide a full wave signal—otherwise it might be necessary to reverse polarity when plugging either the oscillator or the receiving unit into an outlet.

For convenience this apparatus was built into small units each with a plug and cord attached for connection to the lighting circuit. The oscillator or transmitter was equipped with a push button momentary contact switch. The receiver included a ratchet type alternately on and off relay so that successive impulses would turn an appliance or some device on and off as desired. If it were to be used only as a signal, the relay might be replaced with a small buzzer or chime.

Using no extraordinary amount of imagination numerous applications for these devices are apparent for remote signaling and controlling appliances in the home. For example, a radio in the living room may be turned on and off

from an upstairs bedroom. Garage lights may be turned on and off from the house or vice versa. A transmitting unit near the telephone makes it possible to turn the radio off when receiving a call. An attic fan may be controlled from the living room. If a transmitting unit is plugged into an outlet in the bedroom, the coffee percolator or hot water heater may be turned on before rising.

By incorporating a small thermostatic element into the transmitting unit the furnace may be controlled from any room in the house instead of from a single permanent location. This becomes desirable when there is a strong wind. If someone is sick, the bedroom may be regulated to 70 degrees regardless of the temperature in the rest of the house.

The simpler and inexpensive buzzer unit has an equal number of applications in the home. It may be used by small children or invalids to call from an upstairs bedroom to the kitchen, laundry or living room. It may be more convenient than wires between offices and in small shops. As a servant call to a maid's room or chauffeur's quarters it has a unique application.

The attenuation of the line together with a certain amount of filtering effect in the meter current coils makes
(Finish on remote page 63)

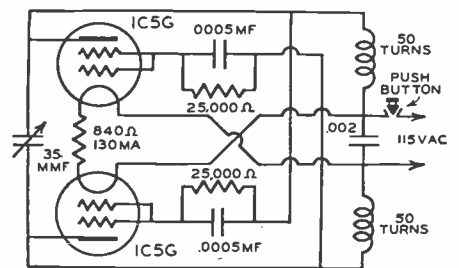

The "Transmitter" and "Receiver"

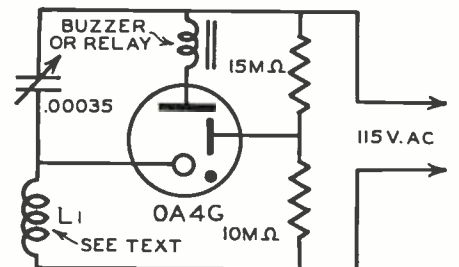

Serviceman's Experiences

by LEE SHELDON

Chicago, Illinois

Don't judge your customers by their foibles, the infirm in mind may be the ones with the most cash.

RANG, but no one answered. I knocked, and the door swung open. The whole call was funny—the customer hadn't given us his name, and the card by the push-button gave only initials: "G. McF."

The radio—a *Crosley 40*—was near the door. I walked in, turned the set on, and tuned noisily from station to station to attract attention. None was attracted.

When the 'phone rang, I jumped guiltily. I waited until it called ten or twelve times; then, when nobody appeared, I walked across the room to answer. It stopped as I reached for the receiver.

Then a man in a bathrobe threw open a door on the second floor and ran down-stairs. He stopped before me when he noticed the ringing had stopped.

"Why didn't you answer it?" he demanded.

"I'm only the radio man," I explained.

"That's no excuse," he replied. "Don't forget—it takes a heap of salt in beer to make it foam. Next time, find out who is calling!"

"Your set—" I began, as he started to walk back upstairs.

"Replace the Mershon," he said, without turning.

"Doesn't need one," I protested. "The set would hum like the dickens if it was shot."

"Replace it anyway," he ordered, slamming the door.

Just like that. No conversation as to symptoms, delivery or price. Al keeps telling me to do whatever work the customer wishes; but in this case, I'd have preferred an argument—even a little haggling—rather than be left up in the air. Radio men have less fun than anybody.

Believe me, I wasn't going to give the set something it didn't need. I picked up my tools and meters, snapped off the set, and walked to the door. The 'phone rang again. Against my better judgment, I answered it.

"Uh—uh—UH!" a reproachful voice warned. "Mustn't pick up other peoples' telephones!"

That was entirely too much. I left angrily and drove back to the shop.

Al, exercising his right as the so-called senior partner of *Salutary Sales & Service*, thought the incident was funny.

"I know who that fellow is," he told me. "He's Gaspay McFullsock, the author. He lives a full life—when he can get whiskey.

"Made his fortune with *Hangover House*. When he came to the final period on the last page of the manuscript, he took a long drink and struck so lustily his hand got caught in the keyboard. He left the house with a list to starboard, machine hanging from his arm, muttering that he should have used a portable.

"His wife, a former actress, was thrown back on her resources. But she did not stay there long. Having heard Providence (R. I.) would protect the working girl, she drifted to the east, where she organized a men's dancing chorus. The act, unfortunately, was intensely mediocre; and, after a dull performance in Frostbite, Alabama, she was jailed for using the males to defraud.

"Gaspay returned home six months later, minus the typewriter, two front teeth, and part of his reason. He now lives under supervision in his own home. Although his friends call him 'Rusty' because he is not quite bright, his book made a fortune, and he can well afford to be eccentric."

"Man!" I said, relieved when I saw Al was not going to bawl me out for losing a customer, "I got out of there just in time!"

"Just in time to pick up a triple-8 electrolytic," Al said, taking one from the shelf. "Here—get going. If Gaspay wants to play, humor him."

"What am I?" I demanded. "A nursemaid, or a repairman?"

"You're no repairman," Al said, "if you walk out on a job just because you don't get it on a silver platter. And you're a poor businessman if you begin to sort out customers according to the way you feel toward them. Go back and work on that *Crosley!*"

I know better than to argue with Al. Better to cope with a madman than to lose to a partner.

The door was still open. I went in and replaced the filter condenser. As I finished, the 'phone rang. I answered it immediately.

"This is McFullsock," someone said. "Is the radio man there?"

"I am the radio man," I replied, "I just finished—"

"Fine," he interrupted. "Come up to my room."

I walked upstairs nervously, carrying my portable oscillator. It weighs seven pounds, has a handle, and can be swung quickly as a weapon of defense.

As I opened the door, he put a vertical finger to his lips and motioned for me to step inside. Then he looked about the hallway cautiously, closed the door, and whispered:

"What say—have a little hooker?"

"I—I'm in a hurry to get back to—" I attempted, but Gaspay had taken a flask from the bottom bureau drawer.

"They try to keep it away from me, but I fool them," he said. "Here—help yourself."

I steeled myself and pretended to swallow. It didn't taste bad at all. I glanced at the label and read: "*Green Tea, 1937.*"

"Imported," boasted my host. "Want to see my stamp collection?"

Naturally, I was more interested in my repair collection, but I remembered my partner's advice and grunted affably.

"This book contains a continuous series," he announced, opening it to page one. "This is the first."

(Continued on page 57)



"How long has my car radio guarantee yet to run?"

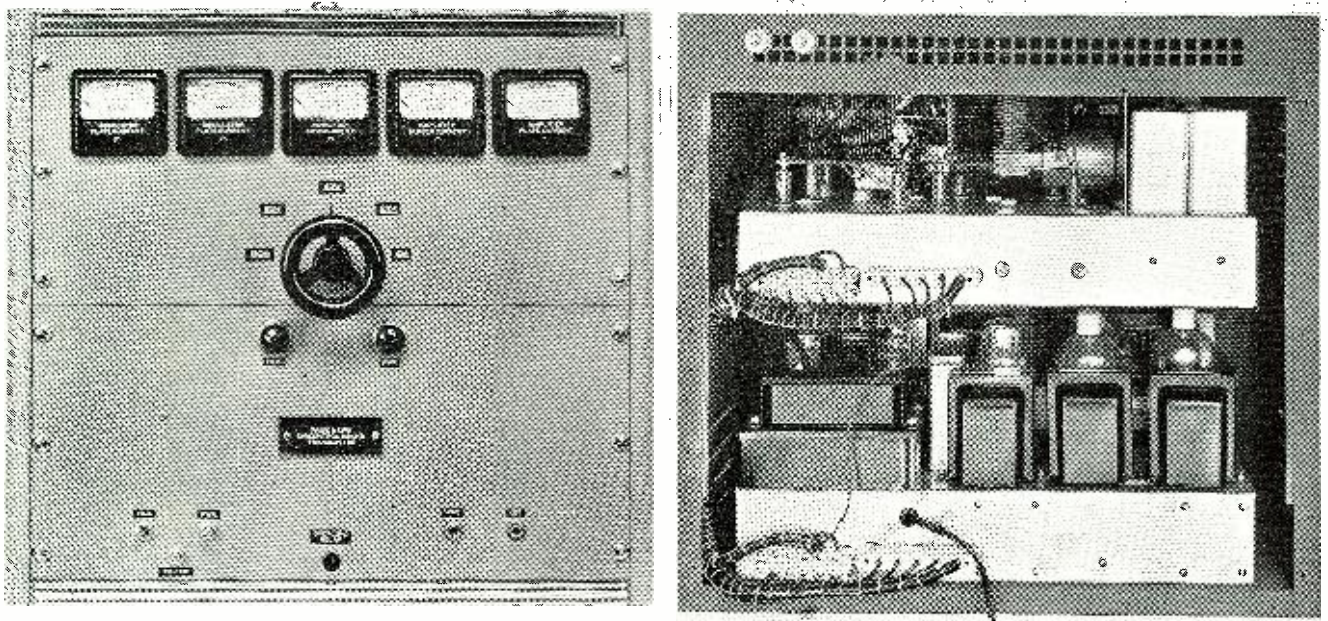

Front and back view of the compact 200-watt *output* Unicontrol 5-Band Transmitter.

THE UNICONTROL 5 BAND TRANSMITTER

by

KARL A. KOPETZKY, W9QEA & OLIVER READ, W9ETI.
 Managing Editor, RADIO NEWS Technical Editor, RADIO NEWS

IN the last issue we discussed the transmitter generally, and described the power supply—modulator—speech chassis more or less in detail. In order for the constructor to follow the building of the units coherently, it might be well to review the last issue's advice somewhat sketchily.

Our original consideration was to design a transmitter which would have as many of the new improvements in it as possible. Among the "musts" we numbered: 1. Compactness; 2. Band-switching; 3. Automatic Modulation Compression; 4. Least number of tubes for the maximum output; and 5. The controls must be at a very minimum.

Considering first compactness, we decided that the size would have to be comparable to the size of the ordinary receiver and speaker, certainly no larger. This limited our available space to about 15" deep by 19" wide by 18" high. Since only two panels (8 $\frac{3}{4}$ "x19") can be put in such a small space, the power supply and modulators have to fit on the bottom chassis behind one panel while the r.f. stages would take up the other panel and

PART 2

Concluding the series with the building of the r.f. chassis and the assembling of the entire transmitter. The gear drive is fully described

chassis. Each chassis was 17"x13"x3".

Taking and reviewing first the power supply chassis, under it were mounted the assorted filament transformers plus one filter condenser and the entire speech equipment. The relays are also to be found underneath the chassis; and the choice of the make of these relays was quite a problem since space was at a premium. Finally chosen were 3 by *guardian* and one by *Ward-Leonard*.

On top of the power chassis are mounted the power transformers, chokes (three of them), the tube sockets, sunk 1" below the top of chassis, three filter condensers, modulation transformer, a filament transformer, power transformer, etc. The constructor is urged carefully to examine the pictures for layout. If this layout is not followed, the parts will not fit to-

gether on the chassis and the rig cannot be built as compactly.

In building the new rig it was decided that it should be 100% safe. Such "safety" was included, that the builder could, if necessary, place his hand upon any top part of the *power supply chassis* while the high voltage was "on" without running the slightest danger of being electrocuted providing only that the insulation did not break down. In order to accomplish this, certain changes were made in the transformer. This "conversion" was fully covered, and the insulated leads and cap can be seen both on the modulator tubes as well as on the power rectifiers. In fact, the sole leads which appear, are those to the plates of the rectifiers and to the plates of the modulators.

Going further into the matter of compactness, we found that the aver-

age ham is more than liable to space his components "all over the lot" sometimes with the unnecessarily long leads, and always allowing for some future rebuilding or adjustment. On the other hand, the commercial engineer has been compacting his equipment until today, some of the commercial rigs that run a kilowatt output could be placed inside the cabinets of some of the ham rigs whose power input is less than one-tenth of that.

When reproached by the commercial operator, the ham builder will always state that his rig is "easier to service" and that with the continual changes in tubes and transmitting components, he may wish to make alterations in his equipment, hence he is unwilling to "tie down" his components in such a manner as to make a rebuilding job a super-human effort.

However, the parts manufacturer has not been standing still, and today there are available to amateurs better components, more carefully engineered, and more compactly built than ever before.

Input vs. Output

Since the transmitter would probably be used in an apartment house where a flickering of the lights every time the switch was thrown, would be annoying as well as inducive of landlord complaints, not to mention B.C.L. anger, the amount of power was limited to 200 watts output.

At this time it might be well to state that while the amateur has continued to use the input to his final stage as a measure of the power of the transmitter, his commercial brother has proceeded along different lines and most commercial transmitters' "powers" are measured in terms of output. True it is that the amateur has been aided and abetted in his choice of input versus output, by the United States Government. The F.C.C. regulations have limited the amateurs' power to that which is fed to the input stage. However, there is not any reason, unless the amateur is running to the very outside limits prescribed by law, why he should continue to measure the capabilities of his transmitter in terms of input. As a matter of fact, if the amateur will begin to think in terms of output, he will thereby begin to think in terms of efficiency. What does it gain an amateur to run an input of 750 watts with an efficiency of lower than 10%, so that his output is only 75 watts, if his neighboring amateur is running a 100 watt transmitter with an efficiency of 80%? It is high time that the amateur began to think in terms of output and, accordingly, this rig was designed with the output power in view.

It is an axiom that the received signal, all conditions being equal, is inversely proportional to the square of the power output, so that a medium powered output rig would be one in the neighborhood of a quarter kilowatt. Assuming that the output was about 250 watts, and that the received signal therefrom would be R5, (the R

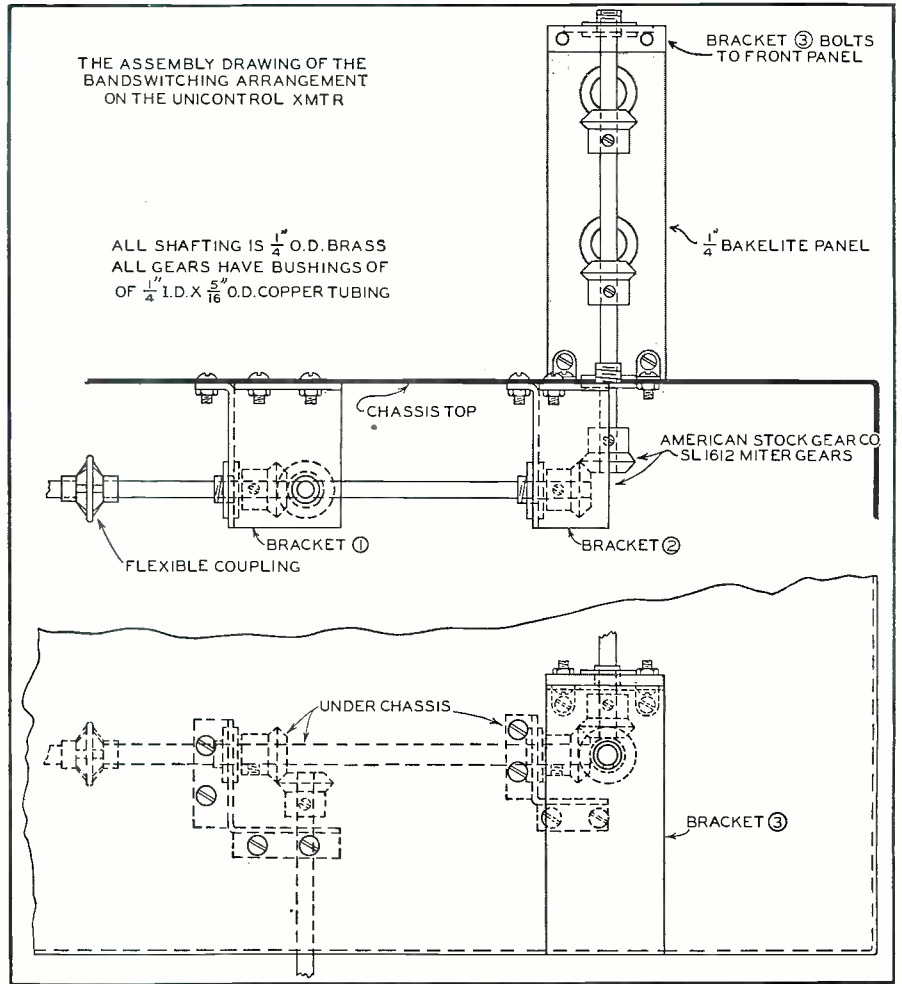

By using this mechanical drawing of the gear assembly, and by watching the illustrations carefully, the constructor should have no trouble in building and running the various switches from one central control.

meter being linear), in order to receive a signal of R10 from the same transmitter under the same conditions, it would be necessary to run a kilowatt output, or four times the previous output power, in order to double the received signal. A cursory inspection of the "Hamchatter" column will show that the average ham rig will run around a quarter of a kilowatt output and be able to work WAC (pre-War) and WAS with comparative ease. Power outputs of less than a quarter of a kilowatt are somewhat less desirable, while those of a greater output than that figure will be found not to

give any superlatively great advantage excepting in QRM conditions. So we decided to use something around a quarter kilowatt output.

Choice of r.f. Tubes

Having found our output figure, the next choice was that of tubes. Using band-switching we were immediately forced to use a pentode in the final r.f. amplifier stage. The question was which pentode to use. Remembering that we wanted to approach a quarter kilowatt of output as closely as possible and still maintain a high degree of efficiency, we scouted through the tube manuals and tube charts. We

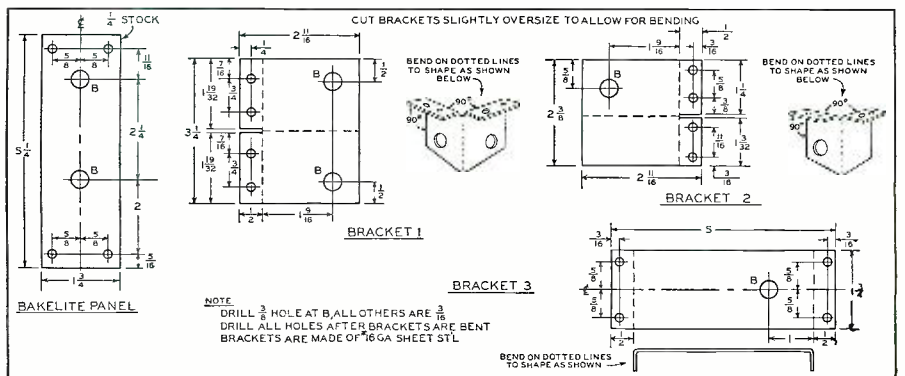

How the brackets are made can be seen from this line drawing.

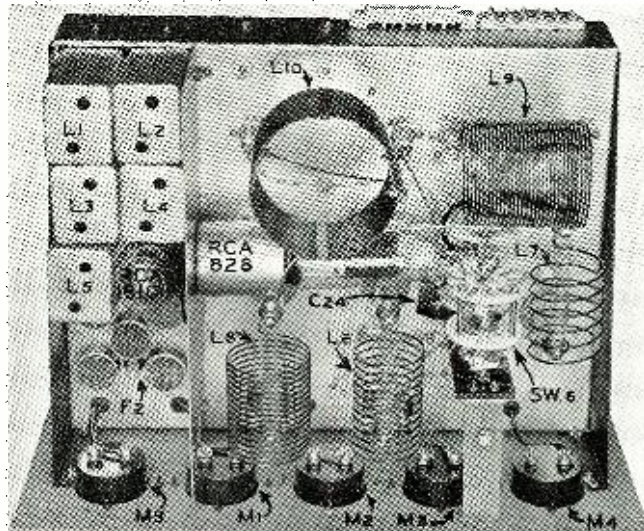
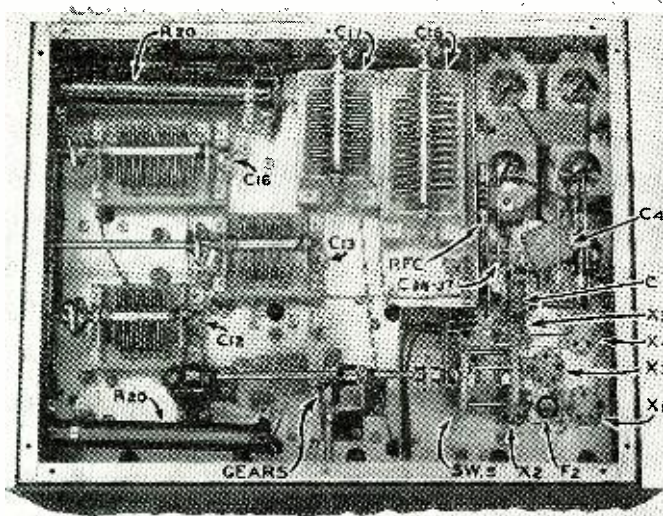

Completed wiring of the r.f. chassis showing the placement of all the parts. Note gears.

were looking for a tube which would run with the highest degree of efficiency we could find, and at the same time which would operate up to 30 megacycles. The new RCA 828 pentode was such a tube.

The next choice was that of the oscillator tube. We had seen the amateur rise from the spark-coil days to the present elaborate rigs and we know how prone the ham is towards using receiving equipment in transmitting positions. This has not been to his detriment, but to his credit, since he has thereby saved a great deal of money in his experimentation. However, since we were going to compact his rig so that servicing would be difficult, and since we wished rugged, trouble-free construction, we decided it would probably be best to use for the crystal oscillator, a tube which the manufacturer recommended exactly for that purpose. Once again, the tube tables came into play and the RCA 1610 was decided upon. This small tube is recommended by the manufacturer especially for use as a crystal oscillator. Actually, such tubes are in use in broadcast stations and we, therefore, thought that the 1610 would answer both the requirements of sufficient output to drive the 828 and at the same time offer the ruggedness and trouble-free operation the unit demands. The r.f. section, finally chosen, was an RCA

1610 crystal oscillator and an RCA 828 r.f. amplifier.

Choice of r.f. Circuit

In view of the fact that it was to be 100% band switching, pre-tuned tank circuits would have to be used. The pre-tuned exciter tank manufactured by *Millen* was chosen because of its compactness and because of its ready adaptability to the circuit. As for the Class C r.f. stage, individual *Barker & Williams* coils stripped of their isolantite bars and mounted as shown in the illustration, together with the *Cardwell* double-space low loss insulated transmitting condensers mounted beneath the chassis were also used.

In talking about band-switching and pre-tuned exciters, some one will surely mention plugin coils. There is nothing inherently wrong with plugin coils except that the inconvenience of rising, opening the top or bottom of a transmitter and placing the coils in their proper positions. If any one of the readers has ever used a table-mounted transmitter with the receiver alongside and the loud speaker on top the receiver, together with the usual papers that clutter up the operating desk, he can readily appreciate the difficulties and the annoyances involved in shifting from one band to another by means of plugin coils. Therefore our choice was a band switching unit.

The average amateur prefers to operate in one or, at most, two, different bands. The bands vary anywhere from 160 and 10 for the usual Class B licensed operator, to 80 and 20 for the Class A licensed operator. Inter-

persed between these two classes, are the code boys who like to use their 40 meter c. w. This eliminated any choice in the matter of band switching and it became imperative that the entire five amateur bands from 160 down to 10 meters be included in the table-mounting rig.

Bias Considerations

The *Thordarson* 19T60 power transformer furnishes 1500 volts at 300 ma. from the filter circuit and this was the power transformer chosen. A small power transformer sufficient to supply proper 400 volts voltage for the RCA 1610, the speech supply and the screen of the RCA 828 was also picked. In order to eliminate bias batteries for the Class C r.f. stage, it was decided to take the minus 100 volts required from the high voltage power supply, running the r.f. stage and the modulators at 1400 volts instead of 1500 volts. By this time the components of the rig had more or less resolved themselves into those which we finally did use. They appear in the parts list.

R.F. Chassis Construction

Before getting into the actual construction of the r.f. chassis, it would be well for the builder to study the illustrations showing the placement of parts. Do not only just "look," but really "study" them. For it is in the placement of the parts that the whole secret of the operation of the transmitter rests. After a full understanding of the parts placement is arrived at, then take the 17"x13"x3" chassis,

(Pse QSY to page 60)

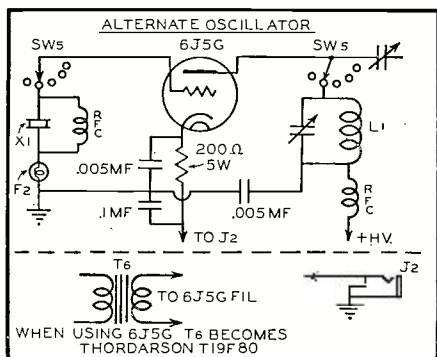
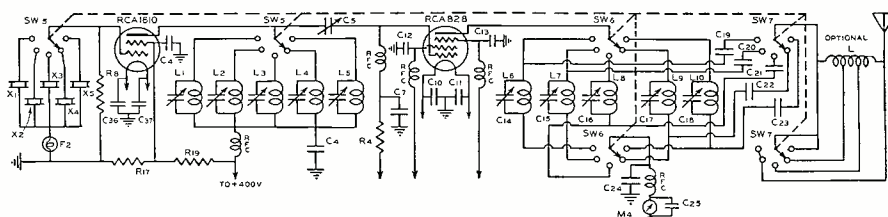
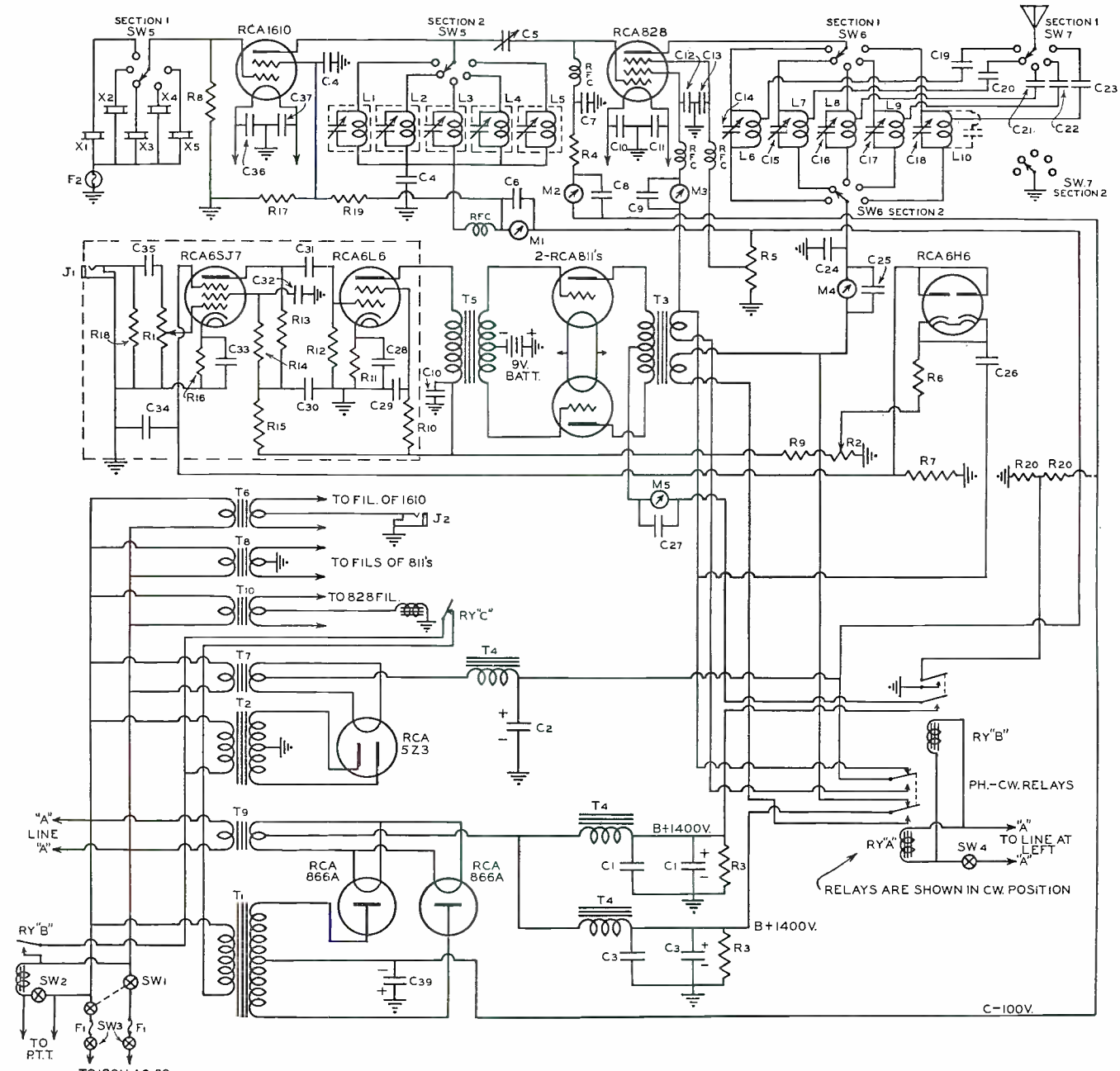

Diagram of the alternate oscillator.



The r.f. section of the Unicontrol 5-Band Transmitter.



- C₁, C₂—2 mf. 2000 v. oil-filled. Aerovox.
- C₃—8 mf. 800 v. electro. Aerovox.
- C₄—.005 mf. 1000 v. mica. Aerovox.
- C₅—75 mmf. variable. Cardwell ZR75AS.
- C₆, C₇, C₈, C₉—.002 mf. 1000 v. mica. Aerovox.
- C₁₀, C₁₁, C₃₀, C₃₁—.006 mf. 1000 v. mica. Aerovox.
- C₁₂, C₁₃—.002 mf. mica. Aerovox.
- C₁₄, C₁₅—mmf. Cardwell NP50DS.
- C₁₆, C₁₇—75 mmf. Cardwell NP75DS.
- C₁₈—100 mmf. Cardwell NP100DS.
- C₁₉, C₂₀, C₂₁, C₂₂, C₂₃—.0025 mf. mica. Aerovox.
- C₂₄—.002 mf. 5000 v. mica. Aerovox.
- C₂₅—.002 mf. 1000 v. mica. Aerovox.
- C₂₆—.5 mf. 200 v. paper. Aerovox.
- C₂₇—.002 mf. 100 v. mica. Aerovox.
- C₂₈—10 mf. 50 v. electro. Aerovox.
- C₂₉, C₃₀—4 mf. 450 v. electro. Aerovox.
- C₃₁—1 mf. 200 v. paper. Aerovox.
- C₃₂—4 mf. 450 v. electro. Aerovox.
- C₃₃, C₃₄—10 mf. 25 v. electro. Aerovox.
- C₃₅—.02 mf. 200 v. paper. Aerovox.
- C₃₆—8 mf. 450 v. electro. Aerovox.
- R₁—500,000 ohm pot. Yaxley.
- R₂—50,000 ohm pot. Yaxley.
- R₃—100,000 ohm, 100 watt. Ohmite.
- R₄—10,000 ohm, 10 w. Ohmite.
- R₅—25,000 ohm 50 w. with adj. tap. Ohmite.
- R₆—10,000 ohm, 1 w. Aerovox.
- R₇—100,000 ohm, 1 w. Aerovox.
- R₈—40,000 ohm, 2 w. Aerovox.
- R₉—50,000 ohm, 1 w. Aerovox.
- R₁₀—10,000 ohm, 10 w. Ohmite.
- R₁₁—500 ohm, 10 w. Ohmite.
- R₁₂—500,000 ohm, 1 w. Aerovox.
- R₁₃—250,000 ohm, 1 w. Aerovox.
- R₁₄—1 megohm, 1 w. Aerovox.
- R₁₅—50,000 ohm, 1 w. Aerovox.

- R₁₆—2,000 ohm, 1 w. Aerovox.
- R₁₇—30,000 ohm, 10 w. Ohmite.
- R₁₈—5 megohm, 1/2 w. Aerovox.
- R₁₉—30,000 ohm, 10 w. Ohmite.
- R₂₀—500 ohm, 100 w. Ohmite.
- T₁—Thordarson T19P60 plate trans. ("Converted")
- T₂—Thordarson T19P54 plate trans.
- T₃—Thordarson T19M16 modulation trans. ("Converted")
- T₄—Thordarson T67C49 chokes (3).
- T₅—Thordarson T19D02 driver trans.†
- T₆—Thordarson 50F61 fl. trans.
- T₇—Thordarson T19F83 fil. trans.
- T₈—Thordarson T19F99 fil. trans.
- T₉—Thordarson T19F90 fil. trans.
- T₁₀—Thordarson T19F95 fil. trans.
- Ry.A—DPDT 120 v. ac relay. Ward Leonard 507-531.
- Ry.B—DPST 120 v. ac relay. Guardian 21139.
- Ry.C—Adjustable overload relay. Guardian X-100.
- J₁, J₂—Single closed-circuit jack. Yaxley.
- SW₁—DPST heavy-duty toggle switch. C.H.
- SW₂—SPST heavy-duty toggle switch. C.H.
- SW₃—DPST door interlock switch. Bud.
- SW₄—2 pole, 11 position selector switch, Shall-cross 532 (xial-tanks). See text.
- SW₅—2 pole, 11 position selector switch, Shall-cross 532 (both coil ends). See text.
- SW₆—2 pole, 11 position selector switch, Shall-cross 532 (1 section used). See text.
- M₁—0-100 DCMA. Triplett Model 326.
- M₂—0-50 DCMA. Triplett Model 326.
- M₃—0-75 DCMA. Triplett Model 326.
- M₄—0-500 DCMA. Triplett Model 326.
- M₅—0-300 DCMA. Triplett Model 326.
- X₁—28 mc. crystal. Hi-Power Ruby.

- X₂—14 mc. crystal. Hi-Power Emerald.
- X₃—7 mc. crystal. Hi-Power Emerald.
- X₄—3.5 mc. crystal. Hi-Power Emerald.
- X₅—1.7 mc. crystal. Hi-Power Emerald.
- F₁—15 amp. 120 v. fuse.
- RFC—2.5 mhy. RF Chokes. 125 ma. Millen. Cabinet—ParMetal DeLuxe. DL 1713. Chassis—ParMetal. 17"x13"x3" steel. Panels—ParMetal. 19"x8 3/4" steel.
- L₁—Millen 70225 Exciter tank.°
- L₂—Millen 70225 Exciter tank.°
- L₃—Millen 70225 Exciter tank.°
- L₄—Millen 70225 Exciter tank.°
- L₅—Millen 70225 Exciter tank.°
- L₆—Barker & Williamson 10 BX 10 meter coil.*
- L₇—Barker & Williamson 20 BX 20 meter coil.*
- L₈—Barker & Williamson 40 BX 40 meter coil.*
- L₉—Barker & Williamson 80 BX 80 meter coil.*
- L₁₀—B & W 160 BX.* Padded by 50 mmfd. air cond.
- ° Condensers included by manufacturer.
- * Remove banana plugs and spacers.
- † Use total primary; Secondary-connect G-G terminals to 2.4-2.4 lugs. Two black leads connect together for center tap. Red lead unused.
- ‡ Primary: Wire No. 1 & No. 6 to plates of 811's; No. 3 & No. 4 connect together, and are primary center tap. Secondary No. 7 connects to 1500 V.D.C., No. 10 connects to R.F. Amp. tank, No. 9 connects to plus 400 V.D.C., No. 11 connects to R.F. Amp. Screen, Taps No. 2, No. 5, No. 8 & No. 12 are not used.

TECHNICAL BOOK & BULLETIN REVIEW

ELECTRICAL COMMUNICATION by Arthur Lemuel Albert, M.S., E.E., published by *John Wiley & Sons*, New York. 534 pp. \$5.00. This second edition by the Professor of Communication Engineering, Oregon State College is a welcome addition to the shelf of the radio engineer. The volume, handsomely bound in cloth, considers the entire subject of electrical communication, including both the wire and wireless transmission of code and speech. The various divisions of telegraphy, telephony and radio are not treated as isolated subjects, but their inter-relationships in providing the public with an adequate and economical communication service are presented. In addition, the opening chapters of the book provide a foundation of fundamental subjects such as speech, hearing, and acoustics upon which a knowledge of communication must rest. The book is a careful revision of the first edition which was designed as a college text book and as a reference book for the communications industry. The plan has been continued in this edition. Many chapters have been entirely rewritten, particularly the last four, to incorporate improvements and bring the material up to date. The volume is profusely illustrated with diagrams, and half-tones. The type is easy to read and understandable.

SERVICING SOUND EQUIPMENT by James R. Cameron, 4th Edition, published by *Cameron Publishing Co.*, Woodmont, Connecticut. 506 pp. This is the 3rd Edition brought entirely up to date with an entire rewrite job. Several new chapters have been added dealing not only with actual servicing, but with tools and instruments necessary for efficient servicing. All trouble shooting charts have been revised and a great number of new ones added, including several dealing with the installation and servicing of television equipment. The book is intended for those constructing, operating or servicing sound reproducing equipment—motion picture—radio—public address—as well as those interested in current television equipment. Profusely illustrated with all manner of diagrams, halftones, and zincs. Complete, yet easy to understand. The trouble charts are world-famous, and no sound technician should be without them.

SERVICE MANUAL OF WIRING DIAGRAMS, compiled by M. N. Beitman, published by *Supreme Publications*, Chicago, Illinois. 220 pp. plus index. \$1.95. Heavy cardboard bound. This manual should be a boon to every serviceman since it contains the diagrams of the most-often serviced radios today. Over 80% of all the sets the serviceman will get into his shop for servicing are included. Also in the book are circuit data, hints, troubleshooting helps making for faster repair jobs and hence greater profits. Over 425 diagrams are printed, together with specifications, and, in many cases chassis layout illustrations. An excellent book for the enterprising serviceman to have.

-30-



LOVE'S LABOR LOST should be the title of the story behind the sinking of the *SS President Quezon* of the Philippine Commonwealth which recently struck a reef off the coast of Japan. The author of it was Brother Jordan, *ARTA* Sec., who proudly reported to your correspondent some time ago that he had wangled an extraordinary contract out of the Philippine government for the American radiop who was billeted aboard the *Quezon*. This vessel was formerly the *Pres. Madison* which was purchased by the P.I.C. Because the radiop went along in the bargain *ARTA* was interested. Although Jordan's efforts eventually proved in vain, the fact that this was a "first" in contracts with a foreign government cannot be taken away from him. Incidentally, we are happy to report that the *Quezon's* radiop was saved, together with all hands and passengers.

ALTHOUGH a bit belated, the pleasant greetings from Harold Craig (HC) from Corinto, Nicaragua, were indeed appreciated. He advises us that he may quit the sea soon for a permanent home billet which, we know, will be deeply regretted by many of his old shipmates. Craig has had many years at sea, having retired from the U. S. Navy with a Chief's pension, continuing his sea duty on various Tuna Clippers off the Southern California coast. Right now he's doing duty on the *MV Santa Margarita* which stopped at Corinto on its way to the Galapagos, long enough for HC to drop us this line. Thoughtful, eh? es tnx.

"THE long nights, ice covered decks, and days of resounding silence being upon us out here where the Norwegian navy does its sailing" was the opening blast from Brother Bolvin who's doing time on the Great Lakes. He wonders if all the boys are keeping up with the latest regs and keeping their logs in good shape.

WMW had its log called in and it came right back with some green tickets attached. This also happened to *WOMT*. And a Broadcast at Manitowoc got the same medicine twice. McKeeson, Supervisor and Chief opr at *WFK*, decided to get the thing straight and drew up what seemed to be a good log form and sent it to the *RI* for an okay. It came back with a few minor notes and one rather grim one to the effect that the form was okay "but it will depend on how the log is kept up." Just a short and sweet warning. The *FCC* is cracking down on every one and ops would do well to make sure their operating procedure and "clerical" work conforms to regulations even if it does mean an extra half dozen log sheets per 8 hour watch.

WHILST we're in the region of the Great Lakes, that little-known section of deep water which is seldom mentioned in the same breath with the Atlantic and Pacific oceans, we find that quite a lot of tonnage annually plies its way between Canadian and home ports. Each year freight traffic averages over 200,000,000 tons valued at over 3 billion dollars. 36.8% of the total domestic water-borne commerce of the U. S. As of May 1, 1939, there were 464 commercial freight vessels and 62 commercial vessels registered, having passenger facilities of 100 gross tons or over, which is a lot of tonnage in any country. So the *FCC* is recommending legislation and other regulations to insure better safeguards, because present radio communication facilities do not adequately

protect life and property. From 1923 to 1937 there were 1570 navigation casualties on these lakes involving American vessels in which 326 lives were lost and property damage amounted to nearly \$30,000,000. Most of the vessels concerned were *not* equipped with radio. In instances where boats were radio-equipped, there was little or no loss of life. Commish Brown is recommending: 1. The method of communication employed for safety purposes should be radiotelephony; 2. The method of radio communication whether *RTG* or *RTP* should be optional for all bay and sound vessels. He further reports that all vessels should, for safety purposes, carry at least one qualified radiop and that a continuous watch should be maintained by a qualified radiop or by an approved type of automatic alarm. The present system of radiotelegraph communication is not sufficient for the adequate protection of Great Lakes shipping because of the limited number of vessels subject to compulsory installation and the short season of operation of boats. Which goes to prove that salt-water sailors haven't a corner on the hero market when *SOS's* start to flash.

AND speaking of this hero business, a suggestion comes in from a correspondent for the formation of a "caterpillar club" for radiops. He asks, "Why shouldn't radiops who have transmitted an *SOS* that saved human life have a similar society as aviators who have had to grab a 'chute to save their lives?" Which isn't a bad question or suggestion, considering the number of men who, during their years at sea, have had to risk their very lives to send out an *SOS*. Men who have been able to keep their balance through the hysteria of such excitement should be signally honored. If such men could get together, either by mail or personally, you can imagine the common bond between them. How many ops are there who are eligible to join such an *SOS Club*? Let's hear from you fellows who have piled over the side after sending a distress call, also those who have sent an *SOS* which resulted in the rescue of some other ship. Now that the standing of the radiop profession, financially and otherwise, has been raised, why shouldn't the social scale be heightened? So let's go and see what the rest of the gang think of this.

WE hear that . . . Lawrence Briggs has opened a radio service business at Herkimer, N. Y. He was formerly radiop at *WIBX* . . . Earl Lund, formerly marine radiop for *TRT*, is now Junioradiop with *CAA* at Rodeo, New Mexico . . . L. S. Thomas is now with *WJSV*. Before this he was radiop at Police radiosta *WPFM*, Birmingham Ala . . . Don Rietske who went back to Washington last year to get some private tutoring from his big brother's school, *CREI*, is now doing maintenance for the Los Angeles Police Department. Which goes to prove what a little burning of the midnight oil will do for one when applied constructively.

THE *FCC* asked for additional men and equipment for use in tracing unlicensed radio stations and maintaining "an effective neutrality patrol of the entire radio spectrum." In its annual report to Congress, the *FCC* said that since the European war it had "undertaken new and exacting burdens in connection with the preservation of neutrality." Among other duties it is charged with preventing unlawful transmission of information. (Further *QRD?* is on page 53)



by **LEE WARD**
Service Manager, San Francisco, California

Here's a problem that has "Signal-Chaser" stopped. Help him out—you may win a prize.

The Case of the Patient Customer

When, in the course of servicing routine, it becomes necessary to learn the electrical value of a chassis component, there is more than one source of information. If meter measurement and calculation are too difficult or require too much time, circuit diagrams or data sheets may be brought into use; surrounding components may lead to a clue, or a colleague's memory might serve.

The problem below provides a means of testing your technical knowledge when none of these easy expedients are available. In other words, you either know the simple fundamentals of the circuits from which you earn a living—or you don't. Most of us do, of course, so the problem offers a pleasant

method of checking speed in such matters.

To Quality

You don't even need a meter to compete. All the necessary information for a correct answer is given in the narrative. Simply combine your experience with the facts given, and send in your solution.

Awards will be chosen from the entries showing the most logical deductions, best presentation, and correctness. Show the steps which brought you to your answer. Address entries to REPAIRMAN'S RIDDLE NO. 5, RADIO NEWS, 608 S. Dearborn Street, Chicago, Illinois.

Duplicate prizes to all tie winners. Entries must be received on or before April 25, 1940 to qualify.

Prizes

Duplicates if duplicate winners
Ziff-Davis Pub. Co. employees and their families are ineligible. Correct answer in June, 1940, issue.

First Prize: Choice of either a **Triplet** Model 426 0-1 d.c. milliammeter, 4" square, or a **Simpson** Model 29 0-1 d.c. 4 $\frac{5}{8}$ " x 4 $\frac{1}{8}$ " milliammeter. Or, if you wish, any other meter of the same retail value you choose.

Second Prize: **Ghirardi's Radio Troubleshooter's Handbook.**

Third, Fourth and Fifth Prizes: Each get a year's subscription to **RADIO NEWS**. If you already are a subscriber, a twelve months' extension. Well—what are we waiting for? Lights! Action!! Camera!!!

As I look back now, I see the customer was a fiend. Otherwise, why did he so deliberately upset my staff and break the smooth routine of my store?

He appeared Monday morning, offering Pete — the *Signal Chaser* — a five-sided metal box, sealed with pitch. A wire came from each of four sides, giving it the general appearance of a large bypass can.

"What's in it?" the customer asked.

"I'll have to test," Pete replied. "What set is it from?"

"No particular set," the stranger said, "but it contains common radio parts. What are they?"

"Would you mind leaving your 'phone number?" Pete asked, sensing something unusual. Sometimes I think he's psychic.

"Here you are," the customer said. "Call me when you finish."

He paused at the door, smiled evilly, and added:

"There are no more than two of each kind of part in that box. If you must use a formula, be sure there's no 'L' in it!"

It was obvious that Pete was puzzled; and, when he walked back to his workbench, Cliff — our customer-chaser — cracked:

"You and your engineering complex! Why couldn't you have rung that thing out while the customer waited?"

"Because I haven't got x-ray eyes," Pete countered. "Anything might be in this tin can."

"You're just like a lot of other servicemen I know," Cliff continued. "You've got to go back to the first

electron in order to solve the simplest problems. If the work isn't made complicated, it wouldn't be worthy of your talent!"

"Go pester a prospect," Pete snarled, untangling his ohm-meter leads.

"What's that you're doing?" I asked, watching Pete draw a list of letters.

"I'm finding out how many ways I can get a two-wire reading when I have four leads to work with," he answered. "The wires A, B, C, and D — running clockwise around the edge — offer six possible paths: A-B, A-C, A-D, B-C, B-D and D-C."

He checked each pair. All but the last read "open." D-C read one thousand ohms.

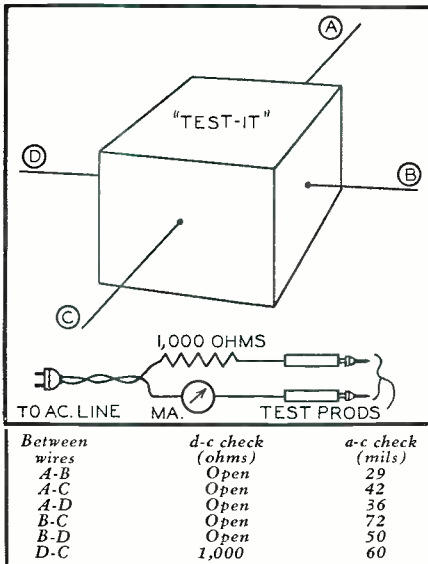

When Pete paused uncertainly, Cliff shoved him aside.

"Gimme that thing," he demanded. "I'll show you how to learn about it quick."

The *Signal Chaser* got so mad you could read his pulse at the edge of his collar.

"Listen here, fellow!" he shouted, "I don't mind your being ambitious—but I warn you: if you take that job from me, don't try to back out!"

"It's a bet," Cliff retorted. "What's more—I'll never bother you again if I can't get the correct answer."

He took a six-foot lampcord, wired in a heavy 1,000-ohm resistor and a 0-100 a.c. milliammeter near the plug end, and shoved the plug into an outlet.

"So we can use a nice, round figure," he explained, "I'll presume the line voltage is the rated one which serves more persons in the U. S. than any other. To simplify things further, I'll disregard the meter resistance—it can't be very high. Now—we'll go through that table of Pete's and get some intelligent readings."

Current passed through each of the six routes. (See diagram.)

"There you are," he announced proudly.

"Where?" Pete demanded. "You haven't told us anything. Want my slide rule?"

"In a few moments," Cliff replied, "I'll tell you the whole story."

That was four days ago. Today, Pete won't speak to Cliff; Cliff won't speak to me. He has gone through his
(Too easy? Then see page 63)

Modernizing Old Receivers

by **CHARLES R. LEUTZ**

Glendale, L. I., N. Y.

PART 2

Continuing the fascinating series which should bring new business to servicemen,—that of renovating and rebuilding old-time radio receivers

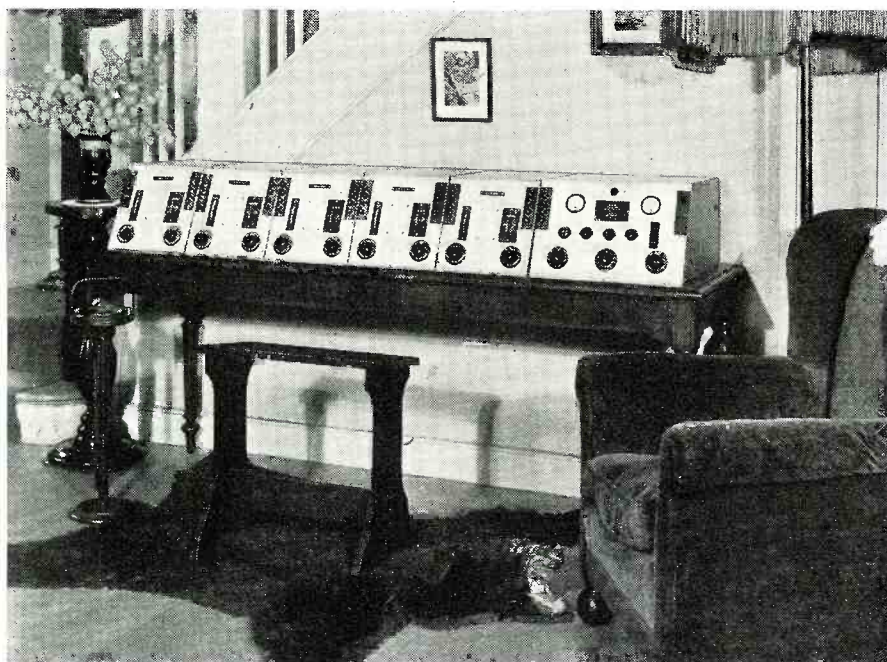

This was in its hey-day a super installation for the modernistic home. While it was an excellent set then, its sensitivity left much to be desired by 1940 standards. When rebuilt, (below) it performed perfectly well.

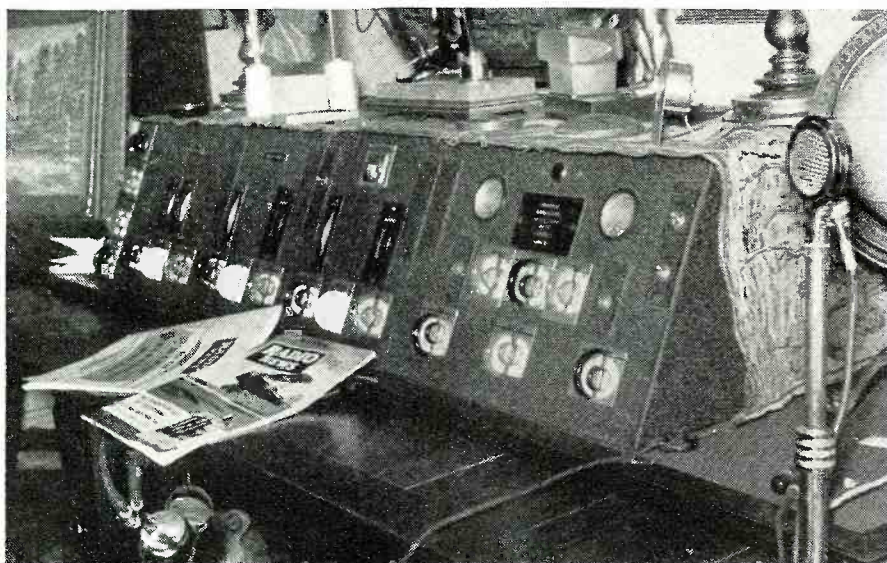

DURING the past ten years or so, tuned radio frequency receiver designs have been more or less neglected by engineers and preference given to super-heterodyne circuits.

It is interesting to note, however, that in the interval, single and multiple stage tuned radio frequency amplifiers have been improved substantially for use in conjunction with super-heterodyne receivers. As a matter of fact it is not uncommon now to find two direct stage pre-selectors being used with a super-heterodyne which already includes one direct stage—making a total of three direct stages!

The performance of any super-heterodyne is limited by the ability and characteristics of the direct r.f. stage or stages with which it is associated. Modern triple grid super-control tubes make it possible to design and construct a very efficient and effective direct tuned radio frequency amplifier for a super-heterodyne pre-selector. With modern improved tubes available, it is possible to construct a multiple stage tuned radio frequency receiver which will compare very favorably with a super-heterodyne, and more important, be free from the several defects inherent to all super-heterodynes. Furthermore in comparing a T.R.F. and S-H receiver, both of essentially equal gain and selectivity, the T.R.F. is much quieter in operation. Both circuits have their advantages and disadvantages but with the T.R.F. set it appears possible to secure final musical reproduction giving superior realism.

The possible modernization of tuned radio frequency receivers ranges all the way from simple three or four tube sets up to the more elaborate multiple tube designs. In the case of small sets originally having three or four tubes, the new circuit can use duo or twin tubes and give performance equal to a five or six tube set. The larger sets can be more completely rebuilt to attain standards of performance only limited by the customer's willingness to pay.

In this article the actual modernization example involves a rather large set, but the circuit and other design considerations apply equally to smaller sets. Accordingly the design and circuit is useful as the basis for any T.R.F. modernizing job, or even to build a new receiver or P.A. tuner. This particular design is confined to the broadcast band exclusively. The tuning range can be extended higher or lower through the use of conventional band switches and additional transformers, for the ranges desired. Incidentally this design makes an excellent intermediate radio frequency amplifier for use with short wave or

ultra high frequency converters.

The radio technician undertaking work of this type should have a fair knowledge of fundamental radio receiver design in order to present the proposition intelligently and to properly carry the order out when obtained. In the case of a job representing a substantial sum, it may be well to go over the following points with the customer, so there will be no misunderstanding as to results which can be obtained at this stage of the art.

1. Sensitivity and Range:

This is only limited by the local noise level (static, disturbances from electrical devices etc.), or in case of favorable locations, limited by the receiver's own noise level (electronic disturbances originating in the first r.f. tube). In the latter case, the disturbance is reduced directly as the degree of selectivity is increased.

2. Selectivity: Some decision should be made as to the selectivity required, for the location involved. No attempt should be made to offer "High-Fidelity" performance, in the sense of full audio frequency range coverage, unless the desired signals have strength ratios 1000 times or more, of that from possible adjacent channel interfering signals. However there is one point in this connection which seems to have been completely overlooked so far; if the desired signal arrives say from the north and the adjacent channel stations are located east and west, then above the average "High-Fidelity" reception can be secured from the "north" station, free from adjacent channel interference of any kind. There are dozens of actual examples wherein the above situation exists. Reproduction of all audio frequencies up to about 5000 cycles, if carried out to give exceptional realism and no distortion, is by far preferred to a "full range" system which shows distortion or lacks realism for one of many reasons.

3. Fidelity: This is so closely related to selectivity that one cannot be changed without affecting the other. Assuming the customer's requirements as to selectivity are reasonable, excellent fidelity can be assured, as is later shown.

4. Volume: Unlimited volume can be provided, as required, however excess over that actually required represents an unnecessary expenditure parts and continual power waste.

5. Operating Ability of the Owner: This is a very important factor because if the owner is technically inclined

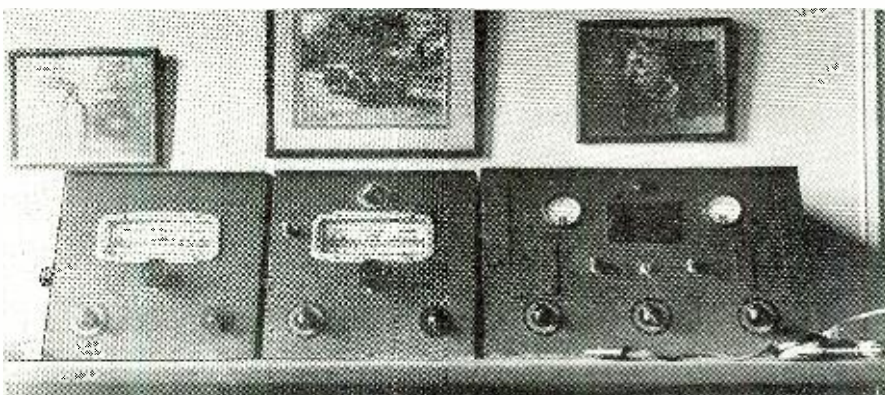

One would hardly believe that this is a rebuilt, revamped old-time radio receiver which the owner had all but given up for the ash heap. Works fine. Below is a view into the three cabinets, showing their clean construction.

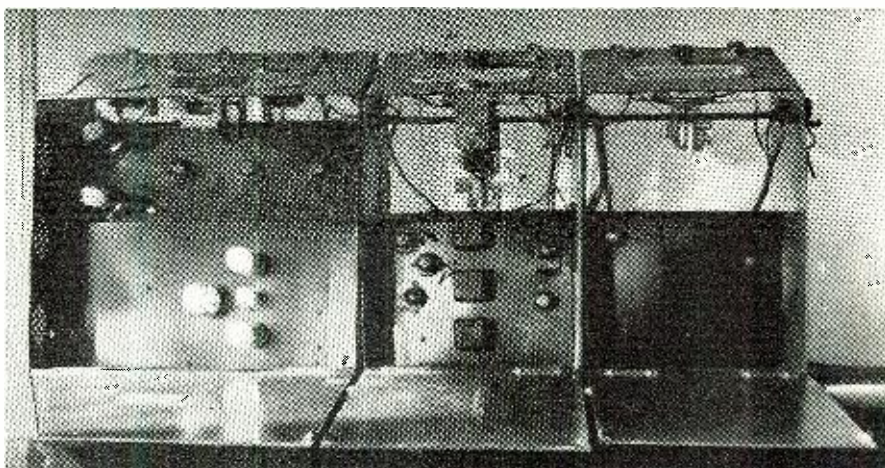

and willing to learn tuning operations, considerable radio frequency regeneration can be used under certain conditions to vary the specifications of 1. and 2. (at a sacrifice of 3.) for certain conditions—a procedure that set manufacturers cannot follow—the advantages of regeneration being sacrificed for stability and simple operation.

Three stages of direct tuned radio frequency amplification, as applied in the circuit to be described, will provide more sensitivity and gain than can be used in most locations. It is most unusual to find a receiving location where the receiver's own noise level is the limiting factor.

These three tuned stages, used with properly designed antenna and radio frequency transformers will provide a degree of selectivity permitting excellent fidelity normally and under other conditions a higher degree of selectivity with corresponding high frequency cut-off. The latter mentioned increased selectivity can be regulated by the operator by applying radio frequency regeneration and can also be used as a means to eliminate adjacent channel interference, when necessary.

The audio amplifying system not only has high power output, but also high overall gain—adjustable as required. The two self-biased push-pull 6L6G's provide an output of from

about 12 watts in Class A₁ to about 32 watts with adjustment for Class AB₂ amplification, but in either case practically free from any noticeable distortion.

This design is not intended for so called "High-Fidelity" reproduction covering the maximum possible frequency range, but is definitely capable of reproduction closely approaching realism, over the frequency range conveniently possible, taking all limitations into consideration. In this connection it is well to review a few angles relating to musical reproduction. For example in comparing two musical instruments, viz, two violins, both of apparent identical design and construction. We find, if they are properly tuned, both will have very similar frequency characteristics as far as pitch curves are concerned. However, in spite of this apparent similarity, one of the violins may only be worth a few dollars and the other one priceless.

This is due to the fact that musical sounds are not distinguished from one or another by pitch alone, but also by the equally important factor of quality. It is well known that any one tone is accompanied by higher frequency harmonics, usually referred to as overtones and the tone quality is limited by the relative intensity of the audible overtones. Beats between the principal components of the many tones which may be involved govern the de-

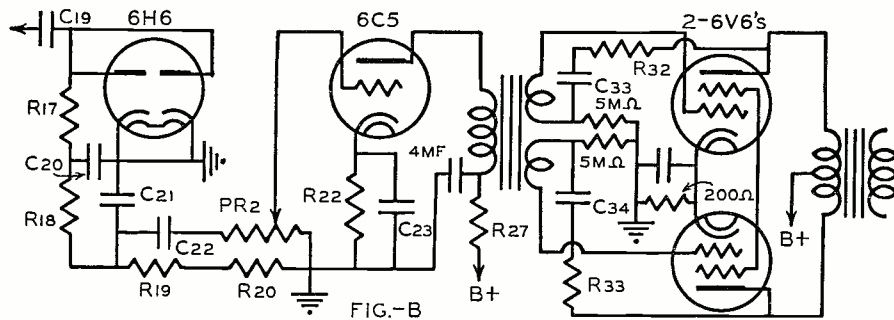

The parts list components are on page 29.

gree of discord or harmony obtained. Relative intensity or volume of the various tones is one of the most important factors contributing to musical expression. Two loud speakers can have apparently identical response curves and yet one may be greatly superior in the reproduction of music involving the simultaneous projection of a multiplicity of tones, harmonics and beats, of different intensities.

Accordingly, at the present stage of the art, speaker response curves cannot be used as a final criterion, especially when the curve is obtained from or confined to one input value. A speaker capable of properly handling say 15 watts at 2000 cycles, may not be suitable to handle one half that power at 200 cycles and even less at lower frequencies.

The choice of speaker depends entirely upon the ability of the amplifier with which it is associated. A wide range, high fidelity speaker requires an amplifier free from distortion over the entire range involved such as the 1940 RN Full Range Amplifier. *It is definitely better to use an amplifier and speaker giving true and realistic reproduction over a limited frequency range than apparatus giving full range coverage with selective distortion.*

Assuming we have ideal *distortionless* and *realistic* reproduction from the speaker, the final result is still limited by the acoustical environment where the speaker is operated. For example, suppose we fire three shots from a .22 calibre rifle, one shot within a small room, another in woodlands and the other at sea on the deck of a boat. In the first instance the sound is deafening. In the woodlands, the sound is not so great but echoes or reverberations are noticed. In the last case the .22 does not sound any louder

than a cap pistol. It must be remembered that in each of the above tests, the loudspeaker power output was exactly the same.

All the aspects of acoustics are taken into consideration by broadcast studio designers. The subject and treatment is equally important at the point of reproduction. Accordingly the installation technician should have a fair knowledge of sound physics and use it to select speaker locations that will insure best possible results.

Assuming that the amplifier, speaker and acoustical conditions are all satisfactory, there still remains the problem of proper coupling between the amplifier output and speaker input. The speaker impedance is not fixed for all audio frequencies, therefore the load impedance on the output tubes varies with frequency. Considerable frequency distortion can be produced in the output circuit unless this condition is corrected. The best method to compensate for this variation is the application of inverse feedback. An alternative method consists of a corrective filter connected across the primary of the output audio transformer and is only recommended when the application of inverse feedback is impossible.

The outline specifications for a modern t. r. f. circuit can then be given as follows:

1. An efficient signal collector, preferably a directional antenna or loop, located with a view to obtaining maximum signal pick-up and minimum external noise pick-up.
2. A cascade radio frequency amplifier normally capable of high gain without operating the tubes to full capacity; also normally capable of passing a

band of 10,000 cycles and adjustable to reduce the band pass width to about 4,000 or 5,000 cycles when required.

3. A linear diode rectifier, properly coupled to the audio input circuit and capable of handling substantial signal energy without distortion.

4. An audio amplifier of ample voltage gain and liberal power output capacity, associated with and properly coupled to one or more high grade electro-dynamic loud speakers, and the latter operated under favorable acoustical conditions.

As a specific example of what can be accomplished with T.R.F. receivers, an original model manufactured in 1924 is shown. This is the theoretically ideal arrangement, separate shielded containers for each r.f. and the detector stage; shielding far removed from r.f. transformer shields and separate A, B and C batteries for each stage.

The performance of the above receiver was only limited to the ability of the tubes available at the time. As

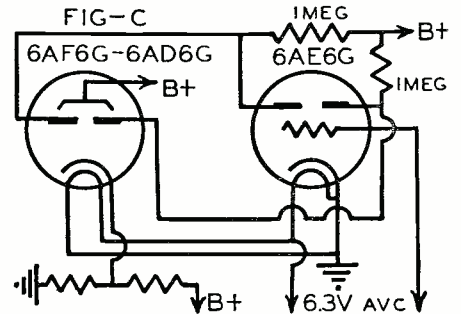

Components same as on page 29.

new and improved tubes became available, they were adapted to the circuit and with improved results. Such changes were made at intervals, first to take the -24A's, later the -35's and still later for the -58's. The -58, having remote cut-off characteristics provided a very substantial improvement, with great reduction of cross-modulation and modulation distortion.

More recently, this same T.R.F. set, now 15 years old, has been modernized to use 6K7's in the r.f. stages in conjunction with new ferrocore antenna and r.f. transformers. During the last modernization it was possible to condense the mechanical arrangement, reducing the number of units from 6 to 3, without any apparent loss in overall performance, due principally to the efficient application of shielding, decoupler filter circuits and careful arrangement of r.f. wiring to reduce parasitic feedbacks to a low minimum.

The result, as far as the broadcast band is concerned, is a receiver comparable to the best super-heterodynes, but with a quality of reproduction believed superior to that obtainable with a super-heterodyne. Normally no tone compensation of any kind is used. The optional "tone control" indicated in the

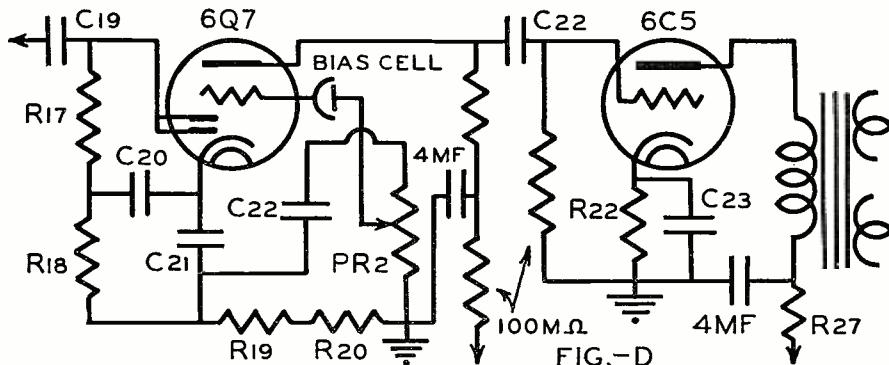

The electrical components are the same as those on page 29.

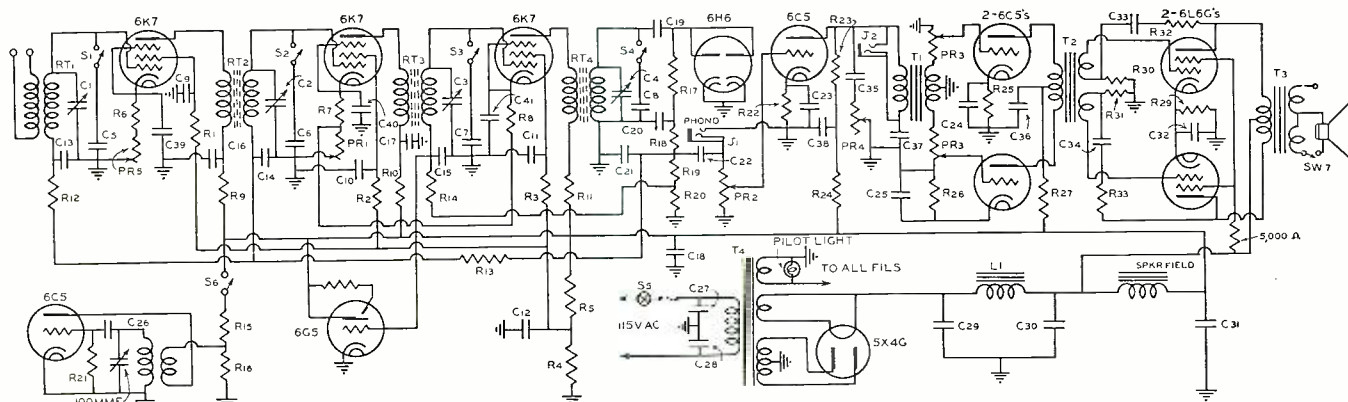

LIST OF MATERIAL

PR₁—25,000 ohm Clarostat.
 PR₂—25,000 ohm Clarostat.
 PR₃—500,000 ohm Mallory.
 PR₄—Twin 500,000 ohm Clarostat.
 RT₁—Meissner Ant. Transf. No. 14-1496.
 RT₂—Meissner R. F. Transf. No. 14-7860.
 BF₁—BFO Coil Meissner No. 17-6753.
 C₁—Meissner No. 21-5224 365 mmf single.
 C₂, C₃, C₄—Meissner No. 21-5222 365 mmf triple gang.
 C₅, C₆, C₇, C₈—.00075, each consisting of one .0005 and one .00025 in parallel, Mallory Mica.
 C₉, C₁₀, C₁₁, C₁₂—.1 mf 600 volt, Mallory.
 C₁₃, C₁₄, C₁₅—.05 mf 600 volt Mallory.
 C₁₆, C₁₇, C₁₈—.1 mf 600 volt Mallory.
 C₁₉—.0001 mf Mallory Mica.
 C₂₀, C₂₁—.00025 mf Mallory Mica.
 C₂₂—.05 600 volt Mallory.
 C₂₃, C₂₄—.10 MF 50 volt Mallory Electro.
 C₂₅—.00025 mf Mallory Mica.
 C₂₆, C₂₇, C₂₈—.01 600 volt Mallory.
 C₂₉, C₃₀—30 MF 450 W. V. Mallory Electro.
 C₃₁—8 MF 450 W. V. Mallory Electro.
 C₃₂—10 MF 50 Volt Mallory Electro.

C₃₃, C₃₄—.05 600 volt Mallory.
 C₃₅—.02 600 volt Mallory.
 R₁, R₂, R₃—10,000 ohm ½ w. IRC.
 R₄—6000 ohm, 3 w. Ohmite.
 R₅—5000 ohm 3 w. Ohmite.
 R₆, R₇, R₈—275 ohm 1 w. IRC.
 R₉, R₁₀, R₁₁—10,000 1 w. IRC.
 R₁₂—100,000 ohm ½ w. IRC.
 R₁₃, R₁₄—500,000 ohm ½ w. IRC.
 R₁₅—100,000 ohm 1 w. IRC.
 R₁₆—7500 ohm 1 w. IRC.
 R₁₇—100,000 ohm ½ w. IRC.
 R₁₈—50,000 ½ w. IRC.
 R₁₉, R₂₀—100,000 ohm ½ w. IRC.
 R₂₁—50,000 ohm ½ w. IRC.
 R₂₂—2000 ohm 1 w. IRC.
 R₂₃—30,000 ohm 1 w. IRC.
 R₂₄—20,000 ohm 1 w. IRC.
 R₂₅—2000 ohm 1 w. IRC.
 R₂₆—5000 ohm 1 w. IRC.
 R₂₇—100,000 ohm 1 w. IRC.
 R₂₈—190 ohm 3 w. Ohmite.
 R₂₉, R₃₀, R₃₁—10,000 ohm ½ w. IRC.
 R₃₂—100,000 ohm ½ w. IRC.
 S₁—Selector Switch Mallory No. 3242-J.

S₂, S₃, S₄—Selector Switch Mallory No. 3242-J.
 S₅, S₆—Mallory No. 20 S.P.S.T. Switches.
 C₃₆—4 Mf 400 V Paper Cornell-Dubilier.
 C₃₇—25 mf 600 volt Mallory.
 C₃₈—4 MF 400 V Paper Cornell-Dubilier.
 C₃₉, C₄₀, C₄₁—.1 400 volt Mallory.
 M₁—0.200 Milliammeter.
 M₂—0.8 voltmeter and 100,000 ohm multiplier.
 J₁—Jack, Mallory No. 701.
 J₂—Jack, Mallory No. 701.
 Dials—Meissner No. 23-8227 5" Slide Rule Type for Broadcast Band complete with esuchtions, bayonet type pilot-light sockets and 6/8 w. bulbs.
 Dial Plates—2 Mallory No. 372, Position 1 and 2.
 Dial Plates—5 Mallory No. 369, 0-100.
 Pilot Light Bracket—1 Mallory No. 310R.
 Speaker Plug and Receptacle—Mallory No. 139 and No. 680.
 Sockets—15 American Phenol KMIP-8 Octal, 1 MAE-6 Eye Socket.
 Transformers—Power—UTC R-13; Audio Input UTC S-4 Class A Input; Interstage Push Pull UTC LS-25; Output Push Pull S-16; UTC 10 Hy. 200 M.A. S-31.

schematic diagram is only useful in reducing static during summer electrical storms.

The excellent performance of this circuit is largely due to the design of the antenna and r.f. "iron-core" transformers. These transformers are of the high impedance (primary) magnetic coupling type, and the magnetic coupling is combined with a small amount of high impedance capacity coupling (both adding), resulting in coupling units providing substantial gain uniformly, excellent selectivity and curve form conducive to fidelity.

This fundamental circuit can be used to modernize practically any T.F.R. receiver, or to build a new receiver along the same general lines, making such variations that may be required for individual requirements. The set to be modernized might have 1, 2 or 3 r.f. stages. Ordinarily more than 3 r.f. stages are not recommended or necessary.

Receivers to be properly modernized, should have a fair sized chassis providing liberal room for the component parts and to allow efficient rewiring without undue crowding. It is essential that the high frequency grid and plate leads be run without the use of shielded braid or wire, if at all possible. Preference is given to bare r.f. grid and plate leads, run in open air, free as possible from surrounding objects and from each other. It may be necessary to shield one or more leads, in which case the suggested method is shown. The r.f. lead is run within a thin copper or aluminum tube. While this method adds a minimum capacity, the capacity is constant, free from atmospheric changes and only adds an insignificant loss.

The antenna and r.f. transformers require variable tuning condensers having a maximum capacity of 365 mmf. If the condensers available have a higher capacity, their capacity can be reduced to the required value by removal of rotor plates. While some of the older gang condensers are of substantial general construction, most makes use inefficient stator insulators. When possible the stator insulators should be replaced by more modern low loss high frequency insulating material, for example one of the Polystyrene family such as *Amphenol 912B*.

The r.f. stages can be arranged for either 6K7's or the single ended 6SK7's, the choice depending upon the best possible arrangement of tuning condenser stator terminals, r.f. transformer terminals and the tube grid, the desired relation being one where all leads are kept to a minimum length. For smaller sets, using series heater circuits, the 12K7GT has the same characteristics as above types.

Where the same circuit is applied to short wave reception, for example with a switching arrangement and additional band transformers, then type 1852, 1853 or the type 954 acorn tubes are preferred. While the circuit is primarily designed for the broadcast band, the tuner provides an excellent intermediate radio frequency amplifier to use with short wave or ultra high frequency converters. In the first mentioned case the intermediate frequency can be set to 455 or 465 KC by switching in the fixed capacities C-5, 6, 7 and 8 with the switches S-1 and S-2-3-4.

In any multiple stage radio frequency amplifier having a tuned input the matter of shielding is of prime im-

portance, especially that of the input stage. In this design, a separate shielded container is provided for the antenna tuning components and the first r.f. tube. The 2nd r.f., 3rd r.f. and detector stages are controlled by a gang condenser and housed in a second shielded container. This arrangement also offers other advantages. It enables using various antenna combinations without worrying about single control tracking. The separate antenna tuning also permits adjustments of "broad" or "sharp" tuning as required to eliminate adjacent channel interference. However, excellent results are also possible with the antenna circuit ganged to the balance of the r.f. amplifier and detector circuits.

Each r.f. transformer is housed in a shielded can. As the 6K7's are metal tubes, the elements are automatically shielded and that is a much superior method as compared to loose cans around glass tubes. The gang condenser must of course have shielding barriers between the stator assemblies. In some cases it is necessary to shield the stators from adjacent r.f. wiring, depending upon the design of the condenser. Therefore the arrangement of shielding effectively isolates adjacent stages and also shields the input from the output of each stage.

A voltage supply circuit common to the various stages of a cascade amplifier will cause undesired feedbacks unless special attention is directed to eliminate this condition. Therefore decoupler filters are inserted in the voltage supply leads to certain tubes. Each r.f. screen grid lead is provided with a filter consisting of a 10,000 ohm resistor and .1 mf condenser, (R1-C9),

(Build further on page 49)

What's NEW in Radio

Allied Radio Corporation, Chicago, presents a new deluxe instrument in the KNIGHT 11 Tube 3 Band Phono-Radio with RCA record changer, incorporating a new Superhet receiver built for reception on 540-1720 kc. 2.3-7.5 megs. 7.5-24 megs.). The new built-in "Air-Magnet" completely eliminates the need for antenna and ground. Six push-buttons are provided for automatic tuning; employs the latest type tubes



(6K8, 6SK7, 6H6, 2-6SF5, 3-6C5, 2-6K6G, 5Y4G). Other deluxe features include: 12-inch Dynamic concert-size speaker; Bass Compensation and Bass Booster; Pre-selector stage; Full A.V.C.; continuously variable Tone Control; heavy duty 3-gang rubber mounted condenser; Wave band indicator; giant slide-rule dial; Built-in Television Connection; and many other features.

Recognizing the need for a voltmeter for testing dry batteries under load, Simpson Electric Company, 5216 Kinzie Street, Chicago has introduced a new pocket-size tester, Model 245. It is expected to find wide application in testing batteries used in portable receivers, transceivers, aircraft radio, hearing aids, clocks, lanterns, flashlights, and similar equipment. For the Model 245, a load condition is set up by introducing an artificial load into the circuit, within the meter. A toggle switch is provided to switch the load off and on, providing an interesting comparison between readings with load off and load on. Six voltage ranges are provided, covering the popular sizes of "A" and "B" batteries. For "A" batteries, the ranges are 0-2, 0-1, and 0-8 volts. For "B" batteries, the ranges are 0-50, 0-100, and 0-150 volts. In each range, the meter has a sensitivity of 1,000 ohms per volt. Any range may be instantly selected by the convenient rotary switch. The silver-etched dial is very easy to read. Separate arcs are provided for the low-voltage "A" batteries and the higher-rated "B" batteries. A green sector in each arc tells at a glance whether the battery is in serviceable condition. The dial also indicates in red, the less common battery ratings of 4.5, 7.5, 22.5, and 67.5 volts.

The Howard Radio Company, 1735 Belmont Ave., Chicago, announces the Howard Model 650 Preselector consisting of a completely self-contained two stage high gain preamplifier with tuning range of 540 kc. to 43 mc. May be used to feed any type of receiver or other radio apparatus. Input may be obtained from standard antenna or from rotatable loops. Four loops are furnished for different frequency coverage. Compass scale at base of loop indicates direction of loops.

RCA Manufacturing Company, Inc., Harrison, N. J., has recently announced to equipment manufacturers: RCA-12K8, Triode-Hexode Converter (Metal Type); RCA-12SR7, Duplex-Diode Converter (Single-Ended Metal Type); RCA-928, Gas Phototube (Non-Directional Type); RCA-1628, Ultra-High-Frequency Transmitting Triode; RCA-1840, Orthicon; RCA-1848, Iconoscope. The 12K8 is similar to the 6K8 except the heater of the 12K8 requires 12.6 volts and 0.15 ampere. The 12SR7 is similar to the 6R7 but utilizes a single-ended metal construction with the grid lead brought out through the base. The 928 is a gas phototube designed with a cesium-surfaced cylindrical mesh cathode which has non-directional light pick-up characteristics. The 1628 is a three-electrode tube of the high-perveance type designed for use as an oscillator or r-f power amplifier at ultra-high frequencies. It can be operated at maximum ratings at frequencies as high as 500 megacycles and with reduced ratings as high as 675 megacycles. The maximum plate dissipation of the 1628 is 40 watts in class C telegraph service. Some of the features of the 1628 contributing to its high-frequency performance are: double-helical filament center-tapped within tube to minimize the effects of filament lead inductance; double grid

and plate leads which are brought out of the tube through individual seals to eliminate common impedances between tank and neutralizing

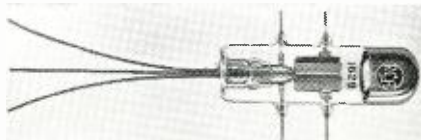

circuits; and tantalum plate and grid closely spaced to increase plate efficiency at high frequencies by decreasing electron transit-time be-



tween filament and plate. The 1840 is a special form of cathode-ray tube designated as the Orthicon. It is intended for "picking up" a scene



to be telecast and converting it to an electrical signal. This new tube utilizes a low-velocity beam for scanning. Outstanding advantages of



the Orthicon are: (1) it has high operating sensitivity; (2) its signal output is free from "dark spot" and other spurious signal; (3) its current-output vs. light-input characteristic is linear; (4) it operates with an anode supply of 250 volts; (5) it does not require keystone correction; and (6) its constant black-signal level simplifies d.c. restoration. The 1848 Iconoscope is also a special form of cathode-ray tube intended for "picking up" a scene to be telecast. This type features small size, high resolution capability, and high sensitivity. Because of these features, the 1848 is especially suited for use in portable television cameras.

This newest instrument the new Jumbo Volt-Ohm-Milliammeter Model 4922-5 is a 9 1/4" rectangular meter, has ranges to cover practically all applications of electrical measurements. Ranges are as follows: A.C. and d.c. volts, 0/10/50/250/500/2500. D.C. Microamperes, 0/500; especially handy for sensitive measurements. D.C. Milliamperes, 0/5/50/500. Ohms, 0/30/48 ohms mid-scale, 5/10,000 (150 ohms mid-scale), 50/1 megohm (15,000 ohms mid-scale), and 500/10 megohms (150,000 ohms mid-scale). Decibels, -10 to +15, 29, 43. Output, 0/10/50/

250/500/2500. This range incorporates a blocking condenser. There is a potentiometer adjust-



ment for change in ohmmeter circuit having battery voltage. Change in battery voltage does not affect the accuracy of the ohm readings. This instrument incorporates a new type rectifier circuit, which will withstand more overload than other types of rectifier circuits, the manufacturer, The Hickok Electrical Instrument Co., 10514 Dupont Ave., Cleveland, Ohio, states.

Jensen has recently announced a new line of Full Range Speaker equipment of unusual character. Type B System, illustrated, consists of a multicellular high frequency horn utilizing two annular diaphragm speaker units, and one of the new Jensen "folded" type horns equipped with two low frequency loud speakers. This is the first time that speaker equipment of this magnitude has been offered to the trade by Jensen Radio Mfg. Co., 6601 South Laramie Avenue, Chicago.

General Transformer Corporation has just brought out a new Porta-power; the "Twin-Power" Model "P." "Twin-Power" is the solution to the problem of eliminating batteries in six volt sets. By providing separate sources of supply to the filaments and to the vibrator, the vibrator disturbance is eliminated and high fidelity performance is assured.

Allied Radio Corporation, Chicago, is currently offering a new KNIGHT Deluxe 11-Tube Console Model Superhet. This new model, No. A10845, includes such outstanding features as: Television connection; Automatic Volume Control; 7 watts output; 12 pushbuttons—6 for tuning, 3 for tone control, 2 for "on-off" 1 for Television or Phono; 7 watts output; 12" Dynamic Speaker; 3 Gang Condenser, rubber floated; two I.F. stages; R.F. Preslector; built-in "Air-Magnet" aerial (eliminates aerial and ground); Giant Slide-Rule Dial; Electro-Static Shield; Two-Band Reception: 5650-18100 K.C. and 540-1550 K.C., etc. The following latest tubes are employed in an RCA and Hazeltine licensed circuit: 1-6A8, 2-6K7G, 5-6J5G, 2-6F6G, 1-5Z3.

L. G. Winney at a recent meeting of the Board of Directors, was elected Treasurer of the Thordarson Electric Manufacturing Co., Chicago, according to an announcement just made by the officials of the concern. This new post comes to Mr. Winney after serving as Credit Manager since joining the company in January, 1934. Previous to his connection with Thordarson, Mr. Winney spent many years with the Marshall Field organization. He therefore brings to his new position a wealth of experience gained through his association with this business added to his work during the past five years with Thordarson. He is familiar with the problems of dealers and jobbers and they will find in him one who is in thorough accord with the Thordarson policy of helpful cooperation with the trade.

Radiobor Company of America, New York, announces the appointment of four factory representatives, according to C. T. Hillman, president. The new members of the Radiobor sales organization are R. H. Campbell, 53 W. Jackson Boulevard, Chicago, Ill., who will cover Illinois, Indiana and Wisconsin; Albert Rapfogel, 700 Prospect Ave., Cleveland, to cover Ohio, West Virginia and western Pennsylvania; Harry Rich-

What's NEW in Radio

ards, 803 Cherry St. S.W., Grand Rapids, Mich., to cover Western Michigan, and Robert Howard Company, 965 Broad St., Newark, for northern New Jersey.

Meissner Manufacturing Company, Mt. Carmel, Illinois, is all set to go after its share of the Vibrator Replacement business with their recently re-designed vibrator. Considerable time and money have been spent in bringing this unit



to its present perfection, but they are now satisfied that it is second to none in quality. To aid jobber sales, an attractive three-color counter display has been prepared. It contains six fast-moving replacement items and carries a powerful sales appeal, pointing out each of the important features of the new vibrator element illustrated on the back card.

Servicemen will warmly welcome a new type of dry electrolytic replacement capacitor just announced by Cornell-Dubilier Electric Corp., So. Plainfield, N. J. This capacitor, known as the type EZ, provides the dual economy features of low cost and quick replacement. In addition,

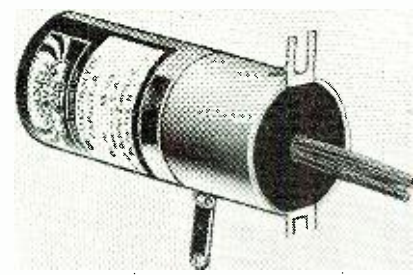

tion, it is universal in its application, serving for replacement of vertical can, spade lug and strap mounted originals. Single, dual, triple and quadruple units are included, with a choice of common negative leads or separate sections. In all there are 38 different varieties and combinations ranging from single 8, 12, 16 and 24 mfd. capacitors with ratings of 250, 350, and 450 volts, to multiple units which provide in a single compact form the several capacity and working voltage values required for different typical receiver circuits. Enclosed in cylindrical cardboard container, all EZ units are clearly stamped with capacity and voltage ratings, and all leads are insulated and color coded.

An improved Model 308 Tube Tester is announced by Radio City Products Company, New York City. This new tester provides facilities for testing all tubes including the OZ4, loctal, single-end, Bantam, Miniature and high-voltage filament types, all ballast tubes (separate ballast tube chart included), pilot lamps and Christmas-tree lamps. Also an additional test position is provided for future tubes with new base arrangements. All tests are made under RMA specified plate voltages and loads. Hot interelement short and leakage tests are provided for between all individual elements, including hot cathode leakage, with high-sensitivity neon indicator. Also provision is included for audible test of noisy tubes and for testing each section of full-wave rectifiers, duo-diodes and all other multisection tubes.

The accompanying photos show 5 receiving units, each comprised of two receivers to be used by the Byrd Expedition. In some units there are two Hammarlund "Super-Pro" receivers and in others, there are two Hammarlund "HQ-120-X" receivers. In still other units, there is one of each type receiver. In all, there

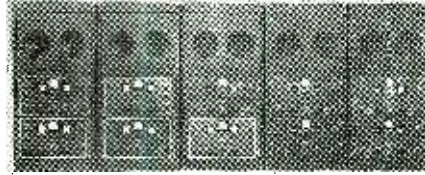

are 15 Hammarlund receivers—9 "Super-Pro" and 6 "HQ-120-X." The large double units will be used in base stations and on ships while individual sets will serve in outpost stations and mobile units. For example, the Condor planes will carry "HQ-120-X's," as will the snow cruiser.

A miniature instrument which combines the functions of an all-purpose meter with those of a trouble tracer, and yet requires little room in the kit, is the Model 456 of Radio City Products Company, New York City. Sixteen measurement ranges are provided through eight test prod jacks which function in conjunction with the 0-1 ma. D'Arsonval meter movement. The multi-scale meter has built-in zero adjustment and provides measurement accuracy of plus or minus 2%. The ranges of the Model 456 are: A.C. Volts, 0-5/50/500/1000; D.C. Volts, 0-5/50/500/1000; D.C. Milliamperes, 0-1/10; Ohms, 0-5000/500,000; Decibels, —12 to plus 8/8 to 28/28 to 48/34 to 54. The instrument is housed in a finely finished hardwood case. Overall weight is 21 ounces. This light weight and dimensions of 6"x3"x2 3/8" make it entirely practical to carry in a coat pocket.

A new device known as the Record-O-Fone has just been announced by the Bell Sound Systems, Inc., 1183 Essex Ave., Columbus, Ohio, measuring only 1 1/2"x1 1/2"x7 1/2". It attaches to any radio and permits both transcribing for phonograph records as well as recording radio programs, or voice, or wax discs may be used. The equipment is offered in two models, the one model is for those wishing only to record radio



programs. The other incorporates an oscillator which permits microphone recording. With this latter unit a desk-type microphone is supplied. Either model is very simply hooked up with the radio and is simply operated by convenient control switches on the top of the unit. Electrical connection is made by plugging into any wall socket carrying 110 volt a.c. current. An automatic control flicker light controls volume.

Universal Microphone Co., Inglewood, Cal., in January started to distribute its new synchronous motor and turntable for playback, manufactured particularly for radio stations and recorders who dub or re-record from other records. For this work engineers require absolutely perfect rotation with a powerful motor that records and plays back with absolute music pitch. The motor is not an induction or so called constant speed motor, but a true synchronous motor similar in many respects to motors used on Universal's professional recording machines. The new apparatus is 100 percent synchronous, changes from 78 to 33 1/3 r.p.m. instantaneously,

and the condensers are the start and run type. The assembly is complete with aluminum plate

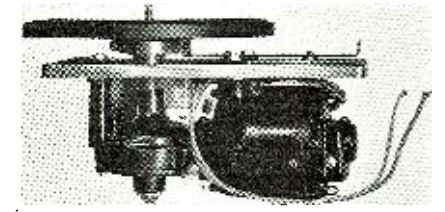

and is ready to mount on the control desk or panel.

Bakelite-molded mica condensers provided with handy meter-mounting brackets, for the purpose of radio-frequency shunting of meter windings, are announced by Aerovox Corporation, New Bedford, Mass. The heavy 3/16" thick brass brackets are mounted and connected to the popular series 1445-57 mica condensers. Long slots in the brackets permit attachment to the terminals of any of the standard panel-mounting meters.

Two accessories serve to make the L-C Checker still more valuable to the radio serviceman, according to an announcement by Aerovox Corporation of New Bedford, Mass., manufacturers of this equipment. First, there are the mounting brackets which serve to mount the Checker on the test panel of the service shop. These four angle brackets are fastened to the sides of the panel by means of the panel screws; the Checker is then slipped into a square hole cut in the test panel, and screws hold the brackets to same. Second, there is the .001 mfd. mica condenser which is used in measuring inductance values. This condenser is connected across the coil to be measured, and the resonant frequency of this L-C combination found by using the loop, magnetic coupling or test-prod capacity coupling. A handy self-calculating table in the Manual indicates the inductance value when using this standard condenser which is fitted with combination binding posts and banana-plug jacks.

Reorganization of the Airplane and Marine Direction Finder, Inc., formerly of Lindenhurst, N. Y., having been completed, the new Airplane and Marine Direction Finder Corp. has moved its laboratories and factories to Clearfield, Pa. Specializing in direction finders and radio communication equipments for the Army, Navy, Coast Guard and other U. S. Government departments, "Amlicco" is now established in ultra-modern "straight line" factory and laboratory buildings in Clearfield, Pa., where it maintains unusually complete engineering and manufacturing facilities.

As of the first of the year, the manufacture and sale of Cinaudagraph loud speakers has been taken over by a new company known as United Teletone Corporation. This new organization will continue to operate at the present plant in Stamford, Conn., manufacturing the same line of speakers with the same personnel. This new company will be operated under the management of I. A. Mitchell and S. L. Baraf of United Transformer Corporation, whose experience in associated fields should further augment the sale and quality of Cinaudagraph speakers.

The Lafayette Model BB-11 Console Grand receiver presented by Radio Wire Television, Inc., 100 Sixth Avenue, New York City, featuring the use of eleven modern tubes, and coverage of 13.7-42.8-137 and 173.5-588 meters. Built-in loop antennas (one for the longer waves and one for the short waves) eliminate antenna and ground leads, simplify installation and permit the utmost freedom in locating the receiver in any room. Push buttons provide instant selection of six predetermined stations and a large slide-rule dial with inset tuning eye and sliding panel facilitates manual tuning of others. A 4-position tone control not only provides regulation of the "highs" but actual bass boosting. Interstation noise is eliminated (and static reduced after a station has been tuned in) by a special static control circuit. A 4-tube audio system with push-pull 6V6's in the output stage, combined with an acoustically matched 12-inch electro-dynamic speaker, provide both volume and tonal quality to please the most discerning ear.

To meet the demand for an amplifier system of unusually reasonable price yet capable of a high grade of performance, Radio Wire Television, Inc., 100 Sixth Avenue, New York City, offers the Lafayette Model 757-T Coordinated Sound System. The foundation of this system is the 7-tube Model 452 "beam-power" amplifier with normal output of 30 watts (peak output of 40 watts) and with complete mixing facilities for simultaneous operation of two low-level micro-

What's **NEW** in Radio

phones and two record pick-ups or other high-level inputs. The gain is 130 db. from the low-level, and 80 db. from the high level inputs. The modernistic metal housing is finished in crackle gray with plastic handles of red and chrome. Fittings include duo-tone dial scales, ivory knobs and pilot light.

Mystic Mike now appears in a DeLuxe Model in addition to the Little Marvel set first produced. The new unit is housed in a beautiful Bakelite cabinet with built-in supersensitive microphone. It is a compact broadcasting unit, operating without the use of wires. The *Olson Manufacturing Company*, 362 Wooster Ave., Akron, Ohio, has designed this handsome Mystic Mike for clear, natural tone quality and brilliant, trouble-free performance. This device consists of a modulated oscillator with tube and microphone; it plugs into any electric socket and transmits to nearby receivers without any electrical connections. The Mystic Mike, with variable frequency control, radiates a signal within the tuning range of all types of broadcast receivers. Speech or music is picked up by tuning to the frequency of this oscillator. Either an a.c. or d.c. lightline is practical for the purpose.

A new "Long Life" phonograph needle capable of 1,000 playings under normal conditions without distortion, and which provides accurate reproduction of tone and a minimum of record wear, has been announced by *RCA Victor*. Individually packaged in a crystal-clear, rectangular block of transparent plastic, the needle has unique display and promotion possibilities. *RCA Victor* enumerates four main points of supe-

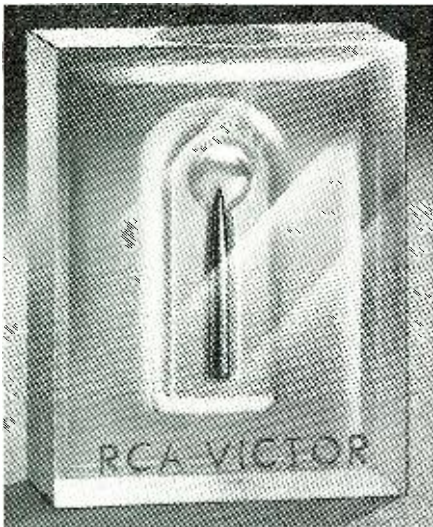

riority for the new needle: long life, kindness to record surfaces, faithful reproduction, and comparatively low cost (suggested list price \$1.00 each). It was developed from an entirely new formula after years of research, and utilizes the rarer alloy of the platinum group of which the rarer are ruthenium, osmium, iridium and rhodium. Molecular structure of the alloy is extremely uniform and fine-grained, making possible a minimum of friction to the semi-circular bottom of the record groove.

A new antenna kit for use in picking up frequency modulation and television signals, as well as standard, short wave, and other ultra-short wave broadcast signals, has just been placed on the market by *Stromberg-Carlson*, Rochester, N. Y. "The No. 6 Perfected Automatic Frequency Selecting Antenna Kit picks up radio waves with super-sensitivity, automatically adjusting itself to the tuning range in use." Radio Sales Manager *Lee McCanne* declared, "It is uniformly sensitive on the standard broadcast and short wave ranges, without switches or adjustments. A special circuit is provided for reception of frequency modulated broadcast stations."

The *RCA "Signalyst,"* a low-priced signal generator designed for increased efficiency in radio and television receiver alignment work, has been announced by *L. W. Tee garden, RCA Tubes and Equipment Sales Manager*. The new service instrument is an important companion to the *Rider Chanalyst* and the *Rider VoltOhmst* recently acquired by *RCA*. Price is \$107.50, F.O.B. Camden, New Jersey. The new *Signalyst* is being introduced under the *RCA "Minimized Obsolescence"* policy for test equipment which, by advanced engineering and skillful planning

for future needs, provides protection against the necessity for early replacement. The instrument (designated as Stock No. 161) has a fundamental frequency range of 100 kilocycles to 120 megacycles on 10 bands, greater than is avail-

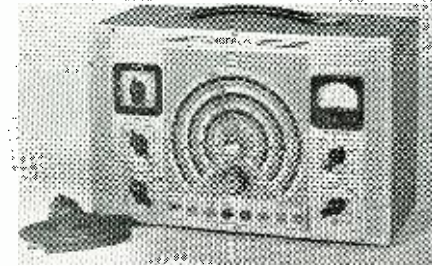

able on any service test oscillator. In addition, the *Signalyst* is accurate and stable to within plus or minus 1% scale calibration. Stray leakage has been kept at a minimum. Heterodyne detection is provided for calibration purposes. Simple to operate and housed in a smartly styled metal case, it operates on 110-120 volt, 50-60 cycle power supply.

A new *Majestic* console listed at \$27.95 is announced by *Majestic Radio and Television Corporation* of Chicago. This console receiver is one that has been conceived and executed to

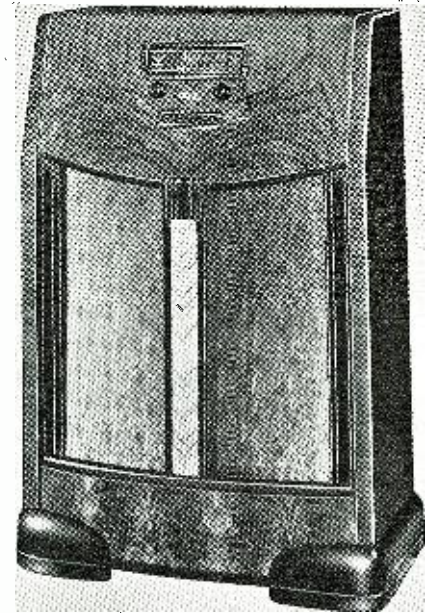

provide a quality unit in the low price field. It is a five tube superheterodyne with two tuning bands for American and foreign reception that operates on 110 volt a.c. and has a full toned 10" electro-dynamic speaker.

Transducer Laboratories, New York, N. Y., wishes to announce that it has assumed all the manufacturing and experimental facilities of the *Manufacturer Corporation*. The laboratories are handling all microphone repairs and sales that were carried on by *Transducer Corporation*, as well as new experimental work in the electro-acoustic and allied fields.

Ward Leonard Electric Co., Mt. Vernon, N. Y., announces a change in the address of their representative, the *Northwestern Agencies* to 2411 First Avenue, Seattle, Washington.

Stewart-Warner Corporation, Chicago, Ill., will introduce in May a representative line of table and console radio sets equipped to receive programs transmitted by the *Armstrong* system of wide-swing frequency modulation broadcasting, according to *L. L. Kelsey*, Manager Radio Division. The frequency modulation sets also will be equipped to receive standard band broadcasts. Cabinets of the new *Stewart-Warner* sets will be styled in keeping with the present trend

of furniture modernism. Sets will be first merchandised exclusively in territories where frequency modulation transmitting facilities are available.

Effective January 1st, *Hans Mannheims* was appointed manager of the *Foreign Sales Department* of the *International Resistance Company*, 401 N. Broad Street, Philadelphia, Pa. He succeeds *Robert E. Keiser*, who has entered another line of work.

Majestic Radio and Television Corporation announces the addition of two more new models to its present line of radio receivers. These models, *Majestic Model 5ADA* and *Majestic Model 5BDA*, introduce a new style of cabinet design which should prove to be a forerunner in the radio field. *Majestic Model 5ADA* is a five tube improved superheterodyne receiver incorporating an inverse feed back circuit. Its single band tuning range covers American broadcast and in

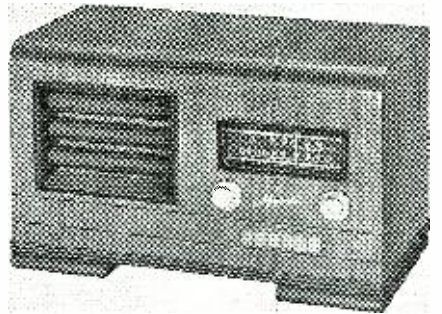

addition receives police calls. It operates on 110-115 volt, 60 cycle a.c. and has an electro-dynamic speaker. *Majestic Model 5BDA* is a new table model five tube superheterodyne with push button control. Two tuning bands provide reception of American broadcast and police calls, and the electro-dynamic speaker gives exceptional quality of tone and reproduction.

Majestic Radio and Television Corporation announces the addition to its line of its new *Model 5CAA*, being a six tube (including ballast) superheterodyne with two dual purpose tubes. It has two wave bands for American and Foreign

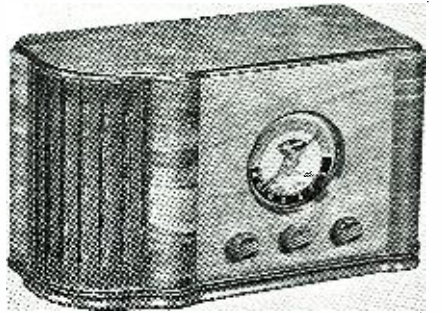

broadcast, and incorporates in its compact chassis eight tuned circuits, automatic volume control and tone control, and is equipped with an electro-dynamic speaker. It operates on either AC or DC line.

Universal Microphone Co., Inglewood, Cal., has discarded its *Fimer* and *Fimex* models of its hand phone, and in Jan. placed in the hands of job-



bers its new hand phone which will be known as models 875 and 820, thus indicating the im-

What's NEW in Radio

pedance of phones used. Model 875 will be 75 ohms d.c. resistance to match into 500 ohms impedance, while model 820 indicates 2,000 ohm receiver used from the plate to tube. Six feet of 4-conductor cable will accompany each assembly. The new hand phones are manufactured entirely from new discs, with a bakelite mold and a modern streamlining effect throughout. A new feature of the phone will be the use of screw caps.

Clarion, Transformer Corporation of America, New York City, introduces a high-powered portable sound system designed to meet the requirements of all large indoor and outdoor public address installations. The amplifier delivers a rated output of 40 watts with a peak output of 62 watts. Four microphone inputs with a gain of 128 db are provided as well as two phone inputs with 84 db gain. Simultaneous control and mixing of any five inputs is afforded as well as individual control of both bass and treble response



by use of the tone equalizer feature. A master gain control, output meter, sloping face panel and speaker matching switch for variation of output impedance from 2 to 500 ohms make this unit the most flexible portable sound system ever developed. The Model C-483 system complete in two modern aero-luggage carrying cases consisting of the amplifier, two heavy duty P.M. speakers, choice of one of five high quality microphones, demountable 3 section floor stand and all cables, connecting plugs and output meter, lists at only \$236.99. Further information and technical specifications are available by writing.

A new tapped Cordohm, now offered by Ohmite Manufacturing Company, provides a tap for pilot lights on a.c.-d.c. radio receivers. This new Cordohm, which replaces the voltage dropping resistor and the ordinary line cord, has a three



conductor cable which furnishes 110 volts for the tube plate, plus a reduced voltage for the filaments; and, in addition, has a fourth conductor to supply pilot light voltage. Another advantage of the Ohmite Tapped Cordohm is that the heat generated in the line-dropping resistor is eliminated from the set, thus insuring longer life for the component parts.

The Type ETN Cornell-Dubilier a.c. electrolytic capacitors for motor starting uses provide a combination of compactness, sturdiness, versatility of application, economy, and above all, excellence of electrical characteristics, which meet all requirements for the great majority of motor starting applications, either as original equipment or replacement. These capacitors are of the etched-foil type, hermetically sealed in cylindrical aluminum containers with Bakelite terminal heads into which aluminum stud inserts are moulded, and which also include safety vents to take care of excessive internal pressure



resulting from accidental or abnormal conditions. In addition, each unit is jacketed with a specially treated cardboard sleeve of high electrical insulation qualities and moisture-proof.

A pocket-type trouble shooter which is extremely inexpensive, yet performs a wide variety of functions, is offered by Radio City Products Co., Inc., 88 Park Place, New York City, in their Model 432. The black-crackle-finished metal housing is only 5 1/2 inches long, 3 inches wide and 2 inches deep, and the overall weight 24 ounces. Both of these are important features in out-of-the-shop trouble shooting. But in spite of its compactness, this instrument does a full-sized job, both as a utility meter and as a trouble shooter. The meter is an 0-1 ma. D'Arsonval type, accurate within 2%. It is equipped with a multi-scale with a separate scale for the low ohms range which makes possible accurate reading of resistance as low as 0.2 ohm. In addition to the ohmmeter zero adjustment there is

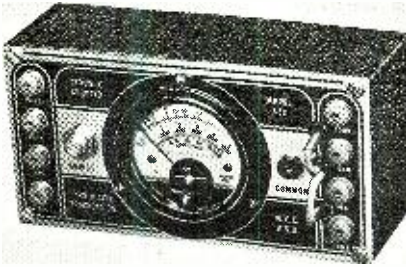

also a mechanical zero adjustment on the meter itself—a feature of great importance in any volt-ohm-milliammeter. The ranges provided are: D.C. Volts, 0-5/50/500 and 1000; D.C. Milliamperes, 0-1/10; Ohms, 0-500/50,000/500,000.

The new Majestic Radio, Model 5ADA, is a 5-tube improved superheterodyne incorporating inverse Feed Back circuit is announced by Majestic Radio & Television Corp., Chicago, Ill. It operates on 110-115 volt, 60 cycle a.c. A single wave band tunes in standard broadcasts as well as police calls. A clear view slide rule dial permits easy station selection and a 5" electro dynamic speaker delivers full, lifelike tone. The Majestic Hi-Q loop which eliminates the need for costly and unsightly outside aerials and the Majestic static Bi-Pass are additional incorporated features.

Easier, faster soldering for home and industrial use is made possible with our general purpose 60 watt iron complete with push button attachments listed at \$3.00. Other designs will be available upon demand from Dual Remote Control Co., Detroit, Michigan. This push button electric soldering iron, as shown in illustrations, consists of a DUCON screw tip soldering iron with a DUCON push button attachment. The new unit fills a long felt need for a soldering tool which could be held in one hand for both heating and applying solder and leave the other hand free for holding the part to be soldered. Push button is pressed to release a drop of solder when needed. In recent years there has been a considerable demand for an iron which would eliminate the "third" hand when using a soldering iron. In many jobs even an experienced user of a soldering iron finds it somewhat difficult to hold the iron in one hand, the solder in the other, and try at the same time to keep the part to be worked on together. With this iron one hand is always free to hold the part that is to be soldered.

Clarion offers in the new Model C-412 portable system, everything the sound man could desire for medium power requirements. Containing a 10 to 15 watt amplifier, 10" P.M. speaker, complete record player, microphone, banquet stand and cables, this single case unit is a marvel of compactness. Precision engineering assures the ample power output of 10 to 15 watts from the amplifier. Push-pull 6V6G Beam-Power output tubes are employed, as well as a 6J7, 6SC7 and a 5Y4G rectifier. The overall gain for mike input is 110 db; for phono input 80 db. Hum level below 10 watts is—47 db. Built-in speaker matching transformer is tapped at 8 and 16 ohms. Frequency response is from 40-9,300 cps. A full range tone control is included so that microphone feedback may be minimized. Operation is from 110 volts, 50-60 cycles A.C. Two-channel inputs are provided for microphone and phonograph. The single amplifier volume control allows complete mixing and fading facilities, as well as regulation of the microphone input. The model C-412 complete with C-59 Crystal microphone, record player, speaker and all cables and plugs lists at only \$90.57. For further details and catalogue, write to Transformer Corporation of America, 69 Wooster Street, New York City.

A new folding style Stock Boy which accommodates a stock of 240 tubes is being announced by Hygrade Sylvania to jobbers, dealers, and servicemen. The new cabinet has two free-swinging compartments which, when open, become accessible shelves measuring 60" full width. When not in use the hinged compartments can be closed and the Stock Boy is then

a small compact unit. Thus, when closed, dirt and dust has a slim chance of spoiling the appearance of tube cartons. Across the front of the closed cabinet appears the message, "Insist on Sylvania Set-Tested Radio Tubes." The cabinet has been designed so that it can be hung on a wall or stood on a flat surface. Important to many servicemen, who have limited space for tube stock, is the fact that a double row of tubes can be kept in the same amount of space ordinarily taken up by a single deep bin cabinet.

The Howard Radio Company of Chicago has just announced four, unusual, new, phonograph combinations with home recording features. The retail price range is from \$119.95 to \$199.50 and all receivers use a beautiful Hepplewhite Period cabinet shown above. This cabinet is available in either Mahogany or Walnut. The unusual features about the Howard Radio Recorders, is that two of the models include automatic phonograph record changers, making them complete instruments for home entertainment. In these automatic models, it is also possible to duplicate any recording. Further, the new Howard "fader-mixer" feature makes it possible to sing, or record comments against radio in the background. A wide market is predicted for these unusual instruments.

The Browning Laboratories, Winchester, Mass., has recently announced a custom-built laboratory calibrated frequency monitor for checking any three bands of frequencies from 1.5 to 60 Mc. A 100 Kc. crystal is used as a secondary standard. This may be readily checked against WWV. Very stable EC oscillators are used to cover a band of frequencies from 50 to 100 Kc. wide. The transmitter frequencies which it is desired to check are included in this narrow band. The circuit is so arranged that the electro-coupled oscillators can be accurately checked at numerous points by means of the 100 Kc. crystal. Transmitter frequencies are checked by the zero beat method which is indicated visually on a cathode ray tube and aurally by means of phones plugged into a jack provided. The accuracy of this frequency monitor is better than 1/100 of 1%.

James L. Fouch, the past 8 years head of research for Universal Microphone Co., Inglewood, Cal., has been elected vice president and chief engineer in place of E. E. Griffin. Robert Griffin, the past 5 years purchasing agent, has been placed in charge of recording sales and service in the southwest, replacing S. E. Shapiro, who has moved to San Jose. Universal has just registered the name Uni-Cord in the U. S. patent office for its new small sized recorder. James R. Fouch, president, is expected back at his desk in March after a major operation at the Hollywood Hospital.

A timely and popular addition to the Westinghouse radio line is the WR-475, a portable radio-phonograph combination. It is described on the attached specification sheet and well pictured on the accompanying copy print. Wherever there is a convenience outlet with proper AC power supply, this set will perform. Its tone is excellent. It will play 10" records with the lid open or closed, and 12" records with the lid closed. Well balanced and sturdily built, the closed cabinet may be carried easily and without rattle. That this is a typical Westinghouse value is indicated by the suggested Eastern retail price of \$34.95. Introduced very recently, the initial orders received from the field indicated greater dealer interest than had been expected.

Atlas Sound Corporation, preparing for "P. A.'s Biggest Year," announces that they are doubling their present factory space and manufacturing facilities of their plant in Brooklyn, New York. R. C. Reinhardt, president and sales manager, predicts that "the 1940 presidential election campaign, plus a greatly increased demand for industrial sound equipment, will keep the wide-awake sound operator busier than ever. If the progressive sound dealer is going to cash in on the big P. A. year of 1940, it is up to him to stock up on equipment suitable for political ballyhoo as well as demonstration apparatus for industrial application."

The new Turner 44X Crystal microphone, manufactured by The Turner Co. of Cedar Rapids, Iowa, is equipped with a switch, located in the side of swivel stand mounting assembly. This switch is provided in order that tone and volume control may remain set, with amplifier heated and ready to go, yet to effectively kill the system instantly "between acts." This switch permits control of the microphone, regardless of the distance from amplifier. The switch is turned off and on by a flick of the fingers, and shorts the line positively without objectionable noise. This switch has instant positive contacts, and will withstand thousands of operations. It is designed to be a part of the mike—not an after thought, and allows the microphone to be used as a "push-to-talk" unit. The Turner 44X Crystal is a selective directional microphone, with 13-15 differential between front and rear pickup, which permits the operator to amplify the sound he chooses, and this also reduces feedback problems.

Reprinted with permission, from **RADIO Trouble Shooters Handbook**. Copyright, 1939, Radio & Technical Publishing Co. Copyright in Canada and Great Britain, and all countries subscribing to the Berne Convention, by Radio & Technical Publishing Co. All rights reserved.

SELECTED CASE HISTORIES

by **ALFRED A. GHIRARDI, B.S., E.E.**

Author of "The Radio Physics Course," "Modern Radio Servicing"; member Radio Servicemen of America, New York Electrical Society, Institute of Radio Engineers.

FADA KA-41, KA-42, KA-44, KA-47
Distorted re- . . . 1) "shorted" or leaky No. 5 section in filter block (two blue leads)
2) "gassy" '27 a-f tubes
Hum 1) connect a 25-mfd. 25-volt electrolytic condenser across present 0.5-mfd. condenser in detector-amplifier stage

FADA KA-60
Intermittent . . . 1) see Case History for this reception
Fading receiver

FADA KF-761, KF-762, KF-764, KF-766
Noisy reception 1) noisy primary in input push-pull transformer

FADA KU-45, KU-45Z
Poor control . . 1) remove old volume control, installing new 15,000-ohm control with taper for antenna and cathode bias. Ground the center arm of the new control. Left arm goes to antenna post; right arm goes to cathode bias resistor. Now ground the old wire leading from screen series resistor through a 5,000 to 8,000-ohm 2-watt resistor
No control of . . 1) "open" 3,500-ohm resistor which bleeds current through volume control from point where r-f tubes obtain plate voltage. Use 10-watt replacement unit

EVEREADY SERIES 50
Inoperative. . . 1) check the small mica condensers around the '27 first a-f tube and '27 detector, for "shorts"
2) check the plate by-pass condenser for the '24 tubes. Replace with 300-v. type
3) faulty or dirty contacts in phone switch. This switch is accessible at the back of the chassis, and is automatically actuated when the tuning condenser dial is turned in the low-frequency position or the "phono" position. To obtain good contact it may be necessary to bend the switch blades until they open and close properly
Hum 1) adjust the set-screw hum-control adjustment located at back of chassis. The control consists of a low resistor connected across the heater winding
High-resistance 1) substitute a 50,000- or 75,000-ohm, 2-watt fixed resistor for the defective section. Replacement of complete unit is unnecessary
Motorboating . . 1) check the screen-grid voltage divider. Replace with a 20-watt wire-wound unit if necessary

EVEREADY 52
See also all Case Histories listed for Eveready 53, 54 receivers
Inoperative . . 1) check the small mica condensers around the '27 tube first a-f, and '27 detector, for "shorts"
Weak signals . . 1) check copper contactors in condenser gang, for "corroded" contacts
2) check coupler coil on end of condenser gang, for poor contact
3) check coupler coil, for adjustment
AC hum 1) the common ground-return of the filter condenser block makes poor contact with the can. This wire is found just inside the end of the can soldered to the tin box

EVEREADY 53, 54
Inoperative . . 1) "open" in the detector plate load caused by poor contact in the phono-radio switch. This switch is fitted to the frame of the tuning condenser, near the dial, and is operated by a lever on it. Switch is easily accessible from the rear of the chassis
Weak reception 1) control shafts short-circuiting to metal panel
Weak reception 1) variometer out of adjustment at high or low frequencies
Noisy tuning. . 1) corroded variometer rotor

Oscillation contact
Noisy reception 1) noisy 0.001-mfd. detector plate by-pass condenser
Hum 1) add filter condenser from either side of speaker field to chassis
2) short-circuited choke "tuning" condenser
High plate cur- 1) open-circuited grid suppressors

FADA A.C.-D.C. MODELS
Inoperative . . 1) faulty ballast resistor, or faulty 198-ohm filament resistor tapped at two 38-ohm sections for pilot light bulbs
2) faulty tube
Hum, 1) filter condensers below normal capacity
Distortion

FADA D-10, D-11, D-30, D-31
Same Case Histories as those listed for K-35 and REV. K-35B receivers

FADA (G-GB) 16, 17, 20, 32 MODELS
Badly distorted 1) voice coil rubbing badly against pole piece, this may be due to a badly warped outside ring casting which throws the cone out of center. (Necessary to replace casting or entire speaker)
Slipping dial . . 1) see case history for this trouble on Fada K-35 receiver

Noisy reception 1) bad contact on tone-control switch. Replace with variable resistor type. If receiver is "noisy" when turning station selector knob clean wiper contact springs on gauged variable condenser. If noise is of a high level check 0.003-mfd. mica condenser in plate circuit of 2nd detector stage
Distortion at . . 1) voice coil tubing may be warped, thereby rubbing on speaker pole. Try to re-center. Replacement of complete cone assembly is advisable
Intermittent . . 1) intermittent high-resistance short-circuit between the primary and secondary of the input push-pull transformer. Replace with a new unit

FADA KW-48, KW-49
Fading. 1) check all by-pass condensers, testing all of them with about 600 volts. Use 600-volt replacement units
2) shield the first r-f tube with an ordinary tube shield. To do this, remove the small metal partition near the tube. Then realign the receiver

FADA M-25 (Using 15C speaker)
Excessive hum 1) open No. 6 section in filter block

FADA RA
Inoperative . . 1) faulty a-f input transformer
Weak reception 1) try another '56 oscillator tube (voltages O.K.)
Continuous . . 1) "noisy" primary of push-pull transformer. Replace the transformer—or install resistance-coupling instead. Disconnect the primary, and couple with a 25,000- or 50,000-ohm resistor and 0.01-mfd. condenser from the plate of the '56 tube to the grid of the '47 tube
Noisy volume . . 1) first try a new '56 tube in the first a-f socket. If this does not help, replace the volume control

FADA RK-100 Auto Radio
Ignition Inter- . 1) check the leads from the power unit to the receiver. The metal shield they are in should be "grounded" to the car frame

FADA RK-101 (MOTOSSET)
Shorted power 1) May be caused by contact points on minimum-voltage relay sticking. Clean and adjust points
Intermittent re- 1) vibrator contacts corroded, (fling will only help temporarily, advise replacing the unit)
Noisy reception 1) poor shielding of leads running from power unit to receiver. See that the metal

sleeve is properly grounded to the car frame; it should be bonded at several points

FADA (CANADIAN) W-452X
Distortion at . . 1) overloading in the r-f section. Remedy: slightly detune the first r-f stage

FADA, 10, 11
No reception, . 1) short-circuited filter condenser in block
(low "B" voltage, or no r-f 2) short-circuited r-f by-pass plate voltage)
Inoperative. . . 1) shorted or ground lugs of r-f coils
Weak reception 2) readjust balancing condensers
Noisy reception, 1) noisy first or second a-f transformer primary
Loud hum, . . . 1) due to electromagnetic interaction between the first a-f transformer and the power transformer or filter chokes. Substitute a type '56 tube for the type '27 detector tube and "short" the grid leak and condenser. Insert a 30,000-ohm resistor, shunted by a 1-mfd. condenser between the detector tube cathode and ground. Remove the first a-f transformer and substitute in its place resistance-capacity coupling

2) pilot-light socket short-circuiting to chassis
3) pilot-light socket lug short-circuiting to chassis
Pitch melts out 1) caused by heat generated by type '80 tube situated close to the transformer. Place a piece of asbestos board between the tube and transformer

FADA 15
Inoperative, . . 1) lugs of r-f coils shorted or grounded to chassis. Inspect these points—trouble will not show up on an analyzer if trouble is in grid circuit

FADA 16, 17, 20
Inoperative. . . 1) lugs of r-f coils shorted or grounded to chassis
Weak reception 1) noisy first a-f transformer primary
Intermittent re- 1) open-circuiting cathode or ception, plate by-pass condenser (block)
Oscillation
Fading 1) noisy volume control. Replace with new unit
Weak reception 1) readjust balancing condensers
No reception, . 1) short-circuited filter condenser in block
(no plate voltage) 2) short-circuited by-pass condenser

FADA 25, 25-Z
No reception, . 1) short-circuited filter condenser in block
(no plate voltage) 2) short-circuited by-pass condenser
Inoperative, . . 1) r-f coil lugs short-circuiting or grounding to chassis
Weak reception
Intermittent re- 1) defective tinsel speaker cord ception 2) poor connection of speaker tinsel cord to phone tips
3) faulty volume control. Replace
Intermittent re- 1) open-circuiting r-f cathode or ception, plate by-pass condenser block
Oscillation
Weak reception 1) readjust balancing condensers
2) defective 0.001-mfd. by-pass condenser between the plate and cathode of the type '27 detector tube. Replace

replace the 0.25-mfd. 400-volt condenser (from "ground" to the green resistor at the bottom center of the chassis) with an 8-mfd. electrolytic unit
Fading 1) noisy volume control. Replace
Hum, 1) open-circuited filter condenser possibly caused by loosened nut which holds the common condenser terminal)
Distortion 2) poor grounding of condenser block
3) "shorted" filter condenser block leads
4) pilot light socket "shorting" to chassis
5) pilot light lug short-circuiting to chassis
6) remove the 0.00025-mfd. condenser connected across the push-pull input of the

(Continued on page 66)



Radio News Reporter W1JOM getting out his report (left). The low end of W2IOP's sky-wire is shown in the middle. Right, the original ham rig of W2IOP in the Maine woods. He operated wholly battery there.

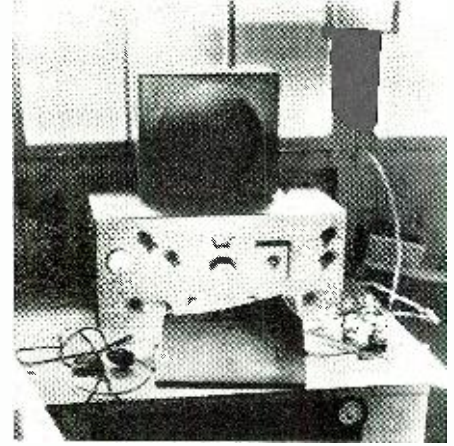

HAM CHATTER

A ham tells us that the best way to find out just what he has been doing on the bands, is to look up his call in this column

RADIO NEWS REPORTER ON SCENE OF ALBANY, GA., HOLOCAUST

Press and Red Cross Messages Handled by Many Hams Who Forgot Their Own Safety and Comfort to Help.

By KEITH W4ARX MATHIS

Albany, Ga. (Special to RADIO NEWS) Death & Destruction, those two terrible Goons of civilization struck with unexpected fury at the city of Albany, Ga., in the form of a tornado on the morning of February 10th and did an estimated damage of over \$10,000,000. The death list is officially set at 25, with many untold hundreds listed among the lesser casualties. A few minutes after the storm struck, all communications from and to the stricken area were wiped out, but the *Albany Radio Club* got their transmitter & receiver on the air clearing press & Red Cross messages. Heeding a call for more hamops, I brought a portable rig from Montezuma, Ga., and went into action.

Using a torn up building (which reminded me of those seen in France during the First World War) as a HQ, with a gasoline driven generator for power, communications were established with the outside waiting world and the handling of urgent messages began to move through. Permanent contacts were set up with W4GEO, Damascus, Ga., W4GHW, Lyons, Ga., & W1FDJ. Other QSO's were with W4FCW & W4GFF, Cordelle, Ga., who stayed at their posts all through Saturday night to expedite messages. We had relief operators from our club, who handled traffic all through the night. These hardy men were W4DIA & W4GLB. Sunday morning W4GHU took over.

Other Hams and Broadcasters Help

Radio station *WGCP* rendered valuable assistance in spite of the tornado damaging their station. Others who were in to help were: W4GIN, W4CJE of Tallahassee, Fla., W4GEO, Atlanta, Ga., W4EFD, W4DPX, & W4EQB, Montezuma, Ga., W4ESA, W4EVT, Valdosta, Ga., W4RM, W4BUW, W4CDU, Atlanta, Ga., and a host of others whose calls will only be known when the whole story has been written.

Army Fort Sends Help

Help in the form of a corps of signal men were sent over from *Fort Benning, Ga.* These men cooperated with the amateurs in the best possible manner and were largely responsible for keeping the amateurs' communications lines intact. General Singleton, Post Commandant of the *Fort* is to be thanked deeply by the amateurs for helping them out under very trying conditions.

YOU have all read about the ham who was "hero-ized." I mean that fellow who stood the gibes and ridicule of his playmates and later his associates while he toyed with wire, knobs, condensers, and the code . . . only to become the key in a situation where his radio operating saved the village belle from a "fate worse than death"—(you know, the Marines to the rescue stuff). The story has been written and played in the movies both silent and voluble. So its no wonder that the tale cloyes and reeks with "corn." Most of us know it by heart, and are very tired of it all. We think our hobby as that of grown-up men, reserve signal operators of our Government,

A REPORT TO THE HAMS

AT the end of one year running Ham-chatter, we are happy to report to the hams that we have grown from a single well-spaced page in the April, 1939, issue to over eight closely printed pages of very small type. That is really progress. Incidentally, for those who like statistics, we wish to report that this month we received contributory manuscripts from 62 different hams, and that they sent in items concerning over 1644 different ham stations. Manifestly, it is impossible to print all of these, but we have carefully edited the items to retain each and every one which can be of interest to the amateur radio fraternity.

So we can say, in April, 1940, we had reports on about 10% of all the active ham-stations! Watch us grow. At this rate we should be reporting on better than 40% of all the active hams on the air in a year.

To those of our readers who made this unusually large fb showing possible, our deepest thanks.

The Hamchatter Editor.

and sometimes just a little bit above all and any other hobbies. Perhaps we are right and perhaps we are wrong . . . it is of no consequence. Well, with that for an intro, here's the story.

Our hero—since all stories must have one of them that animates—lived in the Town of Munsonship, Maine, where he was one of the total population of 97 who voted for Franklin D. This alone served to set him off, since it spoiled the otherwise perfect record of Munsonship as being 100% G. O. P. But I digress. Eventually our hero was assigned the call W1—having done his stint of 13 per and written his reams anent oscillators and the like. He had a Class C license, and that was sufficient for the time being.

The local Postmaster, who was also the blacksmith and the proprietor of the general store, was agast to see the radio parts come in, since for once he did not understand what it was all about—a thing which hurt his pride as local sage no end. In due time W1—had himself a neat 10-watt rig on 10M and a fb superhet. All operated from a water-wheel driven generator from the power obtained from the brook in the back of his home. In the winter time W1—switched over to a gas generator and QSO'd the world. All was well, except that the natives, thoroughly alarmed, what with having a pro-Rooseveltian, and then a dabber in "them thar contraptions" in their midst, did not make life any too easy for our ham.

In fact they got so uppity about the whole thing, that they stopped buying from our pal. He sold odds & ends for horse wear, and was known as one of the best saddlers in the county. This was not so good, since W1—even though

in Munsonship, and even though a pro-Roosevelt man (he didn't care how many terms he got), had to eat like the rest of us.

This situation bothered the ham's father very much since he wanted his boy to grow up to be the fine up-standing man in the community his own father had been. So he went to call upon the "powers that be" in the town.

"What my boy needs," he cackled, "is that something should be done to take him away from that radio set. It has him the same as bewitched!"

So the "powers that be" appointed one ham *Overseer of the Poor* for the county, and he accepted since his business had fallen below an eating scale. The job kept him traveling from one end of the county to the other, and his rig gathered dust in the corner; his house finally lapsed.

The ham had the right stuff in him, though. He got the hang of politics. He moved steadily up the ladder, until one day he found himself appointed commissioner to the P.C.C.

He's still there. And his whole life is taken up with the administration of affairs of radio. One of his first acts was . . . to veto a proposal that Munsonship have its own broadcast station.

"Can't have that kind of thing in Munsonship," he said austerly, "it's very bad for the saddlery business."

Silly fairy story . . . ain't it!

THE postman delivers:

" . . . Thanks for enlightening me as to the journalistic slang that *Time* used to describe *RA*? You fellows have a language all your own . . . (sgd.) George Felber, W2GFW.

[*Tnx, George, glad to help out any time. But how abt the hams—don't they have a language all their own. Come, now, be honest.—ED.*]

FROM Ramon M. Marti, K4FCV:

Just received your card, Tnx. O.K. abt my call. By the way, just got a letter from LX1RB who was the only real LX in c.w. and he tells me they have been off the air for the last three months and that LX1SS is a *foney*. also that there are about 50 QSL's for him in the LX QSL bureau. Would like to know from where did you get the done that LX1SS was real and that he sends QSL cards? I have worked him several times, have QSL via all the people he has said and yet N.D. So how? PZ0ZK and VU2XX are *foney* as far as I know. [Does anyone know the answer? How abt this, John D. Clark?—Ed.]

AGAIN this month the Philippine Islands are responsible for an extremely large percentage of the trans-Pacific amateur stations now audible in the United States. Most of these may be heard on America's west coast from 4:30 to 7:30 A.M., P.S.T., although occasionally one or two have been reported as late as 11:30 A.M., P.S.T.

KALZ, operating on 14.14 and 14.26 meg. has been the outstanding KA phone during the past 30 days. It has been on the air regularly and reported with excellent volume in all parts of the Pacific Coast. In addition to KALZ, the following Manila hams have also been particularly active on 20 meters: KALME (14.14, 14.18, and 14.26 meg.), KALFH (14.14, 14.207, and 14.27 meg.), KALCS (14.13 meg.), KALBB (14.27 meg.), KALJP (14.12 and 14.145 meg.).

Other KAL's which have been logged more than once in the last month include KALCW,

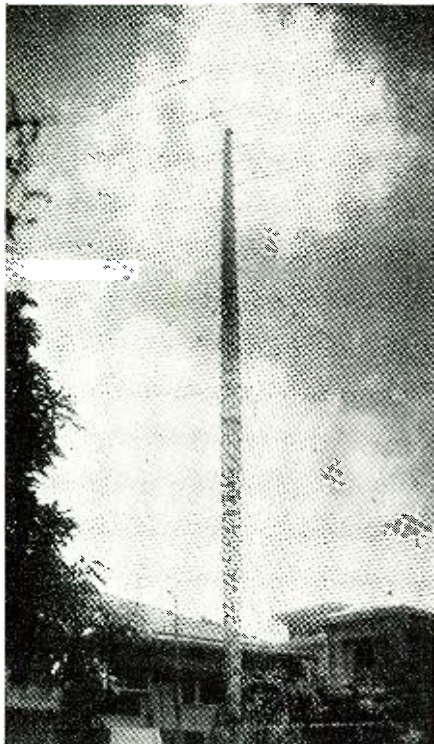

How would you like to have this sky-hook? So would we! Belongs to KAILZ.

Pasay (14.14 meg.); KA1LB, San Juan, Rizal (14.13 and 14.26 meg.); KA1AF, Paranaque, Rizal (14.14 meg.); KA1AP, Calatagan, Batangas (14.14 meg.); KA1AB, San Francisco del Monte, Rizal. Single reports have been received on KA1OA (14.14 meg.), KA1NN (14.11 meg.), KA1AK (14.14 meg.), KA1VX (14.12 meg.), KA1FJ (14.25 meg.), KA1MM (14.125 meg.).

KA2OV, KA3RA, and KA3KK which were heard last month, have been unreported this month.

KA4LH (14.11 meg.) seems to have improved his rig greatly and was heard many times near 4:30 A.M., P.S.T. This one is located in Tagakawayan, Tayabas, with operator Lee Hinckley.

KA7EF (14.11, 14.16 and 14.25 meg.) again figures as one of the most reliable Philippine hams, and has been heard in contact with several W6's near 6:30 A.M., P.S.T.

Surprisingly strong reception of KAILZ, KA1ME, KA1MN, and KA1ER has been reported on the 10-meter band (28.38 meg.). These stations may usually be heard near 6:30 P.M., P.S.T.

ONCE again the following six stations occupy the spotlight as the best Chinese hams now audible in this country: XU6KL (14.04 meg.), XU8RB (14.084 and 14.106 meg.), XU5CX (14.02 meg.), XU7HB (14.15 meg.), XU1B (14.16 and 14.34 meg.), XU7HV (14.06 meg.). The latter is located in Poochow, and although not heard as frequently as the others, it has been responsible for a surprisingly strong signal near 5 A.M., P.S.T.

Our Chinese log also shows four comparative newcomers. These include XU4BC (14.14 meg.), XU4BN (14.20 meg.), XU1DS (14.09 meg.) and XU5O (14.09 meg.). All four were extremely weak in volume, but identification has been confirmed.

Up on 10 meters XUSMC and XU8AJ are the only Chinese amateurs appearing in the log this month. Both were heard on about 29.00 meg. shortly after 3 P.M., P.S.T.

In general, the best hour for reception of 20-meter Chinese transmitters is near 5 A.M., P.S.T., although quite a few are still audible as late as 8:30, and occasionally one or two may be heard shortly after midnight.

THE rapid increase in the number of warring nations in the world today has forced thousands of amateur radio transmitters to leave the air indefinitely.

The number of countries which have issued bans on ham activities has now become so great that it is much simpler to list those still permitting amateur operation than those where a ban has been ordered.

The only trans-Pacific nations left on the air in the ham bands are China, Japan, Manchukuo, Philippines, Netherlands, Indies, Hawaii, and a few odd South Pacific Islands. PK stations in Java, Sumatra, Borneo, etc., are still on the air despite orders to close down by the British Government. In addition, several listener reports indicate that a



Pre-War G5FA. Made lotsa friends!

few transmitters in New Zealand, Australia, India, and Burma are working irregularly, although the British Government has ordered a general ban on all amateurs in these countries.

FORTY meters is fairly good. W6's and W7's are being heard very early. W7ESI at 4 P.M. W2LFX reports excellent conditions, particularly for the West Coast. DX consists largely of K6's. K6CGK, K6QIU, and K6QMC being excellent. HA4H, and HA8D, K4FCV, K4DTH, K4KD, and LU8DM are almost all there is to talk about except the semi-DX CM's. W2BHW worked KA1HR on 7 MC, which is the best bit of DX heard of on the band in the past few months.

W1GYT at the Meriden, Conn. airport is NCR station for Unit 2, section 1.

W2MT may be heard regularly on the N.Y.C.-L.I. net. W1E is selling out his 5 meter in favor of C.W. W3FQL, using an 809 with 33 watts input and a home-made receiver, puts out a rip-roaring signal from his QTH in Cumberland, Maryland.

THE A.R.R.L. QSO party is the latest contest to take the count. Results so far seem to indicate the top scorers will be W3BES, W2GSA, W8OPN, W6KFC, W2IOP, W9VES, and W9FS. Jerry, W3BES, with 350 contacts in 60 sections will probably be National high. The latest ORS party will also find W3BES among the top, if not leading, with thirty-five million points. W2GSA had 360 contacts in 50 sections and will most likely have the greatest number of contacts among the contestants. W8OPN, 313 contacts in 60 sections; W2IOP, 313 contacts in 57 sections; W6KFC with 62 sections is probably the leader in this field, but Vic had under 300 contacts. W9FS worked 263 stations in 60 sections. W9FS blames his poor showing on a red head who broke down his insulation and made him stay out until 1 A.M. The old fu couldn't keep Howie, W9WFS from working 184 stations in 47 sections in the short time he was able to get out of bed. W1EOB had so much trouble with a chirpy note that he quit after having 200 QSO's in 45 sections. Other scores that we've heard about: W2HHF-260/53; W5DBR-127/48; W8RMH-221/44.

W9FS told us about the time W8BTI and some other "catch" went out on a double date. The YL's got so tired of listening to ham chatter they made the boys get out and walk home.

OVERHEARD-ON-THE-BANDS: W9GNB, Palisades, Colorado, complaining about "S" meter readings. He claims they are no more of a standard than ear reports because there is no standard adjustment for them.

W5DQ QSO'ing W2HGB trying to get a mutual friend interested in ham radio and marriage at the same time.

H1GQ "raving" about his line voltage down to 102 volts.

K5AF, K5AM, and K5AC, all passing around



M.V.A.R.C. Treas.-Organizer, WIHXE.

traffic within 50 kc. of each other on 30 meters. CO2XY pounding through with 30 watts. Half of 40 meters calling CM7AC.

W2MBL, Rockville Centre, New York with a three-element rotary to help out his RME and DB20.

W5BK in Texarkana with some foreign speaking operator at the mike.

W5BHK leaving the air so he could work on his "cheat sheet." That's kind of reminiscent of the traveling salesman.

W3CGU and W1LAS heard all over the second call area on two and a half meter phone. W3CGU averaged R7, W1LAS, R8 plus.

W9 Patrick-Peter-Paul warbling CQ with his melodious call.

The XXL at W4DAA threatening to get her rolling pin, crack the OM on the head and put him in the closet (Why?)

FROM the last issue of Xtal, the Canadian Amateur's publication, we have gathered a few miscellaneous facts. The reason for discontinuing Xtal is absence of an amateur market curtailing advertising and making financial difficulties insurmountable. Canadian amateurs were notified to "completely dismantle and render inoperative" all amateur stations. This means that all wiring must be removed from R.F. line-ups; all speech equipment and power supplies disconnected, and all transmitting antenna taken down.

Canadian winner of the B.E.R.U. contest was VE3KE, followed by VE1HK, VE1EA, VE3ES, and VE3QP respectively.

From Xtal we also learn of the Canadian amateur who was asked to keep his rotary pointed away from a certain direction because the birds perched on it and QRM'd the laundry left out to dry. They get you coming and going!

EL2M, Henry Grimes, told us a little about himself in a recent interview. Henry is studying radio engineering with R.C.A. and will be in the United States for another year. Henry first became interested in ham radio when he met EL2A, an American with Fisk. Since there are no laws in Liberia pertaining to amateur radio it was legal for anyone to go on the air with any Liberian call they chose. Hank, one of the chief operators at ELM, the government controlled short-wave station took EL2M. Using one of the station's HRO's he threw together a 300-watt self-excited rig and went on 20 meter C.W. Twenty and ten are the only bands good for amateur communication there, because static makes all low frequencies impractical. The big rig, ELM, running a pair of 700TH's can't break through QRN on low frequency commercial channels either, in case you're interested. Moisture, as ever in the tropical belt, was a big problem, but generally speaking, equipment has stood up quite well. EL2M promised that when he returns home he is going to put on a high-power crystal control phone-CW transmitter, although pounding brass at ELM all day takes a lot of joy out of ham radio. In case you are interested in the kind of stuff you could work from Liberia most of EL2M's contacts were with W's and Europeans. SWL's are asked to note again that no license is required to operate an amateur station in Liberia!

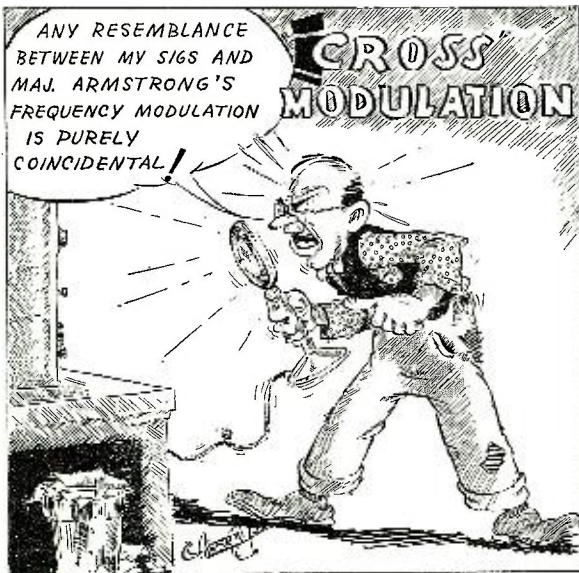

W2E5O is now W4GNQ at Georgia Tech in Atlanta.

W2KVY is thinking of building a FM rig, but will keep his W2 call. Bob is also at Tech.

The Columbia University Radio club is on 2 1/2 with W2AEE, as well as New York University, W2HJ.

W2LW is QRO on 2 1/2 meters with 90 watts to a W5304B.

W2LPL, using a single 76 has QSO'd New Jersey and the Bronx from Valley Stream, Long Island, over 20 miles distance.

W2JNO is outting a mobile 2 1/2-meter rig in his auto.

W2HAP, using a transceiver in his car, worked 10 miles with a consistent R9 report while moving.

W2IOP has an RK34 with 12 watts and a 5-tube superregenerative with a separate quench oscillator.

Several of the boys on Long Island worked the first district as well as W3CGU in Southern New Jersey.

N.Y.C.-L.I. net now holds emergency drills at 9 P.M. Wednesday evenings, at which time members test their emergency gear.

W2LGR is reportedly using .345 watts in his emergency transmitter.



SWL R. R. Heilman's layout.

W2AZV has a battery powered HRO for disaster work.

ANYONE missing Vermont for W.A.S. is invited to 3710 kc. where the Vermont A.A.-R.S. meets at 7 P.M. There are only 135 licensed amateurs in Vermont and since most of them are inactive the 20 members of the A.A.-R.S. represents a very large percentage. Those missing Wyoming will also find numerous W7's in that state active on 80. Among them are W7GFB and W7CJR. Nevada activity is on the increase with W6QQL, W6CW, W6GSSB, W6BFW and W6MTW giving the boys something to go after. W6QQL is principally on 14 mc; W6BBSB, W6BFW and W6MTW operate 7 mc. and W6CW 3.5 mc.

DON WALLACE, W6AM, hits his stride again with the following:

The Oakland Radio Club meets every second and fourth Tuesday at the Alder Branch Library, 52nd Street and Telegraph Avenue, Oakland, California. All are welcome. This is a new meeting place for the club. W6KQQ is President, and W6QPT, Secretary. The Board of Directors are: W6KQQ, K6PLC, W6QPT, W6KTI, and W6EY.

Sam Houston, W6ZM, has his American Legion Network well organized over the State of California on 1826 kc.

Porter Evans, W6BF, is active on the Mission Trail Network, 1804 kc.

W6TH is not so easy to hear at his new location, as he was on the hilltop, although he has a very wonderful station.

W6GN-FIZ, has given up farming, and is back in the amateur ranks.

W6AN, Ex-Director S. G. Culver, has received phone cards from nearly all continents, without actually being on phone.

Stuart Ayres, W6GGA, did a marvelous job overseeing the amateur installation at the World's Fair-W6USA.

Charles Moser, W6HS did a marvelous job with the Oakland Radio Club last year, and was right on his toes. Moser loaned a moving picture machine to the Fresno radio club, just when it was most needed.

Whatever has become of Harold Burchfield, W6JTV?

The Long Beach Amateurs have announced the Southwest Division Convention over Labor Day holidays, August 31st, September 1st and September 2nd, 1940. Tom Niskirk, W6KA, President of the Federation of Radio Clubs, is chairman. Tentative plans include registration on Saturday. Technical session in the Hilton Hotel, Smoker on Saturday evening at the Hilton Hotel; Group breakfast, Sunday morning; Traffic meeting under the direction of S. C. M. Ralph Click, W6MQM, DX Round-up by Herb Becker, W6QD, and banquet at 5 P.M. Sunday. Monday, Labor Day, will be devoted to trips, such as to the Federal Monitoring station, the RCA Marine Radio Station KSE, and to KNX, the World's finest radio station. Tentative committee members are expected to include: Dean Hoffman, W6SEK; Roger Howell, Ex-W7APW; Ralph Click, W6MQM; Larry Lynde, W6DEP; Dr. L. V. Trowbridge, W6EWK; Dr. Esli H. Daniels, W6NZZ; Charlie Fay, W6EJZ; Wally Newman, W6FEX; Bill McClellan, W6CGY; Webb Powell, W6LYP; Harold Scott; Herb Becker, W6QD; Dwight Williams, W6RO; Capt. Dick Loynes; Dr. Gaylord L. Fisher, W6OJZ; Red Wyatt, W6MYO; Tom Hunt, W6HS.

The City of Long Beach is donating the badges, decorating the streets, donating the programs, sending out the mailings, giving the hams a free boat trip through the Long Beach-Los Angeles harbor, and furnishing help in registering the Convention delegates.

THE ARRL Emergency Corps are installing their equipment in the Swimming Stadium headquarters station, Exposition Park, Los Angeles. One 150 meter outfit of about ten watts, is already complete. Another 150 watts is under construction. The latter transmitter will operate on all the emergency bands.

The interesting thing about this location is that it is concrete, earthquake proof, fireproof, and is in the center of a large park, so pre-

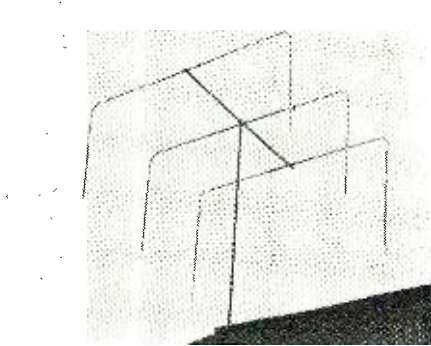

W7HTF's unique 3-element beam.

sumably nothing can go wrong with this installation, and it will make an ideal headquarters emergency station.

The emergency group meets the first Thursday of each month. They drive in from all over Southern California to attend the meetings. Many of the amateurs have mobile emergency equipment in their cars.

J5CW (14.095 and 14.07 meg.), located in Fukookashi, announced over the air that he is the only active J5 phone on 20 meters at the present time. Despite this, however, several listeners have reported reception of J5CC on 14.09 meg.

J8CI, located in Korea, and working on about 14.015 and 14.20 meg. is again being reported regularly this month.

The following Japanese hams have been reported twice at least during the past thirty days, and are usually heard near 5 A.M., P.S.T.: J2NQ (14.07 meg.); J3CX (14.15 meg.); J7CB (14.09 meg.); J2KG (14.20 meg.); J2XA (14.15 meg.); J4CT (14.10 meg.); J7CY (14.00 meg.); and J6DU (14.17 meg.)

A last-minute report from Hawaii indicates that J2NH, J3DF, J2KN, J3FJ, J3FZ, J2OI, and J3CK are on the air and active, but none seem to be reaching America. J9CA, believed to be the only amateur on the Island of Formosa, was logged by two Washington listeners on approximately 14.15 meg. near 5:30 A.M., P.S.T.

SEVERAL MX phones have been logged recently during the early morning hours. MX3H (14.32 meg.) and MX1A (14.20 meg.) are the two most reliable of the Manchukuan hams, with MX5B (14.09 meg.) running close behind.

For CW, MX3A and MX3I are on about 14.40 meg., irregularly. One fan reports an unidentified MX on the 40-meter band, but gives no frequency.

THE log of PK stations is far less than last month. Whether this is due simply to atmospheric conditions, or whether the British order for PK hams to close down has begun to take effect, is not known; but the fact remains that the number of East Indian stations reported this month is less than one-quarter that of last month.

PK4KS, located in Sumatra, seems to have been the most frequent visitor to American shores, operating on 14.20 and 14.244 meg. near 6:30 A.M., P.S.T. Two other Sumatra transmitters PK4AO (14.09 meg.) and PK4KI (14.03 meg.) have been logged several times near 7 A.M. Still another, PK4ID, has been coming through irregularly on 10 meters, the only PK station to appear in our 10 meter log this month. Is PK6XX off the air or not? Although sup-



One of hamdom's oldest,—W5WN.

posed to be off the air, occasional reports still indicate that PK6XX is working irregularly on about 14.02 meg. near 7 A.M., P.S.T.

Only a few Java stations are audible at present. The only ones reported during the last few weeks are PK1MF (14.09 meg.), PK1AF (14.05 meg.) and PK3PL (14.08 meg.)

IN addition to the Hawaiian stations mentioned in this column last month, the following new ones have made their appearance during the past 30 days: K6OQE (14.24 meg.), K6LYB (14.20 meg.), K6BNI (14.20 meg.), K6GAS (14.155 meg.), K6HQE (14.33 meg.), and K6QYI (14.19 meg.). All of these have been logged shortly after midnight.

On the 10 meter band K6GLZ, K6MUV, K6NZC, K6QXY, and K6RDB have all sent good signals to America on more than one occasion.

It might be noted that K6OQE has also been heard on 3.947 meg.

ALTHOUGH a government ban has been placed on amateur activities in Australia, New Zealand, India, and other British territories, several reports seem to indicate that a few stations in these countries continue to operate at irregular intervals.

VK4BC, VK4NC, and VK4DT have been heard near 5 A.M., P.S.T., while ZL3DJ was logged by one fan on 14.216 meg. at about the same hour.

Indian stations VU2CQ and VU2XX, and Ceylon station V8TRG have been reported on 14.005, 13.963, and 14.380 meg. respectively.

R. R. LONGYEAR, HB9RSJ writes in from Geneva, Switzerland:

Dear O M's:
... Perhaps you would like to know what is going on since we have QRT. Well, most of the OB's are mobilized, on active service, and all equipment, even good receivers have been requisitioned.

I am at present in the mountains in Southern Switzerland and at one of the refuges above the

WITH APOLOGIES TO RUBE GOLDBERG

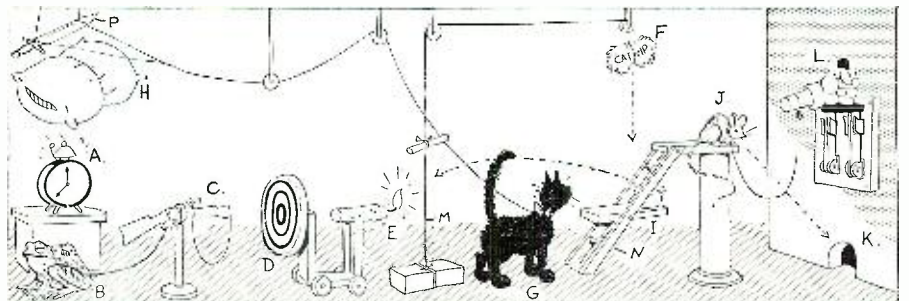

GADGET TO MAKE JOHNNY QRT ON TIME: Alarm clock A rings, waking frog B who jumps pulling trigger of gun C. Cork shot from gun against target D moves candle E to burn string M. This lets catnip F tempt pussy G to climb stairs N tripping board and hurling cuspidor I on candle extinguishing it. Pussy scares mouse J who does a Brodie into hole K pulling switch to the rig L. Pussy's neck makes knife P cut down pillow H which smothers clock A letting the rest of the family sleep again.

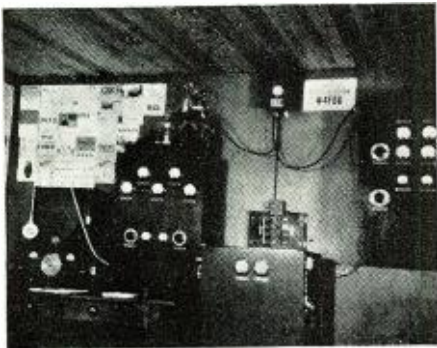

Hamstation W4BB.

village there is a company of Mountain Troops, among which is a ham with whom I have not yet had the occasion to QSO. Even if I knew his call it would be very unwise for me to publicize it and him. Yesterday I dragged up some equipment to 9,000 feet—IN5G, IA7G, IN5G, IA5G to be exact. For an antenna I rigged up my skis with porcelain insulators and I had a very effective two-element beam (8JK) or a dipole with reflector, as I wished. There is no electricity (main) where I am and so my soldering iron is an ice-pick heated over a spirit lamp. Those *Everready* 762's are swell for B plus. My whole pack weighed just a little over 12 pounds.

This summer I was in the States. I arrived at N. Y. C. on the Bremen, saw the Fair and went to spend two weeks in Maine, at Casco Bay. Continuing on journey we passed through Chicago, Ill. and went to spend a week in Yellowstone Park. A bear swiped my A battery. I hoped his tongue burned with Sal Amonica, hi.

Stayed a few days with an aunt in Los Angeles then went on to Boulder Dam. From there to Bryce, Grand Canyon, Zion Nat. Pks. and on to Boulder, Colo. Stayed with another aunt as W1-W2-W5-W9 over W9PGS. I have never seen so many hams in my life in a square mile. All this time my log book was filling up with choice DX (especially Asiatics es S. A.). From there I went to Marquette, Mich. where I stayed two weeks with a third aunt, hi. By the way, who is the wise egg or ham (?) signing AD9DJA? Am sure he is around in Milwaukee because that is where I got him best.

I spent some cash in N. Y. before I sailed on the Europa on her last trip, especially on small parts and hardware which is so expensive in Europe. We were scheduled to land in Cherbourg but in mid-Atlantic the Captain told us that the ship would not call at Southampton nor at Cherbourg and that the course was a secret one. All radios were confiscated but I managed to hide one IN5G in my trunk, but it was useless as I dared not hang any sort of antenna up. My compass was most useful and we changed our course due North, passed through the Faroes and arrived at Bremen on August 30th. By sitting up all night we arrived at Paris the next afternoon and arrived in Switzerland exactly 13 hours before the general mobilization. I had to wait two months for my trunk to arrive, hi. The biggest joke of the lot is that I did not pay a cent duty on a lot of new stuff!



Pre-war ZS5AW.

The weather is wonderful here and it is well worth while to stay up late for DX comes right in up here—let's hope the war will soon be over and we can get on the air again, as ham and not a military signaller. Nearly everything in the food line is rationed here but rations are so large that no one is ever hungry. Those who have oil heating have to be careful about wasting any, and 3,000 liters has to go a long way. Maybe you don't know that there is a Television Station at Geneva. Since the war we are QRT but we have been experimenting mainly on film transmission with fb results. A frequency modulation station is also being built.

By the way, where is FN1PY located? He has just come in RST 479 and I can't find him in the call book. He was QSO with a MX station of which I could not tell if it was MXIC or MX3RT. OMIPY's hands must be cold, hi.

WE might as well get the DX over with. W2GT reports no DX of any kind. Ed heard XU8WS and ZD3H, that's all. The rotary indicated ZD3H was somewhere in the West, and not West Africa. W2KL is also in the "DX" column with nothing to report. W2GTZ added a card from J8PG, but hasn't worked anything startling recently.

While talking about Reeve we're reminded of an incident that happened a few years ago (there's nothing better to talk about this month), involving him and a now equally prominent eighth district DX'er. It seems the W8 was holding a schedule with a VU, and Reeve, having never heard one, wanted it badly. Oh, incidentally, W2GTZ now has 143 confirmed countries. Reeve sent a telegram to W8C—(we almost spilled the beans) asking for the VU's frequency and for reply by collect telegram. He got an answer, but the W8 said "sorry" he wanted the VU for himself. This year the same eight tried to corner the frequency of a CR9 in Macao, but a couple of G's upset the cart by also working the CR9.

W2JB claims a new record—WMPIAR, or "Worked more phoneys in a row." They were Q5F, PRAK9, and KJ4XX. Since it is quite the thing to do you can raise your eyebrows at KJ4XX on the Jefferson Isles. Ben is trying to WAS on 20 meters, says he hasn't anything better to do with his time.

W2IOP worked some K6's and K4's on 40. Lots of CM's and such on, if you want to call that DX.

WE had a talk with a friend of a friend of someone on the "inside" insofar as the A.R.R.L. DX Century Club is concerned. It seems that the boys at Hartford have their

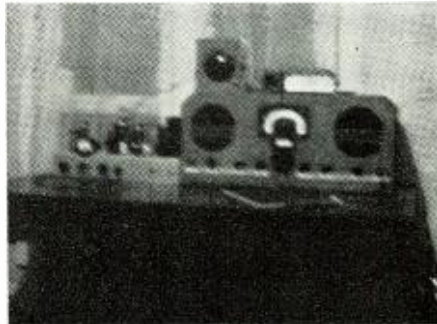

Hamstation W9ZHG.

hands full with "irregularities." Many of them are just accidental mishaps that make a QSL card look bad. Nevertheless, it is surprising to what extremes some pen and ink DX'ers will go to. One W2, whose uncle is in the printing business had some cards printed to send delinquent DX stations for some of the boys. That much was alright, but when he got a letter asking him to "produce" some new countries he discontinued the practice. It seems the DXCC even got to a point where they began to think he got in the CC that way, but it t'aint so they found out.

INCIDENTALLY at the last DX round-up in New York City, QSL's were distributed to all the attending DX men from AC4AA, ZB4UP, and several others. There was no charge for filling them out either. Aside from the fun and trouble revolving around QSL cards it is true a few members of the DXCC have been "invited" to leave for over-ambition. We still say it is the same as cheating in a game of solitaire and if the nuts want to do it that's their business. All such practices are not confined to DXCC members—in fact, in case you've gathered a mistaken impression, most DX men are honest, it is the would-be DX'ers who do the wrong things. A W2 filed out a blank "I" card. Somehow it got back to the original source of the QSL and our industrious amateur was forced to return his WAC certificate under threat of some very unpleasant publicity.

WHICH reminds us of the service started by a DX'er last year. You could buy QSL's at ten dollars for the first five countries and one dollar for each additional country. This same concern carries a swapping department where you may secure OK's, OE's, EZ's, and other extinct countries for European cards which are expected to be worth quite a lot in the future.

NEVADA now has 58 licensed rigs. Some of the foreigners have trouble working Nevada, and we often hear the foreigners calling "CO, Nevada." So far as we know this is the minimum number of amateurs in any one state in the United States. This is a good chance for the amateurs over there to increase their total number of amateurs by 1%. All they have to do is get one more amateur.

One of the new amateurs in Southern California is W6NAJ. He moved here from Utah.

We notice that many of the Alaska amateurs are coming in exceptionally well this year, so it looks as though an increase in radio amateurs is due in that area.

Mike Gibbons, W7KV, is an excellent bowler. W6KW, Johnny Griggs, certainly makes beautiful equipment. When in San Diego, be sure to take a look at his rig.

W6NGQ, we think, is the most regular club attendant in America. He just never misses a meeting of the Bell Radio Club.

By the way, the Bell Radio Club has one of the best emergency power supply we have heard about, too. It is 5 kilowatts, on a trailer, and is built from a gasoline engine. It is simply large to run a large number of the club portable transmitters.

It looks as if W6OCH won the "Radio" DX Contest for the United State on Phone. We haven't heard of any score even approaching the tremendous score he had, in excess of 200,000.

It also looks as if W6GRL will top the CW boys, with his tremendous score, in excess of 300,000.

We were also glad to see W6QD with a high score. Ordinarily Herb doesn't have time to get on, but in the Fall DX Contest, any number of operators can be used in the multi-operator group.

XE2AH in Tijuana, Mexico, has his one-thousand watter all done now, and working beautifully.

W6DNS, who is the first W6 to work across the United States on five meters is still extremely active on five meters, and getting a lot of fine data together. This data really should be published, because he has made some wonderful findings, and can predict quite definitely just what the five meter band is going to do within an area of several hundred miles.

W6BKY, Johnny Bickel, is certainly lost these days without his beloved Australians to work. W6BKY has a reputation in Australia of being the loudest station in the United States.

The National Youth Administration, NYA, is encouraging a group to become radio amateurs. In certain areas, particularly Seattle, this group

THEY'LL DO IT EVERY TIME — with apologies to HATLO





Hamstation W9DDD.

has a large number of amateurs all putting in one kilowatt amateur transmitters. The government furnishes much of the equipment and as soon as the boys get the licenses, things should begin to hum over the air in that particular area.

We still think Stan Velkanje, W7ETX, has the most efficient 160 meter phone possible. Even though it uses only two relatively small tubes, and about 100 watts input, it reaches Southern California stations on a 160 meter phone schedule with ease.

We are certainly missing the fine signals of ZS5Q these days. Just before the South Africans shut down, he was booming in in great shape along with a dozen or so of his fellow South Africans.

George Davis, W6SJ, is going in for television.

W6KJE, Dave Ellis on 40 meter CW is turning out some fast code these days.

W6NAT, the Mobile Hound, is on the air from some hill or mountain top most every Sunday.

We certainly miss the W6CHE and W6UF transmitter at the World's Fair, W6USA, certainly rolled into Southern California on 4 mc. phone. They also worked all continents R9 on twenty meter phone.

KAICS reported to the Southern California Amateurs that he had been sick for three weeks, and in the hospital during one week of that time. He is finally up, but not on the air so much, so I guess that there is a limit to how much an amateur station can be run. One night, however, he worked all districts in two hours and 45 minutes, and that is going some for a station in the Philippines.

W2MO still works the West Coast regularly on 20 meter phone schedules. He recently told the West Coast boys that he had been working Washington, D. C. About 300 miles away daily on five meters with consistent regularity.

W6BIP is still keeping schedules with WLFW on 7 A.M., (P.S.T.) This is the Yacht *California* on 12452 kc.

THE Argentine regulations seem to be more reasonable now, because the Argentine stations seem to come on oftener than when they had their restriction to 4 hours' operation a day.

The neutrality regulations in some of the foreign countries are quite similar to our own. In Chile, for example, the amateurs must not refer to any shipping or give any news items, unless they quote the news source. They must be careful in all their conversations not to offend any other country.

When ZS2AZ announced that all South Africans would be off at Midnight, October 29, little did we realize what a blank spot that would leave in the morning on 20 meter phone.

BUD W9BDO CRAWFORD says:

Maybe I shd hv waited til "April Fool" day b4 pulling this joke 2 find out how many BCLs I had locally. During my regular weekly sked wid "Aimee" AMY, I suddenly broke off my line of hamchatter, es then went into excited comments abt a 29 plus red-headed femme tt wuz passin' by the shack—I sure laid it on! Asked "Aimee" to QRX wife I went out 4 a btr glimpse. Found many of the housewives out sweeping off the front porch es craning their necks in an effort to see this "100% receiver" I'd been raving abt. Hi. After countin' the industrious OWs es those I cud imagine were behind their curtains pecking out, I went back in es finished my QSO wid AMY—not forgetting, of course, to allude slyly abt wat I'd seen, es do U know: some of those OWs won't speak to me nw!

EX-9EEW—mayb sum of us older hams wonder wat has becom of Ralph? The health of this prince of fellows has not bn so good, so decided to give up ham game es preserve his strength to use on his job of despatching trains for CB&Q RR.

9EXP is now carrying rural mail at Columbus. Inactive in ham way.

9FRD—funny red dawg—Ervin married tt gal Roberta whom U used to hr on 160F in vy-early A.M.'s es nw they R "3" es thinkin' abt becomin' active agn wid a batt rig.

EXN had more "harmonics" than a mfr has pickles wen he went to mod the 6L6's in his Utah rig on 160F. Sumbuddy lend Mervin es Mabel BJU ur "harmonic-strainer" as they sure am regusted wid their "all band" xmtr insted of 160 only!

KQC—spect old Lottie stressed tt "beautiful wimmen" part of his slogan wen he invited all his ham neighbors in 2 help him raise a new ant. Es, the ant didn't put-out so gud 4 a wile!

KQX got a thrill out of huking NBX an xyl up!

(More Hamchatter on page 42)

The VIDEO Reporter

by SAMUEL KAUFMAN

THE Allen B. Du Mont Laboratories registered several successive achievements in recent weeks that commanded wide trade attention.

First of the new developments was the new type persistence screen in which special fluorescent salts hold the image for a fraction of a second thereby eliminating the dark interval between consecutive images which is the reason for bothersome flickering.

The Du Mont firm holds that such a halving of the repetition rate may be utilized to cut the required television frequency band in half, or to increase the number of scanning lines to obtain a finer textured image necessary for clear pictures of enlarged dimensions. The company prefers the latter use.

Another development of Du Mont involves a video system which utilizes the vertical synchronizing pulse signal, and a "universal" receiver which automatically adjusts itself to picture reception of any number of lines, regardless of the interlacing and repetitive image rate of transmission. The firm's contention is that this development opens up the field to improved pictures on larger screens. At present, the arbitrary 441-line standard is inflexible in most receivers in public hands.

Du Mont has also introduced a 20-inch diameter cathode-ray tube and a receiver to accommodate it. This huge picture tube produces an image measuring 11 by 16 inches.

AS the year of 1939 made its exit the customary pile of annual reports by various industry executives reached our desk. And on television, particularly, there seems to be a more optimistic outlook than in former years. All of which is as it should be. But we are so used to hearing remarks about television being a thing of the far distant future that it is refreshing to note the comments made by radio and television leaders as 1940 came 'round the bend.

Here are a few quotes:

"Each week in television is the equivalent of a year or more in other media of entertainment and education."—Alfred H. Morton, NBC vice-president in charge of television.

"—we will continue to explore the new frontiers of television, looking towards a proper mastery of technical and program technique rather than mere novelty or exploitation."—William S. Paley, president of CBS.

"The first public service of television programs, adding sight to sound,

was introduced in the United States in 1939, by RCA's broadcasting service, the National Broadcasting Company. It marked the triumph of many years of radio research and technological advance. It represents a pioneering effort of the first magnitude. Those who predicted that the introduction of television would retard radio progress have been poor prophets of the year's amazing results in sound receiver sales."—David Sarnoff, president of the Radio Corporation of America.

"Television is still an engineering achievement and a commercial enigma. The actual sales of television receivers have been extremely limited. Many reasons have been advanced and all are undoubtedly correct to a degree. Some of the causes advanced for the negligible consumer acceptance so far as purchases are concerned are the limited program hours, the type and quality of programs, the list prices of receivers, and the relatively short trade discounts as compared to radio.

"Nevertheless, and in spite of the limited sales, it is the general opinion that the New York experiment has demonstrated that television service can be rendered over the area originally estimated, and that given acceptable programs, such service provides real entertainment value and opens up new educational possibilities."—Dr. W. R. G. Baker, radio and television department, General Electric Company.

EVERY now and then some radio stories pop up about people being able to receive radio programs through the fillings in their teeth or through the water faucets in their bathroom or some such thing. Broadcasting went through almost a score of years with such weird tales reaching the public ear. Now, it seems, television is concerned with similar "freak" reception yarns.

NBC told us some time ago about a complaint from a partially deaf man who was bothered by the sound portion of the W2XBS television programs. It seems that his electronic hearing aid was able to tune in the transmissions from the Empire State Building. And now we receive word from the WOR press department to the effect that an electric guitar located in the WOR New York studios (a few city blocks from the NBC television antenna) also serves as an impromptu receiver for the audio por-

(Continued on page 59)

MANUFACTURERS' LITERATURE

CAPACITOR MANUAL FOR RADIO SERVICING, Edition No. 1, published by the *Cornell-Dublier Electric Corp.*, South Plainfield, New Jersey. This new 256-page manual is a speedy guide to the selection of standard Cornell-Dublier capacitors for use as replacements in all existing types of receivers. Set manufacturers' names appear alphabetically, and under each are listed the manufacturer's models. For each model the data given includes capacitor types recommended for replacement, together with capacitor values in each circuit, working voltages, references to basic filter and by-pass circuits (over 165 of which are given in the rear section of the manual), manufacturer's original parts numbers, and the volume and page number of the Rider Manual in which the complete schematic circuit can be found for checking. The book is handsomely bound in an embossed paper cover printed in two colors, and it will withstand constant handling. Pocket size (5 3/8" x 7 7/8") for maximum convenience. Free to all servicemen through jobbers. (RADIO NEWS, No. 4-100.)

MANUAL OF RADIO SERVICING by M. N. Beitman, published by *Supreme Publications*. A 32-page booklet featuring a short study of repairing of radio sets. Handsomely illustrated and easy to understand. Treats radio set repair from the ground up, and will serve as a starter for the serviceman entering the business. Price within the reach of all, on application. Contains many valuable time-saving hints and kinks. (RADIO NEWS, No. 4-101.)

RADIO'S MASTER ENCYCLOPEDIA, published by the *United Catalog Publishers, Inc.* This master catalog, bound in cloth, runs to well over 800 pages and brings to the serviceman, engineer and jobber illustrations, prices, and specifications of almost every radio part, equipment, or accessory in the industry. This is the 1940 Edition and is just off the press. Price on application. (RADIO NEWS, No. 4-102.)

RCA'S RC-14 RCA RECEIVING TUBE MANUAL, published by *RCA Manufacturing Corporation*. A completely revised and brought up-to-date book containing information on the latest RCA receiving tubes. A total of over 235 types arranged in numerical-alphabetical sequence for quick reference. Obtainable from the local RCA tube distributor for 25c or through this publication. No radio engineer, amateur or serviceman can afford not to have the latest information on the latest tubes readily at hand for instant reference. (RADIO NEWS, No. 4-103.)

GENERAL ELECTRIC SERVICE NOTES RHS 622, 736 and RHBS 421. Service data published by the *General*

Electric Co. on their Radios models H-736, H-708, H-622, H-623 and HB-412. Includes full diagrams. Free to servicemen. (RADIO NEWS, No. 4-104.)

THE GENERAL RADIO EXPERIMENTER, Vol. XIV, No. 8, Jan. 1940, published by the *General Radio Co.* The monthly issue of this interesting house organ features a full explanation of "A Broadcast Frequency Monitor for the 20-cycle Rule." This house organ is available to *genuine* experimenters, engineers, hams and servicemen free. Include a letter of qualification with your request for a year's free subscription, stating why you believe you should receive this brochure. (RADIO NEWS, No. SPECIAL 4-105.)

THORDARSON TRANSFORMER CATALOG No. 400-D, published by the *Thordarson Electric Co.* The catalog contains 24 pages of the entire transformer line manufactured by the company. A novel feature is the index in the front making searching for the right transformer price easy. Free. (RADIO NEWS, No. 4-107.)

SUPPLEMENT NO. 4 to the 3rd Edition **MALLORY-YAXLEY RADIO SERVICE ENCYCLOPEDIA** published by *P. R. Mallory & Co. Inc.* A 24-page supplement bringing the 3rd Edition above mentioned up to date in every respect. Available either from the factory or from this publication. Price on application. (RADIO NEWS, No. 4-108.)

BULLETIN PA 240, published by *The Allen D. Cardwell Mfg. Co.* A handsomely illustrated pamphlet describing the Cardwell 240 watt Phone Output R. F. Amplifier Kit and its construction. Complete details are given and the diagrams are clear and easily followed. Free to all amateurs and experimenters as well as professional engineers. (RADIO NEWS, No. 4-109.)

MAJESTIC'S NEW LINE FOLDER, published by *Majestic Radio & Television Corp.* A new line folder incorporating the 1940 line of Majestic Radio Receivers has just been released. Included in the booklet are illustrations of the new spring line of models recently introduced at the Drake Hotel, Chicago Show. Free to servicemen and jobbers. (RADIO NEWS, No. 4-106.)

ALLIED'S AMATEUR CATALOG, published by *Allied Radio Corp., Chicago*. This 36-page booklet is especially directed towards the amateur and is intended to fill the need for a catalog which will give in complete detail what is new or best for any application in and around the ham shack. Its pages contain complete listings of items in every major equipment line, in addition to an unusually large selection of

small gadgets required in every rig from time to time. Free to all hams and engineers as well as servicemen. (RADIO NEWS, No. 4-110.)

Wm. A. Thomas Co., of Neenah, Wisc. have published a flyer on their new radio chassis cradle. The four-sheet shows the many uses to which the chassis gimbal cradle can be put. Free to all servicemen or experimenters. (RADIO NEWS No. 4-112)

A revised and enlarged circular showing every current Stromberg-Carlson in the line including the new interim models has just been issued. The most complete of any issued, it gives data on frequency modulation and television, and explains the developments that resulted from Stromberg-Carlson's telephone experience. The circular contains a chart showing all the features of each chassis. Tuning and tonal features are illustrated and described. It also shows and describes the new Stromberg-Carlson No. 6 Antenna Kit, Wave Wizard, and Headphone Kit. Printed in black and white, it measures 25" x 19" and folds to size 6 1/4" x 3 3/8". Free. (RADIO NEWS, No. 4-111.)

* * *

INTRODUCING a new service to RADIO NEWS readers. Each month we will print short reviews of the leading manufacturers' literature. Under each review will appear a reference number (for instance, the P.A-240 number this month is RADIO NEWS No. 4-109). All you have to do is to fill out the coupon at the end of the page indicating by number the catalogs you wish to receive, and we will do the rest. There is no charge, unless the review says that there is, and then that is charged by the manufacturer, not us. Each coupon is good for the time limit stated thereon, and no guarantee is made by us that the manufacturer will send out catalogs to all who ask for them, though they usually have done so in the past. We merely forward your request to them.

—The Editors.

RADIO NEWS, Catalog Dept.	
608 S. Dearborn Street, Chicago, Ill.	
Please send me the literature I have checked below. If there is any charge I have enclosed the money.	
...4-100	...4-109
...4-104	...4-106
...4-107	...4-110
	...4-101
	...4-105
	...4-108
Name
P. O. Address
City	State.....
This offer expires May 1, 1940.	

Every REPLACEMENT TYPE FOR Every RADIO NEED



CS STANDARD

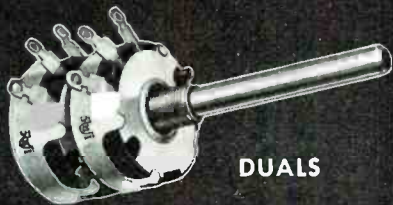

DUALS

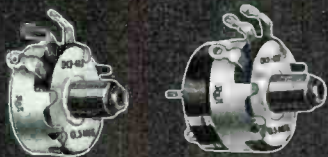

MIDGETS



SPECIAL
STANDARD



SPECIAL
SHAFTS FOR
EVERY NEED



AUTO RADIO



WIRE
WOUNDS



IRC SILENT SPIRAL CONNECTOR

Positive "clockspring" connection—no slide—no friction—no noise.

IRC 5-FINGER "KNEE ACTION" CONTACTOR

Amazingly uniform — permanently quiet.

IRC METALLIZED ELEMENT

Moisture-proof — durable — outstandingly smooth.

IRC COIL SPRING

Assures smooth rotation prevents end play of shaft.

4 EXTRA FEATURES . . NO EXTRA COST!

Only in IRC Volume Controls do you get the exclusive features illustrated above — and an important thing to remember is that you get them at not one cent of extra cost. They mean more for your money. They are your assurance of the smoothest-acting volume controls you ever tried. They mean IRC Controls are quiet — and built to stay quiet.

Every one of these features is included in IRC Midget Controls as well as in the standard and special replacement types. One standard of quality only! Each and every IRC Control is made to the same high standard that has made them tops in performance and dependability throughout the world.



FREE! 1940 SUPPLEMENT TO THE IRC GUIDE IS OUT . . . Most complete, up-to-the-minute listing available. Covers control replacements for practically every receiver made since Edition No. 2 of the IRC Guide was issued. The new Supplement — and the Guide if you need it—free upon request from your jobber or direct from IRC.

INTERNATIONAL RESISTANCE COMPANY

401 North Broad Street, Philadelphia, Pa.
(In Canada, 187 Duchess Street, Toronto)

VOLUME CONTROLS

Makers of Resistance Units in More Types, More Shapes and More Sizes for More Applications Than Any Other Manufacturer in the World

Hamchatter

(Continued from page 39)

in N Dak on 80 CW as tt used 2 b Dean's 'lug-gable call.'

OWR—old windy red—visted GYM es ate up Vic's apples es popcorn while they QSOd on 160 F wid Vic's 6L6 Pierce osc at 10 W inp. FB sig boys, it really wuz OK!

RIH-9 now is hrd fm Crawford on 160 F during wintertime.

VKT—vy kranky transmitter—fm the banks of the Big Muddy sumtimes has an OW wid a FB voice helping the OM QSO on 160F.

YDC is another new ham from our metropolis on 75—darned few Omaha hams using 75 it seems, so we welcome another contact thr.

ZQZ—zed Q zed—is nw op'ing 80CW fm the boarding house in Comstock whr she is instructing mama's darlings. Her father recently took a fling at the Class "C" as did their "tied man" Don Woods, so tt household shud be a real static-house wen they R all home es op'ing. Betcha the pwr co is glad!

W7FXO at Scobie, Montana near Canada line offers gud chance 4 sum DX wid his high pwr rig on 160 F.

W6REO "The Flying Cloud" at Winslow, Ariz is eagerly sought by WAS addicts wen he cums in in late afternoon here on 160F.

The northwest Iowa gang on 160F headed by tt vy-good op KSS sure enjoy themselves wid REH, TTO and QGY being most often present in the go-rounds.

From the "White Spot" 9ATB—a tona brick—writes he has bn on 10 4 long time nw wid pr of 35Ts es did FB wid DX until the nasty-nabors across the big lake moved a *la Mars* es told their hams to sling grenades insted of hamchatter at each other.

9CDL is a new OM on 160 F in the west end of the state—only one hold-out 4 CW left in the Platte Valley Radio Club nw.

9CSE-9 week ends at Miller whr he can use a long aerial on 160 es 10 insted of itty-bitty piece of wire at home QRA.

9CYX is one of the louder 80 CW sigs at noon time hr. Not much activity-ever during day on 80, so I contend it is a shame tt at least the Class "B" hams R not allowed daytime fone privileges ani whr their xtal is on 80. I figger it wud b btr than shoving 'em up on 160 near BCLs 2 do their initial voice experimenting.

It was in 1932 the big "ham slaughter" took place thruout this territory wid the RI calling 'em up 4 exam es knocking off fully 50%. Since then no RI has covered the territory giving exams es it takes quite a bit of dough to make trip to KC or Denver to tri their luck 4 a Class "A."

DOWN Kansas way BVQ, Dale, works for Bell telephone as a "pastime" and oh-maybe to set money to keep his 300-450 W of fire into his sky-wire, which we receive off 160F.

RXJ wid a BC ticket plays around nw es then, on 75 es 160 to QSO us "white spot" residents. Darned good sig generally.

SAM solders joints for the BCLs in the shadow of "Boot Hill" and "only" uses 950 W, lil of which he keeps at home fm way our speaker speaks when we resonate on his freq.

SWR draws his paycheck from WREN's owners, 125 W into 75 M doublet are essential dpe on AI's kickerouter!

VRZ is another "sunflower" wid a big bloom fm his T125 wid 300W es an ant-cps combination. NC-100 to hear 'tother guy wid.

VWP—very wet person—really pushes us ears in es "rates" when one discusses the tops in 160

F sigs thruout the middle west territory.

YHH Ernie is a cop down in Ark City, so a good time to argue wid the officer is when you got him far, far away. HI.HI. 75F.

Over towards the Rockies in Colorado, those who listen may hear CXG—Colorado's ex Gov—on most any band when "Chuck" isn't busy takin the bus fm the BCLs 4 set service. "Chuck" developed a hickey to stick on the side of your telephone which inductively-coupled any telephone conversation into his xmtr in FB shape, thus making it easy for Bill Jones to hear his friends voice if said friend lived on CXG's line.

EYN one of the BC ops in the "Mile High City" popped up on 75F es was renewing acquaintances wid the neighbors.

FPD on 160F is a new one to my ears. MGX—mother goose's xray—old railroading Herb ain't been heard so much this year on 160F as year ago when he was a sure shot wid a hefty sig cumin' dwn the main line.

RGX—real good excuse—that jovial joshing Bern made us 75F men happy other day when 10 folded up es he decided to talk to us white folks a while. Dawg gone! Sure a shame thr aren't more ops like Bern who is the one out-standing on when it comes to a "mis-match" in equipment—he has a decent HJ xmtr, but bl gosh, he has himself extra good receiving equipment and it's a cinch, he'll hear-ya if-ya are "hearable."

So blamed-amin op's spend their mazuma 4 a good xmtr es then "mis-match" it wid sum of the sorriest rec'r 4 tt end es R unable to drag in responses to their CQ's—it's plumb regusting! A simple switch and a lil elbow-grease using it to receive wid, sure makes a wonderful dif in bringing all sigs up to abt same level es giving btr sig-to-noise ratio!

W7GZI-7 still seems to be the most sought of the Wyoming stations by the WAS hounds. The rest of the regular old timers in the buckin' hawsie state are pursued plenti, too. Case of "few toads in large puddle" I guess. HI.HI. I've forgotten the call of the W7 at Greybull, Wyo who is active in early A.M.'s on low-freq end of 75F—he wrkd K60QE right after I signed wid Harold over in Kohonahi which is on the mountains 16 miles out from Honolulu.

I also clicked wid K7GNN Chichagof, Alaska on 75 after he es his brother in Oregon got thru wid their family gossip. K7GNN runs a power plant there. Jim sed he had canned up abt 60 cans of salmon for his cats—TIF mi bro sed he'd can up his surplus of cats es send 'em up to K7GNN to feed the fish wid. So if anybody needs sum fiddle strings, TIF has the cats. K7GNN sed I was most DX he had wrkd on 75 in long time, but he is also on 10 so maybe sum of U can hum Jik on tt band 4 a K7 QSO.

K7DWH is usin' 75F agn this yr. Ol "Dandruff, Warts es Hangnails" informed me last yr his rig is on pier out over ocean es wen tide cums in it affects the tuning on his final—ant was center fed abt 470 ft long as I remember it nw. Fred is nice feller to QSO. He also sent me a "good natured" map of Alaska which "me n-the-BCLs" got lotta giggles off of it.

AKX in South Dakoty has bn hvin' himself sum fun on 160 es 10. He talked to his bro-bi-law thru ZQZ's rig wid IRZ oping es as the visit unfolded ops and all, found they had went to school together, etc. way back wen AKX lived in same Nebr county. But AKX sed he was pushed out tt time he made the parachute jump fm aeroplane es jined the caterpillar club.

EXX gets 35 W inp fm a genemotor run off their 32-V lite line es together with HFS—his fat sis—a neighbor 20 miles away with vy lo pwr, they keep their niche on 160 F hot.

HJV on the ol' Missouri river at Yankton is my morning competition on 160 F low freq end—he beats mi 2 W inp. HI.

OQG Lillie the YF of OQG has bn wrking 160CW lately. The recent "harmonic" in their family had curtailed her op'ing for a while. Lillie uses 40CW a lot, too. Es, sum 160F.

LLG is YF of LMC in same QRA as OQG es OQG, besides being sis of EPH es bro-bi-law of IYN. How's tt 4 families of hams?

QLK has finally gotten themselves an antennae which perks decently on 75F—darned unorthodox slanting wire, but we hear 'em, so what?

YBX-9 is another of those BC ops nw at Yankton who hams a bit.

YDT was wrkd on 75F wid more insects in his xmtr than a Flit ad shows "before." Hi. Mert DKJ is the "boss" of this high skool stn es as sn as he cud get sum of his young "Taz-zans" to climb around es string up a good ant to radiate the RF, his rig was OK. Hi.

ZBU, Larry has a 40 M off-center fed Hertz tt he uses on 3 bands. I clicked wid him on 160F. His sig was loud hr, too.

ZXZ Louie is constantly heard on 75F wid 150 W off his 211 into one of those popular 1/2 wave doublets, so mani of us "R in Fashion" usin' at present. Apparently the BCLs appreciate 'em best!

Now coming back to our own "White Spot" for a last minute item about the vy-new IDR of Pop Rolli (father of YL ZQZ) es believe U me, "Rollie" is hvin' himself more fun in past 27 1/2 hours since he got his ticket (has kept the rig hot most of time. HI.HI.) than U or me did wen we-too were "beginners" wid ink scarcely dry on our ticket! He has bn wrking us who were on 160F es CW, 80CW es 75F. Plans on gg to 40CW, too. Mighty fine place to go visit es ts just what the hams thruout this territory do! Such a hospitable place that there's most always a ham or a half a duzen hams underfoot at "Rollie's." P. S.: Sure Mrs. Rolli's a T9plus cook! E. L.

75 es I hpe to b a hearin' ya snr or later if not B4! Sgd: W9BD0.

THE 1940 officers for the **TU-BORO RADIO CLUB of WOODHAVEN, L. I.** are HVD PRES.-KYV vice-PRES.-HBO SECY.-TREAS. LAU W 2's. Ed.]

The TU-BORO R. C. was organized in 1934 and has been going strong ever since the first meeting. Meetings are held every Tuesday nite. There are classes on Monday and Friday nites for code instruction. At the present writing twenty-three licensed amateurs belong to the club.

In the last Sweep Stakes contest seven members participated with W2KYV making 26,493.75 points W2HBO with a score of 6,750 and W2BVE having 4,406.25 points, those three being the highest of the seven in the contest. Club score was 39,681.50 points.

The club net on 3813 kc. meets every Sunday morn at 11 a.m. with W2HBO as net control station. W2HBO-APM-CTP-BVE-HHW-HKY-KYV were the most consistent station in the net.

The club call W2JQJ was recently changed to W2BMW in memory of Jerry Dodman past President and charter member of the club.

Just now the club rig is undergoing the process of being rebuilt and when finished will be used on 3.5-7 mc. c. w.

"TU-BORO SPARKS" the club paper is published whenever enough dope can be gathered, but the editor finds it tough going trying to squeeze info out of the gang.

W2LJP moved to St. Albans recently. LJP sed with his brand new Meissner signal shifter and indoor antenna he worked a W5, on 14mc.

W2BVE got his class A ticket and is rebuilding the final for a pair of HK 24s with which he will help to put Hollis on the map.

W2DGD of Woodhaven sed he is putting in a 250TH and try his luck on 75 fone.

W2BOT is back on 3.5 c. w. after a lapse of several years with a 6L6-6L6 combination. BOT is now located in Richmond Hill.

(Continued on page 43)

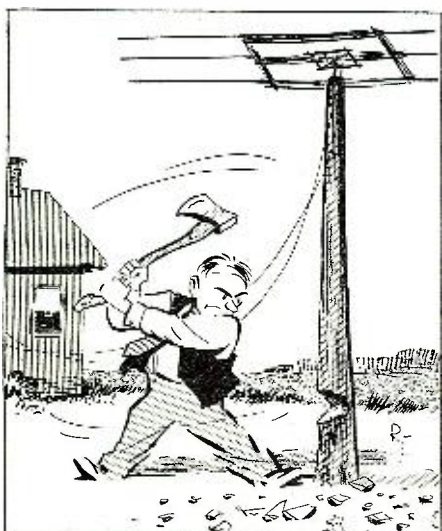

"What the heck do I need a three element beam fer with this War."

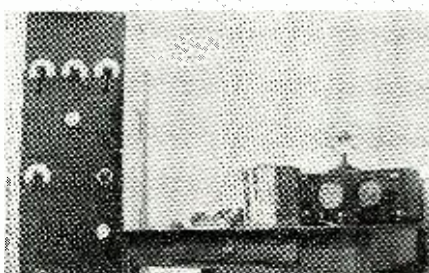

Hamstation W9HNX.



"Say, Butch, I toined it to 30 five times, then to 76 nine times . . . but all I can get is someone calling CQ."

W2HBO from Ridgewood uses a 6J5 xtl osc-6L6 on five bands. In the 3rd ARRL QSO Party HBO made 1,800 points working on three bands. W2LG of Bklyn home for Xmas went back to sea again pounding brass on a tanker. When at home LG is active on 3.5-7 mc. bands. W2BYK whose QTH is Richmond Hill works for WOV a local BC str. BYK is mostly on 14 mc. fone using grid mod.

POEM: (No title Hi!) By W4ENI.

Very early one winter morning,
I ran shivering to the shack,
I turned on the filaments,
And found my crystal cracked!

I turned my mighty receiver on,
My sked was giving me a call,
I tuned the crystal in and out,
But it wouldn't take off at all!

"I think that he's a dirty louse,"
Or so my skedule said,
"I've called him for an hour and a half,
And now I'm going to bed!"

And where was I at all this time?
Does he think I'm a sap?
Why I've been asleep for an hour and
a half,
Taking a nice long nap!

W4EGF is quite proud of his 25 Watts on 75. He thought that it couldn't even get an answer until W4ENI got up early one a.m. and worked the west coast! W6FFN gave him an R 8 report with 25 watts and 80 meter zepp antenna, center fed. W4EGF HAS worked all districts on 75 fone including W7AXY in Idaho. W4BLX got a thousand and two fifty volt power supply for XMAS and he says that Santa Claus forgot the RF section! Hi!

W8SYM portable, has just bought a rotary beam antenna and wants to contact anyone who knows how to put one up! Hi! He is working 40 c. w. now with 100 watts on about 7.155 kc. W4EUS was working 160 meters with an ACT-40 Xmitter at a military institute until he found out that his after hours parties were going out on the B C band! He's off the air now, but he hopes to get back on soon! Hi! Hi!

W4PEX just got a nice QSL card from SP11H in Poland on 40 c.w. The card had been in the QSL bureau. I bet he doesn't do that again soon! He is on 40 c. w. running about 80 watts to the same 616's he worked Poland on!

While visiting at W4BYA, W4ENI and K6DV worked K7ATD in Sentinal Island, Alaska on ten meter fone with R9 on both ends. "The biggest yokel alive" runs 150 watts to a pair of t 20's and can be heard on ten almost any time.

W4EYV is going great guns on 75 and 40 with 400 watts. This is the comparatively new High Point Amateur Radio club and they would appreciate any SWL reports. All SWls answered.

W4ENI is choosy to whom he talks to now since he worked NY4AD AND H15X with R9 reports with 22.5 watts on 20 fone to a single 616 final. He operates 75 and 20 fone now and is a member of the Dixie Breakfast Net on 75.

On Dec. 1, of last year, W4ENI contacted VP7NV on 40 c. w. who gave his QRA as Nassau, Bahamas. Would like to have any dope on this station.

W4DWB also contacted VP7NV on 20 c. w. and believes him to be a bootlegger as he thought that they were off the air down there. Incidentally W4DWB keeps regular skedules on 20 c. w. with XELAW, Mexico, at twelve noon EST!

W4EJC is rebuilding but will be on soon with the first KW around here! Look out boys!

MOTOR CITY RADIO CLUB held their annual election recently and the following new officers were elected: W8FJL, prez.; W8SEU, vice-pres.; W8CHJ, holder of the cash, and W8REJ, the official keeper of the records.

W8HFQ, figured two can live as cheaply as one, so he and the yf walked up that certain aisle and said "I do." Congrats OM.

W8GFL has a new 160-meter sky wire so can be found operating mostly on this band.

W8UGA is a new-comer to Detroit, being formerly W6PYU. Operating at present on 10 meter fone and 40 c. w.

W8QHB is back in town after spending the season of brass-pounding on the lakes.

W8OZP of Baneroff really had some bad luck just before Xmas, his car with Ham call license plates was stolen and to make matters worse he had about \$300 worth of radio equipment in it.

W8MPL wondered why his 10-meter beam would not work, so upon investigating he found that a family of birds had built a nice home inside the rotating mechanism. What next?

W8TJR has a cathode modulated rig and has been getting out quite nicely on 10-meter fone.

QRM from the 5th District by Windy Bill who never worked and never will.

I would like to take this opportunity to tell the fellows that sent me those FB Pixs (which did not appear in RN) that its beginning to look like Mr. Farley is falling down on his job as they apparently were lost in the mail on the way to RN.

The picture of the month is of W5HEJ the old red headed swamp angel and his mate Fanny the fan dancer W5HEK. Fan is attempting to introduce her style of dressing for comfort to the South which she claims is ideally suited for this mode of dress hi. (Sorr, Bill, but we ran

(Continued on page 44)



SEND FOR WARD'S NEW SOUND SYSTEM CATALOG

Shows how to select the correct Sound Equipment ...How to get the best results...How much you can save and many other important facts...

MAIL COUPON

THE MOST UNUSUAL SOUND EQUIPMENT BOOK EVER PUBLISHED . . .

It shows how simple and easy it is for anyone to select sound equipment exactly suited for any particular need. Whether for music or speech, for indoors or outdoors, for a small hall or a large auditorium, nothing is overlooked in this exceptional new catalog. Everything is so plainly illustrated that anyone, even without experience or technical knowledge, can easily make the selection and set it up.

But more than that! You get sound equipment without an equal. It's the product of quality builders of sound systems . . . concerns like Hallicrafters and Lyon & Healy, working under specifications of WARD Sound Engineers. You take no chances. For you get a

15-day trial and a Money-Back Guarantee on every WARD Sound System. Convenient time payments if you wish. You save money, too. WARD'S economical direct-selling methods save you up to half, or even more, on comparable quality and performance.

This new catalog is not yet off the press, but so that you can have your copy with the least possible delay, we urge you to send your name NOW. Requests will be filled in the order received. Don't wait! Mail coupon for your FREE copy NOW!

FREE!

The most unusual Sound System Catalog ever published. Mail Coupon for your copy.

MONTGOMERY WARD
9 GREAT MAIL ORDER HOUSES—OVER 600 RETAIL STORES

MONTGOMERY WARD & CO.
DEPT. RN-36 CHICAGO, ILLINOIS

Please reserve a copy of your new Sound Catalog, and RUSH it to me FREE as soon as it is off the press.

Name

Address

City State.....



HAM CHATTER

(Continued from page 43)

pix in Mch issue RN. Did u see 'em? Ed.]
 K5AT writes and says he has been getting good reports on 20 c. w. with 6 watts to a 614, having worked 32 states in 3 days. Mack says if any of the boys have a modulation transf. that can be used with an 811 modulator at abt 375 watts input to a pair of 812s to send it to K5AT. Mack says all the boys down there are ardent RN fans es he wants to know if you would like to have the dope on the boys down there. [Sure, send it along! Ed.]

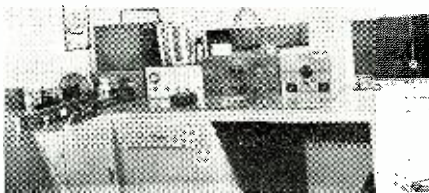

Compare this latest pix of W2IOP with his original rig on page 35.

W5GIZ was a visitor at 5HMV and a good time was had by all.
 W5GXO is very interested in gold mining.
 W4AV/5 seems to be hibernating thru the winter.
 W9OCH/5 is still going strong on 75 fone.
 W5BV is active on 10 es 75 fone every week end. Dan also sports the call W5A00.
 W5FVK has completely recovered from the self-inflicted(?) bullet wound in his foot. Don says it was an accident BUT that ain't the way I heard it.
 W4BGO/5 still has the wimmen under control. In Baton Rouge Ben is now known as the pride of Plaquemine.
 W3HVL is now using cathode modulation.
 W5HEK is so far as I know the only XYL on the AARS. [There are sum in 2nd Dist. Ed.]
 W5HGW 5INF es 5HTR are father son es daughter.
 W5INN is a new one.
 W5IKH the old Ding Dong Daddy in Dumas Texas really makes a Pair of T53s work.
 W5HRC es 5PXF now have those fancy sig shifters.
 W5ML thinks the AARS is the tops.
 W5ARY is now located in McComb, Miss.
 W3COJ has moved to Canton, Miss.
 W5HCE es 5GEB own a 10 meter rig es work out very nicely.
 W5MH really has a good fist on 40 c. w.
 W5GAL is still off the air.
 W5HMV now has the rest of his 500 watt Utah Rig (boy would I like to meet up with Oliver Read). [Send postage—we'll mail him down to u. hi! Ed.]
 W5WN sure has some very charming daughters whose melodious voices are heard over 5WN.
 W5GEF is becoming interested in ham radio again.
 W511R is building up a brand new rig.
 W5BJZ is back on 75 fone.
 W5ADJ says his new vertical steel tower on 160 is working better every day.
 W5GMR has rebuilt his rig.
 W5GUX seems to have forsaken ham radio.
 W51KB is still going strong on 160.
 W5HFI has a rotary beam that really works.

WSNCG has been working HK5ED, K4KD, W3CQR/K4 and K4AAN (Virgin Islands) on 40 meters, also been hearing HC1FG coming through RS on low end of 20 meter c. w. band around 8 p.m. E.S.T. "NCJ" now has confirmations from 45 countries worked and has

hopes of becoming member of *Century Club* someday. Made score of 55,825 in *SS Contest* and 24,200 in *ARRL* members QSO party with his 100 Watt C.C. rig. Thinking very strongly of switching to "ECCO" so as to stand better chance in future contests.

XYL op at "NCJ" worked Utah and New Mexico and has received QSLs from them to complete her W.A.S. She has also joined the *YLRL* (YL Radio League) a recently formed organization of YL and XYL hams, which has a monthly tagelbat called *YL Harmonics*. There seem to be a lot of YL hams coming to the high end of 40 meter band these days, some of those heard more frequently are: WSUDA, WSUCW, WSSJF, and WSROB.

DON "KING OF THE SLOT MACHINES" GUMPERTZ is home on a short vacash, in real life he is W6LCD and has been attending Cal. servicing coin amusement games and working at the Exposition on the side.

W6QKO will have 750 watts of grid modulated HK354 on ten if he ever gets a 10 meter coil for the buffer. Watsa Don.

Clyde W6LFI has been trying to get on 3.6 mc. fone ever since he moved to LA to work for the fone co. (he even has the dough saved for a revr.).

Ask Bill W6SAH about his dual diversity 160 meter fone rig he puts in a swell R 7 3908 kc. in So. Cal.

W6RHB (the red headed baby) has a fb new v. f. exciter, so you guys are apt to find QRT any place in the band now.

Jerry, W6QHK has QSYd to south 1 a, his old QTH at Venice was too far from work not to mention being a poor location for hamming.

Take a listen for W6PDU in Pasadena. Dick packs an R9 plus wallop with that eight watts to a 6L6.

Harold W6RVE has really been getting out since Don, "construction and design engineer" built that eight ball dynamic mike. It got rid of that barely sound in Harold's voice. Don will probably have his call by now and RVE will be without a rig.

Listen for QEU when he hears a YL call CQ. Pete really overmodulates those vocal cords of his. (don't we all? hi hi.)

Those bugs that use YL decoys to call CQ should be hung on their own sky wires. [U sed it! Ed.]

Levth, W6OYV blames his hoarse voice on colds, but by some strange coincidence they always seem to occur after the big SC football games. OYV is a biology student at USC.

What ham sent a QSL to KEWB welcoming them to the 160 fone band, they put out a fb sig on 1,900 kc. over abt a 70 radio. Hi, Hi 1 1!

W6QNH put an RS sig into so calif on 160. Glenn is running 4 1/2 watts to a single —58 up in there in Hanford.

Dutch W6MSW is going mobile on ten with a 6PS-807 combination, do you think the old model A can take it, Dutch?

That W2 operating portable in LA has some of the gang a big thrill on 160 lately.

Why is it that when you ask any of the boys where they get their handset telephone mikes, they always say that they got it from a n o t h e r guy and don't know where he got it?

W6CSC copies PX for a news service and says that it is so slow he doesn't bother to read the tape.

W6MFH spent Christmas with his xyl and it op in Ojai, Harry is now OBS for SF area.

W6RX Palo Alto has a fb sig on the high end of 160, Johnny works for Mackay.

If you want to hear some swell cathode modulation, listen to W6PFF at Garvey. Frank is a film pusher for the Edwards theater circuit.

Bud W6RRD (Where Six Red Roses Died) at Lompoc has 40 watts to an 801 and most of the gang swear that it is half a kw. Bud says that it is all in getting it into the antenna.

Lisen for W6QLY, Earl Damm and all the little "dammitts" on 1925 kc. he and the xyl are swell ragchewers.

W9FZC is now using a *eco* with great success.

W9PRM is active on 80 mtrs. 90BZ is still pounding brass and gets out fb using an 807 in the final.

W9LWX has just completed a new modulator with a pr of 2A3's we haven't heard how it works but tpe it wrks out FB.

W9RQM has his 37 very interested in amateur radio. (Nice goin' Reno.)

W0ZHG is planning a *eco* on 40, 9ESV, the Chief of WSAU, is pretty busy at the station but has done some experimenting on 10.

The *Wausau Ham Club* may handle the Timing of the Skiers, at Rib Mt. when they have their meet, combined down hill and slolom meet Ultra hi Freq. is used es in the past has wrked out very FB. Hams taking an active part in the event are: 9PRM, 9ZTO, & 9ESV.

W4AEG has been working since fb DX on 14 mc. c. w. lately. After a 2-year ab-

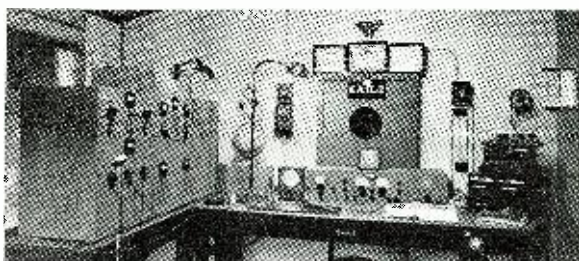

This superb layout is NOT a B. C. station. Nossir! It belongs to that tower on page 36 and is KAILZ.

sence from the air he heard the South Africans coming in so well he built a 300-watt rig and worked Africa for his WAC. AEG threw his DX collection over his shoulder and is spending the winter in Florida to really find out what the score is. Incidentally, he writes back and says the station at 4EQK makes *all the rest* he has seen look sick.

4EKK left Tennessee and is operating 4GEU, a club station at St. Petersburg.

9BUW is planning a rig for 10. And by the way is a new ham.

4EKF sold his rig and is now in Port Arthur, Texas. He says that 5YH, the college there is expected to be on the air soon. EKf has met 5DEW personally. Well, well!

4AFK got over his airplane crash nicely, losing only two teeth. Louis certainly has a fb, 14 mc. c. w. rig and he is active in the Army net on 75 meter phone. Not long ago AFK worked on F8 in Paris and sent him an old card he had at the time. The F8 sent a card in return. Later, Louis had some newer cards of different type printed and sent the F8 one of those. The F8 immediately replies and writes: "Why you send two cards one if so?" Hi, it wasn't what he said but the way he said it!

4FUN is very active on 40 meter c. w. and he says they all want Tennessee for W.A.S. Hi, even FUN doesn't have a confirmation of Tennessee.

4EO moved from his country home and is now living in Franklin, keeping a regular sked. with KAILHR using his vee on the farm, but at his present location he has built a new shack and put up a 200-foot Zep antenna and now he is trying for the Century Club.

4FLI has been heard working Canal Zone on 14 mc. late at night after the band folds up.

4TM has really been rotating that 3 element beam on 14 mc. but there is a KW behind it.

4ABM builds a 2 element vertical beam. Since "a bad monkey" has found out what beams can do he is in the beam business.

The W4 here who was so disgusted with QRM even blamed himself for QRM-ing his own receiver. His rig can now be found in a relative's house across a two-mile stretch. He controls his rig by small underground wires with relays operating at other end and now he has to wait until favorable conditions to monitor his own signal.

SOME of you kinda laughed at the foto of T12LC and his rig in the last issue of RN but believe it or not little Freddy really gets his DX. He has worked South Africa and is well known in Canada. When the cards poured

(Continued on next page)



in down there T18PA was surprised. He went over at 2LC's and tried to buy the little 3 watt'er. Anyway, T18PA is using it now and can be found a little outside the high end of twenty. All cards to T18PA should be sent via T12LC.

Who was the young fellow in the fourth district who rolled a European station off its DX cards with 3,000 miles of ocean and part of Europe between them? A certain swl in this neck of the hills sent a Grecian station a report on his sigs. There was a prompt reply with a photograph of the SV station and its fb array of DX cards on the wall. The swl wrote back and says wow you certainly have some fb cards! I would give one of my fingers for a collection of Asian cards like that. And to this young fellow's surprise after about six months the entire collection came. But hold on boys—every card has been returned. hi!

CX2AJ was asked, "How many ops are down there? You are heard all the time." The reply was "Just, working myself a reputation as Old Faithful." Hi, we believe he will, at that!

PJ7B is trying to get WAS before returning to the States. He now needs Utah and New Mexico but while he is doing that he has grabbed some mighty good ones such as XV8WS and J2OV.

ZB4UC is really believed to be on the Island of Ascension and he says he is using a 6KW commercial rig. A few days before the DX contest he flew to India, carried his rig and operated in the contest under the call of YU2XX. He says he will visit KH6E personally and QSL all. Stuart says not to send any stamps until further dope is found. Anyway, we hope 2XX is not in the bottom of the Indian Ocean.

Some of you South Carolina stations please look for CE3AG, every Tuesday and Friday between 8 to 9 p.m. CE time on 14, 408 kc. 3 AG needs only SC for his W.A.S. certificate. A QSO with him may be worth more than his card. FNIC cannot be passed up. The operator is a 19 yr. old blonde named Barbara. She told W8TIF in a c. w. QSO on 20 that she was single and in the same QSO she said the OM and AC4JS wore out shooting tigers! Q44L has been chewing the rags with all districts in the States. There are 2 ops down there, Ray and Red. They have their antenna away from the shack on a mountain top and it really works out fb. Since the X4L down there has been in the hospital, Ray says he cannot find much operating time because of attending to baby diapers. Ray is ex-CE1AA, ex-HC2EA and ex-W2BBT.

P26ZK had an average of over 15 QSO's for every ten minutes of operation during the contest. It's a funny thing, but when P26ZK worked CX2AJ he said "Hello brother." We wonder if it's because of their signals? He was also heard working HC1FG. When they signed HC1FG sent 88's 6ZK said I will take them personally when the boat leaves for that direction in a few days. We can find out from Judy whether he is OK or not.

U81B just got his cards printed so more than one have waited a long time. Speaking of USSR, the station coming thru most consistently now is U5KY on 1437. UT7, every morning between 6 and 9 a.m. CST. He gives his QTH as U5KY, KIEV, Ukraine.

All cards to H2AC should be sent direct. He QSL's 100%. HA2C and HA3T are the only two stations being heard from Hungary.

HRS1378 writes that most of the hams over there have been soldiers and have been away from home for nearly a year. They returned Christmas.

LY1J the well-known ham who has either been heard or worked from mostly any place in the U.S.A. wrote a letter saying that after a long time he now has W.A.S. and is the only one in the Baltic states or that part of Europe who has the certificate. His 48th state was New Mexico, working W5GGX a few weeks ago on fone. He says he doesn't want any more W cards. He weighed his W cards and had 12 pounds! Not including his DX cards which his wall is too small for. He said he is now ready to QRT. He QSL's 100%. However, he is making tests with phonograph records on 14 mc. and will send any swl a card who sends a report of these tests. He also has an especially designed swl card himself and will exchange with any other swl.

W2HBQ moved some of his equipment from Point Pleasant, over to Sea Girt where he is operating on 75 meter fone under the call W2MSG. He has the rig installed in the office of his dry cleaning and pressing establishment. Some of the boys say that's a good idea for George to run the rig thru the dry cleaning machine—might take some of the bugs out of it.

W2KKZ of Laurelton spends most of his time on 28 mc. fone, using about 300 watts to a pair of T-40s and a 2 element beam of his own construction mounted in the top of what used to be a pine tree until Fred lopped off all the branches. He recently built a new room on the second floor of the house, exclusively for radio.

W2DDV also of Laurelton spends most time operating on Naval Reserve schedule, the two fone transmitters are under construction, and a few meter beam is lying along side the garage. The Meteleconk river fifty feet behind the house with pretty gals swimming around and the boating makes it pretty tough to keep the mind on radio during the summer.

W2LHN of Lakewood recently bought himself a new RME HF-10 receiver, put up a twin

(Continued on next page)



KITS THAT CLICK! They're neat, efficient and complete!

AN EASY WAY TO OWN A FINE, NEW UNIT IS TO BUY A COMPLETE KIT AND BUILD IT YOURSELF!

NEWARK HAS THE LATEST KITS designed by RADIO NEWS engineers

THE UNICONTROL 5-BAND TRANSMITTER... Complete Kit \$323.49

As new as this morning! No plug-in coils; no fiddling with adjustments... just turn the knob and there's your transmitter on the band that you want it! And how about the size? Compact? Yes, compact as a ladies wrist-watch... if you'll pardon the simile! 200-watts output into a space no larger than the ordinary receiver and speaker! Running 270-watts input, 100% modulated at high level, this rig meets FCC requirements for stability and hum-free carrier operation. Includes automatic modulated compression so that you won't overmodulate. Tube lineup: 1610 xtal oscillator always on a fundamental, 828 final amplifier. Modulation in Class B with two 811's. Speech lineup: 6SJ7 into a 6L6. Works from a high impedance crystal or dynamic mike. Uses 6H6 modulation compression tube. Power supplies are with 866A's and a 5Z3. Only RCA tubes used; and within the manufacturer's ratings. Band change by means of positive bevel gears. The kit is complete in every respect and includes 5 High Power crystals, on frequencies of your choice, all tubes, in fact, everything but the antenna, microphone and key. For 'phone or CW operation on any of the five lower bands. All holes are drilled in the chassis, all transformers "converted." Just assemble and wire it (about 3 days work), and hook it on the skywire. Truly the rig of 1940! Layout diagram..... \$6.00

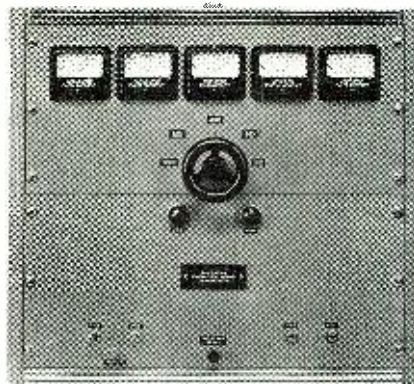

THE HIGH FIDELITY RADIO TUNER..... Complete Kit \$23.57

Just the thing to feed local programs into that new amplifier of yours. Flat response assures that the whole program will get through and will not be cut off at the peaks. So simple that even a tyro can build it. Everything furnished except tubes. All holes drilled and many parts mounted ready for wiring (about 3 hours' work). Uses RCA 6A8, RCA 6Q7, and RCA 80. This unit is self-powered and was designed to feed radio programs to the Full-Range Amplifier recently described in RADIO NEWS. Easy-reading illuminated dial scale included. Layout diagram..... \$1.50

THE QRR "80"..... Complete Kit \$169.03

An adaptation of the Private Flyer's Transmitter for 80 meter ham use. Compact, only 6" cubed, with a 100% modulated carrier output of 12 watts. Includes antenna switchover and push-to-talk relay. Also an airplane type microphone and Carter generator. Weighs only 15 pounds (less batteries) and operates from a 6 volt storage battery. The ideal rig to have ready for that QRR or Field Day operation. Tube lineup: RCA 6J5G and a pair of RCA 6L6's. The kit comes with every hole drilled and many parts already mounted for wiring (can be wired in about 8 hours). Build one of these sets and be ready. Layout diagram..... \$1.50

COMING SOON! The "Super-Streamliner" Superhet Kit!

The last word in receivers... watch for it!

SINCE THERE IS CONSIDERABLE METAL AND MOUNTING WORK, THE ABOVE KITS ARE ASSEMBLED TO ORDER ONLY

[Individualized Credit Terms Arranged]

Above kits sold complete only

NEWARK ELECTRIC CO.

323 West Madison Street

Dept. 4ARN

Chicago, Ill.

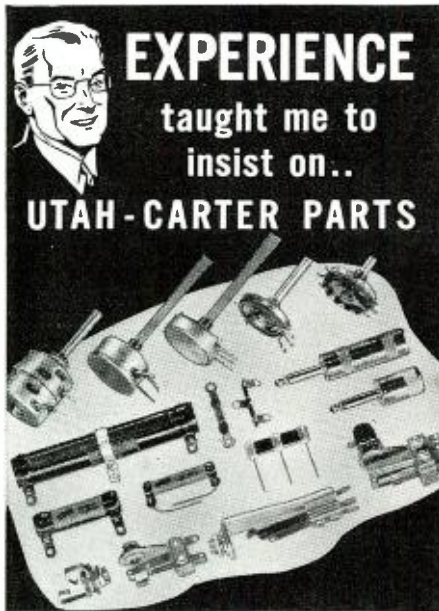

EXPERIENCE
taught me to
insist on..

UTAH-CARTER PARTS

● Hundreds of designers, builders and manufacturers have found that the use of Utah-Carter parts saves time and money—avoids unnecessary replacements. They know by experience that satisfactory performance is assured at every Utah-point in the circuit.

You, too, can have the benefit, with Utah-Carter parts, of more than a decade of experience in the development of resistance units; wire-wound and carbon type volume controls; switches; relays, etc. Utah engineering keeps abreast of all industry developments. And Utah precision manufacturing assures maximum dependability.

Utah-Carter parts are distributed nationally through carefully selected recognized parts jobbers and dealers. Look for the famous Utah trademark on the part or carton. If your supplier can't furnish Utah-Carter parts, write us direct. Utah Radio Products Company, 824 Orleans Street, Chicago, Ill. Canadian Sales Office: 414 Bay St., Toronto, Canada. Cable Address: Utaradio, Chicago.

IT PAYS TO INSIST ON
THESE HIGH-VALUE
UTAH-CARTER PARTS
VITREOUS ENAMEL
RESISTORS
VOLUME CONTROLS
Wire-Wound Type
Improved Carbon Type
POTENTIOMETERS
RHEOSTATS PLUGS
"T" and "L" PADS
LONG and SHORT JACKS
IMPJACKS
JACK-SWITCHES
PUSH-BUTTON SWITCHES
PLUG-IN TYPE D. C. RELAYS



SPEAKERS • VIBRATORS • TRANSFORMERS

(Continued from page 45)

three beam antenna and hrs his transmitter putting out on 28 mc. fone. getting out nicely with a T-21 final.

W2LKG of Beachwood, with a couple of kilowatt rigs on ten and twenty and a fine collection of beam antennas will soon be leaving this location. Mark is a Naval officer stationed at Lakehurst Naval Air Station, and has just received his orders to shove off for sea duty.

W2LIR of Belmar sure has the certain something, morning, noon or night you can hear Mel kidding some sweet young YL on 28 mc. fone. Anyone that would like to get a few good phone numbers or rather call letters just contact W2LIR on ten and he may fix things up for you. Mel is running around 400 watts into a rotary beam and gets into all parts of the country with the greatest of ease.

W2AFU of Lakewood is the chief operator and engineer of the Lakewood police radio station. Elmer sure gets enough radio between the police outfit and his own which runs four to five hundred watts on 14 mc. into a long Vee beam which puts an R9 signal into India.

W2IWI and W2JPU the two brothers of Lakewood have not been heard on the air for a long time.

W2DVM of Manassan ditto.

N2IYS the Naval Reserve radio station at Point Pleasant has not been heard lately. Wonder if it is because they are working on Naval frequency outside of the Ham bands, or is it because some time ago the police department which is located in the same building inadvertently hooked the antenna of the police receiver directly to the transmitting antenna of N2IYS?

THE AMERICAN LEGION RADIO NET is going over with a bang out here on the coast. The c. w. department is a bit slow in coming along due to lack of good operators, however, we are organizing slowly but surely. The net channel is 3669 kc. and skeds are held every Monday, Wednesday and Friday at 0400 GMT.

W6NIF is desirous of communicating with fellows operating c. w. in Orange, Riverside, San Diego and Imperial Counties. (Also San Bernardino Co.) who are interested in this movement. The A.L.N. avoids some fb practise in handling the code, medium speed traffic work, and general improvement of operating ability. There are no strings attached other than to qualify for membership, one has to be over 19 yrs. of age.

The 160 fone division of the net is really a wow out here. Fellows on 160 fone which is supposed to be the black sheep of the ham bands have gone into this with great enthusiasm, and believe me, it's about time some of the "And-uh," "Yowsir," and "I-own-this-frequency" birds on 160 had something better to do.

KEITH C. MATHIS, W4ARX,—the man who never fails—runs in the 4th Dist. Ramblings this month, as usual:—

W4FNY recently went up for class A Examination.

W4FWD says being a "Poppy" sure is not much aid to ham radio. Hi.

W4GKQ is new ham at Lexington, Ga.

W4FBZ is back on air at Washington, Ga. after a long absence.

W4LA is now strutting his stuff on one sissie at Summerville, Ga.

W4FPU, Jacksonville, Fla. is very active on sissie and says that he is using low power.

W4DDK is new ham at Dothan, Ala.

W4CSP at Greenville, S. C. is still on 160 and always is ready for a ragchew.

W4GHO was last heard from on 160 at Salisbury, N. C. and really puts out a fine signal when active.

W4AJD is on 40 meter c. w.

D4W4BOX.

W4CAY is putting out a swell sig on 20 meter phone.

Recently heard W4EPO at Columbia, S. C. on 160 with a very nice signal.

The mayor of East Crisp County (W4GFF) let us suffer a visit with him recently and it seems that a very nice looking y1 was going to be produced for our pleasure but the xyl of GFF's tied a rope around his neck and the other end around her and in that manner kept the MAYOR at home. Then FDJ threatens to tell our red headed six foot tall xyl all that happened on the visit and we are afraid that some diplomatic relations are very strained in our section of the woods. The Mayor and his better half really knows how to serve fried Chicken though even if we did eat six. Hi.

W4GGW of Atlanta recently visited Miami Florida and reports the entire gang very active there. Also visits W4FCW. I have back and tells us that he will have nice increase in power on 160 shortly.

One Editor of this magazine at one time give us the title of Winchell then in last issue hints as to who ever called us such a thing. My dear sir who ever doubts the word of an amateur anyway? Especially a Southern one who is known from all parts of the South for his unusual veracity. Hi.

W4CKE is on 40 c. w. and ready for a ragchew anytime.

W4EEL at Statesboro, Georgia is putting out a FB sig on 40.

W4ENE is also on 40 and has prospects of phone operation.

Are you popular in your own home town? If not, just get on 160 phone and then walk up town the day after you have had a lots of ragchews and get button holed ever few feet with the statement that "Boy, I heard you last night and did you tear up my receiver." Then

you investigate and he has a \$9.99 receiver which some dealer has told him is really the stuff and no matter how you try to break the sad news the bc' just can't believe that the trouble is in his bc set. Hi. Are you this popular Mates? Sad, but tis true; this happens to us every day, Hi.

W4FNW is now on 40 meter c. w.
W4CYO is getting out fb on 40 and really works the DX.

Heard W4CCZ putting out a swell c. w. signal on 40m the other day.

Ask one Atlanta, Ga. ham what he thought about the recent premiere of the well known movie GWTW, Hi.

W4GHW of Damascus, Ga. recently favored your scribe with a week end visit and we did journey over to Lyons, Ga., to see one W4FDJ. Also stopped in on W4ENS at McRae who did tell us that he would re-subscribe to this mag. and that to tell all the gang that he would be back on the air shortly. W4FDJ and his gracious lady; feed us well and the title of *Chicken Eater of Georgia* is still ours. Thanx, Ernest, for a swell time.

W4EWP Portable, Wilmington, N. C. uses a Kwt. on 160 fone. By the way, he was pumping an R7-8 sig up to ex-VE2PF last week.

We got quite a surprise the other nite when we ran across WAOB on 2022 kc. Since when did the Commercials get in the Can. band? WAOB was R9 and was broadcasting music at the time.

VE3QR formerly of Cornwall, Ont. has folded his tent and departed for Calif. We expect that he will be making good use of his 400 watts shortly. Couldn't take it, eh Bernie? *If he's a Canadian citizen, he'll not be a ffb.* Ed)

On 75 XE1GK and another XE1—we were heard on Jan. 6. 1GK was R6. The other R8 but rather hard to follow.

W9ZPK must have some speech amplifier. He was calling C.Q. the other nite and said that he was 40 feet from the mike. Using a megaphone.

W9ZJR says he "put on" a couple of pounds since he quit smoking. Hi!

W9MM landed XE1GE on Jan. 7 on 75 fone. XE1GE was R5 here.

W5ADJ on 160 was R7-8 here in spite of QRM from 1DQK on 1912 kc.

The "Old Cheshire Cat" W1EIU came thru wid a QSL one year after we worked him. Thanks, Duke. We can still hope for some of those W9 cards worked last winter. Hi! De VE2PF.

W9RSO has moved from Webb City, Missouri to Liberty, Missouri where he is attending college. A portable 20 watt transmitter is used in conjunction with a doublet antenna on the 7 mc. band. The first evening on the air 8 districts were worked including the following stations: W5GKA, W9OAY, W8SDL, W8OQF, W2KYT, W3FYD, W4AAO, and W1GUO. The rig uses a single RK 39 in a tritet circuit with 400 volts on the plate.

During the *AZEL go party* W9RSO operated portable with 400 watt and had 310 contacts in 59 sections. All of these contacts were made on the 40 and 80 meter bands. About 18 hours of operating time was spent in this contest.

For the winners we will stick out our neck and do a little predicting—Kansas W9CWW, Kentucky W9FS, Nebraska W9ZAR, Ohio W8OFN, Connecticut W1TS, South Dakota W9POQ, New York City W2IOP, Hawaii K8PAH, Mississippi W3BK, South Minnesota W9VKF, New Hampshire W1BFT, Wisconsin W9RBL, East New York W2EWD, Arizona W6KFC, East Massachusetts W1WV, Oregon W7GPP, Illinois W9VES, North New Jersey W2GSA, Georgia W4AGI, Tennessee W4FCU, Alabama W4EV, Northern Minnesota W9YCR, Maryland-Delaware W3DUK, East Pennsylvania W3BES, Maine W1AFA, Iowa W9LEZ, Idaho W7EMT, West Virginia W8LCN, West Florida W4EPT. This is about as far as we can predict with any degree of accuracy and of course this list is based on the activity of these stations as we heard them here.

W9BRN, W9IMZ, W9RDJ, W9OMG, W9EVP, W9FMZ, and W9FLZ are all outstanding 75 meter phone stations in western Missouri and eastern Kansas.

W9RDJ at Liberty, Missouri, has a kw phone with a very fine antenna system using 3 vertical half waves on 75 meters in a beam array all supported from a tower which is 147 feet high. If any ham wants to build a tower he should see this one first, it's a beauty.

W9EPV North Kansas City, Missouri, has a very fine 300 watt transmitter on 40 meter c. w. using an electron coupled oscillator that has an untuned plate circuit and a vr150 voltage regulator for the screen. The oscillator uses temperature compensation and keys perfectly.

W9BL a prominent Webb City, Missouri, ham is now in Kansas City, Missouri, teaching school.

W5FM is a newcomer to Kansas City, Missouri. He is an employee of the Bell Telephone Company and is operating portable in kc.

W9JWI has a new commercial receiver and is planning to build a new rig using a T240 in the final.

W9TGN in Joplin, Missouri, is active in the NCR. He has a remotely controlled kw transmitter and an HRO receiver.

W9OUD one of the mid-west's outstanding YL operators and SCM for Missouri is doing a good job of traffic handling as well as holding down the responsible job of SCM. She operates entirely on c. w. on the 40 and 80 meter bands.

W9ASV an old timer in Joplin, Missouri, has become active again, this time on ten meters.

(Continued on next page)

Other Joplin hams on ten phone are W9QJE, W9QJP, W9GLQ, and W9TGN.
 DX is very scarce here in Missouri now but some of the gang keep right on working DX anyway. Outstanding active DX hams in Missouri are W9TJ, W9KG, W9NNZ, W9GBJ, W9BEU, W9UYB, and W9LBB.
 DX heard here in the middle west lately includes EA7AY (14,400), J9CA (14,360), TG9BA (14,270), TG9AA (?), and quite a few K6, K4, and XU stations.
 South and Central Americans have been coming in well on the 7 mc. band during the evening but most of them have been using Spanish.
 Anyone wanting to get a QSL card from YN9G will now have to write to him at the Gulf Radio School in New Orleans. *De W9BSO.*

FEW of the Hams in th Northwest section of Detroit set up a complete station at a neighborhood theater where the picture "Everybody's Hobby" was showing. The rig was on the air as portable W8MCB on 160 fone. Quite a neat publicity stunt for amateur radio.
 W8MYG had a new addition to his family recently, the stork presented him with a baby son. There will be plenty of QRM now, anyway congrats Don.
 W8JYH seems to be more interested in ice-boarding at the moment than in Ham radio.
 W8IUD also has left ham radio temporarily, while devoting all his spare time constructing a sail plane.
 W8OOL will soon be all up in the air, but in a plane as he has just obtained his pilot's ticket. He also got himself a new plane.
 Wonder if W8EC plans to get into television, he was heard talking about his 16-inch oscilloscope on the air recently.
 Who said that there is no DX on 160. W8NJP has a QSL to prove it, received it from a listener in England who heard his sigs.
 W8GHV must be working, eating, and sleeping on beams, since last year he has now completed 17 of 'em.
 After being off the air for quite some time, W8AB is back again with a Kilowatt rig. Welcome back OM.

WIGEJ has agn been bitten by the uhf bug and is going full force on 2 1/2 meters. Herbie tells us that he likes it better than the old 5 meter band, also that the dx (of which there is enough to be worked) is much more plentiful. He is also playing wid cathode modulation.
 WIAPK port. Concord, N. H. has a new harmonic. Both baby and father doing fine.
 Next June 13, will be the 30th anniversary of WIAR. Leon's pre-war call was 1LS. He was No. 3 amateur to receive his ticket at the Boston Customhouse. Congrats Leon, and here's hoping we hear u for 30 yrs more.
 Glad to hear WIDFE back on the air agn. Clarence left ham radio two years ago for what he said was "for good." He has a gasoline station in Milton, so when driving thru don't forget to "fill or up."
 WILEU is the proud possessor of a 1940 Super Pro.

Here is some of the 28 meg Dx that is being heard in Boston: ES5X, YV1AQ, YN3DG, CE3AG, CE2cz, CELAH, YV5AK, K60QM, KA1ME, KA1ML, K6MZY, LU1DJ, LU2BG, TG9AA, TL2RC, TI5AV, OQ5AB, EA7BB, PY1AZ, HA1K, XE1QE, XE1CQ, HC2CG, HC2CG, HC1JB, also two J's were heard but wid low signal strength.
 WILWD is with the Byrd expedition. Good luck Elmer, and PSE QSL, hi.
 WIHDJ is employed in one of the local banks. (No he's not the office boy.) Now Freddy will be flooded wid requests for loans. Hihi.
 WIKSA has sold his 500 watt rig and is now operating portable on ten from his store, using abt 10 watts to 6E6. Joe runs a combination radio-barber shop, and is doing fine.
 Sorry to hear that W1JPI is selling out, hpe u will be on the air agn sn.

WICIB has a nw slogan, it's "Casa Manana." (House of tomorrow) George explains it this way—"Never do today what you can put off until tomorrow." He is building a new rf section to use on all bands. His present unit will be for 10 meters and the new outfit will operate from 160 thru 20. George's xyl was overheard the other night saying that she'd rather take to the gun than go into hamradio. Hihi.
 Heard 3GQG the other morning on 10, coming 3-9 plus, one of loudest stations on the band, only to learn that he is running 9 watts to a 19 with a 3 el rotary antenna, all battery operated. George is planning to increase power and purchase a new Windcharger.
 W1JGN recently bot a telephone pole on which he was planning to put a rotary. He invited several of the boys down for the pole raising. They sn found out that the pole was oak and it would need a crew of men to erect it. So now Tommy has his beam on his roof and plenty of wood for his freplece. P. S. Just found out that Tommy got a gang of fellows from his shop and they got the pole up. Good luck Tom.)
 WIIM has a five element beam on ten, but is having trouble wid standing waves. Knowing Jack's ability he'll have them eliminated in short order.

W1GR worked ON4HS for abt 41 times in a row, on 75 meter fone.
 W1GER is jumping between 160 and 75 meter fone and gets out surprisingly well for the low power he is running.
 W1GFO on 29,000 kc, is on every Sunday morning and (8 a.m.) is looking for stations in Boston or vicinity that need his state for 28 meg waas.
 W1GDS is agn active on 80 c. w. Lou is in the market for some band spread coils for his FB-7.

WILSV is a portable mobile station in a trailer called the "Continental Clipper." Myron operates on ten fone and puts in a swell signal up here in the 1st district. At present he is touring New Mexico. Has anyone info on VP2BG, 14,100. He's on early mornings and sounds like a phoney.
 Heard KA1RV the other day on 20, in the middle of the phone qrm-Q5 R9. Running only 20 watts to a 1/2 wave doublet. Proving agn that u don't need a KW and a six element rotary to be heard even in these modern days.

W1JZ has a new RME-70. Her 2nd 70. The first rcvr was bashed up in shipping.
 W5ERV would like to hear from any hams over 50 years of age. Sam is 52 himself, and is planning on organizing a "50 Years or Over" club. Up to date 82 years of age is tops.
 W1IIM is carrying on weekly skeds wid 11Z port' marine in the Caribbean sea. AIZ is running abt 9 watts to a 6L6.

W9SBV was on the Fox Pop program on Jan. 18. Frank who is a policeman was chosen as the typical cop of America for 1940. While on the program he was introduced to another cop who turned out to be a W2, whom Frank has spoken to many times, but never seen.

WI1G the "Impatient Young Girl" rec'd a dynamic mike from his xyl for xmas and he'll live it on sn. BCL trouble has been keeping Jimmy off the air of late. Jim used to live abt 3 doors away from W1KZD, but they didn't contact each other until Jim moved away. Pat works down at *Harvey Radio*, and likes the work there a lot. (That's something unusual.)

W1MGQ takes care of a local skating rink where a flock of the hams and students from Tech (M.I.T.) hangout.
 W13FJU is the fellow to get hold of when ur thinking abt antennas for the lower frequencies. He's on 75 fone and usually plenty occupied.
 W1LWI is pounding brass on 40 and 80 He's rebuilding his superhet to go up to 160 to get on the "Farmers Net." He's running 1/2 KW to 35Ts.

The 2 1/2 meter gang here in Boston meets every Tuesday evening at the *Chez Vous*, a popular skating spot locally. The attendance is very good because of the vl situation.
 WISS wkld 87 miles to the Cape on 2 1/2 wid 14 watts input to a 6E6. 1LAT, 1LEM, and 1MAY all active on 2 1/2. are building ten meter rigs to get a crack at the DX. (?) [All are W's. Ed.]
 W1JTG has left 10 for 2 1/2 to take part in the UHF contest. Many a 5th district vl will have a tear in her eye while Charlie is off.

W1MKV operating on 160 fone is the newest 1st district call out. Al rec'd his ticket 1/6/40. His rig consists of Hy-25 in the final wid abt 33 wts inpt.
 W1BDM is giving French lessons to W1HWV.

(Continued on next page)

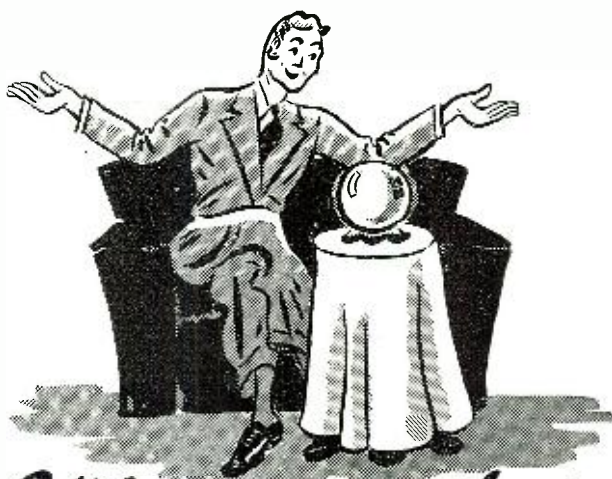

What's your future in Radio?

You don't need to gaze into a crystal globe—just look around you. There you will find the answer. Television—radio facsimile—Electronics in industry, these and other developments in your own business are crystallizing right under your very nose today. Here lies the future of the servicing industry, here lies *your* future in radio . . . IF you are ready to capitalize. Be sure you are prepared by learning all you can about the basics which underlie television, radio facsimile, the cathode ray tube, photo electric cells, etc. You'll have to know as much about these developments as you know now about a superhet—OR ELSE see the most profitable part of your business go to a competitor. The radio business is not fixed, it is progressing, and for those who want to be "ready" we suggest a careful reading of the contents of the books listed below. Order today.

SERVICING BY SIGNAL TRACING
by John F. Rider

Use the system of servicing which is proved and endorsed—the system which is fastest—most modern—the system you can apply to all receivers regardless of age, type or make. Servicing by Signal Tracing operates independently of every limiting factor heretofore encountered. In this new book you learn how all receivers are brought to a common servicing level. You learn how components receive a functional check while the circuits are in an operative condition. Read this book and you will be able to service the most complicated set with greater speed and less effort.
 Over 360 pages—hard covers—only \$2.00

THE OSCILLATOR AT WORK
by John F. Rider
 Just Off the Press!

Get your Money's worth—KNOW! This new book tells all about ALL oscillators. It explains the theory by means of simple illustrations, diagrams and curves. It gives you the practical facts you need to combine theory and practice. Get your copy TODAY! 256 Pages—Illus., \$1.50

THE CATHODE RAY TUBE
by John F. Rider

This is the most complete and practical book ever written on the subject—the only one prepared especially for the radio serviceman. New applications of the cathode ray tube during the past five years require that servicemen know its operation, characteristics and performance. 336 pages—over 450 illustrations \$2.50

AN HOUR A DAY WITH RIDER BOOKS—hard covers—60c

- On *Resonance and Alignment*—Clear explanation of what happens when circuits are tuned to resonance. 96 pages—48 explanatory figures.
- On *Automatic Volume Control*—Chock full of the stuff you need to make your AVC work profitable. 96 pages—65 illustrations.
- On *D-C Voltage Distribution in Radio Receivers*—Theory and practice of D-C voltages—how they are led through various types of networks to tubes. 96 pages—69 illustrations.
- On *Alternating Currents in Radio Receivers*—Explanation of behavior of radio-frequency currents in receivers. Illustrated with diagrams and drawings.

—AND IF YOUR LIVING DEPENDS UPON REPAIRING RADIO SETS

you can depend upon Rider Manuals for complete, authentic data on radio sets issued from 1920 to the present. Be sure you have all ten volumes. Order any missing numbers today.
 Volume X just out. \$10.00



JOHN F. RIDER · Publisher · 404 Fourth Ave., New York
 Export Div. · Radio Int. Elec. Corp. · 100 Varick St., N. Y. C. · Cable: ARLAB

A MARVEL OF ADVANCED RADIO ENGINEERING

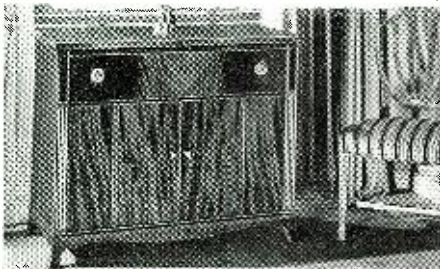

NEW 1940 Custom Built PHILHARMONIC BY

Scott

Long acknowledged "the World's Finest Radio," the new 1940 custom built Scott rises to even greater heights of engineering development and performance. It is guaranteed to give you finer tone, clearer, quieter reproduction of broadcast or recorded music, higher fidelity, greater undistorted volume, wider long distance range . . . is laboratory built and tested with greater precision than any other radio receiver in the world or your money will be refunded. A long and ever growing list of famous musicians (including Toscanini, Barbirolli, Heifetz) have honored the custom built Scott by choosing it above all others for personal use.

BUILT-TO-ORDER BY HIGHLY SKILLED TECHNICIANS

Skillful Scott technicians hand build these superb instruments from materials of finest quality to the most exacting

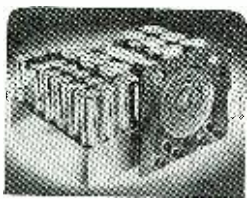

standards known to advanced radio engineering science. The result is an ability to perform that to our knowledge

is more sensational than has ever been attained in radio or record reproduction. Yet the magnificent Scott can be yours for surprisingly little premium over many standard production instruments sold in retail stores.

EXCLUSIVE SCOTT DEVELOPMENTS

Many features available only in Scott receivers are developments of our own engineering laboratories. These are combined with the best general developments in advanced radio design. Here are a few of many desirable features: Record scratch suppressor • 6 noise reducing systems • undistorted Class A power output 40-60 watts • overall fidelity 30 to 16,000 cycles • Continuously variable selectivity 2 to 16 KC • 6 wave bands 3.75 to 2,000 meters including ultra high frequencies.

A FIVE YEAR GUARANTEE!

90 days is the standard guarantee adopted by the radio industry. The custom built Scott, however, is guaranteed for 5 YEARS! A full month allowed for home trial. Extended terms if desired (U.S.A. only). Sold only direct from our laboratories and studios. Get all amazing facts and details of savings you can make by ACTING NOW!

Special Offer • Send for It Now!



Name
Address

Studios: CHICAGO, NEW YORK, BUFFALO, DETROIT, LOS ANGELES

(Continued from page 47)

Admiral Byrd, by the time this goes to press, will be set up and ready to work the hams. They will be on the low end of the 10 meter band. We get it from some of the boys that you must point ur beam north to work the South Pole.

WIKTG is back on ten fone after an absence of abt 2 yrs. You've probably seen her picture on the back cover of *R.N.* in the *Hallucifer* ad. Bee won one of their rcvrs at the *Boston Ham-fest* two years ago. Incidentally, I worked Bee as my 1st c.w. contact on ten. The qso was vy short cuz I couldn't get what Bee had to say and I don't think she got what I had to say. Well, I haven't touched the bug ever since, so my fist is just as bad, but Bee I don't dare say improved cuz it mite hve bn my lack of knowledge of the code) certainly can take it from the best of them. Bee, by the way, writes a column for one of the Boston newspapers.

WIHGJ just came up on ten meters and is using, of all things, a pair of 45's with abt 40 watts input and a *Johnson Q.* Paul plans a larger rig and a more elaborate antenna system for the very near future.

WIDRL is bldg a nw speech amp for W1GOU. We hrd it during its experimental stages and it does a very fine job of reproducing Ernie's voice.

W1BKH is playing around with cathode modulation, and having a few headaches but says he likes it a lot.

W1BDM recently came on ten meters with a few hundred watts to a pr of 35T's. Joe was on five until he got a wavemeter from LMB. He's now looking around for the "best" antenna. As soon as the boys get on 10 the first thing they look for is an antenna.

W2BMK located in N.J. is coming thru on ten. Vy short skip.

W1KJJ up in Kennebunk, Me. is being hrd in the old Bean town Sun. morns, about Q5-R6.

W1KWC worked W1GOU on the sked we mentioned 2 mos. ago.

The local boys on ten are organizing a net of NE states. They meet early morning before the long (?) skip comes thru.

W1KEX and JUJ, both located in N.H. r coming thru on ten.

More on the NE net. GOU (Boston), KTF (Conn.), LYH and KSB (Boston), EHF (Framington) were in a seven-way contact with 2QF and 2BMK in N.J. KTF is the key station. [All W1's.—Ed.]

W1KSF's beam fell down and he had elements, screws and nuts strewn all over the place. Norry spent New Years day putting up a new antenna which he hopes will stay up.

W1LSW has a tower and beam which is really put up to stay. Si purchased one of those towers that the electric company uses to pipe A.C. across the country, and installed it in his backyard on a 6 ft. concrete foundation. It is 60 ft. high.

W1HVW has changed his old rig (only abt 2 mos. old) and has put in an 812 in the final. The tube was a birthday present from Sam's g.f. (Incidentally, if u tho the 809 was a good tube, wait until u try the 812.) This is the 4th rig Sammy has had in the few months he's been on the air. He runs a radio repair shop in Dorchester, and there's always open hous there. Sammy worked a station in Fla. the other day, and the attraction was three y's. He's determined now, more than ever, to pack up and move down South.

W1KJD and LZB (brothers) are on 20 c.w. and 2 1/2 fone.

The *South Shore Radio Club* has a f.b. bowling team and plays other clubs in Prov., Taunton, Brockton, and as Ernie, GOU, says "gave them a trimming."

JNV is on 40 c.w. since the DX contest. W1LMB and LEU are going down on 2 1/2 meters with low power.

W1HDJ is bldg a port 160 meter job for the summer place in the country. He is also that way abt bowling. The sig sounds f.b. since u put in the new Xtal mike Fred.

W1AJA recently went to the movies wid DNL and saw "Real Glory." Near the end of the picture the hero met a barbarian, called something that sounded like Alli Pang. The only means of defense the hero had was an empty revolver. George (AJA) became vy excited and having become vy attached to the hero, jumped out of his seat and shouted the following advice. "Hit him on the head with the gun, you dope. Hit him on the head!" The hero, heeding George's call did as he was told but succeeded only in stunning the barbarian. George agn leaped from his seat and said, "Hit him agn. Hit 'im harder this time and finish him" and the hero so did. The audience applauded loudly as our director friend and DNL left the theatre.

SAYS W6PTJ:

Have been a consisten reader of RADIO NEWS. For the last few years and consider it one of the best. Since the *Hamchatter* column has been going I have noticed that the W6's have been very absent in it's column so decided that I would get busy and dig up a bit of Ham news about the gang out here on the West Coast. So here it comes—good, bad, or indifferent.

W6RCD is one of the high scorers in the recent S.S. contest sponsored by RADIO magazine. I believe his score was in the 89,000's. All on phone.

W6PYA is still active on 40 meter c.w. When are you going to get up on 10 meters, like you have been planning to DYM? Here's hoping we see you up there soon.

W6OIM is another guy that has deserted the "Ham" ranks for the time being. He works for the *Bendix Aviation Corp.* in the radio division and it keeps him busy. It won't be long before he gets that old urge again—they all do—and

then maybe we will see him back on 10 and 20 meter phone again, so don't make us wait too long. Bill.

W6LFN just had a pole blown down which makes the fourth or fifth since I have known him. I wonder if it is the way in which he guys them or is it actually the wind. Hi. Allen is active on 10 and 20 meters and lately is helping to repopulate 5 and 2 1/2 meters. Allen is also portable-mobile 10 meters, but so far hasn't had much luck. He has had good luck tho on 2 1/2 meters portable-mobile, having worked 80 miles and getting an R8 report. Here's hoping you continue to work them, Allen.

W6BP, the old brass pounder is still active on 10, 20, 40, and 80 meters both phone and c.w. Bab's is commercial op. at one of the local government stations handling fruit and vegetable market reports. A swell guy and one of the old-timers in ham radio.

W6QGI is active on 10 meters only at present with about 400 watts of r.f. and with a rotary beam antenna on a 50 ft. tower that a hurricane would have a hard time blowing down. And does George work the DX when its being heard. He has kept a schedule with an Xu in Shanghai, China for over 40 days without a miss on 10 meter phone. Some sort of a record, I'd say.

George just told me the other day that he intends to get up on 5 meters soon, so here's hoping we see you soon, because 5 meters sure needs to be repopulated out here in Los Angeles.

2 1/2 meters is going strong out here in L.A. Understand that there is 50 or 60 fellows on. I presume that means in L.A. and vicinity. Have not the full list of fellows on 2 1/2 meters, but in the meantime will give all the dope I know.

W6RVL is running a little over a 100 watts, cathode modulated and really works out on 2 1/2. He has worked San Diego which is about 130 miles south of L.A. Incidentally, W6RVL sure plus Los Angeles with his call, always announcements "This is W6RVL, Radio's Voice of Los Angeles." Not bad, eh?

W6OIN in San Diego is portable-mobile on 2 1/2 meters and works quite a few of the fellows, both in and around San Diego and L.A. Usually is heard operating from Mt. Soledad near San Diego. Will try and get more info on 2 1/2 meters for next time.

Heard W6ECC "Every Cent Counts" on 5 testing the other day and really putting out a fine signal. W6ECC is also quite active on 10 meters. Ernie is a teacher in some school here in L.A. and is a swell fellow to qso with.

W6QKM on 10 meters and 160. Don is a student at U.C.L.A. and just got initiated into some fraternity a few weeks ago. Hope you got over the initiation ceremonies o.k. Don. Hi.

W6GZZ, W6LSN, W6QZN, W6QVV, and W6RKT are a few of the fellows that are quite active on 10 meters at present.

W6LFN, W6LSN, W6GZZ, W6PAP, W6QAZ, W6NAT, W6LR, W6RCD, W6PTJ, and W6ECC are just a few of the fellows out here in L.A. who are portable-mobile 10 meters.

There are quite a few more portable-mobile rigs here, but as yet I don't know all the calls. Will see if I can't get more mobile info for next time.

W6PTJ at present is exclusively portable-mobile on 10 meters and has been having a lot of fun and luck mobile. He has worked 25 states and made approximately 75 contacts outside of the state of California. All these contacts have been made in the last three months, operating only on week ends. Len has worked the states of Maine, Vermont, and Maryland in his group of 25, which are hard states to work for mobile rig. His rig is a 6F6 oscillator, 807 final using 10 meter crystals, modulated with 605 speech, 6N7 driver, 6N7 modulator. At present running 19 watts and feeding his 1/4 wave rod with Basnet 34 ohm impedance characteristic line. Len says he gives all credit to his concentric line for putting his signal out so consistently. He also has worked the K6's with R9 reports. Len's rig also works very nicely on 5 meters, but at present has no 5 meter converter in the car. He has also built up a 2 1/2 meter rig, using a linear tank circuit with an RK34. Hopes to run 10 or 15 watts output mobile with this rig.

Well, that's all the dope for this time, gang, so 73's fm W6PTJ.

BY W7FHC of Luther, Montana:

The seventh District hams will hold a convention at Salem, Oregon, April 20-21 and expect to have a good turn-out from the 7th & 6th districts, however, hams from other districts are invited also. For programs and further particulars write to W7DZT (E. D. Roseman), 2557 Lee Street, Salem, Oregon.

W7FDL of Basalia, Washington, has been getting over into Montana in fine shape lately, and reports that ten meter band which he also works has been pretty slow lately. Also that he has about got his ten meter antenna up again after the milkman's truck had a runaway backwards and broke it down. Antennas seem to be hard to keep up, don't they, boys. If we just had some good solid sky-hooks that would be something that would hold them—whats-U-think.

W7HFF of Helena, Montna, was off the air from June to November, and is working out fine now using a Zepp antenna. Reports having worked W9VRT and W9LYM at twelve o'clock noon, which is not half bad. He also has motion pictures as his hobby No. 2.

W7FXO of Scooby can be heard on 160 in the wee small hours of the morning working the "Hot Shot Gang" across the U.S.A. on around 1860 kilocycles.

W7HLZ of Helena has moved to Oakland and we have been straining our ears to hear him from here but no luck yrt.

W7CGL one of the old timers on cw is on

phone from Billings, Montana. Has a HK24 in the final and is working out in fine shape.

W7EYR of Caldwell, Idaho, has about 190 watts on 160 Phone now and is expecting to work some dx east soon.

W7FKY of Billings, Mont., is on the air now with a good husky signal but is not on very often till after ten P.M., account of p.c.l. trouble. The same applies to W7DAJ of Laurel, Mont., only he is on Monday night earlier for Army Drill.

Speaking of army drill there is a movement on foot or maybe I should say, in the air, to change the Division W of the Colorado Phones from the Eighth Corps Area to the Ninth Corps Area.

W7CBL of Casper, Wyo., one of the old time c.w. men who is now taking a fling at 160 meter phones, seems to have a xtal on 160 on a lively spot for qrm and when the qrm gets too heavy on his 160 frequency he just jumps to 80 c.w.

W7GRP of Milto, Oregon, is putting a good husky signal over the continental divide to Montana lately. Wonder what he is using out there now?

W7GZI Portable of Cheyenne, Wyo., has been working quite a lot of dx lately since he rebuilt his rig.

W7HKJ of Twin Falls, Idaho, is coming in about the best of any of the Idaho stations at the present.

Yes, sir, just as I predicted, W7HUS of Dillon, Mont., hit the trail back to Watford City, North Dakota, and I have heard the old Lone Wolf of the Badlands howling again at dawn from Watford City.

Had a dandy qso with W7HSJ of Beaverton, Oregon t'other morning and he sure has a fine sounding rig on the air now.

W7FHC "The Old Bear of the Beartooth Mountains" of Lathrop, Mont., in the "Land of the Pink Snow" has been experimenting with power supplies has three different kinds now separate excited a.c. generator run with hi-speed s.e. engine, one 32-volt gene-motor and 6-8-volt vibropack. Would like to have dope from any other ham that has had any luck building a receiver to work on 32 volts using the 32 volts for filament and plate voltages.

W7CDF "The Old Man of the Mountains" formerly of Roscoe, Montana, but now of Absarokee, Mont., reports that they have a new son. That's probably one of the reasons that he is not on the air at present.

W6QUA of Los Angeles, Calif., is now located at Cody, Wyo., and is working portable from there on 1995 kc. At the present time has about 30 watts on the air.

W7FFW of Cody, Wyo., has not been on the air as much as formerly lately owing to working so much overtime.

-50-

Modernizing Receivers

(Continued from page 29)

(R2-C10) and (R3-C11). Each r.f. plate return lead also has a similar filter, (R9-C16), (R10-C17) and (R11-C18). The cathodes are isolated from each other by the "minimum" resistors, each 275 ohms (R-6, 7, 8) and individual .1 mf by-pass condensers (C-39, 40, 41). The first r.f. cathode is connected to a 25,000 ohm variable resistor (PR-5) as a sensitivity control for that stage. The 2nd and 3rd r.f. cathodes connect to a second sensitivity control (PR-1), also 25,000 ohms. Independent control of the first r.f. stage sensitivity is important because this stage can usually be used at full capacity at all times, while the other two stages can be set at an intermediate value to prevent overloading of the last stage. All r.f. by-pass condensers must be of high quality low loss type.

The screen grid voltage is taken from a voltage divider (R-4 6000 ohms) and (R-5 5000 ohms) across the B supply. An alternative method, preferred by some designers consists of series grid resistors and filters direct to the B supply. The first method mentioned detracts nothing from the r.f. amplifier performance because for DX work, the bias adjustments are such that the screen grids are maintained at practically constant voltage with respect to the cathode and full benefit of the long cut-off characteristic of the 6K7

tubes is obtained. This is helpful.

Distortion in the r.f. amplifier is excluded by the use of three stages, each stage ordinarily operating substantially below its full capacity. Two r.f. stages operated at full capacity will give very substantial gain, but with possible distortion and with insufficient tuned circuits to provide the maximum selectivity required.

The problem of sufficient selectivity varies greatly with the individual geographical locations involved and can be simplified substantially by using directional antennae or loops as outlined in the preceding article (March, 1940, RADIO NEWS, p. 19).

The detector circuit consists of a 6H6 diode arranged for half wave rec-

NEW Radio CHASSIS CRADLE

Makes Bigger Service Profits!
ALL METAL FOR FINER, FASTER SERVICE!

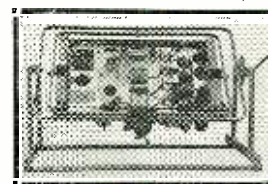

Every service man and shop needs this RADIO GEMBA L (Chassis Cradle) for efficient service work. Made entirely of metal, attractive finish, strong, durable light-weight. Perfect, practical way to handle testing and repairing of receivers or amplifiers. Equipment clamps to cradle which is adjustable to any angle. Excellent way to display receivers.

Write TODAY for illustrated circular.

WM. A. THOMAS CO. ★ ★ NEENAH, WISCONSIN

World's Leading Hamchatter Column is in RADIO NEWS.

25c at your newsstand.

JUST OUT! ALLIED'S Spring CATALOG

EVERYTHING New IN RADIO!

FREE ALLIED RADIO Spring & Summer 1940

"Everybody in Radio will want this new 172 page ALLIED Catalog—it's tops in its field, take it from me..."

"Whether it's Parts, P.A., Test Equipment, or Radio Sets—you'll find everything you need in this book—at lowest prices!"

MORE THAN 60 NEW SETS

• Servicemen, Dealers, Amateurs, P.A. Men, Builders—you'll want ALLIED's new Spring Radio Catalog. It's the complete answer to all your needs — an easy-to-use book that lists Everything in Radio. You can't afford to miss the new developments in Test Equipment, Public Address, Amateur Receivers, Home Radios and Parts! And don't miss the big special Bargain Section!

NEW PUBLIC ADDRESS SYSTEMS

18 new Public Address Systems—6 to 70 watts—for Electioneering, Orchestras, Schools, Churches, rental work, etc. America's finest Sound Systems at startling low prices. New exclusive features—new P.A. applications. Complete accessory listings—new recording equipment, etc. Also P.A.'s easiest Time Payment Plan! See it all!

NEW KITS—HAM SETS—TESTERS

Servicemen—see all the new Test Equipment—new service gadgets, etc. Amateurs—get the "low-down" on new Amateur Receivers and A BIG EXTRA SURPRISE, Builders—there are dozens of brand new exciting kits—easy to build—low in price. You'll find Everything in Radio—more than 15,000 quality Radio items—in ALLIED's great Spring Catalog.

We can supply complete the Radio News Uni-control 5 Band Phone—CW Transmitter described on page 20 of this issue. **WRITE FOR COMPLETE QUOTATIONS.**

ALLIED Radio CORPORATION

Send for **FREE Catalog!**

ALLIED RADIO CORP.
833 W. Jackson Blvd.
Dept. 1-D-O Chicago, Ill.
RUSH me your FREE New Spring Catalog.

Name

Address

City.....State

ANNOUNCING!

NEW

MALLORY

VF-223 FILTER UNIT

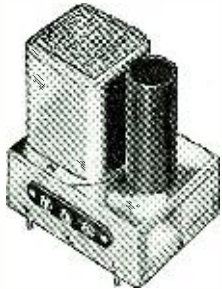

A new audio or hum filter unit, the Mallory VF-223, is now available for use with all single unit Vibrapacks. Designed especially for applications where voltage

regulation is important, as in Class "B" Audio Amplification; or where the utmost in hum suppression is required as in high gain amplifiers, the VF-223 provides a truly deluxe filtering system.

The filter condenser is a three-section Mallory FPT-390, of 15-15-10 mfd. capacity, 450 working volts. The two 15 mfd. sections are used with the choke to form a conventional pi-section filter, while the third 10 mfd. section connects to a separate terminal so that, if desired, a filtered intermediate output voltage may be obtained. The filter choke is rated at 100 m.a. and has a d.c. resistance of only 90 ohms, resulting in a minimum of voltage drop.

Here is the quality filter unit to use with receivers, transmitters, high gain amplifiers and scientific apparatus. See the Mallory VF-223 Filter Unit at your Mallory-Yaxley Distributors.

Be sure you have your copy of Form E-555-B which gives detailed technical data on Mallory Vibrapacks.* Invaluable to all interested in battery-operated apparatus. Available without charge from your distributor, or write . . .

P. R. MALLORY & CO., Inc.
3029 East Washington Street
Indianapolis, Indiana

*TRADE MARK REG. U. S. PAT. OFF.



tification and AVC. The values of the AVC circuit are such that only a comparatively limited amount of automatic volume control is obtained, but providing response over a wide range of signal strengths with minimum or no distortion.

The audio amplifier consists of a 6C5 first audio, two 6C5 in interstage push pull for the second audio, all class A, and the output stage of two 6L6G's in push pull. The latter can be adjusted for class A or any intermediate condition between pure A and AB. The former gives an undistorted output of about 12 watts and the latter up to about 24 to 32 watts with no noticeable distortion. For most conditions the first two stages operate below full capacity and as strict linear amplifiers. The advantages of push pull audio amplification are well known and these favorable conditions are obtained in both the second and output stages. Ideal reproduction is obtained when the volume approaches the original rendition, and this means peak output of around 30 watts should be possible.

Inverse feedback is applied to reduce frequency distortion to an absolute minimum and is obtained at a sacrifice of output, for a given input. However the first and second audio stages provide sufficient new gain and full output can be obtained from the output circuit, by applying higher input signal voltages.

From the information given it is obvious that a discriminating customer cannot be expected to accept a sour sounding installation on the basis of performance curves which indicate perfection. In a similar manner if the trained musical ear indicates realism, curves to the contrary should be disregarded.

The advantages of a volume expander are fully appreciated but same has been excluded from this design because it is a possible source of distortion. An alternative method of securing required volume expansion for record reproduction will be described in a subsequent article.

As previously mentioned the fundamental circuit can be altered in several directions to meet individual specifications for smaller sets. An alternative detector circuit is shown in Fig. 9D wherein a 6Q7 is used as a combined diode detector AVC and first audio stage to save one tube; then feeding into a second audio using a 6C5. From this second audio the input push pull transformer may be connected to either 6V6's or 6L6's.

A smaller power amplifier using only one first audio (6C5) and two 6V6 or 6V6G's in push pull, self biased for class AB, with inverse feedback, providing an output of 8 to 13 watts, is also shown.

The tuning indicator for a three stage r.f. amplifier should be a 6G5/6U5 and for a one or two stage r.f. set, a 6E5. The new 6AE6G single grid twin plate control tube can be used with the 6AD6G or 6AF6G cath-

ode ray tuning indicators wherein one shadow has high sensitivity for weak signals and the other shadow has a remote cut-off characteristic for strong signals.

It is interesting to note that in certain foreign countries all radio manufacturing facilities are being devoted exclusively to war time needs. Accordingly the matter of modernizing becomes increasingly important as it is the only means to keep up with improvements becoming available, at the present time. -30-

Junk Box Hurdy-Gurdy

(Continued from page 7)

measured 21" x 13" x 10" into which was cut an 11" hole for speaker outlet. The port below puts this in the Bass-reflex class. The theory being that in order to produce low tones from a dynamic speaker, sufficient baffle must be provided to keep these tones from canceling. This would require carrying some 10 feet of baffle along, so instead the bass reflex is used which encloses the back of the cone in a box, and by properly locating the hole in the front, under the speaker, the sound wave coming out of it at low frequencies will be 180° out of phase with the radiation from the back of the cone, and thus will reinforce the wave coming from the front of the cone. Low frequencies on this outfit really cause the floor to vibrate in a big way to testify that the theory is sound. The other box measures 18½" x 13¼" x 10". The diagram really gives about all the constructional data that is required, but as there are always a few constructional points that come up during the production of such a job, I might as well call them to your attention now.

Note that the 180 tube may be seen projecting through the base board of the phonograph unit. The transformer is located in the front right of the case as far away from the magnetic pickup as possible to avoid hum. In this position there is no hum while playing, but if tone arm be swung around so that pick up comes above transformer, it really picks up plenty. The tube being exposed, makes it easy to replace, and to see when it needs replacing. The cable going over to the left is the 110v a.c. input line. The cable going to the right is 6 ft. long and plugs into the amplifier. Old tube bases and sockets being used for this purpose. The two small wood stops on the inside of the lid act to hold the tone arm in place on its rest when being transported. The drawing in the lid is carried along "just in case." The volume control is on front of amplifier between cords. The tubes are in a row across the back with the 227's left and the 245's to the right. The tubes, resistances, transformers, condensers, all came out of the Zenith chassis except the pick-up matching transformer, which is an old RCA and may be purchased for less than two dollars new.

You will note that the Zenith set was

transformer coupled originally, and so I made it up, expecting to purchase a crystal pick-up to feed it properly. However during the process of construction the old magnetic was tried and found to be perfectly all right, making no need for buying any new equipment, and with no provision made for the mounting of the matching transformer, removed the inter-stage push pull transformer, substituting resistances, thus making room for the mounting of the matching transformer. The unit seems to perform just about as well one way as the other. Originally used small blocking resistors in series with the plate resistors, and connected in bypass condensers. These are shown in dotted lines, also cathode bypass condenser for first push pull stage. A good authority tells us that it is undesirable to make the low frequency response any better than actually required. This is because the better the low-frequency response the greater will be the difficulty from regeneration at the low frequencies. This was found to be quite true, and required the removal of these three condensers to stabilize the unit.

One of the diagrams indicates how the amplifier and its twenty-foot connecting cord is packed in the speaker box when ready to travel. Note the small slot in the upper left hand side of the box. The cord passes through this slot when the back is in place and the amplifier out and in service. The object of the small block is to press against the volume control button, thus holding the amplifier unit in place, while the cross piece fits over the top of the condenser case and keeps the unit from sliding.

The young lady did not move far with it however, as you may note the look of surprise on her face when she found that all she could do was to lift them. One weighs about 55 pounds and the other about 65. Handled singly, however, they present no problem, and may be thrown into the back seat of any car. In the case of the speaker box, might say that in its construction, all must be heavy and tight, otherwise the strong bass notes will resonate it at some point, and it will sound like its going to fly to pieces whenever the right note is played. A little glue and care will cover that point, however. The box coverings and all hardware were purchased from Montgomery Ward for \$6.25. This makes a low-priced unit that you don't mind scratching some time in transit, and yet will always be well-liked by all.

-50-

Full Floating Tube Tester
(Continued from page 17)

the leakage testing position *before* the tube is plugged in to avoid possible damage to the tube on account of incorrect switch settings. If switches are incorrectly set at F1 and F2, the neon lamp will indicate a short circuit

and no damage will be done. To test for leakage each of the test switches is connected singly to the negative line, which will check each element for leakage from all other elements. With the shunt control at the correct setting, throw the DPDT switch to the "Test" position, press the test switch whose number is listed in column "K" and the emission current will be registered on the meter. Those tubes listed with an "O" in column "K" are filament type, and are tested as soon as the DPDT switch is thrown.

Special attention should be paid to those tubes with tapped heaters, and the correct circuit switch thrown in the "Off" position. Tuning indicator tubes may be tested for shorts and leakages, and if desired an emission

RAD O plus
TELEVISION -mastered by pre-tested Training

No matter where you are or what you do, National has a complete training plan for you—to fit your circumstances. National's plan is for those seeking immediate shop-training as well as for those who cannot give up present employment and income. Mail coupon below. Find out how you can get the finest in radio and television training.



NATIONAL SCHOOLS

NATIONAL SCHOOLS, Dept. RN-4
4000 So. Figueroa St., Los Angeles, Calif

Please send free Literature and full details.

NAME _____ AGE _____

ADDRESS _____

CITY _____ STATE _____

First with the latest developments—
RADIO NEWS!
Make it a habit every month.
25c at the newsstand.

SOUND TIPS ABOUT THE SOUND THAT'S TOPS



MATCHED commercial sound products are as important to your customer's use and satisfaction as matched skiing equipment is to the fellow in the picture above. Because by offering "matched" equipment, you can easily present a more convincing sales story to prospects.

Co-ordination of design is one of the many reasons why it will

pay you to recommend RCA Commercial Sound. Every unit—from the smallest microphone to the largest sound distribution system—is designed to operate perfectly with all other units. And that's the sort of performance efficiency your customers will gladly pay for. The sort of efficiency that means increased sales and profits for you!



For finer sound system performance—use RCA Tubes

Will Send My FIRST LESSON FREE



**It Shows How I
Give You Training
at Home to GET A
GOOD RADIO JOB**

J. E. Smith, Pres.
National Radio
Institute
Estab. 25 years

Salary
In-
creased
\$1,800
Year in
Radio

"I have been regularly employed in radio since my graduation. I have been Chief Engineer of three broadcast stations, and at present time am Chief Engineer of WDDO. My salary has increased \$1,800 per year since entering radio and credit is given you for your excellent training." **JULIUS C. VESSELS**, Station WDDO, Chattanooga, Tenn.

\$10 to \$25 a Week in Spare Time

"I am now making from \$10 to \$25 a week in spare time while still holding my regular job as a machinist. I owe my success to N. R. I." **W. M. F. RUPP**, 61 Green Street, Bridgeport, Pa.

\$3,500 a Year in Own Business

"After completing the N. R. I. Course, I became Editor of the Buffalo Courier. Later I started a Radio service business of my own, and average over \$3,500 a year." **T. J. TELAAK**, 657 Broadway, Buffalo, N. Y.

Clip the coupon and mail it. I'm certain I can train you at home in your spare time to be a Radio Technician. I will send you a sample lesson free. Examine it, read it, see how clear and easy it is to understand. Judge for yourself whether my course is planned to help you get a good job in Radio, a young, growing field with a future. You don't need to give up your present job, or spend a lot of money to become a Radio Technician. I train you at home in your spare time.

Why Many Radio Technicians Make \$30, \$40, \$50 A Week
Radio broadcasting stations employ engineers, operators, technicians. Radio manufacturers employ testers, inspectors, foremen, servicemen in good pay jobs. Radio jobbers, dealers, employ installation and service men. Many Radio Technicians open their own Radio sales and repair businesses and make \$30, \$40, \$50 a week. Others hold their regular jobs and make \$5 to \$10 a week fixing Radios in spare time. Automobile, police, aviation, commercial Radio; loudspeaker systems, electronic devices, are other fields offering opportunities for which N. R. I. gives the required knowledge of Radio. Television promises to open good jobs soon.

Many Make \$5 to \$10 A Week Extra in Spare Time While Learning

The day you enroll, I start sending you Extra Money Job Sheets which start showing you how to do Radio repair jobs. Throughout your Course I send plans and directions which have helped many make \$200 to \$500 a year in spare time while learning. I send special Radio equipment to conduct experiments and build circuits. This 50-20 training method makes learning at home interesting, fascinating, practical. **YOU - A MODERN, PROFESSIONAL, ALL - WAVE, ALL - PURPOSE SET SERVICING INSTRUMENT** to help you make more money fixing Radios while learning and equip you for full time work after you graduate.

Find Out What Radio Offers
Send today. Mail the coupon for Sample Lesson and my 64-page Book, "Rich Rewards in Radio." They point out Radio's spare time and full time opportunities and those coming in Television; tell about my course in Radio and Television; show letters from men I have trained telling what they are doing and earning. Read my money back agreement. Find out what Radio offers YOU! **MAIL COUPON** in an envelope, or paste on a postcard—NOW!

J. E. SMITH, President
Dept. ODR, National Radio Institute
Washington, D.C.

test made to determine the condition of the cathode. However, an emission test is of little value, as the activity of the target decreases long before the cathode fails. If desired, those tuning indicators employing the 6R base may be tested for illumination, by inserting a DPDT switch in the lines from terminals 2 and 4 of the 6-pin socket to the circuit switches, and adding a .3 megohm resistor as shown in Fig. II. The grid pin No. 3 should be connected to B— for this test, by means of the No. 3 switch.

The accompanying tube chart comprises practically all modern receiving tubes announced at this writing, with exception of a few television types not yet in the hands of distributors. To avoid crowding a large number of voltage designations on a comparatively small plate, an ordinary number plate was used, and voltages assigned as follows:

1— 1.5 volts	9— 25 volts
2— 2.0	10— 30
3— 2.5	11— 35
4— 3.3	12— 50
5— 5.0	13— 70
6— 6.3	14— 85
7— 7.5	15—115
8—12.6	

The figures in columns F1 and F2 indicate the circuit switches and their setting, all others being at "S" unless otherwise indicated. The number under "K" indicates the cathode of the tube, and the number of the switch to be thrown to negative for testing. The "Test" column indicates the setting of the shunt control across the meter. All good tubes will register .7 to .9 full scale deflection, and any registering less than half scale should be rejected, as definitely bad.

It should be particularly noted that these calibrations will not apply if a shunt control with a different taper from the one specified is used; and the associated dial MUST be 0-100 in 270 degrees. The pointer knob should be set so that the change in taper takes place at 52 on the dial. This may generally be accomplished by fastening the knob at 100, when the potentiometer is turned fully to the right. Resistor R1, 5,000 ohms, should be very close to that value if test settings are to be duplicated, and the resistor may be ½ watt rating. The 400-ohm resistor, R2, is not critical as to size, and may also be ½ watt rating as normally it carries less than 10 milliamperes.

Ballast tubes may be checked for continuity by operating the tester in the leakage testing position. No filament voltages are used, of course, and reference to a ballast tube base chart will determine the switching to be done.

(The author gratefully acknowledges the cheerful co-operation of the Allied Distributing Company of Indianapolis, in supplying certain new type tubes for testing.)

As I See It! (Continued from page 8)

preponderance of flat rate charges. Not that there is any harm in charging along such lines, because after all is said and done, a flat rate charge is just another way of quoting on an hourly basis, but we were surprised to note the number of men who classify their charges in that way.

Be that as it may, there is one danger in the flat rate charge, namely, that the man estimates the *time it should take* to do the work, rather than knowing the amount of *time consumed* to do the work. Furthermore, flat rate charges, if they are really such usually do not take into consideration one very important detail, the type of receiver. Such flat rate charges embrace both the analysis and the repair, assuming that the charge for the parts used is extra. Of these two, analysis and repair, the former has now, because of the development of signal tracing methods been made pretty much standard in most instances, so that a generally profitable charge is possibly on a flat rate basis for all types of receivers. As to the actual repair however, we seem to feel that it should be a variable, with a definite minimum, and should depend upon the type of receiver as well as the number of components which must be removed and

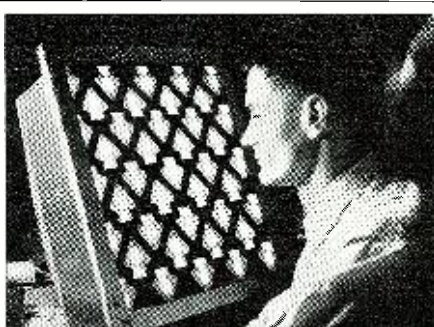

X-RAY PICTURES STOP AIRPLANE SABOTAGE!

One of the most recent and spectacular assignments handed to photography is the role of sentinel guarding against the insidious, unseen workings of saboteurs! Airplane imperfections, planned or accidental, which eventually might plunge flyers to their deaths, cannot escape detection! Here is counter espionage work in the modern manner! Don't fail to read how X-ray photography defeats the plans of saboteurs at every turn. You'll find this informative, brilliantly illustrated article on page 14 of the

★ APRIL ISSUE ★

Popular Photography

NOW ON SALE AT ALL NEWSSTANDS AND CAMERA STORES

Mail this Now FREE
Get 64-page Book

J. E. SMITH, President, Dept. ODR
National Radio Institute
Washington, D.C.

Dear Mr. Smith:
Mail me FREE, without obligation, Sample Lesson and 64-page book "Rich Rewards in Radio" which tells about Radio's spare time and full time opportunities and how I can train at home for them. No salesman will call. (Write or Print Plainly.)

NAME.....
ADDRESS.....
CITY..... STATE..... 2FR

AGE.....

replaced and whatever other work classified within the repair category must be done.

In this connection we have a communication from H.C.B. in Detroit, Mich., who adds a percentage to the list price of every component which is used in the repair. This becomes the labor charge and varies in accordance with the list price of the receiver. It starts at 20 percent (of the component) for receivers listing up to \$95.00 and mounts to 50 percent (of the component) for receivers listing at \$150.00 and higher. We feel that the idea behind the charge is a good one, although the use of the list price as a basis does not seem to be the best. It might be more sound, since modern day production methods have cut list prices down pretty low, to use the number of tubes as a basis, on the grounds, that the greater the number of tubes in a system, the greater the number of components, circuit adjustments, etc. Also it might be well to classify receivers in accordance with the type of tuning, that is push-bottom, motor driven, automatic frequency control, etc. All of these are important in the final adjustment and repair, if not of particular importance in the actual diagnosis and you will find upon analysis that it is possible to classify all receivers without having a tremendous number on the list.

When you consider that by and large the greater the cost of a replacement part, with some few exceptions, the more the work of removal and replacement, it seems quite logical to consider the labor on the basis of the list price of the part; there being of course a definite minimum for either the entire job or for labor. Pick-up and delivery is something else to be handled in whichever way a man sees fit.

-30-

QRD? de Gy

(Continued from page 24)

mation to belligerents or to belligerent warships. Which should mean a few more jobs for qualified radiops.

R. G. SUMMERS, a retired Marine Engineer, steam and diesel, and who has taken up radiop work as a hobby, writes in to say that he gets quite a kick out of listening to the QSO boys of the tuna fleet. He must have been listening in on some tall gab-fests because he wonders why the tuna-boys don't organize. How come he got this idea from their breeze-shooting is a mystery because from sources considered to be reliable we understood that Yurgiano, formerly acting Sec. of Local 7, ARTA, was doing yeoman work down in 'Diego. Incidentally, Summers would like to buy an old OP501A. Anybody got one? He speaks a cash language.

BROTHER WALTER ROLLOCK of the SS Berkshire (KFIE) tells us that the M&M Transportation Co. has just installed RCA-8012-B radiotelephones of the 75 watt, automatic ringer type, on all of their passenger vessels. With the addition of a control panel in the radio room, complete facilities are to be had for switching either the public phone booth or the bridge extension into the Xintr. This is the first time that we've heard of a large coastwise shipping organization actually installing 'phone equipment. Although rumors have been flying

around for the past months that shippers intended to do this, so far they have continued their regular radiotelegraph apparatus. But now that M&M has made the move, it is to be expected that others will follow. What the future holds for direct ship-to-shore traffic is still in the limbo of experiments. So why worry? So with 73 ge GY.

-30-

RCA REVIEW (a quarterly journal), published by RCA Institutes Technical Press, New York. 124 pp. 50c. This issue contains articles by David Sarnoff, Pres. RCA, B. J. Thompson, R. S. Holmes, T. A. Smith, Garrard Mountjoy and many others. Subjects covered include: "Television Reception in an Airplane," "Simplified Television I-F Systems," to mention just two of the eleven features. For the professional and amateur radio and television engineer.

-30-

RADIO ENGINEERING - DEGREE IN 2 YEARS

• Complete Radio Engineering Course in 96 weeks. Bachelor of Science Degree. Radio (television, talking pictures and the vast electronic field) offers unusual opportunities for trained radio engineers. Courses also in Civil, Electrical, Mechanical, Chemical, Aeronautical Engineering; Business Administration and Accounting. Tuition, living costs low. World famous for technical two-year courses. Special preparatory department for those who lack required high school work. Students from all parts of the world. Enter March, June, September, January. 57th year. Write for catalog.

1640 COLLEGE AVE. ANGOLA, IND.

TRI-STATE COLLEGE

The Ham's bible—For gossip and information read RADIO NEWS

"ENGINEERED..."
from every
ANGLE

New
SUPER
PRO

THE Series 200 "Super-Pro" is a masterpiece of engineering. Every detail has been given the utmost consideration and engineered to produce a receiver of maximum flexibility. The "Super-Pro" is a "professional" receiver from start to finish. Engineers choosing "Super-Pro" receivers for commercial service know that they are buying uninterrupted service and peak efficiency. Just look inside one of these receivers and you will see the difference. Everything in it is specially designed. Even the I. F. transformers are totally different from any other set. The special band switch is probably the only one of its kind in the field. All these are manufactured right in our own factory where absolute control of quality is maintained.

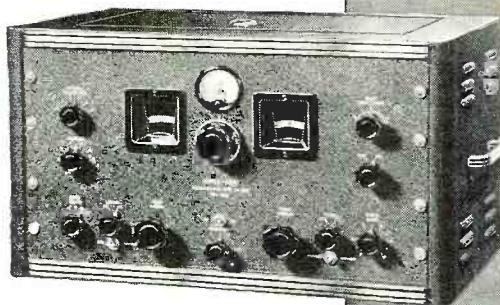

SERIES
'200'

Write for complete technical details

Canadian Office:
41 West Ave.,
No., Hamilton,
Ont.

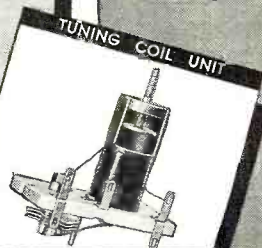
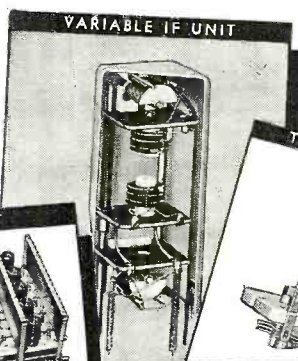
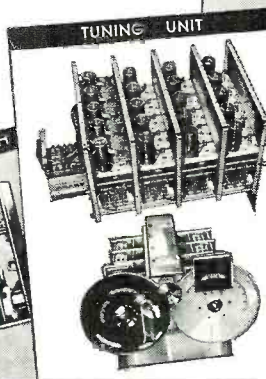
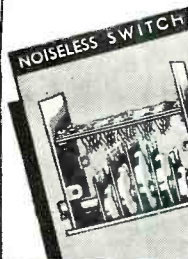

MAIL THIS COUPON NOW

HAMMARLUND MFG. CO., INC. RN-44
424-438 W. 33rd Street, New York City
Please send 16-page "Super-Pro" booklet

Name.....
Address.....
City..... State.....

HAMMARLUND

"NO TROUBLE

when you use
OHMITE
Resistors!"



—because dependability and long life go hand in hand with Ohmite vitreous-enamelled wire-wound Resistors! It's proved by service men, amateurs and prominent manufacturers everywhere who specify Ohmite for their resistor requirements.

—so be sure you get this efficiency—Use OHMITE! See your Jobber today.

OHMITE BROWN DEVILS

Tough, dependable, vitreous-enamelled resistors for voltage dropping, bias units, bleeders, etc. 10- and 20-watt sizes; 1 to 100,000 ohms.



OHMITE DIVIDOHMS

Keep 'em handy for quick replacements or change of resistance value. Ideal voltage dividers. 10 to 200 watts. Resistance to 100,000 ohms.



SEND COUPON TODAY

OHMITE MANUFACTURING CO.,
4883 Flournoy Street, Chicago, U. S. A.

SEND FREE CATALOG 17

Name

Address

City.....State.....

OHMITE

RHEOSTATS RESISTORS TAP SWITCHES

EASY TO LEARN CODE

It is easy and pleasant to learn the modern way—with an Instructograph Code Teacher. Ideal for the beginner or advanced student. Many tapes available ranging from alphabet for beginners to typical messages on all subjects. Speed range 5 to 40 WPM. Always ready, no QRM, beats having someone send to you.

FOR SALE OR RENT

STANDARD with 10 tapes, book of instructions, A.C. motor. \$24.50 with spring-wound motor. \$18.50 JUNIOR with 5 tapes and book of instructions (not rented). \$12.00 RENTAL Standard with 10 tapes and book of instructions \$5.00 first month. \$2.25 each additional month. References or \$10 deposit required. All rental payments may be applied on the purchase price should you decide to buy the equipment.

Write for details today



INSTRUCTOGRAPH COMPANY

Dept. NR, 912 Lakeside Place, Chicago, Illinois

Representatives for Canada.

Radio College of Canada, 54 Bloor St., West, Toronto

Within Earshot (Continued from page 4)

output load harnessed to a tank. As far as oscillators were concerned, he was right. But the phenomenon of frequency stability together with a varying load is old stuff to the radio-man whose every transmitter of the r.f. amplifier type can accomplish just that. What would be more to the point, would be for the short-wave therapy manufacturers to work closer with some radio engineers. This would not only open up new jobs for the radiomen, but would open up new fields for the manufacturers.

* * *

REPORT: Some time back we offered to put the inventor of a certain "death-ray" supposedly operated by radios in touch with genuine researchers in the field of cancer, the scourge of mankind. We offered this because we took exception that the "invention" should have been destroyed as an instrument of war, without its having been tested as a possible aid to peace and medicine. We wish to report that our offer was *not* accepted. We are therefore forced to agree with Ulmer Turner, "The Globe Trotter," that until we see one of them *thar* contraptions, we won't believe it exists. Not that the acceptance of our offer would have proved that such a machine had been "invented"; only that a willingness to offer the use of such a machine (if it existed) for peaceful research would have added color that it might be true—that a "death-ray" radio apparatus had been developed. Incidentally, the nearest approach to the "death-ray," is the cyclotron, that instrument for breaking up atoms. The "ray" of that huge mass of machinery can burn a hand off, and should be able to kill. Anyhow, the workers have to take extraordinary precautions against injury. Cancer research may some day be undertaken with the cyclotron, though to date they are still discovering just what other things it does.

* * *

THE engineers of the Aladdin Radio Industries, Inc., have called to our attention that Author Cavendish in his recent article describing the construction of a high-fidelity radio tuner failed to advise that the tuning unit No. 46-211 should be adjusted to maximum peak performance by tuning the padders. We took this up with Mr. Cavendish who answered that a flat r.f. response curve was what was wanted if high-fidelity was to result. This means that the tuning unit should not be "peaked" beyond the amount necessary for the separation between the carriers of the various broadcasting stations in your locality. As long as the stations come in clear and without interference one with the next, the tuner should be left alone. Of course, if high fidelity is to be dispensed with, then the tuner should be "peaked." We wish to thank both the engineers

of Aladdin and Mr. Cavendish for straightening this out.

* * *

IN a mighty step forward, the Engineering Department of the Radio Manufacturers' Association has recently adopted as an RMA standard, instructions for the correct interpretation of ratings of receiving types of vacuum tubes. The standard was deemed essential because of the confusion existing as a result of incorrect interpretations of tube ratings, especially where these ratings pertained to maximum values of either plate and screen voltages and also plate and screen dissipation.

With the universal adoption of the RMA standards, there will no longer be any excuse for misinterpretations resulting in non-uniform commercial receivers. In other words, the ratings of the tubes will become standard and accepted by the industry at large.

If the RMA Engineering Department standards are followed up by some equally reliable general standard by which the public will be able to measure the audio output of their receivers and in the input N. f. sensitivity, much will have been accomplished towards standardizing the broadcast receiver market. When the prospective purchaser goes to buy a receiver, he will then be able to compare the performance of any one receiver (as far as laboratory standards are concerned) with any other receiver. Such standards of comparison will tend to eliminate the

WAR IN THE AIR

The conflicts in Europe may be a continuation of the "war of nerves" . . . cunning pitted against cunning . . . blockade against counter-blockade . . . but the war in the air goes right back to the point where the First World War left off—a fight for supremacy in design, which means supremacy in performance! This is the opinion of Major Alexander P. deSeversky, famous World War veteran. Don't fail to read his informative, unbiased account of today's war in the air. Turn to page 18 of the

★ April Issue ★

POPULAR AVIATION

NOW ON SALE AT ALL NEWSSTANDS

Get Your Copy Today!

"fly by night" manufacturers, and merchandise which is not "up to snuff" but which, at the same time, has been tremendously "touted."

You will be able to know what you are obtaining in a radio receiver, and no longer need be swayed by the salesman.

If the standards are sufficiently well enumerated, it will be wholly possible to know whether receiver "A" out-performs receiver "B" under a given set of conditions by not doing anything further than looking in the specifications. This is indeed a great stride toward the elimination of undesirable factors which have influenced the public in buying their receivers in the past.

* * *

IN the November issue of our publication we stated that the Germans had perfected a system whereby a number of broadcasting stations operating on identical wavelengths were placed upon the air and the transmissions from each varied without change of programs so as to confuse enemy bombers who might use the broadcast station transmitter as a radio homing device guiding them to their objectives. We said that this caused the German stations to be able to be operated 100% of the time without a shut-down and that the AVC circuit in the listeners receiver compensated for the changing distances from the receiver to the transmitters.

Shortly thereafter, we received a letter from Stanley W. Godfrey of Norwich, London, in which he goes to great pains to explain to us that we had the situation reversed, and that it is the British who have this system of many transmitters on the same wavelength operating in different parts of the country to confuse the German bombers, and not the Germans, as we had stated. Supporting his statement, he annexed two very interesting clippings from the local London papers.

One of these clippings stated that Sir Noel Ashbridge, Chief Engineer of B.B.C. had worked out a broadcasting scheme to baffle enemy bombers. He said he had worked this out in answer to Sir Samuel Hoare's query in the House of Commons as to what was being done to protect the British Isles from bombers using broadcast stations as radio beacons. The locality of the several transmitters operating simultaneously on the same wavelength is a deep dark secret and only 20% of the listeners, it is claimed, notice any difference in their reception.

One of the main reasons for perfecting the system was that the proposed closing down of English Broadcasting stations on the approach of bombers would, in effect, act as an air raid alarm in locations where the bombers were expected, indicating to the enemy that they were approaching their destination accurately. It was more to avoid this than anything else that the

British, it is claimed, have put in the simultaneous transmission system.

* * *

MR. F. W. MEYER of Denver, Colorado, has succeeded in procuring from the Federal Communications Commission an opinion which we expect to be far-reaching in effect.

Briefly, the facts are these: The City of Denver, Colorado, is serviced by radio stations of all three of the major networks. Meyer made an application for a new station to operate on 1310 kilocycles with substantial day and night power, unlimited time. Originally, in May, 1939, the application was denied on the grounds that the public interest, convenience and necessity had not been shown by Meyer

LANGUAGES
 Made *easy* By
LINGUAPHONE

This amazing new Method enables you, in your own home, to speak and read any of 27 foreign languages in an incredibly short time. Endorsed by leading university professors and thousands of men and women as the quickest, simplest and most thorough language method.

SEND FOR FREE BOOK

LINGUAPHONE INSTITUTE
 83 RCA Building New York City

For suitable designs in electronic units — read **RADIO NEWS!**

Stop Searching

FOR THE NEEDLE YOU NEED!

ask your supplier for

PERMO POINT

Phonograph Needles

Permo Products Corporation, for 11 years the leading manufacturer of needles for automatic phonographs, now makes available to you a complete line of long play quality needles for every use.

FOR RECORDING—Permo offers a new stylus equalling the cutting ability of sapphire. It cuts clean, quiet grooves, free from surface noises. Records entire frequency range with a minimum loss of high frequencies, due to special alloy tip. It is very rugged and will stand harder usage than any other cutting stylus available. Permo Metal Point gives longer life. MICROSPECIFIED for uniformity and packed in a special protective metal container.

FOR REPRODUCTION—the Fidelity Permo Point Needle is specially made for home record players and changers. It keeps surface noise at a minimum, and the Permo Metal point assures finest full range reproduction. Record wear is negligible due to the self-lubricating action of Permo Metal point. Will give 50 hours service on standard recordings. Long play for use in home, salon, sound distributing systems, schools, etc.

FOR TRANSCRIPTION—the new Transcription Permo Point Needle gives an even response over entire audio frequency range . . . is constant at over 10,000 cycles. Specially designed to transmit all frequencies useful in modern broadcasting and recording work. Fits standard record groove. Valuable in play-back and dubbing work. Permo Metal tip gives 35-50 hours service. Won't wear acetate, nitrate coated, commercial records—prolongs life with self-lubricating Permo Metal Point.

Microspected **TO INSURE**

PERFECT PERFORMANCE Every Permo Point Needle sold is subjected to the rigid Permo MICROSECTION process before it leaves the Permo laboratories. This process is a positive check on the precious Permo Metal point for perfect uniformity and performance. The above and other Permo Point Needles for professional and home use are available at all leading suppliers.

PERMO POINT

PERMO PRODUCTS CORP.
 6415 Ravenswood Ave.
 Chicago, Illinois

Gentlemen:
 Please send me your free booklet on Needles and Records, and full information on Permo Point Needles.

Name.....

Address.....



SUCCESS

SERVICE

--with the **CENTRALAB**
LEVER ACTION SWITCH

A flip of the Centralab Switch tells all . . . whether to read the tell-tale meter . . . to test a reluctant tube, or to solve the inner mysteries of some intricate testing apparatus.

Just a habit with Centralab . . . to turn out a better mouse-trap so that a world of service men can make a beaten path to our jobbers.

Switches, controls, resistors, ceramic capacitors . . . in each field of endeavor . . . like Abou Ben Adam . . . "our name leads all the rest."



Contact clips of spring brass heavily plated (silver) treated for easy soldering. Switching combinations available use up to 12 clips per section.

Centralab
Div. of **GLOBE-UNION INC.**
Milwaukee, Wis.

in his application. The Commission claimed that the City of Denver was adequately covered by the three broadcasting chains and that was sufficient to deny another station's existence. Meyer promptly renewed his application.

In granting the permit on re-application the Commission said: "Nothing in the Communications Act, our Rules and Regulations or our policy requires a finding of a definite need to support the grant of an application. Cases where such a finding of need is not made are, however, to be distinguished from situations in which a real lack of broadcasting service is made clear . . . In the latter class of cases the Commission will give due consideration to this fact. The 'public interest, convenience or necessity' which the statute provides as a basis for a grant, cannot be construed as a mandate that actual necessity for the particular facilities must be shown. Neither the disjunctive form nor the public convenience as an independent factor is to be entirely ignored. Indeed the words 'public necessity' in the Act are not to be construed narrowly, but rather as calling for the most widespread and effective broadcast service possible."

The Commission said further, "The opposition to granting the application argued that no public need is shown for additional broadcast facilities in Denver. All of the stations operating full time in that city are affiliated with the national chains. Thus the hours during which these stations may reach the greatest number of listeners are not available for local broadcasting. Local governmental, educational, civic, charitable, and community organizations thus lack an effective means of reaching the radio public in the vicinity." It was to afford an opportunity for the local government for educational, civic and charitable organizations to obtain an effective means of reaching the public locally in the City of Denver that the application was finally granted.

The effects of this decision may be quite startling if the decision is followed in some of the other cities. For instance, in the City of Chicago, Station WENR operated part time with WLS. WENR is National Broadcasting Company owned. In the same city, also, is WMAQ, which is owned by the same broadcasting chain. It is quite possible, under the decision of the Denver case, that somebody might make application for WENR's time on the basis that the National Broadcasting Company already had one outlet in the more popular bands and that there was no public need for two outlets to the same chain in the lower wavelengths. It might also be argued that the City of Chicago could stand a local station on the wavelength of WENR for the period of time that WENR was on the air so that the local governmental, civic charitable and educational organizations might be afforded the opportunity of using the

Your Dollars Do Double Duty with New Guardian ANTENNA RELAYS

★ Here is an agreeable price surprise in new Antenna Relays by Guardian. Worth much more—but priced to make your dollars do double duty.

Tested under actual operating conditions these new A-100 Antenna Relays by Guardian have proved themselves capable of handling any power up to a K.W. on any frequency up to and including 28 M.C. on A.F. or R.F. circuits. These A-100 Antenna Relays by Guardian give you more for less.

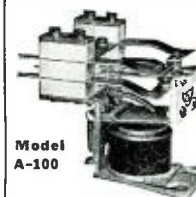

Standard A-100 and A-100-C Antenna Relays Al-SiMag insulated operate on 110 V. 60 Cycle A.C.

Amateur Net Prices:

- A-100 Double Pole Double Throw Relay, net. **\$393**
- A-100-C Single Pole Double Throw Relay, net. **\$219**

R-100-G Triple X insulated, same operating range as A-100 relays, net. **\$330**

Write for New Bulletin "N" and Free Circuit Diagrams!



GUARDIAN ELECTRIC

1630 W. WALNUT ST., CHICAGO, ILL.

FASTEST WAY TO LEARN CODE

Easy, Fascinating, LEARN by EAR To be a GOOD OP.

The New All Electric Master Teletype Code Teaching Machine is exactly what thousands are looking for. No experience needed. Ideal for beginners—steps up WPM for ALL Ops. There is no guess work with Master Teletype, because it records your sending in visible dots and dashes. You SEE and HEAR exactly how you are making your signals. You learn code the way you'll be using it —by SOUND. That's why practically every school teaching code uses TELEPLEX. Complete course included at no extra charge. Used by many schools for teaching code. Low cost; easy terms. MONEY BACK GUARANTEE. Send now for booklet RN4, no obligation. Postcard will do.



TELEPLEX CO., 67-69 Park Place, New York
In Canada write:
CANADIAN ELECTRONIC INST., TORONTO, ONT.

EXTRA MONEY

Have you a few spare minutes a day? Then you can easily earn plenty of extra cash! You could add \$10 . . . \$25 . . . or even \$50 a month to your income. How? Simply by joining the Radio News Booster's Club and discussing RADIO NEWS with your amateur or servicemen friends. For subscription supplies and detailed information on how to increase your income:

SEND COUPON TODAY!

Booster's Club
RADIO NEWS
608 S. Dearborn St., Chicago, Ill.
Please send subscription supplies and detailed information on how to increase my income.

NAME

ADDRESS

CITY & STATE

channel which afforded the range and power that WENR's channel does.

Mind, we do not say that this will actually happen. We only say that the decision, if carried to its final interpretation, makes such a move possible.

If the Denver decision is adhered to, in future cases, it may be that the broadcasting chains will find themselves with only one outlet in most of the cities.

For the courage to make the decision in the Denver case, the public ought to commend the Federal Communications Commission. In the face of repeated accusations that it was operating with unreasonable censorship of radio, the Denver decision may be thrown into the teeth of the accusers as an outstanding example of fairness and public service by the Commission.

THE furor ament television continues to boil and steam. Some of the highly interested parties claiming that television will be the Thing this year, while the skeptics are laughing, "Oh, Yeah?" Some of the estimates of sets which would be in the public's hands are being woefully left by the wayside. For instance, a large manufacturer said that there would be 100,000 television receivers in the hands of the people by December 31st of last year. That there have not yet been 10,000 sold and that the figure is really closer to 3,000 seems to indicate that the gullible John Q. Public is not so fast on the up-take as expected. It is hard to foretell what will happen, but we do predict that television is here to stay, and that it will come more and more into general use.

AND that about winds up the column for another month. Remember that in radio—as in everything else—its the bias that counts. Providing that it's the correct bias. S'long. KAK.

Serviceman's Experiences

(Continued from page 19)

I saw nothing but an ordinary United States one-cent stamp. He turned the page. "This is next," he pointed, displaying a two-cent stamp. "You'll hardly believe this last one," he declared, letting me glance briefly

at a U.S. three. "It completes an unbroken sequence!"

"How about the 1 1/2-center?" I asked.

"Oh, that," Gasp replied, "I save only whole numbers!"

I estimated the distance to the door, and pulled out my bill. You can't blame me for being nervous.

"The price of the repair," I tremolo'd, "is—"

"Say—ever play leap-frog?" he invited.

"I just finished work on the Cros—" I tried again.

"Great exercise, especially under water," he recommended.

It suddenly occurred to me that Al's (Please turn the page)

UNIVERSAL CINEMA MODEL for Movie, Studio, Stage and Orchestra Crystal or dynamic in any impedance...

RADIO DIAGRAMS 25c Any circuit diagram for all radio sets. To help you service radios. Specify manufacturer and model number. Only 25c each. Guaranteed immediate shipment.

INFORMATION You've BEEN LOOKING FOR! SERVICE MEN! RETAILERS! STUDENTS!

GET ALL 3,313 "CASE HISTORIES" UP WITH THE PROFITS! LEARN RADIO AT HOME—QUICKLY! A \$50.00 Training Course Complete for only \$4. Includes: MODERN RADIO SERVICING, RADIO TROUBLE-SHOOTER'S HANDBOOK, RADIO PHYSICS COURSE.

GET ALL 3,313 "CASE HISTORIES"

Smart servicemen are using Ghirardi's complete, world-famous collection of 3,313 receiver "Case Histories" because it shows them how to find the common troubles to which each set is most subject...

BUYERS' GUIDE FOR TEST INSTRUMENTS

Modern Radio Servicing gives you a 420-page section (a whole book in itself) about servicing instruments—the theory behind them—how to use them properly—how to select those most useful for your own service work...

Easy Now to Crack the Tough Ones

Now you'll know just what you're doing! Get right to the bottom of your servicing jobs at once—with Ghirardi's 2 big books for service men—Modern Radio Servicing for service theory and Radio Troubleshooter's Handbook for reference data.

UP WITH THE PROFITS! Cut Down Service Time!

Ghirardi's servicing books are proved time-savers and profit-makers! Put them to work in your shop, get the combined experience of the country's leading servicing organizations packed into 2 handy books for service men.

"Business-Builders"

Want some new ideas on how to promote your servicing business? Modern Radio Servicing will give them to you!

LEARN RADIO AT HOME—QUICKLY!

Now, in spare time you can get your practical training from the man who has been called "The World's Greatest Teacher of Radio," the man who has given thousands of students their start in various branches of the profitable career of Radio—with the easiest, quickest and most thorough home-study course in Radio.

A \$50.00 Training Course Complete for only \$4

Yes, Ghirardi's Radio Physics Course is the equivalent of 36 different radio books bound together in one huge, easy-to-use, profusely illustrated self-instruction book of nearly 1,000 pages.

Used by U. S. Army!

It's used by more schools and students all over the world than any other radio text ever published. Even the U. S. Army and Navy use it in their radio training courses!

RADIO PHYSICS COURSE

- 1. Radio Broadcasting System, 2. Sound, Speech, Music, 3. Electron Theory, Elec. Current, 4. Elec. Units: Ohm's Law, Resistance, 5. Elec. Circuits, Batteries, 6. Magnetism, 7. Electro-magnetism, 8. Electro-magnetic Induction, 9. Inductance, 10. Capacitance, Condensers, 11. A.C. Circuits, 12. Filters, 13. Measuring Instruments, 14. Radio Waves, 15. Broadcasting, 16. Receiving, 17. Vacuum Tube Principles, 18. Vacuum Tube Characteristics, 19. Vacuum Tube Construction, 20. Vacuum Tube Detector and Amplifier Action, 21. Radio Frequency Amplification, 22. "Superhets", 23. I.F. Amplifiers, Tuning Coils, 24. Audio Amplifiers, 25. Speakers, 26. Battery Operated Receivers, 27. Power-Supply Units, 28. Elec. Receivers, 29. Automobile and Aircraft Radio, 30. Phone Pickups; Sound Systems, 31. Short-Wave, 32. Piezoelectric Cells; Cathode-Ray Tubes, 33. Television, 34. Antennas and Grounds, 35. Testing; Servicing, 36. Sound

Books Shipped Postpaid Anywhere

USE THEM 5 DAYS

Send for any or all of these books today. Keep them 5 days to look over at your leisure. Then if not fully satisfied, return them in good condition and we will refund your money at once. You can't lose!

ORDER NOW before prices GO UP!

FREE CIRCULARS!

Descriptive illustrated circulars are available—FREE! Send for them!

\$6.50 FOR BOTH SERVICING BOOKS—IF PURCHASED TOGETHER

RADIO & TECHNICAL PUBL. CO. 45 Astor Place, New York, Dept. RN-40

NAME ADDRESS CITY STATE Please send me FREE illustrated literature describing Books No. 1 No. 2 No. 3



MILLION LABORATORY MULTIMETERS

You get more for your money in Million test equipment. Just look at these features.
 *Built-in test leads *AC-DC Volts, 0-6-120-300-1200* DC Milliampers 0-1-30-300-600
 *Ohmmeter 0-1,000 (50 ohms at mid scale) 0-2½ megohms with self contained batteries. *Decibels minus 10 to plus 12.
 *Large 4 inch meter. *Size 8x5 3/8x3 1/2 inches. Shipping weight 4 lbs.

MODEL VV—1,000 ohms per volt. Complete with handle, rubber feet, batteries and instructions. **DEALERS CASH PRICE \$14.95**

MODEL OM—Supersensitive meter with 20,000 ohms per volt, 50 microampere and 40 megohm scales. Size, ranges and appearance similar to Model VV. **DEALERS CASH PRICE \$24.95**

MODEL VOA—5,000 ohms per volt. Same scales as Model VV but reads to 10 Megohms and has 200 microampere meter. **DEALERS CASH PRICE \$17.45**

MILLION RADIO AND TELEVISION
 577 No. Union St. Chicago, Ill.

advice was very remote to a situation like the one I was in. Gaspy's eye had taken on a strange glitter. I ran downstairs in panic, and didn't even stop to take out my electrolytic. I heard the 'phone ring as I passed through the door, but I had become so eager to get back to work I didn't stop to answer it.

I must have been pretty excited when I came into the shop, because when I heard our telephone ring, I shouted to Al: "Don't answer it!"

He did, though; and while he was at work, I prepared notes for a tirade against business partners who said it was good practise to pamper persons who are balmy in the crumpet.

"Congratulations," Al said after he hung up. "Gaspy's guardian just called to find out how much the job came to, said a check was being mailed, and thanked us for our co-operation in handling his patient. You did exactly right, it seems."

"Mmmm," I commented, stalling to avoid unnecessary conflict.

"Yes," Al continued, "and McFullsock probably recognized a kinship; he has ordered a condenser replacement once a month from now on, providing you do the work. What's the matter—you don't seem to be very enthusiastic!"

"This sort of thing is a new and unaccustomed routine," I said, "so do not make fun of my confusion. Outwardly I might appear calm—but inside, I'm knots!"

"You're crazy outside, too," laughed Al.

Let's see, now—how do you play leap-frog? -30-

200 Watt Fone Xmtr
 (Continued from page 12)

lamps are set below the meter panel and are connected to the filament circuit of the final r.f. These lamps give a subdued illumination to the meters whenever the filaments are turned on. When the a.c. is applied to the plate transformers or in other words you're "on the air" a 40-watt Lumiline Lamp mounted above the panel, brightly lights up giving an unmistakable "go" signal.

One of the causes of BCL trouble has its share of treatment and that is the prevention of r.f. feedback to the a.c. line. This is taken care of by use of the Ohmite line choke and the two bypass condensers, these being mounted at the bottom of the cabinet.

In keeping with the advancement of amateur practices and in compliance with the FCC rulings, a dummy antenna circuit is used for tuning up and testing of the rig. A 250-watt 73-ohm Ohmite Dummy Antenna is mounted in the space behind the meter panel, while a small knife switch on the back of the cabinet permits feeding the r.f. output to either the outside aerial or to the dummy antenna.

The operating control of this rig has

THE EVER POPULAR BUD MIDGET CONDENSERS

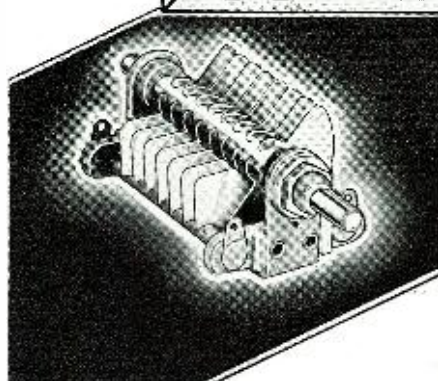

YEAR AFTER YEAR THE OUTSTANDING CONDENSER LINE FOR GENERAL EXPERIMENTAL USE DOUBLE BEARING TYPE

Cat. No.	Max. Cap.	Plates	Amateur Net
MC-1850	15	3	\$.78
MC-1852	35	5	.84
MC-1853	50	7	.90
MC-1855	100	14	1.23
MC-1857	150	21	1.47
MC-1858	200	27	1.59
MC-1859	250	33	1.65
MC-1860	320	43	1.98

Complete listing of all BUD Midget Condensers in latest BUD catalog available FREE at your jobber's!

BUD RADIO, INC.
 CLEVELAND, OHIO

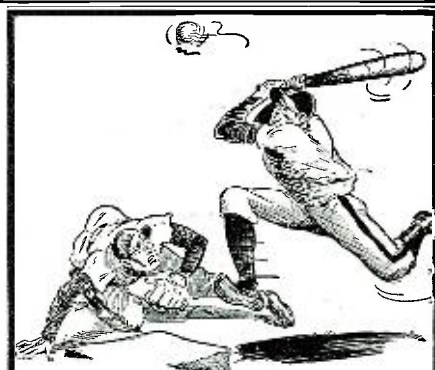

"C'mere and get socked!"

Kelly shouted, and ran in hot pursuit! The ball twisted into the outfield, zigzagged back into the infield, corkscrewed, jitterbugged, cavorted, whirled up and down... did everything except approach the plate! The game was completely forgotten. Spectators, sports writers, big league scouts swarmed down on the field! All anyone cared about was that amazing ball Lefty Lopez threw and its fantastic duel with Kelly. All we care about is that you don't miss "THE WIZARD OF BASEBALL"... one of the most unique and entertaining stories ever presented in

fantastic ADVENTURES

MAY ISSUE ON SALE AT ALL NEWSSTANDS MARCH 20TH!

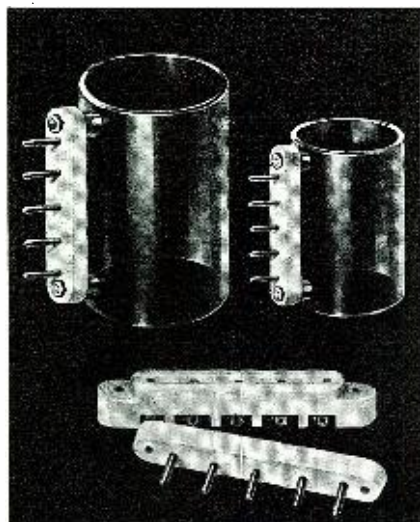

Designed for Application

The new MILLEN line of MODERN PARTS for MODERN CIRCUITS includes: transmitting condensers, receiving condensers, sockets, QuartzQ coil forms, standoffs, dials, IF transformers, RF chokes, safety terminals, etc., etc.

Catalogue Upon Request

TO YOUR OWN PARTS JOBBER

JAMES MILLEN MFG. CO. INC.
 150 EXCHANGE ST. MALDEN, MASS.

RADIO PHYSICS COURSE

by Alfred A. Ghirardi

(Continued from March issue)

"Magnet" originated from the stone were originally found mostly in the city of *Magnesia* in Asia minor. A knowledge of these stones reached Greece as early as 585 B. C. Magnets of lodestone are called natural magnets, because they are found in the earth already magnetized.

up in the first two laws of magnetic attraction and repulsion:

(1) Unlike magnetic poles attract each other.

(2) Like magnetic poles repel each other.

It has become common practice to call that pole of a magnet which is attracted toward the earth's north geographical pole, the *North* magnetic pole. Therefore, it is evident that since unlike poles attract, the earth's magnetic pole in the northern hemisphere must really be a *south* magnetic pole. Likewise, the earth's magnetic pole in the southern hemisphere is really a *north* magnetic pole.

The force of magnetic attraction and repulsion between two magnets decreases very rapidly as the distance between them is increased, and of course increases greatly as they are brought nearer together. This can be proved experimentally by placing the unlike poles of two bar magnets about one half inch apart and noticing the strength of the attraction, and then placing them about four times as far apart and again noticing the attraction. If a delicate spring balance were used to measure the force in each case, it would be found that when the distance is increased four times, the force of attraction or repulsion is only $\frac{1}{16}$ as much. That is:

$$F = \frac{d^2}{m_1 m_2}$$

is found from the equation:

m and m' respectively and the distance between them by d , the force F is found from the equation:

Representing the pole strengths by m and m' respectively and the distance between them.

(3) The force of attraction or repulsion between two magnetic poles is inversely proportional to the square of the distance between them.

This relation is a very important one to remember. We shall see later that the distances between the stationary magnet poles and the poles on the moving parts of loudspeakers are kept as short as is practical, in order to develop strong forces to move the loudspeaker cone or diaphragm. If the air gap is made large the speaker will sound weak. The reader will note the similarity between the laws of attraction and repulsion between magnets and the laws of attraction and repulsion between electric charges already stated.

When a magnetic substance is stroked by a magnet, the induced pole is opposite to the inducing pole. —50—

FACTORY-TO-YOU SAVES YOU UP TO 50%



FOREIGN RECEPTION
Here's our big 20th Anniversary radio special, the 14-tube Midwest Best Built performance and amazing foreign reception 30 Days Trial Absolute satisfaction guaranteed on money—

PUT THIS 1940 14 TUBE CHASSIS IN YOUR PRESENT CABINET
\$19.95 COMPLETE

TELEVISION ADAPTATION

Send for poster for FREE 1940 catalog, showing complete line. (Merchants make extra money!)

Other models from 5 to 17 Tubes, and up to 5 Wave Bands.

See Midwest's Answer to TRADE-INS!

MIDWEST RADIO CORPORATION
Dept. 11-F
Cincinnati, Ohio

#1 DOWN buys this New Sensational 4" WRIST WATCH



- 1 Accurate TIME PIECE
- 2 TELEMETER Distance
- 3 Split-Second STOP WATCH
- 4 M. P. H. TACHOMETER

Just the Thing for **RADIO**

Here's the most MODERN wrist watch in the world—and it's yours for only \$2.00 a month! ONE DOLLAR down buys it—think of the practical advantages and convenience of having—on your own wrist FOUR WATCHES IN ONE!

SIMPLE TO OPERATE

The smart, compact MONROE 4-in-1 Watch has TWO tiny levers to control ALL extra features. Each dial is separate and clear—readable at a glance! With uses of the 4-in-1. It tells time of day and other STOP WATCH with "TIME-OUT" feature. Press lever and it's a TACHOMETER to tell miles per hour. Press lever again and it's a TELEMETER to tell distance from source of light-and-sound!

One Year Written Guarantee

This protects you against any mechanical defect. It's proof that the makers of your MONROE Watch stand back of their product. In addition, you get our money-back guarantee! If not satisfied, return the Watch in 10 days and your money will be refunded.

10-DAY TRIAL OFFER!

Fill out and mail coupon at once. Pay only \$1.00 down on delivery of your MONROE Wrist Watch.

LOWEST CASH PRICE—NO INTEREST OR CARRYING CHARGES

UNEEEDA
125 LIVINGSTON ST., BROOKLYN, N. Y.

NAME _____
ADDRESS _____
CITY, STATE _____

UNEEEDA
125 LIVINGSTON ST., BROOKLYN, N. Y.
275 LIVINGSTON ST., BROOKLYN, N. Y. I will pay \$1.00 on delivery and \$2 a month.

BURSTEIN-APPLEBE COMPANY
1012-14 McGEE STREET, KANSAS CITY, MISSOURI

PROMPT SERVICE
SAVE MONEY.
big valuable catalog and prices. While today for the best national catalog possible your nationally known favorite test sets and kits—ment systems—public address supplies—sets, parts and in radio and everything you need will find and everything you need Here in this one big book needs

FREE CATALOG
IF ITS RADIO

BILEY ELECTRIC CO. • ERIE, PA.

ASSURED STABILITY WITH BILEY CRYSTAL UNITS
10-20-40-80-160 METER BANDS

TYPE B5—This highly active crystal unit for the 40 meter band has less than 4 cycles/mc/°C drift. Price \$4.80.

TYPE LD2—An efficient and powerful low drift crystal unit for the 80 or 160 meter band. Price \$4.80.

TYPE HF2—Simplifies the construction of 5-, 10- and 20-meter transmitters. Drift, 20 meters, 20 mc/°C, 10 meters, 43 mc/°C. Price, 10 or 20 meters, \$5.75.

TYPE BC3—A moderately priced mounted crystal with unusual activity and power output. Drift 23 C/mc/°C. Price, 40, 80 or 160 meters, \$3.35.

As the gears come from the factory, they are bored to $\frac{5}{16}$ ". Since we use a quarter-inch brass shafting, the gears must be pushed. For this purpose we used a standard stock brass pipe, $\frac{5}{16}$ " outside diameter by $\frac{1}{4}$ " inside diameter. Measure the width of the gear through the hole and then cut the gear through the hole and then cut a piece of brass pipe exactly that long. Insert the cut piece, or bushing, into the gear and drive it home with a wooden mallet or a piece of heavy wood. Do not use a metal hammer since it will only serve to bend the brass bushing out of shape. Bush each of the eight gears in the same manner.

Take each of the gears separately and placing it in a vise, drill a set screw hole through both the gear shaft

The Unicontrol 5
(Continued from page 22)

TRIPLETT ELECTRICAL INSTRUMENT CO.
Bluffton, Ohio

Section 154, Harmon Drive

WRITE FOR CATALOG

ing unit . . . Dealer Net Price. . . \$33.67
Also available as rack panel mount-
Case . . . DEALER NET PRICE. . . \$33.00
Lifetime Guaranteed Meters • In Metal
num Tube Rectification • RED•DOT
Jacks for Phone Connection • Uses Vac-
ing positive and negative peaks. Tip
120%. Polarity switch permits check-
ulation control for neon flasher from 50%
Per Cent Modulation • Calibrated Mod-
Two Meters—One for Carrier, One for
tions • 110 Volt AC 60 Cycle Operation
mits compliance with Federal Regula-
• Usable On All Amateur Bands • Per-

AT A PRICE!

MODULATION MONITOR

get more out of your
power with (Triplett)



PEAK EFFICIENCY

TURNER 4X CRYSTAL
AVAILABLE WITH SWITCH

Selective Directional

AMPLIFY THE SOUND YOU WANT!
1-3-1 differential between front and rear picking allows
regardless of distance from amplifier. Positively
switch allows finger-tip "off and on" control,
regardless of microphone noise. Permits
mike to be used as "push-to-talk" unit.

Write for New Mike Catalog

The TURNER CO.
908 Seventeenth St., N. E.
CEDAR RAPIDS, IOWA

Licensed Under Patents of The Brush Develop-
ment Co.

Product \$1.50 for 8 Ft. Cable
Set
\$44X (with Switch) add
52 List

LIST
\$27.50
grams, charmois—
with 25 Ft. cable set, dia-
30-8,000 cycles. Complete
finish. Level—58DB. Range
90° tilting head, satin chrome



TRIPLETT ELECTRICAL INSTRUMENT CO.
Bluffton, Ohio

Section 154, Harmon Drive

WRITE FOR CATALOG

ing unit . . . Dealer Net Price. . . \$33.67
Also available as rack panel mount-
Case . . . DEALER NET PRICE. . . \$33.00
Lifetime Guaranteed Meters • In Metal
num Tube Rectification • RED•DOT
Jacks for Phone Connection • Uses Vac-
ing positive and negative peaks. Tip
120%. Polarity switch permits check-
ulation control for neon flasher from 50%
Per Cent Modulation • Calibrated Mod-
Two Meters—One for Carrier, One for
tions • 110 Volt AC 60 Cycle Operation
mits compliance with Federal Regula-
• Usable On All Amateur Bands • Per-

AT A PRICE!

MODULATION MONITOR

get more out of your
power with (Triplett)



PEAK EFFICIENCY

WITH RCA's anticipated introduc-
tion of a theatre-sized television
system early in 1940, it is believed that
there will be a big boom in this end
of the business. The *Band*, New York,
demonstrations several months ago
proved that images can be clearly
blown-up to sizes large enough to be
seen throughout a large auditorium.

This end of the television business
will undoubtedly be distinct and apart
of the video programs designed for
that the large New York theatres
using such big-screen systems will
count on exclusive rights to the show-
ing of such programs to paying audi-
ences. There are so many details—
particularly legal points—to be ironed
out that, even with such systems in-
stalled in theatres, it may be a consid-
erable time before such things as
prizefights, baseball games, etc., will
be seen in theatres without being
available over facilities simultane-
ously accessible to home listeners.

—50—

Have you tried the "TEST-IT"?

See page 25.

Video Reporter
(Continued from page 39)

—50—

ground.

tial antenna mounted one foot off the
All these, using a 34-foot Premax ver-
resulted in R8-9 and R9 plus reports,
160 within a radius of 100 miles have
ting out." A dozen or more contacts on
Andy was satisfied "he was really put-
had been made on 10-meter phone that
tacts both on the East and West coasts
only a few weeks old but enuf con-
was being written the transmitter was
Results? At the time this article
and the rig is back on the air.
power supplies. A touch of the button
relay to drop out, shutting off the plate
this relay would act causing the off-on
for example, to condenser flash-over
load of the final r.f. stage occur due,
pulls in at 250 ma. Thus, should over-
sistor so adjusted that the armature
lay is shunted by a semi-variable re-
tom of the cabinet. The overload re-
the two relays are mounted in the bot-
small box on the operating table and
fully open. This unit is built in a
closed while the "on" contact is nor-
being arranged so that normally it is
strip of spring metal, the "off" contact
button affair is home made from a
tell the rest of the story. The push
the diagram of this control unit will
another and it's "off." Reference to
push a button and the rig is "on," push

been simplified to bring it down to
the level of a lazy man's pleasure:
push a button and the rig is "on," push
another and it's "off." Reference to
the diagram of this control unit will
tell the rest of the story. The push
button affair is home made from a
strip of spring metal, the "off" contact
being arranged so that normally it is
closed while the "on" contact is nor-
fully open. This unit is built in a
small box on the operating table and
the two relays are mounted in the bot-
tom of the cabinet. The overload re-
lay is shunted by a semi-variable re-
sistor so adjusted that the armature
pulls in at 250 ma. Thus, should over-
load of the final r.f. stage occur due,
for example, to condenser flash-over
this relay would act causing the off-on
relay to drop out, shutting off the plate
power supplies. A touch of the button
and the rig is back on the air.

Results? At the time this article
was being written the transmitter was
only a few weeks old but enuf con-
tacts both on the East and West coasts
had been made on 10-meter phone that
Andy was satisfied "he was really put-
ting out." A dozen or more contacts on
160 within a radius of 100 miles have
resulted in R8-9 and R9 plus reports,
All these, using a 34-foot Premax ver-
tial antenna mounted one foot off the
ground.

RCA Manufacturing Company, Inc., Camden, N. J.
A Service of the Radio Corporation of America

Test Equipment

Only RCA Offers You All These Features!

● All frequencies in fundamentals to 120 Mc
capacitors. . . Ladder-type attenuator with
direct reading in microvolts with meter.
Large dial (approx. 90 inches scale length).
Bands in three colors. . . Internal 400 cycle
modulation and 400 cycle output available
D-C connection for standard as well as
television crystal calibrator, gives direct
calibration of instrument. . . Suitable for
broad band modulation up to 5 Mc such
as required for television signal modula-
tion. . . Regulated plate and screen voltage
supply. . . Frequency range 100 KC—170
KC (10 bands), accuracy ±1%. Maximum
Output Voltage: Low Range .05 V, High
Range .3 V, Minimum Output Voltage:
100 KC to 15 MC, 1 microvolt, 15 MC to
30 MC, 5 microvolts, 50 MC to 60 MC, 25
microvolts, 60 MC to 120 MC, 50 microvolts.

\$1750 NET

Over 350 million RCA radio tubes have
been purchased by radio users. . . In tubes,
as in parts and test equipment, it pays to
go RCA All the Way.
More than 3,000 Rider Channelys are
making money for service men.

● Dollar for dollar, feature for feature,
the new RCA Signalyst is the best buy in
Signal Generators. Its amazing range is
greater than any test oscillator. . . Its accu-
racy and stability are the tops. . . Stray sig-
nal leakage is kept at a minimum. . . AC
operated with regulated power supply. . .
It is beautiful to look at and simple to
operate—truly a magnificent instrument
you will be proud to own.

New service instrument is important companion
to the Rider Channelyst and Rider VoltOhmyst

The RCA SIGNALYST is here!

The Most Modern Signal Generator

Range 120 KC to 120 MC



and bushing. Do not drill all the way through the entire gear. With a well lubricated 8-32 tap, thread the hole previously drilled, using plenty of Lard oil, or similar cutting oil, in the process.

For those who are not familiar with tapping process, you make a quarter of a turn to the right after the tap has bitten in, and then back it off a half a turn. After backing it off a half turn, then make a three-quarter turn forward and back it off a half turn. By this method your threading is done with quarter-turn jumps. When the hole has been completely tapped out, it should accept an Allen 8-32 screw, 1/4" long.

The Allen set-screw is used because it is made of hardened steel and comes equipped with a small recessed hole and a key by means of which it may be tightened far beyond that stage possible with an ordinary screw.

Converting the Switches

As the Shallcross switch comes from the factory, it consists of an uninsulated shaft for one section of the switch coupled to a second section with a small piece of isolantite. It will be necessary to convert one of these switches for use in the plate circuit of the final amplifier. This is accomplished by carefully taking the entire switch apart. Under the isolantite coupling piece will be found two screws, which should be removed. Insert two Cardwell Trim-Air condenser extensions into the holes previously occupied by these screws. The extensions should be tightened as far as possible in a vise. Using a Bud isolantite flexible coupling, the two sections of the switch are then joined together. The side stringers, previously used to hold the two sections of the switch together, are not used in this one unit, and the switch is mounted by means of Cardwell brackets with nuts and bolts through each one of the holes previously occupied by the stringer connector screws. On the end of the switches are mounted Bud or Millen isolantite couplings. These serve to isolate the shafts of the three switches, one from the other, since the gear-train assembly would short all of them to ground. The crystal switch is mounted by means of Cardwell brackets as is the amplifier-plate-tank switch, while the antenna switch is strapped to the plate tank switch.

Gear Parts Assembly

Study the mechanical drawing of the various brackets and the bakelite strip and then construct each bracket carefully and exactly, according to the specifications. Cut the brackets to size and then bend them, leaving the drilling to be done after the bracket has been formed. Do not attempt the construction of these brackets without a square since they form the foundation of the switches as well as the bearings for the gear train. If the bearings are not squared properly, the switches and gears will bind. After the brackets (Pse QSY to page 64)

THE NEW MODEL 1230 SIGNAL GENERATOR WITH FIVE STEPS OF SINE-WAVE AUDIO



"I can't see how you do it at that price!" That one sentence states the consensus of opinion of the top-flight radio experts who examined and checked this new instrument, but you needn't be an expert to appreciate the amazing value we are offering in this new, most-advanced Signal Generator. Designed for appearance by one of the foremost instrument designers and engineered by a Radio Engineer who has specialized in frequency measuring devices for the past fifteen years, the Model 1230 is our bid for all of the 1940 Signal Generator business.

SPECIFICATIONS:

RADIO FREQUENCIES from 100 K.C. to 90 Megacycles in 7 bands by front panel switch manipulation. All direct reading and accurate to within 1% on I.F. and Broadcast bands, 2% on higher frequencies. The R.F. is obtainable separately or modulated by anyone of the five Audio Frequencies.

AUDIO FREQUENCIES: 5 steps of SINE-WAVE audio 200, 400, 1000, 5000 and 7500 cycles **WITH OUTPUT OF OVER 1 VOLT.** Anyone of the above frequencies obtainable separately for servicing P.A., hard-of-hearing aids, etc.

ATTENUATION: Late design, full-range attenuator used for controlling either the pure R.F. or modulated R.F.

The Model 1230 comes complete with tubes, shielded cables, moulded carrying handle and instructions. Size 14" x 6" x 11". Shipping weight 15 pounds. Our net price, **\$12.85**

CIRCUIT: The Model 1230 employs an improved electron coupled oscillator circuit for the R.F. affording positive protection against frequency drift and a Hartley oscillator circuit for the A.F. section.

DIAL MANIPULATION: Large 5 1/2" dial etched directly on front panel, using a new mechanically perfected drive for perfect vernier control.

APPEARANCE: The front panel is etched by a recently perfected process which results in a life-long attractive finish and the instrument comes housed in a streamlined shielded cabinet.

CURRENT SOURCE: The Model 1230 operates on 90 to 130 Volts A.C. or D.C. any frequency.

SUPERIOR INSTRUMENTS CO.

136 LIBERTY ST. DEPT. RN-4 NEW YORK, N. Y.
See Our Full Page Ad On Inside Back Cover of This Issue

This 20-Watt Mobile Amplifier Complete with Tubes \$47.50 CASH Available on Sears Easy Terms

COMPLETELY PORTABLE
IDEAL FOR TRUCKS

1940 ELECTIONS

Will Make You Money With Silvertone P. A. Equipment

One of the most interesting political campaigns of all time is getting under way. Huge sums will be spent by candidates and parties to get their messages to the people. Conventions, meetings, rallies, banquets, sound trucks—all this means more Public Address system sales and greater profits from rentals and service. Sound equipment will have the biggest boom in its history.

Are you prepared to cash in on this enormous business? Let Silvertone Public Address equipment help you, with its wide selection of systems, its greater values and its amazingly low prices.



SEND FOR THIS FREE CATALOG!

Just address Sears Personal Service Department and ask for Catalog RN8132A. Send to our nearest Mail Order House. They are located in Chicago, Philadelphia, Boston, Kansas City, Minneapolis, Atlanta, Memphis, Dallas, Los Angeles and Seattle.

SEARS, ROEBUCK AND CO.

Webster Rim Driven Motor 78 R.P.M. 110 V. A.C., 60 Cycle
New Design, self starting, constant speed, compact and shock-proof.
Complete with 9" turntable. Ship. Wt. 6 lbs., List Price \$6.00, Net Price \$2.69 (plus Postage). 25% Deposit Required with Order. Write for Our Latest Radio Parts Bulletin.
ARROW SALES COMPANY
619 W. Randolph St. Chicago, Illinois

Save on Everything in Radio

NEW 1940 RADIO CATALOG AND PROFIT GUIDE
Most complete line of latest radio sets, amplifiers, kits, tools and replacement parts. All leading brands at lowest prices. Fast Service. Guaranteed Quality.

The **RADOLEK** Company
Dept. W-40, 601 W. Randolph St., Chicago

SEND FOR YOUR COPY TODAY

FREE RADIO PROFIT GUIDE

AHEAD OF THE RADIO FIELD!
IF IT'S NEWS, IT'S IN
RADIO NEWS
GET THE HABIT TO BE RADIO-INFORMED
READ RADIO NEWS EVERY MONTH!
25c At Your Favorite Newsstand

SUPER ACTIVE
HIPOWER
LOW DRIFT
CRYSTAL UNITS
AT
"X" CUT PRICES



"EMERALDS"
 Stability with higher activation. Latest Production plus exclusive Hi Power Grinding method makes these pure Brazilian quartz Crystals phenomenal in price.
 160-80-40 meter **\$3.35**
 Special 20 meter Band.....\$5.50

"RUBIES"
 Finest amateur Crystal Units available. Hi degree accuracy, precision cut, finest Brazilian quartz.
 160-80-40 meter Bands **\$4.50**
 Special 20 meter Band.....\$7.25

SEND FOR FREE CATALOG

AT YOUR PARTS DISTRIBUTOR
 Newark, Chicago; Walter C. Brauns, Chicago; Radio Parts, Madison and Milwaukee; Kerr's Radio Shop, El Paso; Southern Sales, Oklahoma City; Radio Electric Service, Baltimore; Morrissey's Radio Service, Cumberland; Walder Radio & Appliance Co., Miami; Radio Service & Supply, Martinsburg; Auto Service, Birmingham; Arizona Radio, Phoenix; Dutch Village Radio, Portland; Eagle Radio, N. Y. City; Green Mill Radio, Chicago.

HIPOWER CRYSTAL COMPANY
 2055 CHARLESTON ST. CHICAGO, ILL.

RADIO COURSE \$1.95

GREATLY REDUCED
 Amazing offer of latest \$39.00 R.T.I. radio course. Limited number of courses reprinted and reduced to **\$1.95**. Exactly the same as higher priced originals. Prepared for home study; practical facts only; unusual bargains in radio education.

THOUSANDS OF GRADUATES
 Men like you studied Radio Servicing for a short time and today are making good money in radio. Radio Technical Institute's unique radio training will bring rich rewards to you. Pre-tested and approved by thousands. Prepared with the aid of 43 leading radio manufacturers. You can get ready inexpensively, quickly, easily, and in your spare time, for a good job in radio.

THREE COURSES IN ONE
 You get three complete essential courses combined and streamlined: (1) Fundamentals of Radio and Electricity; (2) Practical Radio; and (3) Advanced Training. This is the training which will place you above average radio men—and you get this practical course for only \$1.95. A final test examination may be taken and diploma obtained.

COMPLETE IN ALL DETAILS
 R.T.I. course will give you the radio training you need. The lessons are clear, interesting, easy to master and use. A Gold, now a serviceman in Illinois, writes: "From the very start I learned about practical equipment and methods. You too, can make spare-time money on the radio repair jobs before you reach the 14th lesson."

LATEST FACTS
 The training is remarkably complete. Everything from simple radio facts to advance radio problems. Many servicemen find R.T.I. course excellent for brush-up and study of modern servicing methods. Learn latest facts. Revised and reprinted in 1939. Hurry your order to us today. Limited edition available at reduced \$1.95 price. You must be satisfied or your money is refunded promptly.

FREE EXAMINATION COUPON
SUPREME PUBLICATIONS, Agents
 3727 West 13th St., Room 504, Chicago, Illinois
 Ship complete R.T.I. Radio Course. I must be satisfied or I may get my money back immediately.
 I am enclosing \$1.95, full price. Send prepaid.
 Send C.O.D. I will pay mailman \$1.95 and a few cents postage.
 NAME _____
 Write address below and send this corner.

Guarantee
 Your money back if you are not satisfied. References: D. Van & Bradstreet or any magazine publisher.

EXCERPTS FROM THE R. T. I. COURSE

The armature is then released again and swings back until contact A touches contact C. Meanwhile, the electromagnet is attracting it again so that it keeps on vibrating at its own natural frequency and alternately touching contacts B and C. Now when contacts A and B are closed, the lower half of the primary is directly across the battery, which will result in a heavy current from the center tap downwards. When A touches C, the upper half of the primary is across the battery and a heavy current will flow from the center tap upwards. These two impulses may be considered an alternating current although not of a perfect sine wave form. An al-

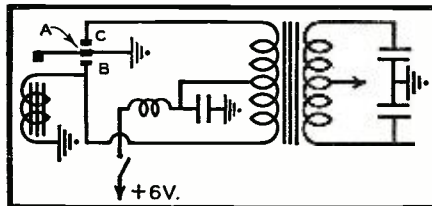

ternating voltage will be induced in the secondary. Because of the turn ratio, the secondary voltage may be made of any required value.

There are some special precautions to be taken in the design of vibrator systems. When the contacts A and B close there is such a sudden increase of current that a high voltage peak is induced in the secondary. The same is true when the other contacts close. Furthermore, sparks are likely to appear at the contacts. Various ways have been devised to eliminate the interference caused by the vibrator. Buffer condensers are generally placed across the secondary and sometimes across the primary. Other manufacturers connect a center-tapped resistor across the primary. The buffer condensers will absorb the sudden charges and thereby improve the waveform. Yet this alone is not sufficient to insure noise-free reception. The B supply filter may contain an r.f. filter in addition to the regular a.f.

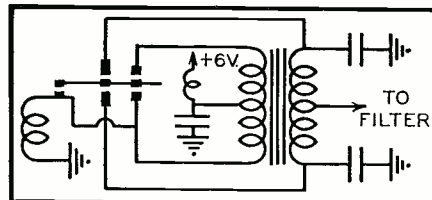

filter and the filament circuit may be filtered too. Also, the filament circuit should not have any part in common with the vibrator circuit—except the battery of course. A typical circuit of an automobile power supply using a non-synchronous vibrator is shown below. This circuit includes the center-tapped resistor across the primary and the usual buffer condenser across the secondary. Sometimes two con-

densers are connected across the secondary with the center tap grounded. The values of these condensers should be about .01 mfd. They must also have high voltage rating.

Note the r.f. filter in the B supply. There are also two filters in the filament supply. The first consisting of RFC₁ and C₁, serves to eliminate the interference caused by the vibrator, while the other section consisting of RFC₂ and C₂ is intended to eliminate ignition interference. In addition to these precautions, the vibrator and power supply must be shielded.

Synchronous Vibrators

The armature of a synchronous vibrator closes another set of contacts which serve to rectify the current in the secondary. The figure shows this principle. When the armature moves downwards it not only closes the primary circuit but also the secondary; when it moves up, the other halves of both the primary and secondary are closed. Buffer condensers are again employed in the secondary to improve the wave form. The usual r.f. filters and a.f. filter are used like in the other vibrator system. (Next page please)

Classified
 Rate 15c per word. Minimum, 10 words.

CORRESPONDENCE COURSES
 USRD Correspondence Courses and Educational Books sold or rented. Inexpensive. Money-back guarantee. Write for Free Catalog listing 4000 bargains. (Courses Bought.) Lee Mountain, Pisgah, Alabama.

INSTRUCTION
 AMATEUR Radio Licenses, complete training in code and theory. Hundreds of licensed students on the air. American Radio Institute, 1123 Broadway, New York.

PATENT ATTORNEYS
 INVENTORS—Before disclosing your invention to any one send for Form "Evidence of Conception," "Schedule of Government and Attorneys' Fees" and instructions. Sent free. Lancaster, Allwine & Rommel, 414 Bowen Building, Washington, D. C.

PATENTS—Advice and booklet free. Highest references. Best results. Promptness assured. Watson E. Coleman, Patent Lawyer, 724 9th Street, Washington, D. C.

RADIO ENGINEERING
 RADIO Engineering, broadcasting, aviation and police radio, servicing, marine and Morse telegraphy taught thoroughly. All expenses low. Catalog free. Dodge's Institute, Elm St., Valparaiso, Ind.

RADIO
 WE buy and sell used radio testing equipment. Harold Davis, Inc., Jackson, Miss.

HAM STUFF
 SACRIFICE for Cash—250 watt phone transmitter. Write, W5HGA, Cleveland, Mississippi.

SPECIAL RATES FOR READERS
 A special classified rate is now offered for readers (non-commercial) who wish to buy, sell, or exchange radio sets, transmitters or parts; 10 words for 50c. Extra words 15c. Payable in advance.

EXPERIENCE ALONE DOES NOT ASSURE SUCCESS



•Experience PLUS Technical Training Prepares You for Advancement in **RADIO & TELEVISION**

ENGINEERING

Years of experience on a routine job does not in itself prepare a man for a more advanced position. Radio, Facsimile, Television are offering constant new opportunities through new developments. But, experience alone cannot qualify you for a job that demands ability based on specialization and modern training. The better job that you want must be earned in your spare time. Hundreds of men in every branch of the radio industry are improving their knowledge and jobs by training in their spare time. CREI home-study courses prepare you for a definite career by backing up your experience with modern technical training.

Write for Details in FREE BOOKLET

Our 48-page booklet — "A Tested Plan" explains CREI home-study and residence courses in detail. In writing please describe your education and present position so we may provide you with pertinent information.

CAPITOL RADIO Engineering Institute

Dept. RN-4, 3224-16th St. N. W., WASH., D. C.



HOK, THE CAVEMAN

... your first human ancestor!

During the process of evolution Hok had to battle for his existence against tremendous odds! By his wits and inventiveness he fought a winning battle against the Gnorrils and lived to found the human race! Yes, this caveman, believe it or not, was your first human ancestor! Don't fail to read the thrilling, logically true story of Hok, the caveman, and how he invented the bow. It's fine entertainment! "HOK DRAWS THE BOW" by Manley Wade Wellman is just one of the six great stories you will want to read in the

MAY ISSUE

AMAZING STORIES

NOW ON SALE AT ALL NEWSSTANDS!

The most common fault with auto radio sets and with house sets employing vibrators, is vibrator trouble. The best procedure is to replace the unit with an exact duplicate.

Usually the vibrators are of the plug-in type and may be easily replaced.

-50-

Bench Notes
(Continued from page 25)

first ream of scratch paper, and locks himself in the store whenever he's left alone. I am very anxious to get the solution so we can write the customer off the books.

In the meantime, my business suffers, and the air is tense. Perhaps you can help me.

What's in that box?

Snap

Give thought to the servicemen who tend the p-a equipment along the European firing lines. Modern warfare stylists, in decreeing amplifiers mightier than the sword, have made the radioman more important than the infantryman.

Bet the boys learn to work fast. Imagine being asked to go "over the top" to center a voice coil!

-50-

Remote Controller
(Continued from page 18)

interference between houses and apartments almost negligible. The transmitting unit oscillates only momentarily so that radio interference is not of any consequence. However, if even momentary interference is undesirable, a filter circuit may be added for 20 or 30 cents and carrier frequencies outside the broadcast band employed.

Tube life is not a factor since the tubes are normally on only a few seconds a day. The models shown have been used for more than six months both in large homes and small apartments. They quickly become an almost indispensable convenience.

-50-

Deviation Meter
(Continued from page 13)

ter to mid scale. Then apply a signal, disengage the flexible coupler and rotate the secondary condenser to a point where it has no effect upon the meter deflection. Tune the primary condenser for greatest deflection and then adjust the secondary condenser for the greatest deflection in the opposite direction. Set the monitor so that resonance is indicated and remove the signal. If the alignment is correct, no change will occur in the meter reading.

If the transmitter to be monitored is a phone, add a .5 mfd. condenser from the indicator tube grid to ground so that the audio voltage will not cause the meter to flicker.

-50-

STOP! LOOK! EARN!

I'LL TRAIN YOU TO MAKE GOOD MONEY in RADIO AND TELEVISION



I'll Prove That You Can Have a Good Job in Radio .. or a Business of YOUR OWN

I offer you a new and altogether different type of practical Training for a money-making career in Radio and Television. No matter if you desire to BE YOUR OWN BOSS in your own business, or hold down a good job in Radio, my Personalized Training will quickly give you the useful knowledge to win success. I make it EASY for you to get started.

YOU LEARN RIGHT AT HOME in SPARE TIME . . . EARN from the START

YOU DO PRACTICAL EXPERIMENTS with real Radio Equipment with your own hands. Thus the principles of Radio become crystal-clear to you. The valuable spare-time **BUSINESS BUILDERS** I supply will show you how to put this knowledge to work in handling profitable Radio service jobs while learning.

YOU GET PROFESSIONAL TEST EQUIPMENT plus EXPERIMENTAL OUTFITS

146 RADIO PARTS • RADIO TOOLS • All-Purpose Analyzer





I GIVE YOU CLOSE PERSONAL COACHING SERVICE

NO PREVIOUS EXPERIENCE NEEDED

It makes no difference what your education has been. My training starts at the beginning of Radio, covers in a simple understandable style all essential subjects including Television, Electronics, Facsimile Radio, Radio-Set Repair and Installation.

READ WHAT THIS STUDENT SAYS Earned \$250, Since Starting Course

"I have only completed one third of the Sprayberry Course and I find it very interesting, which makes it easy to learn. By devoting several hours' spare time daily to studying and servicing I have made about \$250 gross since starting the Course." Earl W. Hostetter, R. No. 4, Lebanon, Pa.

SERVICEMEN

I offer Advanced Training for those already in Radio. Get complete details in my FREE 52-page Book.

REMEMBER — THE SPRAYBERRY COURSE IS SOLD UNDER A MONEY-BACK AGREEMENT

RUSH THIS COUPON FREE for BIG FREE BOOK

DON'T DELAY! ACT NOW!

SPRAYBERRY ACADEMY OF RADIO
F. L. Sprayberry, Pres.
325-D University Place, N.W., Washington, D. C.

Please send me FREE copy of "HOW TO MAKE MONEY IN RADIO."

Name..... Age.....
Address.....
City..... State.....

Tear off this coupon, mail in envelope or paste on penny postcard. Servicemen—Check here

Would YOU Like to Learn Code Right and Be a FAMOUS AMATEUR?

You will never be well known with a fist like a foot. If you've practiced a long time but still copy "letter-for-letter" at slow speed and send poorly with key or "bug," you know something is wrong. You've missed that "coordinative Knack," necessary to speed and copying behind!

No need to worry about it or try further to overcome it by practice. Of course, practice is necessary but you must KNOW the HOW and the WHY of practice for developing the necessary FACULTIES that mean your success in handling CW. Since the alltime speed records are held by Candler-trained operators, Walter Candler's training and personal coaching should help you to reach your goal quickly!

T. R. McElroy Official Champion, Speed 75.2 w. p.m., says "Candler training must be good for it gave McDonald and me our speed and skill."



The New 1940 BOOK OF FACTS

FREE! tells you the whole story and a postal will bring it to you. No obligation.

CANDLER SYSTEM CO.
DEPT. N-4 ASHEVILLE, N. C.
U. S. A.

UNIVERSAL Handi-Mikes
Press-to-talk (illus.), push button or snap switch. Crystal, dynamic or carbon. For gen. use, sm. transmitters, call systems, p.a. work, amateurs, remote control, police cars, spec. events, and other uses. Clean cut speech reproduction. Six ft. 2-conductor cord. Circuit diagram. Available sev. switch and circuit combinations.
UNIVERSAL MICROPHONE CO., LTD.
424 Warren Lane, Inglewood, Calif., U.S.A.

Simplest WAY TO REPLACE BALLASTS
4 STANDARD TYPES of Amperite Regulators replace over 200 types of AC/DC Ballast Tubes now in use. Has patented automatic starting resistor.
List \$1.00
WRITE FOR REPLACEMENT CHART "S"
Amperite Co. 561 Broadway, N. Y. C.
AMPERITE

The Unicontrol 5.
(Continued from page 61)

have been formed, they should be drilled, according to the specifications. The plentiful use of Lard oil on the drill is recommended.

Mounting the Gear Assembly
The switches, brackets, gears, etc., should be laid aside and the holes upon which the switches are to be mounted and the brackets to be fastened to the chassis, should be laid out on the chassis. Brackets and switches are fastened to their respective standards by means of 6-32 bolts and nuts, safetied with lock washers. Mount the gear train assembly brackets first. Thread the quarter inch brass shafting through the proper holes, using standard Yaxley quarter-inch panel bushings as bearings. Be sure that the shaft turns freely. Assemble the gears on the shafts in their approximate positions and tighten them lightly. Now mark and then cut the shaft to exact size. File a flat place where each bevel gear set-screw will "hit." Mount the switches as indicated in the illustrations and on the mechanical drawings. Assemble and mount the bakelite bracket, using Yaxley bushings throughout wherever the quarter-inch shafting passes through a hole.

Adjusting Gear Train Assembly
It is necessary, in order that the gear-train assembly run smoothly, that the adjustments and tightening of the gears and switches be accomplished with a certain routine. First, loosen all bushings so that they are "floating." Next, tighten up all insulator couplings so that the switches will track evenly. Starting with the gear at the end of the Coto wheel shaft, tighten this gear with the Allen key so that it meshes with the bevel gear driving the main length-wise shaft running parallel to the front of the chassis. Tighten the main driving gear on this shaft. Tighten the coupling between the crystal switch and the main drive shafting. At this time, a test should be made to see whether turning the Coto wheel turns the crystal switch and no further adjustments should be attempted until this particular switch turns freely and easily. Naturally, since the bushings are all "floating," there cannot help but be considerable "play." This is of no importance at this time. Having adjusted the crystal switch to perfection, the bevel gear at the other end of the main drive shaft is tightened and intermeshed with the driving gear to the final amplifier plate and antenna switches.

Tests should now be made to see whether turning the Coto wheel not only runs the crystal switch, but turns the shaft from which the final amplifier and antenna switches are to get their turning power, and no further adjustment should be made until this step has been accomplished perfectly.

Next, tighten the coupling between the antenna plate switch and its driving bevel gear. Placing the plate tank

RADIOS .. SAVE UP TO 50%

Deal Direct—Factory Prices Many models to choose from at wholesale prices. A-C-DC midsets \$4.98. Portable, battery sets \$8.98 up. Car sets \$11.75 up. Consoles, all-wave, etc. Samples at 50% off. FREE 1940 bargain catalog giving details of 10 day FREE trial, agent's proposition, discounts. Write today. GOLDENTONE RADIO CO., Dept. RN, Dearborn, Mich.

4.95 EACH

Free Catalog

QUALITY ABOVE ALL

SOLAR CAPACITORS

Write for Catalog
SOLAR MFG. CORP.
BAYONNE, N. J.

Correspondence Courses in RADIO and ELECTRICAL ENGINEERING

Get good grasp of wide electrical field. Prepare yourself at Low Cost, for secure future. Modern course. So simplified anyone can understand quickly. Extra fine course in radio, public address, photo-electric work. Trains you to be super-service man, repair vacuum-tube technician. Experimental kits furnished. Diploma on completion. Either course, only \$25. Deferred payment plan available. Write for free copies of school catalogs, student magazines, full details. SEND NOW!

LOW AS \$25

LINCOLN ENGINEERING SCHOOL, Box 331-R 16, Lincoln, Neb.

RADIO COURSES

- RADIO OPERATING—BROADCASTING
- RADIO SERVICING—a practical course
- RADIO AMATEUR CODE & TELEVISION
- ELECTRONICS—1 yr. day course, 2 yrs. eve. Day and Evening Classes. Booklet Upon Request.

New York Y. M. C. A. Schools
7 W. 63rd St. New York City

RADIO ENGINEERING,

broadcasting, aviation and police radio, servicing, marine radio telegraphy and telephony, Morse telegraphy and railway accounting taught thoroughly. 48 weeks' Engineering course equivalent to 3 years of college radio work. All expenses low. Catalog free. School established 1874. Dodge's Institute, Oak St., Valparaiso, Ind.

SERVICE MANUAL

427 DIAGRAMS YOU NEED
In one handy manual you have all the diagrams of the most - often serviced radios today. Over 80% of all sets you service, every day are included. These important, hint-giving, trouble - shooting circuits make your job easier, permit faster and better repairs every time.

4 OUT OF 5 OF MOST SERVICED RADIOS

4 OUT OF 5 OF CIRCUITS YOU NEED

COMPLETE \$1.95 POSTPAID

DIAGRAMS YOU NEED
In one handy manual you have all the diagrams of the most - often serviced radios today. Over 80% of all sets you service, every day are included. These important, hint-giving, trouble - shooting circuits make your job easier, permit faster and better repairs every time.

HOW TO SAVE TIME
Circuit data, hints, information are time-savers and money-makers for you. Let this diagram manual be your guide to bigger profits and easier service work. Why work blind-folded when 4 out of 5 diagrams you will ever need are included in this new, low-priced manual. Compiled by M. Beitman, radio serviceman, noted author, teacher of Radio in Chicago schools.

LIMITED EDITION
Get your copy of this radioman's biggest time - saver. No need to spend big money for bulky, space-wasting manuals. Only \$1.95 today, brings you our copy of the handiest "on-the-job" handbook of useful diagrams. (Models 1926 to date.) Well printed, with illustrations, large size 8 3/4 x 11 inches. Limited quantity at the special price. Rush order now.

FREE EXAMINATION COUPON

SUPREME PUBLICATIONS
3727 West 13th St., Chicago, Ill.

Ship complete Service Manual. I may return the manual for a full cash refund if not satisfied.

I am enclosing \$1.95, send postpaid.

Send C.O.D. I will pay postman \$1.95 and a few cents postage.

NAME

Write address below and send this corner.

I WILL TRAIN YOU AT HOME
8c. RADIO SERVICE EXPERT

RADIO SPECIALISTS NEEDED
 Radio offers splendid opportunities and good pay to men trained for modern test and service work. Can you qualify?

PRACTICAL HOME TRAINING
 offered by RTA combines "bench work" with theory. Equipment includes professional Circuit Analyzer and experimental outfits.

MAKE SPARE TIME MONEY
 You also learn how to make money almost from the start. Course can easily be made to pay its own way. Don't wait. Write for our complete illustrated Free Book.

RADIO TRAINING ASSOCIATION OF AMERICA
 4525 Ravenswood Avenue, Dept. RN-40, Chicago, Illinois

RADIO ENGINEERING
DEGREE IN 2 YEARS

Intensive, specialized course, including strong basis in mathematics and electrical engineering, advanced Radio Theory and Design. Modern laboratory. Low tuition. Self-help opportunities. Also 2-year courses in Aeronautical, Chemical, Civil, Electrical and Mechanical Engineering. Participation in Civilian Pilot Training Program. Enter June, September, December. March. Catalog.

INDIANA TECHNICAL COLLEGE
 740 E. Washington Blvd., Fort Wayne, Ind.

YOU CAN GET IN AVIATION RADIO

Radio's newest field needs trained men. Study under actual working conditions at SPARTAN. Work beside Radio specialists constructing, operating and servicing aircraft radio equipment used in fast transports. Theory demonstrated under actual working conditions. Training to fit YOU for positions now open. Get ready for a well paying position—WRITE TODAY!

HOME OF THE DAWN PATROL

SPARTAN

SPARTAN SCHOOL OF AERONAUTICS
 Dept. RN-1, TULSA, OKLAHOMA
 Capt. MAXWELL W. BALFOUR, Dir.

RADIO TECHNOLOGY

RCA Institutes offer an intensive course of high standard embracing all phases of Radio and Television. Practical training with modern equipment at New York and Chicago schools. Also specialized courses and Home Study Courses under "No obligation" plan. Catalog Dept. RN-40.

RCA INSTITUTES, Inc.
 A Radio Corporation of America Service
 75 Varick St., New York 1154 Merchandise Mart, Chicago

SO MANY BIG PAY JOBS
BEGIN WITH THIS FREE BOOK!

Earn money in spare time... be your own boss in a profitable business... enjoy an absorbing hobby. *Whatever your ambition*,—added income, big pay job or relaxation after hours, this **FREE BOOK** will get you started. *And enable you to buy the finest, nationally advertised radios, radio parts and accessories, Sound Systems and equipment at remarkably low prices!*

HUNDREDS HAVE PROFITED!

Here's a buying guide so comprehensive, so complete, so up-to-date you can order everything you need—at home. And save on everything you buy! Take advantage of this **FREE** offer. Hundreds have done it, and taken a new lease on life. Our twenty years of experience is your guarantee of dependable merchandise and complete satisfaction. Our staff of trained technicians stands ready to furnish you with helpful information and advice. *Why not send for our FREE catalog today? See what's in it for you. Simply tear out coupon and mail NOW!*

NEW YORK, N. Y. 100 SIXTH AVENUE
 CHICAGO, ILL. 901 W. JACKSON BLVD
 ATLANTA, GA. 245 PEACHTREE STREET
 BOSTON, MASS. - BRONX, N. Y.
 NEWARK, N. J. - JAMAICA, L. I.

LAFAYETTE RADIO

LAFAYETTE RADIO • Dept. 2D, 100 SIXTH AVE., N. Y.
 Rush **FREE** 1940 Lafayette Catalog No. 80

NAME.....
 ADDRESS.....
 CITY..... STATE.....

switch in proper position so that it tracks with the crystal switch, tighten the driven bevel gear on the extension to the final amplifier switch. Next, intermesh the driving gear on the vertical shaft and tighten it so that it will drive the driven gear.

Tests should now be made to see whether turning the *Coto* wheel drives both the crystal and final amplifier tank switch and that these switches are tracking.

The adjustment and tightening of the antenna switch is but a repetition of the process applied to the final amplifier switch.

Completing the Gear Assembly

If everything has been worked out properly to this stage, turning the *Coto* wheel will serve to turn all three switches but there will be considerable "play." The elimination of this play is a slow, tedious, but exact process. Tighten up all of the *Yaxley* bushings closest to each of the three switches. Do this a little bit at a time, testing after each step to see that the switches turn freely, and that the shafting is not binding at any one point. When the bushings mentioned above, have been tightened as far as they will go, attention should be turned to the bushings in the various brackets and these should be tightened in the same manner. Eventually a stage will be reached where all bushings are as tight as they can be made and yet the switch assembly turns freely and smoothly. Do not rely upon oil at the bearings to accomplish this, but make each step carefully and slowly such that the shafting turns with a minimum of friction "as is". Upon tightening all of the bushings to a maximum state, as mentioned above, they should be locked to the chassis and brackets by means of solder. Use acid core solder, if necessary, wiping away all excess acid, and following it up with a bit of rosin-core solder.

Balance of the R.F. Assembly

The shield between the crystal and final amplifier stages should next be constructed and the tube socket mounted where indicated on the illustration. The under-chassis shield should be bent as indicated, inserted, and bolted down, lock washers being used throughout. Either a hole or a slot can be cut for the drive shaft of the gear assembly; but if the former is used the shield will have to be installed before the gear assembly is completed. With a small blow torch, or heavy iron, flow solder along the junction between the under-chassis shield and the chassis so as to make an electrically tight joint.

The balance of the R.F. components may now be mounted in order from the crystal stage forward.

Testing the Unit

While the use of standard *Barker & Williamson* coils is recommended, it may be found owing to vagaries in the wiring, (since no two hams wire alike) that the coil and condenser combinations will not hit the band for which the coils were purchased. This is overcome by taking off turns, one at a

Save Money!
 With the
RADOLEK RADIO PROFIT GUIDE!

EVERYTHING IN RADIO AT LOWEST PRICES!

In the Radolek catalog you will find the **MOST** for your money! **Lowest Prices! Best Quality! Biggest values! Most complete Stock! Fastest Service!** Send for your **FREE** copy NOW!

OVER 15,000 REPAIR PARTS

The world's most complete stock of radio repair parts and exact duplicate replacements. All leading brands at lowest prices!

COMPLETE TUBE SELECTION

All types. RCA, Sylvania, Raytheon, Philco, etc. Includes Kellogg, special Majestic and transmitting tubes. Complete selection.

NEWEST TEST INSTRUMENTS

The most complete line ever displayed in any catalog. All leading makes. Includes latest improved 1940 models at lowest prices.

GREATEST RADIO VALUES

A Huge selection of money-saving set bargains! New Phono-Radio combinations. Automatic tuning sets. Beautiful cabinets. New "Ham" receivers and equipment.

EVERYTHING FOR AUTO RADIO

Complete new auto radio section. Includes vibrator replacement guide, new auto aerials, custom panel control plates for all autos.

COMPLETE P. A. SELECTION

New 1940 public address amplifiers from 5 to 100 watts. Complete P. A. Systems for permanent, Mobile and Portable use.

NEW ELECTRICAL APPLIANCES

Extra profits for you! Standard Brand Electric Irons, Stoves, Heaters, Percolators, Waffle Irons, Vacuum Cleaners, Trains, Clocks, Mixers, etc., at lowest prices!

FREE Mail Coupon

The RADOLEK Co.
 601 W. Randolph, Chicago, Dept. B-40
 Send the 1940 Radolek Radio Profit Guide **FREE**.

Name.....
 Address.....
 Serviceman? Dealer? Experimenter?



● For those applications requiring paper type condensers, be sure you check with the new 1940 AEROVOX catalog.



Despite the preponderant use of electrolytics, AEROVOX maintains a wide choice of paper condensers to meet those needs where only paper dielectric can be safely and satisfactorily used. You can have uncased units for your own grouping and container; inexpensive paper tubulars; various types of metal-can jobs; bakelite-case paper units; oil-filled high-voltage capacitors, etc., etc.



All of which is typical of the AEROVOX aim to provide condensers that fit into your exact needs, rather than expecting you to improvise or warp your requirements to an otherwise limited choice of condensers.

Have You Our NEW CATALOG?

Contains more pages, more items, more choice. Ask your local AEROVOX jobber for your copy—or write us direct. Also ask about the free subscription to the monthly AEROVOX RESEARCH WORKER.



time, for each coil until that coil hits the crystal frequency with the final amplifier tank condenser 50% meshed. As many as four turns, two from each end, may be required to be removed. In the laboratory model, on the contrary, it was found that the 160 meter coil did not hit resonance because the condenser or the coil was too small. It was remedied by padding the tank condenser with a 60 micromicroferad fixed Cardwell air condenser (Cardwell Type EE-60-FS).

The oscillator coils may also need considerable tailoring to accommodate the wiring. The actual coils used in the laboratory model were as follows:

- 160 meters—48 turns, close wound, No. 30 EC.
- 80 meters—30 turns, close wound, No. 28 EC.
- 40 meters—15 turns, No. 22 EC, spaced to 3/4".
- 20 meters—6 turns, No. 22 EC, spaced to 3/8".
- 10 meters — 7 turns, No. 14, tinned, 5/8" diam., spaced to 1".

All the coils excepting the 10 meter coil were wound on Millen 1" forms, while the last mentioned coil was self-supporting.

In testing the set, care should be taken to remove not only the plate but the screen voltage from the RCA 828 while tuning the oscillator, since leaving the screen voltage on the tube with the plate voltage removed might cause its sudden destruction. While the RCA 1610 is a standard oscillator tube, grid bias and screen voltage will have to be experimented with, in order to find optimum operating conditions.

After the laboratory model had been built and was working and because many of the amateurs still feel that they would not care to expend the additional money for a special oscillator tube both the RCA 6V6 and 6L6 were tried as oscillators. Both of these tubes performed excellently and, as a matter of fact, gave increased drive on ten meters.

Suitable changes to accommodate the transmitter for 6V6 or 6L6 operation include the replacement of the 2 1/2 volt filament transformer in the power supply chassis with one of similar physical dimensions delivering 6.3 volts A.C. at 1 ampere. The center-tap of the 6 volt transformer is not grounded and the ground end of the cathode of the crystal oscillator 6V6 or 6L6 is brought out to key-jack J2 with a .1 microfarad by-pass condenser to ground inserted in the R.F. chassis. The circuit for the optional additional crystal oscillator is shown. Metal tubes in the 6V6-6L6 class are to be preferred for this purpose over those made of glass since the feed-back trouble is minimized.

Conclusion

There are several points of general nature which should be considered by the constructor. Firstly, make sure that every connection is tight. You will regret a "Rosin-Core Jernt" more than you imagine. When the unit is finished, it will be very difficult to dig

into its "guts," not only to find the bad connection but to get a soldering iron into the restricted space. "So make 'em good, and make 'em sure."

The switching from band to band with the power on is to be discouraged. Not only will this serve to burn the switch points, but the shock to the tube and the condensers is serious. Before switching from one band to another, turn off the high voltage. It's safer.

While on the subject of safety, do not forget to insert the interlocks on the top of the cabinet. True, there is no need for the interlock during the testing period. That's when you are on your guard. But later you will forget, and put your hand on some coil in changing crystals, or making some slight adjustment, and you will not remember the lethal 1500 volts coursing through the set. That is when the interlock will do you the most good. Don't leave it out for the sake of the few cents you will save. There is no chance for your electrocution from the back of the set, since you will find that its door cannot be closed with the chassis recommended. Remove the door entirely and construct a metal-cane cover to bolt over the entire back; and you must keep your hands out. That is what was done in the laboratory model.

Once the set has been completed, the antenna situation arises. Provision has been made for a double and a single-wire feed type to be used. Tune your antenna for each band separately. We used a 160 meter single wire feed, and found it satisfactory on all bands. Once adjusted, switching is sure-fire and more rapid than the other fellow can QSY on his receiver.

If the instructions have been carefully followed, the resulting transmitter will exceed your fondest dreams, and will leave the proud possessor of what might truly be called the "Rig of 1940".

-30-

Servicemen's Cases

(Continued from page 34)

- | | | |
|----------------------------|---|--|
| Noisy reception | 1) noisy a-f transformer primaries | 2) tube and circuit noises can be materially reduced by shunting each of the grids of the power tubes to the chassis with 50,000-ohm 1-watt resistors. |
| "Frying" noise | 1) replace the first audio transformer | 2) reverse the a-c line plug. One side causes more hum than the other |
| Volume control inoperative | 1) 20,000-ohm green resistor "grounding" | |
| Slipping dial | 1) check clearance between dial drum and volume control | 2) pour some finely-powdered rosin between the disc and the engaging drum on the driving mechanism |

FADA 30, 31

Same Case Histories as those listed for Fada 10, 11

FADA 32

Same Case Histories as those listed for Fada 16, 17, 20

FADA 35, 35B

- | | |
|---|---|
| Inoperative, Weak reception Intermittent reception | 1) r-f coil lugs short-circuiting or grounding to chassis |
| 2) open-circuiting r-f cathode or plate by-pass condenser (block) | |

-30-

PRINTED IN U. S. A.

THE NEW CHANNEL-ANALYZER

Follows the SIGNAL from Antenna to Speaker

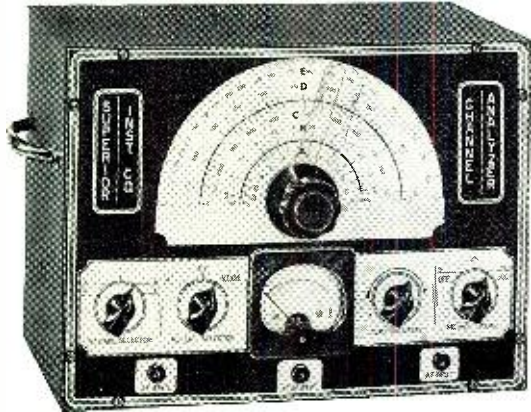

The well-established and authentic SIGNAL TRACING METHOD of locating the very circuit in which there is trouble, and the very component that causes the trouble, is now for the first time available at a price any radio serviceman can afford.

THE CHANNEL-ANALYZER will

- ★ Follow signal from antenna to speaker through all stages of any receiver ever made.
 - ★ Instantly track down exact cause of intermittent operation.
 - ★ Measure both Automatic-Voltage-Control and Automatic-Frequency-Control voltages and circuits without appreciably loading the circuit, using built-in highly sensitive Vacuum-Tube Voltmeter.
 - ★ Check exact gain of every individual stage in receiver.
 - ★ Track down and locate cause of distortion in R.F., I.F., and A.F. amplifier.
 - ★ Check exact operating voltage of each tube.
 - ★ Locate leaky condensers and all high-resistance shorts, also show opens.
 - ★ Measure exact frequencies, amount of drift and comparative output of oscillators in superhets.
 - ★ Track down exact cause of noise.
- The Superior Channel-Analyzer comes housed in shielded cabinet and features an attractive etched aluminum panel. Supplied complete with tubes, three specially engineered shielded input cables, each identified as to its purpose. Also full operating instructions. Size 13"x10"x6". Shipping weight 19 pounds. Only **\$19.75**

THE NEW MODEL 1280 SET-TESTER

Combines Models 1240 and 1250

A complete testing laboratory in one unit, the Model 1280 combines the Models 1250 Multitester and 1240 Tube Tester. (See specifications of each below.)

- ★ Instantaneous Snap Switches Reduce Actual Testing Time to Absolute Minimum.
- ★ Spare Socket and Filament Voltages Up to 120 Volts. Make the Model 1280 Obsolescence Proof.
- ★ Latest Design 4 1/2" D'Arsonval Type Meter.
- ★ Works on 90 to 125 Volts 60 Cycles A.C.

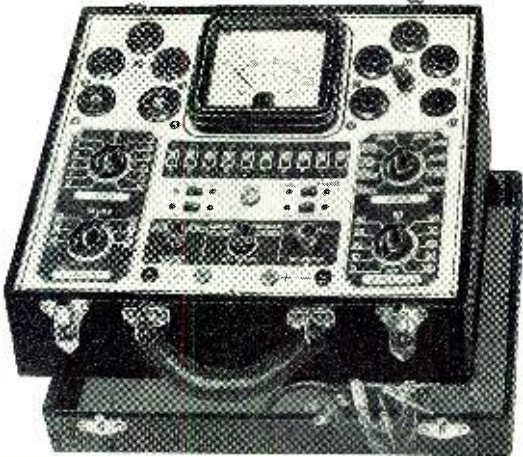

Even those servicemen who through past purchases know they can always get SUPER-VALUES from Superior, will be amazed and delighted when they read the specifications of this all-purpose instrument and then note the unbelievably low price. The Model 1280 features a 4 1/2" D'Arsonval type meter for easy reading of the various scales, and in line with our new policy of stressing appearance as well as serviceability in our new 1200 line of test equipment, our Model 1280 utilizes an aluminum etched panel, designed for beauty as well as ruggedness. The primary function of an instrument is, of course, to make measurements accurately and when designing test equipment this is our first thought. However, we also appreciate the important part the appearance of an instrument plays in the impression a serviceman makes on his customers, especially on home calls. We have, therefore, paid special attention to the outward design of all of our new instruments. For instance, the panel of this Model 1280 is made of heavy-gauge aluminum and etched by a radically new process which results in a beautiful, confidence-inspiring appearance.

Model 1280 comes complete with test leads, tabular data and instructions. Shipping weight 18 pounds. Size 13"x11"x6 1/2". Our net price **\$19.95**

Portable cover \$1.00 additional

THE NEW MODEL 1250 MULTITESTER



SLOPING PANEL FOR PRECISE RAPID SERVICING

Etched Aluminum Panel

Specially Designed Electronic Rectifier Enables Linear A.C. Scale, High Stability and Little or no Temperature Drift.

Here is an opportunity to acquire a Multi-Service, Precision Engineered Instrument, for less than you would have to pay for an ordinary Volt-Ohm Milliammeter. Besides making the usual volt, resistance and current measurements (both A.C. and D.C.) this unit accurately measures the CAPACITIES of mica, paper and electrolytic condensers, INDUCTANCE of coils, chokes and transformers, DECIBEL gain or loss, of power amplifiers and public address systems, WATTS' output of amplifiers, receivers, etc.

SPECIFICATIONS

Complete A.C. and D.C. Voltage and Current Ranges	High and Low Capacity Scales .0005 to 1 mfd. and .05 to 50 mfd.
D.C. Voltage: — 0-15, 0-150, 0-750 volts	3 Decibel Ranges
A.C. Voltage: — 0-15, 0-150, 0-750 volts	—10 to +19, —10 to +38, —10 to +53
D.C. Current: — 0.1, 0-15, 0-150, 0-750 ma.	Inductance: 1 to 700 Henries
A.C. Current: — 0-15, 0-150, 0-750 ma.	Watts: Based on 6 mw. at 0 D.B. in 500 ohms .006000 to 600 Watts
2 Resistance Ranges	
0-500 ohms, 500-5 megohms	

Model 1250 works on 90-120 volts 60 cycles A.C. Comes complete with test leads, tabular charts and instructions. Shipping weight 9 lbs. Size 9 1/2"x11"x6 1/2". Our net price **\$11.85**

Portable Cover \$1.00 Additional

THE NEW MODEL 1240 TUBE TESTER

Instantaneous Snap Switches Reduce Actual Testing Time to Absolute Minimum

▲ Tests All Tubes 1.4 to 117 Volts

▲ Sockets for All Tubes—No Adapters

▲ Superior is proud to offer the newest and most practical tube tester ever designed. Unbelievably low in price—unbelievably high in performance.

- ★ Tests all tubes. 1.4 to 117 Volts, including 4, 5, 6, 7, 7L, octals, loctals, Bantam Jr., Peanut, single ended, floating filament, Mercury Vapor Rectifiers, the new S series, in fact, every tube designed to date.
- ★ Spare socket included on front panel for any future tubes.
- ★ Tests by the well-established emission method for tube quality directly read on the GOOD ? BAD scale of the meter.
- ★ Jewel protected neon.
- ★ Tests shorts and leakages up to 2 megohms in all tubes.
- ★ Tests leakages and shorts in all elements AGAINST all elements in all tubes.
- ★ Tests BOTH plates in rectifiers.
- ★ Tests individual sections such as diodes, triodes, pentodes, etc., in multi-purpose tubes.
- ★ Latest type voltage regulator.
- ★ Features an attractive etched aluminum panel.
- ★ Works on 90 to 125 volts 60 cycles A.C.

Model 1240 comes complete with instructions and tabular data for every known type of receiving tube. Shipping weight 12 pounds. Size 9 1/2"x11"x6 1/2". Our Net Price **\$11.85**

Portable Cover \$1.00 Additional

SUPERIOR INSTRUMENTS CO.

136 LIBERTY ST., DEPT. RN4
NEW YORK, N. Y.

Here's the New Meissner ANALYST

IN KIT
FORM

BUILD IT
YOURSELF

SAVE HALF
THE COST

COMPLETE KIT
ONLY

\$60 Net

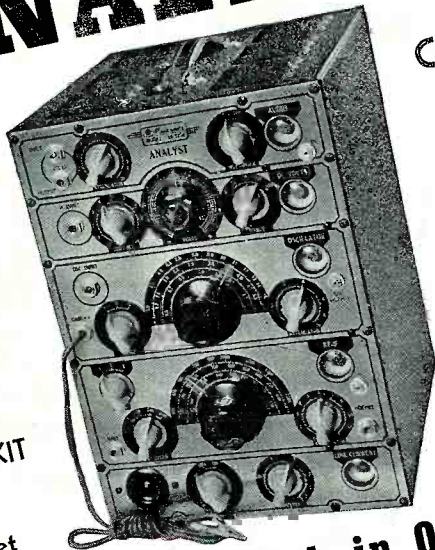

FIVE
CHANNELS

AUDIO
50-50000 cycles

VOLTS
5-15-50-150-500

OSCILLATOR
0.6 to 15.0 MC

RF-IF
95 to 1700 KC

LINE CURRENT
0.1 to 3.0 Amp.

A Complete Service Lab in One Instrument

The same tried and proven circuits—the same dependable components—the same time and money saving performance—now offered in a new dress—a new panel finish and design that makes reading and operation even easier than ever.

It is unnecessary to repeat the numerous advantages of signal-testing over old-time servicing procedures. It is a proven fact, however, that every day you try to get along without this remarkable instrument is costing you money! It will eliminate the long hours fre-

quently spent in trying to locate some obscure fault and will make trouble location the simplest part of your work.

All measurements are made quickly, easily and accurately—during actual operation—without affecting the receiver circuits a bit. All channels of the receiver may be thoroughly tested—individually or simultaneously. A separate panel for every channel!

Don't delay! See the Meissner Analyst at your Jobber's today—or write for fully illustrated descriptive folder.

To obtain any of the literature below, check the items you want, clip the lower part of this ad, write your name and address in the margin and mail to the address below.

FREE DESCRIPTIVE FOLDER

Complete details of the Meissner Analyst, fully described and illustrated in a big four-page folder. Get your copy at once.

BIG FREE CATALOG

The big 1940 48-page catalog contains complete information, illustrations and prices on the entire Meissner line of high-grade kits and parts for the serviceman.

INSTRUCTION MANUAL

See description at left. Be sure to enclose 50c in cash, stamps or money order. Order yours today!

TIME PAYMENT PLAN

The Meissner Analyst and many other products may be purchased on easy monthly payment plan. Small carrying charge. See your jobber for details.

DEPT. N-4

Get Your Copy Now!



A brand new 168-page book, full of live, interesting, up-to-the-minute radio constructional data and information. Contains complete diagrams and instructions for all the Meissner Kit Receivers as well as complete data on ready-wired units.

18-pages of latest Television Theory and practical application in plain language. See your Jobber at once or order your copy direct from factory. Only 50c net.



Meissner

"A FAMOUS NAME FOR TWO DECADES"

MT. CARMEL
ILLINOIS