

SPECIAL TELEVISION ISSUE

RADIO NEWS

MAY 25c

**Television
Grows Up!**

SEE PAGE 6

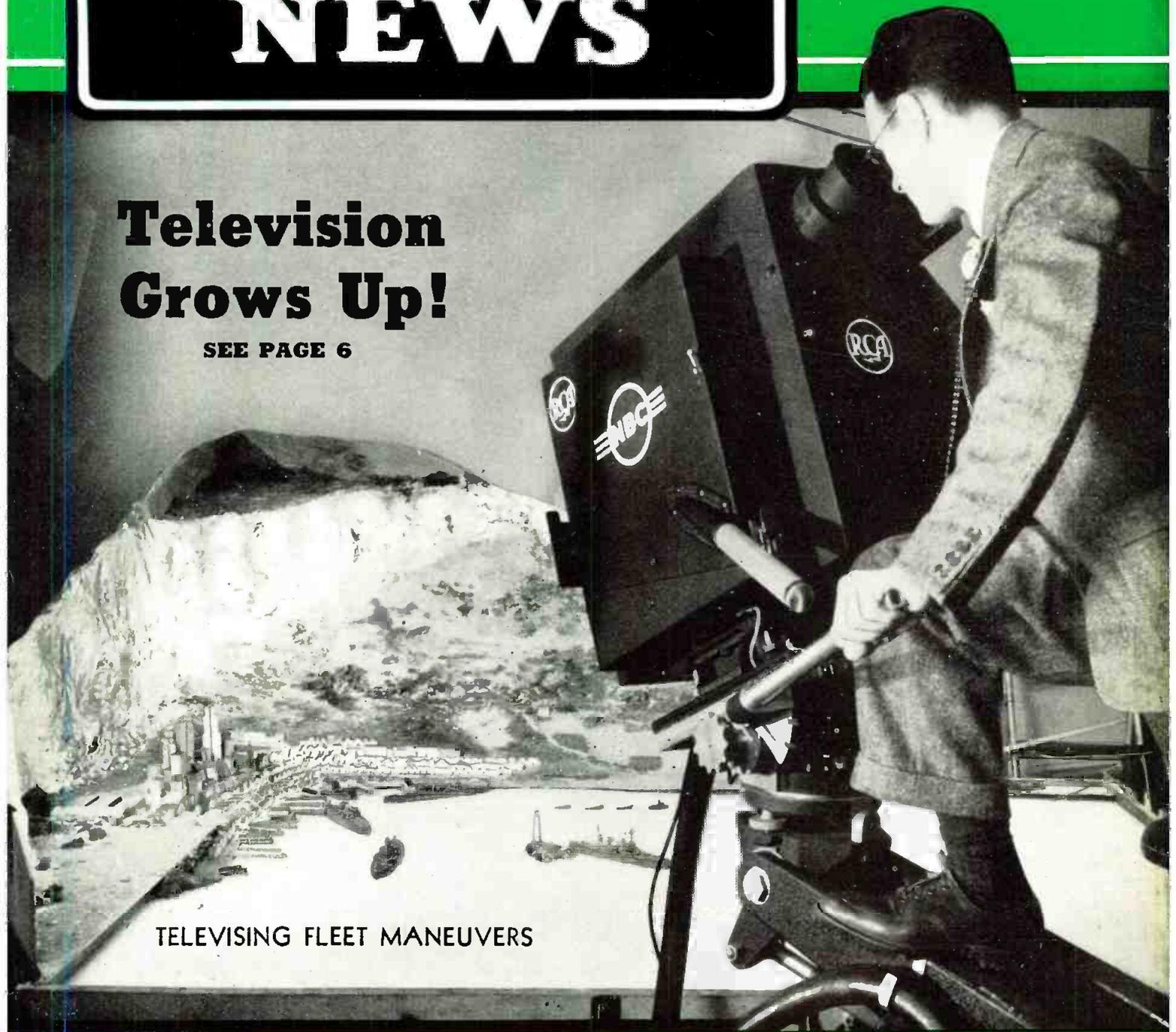

TELEVISION FLEET MANEUVERS

Build Your Own Video-Audio Set
Remote Record Player ★ **Hams' Test Panel**
PORTABLE COMMUNICATIONS RECEIVER



EASY TERMS

ACR-111 COMMUNICATION RECEIVER

The ACR-111 employs a single-signal, 16-tube Superheterodyne circuit with two tuned rf. stages, constant-percentage electrical band-spread, individual carefully isolated oscillators, two I.F. amplifier stages, crystal filter, calibrated input-signal strength indicator (electron-ray tube), noise limiter, noise suppressor, audio driver stages, push-pull power-output stage, and an integral power supply.

MADE TO
SELL FOR . . . \$18950

\$9950

(Limited Quantity)

DAVEGA-63 CORTLANDT ST. (N. Y. C.)

DAVEGA is America's Pioneer dealer in HALLICRAFTER



NEW HALLICRAFTERS SKYRIDER SX 23: A new 11 Tube Receiver with 8 Band Positions, with full coverage from 34 to .54 MC (8.8 to 556 meters), Band Spread Positions for 10, 20, 40 and 80 meter bands, Drift Compensation, Automatic Noise Limiter, Wide Range Variable Selectivity, new, indirectly illuminated Venetian Blind type Tuning Dial and "S" meter.

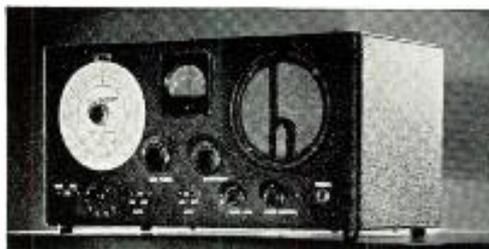

NEW HALLICRAFTER SKY-BUDDY: Full coverage for 10 meters including Broadcast Band • Four Bands • Electrical Band Spread • Full Size Chassis. Complete \$29.50

Davega has the largest stock of Hallicrafter Receivers and Transmitters in America

DAVEGA has the most complete Stock of R. M. E. in America



R.M.E. 70. Latest development of R.M.E. laboratories. One of the finest receivers manufactured today by a company known for its rigid standards of quality. Now on demonstration at Davega. Ready for delivery.

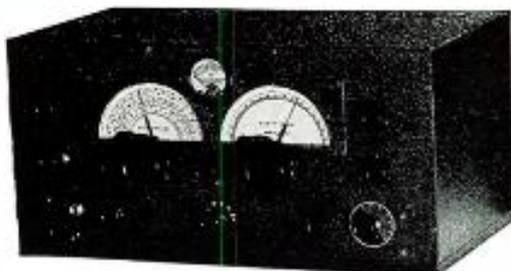

R.M.E. 69. A receiver that is praised by engineers, amateurs and B.C.L.'s throughout the world. One of today's communication standbys.

**EASY
TERMS**

DB 20 by R.M.E. Signal Amplifier, image rejector guaranteed to improve any set enormously or money refunded.

510 X Frequency Expander. Expand your present receiver into 5 meter reception. Utilizes all present power and adds sensitivity.

R.M.E. Rack panel models. All types in stock.

AMATEUR
DIVISION
63
Cortlandt St.,
New York, N. Y.

DAVEGA

HAMMARLUND
H. O. 120
HOWARD
TEMCO
TRANSMITTERS
SARGENT MARINE
PATTERSON

WORLD'S LARGEST RETAIL RADIO DEALER

• **Finest and Largest Display of Amateur Receivers and Transmitters in New York**
SOLE DISTRIBUTORS OF McMURDO SILVER RADIO



J. E. SMITH, President NATIONAL RADIO INSTITUTE Established 25 Years

He has directed the training of more men for the Radio Industry than anyone else.



Broadcasting Stations

Employ managers, engineers, operators, installation and maintenance men for fascinating jobs and pay up to \$5,000 a year.



Repairing Radio Sets

Spare time set repair work pays many \$5, \$10, \$15 a week extra while learning. Full time servicing pays as much as \$30, \$50, \$75 a week.



Loud Speaker Systems

Pulling, installing, servicing and operating public address systems is another growing field for men well trained in Radio.

Lesson on Radio Servicing Tips FREE

I'll prove my Training gives practical, money-making information, is easy to understand—just what you need to master Radio. My sample lesson text, "Radio Receiver Troubles—Their Cause and Remedy" covers a long list of Radio receiver troubles in A.C., D.C., battery, universal, auto, T.R.F., superheterodyne, all-wave, and other types of sets. A cross reference gives you the probable cause and a quick way to locate and remedy these set troubles. A special section is devoted to receiver check-up, alignment, balancing, neutralizing and testing. You can get this lesson Free. No obligation.



MAIL COUPON NOW

The Tested Way to BETTER PAY

I will send you a Lesson Free to show how I train you at home in spare time for Good Jobs in Radio

Clip the coupon and mail it. I will prove I can train you at home in your spare time to be a RADIO EXPERT. I will send you my first lesson FREE. Examine it, read it, see how easy it is to understand—how practical I make learning Radio at home. Men without Radio or electrical knowledge become Radio Experts, earn more money than ever as a result of my Training.

Get Ready Now for Jobs Like These

Radio broadcasting stations employ engineers, operators, station managers and pay well for trained men. Fixing Radio sets in spare time pays many \$200 to \$500 a year—full time jobs with Radio jobbers, manufacturers and dealers as much as \$30, \$50, \$75 a week. Many Radio Experts open full or part time Radio sales and repair businesses. Radio manufacturers and jobbers employ testers, inspectors, foremen, engineers, servicemen, in good-pay jobs with opportunities for advancement. Automobile, police, aviation, commercial Radio, loud speaker systems are newer fields offering good opportunities now and for the future. Television promises to open many good jobs soon. Men I trained have good jobs in these branches of Radio. Read how they got their jobs. Mail coupon.

Why Many Radio Experts Make \$30, \$50, \$75 a Week

Radio is young—yet it's one of our large industries. More than 28,000,000 homes have one or more Radios. There are more Radios than telephones. Every year millions of Radios get out of date and are replaced. Millions more need new tubes, repairs. Over \$50,000,000 are spent every year for Radio repairs alone. Over 5,000,000 auto Radios are in use; more are being sold every day, offering more profit-making opportunities for Radio experts. And RADIO IS STILL YOUNG, GROWING, expanding into new fields. The few hundred \$30, \$50, \$75 a week jobs of 20 years ago have grown to thousands. Yes, Radio offers opportunities—now and for the future!

Many Make \$5, \$10, \$15 a Week Extra in Spare Time While Learning

The day you enroll, in addition to our regular Course, I start sending Extra Money Job Sheets, show you how to do Radio repair jobs. Throughout your training I send plans and directions that make good spare time money—\$200 to \$500—for hundreds, while learning. I send you special Radio equipment—to conduct experiments, build circuits. This 50-50 method of training makes learning at home easy, fascinating, practical.



I Also Give You This Professional Servicing Instrument

Here is the instrument every Radio expert needs and wants—an All-Wave, All-Purpose Set Servicing Instrument. It contains everything necessary to measure A.C. and D.C. voltages and current; to test tubes, resistance; adjust and align any set, old or new. It satisfies your needs for professional servicing after you graduate—can help you make extra money fixing sets while training.

You Are Trained for Television Also

With N. R. I. you take up Television principles right along with Radio principles—the correct method—since Television receivers combine both sight and sound. You also get more than ten text books devoted entirely to Television.

Get Sample Lesson and 64 Page Book FREE—Mail Coupon

Act Today. Mail the coupon now for sample lesson and 64-page book. They're free to any fellow over 16 years old. They point out Radio's spare time and full time opportunities and those coming in Television; tell about my training in Radio and Television; show you letters from men I trained, telling what they are doing and earning. Find out what Radio offers YOU! MAIL COUPON in an envelope, or paste on a postcard—NOW!

J. E. SMITH, President Dept. 9ER NATIONAL RADIO INSTITUTE WASHINGTON, D. C.

HERE'S PROOF



\$10 a Week in Spare Time

"My work has consisted of Radio set servicing, with some Public Address Systems work—all in my spare time. My earnings in Radio amount to about \$10 a week."—WILLIAM MEYER, 705 Ridge Road, Hobart, Ind.



Earnings Tripled by N. R. I. Training

"I have been doing nicely, thanks to N.R.I. Training. My present earnings are about three times what they were before I took the course. I consider N.R.I. Training the finest in the world."—BERNARD COSTA, 952 Manhattan Ave., Brooklyn, N. Y.

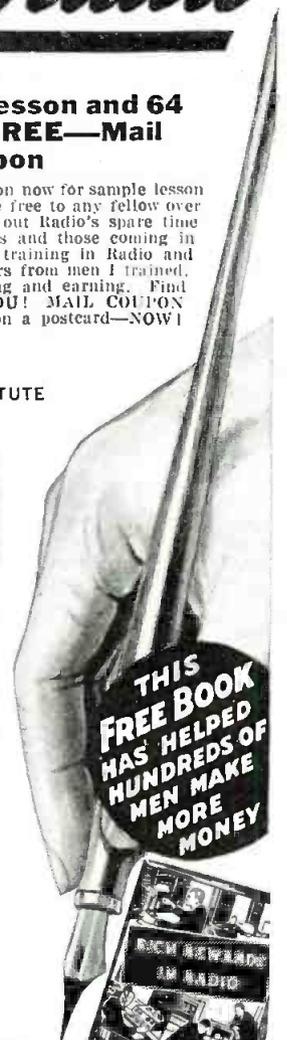

Good for FREE SAMPLE LESSON and BOOK on RADIO'S OPPORTUNITIES

Form with fields for Name, Address, City, State, Age, and a 14X-1 code.

WITHIN

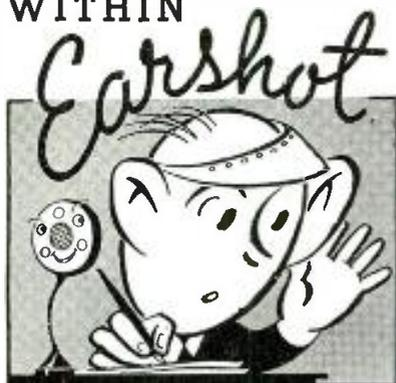

OF THE EDITOR

THE International Morse Code has finally come into its own—on the broadcast band, we mean. What with Jim Fidler and his "JIM-JIM"; Station WIND and its "WIND JOURNAL," NBC and its station break, "NBC"; several announcers who sign "30" and "73"; as well as orchestra leaders who use a series of "V's"; and the Raymond Scott musical piece "SOS"; all in code—we will have to have code classes for the masses to understand their broadcast programs.

* * *

THE time will come when code will be taught in schools just as swimming, shorthand and other generally useful things. Everyone should know the code . . . you never know when you will need it. Once learned, your speed may drop to "one word a minute" but you will never quite forget it entirely.

* * *



Were we flattered when we spotted RN on the table of the NBC International Division when they were listening in on the progress of the Conclave of Cardinals during the recent election of Pope Pius XII? The reproduction is too small, but the arrow points to our World Short Wave Time Table Department.

* * *

INQUISITIVE Harry was just in with this bit of info. He says that there is such a thing as radios that work with filament-less tubes. In other words, there are tubes that can never burn out and are soldered right into the receiver. He wants to know when they will be on the market. Well, Harry, we rather think that after the 7,074,700th different tube has been made with a filament, that the moguls who control our radio set manufacture will bring

(More Earshot on page 57)



Including Articles on POPULAR TELEVISION

The Magazine for the radio amateur experimenter, serviceman & dealer

VOL. 21 NO. 5

Contents for May, 1939

FEATURES

- Television Grows Up** Austin C. Lescarbourea 6
Compare the equipment of 11 years ago with that of today.
- With the West Coast Televisors** Harry R. Lubcke 11
Don Lee-MBS has been telecasting in Los Angeles since 1931.
- Build Your Own Video-Audio Set** Robert T. Thompson 12
The latest in home construction television receivers.
- As I See It!** John F. Rider 14
Does it pay to be truthful in advertising?
- Making a Xmtr.- Revr. from an Auto Radio** Wiley D. Wenger, W9CIJ 15
A completely concealed mobile radio installation.
- Tele-Receiver's Heart** M. W. Thompson 18
The Television Receiver's problem child, the IF transformer. Part 4 of 6.
- The DuMont Receiver** Wilfred S. Rowe 21
Description of a successful commercial television receiver.
- Construct a Tube Tester** Edward Lindberg 22
One of the build-your-own-service-equipment series.
- The Andrea V-A Receiver** Milton B. Sleeper 24
An oldtimer, Frank A. D. Andrea, re-enters the receiver field via television.
- Constructing the Don Lee Video Receiver** Jerry Coldby 25
Building data on a tried and proven television receiver circuit.
- Portable Communications Receiver** McMurdo Silver 27
Battery operated precision all-band receiver for the ham.
- NBC Television Sets the Pace** C. W. Farrier 28
Describing the progress being made for the pending television programs.
- Sight & Sound News** Will Baltin 32
What you may expect to see on your video screen.
- A Useful Test Panel** R. O. Goettmann, W8BUE 35
It is easy to build this much-needed all-purpose tester.
- A Remote Record Player** Harry Paro 37
Build yourself a "mystery" phonograph-radio attachment.
- Servicemen's Case Histories** Alfred A. Ghirardi 40
Beginning a series of actual case histories for the serviceman.

DEPARTMENTS

- | | | |
|----------------------------------|---------------------------------|-----------------------------------|
| Book Review 30 | The Video Reporter 10 | R. N. Seal of Accp't'nce 39 |
| What's New in Radio 38 | QRD? 30 | Radio Physics Course 64 |
| Radio Gadgets 34 | Bench Notes 17 | Hamchatter 31 |
| | Serviceman's Experiences 36 | |

Copyright, 1939
ZIFF-DAVIS PUBLISHING COMPANY
Member of the Audit Bureau of Circulations

RADIO NEWS is published monthly by the Ziff-Davis Publishing Company at 608 S. Dearborn St., Chicago, Ill. William B. Ziff, Publisher; B. G. Davis, Editor; Karl A. Kopetzky, Managing Editor; Oliver Read, Technical Editor; E. Stanton Brown, Associate Editor; Herman R. Bollin, Art Director; John H. Reardon, Circulation Director; S. L. Cahn, Advertising Manager. New York Office, 381 Fourth Ave. Subscription \$2.50 per year; single copies, 25 cents; foreign postage \$1.00 per year additional except Canada. Entered as second class matter, March 9, 1938, at the Post Office, Chicago, Illinois, under the Act of March 3, 1879. Contributors should retain a copy of contributions. All submitted material must contain return postage. Contributions will be handled with reasonable care, but this magazine assumes no responsibility for their safety. Accepted material is subject to whatever revisions necessary to meet requirements. Payment will be made at our current rates upon acceptance and, unless otherwise specified by the contributor, all photographs and drawings will be considered as constituting a part of the manuscript in making payment.

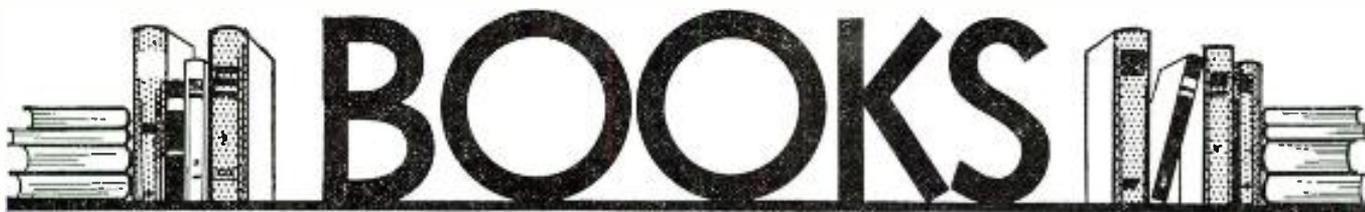

ON RADIO

ZIFF-DAVIS PUBLISHING COMPANY (Publishers of RADIO NEWS)

offers these authoritative books on Radio

Every one written by an authority. Giving you in concentrated, easily assimilated form, the tested experience of practical Radio men, each an expert in his field. Why not add their experience to your own, and so increase your knowledge and earning power in this fascinating profession.

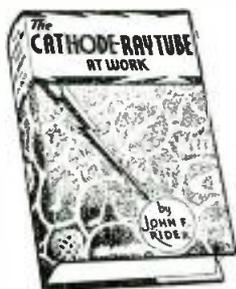

CATHODE-RAY TUBE AT WORK (101)

By John F. Rider \$2.50

A new era in the servicing of radio receivers, public-address systems, transmitters, etc., is in the offing. The theory underlying the functioning of the cathode-ray tube and the circuits that accompany it receives full consideration in this book. The second half of the volume is devoted to specific and practical applications of commercial oscilloscopes to servicing and adjustment problems. Useful for television preparation. 338 pp., profusely illustrated.

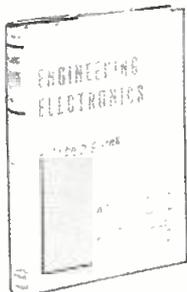

ENGINEERING ELECTRONICS (109)

By Donald G. Fink \$3.50

358 pages, 6x9, 217 illustrations. A working introduction to electronics for the engineer. A practical volume for engineers who wish to take up or review electronic principles and their application in typical engineering problems of tube use and circuit design. Covers the fundamentals of electron physics and electron tube structures, the engineering characteristics of a wide variety of tubes, and a demonstration of the application of tubes and circuits in problems of power transformation, electrical communication, and industrial control and measurement.



THE RADIO MANUAL (110)

By George E. Sterling

Third Edition \$6.00

5 1/2 x 8, 1120 pages. Full and complete information on the structure, installation, upkeep, operation and control of all forms of radio apparatus and equipment. Radio control operating is developed in full. The necessary steps for taking out both an operator's and an amateur operator's license are indicated, together with the requirements and directions governing operator's examinations and theory and ranges through the entire radio field, giving complete descriptions and discussions of all of its phases, and covering every detail of marine and aircraft radio equipment.



RADIO PHYSICS COURSE (104)

By Alfred A. Ghirardi \$4.00

A book that leading radio schools throughout the world have chosen as the most thorough, instructive, and interesting radio book ever written—they use it as their basic text in their own radio courses. Explains in easy-to-understand language all of the essential facts about both electricity and radio from simple fundamentals to the most intricate applications. Invaluable to the radio beginner, student, serviceman. 972 pp., 508 illustrations, 856 self-review questions.



MODERN RADIO SERVICING (105)

By Alfred A. Ghirardi \$4.00

A SENSATION! The greatest text ever published specifically on the technique of Modern Service Work. From coast to coast service men are talking about this remarkable "Ghirardi book." Its 1500 pages contain a complete course on the best up-to-date methods of radio servicing—the construction and operation of all kinds of latest radio test equipment; servicing and repair of all forms of receivers; locating and eliminating noise and interference; special servicing problems; aligning superhets, and tested advertising and merchandising tips. 706 illustrations, 32 chapters.

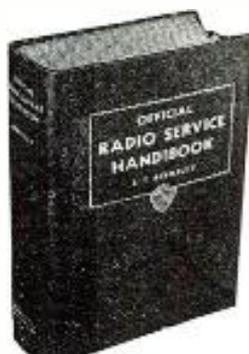

OFFICIAL RADIO SERVICE HANDBOOK (106)

By J. T. Bernsley \$4.00

A text-book for Service Men containing practical, radio theory and servicing information. Includes operating notes and valuable compilations of requisite servicing data. Intended for and dedicated to making the Service Man's daily tasks easier. Gives hints on trouble shooting in the average receivers by make.

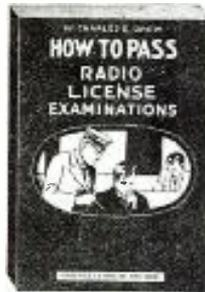

HOW TO PASS RADIO LICENSE EXAMINATIONS (107)

By C. E. Drew \$2.00

(Third Edition in preparation.) A book directed to the professional operator. Explains fully all the questions that are met in taking the Federal Communications Commission's examinations for all classes of radio operator. Deals with the Radio Act and the Federal Communications Commission Rules and Regulations. The explanation of ship's radiotelephone and telegraphy and the method of handling traffic is one of the highlights.



SERVICING SUPERHETERODYNES (108)

By John F. Rider \$1.00

No other circuit in the radio field has undergone all the changes that have been incorporated in the superheterodyne. In order to service these receivers with profitable speed, you must be able to analyze the different portions of the circuit quickly and this is just what Rider tells you how to do in this book. Not only is the theory of all types of Superhets thoroughly covered, but actual servicing details are most complete. 288 pp., profusely illustrated.

Our book lists also present a wide variety on Photography, Aviation, Science

IMPORTANT!

Enclose remittance with order and we will prepay postage.

Check and mail this coupon TODAY. Add to your library the books you need, or secure information and prices on any book on Radio you may be interested in but which is not here listed. DO IT NOW before it slips your mind.

CHECK YOUR CHOICE ON THIS COUPON

Ziff-Davis Publishing Company, Book Department
608 S. Dearborn St., Chicago, Illinois

R.N.3

Gentlemen: Please send me the books whose numbers I have encircled below.
Book No. 101, 104, 105, 106, 107, 108, 109, 110

Price Enclosed \$..... C. O. D. (Plus Postage)

Name

Address

City..... State.....

TELEVISION

1928

"A TINY BABY"

by

AUSTIN C. LESCARBOURA

Croton-on-Hudson, New York

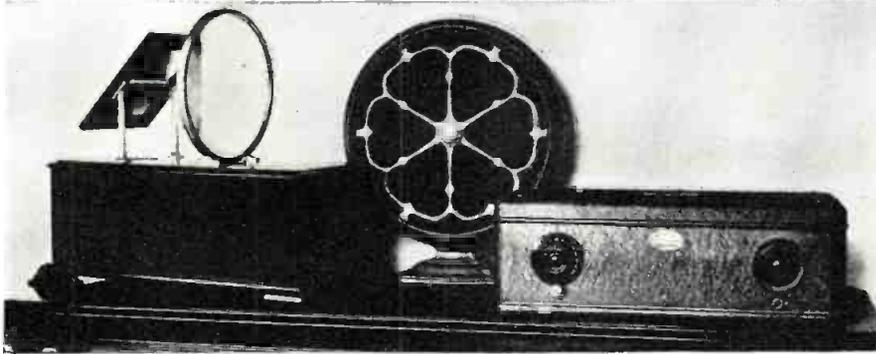

One of the earliest of television home receivers. It consisted of a compact Jenkins drum-type scanner with magnifying glass and an A-K receiver.

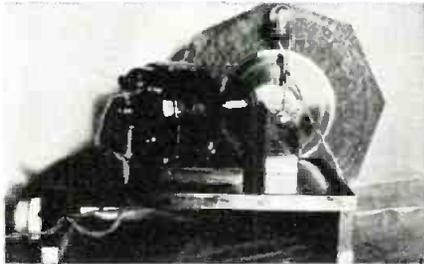

The Jenkins 1928 video receiver as supplied to interested experimenters.

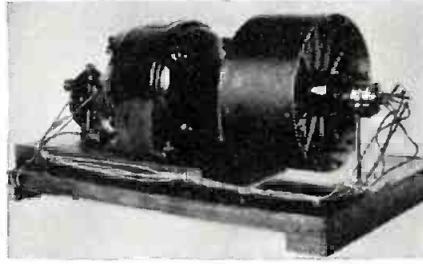

A 1928 Jenkins video receiver made of a revolving drum and a 4-p neon.

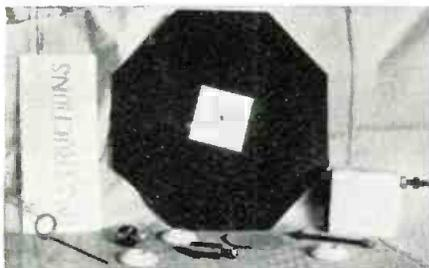

The experimenters kit of 1928 sold at cost. You furnished the motor.

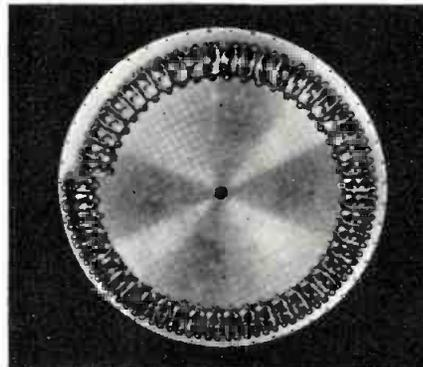

Two attempts at large screen reception. A square of lights and scanner. The disc worked, the square did not.

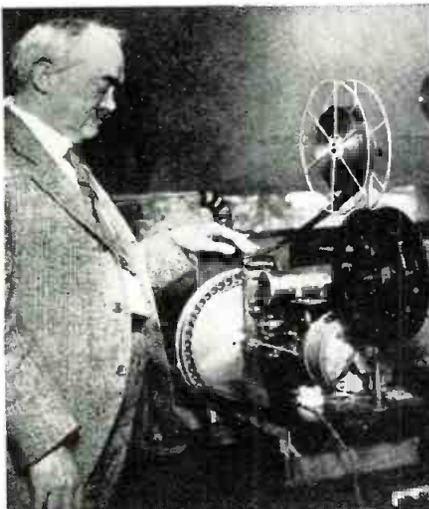

Dr. C. Francis Jenkins at the telecaster of his station in Wash., D. C.

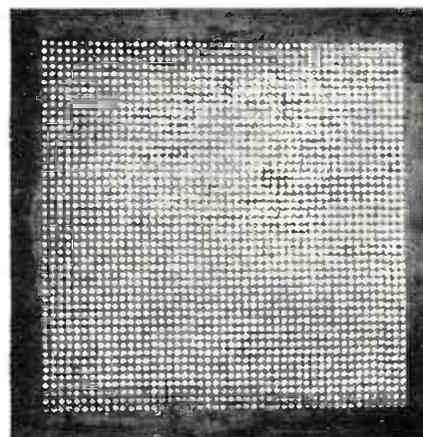

OBVIOUSLY shy, but overflowing with enthusiasm, was this young woman in black, with babe in one arm and another in tow, as she stepped into our television demonstration booth. Doubtless she had read the more-than-generous newspaper mentions of the advent of television in the Quaker City. If not, she had been guided to our booth by blatant streamers and posters plastering the electrical exposition hall, all screaming the marvels of this television demonstration now serving as pivot about which to swing a very commonplace and dull lot of exhibits. Once again, television was in its familiar role of side show to pack 'em in.

"Is this the television demonstration?" she asked. We nodded. She waited for the next demonstration, parking the offsprings and taking the weight off weary limbs. Presently, she was rewarded. She too saw the flickering pink and black blotches through a magnifying lens, which formed faces and figures after a fashion. It was pitifully crude, this demonstration.

But our audience was supremely happy. Now we were to know why.

"My husband . . . he died just three months ago . . . was a radio man. Yes indeed, John lived and loved his radio. He knew all about it, too. From high school days until he died, radio was his main interest. John kept telling me that television was coming soon. It would be another radio boom, he said. Lots of money would be made by smart people. John had not gotten his share of the broadcasting boom, but he sure counted on making his on television." She paused to wipe moistened eyes.

"John left a life insurance . . . five thousand dollars," she went on, after a sniffle or two. "After paying funeral expenses and a few bills, I decided to invest in something that would make money for the babies and me. The man at the bank tried to discourage me when I mentioned television stock. He had no use for it. But you know bankers . . . they don't know anything, anyway. They have no imagination. Anyway, I couldn't help remembering what John had said about television. So I finally invested our little fortune in the XYZ Television Corporation. I'm so happy that television is

GROWS UP.

TELEVISION is not new! It was a going concern over eleven years ago with stations on the air and "viewers." But it has only just recently come into its own as a perfected industry.

"IN SWADDLING CLOTHES"

1929

now here . . . ready for home entertainment . . . for use in theatres. It's all too wonderful for words. I'm sure we'll get plenty of dividends to keep us going." She was all smiles again.

But not so with us. We were sick, through and through. Although our job was solely that of staging a television demonstration, without thought or regard for the financial or stock promotion of this or any other television enterprise, we nevertheless felt like cads. For knowing the many technical difficulties which faced television progress some eight years ago, we had no illusions about rounding the famous corner.

As for the gentlemen then selling television stock, we had a choice name for them. We had seen them make the only real money which has yet been made in television—something like thirty-five millions of dollars extracted from a gullible public in return for nicely engraved television stock certificates.

I for one turned away from pioneer television in sheer disgust. It was a mean game, in which I refused to take part, once I became aware that all our technical efforts were just so much window-dressing for the stock salesmen.



A very rare picture of an early 1929 telecast from General Electric's WGY studios in Schenectady. In the left background is a tele-receiver.

Of the many financial raw deals in history, few can match television. Never before had such lavish promises been made to an investing public. Never did the public buy on such flimsy presentation. With several other factors, I firmly believe the television stock swindle served to bring about the stringent securities promotion laws which now exist to protect the innocent public from similar fleecings, while unfortunately barring the promotion of worthy if daring ideas.

Television is simply history repeating itself. Television has closely followed the pattern of the radio telephone's evolution into present-day broadcasting. As far back as 1910, the wireless telephone was held up to investors as a powerful competitor to the wire telephone. Stock salesmen were sure that individuals would shortly be using pocket wireless telephones to 'phone one another, incidentally saving telephone tolls. The fact that a roomful of equipment was being used for some demonstrations

"STILL GROWING"

1930

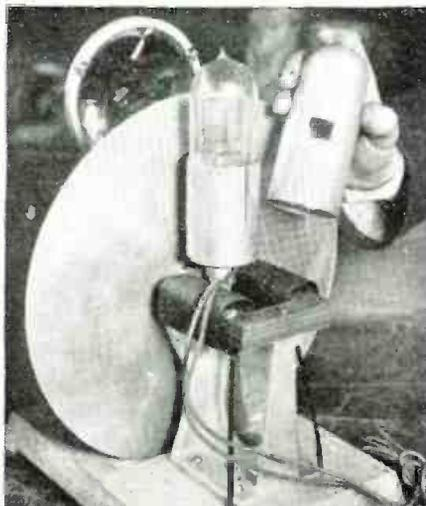

Typical scanner for experimenters sold in 1930. The disk had 60 holes.



Home tele-receiver of 1930 with its huge magnifying glass and scanner.

1931

"STILL GROWING"

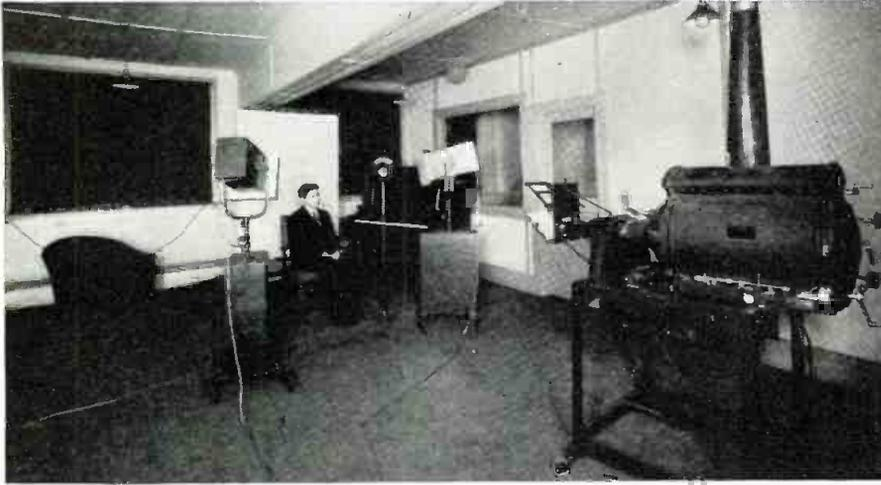

Few know that DeForest was interested in television. A flying spot projector was used in his studios in Passaic, N. J., at W3XCD early in 1931.

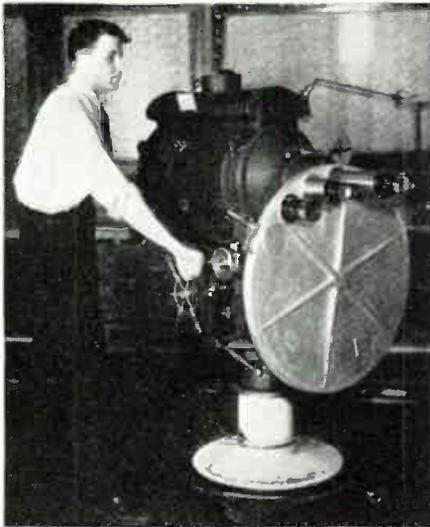

A Jenkins-DeForest scanning disc telecaster used at W2XCR, N. Y. C., in '31.



An experimenter's joy of 1931,—a 48 scanning line television kit.

did not chill the enthusiasm of gullible investors who flocked to the brokerage offices to buy stock.

And so the radio telephone earned its bad name. Too much stock was sold. Some of the stock-selling gentry became guests of the Government in those walled-in hotels with barred windows. Soon the wireless telephone dropped out of sight. It sought the seclusion of the research laboratory, there to be reformed and made socially fit for the world. Changing from the carbon-arc oscillator to vacuum-tube oscillator, amplifier and detector, the reformed radio telephone made its second debut in 1915 as a practical means of long-distance communication. That year it spanned the Atlantic from Arlington, Va., to the Eiffel Tower in Paris. A week or so later it covered the distance from Arlington to Pearl Harbor, Hawaii. Vacuum-tube amplifiers made possible the transcontinental telephone circuit that same year.

In rapid succession came the World War, the need for radio telephone communication, peace again, and experiments here and there leading to organized radio broadcasting. Tens of thousands of home-built receivers provided the first audience and encouragement for early broadcasters. Later came a more perfected technique and the justification for mass-produced factory sets. You know the story from there on.

Now television, so far, has followed that pattern pretty closely. And I for one firmly believe, the opinions of television experts to the contrary notwithstanding, that television must continue in the footsteps of the radio telephone.

Reformed television today is at least emerging from the laboratory after the necessary incubation period. It is no longer an experiment, crude-demonstration, far-fetched promise. No longer can it be used for

1932

"A GAWKY YOUTH"



Dorothy Appleby, stage star, is televised in 1932 at New York's WGBS.

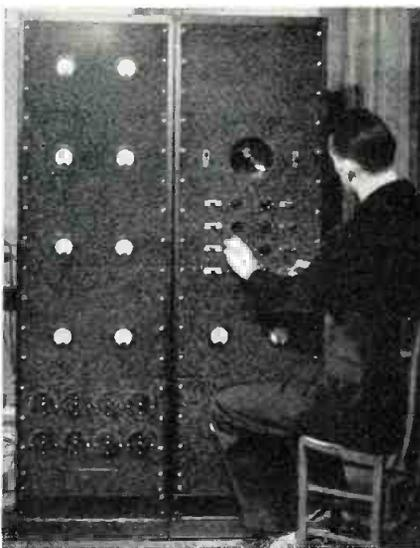

An engineer watches the flying disc at old W2XCR-WGBS in New York City.



Just before the collapse of the pioneer efforts, this was the home set.

"FULL GROWN"

1939

sucker bait. Its fantastic stock-selling days are over for good. What with tens of millions of dollars of television stock certificates strewn about a disillusioned land, memories are still too keen to bite again. Which means that television will have to prove its commercial worth first, through the sponsorship of serious organizations, after which it may obtain legitimate financing only as and when such aid is necessary and warranted.

As with the radio telephone, television technique has changed entirely. No longer are neon lamp and scanning disk utilized for weaving intercepted signals into pictures. The cathode-ray tube can do the job infinitely better and with greater assurance of reasonable uniformity of results.

I well recall early television experiments with as few as 24 scanning lines. Only the simplest black-and-white images could be transmitted—just silhouettes at best. Later came the 48-line scanning standard, and we naively believed we had real entertainment possibilities.

Dr. Francis C. Jenkins of Washington, D. C., a television pioneer, proudly showed me his setup early in 1928. He had a 50-watt television transmitter on the air, transmitting experimental programs. Between pictures his operator would cut in with radio telephone announcements. Poor Dr. Jenkins, now deceased, frankly believed he had another broadcasting situation in the making.

The Jenkins programs consisted of film pickups of simple black-and-white silhouettes—virtually animated cartoons. However, the pictures were actual photographs of live subjects, rather than drawings. The doctor had a 35-mm. or theatre-standard movie camera with which he made short films—about 30 feet at most. He simply stretched a bed sheet across an archway in his home, placed powerful light on the far side, and had his actor in action on the near or camera side. In the absence of light on the near side, the subject was photographed as a silhouette with outline detail and nothing else. Which was about all his crude transmitter and pickup could handle.

I was amazed with what Dr. Jenkins did accomplish by way of public interest, even at that early date. Station W3NK was on the air several evenings per week, on regular schedule. To encourage more lookers-in, he furnished a cardboard scanning disk held by a shaft and wooden bearing, and driven by friction by any small AC or DC motor, together with a so-called "bug lamp" or inexpensive neon night light. The receiving disk was synchronized with incoming signals merely by shifting the friction drive. Of course pictures were obtained—just as you can make photographs with an ordinary shoebox pierced with a pinhole and holding a piece of bare film.

Fan mail came in from all parts of



When Toby Wing was televised by Philco, she was the first person who was able at the same time to see just how the received picture looked.

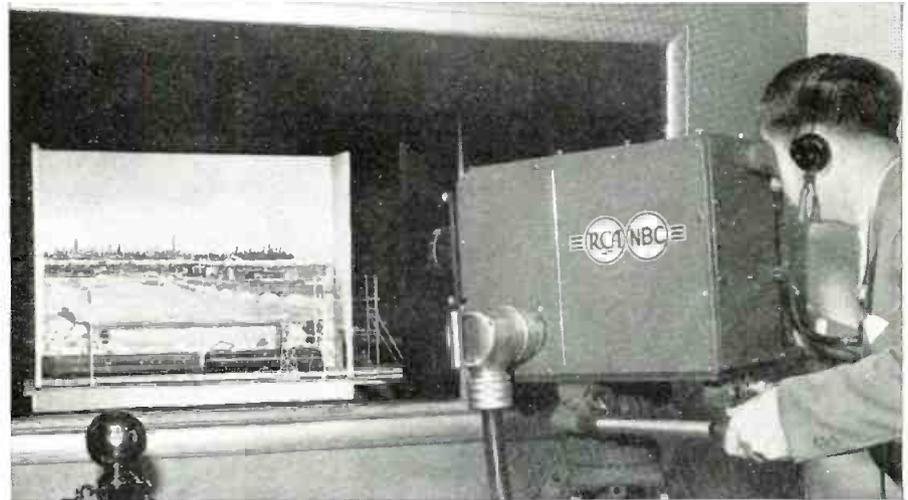

Models are in great demand at the studios and look just like the real thing. Here a "fast express" will appear to hurtle across your screen.



An exclusive shot of a musical setup at the West Coast Don Lee Telecast Studios. Special makeup is used by all who participate in the broadcast.

the East—letters from Montreal, the Mississippi valley, Georgia, Florida, New Orleans, and many points nearer Washington. Yet all the little station had to offer were these simple silhouette pictures showing a little girl bouncing a big ball, a darky chasing a synthetic chicken, or a juggler in action.

Later Dr. Jenkins' efforts were made the basis of a large television corporation. Much stock was sold. Capable engineers were put to work. Most of the efforts were aimed at demonstrations to interest stock salesmen and brokers and ultimate investors, primarily. Tens of thousands of dollars were spent for a single demonstration. A whole room was packed with costly and intricate pickup, amplifier and allied equipment so that a screen-sized picture could be reproduced for a stock-minded audience. Nevertheless . . .

This organization did go on the air with the first television station in the New York metropolitan area, W2XCR in Jersey City. Unfortunately, its several kilowatts of transmitting energy never got much beyond the immediate vicinity. The peculiarities of television transmission were still a mystery.

Later, through an affiliated company, a second station was established at Passaic, N. J., W2XCD. For a time I had charge of the programs for that station. My assistants and I scoured the Gay White Way in search of hungry actors—hungry for publicity and often for a meal. Our "lizzie" made regular round trips between New York and Passaic, bringing talent back and forth. The station was on the air six evenings a week, with scheduled programs featured in the radio sections of newspapers. We subscribed to a non-theatrical film exchange for a steady flow of film subjects. Later came a more convenient setup on Fifth Avenue, New York City, with a sound tieup through a regular broadcasting station, WGBS.

With many kilowatts of power, plus a good deal of advanced engineering, the later stations reached out an amazing distance. Our video signals were around 100 meters, rather than the very short waves used today, which made for a pretty broad coverage. Fan mail came in from Canada, the Middle West, the South. Hundreds of letters were received each week. A sound channel immediately below the sound broadcast band, or around 192 meters, made it possible for any standard broadcast set to be used in tuning in the sound counterpart of our visual programs, for the sight-and-sound entertainment. Later came the WGBS standard broadcast combination.

Thousands of amateurs and experimenters went to the trouble and expense of building their own television receivers. They had little synchronizing difficulty when operating with synchronous AC motors on the same power supply as our transmitter. Later, our engineers developed a neat (Further growth on page 48)



by W. C. DORF

THE lid comes off television with the opening of the World's Fair April 30th, and the announced plans of NBC to start a regular telecasting schedule. Is this to be the real McCoy or just a splash, a series of ripples and then all's quiet on the television front for several more months? It is the opinion of this column that it will be the beginning of a new era in radio. True, its expansion will be slow, which will in itself be a healthy sign. The general radio fan may turn out to be somewhat of a cynic, hesitant to extend due allowances to the art for finding the proper answers to the many difficult problems that still face television. Radio fans (not all, but a great many of them), have become so accustomed to accepting the numerous advances in radio over the last 15 years, that they may look for a finished article. It is a finished product as far as transmission and reception is concerned, but what about program set-up, who pays the bill, coverage, etc.?

The pessimists will have to admit that television has never before made such worthwhile progress, such impressive strides as it has in the last five years. To recount only a few, review the advancements in cathode-ray tubes, the iconoscope or television camera, transmission equipment and technique, television receivers, the new u.h.f. tubes for the receivers, special antennas both for transmission and reception, and so on. Just over the last year there has been a notable improvement in the definition and detail of the images as received on a modern telereceiver. What does the future hold in store for television? Jules Verne or his brother might answer this question.

However the public will not have to wait.

Philco Joins Up

Philco RADIO AND TELEVISION CORP. recently demonstrated in New York City, a portable television transmitter weighing only 450 pounds. It is designed to be rolled in or outdoors by a couple of men and can be used to televise spot news, athletic events or a studio program. At this demonstration the new Philco tele-receivers using a 5 inch screen were also shown. The sets are to be ready and on the market about May 1st. This column will have the complete data on the new line in the next issue.

New Producer for NBC Tele Staff

ANTICIPATING the beginning of a regular television service for the New York City area in April, the National Broadcasting Company today added Thomas L. Riley, one of radio's well known producers of dramatic shows, to the NBC television program staff at Radio City. Riley brings to television a wide experience in sound broadcasting, a brief newspaper record and experience in the theater.

The latest addition to the Radio City television staff follows the announcement that Max

Gordon, noted Broadway producer, will advise and assist NBC in the production of television programs. A statement issued at the time said that Mr. Gordon had agreed to accept the appointment because "he feels that television offers the entire field of the theatre's vast possibilities."

"I hope to prove to theatrical people," said Mr. Gordon, "that television is the greatest supplementary medium for their abilities. It cannot hurt the theatre. In fact it will help and I am anxious to complete plans for our first television program so that I can invite the leading personalities of the theatres to see it. I am sure that it will convince everybody that my enthusiasm for television is justified."

Thomas H. Hutchinson, NBC director of television programs, plans to put several of his more ambitious program items into rehearsal at an early date so as to familiarize the production staff with the numerous physical changes in studio set-up now being completed at Radio City.

Announces

Television Antenna

THE Andrea Radio Corp. introduces a new television antenna kit. It is called the *Teleceptor* and is featured as lightweight, easily assembled and mounted. Supported on 3½ ft. arms, the *Teleceptor* rods are mounted on a coupler unit of "Climate Sealed" design which protects the terminals from rain and carbon smoke deposits. The mast is of two 4-ft. jointed sections. Additional sections are available if extra height is required. 75 ft. of special television lead-in cable are supplied, together with insulators and accessories. The range of the little transmitter is a bit over 175 feet, but the definition of the picture is excellent.



Philco demonstrates its new, wholly portable television transmitter.

5 Inch Tele-Tube for Small Cabinets

A NEW "Stubby" 5-inch cathode-ray television tube incorporating several new features has been announced by the National Union Radio Corporation. The latest addition to the Videotron family, type number 1805-P4, is a streamlined, compact affair measuring 13-inches in length—¾ inches less than earlier designed units with the same size screen.

The 5-inch *Stubby* offers special advantages for adaptation to small cabinets. Electrostatic deflection is utilized and images are reproduced in black and white.

Amos 'n' Andy's Big Experience

AMOS 'N' ANDY, in blackface makeup, were the subjects of an experimental television pickup at the grounds of the New York World's Fair 1939 on February 27, the day the famous NBC entertainers broadcast their half-hour description of the big show's wonders.

The experiment marks two more "firsts" for Amos 'n' Andy—the first television experiment with a commercial program to come from the World's Fair grounds and the first time for the (More video developments on page 49)

With the West Coast Televisors

by **HARRY R. LUBCKE**

Director of Television
Don Lee Broadcasting System
Los Angeles, California

A brief description of what has been going on out at the West Coast, and why they have led the East with telecasts.

THE Radio Corporation of America purchased the patent rights - - to television synchronization methods and apparatus from Harry B. Lubcke, Director of Television for the Don Lee-Mutual radio network. This had to do with the maintenance of television receivers in step with the television transmitter. That these keep step is necessary so that the scanning beam at the receiver must at all times be in the same relative position that its transmitting counterpart occupies in the transmitter field of view. The patents cover means utilized at both transmitter and receiver. At the receiver a device operates to separate the synchronizing pulses from the composite incoming signal which contains both image and synchronizing pulsations.

This does away with the old theory that it was necessary for a receiver to be connected to a city power line so as to synchronize the transmitter to it. And to prove his theory practical, Mr. Lubcke gave a demonstration to a plane load of newspapermen. He flew them high above the city of Los Angeles and gave them a view of clear image reception on his receiver that astounded all skeptics. He definitely proved that with his apparatus there was no need for transmitter and receiver being on the same power line.

Incidentally, let it be understood that this patent purchase was for synchronization of transmitter and receiver and not that of sight and sound.

Mr. Lubcke has certainly traveled far since the days back in 1931, to be exact, December 3rd, W6XAO, went out on the ultra high frequencies to begin a regular schedule of broadcasts of television under the sponsorship of the Don Lee system and his supervision. A regular daily schedule was inaugurated and with the exception of Sundays and holidays, it never went

off the air during this period, nor missed a single schedule.

Very little was known about television at that time but with 150 watts of power pushing the signal out on the assigned frequencies of 45,000 kcs. for sight and 49,750 kcs. for sound, they knew that some one would be able to receive the signals. But Mr. Lubcke did better than just guess about the number of scanners, or listeners, that he could possibly have. He let every one know that he was ready to mail out, without any obligation to experimenters, free of charge, a complete diagram of a television receiver which would pick up his broadcasts. Over three thousand requests for these diagrams were received and it was ascertained that over 100 television receivers were built. These "scanners" cooperated with him by sending in reports on image-clarity from their different locations in every direction and as far as 30 miles distance from the transmitter.

Occasionally, meetings were held where reception and transmission problems were thrashed out and reports made by the "lookers," which gave Mr. Lubcke a fair idea of how his presentations were being received. Experimenting went on with different systems and a few new methods were evolved out of this experimentation and patented.

In 1936, Roger Howell, one of the "scanners," situated at Long Beach, California, 20 miles airline from W6XAO, upon his own initiative demonstrated the television reception to the officials of his city and to the press who were very favorably impressed with this example of the art. After that, regular demonstrations of this high-definition television at distances of from 1/10 of a mile to 10 miles dis-

(Televise further on page 52)



The author with some of the basic equipment used for live subject pickup. The tube is of new Mosaic design.

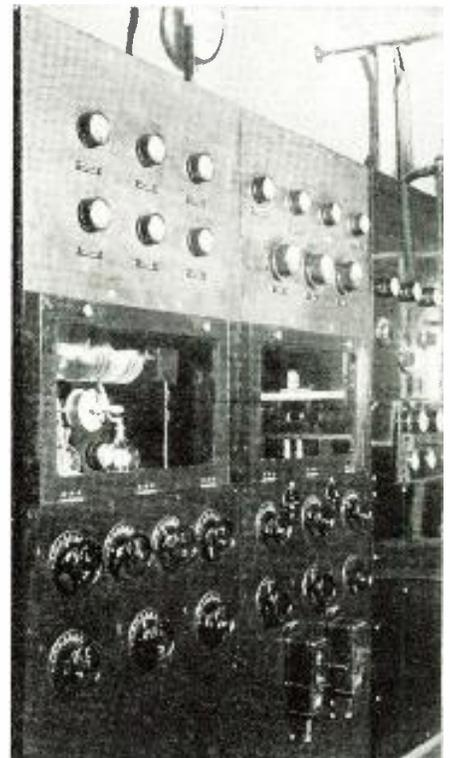

Transmitter panels of the Don Lee television station. They built them.



Special concentric cable developed for use with the tele-camera.

Build Your Own VIDEO-AUDIO SET



by **ROBERT T. THOMPSON**
Television Engineer, Meissner Mfg. Co.
Mt. Carmel, Illinois

With the kit described, the building of a television receiver is easy.

With the power circuits completely enclosed, the safety factor is greatly raised.

THE receiver to be described was built from a kit designed to provide amateurs and experimenters with parts for a complete sound and picture receiver for the RMA Standard Television Signal. It is a superheterodyne covering the 44 to 50 and 50 to 56 megacycle channels with provision made for adding coils to a switch assembly as additional frequency assignments are put to use. Both sound and picture channels are tuned simultaneously by means of this selector switch and a small vernier condenser. There are six controls on the front of the panel.

Four additional, seldom used, knobs are brought out on the left hand side of the chassis. All of these knobs are grouped in a manner that facilitates understanding their use and makes them convenient to use. It is intended that a half wave dipole antennae be used for reception, using a transmission line with a characteristic impedance of approximately 110 ohms to connect the antennae to the receiver. A conventional antennae with a single wire lead-in is *not* recommended be-

cause such an antennae and lead-in pick up reflected signals from several directions and may cause multiple images on the cathode ray tube.

High Frequency Coil Assembly

The radio frequency and oscillator coil assembly consists of a rotary channel switch assembly upon which is mounted a four-section coil for each of the two low frequency television channels. Each of these four-section coils consists of an antenna primary, a preselector, the detector input, and oscillator as shown. This arrangement permits the coupling between windings to be adjusted to optimum conditions for each television band without the compromises involved in covering a larger tuning range with one set of

coils. The channel switch has four positions with two, four-section coils mounted on the switch, prewired and tested. The coil-mounting plate has provision for two additional coil assemblies which will be ample for a given locality for some time to come. Later, this can be changed.

Picture I.F. Amplifier

The picture i.f. amplifier makes use of capacitive coupling to facilitate adjustment of band width. Small iron cores, which tune the coils, are adjusted from the top of the can, while the degree of overcoupling is adjusted with a two-plate trimmer connected between the high potential ends of the coils. A cut-away view of such a coil, shows the simplicity of this arrangement. Plate and grid leads to the tubes are taken from the lower end of the coils and are about one and one-half inches in length. Loading resistors to obtain uniform amplification over the pass-band are connected externally to the coil assembly. A portion of the cathode resistor is not bypassed. This minimizes variation of input resistance and capacity with variation of bias. A trap for the 8.25 meg. sound i.f. frequency is connected to the grid of the first i.f. tube. This trap is also adjusted from the top of the coil can, being tuned by a small iron core.

Picture I.F. Alignment

One way to adjust the i.f. is to apply a voltage from an oscillator with frequency sweep to the amplifier, stage by stage, observing the shape of the selectivity curve on a cathode ray oscillograph connected to the video detector. If the experimenter has access to such a "wobbulator" but has not a cathode ray oscillograph, the cathode ray tube of the receiver will do very well. It is only necessary to apply the vertical sawtooth voltage of

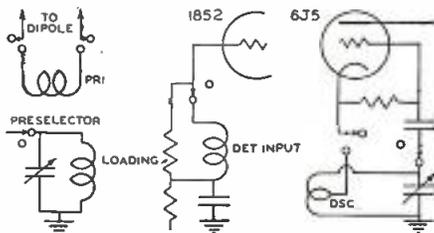

Antenna loading is adjustable.

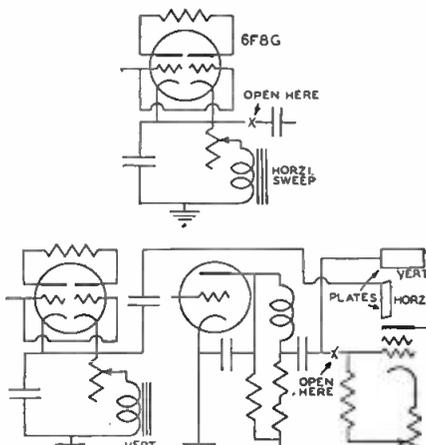

Vertical-horizontal adjustments.

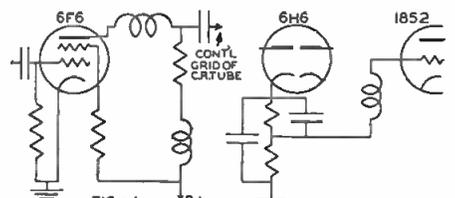

The important low-pass filters.

the sweep circuit to the horizontal deflecting plates, (allowing the horizontal sweep to go unused) and capacity-couple the plate of the video amplifier to the vertical deflecting plate. The trace will "lock-in" well enough to observe the selectivity curve.

The diagram shows how the output of the 6F6 can be applied to the vertical deflecting plate by changing the .05 mfd. 2000 volt blocking condenser from the control grid of the cathode ray tube to the vertical deflecting plate. The grid resistor to the bias supply must, of course, be left connected to the control grid.

Another method of alignment of the

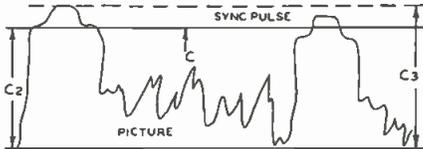

Sync-pulse and picture graph.

picture i.f. is to use a test oscillator and output meter, adjusting the transformers in order, starting with the output transformer. It may be helpful to first plot a selectivity curve for this stage alone, adjusting the capacity coupling so that two peaks will appear at approximately 10.5 and 11.5 MC respectively. Upon going to the next stage, a second curve may be made to have its two points of maximum response at about the same two frequencies. When the signal is applied to the grid of the 1852 converter, this stage is adjusted to "fill-in" the valley between the two peaks and a third curve plotted to show the overall i.f. selectivity. The trap for the sound i.f. frequency may be adjusted before tuning the input picture transformer, but should be "touched up" after the input stage has been aligned.

This alignment procedure will give an overall i.f. sensitivity on the order of 500 microvolts for optimum contrast on the cathode ray screen. For amateurs living outside the "service area" of a television transmitter it is possible, because of the flexibility of the i.f. amplifier, to adjust the band pass characteristic to any reasonable combination of selectivity and gain. Thus, a distance handicap can be compensated for, to some extent, though naturally at sacrifice of picture detail. Similarly, those who are fortunate enough to have a signal input of 4000 or 5000 microvolts may reduce the sensitivity and improve detail, as dictated by their particular locations.

The second detector consists of one diode of a 6H6. The low pass filter which comprises the load of this tube is mounted in the high voltage compartment directly below the horizontally placed 6F6. An inspection of the illustration of the complete receiver will show the advantage of this particular arrangement. It will be noted that the placement of the 6H6 and the 6F6 permit short, direct leads for both the video frequencies and the synchro-

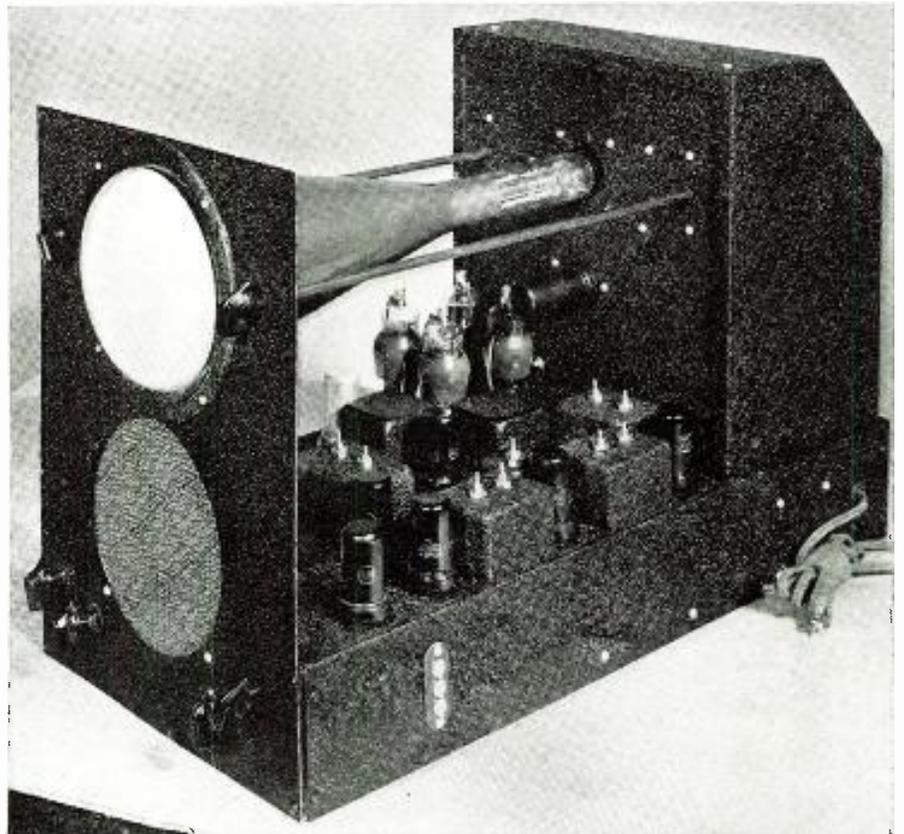

What the completed sound and sight television receiver will look like.

nizing pulses, which are taken from the same (6H6) tube.

Video Amplifier

The video amplifier consists of a 6F6 tube in a circuit which is a combination of series and shunt compensation to give a flat frequency response up to 3 mc. In the video amplifier the experimenter may raise or lower the gain, if so inclined. This flexibility is

desirable since the frequency response of the video amplifier should be comparable to the band pass characteristic of the picture i.f. amplifier system.

The videotron is operated with the cathode and control grid about 2000 volts negative with respect to chassis. For this reason, a rated 2000 volt blocking condenser must be used between the cathode ray control grid (Build further on page 56)

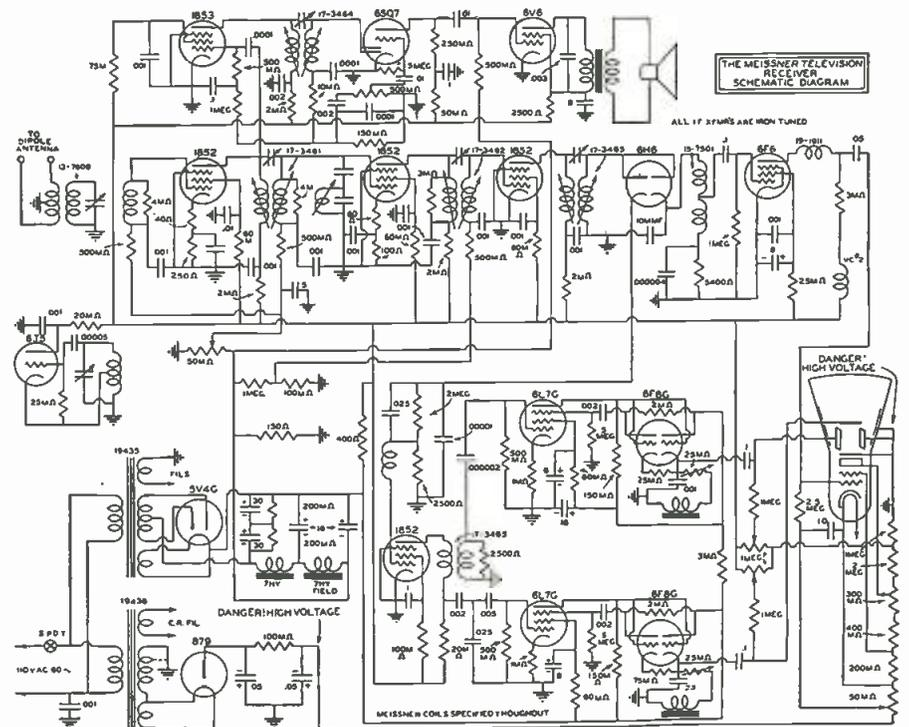

A S H SEE

By **JOHN F. RIDER**

Dean of the Servicemen

When advertising products, how much of the unvarnished truth is told, and how much is permissible salesmanship. Which will pay?

(The opinions expressed herein are solely those of the author, and do not necessarily represent those of the Publisher nor Editors of RADIO NEWS.)

Truth in Advertising

IT'S strange what one letter can do. Time and again you discuss a subject—answer questions, get different opinions from people and promptly proceed to forget all about it. Then one day you have a few moments of leisure and a letter arrives. You glance at it hurriedly because you do not wish to be interrupted while you're doing nothing. All of a sudden you realize that what your correspondent has in mind, has been in the minds of many, but little if anything has been written upon the subject. So you commence writing and this is it.

Our letter writer says "pick up any magazine and you will see a series of ads, advertising the wares of many different manufacturers—some competitive and some not. All laud their products to the sky. . . . Which one should you believe? . . . Is there any truth in advertising?"

He continues, "Am soured on some test equipment in particular because what I got was not what was advertised . . . not even satisfaction. . . . Maybe it would be a good idea to hold the magazines responsible for what the advertisers say."

Advertising in radio magazines is an interesting subject. It is vital to the magazines and vital to the readers. . . . And last, but by far not the least, it is vital to the advertiser. . . . In other words, everybody is concerned. . . . Everybody is concerned because it means dollars and cents. . . . Not that the dollar is the most important thing on earth, but as one speaker once quoted it, "it is a damn good facsimile."

Is it possible to tell the truth in advertising? Yes and no. It all depends upon what you are advertising and your public. Can the serviceman expect any more truth in the ads addressed to him than he addresses to the public? Not that the parts or tube or equipment advertiser takes that into consideration when his agency writes his ads. It is a matter of appeal. All of us know that by and large, a service ad which states "Your Receiver Serviced for \$1.00" does not really mean that. Before the job is

done there are extras here and there; but the ad appears, nevertheless, and it is couched in such terms as to appeal to the pocketbook . . . to attract by the low price.

Human nature is the same the world over. There are those people who are attracted by quality and those by price and sometimes those who like quality are also attracted by price. So that low price always is good bait! You know that baiting a hook is not honest. You're really not offering the fish a meal—you want to get him out of the water. Sometimes the fish fools you and then you call him names. Is that fair?

Advertising is a problem because the advertiser cannot tell the truth in all his ads. Take two advertisers of similar products, intended for the same application. One man sells his product for \$1.00 and the other offers his for 34 cents. Seldom, if ever, will you find that both are identical—yet there are certain similar things which can be said for both and are said for both—but also certain things are left unsaid about the cheaper product.

Being a sensible man you would not expect the advertiser of the cheaper product to tell you that some of the parts used in his product are inferior to the other—that while both can be soldered into the same circuit, the better of the two units will outlive the inferior product by six, eight or ten times . . . by a ratio far greater than the ratio between the two costs. Of course not! How can you expect such a statement when the appeal is price?

Would you expect the manufacturer of a beauty lotion to advertise that it will never help a homely woman? Of course not. It makes all women look "more alluring and seductive"—because all women wish to be beautiful—particularly seductive. He appeals to the vanity in every woman.

Examine the advertisements in all magazines and you will find appeals to romance, adventure, thrift, vanity, the longing for travel, comfort, the desire to swim, ride, golf and many others. Do you think that all of them tell you the truth? Sure you can swim—the lake is only two miles away and you have to climb 146 steps. Certainly you can ride if you wait your turn for four hours until the



John F. Rider

three nags have rested after their last riders. Of course you can play golf if you carry your own scythe to cut the fairways and greens during the game. Yet they are telling the truth, you can swim, ride and play golf, if you want to under the existing conditions. . . .

To get back to radio advertising. Maybe you expect specifications of the various radio products. You can get specifications, but once again it is tied in with the products you seek, with the amount of money you wish to spend, with your ability to interpret the specifications, with the integrity of the concern, with what appeals to you when you buy. In this connection let me assure you that more than one manufacturer of radio products has considered ways and means of properly presenting truthful facts concerning their products, without violating the so-called unwritten code of ethics of not knocking your competitor, of not naming the product used as a basis of comparison.

Paper is very patient. It will carry whatever message you wish it to. One manufacturer may give specifications, truthful data concerning his product and show why he finds it necessary to charge a price which you may consider exorbitant with respect to others. The second manufacturer quotes no specifications, but paints a glowing picture around a price. His appeal is greater. It makes much easier reading. Advertisements are not written to fight other manufacturers, to disprove statements made by competitors. They are written to sell a product by trusting in the ability of the reader to select in accordance with the integrity of the selling organization, the need of the customer, his financial condition, the knowledge of what he wants, the benefits to be derived by buying a reliable product from a reliable organization, the experiences of others.

By and large, advertisements tell the truth. It all depends upon what you want. No one has as yet demonstrated how it is possible to run a suc-

(Please turn to page 50)

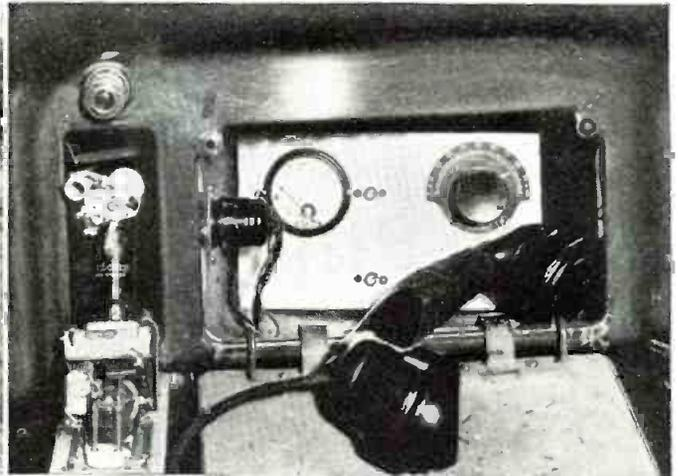

This type of installation will not disturb the XYL nor will it mar the appearance of the family automobile. The rods are a reflector-antenna.

Here is how you can convert that auto radio into a first class UHF radio shack.

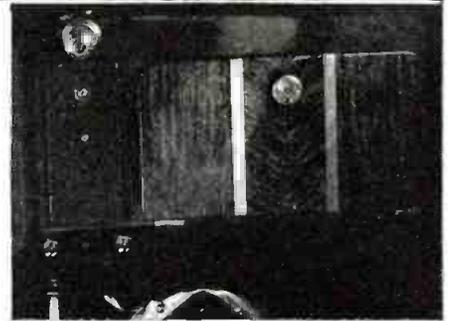

Making a X-nter-Revr from an Auto-Rac

by **WILEY D. WENGER, W9CJL**
 Engineer, Station KFNF
 Shenandoah, Iowa

CONSIDERABLE designing, and about the same amount of re-designing has been done here in our work with the relay-broadcast equipment used under the call letters W9XPL-W9XPM. A pack transmitter of a few designs back, was described in RADIO NEWS, May 1938 by Howard Burgess. Since that time, we have discontinued the use of such pack equipment, for the reason that we found most needed was a layout that would work at any instant it was called upon. We found we were usually setting the pack set on top of the car, to secure some added antenna height.

The transmitter described here, is copied after the type of equipment which we now use. The receiver is the actual one used for talk back reception.

We don't have a truck. The car has to be used as a family conveyance so it cannot look like a portable radio laboratory. It is sometimes necessary to make room for Milady's Pocketbook and the other sundry items that find a resting place in the dash compartment. We think we are lucky to be able to have two antennas on the car, and even then, we have heard remarks as we passed down the street that had something to do with our being interested in buying another radio antenna.

We didn't want to have the usual

thing in battery drain either! Battery drain is the biggest bugaboo in this business of trying to get something for nothing, so to speak. In eliminating drain, we have combined so many functions that it seems, first off, rather hard to explain, but really it is very simple.

We took the regular car broadcast receiver apart. We made it serve the combined purposes of being the IF amplifier for a short wave converter and a speech amplifier-modulator of some 10 watts output. The short wave converter was actually built into the

right hand ash tray of the car. The converter is pre-tuned and normal tuning on short waves is done on the same dial as for broadcast tuning, as it simply shifts the IF frequency around over 500 kc.

In order to conserve battery drain we start by seeing just what has to be done to the car radio to make it function in as many ways as possible. We could have made these same changes in most any car radio, and only chose this one because it had a good class B audio output stage. The original schematic diagram as shown,

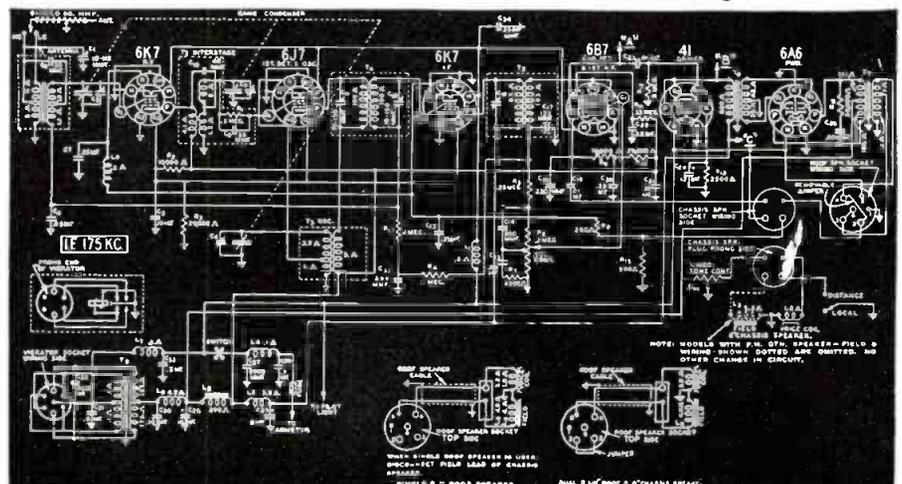

The auto receiver before its conversion.

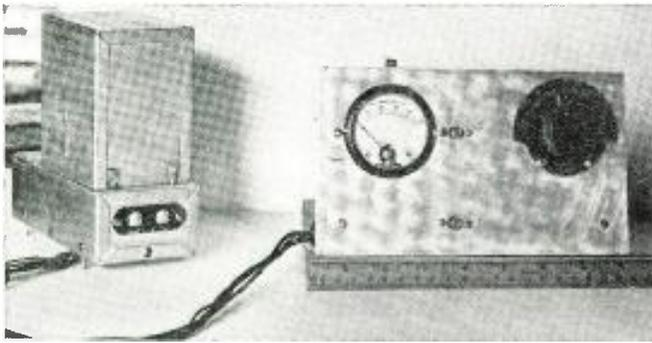

Transmitter and power supply. Note size of each unit.

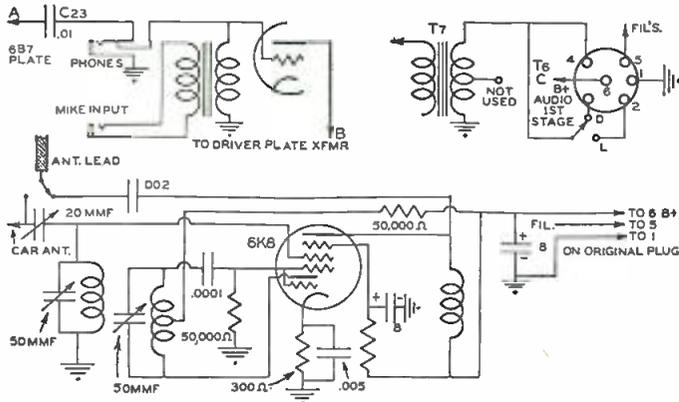

Receiver-converter schematic connection diagram.

was altered in the portions shown in the illustration. We found room inside, to mount a small microphone input transformer which had taps to secure 50-200-500 ohms input connections. We brought the desired impedance out to the jack terminals, so that we could use a microphone, which would operate with a C battery hooked in series, or we could feed a pre-amplifier into the jack. The former "Local Distance" switch was utilized to switch the voice coil winding of the receiver either into the speaker, or into the externally mounted modulation transformer.

The tone control resistors and condensers found across the plate circuit of the 6B7 and a portion of the volume control were removed, as we wanted the *highs* to be gained, rather than the elimination of background noise which the manufacturer intended. As will be seen also, we used the "Extra Speaker" receptacle as the output terminals for the audio of the "Modu-

lator" as well as "A" and "B" voltage for the converter in the ash tray compartment. All leads which were added inside, and which ran any distance, were carefully shielded and bounded to ground points, so as not to only prevent them from becoming shorted against tubes caps and such, after the lid was put back on, but to help prevent any pick-up of vibrator noise. The regular car radio antenna lead was taped to the steering column and brought out to

a small switch clamped on the dash, to place the car antenna onto the radio, or place the lead onto the output termination of the converter. We had hoped to be able to re-wire the '41 driver as a pentode so as to obtain sufficient gain to use the modulator with a low gain mike. We found the limiting distortion to be coming from the pentode connection, and replaced the triode connections. If we aren't so particular about quality, we then have enough gain for a single button mike, and where higher quality transmission is desired, we can feed a portable pre-amplifier into the '41, and drive the modulator to full output with less distortion.

The Ash Tray Converter

In looking about for the logical place to carry the front end of a superhet short wave receiver, the ash tray was found to offer most possibilities, since it was hinged, and had a pretty fair amount of space behind, if one could build in the right direction. The ash tray was lifted out and studied for

several days. Then the parts which we knew would have to be mounted in the converter, were spread before us, and more observation took place. We had previously chosen the new 6K8 as a mixer, oscillator tube as it works much better than previous "front end" combinations.

Simply by sawing off the wider top section of the ash tray, we had left a small chassis, mounted on a front panel. This chassis was but one inch square, and held the octal socket for the tube. Inside it contains the resistors and condensers. We had hoped, at first, to be able to get the complete oscillator section inside, leaving the entire tray to shield the detector circuits. As it is, we have had no trouble with interaction, or regeneration. The leads of the detector tuned circuit could not be any shorter.

The tubes shield was scraped bright and the assembled tuned circuit was soldered onto the shield with a small amount of solder. It is mounted very solidly between there and the control grid cap, and at just the right angle to permit the whole unit to hinge in and out of the space in the dash panel.

To adjust the detector section, the whole thing is simply dropped open, and then folded back into place, as the oscillator can be tuned from the front side of the panel. The detector tuning is not critical. Leads were left long enough so that once the converter is working, they are plugged into the radio and taped into place under the dash. We cannot tell you much about the usual job of removing bugs, as it worked from the instant we turned it on, and it hasn't been taken out of the car once.

We used to use super-regenerative receivers, but the quality of reception on this set, compensates for any advantages which the older receivers may have had. As far as sensitivity is concerned, we have never actually had to use the gain wide open. It seems that we get down to the noise level, even though we didn't have room to use the usual tuned output transformer to feed from the converter into the antenna connection of the broadcast set. We can work break-in from the car up to about six miles, with a frequency separation of about 100 kc. on the two transmitters.

The Transmitter

The transmitter was developed first, (Please QSY to page 65)



Rear view of the auto transmitter.

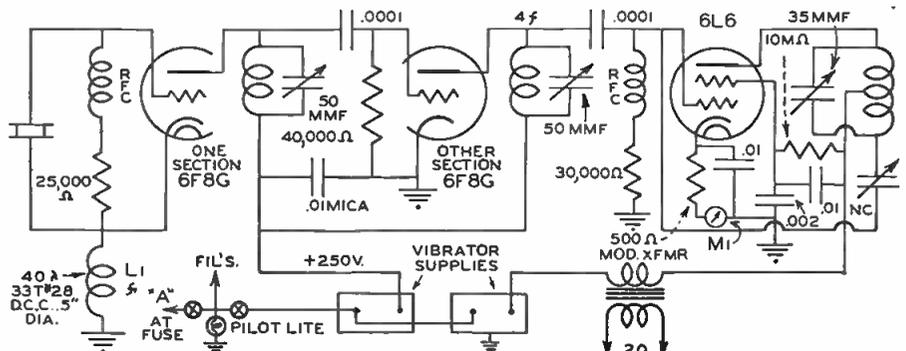

Circuit diagram of the completed transmitter.



by **LEE WARD**

Service Manager, San Francisco, California

Presenting a few hints and kinks for the serviceman

Psychologist on Tap

SUALLY, when a friend asks to see my resistor color-code pencil, he turns the three drums experimentally to correspond to a common resistor value—5,000 or 10,000 ohms—and then returns it to me with the drums aligned so that the colors are matched along the side of the barrel.

The phenomenon has been mildly amusing to me during the past year, but became an acute problem when another serviceman asked for an explanation. I tried to dismiss the question with a casual remark to the effect that the bars were not left in a random position because of a common inherent Will To Keep Things Orderly, but the inquirer insisted it went deeper than that.

BENCH NOTES keeps a psychologist in the office for use in such quandaries. Barely moving from his normal unconscious state, he explained the reason for the color bar alignment was a Jackpot Complex, resulting from Fruit-machine Frustration.

Carbon Welder

"A very efficient soldering tool," writes J. O. Roberts, of St. Louis, Michigan, "which is easily carried in the tool-bag, and which is usable wherever a 2- or 6-volt storage battery is avail-

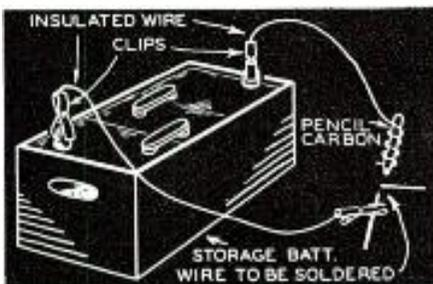

able, can be made with a hard carbon pencil. This material is similar to that used in projector arcs. Connect as shown in the illustration."

Although the stunt is intended primarily for rural servicemen, in sections where no power lines are available, us urban guys sometimes get caught with a small soldering job where we have a power line but no

iron. Might save a trip back to the shop.

"I came across a G.E. with slide rule dial," J. O. continues, "and the customer had lost the pointer after the cable broke. I replaced the cable and used a clock hand for a pointer, bending it into shape and welding it to the proper point on the cable. Care must be exercised to heat the hand at the point of bend—it will break if it is not dull red."

Sounds like Roberts is a good mechanic and business head. How many of you city slickers use the same amount of ingenuity when going out after trade?

Speaker Rent

Some years ago I laid a Nassau chassis alongside me on the seat of the truck, and delivered it to a customer six miles away. When I connected it, I was very discouraged to find I had shaken off all the filaments

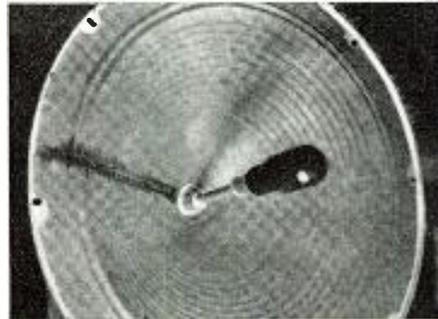

of the 99's during the vibratory trip from the shop. Worse, I had to buy replacements from a nearby hardware dealer because the customer wouldn't wait while I drove an additional twelve miles for my own stock. The fact that 99's had just been dropped in price to @ \$2.75 should have cheered me up, but didn't—the loss more than took the profit out of the repair charge, and put the whole day out of tune. On subsequent deliveries and pickups, I removed all 99's from their sockets, and carted them only after they were wrapped in waddling clothes, lying out of dange.

The other jay I was equally embarrassed when I unloaded a Lyric and ripped the speaker cone because I was

too lazy to make two trips from the truck into the shop, and piled the speaker on the tuning chassis; a corner of the chassis tore through the cone, and I paid for the replacement myself.

I know that should always be laid on the floor face down; that they should be wedged, during truck travel, with the base propped against the wall; that they should be carried alone from house to truck, and that they never should be piled on anything else. I know this, I say, but yet I cause costly casualties whenever I get careless, fast, or too expert. From now on, I'm going to take it easy. Being slow isn't being stupid—not when a free cone replacement is involved!

Dead Weight

Periodically, when my tool-bag becomes heavy and disarranged, I empty it, sorting the contents, and removing all the non-essentials: open volume controls, shorted tubes, old window strips, pieces of wire, and cigarette ashes. During the last cleaning, I inspected all the remaining tools and parts which were going back into the



bag. A 1-pound spool of solder seemed to have the highest specific gravity; its length and weight—compared with the maximum half-inch or so I use on work outside the store—seemed incongruous.

The expedient is shown in the photograph. Eight inches of solder is wrapped around the iron handle—where it is available without further fishing when the soldering iron is pulled out. Saves space, is convenient, and avoids arm fatigue by raising the Plimsoll line of the tool-bag appreciably.

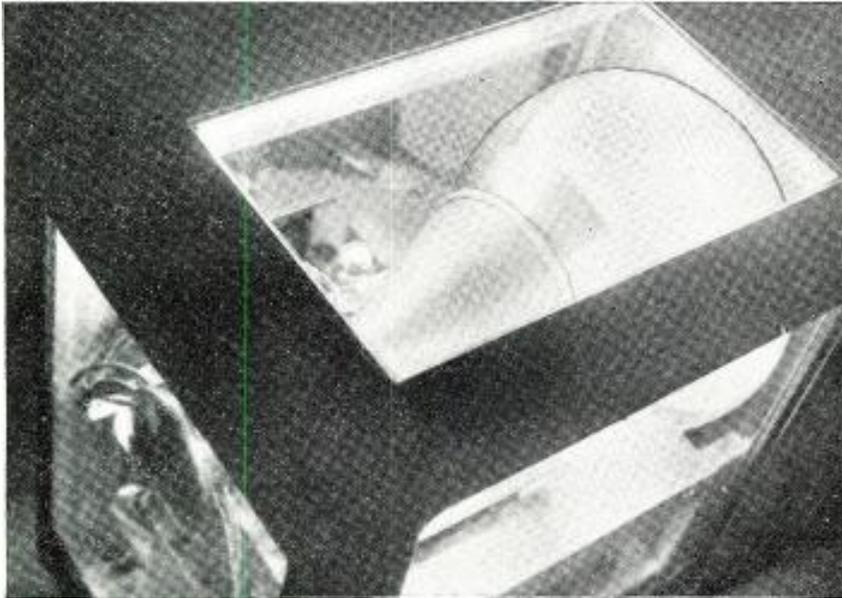

This large C-R tube will not function properly with poor I.F. stages.

The most important unit in the television receiver is its I.F. amplifier. The author describes the many types which are available.

by M. W. THOMPSON
Television Engineer, Chicago, Illinois

The fourth lesson of the television series.

Tele-Receiver's Heart

THE third article, which appeared in the April issue, discussed the peculiarities of u-h-f carriers, some "must" and some "must not" features of television receiver antennas, and circuits to handle television signals while still at 44 to 108 mc. While it is quite feasible to receive the video program on a tuned r.f. receiver, and the audio accompaniment on either another tuned r.f. set or a small "super," the makers of complete sets for the public are planning superheterodyne receivers whereby the converter or first detector will so handle both video and audio carriers that they are heterodyned into separate i.f. passbands to be amplified by independent intermediate frequency systems.

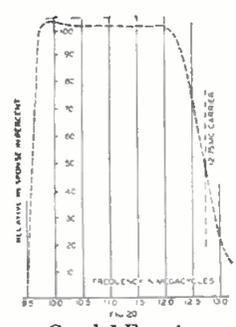

From the standpoint of simplicity of control, this is most desirable. It permits tuning, by a condenser gang, so that as one tunes to the 45.25 mc. video carrier of channel I, he automatically tunes-in the 49.75 mc. audio carrier of this channel, then, when channel II is desired, tuning (with but a single control) so that the 51.25 mc. video carrier is received, brings in the 55.75 audio carrier also. If the tuned circuits consist of ganged switches and pre-tuned air trimmers (as described last month), a single knob or lever gives instantaneous transfer to channels I, II or III. Otherwise, one must first tune the

video receiver and then the audio. Television transmission and reception are, at present, predicated on the use of a single side band. The other side band is not entirely eliminated, the lower frequencies being present to some extent, but for all practical purposes and the current discussion, only one side band is used. Presuming a picture i.f. frequency of 12.75, our band width of 3 megacycles (necessary for good reproduction) is, roughly, 23% of the i.f. This makes impossible what we commonly consider "low loss" circuits, and makes it difficult to secure very good gain per stage.

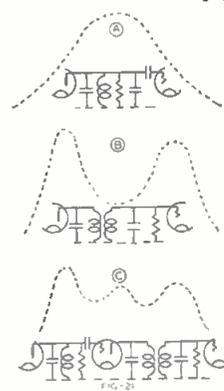

Exceptional engineering design can produce, for laboratory use, a rather flat-topped pass-band three full megacycles wide, with sharp cut-offs at each side and excellent attenuation of frequencies above and below, but for production use and amateur construction some compromise must be made. The gain characteristic of a good video i.f. system is shown in Figure 20; that is what we are trying to secure. Certainly we do not wish more than four i.f. stages, three would be convenient and are going to try to get results from two. Three stages gives us six to twelve adjustable circuit elements with which to secure a reasonably flat, sufficiently sharp cut-off, uniform, much desirable

response band-width. This is needed. Development of coupling units in i.f. amplifiers has progressed along three lines: (1) air core primary and secondary inductances, either or both capacity-tuned, and using either capacity, inductive or magnetic coupling; (2) primary and secondary inductances on finely-powdered, magnetic-material cores (magnetite), tuned either by shifting core position or with capacity, and coupled either inductively or by capacity; and (3) a group of inductances, capacities and resistances in what is called either a band-pass filter or a filter network.

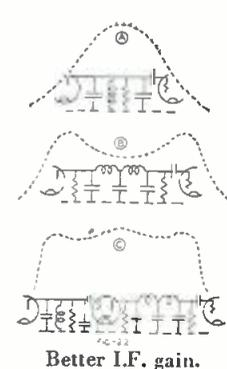

If one experiments with aircore transformers, it quickly becomes apparent the i.f. must become a system of compensatory stages which will (over-all) give substantially uniform response to our 60 cycle-3 megacycle band. It should be recalled that, when two tuned coils are brought close together, one first gets a single "peak" in the response characteristic and, then, as they are brought yet closer, two peaks develop from the "over-coupling."

This double-peak response can be utilized, in conjunction with a coupler giving a single peak, to develop a fair performance curve (see Figure 21). Here, a single-tuned circuit (a) results in the single humped response, while (b) consists of two tuned cir-

cuits over-coupled, and the double-hump performance results. Placing an I.F. amplifier tube between them, a response with three humps (c) would result. Such a non-uniform response from 60 cycles to 2.8 or 3.0 mc. would, however, give very poor television entertainment.

One's first thought is the use of magnetite cores to flatten the humps, but the experimenter then finds himself in *real* trouble. The coupling of the coils would be affected by the movement of the cores, and one would spend a wild evening juggling for a correct value of mutual inductance while trying to hold two correct values of self-inductance. And, when the constructor was through, he would have an insufficiently wide passband anyway.

A considerable improvement results when the single-hump circuit is used with another type of inter-tube unit as shown in Figure 22. Here the second stage is capacitively-coupled, and shunt damping is employed at both ends. The approximate response curve obtained is given as Figure 22c. One might consider these two stages as but half of a 4-stage I.F. unit, and add

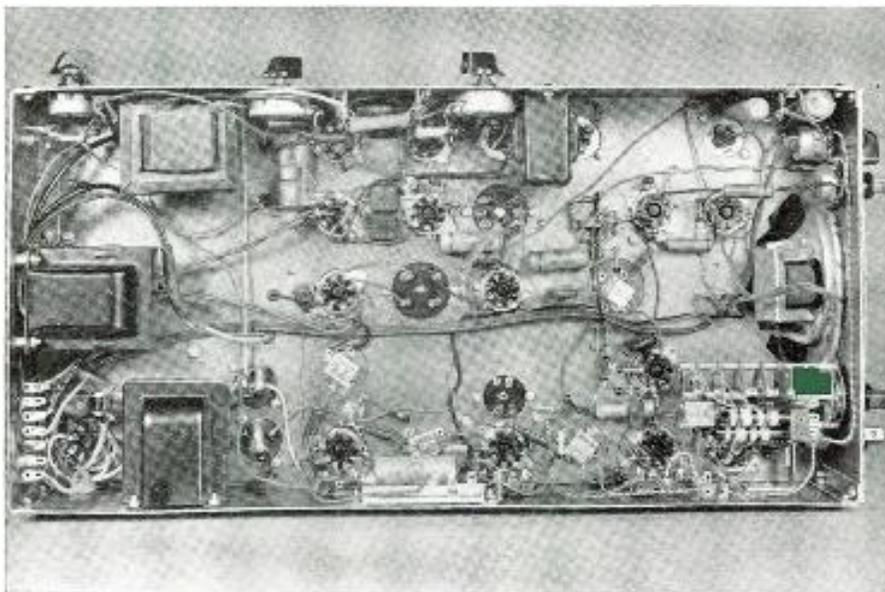

The connections are clearly shown in this experimenters kit.

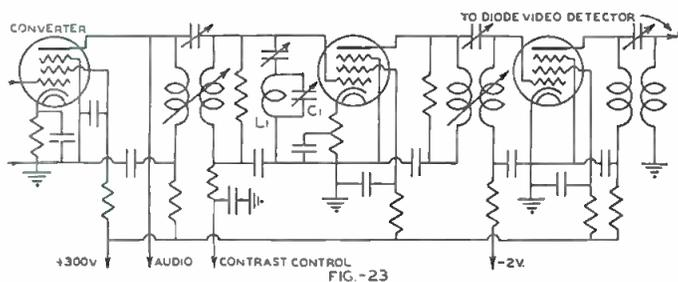

The starting point for I.F. circuits.

another pair like them, in the hope of maneuvering the two single peaks and the two double-peaks into something like a flat top. It is doubtful whether the non professional could, in the end, evolve either satisfactory response or compromise between gain and band width.

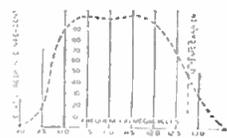

Excellent I.F. gain.

23. For the experimentally-minded this circuit is an excellent place to start; it is the I.F. circuit many factory engineers used as a starting point even though their final designs, as they are coming through now, bear

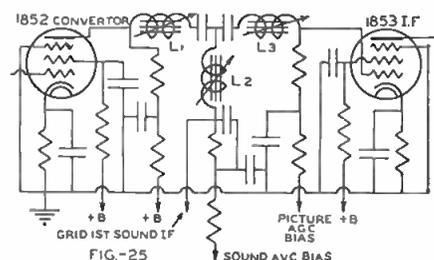

Converter coupling network.

little resemblance to it. The coils are small diameter and of small wire, wound some distance apart on a tube; there is little if any mutual inductance. A magnetite plug can be moved into and out of each coil to tune it, while coupling is secured through the condenser across the "high" ends of the coils.

Three such units are used; when adjusting, one makes the first unit single-peaked and the other two double-peaked. One advantage of this lies in the fact that adjustment of an I.F. system begins at the output end and you work back. Applying an oscillator with sweep frequency to the last stage its transmission shape is observed and variables are juggled for a characteristic that is a good compromise between gain and flat top. Shifting to the tube ahead, the center coupler is adjusted by varying resistance loading, coupling and self-inductance so that a good double hump transmission results. It is then easier to determine roughly how pointed or flat the single-hump first coupler's characteristic should be and where its hump should fall. Fig. 24 shows this response curve.

On first observing the I.F. system response curves, surprise is usually expressed at the placing of the I.F. video carrier on the slope rather than on the rounded corner at 11 to 12 mc. This is because of the remnant of the other half of the carrier's sideband which still comes through; it was in the *lower* frequencies while enroute and in the r.f. circuits, but due to the reversal in the converter, it is now at the *higher* frequency end of the I.F. passband. There is greater I.F. carrier intensity at this point and a tendency

to over-emphasize low video frequencies. This is offset by adjusting inductances, tuning, resistance loading and coupling so that the I.F. carrier frequency is on the high frequency

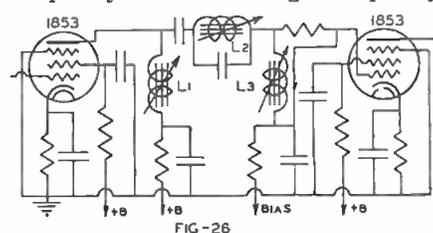

A better form of converter coupler.

slope at a point which is 50% to 75% of uniform response.

In considering Figure 23 the reader may wonder what the tuned circuit between grid and cathode of the first I.F. tube is for. It is not feasible to secure the steep slope at the low frequency end of the curve shown in Figure 24 with the simple coupled circuits of Figure 23 alone, but such a slope is necessary if audio I.F. frequencies are to be kept out of the picture I.F. channel. To secure this sudden attenuation, the trap circuit consisting of L1 and C1 is inserted, and tuned to the 8.25 mc. audio I.F. frequency. Possibly, it may be necessary to set this at 8 mc. so that its attenuating action will not cut too deeply into the 9.5 mc. end of the picture I.F. response curve (Figure 24).

In connection with the circuits already discussed, no mention was made of the tricky little factor known either as "linear phase shift" or "constant

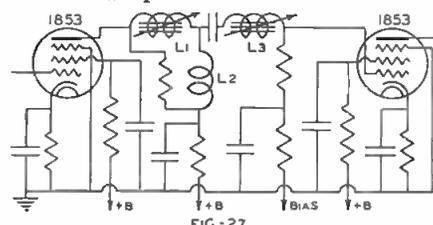

This circuit improves sensitivity.

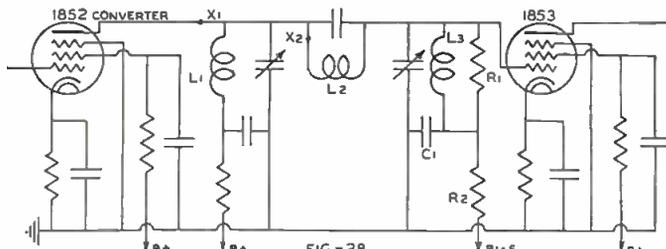

Air core coupling network circuit.

time delay," nor will it be gone into now. It is a subject far beyond 97% of readers—it is, in fact, perfectly clear to only a modest percentage of engineers. Were you going to design an I.F. system from scratch, linear phase shift would have to be considered, measured and accurately controlled; either phase advance or phase delay result in time delay, and what is desired is *uniform* time delay at all frequencies in the video range (60 cycles to 3 mc.). As most readers will build with kits or recommended parts, or will be servicing factory-built models, it will be ignored in this course.

Coupling networks give the finest results from every angle—flat topped curve, gain, attenuation and close approach to linear phase shift. In proceeding from the converter, usually an 1852, to the first I.F. stage (for which the 1853 is particularly well-suited), the circuit of Figure 25 offers many advantages. A coupler of the type indicated could consist of three closely adjacent and parallel 1/2-inch tubes perhaps three inches long, the three windings being placed well apart longitudinally and each consisting of but a few turns; there is practically no magnetic coupling.

The coupling is of the impedance type, as L2 is common to both circuits. Since L2 is made series-resonant to the audio I.F. frequency it is convenient to pick off the sound I.F. at this point and do it across the resistor below L2. Note that a resistor is placed in shunt in both the plate and grid circuits as a load and that a resistance-capacity filter is used in all B-supply leads. Although it would be desirable, from the standpoint of both compactness and ease of construction, to use but one 1/2-inch tube, three are used, that a magnetite core can be inserted in each winding and varied for tuning. As stated earlier, a high L/C ratio is beneficial to gain and this plan eliminates capacity tuning.

While we have been talking, so far, about a video I.F. of 12.75 mc. and a audio I.F. of 8.25 mc., it must not be taken for granted that these must be strictly adhered to in design. Against the two incoming carriers of 45.25 mc. and 49.75 mc. one can just as easily "beat" an oscillator frequency of 58.25 mc. (instead of 58 mc.) and have intermediate frequencies of 8.5 mc. (audio) and 13 mc. (video); in fact some engineers are using this combination.

Presuming our picture I.F. is 13 mc. and our sound I.F. is 8.5 mc., it is necessary to so design that our over-

all I.F. characteristic finds 13 mc. on the high frequency slope and marked attenuation at the 9.0 to 9.5 mc. end. This aim will be aided by the use of one or more couplers of the type suggested in diagram shown in Figure 26. Here the coupling is accomplished by the tuned circuit of L2, and this circuit is adjusted to resonate at 8.5 mc. (the sound I.F.) and so acts as a trap. Note that no resistance load is placed across L1 but that there is one across L3. The characteristic curve for such a stage has so steep a low-frequency slope that the response at 9.25 mc. is but 5% of the response at 10 mc.

To improve the sensitivity, a stage or two such as Figure 27 is desirable. The circuit of Figure 26, while it pro-

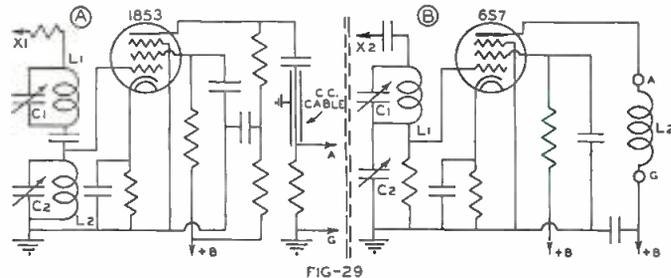

Two types of "sound buffers."

vides exceptional selectivity and rejection of the sound I.F., has not the sensitivity nor as broad a flat top as does Figure 27's circuit. Note that L2 contains no core, so L1, L2 and L3 may be on one tube, well spaced apart, with magnetite cores in each end for L1 and L3. Here, no attempt is made to either eliminate sound I.F. nor to secure a vertical slope around 10 mc. As a matter of fact, the low frequency slope is so far from vertical that response at 9.25 mc. is 60% of that at 10 mc., and 13 mc. falls considerably above the 50% point on the high frequency slope. If we now combine the I.F. coupler of Figure 25 with two of Figure 26 and two of Figure 27, the

result would be as close to perfection as the television art now knows.

A coupling circuit which makes possible the use of air-core windings, and couplers that are considerably easier to build, is presented in Figure 28. Since there are no magnetite cores to be adjusted, and magnetic coupling is not a factor, coils L1, L2 and L3 may be wound on a 1/2-inch core about 4 inches long. If midget condensers are used, all of the units indicated between the 1852 and the 1853 may be enclosed in a shielding can no larger than 4 1/2" x 2 1/2" x 2 1/2". For three stages of I.F., all 4 couplers may be identical with the exception of the last which feeds a 6H6 video detector. In this last unit, condenser C1 and resistor R2 are eliminated, and the lower ends of L3 and R1 go to ground.

X1 and X2 indicate points at which one can take off a lead to the audio section of a receiver. If the set constructor is going to use a short-wave receiver for the audible element in television entertainment (and most

of us are), with the input tuned to about 8.5 mc., a coupling stage known as a "sound buffer" is necessary. Figure 29 shows the essentials for two types—29A would connect into Figure 28 at point X1, while 29B would be at-

tached at X2.

The tube and associated circuits of Figure 29A are, in effect, a trap circuit and a stage of resistance coupled r.f. amplification. The most important function (as a buffer) is, however, to prevent interaction between the oscillator of the audio receiver (presuming it's a "super") and the video I.F. stages. If the super-het has 456 kc. I.F. stages, its oscillator may be functioning at 8.95 mc. for an input at "A" and "G" posts of 8.5 mc. In use, the C1-L1 circuit is adjusted for 10 mc. to trap out any traces of video I.F. frequencies between 9.25 mc. and 10.75 mc. that might try to get in. The

(More data on page 53)

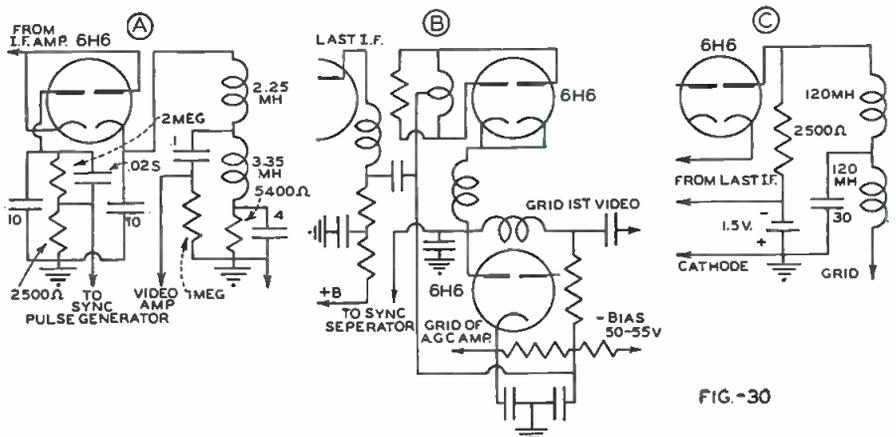

Three types of detectors stages.

The DuMont Receiver

by WILFRED S. ROWE
Croton-on-Hudson, New York

Bringing the television receiver into the reach of the man on the street has been a problem solved by the DuMont Labs.

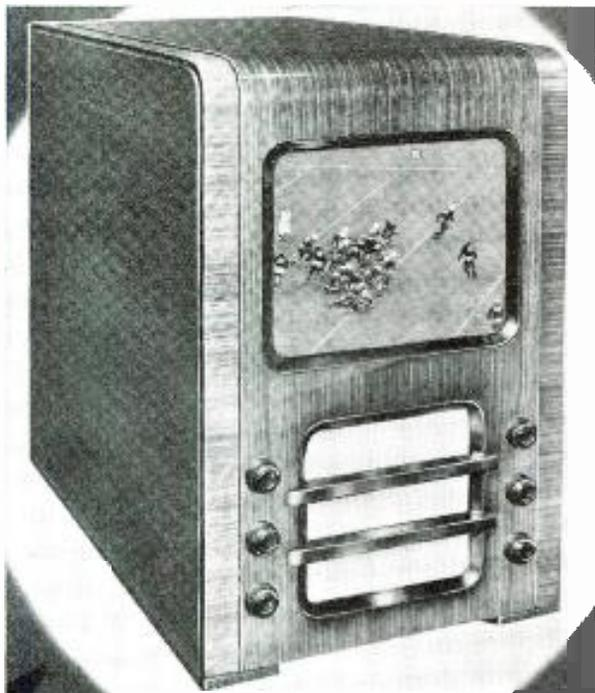

The table mounting model will bring in your program much the same as does this. Above shows televised film.

ABOVE the din of arguments pro and con the immediate commercial practicability of television in the home, there arises irrefutable sounds of factories busily turning out television receivers, openly and secretly as the case may be. What's more, the really practical sets are selling as rapidly as they roll off the production line, even in the absence of scheduled television programs at the moment. But how can this be possible? It doesn't seem to make sense. But wait a minute . . .

Television has a tremendous novelty value. A television set has enormous drawing power, either inert through lack of video signals, or in full operation when those rare experimental programs are on the air. And at any rate, with the official promise of scheduled sight-and-sound programs early in 1939, it won't be long now. So avoid the rush and get that set today. That seems to be the reasoning back of the sales.

The present buyers are mainly dealers and large stores. They want to cash in on the drawing power of television. Dozens of such sets are attracting crowds in the metropolitan New York area. A few scattered sets are being shown beyond the ken of existing television transmitters. Monied folks who pride themselves on being "firsts" in most things, are buying sets to wow their friends with television reception when and as available. Behind these immediate buyers stand tens of thousands of others ready to buy just as soon as tele-

vision programs are on a regular schedule.

So much for the buying interest. But can television sets be produced at a price within reason? Will such sets provide genuine home entertainment — something beyond the novelty thrill which wears off in five minutes or less? Will television be practical for the average home?

We turn to television sets already available or at least announced in search of answers to such questions.

So far as price is concerned, television sets are within reach of many households in metropolitan areas where programs will first be made available. Especially straight television sets for just the video or sight portion of the program. Money can be saved by having a short-wave converter connected ahead of the usual broadcast set, making the latter available for the audio portion of the television program. In this way a video receiver with say a 3-inch tube will probably retail around \$100.00, perhaps less. A 5-inch tube job will sell around \$135.00.

For a complete television set including audio and video channels, the prices will be considerably higher. The 5-inch job will probably retail around \$200.00 and the 9-inch around \$275.00.

Of course the price will be controlled mainly by the size of the screen image. While the 3-inch job with its "postage stamp" image will satisfy the experimenter and even the individual looker-in, just as earphone reception satisfied many beginners in broadcasting, real television entertainment calls for at least a 9-inch tube job, and preferably the 14-inch. Later will come practical projection type receivers, whereby much larger images will be shown on translucent screens. But that now looms as a thousand dollar proposition, which is generally prohibitive.

One of the first de luxe television receivers to be made generally avail-

able is the sight-and-sound DuMont table model. Not a great deal larger than a really good table model radio. And just about as simple. Only the opalescent screen end of the huge cathode-ray tube framed in the upper half of the front panel, gives it away. Below is the 8-inch dynamic speaker grille, on either side of which are six control knobs.

The 14-inch tube provides a full 8 x 10 screen image. The black-and-white pictorial detail is excellent. Images are brilliant, remarkably free from scanning pattern and return trace and without objectionable flicker. They are fully comparable with home movies. A dozen persons can follow *(Televise further on page 47)*



Two chassis views of the DuMont Set. Double decks are used for compactness.

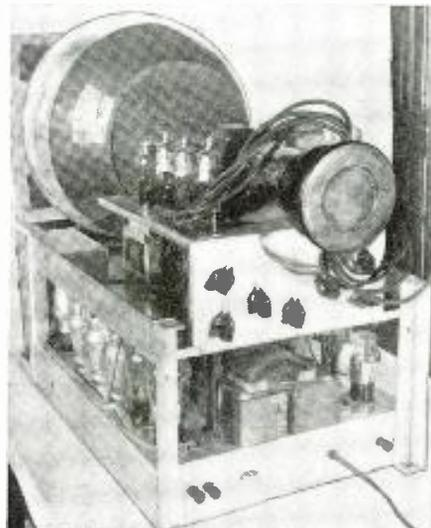

Construct a TUBE TESTER

by **EDWARD LINDBERG**
Sherman, New York

Building an emission type portable tube tester is a fairly easy undertaking if you follow the author's instructions. Because it is portable it will be of great use in making service calls.



Built into an already available carrying case, this tester is very attractive in appearance and does a neat job of testing the tubes.

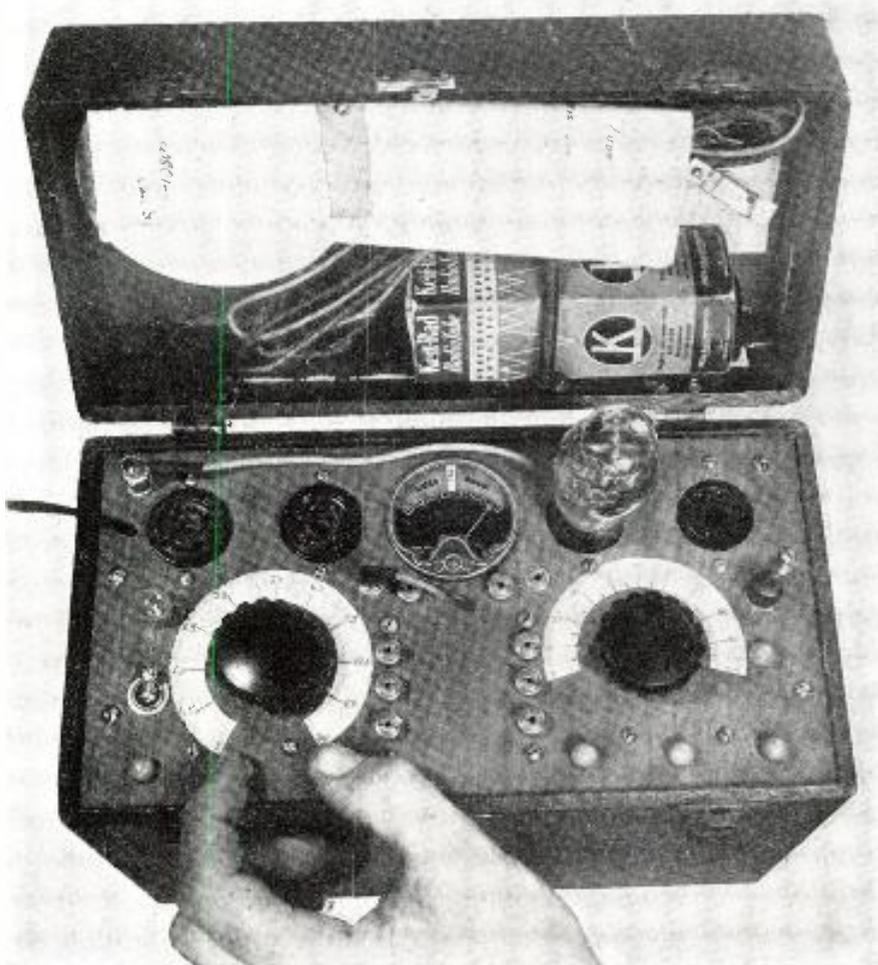

VE can no longer follow the old practice of placing doubtful tubes in an old receiver for a comparison test. Tubes are now too varied in number and application. When a modern circuit fails to function we fell the need of a quick, simple way of testing the most frequent source of irregularity, the tube.

A tube tester fills this need. This one is of the emission type. All the tube elements except the heater and cathode are connected together, and a source of 30-volts a.c. connected across the diode thus formed. A meter reads the total current that all the forced emission from the cathode can produce.

Though this is the simplest type of tube tester it is of great practical value as tube performance is closely correlated with cathode emission. The circuit arrangement is very flexible and new tubes are readily provided for.

It will be noted that only four sockets are provided. The combination 7 prong socket was omitted as the tester was built to fit a carrying case already available. To conserve space, the least frequently used socket was omitted and its services supplied, when needed, by a 7 prong to octal adapter. Of course, if room is available the socket should be included.

In the center of the panel will be seen the primary taps giving adjustments for line voltages of from 98 to 125 in steps of 3 volts.

The push buttons, when pressed, connect each tube element in turn to "B—". As all the other buttons are up they pass through the neon lamp to 115 volts. If any element is shorted or leaks to any other element, the bulb will glow when the button for that element is pressed, or if bulb glows with all buttons up, there is a heater-cathode short or leakage. The test is a most sensitive one. Then when no shorts have been revealed the S.P.S.T. switch is thrown to the right and the button connecting to the tube's cathode is pressed. This connects the cathode to the filament and "B—", and since all the other elements connect to the transformer's 30 volt terminal, a reading will be produced on the meter. This reading will be past the center mark if the tube is in good condition and if the calibrated meter shunt dial has been set at the correct predetermined value for that tube.

The meter is a 2 inch *Weston* Model 506, 5 volt instrument provided with a homemade scale made by cementing a crescent of white paper above the scale provisions. The left hand sector was colored *red* and the right hand side *green* using water colors. If you have a reasonably good meter on hand with a full scale reading of from 1 to 10 ma. you can use it. The *Weston* 506 draws 8 ma. With a 1 ma. meter, a 1000 ohm shunt potentiometer is used while with a 10 ma. meter, this value is dropped to 200 ohms. A 300 ohm value was used with the 8 ma. instrument.

The meter was taken apart and a

lead brought out from the junction of the moving coil and the internal multiplier. Then a 600 ohm adjustable resistor was connected in parallel with the multiplier. With a new 201A tube requiring a setting of 70, this resistor was adjusted until the meter read 90. About 400 ohms were necessary. Then with a good low-setting tube (25Z5), a 40 ohm adjustable wire resistor was placed in series with the whole meter-resistor combination and adjusted until the meter read 90 (with the shunt dial properly set). Nearly the whole 40 ohms were needed. It was then found that readings of other tubes compared well with a commercial tester. Slight corrections to the tube chart will be made in practical use. It is not at all difficult to adjust the resistor combination. However, a 5 ma. meter with tube tester scale and accompanying shunt pot. and dial may be purchased.

The scales on the panel are homemade but if desired they may be purchased, especially if the filament switch and meter potentiometer are purchased, as matching scales are usually available. The writer's rotary fil. switch is homemade from switch points and a bakelite disc.

The grid cap lead is provided with a combination cap and fits on a stud bolted through the panel when not in use.

The panel is a piece of veneer plywood 5½"x10¼". The box, of masonite, is 3¾" deep. The overall size of the carrying case is 6"x11¼"x11½" high.

The filament transformer is a rebuilt midget power transformer. Remove the secondary turns, counting them to figure the number per volt. The primary is then removed and re-wound to 98 volts using No. 28 wire (same as most midget p.t. primaries). A tap is then brought out and at every 3 volts thereafter 'til 125 volts are reached. Wind the secondary with No.

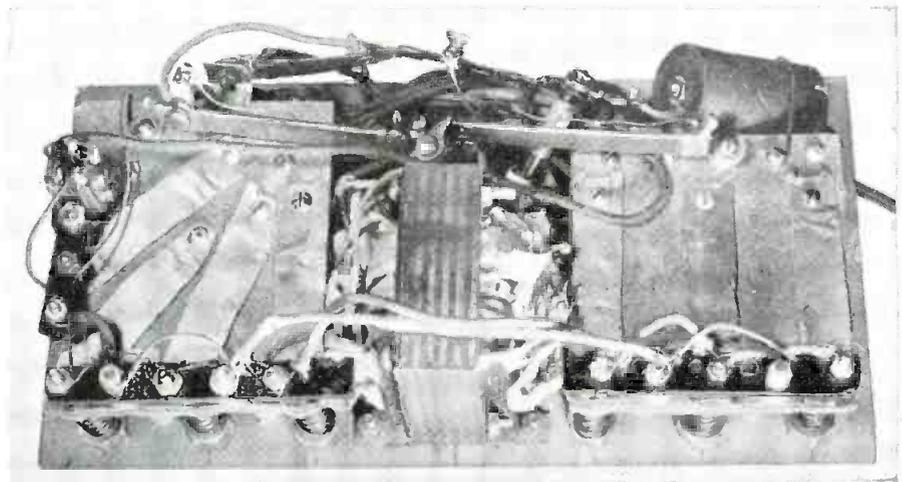

Under chassis view of the portable tube tester, showing the very compact construction which the author advocates as being the most efficient.

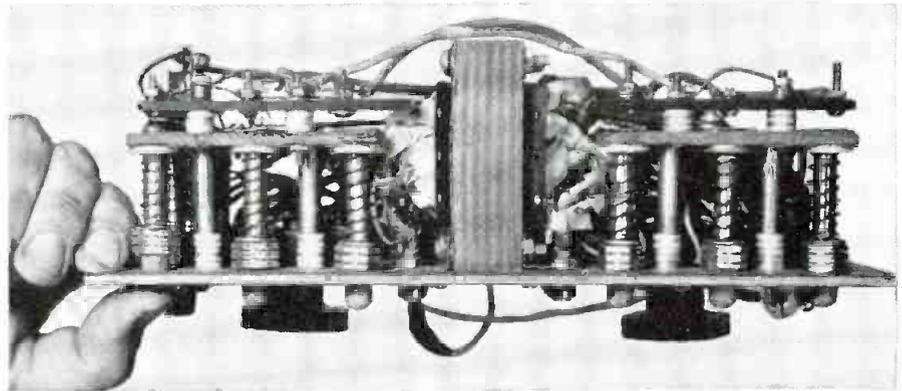

Home made push-buttons are a feature of this unit. They work extremely well and are constructed from odds and ends found in almost every shop.

20. If space is small drop down to No. 24 or even 26 after the 6.3 volt tap is reached. The odd 3.2 volt tap merely make the tap come out handier and was deemed a fair compromise between commercial 3.0 and 3.3 values. Insulate each tap well and mark for identification.

Each of the seven push buttons consists of a long machine screw over which is slipped a brass sleeve and retaining washers for the spring made from light spring wire. At the top is a large washer made by cutting off the center spacers of a variable condenser into suitable sections. The buttons are

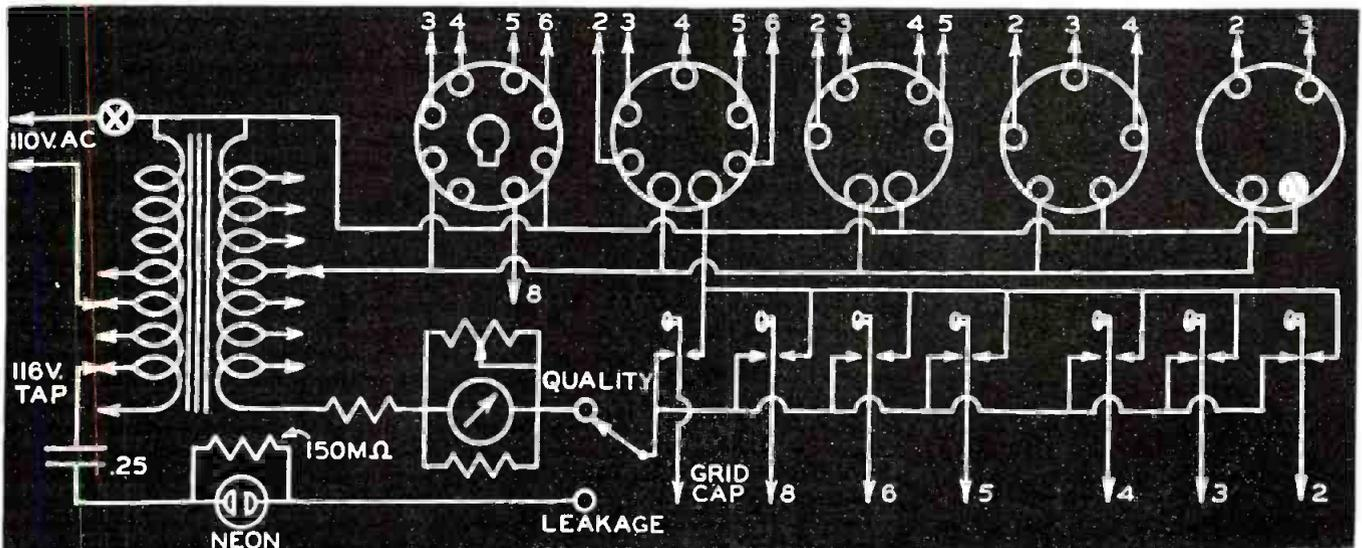

Circuit diagram of the portable tube tester.

bright red handles from old telephone jack switches. Suitable substitutes could be made from wooden dowels or binding post heads, or commercial switches may be purchased.

At the proper distance below the panel are supported two small masonite panels on which the spring switch-levers made by cutting up condenser plates are bolted. Holes are made for passage of the push button screw heads, and thin bakelite strips are supported just below to carry the machine screws which form the lower contacts. Brass strips form the upper contacts.

The tubular 1/4 mfd. condenser is visible at the back of one of these panels as is the 150,000 ohm neon shunt resistor which prevents the bulb from glowing on tiny leakages from normal tubes.

The push buttons as seen from the front are not lettered, but reading from left to right they are numbered 2, 3, 4, 5, 6 and 8 and above No. 8 is the grid cap button. These markings were omitted as they are not needed.

In wiring be sure to make good soldered joints. If the 7 prong socket is omitted it must be remembered in making the 7 to octal adapter that socket terminal No. 1 is connected to plug pin No. 2 and No. 2 of the socket is connected to No. 8 of the octal plug. This arrangement is necessary as pin No. 1 of the octal socket is blank.

In the illustration a 25Z5 tube is being tested. In the cover is a 201A tube used as a line voltage standard. It is inserted in its socket and the primary tap adjusted so that the tube gives a previously logged reading with the selector at 72. The cover also contains a pair of test leads, roll of tube stockers and tube characteristics chart.

-30-

TUBE CHARACTERISTICS CHART (FOR TUBE TESTER)

Type	Q	K	Type	Q	K	Type	Q	K	Type	Q	K
1.4 Volts			35/51-S.....	50	4	6E5.....	85	5	81.....	15	4
1A5G.....	70	—	45.....	52	4	6E6.....	52	4	85.....	46	5
1A7C.....	80	—	46.....	50	—	6E7.....	44	6	85AS.....	40	5
1C5G.....	65	—	47.....	50	—	6F5-G.....	40	8	89.....	42	5
1H5G.....	80	—	53.....	28	4	6F6-G.....	46	8	96.....	26	3
1N5G.....	80	—	55-S.....	42	5	6F7-S.....	48	6	98.....	15	4
2 Volts			56-S.....	46	4	6F8G.....	30	4-8	1221.....	44	5
1A4-T.....	65	—	57-S.....	32	5	6G5.....	90	5	1223.....	44	8
1A4P.....	65	—	58-S.....	40	5	6G6G.....	45	8	1603.....	70	5
1A6.....	70	—	59.....	42	6	6H6-G.....	15	4-8	1612.....	32	8
1B4.....	74	—	82.....	52	—	6J5-G.....	30	8	KR1.....	26	3
1B4P.....	74	—	G84.....	72	—	6J7-G.....	38	8	7.5 Volts		
1B5.....	62	—	879.....	80	—	6K5G.....	50	8	10.....	70	—
1C6.....	62	—	Wond. A.....	52	5	6K6G.....	54	8	50.....	66	—
1C7G.....	62	—	3.3 Volts			6K7-8.....	42	8	81.....	82	—
1D5GT.....	65	—	20.....	85	—	6K8.....	40	8	1602.....	70	—
1D5GP.....	65	—	22.....	75	—	6L5-G.....	48	8	12.6 Volts		
1D7G.....	70	—	X99.....	100	—	6L6-G.....	28	8	12A7.....	20	4-6
1E5G-T.....	74	—	5.0 Volts			6L7-G.....	32	8	50.....	66	—
1E5GP.....	74	—	00A.....	60	—	6N5.....	50	5	18.....	44	5
1E7G.....	35	—	01A.....	72	—	6N6G.....	60	8	HZ50.....	14	3
1F4.....	54	—	5Z3.....	38	—	6N7-G.....	26	8	25.0 Volts		
1F5G.....	54	—	12A.....	50	—	6P5G.....	45	8	25A6-G.....	30	8
1F6.....	64	—	40.....	70	—	6Q6G.....	36	8	25B6G.....	26	8
1F7G-V.....	64	—	71A.....	54	—	6Q7-G.....	25	8	25L6-G.....	22	8
1G5G.....	65	—	80.....	40	—	6R7-G.....	25	8	25Y5.....	15	2-5
1H4G.....	68	—	83.....	15	—	6S7G.....	48	8	25Z5.....	10	3-4
1H6G.....	62	—	83V.....	16	—	6T5.....	90	5	25Z6-G.....	10	4-8
1J5G.....	69	—	182A.....	54	—	6T7G.....	36	8	25Y5.....	10	3-4
1J6G.....	55	—	182B/482B.....	56	—	6U5.....	90	5	25Z6-G.....	10	4-8
15.....	70	4	183/483.....	53	—	6U7G.....	40	8	25Z5.....	10	3-4
19.....	55	—	485.....	48	—	6V6-G.....	32	8	25B5.....	50	5
25S.....	62	—	6.3 Volts			6V7G.....	46	8	25N6.....	50	8
30.....	68	—	1V.....	26	3	6W7G.....	42	8	Miscellaneous		
31.....	70	—	6A3.....	31	—	6X5-G.....	20	8	26.....1.5V	66	—
32.....	70	—	6A4/LA.....	56	—	6Y6G.....	30	8	48.....30V	28	5
33.....	56	—	6A35.....	80	5	6Y7G.....	30	8	Special Tubes		
34.....	70	—	6AC5G.....	50	8	6Z15G.....	38	8	5T4.....	24	8LX
49.....	62	—	6A6.....	24	4	6Z7G.....	28	8	5U4G.....	38	8LX
950.....	65	—	6A7-S.....	42	6	36.....	42	4	5V4G.....	24	8LX
951.....	74	—	6A8-G.....	42	8	37.....	48	4	5W4.....	48	8LX
2.5 Volts			6B4G.....	30	—	38.....	42	4	5X4G.....	38	A
2A3.....	28	—	6B5.....	58	5	39/44.....	50	4	5Y3.....	50	8LX
2A5.....	42	5	6B7-S.....	54	6	41.....	42	5	5Y4G.....	40	A
2A6.....	42	5	6B8-G.....	54	8	42.....	38	—	5Y4.....	40	A
2A7-S.....	40	6	6C5-G.....	46	8	43.....	35	—	5Z4.....	30	8LX
2B6.....	50	5-6	6C6.....	44	5	44.....	35	—	6P7G.....	48	A
2B7-S.....	54	6	6C7.....	40	6	45.....	35	—	6Z5.....	15	2LX
2E5.....	85	5	6C8G.....	25	4-8	46.....	35	—	12A5.....	30*	5-6
2S/4S.....	80	4	6D5.....	55	8	47.....	44	4	25A7G.....	20+	1-3
2Z2/G84.....	74	—	6D6.....	44	5	48.....	42	5	4A6G.....	65*	A
24A-S.....	50	4	6D7.....	44	6	49.....	44	5	1231.....	52	—
27-S.....	45	4	6D8G.....	52	8	76.....	44	4	Abbreviations and notes: Q: Setting of "Quality" dial (meter shunt). K: cathode terminal (RMA numbering system). Press corresponding button to test tube. Dash indicates no button. The "special" tubes marked "A" require adapters. Those in which the cathode button is marked with the subscript "LX" the button must be held down for the tube to light but do not release button as this will put 30 volts across fil. and meter causing possible damage. *12.6 volts. Hold button 6 half way down. Press 5 to test. +Adapter needed, or temporarily wire pin No. 1 to pin No. 8. *4 volts. try 3.2 v.		

THE ANDREA V-A RECEIVER



Building your own tele-receiver is not as hard as you think. Especially when everything is preset for you.

BUILDING your own television receiver is an entirely practical project, and with reasonable skill, the simplest tools, and the usual facilities of the kitchen table workshop you can turn out a sight and sound set that will give fine results.

The Andrea television kit is a 17-tube a.c.-operated set, made up of over 269 parts, one of which is a dynamic loudspeaker built into the front panel. The old design had everything mounted on a bakelite front panel. This new equipment is assembled on a steel chassis, closed on the bottom with a base plate.

All the parts are mounted on the top of the chassis, simplifying the wiring and assembly. There are two separate power supply transformers and circuits—one for the vacuum tubes, and another for the picture tubes. Also, there are two separate superheterodyne i.f. amplifiers—one terminating in the loudspeaker, and the other in

the video (image) control circuit.

Another piece of factory construction, planned to ease the work of the set builder, is the r.f. unit. This is supplied completely assembled and wired on the steel plate, ready to be slipped into an opening at the front of the chassis.

All the tuning controls are arranged at the front. They comprise a tone control, power switch and volume control, brilliance control to regulate the overall brilliance of the images, focus control which determines the size of the spot, station selector switch to provide 44-50 mc. or 50-56 mc. tuning and the contrast control which determines the difference between the lightest and darkest parts of the image.

The controls at the rear vertical hold, horizontal hold, vertical size, horizontal size, and the height and width centering. These are put at the rear

(More tele-data on page 49)

Constructing the DON LEE Video Receiver

by **JERRY GOLBY**
Hollywood, California

The original circuit of this tele-receiver was presented in 1931. It has been brought up to date, and is one of the most used and popular for builders.



One of the many tele-receivers built from information furnished by the famous W6XAO.

HEREWITH is presented the television receiver diagram which Mr. Lubcke of the Don Lee-Mutual Broadcasting Corp. had found could give the best reception performance for his television transmitter. He would rather call this his "experimenters receiver" and wants it definitely understood that this diagram may have to be adjusted to the reception of your local television station. Therefore, he suggests that you check with your local station on this setup.

The receiver shown has sufficient gain for reception within forty miles of the transmitter W6XAO in a line-of-sight, unobstructed location with the recommended antenna assembly 25 or more feet above all surrounding obstacles. When these conditions cannot be met, one or more stage of intermediate frequency amplification must be added to increase the gain, and preserve the wide band pass which is required.

The "high" leads in the grid and plate circuits should be made as short as possible to make the stray capacitance to ground as low as possible.

Oscillator coil L-12 is placed over (surrounding) the grounded end of coil L-11.

The i.f. transformers and associated condensers should be put in a light fitting shield with holes and slotted condenser shafts so arranged that lining up can be done with shields in place while looking at an image. The i.f. is 8000 kc. and the oscillator operates 8000 kc. above the incoming carrier frequency.

Remember that the cathode end of the 905 cathode-ray tube is about 1700 volts below ground. NEVER make adjustments of this circuit with the power turned on.

If deflection sensitivity is less, amplifiers must be added to the sweep

circuit outputs, or the cathode ray tube operated at reduced anode voltage, for 9" C.R. tubes.

Deflecting plates of the C.R. tube, as viewed from the front of the cabinet: (1) right rear, (2) lower front, (3) upper front, (4) left rear.

The C.R. tube should have a magnetic shield. Stovepipe is satisfactory, which may be black enameled or cadmium plated to improve appearances.

Front panel controls are: tuning (C-1 and C-15 ganged), volume control (R-7), low sweep (R-18), high sweep (R-18) and C.R. intensity (R-11) (optional). The other five controls are seldom adjusted and may be placed on the rear of the chassis. R-9 and R-11 should have short lengths of bakelite rod between the resistor and the control knob because of *high voltage*.

The receiver proper and the sweep circuit-high voltage apparatus may be mounted on one large or two small chassis. The high voltage transformer (TR-1) and rectifier (VT-8) should be placed as far away as possible from all other tubes, including the C.R. tube. This receiver has been constructed and tested on the Don Lee W6XAO images.

A suitable sound receiver for the reception of the aural portion of the Don Lee Television programs may be had by constructing and applying the attachment outlined below, to an ordinary broadcast or all-wave radio receiver.

It is important to distinguish between the aural or *sound* portion and the visual or *sight* portions of a television program. An attachment to exhibit the sight portion of modern television programs cannot be constructed or applied to any existing radio receivers.

The aural attachment is known as a superheterodyne converter. It con-

sists essentially of an ultra high frequency first detector and companion ultra high frequency superheterodyne oscillator. The usual radio frequency circuits in the radio receiver are utilized as the intermediate frequency amplifier. The second detector, audio amplifier, loud speaker, and power supply are utilized as usual.

Since the visual and aural transmissions of a television station are correspondingly adjacent in the ultra high frequency spectrum the two tubes—VT1, VT7, and the associated equipment given in the diagram are suitable with but small modifications. The circuit diagram itself is exactly the same from the antenna to the coil condenser combination C3-L3. In other words, Vacuum tubes VT1, VT7, Coils L1, L2, L11, L12, Condensers C1, C2, C13, C14, C15, C16, Resistors R1, R6, R35, R36, R37, R38, R39, comprise the superheterodyne adapter unit. The difference lies in the placement of a broadcast size radio frequency choke from the plate of tube VT1 to R38 instead of the condenser coil combination C3-L3.

Also, from the plate of VT1 terminal of a .0005 mfd. mica condenser is connected and the other terminal thereof is connected to the antenna binding post of the broadcast receiver. The usual antenna is removed from this binding post. The ground connection to the radio receiver may or may not be used as is the usual practice in the particular installation. However, a connection must be made from the metal chassis of the converter unit to the metal chassis of the radio. A wire is also installed from the high voltage terminal of the power supply of the radio to the junction of Resistors 38 & 39. This supplies the plate current for the converter unit. Similarly the heaters of tubes VT1 and VT7 should be connected to the heater transformer

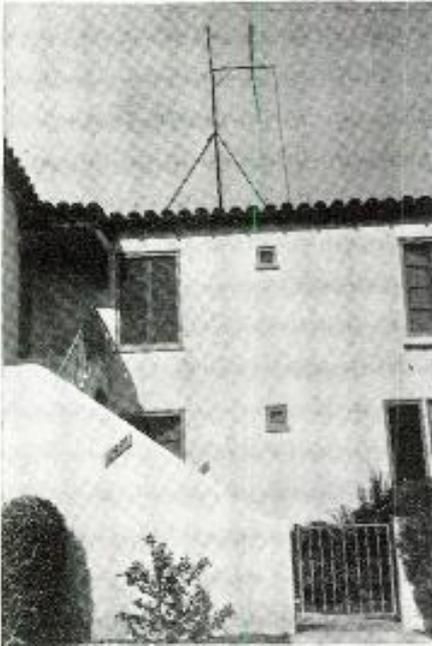

Typical Western television antenna.

diameter spaced to make a coil 1/4" long.

The converter unit should be built on a metal chassis with individually shielded boxes for the tubes and associate equipment for the first detector VT1 and the oscillator VT7.

The most efficient antenna for reception of the Don Lee aural channel is composed of two pieces of copper wire or tubing each 52" long separated by an insulator with a 70 ohm special rubber-covered two wire twisted pair feeder (No. 12 B. & S. wire) known as "EO-1" feeder which should be as

short as reasonably possible. It is often satisfactory to mount the antenna on a four foot bracket near a window close to the television receiver, particularly if it may be located on the side of the house toward the transmitting station and is otherwise clear of surrounding objects. In this case the feeder need not be over 8 ft. long.

The adapter is put into operation in the following manner after the connections have been made as stated. The volume control on the broadcast (Further data on page 59)

of the radio receiver.

Attention must be paid that this is the same voltage as required by the 6L7 and 6J7 vacuum tubes, i.e. 6.3 volts, otherwise a separate transformer must be utilized for these heaters or the type of tube changed to correspond to the heater voltage available in the receiver.

The modifications from the list of parts are as follows: L2 is made of 3 turns, 1" diameter spaced to make a coil 1/2" long or less; L11 is made of 3 turns 3/4" diameter spaced to make a coil 1/2" long; L12 is made of 2 turns 1"

Don Lee Receiver Parts List

- R₁—500 ohm 1 watt Morrill or equal
- R₂—15,000 ohm 1 watt Morrill or equal
- R₃—1000 ohm 1 watt Morrill or equal
- R₄—5000 ohms 1 watt Morrill or equal
- R₅—1 megohm 1 watt Morrill or equal
- R₆—50,000 ohm 1 watt carbon
- R₇—5000 ohm 4 watt pot. wirewound
- R₈—1 megohm 3 watt carbon
- R₉—0.5 megohm 1 watt potentiometer
- R₁₀—150,000 ohm 2 watt carbon
- R₁₁—0.1 megohm 1 watt potentiometer
- R₁₂—4 megohm 1 watt carbon
- R₁₃—4 megohm 1 watt carbon
- R₁₄—40,000 ohm 3 watt (need 2)
- R₁₅—5000 ohm 1 watt pot. (need 2)
- R₁₆—5000 ohm 1 watt pot. (need 2)
- R₁₇—1500 ohm 1 watt carbon (need 2)
- R₁₈—50,000 ohm 1 watt pot. (need 2)
- R₁₉—1000 ohm 1 watt carbon (need 2)
- R₂₀—300,000 ohm 1 watt carbon (need 2)
- R₂₁—2500 ohm 10 watt wirewound
- R₂₂—15,000 ohm 25 watt vitreous enamel adjustable
- R₂₃—15,000 ohm 25 watt vitreous enamel adjustable
- R₂₄—10,000 ohm 1 watt carbon
- R₂₅—100 ohm 1 watt carbon
- R₂₆—20,000 ohm 2 watt carbon
- R₂₇—50,000 ohm 1 watt carbon
- R₂₈—10,000 ohm 1 watt Morrill or equal (need 7)
- R₂₉—25,000 ohm 1 watt Morrill or equal
- R₃₀—25,000 ohm 1 watt Morrill or equal
- R₃₁—10,000 ohm 1 watt
- L₁—1 turn No. 14 enamel 1" diameter
- L₂—6 turns No. 14 enamel 1" diameter spaced to make coil 1" long
- L₃ and L₄—23 turns No. 30 enamel per coil wound solid on 1/2" bakelite form (outside diameter). Coils 1/4" long spaced 1/16th" part
- L₁₁—5 turns No. 14 enamel 3/4" diameter, 3/4" long
- L₁₂—3 turns No. 14 enamel 1" diameter, spaced

- to make coil 1/2" long
- L₁₃—Inca D-22 or equal 20h choke (need 2 or 1 double one)
- C₁—25 mmfd var. isolantite insulation
- C₂—0.1 mfd 400 volt paper (12 needed)
- C₃—50 mmfd midget var. bakelite ends Ok. (or Mica)
- C₄—50 mmfd midget var. bakelite ends Ok. (or Mica)
- C₅—25 mfd electrolytic cond. 25 w.v.
- C₁₂—0.1 mfd mica 2500 volt
- C₁₃—50 mmfd mica 500 volt
- C₁₄—100 mmfd 500 volt mica
- C₁₅—25 mmfd Var. isolantite insulation
- C₁₆—50 mmfd mica 500 volt
- C₁₇—0.1 mfd paper 400 volt (2 needed)
- C₁₈, C₁₉, C₂₀—3-section electrolytic 8 mfd/section, 525 volt peak
- C₂₁—0.1 mfd paper 400 w.v.
- C₂₂—1 mfd paper 400 w.v. (2 needed)
- C₂₃—0.0045 mfd including stray wiring capacity mica condenser
- C₂₄—0.1 mfd paper 400 w.v.
- C₂₅—1 mfd 2000 w.v. Pyranol or equal
- C₂₆—0.5 mfd 2000 w.v. Pyranol or equal
- C₂₇—0.04 mfd 500 volt mica
- C₂₈—50 mmfd midget set at 20 mmfd
- VT₁—6L7 first detector
- VT₂—6K7 second i.f. amplifier
- VT₃—6K7 first i.f. amplifier
- VT₄—6K7 third i.f. amplifier
- VT₅—6H6 diode second detector
- VT₆—955 acorn television (audio) amp.
- VT₇—6J7 Oscillator
- VT₈—879 half-wave rectifier hi-voltage
- VT₉—905 cathode ray tube 5" screen
- VT₁₀—83-V full wave rectifier
- VT₁₁—885
- VT₁₂—885
- VT₁₃—58
- VT₁₄—58
- TR₁—Inca B-7 or equal sec 1200 rms
- TR₂—Inca C-66 or equal sec 750 rms

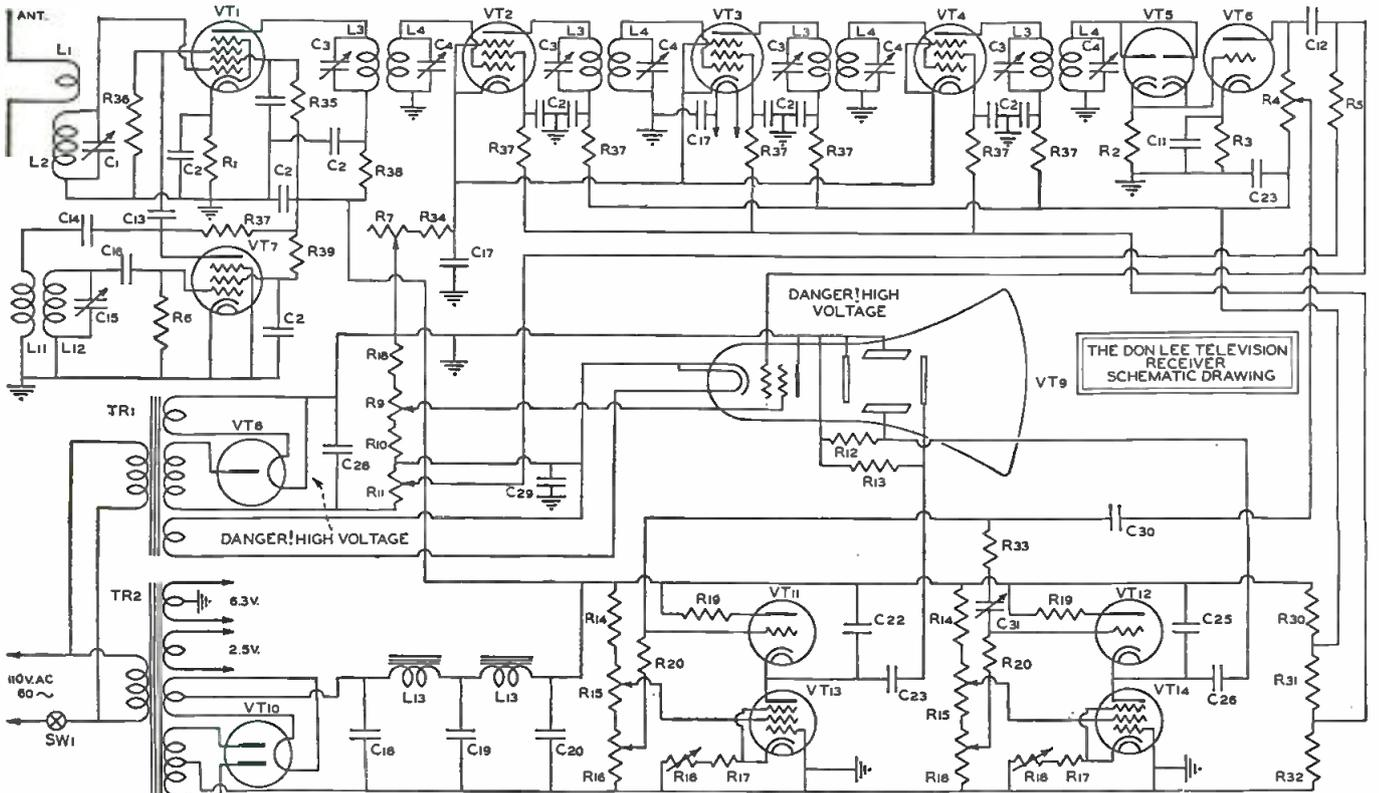

Portable Communications

Receiver

by **McMURDO SILVER**
Engineer, E. I. Guthman & Co.
Chicago, Illinois

Everyone will want this sensitive portable communications receiver for summer sport. Can also be used on 110 v. A.C.



Compare the size of the tube with the complete unit.

All of us have prejudice for or against certain things. When our positive prejudices become at all accentuated they may classify as hobbies, or minor manias. The writer is no exception to this rule and one of his hobbies for over twenty years has been the building of radio equipment of the smallest practical dimensions for the maximum of performance. As long ago as 1923 he built what RADIO BROADCAST magazine was kind enough to describe as the first completely self-contained super-het as well as the smallest built at that time. Much water has passed beneath the bridge of time in the sixteen years since then, but the mania, tho seldom practically indulged off a drawing board, is just as strong as ever.

The amazingly satisfactory results considering cost, the small number of parts employed and the simplicity of the "Silver-Super" briefly reviewed in last month's RADIO NEWS gave rise to the idea that in its design lay the possibilities of condensation which could yield a compact portable receiver of high-performance which would be not only a portable, mobile, or emergency communication receiver, but that would do a full man-sized job on any amateur's permanent operating desk as well. As the contemplated design took form upon the drawing-board it began to look quite nice, and to give

something of a foretaste of the result the completed set actually produced.

Employing six of the latest 1.4 volt Raytheon dry battery tubes—without which it could not have become a reality—this set (known as the "Silver Portable Super") is only 12¼" long, 6½" high and 7¾" deep, and weighs under 16 pounds complete with its self-contained 3½" permanent magnet dynamic speaker, 90 volts of dry B battery and 1½ volts of dry A battery. Its overall size is just over one-third of a cubic foot. Yet its sensitivity is substantially one micro-volt on all six wave-bands, its selectivity continuously variable from broad high-fidelity up to practically single-signal c.w., its signal-to-noise ratio much better than that of most big sets, and its undistorted power output about five-tenths of a watt.

All this is made possible by regeneration—fixed in the first detector circuit where it provides the equivalent gain and effective image selectivity of between one and two tuned r.f. stages, and manually variable in the i.f. amplifier where it provides selectivity continuously variable from practical equality of a crystal filter, to the broadness that may be desired—all at the simple turn of a knob.

The control panel (which on the set illustrated was first painted with black lacquer and then lettered and drawn with white drawing-ink before

a final coat of clear lacquer to insure a permanent finish) carries all necessary communication and broadcast controls. At the center is a full-size 5½" laboratory dial calibrated accurately for the six wave bands—in this case, india ink on clear-lacquered cadmium, with a final binding coat of clear lacquer exactly as in the case of the panel. Thru a positive 1.9:1 gear drive forming a part of the 2-gang, ceramic insulated substantially straight-line-frequency tuning condenser, this dial is enabled to travel 324 degrees to give an effective scale length at the outer edge of 15½" for each band. This is coupled with low-C tuned circuits for maximum weak-signal sensitivity giving a frequency range of only 2.2:1 for each (Please QSY to page 58)

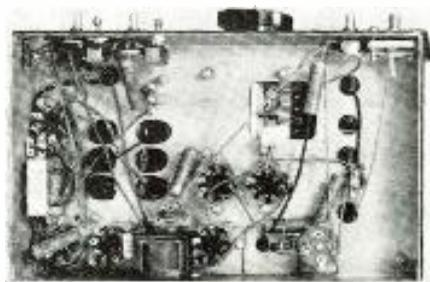

The under chassis and topside views of the efficient portable receiver.

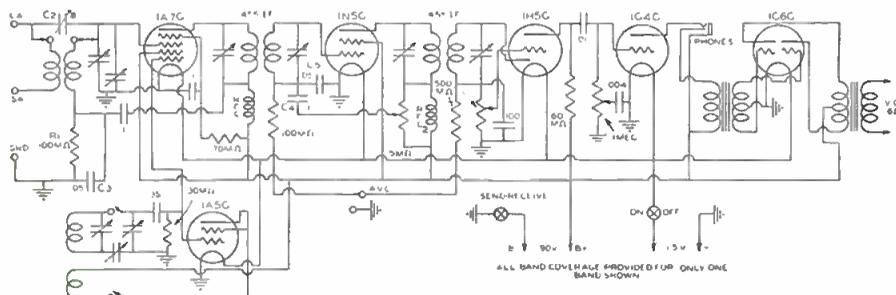

Circuit diagram of the portable communications receiver.



Circuit diagram of the six tube super.

NBC TELEVISION



When it started to rain in Washington, D. C., during a recent public telecast, the delicate equipment was shielded from the water with cellophane.

During telecasts, live and film subjects are interchanged. These men are preparing headings and titles which are an important part of the show.



C. W. Farrier, NBC
Tele-Coordinator

TELEVISION is one of the scientific wonders of the age. The intricate process of converting a light image into electrical impulses and transmitting these through the air for reconversion at the home receiver into a replica of the original picture is as fascinating as it is frequently baffling. Eventually, however, television will be judged, not on its technical perfection, but on the program it delivers. Men will cease to marvel at the marvelous and begin to accept pictures through the air as a commonplace of everyday life. New generations of children will take this amazing art for granted just as we now take the automobile for granted. The big question, now that television is technically on its way, is, therefore—What are we going to do with it?

We hope, of course, to make television economically self-sustaining through the sale of a portion of our time on the air. Sponsorship of commercial programs has made American sound broadcasting the most flexible system in the world. In the same way we hope to make television a vital instrument of public service. We anticipate nationwide networks and trans-oceanic program relays of such events as the coronation of a King of England, momentous diplomatic gatherings and international sports events. NBC has already announced that it will televise the next Presidential Inauguration at Washington in January, 1941. These are things of the future. Meanwhile, during a period of rather severe technical and economic limitations, our plans must be more modest. Just what television will offer in its immediate program service is not yet determined. Audience reaction will, in the last instance, dictate.

We have, however, in a period of nearly three years of constant research and experiment in television programming at NBC, discovered what we believe to be some of the fundamentals of the new art. The program must proceed at a pace slightly more rapid than that of motion pictures; it should have the smoothness of the finished stage production and yet possess the informality of an excellent radio program.

It appears that there is little program material that will lie outside the province of television. The NBC staff,

SETS THE FACE

by **C. W. FARRIER**
NBC Television Co-ordinator
New York City

under the direction of Thomas H. Hutchinson, has presented dramatic material ranging from ten-minute skits to longer pieces approaching the forty-minute length. It has given us variety shows, educational programs, outdoor broadcasts and films of all descriptions. On occasion it has blended live talent, film, stills and special effects into a single television program.

A troupe of trained dogs, "Fats" Waller, acrobatic dancers, Shiela Barrett, jazz bands, magicians and almost every other type of entertainer have done their stuff for the Iconoscope camera at Radio City. Men of learning have actually shown the microscopic life in a drop of water and demonstrated the intricacies of photo-electricity over the television system. Piano, dancing and fencing lessons have gone out on the air from the NBC studios. The NBC mobile units have picked up the graceful gyrations of Hazel Franklin, Vivi-anne Hulten and other renowned figure skaters on an outdoor rink. They have made successful visits to the zoo and broadcast the first interviews, both day and night, from the sidewalks of good old New York City.

At the end of nearly three years of experimentation at Radio City, during which time we have expanded not only the program possibilities but also the technical facilities that open up still more opportunities, we are still not certain what will make a good television show. But we have done what all others must do—we have learned by experience that some material does not make good television and that many other things will make interesting programs. And we have accumulated the experience essential to putting some of these programs on the air. Most important, we have a staff of technicians who know television apparatus, its possibilities and its limitations, and a group of program directors familiar with the basic principles of television production.

Although television will inevitably be compared to the movies, it has certain well defined characteristics that set it apart from all other media of entertainment and education. Television is complete, instantaneous and actual. The performer on the screen of a receiver is there—close, real, alive—even though he be in a studio fifty miles distant. No other form that I know has this quality to so marked a degree.

Nor can any other informative medium compete with television in the
(Televise further on page 62)

The author reveals for the very first time what the feverish secret activity at NBC has all been about.



Television setups resemble those used in making motion pictures to a marked degree except that about four times the lighting is necessary.

In mobile work, signals are sent from the trailer and are re-broadcast by the main station. This saves the extreme cost of long co-axial cables.

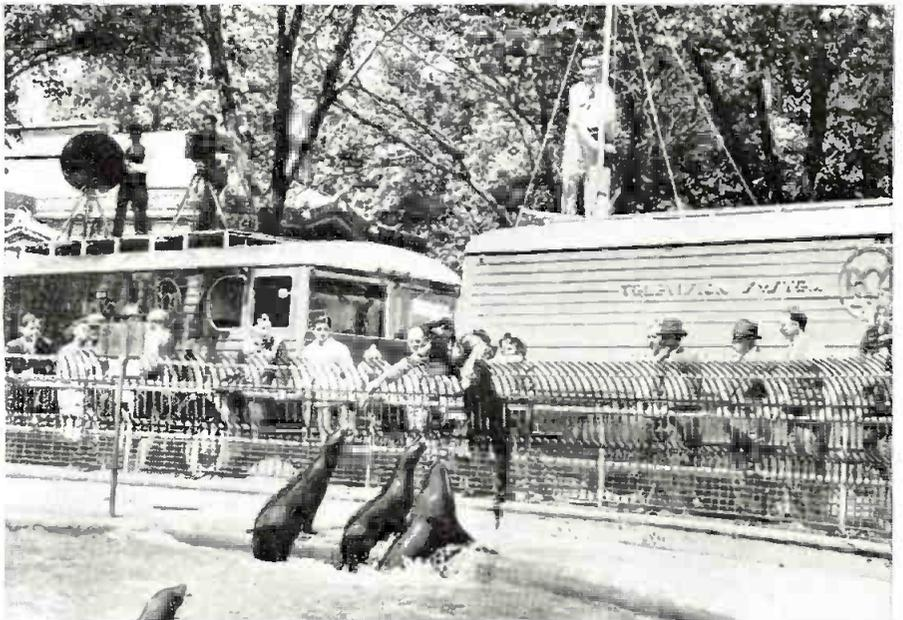

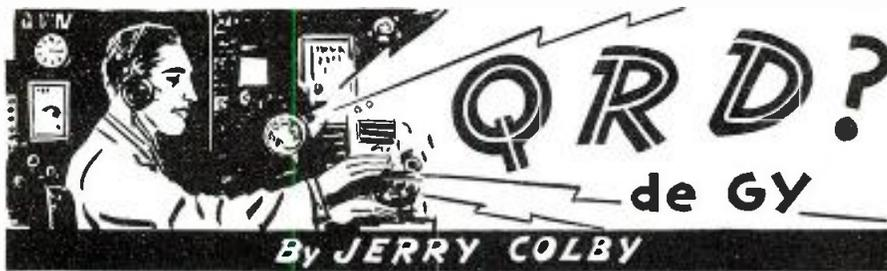

TECHNICAL BOOK & BULLETIN REVIEW

FUNDAMENTALS OF VACUUM TUBES, written by Austin V. Eastman, Associated Professor of Electrical Engineering, University of Washington, discusses at length the principal types of vacuum tubes, mercury-vapor tubes, photo tubes and several special varieties—and the laws underlying each with engineering analysis of their more important applications. Planned to give the reader a thorough grounding in the laws governing the operation of the vacuum tube upon which he can readily familiarize himself with the details of any special application. A partial list of the contents contain: Electronic Emission, Symbols and notations, High-vacuum Diodes, Cold-cathode rectifiers, Triodes-relay action, Gas-filled tubes, High-vacuum types, Photosensitive cells, Photoelectric cells, Modulation and Demodulation, Photovoltaic cells and many other interesting chapters on the many uses of the vacuum tube.

COMMUNICATION ENGINEERING, by W. L. Everitt, Professor of Electrical Engineering at The Ohio State University, and published by *McGraw Hill*, includes a step-by-step analysis of the major problems confronting the radio and television engineer. Every aspect of the unilateral and bilateral networks is carefully explained; and, in each case, the author presents what he terms the "machine tools" of network theory—theorems which apply fundamental similarities of simple networks to new complicated structures. The book contains 727 pages, 6x9, 411 illustrations and many chapters, some of which are: Introduction and classification of impedance Elements—, The functions of networks, Network Theorems, The infinite Line, Reflection, Filters, Coupled circuits, Inductive coordination, Unilateral or control impedances, Modulation and Demodulation, Class A Frequency Amplifiers, Radiation, etc.

MAKING A LIVING IN RADIO, written by Zeh Bouck, Contributor, *RADIO NEWS*, contains 220 pages, 5½x 8", illustrated. Both the technical subfields—servicing, operating and engineering—and the non-technical-writing radio articles, writing for broadcasting, broadcasting, salesmanship, etc.—are given detailed consideration. The remunerative possibilities and probabilities outlined, methods of cost of training described and the problems of getting started are analyzed constructively. Contents: Introduction. The Radio Serviceman. The Business end of Servicing. The Radio Operator. Situation Wanted. The Engineer. The Mike's the Thing. Radio Writing, and, Conclusion. Published by *McGraw Hill Book Co.*, N. Y. C.

BROTHER E. SIIWINSKI of the *SS BaldButte* brings to our attention the fact that . . . "It's surprising the number of ops on ships today who really know code enough to get a license, but once on the air don't fall in with standard procedure. Such things as needless calling on 600 when the land station is working tfe, long calls when only a short last two letters call is necessary, failure to get long haul tfe off becuz they don't listen for tfe lists and then answer usually on 700 with their tfe as the shore station specifies at the end of its tfe list, failure to know and use standard abbreviations in use; in general, the itch to send when they really should be listening."

He adds, also, "the west coast is far ahead of the east coast in their ability to clear up tfe because they answer on working frequencies instead of on 600. East coast stations like *HSC* drown everything out on 600 when they open up." . . . He was kind enough to tell us that he enjoys reading *RADIO NEWS* because it is the only radio magazine that carries a complete column for and about commercial radiomen. Thank you, Brother E. Sliwinski.

AND the question before the house is . . . Does any one know of any ops who hold Ham tickets operating ham stations portable on 10 mtrs, while at sea? And if so, would steamship companies raise Cain about it if they found out? . . . Well, my answer is the FCC regulations permit using and working a short wave job aboard a vessel, but whether a SS outfit would okay it, I do not know. I do know that it wasn't many years ago that an op had to have his own receiver and typewriter when he went aboard a ship. So, if any of you guys and gals listening in can contribute any info on this question, shoot same in to this column. Tnx.

SHADES of Rube Goldberg! (You all know his cartoons showing a cat jumping for a mouse and eventually making the jamoke pot boil.) At the opening of the Frisco Fair, the rays from the sun in Bombay, India, actuated a photo-electric cell and sent a radio impulse 9,000 miles to turn on the light at *Treasure Island* and play a carillon in the 400 foot Tower of the Sun. Wonders will never cease. The State of California which has always boasted about its hot sunshine certainly got slammed.

BROTHER JIM HARTNESS, who held down the operating berth on the *SS Oregon* when she was chartered by the Spanish Loyalist Government, has just returned to San Pedro, thankful to be alive. On December 23, 1937, Hartness arrived in Barcelona. From then on every day was one long nightmare of bombs and fires. In spite of his pay of \$16.75 per day, in good American dollars, he says "never again." He well remembers the day in port when a few insurgent planes swooped by for their daily bombing practice and dropped a couple of 1,000 lb. bombs, hitting a Spanish ship just 300 feet back of the *Oregon*. In three minutes the ship was settling beneath the water, carrying all aboard with her. He repeated the words of one greater than he when he remarked, "War is Hell."

IT seems that radiops in this country aren't the only ones who carry out a successful strike. We hear that the Japanese brass pounders recently won their demands, which puts them in a bracket commanding more

pay than the Chief Mate of the vessel. The beauty of their union is that the whole radiop profession is organized 100%.

LOCAL 7 of the *ARTA* has again struck out with a novel idea. Radiops will take a voluntary vacation so as to give the men on the beach a chance to earn some money and get some needed time in. The plan is expected to begin by the time this hits the press and will do a lot for the morale of the boys. It was a good idea for the regulars, too. They had been afraid of taking a much needed vacation for fear of being laid off. So when the idea was mentioned to them, it was voted through almost unanimously.

BROTHER FRED HOWE of *ARTA Local 2* has been getting himself into the news lately because of his difficulties with the *ARTA*. Reports as to the whys and wherefores of his actions are distinctly biased, so we shall not print them at this time. It has been definitely established that Howe did take his suspension from the *ARTA* into the Civil courts for a hearing. The outcome is still pending.

IT was a pleasure to hear from Brother F. P. Canney who has the berth on the *SS Berkshire*. He has a beef (or he wouldn't be a radiop) and we're remarking that the day one stops kicking he's through, fini. . . . He's complaining about the age discrimination for many of the airlines jobs. Well, if there is discrimination, it's too bad, although we haven't known of any. But he rejoices that there are *Press Wireless* and *RCAC* which don't worry about your age but your ability. He still thinks a raft of ops could practice up on their wrists and his tape tells plenty.

THERE are still a few of the lads who have just managed to get their Second Class telegraph licenses and are a-rarin' to get going to sea. (I wish I was young again!) Well, gentlemen, I'm sorry to throw cold water on such enthusiasm, but there happen to be many more ops than berths. It's the simple logic of supply and demand. But if you are still determined to crash the pearly gates of the radiop profession, write to all the shipping offices and then get in touch with both unions, the *CTU-MARDIV*, 265 West 14th Street, New York, and the *ARTA*, 10 Bridge Street, New York. Then you might try Airways, phone or just plain repair work. After this bit of maneuvering, just rest and leave it in the lap of the Gods. But good luck.

BROTHER W. T. PULLEN, radiop on the ill-fated tanker *Lightburne* which recently sank off Block Island, was hailed for his calm heroism in transmitting msgs and sticking to his post until ordered to leave by his skipper. But it's a shame that after all the effort he put out for the ship that he should lose his job. We wonder why something isn't done about this condition by the unions. When a ship goes down and the radiop is returned to port alive, he should be given a sum equal to twice the amount he would have earned had the ship continued its run. He has suffered much discomfort in his frantic attempt to obtain aid and succor for the ailing vessel and his efforts should not go unrewarded.

WELL, the sleuth hounds hit the trail and answered our recent request as to (*Pse QSY to page 46*)



WHEN Chicago NBC engineers hold their first Radio Dinner Dance here on April 14th, there will be quite a number of silent rigs that night. Thirty (count 'em) hams will be tripping the light fantastic—instead of telling the tall fantastic! Hi!

Ray W9CQI Bierman, who was recently interviewed over 50 kw. of BC Power, has polished up a choice selection of old and pointless gags for the said Dance. It's a 1000 to 1 that W9FQ will drag his equipment to the shindig. He's even bought a ticket for the stuff.

The Union Co. Amateur Radio Association will run a hamfest at Kreuger's Auditorium at Belmont & Springfield Aves., Newark, N. J., on April 22nd. Some swell prizes are offered including an RME 70, billion (oh, all right, only a few thousand) Taylor and Eimac tubes, and also 25 Weston meters, 2500 hams and their friends are planning to attend. "Will you be there, Charlie?"

K7GSC from far-off Inneau, Alaska, writes in to say that International Reply Coupons are NG up there, since Alaska is NOT a foreign country. Gee! Some SWL's faces must be awfully red!

WIBLO is running a kilowatt on 20 working cross band to five almost every night.

W6NRP reports that there are five hams in his town. One is on 10, one on 20, and the rest all on 40, including himself. What, no 160M QRM?

K7FZD piles in with an fb sig on the low end of 40 with his pair of '46's about breakfast time. Here's a chance to hook that new country, fellers!

W9EFA has a new rig which he has named "Michael's Mechanical Mastodon." Why?

W8GTL has returned to his old love, 20 CW. *On reviens tout jours*, etc., etc. (That's some very onsylay enclfray.)

PAQUN is looking for Nevada on 10. Divorce or just DX OM?

G5VU is on 10CW. Listen for him any time the band is open.

W9NYH has a 11Y25 final, and thinks it fb. (It's big thoughts like these that make small sentences like this! Hi!)

W2HGX is rebuilding.

W2BKU came out second on the list in the recent high competitive examination for Chief Operator at the New York City Municipal Broadcasting Station. More power to you, Sam. That examination was plenty tough.

W5AOH (America's orneriest ham—we kill the bull by day and shoot it by nite) has been putting an ear-bending signal into the second district. AOH is fast becoming a second Will Rogers.

CO7VP is another boy that puts a nice wallop into the second district amateurs. Last reports is he was using 50 watts into a Diamond.

One of the oddities of the Radio game—Morton Kahn, who used to make and sell 7 megacycle rocks for forty bucks, and who was once SCM, is now making transmitters for Kings. Real ones! Quite a promotion.

W2APT recently put up a Rotary Beam; the next day the wind took it down. It's still down. The wind is still up!

W2AMD, a real old timer, who in 1926 was the basis of a very fine network between 2CDH, 2AON, 2AMK, 2AGQ and 2APT, is now on 20 meter phone with 600 watts.

VP3AA is a new one on 14120 kc. Also heard on 10 fone a lot. This was reported by W6ITH (who claims he has worked a

total of 98 countries of which 84 are on phone). Extra swell fb, om.

WHAT ham set up his receiver directly under the antenna of a "hidden transmitter" in one of those "hidden transmitter hunts," and was mad as the dickens that he couldn't get a bearing? Ask W3FJ or W3FBZ!

VP7NS located at the Bahamas is reported on 14110 kc. and heard at the West Coast between 7 and 8 p.m.

Didja know that the call letters on the code speed winner at Detroit in 1937 were W8CW?

W6QUT (Freeman Gosden—the Amos of Amos n' Andy) skeds W4FSE regularly.

Believe it or not, the RI has been chasing around the countryside checking the input to final stages. More than one California Kilowatt has been cut to the size of a Pennsylvania Peanut in anticipation of the venerable gentleman's visit. Watch yourselves, because old Unca Sam ain't foolin'!



Leonore Kingston, superb NBC actress, who is studying to become an amateur.

W20J of Schooner Morrisy fame is the proud father of a Junior Op. It's a girl, weight 9½ pounds.

W2MC (W2 Master of Ceremonies to you) is now teaching in one of the vocational schools in New York; i.e., making good hams out of poor ones.

W2IKZ is maintaining regular contacts with his son in the 6th district on 10 meter phone every Sunday. Phil is a real old-timer.

W2BZK has been re-building the rig and is expected on 20 meter phone shortly with high quality and low power.

W2KZT is building a new 10 meter rig using a pair of 11K24's for the final.

W2KYO, Brooklyn, has been knocking the boys dead, having worked over 90 countries in the past 6 months on 20 and 40 meters.

W2HTO had the misfortune to have a beam taken apart by one of those young hurricanes which New York has been having.

W2IUS, a new ham in the Long Island City section, has been stepping out with a 61.6 crystal final.

W2KAO is off the air due to moving troubles.

SOUNDS on the bands: "I gotta get more power"; "If I had his dough, I'd have a kilowatt, too"; "How can he do it. He's on the air more than 24 hours per day"; "I don't care if you don't like Warner, I think . . ."; "So I says to her, what

you gotta give me is cooperation or I don't have to get off the air. So she says, 'that's unconstitutional or something like that, and I walk out of her house. The next day the ole RI clamps quiet hours on me. It ain't right'; "He ain't got no more carrier than a watt but he works 'em all"; "Voice in the background, 'Are you coming or do I have to get violent?"; "Yeah, I tells the store clerk to make the bill for one-third of what it cost so that the NYL won't get wise"; "Them was the good old days!"; "Say, he's been on the air so long that he grows cans on his ears"; "Has he got it? He was born with a silver key in his mouth!"

W9PEB went on a DX rampage recently. He worked a couple VK's, a K6, a South American and a Central American all in one sitting using 14 mc fone. What, no Little America? Hi!

W9AYN has acquired a new receiver, a field strength meter and an outside antenna. Looks like ol' Jesse James is about ready to go to town. Your fone sounds swell here, Craig!

W9WNF who bosses the boys around at WGN during his spare time is building a new rig. We understand it will have plenty of "umph." Here's hoping Earl doesn't encounter too much BCL trouble in that ritzy apartment building. Best BCL eliminator is—"Cut the 110," if you want some advice!

WINW is back on the air and running plenty of power. His friends in the middle-west will welcome this news.

W9VUY sure has his troubles. That rotary beam just started working and his class B transformer gave up the ghost. Cheer up, Bud, the first hundred years are always the hardest. Bud sez he would like to live on a tropical island where his dinner would grow on trees and his Mom wouldn't have to interrupt his QSOs with the dinner-bell. It isn't such a bad idea, at that, but we hope this doesn't start a trek to the South Seas.

W9ZDC sez he thinks it's a shame they don't make coils for his receiver anymore. He'd like to get down on 14 mc. Try any revr. fm RA, ZDC!

W9MEL had a rather short career as an air-conditioning expert. It is said, on good authority, that he installed an electric fan in the furnace to blow fresh air up into the house but neglected to clean out the soot first. Looks like an opportunity for some enterprising paperhanger. Guess this item won't soot 9MEL, though.

One of the 14 mc fone boys got a big surprise not so long ago. It seems the R.I. paid him a visit and read him a typewritten transcription of a transmission from said



Siam's Allen Bassett, who reports . . .

station in which the OW described in detail the method by which she was able to operate the rig in the OM's absence. It seems the OM would leave the rig turned on when he went to work and the OW (with no ticket) went to town on the air. A-wah, a-wah!

W1ESZ was in town the other day. He had a few minutes between planes which he spent on the telephone with W9ISR. ESZ is an engineer for some oil company and flies regularly between his home in Woonsocket, R. I., and the oil fields down in New Mexico.

W8HVO also paid 9ISR a visit and on the same day. He was traveling from Batavia, N. Y., to visit his brother in Seattle. (Follow the QSO to page 54)

SIGHT & SOUND NEWS

by **WILL BALTIM**

Radio-Theatre Editor, *Sunday Times*, New Brunswick, N. J.

A preview of what you may expect to cross your television screen when the chains start their programs this early spring.

“REVIEWS of Coming Attractions.”

You've seen that title flashed on your neighborhood theatre screen at each performance.

How would you like to see a preview or “trailer,” as it is known, of coming Television Attractions?

Take it from one who has viewed with keen delight most of the experimental programs flashed from the tower of NBC's powerful transmitter atop the Empire State building in New York City, television opens a new avenue of entertainment more thrilling than radio, the screen or stage.

During a period of more than two years of experimental telecasts in which the NBC has engaged, its program staff, headed by an able young producer, Thomas H. Hutchinson, has turned out several engrossing television dramas, comedies and variety shows.

A chance acquaintance with Allen B. DuMont of the DuMont Laboratories in Passaic, N. J., opened for us the doors to television and afforded an opportunity to glimpse the animated images as they hurtled through space.

DuMont, during a visit abroad in the summer of 1937, purchased a *Cosmo* Television Receiver in London, converted it to receive 441-line images

TELEVISION STATIONS IN U. S. LICENSED BY FCC.					
Location	Call	Wave Length ^o	Power in KW Video	Audio Power (kw)	Owner
Boston, Mass.	W1XG	6½ & 4	0.5	0	Gen'l Tel.
Bridgeport, Conn.	†W1XA	6½ & 4	3	3	G. E.
New York, N. Y.	W2XAX	6½ & 4	7.5	7.5	CBS
New York, N. Y.	W2XBS	6½ & 4	12	15	NBC
Camden, N. J. (Portable)	W2XBT	3 & 1¾	0.4	0.1	NBC
New York, N. Y.					
Long Island City, N. Y.	W2XDR	6½ & 4	1.0	0.5	Radio Pictures
Passaic, N. J.	W2XVT	6½	0.05	0.05	Dumont
Schenectady, N. Y.	†W2XB	4½	10	10	G. E.
Schenectady, N. Y.	†W2XD	1.4	0.04	G. E.
Camden, N. J. (Portable)	W3XAD	2½	0.5	0.5	RCA
Philadelphia, Pa.	W3XE	6½ & 4	10	10	Philco
Camden, N. J.	W3XEP	6½ & 4	30	30	RCA
Philadelphia, Pa.	W3XP	1½	0.015	0	Philco
Springfield, Pa.	W3XPF	6½ & 4	0.25	1	Farnsworth
Los Angeles, Calif.	W6XAO	6½ & 4	1	0.15	Don Lee
Manhattan, Kansas	W9XAK	150	0.125	0.125	Kan. State College
Kansas City, Mo.	W9XAL	6½ & 4	0.3	0.15	1st Nat'l Tel.
W. Lafayette, Ind.	W9XG	150	1.5	0	Purdue Univ.
Iowa City, Iowa	W9XK	150	0.1	0	Univ. of Iowa
Iowa City, Iowa	W9XUI	6½ & 4	0.1	0	Univ. of Iowa
Chicago, Illinois	W9XZV	6½ & 4	1	1	Zenith
Mobile—Portable	W10XX	6½ & 4	0.05	0.05	RCA

† Construction permit. °In meters, approximately.

and brought it back to his laboratory where invited guests viewed with enthusiasm NBC's periodic experimental shows. A few months later DuMont began building his own receivers and programs were witnessed on these sets.

Whether or not NBC will adhere to the same pattern on April 30 and thereafter when it launches its limited program service, as it did during the experimental period, cannot be definitely ascertained. Most likely it will.

In any event, let's watch the television show as it moves through a mesh of electronic pulses, varying horizontally and vertically at a rate of 441-lines, 30 frames a second:

Assuming that the room lights have been dimmed to permit better vision, and a television receiver stands before us, we wait for the program to begin.

A test pattern suddenly appears on the screen and one of us arises to turn a knob or two for proper focusing and



Two types of television cameras. One is for NBC, the other belongs to G.E.



R.C.A.'s new television transmitter.

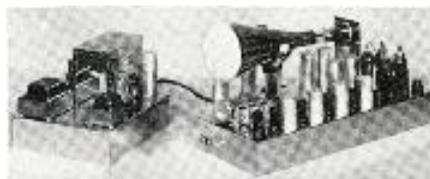

The Garod Television Receiver Kit.

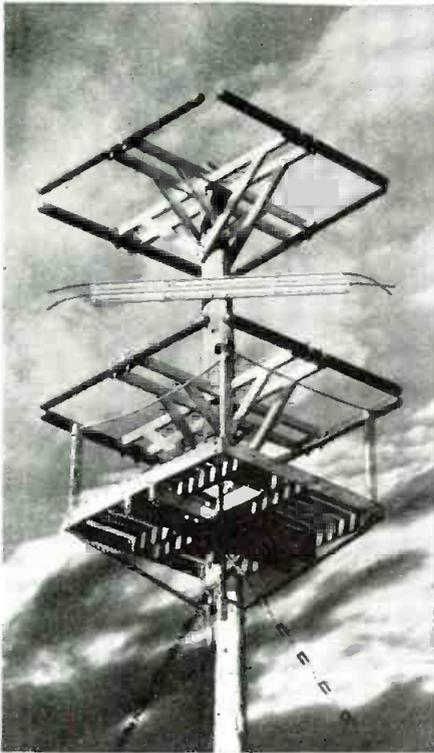

GE's Schenectady television skywire.

adjustment of brilliancy. The screen is about 8 by 10 inches in size—large enough for a small group of us to watch the program in comfort.

The quietude of the room is broken suddenly as the strains of martial music crash through the receiver. Being transmitted on ultra short waves, all static and other noises common to regular radio reception are missing. The music is "crystal clear."

The test pattern vanishes as the music is heard, and a billowy cloud and sky effect appears. Out of the mist, the eye traces a view of *Radio City*, and on top of it two linked cir-



A home-built Don Lee television set.

cles bearing the legend: *RCA-NBC*.

A male announcer's voice booms out of the set: "You are about to witness an experimental television program arranged by the National Broadcasting Company, and coming to you from the NBC experimental transmitter atop the Empire State building in New York City."

The familiar rooster of *Pathe News* heralds the start of the newsreel as the program actively begins.

As the newsreel is completed, a pretty young miss steps before the iconoscope to address the audience. She is Betty Goodwin, NBC's first female television announcer. Betty's attractive features televise exceptionally well.

She says, "The next program you will see is a dramatized offering, during which both studio talent and film will be employed. We hope you will enjoy our presentation."

Betty fades from view and a title is flashed on the screen, obviously on film. It reads:

"THE NATIONAL BROADCASTING COMPANY presents 'THE THREE GARRIBES,' adapted from SIR ARTHUR CONAN DOYLE's *Sherlock Holmes Adventures*, and produced by Thomas H. Hutchinson."

The cast of characters reel before us. No familiar names; television is still a young art. After introductory shorts to create "atmosphere," the play begins, and unfolds over a period of about 35 minutes.

Four studio sets are used during the performance, as well as a strip of film which pictures *Holmes* and *Watson* riding in a carriage through Hyde Park. The film and studio action are so well fused as to lend full credence to the tale.

With the "drama" completed, a bit of lighter entertainment is flashed on the cathode ray screen—a *Mickey Mouse* cartoon.

A *Bob Crosby* musical short (also on film) follows the *Mickey Mouse* offering. Then comes the finale of the transmission. Betty returns to the screen, thanks you for your kind attention and a blare of martial music accompanies the well-known "The



An RCA experimental home receiver.



Philco televises a guest at Palm Beach this winter. Unit is portable.



The American Television Corporation's commercial television receiver.

End" notation. Station call letters follow, and the program is over.

And there you have a television "preview" as it may be construed at this stage of development. NBC has
(*More S & S News on page 52*)

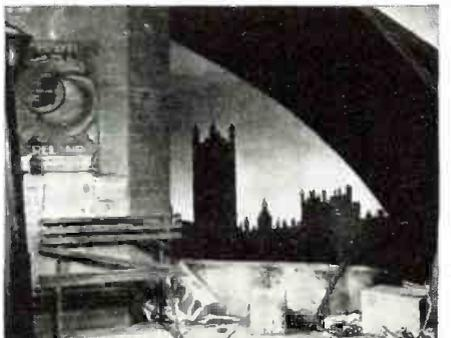

Scenic setup for tele-transmission.

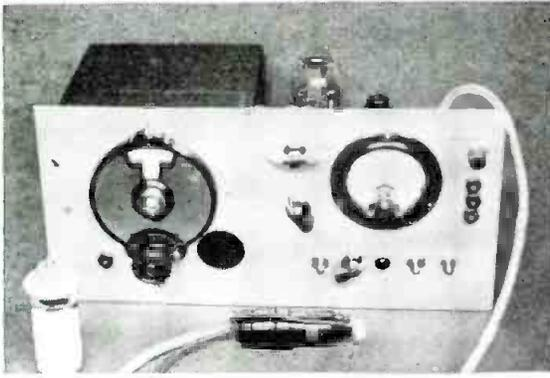

Ease of construction and operation are the outstanding factors of this simple test instrument.

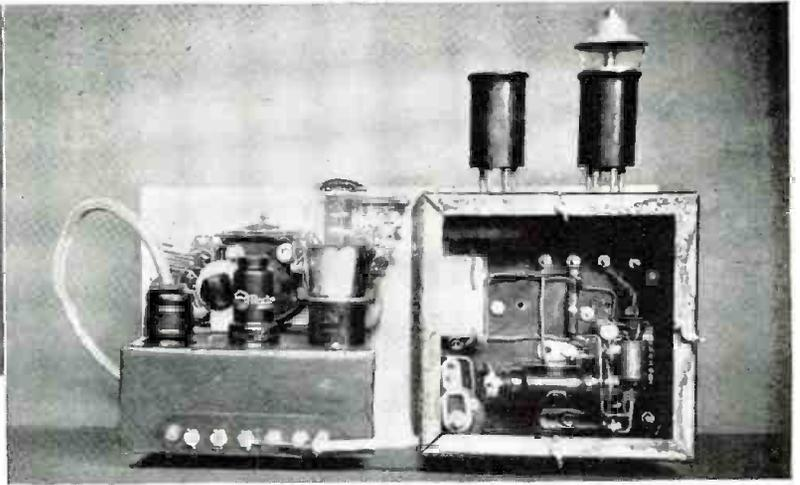

A Useful Test Panel

by R. O. GOETTMANN, W8BUE
Pittsburgh, Penn.

This unit can be used as a calibrated freq-meter, a monitor, a direct-reading vacuum tube voltmeter and a standard ohmmeter.

WHILE the writer was considering the idea of modernizing his old electron-coupled frequency meter, prior to building a signal shifter for the transmitter, the thought came to mind of combining several instruments into one unit. The result is the compact "Test Panel" herewith described. The circuits contained are all standard, nothing tricky about them. They have all been tried-and-proven. The many uses which the single 1 milliamperemeter serves, makes switching somewhat complicated. The test panel performs all of the measurements required around a modern amateur station with the exception of current measurement. Since the transmitter, as a rule, contains all of the meters necessary for that function, the milliammeter circuit was left out. It could easily be included by following the data, many times published, on the construction of such a general current meter from a one mil. meter.

The test panel, in its present stage, contains the following circuits: a calibrated frequency meter and monitor, with provisions to use the audio channel of the receiver for amplification. This provides a continuous monitored signal of the transmitter. A direct reading, vacuum tube voltmeter with ranges of 10-50-100 volts, a.c. or d.c. A standard 1000 ohms per volt meter with ranges of 10-50-100-500-1000 volts. An ohmmeter circuit is also included permitting readings to 500,000 ohms.

A word about the switching arrangement. The milliammeter is first

switched into the bridge circuit of the vt. voltmeter, where it serves the purpose of a null indicator. After zero has been indicated, the meter is switched to the 1000 ohms per volt

meter circuit where it is made to read the voltage drop across R17. This voltage is exactly equal to the peak voltage applied to the input grid circuit.
(More building data on page 58)

- C₁—25 mfd.
- C₂—50 mfd.
- C₃—0.001 mfd. mica
- C₄—.01 mfd. 600 v.
- C₅—1 mfd. 400 v.
- C₆—8 mfd. 450 v. midget
- R₁—50,000 ohms 1 w.
- R₂—25,000 ohms 1 w.
- R₃—100,000 ohms 1 w.
- R₄—3 megs. 1/2 w.
- R₅—5 megs. 1/2 w.
- R₆—6,000 ohms 1 w.
- R₇, R₁₂—40,000 ohms 1 w.
- R₈—100,000 ohms 1/2 w.
- R₉—500,000 ohms 1 w.
- R₁₀—400,000 ohms 1 w.

- R₁₁—50,000 ohms 1 w.
- R₁₃—10,000 ohms 1 w.
- R₁₄—4,000 ohms 1/2 w.
- R₁₅—1,000 ohms pot.
- R₁₆—10,000 ohms pot.
- R₁₇—50,000 ohms pot.
- S₁—S. P. D. T. Toggle
- S₂—Yaxley 1315L
- S₃—4 pole double throw
- S₄—D. P. D. T. Toggle
- S₅—S. P. S. T. Toggle
- R. F. C.—2.5 mh. choke
- Ch—Midget filter choke
- T₁—Transformer RCA 9556
- L₁—79 turns No. 30 D. S. C. 1" tube cathode tap 23rd turn from ground end.

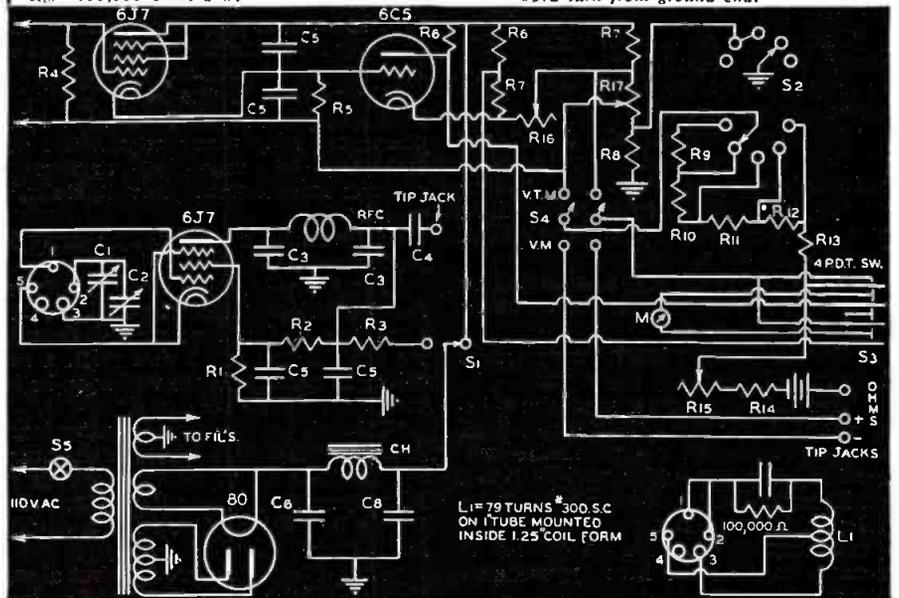

Serviceman's Experiences

by LEE SHELDON

Chicago, Illinois

The telephone in a service shop is to get business, not to diagnose radio troubles. Try and stay off the 'phone as much as possible and use it wisely.

ANYONE could see the man who walked into the shop was no customer. He carried a leather bag, and he looked a lot happier than a prospect usually does when his receiver has stopped.

"Is this *Salutary Sales & Service?*" he asked.

"This is the company misery loves," my partner replied. "Do you want the service department, or the sales department?"

"I got an *I-order*," the fellow announced.

"Nobody here needs glasses," Al stated, with the firm, decisive air of a serviceman about to replace all the bypasses in a fading Philco 40. "To prove it, I'll see you to the door. Here's a dime—go tear the top off a glass of beer!"

"Just a minute," the visitor demanded, pulling his arm away. "Someone at this address asked for a new instrument. Who was it?"

"This is the magician's day off, so it's hard to say," Al replied, opening the door, "and I'm too busy pretending I'm occupied to spend any time on a question bee. So—buzz off, m'boy!"

I hated to explain, because I wanted to keep the secret from Al; but I came to the front of the store, and said: "This fellow is right, Al—he's from the telephone company, in answer to my order for an extension 'phone on the front counter."

"This is the salutary department," Al explained, pointing at me. "Why do we need a new 'phone—is the old one worn out?"

"Just part of a well-thought-out plan," I answered. Then, to the stranger: "Go right ahead with your work, my good man."

"Ah, for the good old days," my partner said, sarcastically, "when I used to take part in the administration of the business! Remember? That was before you made yourself dictator. What's this all about?"

I cleared my throat, and looked as purposeful as I could on short notice: "The telephone—"

"Here comes the blast," my partner interrupted, mocking my mood.

"The telephone is a marvelous invention," I said, very undeterred, "and I have outlined an intensive sales promotion campaign which will be based on its use. We can, by a study of our telephonic customer encounters, improve our trade. This I intend to demonstrate at the first opporchancity that comes my way!"

"I was wrong," Al announced. "That was no blast. You might *think* you're a hot trade wind, but you're more the doldrum type. Don't tell me you bought another book!"

"When a customer calls," I persevered, "one of us can go back and answer the desk 'phone, while the other listens in on the counter extension. Then, after the exchange is finished, we can discuss its good and bad features. Later, when increased income



"Just wait till I find the guy that sold me this slide-rule."

justifies it, I plan to connect a recording device on the second instrument, so that we can play back the records and provide ourselves with a means of further improvement in selling-up."

"You're not in the groove—you're in the rut," Al replied, "and the telephone company won't permit the attachment of recording equipment without special arrangement. Neither will I."

At times I feel the double cross is more than I can bear.

"You are taking the wrong attitude, Al," I pleaded. "The way business has been lately, I am convinced that if we don't spend more time with a receiver in our hands, we will soon be in the hands of the receivers."

"Calm down, my corny companion," Al said. "Trying to increase the number of calls by using two 'phones is like trying to increase the output of a turnip by hooking it up for a double blood transfusion!"

"Well, then," I insisted, "what about that serviceman in Canarsie last

month—the one who got his hand caught in a *Majestic 72* while he was installing a drive cable? Business was so slow he starved to death before the next customer called—and a telephone would have saved his life!"

"Sure," my partner admitted, "but two wouldn't have saved it twice. I'm not arguing against the use of the telephone—it's a very useful prerequisite in a business such as ours. But I do say that a telephonic conversation is valuable only up to a certain point. After that, the serviceman loses money. The sooner he lets go of the receiver after the customer gives his name and the address of an ailing set, the better."

"That's foolish," I argued. "What if the customer doesn't want a serviceman?"

"Go to his house anyway! Make any excuse you think of on the way over. It's a cinch you can't bill the customer for consultation, even if you talk all day over the telephone! Look at it this way: you want work; the customer has it; you know where—so why waste time talking about it?"

"I still insist—" I began.

"Ah—forget it!" Al ordered. "There is a tide in conversations with you, which, taken at their flood, leads on and on to nowhere. Leave the extension in—as long as you already ordered it. By the way, Lee—what's an *I-order?*"

"Employee contraction, meaning *Installation Order*," I replied, proud to flash a facet in my jewel of technical knowledge.

"My stinking word!" Al remarked, "truth is stranger than Brooklyn!"

When the first call came in next day, I waved my partner to the front extension, shouting: "Grab it, and listen in—I'll demonstrate my system!"

"S S and S," I hissed—an octave high—as soon as I eared the receiver. "Sheldon speaking. May I help return music to your home?"

"This is Miss Floral, 206-54 Whitehall Terrace, second floor," a girl replied. "Do you make deliveries?"

"Indeed we do," I said, happily. "What is it you wish?"

"The janitor says a tube is blown out. How soon can you get one here?"

"What model set have you?"

"Does it make any difference?" the customer asked, annoyed.

"Certainly. You see, there are 186 receiver tube types on the market at present. Each set uses a different

(More Experiences on page 46)

What's **NEW** in Radio

Eicor, have just announced a new model electric light plant Type 3AP6, incorporating a number of new features of design. This unit will light twelve 25-watt lamps or operate a standard radio and eight lamps. It also can be used to charge storage batteries. The engine is 4-cycle, single cylinder, air-cooled $\frac{3}{8}$ h.p., with con-

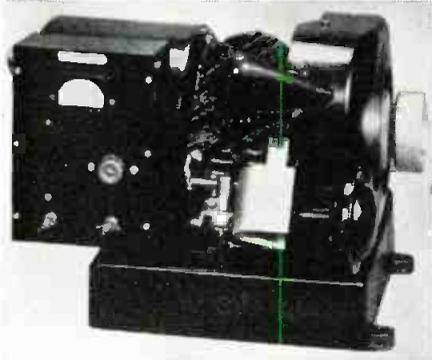

stant speed maintained by fly-ball type governor. High tension magneto ignition. Furnished with push-button starter. A catalog and full information may be had by addressing a card or letter to Eicor, Inc., 515 So. Laflin St., Chicago, Ill.

Andrea introduces Television Model I-F-5 for sight and sound. The first of the Andrea "Sharp-Focus" sight and sound receivers to be displayed uses a special 5", short-neck picture tube, the depth of the cabinet having been reduced to very nearly the proportions of a table-type broadcast



receiver. The standard model covers two sight-and-sound channels which are 44-50 and 50 to 56 mc. Other frequencies can be used by merely changing the tuning unit. This model features "Sharp-Focus" image reception and "Picture-tone" sound, which is distinctly different from the tone of broadcast reception.

Edwin I. Guthman & Co., 400 S. Peoria Street, Chicago, Ill., announce that they will manufacture a Visual Deviation Meter from the plans which appeared in RADIO NEWS (February, 1939—page 13). The meter was developed by Oliver Read, Technical Associate of RADIO NEWS and permits visual checking of drift from a previously established frequency. The V-D Meter will be sold in kit and completed form. Price and details have not been released. The meters are of special use to hams, police departments (for checking

auto-transmitters), private plane transmitter owners and the like.

Wholesale Radio Service Company, 100 Sixth Ave., N. Y. C., have released their "5-10 Meter Kit" which may be used with any receiver that will tune to some frequency above the standard broadcast band. The unit employs one of the new 1853 ultra-high frequency tubes as a tuned r.f. stage, a 6K8GT converter and an 80 rectifier. The r.f. and converter stages are ganged-tuned but a separate tuning control is provided for the oscillator to avoid complications of critical tuning. The kit includes all parts, including a copper-plated punched chassis and drilled cabinet finished in crackle.

Littlefuse Incorporated, 4238 Lincoln Ave., Chicago, Ill., announce a new line of high fatigue resisting beryllium copper fuse clips. The makers claim many improvements through the use of this new metal which will withstand a vibration pressure of 35,000 to 40,000 lbs. per square inch. The average tensile strength of Beryllium copper, 150,000 lbs. per square inch, is about 50% greater than that of phosphor bronze and is even better than that of the average for strip-steel at 120,000 lbs. per square inch.



An important feature is that they will stand 200° C.

Arcturus announce two new midget type tubes designed for the utmost in compactness. These tubes are called "2-in-1" as they make possible the construction of extremely compact receivers by incorporating two separate sets of elements within each bulb. The types are; 32L7GT, may be used as a conventional half-wave rectifier and a beam power amplifier. The type

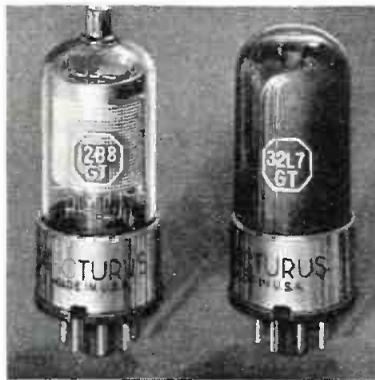

12B8GT has both a pentode and triode section and may be used as a conventional R.F. or I.F. amplifier and the latter as a biased detector. Technical data sheets are now available and will gladly be sent to those requesting them from the manufacturer. Smaller and decidedly inexpensive radios will result from the use of these tubes, say the makers of these tubes.

Clarion Institute of Sound Engineers, 69 Wooster St., N. Y. C., have added a new "Unified Sound System" to their line of amplifiers and public-address equipment.

The model illustrated is Type 70-98. This number is one of the larger types of sound systems. Four input-channels are provided, together with Translucent dials, automatic volume control, automatic volume-expansion, Cathode-ray output indicator and tone control. Four type 6L6 tubes

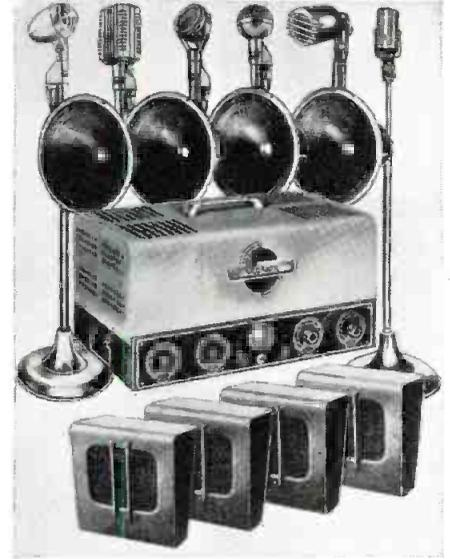

are used in the output stage and furnish outputs of 70-96 watts. A total of fourteen tubes are included in this amplifier. This unit is available from the TRANSFORMER CORPORATION of AMERICA, N. Y. C., and complete information on this, or any of their products may be had by writing direct to the manufacturer.

Illinois Seating Company Corporation, 2138 N. Racine Ave., Chicago, Ill., are making a "Verti-Flex" vertical antenna for the amateur. The rod is constructed from aluminum alloy metal and is designed to give efficient results for its various applications. It is of the self-supporting type and is furnished with an especially designed base insulator to withstand high wind pres-

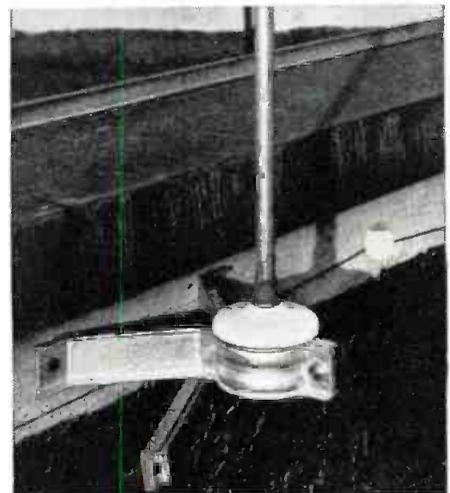

sures. No guy-wires are required for erection to the usual heights. Special mountings are to be had which permit the antenna to be erected in different ways. The unit comes partially assembled so that only a short time is needed for setting the antenna in place. Feeding the rod is by the usual methods used for a vertical type of antenna and instruction sheets are furnished so that the average layman may achieve results without a thorough background in the use of this equipment.

(More new products on page 66)



DECEMBER RADIO NEWS ★ COVER ★ WINNERS



Dear Sir:

Ruffling the pages of the current issue of RADIO NEWS, I find mention of several inquiries regarding the cover on the March issue. I recognized this "bloop" immediately as we once helped service (?) and sell this contrivance to a breathless public.

I'll hold off just a little while longer whilst I josh you for guessing so wrong at the make of the set, particularly when the tubes are shown in plain sight. Reliable records indicate that the screen grid tubes made their first appearance in 1929 (commercially in sets) so the wild stab at the year of 1921-25 is out. Then, too, when did we have a molded grid-cap on the American tubes?

Well, Mr. Editor, the set is a 2 volt, Reece-Mace English portable using a storage cell employing a jellied electrolyte, and the necessary B batteries. It was a four tube job, using all trick tubes and the speaker and loop were in the cover. The case, the best part of the set, was finished in an excellent tan calfskin and weighed fully loaded about twenty pounds. Output was low, speaker magnetic, sensitivity fair, tuning critical. The list price escapes me now, but it was enough! Oh yes, the tube with the large grid-cap connection was a pentode with the plate lead out the top, hence the large shoulder on the connection. We hope that you'll survive the shock of a wrong guess and all, but don't let it get you down. . . .

We wish you and your associates success in your venture and we have continued our subscription for another three years, so we'll be with you for quite a spell yet.

Sincerely,
EDWIN A. WOLF,
West Roxbury, Mass.

Dear Sir:

I saw a copy of RADIO NEWS for April, 1939, and found the inquiry. I can tell you something about the radio receiver shown in the picture. It is a portable receiver made in England by the Reece-Mace people. The receiver is called the "Gnome" and it is a loop operated job using regeneration. It has a built-in speaker in the cover and uses two volt tubes. The source of filament supply as originally used by the company consists of a small two volt storage battery having the electrolyte in the form of a jelly and is supposed to be so that it will not spill. We imported and sold a large number of these receivers when I was with John Wanamaker's in their radio department. . . .

Sincerely,
JOSEPH H. APPEL, JR., W2FDA,
Scarsdale, New York.

● Well, is our face red! We are very happy that our readers caught our mistake and corrected us.—Ed.

Dear Sir:

My heartiest congratulations on what I think is the most rounded out complete radio magazine in the field today, and I take them all. Not only are there articles for the newcomer, but also the serviceman, ham, dxer, experimenter and even the dabbler. Keep up the fine magazine, and the rest will have to take the lead from you in what the reader wants.

Sincerely,
(Sgd) John DeWitt Staunton,
Chicago, Ill.

● Thank you, Mr. Staunton. We will try and live up to your fine opinion of us.—Ed.

ANNOUNCEMENT is made of the following RADIO NEWS Institute Seal of Acceptance awards:

To: J. W. Miller Company, 5917 South Main St., Los Angeles, Calif.

Awarded: Seal of Acceptance No. 110.00

Product: Miller Electric Shaver Filter (Catalog No. 7817).

Description: A shaver filter designed expressly for use with commutator or slip ring types of electric shavers to prevent radio interference energy generated by the contacts of these devices from being fed into the power lines operating the device and thence into the radio receiver either through the supply cord to the receiver, or into the antenna of the receiver through inductive or capacitive coupling to the power supply wiring. Unit enclosed in moulded rubber, is virtually unbreakable, and is shock-proof.

To: National Union Radio Corporation, 57 State Street, Newark, New Jersey.

Awarded: Seal of Acceptance No. 109.00

Product: The National Union Radio Corp. line of radio tubes.

Claims approved: Consistent high standards of quality; every tube guaranteed to be free from mechanical and electrical defects; and every tube is guaranteed for six months of satisfactory operation.

To: Electronic Manufacturing Engineers, 20 East Jackson Blvd., Chicago, Illinois.

Awarded: Seal of Acceptance No. 108.00

Product: A directional loop antenna, Model No. EME Loop No. 100.

Description: A loop antenna which operates in a bi-directional manner for use in direction finding. It is completely and correctly shielded in a novel manner. Furnished optional with two-way or three-way mounting plugs. Coverage of Model No. 100 is 200 KC to about 10 MC. Custom built throughout to customer specifications. Unit offered for test covered 200 KC to 9.5 Megs at 600 ohms input.

SEALS are awarded to those manufacturers whose products exactly measure up to the claims they make for them. The Seals are given out free as a service alike to the buyers and manufacturers. The former can purchase knowing that an impartial source has checked the product against claims made for it, while the latter has the opportunity of getting an unbiased opinion on the article.

For further information, write to the RADIO NEWS Institute Seal of Acceptance Div., 608 S. Dearborn St., Chicago, Ill.

Hereafter each month this Division of the publication will carry a list of products on which Seals have been awarded.

OUR cover titling contest turned out to be a huge success, and we were literally swamped with entries. The judges have worked hard in finding the winners, but we think that they have chosen wisely. Incidentally the most of the replies came from servicemen and not amateurs, as we had supposed they would. We plan to run another of these interesting contests soon. Watch for it.

The Winners

1st Prize of \$25 goes to: Mr. Russel Hamner, R.R. 3, Polo, Illinois for his fine title: "Banged on the Bean with a Beam!"

2nd Prize of \$10 goes to: Mr. Elmer J. Anderson, 1331 Schley St., Butte, Montana, for the title: "Aerial (A real) Claus (clause) not in the December's Regulations."

3rd Prize of \$5 goes to: Mr. A. Norman Feelenyer, 908 North Charles St., Baltimore, Md. for the title: "What do they mean,—WIRELESS??"

4th to 13th Prizes go to the following:

Mr. Ernest Barker, Box 471, Goderich, Ontario, Canada, "Nertz to Hertz!"

Mr. Lloyd T. Erisman, 4801 Lafayette Ave., Little Rock, Ark., "A channel of interference the FCC has not yet cleared."

Mr. David Budreau, RMC, Humarock, Mass., "If, right now, he taps his key, his load will be, spare parts of me!"

Mr. Rudie C. Bartel, Comfort, Texas, "Where's your counterpoise (poise), Santa?"

Mr. William Hakkarinen, Negaunee, Mich., "A good Claus (clause) is 'Hans-trung'."

Mr. Harold Hoeckele, 804 Aston Ave., Santa Rosa, Calif., "This OM gets an indoor loop antenna this year!"

Mr. Melvin H. Levy, 409 East Monroe St., Harlingen, Texas, "Directional Results."

Mr. C. E. Landahl, U.S.S. Milwaukee, San Diego, Calif., "Finally got him with my new array!"

Mr. R. F. Liester, Concordia, Missouri, "Too much body capacity."

Mr. William A. Pahls, Tannersville, Penn., "The neighbors heard him a good R9."

* * *

Honorable Mention Goes To:

Mr. Alan H. Cooper, 38 Putnam St., Beverly, Mass., "Two types of spreaders!"

Mr. J. T. Reynolds, 144 Coleman Ave., Asheville, N. C., "Santa gets hot over a cold radiator!"

Mr. Sperry B. Skilton, R.F.D. 1, Watertown, Conn., "Seems like there 'antenna' justice!"

Mr. Dwight P. Lawrence, 3 Wachusett St., Mattapan (Boston), Mass., "A swinging choke, I heard Santa say . . . Load resistance decreases the 'filter pack' way."

To all who entered the contest, may we extend our thanks, and we hope that they will have another chance to win in the next one.

SHORTCUTS

by **ALFRED A. GHIRARDI, B.S., E.E.**

Author of "The Radio Physics Course," "Modern Radio Servicing," "Radio Field Service Data"; member Radio Servicemen of America, New York Electrical Society, Institute of Radio Engineers, etc.

The Editors are proud to present the first of a series of reprints by a famous serviceman's author on a subject which should lead every serviceman to quicker profits. These actual case histories showing the remedies for sick radios will be invaluable.

ACE A.C.-D.C. MIDGET

Crackling, "Shuttering" noises ...1) a-c line wires from the rear of the chassis touching under the choke. Loosen the choke and run these wires around it instead of underneath it

ACRATONE 2

Inoperative ...1) inspect all parts mounted on shallow sub-base of chassis to determine whether any of them touch and "short" to one another. If so, separate or insulate them from each other

ACRATONE 951

Condensers frequently "shorting" ...1) replace all the fixed condensers that are subject to high voltage during operation, using good-grade condensers of high breakdown rating

ADMIRAL AM-488, AM-787

Tuning dial ...1) remove flywheel from shaft. Make $\frac{3}{4}$ in. washers from thin copper or brass, with $\frac{1}{4}$ in. hole drilled in center. Solder a washer to each exposed side of guide pulleys

AIR CASTLE

Inoperative over part of dial ...1) failure of 6D8G tube to oscillate. Try substituting a 6AS (or 6A8G) for it

AIR CASTLE "ALL-WAVE"

Oscillator tube ...1) if changing the tube, grid cut on and resistor do not eliminate the trouble, check the oscillator section of the tuning condenser for leakage. If a leakage reading is obtained, replace condenser

AIR-KING 32

Inoperative, Intermittent reception ...1) primary windings of oscillator coil and last i-f transformer "open." Replace coils and re-neutralize receiver

AIRLINE (old models using '26 tubes)

Inoperative, Fluctuating filament voltages ...1) riveted junction between r-f tubes do not light up, remove the transformer, and either squeeze down the rivet, or

clean hardened flux or grease from contacts of local-distance switch—even if it tests O.K. on 110 volts

AIRLINE Auto Radio

Interference (not due to car-ignition trouble) ...1) examine and see if a rubber grommet is used over the station-selector drive cable to hold it securely in place. If it is, try removing this rubber bushing and build the space up with $\frac{1}{4}$ -inch shielding to provide better grounding

AIRLINE Alexander

Oscillation, Receiver cannot be properly aligned ...1) check the value of the center-tap resistor of 2 $\frac{1}{2}$ -volt winding. It should be 150 ohms. Replace if necessary

AIRLINE AE-11

Low volume, Broad tuning ...1) section of variable condenser out of alignment. Adjust plates until spacing appears uniform, then realign

Oscillation at 1500 kc ...1) re-neutralize the receiver circuits
2) interaction between the bus-bar grid leads. Bend them close to chassis to reduce interaction effects
3) loose coil shields. Tighten them so that they make good contact

Slipping dial, drive ...1) loosen the set screw holding the tuning drum after wedging the friction drive open. Turn the drum a half turn and tighten the set screw, making sure that the drum engages properly with the friction drive

AIRLINE BATTERY 3

Insensitive, Poor tone ...1) replace the type '34 detector tube (unshielded '34 tube at rear of chassis) with a '32 tube, and make the following circuit change connect the grid return directly to C —9 volts (brown lead), eliminating the 1-megohm resistor from the circuit entirely

AIRLINE "Challenger"

Inoperative, ...1) shorted 1-mfd. condenser

Radio smokes causing excessive current to flow through the 4,000-ohm carbon resistor. Install a new 1-mfd. condenser rated at 400-volts. Replace the resistor with a wire-bound type if necessary

AIRLINE TRF Receivers

Poor tone, ...1) connect a 10,000-ohm resistor across the primary of the push-pull input transformer. Connect a 0.02-mfd. condenser from the plate terminal of the primary to one side of the secondary

AIRLINE 05 BA

Oscillation ...1) replace the 0.002-mfd. detector plate condenser with one of 0.01-mfd. If oscillation still persists, cond. from choke to chassis

AIRLINE 07B (32-volt Farm Receiver)

Noisy (scratching noise) ...1) faulty push-pull input transformer primary winding. Replace transformer

AIRLINE 9

Oscillation ...1) remove the shaft of the gang condenser. Clean it where it contacts the frame, clean spring contacts and adjust screw

AIRLINE 40, 40A

Whistling, especially around 800 kc ...1) replace the oscillator grid leak with one of 40,000 ohms. Try several tubes in the oscillator circuit

Intermittent ...1) open 0.5-meg. resistor in plate circuit of '24 AVC tube. Replace with new unit

AIRLINE 62 SERIES*

Inoperative when new or in use only a short time ...1) defective two-section armored wire-wound resistor. Replace with 25,000-ohm, 1-watt and 1500-ohm, 2-watt units respectively

Intermittent reception ...1) intermittently open-circuiting 3,200-ohm "Candohm" resistor furnishing cathode and suppressor grid bias to the type '57 first det.-oscill. Replace (1-watt unit)

*Note: The prefix "62" in all the model numbers which follow indicates Radio Division in Montgomery-Ward catalog.

AIRLINE 62-11, 62-12

Insensitive ...1) remove the filter choke and its 0.25-mfd. shunting condenser from the circuit. Remove the second filter condenser (a dry electrolytic type) with a 4-mfd. 450-volt unit. If a hum appears, use an 8-mfd. condenser in this position instead

AIRLINE 62-14

Reception only at high-frequency end of dial ...1) check tuning condenser plates for "shorts" at the "in" and "near-in" positions
2) check the value of the 40,000-ohm resistor between the control-grid of the '27 oscillator tube and ground. This often changes, necessitating a replacement

AIRLINE 62-22

Intermittent reception, Fading ...1) "open" cathode by-pass condenser i-f stage

Distortion, Overloading on local stations ...1) if AVC plate voltage is somewhat high when receiver is first turned on, look for an open-circuited resistor between the oscillator and r-f screens to plate of AVC tube. Also check for an "open" in the "localizer"—especially at the "cathode" side of the control. The divider resistance should be 4,300 ohms total, tapped at the 1,100-ohm point. Make tests from suspected point to cathode instead of to ground

2) check for "open" cathode by-pass condenser in i-f stage

AIRLINE 62-68

Intermittent reception ...1) 3,200-ohm "Candohm" resistor (furnishing cathode and suppressor grid bias to the '57 first detector-oscillator) "opens" periodically. Replace with 1-watt unit

AIRLINE 62-70

Intermittent fading ...1) "open" or "leaky" 0.04 mfd. audio-coupling condenser between '56 second detector and grid of '47 output tube. Cond. located below '47 tube (under chassis)

AIRLINE 62-72

Intermittent fading ...1) same trouble and remedy as listed for Airline 62-70 receiver

"Dead" receiver (no voltage on screens) ...1) field coil "open," opening the screen-voltage supply circuit. As this receiver has two speakers, it may be made to operate by bridging the

"open" field (red and yellow wires) with a 10,000-ohm, 10-watt resistor

AIRLINE 62-76

Improving bass, Avoid overload-ing of '47's ...1) change plate resistor in '57 first a-f stage from 50,000 to 25,000 ohms. Shunt a 0.006-mfd. condenser from the variable arm of the manual tone control to high-pot. end of this same potentiometer

AIRLINE 62-89

Weak, Insensitive ...1) faulty last i-f transformer. Replace with Part No. P3127 only, as other transformers are unsatisfactory

AIRLINE 62-97

"Dead" receiver ...1) check the 0.1-mfd. plate by-pass condenser of the '58 tube for a "short." If necessary, replace with a 400-volt unit

AIRLINE 62-99

Inoperative ...1) faulty '32 oscillator tube. Try several tubes. Readjust plate and screen voltages, if necessary

AIRLINE 62-103, 62-105

Inoperative ...1) "open" 415-ohm flexible wire-wound resistor
2) "shorted" screen by-pass condenser on 6D6 r-f and detector stages

Weak, Low volume ...1) no screen voltage on the 6C6 and 6D6 tubes. Due to "open" in the tapped screen voltage-dropping resistor mounted on the rear panel of the sub-base. Replace with a 17,500-ohm 10-watt unit
2) it is also well to replace the 0.25-mfd. screen by-pass condenser

AIRLINE 62-106, 62-107

Inoperative, Weak reception ...1) if d-c voltage at tube socket terminals checks very low, or zero, check the 0.1-mfd. tubular by-pass condenser connected from the plate-supply lug of the 3rd i-f transformer (plate circuit of 2nd i-f '58 tube) to ground. Use a 600-volt unit for replacement

AIRLINE 62-120

Same Case History as that listed here for Airline 62-122.

AIRLINE 62-121

Same Case History as that listed here for Airline 62-106.

AIRLINE 62-122, 62-126, 62-128

Inoperative, Intermittent reception ...1) if '34 second detector tube burns out or is found to be faulty, before replacing it with a new tube test the (50-nmfid.) coupling condenser between this tube and the preceding one.

Case Histories

It is made of braid tubing pulled over a piece of silk-covered wire, and usually becomes corroded inside and "shorts." Sinter the 70-mmf. condenser across the primary of the first r-f transformer, the 45-mmf. condenser across the secondary of the first r-f transformer, the 200 mmfd. condenser in the antenna circuit, and the 35-mmf. grid condenser of the first detector-oscillator tube are also of this type, they should also be checked. All can be replaced with mica-dielectric moulded cond. of these same capacities

AIRLINE 62-131

Inoperative, . . . 1) check the 0.25-mfd. 200-volt tubular by-pass condenser connected in parallel with the 6-mfd. electrolytic condenser from screen-grid to ground. Replace with a condenser having a rating of not less than 400 volts

High-pitched whistling inter- . . . 1) check the 100,000 ohm oscillator grid-leak resistor, and replace if found faulty

AIRLINE 62-135

Weak, or no reception . . . 1) if plate voltages are low all around and there is no bias and heavy plate current on the 2A5 and 2A6 tubes, check resistor R-14 for an "open" circuit. Lack of screen voltage is due to an "open" in resistor R-11. Replace with a resistor of 12,500 ohms

AIRLINE 62-139

Inoperative, . . . 1) Same Case History as that listed for Airline 62-134 receiver

AIRLINE 62-150, 62-151

Same Case History as that listed for Airline 62-135 receiver

AIRLINE 62-177

See also Case Histories listed for Airline 62-196 receiver

Inoperative . . . 1) check for a "shorted" 0.01-mfd. coupling condenser between the plate of the 6B7 tube and the grid of the 6F6

Low volume . . . 1) replace the 300,000-ohm resistor between the screen-grid of the 6F6 and 6B7 tubes

AIRLINE 62-196

Loss of volume, 1) try replacing the 6F6 tube (next to the '80 rectifier tube)

Tuning-dial action . . . 1) shorten the spring controlling the friction drive in order to secure a more positive dial-indicator action in these receivers

General note . . . 1) make certain that the packing bolts have been removed from the receiver, and that the chassis is properly aligned so that no knobs or shafts touch the cabinet

AIRLINE 62-236 Auto Radio

Distortion . . . 1) connect a 25,000-ohm resistor between ground and the first lug on the volume control as you look into the receiver from the bottom

AIRLINE 62-251

Intermittent operation . . . 1) two "hot" leads (running from pin-jacks on the terminal strip of the speaker "B" batteries discharge rapidly during periods of non-operation

tubing over them. Secure leads in place with some cement to prevent them from working loose and interfering with the speaker armature

AIRLINE 62-307

Inoperative . . . 1) oscillator dead. Replace mica condenser connected from grid of 6C5 oscillator to coil terminal

Noisy, . . . 1) replace the 1-megohm volume control (part No. 101-46)

AIRLINE 62-413

Crackling . . . 1) faulty contact in the 156.5-ohm section of the resistor which produces the bias for the AVC and audio tubes. The first-audio 6C5 cathode connection is usually at fault. Install 1.75-ohm resistor between 6C5 first-audio and 6C5 AVC cathodes to replace the faulty section

AIRLINE 62-425

Hum, . . . 1) check the filter condensers and replace if faulty

Oscillation

AIRLINE 61

Weak signals, . . . 1) if volume increases when Tuning meter finger is placed on control-grid cap of first r-f '58 tube the meter is burned out. If inoperative

meter can conveniently be replaced, merely "short" it out.

AIRLINE 77, 95

Poor tone after . . . 1) decrease grid bias from 6-replacing defective '19 tube 4 1/2 volts by shifting the grid bias connection from 6-volt pin to the 4 1/2-volt pin

Static-like noise . . . 1) faulty primary winding of 175 ke push-pull input transformer. Replace

AIRLINE 123, 131, 133, 142, 144

Same Case Histories as those listed under Airline 62 Series

AIRLINE 182

Power trans- . . . 1) the filament leads to the former over-heats various tubes, which are twisted together and bunched close to the chassis, "short" to it. Test for this condition by unsoldering the center-tap of the filament winding from "ground," and check the continuity. Any reading indicates a "short" between the filament leads and chassis

AIRLINE 326-W

Inoperative . . . 1) short-circuit between the two wires running from the high-voltage secondary of the power transformer to the plates of the type '80 rectifier tube due to poor insulation. Replace wires

Weak reception, 1) 2,460-ohm section of speaker field coil "open." Replace

Noise, field coil

Power transf. "smoking"

AIRLINE 811

Volume control 1) change in value of the 25,000-ohm carbon resistor which connects from the common B-plus lead (or r-f plate supply lead) to the screens of the 1st and 3rd r-f tubes. (Another resistor (15,000-ohms) connects from this point to the 1st and 3rd r-f tube cathodes.) Replace the 25,000-ohm carbon resistor with one of higher wattage rating.

AIRLINE 1955

Noisy recep- . . . 1) defective 8-mfd., 275-volt detector plate return filter condenser. Replace with new unit.

No control of volume on strong stations

Intermittent reception . . . 1) open-circuiting 0.01-mfd. coupling condenser connected between the plate of the oscillator tube and a lug on the oscillator coil. This condition can be checked by testing for oscillator signal.

O.K.)

Replace with a new unit if necessary.

AIR MASTER Radios

(See also Case History listings under Automatic Radio Mfg Co.)

AIR MASTER AC-DC

Distortion, . . . 1) decrease in capacity of one or both 8-mfd. filter condensers. The trouble usually occurs when their total capacity drops to less than 12-mfd.

Poor tone at high volume levels

Distortion on low volume (after set heats up) . . . 1) check '43 tube by replacing it with another (even though it tests O.K.)

"Mushy" tone . . . 2) check 0.01-mfd. condenser from screen of 6C6 tube, replacing it if necessary

ALL-AMERICAN MOHAWK (LYRIC)

Oscillation . . . 1) leaky dual by-pass condenser open-circuiting connections at one of the by-pass condensers

ALL-AMERICAN MOHAWK 70, 73, 75

Hum . . . 1) change location of grid leak, isolating it from the a-c filament leads so it will not pick up hum from them

ALLIED RADIO

(See Case History listings under Knight)

AMERICAN BOSCH CORP

(See Case History listings under Bosch)

AMRAD AC-7

Hum, . . . 1) test plate voltages at all r-f tubes and 1st audio tube. If they are all low, test the continuity from B-plus side of 2nd audio transf. to ground. If this ranges between only a few hundred ohms to zero, substitute new plate r-f by-pass condensers for present ones (one at a time) until the continuity reads 3,000 ohms or more—which is the voltage divider resistance unit. When the faulty condenser is located, replace it with a 0.1 to 0.5-mfd. unit.

Noise, Low volume Intermittent reception

often caused by breakdown in the 8-mfd. detector plate circuit by-pass condenser section of the dual condenser. Replace this section with a new 4-mfd. unit, placing it so it will not be heated excessively by the power tubes and rectifier tubes

AMRAD 70

Fading about 3 or 4 hours after being switched on, (no plate voltage on the detector tube when above condition appears)

Hum . . . 1) defective 0.5-mfd. audio coupling condenser (has two yellow leads coming from by-pass condenser block). Replace with a new externally connected coupling condenser

2) poorly soldered connection at the r-f coils. Test by tapping the coils slightly (connection appears)

Hum . . . 1) connect a 1-mfd. condenser from the cathode of the first a-f tube to ground, using leads as short as possible

2) try several tubes in the 1st a-f stage, making separate hum adjustments for each one

Hum . . . 1) check the 4-anode 52-mfd. Mershon electrolytic condenser. Disconnect each wire separately from each anode of the Mershon, inserting a 0 to 10 millimeter in series with it to measure the leakage current. If the leakage indicated is over 4 mls for any 8-mfd. anode, replace with a 400-volt condenser. If it is over 10 mls for any 18-mfd. anode, replace with a 4-mfd. 400-volt condenser. The 8-mfd. anodes are the two that are nearest the copper container

Hum . . . 1) defect in one of the two 18-mfd. wet electrolytic condensers. Try disconnecting each section, one at a time. If hum is reduced considerably when removing connection to one of the units, replace it with a 2-4 mfd. paper or dry-electrolytic condenser. It may be necessary to replace the entire unit.

2) poor connection between the volume control potentiometer and the chassis. Sometimes the potentiometer circuit opens at the "minimum" setting, causing intermittent trouble of this kind

Hum . . . 1) poor connection between the volume control potentiometer and the chassis. Sometimes the potentiometer circuit opens at the "minimum" setting, causing intermittent trouble of this kind

Fading . . . 1) the 0.1-mfd. condensers which are used to couple r-f coil sections to ground often become faulty. Locate the faulty one by direct substitution with a new one

Oscillation . . . 1) clean all rotor wiping springs and all shield contacts on the condenser gang. For permanent repair, install pigtail contacts between the rotor sections of the condensers and the chassis

Intermittent reception . . . 1) leads shorting in cable wiring

2) a-f transformer leads shorting to chassis or shield contacts

Fading . . . 1) corroded or loose fuse-block contacts

2) a-f transformer leads shorting to chassis

3) a-f transformer leads shorting to shield

Hum . . . 1) open-circuited center-tapped filament resistor across the type '27 tube

2) faulty electrolytic condensers out of neutralization

AMRAD 7100

Speaker . . . 1) speaker has dual-coil driving unit designed to operate directly in the plate circuit of the '33 output tubes. These windings develop faults if moisture penetrates them. Secure a replacement coil, and before installing it, coat it with insulating varnish and allow to dry thoroughly

Hum at resonance . . . 1) loose turns of wire on the erratically volume-control resistance

APEX "Aircell" Models

Speaker . . . 1) speaker has dual-coil driving unit designed to operate directly in the plate circuit of the '33 output tubes. These windings develop faults if moisture penetrates them. Secure a replacement coil, and before installing it, coat it with insulating varnish and allow to dry thoroughly

APEX "Midget"

Volume varies . . . 1) loose turns of wire on the erratically volume-control resistance

(More diagnoses on page 51)

SHORT WAVE FLASHES

BY CHARLES A. MORRISON
and JOHN D. CLARK

By Charles A. Morrison

Frequency in megacycles Time is Eastern Standard

S. A. Expeditions to Bring New Thrills

The "Expedicion de la Gran Sabana," sponsored by the Venezuelan Government, is now exploring the wild jungle hinterlands in the south-eastern part of Venezuela, along the frontiers of Brazil and the Guianas. The expedition keeps in touch with the outside world by means of a 1,000 watt amateur station, YV9AB, which operates on 14.125, 7.284 or 7.222 mcs., usually near 7 a.m. E.S.T. Reception reports, which should be addressed to *Ministerio de Fomento, Servicio Tecnico de Minería y Geología, Expedicion de la Gran Sabana, Caracas, Venezuela*, are welcome and will be verified when the expedition returns to civilization.

The Andean Anthropological Expedition, sponsored by the Arizona Anthropological Association, plans to conduct investigations near the head-waters of the Amazon River, in Ecuador and Peru. According to L. D. Brewer of Phoenix, Arizona, who has been in touch with Dr. Solosth, and W6HJX, Lloyd Demrick, who are to accompany the expedition, the latter to be in charge of all radio activities, the first base-camp is to be established in the Jivarro Indian territory of Ecuador. Here, the main 1,000 watt transmitter is to be set up. It will maintain contact with the outside world and with the two advance camps, each of which is to be equipped with a 100 watt rig. Scientific groups in the field will keep in touch with the advance camps by means of 10 watt transceivers. Communications between camps, and between field parties and camps, will be carried-on on the 20, 40 and 80 meter amateur bands, while broadcasts to the outside world will be made on frequencies of approximately 15.79, 8.57 and 6.00 mcs.

New Short-Wave Stations

(On the Air)

BURMA—XYZ (6.007), the new 10,000 watt transmitter of the Burma State Broadcasting Service, at Rangoon, is reported to be testing. This replaces the low power station that formerly broadcast on the same frequency. The new transmitter is also licensed to broadcast on 3.488, under the call XZZ.

CAYMAN ISLANDS—Station V1Y, or Z1Y (6.995) on Grand Cayman, Cayman Islands, is reported to be broadcasting irregularly—6 to 10 p.m.

CHILE—CB1510 (15.1), Valparaiso, has been conducting initial tests.

CHINA—XMHA (12.23), *Call of the Orient*, 445 Race Course Road, Shanghai, operated by the Continental Broadcasting Service, is being heard with fair signals from about 4 to 7 a.m. Chimes serve as an identification signal, and the station announcement is given each half-hour.

The powerful Central Broadcasting Station at Chungking, mentioned before as broadcasting on 15.19, nightly from 8 to 11 p.m., under the call XGOX, is now conducting experimental broadcasts on 9.5, under the call XGOY.

A. Willis of St. Thomas, Ontario, Canada, logged XGOY with loud signals from 6:15 to 7 a.m., while C. J. Fern of Lihue, Hawaii, heard the station between 2 and 3 p.m.

COLOMBIA—Martin Olthoff of Independence, Kansas, reports HKF (9.71), "La Voz de Bogota," Apartado 312, Bogota, heard with loud signals at 10 p.m.

CUBA—According to *Radio-Guia*, COCE (12.23), "La Voz Del Transporte," Prado 13, Havana, power 1,000 wats, is now relaying broadcast station CMC (1530 kc.), weekdays from 8 a.m. to midnight, and on Sundays from noon to midnight.

Ricardo Rubio of Havana, Cuba, writes the Cuban Army will be on the air soon using calls and frequencies: COY (4.29) and COX (6.39).

DOMINICAN REPUBLIC—A station whose call starts with H18?, thus far not fully identified, is broadcasting almost nightly on 5.88.

FINLAND—The new 2,000 watt Finnish transmitter OIH (17.8), is broadcasting daily from 4 to 9 a.m.

FRANCE—"Paris-Mondial," at Essarts, is at present utilizing a new frequency of 7.28 for the nightly 9:30 p.m. to midnight broadcast for North America. During the early part of February, "Paris Mondial," was radiating the North American transmission on another new frequency of 9.62.

GUATEMALA—TGX1, or TGS1 (6.132), P. O. Box 23, Guatemala, operates daily from 10 a.m. to 6, and from 8 p.m. to 1 a.m., with a special dx program for the United States each Sunday morning until 2 a.m.

HONDURAS—HRK1 (5.795), Tegucigalpa, is being heard with weak signals irregularly to 11 p.m.

INDIA—YUM2 (11.87), a new frequency for the Madras station, is in operation daily from 6:30 a.m. to noon, according to the latest official schedules from All-India Radio.

IRAQ—Y1JG (7.2), Baghdad, is now on the air and operating daily from 8:30 a.m. to 4 p.m. Music is mostly of the native type, and occasionally announcements are made in English. The broadcast closes down with the playing of the Iraqi National Anthem.

IRELAND—"Radio Eircann," at Moydrum, near Dublin, which should have been on the air long ago but completion of which has been held up pending the arrival of certain equipment, will, according to latest advice, be testing on the following frequencies soon: 6.19, 9.55, 11.74, 15.12 and 17.84.

JAPAN—H. M. Allen of Quincy, Mass., reports the evening overseas hour for North America, heard nightly from 8 to 8:30 p.m., is now being radiated over JLG3 (11.705). Walter H. Guthrie of Los Angeles, California, is hearing a new station announcing as JLK, Tokio (6.2), near 8 to 9 a.m. News and announcements were given in Japanese, Chinese, French and English.

LITHUANIA—According to reports from Charles Guilbert of Paris, France, and A. Tuffs of London, England, LYR (9.28) of Kaunas, is now on the air, and operating daily after 11 a.m. Additional tests are expected soon utilizing the following frequencies and calls: LYZ2 (9.523), LYZ3 (11.9) and LYZ4 (15.13).

NORWAY—The new 5,000 watt transmitter of the Norwegian State Broadcasting Company, at Lambertser, near Oslo, is operating as follows: over LKV (15.17), from 6:40 to 10 a.m.; over LKQ (11.735), from 2 to 6:40 and 10 a.m. to 3 p.m. and over LLG (9.61), from 3 to 6, 8 to 9, and 11 p.m. to midnight. The old transmitter at Jeloy, is operating experimentally on a new frequency of 8.025, from 8 to 9 and from 11 p.m. to midnight in parallel with LLG.

PARAGUAY—ZP14 (11.72), "Radio Cultura," Villa Rica, is broadcasting nightly from as early as 5:30 to approximately 7:50 p.m.

SOUTH AFRICA—ZRD (4.875), Durban, is operating on this new frequency daily except Sundays from noon to 3:45 p.m. and on Sundays from noon to 3:20 p.m.

SOUTH-WEST AFRICA—An illegal transmitter somewhere in South West Africa, is broadcasting to Germany, nightly from 9 to 11 p.m., on either 7.14, 9.09 or 10.71.

SPAIN—Herbert Campbell of Athens, Pa., has logged a new Loyalist transmitter, using the call EAL, on approximately 7 mcs., between 9 and 10 p.m. It was as loud as either EAQ or EAR.

UNITED STATES—General Electric's new 20,000 watt transmitter W6NBE, located on *Treasure Island*, at San Francisco, Calif., went on the air on February 18, simultaneous with the opening of the Golden Gate International Exposition. At this time the station is operating on 15.33 only, daily from 7 to 10 a.m. beamed on Asia, and from 6 to 10 p.m. beamed on South America.

URUGUAY—CXA6 (9.62), relays CX6 of Montevideo, nightly to 9 p.m.

VENEZUELA—R. B. Oxrieder of Corozal, Canal Zone, writes that YVA (5.225), Caracas, is being heard irregularly evenings.

Under Construction

ENGLAND—Two new 100,000 watt transmitters

at Daventry, will be put into operation next September on the new 40 meter broadcasting band (7.2 to 7.3 mcs.), for service to Asia.

SOUTH AFRICA—The African Broadcasting Corporation is installing new transmitters at Capetown and Bloemfontein respectively. The Capetown station will be ready for operation by the middle of the year.

SWITZERLAND—The new 25,000 watt government transmitter at Schwarzenburg, which will be opened next month, will operate on 6.056, 9.537, 11.867, 15.306, 17.783 and 21.52 mcs. Four beam aerials will be used to direct programs to North America, South America, East Africa and Asia, respectively.

Notes of Interest

A mystery station announcing as "Radio Corse Libre" (9.57), is being heard daily from 3 to 5:30 p.m., broadcasting vehement anti-French talks. The location of the station is unknown.

Imperial Airways Service is installing 5,000 watt aircraft stations at Auckland, New Zealand, Sydney, Australia, and on Norfolk Island.

ALASKA—L. R. Underwood of Estacada, Oregon, writes Alaska Aeronautics and Communications Commission stations K7XFQ, Anchorage, K7XFU, Juneau, and K7XFS, Fairbanks, are on the air hourly after 4 p.m. talking to each other, and giving weather reports on a frequency of 8.11.

ALBANIA—ZAA "Radio Experimental Tirana," has been testing on the following frequencies: 9.987, 7.88, 7.487 and 6.086. It is likely the latter frequency will be put into use daily from 1:30 to 7 p.m.

BECHUANALAND—Hal Clein of Los Angeles, Calif., would like to nominate ZNB (5.9), Mafeking (and its personnel Chips Britz, and Wally Combs), as the most friendly station in the world. International reply coupons are always returned and each report is answered with a cheery personal letter.

CELEBES—R. Legge of Binghamton, New York, states PNI (8.775), was heard at 6:30 a.m., and verified his report within three months from Bandoeng, Java.

D. R.—HI3X (15.27), is broadcasting irregularly on Sundays.

ETHIOPIA—Harold Amers of Pomona, California, is hearing IABA (9.65), Addis Abeba, I. E. A., daily from sign-on at 11 a.m. to fade-out near 11:30 a.m. The program begins with a short musical selection, after which a woman announcer gives the news in what is presumably Italian until 11:25 a.m., following which the musical program is resumed.

GERMANY—The anti-Nazi station, "Deutsche Freiheits Sender," is reported to be off the air, following the finding and confiscation of an unlicensed short-wave transmitter in a panel body truck. Too bad!

JAVA—NIROM stations PLP (11), PMN (10.26) and YDC (15.15), are being heard with good signals from 6 to 7:30 p.m., broadcasting the early morning setting-up exercises.

NEW ZEALAND—ZLT (10.96), may often be heard calling VLZ for traffic near 1:30 a.m.

PANAMA—HP5F (6.08), Colon, is again being heard evenings from 7 to 8:50 p.m., or later.

PERU—OAN4T (9.56), Lima, is putting a good signal into the United States, from 7 to 8 a.m., but the volume drops rapidly after 7:30 a.m.

PORTUGAL—CSW5 (11.04), Lisbon, commences its transmissions at 11 a.m. on Sundays. . . . Ray Messer of South Portland, Maine, writes he logged a station announcing as "Radio Dijosora Nacional," Lisbon, one Sunday morning between 7:30 a.m. and sign-off at 9:06 a.m., on a frequency of 15.12.

SOUTH AFRICA—ZRD (9.72), Durban, is occasionally heard from 11:45 p.m. to 12:45 a.m. with weak signals.

S. S.—The radio equipment used in the Kuala Lumpur station for radio telephone service between Great Britain and Malaya is considered obsolete and money has been appropriated for the purchase of a new transmitter which will cost in the neighborhood of \$70,000.

TRIPOLI—IQN (9.46), verified in six weeks from Rome.

U. S. S. R.—Harold Clein of Los Angeles, Calif., writes that a letter from Radio Center, Moscow, states that no future reports to RV15, Khabarovsk, will be verified, or even acknowledged. . . . It is reported that the Soviet station on 9.6, is now using the call RAL.

VATICAN CITY—HVJ (15.12), was on the air with frequent broadcasts to North America, during the period immediately following the death of Pope Pius, and the consequent elevation of the new Supreme Pontiff.

YUGOSLAVIA—All listeners that send reception reports to YUA (6.10), Belgrade, are automatically

(More DX notes on page 44)



FACTS
on this GIANT issue

- ★
475
Photographic Illustrations
- ★
237 Cameras
Completely Described
- ★
149 Films, Full Details
- ★
1480 different units of
photographic equipment
- ★
All included in 182 pages of
the most stupendous collec-
tion of photographic facts

**The Biggest Thing
in Photographic History!**

Never before has anything been attempted in the photographic field that can compare with our GIANT DIRECTORY ISSUE. No camera owner, professional or amateur, hobbyist or experimenter, artist or commercial photographer, can afford to miss this tremendous issue. It's BIG, and for sheer worth to anyone who has ever taken a picture or ever intends to, it is absolutely priceless. The most complete photographic directory ever assembled, crammed with indispensable, hard to get information, arranged in amazingly convenient order, *plus* the regular monthly features, including the most imposing array of articles and really big names in photography ever gathered together for one big issue, at no extra cost. 25c at all newsstands.

WHATEVER YOU DO, DON'T MISS THIS GIANT DIRECTORY ISSUE

NOW ON SALE At All Newsstands

Short Wave Flashes

(Continued from page 42)

added to that station's mailing list for monthly advance program notices.

Special Transmissions of Interest

Sundays—6 to 7 p.m., "Hour of Mexico," over XECR (7.38) and XEWW (9.503); 12 mid. to 12:30 a.m., "Hour with the Bible," English services, conducted by Rev. A. Pain, over COCQ (8.83).

Wednesdays—8:30 to 10:30 p.m., "Jamaica on the Air," over HH2S (5.95) of Port-au-Prince, Haiti.

Saturdays—1 to 1:30 a.m., "Across the Sea to NBC," over KQH (14.92) and KKH (7.52) of Kahuku, Hawaii; at 5 p.m., "XNRC on the Air," over WXJI (26.3); 9 to 9:30 p.m., "Hawaii Calls," over KQH (14.92) and KKH (7.52).

Revised Schedules

AUSTRALIA—VK2ME (9.59), Sydney, is now operating Sundays from 1 to 3, 5 to 9 and from 9:30 to 11:30 a.m.

CZECHOSLOVAKIA—The North American transmissions from Prague, nightly from 8 to approximately 11:15 p.m., are radiated on various frequencies depending upon the season of the year, but at the time of writing are usually broadcast over OLR4A (11.84).

FINLAND—The Lahti transmitters are at present operating as follows: over OFE (11.78), daily from 1:05 a.m. to 12:05 p.m. and over OFD (9.5), from 12:15 to 5 p.m.; over OIE (15.19), daily from 1:05 to 4 a.m. and from 9 a.m. to 5 p.m. and over OIH (17.8), from 4 to 9 a.m.

INDIA—According to the latest schedule from India, the All-India Radio stations are now operating as follows: over VUD2 (9.59) and VUD4 (15.29) of Delhi, daily from 1:30 to 3:45, 7:30 a.m. to 12:30 and from 9:30 to 11:30 p.m.; over VUB2 (9.55) of Bombay, daily from midnight to 3:30, 4:30 to 7, 7:30 a.m. to 12:30 and from 9:30 to 10:30 p.m.; over VUM2 (4.92 and 11.87), Madras, daily from 6:30 a.m. to noon, and over VUC2 (4.84 and 9.53), Calcutta, daily, from 2 to 4 and 6:30 a.m. to noon.

ITALY—The following English transmissions are now in effect from the Italian Short-Wave Center, according to information received by Ray Shaffer of Waterloo, Iowa (these schedules are subject to frequent revisions): directed to the Far East, 6 to 7:30 a.m., over 2R04 (11.81) and 2R08 (17.82); to the Near East, 10 to 11:15 a.m., over 2R04 and 2R08; 1:19 to 1:36 p.m., over 2R03 (9.635) and 2R06 (15.3); the E. I. A. R. Musical Program, 3 to 5:30 p.m., over 2R03 and 2R06, and the American Hour, 7:30 to 9 p.m., over 2R03, 2R04 and occasionally 2R06.

U. S. S. R.—The following additional transmissions are now in effect over the Soviet stations: over RV96 (15.18), nightly from 7 to 9:15 p.m.; over RNE (12), weekdays, from 10 to 10:30 a.m. in Spanish; over RV96 (9.52 and 6.03), from 5 to 6 p.m. in Spanish or German, and from 6 to 7 p.m. in Spanish.

UNITED STATES—WXAD, Schenectady, N. Y., now operates as follows: on 21.5, 8 to 10:15 a.m.; on 19.33, 10:30 a.m. to 6 p.m. and on 9.55, 6:15 to 5 p.m. . . . The schedule for W3XL (17.78) of New York City, has been slightly revised as follows: daily from 9 a.m. to 4 p.m. on European beam, and from 4 to 11 p.m. on Latin American beam. . . . WXAU of Philadelphia, Pa., is now operating as follows: on 21.52, daily, from 1 to 2:30 p.m.; on 15.27, daily from 3 to 7 p.m.; on 9.59, Mondays and Thursdays, 7:30 to 11:30 p.m., and on 6.06, Sundays, Tuesdays, Wednesdays, Fridays and Saturdays, 7:30 to 11 p.m., Mondays, Tuesdays and Thursdays, 12 mid. to 1 a.m., Sundays, Wednesdays and Fridays, 11:30 p.m. to 1 a.m. and on Saturdays, 11:30 p.m. to 2 a.m.

VATICAN CITY—At present HVJ is operating as follows: on 15.12, Sundays, 1 to 1:30 p.m., Tuesdays, 10:30 to 10:45 a.m. and Wednesdays, 2:30 to 3 p.m.; on 11.74, Tuesdays, 6:30 to 7 a.m.; on 9.66, Sundays, 5 to 5:30 a.m., and on 6.19 or 6.03, Mondays, Wednesdays, Thursdays and Saturdays, 2 to 3:30 p.m. and on Tuesdays and Fridays, 2 to 3 p.m.

Frequency Changes

CHILE—CB970, Valparaiso, to 9.73; CB1180, Santiago, to 11.97.

COLOMBIA—HJ1ABG, Barranquilla, to 4.905; HJ3CAH, is varying in frequency between 4.895 and 4.903; HJ7GAB, Bucaramanga, to 4.772.

COSTA RICA—TILS, San Jose, to 6.165; TIGPH2, San Jose, to 5.883 (TIGPH, San Jose, a separate station remains on 5.83); T12XD, San Jose, to 11.94.

CUBA—COCD to 6.138; COCI, still highly variable in frequency, roaming between 9.8 and

9.985; COCQ, seems to have definitely settled down on 8.83.

DOMINICAN REPUBLIC—HI9B, Santiago, to 6.39.

GADELOUPE—FG8AH, Pointe-a-Pitre, to 7.44.

HAITI—HH2S to 5.95; HH3W to 9.77.

INDIA—VUD2, Delhi, to 4.96; VUM2, Madras, to 4.92; VUB2, Bombay, to 4.88; VUC2, Calcutta, to 4.84.

VENEZUELA—YV5RD, back to 6.163.

Data

ANGOLA—CR6AA, Lobito, operates on 7.114 and 7.177, according to its verification card. The station was recently heard on 7.745 also.

AUSTRALIA—9MI, M/V Kanimbla, is often heard on 6.01, as early as 6:30 a.m.

AZORES—CT2AJ (4) at Ponta Delgada, operates on Wednesdays and Saturdays, from 5 to 7 p.m.

BRAZIL—G. Magnuson of Providence, R. I., reports that PRAS (6.01), operated by Radio Clube de Pernambuco S. A., Ave. Cruz Cabuga-394, Pernambuco, issues an attractive blue and white QSL card, picturing the station's vertical aerial tower.

CANADA—CJXC (6.01) of Sydney, N. S., verifies with a black on buff QSL card. . . . CFRX (6.07) of Toronto, issues a QSL card that depicts the Ontario Parliament Buildings on one side, and the station data on the reverse side.

CHILE—R. Shaffer of Waterloo, Iowa, writes that on a QSL card recently received from CD1190, Valdivia, the station's schedule is given as 10 a.m. to 1, 3 to 6, and 7 to 10 p.m. . . . CB1170 (11.7) of Santiago, signs-off after playing its signature selection "Marching Through Georgia."

COLOMBIA—HJ1ABE (4.835), Cartagena, is now operating daily from 7 a.m. to 6 and from 8 to 11 p.m. . . . According to H. Amers of Pomona, Calif., the QSL card issued by HJ1ABG (4.905), pictures two aerial masts supporting the call and slogan, "Emisora Atlantico." A harbor scene is depicted at the bottom of the card.

CUBA—The revised mailing addresses for all short-wave stations in Havana, are as follows: COCO, San Miguel 314; COCQ, Monte 103; COBZ, San Rafael 108; COBC, Monte 467; COCW, Prado 553 Altos; COCM, Calle 25 No. 1113, Vedado; COBX, San Miguel 570; COCA, Galliano 464; COCD, Calles 25 y G, Vedado; COCH, Prado 63, Altos, and COCX, Reina 314, Altos (all in Havana).

DOMINICAN REPUBLIC—HI1L (6.485), Santiago, sounds four chimes as an interval signal. . . . HI1X (6.34), Trujillo City, operates weekdays from 8:10 to 10:10 p.m. and on Sundays from 7:40 to 9:40 a.m. . . . HI6H, Trujillo City, is again being heard nightly from approximately 7:40 to 8:40 p.m.

ECUADOR—H. Amers of Pomona, Calif., states that HC1GQ (9.163), "Naris del Diablo" (Devil's Nose), P. O. Box 159, Quito, power 150 watts, issues a very novel red, white and green folder type QSL card. . . . HC2CW (9.13), "Ondas del Pacifico," owned by A. E. Wilmot, P. O. Box 1166, Guayaquil, issues a white QSL card having a stencil drawing in blue, which gives the schedule as daily from 11 a.m. to 1 and from 7 to 11 p.m.

EL SALVADOR—YSM (11.71), verifies with a blue, red and yellow QSL card picturing the station's aerial towers and a coffee tree.

ETHIOPIA—IABA (9.65) of Addis Ababa, is now operating daily from 3:55 to 4:05, 4:15 to 4:45, 11 a.m. to noon and from 1 to 3 p.m. and on Sundays from 3:30 to 3:55 a.m. This latter transmission consists of a broadcast of mass as celebrated in the Procatheedral.

FRENCH-INDO CHINA—According to information received by Jack Gardner of Cleveland, Ohio, "Radio Boy Laundry" of 17 Place A. Foray, Saigon, operates on 12, 9.8 and 6.18 (depending upon the season), daily at 1, 7:30, 9:15 and 11:45 p.m. Reports are welcome.

GUATEMALA—TG2X (5.94), power 500 watts, verifies with a blue on white QSL card with photo on reverse side.

HOLLAND—PCJ of QUIL, sends an attractive, black, white and orange QSL card, picturing the station's famous rotating aerial towers.

INDIA—VUD4 (15.29), a new frequency for the Delhi station, is being heard nightly with loud signals from 9:30 to 11:30 p.m.

JAPAN—JVN (10.66), verifies with a brown-tone card picturing the new Diet Building, and an old pagoda surrounded by cherry blossoms.

MEXICO—XEUZ (6.117), uses an organ and guitar selection of "Song of the Islands," as an interval theme every half-hour. News in English is generally given at 10:30 p.m. Listeners reporting this station receive beautiful scenic Mexican postal cards.

NEWFOUNDLAND—Commercial station VOFB, which is heard on several frequencies at irregular times in communication with Montreal, is operated by the Avalon Telephone Company of St. John's, Newfoundland.

NORWAY—G. Magnuson of Providence, R. I., writes that LKQ (11.735), power 5000 watts, verifies with a beautiful scenic QSL card picturing the mountainous landscape in the vicinity of the station.

PANAMA—HP5H (6.12), is badly QRMed by COCD and XE2Z; usually signs off at or near 10:30 p.m. with the signature selection "Whistler and His Dog"; uses chimes as an interval signal.

PERU—R. B. Oxrieder of Corozal, Canal Zone, reports OAN2A, "Radio Rancho Grande," Trujillo, is now on 5.942, and operating Sundays, Tuesdays, Thursdays and Saturdays, from 7 to 10 p.m.

PHILIPPINES—C. J. Fern of Lihue, Hawaii, writes, KZIB (9.49), broadcasts nightly from 8:30 p.m. to 2:45 a.m., and daily from 6 to 9 a.m.

SPAIN—A Tufts of London, England, informs me that "Radio Malaga," Malaga, Spain, operates on 7.22, daily from 10 to 11 a.m., 3:30 to 5:40 p.m. and on 14.44, from 5:45 to 7:30 p.m.

SPANISH MOROCCO—R. Legge of Binghamton, N. Y., states that EA9BJ (7.12), Alcazarquivir, verified with a typewritten card signed by the director Gonzalo Gregori. . . . EA9AI (7.184), power 200 watts, issues a plain white card, with call in blue.

SWITZERLAND—The correct mailing address for reports to "Radio Nations," is as follows: "Radio-Suisse, Radio Nations," 12 Quai de la Poste, Geneva.

TURKEY—Leo Herz of Chicago, Ill., has received an official communication which gives the schedule of the Turkish transmitter at Ankara, as follows: over TAQ (15.195), daily from 5:30 to 7 a.m., and over TAP (9.465), daily from 11 to 5 p.m. The correct mailing address for reports is as follows: Radio Ankara, Turk. Muehlendirisler, Birligi, 5 No. Lu Oda Yeni-Sehri, Ankara.

UNITED STATES—General Electric stations W2XAF and W6XBE, have been granted additional frequencies of 6.19 and 21.59.

VENEZUELA—YV3RA (4.99), Barquisimeto, operates daily from 10 a.m. to 11 p.m. . . . YV5RD (6.165), Caracas, signs-off after playing the selection "Unidos para Siempre."

YUGOSLAVIA—M. W. Slopoff of Allegheny, N. Y., reports that YUA (6.10), may be heard coming on the air nightly at 12:43 a.m. with the National Anthem. This is followed by a short announcement, and one stroke on a gong is given at exactly 12:45 a.m.

Amateur Reception Notes

ALASKA—K7FST's new QRA is Charles W. Deremer, Kotzebue, Alaska (situated on coast at edge of Arctic Circle).

CANTON (Phoenix Group)—KF6DHW (14.378), operated by ex-W6GHW, is being heard almost nightly from 10 to 11 p.m. The transmitter is also being heard on its commercial frequency of 8.1, irregularly throughout the night. KF6DHW is operated by the U.S.A. Interior Development Expedition. Reception reports should be addressed to Canton Island, via Honolulu, T. H.

GUATEMALA—TG9BA QSL's with a blue and brown card picturing a volcano in the background and an Indian village in the foreground.

KENYA COLONY—VQ4KTB is now issuing QSL cards. Carl Weber of Camden, N. J., states his report was verified in two months.

LATVIA—The recent special dx transmission put on by YL2CD (28.08), was well heard by several listeners in the Eastern part of the United States.

LITHUANIA—Ray Messer of South Portland, Maine, writes he logged LY1CC (14.05) recently at 12:50 p.m. LY1CC was trying to raise W8CMA but finally gave it up.

MADEIRA—M. W. Slopoff of Allegheny, N. Y., has been hearing CT3AN on a frequency of 7.07.

NIGERIA—According to a QSL card from ZD2H, received by Roy Myers of Los Angeles, California, this transmitter is on the air on a frequency of 14.3, almost nightly at 11 p.m. Power input is 50 watts.

PALESTINE—Robt. Pybus of Chorlton-cum-Hardy, England, reports hearing another new Palestine amateur, namely ZC6AP, America-Paris, on a frequency of 14.25.

PHILIPPINES—It is my sad duty to record the passing of Mrs. Ted (Babe) Curnutt, NYL operator of KAI2L, and ex-W6BAY. Listeners will recall a mysterious amateur station XW6A which was on the air about a year ago. This was the call used by Mrs. Curnutt on board ship while enroute to the Philippines. Listeners and amateurs alike will miss "Babe"!

UNITED STATES—Yowsah! none other than Freeman Gosden, the Amos of NBC's Amos 'n' Andy, has installed W6QUT, a portable mobile short-wave transmitter in his automobile and spends his time between the studios, home and office in QSO with "hams" throughout the country.

U.S.S.R.—Robt. Pybus of Manchester, England, is the proud possessor of a QSL card from U1BQ

of Leningrad. It pictures a map of the U.S.S.R. in red with the balance of Europe in black. Superimposed on the map is a photo of the Ice Breaker Chelyuskin, and a polar bear on an iceberg. The lettering is in gold and the station call in purple.

Last Minute Notes

The transmitters of the Italian Short-Wave Center are now operating as follows: over 2R03 (9.635), 1:01 to 2:55, 5:30 to 9 p.m.; over 2R04 (11.81), 4:30 to 8:45, 10 a.m. to 2:30, 6 to 9 p.m.; over 2R06 (15.3), 10 a.m. to 12:04 p.m., 3 to 5:30 and 6 to 9 p.m.; over 2R08 (17.82), 4:30 to 8:45 a.m.; over 2R09 (9.67), 12:40 to 1 and 1:37 to 5:30 p.m.; over 1RF (9.835), 12:05 to 12:25, 12:40 to 1, 1:37 to 3:35 and 6 to 9 p.m.; over IQY (11.673), 5 to 5:15 a.m. and 3 to 3:35 p.m. and over IQA (14.795), 4:30 to 5 a.m.

JAPAN—August Balbi of Los Angeles, Calif., writes that JLK (6.18) of Tokio, is now operating daily from 8 to 9:30 a.m.

MEXICO—XEYU (9.6), Mexico City, is again on the air and being heard nightly from 9 to 11 p.m.

SPECIAL GUATEMALAN DX BROADCASTS—Short-Wave station TG2 (6.195), "Radio Morse," Guatemala City, Guatemala, will transmit a special dx broadcast especially dedicated to the International DXers Alliance, every Sunday morning from 2 to 2:30 a.m. EST. All reports will be verified immediately and it is not necessary to send international reply coupons.

JARVIS ISLAND—W6ITH notifies me he worked KG6NVJ (28.39) on Jarvis Island, at 8:12 p.m. EST. The rig has a power of 50 watts. The operator says the total population of the island is four young fellows who are there for the U.S. Department of the Interior.

By JOHN D. CLARK

All times are Pacific Standard China

FOR the first time in many years regular broadcasts from China are now available to western listeners in both morning and evening.

Station XGOX has now inaugurated what appears to be a permanent schedule on 15.19, and is being received in all parts of the Pacific Coast with excellent volume from 6:30 to 8:30 p.m. daily.

News in English is scheduled for 7:20, and is followed at 7:40 by comments in English on current topics. News in Chinese is released at 6:35 and 8 o'clock, while the balance of the program consists almost entirely of native Chinese music.

A powerful new Chinese broadcaster has just been logged for the first time as we go to press. It announces XGOA and XGOY, and operates from 6 to 7:40 a.m. on approximately 9.50, concluding transmission with the Chinese national anthem. Although considerably weakened in signal strength (probably because a different directional antenna is employed) the station returns to the air at 8 a.m. and is audible until the band fades out shortly after 8:30.

XPSA of Kwei Yang is now being heard with good volume until as late as 8 a.m. despite the fact that its schedule calls for sign-off at 7:10. Announcements are in English as well as Chinese.

A station which may be either NTJ of Canton or XGRV of Chungking is reported on frequencies varying between 11.42 and 11.83. Since it uses the slogan "The Voice of China," this is probably XGRV, and it is usually heard between 9 and 9:30 p.m. and between 4 and 4:30 a.m.

The old CQN of Macao, Portuguese China, is back on the air again with new call letters. Working on the same frequency of 6.08, the station now announces CKY9, and broadcasts every Monday from 5:30 to 7 a.m. Power has evidently been increased, since volume in this region has greatly improved. Identification is in both Portuguese and English, as well as in Chinese.

Nippon

The powerful JVP (7.51) has been taken off the daily 5 to 6:30 a.m. transmission from Tokyo, and has been replaced by a newcomer to the abbreviated wavelengths. The new addition is station JIC, operating on 6.19 (announced), and it works simultaneously with JZJ (11.8) during this morning broadcast.

Taiwan's JIB (10.53) is now excellent,

and JFO (9.62) is fair during the daily English newscast at 6:05 a.m.

JDY of Darien, Kwangtung now transmits news in English on 9.92 at 4:45 a.m., using a power of 10,000 watts.

Although JZJ (11.8) is still carrying the daily 9:30 to 10:30 p.m. Overseas Program from Tokyo, it is probable that a shift will be made to JZK (15.16) in the very near future.

Russia

According to information just received from Moscow, the Russian stations which have been received with such excellent volume on the Pacific Coast near 9.52 and 6.03 both go under the call of RV96. The Moscow schedule shows a period in English every Sunday from 7 to 8 a.m., but daily transmissions in Russian are audible between 6 and 8:30 a.m.

RAN of Moscow is now broadcasting on 9.6 from 4 to 6:15 in English and from 6:15 to 7 p.m. in French. Although interference from other stations is quite serious

on this band, RAN usually manages to reach the west coast with fair volume.

RV15 of Khabarovsk, Far East, U. S. S. R., has evidently decided to remain permanently on 4.27. After shifting from one frequency to another during experimental tests, the old reliable RV15 is again being received from 11 p.m. to 8 a.m. on the 70 meter wavelength.

Straits Settlements

After an absence of several months, Singapore's ZHP announced "P for Progress," is back on 9.69 from 3:40 to 6:40 a.m. daily. Announcements are in English, and the station closes down with "God Save the King." Signals are always strongest just before sign-off.

A careful check during the past few weeks has failed to reveal any sign of ZHO (6.17), and it is probable that this transmitter has been taken off the air and replaced with ZHP.

India

Several changes have taken place (and

THE NEW HAMMARLUND "HQ-120-X" is radio's most outstanding communications type receiver. Hams and short wave listeners everywhere are amazed with its remarkable performance. The ability of the "HQ-120-X" to pull in weak, distant stations is providing new thrills for the DX'er. The reason for this is the fractional microvolt sensitivity throughout the entire range of the receiver. In order to derive full benefit of extreme sensitivity a receiver must have a widely variable selectivity characteristic, since most short wave bands are considerably crowded. The new Hammar-

lund developed variable selectivity crystal filter, incorporated in the "HQ-120-X", allows the operator to select the proper band width for best results. This new filter woks as well on phone reception as CW. Crowded phone bands are more than doubled in effective width when using the "HQ-120-X" crystal filter. In other words, there are more than twice as many usable channels made available for perfect reception. There are many other features thoroughly described in a 16-page booklet available without charge. "The rush is on!" Try the "HQ-120-X" and judge for yourself.

WRITE DEPARTMENT RN-5 FOR FREE 16-PAGE BOOKLET.

HAMMARLUND MFG. CO., INC.
 424-438 WEST 33rd ST., NEW YORK
 CANADIAN OFFICE: 41 WEST AVE., NO., HAMILTON, ONT.

are evidently being made permanent) in frequencies and time schedules of Indian stations. VUD3 is now definitely on 15.29 instead of 15.16, and programs begin at 6:30 p.m. daily.

A new VUM2 of Madras has appeared on approximately 11.86 from 12:30 to 1 a.m., while the old VUM2 has shifted to 4.92, reaching peak volume near 5 a.m.

A general shake-up of 62 meter Indian broadcasters which took place last month seems to have been a permanent move, and we now find VUB2 of Bombay on 4.88, VUC2 of Calcutta on 4.84, and VUD2 of Delhi on 4.90. All these stations are heard best in this country near 5 a.m. VUC2 broadcasts the Church services in English every Sunday from 4:30 to 5:20 a.m.

Miscellaneous

KZIB or KZIG of Manila is again occupying its 9.50 frequency after a silence which lasted almost two months. Transmissions conclude with English announcements at 6 a.m.

NORWAY . . . Test broadcasts from Oslo are being heard nightly, as we go to press, on 9.61 from 8 to 9 p.m. Reception is excellent during the first 45 minutes, but the powerful signals of South Africa's ZRK usually block reception during the last quarter-hour. According to our records this is the first time that a Norwegian station has ever reached the Pacific Coast with good volume.

BURMA . . . A communication just received from India advises that the call letters of the Burma station which is now being received on 3.49 and 6.01 from 4 to 7 a.m. daily (except Sunday) are XYZ.

AUSTRALIA . . . Several listeners report a new station on 6.73 relaying the programs of VK2ME every Sunday from 2 to 6 a.m.

NEW ZEALAND . . . A new broadcaster in Wellington was logged on 6.96, signing off at 4 a.m. one Sunday morning, and announcing an additional frequency of 3.48 which was not audible at the time. A peculiar thing is that another New Zealand station was heard on approximately 4.28, leaving the air at the same time, but with a different program. Both transmitters are evidently on the air for experimental broadcasts Sunday morning only.

ALASKA . . . WNA of Juneau, Alaska, has been testing with Seattle on about 11.5 near 4 p.m. irregularly.

COSTA RICA . . . One of the strongest Costa Rican stations ever logged in this region is the new TILS which works on 6.17 until 8:30 p.m. daily. W2XE occupies the

same frequency after TILS leaves the air. **DX on the West Coast**

Our listeners tell us . . . that the new Turkish station TAP is audible weakly on 9.46 when it first comes on the air at 8 a.m. . . . that a new broadcaster in Papua has been heard on approximately 8.07 between 4 and 6 a.m. . . . that the latest schedule of FKSA "Radio Noumea" on 6.12 is Tuesday, Wednesday, Thursday, Friday, from 11:30 p.m. to 12:30 a.m. . . . that OIE of Lahti, Finland is on 15.19 from 10:05 p.m. to 6 a.m., and is weakly audible on America's west coast . . . that the new station in Bagdad, Iraq is being received quite weakly on 7.2 near 5:45 a.m. Some code station completely blocks the broadcaster's signals from time to time . . . that TI4NRH of Heredia, Costa Rica has shifted frequency from 9.67 to 9.69 to avoid interference from code stations . . . that HP5A of Panama City (11.7) often replays programs from HH2S of Port-au-Prince, Haiti, between 5:30 and 6 p.m. . . . that a new French-speaking transmitter, believed to be located in the French West Indies has been heard on approximately 7.45 signing off at 4:30 p.m. Address is given as P.O. Box 145, but code interference in this region has made it all but impossible to understand the location . . . that VR6AY of Pitcairn Island is still testing irregularly between midnight and 4:30 a.m. on 14.36. Strongest signals are usually available during the last hour . . . that YDE2 of Solo, Java, is broadcasting programs of native Eastern music on 4.82 near 4:30 a.m. . . . that a Peruvian station, believed to be OAX2A, is now on 11.85 until 6:30 p.m. irregularly . . . that OLR4B of Prague, Czechoslovakia, working on 11.76 comes through with a fairly strong signal from 6 to 6:50 a.m., and from 7:20 to 8 a.m. This transmission is not listed in the Prague time schedule, and it is not known whether it will be continued permanently.

Trans-Atlantic

It is interesting to note that the 19 meter band which has for several months been extremely weak, has suddenly snapped back into life during the late afternoon and early evenings.

The new Italian station 2RO5 (15.30) has been one of the strongest 19 meter Europeans during the early morning hours. The news in English from 8 to 8:15 a.m. thunders into California with surprising volume every morning.

Peculiarly enough, the 16, 19, and 25 meter bands seem to have a habit of reaching a morning peak at the same time. European

broadcasters on all three bands are inaudible before 6 a.m., gradually build up to peak volume at about 7:30, and promptly fade into practical inaudibility by 9 or 9:30. Stations on the 31 meter band usually reach peak about 6:30 a.m., and have faded out again before 8 o'clock.

Dutch schedules have been listed, relisted, and rescheduled so many times during the past 30 days that it is almost impossible to give an accurate schedule at the present time. PCJ (9.59) is still the best bet from Holland near 5 p.m. irregularly.

ZRK of Johannesburg, South Africa, is the only African station to provide reliable reception for Pacific Coast fans at the present time. Its 8:45 to 9:45 p.m. transmission on 9.61 is now received with truly amazing volume. -30-

Radio Gadgets

(Continued from page 34)

silk, or otherwise, dial cable to replace, and without any to replace it. You are in a hurry, and the nearest radio supply house is a day or week away from you.

The nearest shoe repair shop can probably remove the difficulty easily. Just get a foot or so of the thread nearest the size of the broken one, that "Joe" uses to fix shoes, or perhaps the kind of thread used to repair harness. Replace with this and you will get long, happy service, for you will find it very strong and without any stretch.

If it happens to be heavily waxed it's advisable to remove as much as possible by running over your thumb-nail before using. -30-

QRD?

(Continued from page 30)

the whereabouts of Don Hekking. Relayed through W9VS, this msg signed KD-WLM gave us the dope quote Am quite sure you might get in touch with Don Hekking through McDaniels, President, Buffalo Technical Institute, Niagara Street, Buffalo, New York. Stop. He was my instructor there two years ago. Unquote. So there you are, OM, and you can thank KD for supplying the answer to your recent request.

AND so, me hearties, another column goes under the hammer and we're sorry but our optimistic nature doesn't see many more vessels hitting the ways. But we're enthusiastic about other radio fields opening up for ops. Men with good records can be used in various civil service jobs in city, county and state. So give a heed to published examination reports, fellows, there may be something there for you, too. So with 73 . . . ge . . . GY. -30-

Serviceman's Experiences

(Continued from page 36)

tube combination, and I must know the model you have before I can choose a replacement."

"Well, I'll look," she said. "Hold the line." While I waited, I got my file of socket layouts ready, and, as soon as she told me she had a Baffo 39, I pulled the proper card out, and said:

"Your set has four types of tubes, Miss Floral. First the TR-443j. Do you want one?"

"No—I don't think so."
"The next one is the NC-985½—the new spiral inverter."

"No—not that, either."

Sure you can own a RIDER CHANALYST!

NATIONAL UNION WILL GIVE YOU ONE IF YOU BUY 80 N. U. TUBES AND/OR ELECTRO CONDENSERS PER MONTH

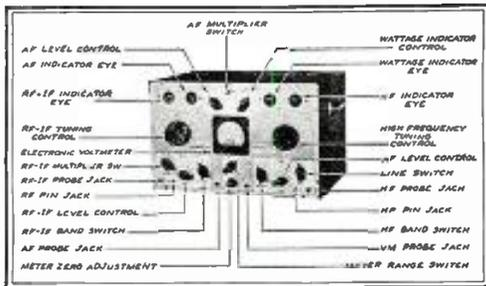

ASK YOUR NATIONAL UNION JOBBER HOW TO GET A CHANALYST FREE

The CHANALYST is a great piece of modern high efficiency test equipment . . . an invaluable asset to your service business. It is guaranteed by John F. Rider and approved by National Union Engineers. Now YOU can own one.

Form with fields for Name, Street, City, State, and National Union Radio Corp. Newark, New Jersey. Includes a coupon for a free Chanalyst.

Come on! BUILD CUSTOMER CONFIDENCE WITH NATIONAL UNION TUBES and CONDENSERS!

ANNOUNCING
The
RIDER CHANALYST
with
RACK AND PANEL ASSEMBLY



Brings All the Leads Out in Frant — Adding Still Further to Time Saved by Chanalyst.

SERVICEMEN Continue to Praise

"I find the Chanalyst indispensable. Every time I use it, it seems to become more valuable." — A. Coppotelli. A. C. Radio Service, Chicago Heights.

"Your Chanalyst advertisements express my sentiments exactly. I find the instrument indispensable in my work, and use it constantly." — I. Rosenberg, Custom Radio & Elec. Lab., New York City.

"Wouldn't be without the Chanalyst — **INDISPENSABLE!**" — Carr & Pheil, Chambersburg, Pa.

"A terrific weapon against those 'hard to isolate' troubles." — Bruce N. Carpenter, New Castle, Del.

"Going through a set with the Chanalyst is almost instantaneous. With . . . (another instrument I have) I took all day and was angry before I was through." — Lester J. Berry, Newark, Ohio.

"I am very pleased with my Chanalyst. It has helped me find the trouble in several tough jobs already and I am learning new uses for it every day." — Carl J. Anderson, Marietta, Ohio.

The rack and panel is sold separately at \$15. The price of the Chanalyst complete with rack and panel is \$122.50 (without, \$107.50)

SEND 25c FOR 80 PAGE BOOK ON OPERATION — PERFORMANCE OF CHANALYST

The RIDER Chanalyst

SERVICE INSTRUMENTS, INC.
404 Fourth Avenue, New York City
Foreign Division — 147 W. 45th Street, N. Y.,
Cables — "Servicin"

"A special sidewheeler comes next — 95 1/2 sub k," I continued.

"No."

"Then this last one must be it—the MGM119Z45/GSL4," I offered, after a deep breath.

"That isn't it, either," the customer announced, piqued.

"I've named them all," I said, disappointedly.

"Well, I'm surprised you haven't any," Miss Floral remarked, as if she was anxious to hang up. "It's such a small one, too!"

"Small?" I asked, "How do you know?"

"I have the old one in my hand!"

"Fine," I said, greatly encouraged.

"Is it metal or glass?"

"Both—it's glass on top, and metal on the bottom. But don't bother—I'll call some store that carries a more complete stock."

"Please wait a moment," I requested. "I'm sure we have one. What does it say on the base?"

"It says 'Mazda, 6.3 volts', if that means anything," she said, and I was so surprised I couldn't answer before she hung up.

I waited a while, embarrassed, for my partner to make some sarcastic remark; but, when I walked out, he wasn't there. Neither was the truck.

He came back about a half hour later, carrying a chassis and speaker. "These component parts," he announced, "are the vitals and innards of Miss Floral's Baffo 39. The tubes are okay, but we are going to replace the power transformer. Sold her a phono pickup before I left, too."

"Didn't you listen in?" I asked.

"Only until she gave her address," Al replied, "and by that time you were so hypnotized by the sound of your own voice you didn't hear me leave. Incidentally, the pilot light is still good—it fell from the socket, and the janitor found it. He was fooling with the set when I arrived. Fine situation, isn't it—a janitor doing radio work, and an unemployed radio man talking about it over the 'phone with the set owner? If the characters or incidents just described have any similarity to those living or dead, I have made my point clear!"

"Modern business—" I attempted.

"Yeah, sure," Al replied, "just pay more attention to getting business, and remember that most of your time at the telephone is wasted. Get away from that desk while I call the Baffo distributor!"

DuMont Receiver
(Continued from page 21)

the pictures in comfort. Another dozen can be squeezed in. As many as 50 spectators at a time have sat in on demonstrations.

Beyond genuine entertainment the designers of these early television sets have sought simplicity of operation—real television entertainment for the living room, for the layman, for instant use.

A NEW ELECTRONIC D-C-

VOLTMETER-OHMMETER

WITH EXTREMELY

Wide Ranges

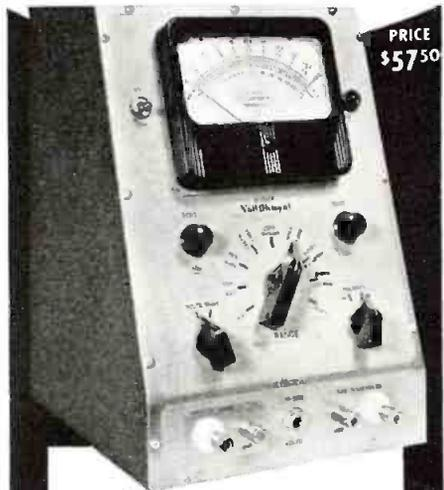

PRICE \$57.50

Unlike anything heretofore available to the servicing industry, it fills a long-existing gap.

THE VOLTMETER

Measures from 0.05 to 5000 volts.

Input resistance constant at 15 megohms on all ranges.

"Contact potential" error eliminated. No readjustment of zero when changing ranges.

Measures d-c operating and control voltages under dynamic conditions with r-f and a-f present—input capacitance 1 mmf.

Checks oscillator operation up to and including ultra-high frequencies.

Will indicate plus or minus voltages without switching leads.

THE OHMMETER

Measures from 0.1 ohm to 1 billion ohms.

Low voltage across resistance being checked—from 0.030 volt across 0.1 ohm to a maximum of 3 volts across 1000 megohms.

Convenience of operation—one scale—one zero adjustment—does not require readjustment when range is changed.

7 overlapping ranges for maximum accuracy and ease of reading.

Stable zero.

Finest parts — high safety factors — protected against humidity.

SEND FOR COMPLETE SPECIFICATIONS AND LITERATURE

The RIDER VoltOhmyst

SERVICE INSTRUMENTS, INC.

404 Fourth Avenue, New York City
Foreign Division — 147 W. 45th Street, N. Y.,
Cables — "Servicin"

Dealers! Servicemen! Amateurs!
Soundmen! Builders!



FREE

ALLIED'S Spring RADIO CATALOG
JUST OUT—SEND COUPON!

EVERYTHING IN RADIO AT LOWEST PRICES



NEW SETS!

New KNIGHT Radios, with Push-Buttons, built-in "Air-Magn" aerials—at new low prices! 50 models—portable, AC, AC-DC, 11 1/2 ft. and 22 volt., etc.—as low as \$5.95!—and radio's biggest line of recording players, phonographs, gram-radios!



NEW SOUND!

New P.A. values for every purpose. 5-65 watts—Monitor Speakers. Remote Control, de luxe and standard models—permanent, portable, and mobile—and complete line of recording equipment, discs, etc!

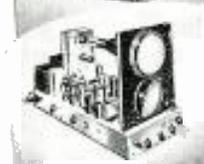

NEW KITS—PARTS!

More than 14,000 parts! New Build-Your-Own Kits: Meissner, 1, 2, 3 tube, new "Pro-Wees", Television, Mystery Phone and Mike Kit, and many others. Write for Free Parts Lists, New Builder's Handbook for beginners, 10c plus postage.

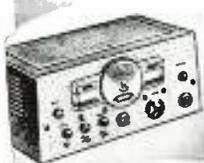

NEW HAM GEAR!

Giant new Ham section—all new station-checking equipment to meet F.C.C. regulations. Rotary Beam Antenna Gear, Television 11 1/2 ft. w/ Hallcrafters, Howard, R.M.E. Models—all leading lines at lowest prices! See what's new in ALLIED'S new Catalog!



NEW TESTERS!

All leading lines! See new equipment with provision for new Local Tubes, etc.—Tube Checkers, Set Testers, Analyzers, Oscillographs, Meters—and over 14,000 parts at lowest prices!

Fastest Service,
Highest Quality, Low-
est Prices always!
Write for ALLIED'S
new Spring Catalog!

Free!
SEND COUPON



ALLIED Radio Corp.,
Dept. I-E-9,
833 W. Jackson Blvd.,
Chicago, Ill.

- Send me your new FREE Spring Catalog.
- Enclosed find 10c (plus 3c postage) for Builders' Handbook.

Name

Address

City State

Television Grows Up
(Continued from page 10)

little auxiliary motor which, reacting to the advancing or retarding effect of our synchronizing impulses included in our carrier, made good synchronization possible beyond our common power supply.

Crude? Admittedly so. Entertainment? Negligible. Commercial possibilities? Very weak. All that was true of television up till 1932, when it suddenly went into voluntary hiding after the stock promoters had cleaned up.

Nevertheless, I do believe that television could have been put over at that early date, even with the limited scanning disk technique, had the approach been purely from the commercial rather than the stock-selling angle. I well recall my reactions one evening when viewing a program from our Passaic W2XCD transmitter at some 6 miles' distance. We were broadcasting a couple of singers. Pictorial detail was good. Sound was even more so. Then followed a typical motion-picture pickup. One scene showed an auctioneer in action. We could see the different articles he was holding up—a watch, a clock, a bracelet.

I was sold on commercial television that evening. I went home firmly convinced that television, as a home-built-set proposition, was here. But . . .

The stock-selling game collapsed. Money which had been raised never seemed to percolate to the engineers in sufficient quantity to make that last hill. Early television enterprises folded up. The public was left with bulging portfolios of stock certificates. *The stench was appalling.*

About two years ago, television once more poked out its neck, turtle-like. It sniffed the air. The stench had by now blown over. Anyway, television was henceforth being sponsored by RCA, NBC, Westinghouse, G.E., Paramount, and other top-flight organizations. Hog-wild stock-selling was simply out of the question with such backing.

During the past twelve months, NBC has been engaged in experimental broadcasting from the Empire State Building in New York. Cathode-ray technique is employed at both pickup and receiving ends. The present scanning standard is 441 lines, 24 pictures per second. Pictorial detail is wonderful, without flicker. The entertainment value leaves very little to be desired even at this early date. It is a brand new, refined, commercially-feasible television.

As with radio telephony, television has been through hasty laboratory experimentation, premature birth in everyday life, the sucker-bait stage, terrific disgrace, retirement to the cloistered confines of the research laboratory, and renaissance in refined form. Television is precisely where the

radio telephone was in 1920, when Station KDKA of Pittsburgh went on the air with its first scheduled programs, and handymen and boys all over the East hastened to build their own radio receivers.

But where do we go from here? Simply in the footsteps of sound broadcasting. To think otherwise is to deny that history repeats itself.

Television is really ready. It is good home entertainment. There is a potential demand for it. Television, like broadcasting, can be that *new thing* which will put many men back to work in its own right, and give America that much needed shot in the arm that will once more enthuse Americans to *get going*.

We have got to have regular television programs. The present experimental license basis won't do. Under such license, the station is under no compulsion to broadcast. It can go on with a program today. Tomorrow it can simply broadcast a meaningless pattern or trademark hour after hour. The next day it can shut down, without notice, because it wishes to make certain changes.

Hundreds of factory-built television sets have recently been sold in New York City. Radio shops, sporting goods stores, department stores, restaurants, hotels, clubs—these and others have bought television sets to demonstrate television. And yet the only source of programs has shut down for weeks at a stretch. Under which conditions any television set is worthless.

Regular programs are going to be demanded. Broadcasters will simply have to provide them—by popular demand. Sets are going to be home-made or kit-assembled in the majority of instances. Amateurs and experimenters will once again provide invaluable collaboration. Television coverage at first may be limited to a couple of dozen miles' radius from lofty transmitters. No matter. There will be plenty of folks to "look in" within such limited metropolitan areas. Later will come technical and economical means for "piping" programs from network studio to affiliated television stations, regardless of the cost of coaxial cables or relaying transmitters. It *can* and *will* be done.

Pretty soon we shall have a radio boom all over again. There will be tremendous enthusiasm. Millions of dollars of components and tubes and cathode-ray tubes will be sold. Hundreds of millions of dollars of factory-made television sets will be sold.

* * *

THE little mother in black, now penniless, but her children pretty well grown up, will sigh again with the satisfying thought that John, her late husband, was a far-sighted radio man after all. That this is an entirely new television setup with about as much similarity to earlier television as today's automobile bears to a 1920 jalopy, will go unnoticed. People are just like that.

Video Reporter
(Continued from page 10)

team ever to face a television camera.

Grover A. Whalen, president of the New York World's Fair 1939, took part in the television experiment as well as the broadcast from the fair grounds, when he pointed out the sights to the visitors from a mythical Harlem.

Tele-Casts

THE Farnsworth Radio & Television Corp. plans to take over the factories of the Capehart company at Fort Wayne, Ind., and the U. S. Radio & Television Company at Marion, Ind., as well as the laboratories of the former Farnsworth organization at Philadelphia.

E. A. Nicholas, former head of the RCA license division, will head the new company as president, and Philo Farnsworth will be vice-president in charge of research. Ray Cummings, for years in charge of transmitter engineering and design for General Electric and RCA, will be assistant vice-president. The new Farnsworth corporation plans to manufacture television receivers and transmitters under the Farnsworth patents.

Allen D. DuMont Labs, has an elaborate lithographed two-color 2½x3½ foot wall chart showing a large cross-section view of a cathode ray tube with lettered components and corresponding explanatory notes. A dozen typical screen patterns with brief explanations, cover the various broad applications of the tube. The chart is particularly applicable for use in classrooms, and servicemen's gatherings. There is a charge of 50 cents for the chart and for additional information write to the above company, Passaic, N. J. This same company have just printed a new 1939 catalog on cathode ray tubes for oscillograph and television purposes, that can be had for the asking.

Television reproduction was not very flattering to Gov. Lehman, Mayor LaGuardia, and District Attorney Dewey at the annual dinner of the Inner Circle, New York's political writers association, recently held at the Waldorf Astoria. Probably the lighting or some technical detail was out of step. This is certainly excusable considering the fine tele demonstrations which have taken place in the last month.

The radio parts industry looks forward with a great deal of optimism to television's official bow at the end of this month. A television receiver consists of a great many parts, i.e. ten or more controls, numerous resistors and condensers and other parts, all of which is good news to the industry and likewise to the radio parts jobber.

Prof. H. H. Sheldon of New York University has just started a fifteen week lecture course in television.

Andrea Receiver
(Continued from page 24)

because, once adjusted, they need no further attention.

The front panel carries the loudspeaker. This can be separated from the chassis by pulling out a plug which fits into a small socket on the chassis.

From the video and sound carriers included in a 6-mc. television channel, a 6J5 oscillator tube produces the separate video and i.f. frequencies. The video i.f. is fed through two wide-band amplifiers using 1852 tubes, into a 6H6 second detector and synchronizing clipper. Next comes the 6V6G amplifier which controls the brightness of the spot in the picture tube. The clipper portion of the 6H6 feeds one 1852 sync. separator, the output of which goes to two 6N7 deflection oscillators (vertical and horizontal). Each of these feeds a 6F8G push-pull deflection amplifier, connected in turn to the picture tube.

The 1852 sound i.f. amplifier goes

into a 6SQ7 second detector on AVC, then from a 6V6G amplifier in to the loudspeaker. Voltages for the vacuum tubes and the picture tubes are supplied by a 5V4G and 879 rectifier tube.

The Teleceptor television antenna is constructed of a two-piece mast, 8 ft. high, carrying at the top a wooden block which supports two lateral wooden arms, and serves as a mounting for the Telecoupler. Brass rods, constituting the di-pole, are fastened to the Telecoupler, and are braced by insulators on the wooden arms. These arms have been found essential not to brace the brass rods, but to keep them from whipping around in the wind. This arrangement may not be as pretty as the unsupported rods, but it does eliminate any tendency for the wind to cause a modulation of the received images.

The Telecoupler of porcelain, is sealed against the weather and the accumulation of carbon soot deposits. From this unit, a special twisted pair lead is brought down to the receiving set.

It is easy to mount this antenna, for the complete Teleceptor is so light that it can be held at arm's length. Several mounting devices are supplied, to take care of all contingencies.

Generally, the Teleceptor should be mounted as high as possible, for the gain in signal strength more than offsets the loss due to increasing the length of the lead-in. Best reception is generally obtained with the rods at right angles to the line of reception. If reflections are received, they can be eliminated usually by swinging the rods until the reflections disappear.

-30-

Andrea

"SHARP-FOCUS"

TELEVISION

**Ready for Experimenters,
Set Builders, Servicemen**

Frank A. D. Andrea, famous radio pioneer, now leads in television progress! You may be confident of success with the KT-E-5 kit. It is a product of the Andrea television development laboratories, whose equipment and personnel are among the finest in the world. —When assembled from the step-by-step instructions, your Andrea KT-E-5 will give you the same "Sharp-Focus" images that have amazed television engineers during New York demonstrations.— Be the first in your neighborhood to build an Andrea "Sharp-Focus" receiver.



Complete to the Last Detail
Manufactured by Andrea Radio Corp.

5" picture tube, 16 set tubes, 441 lines, 30 frames interlaced, 44-50 and 50-56 mc. tuning, chassis and base-plate holes stamped, R.F. unit assembled and wired, 6½" speaker, step-by-step instructions and wiring diagrams in 5 stages assure successful assembly. KT-E-5 kit only, \$79.95, picture tube \$27.50, 16 set tubes \$27.50, Teleceptor antenna \$9.50.

Prompt Service on Mail Orders

HAYNES-GRIFFIN

Authorized Andrea Dealers
373 Madison Ave., New York City

YOUR FUTURE IN RADIO TELEVISION

• These growing industries need trained men for sales, service, operation. Your chance for employment and advancement depends on thorough training. National Schools offer you time-tested training. Complete, modern facilities and equipment in the largest trade school in the West. Established 1905.

NATIONAL SCHOOLS
4000 S. Figueroa Street, Los Angeles

NATIONAL SCHOOLS, Dept. 5-RN, Los Angeles
Please send free Radio and Television Booklet.

NAME _____ AGE _____
ADDRESS _____
CITY _____ STATE _____

SOLAR gives you MORE for your money

MINICAP



Catalog upon request

SOLAR MFG. CORP., 598 Broadway, New York

A REAL HOWARD Communication Receiver*

COVERS BROADCAST
WAVELENGTHS DOWN
TO 7 METERS



Model
430

BUILT with
Traditional
HOWARD
QUALITY

Only
\$29.95
NET

4 Bands—6 Tubes
Built-in Speaker
Complete ready to
plug-in A.C. Outlet

HERE is a radio set that will thrill every lover of distant and short wave reception. An ultra-sensitive receiver with electric bandspread to separate stations. You can listen to everything on the air from .54 MC to 43 MC (7 meters to 555 meters), foreign, domestic, amateur and commercial, broadcasts and code!

Model 430 is now used by thousands of amateur stations, aeroplanes, ships, forest patrols, police, armies and navies the world over.

* For \$12.50 additional the new model 610 DC power supply now makes the 430 communication receiver available for use in your home on 110 volts AC and you can use it on six-volt storage battery operation for portable and emergency use; on four Summer vacation; camping, Marine or pleasure boat use. The model 430 also makes a dandy mobile receiver for the popular 10 meter band, for auto and trailer installation.

Here's the greatest value in the communication field for only \$29.95! A hand-built Howard with the custom parts, fine engineering and spectacular performance; features of communication receivers selling for twice the price or more. Check these outstanding features: 4 Bands—broadcast to 7 meters inclusive, Ceramic Coils, Iron Core H. I. Q. I. F. Transformers, Electrical Band Spread, Excellent Ultra-High Frequency, and eleven additional communication features.

* Pacific Coast and Export Prices Slightly Higher

America's Oldest Radio Manufacturer

Free Send Coupon for Technical Data and Name of Nearest Parts Jobber.

Howard Radio Company,
1731-35 W. Belmont Ave., Chicago, Ill.

- Please send me Service Manual on Model 430.
 I desire demonstration of Model 430.

Name

Address

City..... State.....

As I See It (Continued from page 14)

cessful business by giving \$10.00 worth for \$5.00. It is not being done because it cannot be done. You always get what you pay for. No one can tell you what to buy. You must be the judge and unfortunate as it may be, experience is the best teacher. Buying by reputation, you never go wrong because a reputation can be built only upon given satisfaction to the customer.

If and when you may have a disappointing experience with a product, you cannot blame the advertising medium. It is not the fault of the magazine. You cannot expect a magazine to sit in judgment upon a manufacturer's product. If it ever did, it would stick its chin out for the first knockout punch.

Neither can you expect the magazine to sample products before they accept the ad.

There is one thing, however, that magazines can do in justice to their readers and that is to close the pages of the magazine to an advertiser if a controversy between advertiser and customer develops and after investigation, the customer is shown to be in the right and the manufacturer refuses to make good.

Beyond this, I'm afraid that customer's grievances occasioned by what is misleading or fraudulent advertising must be taken up with the U. S. Post Office, who in the final analysis have complete jurisdiction over magazines. This branch of the Federal Government may be slow in action, but like the Canadian Northwest Mounted Police, "they get their man."

No sir, it would not be fair to hold the magazines for what the advertisers say, no more than it would be fair to hold one of the national broadcast chains because your Aunt Tillie did not find romance after 53.

It's Still Basic Radio

THERE is quite a flurry among servicemen to secure technical training in television. No doubt many are making plans to enroll in schools. All of this is admirable, but it might be well to voice a few words of warning.

Television is a new development in the radio industry and it is accompanied by facsimile. However, both are still founded upon certain basic radio principles. It is true that certain phenomena, units and methods hitherto not discussed in connection with broadcast radio reception represent new items, but essentially an understanding of television and facsimile requires a grounding in basic radio.

If we look back upon the past five years of radio development as witnessed in radio receiver design and the capabilities of the radio servicing industry we cannot help but note how clearly servicing operations were being reduced by lack of comprehension

of the basic principles underlying these developments.

It is quite a safe statement to make when I say that more than three hundred letters have been received during the past five years from servicemen wherein the men stated that they had been in business for years, had been operating in a satisfactory manner, but were slowly approaching the point where receiver developments were past their understanding. Not that they could not repair the receiver if given sufficient time, but rather that they felt that they could not service receivers in a profitable amount of time. For each of the men who wrote such a confession, there must be at least ten others who felt the same way but were not equally articulate.

Possibly as a result of material which they had read, they analyzed their problems and found that what they lacked was basic radio knowledge. Some acknowledged poor business ability to boot, but it was tragic to receive letters from men who had been servicing since 1921—men who had been commercial operators in the years gone by and had retired from the sea or land stations—men who liked radio service work—believed in it as a respectable means of earning a livelihood—but who now realized that they were behind the times. Some of these men were too old to go back to school. After all, it is difficult to tell a man 40-45 years old to try to absorb theory—the basic radio he missed. Many were resigned to their fate, to carry on the best they could—to try to find some niche in the gallery of radio servicing.

This basic knowledge is still the all-important thing, neglecting for the present such things as relate to sales and business administration. The man who lacks his fundamental grounding is going to find it extremely difficult to get into television. To get into television properly, this basic foundation is essential. And when this basic knowledge is secured, it will not only open the doors to television servicing, but will be the open sesame to all of the mysteries of the developments exploited during the past five or six years.

Don't be misled into believing that after having found it difficult to cope with automatic volume control systems, automatic frequency control, bass compensation circuits, volume expansion, in general with the modern multi-wave broadcast receiver—because you lack the basic A-C theory—that you will be able to face the facts related to television and facsimile transmission, reception and servicing without getting the basic facts.

Fortunately there is ample time for all concerned, that is, ample time to get the foundation before television becomes widespread—but the foundation you will need. If you lack basic theory, get that first and then the television data. If you don't you will put yourself right back where you

started. You will have a smattering of what is needed, but not enough to be able to successfully overcome the various obstacles now in the path of the radio servicing industry.

Sure, television is a new radio industry, but you just can't flop right into it. Analyze your television receiver as you see it described in the various radio magazines. What do you find? A definite similarity in circuit structure to receivers used for years. The frequencies involved are different—the band pass of the coupling units is increased, but cascade amplification is still used and control circuits are still used. If you did not understand the various control circuits in the broadcast receivers sold during the past few years, because you did not know the underlying principles how will you follow them in the new receivers?

Being a new development, television receivers embrace many new ideas and the understanding required to enable proper servicing can come only if the underlying principles of operation are understood. Maybe you think that we are harping too strongly upon these fundamental principles! Believe us when we say that such is not the case. As a matter of fact, we say that if you *lack* basic radio, *don't* enroll in a television course—*get the basic facts first*. For that matter, we doubt if any reliable radio school teaching television servicing will enroll a student unless he shows the required basic knowledge, with the possible exception of a school where television comes after a thorough drilling in fundamentals and it is a part of the television course.

Don't be misled by the fact that some of the television receivers talked about have five or six knobs or buttons on the front of the panel and all you will have to do to receive a program is to turn a knob or push a button. The works are still inside and that's where you work.

Maybe you have come in contact with many people who were tone deaf and never did know if the quality of reproduction available with a broadcast receiver was up to par—but there is a big difference between seeing and hearing. You can tell a woman that the hiss comes from the station but you'll have a tough time convincing her that the carpet pattern upon the television screen really is Jack Benny in person. —30—

Case Histories
(Continued from page 41)

- strip. Install a new 8,000-ohm control
- APEX 7**
- Inoperative . . . 1) 0.1-mfd. condenser in screen-grid circuit "leaky"
- Intermittent reception 1) intermittent "open" in 3,200-ohm cathode resistor for the '24 oscillator tube. Replace this resistor
- Intermittent reception 1) filter condensers check O.K. on leakage test, but capacity (on low-fre-

quency end of dial only, perfect reception otherwise)

Weak reception . . . 1) in receivers above Serial No. 1,074,051 the oscillator 600-ke trimmer has been omitted and is replaced by a fixed condenser. Often, this drops somewhat in capacity. In such cases, replace with approximately a 775-mmfd. mica type unit shunted by an 85-mmfd. trimmer. Adjust the trimmer for maximum signal at approximately 600 ke

APEX 7A

Unsatisfactory performance (all voltages normal, tubes test O.K.) 1) replace the first detector-oscillator tube with a '24A. Trying several tubes until a satisfying one is found

Reception cuts off after operating satisfactorily for a while (oscillator section ceases to function) 1) "open-circuit" in one of the tapped portions of the oscillator "tank" coil (all operating voltages will check O.K. in this case) 2) "open" 0.01-mfd. '24A oscillator tube cathode by-pass condenser (all operating voltages will check O.K.) 3) try substituting a 2,000-ohm resistor for the 3,200-ohm unit now in the cathode circuit-oscill. tube. Also try a

cut of the '24A 0.005-mfd. by-pass AVC action . . . 1) "open" 3,200-ohm Candohm resistor in the AVC plate lead. Replace with 10-watt resistor of the same value

Weak reception, Receiver difficult to align, Intermittent reception 1) poor tracking or inability to obtain critical adjustment on any i-f trimmer indicates moisture absorption by the i-f transf. and oscill. coil. Remove same (first label all leads) and check leads for breaks or corrosion. Then drive out moisture in coils by baking

APEX 7D (Chassis 700)

Fading or Low volume . . . 1) voice-coil wires "shorting" together at the start of the coil due to vibration of the cone. Clean the coil and paint it with a quick-drying insulating lacquer. Keep wires apart as much as possible

APEX 8

Inoperative, Weak reception . . . 1) check the 50,000-ohm oscillator-plate resistor. If charred or faulty, replace with a wire-wound 2-watt unit

AVC volume drops . . . 1) "open" 0.5-mfd. condenser connected between the r-f cathode and the grid returns of the r-f and i-f coils. Replace with a 400-volt condenser

Intermittent operation . . . 1) remove the condenser filters from the grid returns of the AVC-controlled tubes. Replace with new 0.5-mfd. 400-volt condenser

APEX 8A

Distortion . . . 1) filament center-tap for '47 tube "open"

(after receiver has played for about 30 minutes, grid of '47 tube gets red hot)

Distortion, Low volume, Motorboating with volume control at maximum setting . . . 1) faulty type '27 second detector tube decrease in capacity of the 8-mfd. condenser across the output of the filter unit. Replace with new unit

Sudden increase (or decrease) in volume when a nearby light is turned on 1) 0.5-mfd. condenser connected between the r-f cathode and the grid return of the r-f and i-f coils "open." Replace with 400-volt unit

Loud hum immediately after switch is snapped on 1) open-circuited 8-mfd. cardboard electrolytic filter condensers. Replace with new units

Fading . . . 1) faulty 0.04-mfd. coupling condenser between the grid of the type '27 second detector tube and the type '47 output tube. Replace with new unit.

Reprinted, with permission, from **RADIO Trouble Shooters Handbook**, Copyright, 1939, Radio & Technical Publishing Co. Copyright in Canada and Great Britain, and all countries subscribing to the Berne Convention, by Radio & Technical Publishing Co. All rights reserved.

(This series will be continued next month.—Ed.)

WATCH FOR THE SERVICE-MEN'S SURVEY. COMING SOON!

Band Switching for Your Rig!



Now a reality with MALLORY-YAXLEY HamBand Switches

Now you can change bands with the turn of your wrist . . . as conveniently as you change bands on your communications receiver. Now you can enjoy the advantages that different amateur bands offer over certain distances during certain times of the day. Mallery-Yaxley 100C HamBand Switches are rated for use in transmitter plate circuits using up to 1000 Volts DC with power up to 100 watts inclusive. Convenient terminal arrangements, wide spacing of current carrying parts, heavy silver-plating on contacts, and low-loss magnesium silicate ceramic insulation arc features especially designed for high frequency applications.

Sketch at right shows how the 162C can be used to make a simple "Turret" assembly.



Many other applications are practical with these dependable HamBand Switches. Get technical data sheet from your distributor or send QSL Card to

P. R. MALLORY & CO., Inc.
INDIANAPOLIS INDIANA
Cable Address—PELMALLO

Use **MALLORY** APPROVED RADIO PRECISION PRODUCTS

Use **YAXLEY** APPROVED RADIO PRECISION PRODUCTS



—with an Augmented (bigger) Company of

Centralab

LOW CAPACITY LEVER ACTION SWITCHES

It's been a "sell out" from the very start . . . Now . . . augmented combinations cover every probable requirement you may have. The program (libretto) now lists the complete line-up. Just write and ask for special Bulletin No. 680 for full details, or see your jobber.

CENTRALAB
Div. of Globe Union Inc., Milwaukee, Wisc.

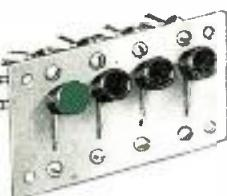

Contact clips of spring brass heavily plated (silver) treated for easy soldering. Switching combinations available use up to 12 clips per section.

Subscribe to RADIO NEWS—\$2.50

Sight & Sound News

(Continued from page 33)

promised only two such hours of transmissions weekly, and program material will naturally be limited.

"The Three Garridebs," of course, is but one of the many dramatic offerings attempted by NBC's television staff. Briefly, here are "previews" of other offerings:

"Good Medicine"—Has a cast of three characters: a doctor, his wife and a wealthy patient. Well-written comedy dealing with a young medico who finds it difficult to make both ends meet. He barter's his medical books for a few cans of sardines, a pound of ham, coffee and bacon. How the wealthy patient saves everything makes for gay comedy. Two interior sets are used, plus a miniature model of the exterior of a house. The model is magnified into natural proportions. Rating: Highly entertaining—don't miss it.

"Mysterious Mummy Case"—Has large cast, several interior settings and employs film for exterior shots. Locale shifts from London to Egypt. Written by Tom Terriss, noted traveler, lecturer and author of several motion picture adventure shorts. Concerns a collector of Egyptian mummies who experiences several frightful moments when he purchases a mummy plagued by a curse of the Pharaohs. Has exciting climax. Rating: Thrilling stuff.

Fashion Revue—A half-hour presentation bringing to the fore the newest modes for milady fair. Shown at time of "preview" were a bois de rose slipper satin gown with brown velvet jacket; hostess gown of tangerine silk jersey and bolero jacket of maroon velvet, embroidered in silver; pastel blue satin negligee with matching ostrich feathers. Lester Gaba and his famous dummy model, Cynthia Cynthia, were featured. Rating: Strictly for the women, but interesting to observe.

"Susan and God"—First Broadway show ever televised. Introductions by John Golden, producer, and David Sarnoff, president of RCA. Featured are Gertrude Lawrence, Paul McGrath and Nancy Coleman. Only one scene from actual production is shown. Close-ups and long shots blended perfectly, although lighting could have been improved. Rating: Interesting experiment.

"Return of the Scarlet Pimpernel"—First full-length motion picture televised in the U. S. Imposing spectacle, 90 minutes long. Only crowd scenes failed to impress. Audience's attention on screen remained intact throughout. Rating: Splendid.

Fencing Lesson—Demonstration of the ancient art by two experts. Rating: Pretty dull.

Films—Principally Pathe News. Mickey Mouse and March of Time. Also periodic showing of Universal musical short subjects; Paramount orchestra shorts; travelogues and Bob Benchley satires. Rating: Very good.

Outside Telecasts—These have been few and far between during experimental period. Best of lot was automobile show televised last November. This medium of television likely to be most popular in view of spot news and sports events which can be flashed through the air. Rating: Desirable.

Only a meagre hundred or more persons have been privileged to witness NBC's experimental efforts to date. With public introduction scheduled for April 30, the size of the audience is expected to be increased to a million or more, depending on the sale of sets in the metropolitan area.

The type of programs which the Columbia Broadcasting System is to make public in the Spring has not yet been revealed. But the CBS has announced that it intends to launch its telecasts simultaneously with NBC on April 30 and four hours of programs weekly between the two networks is virtually assured.

West Coast Television

(Continued from page 11)

tance from the transmitter were instituted by Mr. Lubcke.

W6XAO, situated in Los Angeles, was considered to be in a bad spot because of the surrounding high mountain ranges on three sides of the city. But in comparison with similar television activities conducted elsewhere, it managed to cover fairly large distances. The transmitter system used is of the high definition cathode-ray type 300 lines, 24 frame standard. On account of widespread 50 and 60 cycle power systems in and surrounding this area, this type was deemed to be the best. Within the service area of this transmitter approximately one million people are supplied with 50 cycle power and the other one million with 60 cycle power. Then there is the Mosaic live pickup camera equipment for broadcasting newsreels, shorts and test items.

The visual images are broadcast on the ultra-high frequencies of 6 3/4 meters and the accompanying sound is transmitted on 5 1/2 meters although this latter was, in the very beginning, on the same frequency as the television. A simple line-image of constant intensity and an accompanying 1000 cycle tone are broadcast at the beginning and end of each transmission on the bisula and aural transmitters, respectively. The image produces as 38 parallel horizontal bright bars in the field of view on properly operating television receiver and the sound is

GET ON THE BAND WAGON WITH DOWN BEAT!

For Twelve Months

- Get a grandstand view of the "big shots" on the "Down Beat".
- Authentic news about musicians written up in a "swing" style!
- Record reviews, tips on arranging, accordion, piano, bass, drums, sax, trumpet, etc. Review of best orchestrations of the month.
- Know who's who in the big name bands and where they are.
- Candid camera shots and photos of your favorite bands and orchestras.

Subscribe now to



Room 970, 608 S. Dearborn St., Chicago, Ill.
"Music News From Coast To Coast"

<input type="checkbox"/> 8 MONTHS - - - - \$1.00	<input type="checkbox"/> CANADA - - - - \$1.75
<input type="checkbox"/> 1 YEAR - - - - 1.50	<input type="checkbox"/> FOREIGN - - - - 2.00
<input type="checkbox"/> 2 YEARS - - - - 2.75	(PER YEAR)

Enclosed find \$_____ for _____ subscription to DOWN BEAT.

Name _____
Address _____
City & State _____

heard as a constant medium-high tone. A change in the intensity of these signals after a change has been made in a receiver is a measure of the effect of the change.

The image broadcast is a 300 line sequentially scanned picture with a framed repetition frequency of 24 per second which, of course, can be received on television receivers operating on 50 or 60 cycle home electric current. But a nine-inch cathode ray tube is required to reproduce the full details of the images broadcast and for rough experimental work, or where the expense of a large tube is prohibitive, recognizable images can be obtained on the DuMont 2" tube type 24XH or the RCA 1" tube, type 913. A standard negative image is radiated from the transmitter and on the average scanning receiver, if the image shown on the cathode ray tube is a photographic negative (white objects reproduced black and vice versa), one more or less stage of "audio" frequency amplification (following the second detector) will give the proper "positive" synchronizing pulses transmitted at the end of each line (7200 per second) and at the end of each complete image (24 per second). These pulses are of opposite polarity to the image signal variations according to the standard practice.

Television broadcasting station W6XAO is located in the Don Lee Building at Seventh and Bixel Streets in Los Angeles. It comprises two transmitters, operating on ultra-high frequencies. The vision signal is broadcast on a frequency of 45 megacycles, and the sound signal on a frequency of 49.75 megacycles. The power is 1000 watts.

Television as a great vehicle for cultural and educational benefits is visualized by Mr. Thomas S. Lee, president of the Don Lee Broadcasting System and owner of the west's only television station.

"Thus far, the television medium has been regarded in the same light as motion picture and radio," said Mr. Lee, under whose guidance the Don Lee network undertook the operation of W6XAO some nine years ago.

"While it is true that the scope of entertainment will undoubtedly be enlarged," he continued, "the infinite possibilities of television from a purely cultural standpoint have not yet been probed.

"The teaching of music by showing the fingering of stringed instruments; the picturing of a great musical conductor in action; the dancing of a master of the ballet, will be brought into the home to enrich the cultural outlook of the average family.

"Works of art may be shown in the process of creation. The finishing touches by the sculptor on a monument; the last brush strokes on a portrait; a lithograph in the interesting process of completion, will all be transmitted via the new medium."

According to Harry R. Lubcke, television director of the Don Lee net-

work, activities have been aggressively carried forward during the past year.

During the daily transmissions, many details of the new technique of television have been uncovered. "One of the most startling of these," says Lubcke, "is the ability to change the apparent color of the hair of a subject from blonde to brunette, according to the lighting treatment of the set. Recently, a long shot of our performer, Gertrude Aitken, was so illuminated that she appeared as a brunette at distant television receivers. Later in the same program, on a 1/2 length shot, she was definitely blonde. It will be admitted that this change was stumbled upon accidentally; however, it gives an indication of the power of the television instrumentalities in producing special effects. This particular effect was achieved through proper proportioning of light upon performer and background."

The close and continued teamwork necessary throughout a performance on the part of the technical and producing crew is a considerable extension of that required in radio, according to members of the Don Lee staff.

There must be continuous correlation between the sight and sound part of the performance and this, coupled with the more involved nature of the visual operations.

Nine years ago, the Don Lee Broadcasting System pioneered the introduction of television on the west coast, according to Lewis Allen Weiss, general manager of the network which operates a chain of 28 radio stations on the Pacific Coast. Through constant experimentation and development, the only western television station has undergone a steady process of growth and improvement.

The W6XAO television schedule now covers seven hours a week, with one or more broadcasts each day except Sundays and holidays.

Of this time, 1 1/4 hours are given to transmissions from film; 5 1/4 hours are live subject production. In order to present the live programs, 11 1/4 hours of rehearsal are spent by the cast and staff each week, with so-called "skeleton" rehearsals held prior to each telecast. The latter are the equivalent of the well-known dress rehearsal in radio and the show business. —50—

Television Lessons
(Continued from page 20)

C2-L2 circuit, on the other hand, is tuned to 8.5 mc. and acts as input to the 1853. To prevent pick-up of video I.F. strays the output of the 1853 is carried to the sound receiver in concentric cable.

The buffer stage of Figure 29B is similar as to what it does, but L1 is common to both the rejection (C1-L1) circuit and the acceptance (C2-L1) input circuit. It does not provide its own output load; L2 is the primary of the input transformer of the sound receiver.

Getting now to the video detection



**THESE TUBES
PAY FOR THE
EQUIPMENT
YOU NEED!**

**.. with the
ARCTURUS
EQUIPMENT DEAL!**

The Arcturus Equipment Deal brings you an almost unlimited variety of the newest store and shop equipment . . . practically FREE! It enables you to make your shop more efficient, absolutely up-to-the-minute . . . it actually gives you EXTRA PROFITS in the form of valuable equipment!

NEW EQUIPMENT . . . PRACTICALLY FREE!

You'll find the Arcturus Deal gives you more for your money than any other. Lower Down Payments. Low Tube Requirements. Immediate Delivery—and only Standard Prices for tubes!

Send for details, and your FREE copy of the ARCTURUS DEALER HELPS folder. See how simple it is to get new equipment—how your purchases of Arcturus Tubes actually pay for it—how Arcturus Cooperation helps you sell!

NEW TUBES . . . NEW PROFITS!

Arcturus recently introduced several new tube types . . . more are on the way! These, and the famous Arcturus GT "MIDGETS", will further increase the huge replacement market now open to Arcturus dealers. Cash in on it! "Go Arcturus!"

MAIL THE COUPON!

ARCTURUS

ARCTURUS RADIO TUBE CO., Newark, N. J. N-17
Without cost or obligation, send my copy of the ARCTURUS DEALER HELPS Folder and details of the ARCTURUS EQUIPMENT DEAL.

Name.....
Street.....
City.....State.....
 I am a dealer I am a serviceman, My
jobber is.....

For your convenience this coupon can be pasted on a penny postcard



It is the last word in modern radio reception. Originally designed for the reception of television signals, the Verti-Flex Antenna was discovered to be the *perfect* aerial for regular radio receivers as well.

It is a 9-foot aluminum "buggy-whip" type telescoping aerial. Sold, during its introduction, at only \$1.00. Just pin a dollar bill to the

coupon and your Verti-Flex Antenna will be shipped POST-PAID. C. O. D. shipments will include postal charges. MONEY BACK GUARANTEE if you are not satisfied. VERTI-FLEX AMATEUR TRANSMITTING ANTENNA

Write for literature on 34 ft. Self-Supporting Amateur Transmitting Antenna!

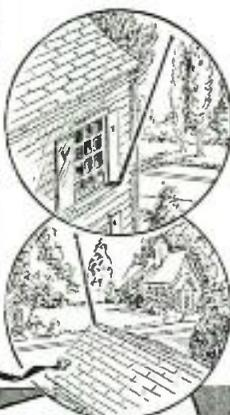

Verti-flex
THE MODERN ANTENNA

MAIL THIS COUPON NOW!

VERTI-FLEX DIVISION
ILLINOIS SEATING CORP.
2136 N. Racine Ave., Chicago, Illinois
Please RUSH me postpaid ONE Verti-Flex Antenna. I am enclosing \$1.00. Ship it C. O. D., \$1.00 plus postal charges.

Name.....
Address.....
City..... State.....

of television signals, a point of considerable interest to the experimenter should be brought out. Our signal at this point consists of both the video modulation for the picture and synchronizing pulses. Around a 6H6 double diode tube, innumerable methods of handling the video and sync signals can be developed—(a) one diode can be used as a detector and the other as a "clipper" or sync signal separator; (b) the two halves of the diode can be utilized for full wave detection with a lead taken from the 6H6 output to another tube used to separate sync signals from video; or, (c) one-half of the 6H6 can be used to rectify, then both sync and video signals are passed through video amplifiers before separation.

Figure 30 depicts these three types of detector stages, in the order listed. One thing, it will be noted, is common to all three; the output low-pass filter. The chief requirement of such a filter is that it pass the full range of video frequencies (60 cycles to 3 or 4 mc.) and then offer marked attenuation or cut-off to higher frequencies—in this case, the I.F. carrier and harmonics of the video frequencies. If these harmonics are not eliminated they tend to couple back and show up as an interference pattern in the picture. While the two inductances should be placed at right angles for zero coupling at first, some improvement may be developed by later giving them a slight coupling and increasing the load resistor and compensating inductance of the first video stage.

The first arrangement, as shown by Figure 30a, is desirable in that it saves a tube. The other plans make necessary a separate clipper tube to provide sync pulses free of video signal; 30a permits one to take sync signals directly from the cathode resistor-capacity network and put them into a tube that will separate horizontal and vertical impulses. The circuit of 30b is interesting; the full wave hookup to the diode causes the I.F. appearing in the output network to be double over that obtained from a half-wave diode, and thus it is more easily eliminated. The circuit also shows one method of obtaining Automatic Gain Control (A.G.C.), which subject will be gone into later; there are other methods.

The circuit of Figure 30c is, perhaps, the easiest to put into use. The cathode and its plate, of one half of the 6H6 are grounded; the other pair of elements are used as shown. The inductances may be 175 turns of No. 34 enameled on a ½-inch form, while the 1.5 volts negative bias can be secured from a pen cell. Such a circuit passes both sync impulses and video signal into the video stages, separation being accomplished later.

The next article will present A.G.C. systems, methods of separating sync pulses from video signal, of separating horizontal and vertical pulses from each other, scanning frequency oscillators and amplifiers.

Hamchatter

(Continued from page 31)

Washington. He plans to return via Hollywood and the southern route. All this traveling on an Annie Oakley, too, the lucky stiff.

IN answer to the thousands of inquiries we got about W5BEN/9's "Rockaboar" story of last month, here's the dope. It seems down in the hill country of Tennessee, the razor backed hogs have developed hill-side legs. Those on one side being longer than the ones on the other. Left-handed rockaboars travel counter clockwise around the mountains, right-handed rockaboars making clockwise circuits. These animals are quite stubborn, often starving rather than giving trail to another. In fact, this accounts for a large percentage of the mortality among rockaboars. Their tough hides will turn rifle bullets with ease. It sometimes happens a right-handed rockaboar will mate with a left-handed rockaboar producing hybrid progeny known as ridgerunners. These critters inherit the forelegs of one parent and the hind legs of the other, this is no handicap since a ridgerunner travels a-straddle the ridges, hence his name. Could you call this tall story *biased*?

Incidentally, the bristles from a rockaboar make the best brushes for dusting CW rigs. For fone rigs, we recommend the neck bristles of the ridgerunner as being definitely superior. W5BEN/9, how could you!!!

NEIGE (who uses only eight receivers) was practically off the air the other evening due to failure of one of the thirty-eight meters in his 14 mc transmitter. After making the thirty-five mile trip from Cuernavaca to Mexico City, he still needed the meter so he telegraphed an order to the States to have one shipped by airmail. Oh, yes, it was an 0-500 volt meter he needed for the buffer bias supply. We hope Dr. Hard will be back on the band again soon.

W9ITA must be a party-waist eating a bowl of cereal every night before hitting the hay. Is that how you got that sylph-like figure, Frank?

To W9NSK: "Beg pardon, Al, that YV5 came in too late to make last month's HAM-CHATTER."

W9ANF of WBBM is on the air again. Welcome to our city, Harry.

W9DZO is rearing to get back on the Lake. Seems a steam roller ran over his pocketbook. Pretty tough being beached for the winter, but Ellis knows how to save his sheekels.

W9TLO gets 2000 volts at 600 ma out of a 2"x2" cross section transformer.

W4FBE was so anxious to try out his Rotary beam he couldn't wait to install the motor, so he had a boy on a ladder holding the beam on Chicago during a one hour rag chew. We think this is tops for ham enthusiasm. Pretty tough on the boy, however.

W9ISR says that so far forty percent of *The Vigilantes* took the trouble to vote, and that ballots were sent to each member. All the propositions seem to be carried, and John says he thinks the showing is fairly good. More ballots are continuing to pile in. Live bunch, these *Vigilantes*!

With *The Vigilantes* on their toes and more vigilant, it's going to be too bad for non-amateurs in 1942.

W9YAZ out in Grey Eagle, Minn., was worried because his two tubes in his final don't show the same amount of color. Well, Deane, maybe one of them is a little closer to the powerhouse.

Overhead on 40 meters: "The wolf had pups on his front porch. I bought the parts for this rig with bounty money." How some of these fellows exaggerate!

W9QEA-W9ETI are designing what they hope to be the first ham television transmitter. It will be able to pick up "live" programs with a new ham's television camera. More dope on that here, later.

Heard on ten: "I can remember way back when I bought something for the rig, and it didn't work."

W9KQH, who is some pumpkins out to the Stewart-Warner Plant, has two of his

kids who call CQ to each other (without a radio transmitter) each night in bed, and since they both keep calling and they do not know how to answer themselves, they go to sleep very, very fast. We wish that this would happen to those bosomeams hams who do the same thing on the air!

What ham can be heard on about 1200 kc. almost every night in Chicago? He is so funny, and goes on so late that none want to turn him in.

W9ETI has had to give up that 500 watt power plant in the back of his *Cherry*. It seems that he installed it when his family consisted of an NYL plus three junior ops. Now there are four junior ops, and they have all grown so-o-o-o-much that the weight limit of the car has been exceeded and the Missus made Ollie remove the power plant rather than leave one of the kids at home these nice Sunday afternoons. Who says that NYL's have nothing to say about xmtrs?

What's become of the Greater Chicago Area Amateur Committee?

W6USA, located on Treasure Island, California, is on 29,500 fone.

What group of Arizona hams have built themselves a "Metal Finder" and are going to prospect for gold this summer?

W1LFO claims the world's flea power record. With 4 watts input, and a rig measuring 4"x6", he worked Chicago, Q4R6, with a skywire 25' long, 12' above the ground at Manchester, N. H. Is there a still greater record on flea power?

Hamchatter solicits informative items on hams. A prize of \$5 will be paid for the best ham-news-gossip scoop of each month. All items become the property of *Hamchatter*, none can be returned, and the decision of the Editors is final. If duplicate items are submitted, duplicate prizes will be awarded. This month's prize goes to John Harvey, W9ISR, of Chicago. Congrats, Newshawk Harvey!!

THERE was a fight in the Argentine between the two internal factions of their local ham society (similar to our ARRL.). One side was pro government and the other anti. The pro group won with the government taking drastic steps such as: Only licensed hams can use a mike, and only Spanish can be spoken over the mike. Well, their English was hard to understand, and our Spanish just isn't even legible.

9TIZ has a rotary built for him by 9NLP. Works nothing but South Africans and 9ISR, the lucky stiff.

9NLP is a moon picture op. Increases his increment (makes money, to youse) by renting out a PA system with a fonograh attached plus a hummert records. Price: \$1.00 per night. If that machine could only talk!

9KQH keeps in touch with his home town via 9EWU. Incidentally, he is rebuilding.

9YUR has a rig but can't keep it in the same place with his NYL, so he's moving it to the South Side of Chicago where he will operate from time to time.

WE1MQ operates electron coupled between 2000 and 2050 kc. with 15 watts input, and has worked out to Toronto and South into North Carolina using an 809 in the final with grid modulation.

VE1MJ on 1785 kc. has only 10 watts input but has cards from Manitoba and all the U. S. districts except the 6th and 7th. Uses 6A6 final and has storage batteries and vibropack for power. QTH is on an island in the Bay of Fundy.

VE1FF is new at Gannet Rock Light Station. He uses 4 watts input and has VE3AMV for his greatest DX.

VE2HB Quebec City actually had a QSO with VE3KE despite the fact that his transmitting antenna was broken and only 25 feet of it was in use! hi!

VE2PF is on 2004 and 2038 kc. phone every Saturday night and early Sunday mornings. Has all U. S. districts except 6 and 7 and has worked VE4FA and VE4AFU. Using 30 watts to a 6L6G final.

VE4AFU has 20 watts input on 1785. He puts a signal down to the East Coast without much difficulty.

Some of the "VE1" boys have gone to town working those "G" stations on the c. w.

band near 1775 kc.! VE1IE seems to have had most luck with them.

VO3M heard working VE's near 1820 kc. VO3M, on c. w., heard working VE's near 1820 kc.

K4EIL reported several times on 160 phone in Canada!

W9KDA, operated by *Jinx* Jenkins, calls his xmtr. a jinx rig, ditto his receiver, and he uses self designed jinx beam array and works the darndest jinx dx with it. Thank to B. Sanders for this info.

Henry (W6PJT—exNY2AE—ex1DBI) Poole hastens to take up the glove dropped in last month's *HC*, by telling us that station KOY has the following hams: W6NAF, W6DPS, W8AND and himself. They claim another record there. 3 of the 4 hams have Private Airplane Pilot Licenses, and W6NAF is on the way to his. One other person at KOY holds a P.A.P. License, he is a salesman, Gordon Wiggins. Our sister publication, *Popular Aviation*, please note!

W9V SX has a *Berne Special* on 28MC that really goes to town. You ought to see that final stage with its snooty '10 perkin over the band and grabbing the dx QSO's. Bill's an active *Chi-Hamfester!*

W9WPI, synchronizing engineer with Chicago CBS, puts a whale of a wallop on 28 these early evenings. Has worked plenty of important DX, too. Fb, om!

W3CXI is rebuilding, and has junked the final pp 860's in favor of pp 803's. KA1HR skeds K6DV daily on 7 mc. They are WLXP and WLXA in the A. A. R. S., respectively.

WLNA/W2PF has a fb article in this month's issue of the A. A. R. Bulletin. It will pay all hands to read it. (P.S. we don't know how you can get a copy, but perhaps 2PF will accommodate you. Or *QST* might be induced to reprint it!)

W2USA will be the World's Fair Station to be run by the New York World's Fair Radio Club. The installation will include transmitters for every ham band from 160 through 5, both fone and CW. Directors of the N. Y. W. F. R. C. are W2DKJ, Managing Director; W2CLA, Membership Director; W2BW, Coordination Director; John S. Young, W. F. Liaison Director; and C. B. Cooper, Fiscal Director. Does anyone know what the San Francisco Fair is doing with ham radio?

W2DKJ/2 can be heard on 59,060 kc. with 400 watts every Friday night at 9:45 p.m. EST. Retransmissions of this weekly *QST* or the text and reports of reception are welcomed.

A series of hamfests at the N. Y. W. F. R. C. will be under the leadership of W2AOE.

A. A. R. S. members who wish to volunteer their services in connection with W2USA should advise W2PF.

We are reliably informed that W2DBQ is a harmonica vocalist of note. (Joke?)

On January 30, 1939, W2BCX won the speed code contest with 60 wpm. Can he take it!

W6AM has worked 34 countries on 20, 23 on 40, 9 on 10. This is really a record, we believe. Can anyone better that? (Yes, we know you don't have the antennae, but a country worked is a country worked, and ham radio does not *always* follow the best antennae. Ask W9HPW who made WAC with 9 watts and the most haywire skywire in the world!)

The following W sigs were reported in Bangkok, Siam, by Allen Bassett: 1BF, 8AZQ, 2AV, 8AU, 8CJJ, 8CYT, 2KL, 1AB, 6MBJ, 8LCN, and 6VNO. Is there a W6VNO? All sigs were in the 20 meter band and were received on an SX16. Siam does not permit Bassett to have a transmitter although he has been a ham since 'way back when!

RAY GUDIE is operating quite a bit at W6CIF. Hams will remember Ray Gudie as the designer of a number of popular receivers still in use.

W6QD is having fine luck in his new location at South Los Angeles, and is working Europeans on 40 meters.

The beautiful high powered note of W6CUH was reported r8 in Peru, on 40 meters when other signals from this area

Radio's MASTER ENCYCLOPEDIA

The Radio Industry at your Fingers tips

REFERENCE BOOK
•
BUYING GUIDE
•
SALES CATALOG
•
ENCYCLOPEDIA

1939 EDITION—OVER 600 PAGES

THE ONLY OFFICIAL EQUIPMENT MANUAL of the Radio Industry!

Compiled in cooperation with and approved by Radio Manufacturers, this authentic source book of over 600 pages is crammed full of vital, essential information that is indispensable to everyone identified with Radio and allied lines.

GIVES THIS IMPORTANT DATA

The New 1939 Edition of Radio's Master Encyclopedia is the most comprehensive ever issued. No other book like it. Important data that you need in your business—conveniently cross-indexed for split-second reference. Thousands of illustrations, specifications and prices on every conceivable type of Equipment, Accessories, Parts; ranging from Tubes to Transmitters, and including the latest in television tubes and parts.

Contains Directory of over 1,000 Manufacturers, where located and what they make—gives index of trade names.

• WHO USES IT? •

Universally used and accepted by Radio Dealers, Service Men, Amateurs, Jobbers, Schools, Colleges, Libraries, Governmental Agencies, Industrial Organizations, Purchasing Agents, Police Departments, Steamship Lines, etc. In addition, the Service Man and Dealer will find the Encyclopedia a valuable aid in soliciting business. Only List Prices are shown, so that the book can readily be opened before the prospective customer.

SAVES TIME—SAVES MONEY

Radio's Master Encyclopedia is truly a complete Radio and Equipment Manual all bound under one cover, taking the place of files and files of miscellaneous catalogs and information. **WHERE—WHAT—HOW MUCH**, instantly at your fingertips! Thousands in everyday practical use proving invaluable and unsurpassed as a **REFERENCE BOOK, SALES CATALOG or BUYING GUIDE.**

MONEY BACK GUARANTEE!

Radio's Master Encyclopedia, now in its third year, has served the industry well. That's why, with complete confidence, we are ready to send it to you on an absolute "Money Back in 5 Days" Guarantee, if you are not 100% satisfied. To save the cost of transportation, send your remittance with order—\$2.50 in U.S.A., \$3.00 Elsewhere. Or if you prefer, we will ship C.O.D. plus postage charges—in either case, our "Money Back in 5 Days" is your assurance of complete satisfaction.

UNITED CATALOG PUBLISHERS, INC.
9 WARREN STREET, NEW YORK, N. Y.

METER CASES



For Conveniently Housing All Types And Makes of 2" And 3" Panel Mounting Meters And 3" Speakers

Made of Black Cracked Steel with ceramic mounted terminals. No. 1241 is for 2" meters. No. 1242 is for 3" meters. Either size only 90c net at your BUD distributor. For latest catalogue supplement RN-59 write

BUD RADIO, INC.

5205 Cedar Avenue Cleveland, Ohio

BUILD YOUR OWN FACSIMILE RADIO PRINTER



CROSLY READO KIT \$49.50

GET IN ON THE GROUND FLOOR WITH RADIO'S MOST PROMISING DEVELOPMENT

Already daily broadcasting experiments from leading radio stations offer fascinating study and fun. This new art holds promise of a great future, and another chance to grow up in a field as prolific of personal profit and satisfaction as radio was 20 years ago. Time is not far distant when radio facsimile printers may constantly deliver into American homes an exciting stream of pictures of events as they happen together with visual reports, vital information and news. Already the progress provides much of interest and for study in the early morning broadcasts of news and pictures with many stations operating on ultra high frequency during daylight hours.

The Crosley "Reado" radio printer is a development of the Finch method and is being used in many spots throughout the country today. When you have built the printer it is easily attached to your own radio receiver. We provide all the necessary parts carefully precision machined ready to build, packed in a special kit. Most Crosley dealers will display them. If none are convenient to you, write us.

THE CROSLY CORPORATION
READO DEPARTMENT POWEL CROSLY, Jr., Pres.
104 ARLINGTON STREET CINCINNATI, OHIO

Please send me literature about the Crosley READO, all facsimile broadcasting activities and list of stations now doing experimental broadcasting. Also, the name of my nearest Crosley dealer to carry the Reado Kit.



NAME.....
ADDRESS.....

were only coming in r5 and r6.
Looks like W6GRL and W6CXW are battling to the finish on the DX test, at the time this is written. The West Coast has had a rather tough time with ten meters during the DX CW tests although 40 meters is unusually good this year. 20 meters is about the same as last year.

W6BPP at Radio Supply Company, Los Angeles, has his 2d class telephone ticket.

During the DX CW contest the EC boys behaved well, and instead of riding in on top of the DX stations, kept approximately 5 KCs on one side. This made DXing this year far easier than last, because last year the EC boys would dead beat with the foreign stations unless they all happened to quit calling at once, the foreign station would be wiped out.

Once in a while someone has a crystal right on the foreign station and, of course, he cannot shift that, but that is only one or two stations in place of the large number before.

Another interesting thing about the DX test this year is that a great number of the stations used two receivers and in that way could keep track of both the DX station, and the United States Station being worked.

W6CHU is very active in the Bell Radio Club, and recently arranged for a safety talk at the club.

It is certainly good to see Wally Gee back on the air again, working DX with his famous W6EGH.

W6GRX, as usual, will have a high score in the DX test this year.

W6MHH worked Sumatra on 20 meters. W6AM had a good look at the wonderful ham shack of W6KW in San Diego. W6KW is making a one kilowatt phone and CW rig for our old friend Fred Ferreira at Tijuana.

W6FZL, one time high man in the L. A. Section DX contest, is going to have a good score again this year.

Our old friend, W6KRI, is active on the 10 meter band.

W6QUT, "Amos" of "Amos and Andy," has gone to Palm Springs. When he comes back a new radio room will be completely installed, together with rotary beam directly overhead, RME-69, DB-20, 510X, and a large transmitter.

W6GCT, who worked so many Europeans in last year's DX test in San Diego, was caught in the midst of rebuilding, and was unable to get on the air this year.

W6CGX is doing good work on 20 meters. We all remember his marvelous work in QSOing 50 countries in the 10 meter phone tests last year.

W6NSY is training a junior op. W6GWY sticks to the ranks of the CW hounds.

The big beams of W6LYM are working Europe in great shape these days on 20 meters.

W6CHY comes in fine on 5 ms, at sea level, Catalina Island. This is about 40 miles away, and about approximately 800 feet below the horizon.

Honolulu, and the East Coast come in well on 60 (yah mean 60??) meter phone these days.

One of the San Diego Amateurs worked New Zealand on his 12 watt flea powered transmitter. This was on 75 meter phone, and speaks well for the San Diegan's antenna system!

W6TT, Elvin Feige, puts in a marvelous 20 meter signal here in Long Beach, at a distance of 400 miles.

W6RO has two 90 foot telephone poles besides the 90 foot tower made by W6DDS, and the 9-90 gang.

The Southwest Experimental Radio Amateur Association (Bell Club) held their annual banquet on March 10.

W7RT's snappy fist sounds good over the air these days. You may remember John as the chap who spent nine months in the Alaskan interior, and contacted the Russian Scientists on the ice floe.

XE2N seems to be on all bands. No doubt he shifts from 10 to 20 to 40 meters, but it sounds as if he is always on.

W1JPE is most consistent of the Hartford Headquarters Gang outside of W1AW. We have noticed out on the West Coast

that unusual DX comes in during, or just after a rainstorm. This is due partly, no doubt, to the power noises being drowned out, but partly due to the low pressure area coming in from certain directions, thus clearing up the air.

California's Mission Trail net has been assisting the American Legion in organizing an emergency system. The American Legion Posts of each city are furnishing funds.

Some of the stations coming in good during the DX test include the following: On 7 megacycles — YS2LR, J8CB, VM8AB, F8CQ, ON+MW.

Some of those coming in at L. A. on 20 meters, include: VP2LC, SM7MU, ON4NW, SP1MX, PY2BJ, OZ2M, OZ9Q, ES5C, ES5D, G6MC, G2MI, VO1D, PA0QQ, HH2MC, PK1WA, PK4KS, G6WY, F8KJ, and DJ6KHW.

W9LME tells that one day an SWL came to him and asked, "Who is this guy CQ that everyone calls? I can never tune him in!"

W9VVO has had an amateur license for four years and hasn't been on the air yet!

In his excitement over the birth of a YL junior op, what ham put a 160M crystal in his rig and tried to tune to 20 meters? How could he double to 20 meters with one doubler, push-pull buffer, and push-pull final?

Because his '36 call book listed the call and name differently, W9YTM thought the present W9LME a "hootie." No hard feelings after all was straightened out, though!

-50-

Build a Tele-Receiver

(Continued from page 13)

and the plate of the 6F6 video amplifier. Also, the condenser from the cathode ray control grid to its cathode must be insulated for 2000 volts to ground. The focusing and bias potentiometers are part of the high voltage bleeder and are mounted on bakelite sub-panels and supplied with insulated extension shafts. The videtron tube socket is mounted in a manner that

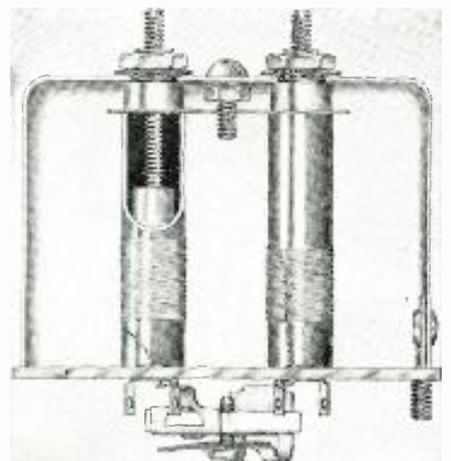

Internal I.F. construction permits a few degrees rotation about its long axis so that the edges of the picture may be made truly vertical and horizontal. Provision is also made at the tube socket to accommodate the commercial variation in the overall length of the tubes.

Synchronizing Pulse Clipper

Returning to the 6H6, the synchronizing circuit begins with the other diode plate, the cathode of which is

connected to a resistance capacity network.

Synchronizing pulses are separated from each other in the "synchronizing separator coils" in the plate circuit of the 1852 synchronizing separator tube. Horizontal synchronizing pulses appear at the secondary coil while vertical synchronizing pulses appear across a condenser in the plate circuit of the 1852 tube.

The sweep circuits are of the multi-vibrator type and are easily adjusted for sweep amplitude and frequency. The separated synchronizing pulses are applied to the control grids of the 6L7G's through suitable coupling condensers.

The sound channel consists of an 1853 i.f. amplifier, a 6SQ7 second detector, first audio and A.V.C., a 6V6 output tube, and a 6-inch electrodynamic speaker, the field of which is a part of the low voltage filter. The same type of tuning and capacity coupling system used in the picture i.f. transformers is employed, although, of course, the pass band of this stage is far sharper and the amplification higher than in a picture i.f. stage. The sound i.f. should, however, be broad enough so that some adjustment of the oscillator frequency may be made (for best picture) without noticeably affecting the sound reproduction. The frequency to which the sound i.f. is tuned is 8.25 mc. —50—

Within Earshot
(Continued from page 4)

out that brain child of yours.

We urge that you do not hold off buying that radio set until that time.

* * *

WE wrote to many persons asking their opinions on television. Some of the replies we received follow:

"I am vitally interested in the development and perfection of Television. It will accomplish much for the people of the United States in the way of entertainment, education, employment, and public enlightenment of important questions. Radio has filled a long existing need and brings a closer relationship between people and leaders of industry, government and education. Television will bring a still closer contact between those who must carry their message to the public, whether it be through entertainment, advertising or commercial purposes, or in political and public matters. I believe the surface has only been touched and the years to come will bring to us all a communication system that many who are today engaged in the development of the industry, believe impossible. I heartily congratulate those who have pioneered this industry, and to those working for perfection I give my assurance of co-operation and support in any manner where I may be able to aid in the development of this great industry."

Culbert L. Olsen,
Governor, State of California.

Dear Sirs:

It is indeed encouraging to know that the practical application of television is about to be realized in America. In my opinion, television will usher in a new era of entertainment and education that will be of immeasurable value to our people. In addition, it will provide a new field of employment as well as furnish a further impetus to the march of progress in this country.

Sincerely yours,
Edward J. Kelly,
Mayor, City of Chicago.

Dear Sirs:

The study of music is only one way in which television may be used to enrich the lives of all the people. Carry this example over into the fields of art, of science, of

sport, of entertainment, of diplomacy! There are no limits which cannot be reached, and no promise which cannot be fulfilled by the miracle of the future—Television!

Sincerely,
Leland W. Cutler,
President, Golden Gate
International Exposition.

Dear Sir:

Television will open new fields of entertainment which stagger the imagination when viewed in the light of new accepted standards.

Naturally, it is in its infancy. The present development may be compared to the commercial broadcasting of 1922—but remember the pleasure we derived then from the broadcasting of that era.

In those days there were hundreds of thousands of experimenters playing with the problems of the newly developed art. How much more has Television to offer the experimenter of today than the simple circuits of yesterday.

Very truly yours,
Vince Rockey,
Vice-President, Meissner Mfg. Co.

To these gentlemen, as well as the others who so kindly answered our inquiries, we offer our grateful thanks. We received many more expressions, but space requirements prohibit their inclusion in the column.

* * *

A GREAT many of those interested in radio are at the same time followers of the art of Daguerre. Right across the isle from our office there has been a lot of hustle and bustle. Curious, we finally cornered Andy Hecht, Managing Editor of *Popular Photography*, our sister publication, and asked what was going on. He threw over the dummy of the next issue of his publication for our inspection. It is practically a complete directory of photography. We never knew there was so much to that interesting field. The magazine contains a listing of cameras, projectors, film, lights, enlargers, developing chemicals, printing papers, bromide papers, etc., etc. Andy told us that it was a swell catalog of modern photographic equipment. We pass this information on to you. Make sure that you won't miss this great May issue of *Pop. Photo*.

* * *

WE had occasion to talk to OQ5AE who paid us a visit. When he did he was over 10,000 miles away from his home in the Belgian Congo. He was on his way back. Instead of crude hand run equipment which he had last year, he goes fully fitted out with gasoline driven generators and fine equipment. Among the very many interesting things that he told us was the fact that he has to go over 800 miles to get his mail. We were exceptionally fortunate in making an exclusive contract with OQ5AE to publish his experiences in the forthcoming issues. He has promised us thrilling stories of his ham work in one of the most out-of-the-world QRA's.

* * *

WHEN the broadcasting industry was in its infancy, not so very long ago, the very first listening audience was composed almost entirely of experimenters who built their own receivers. Most of the information for the building of these instruments was furnished by the manufacturers alike to all. Today, the one thing that is holding back television most, is the lack of a large number of "viewers." In the final analysis this audience will come via the home-constructors and experimenters who will lead the expected millions of every-day listeners and viewers into the field.

As in the past, it will be the experimenter with his advanced knowledge who will pioneer the general television audience. A large number of these pioneers already exist in the West where Don Lee made plans of receivers available to all simultaneously with the erection of his telecasting stations.

While there is much to be said on the side of manufacturers in keeping their circuits secret, and thus attempting to maintain superiority over their competitors, the eventual universal acceptance of television rests entirely with the public. What better way is there to get that public "hot" for television than to "let them in on the inside" and give the many who are anxious to build television receivers, the impetus they need with complete information? KAK.

EARN BIG MONEY
selling new Lafayette streamlined P.A.



MODERNIZE

is the word today. Restaurants, ball-rooms, schools, churches, hospitals— institutions of every kind are taking heed! The standout trend is to Public Address:— and the standout buy in Public Address is LAFAYETTE!

YOU CAN DO IT --

Sell this new streamlined P.A. Earn big money. Hundreds of restaurant owners, public officials, institution superintendents are eager to have sound re-enforcement equipment. You can sell Lafayette systems easily— prices are unusually attractive. Lafayette systems can be sold with confidence! Lafayette enjoys the benefit of 18 years' engineering experience, the facilities of the world's largest plant exclusively devoted to P.A.

YEARS-AHEAD P. A.

For 1939 Lafayette offers a line of sound systems so new, so advanced in scope and style and engineering, so packed with Tomorrow's features, that the prices you quote become purse-openers every time! With Lafayette, you have a sound system to fit every prospect's needs. For this year Lafayette—and only Lafayette— offers three complete lines of P.A.—the Lafayette Economy, Standard and Deluxe ranges.

WRITE AT ONCE
for complete information and catalog. Earn big profits. Be the man to see for P.A. in your district. Remember—Lafayette is the most complete line of sound equipment in the world!

LAFAYETTE
p. a. sales division
NEW YORK • ATLANTA
CHICAGO

LAFAYETTE RADIO CORPORATION
Dept. 2EP9, 100 Sixth Ave., New York, N. Y.
Yes—send me complete information on how to make more money in P.A.

Name _____ PLEASE PRINT
Address _____
City _____ State _____

RADIO ENGINEERING, broadcasting, aviation and police radio, servicing, marine and Morse telegraphy taught thoroughly. 48 weeks' engineering course equivalent to three years' college radio work. School established 1874. All expenses low. Catalog free. **DODGE'S INSTITUTE**, Oak St., Valparaiso, Ind.

New Style and Performance to Modernize Your Equipment at Amazing Low Cost!

New TURNER Torpedo Crystal Microphone



MODEL 55C

Slide open coupler, 15 ft. cable. Level -50DB. 50-7000 cycles, free wiring diagrams.

IT'S easy and inexpensive to give your equipment up-to-date good looks and top-quality performance with the new Turner Torpedo. Impressive full-plated finish. Streamline design and absolute absence of peaks reduce feedback. Guaranteed to out-perform many mikes selling for 50% more! Works directly into grid of almost any amplifier. Order today.

Write for Bulletin 41-A. Learn all about the latest developments in microphones. Details and applications of all models given in Free Bulletin 41-A. Know your stuff about mikes; write for your copy today!

\$1595 LIST

THE TURNER CO.

CEDAR RAPIDS, IOWA

Licensed Under Patents of the Brush Development Co

Please mention RADIO NEWS when writing to advertisers.

Ghirardi books for SERVICE MEN

MODERN Radio SERVICING

LEARN How with This! **TO STUDY UP**

Here is your practical training for radio service work complete in this 1 big 1300-page book—explains everything essential for a thorough grounding in the basic fundamentals of modern service work. Ghirardi makes it all wonderfully clear and easy to understand. It's the best word in radio servicing course! Here's what it covers:

- Test Equipment—Theory, Descriptions and Diagrams of all Commercial Instruments, How they Work, Construction Data, etc.
- Trouble-Shooting—Nearest short-cut methods for trouble-shooting even the most complicated receivers.
- Repairing—Advanced "Factory-Method" for Repairing all Parts, explained fully.
- Special Problems—Servicing All-Wave and High-Fidelity Sets, "Water-tight" Sets, Auto Radios, etc.



\$4
1700 PAGES 706 ILLUS.

RADIO Trouble-Shooters HANDBOOK

WORK with This! **TO SPEED UP**

Here's a new kind of time-saver for service men—different from anything you've ever seen before. It's chock-full of factory-checked "bench-data" that will speed up every service job you do! It's the greatest mass of practical working data ever assembled in one book! It's a Profit-Maker!!

- 313 Case Histories—Trouble Symptoms and Remedies compiled from actual Service Records.
- I-F Peaks—Over 15,000 Listings for alignment of all Superhets.
- Other Data—Auto-Radio Data for Installation, Interference Elimination, etc.; Trouble-Shooting Charts; Servicing Intercommunicator; Trade Directories; Tube Data; and dozens of Charts and Tables.



\$3
538 PAGES, 134 ILLUS., Standard Manual Size (8 1/2 x 11), Fabricoid-bound.

USE THEM 5 DAYS—our risk

Return them if not satisfied

Radio & Tech. Publ. Co.
45 Astor Pl., New York, Dept. RN-59

Enclosed find payment for:—

MODERN RADIO SERVICING RADIO TROUBLE-SHOOTERS' HANDBOOK BOTH books at Special Combination Price

NAME.....
ADDRESS.....
CITY..... STATE.....

Check Here for FREE Circulars

MAIL NOW!

Test Panel
(Continued from page 35)

cut. To read DC volts, where such a sensitive indicator as a vacuum tube voltmeter is not needed, S4 connects the 1000 ohms per volt meter circuit to a pair of tip jacks. S2 permits the selection of the proper resistors of the multiplier for the voltage to be read. This selection applies to both the vacuum tube voltmeter and the regular voltmeter. S3 is necessary to throw the milliammeter into the bridge circuit at the same time shorting the position it was in, in the circuit.

Construction

The frequency meter-monitor section is housed in a 6" cubed cabinet fastened to the front panel. The parts used in this circuit are first built up on a 5 1/2" square bakelite panel which is then fastened vertically in the cabinet by means of small angle brackets. The padding condenser is accessible through a 3/8" hole in the rear of the cabinet.

The coil was made to plug in from the front of the panel; it was planned to use the instrument as a field strength meter and as an indicator when neutralizing RF amplifiers. The power supply and vacuum tube voltmeter are built on a 6"x6" chassis.

All controls are accessible from the front of the panel with the exception of the ohmmeter adjustment. Since this need only be adjusted when the battery voltage drops, this was placed behind the panel. The two tubes on this chassis are placed at the rear, in line with the octal socket into which is plugged the cable of the 6J7 used in the vacuum tube voltmeter. This cable is made up of one male and one female octal plugs joined together by a three foot length of 5-wire shielded cable.

Under the chassis is mounted the power transformer, choke and condensers, along with the resistors which form the bridge circuit. The resistors, which form the regular voltmeter circuit, are placed on top because of the lack of space underneath.

The dial used on the frequency meter was chosen for financial reasons. However, a vernier dial may be used permitting more accurate calibration. The frequency meter was calibrated by the well known method described in any handbook or back issues of RADIO NEWS, so there is no need to go into details here.

Operation

The frequency meter is operated in the usual manner, being sure S1 is in the proper position to supply plate voltage to the unit. To obtain the signal, connect a lead from the tip jack of the monitor to the input grid circuit of the audio stage of the receiver. This lead had best be shielded, the shield being grounded on both the receiver and the test panel.

To operate the vacuum tube voltmeter, throw S1 to proper position.

Short circuit grid input leads across R4. Set R17 to minimum and S4 to VTM position. The meter should now read zero. Throw S3 into the up position and S2 in the approximate range of voltage to be measured. Adjust bias resistor R16 so milliammeter reads zero. Clip input leads to circuit being measured, placing a .1 mfd. condenser in series with the grid lead if a.c. is being measured. If d.c. is being measured, omit the condenser. Now adjust R17 so that meter again reads zero. This indicates that the bucking voltage, supplied by R17, has balanced the bridge circuit. This voltage is equal to the peak voltage introduced into the grid circuit of the 6J7 tube. Now throw S3 to the down position which will connect the meter, through the multiplier resistors, R9, R10, R11, R12, R13, to read this voltage. To find the RMS voltage multiply by .707.

To utilize the regular, 1000-ohms-per-volt meter, throw S4 to connect the tip jacks, S3 down, and S2 to range of voltage being measured. The ohmmeter is used in the regular manner.

The uses to which this test panel may be placed, besides those already mentioned, include the measurement of AF and RF voltages, AVC and AFC voltages, determining values of inductance and capacity, and for receiver alignment. Its flexibility permits its use in a great variety of other applications.

-30-

Communications Receiver
(Continued from page 27)

band. At the lower right are the i.f. gain, or selectivity-c.w. knob, and the antenna trimmer—for no chances are taken with exact circuit tracking by using fixed antenna trimmer condensers. This just doesn't work with such selectivity as is had from a properly regenerating first detector. At the upper right is the knob of the six-position insulated wave change switch which selects individual coils for each band, automatically shorting all unused coils out of circuit. At lower left are tone and volume controls, head-phone jack, send-receive switch and a.v.c. on-off switch.

Directly behind the tuning condenser gang is the 1A7G first detector tube, with at its right the 1A5G oscillator—a power pentode to insure plenty of output at all frequencies throughout the receiver's tuning range. Directly behind these tubes are the first i.f. transformer, 1N5G regenerative i.f. amplifier, second i.f. transformer, 1H5G diode second detector, a.v.c. and first audio, and 1G4G audio driver amplifier, transformer coupled to the 1G6G twin-triode Class B power amplifier at the left front of the chassis.

This logical progression of circuits makes for maximum compactness and shortest possible leads, and at the same time leaves space for the Bur-

gess No. 44 1½ volt A battery and two Burgess No. Z3ON 45 volt B batteries on the chassis. These batteries will give about 30 days life at a rate of an hour or two a day usage, are cheap and easily replaced when needed from the stock of almost any radio dealer. For permanent station use larger external batteries would be preferable, while a small a.c.-d.c. "B" pack will probably be available to fit in place of the B batteries for permanent station use. Thus one set serves two purposes—and serves each one well—as both portable and permanent communication receiver.

Circuit-wise, the receiver closely resembles the "Silver-Super" reviewed last month, and from which it takes its origin. It has a number of new points of interest, however, in the lineup of the six tubes. First is a 1A7G regenerative, with its normal oscillator grid used for separate oscillator injection, since the 1A7G when functioning as both detector and oscillator will not operate satisfactorily down to 5 meters. Only one set of coils, as for one wave-band, are diagrammed for detector and oscillator, but actually there are twelve coils, a pair to each of the six wave-bands. The antenna circuit trimmer condenser C2, is shown connected from antenna to grid. This is a neat little trick that enables it to trim the grid circuit at the same time it adds a bit of capacity coupling between primary and secondary—so desirable to equalize r.f. gain over

each band. Regeneration is had in a somewhat new manner which both renders it stable and free of antenna reaction when used with high-impedance antenna primaries, but which prevents any marked reaction on circuit frequency. An r.f. choke of quite special design, tho very ordinary appearance (no, just any 10 mh. r.f. choke *won't* do the job) is included in the plate circuit between B+ and the first i.f. transformer primary. The r.f. voltage developed across this choke is fed back to the grid circuit (actually across the impedance of C3 in the grid return) thru C1. The direct current grid return is thru R1, the impedance of which is much greater than that of C3.

The balance of the circuit is quite conventional, even tho it employs the new 1G4G driver and 1G6G (1.4 volt version of the 2 volt type 19) twin-triode, push-pull Class B tubes to get what is plenty of loud-speaker volume.

-30-

Don Lee Receiver
(Continued from page 26)

receiver is increased to a maximum value, and the tuning dial set to some position near the high frequency end of the broadcast range at a point where a broadcast station is *not* received. Nearby powerful broadcast stations are sometimes received by stray pickup in a receiver and this must be avoided otherwise the program of such station and the television aural program will be heard simultaneously.

Condensers C1 and C15 may be brought to two separate dials on the front of the converter unit, or if ganged, should be coupled by an adjustable coupling. This may be of any simple type. To tune in the aural program attempt to do so during a regularly scheduled program and adjust condensers C1 and C15 opposite to each other until the program is received. The inductance of the coils may also require adjustment. This is accomplished by squeezing the turns closer together to increase inductance, or pulling them apart to decrease inductance. There must be a slight mismatch between the tuning of the first detector resonant circuit and the oscillator resonant circuit so that the intermediate frequency may be produced according to the usual theory of the operation of the superheterodyne receiver. In this instance the intermediate frequency provided by the circuits of the broadcast receiver as a whole is in the neighborhood of 1400 kc. Final adjustment of the tuning dial of the broadcast receiver will give a vernier tuning adjustment.

If you desire to utilize the new electro magnetic deflection Kinescopes type RCA 1800 or 1801 they may be adapted to the diagram.

The scanning sources shown as "low frequency sweep" and "high frequency sweep" on the diagram are adapted for electrostatic deflection of the RCA

SUMMER EQUIPMENT FOR THE SERVICEMAN

HOW about that battery equipment, those camping sets, trouble in out-of-the-ordinary circumstances? Can you service a radio set under those conditions? Are you prepared for the summer? Get ready for it, by reading up on all the latest servicing equipment especially designed for that purpose. You'll find a wealth of information all through the



BIG JUNE ISSUE

RADIO NEWS

ON SALE MAY 10

An RCA DOUBLE FEATURE that's good news for you!



AMAZINGLY LOW-PRICED AC TEST OSCILLATOR



\$29.95 NET
Stock No. 153

Here's an instrument that will align even the toughest receivers! This RCA test oscillator features a giant 6" dial—actually more than 50" in length—which makes settings easy to read. The high frequency range alone covers 10"! Frequency range 100-30,000 kc. on fundamentals. Also features stability of circuit design. Uses RCA Metal Tubes. Among its many other features is complete fuse protection. And look at its low price!



NEW RCA MULTI-RANGE WAVE TRAP

\$1.85 LIST PRICE
Stock No. 31033P



Here's your answer to the problem of poor reception due to unwanted interference! It's the RCA Multi-Range Wave Trap—frequency range 450-2100 kc. This new unit is tuned by a magnetic core which provides a simple linear and permanent adjustment. It is adequately shielded for protection against interference and reaction with receiver circuits. Attenuation 40 to 1. It is small—easy to install—at a price hard to beat!

Listen to the Magic Key of RCA every Sunday, 2 to 3 P. M., E. D. S. T., on the NBC Blue Network
Over 325 million RCA radio tubes have been purchased by radio users...in tubes, as in parts and test equipment, it pays to go RCA All the Way.



I assure you

that a fair and square deal, every time, is the only way to keep up a successful business. That must be right, because since 1925 more and more men have been buying their radio equipment from me.

You, too, will find it to your advantage to deal with me whenever you want to buy a new receiver, transmitter, or any other equipment.

My personal attention to your wishes, fair trade-in allowances, reasonable terms for your convenience, prompt safe delivery, and above all—a sincere desire to give you full co-operation—is your assurance of complete and lasting satisfaction.

Be sure to write to me.

Bill Harrison, W2AVA

TIME PAYMENTS?

Check these easy terms—

Receiver	Cash Price	Down Payment	Monthly Payments 8 OR 12
NC-101-X			
HQ-120-X	\$129.00	\$19.96	\$14.21 \$9.66
NC-100A	120.00	18.48	13.22 9.00
S-16, Breting-49, NC-81-X, NC-80-X	99.00	15.34	10.90 7.41
SX-23, speaker	127.50	19.40	14.01 9.58
SX-16, speaker	123.00	15.60	13.47 9.16
SX-17, speaker	149.50	22.60	16.53 11.25
RME-69	152.88	24.10	16.78 11.41
RME-70	138.60	21.10	15.31 10.41

I can change these terms to suit your convenience.

Also terms on all Hallcrafters, Hammarlund, National, RME, Howard, Sargent, Breting, Patterson, Tenico, RCA, Thordarson, Utah, etc., Receivers, Transmitters and Kits.

Good values! Send stamp for list.

OUR USED DEPT

has many good reconditioned and guaranteed trade-in Receivers and Transmitters at attractive prices.

HARRISON RADIO CO.
11 West Broadway, New York City

"DYNAMIC CONDUCTANCE" TUBE TESTER



Tests Loktal and Single Ended Tubes



This new Model 9000 tube tester takes full advantage of the greater accuracy afforded by dynamic mutual conductance circuit. Also tests pilot lamps and Christmas tree bulbs. Portable or counter use. Costs only \$37.50. See your jobber today!

CONSOLIDATED CORPORATION
WIRE AND ASSOCIATED

526 S. Peoria St.

Chicago, Ill.

905 five inch DuMont 54-8-H five inch, or Mullard A41-G4 (England) four inch tubes, and with a push-pull amplifier added to the output thereof, for the DuMont 54-10-T five inch and 144-10-T twelve inch types. A deflecting yoke of either the simple or improved type must also be constructed for magnetic deflection.

In placing the superheterodyne visual frequency receiver in operation if constructed according to diagram it is likewise important that Condensers C1 and C15 be staggered to give an intermediate frequency of approximately 8000 kc. To accomplish this the two condenser rotors must be misaligned mechanically about 1/8" on the periphery thereof. Neglect in making this adjustment has sometimes caused needless trouble in putting the visual receiver into operation.

Record Player

(Continued from page 37)

entertainment is the provision of a microphone jack as shown. When a single-button carbon microphone is plugged into this jack the voice of anyone speaking into the microphone is heard through the radio. Thus announcements can be made in-between recorded selections, recorded music may be made to serve as an accompaniment for the voice, or the listeners may be "kidded" no end if the record player and microphone are located in another room out of their sight.

As shown in the circuit, a 6A8G pentagrid converter tube is employed in a somewhat unorthodox manner in that grid No. 4 and the plate serve as the r.f. oscillator elements rather than the more usual No. 1 and No. 2 grids. Grid No. 2 is not used at all. By impressing the audio output voltage of the pickup on grid No. 1 the electron stream is modulated and this in turn modulates the oscillator output. In this way effective modulation of the carrier is obtained with the minimum of equipment and complications.

The oscillator coil, which may be an ordinary broadcast oscillator coil, and tuning condenser (one of the trimmer type) resonate the circuit in the broadcast band. Normally this circuit is tuned to the vicinity of 1200 kc. (250 meters) but should there be a powerful local broadcast station on this frequency the oscillator may be adjusted by means of a screwdriver to any nearby channel that is clear. The presence of a distant station on the same channel will not cause interference as the output of the record player, if located within a few feet of the receiver, will be sufficiently great to blanket the distant station.

CONSTRUCTION

It matters but little as to just which method of building the unit is used as long as short leads may be used between parts. A metal chassis would be very suitable provided that no direct wiring is made to this base. Remember that one side of the line is

ELECTRICITY

FROM YOUR OWN ELECTRIC PLANT WHEN POWER LINES FAIL

ONAN A.C. ELECTRIC PLANTS supply current for Radios, Transmitters and Receivers, F. A. Systems, Movie Projectors, Sound Truck Apparatus, Tools, Lights, All Appliances, Used as Standby Equipment in Schools, Hospitals, Theatres and Public Buildings in case of Power Line Failure due to Storms, Floods, etc. Available in 110 or 220 Volt A.C.—12, 32 and 110 Volt D.C.—Also Dual Voltage AC-DC Types. Manual, Full-Automatic & Self-Starting. Big and up. Shipped, Ready to Run.

D. W. ONAN & SONS
1487 Regalton Avenue, Minneapolis, Minn.

Check the NEW LOCTAL TUBES with Certainty!

Naald adapters are the ones you can safely buy—worked out in collaboration with instrument and tube manufacturers, they insure perfect operation over long life period.

Insist on Naald sockets in any new equipment which you purchase—use no other than Naald to bring your present equipment up to the minute.

It is an item you buy but once—get the best—correctly wired—correctly thought out—with contacts which have proven themselves superior in long life service.

Order through your jobber or write us direct.

ALDEN PRODUCTS CO., 717 Center St., Brockton, Mass.

WE HAVE The RADIO YOU WANT

Our 1939 catalog is chock full of new Standard Brand Radios for Home - Farm - Auto. Over 400 models. Also hundreds of Electric Appliances for the home. Celebrating our 50th Anniversary with Big Bargains. Write for your copy today. It's FREE.

MODELL'S, Dept. G-27 Cortlandt St., N. Y. C.

EVERYTHING IN RADIO!

A COMPLETE SOURCE FOR YOUR RADIO NEEDS

Our immense stock of radio sets, parts and supplies enables you to purchase your entire needs on one order. You will find all your Nationally Known Favorites in this big book which is FREE for the asking. Practically every order is shipped the same day it is received.

WRITE FOR BIG NEW CATALOG

BURSTEIN-APPLEBEE CO.
2012-4 McGee St. • Kansas City, Mo.



WILLIAM PORTER MILLARD BELIN IVAN STEMENOV

THEY GAVE DEATH WINGS

When destiny places three such as these at loggerheads in the "most dangerous game" something is bound to happen. Here is a powerful, potent glimpse of an incredible aerial menace that COULD COME TO AMERICA! You'll thrill to this prophetic vision in

The WHISTLING DEATH

by ABNER J. GELULA

JUST ONE OF THE SEVEN SUPER STORIES IN THE ALL STAR JUNE ISSUE

AMAZING STORIES

On Sale Now At All Newsstands

When writing to advertisers please mention RADIO NEWS.



E. H. RIETZKE PRES. OF CREI

Is Radio . . . Just A Job to You?

If you can equip yourself with the necessary training . . . Radio can offer you a future in other industry can. Continuous new developments have created a need for technically trained men, who have kept their knowledge up with Radio's fast pace.

YOU CAN'T BLUFF YOUR WAY

CREI courses are planned only for serious minded men who know that it takes Training to qualify for and to hold the big jobs and salaries that go with them. Let us suggest the course best suited for you and the easy ways of paying for it.

Write for the CREI "TESTED PLAN"

Sent free on request. Answers all questions about yourself and your future. Fully illustrated and crammed with information. Write for your copy now.

CAPITOL RADIO
Engineering Institute

MAIL THIS COUPON TODAY!

CAPITOL RADIO ENGINEERING INSTITUTE
Dept. RNS, 3224-16th St. N. W., Wash., D. C.

Please send me your booklet "A Tested Plan for a Future in Practical Radio Engineering." I am interested in the course checked:
 Home Study Course. 1-Yr. Residence Course.

Name..... Age.....
 Address.....
 City..... State.....

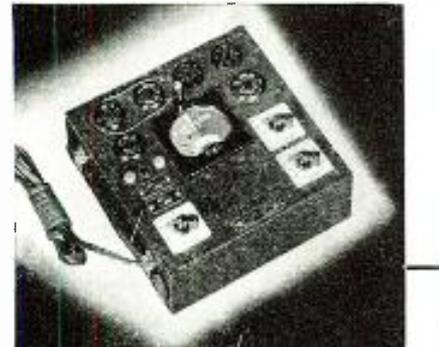

• MILLION •

UNIVERSAL TUBE TESTER
FOR ALL TUBES
LOCTAL SOCKET—NO ADAPTERS

MODERN
ACCURATE
DEPENDABLE
ECONOMICAL

\$13.95

NET CASH

Up-to-the-minute in design. Tests emission of all tubes including the new Loctals. Neon shows all shorts or leaks up to 2 megohms with the tube hot. Line voltage adjustment. D'Arsonval meter with special good-bad scale. Rotary selector switch for speed on emission and short tests. Every service man should have one. Up-to-date charts are always available for Million instruments.

All current model Million Tube Testers test both Loctal and S Series tubes without adapters. Older models can be modernized—write for prices.

*If your jobber cannot supply you,
Write us direct.*

MILLION RADIO AND TELEVISION LABS.
577 N. Union St. Chicago, Ill.

"hot" and a condenser should be connected between the filaments and ground as shown in the illustration. The constructor may also mount the parts directly onto the underside of the turntable board where convenient. The coil may be made by revamping a standard broadcast coil. Remove the primary winding from the coil and then wind about 35 turns of No. 32 enamelled wire close to the original primary position. If the primary has this number of turns, it may be retained as-is. Connect the other parts as shown and complete the wiring.

Filtering of the A.C. ripple is done with a 7500 ohm resistor and two condensers of 16 mfd. each. It is not necessary to use a filter choke in this position as the current drawn by the tube is very low in value. The tuning condenser across the oscillator coil is given as 300 mmfd. (.0003) but this value may have to be changed for certain coils. To be safe, it will be best to use a value at this position that was used on the discarded coil from some old receiver. Better yet, use one of the small compression type padder condensers which can then be mounted within the can with the other parts and adjustments made with a screw-driver.

The .05 mfd. condenser across the line has been found important in eliminating the last traces of hum. The filaments of both tubes are supplied through a 360-ohm resistor, preferably of the line cord type.

It may be well to point out here that while this unit is actually a transmitter, it does not fall within the class requiring a license from the F.C.C. because of its relatively infinitesimal radiation and because it is not employed for communication. However, the constructor should not, under any circumstances, employ a long wire for the radiating antenna, higher voltages for plate and screen supply, nor a higher power oscillator tube than those indicated in the circuit. Any of these variations may result in radiation high enough to interfere with broadcast reception in neighboring apartments or houses, making the possessor of the radiating device liable to prosecution by the Federal Government. Such radiation places the device in the class with regular radio transmitters for which both station and operator's licenses are required. The F.C.C. tentative specifications state that to avoid causing interference a device such as described here must not radiate a signal greater than 15 microvolts per meter when measured at a distance which, in feet, is arrived at by dividing 157,000 by the frequency in kilocycles. If the frequency is 1200 kilocycles, this means approximately 130 feet. It is impossible for the average experimenter to make actual measurements of this kind so the only safe way is to keep radiation so low that infraction of this rule will be impossible.

**MY FREE BOOK SHOWS HOW
YOU CAN BECOME A
MONEY-MAKING
RADIO EXPERT!**

with my New
SPRAYBERRY
Personalized
HOME TRAINING
in
RADIO
AND TELEVISION

EASY TO START...
EARN WHILE YOU LEARN

I Train You Quickly
in Your Spare Hours
Right at Home

You Do Practical Experiments with
Real Equipment

I offer you a new and altogether different type of practical training for a money-making career in Radio and Television. I teach you in a simplified, logical, understandable style . . . all about Television, Electronics, Encasible Radio, Radio Set Repair and Installation. I GIVE YOU PERSONAL COACHING ALL THE WAY.

TRAINING PREPARES YOU FOR GOOD RADIO JOBS . . . at Excellent Pay

No matter if you desire to BE YOUR OWN BOSS in your own business or hold down a good job in Radio, my Training will give you the useful information and knowledge to win success. DON'T JUST WISH FOR MORE MONEY—START TRAINING FOR IT RIGHT NOW.

Read What This Student Says:

EARNED \$250 SINCE STARTING COURSE

"I have only completed one-third of the Sprayberry Course and I find it very interesting, which makes it easy to learn."
 "By devoting several hours of my spare time daily to studying and servicing, I have made about \$250 gross since starting the Course." Earl W. Hostetter, R. No. 4, Lebanon, Pa.

**YOU GET
PROFESSIONAL
TEST EQUIPMENT
PLUS EXPERIMENTAL
OUTFITS**



140 RADIO PARTS

Includes a complete 5-tube Radio Receiver, RADIO TOOLS, ALL-WAVE, ALL-PURPOSE ANALYZER. Besides its invaluable use in experimental work, my equipment will enable you to make spare time profits while you're learning and can serve you in your own Service business later on. I give you DATA SHEETS on how to build popular Radio circuits. Also you receive BUSINESS BUILDERS which show you how to get and do spare time, non-hourhood Radio Service work.



RADIO TOOLS



ALL PURPOSE ANALYZER

**NO PREVIOUS EXPERIENCE
NEEDED**

My Training starts right at the beginning of Radio . . . covers all the essential subjects. It makes no difference what your education has been. I can fit you for an excellent paying job in Radio. Your success is my full responsibility. I know how to get Radio news so that you will understand it . . . and remember it.

SERVICEMEN

I offer Advanced Training for those already in Radio. Get complete details in my FREE 52-page Book.

REMEMBER — THE SPRAYBERRY COURSE IS SOLD UNDER A MONEY-BACK AGREEMENT

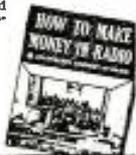

RUSH THIS COUPON FREE BOOK
for BIG FREE BOOK

DON'T DELAY! ACT NOW!

SPRAYBERRY ACADEMY OF RADIO
E. L. Sprayberry, Pres.
225-E University Place, N.W., Washington, D. C.

Please send me FREE copy of "HOW TO MAKE MONEY IN RADIO."

Name..... Age.....
 Address.....
 City..... State.....

Tear off this coupon, mail in envelope or paste on penny postcard. Servicemen—Check here

Select your FOUNDATION INSTRUMENTS from TRIPLETT'S complete line

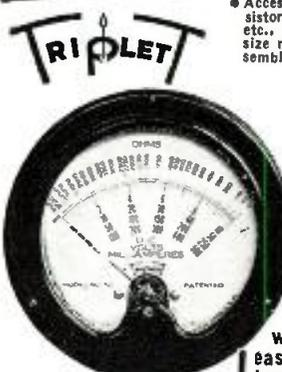

• Accessory shunts, resistors, terminal wires, etc., available for all size meters in kit assemblies.

5" Model 521

Long Scale, 1000 Ohms per Volt. Accuracy 2%.

Has full open white dial with easily read markings in black.

• Model 521 5" Instrument only..... Dealer Price, \$7.00
Shunts and resistors may be purchased for required ranges.

OTHER TRIPLETT FOUNDATION INSTRUMENTS—All 1000 Ohms per Volt.

Model	Case Style	Net Price
Model 321	3" Round	\$ 5.00
Model 326	3" Square	5.00
Model 421	4" Square	6.33
Model 726	7" Square	11.67

Write for Complete Information on Kit prices—also 25,000 Ohms per Volt Instruments.

SEE YOUR JOBBER
WRITE FOR CATALOG SECTION 155

THE TRIPLETT ELECTRICAL INSTRUMENT CO.
Bluffton, Ohio

NBC Television
(Continued from page 29)

matter of instantaneous transmission. The fire on Ward's Island, broadcast by the NBC mobile television station last September, was seen by viewers at Radio City while the blazes still leaped into the air. So too, will the sports events and other remote broadcasts we expect to televise have this same quality of suspense, a quality now most closely realized by sound radio. Television alone can tell a complete story whose end cannot be foretold when the story begins to unfold. Television tells a story that cannot be told by sight alone or by sound alone. The audience cannot get a more complete account except by being on the scene itself when an event is occurring.

In discussing the mechanics of picking up a television program, I shall confine myself to live talent studio productions. From a technical standpoint, they are the most difficult of the three general types of program. We may depend on outdoor program material lending itself to television. In any case, we shall probably have no more control over the greater part of the outdoor material we televise than we now have over the subjects of remote broadcasts over our radio networks. Film programs present no problems not taken care of by special projection apparatus and the proper selection of film material.

Let us take a glimpse into the main studio at Radio City. Here, under batteries of overhead lamps which furnish key lighting of several sets adjoining one another on the studio floor, are three Iconoscope cameras. Two of these are on "pedestals" and may be raised or lowered by a silent, motor-driven mechanism. The third is mounted on a standard motion picture "dolly." All move noiselessly before one or more of the stage sets, each taking the successive "shots" indicated on an operations chart drawn up for each camera operator. Lighting technicians apparently find whatever space they can to maneuver standards and an ingenious, flexible lighting "dolly" to give the modeling illumination that lends depth to the televised subject. A boom microphone always hovers above the action, following the cameras from set to set. Separate cables carry the electrical outputs of cameras and microphones to the studio control room, located at one end of the room at a level considerably higher than the studio floor. The control room is the nerve center of the unfolding television program. There are made the final decisions on image characteristics, sound quality and the televised "shots" that go into the broadcast. Flanked on either side by control engineers, the program director selects the image to go out on the air from one of the three monitoring Kinescopes. "Cuts" from one camera to another, or "fades" where these give more artistry to the

It's EASY to learn code THE CANDLER WAY!



If you are having trouble learning code—if you can't make the speed you need for your license—if you want to develop your code so that you can get more real fun out of CW—write Candler! You'll make real progress with the Candler system—you'll learn the correct fundamentals and mental co-ordination—you'll develop sound consciousness—and in a few weeks you'll make more real progress than you will in months of un-directed practice. You'll be amazed to find that you can read code as easily as you read print, without strain or conscious effort, an accomplishment well worth the low cost of Candler Training. Write today for the FREE "Book of Facts." See what others say about the Candler System of learning code—including such Candler trained operators as T. R. McElroy, World's Record Holder and Champion. Do it today—take the first step toward real code proficiency! **FREE! Book of Facts!**

CANDLER SYSTEM CO.
Box 331, Dept. N-5
Asheville, No. Carolina, U. S. A.
British Address: Room 56, Craven House
Kingsway, London W. C. 2

RADIO ENGINEERING



RCA Institutes offer an intensive course of high standard embracing all phases of Radio and Television. Practical training with modern equipment at New York and Chicago schools. Also specialized courses and Home Study Courses under "No obligation" plan. Catalog Dept. RN-39.

RCA INSTITUTES, Inc.
A Radio Corporation of America Service
75 Varlok St., New York 1154 Merchandise Mart, Chicago

Correspondence Courses in RADIO and ELECTRICAL ENGINEERING

ELECTRICAL ENGINEERING Get good grasp of wide electrical field. Prepare yourself at Low Cost, for secure future. Modern course. So simplified anyone can understand quickly.

RADIO ENGINEERING Extra fine course in radio, public address, photo-electric work. Trains you to be super-service man, real vacuum-tube technician. Experimental kits furnished. Diploma on completion.

Either course, only \$25. Deferred payment plan available. Write for free copies of school catalog, student magazine, full details!

LOWAS '25
BENJ. NOWLIN
LINCOLN ENGINEERING SCHOOL, Box 931-R5, Lincoln, Neb.

PHOTO ENLARGER \$5.94



Money back guarantee
A REAL Photo Enlarger that does fine work. Focuses automatically. Also COPIES and has a Contact Printer and Retouching Table. Interesting circular free. Only \$5.94 complete, Lens included.

IDEAL-H, 122 East 25th St., New York

RADIO ENGINEERING DEGREE IN 2 YEARS

Intensive, specialized course, including strong basis in mathematics and electrical engineering, and advanced Radio Theory and Design. Modern laboratory, thorough instruction. Low tuition. Self-help opportunities. Also 2-year courses in Aeronautical, Chemical, Civil, Electrical and Mechanical Engineering. Terms open June, September, December, March. Catalog.

INDIANA TECHNICAL COLLEGE
247 East Washington Blvd., Fort Wayne, Indiana

NOW LEARN A NEW LANGUAGE



in your own home quickly, easily, correctly by the world-famous **LINGUAPHONE Method**. Endorsed by thousands of students, schools and colleges. Send for **FREE Book and 7 Days Trial**.

LINGUAPHONE INSTITUTE
83 R. C. A. Building New York, N. Y.

ACME VOLTROL . . .



For regulating voltage or testing all electronic functions this new Acme Voltrol offers many advantages. Manually operated. Continuous duty. Complete stepless control from 0 to 130 volts. Panel mounting type illustrated especially adapted for radio work. \$12.00 Write for Free Bulletin.

THE ACME ELECTRIC & MANUFACTURING CO.
27 Water Street Cuba, N. Y.

AN AIRMAN Tells How!

GARLAND LINCOLN



famous veteran pilot, leads a parade of equally famous pilots in telling the real truth of how they learned to fly. The absorbing story of the strange incidents that meant the difference between an expert and just an ordinary flyer. You'll be thrilled when you read

I LEARNED ABOUT FLYING FROM THAT

First of a series of revealing articles by noted airmen, in the

Big May Issue

POPULAR AVIATION

ON SALE NOW AT ALL NEWSSTANDS

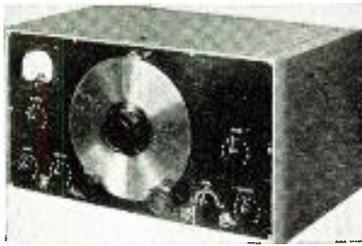

NOT AT twice ITS PRICE!

THE new GUTHMAN U17 "Silver-Super" gives you combined features you can't buy in any other communication receiver at twice its price.

- Calibrated 3" S-Meter
- Six low-C Wave Bands, 5 thru 612 Meters
- New Noise Suppressor System
- Continuously variable selectivity from single-signal c.w. to High-Fidelity
- Automatically stabilized B Voltage
- Terminals for extra external S-R switch and for anti-fading Dual-Diversity Coupler

Priced at only \$49.50 net from all leading jobbers, this outstanding buy comes completely assembled, ready to wire, with every wire color-coded, cut to length and with ends skinned. By wiring it yourself, following complete instructions you learn while you save many dollars.

Send for full details of this new receiver, which brings you features you can't buy at twice its price. And for the P. A. specialist, we have something equally new and startling in U21 P. A. Tuner and 10, 15 and 30 watt power amplifiers. For the amateur, the famous U-10 Frequency Meter-Monitor, U14 Visual Frequency Deviation Meter and modern parts . . . including compact stable U.H.F. variable condensers and r.f. chokes of design that will surprise you.

SEND TO DEPT. RN5 TODAY FOR DETAILS



RADIO NEWS

1939

RADIO and TELEVISION

Data Book

Published by RIFP-DAYN PUBLISHING CO.

It's
FREE
with our
SPECIAL OFFER

NOT FOR SALE!

published entirely as a gift to RADIO NEWS subscribers. You can get your copy, absolutely free, simply by subscribing now to 6 issues of RADIO NEWS for \$1. Present subscribers can obtain copies by extending their subscription for six months. Here's a bargain you can't afford to pass up. Use the coupon below now!

Radio News, Dept. 29D
608 S. Dearborn St., Chicago, Ill.

Enclosed find \$1. Send me the next six issues of RADIO NEWS and rush a copy of the 1939 RADIO DATA BOOK to me without charge. (If renewal, check here).

Name

Address

City State

If you are a serviceman please check here .

production, are made at the touch of pushbuttons. A second control engineer busies himself with each image's overall lighting, and the shading of its various sections. Sound is monitored and controlled in the manner prevalent in sound broadcasting. The studio staff communicates over private line telephone circuits.

The limitations of the television camera have placed an undue importance on textures. Colors apparently identical sometimes appear very different to the Iconoscope. In one instance, about a year ago, a gentleman in a dinner jacket—with woollen body and silk lapels—came out of the Kinescope with a gray jacket trimmed in black.

We have also found it necessary to use comparatively intense lighting in producing programs in our studios. Curiously, our outdoor work has resulted in excellent pictures even under what seemed poor light conditions. Our studio lighting, however, is of about the same intensity as that employed in the production of color films and about twice that used in the production of black-and-white films. Despite this comparatively intense lighting it has been found possible to introduce considerable modeling light from standards and mobile lighting devices on the floor. An entirely new art of studio lighting may arise as the result of experiments in the tele-studios.

Fortunately, none of these obstacles to better television are insuperable. The Iconoscope becomes better month by month. I feel certain that we shall soon find it possible to reduce the amount of studio lighting and make impressive gains in the matter of focal depth. I am sure that with the experience our staff has accumulated during our years of experiment and research we shall surprise even ourselves in the progress we make in all directions once we are on the air regularly.

It is important to emphasize that the problems I have enumerated are essentially transmitter problems; they do not apply to the design of receiving sets. The transmission standards chosen for the launching of an American television service, we feel, are the most advanced in the world. More than that, however, they offer room within their limits for vast improvement in picture quality. In other words, we at the broadcasting end of television can brighten our pictures, improve their detail and eliminate many of the faults that we, who are close to the technical situation, are aware of without necessitating a single change in any of the receivers to be marketed about the time of the opening of the New York World's Fair of 1939. Which is exactly as it should be. The enjoyment of continually improving television pictures and programs will be the lot of the receiver buyer; the headaches will remain with the broadcaster, where they belong.

A NEW Ultra High Frequency Dual TRANSMITTING CONDENSER

This popular "N" series is now augmented by the new type NT-50-GD, shown here with a pair of the "M" mounting feet.

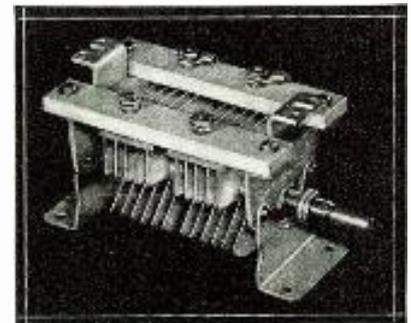

NT-50-GD (Protected by U.S. Pat. No. 1626391)

The wide popularity of our type NP-35-ND for diathermy machines, ultra high frequency oscillators and P.P. amplifiers, has indicated its versatility, and we are flattered by its universal acceptance.

A dual 50 mmfd. unit has been requested, capable of operating in a push pull class "C" amplifier, 100% plate modulated, using such tubes as a pair of T-20's, etc.

SPECIFICATIONS ARE AS FOLLOWS:

TYPE NT-50-GD

- Frame—Same as NP-35-ND
 - Capacity—7.50 mmfd. per section
 - Airgap—.070"—3000 volts peak
 - Plates—Buffed and polished—rounded edges.
 - List \$6.00 each Amateur Net. \$3.60 each
- Above prices are less type M mounting brackets shown in illustration. List Price .20 each. .12 net to amateurs.

THE ALLEN D. CARDWELL MANUFACTURING CORPORATION
89 PROSPECT STREET, BROOKLYN, NEW YORK

TAKE A LOOK!

BIG SAVE-MONEY BOOK FREE

Yes, yours for the asking. Whether you build or buy, you need this amazing catalog. Brand new, up-to-the-minute and crowded to the covers with important savings in radio. Not just a scattering of bargains to deceive you, but page after page of genuine values — all nationally advertised parts, tubes, build-your-own kits and test equipment — the remarkable Lafayette line of receivers, significantly rated "best buys" by consumer groups — new P.A. streamlined for Sell — and on everything you buy, prices consistently lower. It's a grand guide to savings this book. Tear off coupon and mail at once for your FREE copy of catalog 76.

LAFAYETTE RADIO CORP.
WHOLESALE RADIO SERVICE CO.
NEW YORK, N. Y. • CHICAGO, ILL. • ATLANTA, GA.
506 SIXTH AVENUE • 257 W. JACKSON ROAD • 245 TRACHENBERG ST.
BOSTON, MASS. • BRUNN, N. Y. • NEWARK, N. J. • JAMAICA, L. I.

Rush New FREE Radio Catalog No. 76.

Name..... PLEASE PRINT

Address.....

City.....State.....

LAFAYETTE RADIO CORP.
Dept. 2E9—100 Sixth Ave., New York, N. Y.

PASTE COUPON ON PENNY POSTCARD

Learn RADIO

with Ghirard's Home-Training Course
COMPLETE IN 1 BIG BOOK

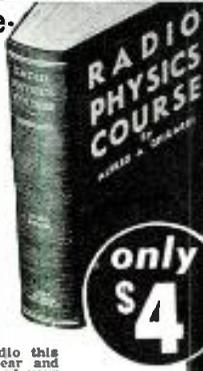

Here is Four BIG CHANCE to get into RADIO! This ONE handy volume gives you the complete fundamentals of Radio, Electricity, Television, Sound and Cathode-Ray Tubes—the same course used by more radio schools and students than any other radio book in the world. Think of it!—for \$4 you too can thoroughly equip yourself for a lifetime radio career!

EASY AS A. B. C.

It's a pleasure to learn radio this way! Everything is made clear and simple—practical short-cuts speed your training. No math—no previous training necessary!

36 VOLUMES IN 1—972 PP.—508 ILLU.

1. Radio Broadcasting System. 2. Sound. Speech, Music. 3. Electron Theory. Elec. Current. 4. Elec. Units; Ohm's Law; Resistance. 5. Elec. Circuits; Batteries. 6. Magnetism. 7. Electromagnetism. 8. Electromagnetic Induction. 9. Inductance. 10. Capacitance; Condensers. 11. A.C. Circuits. 12. Filters. 13. Measuring Instruments. 14. Radio Waves. 15. Broadcasting. 16. Receiving. 17. Vacuum Tube Principles. 18. Vacuum Tube Characteristics. 19. Vacuum Tube Construction. 20. Vacuum Tube Detector and Amplifier Action. 21. Radio Frequency Amplification. 22. "Superhets." 23. R.F. Amplifiers Tuning Receivers. 24. Audio Amplifiers. 25. Speakers. 26. Battery Operated Receivers. 27. Power-Supply Units. 28. Elec. Receivers. 29. Automobile and Aircraft Radio. 30. Photo Pickups; Sound Systems. 31. Short-Wave. 32. Photoelectric Cells; Cathode-Ray Tubes. 33. Television. 34. Antennas and Grounds. 35. Testing, Servicing. 36. Sound Films . . . 856 Self-Review Questions!

USE IT 5 DAYS—OUR RISK!

Yes, if you can part with the book after 5 days, return it and get your money back. No risk—no trouble—just clip the coupon—and mail it NOW!

MAIL COUPON TODAY!

Radio & Technical Publishing Co.,
45 Astor Place, New York, Dept. RN-59.

Here is my \$4. Please send RADIO PHYSICS COURSE postpaid, with money-back guarantee.

NAME
ADDRESS
CITY STATE

Send free descriptive literature.

RADIO ROBOTS

SUPERHUMAN, they were, these metal creatures, made to serve man. But can super machines always be controlled? When mankind finally produces servants such as these, what will he do if they get out of hand? Read the amazing answer to this question in

The REVOLT of the ROBOTS

By ARTHUR R. TOFTE

Just one of many breathless tales of red blooded, unusual adventure

IN THE BIG MAY ISSUE

Fantastic ADVENTURES

NOW ON SALE AT ALL NEWSSTANDS

When writing to advertisers, please mention RADIO NEWS.

RADIO PHYSICS COURSE

(Continued from last month)

Practical aspects of the radiated energy: The intensity of the induction electromagnetic field diminishes as the square of the distance from the antenna, since it spreads out over a large area. This means that if its strength is a certain value at a distance of one foot from the antenna, the strength at 5 feet is one divided by 5 squared, or 1/25 as much. At 10 feet it is 1/100 as much, at 100 feet it is 1/10,000 as much. This means that the effects of the field rapidly weaken as the distance from the antenna is increased. Therefore it plays practically no part in ordinary radio transmission, for at any considerable distance from the transmitter it does not exist at all.

Signals can be transmitted over relatively short distances by the induction field, using a.c. of a frequency from about 300 to 3,000 cycles. This is called "inductive signalling." One of its applications is in transmitting signals from a submerged cable to a ship almost directly over the cable, to aid the ship in navigating in darkness and fog through congested harbors.

Likewise, the induction electrostatic field around the antenna, diminishes in strength *directly* as the distance from the transmitting antenna is increased. Thus at two feet from the antenna the strength is one-half of that at one foot; at 1,000 feet it is one-thousandth of that at one foot, etc. This assumes of course that there are no absorbing bodies in the path of the field. If the induction electrostatic and electromagnetic fields just described, diminish so rapidly in strength as we go away from the transmitting antenna and therefore do not take any important part in ordinary radio transmission over relatively long distances, what then makes it possible to receive our messages? The answer to this question is one of the things which our foremost scientists are now working hard to explain. We cannot see, feel or even measure these fields directly. We must measure them indirectly and must visualize them by means of the effects they produce.

While the author is naturally inclined to favor the explanation he has presented above in terms of the quantum theory, he wishes to caution the student against accepting either of these theories blindly at their face value. They have been given here in detail in an attempt to satisfy the natural curiosity of the student as to just how radio energy is produced and transmitted, to give some idea of what may be going on in the space around radio transmitting stations, and as an incentive for the student to do some original thinking on the subject for his own satisfaction and mental training.

(To be continued)

Classified

Rate 15c per word. Minimum, 10 words.

CORRESPONDENCE COURSES

USED Correspondence Courses and Educational Books sold or rented. Inexpensive. Money-back guarantee. Write for Free Catalog listing 4000 bargains. (Courses Bought.) Lee Mountain, Pisgah, Alabama.

PATENT ATTORNEYS

INVENTORS—Before disclosing your invention to anyone send for Form "Evidence of Conception;" "Schedule of Government and Attorneys' Fees" and instructions. Sent free. Lancaster, Allwine & Rommel, 414 Bowen Building, Washington, D. C.

PATENTS—Advice and booklet free. Highest references. Best results. Promptness assured. Watson E. Coleman. Patent Lawyer, 724 9th Street, Washington, D. C.

INVENTIONS WANTED

INVENTIONS Commercialized. Patented or unpatented. Write Adam Fisher Company, 278 Enright, St. Louis, Missouri.

RADIO ENGINEERING

RADIO Engineering, broadcasting, aviation and police radio, servicing, marine and Morse telegraphy taught thoroughly. All expenses low. Catalog free. Dodge's Institute, Elm St., Valparaiso, Ind.

RADIO

WE buy and sell used radio testing equipment. Harold Davis, Inc., Jackson, Miss.

PLANS 18 Record-breaking Crystal Sets, with "Radiobuilder"—year, 25c. Laboratories, 7700-H East 14th, Oakland, California.

FOR SALE: From old transmitter, but in good condition: 1 Cl.B Output xfmr 809's to 6000-8000 ohms. 1 Cl.B input 500 ohms to pp grids. 1 plate xfmr 1000v. dc. @ 300ma. 4-300MA chokes. 2 dual 100MA chokes. 4 multiple fl. xfms 6.3v, 7.5v, 2.5v, 5v. 3—16mfd 450v. electrolytic cond. 1—2mfd 1500v. oil filled cond. 3—5mfd 1000v. oil filled cond. 2—8mfd 450v. electrolytic cond. 1—16-12mfd dual 450v. electrolytic cond. All of the above have been checked in actual service. Price: \$40 for the lot, or make offers for any part. **RADIO NEWS**, Technical Dept., 608 S. Dearborn St., Chicago, Ill.

MISCELLANEOUS

PHOTOSTAMPS: 1c each from your favorite photograph. Use on QSL's, etc. Hi-Gloss finish. Minimum order \$1.00. U. S. Ultra Service, Upper Sandusky, Ohio.

35MM Fine Grain Developing and 36 3 1/4 x 4 1/2 glossy enlargements \$1.49. Roll developed and glossy print of each 35c. One 5x7 enlargement free. Immediate Service. Satisfaction guaranteed. Photolab, Box 5544, Dept. p, Chicago.

SPECIAL RATES FOR READERS

A special classified rate is now offered for readers (non-commercial) who wish to buy, sell, or exchange radio sets, transmitters or parts; 10 words for 50c. Extra words, 15c. Payable in advance.

BRUSH

• BJ HEADPHONES

Communications type — light-weight, durable aluminum case—phones encased in molded rubber jackets — good earseal.



Write for your Brush Catalog today.

THE BRUSH DEVELOPMENT CO.
3312 Perkins Ave. Cleveland, Ohio

LEARN TO SEND AND RECEIVE CODE

Learn to send and receive code signals, like operators on ships at sea and at commercial and amateur land stations. Intercept distress signals, news flashes, bulletins, and dozens of other kinds of interesting radio communications. MASTER TELEPLEX teaches you to receive code exactly the way the world's best operators do—by sound. A heavy waxed paper tape, running through a machine, operates an automatic key which sends messages to you, at any speed you desire. As you improve in speed, the machine sends faster, gradually preparing you for top-speed amateur and commercial signals. With the new all Electric MASTER TELEPLEX you learn to send by sending and the signals you send are repeated back to you, exactly as you sent them, thus enabling you to correct your own errors. We furnish a complete course, lend you the improved All Electric MASTER TELEPLEX and give you personal instruction with a MONEY BACK GUARANTEE. Send for our new TELEPLEX FOLDER R-55 today. IT'S FREE.



TELEPLEX CO., 67-69 Park Place, New York
In Canada write:
CANADIAN ELECTRONIC INST., TORONTO, ONT.

RADIO ENGINEERING

• Complete Radio Engineering course in 96 weeks. Bachelor of Science Degree. Radio (television, talking pictures and the vast electronic field) offers unusual opportunities for trained radio engineers. Tri-State graduates in Radio Engineering can complete the Electrical course in 24 weeks. Courses also in Civil, Electrical, Mechanical, Chemical, Aeronautical Engineering; Business Administration and Accounting. Also short diploma courses (36 weeks) in Surveying, Drafting. Tuition, living costs low. World famous for technical two-year courses. Special preparatory department for those who lack required high school work. Students from all parts of the world. 56th year. Enter June, September, January, March. Write for catalog. Burton Handy, Pres.



DEGREE IN 2 YEARS

1659 COLLEGE AVE. ANGOLA, IND.
TRI-STATE COLLEGE

WOODSTOCK TYPEWRITERS

Auto Radio (Continued from page 16)

although we describe it last. It was due to the luck we had had with smaller and smaller transmitting units, that led us design the receiver installation. We had always felt that it was necessary to use forty meter crystals to operate on five and ten meters. Too many tubes began to use up power from the storage battery, and the addition of another doubler always made the rig uneconomical, unless we were to be satisfied to modulate a doubler stage. Previous two tube sets working on ten, were made to use a push-push doubler. These sets always had some regeneration in the stage too, in order to secure enough output.

The increased efficiency to be had when it comes to modulating a final that is operating class C, is well worthwhile, but is usually off-set by the additional tube required to drive it. In this rig, we get to ten in the first tube. We can drive a class C final on ten with that. We then have our choice of adding another tube on five, or just doubling there in the final and modulating the doubler. In any case, the oscillator circuit shown will quadruple better than any we have been able to build. We never liked to attempt to go so far in one tube and were always satisfied to put up with a bit of regeneration in a doubler which followed a doubler. This circuit, which was only possible due to the new 6F8 tube, puts out sufficient excitation to drive the 6L6 in the final. It lights a flash light bulb to full brilliancy on ten meters. It was not the least bit erratic. Crystal current has never been excessive, even when the plate voltage is raised from the normal 250 volts to something over 300.

The first section of this twin triode is used as a cathode-type oscillator. The inductance in the cathode circuit causes the tube to oscillate with a forty meter crystal with plenty of output in the twenty meter tuned circuit placed in its plate lead. This is coupled to the grid of the second section of the tube, which is *grid leak biased* as shown in the schematic. The ten meter output at the plate of this section will be enough to drive even a larger final than we cared to use.

The values of resistance shown in the grid circuits were found to give the most output with the least current in the various circuits. We let the oscillator loaf along at low voltage so as not to overload the power pack, when using the final amplifier at about 25 watts input.

The dropping resistor in the screen of the final is by-passed so that too much power is not lost in modulating the screen along with the plate. The by pass from screen to ground, of course is just big enough to bring it to ground potential as far as r.f. voltage is concerned.

The entire transmitter can be seen along with the vibrapack. The rule in-

1939

the NEW RADOLEK

Everything in Radio

RADIO PROFIT GUIDE!

Everything in Radio — is in your copy of the RADOLEK PROFIT GUIDE. If you do not have a copy, send coupon NOW! When you order from Radolek, you get just what you want, promptly and economically. Over 25,000 Radio Servicemen and Dealers now depend on Radolek Service.

Complete line of Radio Sets. A model for every purse and purpose—from midjets to large phonograph combinations. Also Auto radios, battery sets, new "Ham" receivers and transmitters are included.

Newest Test Instruments. The most complete line ever displayed in any catalogue. Latest models with newest designs.

Over 12,000 Repair Parts, Tools, Books, etc., All leading brands represented. Every item guaranteed! Also includes new items such as electrical appliances, shavers and clocks.

All Tubes, RCA, Sylvania Raytheon, Philco, etc. Includes Kellogg, special Majestic types and transmitting tubes. An 8 page tube data chart is bound right in the Radolek Profit Guide!

Everything in Public Address

Radolek Public Address Systems are especially designed to fit every type of installation—permanent or mobile.

Complete Selection. Radolek offers a choice of 11 amplifier models and 21 models of complete P.A. systems. Outputs range from 3 watts to 100 watts. Radolek prices are the LOWEST. Send for the Profit Guide and Profit Now!

P.A. Accessories including speakers, baffles, cables, phono motors, tick-taps, microphones, stands and other equipment is shown in the Radolek Profit Guide.

Send for **FREE Catalog**

The RADOLEK Co.
601 W. Randolph, Chicago, Dept. B-29

Send the 1939 Radolek Radio Profit Guide FREE.

Name

Address

Serviceman? Experimentor? Dealer?



• There's no way of telling what unknown condensers really cost until they "blow." First cost means little. But hundreds and even thousands of hours of extra service have established HYVOLs as the real "buy" today for those who must count pennies. So make it HYVOL OIL-FILLED for your heavy-duty jobs, and HYVOL WAX-FILLED for normal-duty jobs at a substantial first-cost saving. Popular capacities and voltages. Both are same physical appearance and size.

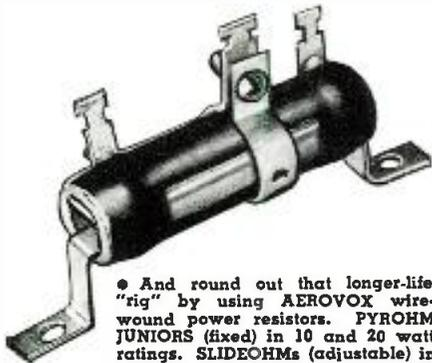

• And round out that longer-life "rig" by using AEROVOX wire-wound power resistors. PYROHM JUNIORS (fixed) in 10 and 20 watt ratings. SLIDEOHMs (adjustable) in 25, 50, 75, 100 and 200 watts. All popular resistance values. And they sure can "take it!"

Ask for CATALOG . . .

• Your local AEROVOX jobber has the latest catalog covering this extensive line of condensers and resistors. Ask for your copy—or write us direct.



indicates that it is 7 and 7/8" long, it is four inches deep and four and one half inches high. At the top is the screw-driver adjustment for the doubler section of the 6F8 and directly below is the quadrupler tuning. The knob and pointer is the final tuning control. The 0-50 ma. meter was shunted so as to read twice normal scale, as the screen and plate current shown on it runs about 80 mills if the transmitter is loaded down. A 0-100 milliammeter would be more suitable if one is on hand.

The illustration shows the main part of the whole installation as placed in the car. The mechanical layout of the converter as hinged in place in the ash tray compartment can be seen just as it is opened up preparatory to tuning the detector circuit. The oscillator tuning condenser and coil can be seen mounted on the panel, and directly back is the output choke, B+ by-pass condenser and tube socket mounting. Everything else is mounted under the tube in what was left of the original ash tray.

The transmitter mounts far enough back in the compartment to allow plenty of room for the hand set, tools, spare fuses, and head phones. It is then still possible to get the lid shut. The five prong socket just cleared when mounted behind the side of the pocket, so as to let the plug fit in front of the set. To remove the transmitter, it is only necessary to remove the plug and pull it out. The antenna connection is flexible and long enough to be removed after the set is out on the lid of the compartment. Should it be necessary to remove the converter, it lifts out in the original manner.

The A and B switches and pilot light for the transmitter can be seen right below the converter to the right of the ignition key.

We think that the illustration and such description as we have given you, may tend to encourage you to try this five meter portable business, or to pack an emergency set away in the car. If a few of you can use the illustration to help convince the XYL that such an unobtrusive little gadget in your family car wouldn't hurt a thing, and still may prove to be quite useful, we feel well repaid for the effort of telling about it.

What's New in Radio
(Continued from page 38)

Consolidated Wire Corporation, 526 So. Peoria St., Chicago, Ill., announce a complete line of fixed carbon resistors in



standard sizes and ratings. They are of solid moulded construction—permanently bonded into one compact unit. Tolerance or resistance variation is maintained at a

5% average and is guaranteed within 10% plus or minus. They are quiet in operation, completely moisture-proofed and non-inductive, having no capacitive effect. They are said to maintain their resistance values over an extremely wide temperature range. Coding follows the RMA standards and are clearly shown on each resistor. Further information on these resistors or any product of the above concern may be had by writing the company direct.

Service Instruments, Inc., 404 Fourth Ave., New York City, announce the Rider VoltOhmyst for the serviceman. This instrument is in line with the trend of instruments towards the electronic methods for rapid service analysis. It features an extremely high input resistance and a stable push-pull circuit. Resistances from 0.1 ohm to 1000 megohms and d.c. voltages from 0.05 to 5000 volts can be measured. All of the nine overlapping voltmeter



ranges have the same high constant input resistance of 16 megohms; in the ohmmeter circuit, seven overlapping decade ranges are provided which use the same scale in conjunction with multiplying factors extending from Rx1 to Rx1,000,000. The voltage across the resistance being checked never exceeds 3 volts, this maximum value being reached for a resistance of 1000 megohms. Only one zero adjustment is used and this does not require resetting when changing from one range to another.

Webster-Chicago present two new model microphones, featuring improvements in both performance and appearance. Model 1236 is a diaphragm type crystal mike, especially adapted to high-quality p.a. work. The high-capacity torsion-drive crystal is



moisture-sealed. Reproduction range is said to be from 40-10,000 cycles with an output level of -52 db. The new dynamic unit utilizes a moving-coil mounted on a Dural diaphragm. The frequency response is rated at from 50 to 9,000 cycles. The output level is -56 db. Assembly includes a

balanced quadropi type wound transformer to eliminate stray electro-magnetic pickup. It is made in two types—Model 1245 being high impedance and Model 1245A low-impedance (200 ohms). Full information may be had on request from Webster-Chicago, 5622 Bloomingdale Ave., Chicago.

SUPERIOR PRESENTS 5 INSTRUMENTS

from its NEW 1100 series!!!! Never before has Superior offered so much for so little! Always the Best Buy in the Instrument Field, Superior in this new 1100 series gives you even more value! We have incorporated many refine-

ments, many new features . . . all proven to be sound and practical. We urge you to read the descriptions below carefully; see how these instruments fit your needs. Buy direct from manufacturer and save 50%.

SUPERIOR INSTRUMENTS ARE GUARANTEED FOR ONE YEAR

THE NEW MODEL
1175-S

FREE POINT ANALYZER UNIT

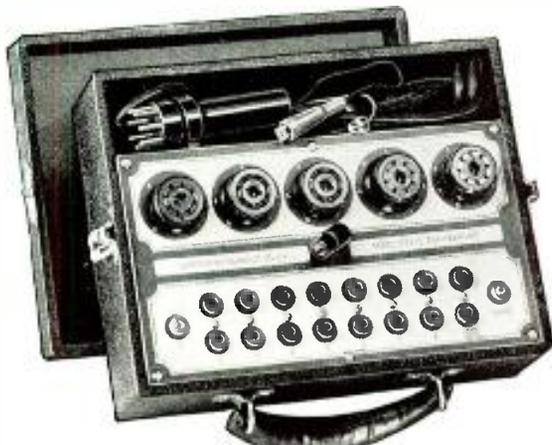

Complete with portable carrying case and cover.

May be used with any multimeter or set tester for testing by the point-to-point method of isolating and locating trouble.

SPECIFICATIONS

1. Enables you to test tubes by the plate current method when used in conjunction with any multimeter. 2. Rapid current measurements under actual operating conditions without opening circuit for meter insertion. 3. Enables you to locate defects in any particular stage without removing chassis from cabinet. 4. Permits rapid and precise voltage and resistance measurements between any two points in a radio receiver, terminating at a tube socket. 5. Standard R.M.S. numbered tube chart for quick identification of tube elements. 6. Sockets are all R.M.S. coded. Complete with six slip-proof adapters, slip-proof type analyzer plug, dual insulated zero ray. 7. Finished aluminum panel, housed in leatherette covered portable type cabinet, cover included. Model 1175-S complete in carrying case and cover, with all accessories included, all necessary adapters, plug, R.M.S. coded tube base chart and instructions. Shipping weight 7 pounds. Our net price

\$885

THE NEW MODEL
1130-S

Signal Generator with Audio Frequencies

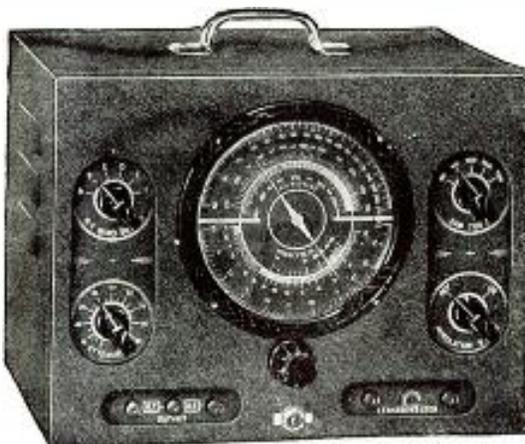

SPECIFICATIONS:

1. Combination R.F. and Audio Signal Generator, R.F. 100 kc. to 100 Mc. A.F.—100-7,500 cycles. All direct readings, all by front panel switching. 2. R.F. and A.F. output independently obtainable alone or with A.F. (any frequency) modulating R.F. 3. Accuracy is within 1% on I.F. and Broadcast bands; 2% on higher frequencies. 4. Audio frequencies in 5 bands; 100, 400, 1000, 5000, and 7500 cycles. 5. Giant airplane full vision, direct-reading dial. 6. Condenser and other leakages tested to 100 megohms. 7. All services on 90-130 volts A.C. or D.C. (any frequency).

Model 1130-S comes complete with tubes, test leads, carrying handle, instructions. Size 12" x 9" x 6 1/2". Shipping weight 15 pounds. Our net price

\$1185

THE NEW MODEL 1150-S SUPER-ALLMETER

Featuring the New Sloping Panel



A genuine achievement! For accurate and rapid measurements. Note the following features: A.C. and D.C. Volts, A.C. and D.C. currents, Resistance, Capacity, Inductance, Decibels, Watts.

SPECIFICATIONS:

D.C. Voltage: 0-15, 0-150, 0-750 volts D.C.
A.C. Voltage: 0-15, 0-150, 0-750 volts A.C.
D.C. Current: 0-1, 0-15, 0-150, 0-750 ma. D.C.
A.C. Current: 0-15, 0-150, 0-750 ma. A.C.
2 Resistance Ranges: 0-500 ohms
500-5 megohms
High and Low Capacity Scales: .0005 to 1 mfd. and .05 to 200 mfd.
3 Decibel Ranges: -10 to +19, -10 to +38, -10 to +53.
Inductance: 1 to 700 Henries
Watts:

Based on 6 mw. at 0 D.B. in 500 ohms. .006000 to 600 Utilizes new 4 1/2" square 0-1 d'Arsonval type meter with precision resistors housed in our newly devised sloping ease for rapid and accurate servicing.

Model 1150-S supplied complete with test leads, tabular charts, and instructions. Size 10" x 7 1/4" x 4 1/2", shipping weight 9 pounds. Our net price
Model 1150-A Portable carrying cover 75c additional.

\$1185

THE NEW MODEL 1180-S SET TESTER

A Complete Laboratory All in One Unit!

Featuring Our New Type Sloping Panel for Precise and Rapid Servicing



A complete testing laboratory all in one unit! Combines Superior models 1140-S and 1150-S. For specifications read the description of both these models herewith. Comes housed in sturdy, black case with sloping panel for rapid and simple measurements. Complete with test leads, tabular charts, instructions and tabular data for every known receiving type tube, including many transmitting types. Size 11 1/2" x 9 1/4" x 5"; shipping weight 18 pounds. Our net price
Model 1180-A for Portable Cover, add 95c.

\$1785

THE NEW MODEL 1140-S TUBE TESTER



A really modern tube tester conforming to all standards of good engineering practice. Utilizes a 3" d'Arsonval type meter with calibrated scale. Furnished in a sturdy black case with sloping panel for easy operation. Removable cover and carrying handle for either portable or counter use.

SPECIFICATIONS:

1. Tests all 4, 5, 6, 7, 7L, and Octal base tubes, including diodes.
2. Tests by the well-established emission method for tube quality, directly read on the GOOD? BAD scale of the meter.
3. Affords separate neon test for leakage and shorts between elements.
4. All services performed by the use of only five controls at maximum, and many tests do not require working all the controls.
5. Supplied with instructions and reference table so that filament voltage and emission measuring controls may be properly set for the enumerated long list of tubes, which includes all tubes commonly encountered in servicing.
6. Works on 90-120 volts A.C. 60 cycle.

Model 1140-S comes complete with instructions and tabular data for every known receiving type of tube as well as many transmitting types. Shipping weight 10 pounds, size 10" x 7 1/4" x 4 1/2". Our net price
Model 1140-A with Portable Cover 75c additional

\$1085

SUPERIOR INSTRUMENTS CO.

136 Liberty St., RN-5
NEW YORK, N. Y.

WANT A GOOD RECEIVER? BUILD IT YOURSELF!

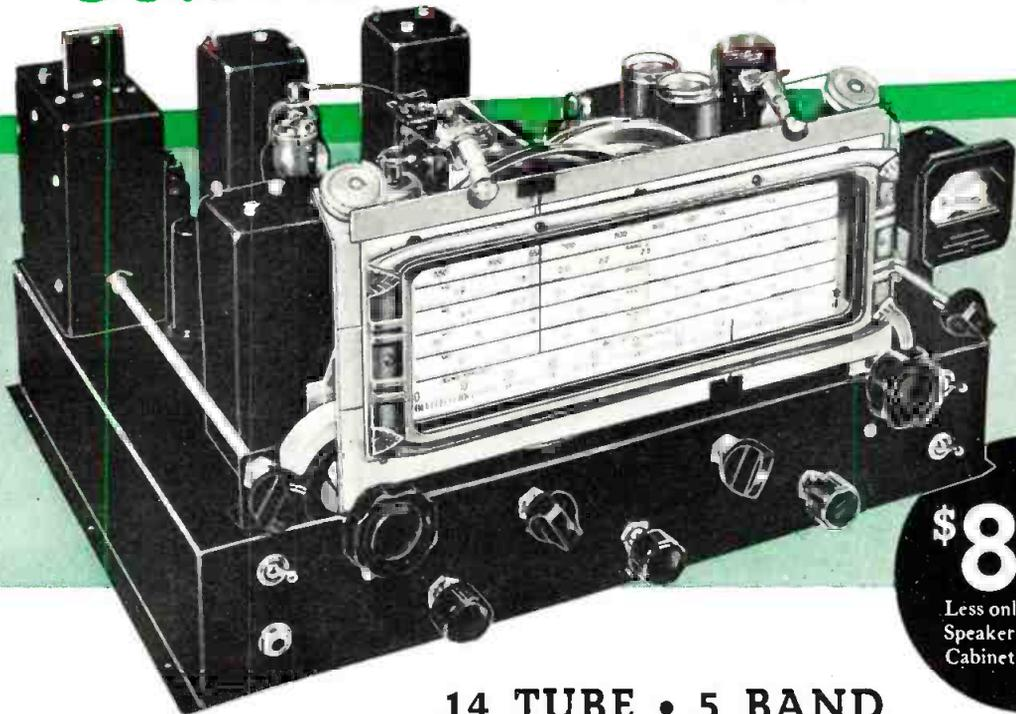

\$81⁹⁰

Less only Tubes and Speaker. Panels and Cabinet available.

14 TUBE • 5 BAND

TRAFFIC MASTER Communications Receiver

A few evenings of fun with a screwdriver, a pair of pliers and a soldering iron—and you have a complete 14-tube communications receiver. And what a receiver! 5 bands covering the radio spectrum from 9.25 to 365 meters, from the 10 meter band to the top of the broadcast band. Every major improvement known to radio engineers. All the sensitivity and selectivity you can use, plus a high signal-to-noise ratio! Performance that even the finest commercial re-

ceivers can't beat!

The TRAFFIC MASTER comes to you complete (except tubes and speaker) in easy to assemble form, with its all-wave Tuning Unit, completely assembled, ready to mount. It's no job at all to assemble this unit with Meissner pictorial diagrams. See your parts jobber, or write today to Dept. N-5, Mt. Carmel, Ill. for FREE 44-page catalog describing this and 21 other Meissner Kits.

AMATEURS—MAKE YOUR QSO's 100% WITH A MEISSNER SIGNAL SHIFTER

What an instrument. An electron-coupled Exciter Unit with almost unbelievable stability.

Variable, too, so that you can cover any amateur band right from your operating position. Won't drift between QSO's! Removes the curse of QRM! Completely assembled except for tubes! Ask your Parts Jobber for demonstration, or write Dept. N-5, Mt. Carmel, Ill. for full information.

NET PRICE only \$39.95



NEW! INFORMATIVE!

Packed full of valuable data, graphs, charts, pictorial diagrams, schematics, alignment data. Construction data on 21 Meissner Kits. Ask your Parts Jobber or write direct. Price 50c.

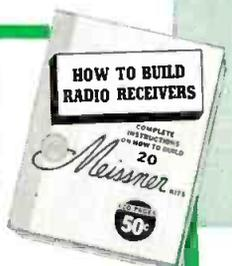

Meissner

DEPT. N-5

MT. CARMEL, ILLINOIS

"A FAMOUS NAME FOR TWO DECADES"