

THE STATUS OF TELEVISION

RADIO NEWS

AND

SHORT WAVE RADIO

SHORT
WAVE
TIME
TABLE

OCTOBER

World's
MOST SENSITIVE



RECEIVER

See Page 206



25¢

U. S. AND
CANADA

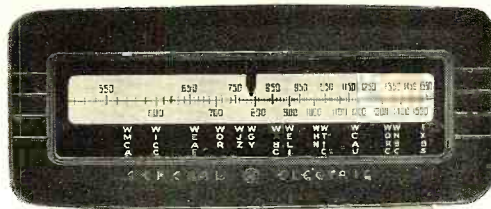

At Last . . . **A RADIO THAT REVOLUTIONIZES
TUNING . . . AUTOMATICALLY ASSURES PERFECT TONE**

If you should unknowingly tune-in a station the slightest bit off-tune — *and nine out of ten people do* — instantly, the new G-E Focused Tone Radio corrects your error and shifts itself into hair-line tuning for perfect reception. Immediately, the new G-E COLORAMA DIAL changes from red to green to tell you "your station is perfectly tuned." The call letters flash on to announce the local station tuned in. This G-E "custom-tailored" PERSONALIZER scale puts an end to hunting up the kilocycle numbers of your fa-



vorite stations. It's done like magic and just as silently too, for the G-E SILENT TUNING CONTROL silences all noise as you switch from one program to another.

HOW GENERAL ELECTRIC FOCUSED TONE RADIO AUTOMATICALLY AND INSTANTLY SHIFTS ITSELF INTO HAIR-LINE TUNING

G-E *Focused Tone* combines all the revolutionary new features described above, plus these new General Electric Radio inventions and developments — G-E METAL TUBES, G-E SENTRY BOX, G-E STABILIZED DYNAMIC SPEAKER, G-E SLIDING-RULE TUNING SCALE and G-E "V-doublet" ALL-WAVE ANTENNA SYSTEM.

Only the New

GENERAL ELECTRIC

AUTOMATICALLY



RADIO GIVES IT TO YOU

VISIBLY . . . INSTANTLY

The new G-E Focused Tone Radio brings you every radio service on the air . . . Standard Broadcasts; Foreign Reception; Police Calls; Amateurs; Aviation; Ultra Short-

wave; Experimental Broadcasts. General Electric Radio comes in 26 handsome models, priced from \$29.95 to \$750.00 (Eastern list) - Slightly higher in West and South.

GENERAL  ELECTRIC

Focused Tone Radio

YOU'LL ALWAYS BE GLAD YOU BOUGHT A G-E



Be a Radio Expert

Many make \$30 \$50 \$75 a week

I will train you at home for many Good Spare Time and Full Time Radio Jobs

J. E. SMITH, President, National Radio Institute

The man who has directed the home study training of more men for the Radio Industry than any other man in America.



Set Servicing

Spare time set servicing pays many \$5, \$10, \$15 a week extra while learning. Full time servicing pays as much as \$30, \$50, \$75 a week.

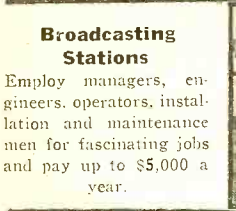

Broadcasting Stations

Employ managers, engineers, operators, installation and maintenance men for fascinating jobs and pay up to \$5,000 a year.



Loud Speaker Systems

Building, installing, servicing and operating public address systems is another growing field for men well trained in Radio.



HERE'S PROOF THAT MY TRAINING PAYS



\$80 Monthly in Spare Time

"I work on Radio part time, still holding my regular job. Since enrolling five years ago, I have averaged around \$80 every month." JOHN B. MORISSETTE, 773 Silver Street, Manchester, N. H.



Makes \$50 to \$60 a Week

"I am making between \$50 and \$60 a week after all expenses are paid, and I am getting all the Radio work I can take care of, thanks to N. R. I." H. W. SPANGLER, 308 Walnut St., Knoxville, Tenn.



Operates Public Address System

"I have a position with the Los Angeles Civil Service operating the Public Address System in the City Hall Council. My salary is \$153 a month." R. H. ROOD, R. 136, City Hall, Los Angeles, Calif.

Lesson on Radio Servicing Tips—FREE

I'll prove that my Training information, that it is easy to gives practical, money-making understand—that it is just what you need to master Radio. My simple lesson text, "Radio Receiver Troubles—Their Cause and Remedy" covers a long list of Radio receiver troubles in A.C., D.C., battery, universal, auto, T. R. F., super-heterodyne, all-wave, and other types of sets. And a cross reference system gives you the probable cause and a quick way to locate and remedy these set troubles. A special section is devoted to receiver check-up, alignment, balancing, neutralizing and testing. Get this lesson Free. No obligation. Just mail coupon.

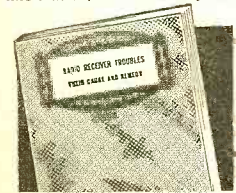

Do you want to make more money? Radio offers you many opportunities for well-paying spare time and full time jobs. And you don't have to give up your present job or leave home and spend a lot of money to become a Radio Expert.

Many Radio Experts Make \$30, \$50, \$75 a Week

Radio broadcasting stations employ engineers, operators, station managers and pay up to \$5,000 a year. Spare time Radio set servicing pays as much as \$200 to \$500 a year—full time jobs with Radio jobbers, manufacturers and dealers as much as \$30, \$50, \$75 a week. Many Radio Experts operate their own full time or part time Radio sales and service businesses. Radio manufacturers and jobbers employ testers, inspectors, foremen, engineers, servicemen, paying up to \$6,000 a year. Radio operators on ships get good pay and see the world besides. Automobile, police, aviation, commercial Radio, and loud speaker systems are newer fields offering good opportunities now and for the future. Television promises to open many good jobs soon. Men I have trained are holding good jobs in these branches of Radio. Read their statements. Mail the coupon.

There's a Real Future in Radio for Well-Trained Men

Radio already gives jobs to more than 300,000 people. In 1935 over \$300,000,000 worth of sets, tubes and parts were sold—an increase of 20% over 1934! Over 1,100,000 auto Radios were sold in 1935. 25% more than in 1934! 22,000,000 homes are today equipped with Radios, and every year millions of these sets go out of date and are replaced with newer models. Millions more need servicing, new tubes, repairs, etc. Broadcasting stations pay their employees (exclusive of artists) more than \$23,000,000 a year! And Radio is a new industry, still growing fast! A few hundred \$30, \$50, \$75-a-week jobs have grown to thousands in less than 20 years!

Many Make \$5, \$10, \$15, a Week Extra in Spare Time While Learning

Practically every neighborhood needs a good spare time serviceman. The day you enroll I start sending you Extra Money Job Sheets.

They show you how to do Radio repair jobs that you can cash in on quickly! Throughout your training I send you plans that made good spare time money—\$200 to \$500 a year—for hundreds of fellows. My training is famous as "the Course that pays for itself."

I Give You Practical Experience

My Course is not all book training. I send you special Radio equipment and show you how to conduct experiments and build circuits which illustrate important principles used in modern Radio receivers, broadcast stations and loud speaker installations. I show you how to build testing apparatus for use in spare time work from this equipment. This 50-50 method of training makes learning at home interesting, fascinating, practical.

You Get a Money-Back Agreement

I am so sure that I can train you successfully that I agree in writing to refund every penny you pay me if you are not satisfied with my Lessons and Instruction Service when you finish. I'll send you a copy of this agreement with my Free Book.

Find Out What Radio Offers You

Act Today. Mail the coupon now for "Rich Rewards in Radio." It's free to any fellow over 16 years old. It describes Radio's spare time and full time opportunities and those coming in Television; tells about my training in Radio and Television; shows you actual letters from men I have trained, telling what they are doing and earning. Find out what Radio offers YOU! MAIL THE COUPON in an envelope, or paste on a postcard—NOW!

J. E. SMITH, Pres., National Radio Institute
Dept. 6KR
Washington, D. C.

THIS FREE BOOK HAS HELPED HUNDREDS OF MEN MAKE MORE MONEY

Rich Rewards in Radio

This Coupon is Good for One FREE Copy of My Book

J. E. SMITH, President, National Radio Institute, Dept. 6KR, Washington, D. C.

Without obligating me, send your service manual "Radio Receiver Troubles—Their Cause and Remedy" and free book about spare time and full time Radio opportunities and how I can train for them at home in my spare time. I am particularly interested in the branch of Radio checked below.

<input type="checkbox"/> Radio Service Business of My Own	<input type="checkbox"/> Loud Speaker Systems, Installation and Service
<input type="checkbox"/> Spare Time Radio Service Work	<input type="checkbox"/> Auto Radio Installation and Service
<input type="checkbox"/> Retail Sales of Radio Sets and Equipment	<input type="checkbox"/> Television Station Operator
<input type="checkbox"/> Service Expert for Retail Stores	<input type="checkbox"/> Designing and Constructing Testing Equipment
<input type="checkbox"/> Broadcasting Station Operator	<input type="checkbox"/> Service Expert with Radio Factory
<input type="checkbox"/> Aviation Radio Operator	<input type="checkbox"/> Commercial Radio Station Operator
<input type="checkbox"/> Ship Radio Operator	<input type="checkbox"/> All-around Servicing Expert

(If you have not decided which branch you prefer—mail coupon now, for information to help you decide.)

NAME.....PAGE.....

ADDRESS.....14X-1



Edited by LAURENCE MARSHAM COCKADAY

S. GORDON TAYLOR WILLIAM C. DORF
Managing Editor *Associate Editor*

JOHN M. BORST JOHN H. POTTS
Technical Editor *Assoc. Tech. Editor*

WESLEY G. HILLS
Art Editor

Vol. XVIII October, 1936

No. 4

Reading Guide to this Issue—

AMATEURS—2, 3, 4, 5, 6, 7, 8, 9, 11, 20, 22, 24, 25, 29, 30, 31
 BROADCAST FANS—2, 3, 10, 13, 14, 18, 19, 30
 DEALERS—1, 2, 3, 7, 8, 9, 11, 18, 19, 20, 21, 22, 23, 25, 26, 30, 31
 DESIGNERS—3, 4, 7, 8, 11, 12, 14, 25, 30, 31
 DX FANS—3, 13, 14, 15, 16, 18, 30, 31
 ENGINEERS—3, 4, 11, 12, 14, 20, 22, 23, 25, 30, 31
 EXPERIMENTERS—2, 3, 4, 9, 11, 12, 16, 19, 24, 25, 29, 30, 31
 MANUFACTURERS—2, 3, 4, 8, 11, 20, 22, 30, 31
 OPERATORS—3, 28, 30, 31
 SERVICEMEN—1, 2, 3, 4, 11, 18, 19, 20, 21, 22, 23, 24, 25, 26, 29, 30, 31
 SET BUILDERS—3, 4, 9, 11, 20, 22, 25, 29, 30, 31
 SHORT-WAVE FANS—2, 3, 9, 14, 17, 18, 30, 31
 STUDENTS—2, 3, 4, 9, 11, 14, 20, 22, 24, 25, 27, 29, 30, 31
 TECHNICIANS—2, 3, 4, 11, 12, 20, 22, 24, 25, 30, 31

Coming Next Month

The "interests" are striving diligently to establish and maintain control over television development. The Editors feel, on the other hand, that the amateur experimenter should have every opportunity to participate in this development, just as he did in the development of radio. RADIO NEWS will, therefore, keep readers fully posted on progress in the television field during coming months—and will present complete design and constructional articles just as soon as models can be developed and perfected.

1	Serviceman's Diary	<i>Anonymous</i>	196
2	The Mad Television Scramble	<i>The Television Reporter</i>	201
3	What's New in Radio	<i>William C. Dorf</i>	203
4	5-10-20 Meter Super	<i>Frank H. Jones</i>	204
5	5-Meter Linear Oscillator	<i>Paul Cintrat</i>	207
6	The "Ham" Shack	<i>Everett M. Walker</i>	208
7	New Ultra H.F. Transmitter Tube	<i>J. Van Lienden</i>	209
8	Inexpensive Portable Transmitter	<i>Arthur H. Lynch</i>	210
9	The Radio Beginner (Part 6)	<i>John M. Borst</i>	212
10	The Photo-Mike	<i>Samuel Kaufman</i>	213
11	Beam-Power Amplifier Design (Part 2)	<i>I. A. Mitchell</i>	214
12	Synchronous Television Motor	<i>Frederick Siemens</i>	214
13	Station List (Trans-Pacific Broadcast)	<i>John M. Borst</i>	215
14	New "Lab-Built" Super	<i>McMurdo Silver</i>	217
15	The DX Corner for the Broadcast Band	<i>S. Gordon Taylor</i>	218
16	The Radio News "Tenatuner"	<i>The B.B. DX Editor</i>	218
17	The DX Corner for the Short Waves	<i>Laurence M. Cockaday</i>	220
18	World Short-Wave Time-Table	<i>The Editor</i>	222
19	"Wind" Radio for the Farm	<i>Joseph Powell</i>	225
20	New B.F. Oscillator	<i>Robert Ames</i>	225
21	"Selling Service" (Part 6)	<i>A. A. Ghirardi and T. S. Ruggles</i>	226
22	Serviceman's Oscillator	<i>James Parker</i>	227
23	New P.A. System for Schools	<i>Victor Hall</i>	227
24	Future for Trained Television Men	<i>F. G. Wellman</i>	227
25	Inexpensive, Precision "Lab" Amplifier	<i>John H. Potts</i>	228
26	The Service Bench	<i>Zeh Bouck</i>	230
27	Students' Radio Physics Course	<i>Alfred A. Ghirardi</i>	232
28	QRD?	<i>By GY</i>	234
29	The Radio Workshop	<i>The Associate Editor</i>	236
30	The Technical Review	<i>The Technical Editor</i>	242
31	Free Bulletins	<i>The Service Editor</i>	243

Published Monthly by

Teck Publications, Inc., Washington and South Avenues, Dunellen, N. J.

EDITORIAL AND EXECUTIVE OFFICES

461 EIGHTH AVENUE, NEW YORK CITY, N. Y.

Entered as second class matter at the Post Office at Dunellen, N. J., under the act of March 3, 1879. Copyright, 1936, by Teck Publications, Inc., in U. S. and Canada. All rights reserved. Registration of title of this publication as a trade mark applied for in United States Patent Office. Printed in the United States of America. The contents of this magazine must not be reproduced without permission. We cannot be responsible for lost manuscripts, although every care is taken for their safety.

25c a copy. Subscriptions: \$2.50 a year, \$4.00 for two years. In Canada and Foreign Countries \$3.00 a year, \$5.00 for two years. Subscribers are notified that change of address must reach us five weeks in advance of the next date of issue.

Lee Ellmaker
President and Treas.
 B. Holcepl
Secretary
 H. D. Crippen W. P. Jeffery
Advertising Management
 Virgil Malcher
 205 W. Wacker Dr., Chicago
Western Representative

"Does Your Radio Miss this half the Program?"

With a SCOTT Hear ALL the High Tones and Overtones

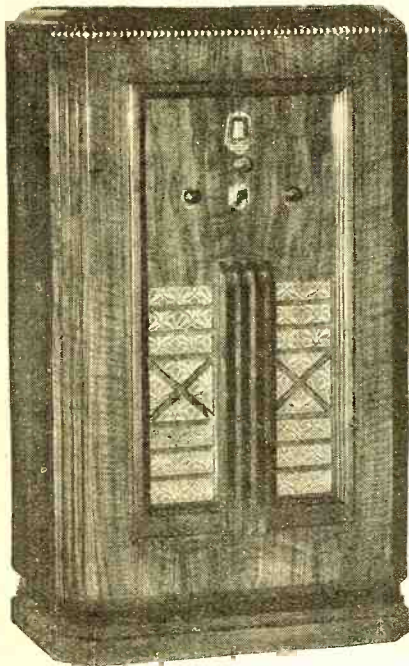

Why the SCOTT Full Fidelity Radio Gets More Stations with Finer Tone-

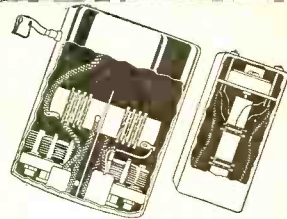

SCOTT I.F. Transformer (left) and production radio's transformer (right) in true comparative sizes.

At right—5-inch SCOTT I. F. Transformer designed in SCOTT Laboratories and used exclusively in SCOTT 23-Tube Full Fidelity Radio. Large shield three times size of shield on transformer of production type radios—Five of these powerful Transformers in every SCOTT.

HERE IS THE SECRET OF WHY THE SCOTT ALONE GETS ALL THE BEAUTY OF THE PROGRAM—ALL THE GLORIOUS HIGHS AND OVERTONES ON THE AIR.

Far right—Three such small distant stations. Holes in shield let in dust and moisture. Cramped shield prevents full amplification of program signal.

WE have long made unmistakable claims for the marvelous tone and incredible distance performance of the 23-tube SCOTT. Here you see the proof—proof that backs these claims! You find the same superior engineering and custom-building throughout every detail of the SCOTT—just as demonstrated here with the I. F. Transformers. As a SCOTT owner you receive the positive guarantee that if your SCOTT does not bring in more foreign and domestic stations with more startlingly true, beautiful tone, with less noise and greater undistorted volume—you may return it anytime within 30 days if you live in the U. S. A. and your money will be refunded without question.

THE SCOTT IS NOT EXPENSIVE

How amazing it is that hundreds of celebrated musicians such as Gny Lombardo and Toscanini, and financial leaders such as Baron de Rothschild have chosen to own a SCOTT—when the SCOTT is actually priced at \$25 to \$100 less than many ordinary mass production sets! You cannot overestimate the importance of this astonishing fact.

Here is the explanation! When you buy a SCOTT you pay no middlemen's profits. You get custom-building for the price of mass production sets—with all the superior performance custom-building gives.

Put the SCOTT in your own home for 30 days—in a side by side comparison test with any other radio, regardless of price. Get the glorious domestic short wave programs from the east—the pick of American popular music—of finest concert music—music in the morning! Programs directed at Europe—yet your

SCOTT pulls them in with a truth and beauty of tone which is unbelievably real.

Turn up the SCOTT Variable Selectivity—you can aim it so sharply that you get WOR—jammed between WGN and WLW.

Get Germany, Australia, Italy, England, Spain, Holland—the news and music of all the world from the lands of their exciting origins. Compare your results with those on any other radio.

MANY EXCLUSIVE FEATURES

The only radio—by test of national High Fidelity radio station*—which gives you all the radiant, vital high fidelity overtones up to 16,000 cycles, wherein lies the greatest beauty of all music.

Exclusive SCOTT Magic Maestro, actually restoring the musical expression cut by the broadcasting station. Exclusive SCOTT Rotary Wave Band Changer. Exclusive SCOTT variable Station-Tuning Condenser. Exclusive SCOTT Air-Cooled Power Transformer. Exclusive 35 watts "A" Power—from the faintest whisper, to the mightiest crescendo, without any distortion or rattle detectable to the human ear.

These are but a few of the features which have made the SCOTT probably the outstanding custom-built radio in the world today. Fill out the coupon now—get this unparalleled story of tone and distance performance! Discover for yourself the vast new wealth of fascinating radio entertainment which is enjoyed only by SCOTT owners.

*Name upon request.

Top—SCOTT 8 segment air condensers in I.F. Transformers of SCOTT radios. Each segment does its share in capturing full signal. No dust can settle between segments to cut down sensitivity or damage tone quality.

Bottom—Semi-fixed condensers in production radios. Less ability to pull in distant stations. Dust collects. Makes hiss in tone.

Top—SCOTT 8 section transformer coils. Higher efficiency. Permanently fixed on bakelite tube. No shifting of space between coils. Sharper station selection.

Bottom—2 section coils of ordinary radio. Mounted vertically. Wood dowel shrinks in dry climate—coils slip down. Expands in wet climate—compresses wires, causes short circuit.

Top—SCOTT brass shield between primary and secondary coils. Increases sensitivity which can be built into set. Enables you to get more stations.

Bottom—No shield between coils in ordinary radio. Signals jump back and forth, making howl. Factory cuts sensitivity to end howl—thus you miss many stations.



FREE-SEND TODAY FOR DETAILS

E. H. Scott Radio Laboratories, Inc.
4440 Ravenswood Ave., Dept. 5R6
Chicago, Ill.
Send "PROOF" of unequalled tone and DX performance of 23-tube SCOTT.

Name.....
Address.....
City.....State.....

E. H. SCOTT RADIO LABORATORIES, INC.

4440 Ravenswood Avenue, Dept. 5R6, Chicago, Illinois
630 Fifth Avenue, New York, N. Y. 115 N. Robertson Blvd., Los Angeles, Cal.
BUILDERS OF THE WORLD'S FINEST CUSTOM-BUILT RADIOS

Pages From A
Serviceman's
DIARY

WEDNESDAY. Away for an early start this bright morning. Made a short run over to the Saracine home (Gene Sarazen to you). It is set far back from the street, surrounded by trees, shrubbery and winding drives which may be simple for a champion golfer to negotiate but are not so easy for this serviceman.

(My few experiences at golfing were greatly hampered by the uncanny ability of the ball in avoiding the club. After a few terrific swings before an appreciative gallery had left the object of my attention still reposing on its tee, my recreation time has been devoted to other pursuits.)

The receiver was a Westinghouse grandfather-clock model with an 80 chassis. Complaint, intermittent fading. Checked the tubes and installation, cleaning up the wiring around the window, but was not sure I had located the trouble so hauled the whole set out. It doesn't pay to pull the chassis alone on this model, since the instrument is too awkward to handle in a home. Will probably find a defective i.f. transformer, as intermittent opens sometimes occur in this model.

Picked up a nursery model RCA midget at the store, all decorated with Mother Goose characters, for delivery and installation (a handsome brick house in the best section of the town). Lugged the set up two flights to a small room specially decorated for the two youngsters. A governess was telling them the story of Noah's Ark and its motley assemblage, including horses, giraffes, elephants, and all other living things. Most of us would have been just as happy if mosquitoes and other pests had missed the boat and perished in the flood.

An Extra \$5.00

Finished the installation, giving them an indoor antenna which was adequate for the purpose. Went down to the kitchen to check over a defective Hoover vacuum cleaner. Found the belt broken and installed a new one. Most people prefer to have radiomen repair their vacuum cleaners and other appliances since dealers too often send out high-pressure salesmen to attempt to sell new apparatus when only the simplest repair is required. Checked over the power cords on the bridge and reading lamps throughout the house and replaced all frayed cords and one defective socket. Replaced an old heavy electric iron with a new light-weight automatic type (left with a larger profit on these incidentals than we made on the midget radio sale).

Off for lunch. Then out to check over a Stromberg 635. Complaint, intermittent noise. Tried the set. Operating O. K., of course. Tapped tubes. Still O. K. Pounded chassis while operating. Plenty of noise. Checked aerial and ground. O. K. Pulled chassis and made a quick examination. No loose connections apparent. Removed the chassis to the front porch and tried again. Operated O. K. now. Replaced the chassis in its cabinet and tried again. Still noisy when pounded. Stamped on the floor. Again noise. Left set operating with vol-



NO SERVICEMAN WOULD SNEER AT AN EXTRA \$5.00

The radio serviceman, when in a client's home on a radio repair job, by simply opening his mouth and courteously inquiring "Any other electrical appliances in your home need repairing?" can earn at least an extra \$5.00. Electrical flat-iron cords, new belts for vacuum cleaners, rewiring of floor lamps are a few of the regular needs of the home that just naturally slip the mind of the home-owner. The serviceman can easily pick up these odd jobs and make his visit more than profitable.

ume control full on and went down in the basement to check the power wiring. Fuse box O. K.—no loose fuses. Also no loose electric light bulbs. Traced the BX cable, which seemed O. K. at all the junction boxes. Followed it along to the side of the cellar stairs. Found it touching a water pipe when it crossed over. Gave it a gentle tug. Sure enough! Plenty of noise in the receiver upstairs. Taped up the BX and pipe and anchored them well apart. Went upstairs and rechecked the set. All O. K. now!

Next. Two easy tube replacement jobs. Then moved on to a Sparton Ensemble, using a crudely operating but strangely fool-proof record-changer. Never seems to give any trouble. Complaint here was rather indefinite—poor reception. Opened the cabinet doors and tried to remember which knob worked the "on-off" switch. It pulls out on this model and if you pull the

wrong knob it comes off. Wasn't sure so I pulled both gently at the same time, locating the proper one on the left side. Finding the "on-off" switch quickly is one of the biggest problems when servicing unfamiliar models. Any fumbling around creates a bad impression on the customer who invariably feels that a serviceman unable to locate the switch instantly must be totally incompetent. My usual practice in such cases is to start checking the installation and line voltage. If the customer leaves the room meanwhile, the switch can be located at leisure. If he or she stays around, I sometimes ask to have the set turned on while I am at the window checking the lead-in.

Checked over this set, noting a speaker rattle. Removed speaker and found the seam on the cone had opened. Brought to the shop for recementing with Duco.

Storms Make Business

Next. A Philco midget. Complaint, weak reception. Checked tubes. O. K. Installation O. K. Coupled antenna loosely to grid r.f. tube. Much better reception. Removed chassis and examined r.f. coil. Primary badly burned, a charred mess (Recalled the storm yesterday). Apparently the antenna had been struck by lightning, burning out the coil. An unusual but not a rare occurrence. Showed it to the customer, explaining that the aerial had undoubtedly protected the house during the storm even though the receiver had been damaged. Took it out for shop repair.

Returned to the store and spent the balance of the time clearing up some of the jobs on hand.

THESE records from an anonymous serviceman's diary should be of decided interest to veteran servicemen, as well as to those whose experience in the service field is more limited. Written by a man who "knows his stuff," and shot with an occasional outcropping of humor, these items provide many hints not found in text books. More of these pages will appear from time to time.

Everything in Radio

IN THIS NEW
1937 CATALOG

AT
LOWEST
PRICES

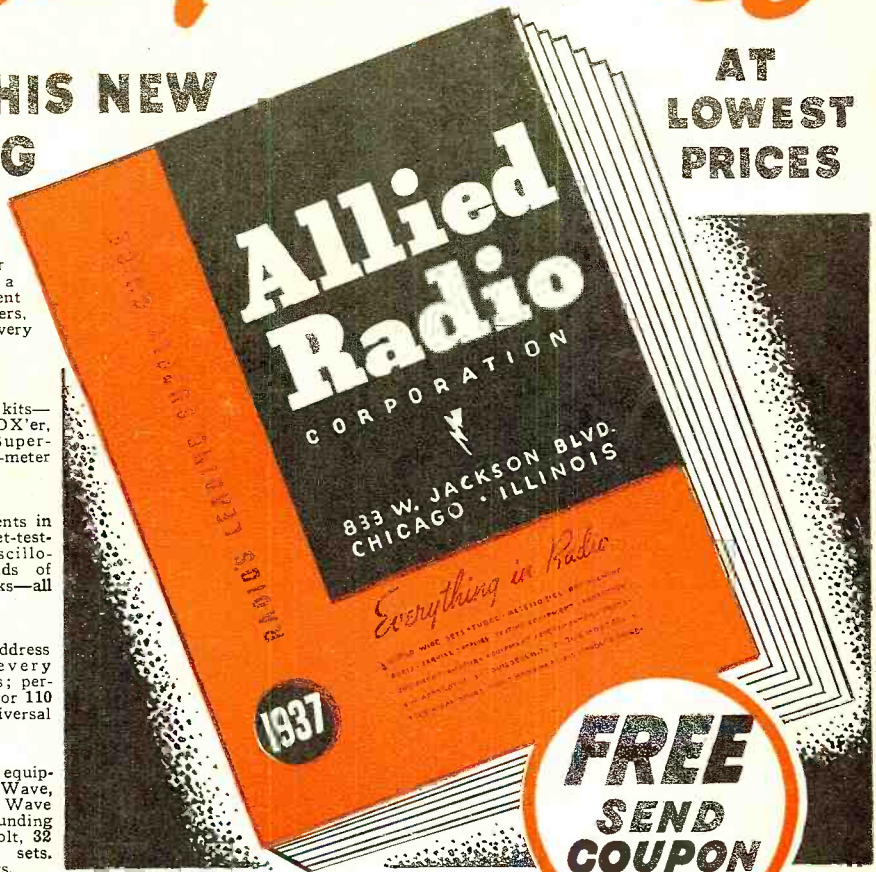

- Amateurs** A complete amateur section loaded with a tremendous assortment of transmitters, receivers, and transceivers to meet every Ham requirement.
- Set-Builders** Dozens of new kits—new metal tube DX'er, Knight Metal Tube Super-Gainer, new 6-volt all-wave set, 5-meter transceiver and many others.
- Service Men** Newest developments in tube-checkers, set-testers, analyzers, oscillographs, meters. Thousands of replacement parts, tools, books—all standard lines.
- Sound-Men** Latest Public Address equipment for every sound need. 8-50 watts; permanent, mobile and portable, for 110 volts AC, 6 volts DC, and universal operation.
- Dealers** Complete service equipment and 37 new All-Wave, Dual-Wave and Short Wave sets from 5 to 17 tubes, with astounding new features, as low as \$8.45. 6 volt, 32 volt, AC-DC, battery and auto sets. Ruripower units and Windchargers.

152 BIG PAGES - - - 10,000 PARTS - - - LATEST DEVELOPMENTS

Whether you operate a "ham station", build your own sets, service radio receivers, install P.A. Systems, or sell radio equipment, *you need this book!* You'll find in it everything in radio—at lowest prices. 10,000 duplicate and replacement parts—latest types of amateur transmitting and receiving gear—newest test instruments and service equipment—1937's finest metal-tube, all-wave radio receivers—pages of new kits for set-builders—complete lines of advanced public address equipment—tools, books, etc.

With this complete radio supply guide handy, there's no need to hunt or shop for equipment. Everything is logically arranged for quick reference. Deal with ALLIED and you'll have the satisfaction of knowing you are saving money on every order. A free copy of the new 1937 ALLIED Catalog is ready for you—just send coupon below.

Why Your Dollar Buys More at Allied

Because we are able to buy in vast quantities we get lower prices, and sell for less. If you ever find identical brand and quality offered elsewhere at lower prices, we'll refund the difference.

Highest Quality Merchandise

We handle only the highest-grade, new, clean merchandise in first-class condition. Every item in the ALLIED Catalog must come up to our exacting standards. You're always assured of highest quality when you buy from ALLIED.

Fastest Service

Everything under one great roof—our vast stocks, offices, laboratories, technical departments, and shipping rooms are conveniently located in one

great building. Our Complete stocks mean that you get your order when you want it; our central location means faster shipping; our efficient organization gives you better personal service.

Everything in Radio

No matter what your radio requirements are, you'll find them answered at money-saving prices. For greater values, faster service, and lower prices—order from the new 1937 ALLIED Catalog. Send coupon now for FREE copy.

I ALWAYS FIND EVERYTHING I WANT IN THE ALLIED CATALOG AT PRICES THAT SAVE ME MONEY!



ALLIED RADIO CORPORATION
833 W. JACKSON BLVD. CHICAGO, ILL.

Allied Radio Corp., 833 W. Jackson Blvd., Chicago, Ill., Dept. 1-K
 Rush me a copy of your new 152-page 1937 Catalog absolutely Free.
 Name
 Address
 City State

I am particularly interested in:
 Servicing sets Building sets Selling sets Operating an amateur station
 Installing P.A. Systems

Announcing a new

BENDIX

DAYRAD

COMBINATION TESTING UNIT

Gives the service man confidence—and gives the customer confidence in the service man!

Handsome and impressive in appearance, compact, convenient, sturdily protected against rough usage, reliable and precise in its readings, very simple to use . . . analyze this new Bendix Day-Rad Radio Testing Unit and you'll find it's all this and more!

The price is most reasonable. The easy terms—a small initial payment and plenty of time on the balance—are available to every responsible radio service shop. See the new Bendix Day-Rad Model 200 at the New York Radio Trade Show—send the coupon for full information.

Complete Radio Tube Tester, combined with Radio Analyzer, Voltmeter, Milliammeter, Ammeter and Ohmmeter

WHAT IT DOES:

Checks all radio tubes (automobile as well as household sets). Automatically furnishes exact load on tube under test. Indicates tube leakage and shorts by ultra-sensitive neon indicator. Gives instantaneous reading of tube performance on patented English-reading type dial. Provides for future types of tubes through extreme flexibility of circuits. Three controls make unit simplest and quickest to operate. Index Chart system eliminates confusion when making tests. Tests all new type metal tubes and Octal "G" type tubes.

Allows complete point-to-point analysis of household or auto radio sets—checking batteries for voltage and amperage—checking high-tension coils and ignition circuits for continuity—checking condensers for shorts. Operates from 110-volt AC-60 cycles. Size: 15" wide, 14" deep, 4" high. Weight: 15 lbs.

Sold on Easy Terms—Low Down Payment, Extended Time Payments

Write for full details now . . . today . . . before you let it slip from your mind!

BENDIX PRODUCTS CORPORATION

(Subsidiary of Bendix Aviation Corporation)
401 Bendix Drive, Dept. 29, South Bend, Ind.

SEE IT ON
DISPLAY AT
NEW YORK
RADIO TRADE
SHOW

BOOTH 43 AND 44

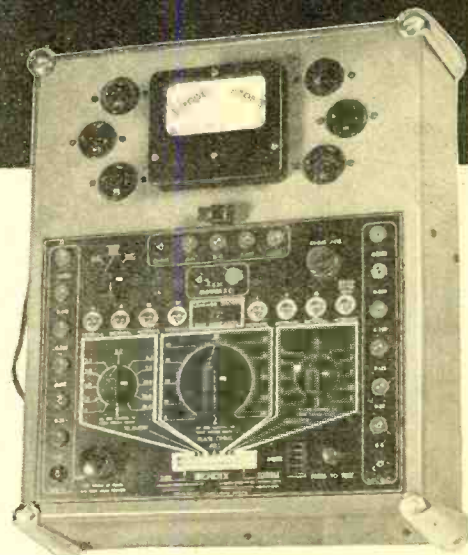

New Series "200"

A turn of the switch transforms this unit into a sensitive volt-ohmmeter.

- Reads AC voltages from 0 to 1250
- Reads DC voltages from 0 to 1250
- Reads Milliamperes from 0 to 1250
- Reads Ohms from 0 to 30,000
- Reads Ohms from 0 to 300,000
- Reads Ohms from 0 to 3,000,000
- Reads Amperes from 0 to 25

(All ranges to an accuracy of 2% plus or minus)

BENDIX PRODUCTS CORPORATION, 401 Bendix Drive, Dept. 29, South Bend, Ind.

Send me complete information regarding your new Bendix Day-Rad Series 200 Testing Unit, also your new catalog of Bendix Day-Rad Radio Service Instruments:

Name Address

City and State Jobber's Name



NEW hallicrafters

COMMUNICATION

RECEIVERS for 1937!

Now Available on Easy TIME PAYMENTS

SKY BUDDY



Five new receivers—each one unsurpassed in its class—with new features of engineering, of design, of construction. Now there's a Hallicrafters precision-engineered communication receiver for every purpose, for every purse—all available to you on the new Hallicrafters Time Payment Plan! See them at your jobber's, or write for complete details!

The Sky Buddy

A real 5-tube Hallicrafters engineered communication receiver at an astonishingly low price, with amazing performance characteristics, that compare favorably with those of many higher priced receivers. A splendid receiver for the beginner in amateur radio.

- Tunes from 16.5 to 544 KC. in 3 Bands.
- Single Iron Core I.F. Stage.
- 5 Tubes do the work of eight.
- 36 to 1 Band Spread.
- Built-in Speaker and Power Pack.

SKY CHIEF

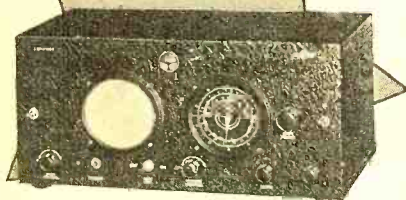

The Sky Chief

This new 7-tube Superheterodyne is designed with all the latest features usually found only on much higher priced sets. Tunes from 17.6 MC. to 540 KC. and is equipped with all the features and controls so desirable to critical operators.

- Single Stage 465 KC. Iron Core I.F.
- 17.6 to 540 KC. in 3 Bands.
- Variable Beat Oscillator.
- Mechanical Band Spread.
- Automatic Volume Control.
- Built-in Speaker and Power Pack.

ULTRA SKY RIDER

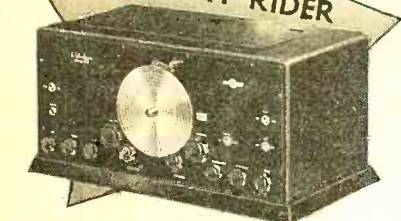

The Ultra Sky Rider

A new and unique approach to high-frequency reception—the finest Hallicrafters receiver built. Experts marvel at its sensitivity and amazing performance. It is the perfect receiver for the Ultra-High-Frequency operator.

- 3.76 to 53 Meters in 4 Bands.
- Built-in Lamb Noise Silencer.
- Direct Calibration Tuning—No Charts or Tables.
- 1600 KC. Iron Core I.F. Transformers.
- Electro Mechanical Band Spread.
- 338 Degree Dial.
- 100 KC. Expansion.
- Individual Coils for each band.

NEW 1937 SUPER SKY RIDER

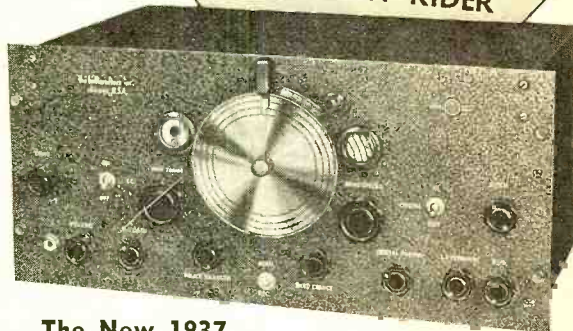

The New 1937 Super Sky Rider

With 11 tubes, selectivity beyond last year's model, greater sensitivity and finer phone reception, this receiver has reached superlative heights in performance. Many new features add to its efficiency and convenience in operation.

- 11 Tubes, 10 of them metal.
- 40 MC. to 535 KC. in 5 Bands.
- Electro Mechanical Band Spread.
- 14 Watts Undistorted Output.
- Direct Calibration Tuning—No Charts or Tables.
- Field Strength Indicator.
- Improved 10-meter performance.
- Iron Core I.F. System.

SKY RIDER COMMERCIAL



Sky Rider Commercial

An 11-tube Superheterodyne especially fitted for commercial service, that tunes from 30 to 3000 meters and can be used for practically all long-wave reception, as well as short wave down to the 31-meter short-wave broadcast band. With the Ultra Sky Rider it provides complete reception of the radio spectrum.

- Direct Calibration Tuning—No Charts or Tables.
- 1600 KC. Iron Core I.F. System.
- 14 Watts Undistorted Output.
- Micro-Vernier Band Spread.
- Field Strength Indicator.
- 338-Degree Dial.

the hallicrafters inc.

MARION, INDIANA

Patent applied for



Perfect Smooth Tapers.



Pure Silver Shortouts
for Switch Action.



New Spring Wedge
Prevents Loose Terminals.



At Last!
a really
SILENT
Volume Control
of course... It's a
YAXLEY

"No foolin'" — it's really here. They said it couldn't be done. But here it is — a triumph of Mallory-Yaxley engineers — the new SILENT Yaxley Replacement Volume Control.

Here is silent operation with a capital "S". You Can't Hear It! There's not the slightest sound — not even a whisper.

Consider these features (and there are many more):

- ① Perfect Smooth Tapers, feather edged to insure electrical smoothness, and applied to promote mechanical smoothness — and silent operation.
- ② Pure Silver Shortouts for Switch Action — and silent operation.
- ③ Silver to Silver Contacts. No corrosion — but silent operation.
- ④ Highest current carrying capacity; uniform characteristics, long life — and silent operation.
- ⑤ Perfect Contact between moving arm and carbon element through the special Yaxley "M" roller (that doesn't roll). Perfect contact for silent operation.
- ⑥ Low humidity and low temperature coefficients. Never fear "damp spots" or "hot spots." Depend on Yaxley for silent operation.
- ⑦ Universal Application — equipped with the famous Yaxley attachable switch — and other exclusive universal features.

Here's a golden opportunity for you! Take the lead in your locality! The Yaxley "Silent" Volume Control builds reputation and builds business. Get in touch with your distributor today and place your order.

YAXLEY MANUFACTURING DIVISION

P. R. MALLORY & CO., Inc.
MALLORY

of P. R. MALLORY & CO., Inc.
INDIANAPOLIS INDIANA

Cable Address — PELMALLO

YAXLEY

Radio News

October, 1936

The Mad Scramble For **TELEVISION PRIVILEGE** *Threatens Amateurs*

The complicated status of television today is envisioned by a careful survey of the testimony presented recently before the Federal Communications Commission at an informal hearing on the allocation of frequencies in the ultra-high frequency range. The need for standardization without creating monopoly and allowing freedom of future development is stressed

By the Television Reporter

THE recent informal ultra-high-frequency hearings before the Federal Communications Commission in Washington brought many contradictory viewpoints from the various claimants for television privileges on the ultra-short bands. And the indications are that the battle for the high-frequency channels will be bitter indeed at future *formal* hearings if the forthcoming testimony follows the trend established at the *informal* gabfests.

Virtually every branch of the industry was represented by legal and technical experts. If the hearings served any purpose at all, it was the releasing of hitherto hidden objectives. Because so many of these objectives clash, it must be recognized that a mad scramble for the legalized attachment of ultra-high frequencies by many "interests" is now under way. The next big blast from the various fronts can be expected in October when further FCC hearings will be conducted.

Television Stressed

Television was the central focus of the outstanding points in the testimony with some experts seeking delay in public application of the new art and others de-

manding the immediate start of visual transmissions, with amateurs and experimenters being given the opportunity of sharing in the progress of sight broadcasting.

Amidst all this testimony, some of which was fair and open and much more of which was strongly biased and obviously designed to pull the wool over the eyes of the Commission members, the danger loomed of amateurs losing the 5-meter band. It would be irony, indeed, to snatch away these ultra-low channels from the non-commercial radio enthusiasts who, without personal profit, have really developed them and discovered their practical utility. This most emphatically must never be allowed, as the 5-meter band is becoming of greater and greater importance to the amateur.

AMERICA WANTS TELEVISION NOW!

As an indication of the average American's interest in television it may be stated that anywhere there is a public demonstration and they are few and far between, the citizens of this country are always on hand in large numbers to take a first "look-see". The scene, below, is a demonstration, on June 4th, 1936, of the first Don Lee Broadcasting System's television service.



Near or Far?

Is television near or far? If you want your answer from the testimony at Washington, it is paradoxically both near and far! It is obvious that some individual broadcasters and manufacturers base their often contradictory viewpoints on their own welfare, seeking to delay television if it means greater gains in the longer run, or to

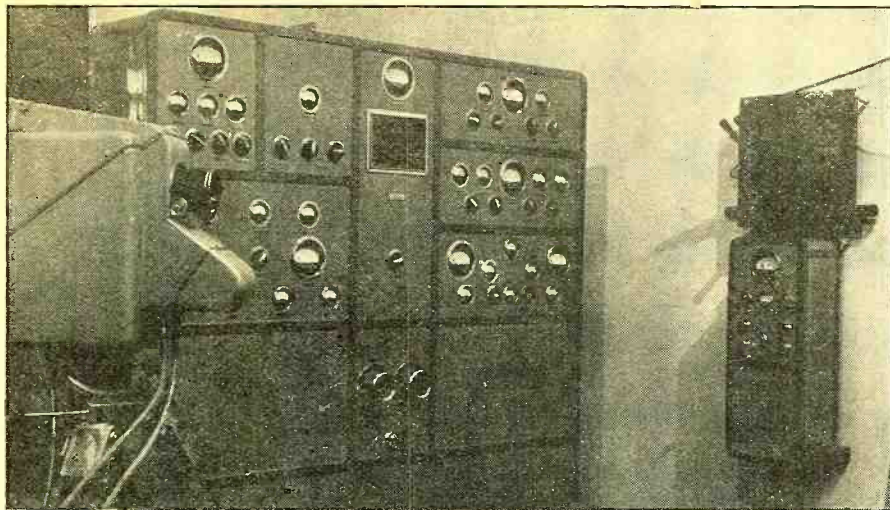

HIGH-DEFINITION SYSTEM

As an illustration of European Television development this picture of the Soviet cathode-ray television transmitter with a picture detail of 70,000 picture elements is published. It was built under the direction of V. L. Kreitser, Engineer of the All Union Scientific Research Institute for regular service in that country.

hasten it if they desire to get what they can while they can.

Can the delay be used to set up a monopoly in the art? We point out that there is danger of this happening! There are after all, broadcasters, manufacturers, patent pools, television companies, amateurs and, of course, the huge radio public to take into consideration, and whatever is done must be carefully considered if no serious errors are to be made in the Commission's decision.

Monopoly is the vital issue. Lee Ellmaker, President of RADIO NEWS, points this out in the boxed editorial accompanying this article. "We must however warn," he states, "that we should not let television fall into the hands of two corporations as has radio broadcasting."

Let All Participate

From the individual and smaller television experimenters comes the cogent plea that anyone who is developing television should have a *full chance*. There should be a release of data, equipment and facilities for amateur as well as commercial participation. The amateur's claim is necessarily strong and weighty with his Government because, in the scramble for the tiny waves, he must be permitted to hold his present facilities in addition to having a hand in future radio progress, a hand that he has always willingly offered to his Government and the radio art in general. The amateur cannot possibly be suspected of any "monopoly"; he is simply interested in radio progress and improvements, and should be guaranteed a future chance to add his knowledge to solving radio's problems.

American radio executives have frequently pointed out that this country has equalled or surpassed, in laboratory development, any television achievements

A Basic Television Standard

ENGINEERS of the radio industry have reached an agreement on the basic factors of development for television. This is to be commended.

The Communications Commission may well follow the advice of James M. Skinner, Chairman of the Radio Manufacturers Association, when he asked that regulations be adopted which will lead to a single technical standard of television transmissions so that one set may take advantage of all methods licensed to broadcast.

It is only natural to believe that a policy of give and take had to be assumed by the factors of this new industry. In doing this, however, we must be careful that the harmony among natural competitors in this field does not extend to the point where there will not be free competition in the development of television and the sale of sets in the future.

We must further warn that we should not let television fall into the hands of two corporations as has radio broadcasting. Rather than do this, we would even accept the principle that the air waves for television be conserved by the government and that programs be provided by license fees rather than commercial broadcasts.

LEE ELLMAKER, Publisher,
RADIO NEWS.

of foreign nations. Even the Soviet and Japanese as well as the British, German, French and Italian equipment bears striking resemblance to the Farnsworth and Zworykin apparatus, at least in outward appearance if not in performance. The point is that England, Germany, Russia, France and other countries are bringing their television systems out into the open, with public participation, while the U. S. A. thus far is keeping its sight broadcasting achievements behind closed doors. Much of the American delay is caused by individual manufacturers and broadcasters who hold that television must be perfected before it is launched. *We sus-*

pect that the delay may be incidental to efforts to grab control of the television industry before it is born.

America's supremacy in sound broadcasting and reception is an acknowledged fact. Other nations gauge their radio progress in terms of how many years they are behind the U. S. A. Now, must America yield this position of scientific and industrial prestige to satisfy the whims of certain individual firms? Shall these firms risk for the entire industry a secondary world rating for American television?

The Manufacturers Angle

It has been said that America might profit by the mistakes other countries will make in television and that a belated start here will lead to ultimate greater gains. But this theory's weakness lies in the fact that there may not be any mistakes made abroad and that the pioneer television nations will benefit by immediate gains. And, even if there are errors, the opportunity of benefiting by them will first be accorded the television nations making them.

The highlight of the Radio Manufacturers Association television proposals as set forth by James M. Skinner, President of Philco and chairman of the RMA Special Committee on Television, was his basic 5-point program "for the successful development of television in the public interest. The summary of the plan follows:

"1. Establishment of a single set of television standards for the United States so that all receivers shall be capable of receiving the signals of all transmitters.

"2. Development of pictures free from distortion and blur, approaching ultimately the distinctness and clarity obtainable in home movies.

"3. Provision for services giving as near nationwide (Turn to page 247)

A NEW HEIGHT IN BRITISH TELEVISION TRANSMISSION

This is London's newest television landmark. The television aerial mast at Alexandra Palace is 600 feet above sea level and it is from this point of vantage that the London Television Service is being inaugurated.

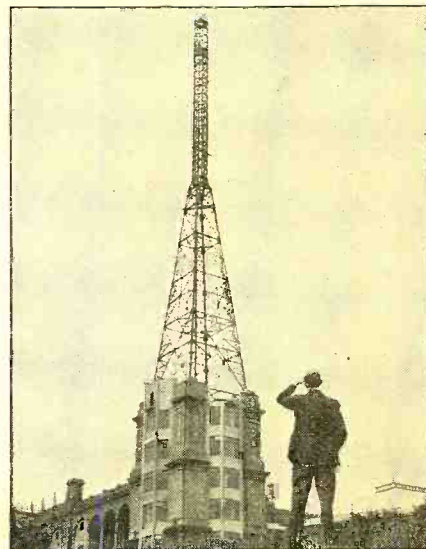

WHAT'S NEW in RADIO

By W. C. Dorf

6L6G Tube

The Raytheon Production Corp. is now manufacturing a type 6L6G tube with octal base, its characteristics conforming to those of the 6L6 type metal beam-amplifier tube. It is enclosed in an ST-16 glass bulb and this company advises that with the new tube, stem press insulation is more than adequate to care for the

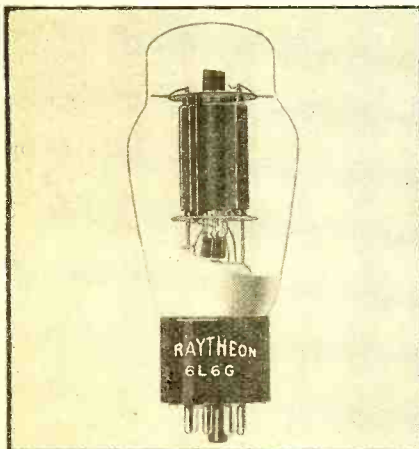

transient voltages which are likely to appear in the plate circuit of such a high-power amplifier.

Features Natural Tone

The RCA model 9K2 is illustrated with a mirror view of the interior showing the "cylinders" of the new "Magic Voice" installation. This is a feature designed to eliminate the "boom" of cabinet resonance and allows only the desired "controlled" notes to radiate into the room. It is a 9-tube, 5-band superheterodyne providing a

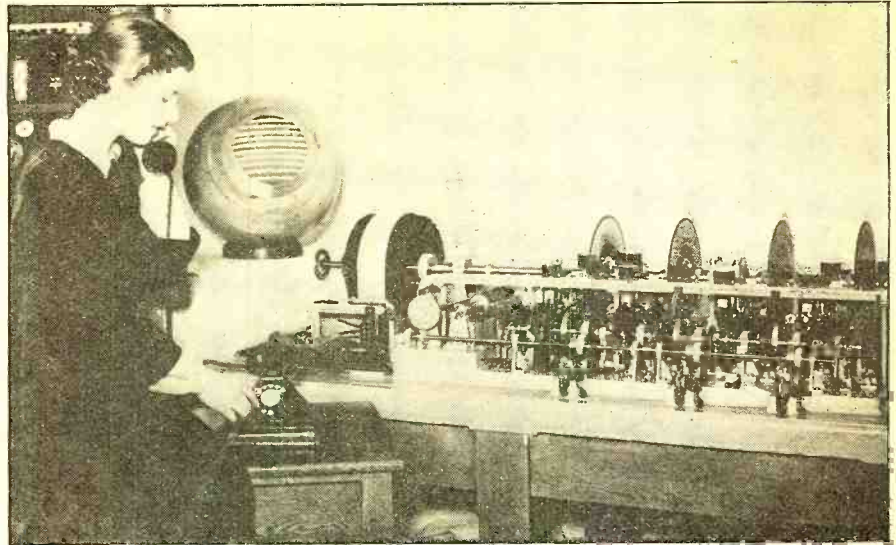
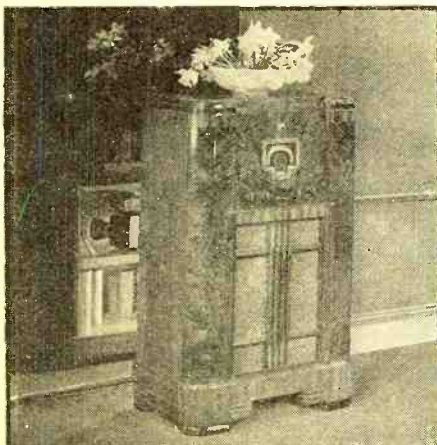

WONDERFUL NEW ROBOT VOICE TELLS YOU THE TIME

In the future this radio invention may be used by telephone companies to tell you the correct time. By its use you simply dial a number and an automatic switching arrangement connects a phonograph disc into the circuit which reports back for you in spoken words the correct time of day. The photo shows Miss Ethel Cain, whose voice was used for making the records of this ingenious new talking time-clock.

tuning range from 150 kilocycles to 60 megacycles. The set incorporates other new developments which include automatic tone compensation, magnetite core i.f. transformers, cathode ray tuning eye, etc.

20-Watt Portable P. A. System

The Operadio model 110R sound reproducing system should meet with a great deal of favor among servicemen and dealers. It is especially applicable to outdoor gatherings, political rallies, large auditoriums and offers a profitable sideline for direct sale or rental. It features an "acousti-reflex" principle of sound reproduction and is complete with crystal type microphone, speaker, tubes, carrying cases, etc.

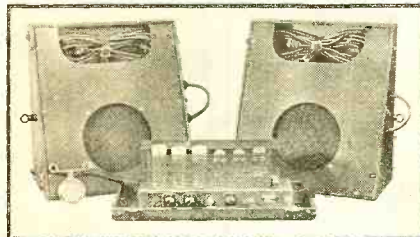

The specifications show that 4 stages are employed, using three 57 type tubes and two 6B5's and its overall gain is 110 db.

New Tuning Condenser

In step with the rapid development of ultra-high frequencies for radio transmission and physiotherapy, the Allen D. Cardwell Mfg. Corp. has developed two types of ganged variable air condensers to combine all the essential features to produce efficient performance at frequencies of the order of 30 megacycles and up. The model NP35GD, illustrated, is especially designed for use with amateur high-frequency transmitting equipment of moderate power. It is also used in the therapy field for resonating the output or patient-pad circuit.

Specifications follow: maximum capacity per section, 35 mmfds.; minimum capacity per section, 5 mmfds.; voltage rating, 4,000 V. peak flashover; Isolantite insulation and single hole mounting. The model JD28GD balanced type of "all insulation" frame, high-frequency air capacitor has a max. cap. per section of 28 mmfds. and a

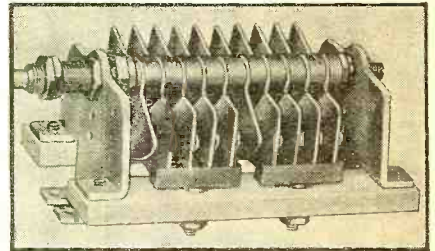

minimum of 5 mmfds. The voltage rating is 4600 V. peak flashover.

Adjustable Iron Core I.F. Transformers

As a remedy for instability of alignment and mechanical shifts of capacitance, a new type of intermediate-frequency transformer with adjustable Polyiron cores for both primary and secondary windings are offered by the Aladdin Radio Industries. This new transformer is designated Type P and the announcement states that the

(Turn to page 244)

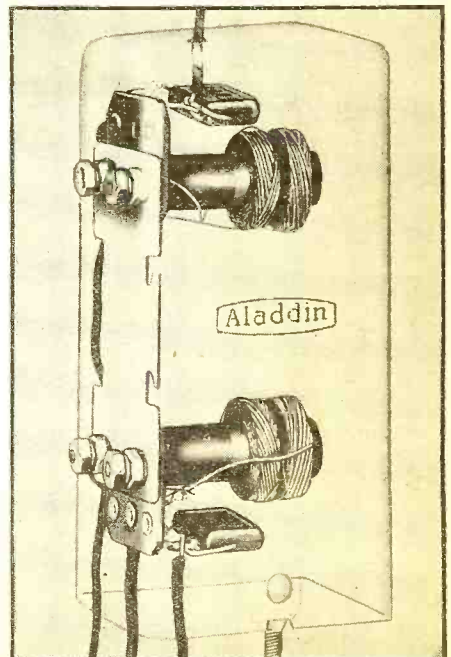

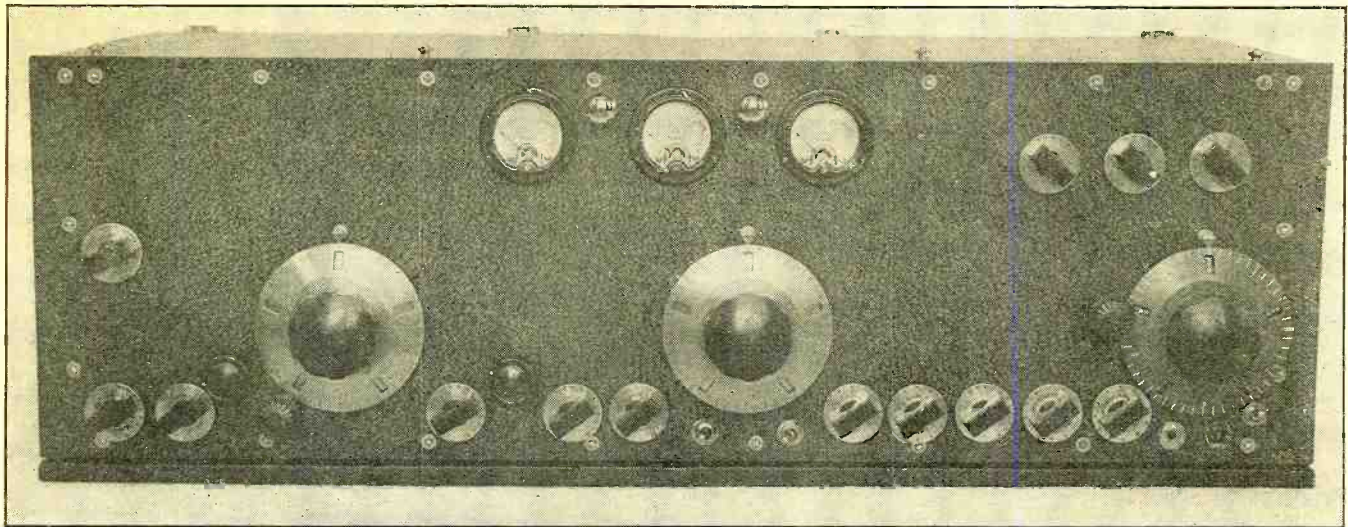

FRONT VIEW OF THE HIGH-SENSITIVITY, HIGH-SELECTIVITY RECEIVER FOR AMATEUR USE
 Here is a new communications type receiver that has "everything." The utmost in sensitivity, it will tune "like a hair" when you need it, includes two kinds of a.v.c., triple or quadruple detection and many other features.

The Radio News Laboratory Model 5-10-20 METER SUPER (Communications Type)

By Frank H. Jones

THIS experimental laboratory model RADIO NEWS 5-, 10- and 20-meter Communications type receiver to be described, was discussed in its technical details with our very good friends, Laurence Cockaday and S. Gordon Taylor as early as 1935—especially, the unusual features of triple-detection for procuring desirable effects in steepening the opposite sides of the over-all selectivity curve of this receiver. Four frequency changes are resorted to in one hook-up to take advantage of super-regeneration at the high frequencies in the neighborhood of 30 megacycles, for a.v.c. effect. There is also some noise-quenching effect besides the inherent a.v.c. action, which helps

the regular over-all a.v.c. circuit of the entire receiver combination.

No startling ideas are embodied in this set. Some schemes are unusually combined to make for flexibility. A receiver of this type is bound to be rather complicated, and somewhat expensive. It's not for the bargain hunter. It is, nevertheless, straight-forward in design, and relatively simple in operation. Numerous dials and small knob controls are shown, but this does not mean that you use all of them all of the time, not by any means. Most of them are rarely touched, but when conditions arise for their need, they are there to help you bring in that elusive signal, and to let you complete a 100 per cent QSO. If

all signals came in loud and in the clear, a very simple receiver would suffice.

Naturally, any good communications receiver must have high sensitivity. This one has all you can possibly use. When you are working in the 20-meter amateur band on phone, you want selectivity of a very high order. However, do not expect to separate phone signals with any intelligibility or quality left over, if the unwanted signal is *literally* right on top of the one you want who may be considerably weaker. It just can't be done with present methods of carrier modulation, all claims to the contrary, notwithstanding. There must be at least about a k.c. difference to make the attempt at a QSO (Turn to page 206)

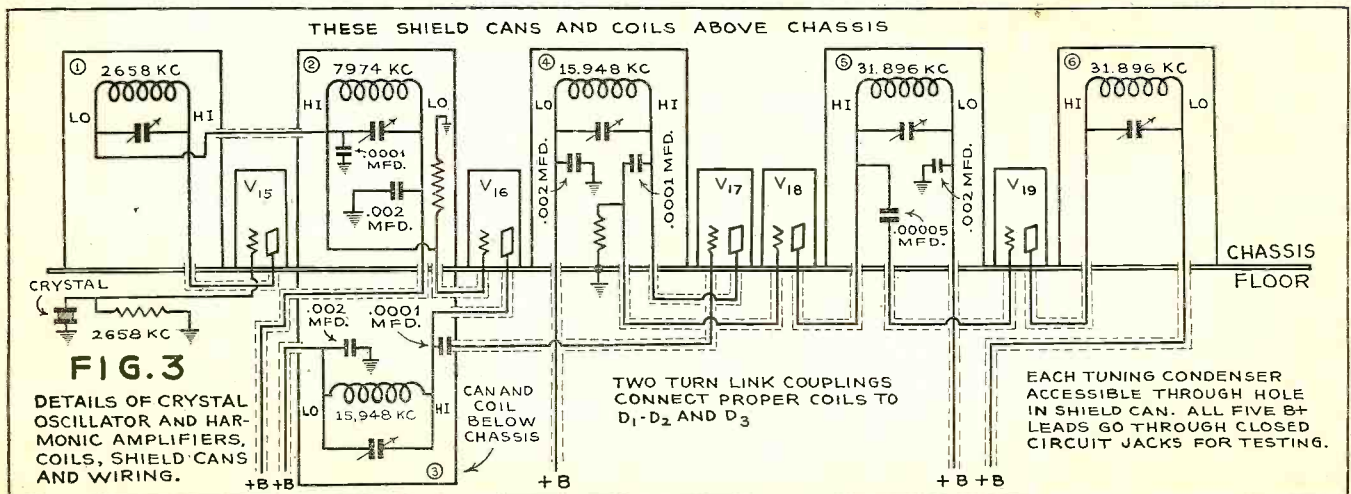

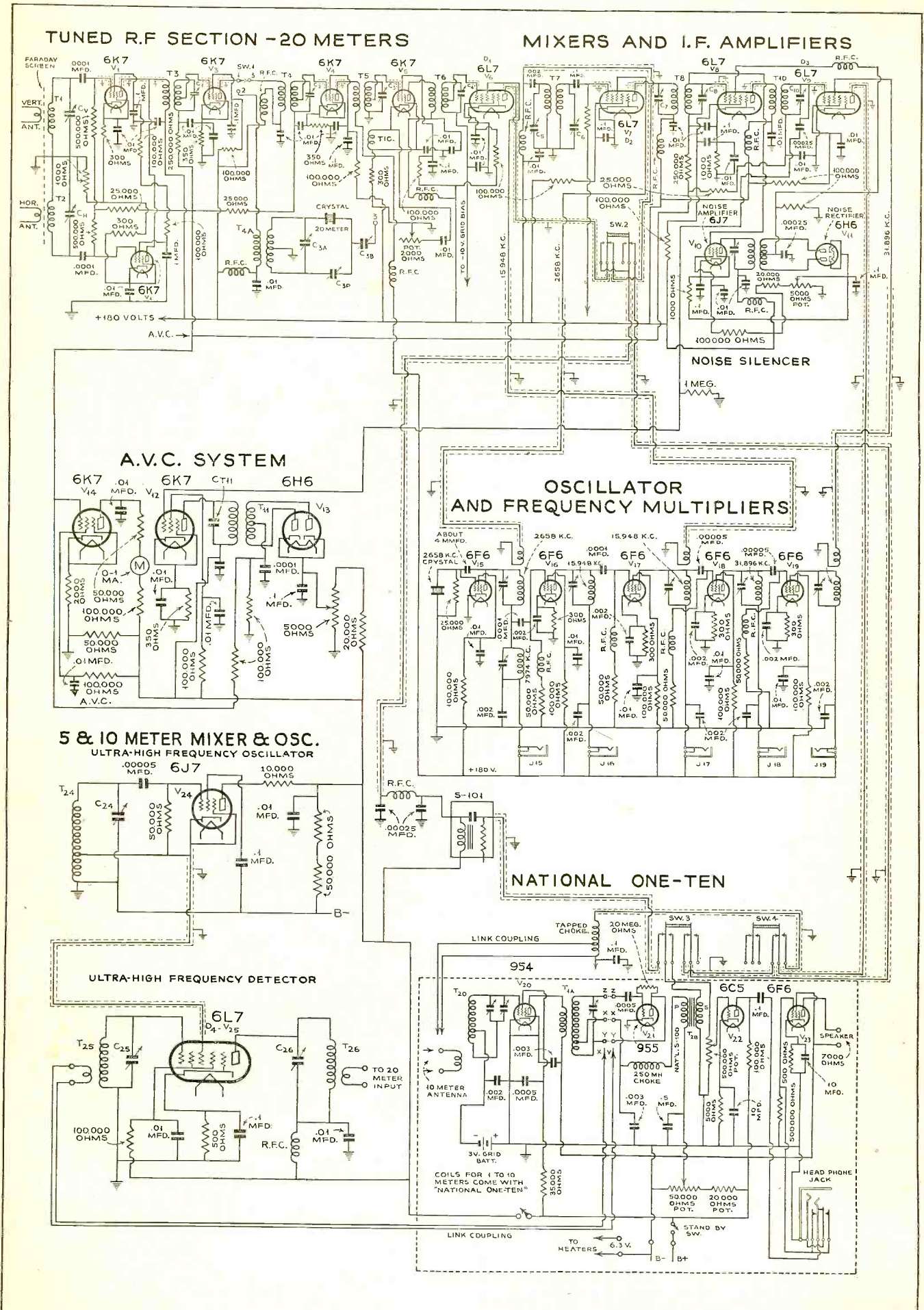



I DESIGNED this receiver for the advanced amateur who wishes to have at the touch of a control all of the recourses known to the radio-reception art. Originally, it was planned to follow rack-and-panel commercial design, but this idea was dropped, as it was thought that more amateurs might tackle the job of building this receiver if a less pretentious model were laid out. Also, lest there be any mistake at the start, let me say that this is not a combination all-wave receiver for the BCL. It is strictly a short-wave receiver for communications service in the 5-, 10- and 20-meter bands and mainly for phone.—*Frank Jones, CO6OM.*

worthwhile. Personally, I would rather not talk with a friend over amateur radio, if I can't hear his voice in its natural tones. Amateurs can not have exclusive frequency assignments, so naturally, in crowded channels, there is bound to be some strong signal on top of a weaker one, at some times. Selectivity, then, must be good enough to get a weak phone signal one or two k.c. away from a more powerful one. A crystal filter will do a little better than this.

Straight, inherent close-up selectivity can also do the job in good shape. However, we have all the methods available in this Laboratory Model, although the crystal is used in an unusual manner. Besides the crystal filter, there are numerous methods of obtaining a high order of selectivity, and these are all incorporated in this receiver.

Certain absolutely essential features for such a set may be enumerated:

(a) Highly-efficient coil forms, in combination with high-grade condensers, and isolantite or victron insulation to help in obtaining high "Q" circuits.

(b) Absolute stability in the oscillator circuit or circuits. This can only be obtained by using crystal controlled oscillators and harmonic amplifiers.

(c) No regeneration in any circuits where you don't want it.

(d) Some regeneration where you do want it, and so controlled as to be "non-finicky" and have a high degree of "stay-puttedness."

(e) A crystal filter to use if you want to, but applied in this receiver in a new way.

(f) A double input circuit of very high gain to off-set tube-noise and certain types of fading, and to give a good signal-to-noise ratio. Both a vertical and a horizontal antenna are used with this receiver at the same time and means, to be described later, to pick out the signal on the antenna with the best signal-voltage, noise-voltage, ratio. A sort of diversity-effect receiver, although out of phase voltages are not successfully handled.

(g) You must have a very high gain before the 1st. detector or mixer. This receiver has FOUR STAGES of t.r.f. before the first detector. This set up spells goodbye to image frequencies, and contributes to a very high conversion factor in mixer No. 1.

(h) All possibly interacting circuits must be completely shielded. Some parts must be double shielded. With the antenna tip plugs pulled out, there is no pick up from a powerful transmitter 3 feet away.

(i) Compactness in design has many advantages, and the new metal tubes are part of the answer to this problem, although these new metal tubes are getting so small, that there is more space required for the associated by-pass condensers and resistors, than there is for the tubes themselves.

(h) In line with the idea of compact-

EXPLANATORY DIAGRAMS

The two diagrams below show Mr. Jones' ideas, explaining the use of frequency changers to steepen the sides of the resonance curve of the receiver. At the left is Figure 4 and at the right is Figure 17.

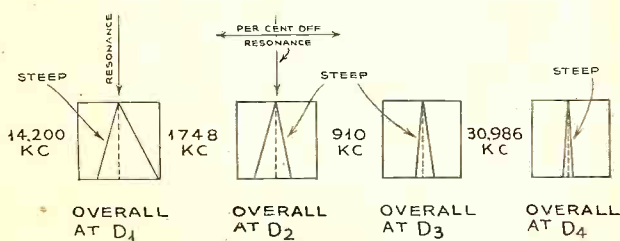
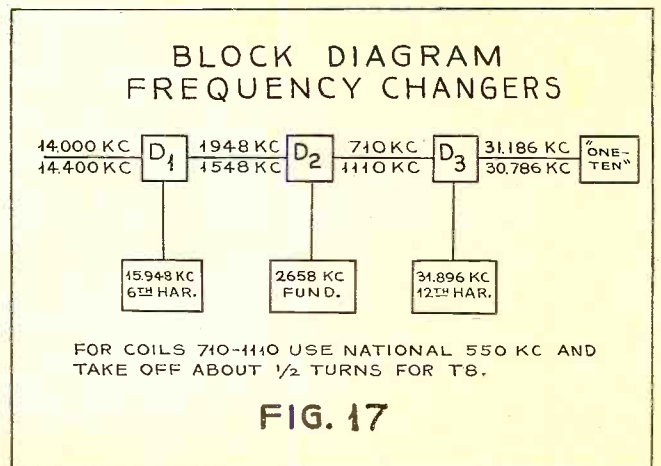
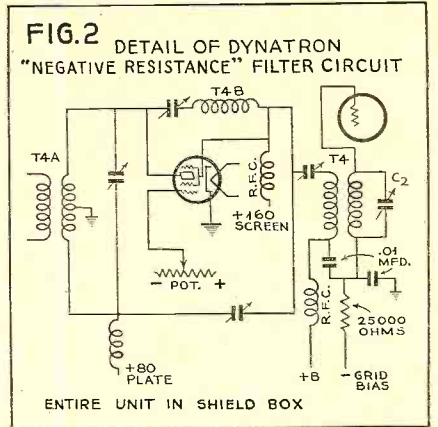

FIG. 4 SHOWING HOW SUCCESSIVE FREQUENCY CHANGES STEEPENS FIRST, ONE SIDE, AND THEN OPPOSITE SIDE OF SELECTIVITY CURVE. THIS ACTION EFFECTIVELY MAKES FOR VERY SHARP TUNING, DUE TO EXTREME STEEPNESS OF BOTH SIDES OF CURVE. DIAGRAMS TRACE A TYPICAL CARRIER THROUGH ALL FREQUENCY CHANGES.



FOR COILS 710-1110 USE NATIONAL 550 KC AND TAKE OFF ABOUT 1/2 TURNS FOR T8.

FIG. 17



THE DYNATRON FILTER

Figure 2. Showing the basic circuit of the experimental filter-circuit employed by Mr. Jones.

ness, it may be said that the really ideal layout for a communications receiver, is the relay rack form. This allows complete isolation of the various sections and has many additional advantages. However, the amateur usually likes his receiving equipment spread out handily on a convenient operating table. In the design of this receiver, this necessitated a cabinet rather longer, horizontally, than usual, to get the receiver into reasonable table dimensions.

(k) Power-pack plus "B" supplies are outside the receiver where they should be for complete absence of hum troubles, heating, etc.

(l) James Lamb's contribution of the noise-silencer circuit, would not have been integral with this receiver if we had finished it last summer. This circuit has been incorporated in our Laboratory Receiver, and is a distinct asset, on 5, 10 and 20 meters.

Design Features

The basic idea back of the 20-meter circuit in this particular superheterodyne receiver was to obtain a very considerable part of the selectivity in the tuned-radio-frequency stages. While it is generally easier to obtain good selectivity in the low frequency stages it was thought possible to design four stages of tuned radio-frequency input, in which the gain per stage (Turn to page 249)

A Record Making LINEAR Oscillator for 5 Meters

By Paul Cintrat (W2IPH)



A PIONEER TELLS HOW HE DOES IT

The author of this article, shown seated before his 5-meter and 10-meter rigs, describes the apparatus he uses for long-distance transmission on the ultra-high frequencies. The linear oscillator is shown in the background at the left.

DESCRIBED last month was the author's 10-meter crystal-controlled transmitter, including the exciter unit, with an oscillator on 40 meters and doubling down to 5, and a final amplifier using 801's. The article this month describes the author's 5-meter transmitter using the popular so-called "long lines" oscillator. Also described is the audio amplifier and modulator unit that is used with both rigs on 5 and 10 meters.

POSSIBLY the easiest way to get a fairly stable oscillator with sufficient amounts of power for operating on the 56-60 mc. amateur band is to use a linear amplifier using "rods" in the grid and plate circuits of push-pull tubes such as the 801's, 210's or 45's. At least that has been my experience and I have had exceptional results in working First and Third District stations from New York with such an outfit. I use a pair of 801's in the circuit shown in Figure 1.

The oscillator in my case is powered by the same power pack I described last month for use with the final stage in my 10-meter rig. All I have to do is to switch over the B from one rig to the other. I also employ a type B46 modulator the circuits of which are shown in Figure 2 to modulate both rigs. The connections of the out-put transformer on the modulator are simply shifted from one circuit to the other and in this way I have a very economical use of all the apparatus in my station, as the final tubes on the 10 meter rig are 801's also.

Returning to the linear oscillator, it is built up of a kit consisting of a square panel upon which are mounted the two tube sockets as well as the holes for mounting the 4 copper rods. The insulating material of the square panel is

mycalex. The top ends of the four rods are similarly held in correct position so that they will not vibrate. In the diagram this is shown by four supports one at each end of the two rods but it should be understood that the two supports at each end are really one and the same. One set of the rods tunes the grid circuits and one tunes the plate circuits as the diagram shows. The grid shorting bar is connected through an r.f. choke and a variable resistance to the center tap of the filaments of both tubes. The plate shorting bar is connected through an r.f. choke and through a milliammeter to the B terminals on the power pack.

Tuning the Rig

It is quite a simple matter to tune up the resonant lines by simply sliding up and down the plate (Turn to page 255)

CONSTRUCTION DETAILS OF THE OSCILLATOR AND MODULATOR

Figure 1, at right, shows the circuit used in the linear oscillator which can be built from a simple kit of parts. Figure 2 gives the circuit and electrical constants of the high-quality modulator used at W2IPH.

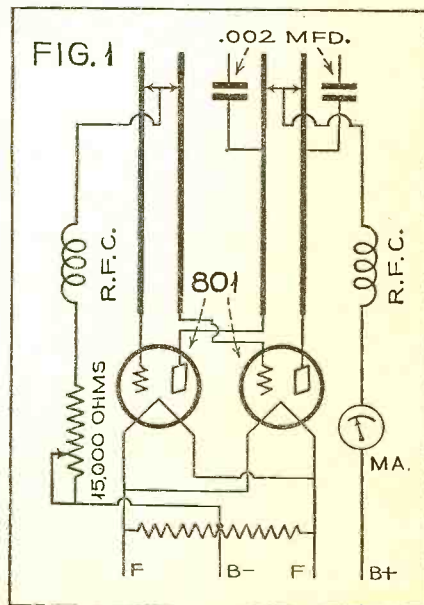
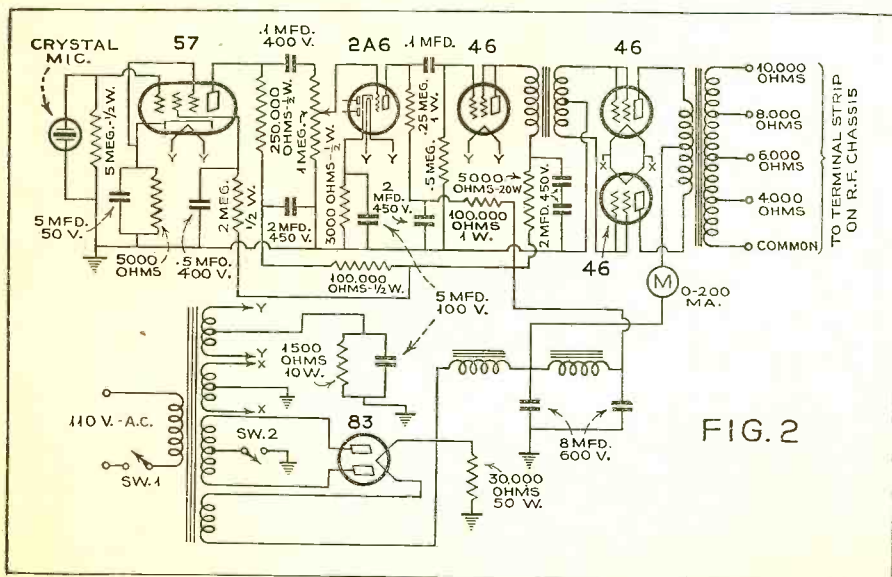

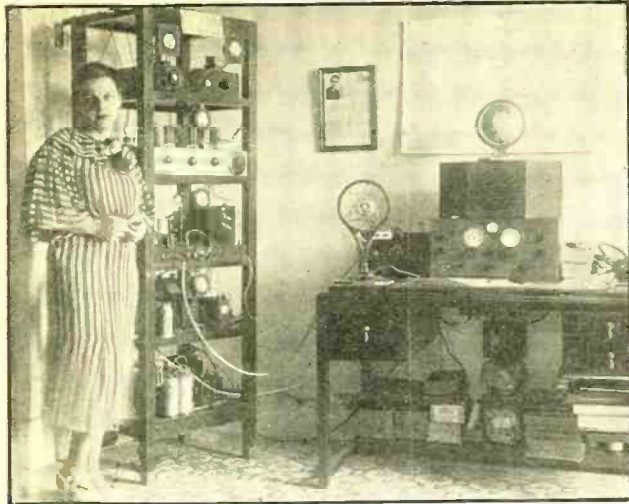

The "HAM" Shack

Conducted by
Everett M. Walker
Editor for Amateur Activities

IN CUBA
Meet the second Op (or should we say the first) of amateur station CO2KY. This station has done fine work, along with H17G, on hurricane warnings.

double triode. It consists of 17 turns of No. 14 tinned-copper wire $\frac{5}{8}$ inch in diameter. All other accessories, such as bypass condensers, radio-frequency choke coils and resistors, are mounted under the chassis out of view. A switch is provided under the tuning dial for breaking the plate circuit during stand-by periods. A jack is provided at the end of the chassis for measuring plate current on both plates of the oscillator tube.

A shielding partition divides the oscillator and modulator circuits. This is necessary to keep the r.f. out of the audio circuit wherein its presence would naturally cause trouble. Here again the components are mounted to follow the schematic wiring diagram. At the right and near the front panel is the microphone input transformer. The gain-control, as 0-500,000 variable resistor, is mounted on the front panel, immediately below the input transformer. Immediately behind the transformer is the 37 tube. At the left is the modulation choke and behind this is the 6L6 modulator tube.

Resistance Coupled

The 37 tube is resistance-coupled to the 6L6 modulator. If higher audio gain is desired a higher- μ type tube may be substituted for the 37, but in this particular unit it was found this arrangement provided more than sufficient amplification, when using a single-button microphone. Terminals are provided for the microphone and its associated battery at the input end of the chassis. All of the wiring for this section of the unit with the exception of the leads to the transformer and the choke coil are below the subpanel.

Coupling between the modulator and oscillator is accomplished by means of a 30-henry choke coil. This coil must be capable of carrying both the plate current of the RK-34 and the 6L6, and preferably should be rated at about 150 milliamperes. Another point; it was found necessary to shield the grid lead between the potentiometer and the grid of the 37 tube. All of the small components are mounted on chassis support insulators. This arrange-

Efficient 5-METER Transmitter

A SIMPLE, efficient, low-powered 5-meter transmitter is something that should be part of the equipment of every amateur station. It, preferably, should be portable or semi-portable, but at the same time be designed to give the utmost efficiency. Five-meter equipment is an extremely valuable accessory during times of disaster, when emergency communication is necessary and the amateur is called upon to supply it. Furthermore, in addition to the possibility of emergency communication need, there is much interesting work being done on the ultra-high-frequency bands, and the old stand-bys of the other bands who have never tried 5 meters should give it a whirl.

MUCH is being found out about ultra-high-frequency phenomena these days. With the 5-meter band opening up now and then for extreme DX, interest in the band has been greatly increased in the last few months. The operators who captured the cream during these phenomenal periods proved something that has been believed impossible for some time. They also proved that it is not necessary to use a large amount of power to get in on the DX when the band opens up. The majority used inputs between 20 and 50 watts.

An interesting little transmitter recently was brought to the attention of the

writer. It has a number of features that we believe worth passing on. It was built by Edward Clegg, of Belleville, N. J., son of W2HNA, a well-known amateur. The transmitter and modulators are contained in one small unit and two power supplies are available: one for A.C. mains, the other a dynamotor, storage-battery arrangement that facilitates portability for mobile operation.

The transmitter unit is mounted on a chassis, 7 by 12, by 3 inches and has a front panel, 7 by 12. An RK-34 is employed as push-pull oscillator in a TNT circuit. This portion of the unit is contained in a space $4\frac{1}{2}$ inches wide on the chassis. The modulator is contained in the remaining $7\frac{1}{2}$ inches of chassis space and includes a single 37-type tube, resistance coupled to one of the new 6L6 type tubes as a modulator. When using a single button microphone, more than sufficient gain and audio power are available to modulate twenty watts input on the RK-34.

The layout essentially follows the schematic wiring diagram. The oscillator unit is mounted at the extreme left of the panel, and its tuning control, a 15-mmfd midget condenser is mounted on the front panel. It is insulated from the chassis of course. Immediately behind the tuning condenser is the plate coil, which has 4 turns of No. 10 wire $\frac{3}{4}$ inch in diameter. The coil itself is mounted on $\frac{1}{4}$ inch stand-off insulators, atop of which are mounted additional stand-off insulators of the threaded variety for supporting the one-turn antenna pick-up coil.

Immediately behind the plate-tuning circuit is the oscillator tube and its associated socket. The grid coil is mounted directly on the tube socket, each end, of course, being connected to the grids of the

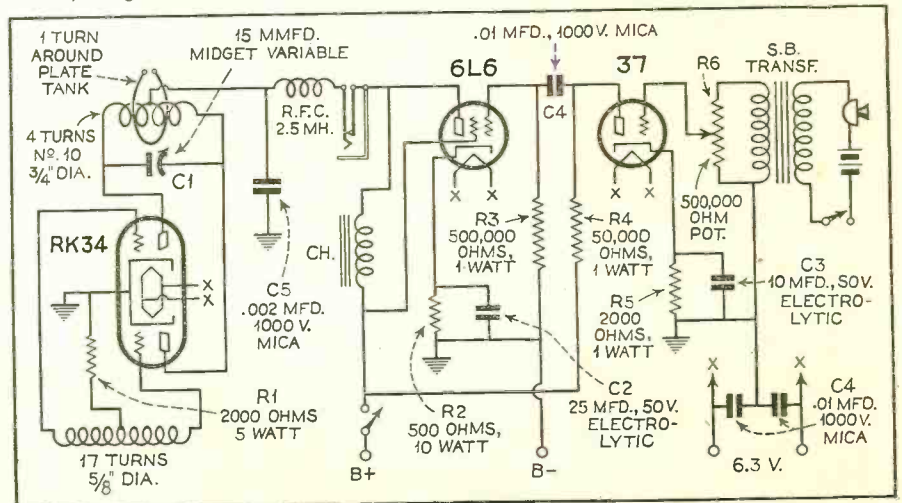
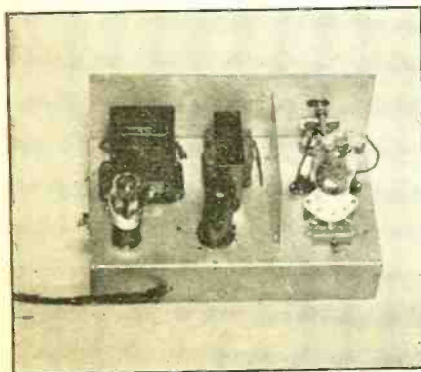

Q A Department for the amateur operator to help him keep up-to-date

ment insures rigidity, an essential feature when such a unit is to be used for portable or mobile work.

Power leads to the transmitter are brought out through a 4-wire cable connector and a tube-socket plug. The plug may be connected either to the a.c. power unit or to the dynamotor and storage battery.

The Power Unit

The a.c. power unit is more or less conventional. It uses condenser input, a 5Z3 rectifier tube and delivers slightly more than 300 volts. Any convention arrangement of components in the power supply will be satisfactory. The one used with this transmitter is mounted on a 7 by 9 by 2 inch chassis, with the transformers and choke coils mounted in a line on one side of the chassis and the tube and filter condensers on the other. An a.c. power switch, of course, is provided. A 20,000-ohm bleeder is connected across the output to insure good regulation.

The portable-mobile power unit used a Gen-e-motor which delivered 300 volts at 100 milliamperes and was used in conjunction with an automobile storage battery.

Almost any type of antenna may be used with such a transmitter. The single-turn, loop coupling works exceptionally well with a half-wave antenna coupled to the transmitter by means of a twisted pair. For mobile work a quarter-wave, or 4-foot antenna and ground arrangement using the car chassis as the ground works well, too.

As for performance, the transmitter gave excellent results, stations up to 25 miles distant being worked with regularity. The quality reports were excellent, and stations with super-heterodyne receivers frequently commented on the stability of the signal.

List of Parts for Transmitter Unit

- One 15 micromicrofarad condenser (Hammarlund) C1
- One single but on microphone input transformer (Trutest)
- One 30 henry 150 ma. choke coil (Thordarson) Ch
- One seven-prong isolantite socket for RK-34 (National)
- One metal tube wafer socket
- One five-prong wafer socket
- One 0 to 500,000 potentiometer (gain control) (Electrad) R6
- One 2000 ohm 5 watt resistor R1
- One 500 ohm 10 watt resistor R2
- One 500,000 ohm 10 watt resistor R3
- One 50,000 ohm 1 watt resistor R4
- One 2,000 ohm 1 watt resistor R5
- One 25 mfd. 50 volt electrolytic condenser C2 (Tubular type)
- One 10 mfd. 50 volt electrolytic condenser C3 (Tubular type)

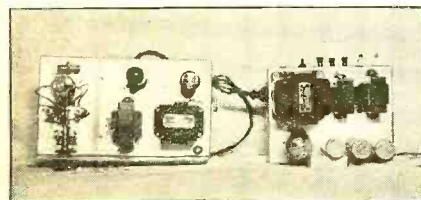
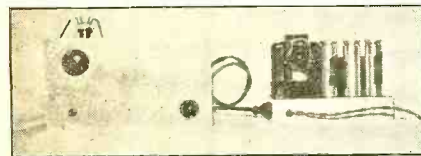

Two New TUBES for Amateurs

By J. Van Lienden

TWO new tubes of special interest to amateurs are the Taylor tubes, types T-55 and 814. The T-55 is a high-voltage, low-current, triode for use as an oscillator or Class C amplifier which will work efficiently down to 2 1/2 meters. It delivers 168 watts as an r.f. amplifier with 1,500 volts plate supply; 66 watts as an oscillator.

The tube employs a carbon anode of a unique and sturdy construction. The internal elements of the tube are supported by high-resistance insulators, thus preventing any misalignment as in tubes with self-supported elements. An Isolantite base of the UX type is employed; the plate comes out at the top of the tube, where a large cap makes connections easy.

Full power can be obtained at frequencies as high as 120 mc. For such work all connections must be of the nut and bolt type or pure lead solder; ordinary solder melts! The following are the characteristics.

Type T-55

Filament volts	7.5
Filament current, amp.	3.25
Plate resistance, ohms	9000
Mutual conductance, micromhos	2200
Amplification factor	20
Maximum length, inches	7
Maximum diameter, inches	2 3/4
INTERELECTRODE CAPACITANCE	
Plate to grid, mmfd.	2.5
Grid to filament, mmfd.	1
Plate to filament, mmfd.	7

Class "C" Power Amplifier and Oscillator

	Class C	Osc.
Max. operating plate volts		
Unmodulated d.c., volts	1500	1250
Modulated d.c., volts	1500	1000

- Three .01 mfd. 1,000 volt condensers (Dubilier) C4
- One .002 mfd. 1,000 volt condenser C5
- One 2.5 m.h. radio frequency choke coil (National)
- One closed circuit jack for meter
- One chassis 7 by 12 by 3 inches
- One panel 7 by 12 inches
- Necessary stand-off insulators, screws, dials, etc.

Parts for A.C. Power Supply

- One combination plate and filament transformer (Thordarson type 7062)
- Two filter choke coils (Thordarson)
- Three 8 mfd. electrolytic condensers (Polymet)
- Two wafer sockets (one for tube; one for connector to transmitter)
- One 20,000 ohm 100 watt resistor (Ohmite)
- One power switch
- One chassis 7 by 9 by 2 inches

'Phone Men Petitioning for More Frequencies

The two factions of amateur radio—'phone and C.W.—are again circulating petitions. Both are to be presented before the Federal Communications Commission at its scheduled hearing on the amateur situation on October 20. The C.W. men are quietly going about the task of getting

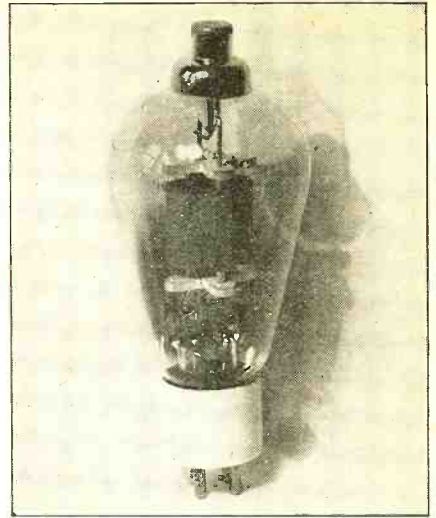

Max. plate current (d.c.), ma.	150	125
Max. grid current (d.c.), ma.	40	40
Max. plate dissipation, watts	55	55
R.f. output, watts	168	66
Efficiency, percent	75	40

Normal Operation

EP = 1250 Eg = -120 Ef = -7.5

The 814 is a triode suitable as a Class C r.f. power amplifier or oscillator. The maximum r.f. output is 400 watts and the high trans-conductance makes it use a kilowatt input for phone operation in a push-pull Class C amplifier, while the grid requires only 60 watts to drive them to full efficiency. It is designed for most efficient output between 10 and 160 meters.

A neutralizing condenser of 25 mmfd. and 6000 volts rating is needed for this tube. Characteristics of the 814 tube follow:

Type 814

Filament voltage	10
Filament current, amps.	4
Plate resistance, ohms	2400
Mutual conductance, micromhos	5000
Amplification factor	12
Maximum length, inches	9 1/2
Maximum diameter, inches	2 1/2
INTERELECTRODE CAPACITANCE	
Plate to grid, mmfd.	13
Grid to filament, mmfd.	7
Plate to filament, mmfd.	5.5

Class "C" Power Amplifier and Oscillator

Max. Operating Plate	
Unmodulated, d.c., volts	2500
Modulated, d.c., volts	2000
Max. plate current (d.c.), ma.	300
Max. grid current (d.c.), ma.	75
Max. plate dissipation, watts	200
Max. r.f. grid current, amps.	8
Max. r.f. output, watts	400

Normal Operation

EP = 2000 Eg = -400 Ef = 10'

as many names as they can that are agreeable to the theory the present allocations to the amateur are adequate. This, at least for the present, would stop any move for additional frequencies and at the same time implies that additional frequencies are not desired for 'phone operation.

On the other hand, the 'phone have been less secretive about their petition. It has been circulated through the mails and much comment has been made about it on the air. Obviously, the intent is to offset any effect the petition of the C.W. men may have on the governing authority and leave the situation open to discussion for both sides at the October 20th hearing. It

(Turn to page 216)

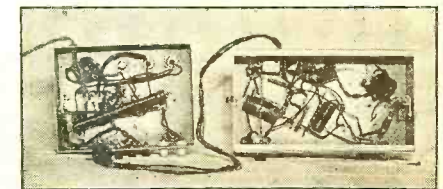

An Effective PORTABLE

The construction data on a simple but effective 5-meter transmitter which is ideal for automobile, aviation or marine use are discussed in detail so that anyone can duplicate the fine results obtained with the first model

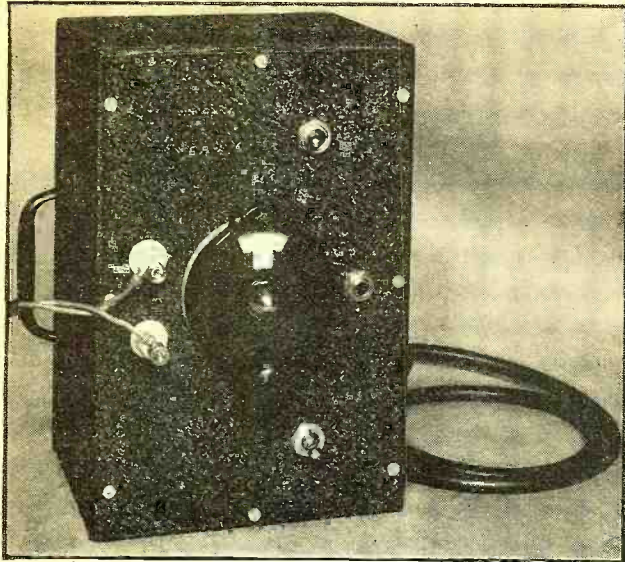

A LITTLE UNIT WITH A BIG "KICK"

Although the GC-2 mobile transmitter may be small, as indicated by this front view, certainly it is able to put out a strong carrier when used as a portable. The central tuning dial controls the frequency and the upper and lower toggle switches control the plate and filament power, respectively. The jack is for the microphone and the two antenna terminals are shown at the left.

IN past issues of RADIO NEWS the activities of the Garden City Radio Club at fixed stations, as well as car, boat and air-craft stations, have been pretty thoroughly covered. While the first transmitter designed by the Club's technical committee under the chairmanship of Edwin Ruth, 3rd (W2GYL) and actually built by Harry Lawson (W2IER) was ideal for certain types of mobile operation, it was thought that a transmitter of somewhat simpler design and requiring somewhat less power to operate would be worthwhile. This idea was brought home to the club's members during the first race from City Island Yacht Club to Stratford Shoal and return. It was found that even with very moderate power the yachts were able to maintain communication with shore stations that had been selected to handle their traffic.

Low Power, High Efficiency

In the next race which started at the southeasterly end of the Sound and ran up to Block Island and back a new method of reporting was employed and two power cruisers, equipped with comparatively high-power, 5-meter transmitters were used to effect communi-

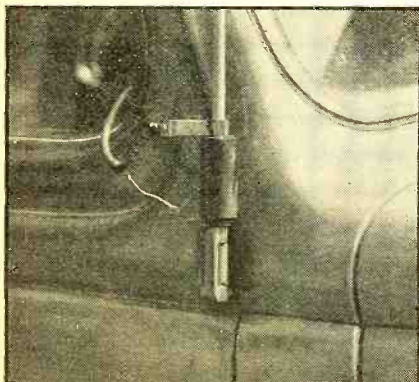

tion with the yachts and they in turn forwarded information to the shore relay stations. The need for long-distance transmissions from the yachts themselves is, therefore, eliminated. While the power to be had from transmitters or other light portable units, generally available, is still insufficient, the simple transmitter to be described has proved to be a revelation in ability to cover real distance with ridiculously low power consumption.

While the circuit employed is strictly conventional, a few practical short-cuts have been incorporated and their value will be recognized at once as they are described. The entire transmitter is housed in a metal cabinet, 6 x 9 x 5 inches. All of the components are attached directly to the front panel and it is only necessary to remove the screws which hold this panel to the rear of the cabinet to withdraw the entire transmitter from its case. Symmetry of design has been given consideration and

conservation of space and weight, in spite of the fact that the units employed are rated very conservatively in this unit, have been thoroughly considered.

Two Antennas Employed

Before outlining the details of this transmitter which is to be known as the GC-2 it may be well to indicate some of the results that already have been obtained with it. The photograph of our car indicates that two antennas are employed. One is attached to the upper hinge on the right-hand, front door. The other is attached to the upper hinge on the left-hand, rear door. Both antennas are 4 feet high.

The design of these units is such that they can bend back on themselves to a point where their tips can be made to touch the roof of the car, without breaking or permanently bending them. In spite of the fact that they can whip around a great deal there is no notice-

CONSTRUCTION DETAILS

At left: The manner of mounting the antennas on the hinge of the car door.
At right: The top view of the chassis.
Below: The transmitter circuit.

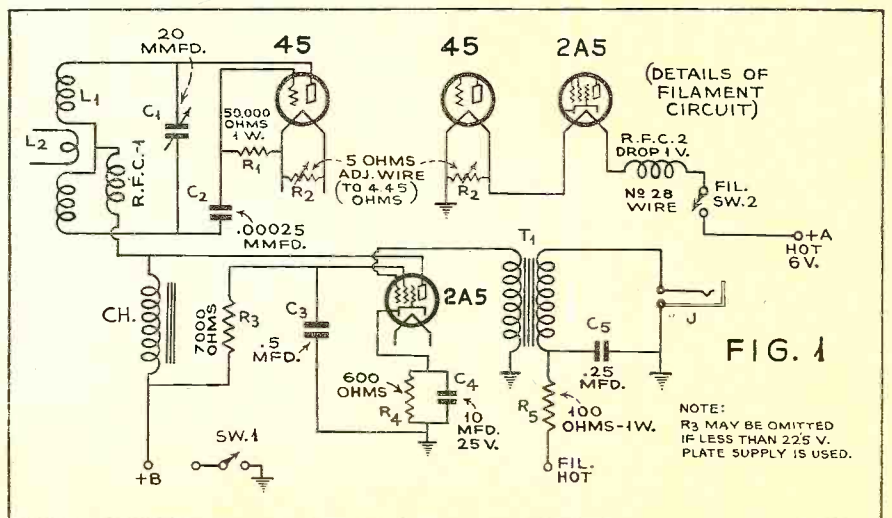
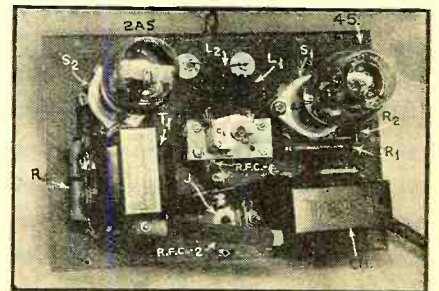

and Inexpensive Transmitter The GC-2

By Arthur H. Lynch



THE AUTHOR TALKS AS HE RIDES

The only indications of a portable-mobile transmitter and receiver appearing on the author's car, shown above, are the two special vertical 1/4-wave Marconi type antennas. The transmitter is powered by B batteries.

able wavering of received or transmitted signals. The antennas are fed in Marconi fashion with a 2-wire transmission line running to the receiver, in one case, and the transmitter in the other. One side of the transmission line is grounded to the car body and the other side is connected to the lower end of the quarter-wave antenna rod, as indicated in the complete circuit diagram.

All the equipment for the transmitter is in the trunk, including the Eveready layer-built "B" batteries which supply the plate voltage for both transmitter and receiver. A s.p.d.t. switch, mounted on the dash, beside the receiver, makes it possible to switch the "B" supply from the transmitter to the receiver, instantaneously, and this provides very rapid "break-in." This is more desirable than attempting to use a single antenna and transferring the lead from the transmitter to the receiver.

Contacts W2JCY

When the transmitter was finished it was turned over to us for test for the reason that we do considerably more driving than most of the other members of the Club. Garden City is some 25 miles from New York and on many

occasions we have picked up stations at Kew Gardens and Jamaica which are about half-way between these two points and have carried on continuous chats with them until we arrived in New York City. On one evening we parked on the top of a hill at Little Neck and got a report of R9-plus from Mr. Cockaday, W2JCY, the Editor of RADIO NEWS, and we were able to maintain contact with him all the way to Garden City, although by the time we reached home our signals were down to a point where they were not too intelligible.

DX from a Plane

The day the Queen Mary arrived we flew this little transmitter in a plane and at a height of about two thousand feet we were heard, R8, at New Haven, Connecticut, while we were flying over New York. The average distance that we can count on for satisfactory operation from the car, even over territory where the road goes up-hill and down-dale is approximately 7 miles. Under reasonably good conditions we can cover 25 miles. The concensus of opinion on the part of those who have heard this

little transmitter is that, considering the amount of power used it delivers plenty of "sock" and the quality of voice reproduction is exceptional.

Motor generators, vibrators and other forms of "B" supply have been tried but, for simplicity of operation and general dependability as well as to avoid overloading the car generator we have attempted to hold the filament drain down to a minimum and have found heavy duty "B" batteries most suitable. The actual filament drain for the tubes used in the transmitter is 1 3/4 amperes. The plate voltage is 200 volts and the tubes consume 48 milliamperes with the antenna fully loaded. This means a plate consumption of 9.6 watts and of this only 4 watts is used as the input to the oscillator. These figures are the result of a check made after the batteries have been in operation for more than two months, during which time the transmitter were used on an average of from 2 to 3 1/2 hours per day. One important consideration is found in the fact that, while we have made very few long runs, the car generator has provided suitable power for the car battery without requiring outside charging.

Type 45 Oscillator

After testing a great many types of tubes for the oscillator, it was found that a regular type-45 tube was the most efficient. It was found, too, that employing this tube in an ultra-audion circuit resulted in equal efficiency in the oscillator circuit in all parts of the band. This permits the rapid changing of frequency to avoid interference, without any serious loss of efficiency. Of course best radiation is found when the oscillator is in resonance (Turn to page 251)

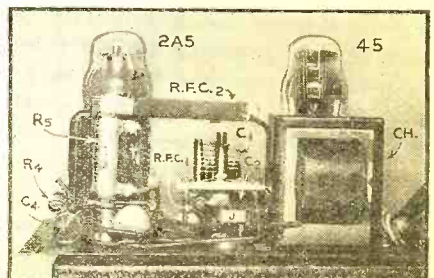
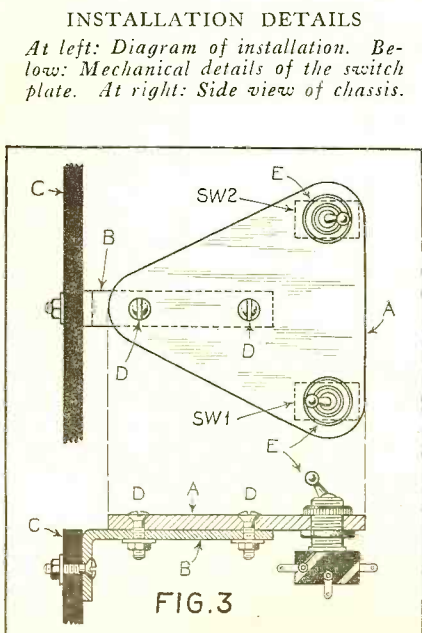
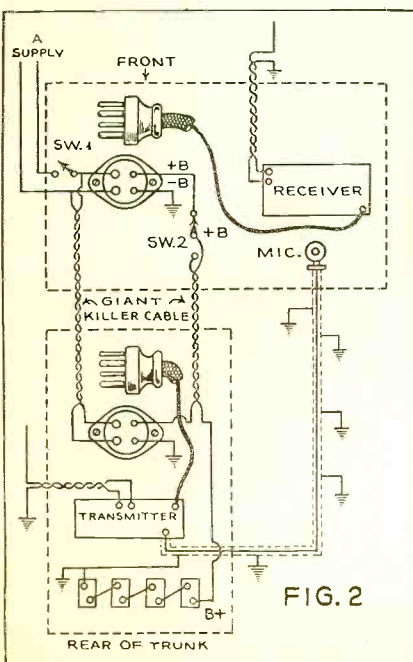

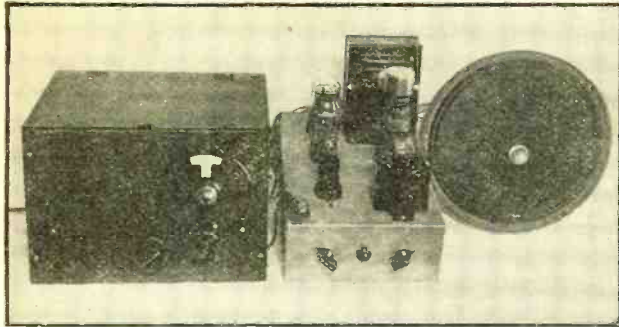

THE SET-UP TO DATE

Here the tuner is shown connected to the amplifier described in the two previous articles of this series. The amplifier supplies the operating voltages for the tuner and field excitation for the Wright DeCoster 820-B speaker.

Practical Construction The Radio

This series of articles is presented here to obtain a working knowledge have some theoretical knowledge tical experience which is so essential

Part 6—Two-Tube

By John M.

THIS article describes the construction and operation of a 2-tube, all-wave tuner employing one untuned r.f. stage and a detector. Connected to the power pack and amplifier described last month, all operating voltages from the a.c. line and good loudspeaker volume are obtainable. The article next month will describe small changes required to convert the untuned r.f. stage to a tuned stage.

So far this series has explained the action of diode and triode detectors. There is a way, however, to make a detector much more sensitive and also somewhat more selective. This is done by means of Armstrong's famous principle of regeneration, employing a cir-

cuit like the one in Figure 1 in which a coil, L1, in the plate circuit is in inductive relation with the tuned circuit L2, C connected to the grid.

This is what happens: As soon as the tube is heated, the tube plate starts to draw current; this current increasing rapidly at the beginning. This rapid increase of current in coil L1 induces a voltage across coil L2 making the grid positive. A positive grid further increases the plate current which causes a still more positive grid and a still greater plate current. Saturation current is reached, however; then the plate current stops increasing which means that the coil L1 no longer induces a voltage in coil L2, the grid-voltage is no longer positive and the plate current decreases. As soon as the plate current decreases, L1 induces a reverse voltage in L2 making the grid negative.

Oscillation Method

The negative grid further reduces the plate current which again makes the grid increasingly negative, etc., until the plate current cannot decrease any more. Then the induced negative voltage disappears. The plate current must then increase to become normal, but by increasing it in-

duces another positive voltage on the grid and the whole cycle of operation will be repeated indefinitely. The result is that an alternating current will flow in plate and grid circuit, the frequency being determined by the sizes of L2, L1 and C. This condition is called oscillation.

The Regenerative Detector

If a fraction of the output power of a tube is fed back to the grid, it can keep itself in oscillation. There are various ways of accomplishing this result and there are many different forms of oscillating circuits. The energy need not be fed back by means of coils, sometimes it can be done through condensers or resistors. The main idea is to apply the proper amount with the proper timing (or phasing). Generally there is so much accidental coupling that oscillation may take place when it is not wanted, this is especially so in high-gain amplifiers and is the main reason for shielding.

When the voltage which is fed back to the grid is slightly decreased (by moving L1 farther away from L2, for instance) oscillation will stop. When a

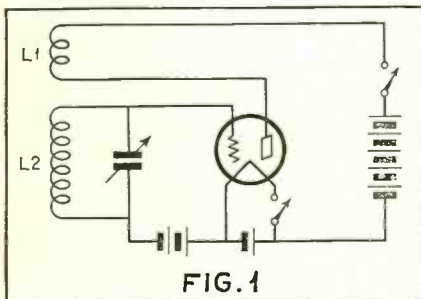

FIG. 1

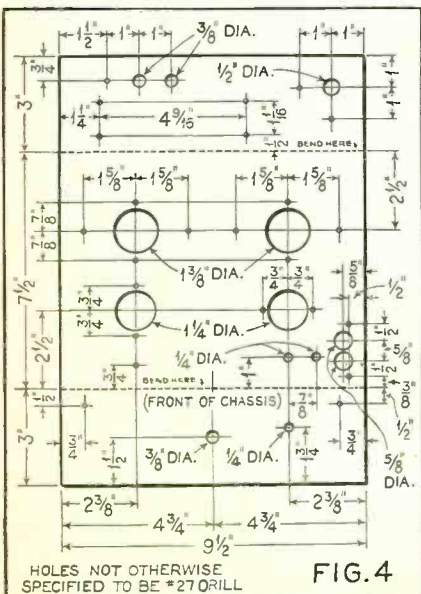

FIG. 4

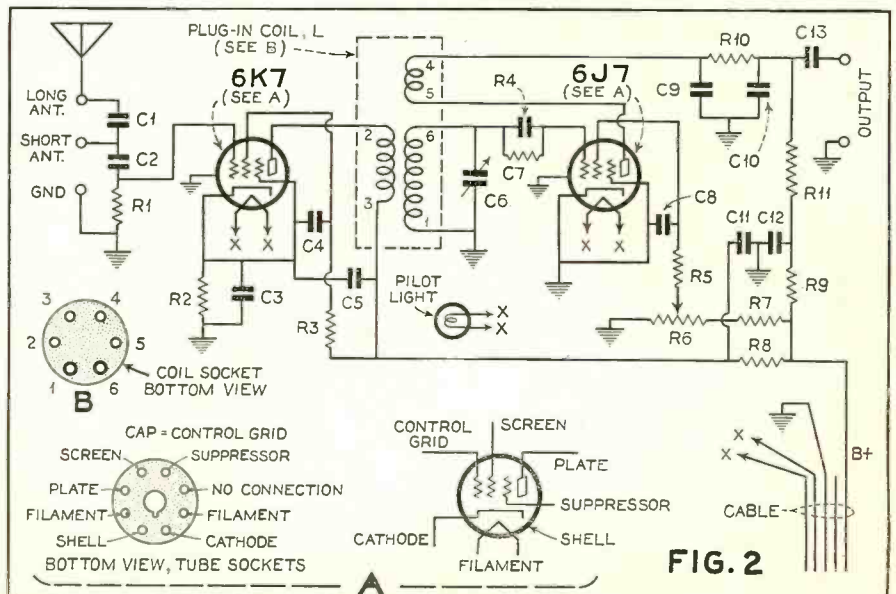

FIG. 2

and Instruction for Beginner

for the benefit of beginners who de- of radio, and also for those who of the subject but lack the prac- to thoroughly understanding radio

Regenerative Tuner Borst

signal is now introduced in the system by a third coil L3 (not shown in Figure 1) the signal will cause large fluctuations in the plate circuit and these will again induce grid voltages which build up the signal tremendously. This is called regeneration. The greatest amplification of speech or music is obtained when the tube is almost at the point of oscillation. C. W. telegraphy, on the other hand, is best received with the feedback adjusted so that the tube is just barely oscillating.

The above statements illustrate the necessity of being able to control the regeneration (or the amount of voltage fed back). This used to be done by arranging the coil L1 to rotate within

the coil L2, or to move away from L2, but that has the drawback of changing the tuning too. So, nowadays, we change the amplification of the tube. In a triode, this could be done by varying the plate voltage.

Radiated Interference

Now it is clear that for reception the tube is sometimes oscillating and at such times it is a miniature transmitter capable of causing interference in neighboring receivers. In the interest of better reception, such a detector should not be coupled directly to the antenna. If an amplifying stage is inserted ahead of the detector, there is practically no energy reaching the antenna since the tube is a one-way device. For this reason, an untuned stage was included in the receiver described this month.

Figure 2 shows the diagram of the unit which is described this month. As

THE WIRED CHASSIS

Practically all wiring is confined beneath the chassis. The extra holes in chassis and panel will be used next month in converting the present r.f. stage to one of the tuned type. The removable coil shield is shown to the left.

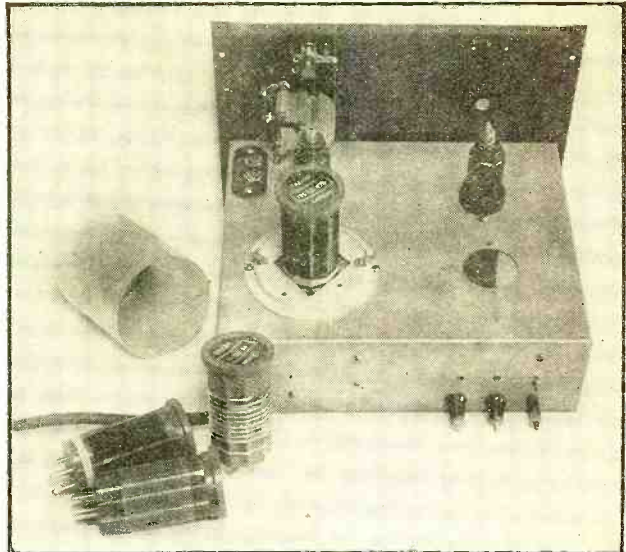

both detector and amplifier, metal tubes of the pentode type are used. Next month some discussion of the pentode and its merits will be presented. It suffices now to explain that a pentode is a tube with five elements, three of which are grids. By placing proper voltages on these grids the tube acts as an amplifier, providing much greater amplification than a triode. Furthermore, amplification and regeneration can be controlled by varying the voltage on the "screen" (the second grid from cathode). The third grid, called the "suppressor" is simply connected to ground or to cathode.

The circuit of Figure 2 employs one of these pentodes, a 6K7, as an untuned r.f. amplifier. The antenna is simply connected to a 50,000 ohm resistor, no tuning (Turn to page 216)

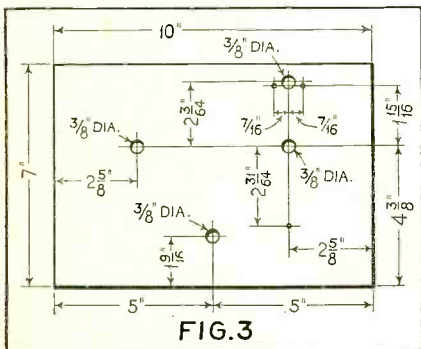
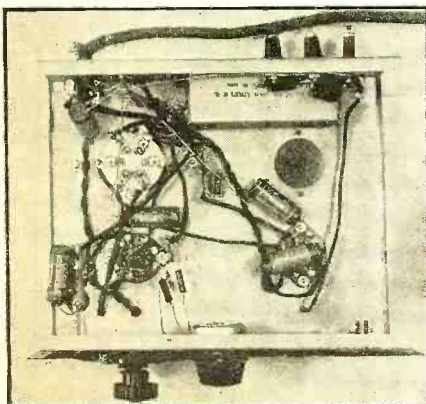

FIG. 3

PANEL AND WIRING LAYOUT

Figure 3, above, provides the panel drilling specifications, while the under chassis arrangement is shown in the photograph below.



And Now The PHOTO- MIKE

By Samuel Kaufman

THE name "photo-mike" sounds like some television gadget, but actually it applies to the new combination miniature ultra-short-wave transmitter and candid camera designed by CBS engineers. A reflex camera case houses the entire works. Just above the lens opening is a microphone. The "station", mounted on a standard tripod, is so designed that when the speaker faces the mike he is within picture range of the candid camera.



The unit functions on low power and has ample range for relaying pick-ups to the network. Of course, the camera has no direct relation to the program, which is entirely voice transmission. The added device merely provides a visual record of the persons utilizing it.

Ideal Beam Power AMPLIFIER

By I. A. Mitchell

Part Two

THERE are many applications in P.A. and home-amplifier operation where tone equalization is very desirable. Acoustic conditions may require an increase in highs or lows. Frequently, amplifiers of this type are used with microphones or loudspeakers which are deficient in highs or lows. To take care of such contingencies, the first audio transformer used in this amplifier includes a self-contained equalization circuit which is brought out to a control on the chassis which is calibrated directly in db. With the control rotated to the left, both low and high frequencies are raised simultaneously. With the control rotated to the right, low frequencies alone are increased. Figure 8 illustrates typical frequency curves that are obtainable with this amplifier. When the equalization is set

at the zero point, the overall response is fairly uniform from 60 to 10,000 cycles.

Circuit Modifications

As mentioned before, this amplifier is suitable for operation with either self or fixed bias. Figure 1, shown last month, illustrates the normal self-bias operation. Where fixed bias is used, the power is increased from 35 to 55 watts. The output transformer must be changed to a larger unit as shown in Figure 2a in the preceding article. The bias resistor is removed, the cathodes are grounded and a 22½ volt C battery is inserted to apply bias to the grid circuits. A mounting bracket

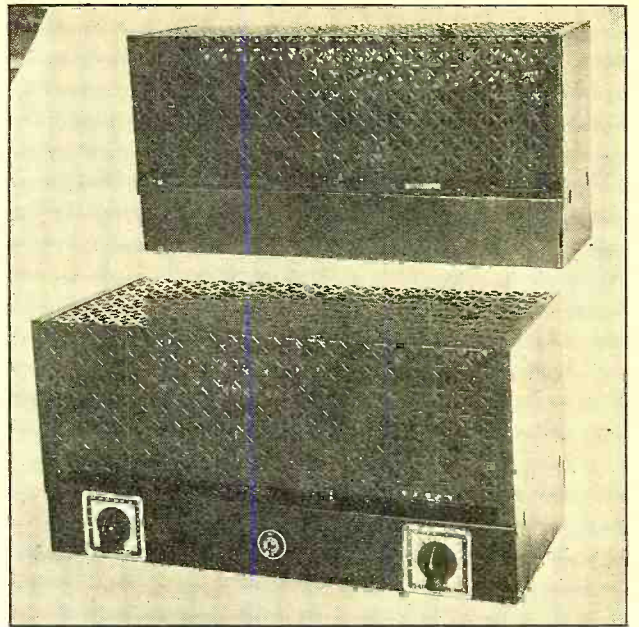

is provided for this C battery underneath the audio deck. For mobile service, it is desirable that a minimum of plate power be taken. In this operating condition, the C battery is used again to permit the use of the full genemotor output for plate supply. Operating in this manner, a power output of 20

Synchronous MOTOR for Television

By Frederick Siemens

A NEW midget motor, which automatically synchronizes optical-mechanical television receivers to all transmissions, whether they are intended for mechanical or cathode-ray use, has just been designed by William Hoyt Peck, president and chief engineer of the Peck Television Corporation. It is driven by an amplified component of the signal radiated by the station broadcasting, its speed being governed by the number of impulses (picture elements per image, multiplied by the number of frames) per second, much as an electric clock motor is kept at constant speed by the usual 60-cycle house current.

The incoming signal is put through the usual tuning, intermediate and detection circuits, and then is fed into two audio amplifiers. One of these feeds the light-modulator cell, which controls the brilliance of the beam which scans the screen.

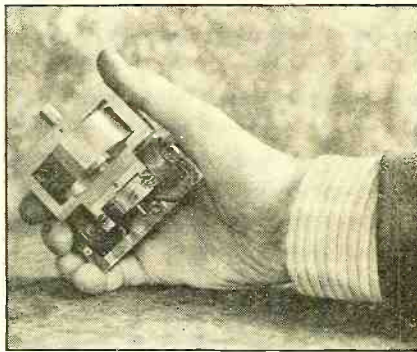

The second operates a relay tube, the output of which is connected directly to the fields of the motor. In tests at the Peck laboratories, the motor has been synchronized at speeds ranging from 300 to 2800 revolutions-per-minute.

Using oil-less bearings, which require no attention over a period of years, the motor is claimed to be entirely trouble free. It employs no brushes, working entirely upon an induction principle. The power developed is approximately 1/100 horsepower, more than ample to drive a 2-inch disc, weighing 1¾ ounces, with which scanning is accomplished.

The new motor was designed primarily for use in the 180-line, 24-frame transmission and reception equipment which Mr. Peck is now using in the Toronto area. It was refined so that receivers equipped with the Peck optical-mechanical system will automatically synchronise with any other transmitters that may be on the air, for the motor will enable the reception of all scanning frequencies from 45 lines to 503
(Turn to page 253)

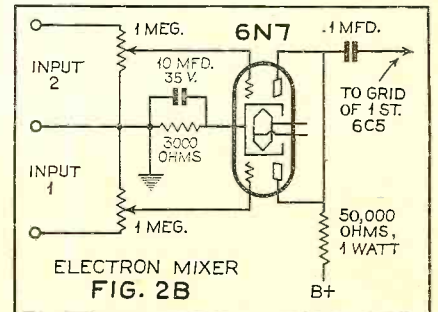

watts can be obtained using a 350 volt, 100 ma. genemotor.

With the increased use of high-impedance microphones such as the crystal microphone and the ribbon microphone with self-contained transformer, there are frequent (Turn to page 256)

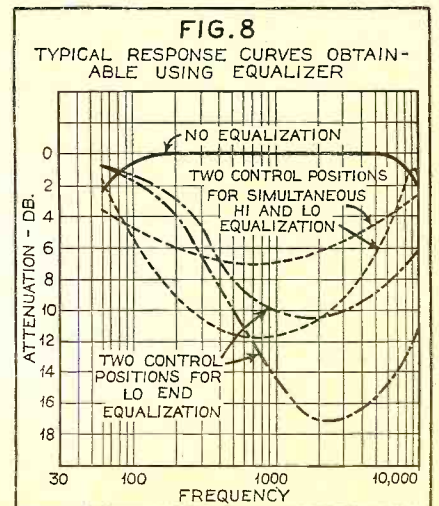

BROADCAST STATION LIST

(Africa, Australia, Asia)

AFRICA				MANCHUKUO			
ALGERIA				PALESTINE			
Call	Location	Kc.	Kw.	Call	Location	Kc.	Kw.
.....	Algiers	941	12.0	Jerusalem	668	20.0
CANARY ISLANDS				SIAM			
EAJ50	Las Palmas	1500	0.25	HS7PJ	Sala Daeng (Bangkok)	750	10.0
.....	Cairo (Abu Zabal)	630	30.0	HSPJ	Phyathai (Bangkok)	857	2.5
.....	Alexandria (Ras-el-Tin)	1124	0.5	TURKEY (ASIATIC)			
.....	Alexandria (Ras-el-Tin)	1340	0.5	TAC	Ankara	153.9	7.0
.....	Cairo (Abu Zabal)	1348	0.5	U. S. S. R. (SIBERIA)			
KENYA				RV14	Irkutsk	187.5	20.0
VQ7LO	Nairobi	857	0.7	RV76	Novosibirsk	217.5	100.0
MOROCCO (FRENCH)				RV11	Tashkent	256	25.0
CNO	Casablanca	983	0.025	RV60	Alma-Ata	310	10.0
CNR	Rabat	724	2.0	RV66	Krasnoyarsk	333	1.0
MOROCCO (SPANISH)				RV19	Ashkabad	333	10.0
EAJ21	Melilla	1492	RV63	Verhne-Udinsk	350	10.0
EAJ46	Ceuta	1492	0.5	RV47	Stalinabad	421	2.0
SO. RHODESIA				RV83	Oirat-Tura	450	1.0
.....	Bulawayo	618.5	0.57	RV44	Omsk	472	1.0
ZEC	Salisbury	681.8	0.6	RV52	Chita	556	20.0
TUNISIA				Cheliabinsk	577	10.0
TUA	Tunis	583	0.8	RV28	Vladivostok	635	0.3
.....	Sfax	1411	0.1	RV38	Alexandrovsk	662	2.0
.....	Bizerte	1465	0.15	RV46	Karaganda	686	1.0
UNION OF SOUTH AFRICA				OCEANIA			
ZTU	Grahamstown	560	10.0	AUSTRALIA			
ZTC	Capetown	600	10.0	3AR	Melbourne, Vic.	580	4.5
ZTI	Johannesburg	645	15.0	7ZL	Hobart, Tasmania	590	1.0
ZTD	Durban	740	1.0	2FC	Sydney, N.S.W.	610	3.5
ZTE	Bloemfontein	809	0.75	5CK	Crystal Brook, S. Aus.	640	7.5
ZTP	Pretoria	952	0.05	7BU	Burnie, Tasmania	660	0.05
ZTX	Pietermaritzburg	697.7	10.0	2CO	Corowa, N.S.W.	670	7.5
ASIA				Perth, W. Austr.	690	3.5	
CHINA				7NT	Kelso, Tasmania	710	7.0
XLHB	Shanghai, Kiang-su	560	0.045	5CL	Adelaide, So. Austr.	730	2.0
XHJA	Hankow, Hoope	570	2BL	Sydney, N.S.W.	740	3.0
XQHA	Shanghai, Kiang-su	580	0.25	3LO	Melbourne, Vic.	770	3.5
XGOH	Changsha, Honan	590	0.15	4QG	Brisbane, Queensl.	800	2.5
XHKB	Tengchow, Shantung	590	0.1	2LV	Inverell, N.S.W.	820	0.1
XMHA	Shanghai, Kiang-su	600	0.6	3GI	Sale, Vic.	830	7.0
XGSS	Tsunshi, Che-kiang	610	0.015	5RM	Renmark, So. Austr.	850	1.0
XHHK	Shanghai, Kiang-su	620	0.1	7HO	Hobart, Tasmania	860	0.05
ZEK	Hong Kong	620	0.25	2GB	Sydney, N.S.W.	870	1.0
XGOA	Nanking, Kiang-su	660	75.0	6PR	Perth, W. Austr.	880	0.5
XGOV	Yunnan-fu, Yunnan	697	0.25	3MA	Mildura, Vic.	900	0.1
XMHC	Shanghai, Kiang-su	700	0.5	4WK	Warwick, Queensl.	900	0.05
XGOS	Chungking, Honan	711	1.0	4RK	Rockhampton, Queensl.	910	2.0
XGML	Kashing, Kiang-su	714	0.0075	3UZ	Melbourne, Vic.	930	0.6
XLHC	Shanghai, Kiang-su	720	0.05	2UE	Sydney, N.S.W.	950	1.0
XLHD	Shanghai, Kiang-su	720	0.05	5DN	Adelaide, So. Austr.	960	0.3
XHGS	Wuchow, Kwangsi	740	0.05	3BO	Bendigo, Vic.	970	0.2
XHHB	Shanghai, Kiang-su	740	0.1	6AM	Northam, W. Austr.	980	2.0
XGOK	Canton, Kwantung	750	1.0	4AY	Ayr, Queensl.	980	0.3
XQKB	Tientsin, Pechili	750	0.15	2GZ	Orange, N.S.W.	990	2.0
XLHI	Shanghai, Kiang-su	760	0.0075	4GR	Toowoomba, Queensl.	1000	0.5
XLHJ	Shanghai, Kiang-su	760	0.1	3HA	Hamilton, Vic.	1010	0.3
XLHA	Shanghai, Kiang-su	780	0.05	2KY	Sydney, N.S.W.	1020	1.0
XLHJ	Wusih, Kiang-su	790	0.075	3DB	Melbourne, Vic.	1030	0.6
XLHK	Shanghai, Kiang-su	800	0.0075	5PI	Crystal Brook, So. Austr.	1040	2.0
XLHL	Shanghai, Kiang-su	800	0.1	2CA	Canberra, F.C.T.	1050	0.5
XQHC	Tientsin, Pechili	810	0.2	3YB	Warrnambool, Vic.	1060	0.05
XLII	Wuhu, Nyan-li-wei	830	0.03	4MB	Maryborough, Queensl.	1060	0.1
XGF	Tsinan, Shantung	833	0.0075	2AD	Armidale, N.S.W.	1080	0.1
XGTM	Changsha, Kiang-su	840	0.015	3SH	Swan Hill, Vic.	1080	0.05
XHHA	Shanghai, Kiang-su	840	1.0	4LG	Longreach, Queensl.	1100	0.3
ZBW	Victoria, Hong Kong	845	2.0	7LA	Launceston, Tasm.	1100	0.3
XQHB	Shanghai, Kiang-su	850	0.1	2UW	Sydney, N.S.W.	1110	0.75
XLIO	Hangchow, Che-kiang	850	0.05	4BC	Brisbane, Queensl.	1120	1.0
XGOF	Tsinan, Shantung	852	0.5	6ML	Perth, W. Austr.	1130	0.5
XHHH	Shanghai, Kiang-su	860	0.05	2HD	Newcastle, N.S.W.	1140	0.5
XLIL	Suchow, Kiang-su	870	0.075	3WG	Wagga, N.S.W.	1150	1.0
XHHV	Shanghai, Kiang-su	880	0.1	2KA	Mackay, N.S.W.	1160	1.0
XGKA	Kashing, Che-kiang	895	0.015	4MK	Mackay, Queensl.	1160	0.1
XGOI	Shanghai, Kiang-su	900	0.5	4TO	Townsville, Queensl.	1170	0.2
XLIM	Haining, Che-kiang	910	0.05	3KZ	Melbourne, Vic.	1180	0.6
XHHX	Shanghai, Kiang-su	920	0.5	2CH	Sydney, N.S.W.	1190	1.0
ZGON	Nanking, Kiang-su	930	0.2	5KA	Adelaide, So. Austr.	1200	0.3
XHHE	Shanghai, Kiang-su	940	1.0	2GF	Grafton, N.S.W.	1210	0.05
XGOP	Peiping, Pechili	950	0.3	6KG	Kalgoorlie, W. Austr.	1210	0.5
XHHF	Shanghai, Kiang-su	960	0.1	4AK	Oakey, Queensl.	1220	2.0
XHIB	Wusih, Kiang-su	970	0.075	2NC	Newcastle, N.S.W.	1230	2.0
XMHB	Shanghai, Kiang-su	980	0.5	3TR	Sale, Vic.	1240	0.5
XGCK	Chuching, Che-kiang	990	0.0075	6IX	Perth, W. Austr.	1240	0.5
XGOD	Hangchow, Che-kiang	990	2.0	3WR	Shepparton, Vic.	1260	0.05
.....	2SM	Sydney, N.S.W.	1270	1.0
.....	3AW	Melbourne, Vic.	1280	0.6
.....	4BK	Brisbane, Queensl.	1290	0.5
.....	2TM	Tamworth, N.S.W.	1300	0.05
.....	5AD	Adelaide, So. Austr.	1310	0.3
.....	3BA	Ballarat, Vic.	1320	0.05
.....	4RO	Rock'm'ton, Queensl.	1330	0.05
.....	2XN	Lismore, N.S.W.	1340	0.5

5MU	Murray Bridge, So. Austr.	1340	0.1
3GL	Geelong, Vic.	1350	0.05
2MO	Gunnedah, N.S.W.	1360	0.05
2BH	Broken Hill, N.S.W.	1360	0.1
4PM	Port Moresby, N. Guinea	1360	0.1
3HS	Horsham, Vic.	1370	0.05
4BH	Brisbane, Queensl.	1380	1.0
2GN	Goulburn, N.S.W.	1390	0.2
4CA	Cairns, Queensl.	1390	0.1
2KO	Newcastle, N.S.W.	1410	0.5
3XY	Melbourne, Vic.	1420	0.6
3WL	Wollongong, N.S.W.	1430	0.3
4VL	Charleville, Queensl.	1430	0.05
2QN	Deniliquin, N.S.W.	1440	0.05
4IP	Ipswich, Queensl.	1440	0.05
7UV	Ulverstone, Tasmania	1460	0.3
2BE	Bega, N.S.W.	1470	0.1
2AY	Albury, N.S.W.	1480	0.1

4BU	Bundaberg, Queensl.	1480	0.1
3MB	Birchip, Vic.	1490	0.1
3AK	Melbourne, Vic.	1500	0.2
FIJI ISLANDS			
ZJV	Suva	920	0.4
NEW ZEALAND			
2YA	Wellington	570	5.0
4ZP	Invercargill	620	0.45
1YA	Auckland	650	10.0
3YA	Christchurch	720	10.0
2YB	N. Plymouth	760	0.1
4YA	Dunedin	790	10.0
2ZH	Napier	820	0.09
2YC	Wellington	840	0.35
1YX	Auckland	880	0.15
2ZP	Wairoa	900	0.21
2ZR	Nelson	920	0.06

3ZR	Greymouth	940	0.25
2ZF	Palmerston North	960	0.25
2ZJ	Gisborne	980	0.3
4ZO	Dunedin	1010	0.05
4ZM	Dunedin	1010	0.1
4ZB	Dunedin	1010	0.078
1ZB	Auckland	1090	0.35
4YO	Dunedin	1140	0.2
2ZM	Gisborne	1150	0.03
2ZD	Masterton	1170	0.012
3YL	Christchurch	1200	0.25
4ZL	Dunedin	1220	0.1
2ZL	Hastings	1240	0.05
1ZM	Manurewa	1260	0.2
4ZC	Otago	1280	0.045
3ZE	Greymouth	1300	0.025
1ZJ	Auckland	1310	0.1
4ZR	Balclutha	1340	0.01
2ZO	Palmerston, North	1400	0.1
3ZM	Christchurch	1470	0.1

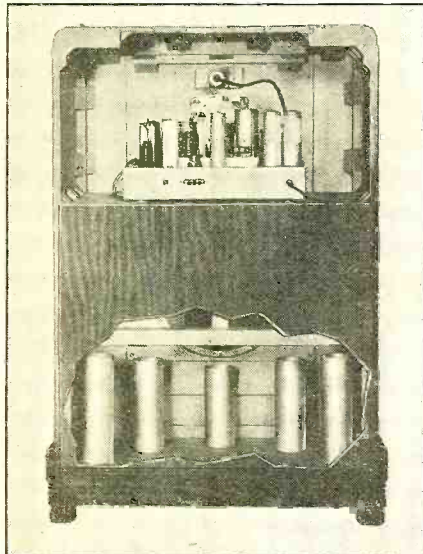

The MAGIC VOICE

By H. J. Robinson

The latter term, the feature of the 1937 line, applies to a new baffle technique. Or, as the manufacturer cunningly puts it, "Magic Voice solves a 'baffling' problem."

In a closed chamber, between the chassis and cabinet base, are five organ-like pipes. These are designed and placed scientifically in relation to air-space and the loudspeaker. The pipes manage to control and release into the room only those desired low notes required to blend with the tones from the front of the speaker. (See Figure 1.)

Heretofore, the engineers point out, sounds from the back of the loudspeaker reverberated within the cabinet, badly affecting tones from the front of the speaker; this was a type of hollow boomi-

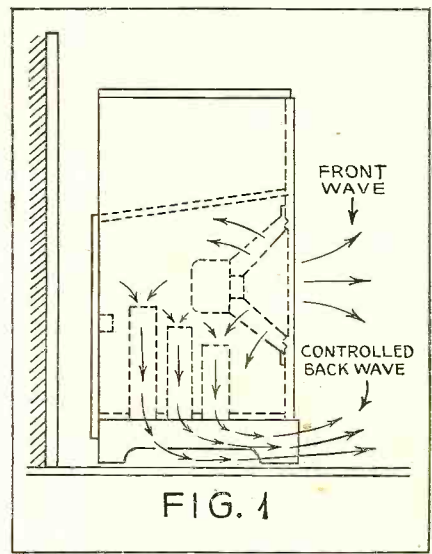

THE word "magic" has appeared so consistently in new RCA Victor products that it begins to seem that those engineering lads at Camden are masters of legerdemain. To the "Magic Brain" and the "Magic Eye" of recent seasons is now added the "Magic Voice."

ness. The "rainbarrel" effect, as it is termed, is prevented in large auditoriums by the use of large baffles. Since it is not practical to install such a professional-size baffle in an average home, the designers claim that this compromise gives the same pure tone as 144 square feet of baffle.

The "Ham" Shack

(Continued from page 209)

is expected the American Radio Relay League this time will be in the position of asking for more 'phone frequencies on the 75-meter band in keeping with the resolution adopted by the Board of Directors last May. This request was made to the commission, but was turned down pending the hearing on October 20.

The 'phone men already have acquired 3,000 names at this writing, and there still are several thousand petitions awaiting to be returned. The tremendous work of circulating the petition is being done by W. H. Jacobs, of Fort Bragg, N. C., better known on both 20 and 75-meter bands as "Jake" of W4CVQ. By August 15 it is expected more than 5,000 names will have been signed to the petition. The text of the 'phone petition follows:

"1. We the undersigned (licensed amateur radio operators) believe that the frequencies authorized for restricted radio-telephony use in the amateur bands are entirely inadequate and out of proportion for the following reasons:

"(a) Within the past two years the trend to radio-telephony has been so great that the congestion in the 3,900—to 4,000 kilocycle and 14,150 to 14,250 Kc. bands defeats the purpose of amateur radio.

"(b) Since the trend to radio-telephony has been so great it is evident that the congestion in the bands restricted to the

use of radio-telegraph has been lessened.

"2. We hereby respectfully request that the following frequencies be authorized for restricted radio-telephony: 3,800 to 4,000 and 14,200 to 14,400 Kc."

The text of the petition being circulated by the C.W. men is not available.

Calls Heard

By N. C. Smith, 53 Birch Tree Road, Petts Woods, Ongington, Kent, England, on 20 meter C.W.: YU7CL, WS4U, YL2BH, VE3TD, W3DK, J2CL, U9AY, CT1AA, U5AE. On 20 meter 'phone: PK4AU, VE1CF, HC1GB, CO2LL, VP2BG, YV4AC, CO5RY, LU1AX, VE1BY, VE2CA, VE9AL, VE3JB, VO1I, W81DP, VE1AQ, H15X, VE2DX, VE2HK.

By Merton T. Meade, Kansas City, Mo., on 20 meter 'phone: CO2AN, CO2HY, CO2JM, CO2KC, CO2KY, CO2WZ, CO8RQ, EAS1W, FASAP, HC1RF, H15X, H17G, K6CMC, K6KKP, K6LIV, NY2AE, OA4AA, TI2AV, TI2RC, TI3AV, YV4AC, VE1CR, VE1DS, VE1FN, VE2BE, VE2EE, VE2FO, VE2FR, VE2HK, VE2HN, VE2IJ, VE3AB, VE3AFD, VE3AHW, VE3BK, VE3DF, VE3FC, VE3HK, VE3GK, VE3JK, VE3JK, VE3JK, VE3LK, VE3NF, VE3NU, VE3OD, VE3TP, VE4AC, VE4FD, VE4IT, VE4LX, VE5ES, VE5HA, VE5HI, VE9AL.

By John Corothers, 2407 Garfield Street, Lincoln, Neb., on 20 meter 'phone: XE2N, XE1G, XE1K, XE2CK, XE3AG, XE1AI, XE2AH, XE1CC, CO2HY, CO2SV, CO2LL, CO2WZ, CO2KY, CO2KC, CO7CX, CO6OM, CO8YB, VP2CD, VP7NC, VP4TH, VP3BG, VP9R, H115PA, H11W, H12K, H15X, H17G, H11C, K4DDH, TI2RC, TI2AV, TI3AV, NX2Z, YN1OP, HP1A, NY2AE, CT1BY, OZ4H, OA0FB, PA01DW, HK1ABM, HK1Z, OA4B, OA4AK, OA4AA, CE1BC, CE1AR, ON4VK, ON4AA, ON4PA, G6LK, G5NI, G5ML, G5BJ, G2BY, F8DR, EA7AL, EA3DQ, EA4BM, EA5BE, KA1AN, OM2RX, K6LIV, K6CMC, K6JCY, K6MHY, PY7AA, PY1CK, PY2CK, LU4BH, LU5CZ, LU6AP, LU8DR, LU9PA, YV4AC, YV5AA, SU1CH, VO1I,

EI2J, EA8AI, SM5SN, VK2AP, VK2NO, VK2AZ, VK3KX, VK2BW, VK2AB, VK4JU, VK5JC, VE1DQ, VE1BR, VE5CL, VE5HU, VE5FL, VE5DK, VE5OT.

The Radio Beginner

(Continued from page 213)

being done here. The second tube is a 6J7, also a pentode but more suitable as a detector.

A set of three-circuit plug-in coils is used, covering the range from 16 to 550 meters. The detector circuit employs the well-known grid-leak, and regeneration is controlled by means of the potentiometer R6, which varies the screen voltage.

After the signal is rectified, the r.f. component must be filtered out, or else it will get into the audio amplifier where it may cause overloading and instability. The resistor R10 and the two mica condensers C9 and C10 form this filter which passes the a.f. currents but causes the r.f. currents to return to ground. The customary resistance coupling is employed between the detector and the audio unit.

Circuits with high-gain amplifiers require careful isolation of the stages so that no accidental voltages are fed back which might cause undesired oscillation. The shield can over the coil serves this purpose. The filters R9, C12 and R7, C11 are to overcome "motorboating," a form

(Turn to page 246)

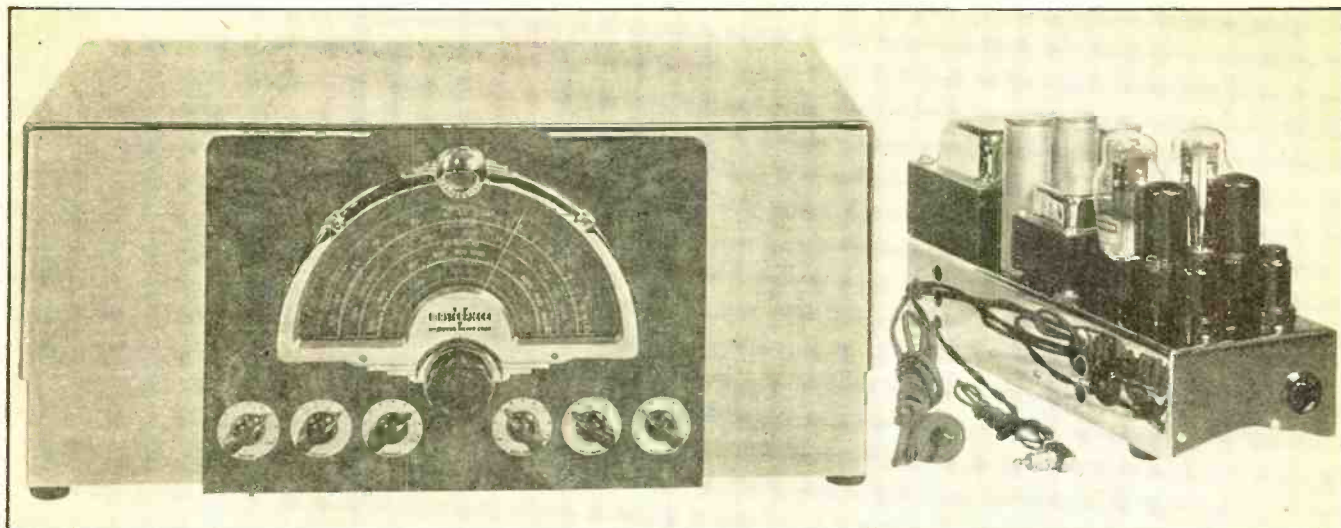

A RECEIVER BOTH BEAUTIFUL IN APPEARANCE AND PRACTICAL IN OPERATION
 The tuner assembly is chromium plated throughout with extra shielding provided by the overall chromium cover. The unit at the right is the power supply and 30-watt beam-power amplifier.

1937 Refinements in a New "Lab-Built" Super

Presenting information on this new receiver which is now undergoing "air tests" at the Fairfield Listening Post, the results of which will be covered in a near future issue

By McMurdo Silver

TO attempt in a brief article to fully describe a new receiver which offers a number of new engineering developments is an impossibility. What follows is therefore only the "high-spotting" of the new 20-tube Masterpiece V which consists of the 14 tube completely shielded tuner, the 6-tube electron beam-power amplifier and power supply, and the new 18 inch, 68 lb. speaker, several times more efficient and sensitive than existing speakers. Figure 1 shows the complete tube line-up, and while in itself unique and new, it gives no inkling of the many new circuit developments which it cannot show. The complete schematic diagram will be shown next month, together with further discussion of the circuit features.

4.2-2140 Meters

The tuning range, in five bands accurately calibrated on the 9-inch dial, is 140 to 430 kc. for long waves, and 535 to 70,000 kc. without a gap. This is 2140 to 700 and 560 to 4.287 meters, which covers every broadcast service on the air from long wave Europeans down to below the 5 meter ama-

teur band, and includes the rapidly developing ultra high frequency "apex" bands of 26 and 31 to 40 megacycles.

The new "lance" dial makes tuning surprisingly easy for it sensibly enlarges tuning scale size for successive short-wave bands, making the 49 to 16 meter dial band 7 inches in diameter and the 16 to 4.3 meter dial being 8 inches in diameter. The dial can be read to 10 kc. even at 25 meters. This accurate reading is made possible by a knife edge pointer that effectively eliminates the parallax reading error of ordinary flat pointers spaced appreciably away from

the calibrated scale of the dial itself.

Separate band-spread reading is provided by a new micrometer dial behind the tuning knob, upon which main dial station spread and separation is amplified ten times for precise tuning. This method of band-spreading permits accurate "logging."

The single tuning knob provides a 50:1 ratio for one knob turn (in either direction) and then automatically shifts to a 10:1 ratio. Accurate tuning is made easy, and mandatory, by this "free wheeling" dial, and the "Magic Eye" on the dial, calibrated to measure signal strength, fading and over modulation of stations as weak as 1 microvolt.

Circuit Features

Circuitwise, the two stages of air-tuned radio-frequency amplification pioneered in all-wave broadcast receivers by the Masterpiece IV are retained in the new set. These are in circuit on four bands, from 140 kilocycles to 19 megacycles, and account for the complete absence of "repeat points" on short waves, and the phenomenally low inherent circuit noise. (Turn to page 256)

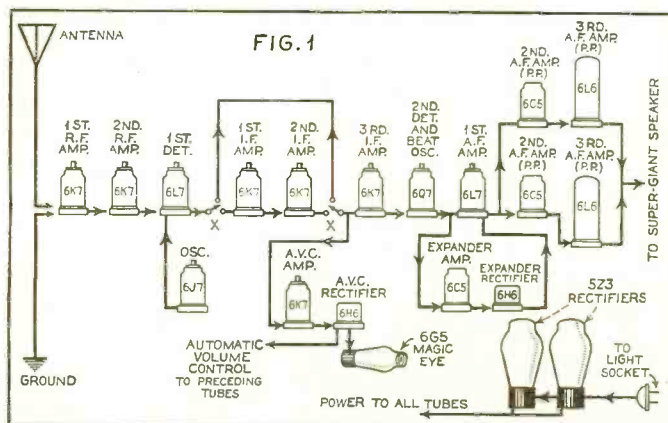



THE DX CORNER

S. GORDON TAYLOR
(For Broadcast Waves)

Pepping Up Reception

The majority of DX'ers are interested in DX as a hobby and have little if any interest in the technical side of radio. Nevertheless there are some things of a technical nature which would be helpful to know and the effort will be made here to bring some of these points to the attention of readers in as non-technical a manner as possible.

In a good quiet receiver location, when reception conditions are good, the two factors which limit the DX range of the receiver are inadequate sensitivity and tube noise. There is little that can be done to increase the power of amplification in the radio set itself unless the owner has a fair understanding of technical problems. However, it is possible in a great many cases to overcome the problem of tube noises thereby greatly increasing the DX range. This is particularly true of superheterodyne receivers but likewise applies to tuned r.f. sets.

The main source of tube noise in a t.r.f. receiver is the first radio-frequency amplifier tube; in a superheterodyne it is the first detector or converter tube. There is little that the owner of a receiver can do to

actually reduce tube noise. The obvious solution of the problem is therefore found in taking steps to build up strength of incoming signals so that the signal voltage applied to the first tube (or to the converter in a super-het) is greater than the noise voltage developed in that tube. There are two practical ways for the DX'er to accomplish this. He can improve his antenna or he can tune the antenna—or both.

Make the antenna as long and as high as practical. In doing this there is just one thing to watch out for and that is to see that the increased capacity of the long antenna does not detune the input circuit of the receiver. In modern receivers this is not so likely to occur but in older receivers it is, therefore it is always advisable to realign the tuned circuit of the first tube whenever a long antenna is installed. Unless one is capable of doing this job himself, it is worthwhile to call in a radio serviceman to make this adjustment; at the same time he can align all other stages to match so that maximum efficiency is obtained.

It is not always practical to put up an antenna 200 or 300 feet in length but whether it is done or not a decided increase in signal strength will be obtained by tuning the antenna. If there ever was any question concerning this fact it has been completely eliminated by actual measurements made before and after connecting a good antenna tuning device ahead of a standard receiver—and by reports received from numerous Official Observers who constructed the RADIO NEWS "Tenatuner" which was described in the July 1935 issue of RADIO NEWS. One after another Observers who built this unit have reported understandable reception of foreign stations which could not even be heard without the Tenatuner. Actual measurements in the RADIO NEWS Lab showed that the average signal increase through the broadcast band was 820 per cent. Certainly a device which can be readily constructed at a cost of \$3 or \$4 and which will increase the strength of weak signals more than eight times is a distinctly worthwhile addition to the equipment of any DX'er.

For those who did not see the original article in RADIO NEWS the circuit of the Tenatuner is shown in Figure 1. The coil consists of 135 turns of No. 28 double silk covered copper wire wound on a bakelite tube $3\frac{1}{4}$ inches long and $1\frac{1}{4}$ inches in diameter. Taps are brought off at every 15th

3YA, GEBBIES PASS, N. Z.

The Transmitter Hall, antenna and cottages shown here are at Gebbies' Pass. Studios are at Christchurch, 18 miles away. The 300-foot masts support a "T" antenna. Insert shows one of the popular announcers.

Photos—Courtesy Observer Watson

Official RADIO NEWS Broadcast Band Listening Post Observers

United States

Alabama: Ray Wood
Arkansas: James Halsey
California: Eugene S. Allen, Frank D. Andrews, Roy Covert, Bill Ellis, Henry Evansmith, Randolph Hunt, Walter B. McMenemy, Radio Fellowship, George C. Sholin, Warren E. Winkley
Connecticut: Fred Burligh, James A. Dunigan, Stanley Grabowski, Joseph J. Mazel, R. L. Pelkey
District of Columbia: George Day Cockrell, Jr.
Illinois: Herbert H. Diedrich, H. E. Rebensdorf, D. Floyd Smith, Raymond S. Swenson, Donald C. Truax
Indiana: Earl R. Roberts
Iowa: Donald Barnes
Kansas: Dudley Atkins III, T. R. Grosvenor, Vernon Riner
Louisiana: Aubrey V. Deterly, Wilbur T. Golson
Maine: Danford Adams, Floyd L. Hammond, Roger Williams
Maryland: William L. Bauer, Louis J. McVey, William Rank, Frank Zelinka
Massachusetts: William W. Beal Jr., Walter C. Birch, Russell Foss, Simon Geller, Warren C. Reichardt, Evan B. Roberts
Missouri: M. F. Meade
Minnesota: Floyd Biss, Walter F. Johnson
Mississippi: Mrs. L. R. Ledbetter
Montana: R. W. Schofield
Nebraska: Bud Crawford, John Havranek
New Jersey: Robert F. Gaiser, Morton Meehan
New York: Jacob Altner, Murray Buitekant, Paul J. Crowley, Ray Geller, Edward F. Goss, Arthur B. Johnson, John C. Kalmbach, George J. Karesh, Harry E. Kentzel, Maynard J. Lonis, Harold Mandler, Robert C. Schmarler, R. H. Tomlinson, William Wheatley
North Carolina: E. H. Goodman
North Dakota: O. Ingmar Oleson
Ohio: Stan Elcheshen, A. J. Parfitt, Donald W. Shields
Oregon: David Hunter
Pennsylvania: Robert W. Botzum, Stanley Brus, Robert H. Cleaver, Harry M. Gordon, Jack Horner, Edward Kocsan, Warren Rutzahn, Francis Schmidt, Joseph Stokes, Paul V. Trice
Rhode Island: Spencer E. Lawton
South Dakota: Mrs. A. C. Johnson
Texas: Isaac T. Davis, Thomas H. Housenfluck, E. L. Kimmons
Vermont: Henry T. Tyndall, Jr.
Virginia: C. C. Wilson
Washington: W. Russell DuCette, H. J. McClain, Jack Staley
West Virginia: Clifford Drain

Foreign

Alaska: S. A. Tucker
Australia: Albert E. Faull, George F. Ingle, Aubrey R. Jurd
Canada: Fred W. Alfred, Bernard J. Clancy, John W. Ker, Ernest W. Law, Art Ling, Philip H. Robinson
Cuba: Rafael Valdes Jimenez
England: R. T. Coales, F. R. Crowder, Charles E. Pallatt, J. S. Phillips
Germany: Reginald Pick
New Zealand: Alexander N. Chalmers, L. W. Mathie, R. H. Shepherd, Eric W. Watson
Switzerland: Dr. Max Hausdorff
Turkey: A. K. Önder

turn. The switch, SW1, is a 10-point inductance switch with point No. 1 connected to the 15th turn of the coils, point No. 2 to the 30th turn, etc. The other switch, SW2, is a three-gang, 5-point switch con-



A MASSACHUSETTS DX'er
J. Gerbert Hyde, Elmwood, Mass., an
"Official DX Ace" in the 6000-12500
Mile DX Club.

sisting of gangs A, B and C on a single shaft. The variable condenser is a two-gang condenser, each unit having a capacity of .00036 mfd. The two gangs are connected together in parallel, thus providing a total tuning capacity of .00072.

Space does not permit giving complete construction details of the finished unit but for those who desire more information a blueprint including large photographs of the Tenatuner, a baseboard layout, picture wiring diagram and explanatory material may be obtained from RADIO NEWS for 25 cents in U. S. postage, check or money order.

To install the unit the antenna is connected to the terminal marked 1, the antenna post of the receiver is connected to terminal 2 and the ground post of the receiver to terminal 3. The ground should also be connected to terminal 3 or to the ground post of the receiver. The actual tuning is accomplished by means of the switch SW1 and the variable condenser. The switch SW2 is set in the position which gives best results with the particular type of receiver used.

This is a simple gadget to build and even one who has had no experience at radio construction can readily follow the picture wiring diagram contained in the blueprints mentioned above. For those who desire such a unit but do not care to construct it themselves, it is possible to obtain the unit built up ready for use and the editor will be glad to supply the name and address of the source.

N. N. R. C. Picnic

Mr. and Mrs. Harold Robinson of Lansdale, Pa., entertained 60 members of the N.N.R.C. recently. Messrs. Potts, Kramer and Fleischman from Newark were among those present. Incidentally, 1936 will start N.N.R.C.'s tenth year. Anyone desiring further information concerning this organization may obtain same by addressing an inquiry to the Newark News Radio Club, 215 Market Street, Newark, New Jersey.

Observer Meade's Inquiry

Robert A. King, C.C.C. Camp Galva, Galva, Illinois and Louis Horwath, Jr. of

Chicago have both written to inform Observer Meade (Kansas) that the station he reported in the July issue on 560 kc. was WIND at Gary, Indiana. This is in response to an inquiry from Observer Meade concerning a station he heard but could not identify.

The Universal DX Club

The Universal DX Club, with head-

Observer Lyell

DX'ers everywhere will learn with regret of the death of A. C. Lyell of Johannesburg, South Africa, Official Observer for both the Broadcast Band and the Short-Wave DX Corners. Located in South Africa, all radio reception was DX to him and his regular reports on reception conditions in that part of the world during the past two years have been of interest not only to RADIO NEWS readers but to the members of various DX organizations in which he held active membership.

In his last report he mentioned his continued illness and one of his last acts was to send a list of DX stations heard by him during the past fifteen months. These included 107 stations on the broadcast band, located in practically every part of the world.

Observer Lyell was a worthy DX'er in every sense of the word—capable, modest and always working for the good of the DX game in general. We know that other DX'ers will join us in extending our sincere sympathy to his family and friends.

quarters in Oradell, New Jersey was organized in September 1933. From its inception the club has issued "Universal News", the official club publication, regularly on the first and fifteenth of each month, excepting June, July, and August, when it appears only on the first of the month. The bulletins are sent to all members.



ANOTHER DX ACE
Irwin Goodeve, Kalamazoo, Mich., another member of the 6000-12500 Mile DX Club, takes pride in his verified reception of B. B. Stations.

International DX'ers Alliance

Broadcast Band and Short Wave Contests for the coming season have been announced by this organization. These contests are open to all DX'ers. The entrance fee is 50 cents and all contestants are invited to forward their entrance fee, stating the Model of receiver and number of tubes to J. Dickenson, Contest Director, P.O. Box 95, Regina, Saskatchewan, Canada. Prizes will be announced later. Here is an opportunity for DX'ers who have no club affiliations to enter either one of these worthwhile contests. Any further information desired may be obtained from Mr. Dickenson.

N. Z. Goes "Commercial"

Observer Watson, Christchurch, New
(Turn to page 240)

TWO POPULAR TP'S

4YA (top) at Dunedin, N. Z., uses a vertical radiator mast 500 feet high. Below is the famous 2YA at Wellington, N. Z. Both of these stations are heard throughout the U. S.
(Photos—Courtesy Observers Watson and Shepherd)

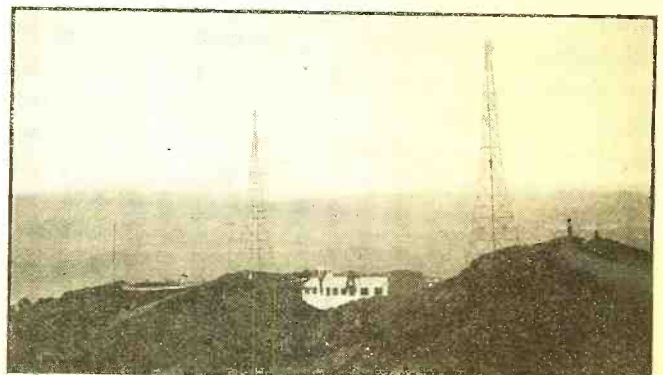
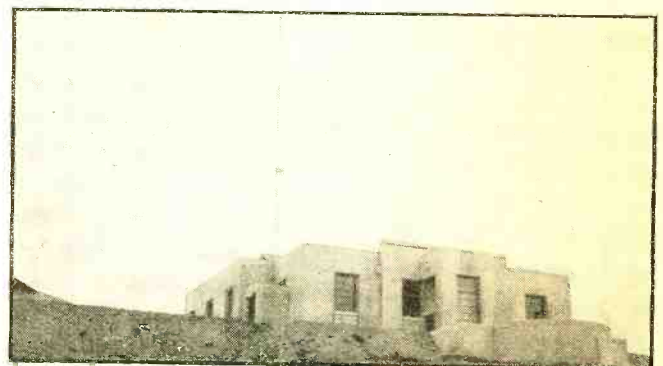
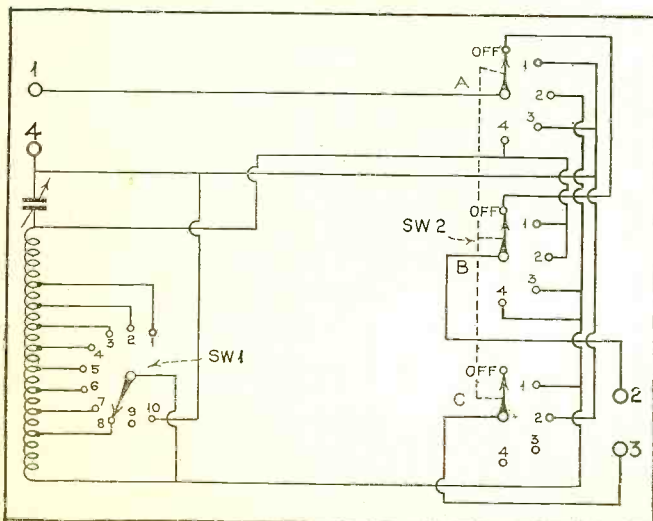

FIGURE 1

The R.N. "Tenatuner" Circuit





EXPERT DX'er
One of the most expert of our Middle Western Observers is Dr. G. W. Twomey, shown seated in his DX Corner before his short-wave receiver

The DX for the

Conducted by

Laurence

THE forty-third installment of the DX Corner for Short Waves contains the World Short-Wave Time Table for 24-hour use all over the world and Official Observers reports of stations heard this month. Consult these two items regularly and make your all-wave set pay big dividends!

News Reporting Method Proves Its Worth

The use of post cards in sending in reports has increased the efficiency of our reports. We wish to especially commend the following Observers for their fine reports of the past month: Partner, Atherton, N. C. Smith, Styles, Mallet-Veale and Sahlbach. What we need on the card reports are short, concise statements about new stations or station changes. We repeat again for our Observers and listeners who wish to send in regulation reports that they can be arranged in paragraphs on post cards in two ways, as follows:

New Stations

W8XK, Pittsburgh, Pa., 11879 kc., daily 5 p.m. to 9 p.m., E.S.T. (Verification.)

Station Changes

CB960, Santiago, Chile, moved to 9590 kc., same schedule as before. (Announcement.)

Welcome to Our Organization

The following new Listing Post Observers have been appointed for the remainder of 1936:

In the United States

Indiana: Karl W. Miles.
 New York: Russell M. Ballard.

In Other Countries

Canada: Fred W. Alfred.
 Malaya: S. P. Shotam.
 Poland: P. Piorko.
 South Africa: Edward R. Greaves.

Reports of Listening Post Observers and Other Short-Wave Readers of the DX Corner

Listed in the following columns is this month's consolidated reports of short-wave stations heard by our wide world listening posts. Each item is credited with the Observer's surname. This allows our Readers to note who obtained the information. If any of our Readers can supply Actual Time Schedules, Correct Wavelengths, Correct Frequencies and any other Important Information (in paragraphs as recommended) the DX Editor, as well as our Readers, will be grateful for the information. On the other hand, Readers seeing these reports can try their skill in pulling in the stations logged and in trying to get complete information on these transmissions. The report for this month, containing the best information available to date, follows:

Europe

"Radio Podebrady" has been heard testing on 15230 kc., 11760 kc. and 6115 kc., from 2 to 11 p.m., E.S.T., and asking for reports. (Frost, Poehm, Carville, Mechling, Alfred, LeLaet, Shamleffer, Partner, Wolf, Hill, Bills, Quinn, Pigrim, Styles). They have allocated the following additional frequencies that they may be heard testing on in the future: 21450, 15320, 11875, 11745, 9504 and 6010 kc. In current tests they change frequencies every half-hour. We request Observers to listen for them to determine the frequency they choose finally and also their operating schedule. Station address: Radio Podebrady, Czechoslovakia.

LZA, Sofia, Bulgaria, 14970 kc., 2 kw., heard transmitting Sunday mornings 5 to 7 a.m., and also reported heard 10 a.m. to 4:30 p.m., as well as 12 midnight to 8 a.m., E.S.T. Some listeners

HE LISTENS IN CALIFORNIA
Meet Jack Knapp of Los Angeles, a DX'er who finds great enjoyment in pulling through hard-to-get Asiatics at his Listening Post.

report them off at 2 p.m. (Williams, Miller, Ballard, Partner). Station address: C. E. Tobalov, Radio Carata, Station LZA, Sofia, Bulgaria.

RAN, Moscow, U.S.S.R., reported variously on 9510, 9520 and 9615 kc., with a program from 7 to 8 p.m. Their program in English runs from 7 to 7:30 p.m., E.S.T. (Styles, Dixon, Piorko, Craft, Andrews, N. C. Smith). Other listeners report the call as RKW.

RV96, Moscow, U.S.S.R., 15180 kc., 20 kw., reported heard Sundays transmitting in English and Spanish 10:30 to 11 a.m., E.S.T. (Craft, Andrews, Kemp, Partner, N. C. Smith). Observer Styles says they go off the air at 2 p.m. Some report the call as RKI.

RRZ, Moscow, U.S.S.R., 440 kc., reported heard 4:30 p.m., E.S.T. (Westman, Hartman).

I2RO4, Rome, Italy, is now reported on 11810 kc., for all afternoon and evening programs (O'Connell, Messer, Dressler, Messe).

EAQ, Madrid, Spain, 9860 kc., reported heard as per Time Table with reports and news items concerning the Spanish revolution (Piorko).

DZB, Berlin, Germany, 10042 kc., reported heard 8:30 to 9:15 p.m., E.S.T., with a description of the Olympic Games (Jordan).



Corner SHORT WAVES

M. Cockaday

DZC, Berlin, Germany, 10285 kc., heard at 9 p.m., carrying the same program as DJA and earlier. 12:30 to 2 p.m., E.S.T., with a description of the Olympic Games (Atherton, Jordan).

DJK, Zeesen, Germany, 12035 kc., reported heard from 9 a.m. to 5:15 p.m., E.S.T., with descriptions of the Olympic Games (Dressler).

DJA, Zeesen, Germany, 9560 kc., heard 5 p.m. to 12 midnight, E.S.T. (Messe).

DJB, Zeesen, Germany, 15200 kc., 12:30 to 11 a.m., E.S.T. (Partner, Silvius, Kemp, Messer).

DJL, Zeesen, Germany, 15110 kc., reported heard 12 noon to 4:30 p.m., and 4:50 to 10:45 p.m. (O'Connell, Deater, Dressler, Alfred, Wolf, Partner, Rodriguez, Silvius, Stabler, Dressler, DeLaet, Allison).

ORK, Ruysselede, Belgium, 10330 kc., reported heard 1:30 to 3 p.m., E.S.T., is soon to have a new 85 kw. transmitter and to extend service (Styles).

A new Swedish station on 11705 kc., is reported heard using 500 watt transmitter with programs in English during afternoons and evenings (Styles). Observers are requested to send in call letters and schedule.

HVJ, Vatican City, 5960 kc., reported heard Sundays 5:25 a.m., E.S.T. (Sahlbach).

CSW, Lisbon, Portugal, reported on 9550 kc. (Styles).

TPA2, Pontoise, France, 15244 kc., reported heard daily at 1 a.m. (Stabler).

TPA3, Pontoise, France, 11880 kc., reported heard daily (Stabler).



ONLY A FEW HAVE THIS VERIFICATION

Away off in Lourenço Marques, in Portuguese East Africa, there is a tiny station, CR7AA. We wonder how many American listeners can pull this station through and obtain this fine verification card.

TPA4, Pontoise, France, 11720 kc., reported heard 8:15 to 10:15 p.m., E.S.T. (Cindel).

HAS3, Budapest, Hungary, 15370 kc., has not been heard for four weeks according to Observer Cindel.

GSF, Daventry, England, 15140 kc., is now heard 9 to 11 p.m., E.S.T. (Partner, Messe, Dressler, Kemp, Rodriguez).

GSH, Daventry, England, now reported heard 21470 kc., 6 to 8 p.m., E.S.T. (Partner). Observer Howald also reports them on 7 to 9 a.m., E.S.T.

GSG, Daventry, England, 17790 kc., reported heard 6 to 8 p.m., E.S.T. (Partner.)

GSB, Daventry, England, 9510 kc., reported heard 9 to 11 p.m., E.S.T. (Dressler).

Radio Beograd, Belgrade, Yugoslavia, 6100 kc., reported heard Saturdays at 3 p.m., E.S.T. (N. C. Smith, Davis, Pilgrim).

Short Waves from Asia

OUTSTANDING among the short-wave broadcasts from Asia are those from two new Chinese stations and from a new station in Siam. Observers report the Japanese stations coming in better than ever.

XGOX, Shanghai, China, 9640 kc., 20 kw., reported heard daily 7 to 8 a.m., E.S.T., and Sundays, 7:40 to 9:30 a.m., E.S.T. (Smith, Georges). Listener Daily reports he heard them on 9490 kc., testing on Sundays 8 to 9 a.m., E.S.T.

XGO, Shanghai, China, 7510 kc., reported heard testing Sundays 5 to 5:30 a.m., E.S.T. (Sahlbach, Atherton).

XGW, Shanghai, China, 10420 kc., heard testing irregularly 10 a.m. to 3 p.m. (Partner).

HS8PJ, Bangkok, Siam, reported heard 10955 kc., Sundays and Mondays, 8 to 10 a.m., E.S.T. On Sundays they use a frequency of 9350 kc., 8 to 10 a.m. (Partner, Gallagher, Westman, Howald, Sahlbach, Andrews, N. C. Smith). Station Address: Lieut.-Col. Thra Aram, Experimental Radio Broadcasting Station HS8PJ, Post and Telegraph Department, Saladenj, Bangkok, Siam.

EXHIBITS HIS DX HAULS

Irvin Goodeve of Kalamazoo, Michigan, picked out his favorite cards and hung them outside his house to make this picture for RADIO NEWS.



JVN, Nazaki, Japan, 1066 kc., heard excellently on Mondays and Tuesdays testing with special tests to Northern U.S., asking for reports (Sahlbach, Daily, Mascarenhas) was reported heard at 11 p.m. (Howald).

JVM, Nazaki, Japan, 10740 kc., heard with same program and tests as JVN (Sahlbach).

JVT, Nazaki, Japan, 6750 kc., heard with same program and tests as JVN (Daily).

JVH, Nazaki, Japan, 14600 kc., heard daily 12 p.m. to 1 a.m., E.S.T., with news (Wolf, O'Connell, Gallagher, Mascarenhas). Listener O'Connell reports them on the air 4 to 5 p.m., E.S.T. also. Listener Elsnor reports hearing them Tuesdays and Fridays, 2 to 3 p.m.

VPB, Colombo, Ceylon, 6160 kc., heard transmitting irregularly 10 a.m. to 12 noon (Westman). Observer N. C. Smith says he hears them 12 noon to 2 p.m.

YDG, Batavia, Java, 4865 kc., reported heard Saturdays, Sundays, as late as 10:30 a.m. (Libanto). Station Batavia Radio Club, Koningsplain luid 12, Batavia C.

PLO, Bandoeng, Java, 11490 kc., reported heard 5:30 to 11 a.m., E.S.T. (Partner).

PLO, Bandoeng, Java, 11490 kc., reported heard 5:30 to 11 a.m. (Partner).

PLP, Bandoeng, Java, 11000 kc., reported heard 5:30 to 11 a.m., E.S.T. (Partner, Kemp).

PMN, Bandoeng, Java, 10260 kc., reported heard 5:30 to 11 a.m., E.S.T. (Partner, Rodriguez).

RIR, Tiflis, U.S.S.R., 10080 kc., reported heard 7 to 8 p.m., E.S.T. (Dixon).

RIO, Baku, U.S.S.R., 10170 kc., reported heard 7 to 8 p.m., E.S.T. (Dixon).

Short Waves from Africa

MORE dope on the African stations and times of operation are disclosed in these reports. The Italians are testing with the Ethiopian stations under new call letters.

ZEC, Salisbury, Southern Rhodesia, 6000 kc., 1/2 kw., are on the air Sundays, 3:30 to 5 a.m.; Mondays, 11 a.m. to 12 noon; Tuesdays, 1:15 to 3:15 p.m.; Thursdays, 10 to 10:45 a.m., and 11 a.m. to 12 noon; Fridays, 1:15 to 3:15 p.m. (Mallet-Veale, Greaves).

(Turn to page 224)

RR 366136

Situation *100.32.00 E 13.7.24*
 Wave-length: *27.38 10955*
 Power: *5 kw*
 Antenna: *dipole*
 Modulation: *grid direct c*
 Tubes: *2-2-A & Telefunken*
 H. T. *2000 r max*
 L. T. *---*
 Mike: *Telefunken Raiser carbon*
 Pick up: *---*
 Audio amp. *---*

SCHEDULE OF TESTS

Owner *Post & Telegraph Dept.*
 Mode of Xmr *home-made*
 Days *Mondays*
 Time *1200-1500 gmt*
 Type of programme *musical + foreign music & news*
 Engineer I/C *Col. P. S. ...*

H S P J

**THE EXPERIMENTAL RADIO BROADCASTING STATION
 AT SALADENG, BANGKOK, SIAM.**

With thanks we beg to verify correct your report of
 reception dated *30 March 1936*
 Further reports will always be appreciated.

The DX Corner (Short Waves)

(Continued from page 221)

ZEB, Bulawayo, Southern Rhodesia, 6147 kc., 500 watts, same program and schedule as Salisbury (Mallet-Veale, Greaves). Station addresses for ZEC and ZEB: General Post Office, Southern Rhodesia.

CR7AA, Lourenco Marques, Mozambique, Africa, 6137 kc., time on the air daily except Sundays, 11:45 a.m. to 1:15 p.m., 7:45 to 10:15 p.m., Sundays, 3 to 5:30 p.m. South African Standard Time. Observer Westman says the best time to hear them is 4:45 to 6:15 a.m., E.S.T.

CR6AA, Lobito, Angola, Africa, 7177 kc., heard as per Time Table and also from 2 to 4:15 p.m., E.S.T. (Westman).

ETA, Addis Ababa, Ethiopia, is now on the air again testing with Rome irregularly with the call letters IUA.

ETB's new call letters are IUB. Two other new frequencies are IUF, 6920 kc., and IUG, 15450 kc. (Andrews).

EA8AB, Tenerife, C.I., 7010 kc., is on the air Mondays, Wednesdays and Fridays, 3:19 to 4:19 p.m., E.S.T. This station would like reports (Seright). Station address: Radio Club Tenerife, Apartado de Correos 225, Santa Cruz de Tenerife, Canary Islands.

North America

LISTENERS report a new Cuban station and some worthwhile data on ultra-short-wave American stations.

COCCQ, Havana, Cuba, 9750 kc., is a new station who is reported heard 8 a.m. to 1 p.m. (Messer, O'Connell, Horwath, Partner, Howald, Fallon, Flick, Schamleffer, Silvius, Stabler, Pilgrim, DeMent, Betances, Wolf, Sahlbach, Hartman, Davis, Gallagher, Black, Poehm, Hartshorne, Atherton, Kemp, Pickering, Harris). Observer Anca reports hearing them 7 a.m. to 1 a.m., E.S.T. Observer Atkinson reports hearing them from 7 a.m. to 10 p.m., E.S.T. Listener Augustine reports hearing them testing on 9930 kc. Station slogan: "RCA Victor, La Casa de las Medias." Station address: P.O. Box 1373, Havana, Cuba.

ONE YOU'VE BEEN LOOKING FOR
Official verification of HS8PJ, received by Observer Partner, of Tacoma, Washington. Don't you wish you had one?

COCH, Havana, Cuba, 9420 kc., heard as per Time Table (Sahlbach, Wolf).

COKG, Santiago, Cuba, 6050 kc., heard as per Time Table (Sahlbach).

CO5RY, Matanzas, Cuba, 6250 kc., reported heard 7 to 9 p.m., E.S.T. (Partner).

XEXA, Mexico City, Mexico, 6130 kc., reported heard daily except Sundays, 2 to 5 a.m., 9 to 10:45 a.m., and 1 to 5 p.m., E.S.T. (Atherton). Station address: Radiofusoras de la Secretaria de Educacion Publica de Mexico, Mexico D.F., Mexico.

ZFD, St. George, Bermuda, 10335 kc., heard testing 7:30 to 8:15 p.m., E.S.T., Sundays (Deater, Hartshorne, Sahlbach, Messer).

W2XAD, Schenectady, New York, 15330 kc., has increased its schedule to include 10 a.m. to 3:45 p.m., E.S.T. (Wassmansdorf, Rodriguez). There will be a special program from this station on November 20th, 3 to 4 p.m., E.S.T. for the N.N.R.C., and Radio News Listeners.

W2XAF, Schenectady, New York, 9530 kc., new schedule is 4 p.m. to 12 midnight (Wassmansdorf, Rodriguez), will have special program October 15th, 3 to 4 p.m., arranged by Oliver Amlie, Pres., 6000-12500 Mile Club.

W3XAL, Bound Brook, New Jersey, 6100 kc., will have a special DX program September 20th, at 1 a.m., arranged by Oliver Amlie, Pres. of 6000-12500 Mile Club.

W1XAL, Boston, Mass., 15250 kc., again heard testing and soon to resume programs 10 to 11 a.m. (Smith).

W9XAH, heard testing on about 12200 kc., at 12:15 a.m. (Alfred).

W2XGB, 17310 kc., heard testing 9 a.m. to 5 p.m., E.S.T. (McKay).

W6XKG, Los Angeles, California, has changed frequency to 31600 kc. (Howald).

W9XPD, St. Louis, 31600 kc., trans-

AN ARDENT SHORT-WAVE OBSERVER

Meet Harry J. Potthoff, who operates the Bronx Emergency Receiving Station in that borough of New York City. There isn't much Harry misses that goes on over the air.

mits regularly 9 a.m.-1 a.m. (Partner, Andrews).

TFJ, Reykjavik, Iceland, 24.53 meters is now heard 1:40 to 2:35 p.m. (Alfred).

Central America

DO you ever try to log Central American stations? Here is some data on a few new ones and some new data on some of the old ones including frequency changes. Try your hand at these and at logging new ones that will come on the air in time for the next issue of the DX Corner.

TI4NRH, Heredia, C. R., is back on the air on 9735 kc., according to Listener Boehm.

TI4WX, Heredia, C. R., 9000 kc., 50 watts, reported heard 7:30 to 10 a.m., 1:30 to 5 p.m., 5 to 9 p.m., E.S.T. (Gonzales). Station address: G. E. Gonzales, Radiofusora "Costa Rica", Heredia, C. R. Station slogan: "La Voz de la Patria".

TIVL, C. R., 6870 kc., heard evenings (Betances).

TIPG, San Jose, C. R., has moved to 9559 kc., 1000 watts, 7:30 to 9:30 a.m., E.S.T., 12 noon to 2 p.m. and 6 to 11:30 p.m., E.S.T. (Robertson, Partner, Alfred, DeLact). Observer Stabler says the frequency is 9556 kc. Station slogan: "La Voz de la Victor".

HP5J, Panama, 9605 kc., is the correct frequency and not 9590 kc., according to Observer Oxrieder.

HP5K, Colon, Panama, 6005 kc., reported heard 8:30 to 10 a.m., 1 to 2 p.m. and 7 to 10 p.m., E.S.T. (Amos).

HI8Q, Trujillo, D. R., 6240 kc., reported heard 11 a.m. to 2 p.m. and 5 to 8 p.m., E.S.T. (Robertson, Betances, Styles).

HI5E, Trujillo, D. R., 31.5 meters, reported heard 7:50 to 8:40 p.m., E.S.T. (Atherton).

HIT, Trujillo, D. R., 6640 kc., reported heard 8 p.m., E.S.T. (Kemp). Observer Partner says he heard this station at 8 p.m. on 12262 kc. This is probably an harmonic.

HIX, Trujillo, D. R., 12262 kc., heard at around 9 to 10 p.m., E.S.T. (Partner). This is another harmonic.

HI2D, Trujillo, D. R., 6900 kc., re-

(Turn to page 238)



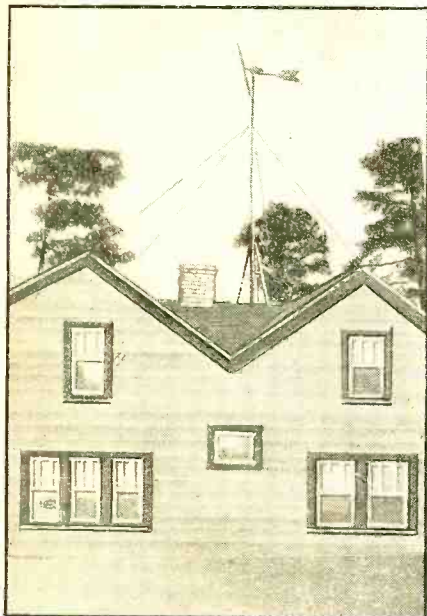

A TYPICAL INSTALLATION

An extension mast may be inserted between tower and propeller assembly, as shown in the photo of a farm-home installation.

APPARATUS especially designed for unwired homes is offered by the Wincharger Corporation. The new De Luxe Wincharger, shown in the photograph, starts battery charging at wind velocities as low at 8 3/4 miles per hour. In most sections of the country velocities in excess of this are normal and fairly constant.

The type of windmill shown is designed particularly for radio work. The

"Wind" RADIO for the FARM

By Joseph Powell

DURING the past five years there has been a constantly increasing interest in the use of windmills to operate electric-current generators. When relatively small power is required, such as is needed for the operation of 6-volt radios, a wind-operated generator provides the most economical method for charging the battery in homes not wired for electricity. It is not generally realized that there are five million such homes in this country.

generator requires a minimum of attention and the cost of operation for the entire apparatus is estimated not to exceed fifty cents a year. The manufacturers recommend that the Wincharger be installed well above trees, houses and other wind-breaking objects. A typical house installation is illustrated. A storage battery of generous proportions,

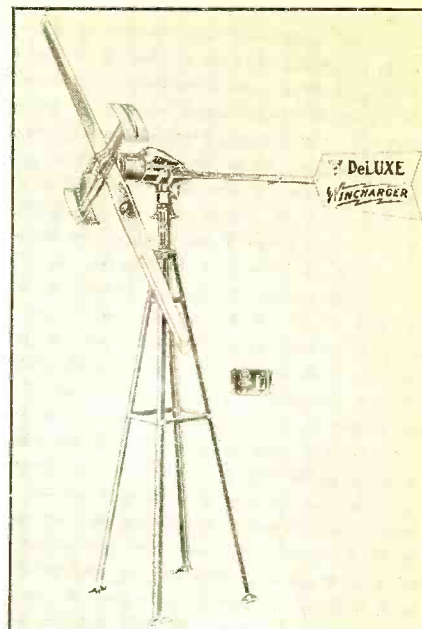

DETAILS OF THE EQUIPMENT

The entire assembly is shown here, requiring only a cable to carry the generated current down to the storage battery. The generator is in the small cylinder mounted immediately behind the 6-foot propeller and its spring tension governor arms.

such as the 160 ampere hour size is desirable.

This combination of windmill and battery makes the present highly efficient 6-volt radios available for un electrified areas. It should prove a boon to the millions of such homes now using less economical and less satisfactory radio installations.

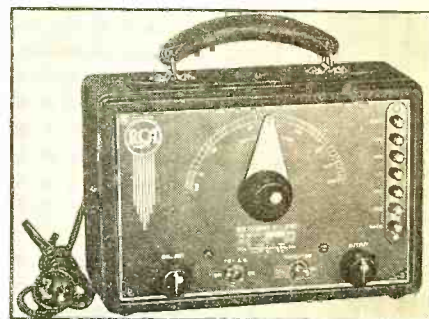
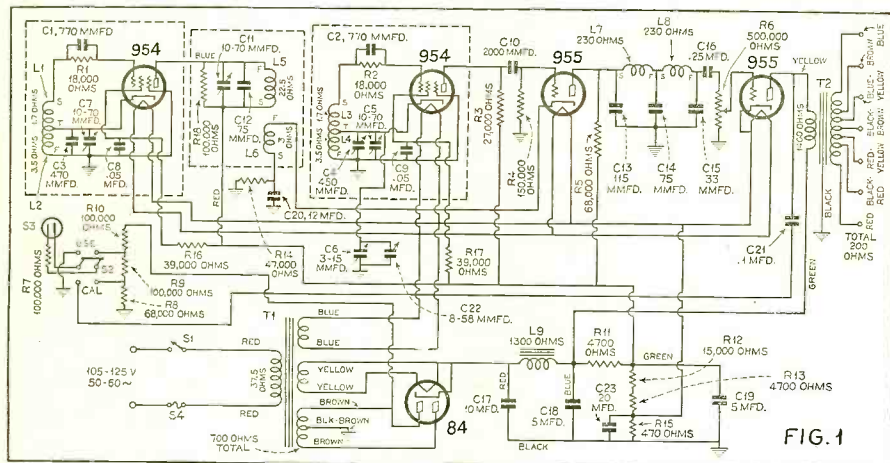

NEW TEST INSTRUMENT

The small beat-frequency oscillator shown above has features hitherto obtainable only in bulky, battery-operated, laboratory instruments.

New B. F. AUDIO Oscillator

By Robert Ames

A NEW beat-frequency audio oscillator of unusually compact design has been designed by engineers of the RCA Manufacturing Co. The frequency

range extends from 30 to 15,000 cycles, which is directly calibrated. A unique neon-tube method permits calibration adjustment at the power-line frequency of 60 cycles and also, if desired, at 120 and 180 cycles.

The compact assembly is greatly aided by the use of four acorn tubes in the circuit. As shown in Figure 1, the instrument is completely a.c. line operated, an 84 rectifier being used. Both the fixed and variable frequency oscillators are 954 pentodes in an electron-coupled circuit. The mixer is a 955 triode which is resistance-capacity coupled to the variable-frequency oscillator and inductively coupled to the

fixed-frequency circuit. The fixed frequency is 350 k.c. and the variable frequency is adjustable from 335 to 350 k.c.

The output is rated flat to within plus or minus 1db. from 120 to 10,000 cycles and is down only 2db. at 30 cycles. The maximum output is 60 milliwatts. The over-all distortion is rated at less than 5% (with 20 milliwatts) and less than 10% (at 60 milliwatts external load). The output impedances are 250, 500 and 5000 ohms, all of which are center-tapped to ground.

Oscillators of this type are a necessity for measuring receiver and audio-amplifier fidelity and for a wide variety of laboratory and radio-service testing.

"SELLING SERVICE" (Your Service Car)

By A. A. Ghirardi
and T. S. Ruggles

Part Six

NOT content with the use of the many forms of advertising and publicity already explained in this series of articles, the smart serviceman makes his service car give him "advertising on wheels"—advertising that repeatedly flashes its message throughout his community at slight cost. He also sees to it that his general appearance, his manners and his speech work for him in creating confidence and friendship. They are all part of his business assets—they help to "sell his service" at a profit.

A GOOD, reliable service car or truck is an asset to any radio service shop as a means of rapid transportation for his test equipment, radio sets, supplies and himself. But, with a little ingenuity, it can be transformed into a powerful mobile advertising influence as well—one that will be on the job in every part of the community that the serviceman enters. It will be seen by large numbers of persons, and if distinctive enough, any advertising message it carries will register on every observer! If it bears a clear-cut name and telephone number, it is bound to add new customers to the roster.

If you use your personal passenger car in your service work, have your name, phone number and the words "RADIO SERVICE CAR" neatly lettered in gold leaf on the outside of each front door panel or a larger message attractively painted on each spare tire cover. This can be done by your local sign painter, but be sure the lettering is of the simple legible "block" type and

large enough so it can be easily read at a distance. This latter point is very important. If you do not wish to deface the doors of your car, have the message painted on panels of wood which can be hooked on over the doors and quickly removed when you use it out of town for pleasure.

Service Trucks

The larger radio dealers who employ service trucks for new-set delivery and service work have wider opportunities for making their vehicles distinctive. Anderson Radio Hospital of Seattle, for example, use a distinctive white truck bearing the red cross and neat lettering shown in the accompanying illustration. Put a short, snappy slogan on the truck—one that passers-by will remember. A good slogan is worth a great deal. Keep the truck circulating freely wherever crowds gather at fairs, airports, parades, municipal events, etc. It seems almost unnecessary to point out that after time and money have been spent to make a service car or truck attractive, it should always be

SOUND TRUCKS THAT PAY

The sound truck at the left, below, is one of many operated by the Cascadian Sound Equipment Company of Portland, Oregon, and each one they own is a fine revenue producer. At the lower right is the unique mobile sound installation of Merrill and McIntyre of Sellersville, Pa., which always draws a crowd on festive occasions.



YOUR BUSINESS AT A GLANCE

The service car can be made to tell your story as it goes through your neighborhood and thus be a constant advertisement for your business. The Anderson Radio Hospital of Seattle, Washington, has found this type of car has brought them many times its cost in new business.

kept clean and well-painted so that it may exert its maximum advertising force.

The "You" Part in Selling Service

Servicemen who have read this entire series of articles no doubt realize by this time that there are many angles to the business of selling their service profitably. You must also realize, however, that since most of these business-getting methods cost money, it is essential for you to get repeat business from every new customer they bring you. Therefore, when you've done your first job for a new customer it is entirely up to you to see that you get future calls! This means first of all, that you've got to make him feel that you gave him competent, honest service at a reasonable price. It also means that you've got to make a good personal impression on him. And of course, you've got to keep reminding him about YOU by having some part of your advertising reach him at regular intervals so that he won't forget you.

Your Personal Appearance

A great many radio servicemen are much too careless about their personal appearance. If you make personal calls to either new prospects or old customers to solicit business, make sure that you are dressed neatly—but not flashily. It isn't good business to look like a beggar—on the other hand, it isn't a crime to dress well.

There's a lot of (Turn to page 254)



A 100-30,000 Kc. SERVICE OSCILLATOR

By James Parker

THE latest improvements in compact test oscillator design are well exemplified in the recently announced Triplett model 1231 Signal Generator which measures only 6½ by 8 by 4½ inches. Special attention has been devoted to factors making for stability, convenience and simplicity in operation. The calibrated dial is direct-reading on fundamental frequencies extending, in six ranges, from 100 kilocycles to 30 megacycles. The attenuator is carefully shielded and terminals are supplied for both high and low output levels. The signal is normally 40 percent modulated at approximately 400 cycles but a switch is provided so that an unmodulated signal may likewise be used. Audio circuit testing is facilitated by separate terminals which make available the 400 cycle audio note. The six oscillator coils are individually shielded and calibrated.

Battery Operated

As shown in Figure 1, the circuit em-

ployes two type 30 tubes with the filaments operated in series from a 4.5 volt source. The r.f. oscillator utilizes the well-known tickler feedback circuit. The band switch is mounted directly under the coil shelf and is so arranged that the leads are very short, assuring stability. The plate battery supply of 67.5 volts is made up of Burgess "ribbon" type battery assemblies, conveniently and rigidly held in place by brackets. They may be readily removed when replacement is found necessary.

Excellent Signal Quality

Tests in the RADIO NEWS laboratory show that the instrument supplies a good sharp signal of excellent aligning character on all bands. The operation of the attenuator is unusually effective and compares favorably with that of higher-priced instruments. The dial calibration is sufficiently accurate for all practical service applications. The shielded cable is well constructed, with large-sized test prod (Turn to page 235)

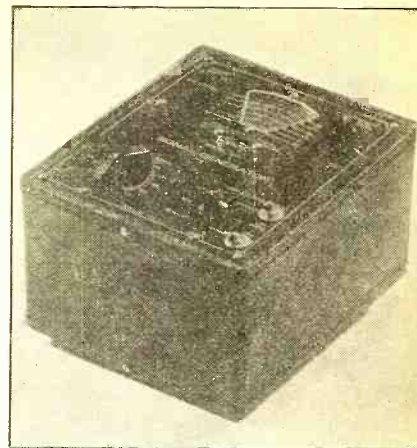

A WELL-SHIELDED INSTRUMENT

The excellent shielding provided by the tight steel case aids materially in obtaining effective attenuation control.

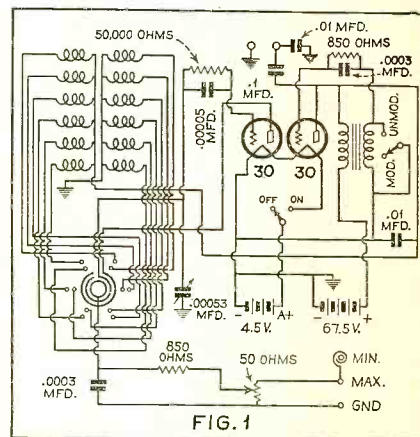

New SCHOOL P.A. System

By Victor Hall

NOW that the advantages of modern sound systems are becoming better known, an urgent demand has been created for complete, self-contained units suitable for schools, hospitals, hotels and similar institutions. To meet such requirements, engineers of the Webster Company have just designed the new Series "S" sound systems shown in the accompanying photograph.

This new unit is a standardized model which incorporates features formerly supplied only in expensive, custom-built apparatus. Each unit will distribute a choice of radio, or phonograph reproduction, or speech transmission via microphone, to ten remote points. Also, if desired, two-way communication may be maintained from the central control to each point. Further, it can be arranged to distribute two programs at the same time. One group of rooms may listen to a radio program while another group is being served by phono-

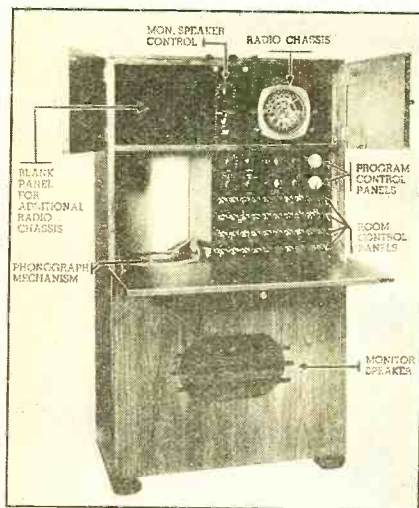

graph or microphone. An emergency control permits breaking in at all points at any time for a general announcement.

The standard unit contains a single 7-tube, all-wave, superheterodyne receiver which is equipped with a visual-tuning indicator, automatic volume control and tone-compensation control. A blank panel is provided for an additional radio chassis.

A dual-diaphragm crystal microphone, with a banquet stand and cable, is provided for speech input. The phonograph turn-table and pick-up will play either 10 or 12-inch records. The amplifiers consist

of 4-stage, 15-watt, Class A sections and space is provided for 8 units in the cabinet. The speakers are 6-inch permanent-magnet dynamics, mounted in walnut-finished cabinets, with the baffle carefully set at the proper angle for best sound distribution.

The low cost, which production manufacture of this unit makes possible, will enable many institutions with limited appropriations to secure sound facilities hitherto beyond their means. The sectionalized character of the design provides for simple expansion without reconstruction when more elaborate facilities are required.

Big Future for Trained Television Men

By F. G. Wellman

Chicago Engineering Works

As an educational institution, we look upon the future of Television from the point of view of the man who will be required to manufacture, install and maintain the apparatus required for the purpose and on this basis we see a repetition on even a larger scale, of the tremendous activity brought about by radio from 1922 up to this time. We believe radio for the eyes has before it a greater future than was apparent for radio for the ears, when it was in the same stage of development as Television is today. We think the man who makes himself familiar with the principles of radio and all he can learn about Television right now has a most unusual future ahead of him.

Inexpensive, Precision AMPLIFIER for the "Lab"

By John H. Potts

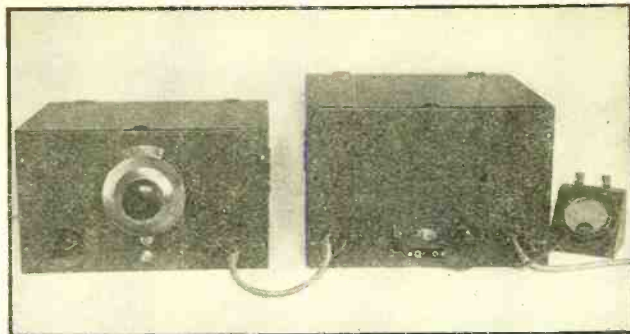

IN THE RADIO NEWS LAB

Here the new amplifier is shown connected to the beat-frequency oscillator, design and construction details of which were given in the September issue. This makes an excellent combination for all sorts of a.f. test and measurement work.

THE b.f. audio oscillator described in our constructional article in the September issue was designed for use with a separate amplifier. By thus dividing this apparatus in two units, its range of application is greatly extended. The amplifier to be described, for instance, may be employed not only with the beat-frequency audio oscillator but also for low-power public address systems where a high-gain amplifier of excellent fidelity characteristics is essential. The undistorted output of 2.5 watts will be found adequate for a wide variety of work. In general shop servicing, it may be used to replace temporarily a suspected audio system in order to determine definitely if the receiver audio system is faulty. Also, for modernization jobs, the improvement in tone quality which may be realized in receiver performance by rebuilding an obsolete audio system to conform to this design may be instantly demonstrated. This will serve to clinch many sales where mere advice will leave the customer feeling that he is gambling on an unproved theory.

The beat-frequency oscillator in conjunction with this amplifier may be used for testing speakers directly since its output is more than adequate for the purpose. Rattles, microphonic disturbances, acoustic howl and other forms of distortion are quickly revealed when a pure tone of wide frequency range is employed. Such defects are often not apparent on broadcast reception when the nature of the program is such that the disturbing frequencies are absent or

masked in a complex tone. The high output obtainable will force a signal through any audio system, making for greater ease in service procedure. For adjusting 10,000 cycle filters in high fidelity receivers, it is indispensable.

This amplifier is simple both in design and construction, yet incorporates many unique features. The input tube is a type 75 duo-diode high mu triode. The triode section has an amplification factor of 100 which is not equalled by any of the present type single purpose triodes. The diode section is utilized to adapt an external d.c. meter for use in measuring the a.c. output level. This feature makes it unnecessary to employ complicated compensating systems in the amplifier to secure a flat frequency characteristic over the wide range available. The output tube is the double triode 6B5 which is rated at 2.5 watts undistorted output at the voltages employed. Actually, we make use of a little less than one-half this output in order to avoid the slight increase in distortion which results when the tube is operated at its maximum rating.

The Stancor output transformer is tapped at 4, 8, 15 and 500 ohms. These points are brought out to a Yaxley tap switch. In addition, a connection is made to the output of the first stage to provide a high-impedance output of extremely pure wave form for use with an oscillograph or to test P.A. or inter-stage amplifiers with resistance input.

The rectifier tube is a metal 5Z4, which was employed because it is a slow heater and therefore no bleeder resistance is required. The single choke and resistance in the filter system are adequately by-passed and, in conjunction with the resistance-capacity filter in the first stage plate circuit, provide a high degree of filtration at a saving in weight, cost, and size of the unit.

Anyone who has had to cut out large rectangular holes in a steel chassis will appreciate the design of the transformers and chokes used in this amplifier. All terminals are above the chassis; therefore only a few easily drilled holes are required for mounting and terminal connections. This eliminates one of the most arduous tasks of the constructor with limited equipment. (Turn to page 255)



LAYOUT DETAILS

These top and bottom views provide a good idea of the arrangement of parts. The oversize power supply equipment, in addition to supplying this amplifier, will provide power for other laboratory instruments.

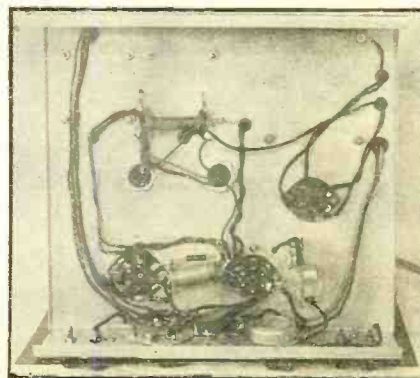
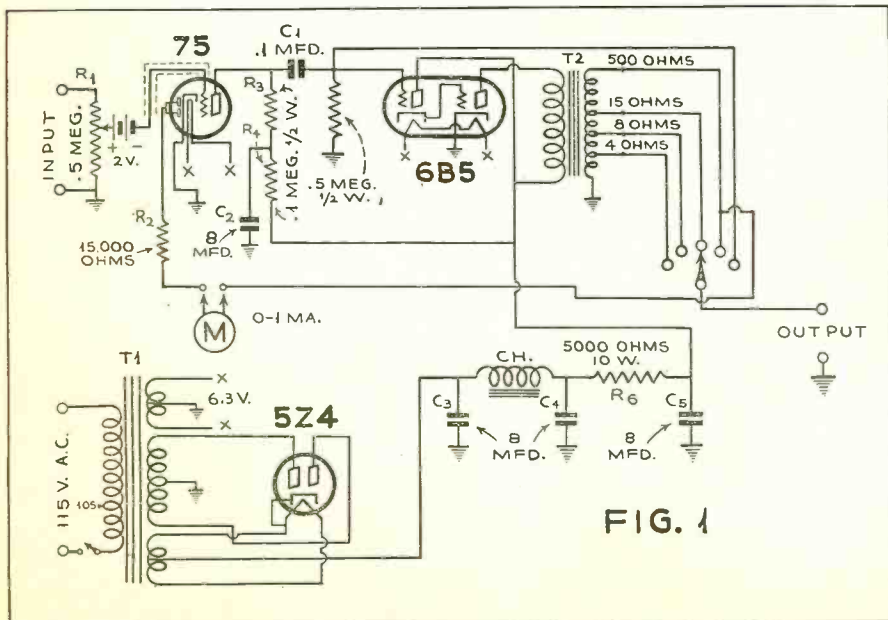

Here's the important catalog news you've been waiting for...

Actually the First **RADIO** **BLUE RIBBON** Catalog and it's **FREE!**



HEAD-AND-SHOULDERS AHEAD OF THE FIELD IN EVERY DEPARTMENT

RADIO MARCHES ON! Modern science knows no resting place. New ideas—new designs—new improvements in sets, parts, amateur and public address equipment—these are all part of radio for 1937.

Wholesale Radio Service Co., Inc., sets the pace! For 1937 it presents the first BLUE RIBBON Radio Catalog—a book designed to give you positive "purchase-insurance"!

Yes, this is truly a "different" radio catalog. Every single radio item listed in this great new bargain book has been checked and approved in our huge Testing Laboratories and has been awarded "THE BLUE RIBBON SEAL"—a seal that certifies unquestioned value and mechanical excellence—*your assurance of quality!* Only those items which met the rigid standards of our Testing Laboratories were included in this great new catalog—a catalog destined to become a world-wide guide to radio quality.

5 Huge Convenient Branches Brought to You in the Pages of the Largest Catalog in All Radio

In order to give you the fastest, most complete service in the radio field, Wholesale Radio Service Co., Inc., maintains 5 great branches in New York, Chicago, Atlanta, Newark and the Bronx. The huge stocks, the friendly co-operation, the ability to give you prompt, reliable service are all brought to you in the pages of this new blue-ribbon edition.

Send for this book of a thousand bargains today. It's FREE! See what Wholesale Radio Service Co., Inc., has to offer you! A brilliant array of NEW RECEIVERS, from 4 to 24 tubes, with surprise features for 1937. Special FARM RECEIVERS with new improvements; special RECEIVERS for European reception; BATTERY SETS—32 Volt SETS—AUTO SETS. A great selection of REPLACEMENT PARTS—TUBES—KITS—AERIALS. Latest SHORT-WAVE and HAM equipment; PUBLIC ADDRESS AMPLIFIERS, SYSTEMS and ACCESSORIES. Everything in *Quality* Radio at lowest "Wholesale" Prices. Use the convenient coupon—it will bring you the first BLUE RIBBON RADIO CATALOG ever issued—FREE!



When You See a Product Listed in this Great New Radio Catalog... You Know

1. That every radio item has been checked and approved by the Testing Laboratories of Wholesale Radio Service Co., Inc.—the largest radio supply house in the world.
2. That it has been awarded the Blue Ribbon Seal—your assurance of quality and value.
3. That you can buy with confidence! Lowest prices, fastest service and a liberal guarantee!

MAIL COUPON FOR FREE CATALOG

WHOLESALE RADIO SERVICE CO. INC.

CHICAGO, ILL. 901 W. JACKSON BLVD. • NEW YORK, N.Y. 100 SIXTH AVENUE • ATLANTA, GA. 430 W. PEACHTREE ST. N.W.

BRONX, N.Y. 542 E. FORDHAM RD.

NEWARK, N.J. 219 CENTRAL AVE.

WHOLESALE RADIO SERVICE CO., Inc.
100 Sixth Avenue, New York, N. Y.

Rush FREE BLUE RIBBON Catalog No 65-k2.

Name _____

Address _____

Town _____

State _____

GET THIS BOOK

make more money



This new fact-packed book tells how to make your business ability match your technical expertness — how to calculate costs, and determine the fair price for each job. A few minutes a day will provide the figures that show whether you are making enough money on your volume of business. This 220-page book, "Radio Service Business Methods" by John F. Rider and J. Van Newenhizen, costs only \$3, but all RCA Parts Distributors and RCA Tube Distributors have special offers for dealers and service engineers. Ask for details.



Parts

Parts Division, RCA Mfg. Co., Inc., Camden, N. J.
A Service of Radio Corporation of America

ADVANCE TRAINING FOR

Servicemen

WHO WANT TO GET AHEAD

HERE'S THE "KEY TO SUCCESSFUL SERVICING"

A complete home-study course for professional Servicemen who know **TRAINING PAYS!** The result of years of experience by the faculty in actual Service work and in studying the needs of the Serviceman.

STUDY IN YOUR OWN HOME

Complete training in Servicing and Public Address, with or without Television. Start any time—take up to 3 years.

LOW COST—EASY TERMS

Smart men are insuring their technical future now. Get details today. Be a success NOW—ability is always recognized.

FREE!
WRITE TODAY FOR THIS INTERESTING ILLUSTRATED BOOKLET — "THE KEY TO SUCCESSFUL SERVICING"



RADIO SERVICE INSTITUTE

Subsidiary of C. R. E. I.
DEPT. RN-10—3308 14th STREET N. W.
WASHINGTON, D. C.

See Page 241 for
BIG MONEY-SAVING OFFER
on Radio News



THE SERVICE BENCH

ZEH BOUCK

Service Shops . . . Service Kinks . . . Auto Radios . . . Auto Radio Antennas . . .
Bridge Tests . . . Symposium on Majestics . . . **SERVICING:** Pontiac, Zelton,
Stewart Warner . . . Service Notes . . .

THIS MONTH'S SERVICE SHOP

OUR head photo this month shows the service shop operated by P. P. Pratt as the Winton Radio Laboratories, Buffalo, N. Y. Mr. Pratt is a member of the O. R. S. M. A. and of the A. R. R. L., operating station W8KDT. That he is an old timer is demonstrated by the informal snap-shot of Figure 1 showing his original shop (which provides quite a contrast with his present layout!) with its proprietor servicing a short-wave receiver of ancient vintage.

Our head photo is particularly interesting in that, reduced to post-card size, it is used as an advertisement for the Winton

Radio Laboratories. The back of the card reads, in the space for correspondence—"A radio repair service, fully equipped to take expert care of your radio troubles. Place this card near your receiver. It is good for one (1) free inspection and check-up on your set!" The photo on the other side certainly suggests efficient, neat work. And Mr. Pratt, as he says, has the equipment with which to do it. The panels, from left to right, contain the following: 1—Universal dynamic speaker, operable with any impedance combination, field resistance or field substitute. 2—Weston 682 tube checker. 3—Upper section—d.c. meter panel. Lower section—Clough-Brengle oscillator. 4—Radiart P6 vibrator analyzer. 5—High-resistance d.c. volt-ampere-ohmmeter, with Weston meters. 6—Upper section—d.c. galvanometer. Lower section—Triplet 1220A point-to-point analyzer. 7—d.c. multi-purpose instrument and galvanometer. 8—Upper section—Supreme neon lamp tube short-circuit tester. Lower section—Shallcross type 686 a.c. utility meter. 9—Blank. 10—Upper section—condenser bank for substitution. Lower section—resistance bank for substitution. 11—Upper section—Tobe condenser analyzer. Lower section—Thordarson condenser tester. 12—Electromagnetic speaker.

Underneath panel No. 1 is a Westinghouse watt-hour meter for measuring all electricity used in service work. Portable equipment consists of a Supreme 85L tube checker and a Supreme 333 analyzer. The

(Turn to page 252)

FIGURE 1

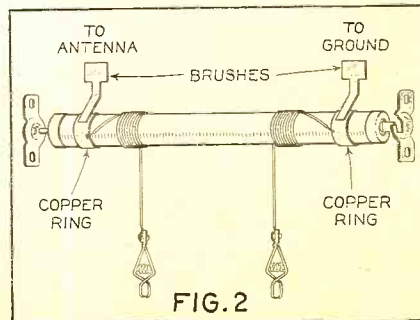
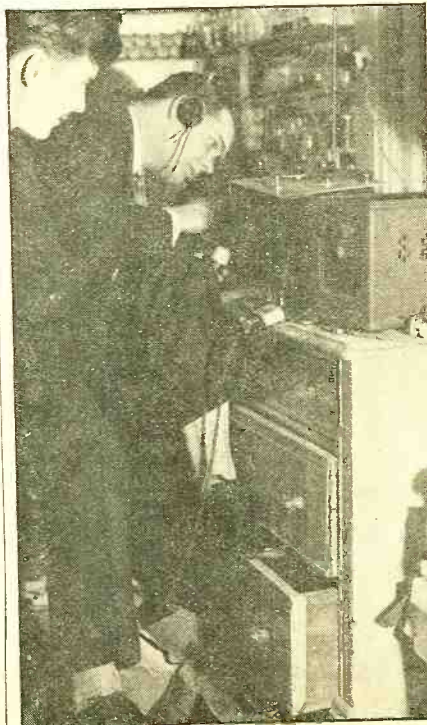

No Headaches over
HIGH SURGE

P. R. MALLORY & CO., Inc.
MALLORY

Replacement Condensers are Surge-Proof

Surge-Proof — because an exclusive Mallory development makes use of the "Constant Wattage" characteristic of radio power packs to keep surge voltage well below the danger point.

That's a big help! You will never "get a pain in the neck" from high surge troubles when you use Mallory for replacements.

"Surge-Proof" is only one of the many features of Mallory Replacement Condensers — they have greater efficiency; are humidity-proof; built to meet high temperatures; easy to install because of smaller sizes and the exclusive Mallory Universal Mountings — a combination of advantages that only Mallory can offer.

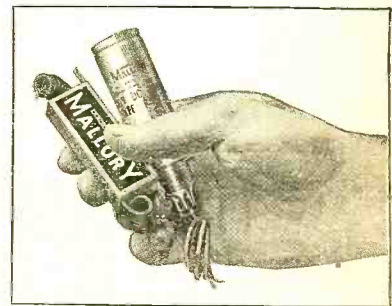

Twenty Minutes Reading Saves You Hours of Servicing

Read the Mallory Replacement Condenser Manual! A 94-page book — but only twelve reading pages (reading time: 20 minutes) gives you the complete story, — shows you just how the Mallory Universal Replacement idea saves you hours of servicing and insures real profits from the finest servicing any man can do. You owe it to yourself to study this manual.

Everywhere service men are saying — "a swell help — the Mallory Manual and Mallory Parts" . . . "Invaluable for the best service" . . . "Worth its weight in gold" . . . "Mallory Condensers can really take it" . . . "I can depend on Mallory" . . . We receive thousands of such letters from satisfied service men. It is proof positive that Mallory Replacement Condensers for universal replacement service have what it takes to produce quality service, solid profits and satisfied customers.

Use Mallory Replacement Condensers — ask your distributor now!

Two Examples of New Mallory Universal Replacements

UR 189

200V 25V

RED	RED	BLUE	YELLOW	YELLOW
+	+	+	+	+
8	8	8	5	5
-	-	-	-	-

BLACK BROWN GREEN

NOTE: UR 189 = UR 188 EXCEPT FOR CARTON

UR 188

P. R. MALLORY & CO., Inc.
MALLORY

P. R. MALLORY & CO., Inc.
INDIANAPOLIS INDIANA
Cable Address — PELMALLO

YAXLEY

BRUSH Spherical Microphone



For remote pickup, "P. A.," commercial interstation and amateur use. Low in price... but built to Brush's traditionally high mechanical and electrical standards. Wide frequency response. Non-directional. No diaphragms. No distortion from close speaking. Trouble-free operation. No button current and no input transformer to cause hum. Beautifully finished in dull chromium. Size only 2 1/2 inches in diameter. Weight 5 oz. Output level minus 66 D.B. Locking type plug and socket connector for either suspension or stand mounting at no extra cost. Full details, Data Sheet No. 13. Free. Send for one.

BRUSH Lapel Microphone



For after dinner and convention speakers, lecturers, etc. Gives great mobility. The smallest, lightest microphone on the market. Size 1 1/2 x 1 1/4 x 3/8. Weight with coat attachment less than 1 oz. Special internal construction and rubber jacketed outer case insure quiet operation. No interference from breathing noises, etc. Typical Brush sound cell response and trouble-free operation. Details on request.

BRUSH DEVELOPMENT COMPANY
 3889 E. 40th St. CLEVELAND, O.
 MICROPHONES • MIKE STANDS • TWEETERS • HEAD PHONES • LOUD SPEAKERS

GET ON THE LIST FOR THESE CATALOGS



Here are the four big catalogs sent to every Burstein-Applebee customer this year. Each catalog is brim full of latest information and lowest wholesale prices on Radio, Electrical and Refrigeration Equipment. Write today—get on the list.

BURSTEIN-APPLEBEE CO.
 1012-14 McGee St., Kansas City, Mo.

TRI-STATE COLLEGE
Radio Engineering Degree in 2 Years

Complete Radio Engineering course in 96 weeks. Bachelor of Science Degree, Radio (television, talking pictures and the vast electronic field) offers unusual opportunities for trained radio engineers. Courses also in Civil, Electrical, Mechanical, Chemical, Aeronautical, Engineering, Business Administration and Accounting. Low tuition, low living costs. World famous for technical two-year courses. Those who lack high school may make up work. Students from all parts of the world. Located in picturesque hill and lake region of northern Indiana. Enter January, March, June, September.

16106 COLLEGE AVE. ANGOLA, IND.
 Write for catalog

Ken-Rad Radio Tubes
 THE KEN-RAD CORP., Inc., Owensboro, Ky.

RADIO PHYSICS COURSE

ALFRED A. GHIRARDI

Lesson 55. Filters

GENERALLY speaking, a filter is a device for separating things of different characteristics from each other. Mechanical filters are commonly used in everyday life. Thus a mechanical filter or screen is used to separate sand from stones, a coffee strainer separates the coffee grounds from the liquid, etc. Similarly, when a circuit contains currents of several frequencies, electrical filters may be used to separate currents of certain frequencies from those of other frequencies. The perfection of the modern a.c. electric receivers has resulted in the widespread development and use of electrical filters, both in their power packs and in the radio and audio amplifier systems.

The purpose of the electric filter is not very much different from that of any mechanical filter; it is simply designed to separate currents of different characteristics from each other, i.e., for separating direct from alternating currents, or separating alternating currents of different frequencies from each other. Although the design of some complicated filters involves intricate calculations, the more simple types may be easily understood by the novice.

The action of all types of electrical

they have an effect upon the sharpness of the filter—they determine whether the dividing line between the frequencies which pass and those which do not is finely drawn, or whether the division between the two is of a more gradual kind. The less the resistance in any filter the sharper will be the dividing line between the frequencies which are let through and those which are blocked, and it is usually desirable to have this division as sharp and clean-cut as possible. There is another factor, also, which affects the sharpness of the "cut-off" of a filter. This will be taken up later.

By proper arrangement of condensers, inductors and tuned circuits therefore, any desired electrical filtering action may be obtained. There are four general classes of filters. The first is the *low-pass filter* (Figure 1). This is the type designed to pass all frequencies below a pre-determined critical or "cut-off frequency", and substantially reduce or "attenuate" the amplitude of currents of all frequencies above this cut-off frequency. This type of filter will also pass direct current without opposition.

Let us consider first the simple low-pass filter shown at the left of Figure 1. Notice that an inductor is connected in series with the circuit and a condenser is connected

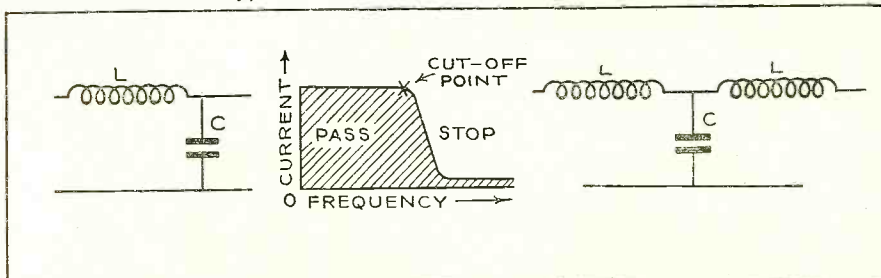

Figure 1—Left: Single section of a low-pass filter. Middle: The frequency-current characteristic of a low-pass filter. Right: Single section T-type low-pass filter.

filters depends upon the following three main principles of alternating current circuits:

- (1) An inductor ("inductance") offers much less resistance or opposition to the passage of direct currents and low frequency currents than it offers to high frequency currents.
- (2) A condenser ("capacitance") offers much less resistance or opposition to the passage of high frequency currents than to low frequency currents, and stops or "blocks" the flow of direct current altogether.
- (3) That a "series tuned circuit" offers a low impedance at resonance, and will permit the passage through it of those alternating currents which lie in a narrow band of frequencies near the resonant frequency, and will oppose the flow of currents of all other frequencies.
- (4) That a "parallel tuned circuit" offers a high impedance at resonance, and opposes the flow of those alternating currents through it which lie in a narrow band of frequencies around the resonant frequency, and will permit the flow of currents of all other frequencies.

Resistances do not provide any filtering action in themselves, for they impede all currents which pass through them, regardless of frequency. Resistances do have an effect of a different kind upon a filter however. They do not determine which frequencies the filter will pass or impede, but

across the circuit. If we remember the action of an inductor and a condenser in an a.c. circuit, it is easy to understand the action of this arrangement. The low-frequency currents which are to be passed through the circuit find an easy path back and forth through the inductor since the reactance which an inductor offers to low-frequency currents is small ($X_L = 2\pi f L$). These low-frequency currents cannot get in and out of the condenser plates to any great extent since the reactance of a condenser to currents of low frequency is very

$$\text{high } X_C = \frac{1}{2\pi f C}$$

Therefore low-frequency currents are not appreciably shunted or short-circuited by the condenser across the line.

The high-frequency currents which may also be in the circuit at the same time, find that the inductor offers a high impedance to their flow through the circuit, but that the shunting condenser allows the current to surge back and forth between the plates, (in the electrical circuit) since it offers a low impedance to currents of high frequency. Thus we see that the action of this filter is to offer very little impedance or opposition to low-frequency currents passing through it, but to offer a high impedance to high-frequency currents passing through it, besides partially short-circuiting them across the line.

(Turn to page 241)

QUALITY COMBINATIONS FOR RADIO SERVICING

THE NEW



LINE

Complete for Shop or Field

COMBINATION FREE POINT TESTER AND MULTIMETER MODEL 640-740

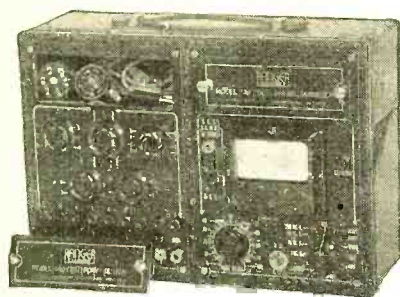

Model 640 Free Point Tester has 5 sockets. Panel includes eight automatic switch type and ten single action jacks.

Model 740 Volt-Ohm-Milliammeter Unit has a Triplett Precision instrument scale reading 10-50-250-500-1000 A.C. and D.C. volts at 1000 ohms per volt. 1-10-50-250 M.A.; low ohms 0-300; high ohms to 250,000 at 1.5 volts. Rheostat adjustment.

Case is same as for Model described opposite.
Dealer Price \$27.00

COMBINATION TUBE TESTER AND SIGNAL GENERATOR 440-540

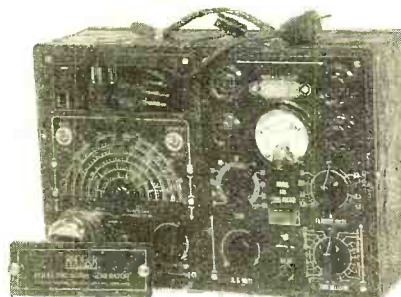

Model 440 Tube Tester checks all glass, metal and glass-metal tubes. Condition of tubes read directly on GOOD-BAD instrument scale while load values are applied. Circuit designed to indicate inter element shorts and leakages. Illuminated dial A.C. instrument for line volts adjustment. Shows when tester is connected to power supply.

Individually calibrated plug-in type coils in Signal Generator Model 540 set new standard for obtaining laboratory accuracy at low cost. See description for Model 557 Signal Generator.

The sturdy case is metal, with built-in compartments having snap-on covers for accessories finished in electro black baked enamel, panels in silver and black.

Complete with all batteries and two type 30 tubes and necessary accessories.
Dealer Price \$33.60

SENSATIONAL DEVELOPMENTS AT SENSATIONAL PRICES

DIRECT READING SIGNAL GENERATOR MODEL 557

The direct reading Signal Generator Model 557 has plug-in type coils. Five frequency bands from 110 to 20,000 Kc. All fundamentals. Each coil is individually calibrated by peaking with trimmer condensers. Accuracy less than 1% on all bands. Completely shielded. Attenuation and stability are outstanding features.

Supplied in black leatherette case. Silver and black panel.

Dealer Price \$18.00

Model 554-A—same as Model 557, but not direct reading. Calibrated graphs included for accuracies under 1% on any band.

Dealer Price \$14.40

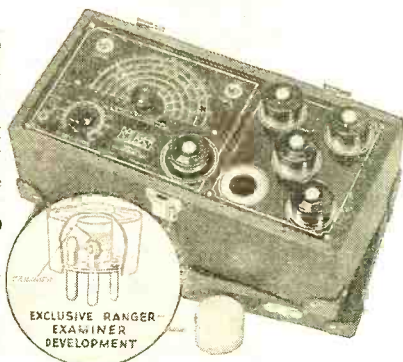

D.C. POCKET VOLT-OHM-MILLIAMMETER MODEL 735

Contained in sturdy black molded case with silver and black panel, rounded corners. Ranges are 15-150-750 volts; 1.5-15-150 M.A.; 1/2-1,000 low ohms; 0-100,000 high ohms at 1.5 volts. External batteries may be used for higher resistance measurements.

Has Triplett D'Arsonval precision instrument accurate to 2%. Selector switch for all ranges. Provides for all D.C. measurement requirements of the serviceman.

Size is 3" x 5 7/8" x 2 1/2" thick—is easily carried in the pocket, and handy for the laboratory.

Dealer Price \$10.80

ADDITIONAL COMBINATIONS

Model 540-740—Signal Generator and Multimeter. Dealer Price \$36.00

Model 440-740—Tube Tester and Multimeter. Dealer Price \$37.50



The new Ranger-Examiner line of radio test instruments is precision built throughout. All instruments have been designed and constructed for the utmost in compactness, in accuracy and durability. Compare these test instruments . . . Check their accuracy, note ease of operation and speed with which they can be used . . . See how light they are in weight . . . And then note the price.

Ask your jobber to show you the Ranger-Examiner line. Write for more complete information.



READRITE METER WORKS
1015 College St., Bluffton, Ohio

Please send Ranger-Examiner catalogue.

I am interested in more information on Model

Name

Address

City State

**NEW 1937
12 TUBE
HETRO
Super De Luxe
5 BAND RADIO**

**SAVE
OVER
50%**



**10 DAYS
FREE TRIAL**

- 15 Tube Efficiency
- 7-2100 Meters
5 Bands
- Metal Glass Tubes
Metal Tubes
- Exclusive Mono-Unit Coil Assembly Robot
Tuner
- AVC Electric Eye
- Variable Selectivity
- Beam Power Push
Pull Audio

We allow very large discounts. The extensive HETRO line offers real money-making opportunities. Write for your discount today.

—RUSH THIS COUPON—

**HETRO ELECTRICAL INDUSTRIES, Inc.
4611 Ravenswood Ave., Chicago, Ill., U.S.A.**

Without obligation on my part, send me your new FREE Booklet and complete details of your liberal 10-day FREE trial offer.

Name.....
Address.....



**AMERTRAN
TRANSFORMERS
GREW UP
WITH RADIO**

AmerTran helped pioneer in the development of audio transformers and has progressed with the best brains in the industry striving for quality sound reproduction. Witness today the unanimous opinion of technicians everywhere: *AmerTran quality results in clear, natural, dependable amplification under all circumstances.* Bulletin No. 1002 describes our complete line. It's free. Write

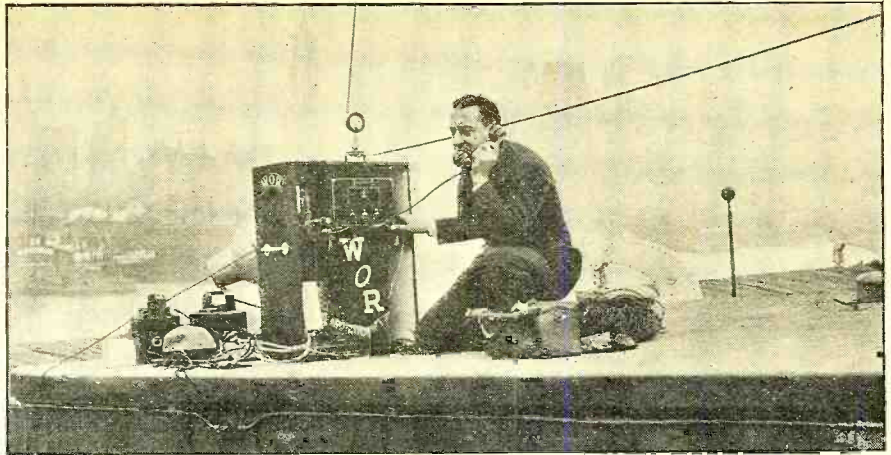

QRD? QRD? QRD?

CONDUCTED BY GY

RAUDIO communications today hail the approach of new facsimile services by which business men will send one another entire letters by telegraph, instead of terse ten-word telegrams, and in which social notes will speed through space to be received and delivered in the exact handwriting of the senders.

THE first demonstration of RCA's new facsimile service was made recently ultra-short-wave radio circuit connecting New York and Philadelphia. The circuit is unique in that it employs ultra-short radio waves, with automatic relay stations and enables the transmission of drawings, type matter, handwriting and other visual material in facsimile, along with the simultaneous operation of automatic typewriter and telegraph channels. It is a completely "secret" system. As Mr. Sarnoff, RCA executive said, "Having developed a technique of operation for the 3-meter band of radio wavelengths, we find in that region a medium of transmission unlike anything that we have ever known. . . . Now we find that the ultra-short-wave portion of the radio spectrum gives us a medium of almost unbelievable possibilities. We can not only send messages in facsimile as fast as present equipment will allow, but we can send two pictures simultaneously, and on the same radio channel we can also add two automatic typewriter channels and a telegraph channel. Of course, this means that we do all these things in both directions at the same time."

(Ed. note. We lose some of the beauty of this because we can't be surprised at anything any more.)

Ultra-short-wave "pick-ups" for remote transmissions to the broadcasting station now seems to be the thing! This should increase the demand for operators for field service. The photograph in our heading this month shows Charles Singer WOR Technician during such a pick-up from the S.S. *Manhattan*.

In a recent communication by Pres. Haddock of the ARTA, he stresses the fact that members' wives could be a great help. "This member's wife is even more militant than himself. It is my opinion that we must give more time toward members' wives and families, that this weakness may be eliminated from our organization, and with this in mind careful consideration should be given to organizing women's auxiliaries. While I feel that the People's Press, if adopted, by going into the home and being read by them will do much toward improving the family's knowledge of our organization, and thus place them behind our members in whatever action taken, it is not enough." Not a bad idea, but doesn't brother Haddock know that

the average wife of the member does not get the truth as to why a strike is called or whenever militant action is planned? If she did get the truth there wouldn't be any strikes in nine out of ten cases. The only way to get them to stand behind their husbands in any action is for them to receive the proper type of propaganda to incense them and then "Hell hath no fury like a woman sore."

A photograph that would have done the heart of a movie magnate good was the effects of the crash of the SS *San Simeon* with the SS *Dakotan* off Sea Girt, N. J., recently. Limping into port with the aid of the Coast Guard cutters, Galatea and the Pontchartrain, she had 11 feet of water in her holds. A terrific gaping wound on her port bow looked as though a 16-inch shell had hit her, but luckily no one was hurt or lost by the heavy impact of the *Dakotan*. The latter vessel was able to proceed on her way south.

Again affiliation of CTU-ARTA comes to the forefront with a lot of I-saids and You-saids being thrown from side to side between Pres. Powers of the CTU and Pres. Haddock of the ARTA. There are certain provisions in the constitution of the CTU and certain ethics which this organization states must be observed before an amalgamation could possibly take place and not afterwards, as Pres. Powers states. The latest communication between the executives of the two organizations does not completely sever relations but states that "affiliation should be postponed until such time that certain procedure in accordance with certain actions on the part of the ARTA is observed." We put our small voice into the discussion to enquire whether this is a personal matter between the executives or whether the rank and file of both organizations have been apprised of the actions being taken and are solidly behind each of their respective leaders. We personally hope that whatever is right will win and that discussions can be left for the insignificantly small details to be worked out in more leisure time.

The days of the pipe-smoking, heavy drinking, crouched-over-mill appearance of a newspaper reporter will be something of the past, with the request by Hearst Radio, Inc., for allocation of ultra-high-freqs. for the purpose of equipping news hawks on the job with portable equipment to keep in continuous communication with

City Editors by phone. The aura of secretive hurrying and scurrying for phone booths after something has happened will be replaced by some young chap, seemingly talking to himself in the middle of the street giving the info to his editor through a mike on his lapel! Ah, the progress of mankind from the "horse and buggy" days.

And now we again have our West Coaster broadcasting after a short absence. Says he, "That jobs have at last taken an upturn and indications are for many more to open . . . plenty of opportunities for trained men, no bluffers. Best bets for ops: practice on the old mill and read the latest books. . . . Well, look who is back with us again. . . . Mathison, former West Coast delegate of ARTA. He's back in the ARTA local at San Pedro and members there say he acts as adviser. . . . Delvin Eugene Axe, now with Pan American Airways at Alameda, married Joe Dockendori's sister, which makes two ops in one family. (Ed. note. Joe should not have permitted it. Think of the poor girl trying to keep peace in the family trying to side with her husband and pacifying her brother. What a diplomat she'll have to be).

You East Coast and Great Lakes and Gulf ops take notice: Being a member of one local does not mean that you have freedom of motion and can sail out of Los Angeles, for recently a member of S.F. and a member of N.Y. locals were both refused a clearance, even though the Steamship Co. and the Radio Service Co. wanted them on board "Ruth Alexander" and "San Pedro." Reason: Had not been around San Pedro local for 30 days, a rule passed by the San Pedro local to discriminate against members of other locals. So it appears that even though a member of one local, you cannot sail as you please. Isn't that curbing personal liberty and freedom as permitted by the laws of this nation? In other words, the San Pedro local has taken it on themselves to decide who shall and who shall not be allowed to sail, *EVEN THOUGH* a member of ARTA in good standing. We thought the unions were permitted under the Wagner act to exist in order to prevent discrimination by employers and raise standards of those in the professions. Wonder what the law says about acting thisaway against their *OWN* side. And how can 10 or 12 or 15 members meet in a union hall and pass such rules as to discriminate against the ones who are working, out at sea, and paying dues to support the chair warmers? And how can a delegate read the future and forecast what rules the union will pass at its next meeting? Well, well, and again well, brother ops, things have come to a pretty pass and it is about time some of you guys got up to make a statement . . . so with 73 . . . ge . . . GY.

Service Oscillator

(Continued from page 227)

terminals, which enable rapid stage-by-stage analysis. Also, extra clip terminals are provided for quick connection to screw terminals.

Entirely Portable

The above features and general design indicate careful consideration of the requirements of modern radio servicing. Battery operation makes it indispensable for auto radio servicing and, in other applications, its independence of a line voltage supply source makes for convenience and speed in handling.

EXPLORE THE SOUND BUSINESS ... THE NATIONAL UNION ★ WAY

Handle NATIONAL UNION Radio Tubes

AND EARN

FREE

SOUND SYSTEM

RADIO SERVICEMEN Are you familiar with the rapid strides made by the sound division of radio this year? Volume has grown enormously. There are outstanding profit-making opportunities for selling complete sound systems and renting sound systems. It is estimated that less than 10% of the radio service dealers are actually working on sound. Get a demonstration sound system the easy National Union Way. Here is an easy way to expand your business for sales, rentals and service.

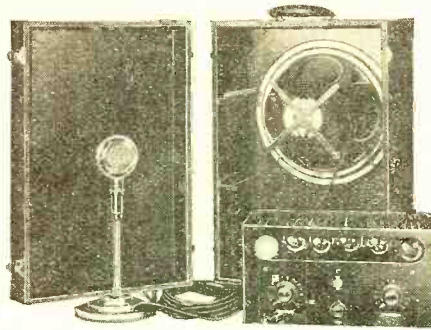

Model PA-417A



System includes 17-watt 4-stage amplifier, using 6 tubes, dual input mixing system, dual diaphragm crystal microphone, and 12" D.C. diamond speaker. System is complete, portable, operates on A.C. current. All accessories such as tubes furnished with system.

NATIONAL UNION RADIO TUBES

National Union manufactures a complete line of radio tubes in glass, metal and G-type. National Union's high quality has made them the outstanding favorite in the radio service profession. All sales policies have been formulated with the idea of making National Union radio tubes the ideal replacement tube for the radio dealer. This has been backed up with a selling program that means real support and help to the wide-awake dealer. Dealers and jobbers handling National Union radio tubes are the leaders in repair parts and service.

Let National Union Help You
Write for Information

OTHER NATIONAL UNION OFFERS

In **SOUND EQUIPMENT** items available include 17-watt portable system, 10-watt portable system, 6-watt portable system, phonograph pickup and turntable, etc.

In **SERVICE EQUIPMENT** items available include tube testers, analyzers, oscillographs, signal generators, modulators, meters, etc.

In **SHOP EQUIPMENT** items available include stock cabinets, coats, display signs, etc. All items absolutely free the National Union Way.

* The National Union Way makes the purchase of National Union radio tubes doubly profitable. Besides full protection on the highest quality radio tubes, each National Union tube purchased helps to earn free equipment. But, possession of the equipment is obtained at once with just a nominal cash deposit. (Deposit is rebated when required number of tubes have been purchased.) Over 50,000 completed deals with progressive radio dealers. Don't be misled. See your National Union jobber and get all the facts.

THE ROAD TO BETTER BUSINESS

1. Full guarantee on highest quality radio tubes.

2. Cut price business not solicited.

3. Price Protection.

4. N. U. jobber stocks are complete...No hunting for odd types.

5. Timely business building aids.

National Union Radio Corporation
570 Lexington Ave., New York City

RN 10-36

Free offer for Model PA-417A.

Free offer for

Dealer's Name

Address

City

State

THERE'S A GOOD JOB FOR YOU IN RADIO

We Will Train You Quickly to Qualify

The servicing of modern radio receivers requires experts—men trained for this work are needed everywhere.



FREE

OF EXTRA COST

This time-saving trouble-finder and circuit analyzer included.

RADIO OFFERS BIG OPPORTUNITIES

Your possibilities of making money are limited only by your ability and skill. There is no room for the soldering iron "guesser". But you must be trained—the sooner you begin the quicker you'll cash in.

LEARN AT HOME

We will train you at home to service and repair radio receivers of all types. Invest for future success in R.T.A. training.

NO EXPERIENCE NEEDED

You need no previous experience in Radio. We show you how to make money almost from the start. Hundreds of men are enjoying the rewards of R.T.A. training.

Full details of this great opportunity **FREE** are explained in a helpful book that is

Send for it today. It will be mailed at once.

RADIO TRAINING ASS'N. OF AMERICA
Dept. RN610 4525 Ravenswood Ave., Chicago



noise-filtered radio
MADE POSSIBLE WITH

NOISE-MASTER
ALL-WAVE ANTENNA

CORWICO Static is the undesirable element in radio reception, as dirt and dust are the impurities of water and air. "Man-made" static and other extraneous noises are effectually "strained out" by the scientific "NOISE-MASTER" Antenna, which improves reception on both shortwave and broadcast bands. Set owners, let "NOISE-MASTER" give you a new conception of PURE reception!

"NOISE-MASTER" No. 14 list price **\$6.75**
Amy. Aeves & King patented. Brings in overseas signals stronger, and eliminates "man-made" static on broadcast as well as shortwave band. For better reception in EVERY location.

"NOISE-MASTER" No. 18 list price **\$3.40**
First time at this popular price; licensed Amy. Aeves & King antenna of simple doublet type. SELF-SELECTING, recommended for clarifying shortwave reception.

"NOISE-MASTER" No. 19 list price **\$4.30**
SELF-SELECTING doublet type. Amy. Aeves and King licensed, with junction-box in the antenna line. Assures excellent all-wave reception.

Service Men: Use "NOISE-MASTER" on your next job!

CORNISH WIRE CO., Inc.
30 Church Street New York City

The RADIO WORKSHOP

Items of interest for beginners, experimenters and radio constructors.

Conducted by The Associate Editor

A New Aid for Tuning Transmitters

The "Senco Tuning Wand," made by the Sundt Engineering Co. is a narrow tube filled with neon gas which will glow with more or less brilliancy as a tuning circuit is adjusted for resonance. It should find special favor among "hams" because of its physical shape. It is ½ inch in di-

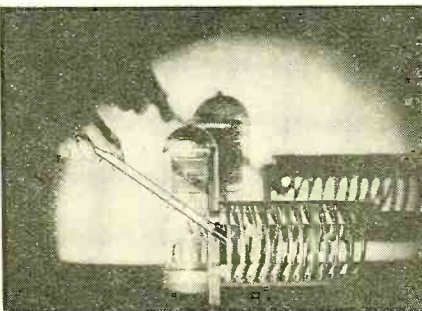

ameter by 10 inches long—long enough to determine r.f. voltage conditions in inaccessible parts of the transmitter. It is safe because the caps are made of heavymolded bakelite thus insuring protection against shock or burns.

New Tool of 1001 Uses

Something entirely new in a small motor-

driven hand tools is the Chicago Wheel & Mfg. Company's "DeLuxe Hand-ee Grinder" shown in the accompanying illustration with its assortment of accessories that can be used to grind, drill, cut, carve, sand, saw and engrave on a host of different materials. Experimentors and home shop-workers of every kind will welcome a tool of this type as its uses are limited only by the imagination.

It weighs only 12 ounces, operates from either 110 volt a. c. or d. c. line supply turns at 25,000 r. p. m. and features an interchangeable spring-collet wrenchless chuck, patented S-type switch protective sleeve, etc.

While the illustration shows 26 different accessories there are over 200 different mandrels, saws, brushes, shanks and mounting wheels available. The illustration shows how the tool was employed to saw a hole from an aluminum shield base also how a veining router bit was used for engraving.

Handy Tuning Knob Kink

The sketch shows a 2¼ inch diameter knob which I use in place of the ordinary knob on a vernier dial on a short-wave set. Attached to such a dial, the large knob provides still finer vernier action and it does not cramp the fingers during a long hunt for short-wave stations. The two

Be a TELEVISION EXPERT

LEARN TELEVISION with RADIO-NOW!

Great opportunity for experts in this amazing new industry. Recent developments in radio make television a certainty NOW. We teach you by our "on the job" method Radio and Television from beginning to end in our marvellously equipped labs and studios. You actually operate thousands of dollars worth of expensive equipment. You get expert instruction and skillful guidance by radio-television specialists.

Demand for Television Experts

Television now perfected and ready for the market ON THE NEXT BIG BUYING WAVE. Business leaders predict new system television will require thousands of relay and broadcasting stations. Ultra-short waves will permit eighty thousand television stations in America alone.

GET IN NOW and "build up" with the world's next billion-dollar industry.

6 MONTHS THOROUGH PRACTICAL TRAINING

Qualifies for radio phone license (1st Class). Complete up-to-the-minute training on modern "workable" television equipment including the new cathode ray. Practical experience in studio control room. Transmitter operation of Television Station WJX.M. Employment aid while training and upon graduation. Write for free book "Pictures On the Air" NOW!

S. Q. NOEL, Pres. First National Television, Inc.
Dept. D-10 Power & Light Bldg., Kansas City, Mo.
Without obligation, send me postpaid FREE Illustrated Book—"Pictures On the Air", telling about new opportunities in television. I am 17 years or older.

Name _____
Address _____

JOHNSON UNIVERSAL REPLACEMENT TRANSFORMER

Guaranteed equal to original. First-quality, new stock, correctly engineered and carefully made by skilled workmen.
Radio & Neon Transformers Rebuilt
Quality work fully guaranteed. Jobbers, Dealers, Servicemen. Save money with Johnson Universal Replacement and Rebuilt Transformers. FREE! New 8 Page Catalog and low Price-List. Write Today.
JOHNSON TRANSFORMER CO.
2206 N. Western Avenue Chicago, Illinois.



Cash for Kinks

EVERY experimenter, from time to time, works out some simple idea or kink that could be profitably passed along to his fellow experimenters through the "Radio Workshop", a department which caters especially to the exchange of such ideas. Send your ideas to the Workshop Editor, and wherever possible include a simple but clear drawing or a photograph. All ideas published will be paid for at regular space-rates.

small brass balls allow the dial to be quickly turned from one end of the scale to the other. Single and double brass knobs were both tried but the use of two was found best.

The knob is made up of two pieces of 3/16-inch bakelite from an old panel; the brass knobs hold both pieces together as one piece is drilled to clear a 6-32 thread while the rear piece is tapped for the 6-32 threaded ends of the brass knobs. While

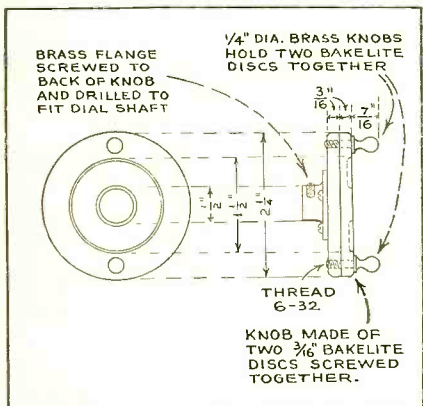

a lathe could be used to real advantage to turn up the bakelite discs, by careful work in sawing and filing and mounting upon a rod held in the chuck of a hand drill for finish turning, this work can be done by hand. A brass flange was turned up, drilled for the shaft and screwed to the rear of the disc.
H. H. PARKER,
Los Gatos, Calif.

Flexible-Shaft Screwdriver

Radio constructors, servicemen and experimenters will welcome this new Commonwealth Products Co.'s flexible-shaft screwdriver that actually goes around cor-

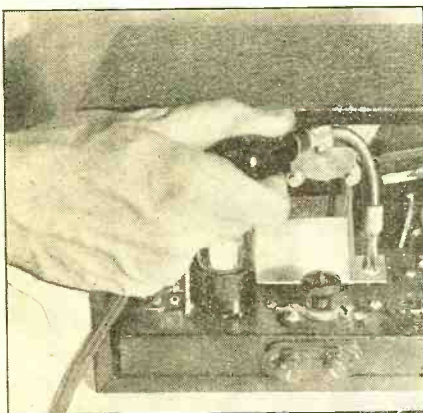

ners and is particularly suitable for use in those hard-to-get-at places. The shaft is made of a coil of heavy laminated steel wire and the blade from tempered steel. Its overall length is 8 inches.

PLUS POWER PLUS APPEARANCE PLUS ECONOMY



60 WATT ... 4 POSITION AMPLIFIER

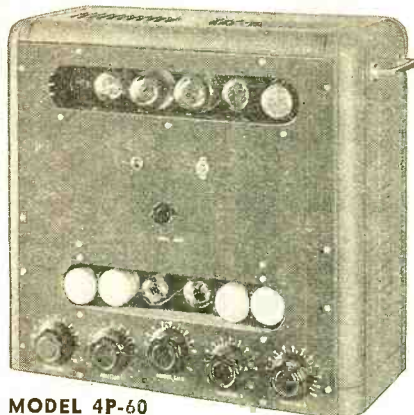

USING NEW 6L6 TUBE MODEL 4P-60

- 60 Watts Undistorted Output
- One to Four position Input
- High Gain 143 db.
- Handles one to 10 Permanent Magnet Speakers.
- Tapped Output Impedance
- Uses 4-6C6, 2-6A6, 1-76, 1-6E6, 2-6L6, 1-83, 1-5Z3 (furnished).

WEBSTER-CHICAGO manufactures a complete line of synchronized public address systems, sound equipment amplifiers and accessories of all kinds.

MODEL 4P-60

FULLY LICENSED STRICT DEALER POLICY TIME PAYMENT PLAN

See Your Jobber or Write

WEBSTER-CHICAGO engineers have designed this extraordinarily powerful amplifier in compact, sturdy, attractive cabinet. The 6L6 is an audio amplifying tube, using the newly discovered beam principle of controlling electronic emission. Properly handled, this tube develops a new order of amplification. Think of a sound system having 60 watts undistorted output and yet the amplifier being no larger nor weighing any more than many amplifiers that heretofore developed but one-half or less power. As you would expect, the economy is in proportion too. You will want to learn more about P. A. systems with this Webster-Chicago development. It opens up new possibilities for all sound dealers or engineers. The development of this amplifier is again proof of Webster-Chicago leadership in this fast moving field. Sound dealers and engineers are urged to visit displays at Webster-Chicago jobbers.

Webster-Chicago
Section 0-6,
3825 W. Lake St.,
Chicago, Ill.

Please send me more information on Model 4P-60

I am also interested in

Name.....
Address.....
City..... State.....

TRIAD

THE QUALITY NAME IN RADIO TUBES

TRIAD MANUFACTURING CO., INC. PAWTUCKET, RHODE ISLAND

"COSMAN 4"

5 Band Switch Type Receiver

- No Plug-in Coils
- Continuous Band-spread
- Uses 2 New Metal Tubes
- Dynamic Speaker

Just the receiver for the "Ham", or short wave enthusiast. Incorporates all recent developments in its design. Provides a continuous tuning range of from 15 to 550 meters. NO SKIPS. Uses 2-6K7's, 1-43 and 1-25z5 tubes. Absolutely no plug-in coils are required for operation. Simply throw switch to any desired band.

Complete kit of parts with instructions, less tubes and cabinet..... **\$10.50**
 Wiring and Testing..... **2.25**
 Set of Matched Sylvania Tubes..... **2.25**
 All Metal Crystallized Hinged Cabinet..... **2.25**

IMPROVED "SCOUT" One- and Two-Tube Battery S. W. Receivers

Here we present an entirely new version of the famous Scout one and two tube Receivers. The one tube model now makes use of a type "10" dual element tube whose characteristics are similar to two separate tubes. The two tube model uses 1-1A4 and 1-33 tube and has sufficient power output to drive a loudspeaker at ordinary room volume on local stations. Both models furnished with 4 plug-in coils which tune from 15 to 200 meters.

ONE TUBE "SCOUT"		TWO TUBE "SCOUT"	
Complete kit of parts including picture and schematic diagram.....	\$2.95	Complete kit of parts including picture and schematic diagram.....	\$4.25
Matched Sylvania 19 tube.....	.55	Matched set of Sylvania Tubes.....	1.39
Wiring and testing.....	1.00	Wiring and testing.....	1.25
Set of batteries.....	1.39	Set of Batteries.....	2.28
200-550 meter broadcast coil.....	.29	200-550 meter broadcast coil.....	.29

"Buddy Two" A.C.-D.C., S.W. Receiver

Operates on either A.C. or D.C. Makes use of 1-6L7 METAL TUBE, and 1-12A7 as a combined rectifier and pentode output tube. Furnished with four plug-in coils which tune from 15 to 200 meters. Additional coils to extend the tuning range of the "Buddy" down to 9.5 meters and up to 2000 meters are also available.

No. B2U Complete kit of parts for "Buddy 2" receiver, less tubes and cabinet..... **\$4.50**

Wiring and Testing, Extra..... **\$1.25**
 Set of Matched Sylvania Tubes..... **1.50**
 Crystallized Metal Cabinet..... **.95**
 Extra Set of Coils, 0 1/2-21 and 200 to 2000 Meters..... **1.75**

TRY-MO RADIO CO., Inc., 85 Cortlandt St., N. Y. C.
POWERTONE ELEC. CO., Inc., 179 Greenwich St., N. Y. C.

TUNG-SOL DEALERS
make money
WITHOUT INVESTING A CENT

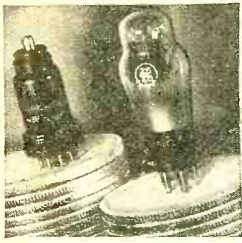

The Tung-Sol plan was the first and is today the only nation-wide consignment plan for selling radio tubes. It has been successful because Tung-Sol dealers carry adequate stocks of tubes which build customer satisfaction, and make full profits on their sales.

There are still desirable locations where independent service organizations who can meet requirements may be appointed as agents. Ask your nearest Tung-Sol wholesaler.

TUNG-SOL
Tone-flow radio Tubes.
TUNG-SOL LAMP WORKS, INC.
Radio Tube Division
NEWARK, N. J.

HANDEE
Tool of 100 Uses

Does away with slow hand work. Plugs in any light socket, A. C. or D. C. 110 v. 13,000 r. p. m. For home, shop or tacketojob. Uses 200 different accessories... grinds... polishes... routs... drills... cuts... carves... sands... saws... sharpens... engraves.

Order on our Ten-Day Money-back Trial... or send for FREE Catalog.

\$10.75

And up Postpaid, 3 accessories FREE. Send order today. Chicago Wheel & Mfg. Co., 1101 W. Monroe St., Dept. AB, Chicago, Ill.

New CRAFTSMAN Project Book
"Pleasure and Profit with a Handee." Easy working plans for making many interesting and unusual projects. 25c, stamps or coin.

You, too, Can become
a RELIABLE SPEED RADIO OPERATOR

(LEARN AT HOME)

Learn Code From Beginning or increase your code speed scientifically with the system that trained the champions. Obtain your Amateur or Com'l Ticket easiest and best way. Send for FREE BOOK OF FACTS! Answers all questions and gives valuable information. No obligation.

CANDLER SYSTEM CO.
Dept. N-10, Asheville, N. C.

FREE

T. R. McELROY
WORLD'S CHAMPION RADIO TELEGRAPHER
23 Bayside Street, Boston, Mass

MAC KEY @ \$7.95 a real speed key
MAC KEY DELUXE @ \$15.00
MAC CORD @ \$1.00
MAC CASE @ \$3.95
MAC OSC @ \$3.95 ac-dc oscillator, Tone control.

If u hv Mac Key wri me 'o xmy ipt & dsrb ifn.
All my stuff emcy god best pduts obl. 73 Mac.

The DX Corner
(Short Waves)

(Continued from page 224)

ported heard (Betances). Station slogan: "La Voz Catolica".

HIH, Trujillo, D. R., has moved to 6780 kc., from 6796 kc., according to Observer Oxrieder.

HRN, Tegucigalpa, Honduras, 5910 kc., heard irregularly 8 to 10 p.m., E.S.T. (Stabler).

YNLF, Managua, Nicaragua, 9560 kc., 1 kw., reported heard 6 to 10:30 p.m., and on Sundays at 8:15 a.m., E.S.T. (Sahlbach, Betances, Partner).

South America

A NUMBER of changes in frequency and schedule among the South American stations makes the following data valuable. Anyone who understands Spanish can render a valuable aid in concentrating on logging the Spanish and Portuguese-speaking South American short-wavers.

HJ1ABB, Barranquilla, Colombia, has increased power and moved to 6120 kc., with the same schedule till 11 p.m., and a special broadcast from 12 midnight to 1 a.m., E.S.T. (Partner). Observer Betances says they have moved to 6135 kc.

HJ1ABE, Cartagena, Colombia, 9550 kc., transmitting with a new 1 kw. transmitter, heard 9 a.m. to 10:30 p.m., E.S.T. (Partner, Sahlbach, Pilgrim). Observer Atherton says the frequency is 9500 and he hears them 7:30 to 9:30 p.m., E.S.T. Station address: P.O. Box 31, Cartagena, Colombia.

HJ1ABA, Barranquilla, Colombia, 9540 kc., reported heard 11 to 12 p.m., E.S.T., Saturday and announcing HJ1ABA and HJ1ABB. (Schamleffer). Station slogan "La Voz de Barranquilla." We believe this is really Station HJ1ABB as in the previous paragraph.

HJ1ABG, Barranquilla, Colombia, 6045 kc., or 6042 kc., is now transmitting with increased power daily 11 a.m. to 11 p.m., and Sundays, 11 a.m. to 8 p.m., E.S.T. (Amos, Partner).

HJ1ABP, Cartagena, Colombia, 9600 kc., heard as per Time Table (Partner, Sahlbach, Howald, Flick, Pickering).

HJ2ABC, Cucuta, Colombia, now transmits on 9570 kc., with the same schedule as before (Partner).

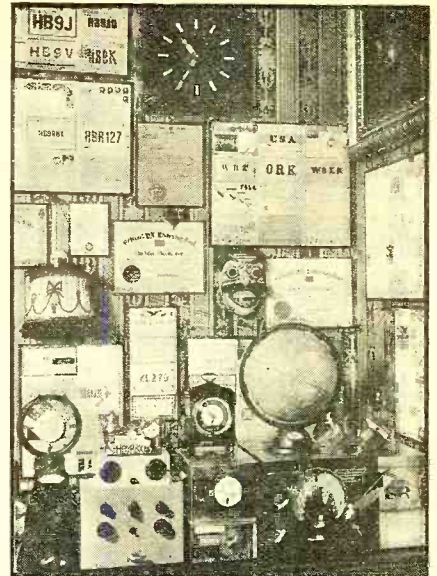

A SWISS DX CORNER

This is the latest photograph of Observer Dr. Max Hausdorff's Listening Post at Lugano-Viganello. He is an Official Observer for RADIO NEWS. He uses a Midwest receiver.

HJ3ABD, Bogota, Colombia, 6050 kc., now goes off the air at 12 midnight (Williams).

HJ3ABX, Bogota, Colombia, is reported heard on 6120 kc. (Smith).

HJU, Bogota, Colombia, 9510 kc., heard 8 to 11 p.m., E.S.T. (Pickering, Howald).

YV7RMO, Maracaibo, Venezuela, 6070 kc., reported heard 6 p.m. to 12:05 a.m., E.S.T. (Partner).

YV6RV, Valencia, Venezuela, 6520 kc., reported heard 11 a.m. to 2 p.m., and 5 to 10 p.m., E.S.T. (Fallon).

YV9RC, Caracas, Venezuela, 6400 kc., reported heard (Vassallo). Station address: Radiofusora YV9RC, Gonzalo Veloz, Caracas, Venezuela. Station slogan: "Ondes Populares."

OAX4G, Lima, Peru, 6230 kc., heard 7 to 10 p.m., E.S.T., increasing power to 2 kw., during the month of August (Deater).

O4AR, Lima, Peru, 14598 kc., reported heard 6:30 to 7 a.m., and 4:30 to 5 p.m., E.S.T. (Potthoff).

PRF5, Rio de Janeiro, Brazil, 6501 kc., reported heard 4:45 to 5:45 p.m., E.S.T. (Hartman, Alfred).

PZH, Paramaribo, Dutch Guiana, 6990 kc., reported heard Tuesday and Thursday, 8:30 to 10 a.m., and Saturday until 2:30 p.m. (Daily).

PZ1AA, Paramaribo, Dutch Guiana, 14 mc., 25 watts, is an experimental station heard by Observer Seright.

CEC, Santiago, Chile, 10670 kc., reported heard 7 to 7:15 p.m., Tuesdays and 8 to 10 p.m., on Sundays. (Partner, Schamleffer, Hartman).

VP3MR, Georgetown, British Guiana, 7080 kc., reported heard irregularly 8 to 10 p.m., E.S.T. (Stabler).

LSX, Buenos Aires, Argentina, 10350 kc., reported heard Tuesday 9 to 11 p.m., E.S.T. (Messer, Hartman).

LRX, Buenos Aires, Argentina, has changed frequency to 9660 kc., heard (Turn to page 240)

MASSACHUSETTS HEARD FROM
This is the compact apparatus of Listener Queen of Dorchester, Massachusetts

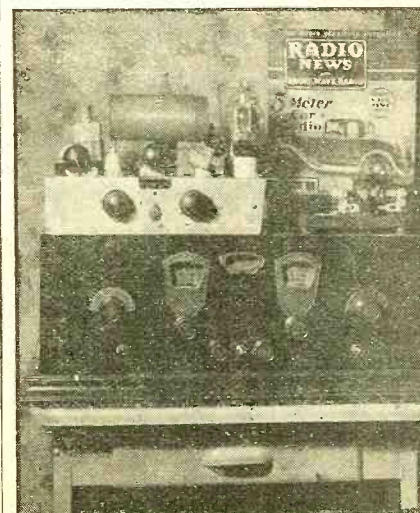

20,000 ohms per Volt!

**THE NEW
WESTON**
MODEL 772
*Super-sensitive
Analyzer . . . with*

sensitivity of 20,000 ohms per volt . . . PLUS resistance ranges readable up to 30 megohms PLUS current indications as low as .5 microampere



Model 772 is furnished mounted in a durable, brown leatherette carrying case, with plenty of room for tools and accessories.

PRICE \$ **46⁵⁰**
NET
TO DEALERS IN U. S. A.
(carrying case included)

Unequaled for radio testing...
essential when television comes!

Check all these features of Model 772 . . . then make your own comparison:

1. SENSITIVITY... 20,000 OHMS PER VOLT!
... for the first time, WESTON gives you the sensitivity you must have to best analyze any receiver circuit, old or new . . . especially those involving A.V.C., noise suppressor circuits, tone fidelity control, etc.

2. A BIG, ULTRA-SENSITIVE WESTON METER!
... a big, standard WESTON super-sensitive meter, with a large, easy-to-read scale with widely spaced markings. Big value alone in the meter!

3. TRUE VOLTAGE READINGS
... with this ultra-sensitive meter, plate voltages in resistance coupled circuits, grid bias and other DC voltage measurements can be made with certainty . . . for so little current is drawn by the meter that readings will not be greatly in error as is the case with less sensitive instruments.

4. THE ULTIMATE IN CURRENT MEASUREMENT!
... with Model 772, you can measure current far below present limitations. Currents

of 10 or even 5 microamperes coming from the diodes can be accurately measured. Also cathode ray tube and photo-cell currents.

5. RESISTANCE MEASUREMENTS MADE EASY
... Model 772 provides a readable deflection as high as 30 megohms, with the high resistance values above 1 megohm sufficiently spaced out to permit an accurate check on all resistors in common use. The increased deflection at high resistance values gives a more critical check for condenser leakage.

6. DESIGNED FOR RAPID USE
... a convenient system of pin-jacks, along with a rotary switch, permits rapid changes of range and function for AC and DC measurements, and for use as a sensitive output meter. Separate jacks for the 1 M.A. and 100 microampere ranges protect the instruments from accidental damage. Can be used with WESTON Socket Selectors. Precision resistors used throughout. Built to WESTON'S unequalled standards of quality and workmanship.

7. WIDER RANGE OF USEFULNESS... INCLUDING TELEVISION
... with Model 772 you will also be equipped for servicing sound movies, amplifiers, photo-cell circuits and any circuit where current is small, even down to 1/2 microampere—as well as for television. WESTON has already built the instruments for television broadcasting, so Model 772 was designed to include television servicing.

8. PRICE \$46.50 net... INCLUDING CARRYING CASE
... never before, has value of this kind been offered to the serviceman. WESTON provides it because of their large production on sensitive, quality instruments which are universally used by laboratories, and throughout industry. Investigate Model 772 today . . . before you buy any analyzer. See it at your jobber's . . . or, return coupon for complete data . . . Weston Electrical Instrument Corp., 615 Frelinghuysen Avenue, Newark, New Jersey.

REMEMBER . . . YOU CAN'T SERVICE TELEVISION WITHOUT 20,000 OHMS PER VOLT!

WESTON

Radio Instruments

-----MAIL THIS COUPON TODAY-----

WESTON ELECTRICAL INSTRUMENT CORP.
615 Frelinghuysen Ave., Newark, N. J.

Rush me complete data on the new Model 772 Super-Sensitive Analyzer.

Name _____

Address _____

City _____ State _____

NEW WRIGHT-DECOSTER 12" NOKOIL Speaker



Model 982

The permanent magnet used in the Model 982 furnishes a field comparable to the electro dynamic units.

- Universal Transformer
- Para-Curve Diaphragm
- Impressive Appearance
- Draws no Current
- Electro Dynamic Performance

List Price \$9.82

The extreme sensitivity of this reproducer makes it adaptable to all types of battery sets. The demand for this unit has already been created and at the price it is destined to be one of the fastest selling items the radio industry has ever had.

Write for complete catalog and name of nearest distributor. Wright-DeCoster distributors are always anxious to cooperate.

WRIGHT-DECOSTER, Inc.
2255 University Ave., St. Paul, Minn.

Export Dept.: M. Simons & Son Co., New York
Cable Address: "Simontrice"

Canadian Office: Wright-DeCoster, Inc., Guelph, Ont.



E. H. RIETZKE

PRES. OF CREI

ARE YOU KEEPING PACE WITH RADIO?

CREI Practical Radio Engineering Insures Your Future By In- creasing Your Technical Ability

You must be alert to Radio's ever-changing, advancing methods. **Technical Training NOW** insures your professional future and means that you will be ready to step into a better job ahead of others. Radio isn't satisfied with satisfied men . . . but, if you're ambitious and realize the rewards that specialized training offers . . . then CREI can help you as it has helped others to top positions in the Radio industry.

"Invest" One Cent Now . . . Write Today for FREE Illustrated Catalog

It explains our home study courses and the one year Residence Course (new term Sept. 21) and shows easy terms you can afford. Your inquiries invited.

CAPITOL RADIO ENGINEERING INSTITUTE

Dept. RN-10

Washington, D. C.—14th & Park Road
New York City—29 Broadway



TRI-JAY BI-PASS CONDENSER GUARANTEED

Full Capacity—No Leakage—Full Voltage
FREE TO JOBBERS AND DEALERS

Send for TRI-JAY SAMPLE CARD containing 3 condensers and descriptive literature. Sent to SERVICE MEN on receipt of 10c to cover mailing. WRITE TODAY.

TRI-JAY PRODUCTS CO.
4440 Elston Ave. Chicago, Ill.

To Radio NEWS
a S.W. Radio

ARRL
14400 KC
28000 KC }

JUN 2 1936

H. E. J. Smith

Ex-CT 2BK
c/o Standard Oil
Co. of Bolivia
La Paz

This station acknowledges all reports

CP1AA

CC 20 watts

Confirming QSO of193 atE. S. T

YourMC ^{CW} Fone was QSART

Next Month

The DX Corner (Short Waves)

(Continued from page 238)

5 to 9 p.m., E.S.T. (Atherton, Pilgrim, Deater, Mascarenhas, Partner).
LRU, Buenos Aires, Argentina, 15290 kc., reported heard 7 a.m. to 4:45 p.m., E.S.T. (Partner).

Oceania

VK3LR, Lyndhurst, Australia, 9580 kc., heard 7 to 9 a.m., E.S.T. (Howald, Wolf, Kemp).

Radio Oceania, Papeete, Tahiti, 10070 kc., heard testing irregularly (Smith).

KKP, Kahuku, Hawaii, 16030 kc., has replaced KKH, on the special C.B.S. Broadcasts to the United States, heard 11:30 to 12 midnight, E.S.T. (Favor, Partner).

Readers Who Are Awarded "Honorable Mention" for Their Work in Connection with This Month's Short-Wave Report

George G. Jones, Matthew Bills, H. Kemp,

AN AMATEUR QSL CARD
Mr. Smith, the owner and operator of amateur station CP1AA, sends us a sample card and states (as one can easily read) that his station acknowledges all reports. Come on, fellows, let him know you hear him.

Robert Muguet Edward DeLaet, Oliver Amlie, David B. Wentz, Mike Janyon, James E. Ostergren, Eric Butcher, Ben Boucher, Fred W. Alfred, Wilbur Croston, S. P. Shotam, Peyton B. Black, E. Geneve, Edward R. Greaves, P. Piorko, J. J. Kolibonso, Russell M. Balland, Harry Wolf, J. F. Carville, Harry J. Potthoff, Jack Knapp, Fred Cox, J. Wendell Parmer, D. E. Scala Jr., Reeve Owen, R. F. Shamleffer, Kenneth Dressler, Thomas P. Jordan, Sahlbach, Fred Atherton, Flavio C. Mascarenhas, W. E. Frost, Miss Lilly Elsner, Bernard L. Ahman, Jack Staley, Tom Mechling, Fred A. Pilgrim, Rudolph Koether, Earl P. Hill, Murray Buitenkant, Ed McKay, Werner Howald, James L. Davis, Louis Herwath, Harold H. Flick, Byron Silvius, A. W. Quinn, Stabler, Fletcher W. Hartman, G. W. Dixon, N. C. Smith, Manuel Betances, Vic Seright, Albert Faber, G. Hampton Allison, John Hartshorn, R. Messe, Edgar J. Vassallo, Thomas Fallon, Jr., Albert Pickering, J. Rodriguez R., Augusto Anca, G. E. Gonzalez F., Gilbert L. Harris, J. T. Atkinson, Roy E. De Ment, John C. Kaimbach Jr., Harold Flick, Harold E. Schrock, E. J. Dailey Jr., Anton J. Cindel, Melton Amos, Albert Augustine, L. E. Williams, W. C. Robertson, Joseph V. O'Connell, R. C. Messer, Charlie E. Hansen, G. C. Gallagher, Glen Deater, Jerry M. Hynek, John Boehm, H. Westman, Joe Miller, Isaac T. Davis, Carl Scherz, L. C. Styles, H. Mallet-Verale, Frank Andrews.

The DX Corner (Broadcast Band)

(Continued from page 219)

Zealand, writes that the New Zealand Broadcasting Board is being abolished. There will be a Minister for Broadcasting together with an Advisory Council. The "B" Class stations will be subsidized and the Government will control special commercial stations for radio advertising. The press is vigorously opposing the latter idea, anticipating that expenditures for radio advertising will cut down the revenue of the newspapers.

It will be interesting to note the developments in New Zealand under this new system which represents a cross between the British and American systems.

Notes from Readers

Observer DeLaet, (Dayton, Ohio): "H1J, Santo Domingo will soon have a new 250 watt transmitter. LKJ1, Jelyo, Norway is to have a new 25

kw. transmitter. SM5SD, Stockholm, Sweden, is increasing its power to 300 watts."

Observer Pick, (Leipzig, Germany): "Graz and Linz both operate on 886 kc. Linz uses 15 kw. and was formerly on 1294 kc. Two new Czechoslovakian stations are planned in place of Prague II and Brno. Power will be 100 kw. and it is likely that new frequencies will be assigned. Uzhared will be the location of another 100 kw. Czechoslovakian station."

Observer Winkley, (Hughson, California): "KFAC, 1300 kc., 1 kw. presents Bill Ellis (another Californian Observer) every Monday night from 10:05-10:30 P.S.T. His DX talks are always interesting and educational." Observer Winkley writes further: "In a letter received from 4WK, a 50-watt station in Warwick, Australia, they state that I am the only person in America to report reception of their broadcasts. I have only heard the station once but that was enough to obtain a verification."

Observer Watson, (Christchurch, New Zealand): "The new transmitter

of 2YA will be rated at 60 kw. and is expected to be on the air by the coming December. The new antenna rises to a height of 730 feet and is said to be the tallest structure in the Southern Hemisphere."

Observer Crowley, (Rochester, New York): has 923 stations listed in his log and of this number 434 have been verified. Among these are the following:

British	Logged—12	Verified—9
German	Logged—7	Verified—5
French	Logged—8	Verified—4
Australian	Logged—5	Verified—2
Argentine	Logged—2	Verified—1
Belgian	Logged—1	Verified—1
Austrian	Logged—1	Verified—1
Italian	Logged—1	Verified—1
Total:	37	24

Observer Roy Covert, (San Francisco, California): "The regular DX broadcast over KGGC, 1420 kc. has been shifted to 12:45 a.m. E.S.T. to avoid conflict with the KFI DX broadcast. Under the name "The Good Ship DX", the KGGC broadcasts are dedicated to the Radio News DX Corner.

Observer Botzum, (Reading, Penna.): "XEP, Savoz, Pan Americana, 1160 kc., 5 kw., broadcasts every Sunday from 2-4 a.m. E.S.T. from the "Nite Club de los Tecolotes." They sent me a nice verie card and also a membership card in the night club from which programs originate.

Observer Hunt, (Encinita, California): "Going into the 1935-1936 DX season I found myself with 43 verifications from stations at a distance of 5000 miles or more. The only DX'ing of the season was an attempt to run the 5000 mile verifications to 50, this was accomplished by DX'ing twice in January and three times in (Twin to page 246)

Radio Physics Course

(Continued from page 232)

The result is shown by the graph in Figure 1. The frequency is plotted along the horizontal axis, increasing toward the right. The current is plotted vertically. This is sometimes called the *transmission curve* of the filter, for it shows how the filter transmits current through the circuit. Notice that at low frequencies the current is strong since the filter passes it easily. The shaded portion of this graph shows the frequency range over which the filter easily passes current. Above the cut-off point the current is low, because the inductor presents a high impedance to the flow of these currents through it, and the condenser plates acts as storage reservoirs for these currents during each cycle, thereby shunting them from the load circuit.



"SUPER-PRO'S" ACCLAIMED

The Hammarlund "SUPER-PRO", since introduction, has been acclaimed by amateurs and professionals in every corner of the world for its remarkable performances. Of its effectiveness, the plant supervisor of WOR, Charles Singer, says, "The 'SUPER-PRO' . . . operating in our immediate 50,000 watt field . . . exposed to an R.F. field from WOR of 10 cr more volts. Able to tune in all broadcasting stations between 500 and 1600 kc. . . no inter-channel interference. On SW, pre-selection enough to pick up all foreign

and local stations with 5 and 10 kc. separation from our harmonics. Followed Queen Mary from dock in England to N. Y. Only receiver of many tested that performed so well in our immediate transmitter field."

Among the "SUPER-PRO" exclusive features are electro-statically shielded input; air-tuned I.F.'s; silver plated precision 5-band switch; continuously variable selectivity; high fidelity; direct, accurately calibrated dial; band spread tuning and variable crystal filter.

Write Department RN-10, today, for full details
THE HAMMARLUND MANUFACTURING COMPANY, INC.
 424-438 West 33rd Street New York City

HAMMARLUND'S 25TH YEAR

New . . . UTC UNIVERSAL BEAM POWER AMPLIFIER KITS . . .

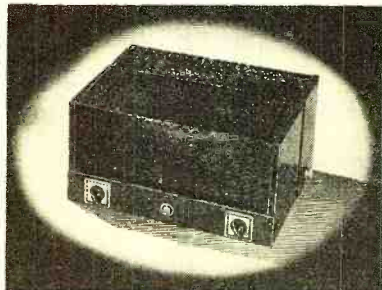

* **PAK** amplifier kits feature: Power output, 35 watts self bias, 55 watts fixed bias; gain 118 DB, immediate change-over to 95 DB; separate power supply and audio decks; stabilized feedback; mobile operation with genemotor—20 watts output; provision for electron mixer or low impedance input if desired.

* See pages 143, 175, of last month's issue of Radio News.

For more complete data, prices and circuit details, write for the new PAK amplifier bulletin.

UNITED TRANSFORMER CORP.

72 SPRING STREET NEW YORK, N. Y.
 EXPORT DIVISION: 100 VARICK STREET NEW YORK, N. Y. CABLES "ARLAB"

Save Money By Subscribing Now!

For the first time in years, we offer our readers two years of RADIO NEWS for only \$3—a saving of 50% over the regular newsstand cost of 24 issues! (Canada and Foreign \$4.) Think of it! You save \$3 by placing a subscription and sending it now! If you are already a subscriber, we will extend your present subscription. This offer cannot be held open much longer—so send in your remittance today!

RADIO NEWS

Dept. 3610A 461 Eighth Ave., New York, N. Y.

Send QSL card or 10c for Technical Data Sheet 536
 Aladdin Radio Industries, Inc.
 466n W Superior St.
 Chicago, Ill.

BIGGER AND BETTER

That's RIDER'S VOLUME VII

It will have

- 1600 PAGES more than ever before
- MORE COMPLETE SERVICING DATA than ever before
- MORE CHANGES than ever before
- MORE MANUFACTURERS than ever before
- SERVICE DATA ON 1936-1937 SETS announced up to November, 1936



AND A COMPLETELY REVISED INDEX COVERING ALL SEVEN RIDER MANUALS PRICE \$10

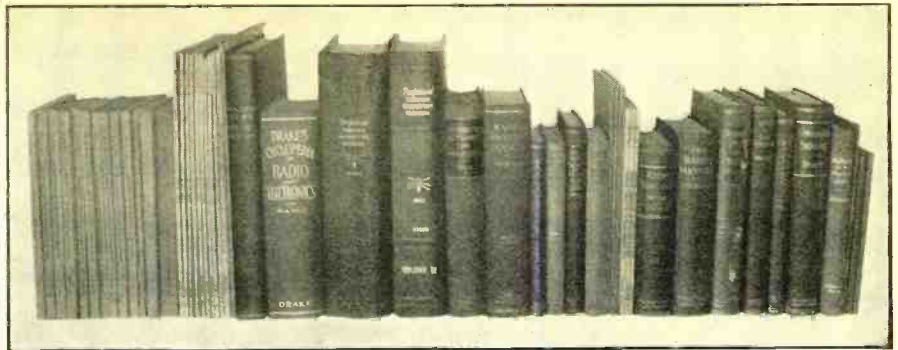

THE TECHNICAL REVIEW

CONDUCTED BY THE TECHNICAL EDITOR

A Fugue in Cycles and Bels, by John Mills; Van Nostrand Company, 1935. This book aims to tell the intelligent layman, what the radio engineers have found out about music and hearing, what are the present possibilities and shortcomings of the electrical reproduction of music and what science can do for music in the future.

Music lovers and musicians may be somewhat surprised at some of the statements made by the author, but they should lead to a better appreciation and understanding of the problems confronting the radio engineer.

The mind of the average listener as well as many musicians is cluttered up with a large amount of misinformation concerning radio transmission as well as music itself. It leads to incorrect operation of the receiver so that the best reproduction is never attained. It also impedes the progress of the radio industry in an indirect way, since listeners become satisfied with inferior reproduction and equipment.

The book first traces the history of man formulating the laws of musical sounds, and shows that not until the advent of electrical reproduction did research advance noticeably. The reader is introduced to the various electrical units, and the tests by engineers are described. These tests show the accuracy or the lack of it of the human ear and just what is the least difference in pitch, loudness it can appreciate.

Then there are chapters on the problems of broadcasting, its limitation and the different kinds of distortion. The last part of the book attempts to describe the things which are still in the laboratory stage but which might add to the possibilities of musical reproduction.

D.C. Voltage Distribution in Radio Receivers, published by John F. Rider, 1936. The second in a series of booklets under the general title "An Hour a Day With Rider." This one analyzes the d.c. circuits of a receiver in all its complications which should be of interest to those employing analyzers, point-to-point testers and ohmmeters.

La Moderna Superheterodina, second Edition, by D. E. Ravalico, published by Ulrico Hoepli, 1936. The second edition has been completely revised and brought up-to-date. This is a book written in Italian and covering the principles of superheterodyne receivers, example of typical receivers and chapters on trouble shooting and repairs. A book of interest to servicemen and set builders.

Review of the Proceedings of the Institute of Radio Engineers for July, 1936

Rain Static, by H. K. Morgan. Aircraft communication is hampered due to charged

particles of rain, snow or dust striking the antenna. An electrostatically-shielded loop antenna reduces the interference materially.

Modes of Oscillation in Barkhausen-Kurz Tubes, by W. D. Hershberger. The author described the result of studies which illustrate the complicated character of Barkhausen-Kurz oscillations and points out the conditions favorable for the production or suppression of parasitic oscillations.

Recent Developments of the Class B Audio and Radio-Frequency Amplifiers, by L. E. Barton. Distortion in amplifiers can be kept low when the distortion in each stage is reduced as much as possible rather than employing balancing schemes. Practical data are presented for medium and high powered audio and radio systems. The author restates the definitions of Class A, AB, B and C amplifiers. These bring out that such definitions have been generally misunderstood. The bias of the tube is no index of the type of amplifier.

General Theory and Application of Dynamic Coupling in Power-Tube Design, by C. F. Stromeyer. A comprehensive discussion of the theory and characteristics of the 6B5 tube.

A New Electron Tube Having Negative Resistance, by J. Grozkowski. A description of a new tube employing a grid of the form of a venetian blind. This tube can be used to obtain negative resistance in the circuit of the anode (electrode with highest potential).

Review of Contemporary Literature

Reforming Telegraph Systems, by J. H. Bell; Bell Laboratories Record, July 1936. The article describes a type of repeater for teletype signals which is operated by a small part of the incoming impulse and restores the proper duration by means of disks rotating in synchronism with the sending apparatus. The system appears to be limited to telegraph codes which employ letters of the same length.

The Diode As Half-Wave, Full-Wave and Voltage-Doubling Rectifier, by N. H. Roberts; The Wireless Engineer, July 1936. A mathematical treatment of the rectifier in all its applications.

Mutual Inductance, by J. Greig; The Wireless Engineer, July 1936. Introducing a system of notation which helps to fix the direction of induced voltages which should be useful when writing equations of a.c. circuits.

Automatic Tuning, Some Applications of the Principle to Test Apparatus, by F. L.

MILLION TUBE TESTER



FEATURES

1. Emission
2. Metal Tubes
3. Shorts Hot
4. Leakage Hot
5. Resistance
6. Electrolytics
7. By-Pass Condensers
8. Neon Alignment

MODEL CN
\$9.95
NET

Here's what the Service Men say about the New Million Tube Tester! "Most valuable purchase of test equipment we made during the last year." "It shows up weak tubes better than my expensive — tester."

If your jobber cannot supply you—order direct—20% deposit required on C. O. D. orders. Tear out this ad and send it to us NOW for complete information on the entire Million line.

MILLION RADIO AND TELEVISION LABORATORIES

363 W. SUPERIOR ST., CHICAGO, ILL.

LES Correspondence Courses in RADIO and ELECTRICAL ENGINEERING

ELECTRICAL ENGINEERING Covers complete electrical field. Most modern course. So simplified anyone can grasp quickly. Prepares you for secure future. **LOW COST.**

RADIO ENGINEERING Ultra-modern course in radio, public address, photo-electric work. Trains you to be super-service man, real vacuum tube technician. Diploma given. Tuition only \$25, either course. Deferred payment plan. Send name quick for free copies of school catalog, student magazines, etc. **SEND NOW.**

FREE!

Lincoln Engineering School, 857-M So. 37th St., Lincoln, Nebr.

NEW GUIDE NOW READY!

Most complete volume control facts ever assembled in one book. Free with one complete Electrad carton.

Write Dept. RN10
175 Varick St., New York, N.Y.

ELECTRAD

Hill; the Wireless Engineer, July 1936. Circuits employed for automatic tuning can be applied to a beat-frequency oscillator so as to sweep the complete audio spectrum by varying one of the r.f. oscillators. The variation can be done logarithmically with respect to time. The instrument is used to test amplifiers, speakers, etc.

A Compound Horn Loudspeaker, by H. F. Olson and F. Massa; Journal of the Acoustical Society of America, July 1936. This paper describes a loudspeaker employing a straight exponential horn for high notes and a folded exponential horn for low notes, both energized by the same diaphragm. The speaker has a response from 50 to 9,000 cycles and an efficiency of 50 percent over a large portion of this range. The outside dimensions are 40x40x17 inches.

Simplifying the Push-Pull-Push Crystal Oscillator, by J. Stanley Brown; QST, July 1936. Description of a transmitter circuit employing a single-stage, crystal-controlled oscillator with 802 tubes. The grids are in push-pull, the screens are in push-pull and include a circuit tuned to the fundamental. The plates can be in push-pull to obtain the fundamental or in parallel for second harmonic.

Peak Voltages, Aerovox Research Worker, June 1936. Simple apparatus to check the peak voltages across condensers and other circuit components in power packs, amplifiers, etc.

Methods of Phase Inversion, Aerovox Research Worker, June 1936. A compilation of different ways to obtain resistance coupled push-pull with a discussion of the respective merits of each circuit.

Beat-Frequency Oscillators, by A. W. Barber; Radio Engineering, July 1936. A study of beat-frequency oscillators which gives considerable data on temperature effects and all the combinations of frequencies which may cause undesired beats.

Free Bulletins

1937 Catalog

The new 1937 catalog of the Insuline Corp. of America lists an unusually large assortment of radio parts, panels and tubing, racks, cabinets and chassis for all purposes. Copies may be had free from Radio News, 461 Eighth Avenue, New York City.

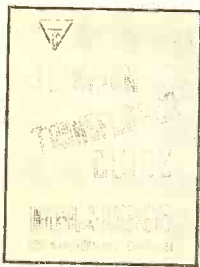

Transformer Catalog

A large listing of universal replacement power transformers is given in the new 8-page guide of the Johnson Transformer Co. The bulletin also contains information on rebuilt and special transformers. To obtain a free copy, write to Radio News, 461 Eighth Avenue, New York City.

RADIO NEWS Booklet Offers Repeated

For the benefit of our readers, we are repeating below a list of valuable technical booklets and manufacturers' catalog offers, which were described in detail in the April, May, June, July, August and September, 1936, issues. The majority of these booklets are still available to our readers free of cost. Simply ask for them by their code designations and send your requests to Radio News, 461 Eighth Avenue, New York, N. Y. The list follows:

A2—"Your Future in Radio", 32-page book of Sprayberry Academy of Radio. Free to read-

ers seriously considering a modern education in radio.

A3—Radio Capacitor catalog of Solar Mfg. Co. Free.

M1—Information on a new antenna system. Technical Appliance Corp. Free.

M2—Condenser bulletin of Cornell-Dubilier Corp. Free.

M3—Free. Instructive bulletins on measuring resistance and proper use of resistors to extend meter ranges. Aerovox Corp.

M4—Free. Folders on Polyiron core coils. Aladdin Radio Industries, Inc.

M5—1936 condenser catalog. Sprague Specialties Co. Free.

Je1—Sound Equipment Catalog of the Webster Co. Free.

Je2—Radio Parts Catalog of Allied Radio Corp. Free.

Je3—Transmitter Bulletins of the Collins Radio Co. Free.

Je4—Radio Supply Catalog of Wholesale Radio Service Co., Inc. Free.

Je5—Spring Radio Catalog of Radolek Co. Free.

Jy1—Tube Engineering Bulletin on Harmonic Analysis of Modulation. Ken-Rad Corp. Free.

Jy2—Free Tube Chart of the Raytheon Production Corp.

Jy3—Public Address Catalog of Operadio Mfg. Co. Free.

Jy4—Latest Radio Parts Bulletins Utah Radio Products Co. Free.

Jy5—Commercial Refrigeration Booklet of the Frigidaire Corp. Free.

Jy6—Short-Wave Catalog of Harrison Radio Co. Free.

At2—Modulation Booklet. United Transformer Corp. Free.

At3—Precision Instrument Catalog. Clough-Brengle Co. Free.

At4—P. A. Equipment Catalog. Wholesale Radio Service Co., Inc. Free.

At5—Amateur Radio Booklet. New York Wireless School. Free.

S1—Catalog on Permanent Magnet Speakers. Cinadagraph Corp. Free.

S2—Recording Equipment Catalogs. Presto Recording Corp. Free.

S3—Cornell-Dubilier Corp. Folder on New Service Condensers. Free.

S4—Webster Company Catalog on Sound Systems and Accessories. Free.

S5—Transformer Replacement Catalog. United Transformer Corp. Free.

"Matched" P. A. Systems

In presenting the article, under the above head, on page 150 of the September issue the 3 curves referred to were omitted. They are therefore shown here for the benefit of readers who are interested.—THE EDITORS.

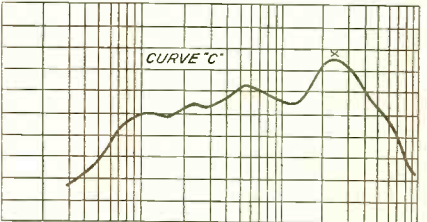
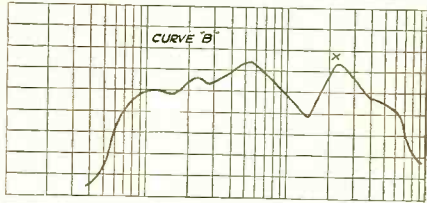
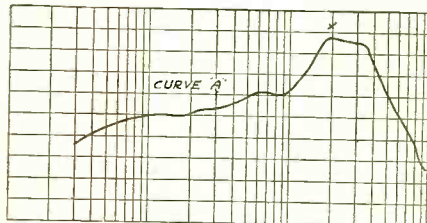

Television—Telephone Service

Berlin, Germany—A new type of telephone service, the first of its kind, was opened between Berlin and Leipzig on May 25. This service permits the two parties to see each other during the telephone conversation. A specially constructed cable is employed which transmits frequencies up to 500 kc.

BY POPULAR DEMAND!



New 1936-37 edition of Sylvania Service Booklet just off the press! Send for your FREE copy now . . . TODAY!

Here's news! Sylvania engineers have just completed a brand new reference book on auto-radio installation and servicing. This handy, compact pocket manual contains the largest collection of brand new service tips on auto-radio installation and servicing you've ever seen . . . A world of practical information written in the service man's language.

Here are just a few points covered by this new up-to-date manual: Elimination of motor interference for every make of 1936 cars . . . Tube complement chart for practically all models of automobile radio sets, with I.F. peak frequencies . . . Set and Antenna Installation hints . . . Power Supply hints, etc. These and hundreds of other problems you will meet in auto-radio installation and servicing are covered in this amazing book.

You'll say it's worth its weight in gold . . . but we're not selling it. It's FREE to any service man who can use it. Fill out the coupon below and mail it now . . . today, and you will receive your copy of this valuable booklet in a few days.

Hygrade Sylvania Corporation. Makers of Sylvania Radio Tubes and Hygrade Lamps. Factories at Emporium, Pa., Salem, Mass., and St. Mary's, Pa.

SYLVANIA

The Set-Tested Radio Tube

Hygrade Sylvania Corp. RN-106
Emporium, Pa.

Please send without obligation your new service book "Auto-Radio Installation and Servicing."

NAME

ADDRESS

CITY.....STATE.....



An Outstanding Unit in our NEW Public Address Line

**Type 60-C Amplifier
60 WATTS OUTPUT**

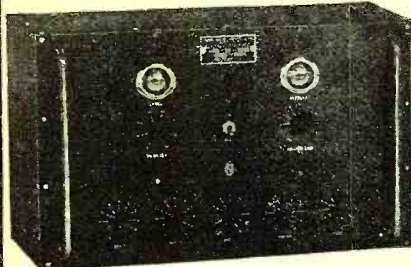

60 Watts of Audio Net \$76.26

- Beam Tubes—All Metal
- Built-in Faders for Three Ribbon or Crystal Mikes and Phono.
- Electric Eye Monitor and Overload Indicators.
- Rugged Export Construction.

Write for No. 106 PA Catalog Illustrating U.S.E.'s New PA Products

UNITED SOUND ENGINEERING CO.

Manufacturers of Electronic Equipment
2237 University Ave., St. Paul, Minn.

Reliable in Every climate

WET
DRY
MICA
PAPER
TRIMMER

Condensers by **SOLAR**

SOLAR MFG CO.
589-601 Broadway, New York

COMPARE VALUE!

New All-Wave Antenna

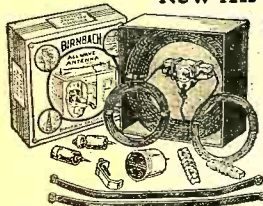

\$4.25 List Price

CATALOG NO. 375
Factory connected and soldered. No switching required for short wave or broadcast reception. Kit No. 376 without receiver coupler. List price, \$3.50. Write Dept. RN10 for Catalog.

U. S. Pat. No. 99911, other Pats. Pend.

BIRNBACH RADIO CO., Inc.
145 Hudson St., New York City

RADIO ENGINEERING,

broadcasting, aviation and police radio, servicing, marine radio telegraphy and telephony, Morse telegraphy and railway accounting taught thoroughly. Engineering course of nine months' duration equivalent to three years of college radio work. School established 1874. All expenses low. Catalog free.
Dodge's Institute, Oak St., Valparaiso, Indiana

WHAT'S NEW IN RADIO

WILLIAM C. DORF

(Continued from page 203)

inductance values are not affected by vibration, humidity or temperature changes.

Powerful Amplifier

Sound engineers, dealers and others engaged in the public-address field will be interested in the new model 60C, 12-tube power amplifier manufactured by the United Sound Engineering Co. Metal type tubes are used throughout except for the rectifier, as follows: four 6F5's, one 6C5, one 6F6, two 6L6's, one 83, one 5Z3, and two 6E5 electron-ray tubes employed as

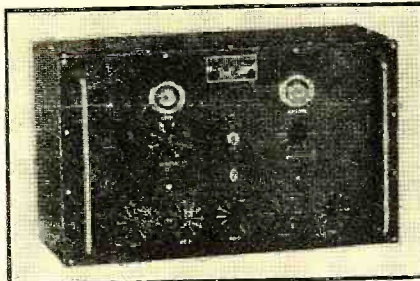

monitor and visual overload indicators. From 2 to 6 loudspeakers can be used with the amplifier, it has a built-in fader arrangement for ribbon or crystal microphones, phono or radio. The specifications show gain 136 db., and frequency response plus or minus one db. from 40 to 12,000 cycles. The overall cabinet dimensions are 10 3/8 by 10 1/2 by 17 inches. This company also produces an auxiliary amplifier to furnish an additional 60 watts audio output where desired.

Universal Tester

The "Master Multitester" model 410, made by the Radio City Products Co. is a universal testing instrument that can be employed in many different testing and measuring services. Measures resistance from a fraction of an ohm to 40 megohms in 6 ranges; capacity from .0001 to 300

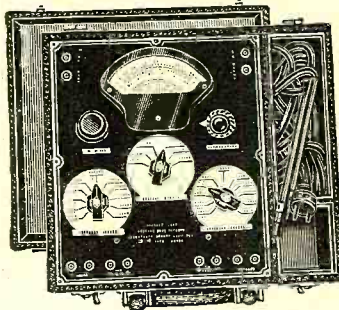

mfd. in 5 ranges, can measure both a.c. and d.c. voltages up to 1000 volts, and both a.c. and d.c. microamperes, milliamperes and amperes. Both power level (decibel) and inductance measurements can be made in several ranges. It is housed in a portable case with removable cover and measures 5 1/2 x 10 1/4 x 11 1/2 inches. Weight 8 3/4 pounds.

Low-Level Reproducer

The Fox Sound Equipment Corp. low-level reproducing unit is made to cover a wide range of frequencies. Particular attention is given to the technical correctness of the curve of the bell. This "Tone-Bell" reproducer, as it is called, is designed to augment and strengthen sound

distribution, without annoying projectional features. It is constructed of a special alloy aluminum. The cradle of the mounting bracket is free to turn through a radius of 360 degrees. The unit can be furnished complete with an 8-inch cone speaker hav-



ing an impedance of 500 ohms and a field of 7500 ohms. The diameter of the bell is 18 1/2 inches.

Velocity Microphone

The velocity microphone in the streamline case, shown below, is made by the Electro-Voice Mfg. Co. It is a low priced

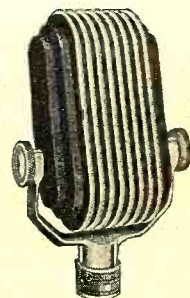

companion to their present "V" series microphone. It is furnished complete with an 8-foot cable and equipped with standard output impedance, connection direct-to-grid. It is finished in black and chromium and is made for quality reproduction of voice and music.

Permanent Magnet Speaker

The new Wright-DeCoster model 982, 12-inch "Nokoil" reproducer features a permanent magnet providing a flux dens-



ity comparable to an electro-dynamic type speaker of the same size. It is equipped with a new universal transformer to match all standard tubes and it has a para-curve diaphragm to provide fidelity of reproduction.

New Headphones

The Brush Development Co. has just announced two new models of crystal headphones. The first is a single phone in-

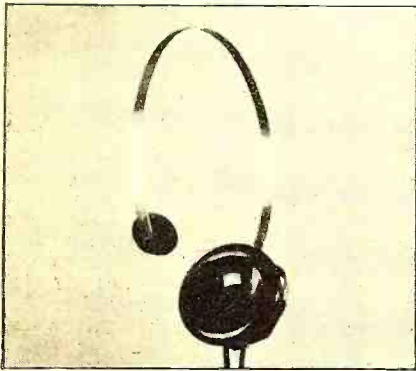

strument with head band and soft rubber pad which holds the phone securely in place against the ear of the user. This unit is shown in the illustration. The second model is also a single phone mounted on a 12-inch lorgnette type handle, which can be extended to 17 inches. These new receivers are ruggedly constructed and provide high sensitivity. They find particular application in group-hearing aid systems in churches, schools, etc., because of their wide frequency response and light weight.

Attractive Table Type Set

The new General Electric model E72, "Focused Tone" 7-tube all-wave receiver shown in the accompanying photograph

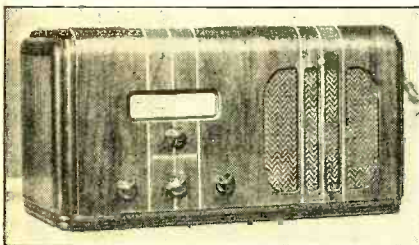

employs the following type metal tubes: two 6K7's, one 6A8, one 6H6, one 6F5, one 6F6 and one 5W4. The term "Focus Tone" is applied to the new 1937 line of General Electric receivers to describe fidelity of reproduction and peak performance results made possible by the new simplified color tuning methods, automatic frequency control, silent tuning and other advances.

Replacement Condensers

The standard Sprague 450 and 600 line condensers are now produced in a convenient square size and in uniform 2 1/2-inch lengths so that they may easily be strapped together with a mounting strap to form any replacement combination. Where mounting is a problem, the new

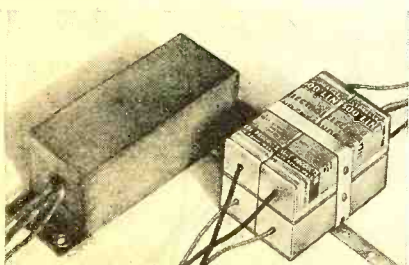

Sprague universal mounting flange can also be employed, thus enabling the serviceman to make a quick, easy replacement to match the original holes in any set.

Tiny Wave Trap

To overcome commercial ship-to-shore code interference from spoiling broadcast

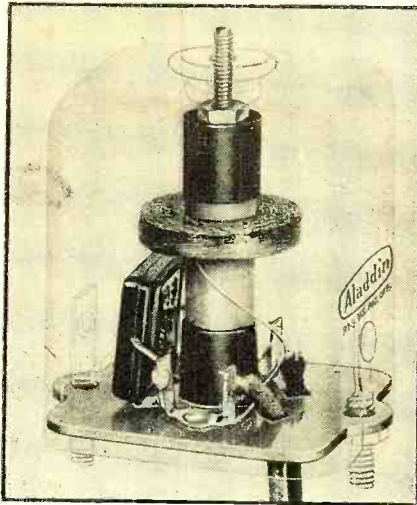

radio reception, the Aladdin Radio Industries has recently introduced a new type of wave trap. It is tuned by the movement of a magnetic core which varies the inductance of the coil. This, in combination with a fixed capacitor, tunes to the frequency of the undesired code signals. The new wave trap is particularly effective on superheterodyne receivers which do not have a radio-frequency stage.

Universal Testing Instrument

A new DayRad combination service testing unit has just been introduced by the Bendix Products Corp. The instrument combines in a single compact assembly a tube checker of advanced design, a voltmeter covering both a.c. and d.c. voltages in several ranges up to 1250

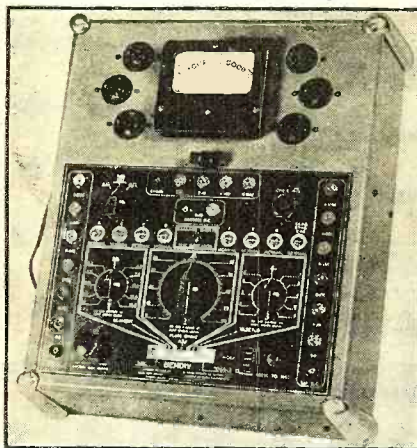

volts, a milliammeter with an equal number of ranges; also a high current range extending to 25 amperes, adapting the unit to auto-radio and other similar testing requirements for which the ordinary analyzer is not equipped. Three ohmmeter ranges are provided, enabling tests up to 3 megohms.

Table Model Set With Large Tuning Dial

This new RCA model 5X4 meets the housewife's wish for a personal kitchen radio. It is finished in porcelain white lacquer with a black base and measures 7 3/8 inches high by 10 3/8 inches wide. It is a 5-tube a.c.-d.c., 2-band superheter- (Turn to page 255)

Learn RADIO from REAL RADIO ENGINEERS!



Kendall Clough
Chief Engineer,
Clough-Bronde Co.
E. E. Gramer
Chief Engineer,
Standard T'F'air Co.
Karl E. Hassel
Chief Engineer,
Zenith Radio Corp.
F. H. Schnell
Radio Engineer,
Gutnow Radio.
F. D. Whitten
Service M'gr. Phileo,
Radio & Telev. Corp.
Dr. C. M. Blackburn
Radio Engineer,
P. R. Mallory & Co.

Train Now at Home for Good Pay Spare-Time and Full-Time Jobs that Pay Up to

\$75 a Week

If you're dissatisfied with small pay—and an uncertain future—here's an opportunity that's too good to miss. Get my big brand new FREE book, "RADIO'S FUTURE AND YOUR OPPORTUNITY." This book tells how you can learn at home under the supervision of factory engineers. To make more money almost at once in Radio—how to make Radio your life's work, or use it to pick up \$5 to \$20 a week extra in your spare time.

MORE OPPORTUNITIES THAN EVER BEFORE

Radio is still forging ahead. 1935 was its biggest year. Over 5 million new sets sold. Over 30 million dollars paid for service alone in 1935. Where only a few hundred men were employed a short time ago, thousands are employed today. And where a few jobs paid up to \$75 a week—there are thousands of such jobs today—many paying even more. New full time jobs and spare time jobs are being created all the time. Get my book and see how easy you can get started.

"SHOP TRAINING" FOR THE HOME

R-T-I Training is different. It comes to you right from the heart of the Radio Industry—right out of the factories where Radio sets and other vacuum-tube devices are made. It was planned and prepared and is supervised by big radio engineers IN these factories—by men appointed for the purpose. R-T-I will train you as the Radio Industry wants you trained.

TELEVISION, PHOTO ELECTRIC CELLS PUBLIC ADDRESS SYSTEMS INCLUDED

Radio service work is plentiful but it's only the starting point in R-T-I Training. From there you'll go through the whole field of Radio and Electronics. You will learn about every new development, including Tele-

vision so you'll be ready when Television breaks. You'll also learn the big money subjects such as Aviation and Auto Radio; Public Address Systems; how to handle Photo Cells; Sound Picture Recording, Etc.

4 WORKING OUTFITS FURNISHED

Start almost at once doing part time radio work. I furnish 4 outfits of apparatus that you build into test equipment with which you can do actual jobs and earn extra money. My Training pays its own way and you get your money back if not satisfied. Age or lack of experience is no handicap.

FREE BOOK

Find out why R-T-I Trained men get "Quick Results" and "Big Results." Send for "Radio's Future and Your Opportunity" today. It tells about Radio's amazing opportunities. It describes my approved training, — what R-T-I students are doing and making. It gives the names of 50 firms who endorse and recommend R-T-I. It's FREE.



RAY D. SMITH,
President
RADIO AND TELEVISION INSTITUTE

Dept. 47
2150 Lawrence Ave.
Chicago

MAIL COUPON FOR FREE BOOK

RAY D. SMITH, President
Radio and Television Institute (R-T-I)
2150 Lawrence Ave., Dept. 47, Chicago, Ill.
Without obligating me, send new FREE Book about spare-time and full-time Radio opportunities and how I can train for them at home.
Name.....
Address.....
City..... State.....

The Television Scramble

(Continued from page 202)

coverage as possible, so that the benefits of television may be available to all sections of the country.

"4. Provision for a choice of programs, that is simultaneous broadcasting of more than one television program in as many localities as possible, to avoid monopoly and to provide variety of educational and entertainment features.

"5. Lowest possible receiver cost and easiest possible tuning, to stimulate domestic installations of television receivers, both of which are best achieved by allocating for television as nearly a continuous band in the air waves as possible."

There were some controversial statements in Skinner's testimony. For example, he held that, while it is not possible at present to determine precisely what the selling price of a television receiver will be, it will most likely "cost less than the average motor car." This might, in the public mind, convey the thought that television must necessarily be expensive if its cost is compared to automobiles, even with the prefix of "less than." And a further remark of Skinner's that most of the industry does not agree with, is that "Commercial television must be born full grown."

While some of Skinner's points are well placed from the industrial angle, the indication of possible future claiming of the amateur 56-60 megacycle band is made clear. But Skinner shrewdly commends the amateur's contributions to radio. His remarks on this phase follow:

The most valuable part of the spectrum for television starts at 42 megacycles. At this frequency a given amount of broadcasting power provides the greatest signal intensity in the surrounding territory. The RMA Television Committee report will request therefore a television band extending from 42 to 90 megacycles.

"From 56 to 60 megacycles, there is a band allocated to amateurs. RMA recognizes the service the amateurs have contributed to radio development and their importance to the nation in providing a reserve of trained radio operators in times of emergency. RMA will therefore not request these frequencies for television unless it is found by the Commission that this band is not urgently needed by the amateurs, or is not especially well suited for amateur work. If so, another desirable television channel could be provided from 54 to 60 megacycles and a highly desirable continuous television band would result."

When asked to express his views on the foregoing, Laurence M. Cockaday, Editor of RADIO NEWS, made the following statement: "There is no real necessity for even considering the confiscation of the 56 to 60-megacycle amateur band and reallocating this band for television. The RMA Television Committee's report containing the requests for television band from 42 to 90 megacycles on the basis that a "continuous" television band would be highly desirable will not hold water. RMA's statement that they will not request these frequencies for television unless it is found by the Commission that the band is not urgently needed for amateurs or is not especially well suited for amateur work, is merely a thin veil thrown over the strong presentations made by television interests for these particular frequencies that the amateurs have opened up so successfully. And the statement that the most valuable part of the spectrum for television starts at 42 megacycles is not even worth considering. In fact, it is

my own opinion that the frequencies from 42 to 56 megacycles would serve a much more useful purpose if they were allocated for high-fidelity, ultra-short-wave sound broadcasting. The television bands, themselves, could then start at 60 megacycles (or higher) and extend continuously to as high a frequency as found desirable in future experimental practice and this band could be made "continuous" leaving the 56 to 60 megacycle band for the amateurs where it is proving so successful as a local and, during the summer, a DX band.

"This latter point brings up another consideration, where the low-frequency end of the proposed RMA television spectrum might prove an actual hazard for permanent, successful television operation. The reason for going to high frequencies for television, in the first place, is to escape the troubles accompanying interference between the ground waves and the sky waves in lower-frequency transmission. It has been proven conclusively this summer that even as high as 60 megacycles there are at various times in the year strong sky-wave signals making possible 5-meter transmissions at distances of 1000 to 1500 miles. At these periods of time television signals would be distorted on these frequencies and interference between television transmissions of various cities a number of thousands of miles apart would be experienced."

Mr. Cockaday suggested that still higher frequencies than 60 megacycles should be used where there will be no possibility of sky wave effects. He also states that the Federal Communications Commission cannot conscientiously decide that the 5-meter band is *not urgently needed by the amateurs or is not especially well suited for amateur work when around a city like New York alone there are over a thousand licensed amateurs using this band day and night.* Certainly it seems logical that the Commission could not say it *wasn't useful to the amateurs* and then turn it over to television interests as the *most valuable part of the television spectrum.* It looks as though the RMA lacks the nerve to come right out and say they want the amateur band for television and to throw out the amateur—but that is what they mean alright!

The president of RCA, David Sarnoff, got his customary top billing at the informal engineering conference. And no one apparently begrudged a spotlight being aimed at him because all concerned were anxious to know the course his company intends taking in the new art. His utterances, if they were for a change, revealing, could give almost everyone else in the looming television industry an idea of what FCC hearings and legal battles lie ahead in the fight for an equitable allotment of visual frequencies.

But when the squire of Radio City came out with one of his typical statements: "Technically, television is an accomplished fact, although it is not yet ready commercially," it was apparent that RCA still was trying to *hold television on the shelf!* But other recent television activities of the company indicate that it is *making both plans and strides for its commercial affiliation with the new art!*

Sarnoff set forth a seven-point summary of his suggestions, the first four points of which, relative to the ultra-short allocations, are herewith presented:

"1. Because of the rapid strides of the radio art, advance reservations of frequencies should be made by the Federal Communications Commission to meet the needs of future services, such

TEST BREAKDOWN WITH NEW

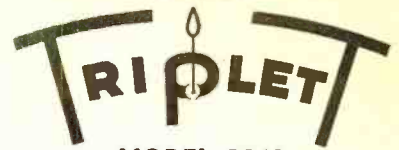

MODEL 1240 CONDENSER TESTER



MODEL 1240 CONDENSER TESTER

DEALER PRICE... **\$24.83**

- ★ Checks capacities accurately.
- ★ Detects shorts and leakages.
- ★ Performs breakdown tests.
- ★ Discharges condenser on removing, preventing shocks.

This 1937 Model Triplet Condenser Tester gives a true breakdown test, thus identifying faulty condensers. The Triplet Condenser Tester is operated easily and quickly. All tests are shown on a single meter dial. D.C. voltage is available for breakdown tests up to 1,000 volts in steps of 2, 20, 60, 200, 600 and 1,000 volts. A.C. voltage is available also up to 1,000 in the same steps. Has illuminated dial line voltage indicator with control for extreme accuracy in capacity readings. Complete in modernistic steel case with popular black wrinkle finish.

Dealer Price..... \$24.83
Can be handled alone or will fit Master Unit Cases.

OTHER NEW 1937 MASTER UNITS ARE:

	<i>Dealer Net</i>
Model 1250 Vacuum Tube Voltmeter.....	\$33.34
Model 1260 Audio Oscillator.....	28.34
Model 1200-A Volt-Ohm-Milliammeter.....	21.67
Model 1200-B Volt-Ohm-Milliammeter (with copper-oxide A.C.).....	26.67
Model 1295 Modulation Monitor.....	24.83

PRECISION WITHOUT EXTRAVAGANCE
See Your Jobber



ELECTRICAL INSTRUMENTS

The Triplet Electrical Instrument Co.
1510 Harmon Drive, Bluffton, Ohio

Without obligation please send me more information Triplet Master Unit Model
New 1936 Catalogue

Name.....

Address.....

City..... State.....

200 WATTS-DC

6 or 12 Volts
The PIONEER "Cub"
Gas-Electric Power Plant



\$44⁹⁵

Here's a new way to big profits. The PIONEER "Cub" is a real value. Every farmer wants electricity—sell him the lowest priced gas-electric plant on the market. It will operate a lighting system—charge all 6-volt batteries—run small machinery mechanically. List price \$44.95.

PIONEER "Blue Diamond"
110 volts — 300 watts
AC-Gas Elec. Plant

Lowest priced "city" light plant ever offered! Also has DC winding for charging 6-volt batteries. Write for full information today!

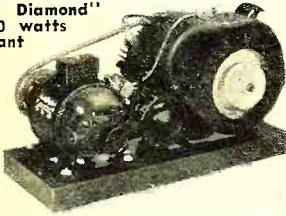

Pioneer Gen-E-Motor Corp.,
464-Z West Superior St., Chicago, Ill.

Rush full information:
 Gas-Electric Power Plants
 Gen-E-Motors Converters

Name..... Address.....
State..... City.....

TELEVISION
with
CATHODE RAYS
ARTHUR H. HALLORAN

FLASH!

Now, for the first time, you can read **AUTHORITATIVE** information on the systems of Television actually used by the large television corporations. This newest book, "Television With Cathode Rays," tells you what you want to know. Price \$2.75 per copy, including one year supplementary service. Order from:

Pacific Radio Pub. Co., Inc.
P. O. Box 3278
San Francisco, California

One Year SUPPLEMENTARY SERVICE... Included without Extra Charge

FULL PRICE \$2.75

NEW "The Rex"

A new Acme bipolar headset. Designed expressly for high quality reception in a low priced phone. Bipolar construction. Molded caps. Try our 20,000 Ohm Impedance for Short Wave.

Write to Dept. R.N.10 for information

ACME SPECIALTY CO.
1770 W. Berteau Ave. Chicago, Ill.

RADIO COURSES

RADIO OPERATING: Prepare for Gov't License Exam. ● RADIO SERVICING: Including Short Wave ● AMATEUR CODE ● New Course in ELECTRONICS:

Day and Evening Classes—Booklet Upon Request

NEW YORK Y.M.C.A. SCHOOLS
7 W. 63rd Street, New York City

as television, facsimile and high-frequency broadcasting. This will enable these achievements of radio to give their greatest possible public service as soon as developed, instead of compelling them to contest with older services for adequate space in the spectrum.

- "2. Except for experimental purposes, no allocations to individual applicants should be made in these reserved frequencies until actual public service is possible. No one should be permitted to reserve frequency space for future use and then let it remain idle while others carry the burden of development.
- "3. In allotting frequencies the greatest economy and usefulness of the available channels should be promoted by requiring, so far as feasible, the multiple use of frequencies.
- "4. In determining precedence in the allocation of frequencies, consideration should be given to services on the basis of their comparative importance to the public, the urgency of the tasks to be performed, and the requirements of the public to be served. Radio has made possible outstanding progress in mass communication. Ample allocation should be made for the greatest use of this public service for the broadcasting of sight as well as of sound, nationally and internationally."

With this official viewpoint of RCA on record, one can compare its plan for de-laying the entire industry with its own current progress. Its \$1,000,000 experimental field program has begun. The Empire State station, established in 1931, is providing programs for the company's own receivers. The Radio City television studio on the third floor of the NBC building is already in use, the A.T. & T. coaxial cable between Philadelphia and New York is nearing completion (although its use, by Government order, is not confined exclusively to RCA), and the company is busily aligning the interest of manufacturing licensees and broadcast stations.

Licensees of RCA were shown the company's television progress at a confidential New York demonstration which was followed by a banquet. Although *sotto voce*, the RCA message to the licensees by Sarnoff, Harbord, Schairer and other executives, was a well-aimed sales spiel. And, in Chicago, at the convention of the National Association of Broadcasters, I. R. Baker, chief of transmitter sales of RCA, made the announcement that high-fidelity television will be thrown open to inspection of broadcasters in New York in September.

It is also significant and interesting to note that RCA has been busy turning out television publications, although most of them are not for public distribution. Among three recent issues were: "Preliminary Specifications of Test Equipment Suitable for Television Research Development," "Licensee Bulletin LB 370: RCA Television System and 1936 Field Test Plan" and a 452-page volume entitled "Television," a compilation of technical papers delivered in the past by company engineers. Only the last named publication will be made available to the public, it was said, at a possible cost of \$2.

So, apparently, RCA is looking out for its own share of the new field's returns. How about other firms getting the same opportunity? That's a question that comes to the fore.

Samuel E. Darby, Jr., appearing for eleven independent radio receiving set manufacturers—American Bosch, Philco, Zenith, Crosley, Sears Roebuck, Montgomery Ward, Emerson, Stromberg-Carlson, Motorola, Stewart Warner and Spar-

ton—severely criticized the RCA patent pool.

"When, to use the words of Mr. Skinner," he declared, "television is born full-grown, it will be born with a full-grown levy of tribute of millions of dollars a year by RCA although RCA may not actually own a patent that bears directly on television, and solely because of radio patents in its pool by means of which approximately 50 million dollars have already been levied on and collected from the public.

"The Commission which will grant licenses in the new portion of the spectrum will have to consider the record of those who apply for channels.

"And I respectfully submit that the Commission should not be a party, in the assignment of frequencies, to the expansion of a monopoly that has already exacted a toll from the American public of approximately 50 million dollars and that holds forth the possibility of exacting as great or a greater amount from the public in the field of television."

Philo T. Farnsworth, of the Farnsworth Television Corporation, insisted that amateurs participate in television's development.

"It is our belief," he said that television offers no more difficulty to amateur receiving set builders than did radio in 1921 and 1922."

He took issue with other testimony that television must be born a finished service.

Farnsworth is one television inventor who has always been anxious for an early public start of visual transmissions. Just a few weeks after his testimony, there was set for hearing before the FCC his application for a construction permit for a new visual station on the 42-56 and 60-86 megacycle bands. The proposed site is Springfield, Pa.

The Don Lee Broadcasting System, of Los Angeles, and the DeForest Television Corporation, of Hollywood, were in accord with Farnsworth's views that television is virtually ready for the public and should be introduced soon on an experimental basis. The Don Lee firm is already, since June 4th, 1936, presenting regularly-scheduled programs of high-definition television films being utilized at the start.

Ralph A. Clark, of the Television Corporation of America, also favored early public participation. "During the past year," he said, "we have monitored and made transmissions in the high-frequency spectrum between 30 and 300 megacycles. An average of 6 hours daily was spent doing this. Much of this experimentation was done in conjunction with the editors of RADIO NEWS. Mr. Cockaday suggests that television will ultimately use frequencies higher than 60-120 megacycles, due to the occasional detrimental sky-wave effects at lower frequencies." Clark assailed the idea advanced by Sarnoff, Skinner and William S. Paley—CBS president—that the cost of television is "excessive." "The cost," Clark said, "according to our most careful estimates is not \$500,000! Nor is it one-tenth of that sum. Nor will the cost of a high-definition television receiving set with a high-fidelity, all-wave radio set be the price of a low-price automobile. Rather, it will probably cost the public the price of two ordinary radios."

Clark later added: "We are opposed to the idea of introducing television 'full-blown,' as one speaker here has put it. This is not the way radio was developed. Only by constant change and experience in actual amateur and commercial operation did it reach its present high standard." Clark also stressed that the amateur bands must be left "untouched."

Thus, the case was presented by the

various parties concerned. There will be much deliberation. But the scramble for television high-frequencies is definitely on. The Fall hearings should tell the story of the course the FCC decides television must take. And keeping in mind that there are Courts to offset a prescribed course, it can be expected that there will be plenty of legal action down the ultra-short field. Let's hope it will speed television!

A 5-10-20 Meter Super

(Continued from page 206)

did not run much greater than that sufficient to offset losses and give some useful gain per stage. As you will note by inspection of the circuit diagram in Figure 1, the second, third and fourth t.r.f. stages have the grid leads tapped down about two-thirds on the secondaries or grid sides of the transformers. The tuning condensers are across all of the turns of each coil. Tapping down on the secondaries also gives a better impedance match to the grids of the tubes. This procedure was not adopted in the first stage as we wished to get as high a signal voltage as possible on the grids of the first tubes.

Further inspection of the diagram will show that a crystal filter can be switched into the circuit between the second and third stages if its use appears desirable. The fourth stage is so designed as to make available a small amount of regeneration. This makes possible a further increase in selectivity of the t.r.f. portion of the receiver and can be utilized as a beat oscillator.

It was found after actually testing out the receiver that very good reception results could be obtained solely with the use of this t.r.f. portion. This combination can be made use of by turning switch No. 2 which puts the audio circuit of the National 1-10 unit directly after the first detector. It might be well to point out here that the audio circuit of the 1-10 unit is the only audio circuit of the receiver and is used as the audio portion in the various combinations in which this receiver can be operated. Headphone operation may be had in any combination of this receiver by plugging into the phone jack.

While this receiver is intended to be used with well-designed antennas, we find on test that a foot of wire on one of the antenna jacks was sufficient to bring in perfectly audible signals from Europe or Argentine, using only the tuned-frequency portion of the receiver. Naturally if there is much QRM, more selectivity is required than can possibly be obtained in the t.r.f. stages, although in this particular combination the selectivity is really quite remarkable, even without the use of the crystal. However, making use of the regeneration available in the fourth stage, the selectivity can be greatly increased even though we use only the t.r.f. portion of the receiver.

The normal way of operating the 20-meter portion of this receiver, for maximum sensitivity and selectivity, makes use of two frequency changers. Referring to both the main circuit in Figure 1 and block diagram Figure 17, it will be apparent that the frequency is changed in the first mixer, D1, to frequencies in the range between 1500 and 1900 kc. In mixer D2, the frequency is again changed to a band between 700 and 1100 kc. The signal is then amplified in tube V8 and rectified in tube V9.

It should be particularly noted that this receiver uses fixed oscillator frequencies for

I WILL PROVE TO YOU THAT 17 CENTS A DAY

ACTUALLY SETS YOU UP IN BUSINESS...



... in an Industry That Is Providing Fortunes for Wide-Awake Men ...

This NEW and DIFFERENT RADIO TRAINING teaches you not only about ALL BRANCHES of Radio, but backs it up with equipment which gives you PRACTICAL EXPERIENCE.

Remember, no matter what kind of Radio training you take, it is absolutely necessary that you have equipment of this kind BEFORE you are ready to start making real money.

Sprayberry Training brings it to you almost at the start—teaches you just how to use it under actual Service conditions. Theory is cut to a minimum. You'll find it all intensely interesting—you'll learn the PRACTICAL way.

Don't delay! Radio is progressing rapidly. Television is on its way. Now is the time to get started—and Sprayberry Training is designed to start you right.

This complete training including the ALL ESSENTIAL EQUIPMENT costs you only 17 cents per day—just a little more than the price of a package of cigarettes. Write for complete details NOW!

LEARN QUICKLY AT HOME—NO PREVIOUS EXPERIENCE REQUIRED

You'll find Sprayberry Training complete—modern—practical—and easy to understand. You learn quickly in your spare time. Students can often make extra money on ordinary service work even before completing their Training.

Besides the necessary fundamental teaching, the Course includes the famous Sprayberry Practical Mechanics of Radio Service formerly sold ONLY to men already in radio—many of whom found ordinary training inadequate for today's Radio needs.

Moreover, Sprayberry is the ONLY school that furnishes you with COMPLETE RADIO EQUIPMENT!

THIS ESSENTIAL RADIO EQUIPMENT IS YOURS!

Upon completion you have complete business and technical training PLUS complete radio equipment to enter business at once for full or part time profits—or to start in any one of Radio's specialized fields such as aviation radio, broadcasting, sound, etc. Certainly you owe it to your future to investigate—TODAY!



SPRAYBERRY ACADEMY OF RADIO

2546 University Place, N. W., Washington, D. C.

BEFORE ENROLLING FOR ANY COURSE YOU OWE IT TO YOUR FUTURE TO INVESTIGATE THE UNIQUE ADVANTAGES OF SPRAYBERRY TRAINING.

Without cost or obligation on my part, please rush complete details of your NEW type of Radio Training, also your booklet "MY FUTURE IN RADIO"

NAME..... AGE.....

ADDRESS.....

Cut out this coupon and paste on back of post-card RN 10/36

MODERNIZE YOUR TRANSMITTER WITH THE LATEST NATIONALLY ADVERTISED RADIO PARTS WE STOCK EVERYTHING IN AMATEUR EQUIPMENT Write for free catalog

CAMERADIO
601-3 GRANT ST., PITTSBURGH, PA. • 30 TWELFTH ST., WHEELING, W.VA.
Established 1919

RADIOS SAVE UP TO 50% ALL NEW 1937 MODELS!

DEAL DIRECT - FACTORY PRICES! Iron-Glad Guarantee Written

A penny post card brings you our new, full-color 24-page BARGAIN CATALOG free. Many models to choose from: 4 to 17 tubes; AC-DC, All-Wave, Car and new Farm sets that operate like city radios! Send post card or coupon below for full details of 30-day no-risk trial and Agent-Use proposition. Write now!

30-DAY NO RISK TRIAL! Enjoy it a month, then decide. Write! \$6.98 MAIL COUPON Free Catalog Goldentone Radio Co., Dept. A, Dearborn, Mich.

FREE!

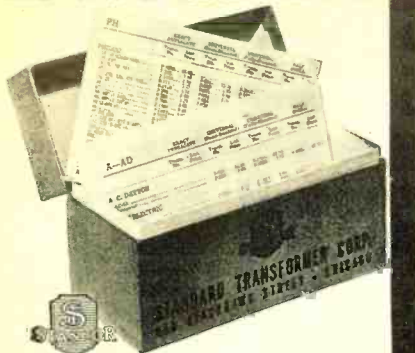

REPLACEMENT

TRANSFORMER GUIDE

Don't hunt through page after page of catalogs for the right transformer for that replacement job—all the information is here, printed on cards in a handy card file—listing the right transformer for any receiver. It's FREE to users of Stancor Transformers. Mail the coupon.

SEE OUR EXHIBITS

Booth 2, IRSM SHOW, Sept. 18-20
Hotel Pennsylvania, New York
Booth 34, AMATEUR RADIO SHOW, Sept. 5-7
Hotel Sherman, Chicago

MAIL THIS COUPON

STANDARD TRANSFORMER CORP.
Dept. D, 866 Blackhawk St., Chicago, Ill.
Please send me Stancor Replacement Guide.
 I am enclosing Stancor Box Top or
 I am enclosing 25 cents to cover mailing cost.
Name.....
Address.....

LEARN CODE

the way you'll be using it

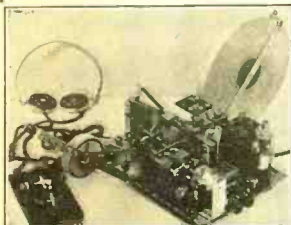

by
SOUND

There is only one way to learn to read code and that is by listening to code. There is only one way to learn to send code and that is by hearing your own sending repeated back to you. With the Master

Teleplex Code Teaching Machine you learn code the natural, easy, fascinating way. Only instrument ever produced which records your sending in visible dots and dashes—then SENDS BACK your own key work at any speed you desire. We furnish complete course, lend you the All Electric Master Teleplex, give you personal instruction with a MONEY BACK GUARANTEE—all at a surprisingly low cost per month. Write today for FREE catalog R.N.10. No obligation.

"HAM" SPECIAL STANDARD TELEPLEX CO.

A highly efficient code teacher using specially prepared waxed paper tape, having two rows of perforations. Write for free folder "R.R.10."

We are the originators of this type instrument
TELEPLEX CO.
72-76 Cortlandt St., New York City
TELEPLEX—The Magic Key of the Air Ways

Save Dollars on Radios

30 DAY TRIAL
Many models to select from. Factory prices.
A.C. - D.C. All Wave, farm, car and new metal tube models.
Public Address and Communication System. Send for new 1936 bargain catalog free.
Autocrat Radio Company
385 North Hamilton Avenue
Dept. 501 Chicago, Illinois

all mixers, controlled from one single, master, crystal-controlled oscillator. Consequently it is necessary that all of the intermediate amplifiers and the second and third detectors employ variable tuning. Using the circuit as described up to this point covers tubes V1 to V9 inclusive, and comprises the r.f. portion of the 20-meter circuit. The two-stage audio portion of the 1-10 receiver is normally coupled to the output of detector No. 3.

It was thought worthwhile, as this is an experimental receiver, to make still another combination available. It will be noticed that the twelfth harmonic is selected from the crystal frequency, then amplified and mixed in the third detector to produce a frequency in or near the 10-meter band. For obtaining this combination, simply throw Switch 4 off normal and connect the link coupling from the tapped choke to the input binding-posts of the 1-10 portion of the receiver. This combination adds an inherent a.v.c. action of the super-regenerative detector.

For operation on 10 meters, two combinations are available, and this also applies to any signal from 10 meters down. The 1-10 receiver with a suitable antenna connection to the input binding posts of the 1-10 portion, can be operated straight through, which consists of one stage t.r.f., a superregenerative detector followed by two stages of audio. The superregenerative detector circuit, even with a tuned r.f. circuit before it, does not have too great selectivity, although the sensitivity is sufficiently high for receiving distant stations at good signal strength. In this particular receiver the selectivity of 10-meter signals may be very greatly increased by making use of the following combination. V24 is an ultra-high, variable-frequency oscillator, electron-coupled to the detector circuit in V25. An inspection of the circuit diagram of the 1-10 portion of the receiver or of the actual 1-10 receiver will show that there is a tap for regeneration on the grid coil of the 955 acorn tube. The points X, Y and Z may be opened up in the 1-10 and a link circuit, as indicated, may be connected at points X and Y so that the incoming 10-meter signal, after passing through the 954 amplifier tube is applied to the mixer circuit, V25, and heterodyned by V24, preferably to a 20-meter frequency, then taking the audio from V6. Further selectivity may be obtained by using regeneration in V5 or by switching in the crystal filter and tuning V24, since the crystal demands a fixed intermediate frequency.

Five-meter signals may be handled in an identical manner.

In the first experimental model that we developed, there was included a regenerative, dynatron filter circuit, to be used similarly to a crystal-filter circuit. This circuit works well and has wonderful possibilities, but it was found, however, to be somewhat tricky in operation. (See the basic idea in Figure 2.) Its action is similar in some respects to the crystal filter and is tuned and phased in like manner. Originally it was built in a shielded can with the same physical dimensions as the crystal-filter circuit, and was intended to be plugged in, as was also the crystal filter. You can have a lot of fun experimenting with it and maybe you can whip the bugs out of it. If we do we'll let you have it in another story.

A view of completed receiver is shown at heading of this description.

Before going much farther, you had better take a look at the complete circuit of the entire receiver, shown in Figure 1. Note that the crystal circuit is in the t.r.f. section as was originally, the dynatron filter. With the crystal, this seems to re-

strict the filter to the 20-meter band and one frequency at that, whereas, the dynatron filter was tunable over the whole band. The point is this: You are not going to have lots of QSO's with everybody in the band. Also the selectivity of this receiver is so good that you can work (ordinarily) with no filter! There will be, however, certain friends and acquaintances with whom you want to work at any time. OK. Have made up 20-meter crystals to correspond with those with whom you want to carry on day-in and day-out contacts. With the right crystal, you don't even have to line up the crystal in the amplifier. You just shove it in, and tune to that frequency. A flip of the crystal switch puts the crystal filter in circuit or out. Note that such resonator crystals for the receiver should be ground about .5 per cent lower in frequency than the twin crystal to be used at the transmitting end of the circuit.

The Crystal on 10

However, when you are working from 10 meters and down, and the ten meter section is switched for super-het operation in place of super-regeneration operation, the crystal in the normal t.r.f. section of the receiver, then becomes a filter in intermediate section for ten meters or less.

Note that with triple and sometimes quadruple detection, the problem of three absolutely stable oscillators is solved by the use of a fundamental crystal-controlled oscillator on 2658 kc. and then picking out various harmonics and amplifying as necessary. Thus every heterodyning oscillator voltage "stays put" in its relation to the various detectors. (See details of crystal oscillator in Figure 3.)

The a.v.c. circuit is conventional, but seems to maintain very good control even on very weak signals, and on phone even in the presence of a very strong adjacent signal, the a.v.c. keeps control, due primarily to the high order of selectivity of the receiver, especially in the 20-meter band. However, in case of necessity, the a.v.c. can be switched off, as there are cases of a very weak signal to be received, with a very strong one right on top.

Multi-detection

Let us consider for a few moments, part of my reasons for the multi-detection circuit. In my experience most selectivity curves of intermediate or other radio frequency amplifiers show a slight dissymmetry. (See Figure 4) that is, one can notice that one side of the curve seems much steeper than the other. Advantage of this effect is taken by using triple or quadruple detection, as when the whole receiver is used on 20 meters, for example.

By so selecting the beating frequencies from the oscillator and oscillator amplifier sections, the carrier, as it goes through the receiver, is in effect filtered steeply on one side, then the carrier is in effect "turned over" and filtered steeply on the other side and so on over again on the third frequency change (and the fourth if used). Notice the diagrammatic representation of this steepening of the sides as the carrier progresses through the receiver, in Figure 4.

In my opinion this results in very steep sides in the over-all selectivity curve with its attendant advantages of razor-like selectivity, without the terrific side-band cutting of the crystal filter. Fixed bias voltages for the grids are used on all the mixed or detector tubes. This results in additional gain and in this circuit really encourages stability.

Next month Mr. Jones continues his description of this really remarkable receiver in more detail—Editor.

The GC-2

(Continued from page 211)

with the antenna but, if the antenna is cut to resonate at 58 megacycles, we still have plenty of radiation at either 56 or 60.

While we are using approximately 200 volts, plate voltages between 135 and 300 will be satisfactory but the drain on the "B" batteries, when voltages in excess of 225 are used, is not warranted because of the increased cost of operation. It has been found, that, even with the high voltages it is practically impossible to over-modulate the oscillator. This, combined with reasonably loose coupling between the oscillator tank circuit and the antenna coupling coil, as well as the use of a modulation choke which is greatly oversized, results in the production of good tone quality.

While the details of the circuit and the

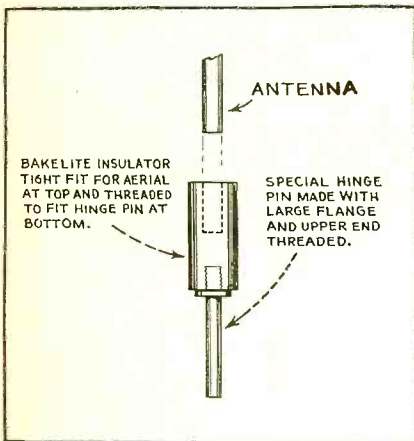

layout, which is well shown in the accompanying pictures, are extremely simple, they are the result of much experiment and it would be well to follow this layout as accurately as possible. Since the entire list of parts for this transmitter can be had for a very low price we suggest the use of nothing but the best. This is particularly advisable where the transmitter is likely to be employed for marine use. We have employed one of the small vernier dials for tuning the oscillator tank as specified. In addition to providing a check on the frequency on which we are operating this vernier dial is desirable for mobile use because it eliminates the possibility of the tank condenser shifting as a result of vibration.

The microphone transformer has been set up on stilts in order to provide room for the by-pass condensers C3 and C4, and to reduce the length of leads. The tank condenser has also been set back from the front panel so as to make room for several of the smaller components as well as to isolate the entire tank circuit from the can itself. The rotor plates of the tank condenser are isolated from the front panel by means of the type TX-10 flexible coupling unit and a short piece of 1/4-inch bakelite shafting which is used to connect the coupling at the center of the dial.

The two halves of the tank circuit are spaced at the center so as to make room for the introduction of the 2-turn, antenna-coupling coil. The only connections it is necessary to make in order to put the transmitter in operation include the Giant-Killer cable which is attached to the feed-through insulators on the front panel and the 4-foot length of 3-conductor, shielded, rubber-covered, microphone cable which is permanently attached to the transmitter

and brought out the rear of the case through a rubber grommet. It is desirable to provide a 4-prong plug at the end of this cable so that the transmitter can be removed from the car or boat at a moment's notice.

Several years of portable-mobile operation have convinced me that there is a lot to be said for the generous use of lock washers in transmitters for this type of operation. They will give much less trouble if, also, they are mounted on 1-inch sponge rubber to absorb shocks.

A look at the circuit diagram of the transmitter will indicate its simplicity. It will be seen that a single button microphone is fed through the transformer T-1 into the grid of the 2A5 modulator tube. Here we come to a point of interest as few operators who have built portable-mobile units have attempted to modulate without the incorporation of at least one stage of speech amplification in their transmitters. Of course, such a stage could be added to this transmitter but it is unnecessary and might bring about difficulties which are not experienced at present.

We have avoided the use of 6-volt tubes for the reason that using them would mean that they would have to be connected in parallel and thus the filament drain would be the sum of the drain of each of the tubes employed. In this case the drain of the 2A5 is 1.75 amperes and the normal drain of a 45 would be 1.50 amperes. In order to provide full filament current for the 2A5 it is simply necessary to add a shunt resistor across the filament terminals of the 45 so that it, too will pass 1.75 amperes. We have found that the simplest procedure for this connection is the use of a 5-ohm, 10-watt, adjustable, wire-wound resistor. Since both of the tubes are designed for 2 1/2-volt operation, placing them in series indicates a filament voltage of 5 volts. In order to increase the resistance of the filament circuit so that the 6-volt battery in the car can be employed, a radio-frequency choke, shown in the circuit diagram as RFC-2 is employed. This choke provides another beneficial effect. It also acts as a filter in cutting out any radio-frequency feed-back from the oscillator as well as pick-up from the ignition system. In our own transmitter the condenser C5 was not used and it may not be necessary unless ignition noise modulates the transmitted carrier. Where such a condenser is necessary the polarity must correspond to the car battery.

The accompanying list of parts, with the suggestions that it contains, should be all the additional information that is necessary for the duplication of this transmitter. The details of the installation in our own car are shown diagrammatically and it is quite likely that they will be helpful to others in making a suitable layout. We have found the specified cable to be highly satisfactory, where long leads are necessary for coupling the transmitter or the receiver to the antenna as well as for use in those d.c. circuits where ordinary wiring would be subjected to wear or to the disintegration caused by oil and grease. The mounting of the triangular bakelite insulator on the front dash is a great convenience and the switch at the left controls all of the filaments while the switch at the right is used to throw the plate supply from the transmitter to the receiver.

Parts List for the GC-2 Transmitter

- R1—1.R.C., 50,000 ohms, 1 watt
 - R2—Electrad, 5 ohms, 10 watt, adjustable wire wound
 - R3—1.R.C., 7,000 ohms, 1 watt
 - R4—1.R.C., 600 ohms, 1 watt
 - R5—1.R.C., 100 ohms, 1 watt
- (Turn to page 254)



FREE
Centralab
HANDY
Fixed Resistor Rack

is yours absolutely FREE with a SPECIAL DEAL consisting of 20 1 1/2 watt 316 type and 20 1/2 watt 310 type CENTRALAB RESISTORS.

The RACK is of heavy sheet metal and will give years of service. The R.M.A. Color Chart is in full colors. Write for descriptive information today.

Centralab

MILWAUKEE, WIS.

British Centralab, Ltd. Canterbury Rd., Kilburn London N. W. 6, England	Centralab 68-70 Rue Amelot Paris, France
---	--

NEW ALL-WAVE

DOUBLE DOUBLET

PYRAMID ANTENNA

EVERYTHING THAT YOU NEED PACKED IN INDIVIDUAL CARTON

ONE-ROOF JOB :: SAVES TIME & SPACE

Better than any straight-line aerial! Compact, easily installed, one-roof mounting, non-directional pick-up, noise-reduction transmission, peak signals on short-wave. Kit fully assembled with 7-foot PREMAX Adjustable Tubular Steel Mast. At your dealers or sent prepaid for \$5.95. Catalog.

PREMAX SALES, Chisholm-Ryder Co.,
3805 Highland, Niagara Falls, N. Y.

RADIO

biggest opportunities still ahead

ALMOST in a decade radio has become a giant industry. The opportunities created will be enjoyed by trained men. The International Correspondence Schools Radio Course, prepared by leading authorities and constantly revised, will make you a trained man! A fascinating book—free.

INTERNATIONAL CORRESPONDENCE SCHOOLS

Box 8282-R, Scranton, Penna.

Send me—free—information on subject checked:

<input type="checkbox"/> Radio	<input type="checkbox"/> Radio Service Man
<input type="checkbox"/> Radio Operator	<input type="checkbox"/> Electrical Engineer

Name.....

Address.....

BIGGER VALUE

CHECK THE NEW C-D PRICE SCHEDULE

You will find that we have made it possible for you to buy C-D quality condensers at an average saving of ONE THIRD.

We've had to increase our factory space, our production machinery, our payroll, to take care of the demand for C-D paper tubular condensers. With increased production came closer production control, greater efficiency and lowered costs.

Naturally, we pass this saving along to you who have made it possible by your enthusiastic acceptance of C-D products.

NEW "DWARF-TIGER" LIST PRICES		
.1 Mfd.	400 Volts	\$.20 List
.25 Mfd.	400 Volts	.25 List
.5 Mfd.	400 Volts	.35 List
.1 Mfd.	600 Volts	.25 List
.25 Mfd.	600 Volts	.35 List
.5 Mfd.	600 Volts	.50 List
1. Mfd.	400 Volts	.50 List

Your local jobber now has complete listing.
 NEW PRICES—CATALOGUE 132A ON REQUEST
 CORNELL-DUBILIER CORP. 4387 Bronx Blvd., N. Y.

CORNELL DUBILIER

The Service Bench

(Continued from page 230)

banquet mike shown at the extreme left is part of the enterprise's P. A. equipment.

THE DAY'S WORK

The fact that antenna and ground wires have a way of cluttering up the service bench will hardly be news to most servicemen. The pulley and weight arrangement finds favor with many operators. However, J. E. Haynes, of Robertson and Haynes Radio Service (Philco dealers), Manchester, Ga., suggests going above the bench rather than below it. Mr. Haynes' device is illustrated in the drawing of Figure 2, which is fairly self-explanatory. An ordinary shade roller has been cut down to a total length of about fourteen inches. It must, of course, be cut down from the end opposite the spring. It can be mounted on the wall, under a shelf, or on the ceiling with the usual brackets. The rings are made from 3/4 inch wide strips of copper soldered around the roller so as to provide a smooth wiping contact against the brushes which were made from springs removed from discarded condenser rotors. (Off-hand, we can't think of any really good reason why the rings and brushes could not be dispensed with, and the leads soldered to the end pieces. The antenna and ground, of course, would connect to the brackets.—Editor.)

A Symposium on Majestics

"Servicing the Majestic 70-90 and 100 models. If when the set is turned on the pilot light drops far below normal brilliancy, either the rectifier tube or the power-pack is shortcircuited. Heavy current drawn as the result of a short-circuit, causes a high IR drop across the ballast tube in series with the primary of the transformer, with all voltages affected."—E. Scribner, Schoharie, N. Y.

Mr. C. W. Johnson, of Morris, Oklahoma, sends in the following which is equally applicable to other sets of similar vintage: "A model 92 Majestic was brought into the shop recently with the complaint of fading and noise. Everything checked okay—tubes—voltages—coils. But still the fading. I took the bottom off and examined the tube sockets. On one side there are four 27s in a row—three r.f. and one detector. The 5-point sockets all depend upon a horseshoe-bent spring for contact. These were so badly corroded that some of them fell apart when touched with the screw-driver. Upon replacing these four sockets with new ones the set functioned perfectly."

Majestic 70s and 90s

"Intermittent frying sounds: Replace ballast resistor, or re-clamp the resistance wire to the rivets."—S. Solway, Monticello, N. Y.

Majestic 15 and 55

Morris Chernow, Brooklyn, N. Y., sends

FIGURE 3

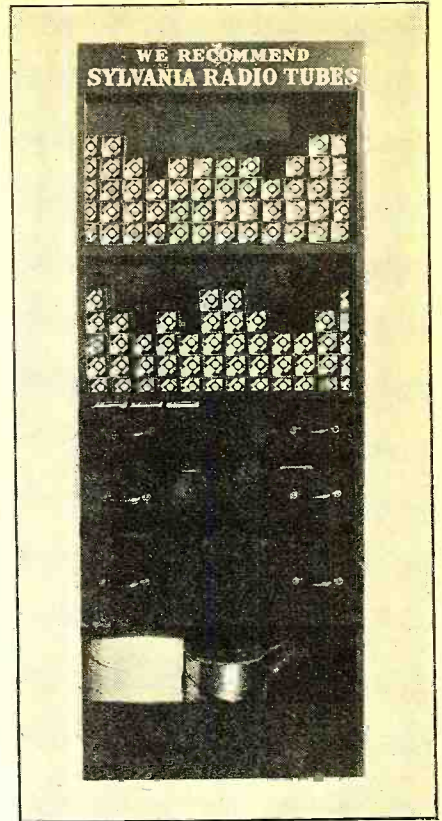

FIGURE 4

us the following dope on increasing the sensitivity of these models: "In these two models of Majestic sets, the antenna feeds into a preselector circuit. Loss of sensitivity, despite re-alignment and other attempted remedies, seems to be a common ailment with these sets. The only way I have found to restore the original sensitivity is to connect a fixed condenser of about .0005 mfd. between the two stator sections of the gang condenser. In other words, the condenser is connected between the grid of the first tube and the secondary of the pre-selector coil. This kink is both simple and effective, and permits the set to be realigned better than ever!"

Mr. Chernow also sends along the following data on a—

Pontiac 544267

"In this auto set, failure of the oscillator to tune over the entire range, especially on the low frequencies, is due to a change in

Transformer Replacement Guide

A very helpful addition to the busy serviceman's kit is the new "Stancor" transformer replacement card file. The guide covers practically every commercial receiver made and the efficient listing on each alphabetically filed card enables the serviceman to have at his finger tips information and prices on the correct transformer for any type of replacement job.

The Standard Transformer Corp. offers this guide free to the users of Stancor transformers. To obtain one free, it is only necessary to send in a top of a Stancor box. Without the box top, the file is available for 25c to cover mailing cost. Address request to RADIO NEWS, 461 Eighth Avenue, New York City.

HOW TO Make More Money IN RADIO SERVICING

Hundreds of money-making ideas tested and used successfully by the leading servicing organizations in the country. Practical up-to-the-minute repair methods, instruments test methods, repair methods, etc., etc.—the only book in the world that explains everything you need to know about modern radio servicing. It's the Serviceman's Book of Field Data Supplement Book there are over 1500 pages crammed full of data you can use today. Read "Selling Service" by Ghirardi and Ruggles in *Aug. Radio News*.

A. A. Ghirardi's "MODERN RADIO SERVICING"

and Supplement "RADIO FIELD SERVICE DATA" \$5.00

SEND TODAY! RADIO & TECHNICAL PUBL. CO. 45 Astor Place, N. Y. C. Dept. RN-106

OHMITE noiseless WIREWOUND RESISTORS

Use WIREWATT in place of 1 watt composition units. They are wire-wound—no noise or fluctuation in value with temperature changes. Ask your dealer or write

OHMITE MFG. CO.,
4840 Flournoy St. Chicago, Illinois

A New Service Contest

WITH this issue, RADIO NEWS announces another popular servicemen's prize contest with five cash prizes of \$10, \$5, \$5, \$3 and \$2 for good photographs of service activities accompanied with full details. Other illustrative material, such as clever advertisements, sales literature, etc., may be entered. The subject matter may be your Service Bench, a novel Window or Counter Display, a Sales Campaign, Publicity Stunt, a successful P. A. Set-up, etc. All material used, other than that of prize-winning caliber, will be paid for at our usual rates. Prize winners will be announced in the November issue. Send your contribution to—

Yours for better servicing,
THE CONTEST EDITOR.

the capacity of the fixed padding condenser, employed in the oscillator circuit. The only remedy is replacement with an identical capacity secured from the United Motors Service, as the capacity value is critical, and is not easily duplicated among the common range of condenser values on the open market."

Stewart Warner Auto Radio

"A late model, installed on a Ford, 1935, V8. The complaint was severe motor noise, and several other radio repair shops had given up in disgust. We found that by shielding the wire from the dial to the set, and grounding the shield, that the motor noise was practically eliminated. The interference could be noticed only with the volume full on and between stations."—J. O. Roberts, Roberts Radio Service, St. Louis, Mich.

While on the matter of automobile radio it might be well to point out that the new auto-pole type of antenna is the solution to many of the serviceman's problems with such sets. These serials can be almost instantly mounted on the rear bumper bracket of any car. Extended they provide up to eight feet of vertical antenna, which means effective height and which in turn means taking advantage of "microvolts-per-meter." Mounted far aft of the motor, there is less pick-up of ignition interference which still further increases the signal-to-noise ratio. Operated with a transmission line or shielded lead-in and properly designed transformers, at both antenna and set terminals, a highly efficient noise-reduction antenna system can be had.

There are thousands of auto-radio owners who are not satisfied with the purely local reception from a few stations to which they are limited by the older types of antenna systems in modern cars. This

STANCOR FILE BOX

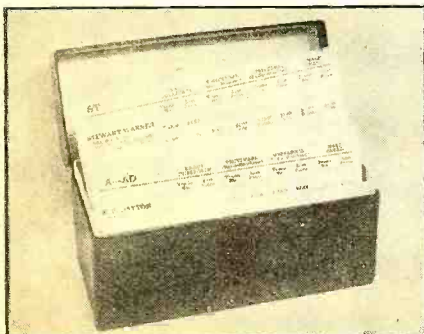

means profits to the serviceman who will circularize such potential customers with the promise of improved auto radio reception.

About the only sales resistance encountered has been an objection to the appearance of the rod antenna. However, this has been largely overcome by chromium plating and a psychological revision as a result of their common use during the last three months. Telescoped, such auto poles extend about two feet above the rear bumper.

Zelton

"I replaced an 80 tube in a Zelton (746 and 747) recently. A week later the electrolytic condensers went 'haywire.' This is not an uncommon experience with these receivers. The best policy to follow is to replace the condensers whenever a new 80 is installed."—J. L. Hoard, Providence, R. I.

As a matter of fact, it is always a good idea to check the electrolytics when replacing rectifying tubes—particularly if the rectifying tube has been short-lived. The check is best made on a capacity bridge, such as the Tobe or Solar, and measure the power factor of the condenser. Power factors in excess of .05 indicate deterioration and anything over .2 certainly should not be used for filtering purposes in a power supply.

SERVICE NOTES

There is every indication that the manufacturers are extending their co-operation to the radio servicemen, particularly in the direction of sales resistance. Some of the old timers will have no difficulty in recalling the days when the serviceman couldn't get a wiring diagram—let alone a boost on the service sales end. Figure 3 shows Philco's (RMS) flashing sign for the counter or window display. Sylvania is co-operating with the handsome steel shelf and cabinet combination shown in Figure 4. It is designed to hold a full stock of replacement tubes on the two shelves, while there is adequate space for other parts and equipment in the different size drawers and the large bin at the bottom. Available to servicemen from their jobbers at cost.

Television Motor

(Continued from page 214)

lines, and from 12 to 60 frames-per-second. These, Mr. Peck believes, represent the extremes likely to be encountered within the next few years.

Besides automatic synchronization with all television broadcasts, other advantages claimed for the Peck system are more brilliant images on the screen, a larger screen (about 20 by 24 inches), simpler tuning, lower replacement costs, and greater freedom from high voltages than are possible with other systems.

Mr. Peck, who has been prominent in the optical industry since 1907, has been devoting his attention to television for the past seven years. Among his inventions in this field are the compact light-modulator cell, the 1440 r.p.m. synchronous motor, the hemispherical reflecting lens, and the spheric reflector, which increases the light available from a standard source by about 600%.

Television In France

Paris, France—The antenna power of the Eiffel Tower television station has been increased from 1 kw. to 10 kw. It is estimated that this will insure a service radius of 70 kilometers. A number of French manufacturers are now making television receivers.

MORE THAN
3,000,000
RADIOS, NOW IN USE,
HAVE UTAH PARTS AS
ORIGINAL EQUIPMENT

FOR THE PAST FIFTEEN YEARS, UTAH HAS BUILT THE BEST SPEAKERS, VIBRATORS, TRANSFORMERS, CHOKES, VOLUME CONTROLS, TONE CONTROLS, RESISTORS, JACKS, JACK SWITCHES, PUSH BUTTON SWITCHES AND PLUGS. USE GENUINE UTAH PARTS! WITH ONLY TWENTY MODELS, UTAH CAN SUPPLY REPLACEMENT SPEAKERS FOR PRACTICALLY ANY MAKE OR MODEL OF RECEIVER! VISIT OUR EXHIBIT AT: R. S. M. SHOW, BOOTH 35, HOTEL PENNSYLVANIA, SEPTEMBER 18, 19, 20.

PART OF THE HUGE PUNCH-PRESS LINE IN THE UTAH FACTORY WHERE THE STURDY, RIGID SPEAKER FRAME AND BASKETS ARE FABRICATED

15 YEARS OF LEADERSHIP

RADIO ENGINEERING

RCA Institutes offers an intensive course of high standard embracing all phases of Radio. Practical training with modern equipment at New York and Chicago schools. Also specialized courses and Home Study Courses under "No obligation" plan. Catalog Dept. RN-36.

RCA INSTITUTES, Inc.
75 Varick St., New York 1154 Merchandise Mart, Chicago
Recognized Standard in Radio Instruction Since 1909.

POCKET TROUBLE SHOOTER **25 CENTS**

Buy this ingenious servicemen's reminder and time-saver. Take it with you on all your service calls.

Radio & Technical Publishing Company
45 Astor Place, New York City, Dept. RN-106

The GC-2

(Continued from page 251)

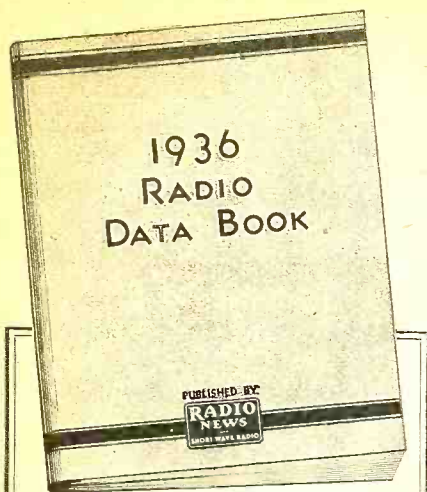

1936
RADIO
DATA BOOK

- C1—National, UM25, double spaced, midjet condenser
- C2—Aerovox, 250 mmfd., mica
- C3—Aerovox, .5 mfd., 400 volt, tubular
- C4—Aerovox, 10 mfd., 25 volt, electrolytic
- C5—Aerovox, 25 mfd., 25 volt, electrolytic
- T1—Thordarson T2357, microphone to grid transformer
- CH—Thordarson T6807, modulation choke
- RFC1—1 1/4" winding on 3/4" bakelite rod, No. 30 DCC copper wire, painted with National coil dope
- RFC2—Approx. 100 turns No. 28 DCC copper on 3/8" Bakelite rod, painted with coil dope
- L1—6 turns No. 12 enamel on 3/8" inside diameter, spaced 1 diameter, 4 diameters in center to allow for L2
- L2—2 turns No. 14 enamel, 1/2" I.D., spaced 1 dia.
- I—Yaxley open circuit midjet jack
- SW1, SW2—S.P.S.T. toggle switches
- S1—National, 4 prong, isolantite socket
- S2—National, 6 prong, isolantite socket
- M—Midget, porcelain, feed-through insulators
- D1 National type BM dial
- Bud can
- National coupling, flexible, TX10
- short length 1/4" bakelite rod, to go from TX10 coupling to dial

NOTE: All r.f. wiring No. 14, solid, enamel, with leads as short as possible (do this first). Remaining wiring done with No. 18 push-back wire. Some units do not correspond to parts list, because those used happened to be available. Tank coil L1 mounted directly to tank condenser, L2, on lugs provided and entire assembly mounted away from metal panel with spacers.

flashes across her mind. "I wonder who it is. What's he look like," etc., are her thoughts. With these in mind, she opens the door and there *you* are standing (with your hat in your hand, let us hope). She sizes you up at a glance. If she is greeted by an individual with dishevelled hair, unkempt clothes, soiled shirt and dirty hands, her immediate reaction is to say "No"—no matter what his request may be. On the other hand, if she is greeted by a cheery smile from a gentleman who looks clean, neat and business-like, she is much more inclined to at least listen to his story.

If you go out on a service call, there's no excuse for soiled clothes, dirty hands, etc. Enter the home in your business suit, but carry a pair of unionalls or a service coat along with you in your car. If you find the job is going to get you dirty, slip these temporary work clothes on in the home. It takes but a moment. And don't let these work clothes get too soiled before you have them laundered. It is a good plan to carry a piece of plain cotton cloth about 24x36 inches along with you. Then if you *must* lay the dusty set chassis (or your tools) out on the living-room rug, you can put this cloth under them.

Be Courteous and Speak Well

Make it your business to be courteous to your trade—no matter how tired you may be, or how trying a customer may be at times. Answer all questions politely—don't be brusque, smart or flip. Use good English. If something goes wrong and you *must* swear, think it to yourself.

If all servicemen would strive to put all of these things into practice, the entire profession would be held in higher esteem by the general public. You may well look to your local physician as an example of how you should conduct yourself professionally when you are in the homes of your customers. Be cheerful, be friendly, but also be neat, considerate and dignified! And educate yourself to give expert, reliable, technical service. Be the *best* serviceman in your community! Then you can feel justified in asking reasonable and profitable rates for your service work—and your customers will praise you and won't complain.

BEE!

1936 Radio Data Book Given Free to Readers Placing Subscription for 5 Months Radio News at \$1

Even a casual glance at the partial list of contents given below will prove, beyond a doubt, that the 1936 Radio Data Book is one of the most useful radio volumes ever published. It is a large 8" by 11" book—with over 120 illustrations, charts and hook-ups—crammed full of worthwhile information. Get your free copy now by placing a subscription for 5 issues of RADIO NEWS.

Partial List of Contents

Here are a few of the dozens of articles: Disk vs. Cathode Ray Television Systems—Description and Characteristics of Metal Tubes—S-W Reception Aids and Charts—S-W Circuit Design—Constructional Details on S-W Receivers—Amateur Transmitters, Receivers and Transceivers—Transmitting Tubes—Broadcast Receivers—S-W Converter—Trap-Circuit Tenatuner—DX Converter—Cathode-Ray Oscillographs—P. A. Systems—Service Sales Tips—Engineering Design—Hints and Kinks—and plenty of other worthwhile information. Mail the coupon with your remittance today!

Radio News

Radio News, Dept. 3610
461 Eighth Ave., N. Y. C.

Enclosed find \$1 (Canada and Foreign \$1.25) for five issues of RADIO NEWS. Send me the 1936 Radio Data Book without cost.

Name.....

Address.....

City.....State.....

Selling Service

(Continued from page 226)

psychology behind the average housewife's response to a door-bell ring. Just put yourself on her side of that door mentally. Picture her at home doing one of the hundreds of things a housewife has to do around the house every day. The door-bell rings! Very likely she is disturbed by it and comes to the door grudgingly. "Darn it, I wonder who that is." "What does he want anyway." "Every time I start to do something either the phone or the door-bell rings"—etc., etc., are some of the thoughts that flash through her mind. She gets to the door and for a split-second the inevitable woman's curiosity

INDEX TO ADVERTISERS

Acme Specialty Co.....	248	Million Radio & Television Lab.....	242
Aerovox Corp.....	246	National Radio Institute.....	193
Aladdin Radio Industries, Inc.....	241	National Schools.....	246
Allied Radio Corp.....	197	National Union Radio Corp.....	235
American Transformer Co.....	234	New York YMCA Schools.....	248
Autocrat Radio Co.....	250	Ohmite Mfg. Co.....	252
Bendix Products Corp.....	198	Pacific Radio Publishing Co.....	248
Birnbach Radio Co., Inc.....	244	Pioneer Gen-E. Motor Corp.....	248
Brush Development Co., The.....	232	Premax Sales Division.....	251
Burstein-Applebee Co.....	232	RCA Institutes, Inc.....	253
Cameradio Co.....	249	RCA Manufacturing Co.....	230
Candler System Co., The.....	238	Radio City Products Co.....	256
Capitol Radio Engineering Inst.....	240	Radio Service Inst.....	230
Central Radio Laboratories.....	251	Radio & Technical Publishing Co.....	252, 253
Chicago Wheel & Mfg. Co.....	238	Radio & Television Institute.....	245
Classified Advertisements.....	256	Radio Training Ass'n of America.....	235
Cornell-Dubilier Corp.....	232	Kadolek Co., The.....	255
Cornish Wire Co., Inc.....	236	Readrite Meter Works.....	233
Coyne Electrical School.....	255	Rider, John F.....	242
Dodges Institute.....	244	Scott Radio Labs., Inc., E. H. Silver Corp., McMurdo.....	195 Inside Back Cover
Electrad, Inc.....	242	Solar Mfg. Corp.....	244
First National Television, Inc.....	236	Sprayberry Academy of Radio.....	249
General Electric Co.....	Inside Front Cover	Standard Transformer Corp.....	250
Goldentone Radio Co.....	249	Teleplex Co.....	250
Hallcrafters, Inc.....	199	Triad Manufacturing Co., Inc.....	237
Hammarlund Mfg. Co.....	241	Tri-Jay Products Co.....	240
Hetro Electrical Industries.....	234	Triplett Electrical Instrument Co.....	247
Hygrade-Sylvania Corp.....	243	Tri-State College.....	232
Instructograph Co.....	246	Try-Mo Radio Co., Inc.....	237
International Correspondence Schools.....	251	Tung-Sol Lamp Works, Inc.....	238
Johnson Transformer Co.....	236	United Sound Engineering Co.....	244
Kato Engineering Co.....	246	United Transformer Corp.....	241
Ken-Rad Corporation, Inc., The.....	232	Utah Radio Products Co.....	253
Lincoln Engineering School.....	242	Webster Co., The.....	237
McElroy, T. R.....	238	Weston Electrical Instruments Corp.....	239
Mallory & Co., Inc., P. R.....	200, 231	Wholesale Radio Service Co.....	229
Midwest Radio Corp.....	Back Cover	Wright DeCoster Co., Inc.....	240
		Zephyr Radio Co.....	246

What's New

(Continued from page 245)

odyne receiver covering a tuning range from 540 to 6,500 kc. The tube equipment comprises one 6A7, one 78, one 75, one 43 and one 25Z5, rectifier.

Easily Installed Car Antenna

The Ward Products Corp recently introduced a new motor-car radio antenna known as the model 4RC streamline single aerial. The complete unit is sealed in leak-

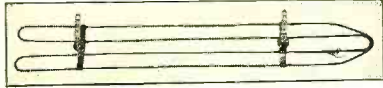

proof rubber, has a molded lead wire connection, and features quick and easy installation.

Correction

In the August issue of RADIO NEWS, on page 126 there is a description on a new line of a.f. transformers as manufactured by Ferranti Electric, Inc. Unfortunately, due to a typographical error, the article reported the frequency response curve as plus or minus 1½ db. It should have read plus or minus ½ db. from 30 to 16,000 cycles.

Precision Amplifier

(Continued from page 228)

Bias for the grid of the 75 is conveniently supplied by the new miniature Mallory grid-bias cells. Two cells provide approximately the rated 2 volt bias for this tube, which cannot be obtained with the usual type of dry battery without additional apparatus. The use of battery bias is necessary in order to keep the cathode at ground potential and also to increase the low frequency gain.

The diode section of the 75 is connected to the 500 ohm winding of the output transformer. A 15,000 ohm current-limiting resistor keeps the load on the circuit at a low value. In operation, current flows through the meter during the positive half-cycle only. If desired, the meter may be calibrated in db. or in volts, using preferably, a tube voltmeter or a copper-oxide type a.c. meter.

In wiring this instrument, the input grid should be carefully shielded to keep hum pickup at a minimum. In using this apparatus, shielded and grounded cable should be used between the two units and also for the output leads from the amplifier. The output transformer should connect to its rated load. When connecting a high impedance load to the output terminals the switch should be set at point 5 or the 500 ohm line should be loaded by connecting a 500 ohm resistor across it. In testing a speaker, make certain that it is mounted on a baffle, preferably in the cabinet in which it is designed to be used. After adjusting the volume control to the desired output level as indicated on the meter, it may be desirable to disconnect the meter. Otherwise, the minute current drawn by the diode will slightly load the positive half-cycle of the wave causing slight distortion which may be barely detected by a keen ear. This effect is negligible for all ordinary testing.

The heater supply for the b.f. oscillator tubes may be drawn from the power transformer without exceeding its rating.

Parts List

C1—Aerovox tubular fixed condenser, 0.1 mfd., 400 volt

- C2, C5—Aerovox electrolytic condensers, type GGL-5, 8-8 mfd., 525 volt (peak), both in same can
- C3, C4—Aerovox electrolytic condensers, type GGL-5, 8-8 mfd., 525 volt (peak), both in same can
- R1—Yaxley volume control, type N, 500,000 ohms
- R2—I.R.C. metallized resistor, 15,000 ohms, 1 watt
- R3—I.R.C. metallized resistor, 0.1 megohm, ½ watt
- R4—I.R.C. metallized resistor, 0.1 megohm, ½ watt
- R5—I.R.C. metallized resistor, 0.5 megohms, ½ watt
- R6—I.R.C. wire wound resistor, type PB, 5,000 ohms, 10 watts
- M—Weston, model 301, 0-1 ma., d.c., milliammeter
- Ch—Stancor filter choke, type XV1410, 20 henries, 100 ohms, 175 ma.
- T1—Stancor power transformer, type XP-3001, pri. 105-115 v. sec. 6.3 v. 2.5 a., 2.5 v. 3.5 a., 2.5 v. 3.5 a., 5 v., 3 a., 350 v. 100 ma., all secondaries center-tapped
- T2—Stancor output transformer, type NA-3304, sec., 4, 8, 15,500 ohms
- 1—Hammarlund tube shield.
- 1—ICA steel cabinet, type 3829, 12 x 11 x 8 inches
- 1—ICA blank steel chassis, type 1531, 11 x 7½ x 2½ inches
- 1—ICA toggle switch, single pole, single throw
- 1—Yaxley single gang switch, single circuit, 1 to 6 points
- 1—Yaxley etched plate, marked 1 to 6
- 2—Mallory grid bias cells
- 1—Grid bias cell holder (for 2 cells)
- 2—Lug terminal strips
- 1—Twin pin jack strip
- Push back wire, cord and plug, screws, nuts, etc.
- 2—Eby twin binding post assemblies

Linear Oscillator

(Continued from page 207)

and grid shorting bars to get the right frequency and then to move the antenna clips up and down to obtain the proper degree of antenna coupling. These antenna clips are those shown connected to the two .002 mfd. condensers that lead through the feeders to the antenna. For 5-meter work I use either a Johnson "Q" or a matched impedance antenna.

The wiring diagram for the linear oscillator is self-explanatory, as I have already described all that is necessary to know about tuning up.

We will now pass to consideration of the modulator circuit. Looking at Figure 2 we start with a crystal microphone, which at my station is a D104 diaphragm type. It is coupled by a shunt-resistance circuit to a type 57 tube which in turn is resistance-coupled to a 2A6 tube. The grid circuit of this tube contains a potentiometer for controlling volume. The 2A6 is in turn resistance-coupled to a 46 tube which is transformer-coupled to a pair of 46's in push-pull, with the output modulation transformer in the plate circuits. The whole unit is powered through a self-contained power pack and filter using a swinging choke input with 8 mfd. on either side of the second choke and with an 83 type rectifier tube furnishing the d.c. This is the only apparatus that I have which is mounted in a cabinet and it is placed alongside my receiver on the operating table, not shown in the photographs.

I have been using this complete arrangement now for over a year with excellent results and quality reports on both bands. I consider it to be practically foolproof and an ideal installation for any "ham" who wants a rig that has ability to get out to distances and still is reasonable in cost and simple to put together and operate. Both the linear oscillator and B46 modulator may be obtained from Wholesale Radio in kit form or built and wired. In this way one can obtain all the parts together, or if desired, completely wired up. I will be very happy to have fellow "hams" write me, care of RADIO NEWS, if there are any points that they would like further information on.

Train for RADIO IN 12 WEEKS AT COYNE

The great Coyne Shops in Chicago have a world-wide reputation for training men in this big-pay field in **Only 12 Weeks**. Then they assist you and help you to success by giving you life-time employment service. By their new plan YOU can take advantage of the wonderful method of learning-by-doing. No need to lose time and money while you strive and save to raise the necessary tuition.

ARRANGE to FINANCE YOUR TRAINING

Come to Coyne at once. Get your training. Then start paying for your training in **small monthly payments** to begin **5 months from the day you start school**. Then you have **18 months to complete your payments**.

If you will write to me at once I will send you complete details of this sensational new plan, together with the **BIG FREE illustrated BOOK** telling all about COYNE training without book study or useless theory, and how many earn while learning.



H. C. Lewis
President

SEND NOW FOR FULL DETAILS!

MR. H. C. LEWIS, President

500 S. Paulina St., Dept. 76-3K, Chicago, Ill.

Tell me how I can finance my training at COYNE and send me the BIG FREE Illustrated Book on RADIO.

Name
 Address
 City State

Your Guide to Profits!



Everything In Radio

New Radio Profit Guide

Completely revised—right up to the minute—everything in radio—at the right price. Radolek makes money for you. Over 10,000 Repair Parts—a complete selection of Receivers, Amplifiers, Tubes, Tools, Books, Instruments—always in stock—ready for speedy shipment to you. You need this big Radio Parts Catalog. It's free. Send for it. Over 160 pages of "money-savers."

Radolek endeavors to restrict distribution of The Profit Guide to those actively and commercially engaged in the Radio business. Please enclose your Business Card or Letterhead with the coupon below.

RADOLEK

612 W. RANDOLPH, CHICAGO

Send Me the Radolek Radio Profit Guide Free.

Name
 Address
 Serviceman? Dealer? Experimenter?



**"DEPENDABLE"
MASTER
ANALYZER**
only **\$38.95**

Master Performance 41 ranges—measures AC and DC microamperes, milliamperes and amperes, ohms to 40 megohms, capacity to 300 mfd., AC and DC volts to 1000 volts, power level in DB and inductance in millihenries and henries to 10,000.

Attractive, simple to operate, and inexpensive. Nothing else to buy. See your jobber today, or write direct to factory.

We shall be glad to send you an attractive booklet describing latest developments in radio service instruments.

RADIO CITY PRODUCTS CO.
88 PARK PLACE
NEW YORK CITY
"DEPEND ON
DEPENDABLE"

Read Classified Advertising—It Pays

Advertisements in this section twenty cents a word for each insertion. Name and address must be included at the above rate. Cash should accompany all classified advertisements unless placed by an accredited advertising agency. No advertisements for less than 10 words accepted. Objectionable or misleading advertisements not accepted. Advertisements for these columns should reach us not later than 3rd of 2d month preceding issue.

TECK PUBLICATIONS, INC.
461 Eighth Ave. New York, N. Y.

Lab-Built Super

(Continued from page 217)

These two stages of t.r.f. set the limit of inherent noise down at that low level of 15 milliwatts at maximum sensitivity—a small fraction of the internal noise found in receivers using only one r.f. stage.

Sensitivity from 140 to 19,000 kc. is set at one-half microvolt absolute due to the seven times greater Super-Giant speaker efficiency. Circuit and tube noise are substantially zero at sensitivities of 5.0 microvolts or greater.

Sensitivity is automatically regulated by an improved automatic sensitivity control (a.v.c.) and by a sensitivity switch on the expander knob which reduces sensitivity to 5 microvolts, at will, for local reception. This a.v.c. system uses two tubes, a tuned a.v.c. amplifier and a rectifier, and through its circuit position and constants holds all signals above 20 microvolts at the same apparent ear volume.

Selectivity is no longer the conventional V-shaped side-band cutting curve, but rather one of the band-pass type. The fidelity knob gives the choices of 18 kc. or 8 kc. selectivity (corresponding to 9,000-cycle high fidelity and 4,000-cycle high-selectivity audio modulation bands.) Non-microphonic tuning and trimmer condensers and wiring, plus unusually thorough cushioning, completely eliminates that short-wave bugaboo, microphonic howling. Through the fidelity knob, a choice is provided of three 465 kc. dual air-tuned i.f. amplified stages for extreme DX, or one stage for local high-fidelity reception.

The diode second detector is unusual in that it is operated at the very low level of 1.0 to 1.5 volts, to decrease second-detector distortion. The triode portion of this 6Q7 tube is the beat oscillator, which operates at its second harmonic to eliminate spurious beats.

Following the second detector comes the three-stage audio amplifier with a built-in electronic volume expander and the new 6L6 electron beam power tubes which have long been awaited. The volume expander knob first drops average volume 20 db. and then adds it back into reproduction by expansion or the loudening to original naturalness of studio-compressed music. It is impossible to describe the effect on the listener of this expansion, so new and thrilling are its effects on music. The writer recalls in July, 1935, being one of over 100 engineers at the I. R. E. Convention demonstration of the first expanders. Being hard boiled we came to scoff—and remained to shout and stomp with enthusiasm when we heard it. Since that first revelation, expander adaptors have been made but it has taken a year to design and perfect the built-in expander employed in this new receiver.

The audio amplifier is resistance-coupled throughout to eliminate the last traces of the hysteretic distortion of audio transformers. Total distortion of all types is only 2 per cent at full 32 watt output, while at ordinary home play levels of one to five watts, it is so low as to be practically unmeasurable.

The net result of all this is tone so clear that the last small trace of scratch and "marbles" of previous fine amplifiers is completely eliminated. This tone is controllable (in addition to automatic aural tone compensation), to be anything desired. By two tone knobs it can be set "flat" from 20 to 9,000 cycles or its treble range can be boosted 10 db. to make up for treble tone absorption in particular rooms, or smoothly cut down so there are no treble tones left above 1500 cycles. Bass can similarly be cut completely out for

noise reduction in DXing, or it can be boosted a total of 18 db. to the point where deep organ notes actually cause walls to shake. This new and complete control of tone makes the tone of this receiver instantaneously anything desired at the will of the user—all things to all men.

Conservative operation of the push-pull 6L6's dictates an undistorted power output of 30 to 32 watts. Intelligent design says that to put 30 watts into any ordinary loud speaker of 5 per cent efficiency is to get only 1.5 acoustic or sound watts. So for the "Masterpiece V" a totally new speaker of 35 per cent efficiency was developed. Its seven times greater efficiency results in this 30 watts equalling 210 watts fed to any ordinary loud speaker and more than takes care of crescendos in music—doing it without the least trace of blasting or distortion.

The new Super-Giant speaker is both a bass and "tweeter" speaker in one unit. It is the first loud speaker to cover the range of 20 (note the 1 to 2 bass octaves added) to 9,000 cycles. It does this by virtue of a new dual cone invention of Major Glen. The inner cone is stiff and small for "tweeter" operation, while the outer 16 inch cone is large and relatively softer, as it should be for bass tone.

As this 9,000 cycle range is higher than is needed for 6,000 cycle chain network programs or for any but the very best studio originated programs, a three-section "high-fidelity" filter in the speaker is cut in or out by a switch on the speaker base. This at last permits clearing up of distortion due to prevalent station overmodulation (indicated by "Magic Eye" flicker) and the elimination of noise during the 90 per cent of listening time that only 6,000 cycle chain net-work tone range is needed.

Beam Amplifier

(Continued from page 214)

occasions where it is necessary to mix two of these microphones into one input. An electron mixer for this service can be readily adapted to this chassis. The socket for the electron mixer tube replaces the input terminal socket.

The circuit is illustrated in Figure 2b. Low impedance input is generally quite difficult to obtain in a high gain amplifier of this type. A considerable advantage in this respect is obtainable in this amplifier through the use of separate chassis for audio and power components. The induced hum is naturally reduced very greatly. A small input transformer having dimensions only $1\frac{1}{8} \times 1\frac{1}{8} \times 1\frac{1}{8}$ is available which can be readily mounted on this chassis. Due to its small size, this transformer intercepts a minimum of stray flux and consequently has very low pickup.

The combined overall dimensions of the two decks with perforated covers is $16\frac{1}{2} \times 12\frac{1}{2} \times 8$. These dimensions permit this amplifier to be readily mounted on a rack or in a cabinet. In addition, the separate chassis construction permits the units to be mounted individually in a radio set cabinet or in a portable amplifier cabinet with loudspeakers. The terminal strips which connect the power supply and audio amplifier are placed adjacent to each other on the chassis so that there is no possibility of improper connection. The terminal strip for the output of the amplifier is arranged so that the leads can be brought directly out from the strip through the perforated protective cover. The output impedances are 500, 200, 16, 8, 5, 3, and 1.5 ohms.

Printed by Art Color Printing Company,
Dunellen, New Jersey, U. S. A.

A.C. Auto Generators

TURN scrap into money. Autopower shows you how easily and economically auto generators can be converted into A.C. or D.C. generators and D.C. motors, 2 to 1000 volts; for sound, radio, power, light, or welding. No previous experience necessary—complete information all in new book, with simple instructions and illustrations. Endorsed by thousands. Only \$1.00 postpaid. Autopower, Inc., 410-V S. Hoyne Ave., Chicago.

Correspondence Courses

USED Correspondence Courses and Educational Books sold or rented. Inexpensive. Money-back guarantee. Write for Free Catalog listing 4000 bargains. (Courses Bought.) Lee Mountain, Pisgah, Alabama

BIG BARGAIN Catalogue Courses 10c. Handling, P-799 Broadway, New York

Patent Attorneys

PATENTS. Instruction "How to Establish Your Rights" and form. "Evidence of Conception" sent Free! Lancaster, Allwine & Rommel, 414 Bowen Building, Washington, D. C.

PATENTS—Advice and booklet free. Highest references. Best results. Promptness assured. Watson E. Coleman, Patent Lawyer, 724 9th Street, Washington, D. C.

Patents and Inventions

INVENTIONS COMMERCIALIZED. Patented or unpatented. Write Adam Fisher Company, 278 Enright, St. Louis, Missouri.

Radio

GENUINE PHILCO parts and tubes. Wholesale Catalog sent free on request. Williams Philco, Inc., 800 S. Adams St., Peoria, Illinois.

KEEP POSTED, save money with Radio Data Digest. Stamp brings sample. Kludig, Kent, Ohio.

Radio Instruction

AMATEUR RADIO licenses, complete training. Resident and correspondence courses. Every graduate a licensed operator. N. Y. Wireless School, 1123 Broadway, New York.

RADIO AND ELECTRICITY advanced students: finish your training with us, and start earning big money now. Send for free particulars. Universal Technical Institution, Box 1070, Los Angeles, Cal.

Salesman Wanted

WANTED COUNTY DEALER: Man with car to demonstrate and service for large manufacturer. First class job. 247 Fyr-Fyster Company, Dayton, Ohio.

THE WORLD'S ONLY TRULY
Custom built RADIO CAN

NOW
 BE PURCHASED
 ON EASY
 TERMS



**14 EXCLUSIVE
 FEATURES**

Now it is practical for anyone to own the finest radio in the world, built especially for him.

**\$34.00 DOWN —
 \$17.08 MONTHLY**

Use our Easy Payment Plan to put the "millionaire's radio" into your home!

5 YEAR GUARANTEE

Every part in a MASTERPIECE V is unconditionally guaranteed against mechanical or electrical defects for five years!

1 YEAR FREE SERVICE

Check up and laboratory service on your MASTERPIECE is absolutely free for a full year!

1 MONTH FREE TRIAL

Your MASTERPIECE V is shipped to you for a full month's free trial in your own home!

\$30.00 CASH CREDIT

After you once become a MASTERPIECE owner you always have the privilege of purchasing a new model for \$30.00 less than anyone else but another owner.

The MASTERPIECE V is new from stem to stern. It has 14 important engineering developments absolutely new and never found before on any radio receiver ever built! Such startling inventions as a new patented 18", 70 pound Super-Giant speaker that laboratory tests prove to be 700% more efficient than any console speaker ever built.

Another experience for you is listening to the built-in Electronic Volume Expansion. What that gives in tone quality to the MASTERPIECE V is unimaginable!

**CUSTOM-BUILT
 FOR You!**

When you order your MASTERPIECE V one is not simply taken down from a shelf and shipped to you. Far from it! Work is not started on your set until our laboratory staff goes over the detailed information you give us when you order. Then a MASTERPIECE is built which exactly fits your requirements. Two engineers construct your set under McMurdo Silver's personal supervision, and stake their professional reputations on its being the finest radio that can be built for operation in your home.

**24 COUNTRIES
 IN 24 HOURS!**

"First report on MASTERPIECE V — all bands hot — tone so wonderful a person is loath to tune in another station. Its the most life-like reproduction of music I ever heard from any set, regardless of price.

The great amount of power at your finger tips gives you "local" reception on most any station, with life-like clarity.

Broadcast band stations on every channel. Twenty-four countries in around the clock, tuning as follows: U.S.A., Canada, Russia, Austria, Switzerland, England, Germany, France, Spain, Java, Poland, China, Japan, Cuba, Mexico, Australia, Chile, Brazil, Columbia, Panama, Fiji Islands, Venezuela, Costa Rica, Africa.

Send anyone you like here to hear this set. Its a shame every person who now owns a radio can not hear the difference between their set and this one."

Nelson F. Hardleber
 (Signed)
 1580 Penns. Ave.,
 Detroit, Michigan. ★

**McMURDO SILVER
 MASTERPIECE**
 CHICAGO STUDIO—3354 NORTH PAULINA STREET
 NEW YORK DEMONSTRATIONS—63 CORTLAND STREET

**MAIL
 THIS COUPON**

McMurdo Silver Corp.
 3354 N. Paulina St.,
 Chicago, U. S. A.

Please send me full details on the new MASTERPIECE V.

NAME _____

ADDRESS _____

"THE WORLD'S ONLY TRULY CUSTOM-BUILT RADIO"

*Doubles
World-Wide
Radio Enjoyment
and Slashes
Radio Current Bills
in Half!*

Only **MIDWEST GIVES YOU**
PUSH BUTTON TUNING

plus Exclusive New
ELECTRIK-SAVER
for 1937

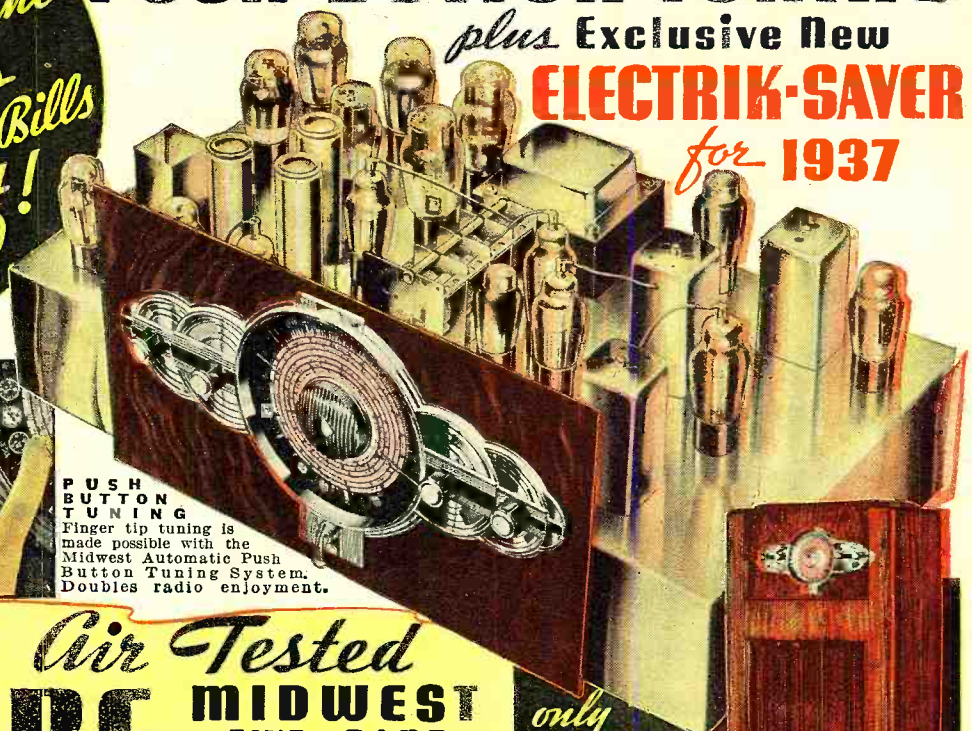

ELECTRIK-SAVER cuts radio wattage consumption 50% - enables 16-tube Midwests to consume no more current than ordinary 7-tube radios and to operate on voltages as low as 80 volts.



PUSH BUTTON TUNING
Finger tip tuning is made possible with the Midwest Automatic Push Button Tuning System. Doubles radio enjoyment.

NEW 1937 *Air Tested*
6-TUBE **MIDWEST**
RADIO **FIVE-BAND**

only
\$49.95



SAVE UP TO 50% DIRECT FROM FACTORY

NO middlemen's profits to pay! See for yourself that Midwest offers you greater radio values—enables you to buy the more economical factory-to-you way that scores of thousands of radio purchasers have preferred since 1920. Never before so much radio for so little money! Why pay more? The broad Midwest Foreign Reception and Money-Back Guarantee insure your satisfaction. You get 30 days FREE trial in your own home!

74 ADVANCED 1937 FEATURES

This Super DeLuxe Midwest is so powerful, so amazingly selective, so delicately sensitive that it brings in distant foreign stations with full loud speaker volume on channels adjacent to powerful locals. Scores of marvelous Midwest features, many of them exclusive, make it easy to parade the nations of the world before you. You can switch instantly from American programs . . . to Canadian, police, amateur, commercial, airplane and ship broadcasts. . . to the finest and most fascinating foreign programs. With a Midwest, the finest entertainment the world has to offer is at your command. It is preferred by famous orchestra leaders, musicians, movie stars and discriminating radio purchasers everywhere. You can order your Midwest "Air-Tested" radio from the new 40-page catalog with as much certainty of satisfaction as if you were to come yourself to our great factory. (It pictures the beautiful 1937 radios in their actual colors!) You pay as little as \$5.00 down! Three iron-clad guarantees protect you: (1) A Foreign Reception Guarantee — (2) Absolute Guarantee of Satisfaction — (3) One-Year Warranty.

WITH
GIANT THEATRE-SONIC SPEAKER
(LESS TUBES)

TERMS AS LOW AS \$5.00 DOWN

Only **MIDWEST** *Gives You*

16 TUBES • 5 WAVE BANDS

9 TO 2200 METERS • ELECTRIK SAVER

• PUSH BUTTON TUNING •

• AUTOMATIC AERIAL ADAPTION •

DUAL AUDIO PROGRAM EXPANDER

Once again, Midwest demonstrates its leadership by offering the world's most powerful and most beautiful ALL-WAVE 16-tube, 5-Band Radio. A startling achievement, it makes the whole world your playground. Powerful Triple-Twin tubes (two tubes in one!) give 18-tube results. This advanced radio is a master achievement, a highly perfected, precisely built, radio-musical instrument that will thrill you with its marvelous super performance...glorious crystal-clear "concert" realism... and magnificent foreign reception. The Dual Audio Program Expander gives a living, vital realistic quality to voice and musical reproduction.



MIDWEST USES LESS CURRENT THAN AN ORDINARY LIGHT BULB Fill in coupon NOW, and mail TODAY!



I FIND MYSELF SINGING ALONG WITH MIDWEST'S MARVELOUSLY LIFE-LIKE PROGRAMS—
Irene Dunne



A COMPARISON CONVINCED ME I SHOULD HAVE A MIDWEST. IT IS A SPLENDID PERFORMER.
Fred Mac Murray



MIDWEST RADIO CORP.

DEPT. D-11 **CINCINNATI, OHIO, U.S.A.**
Established 1920 **Cable Address MIRACO...All Codes**

MAIL COUPON TODAY for

Free 30-DAY TRIAL OFFER and 40-PAGE FOUR-COLOR **Free CATALOG**

MIDWEST RADIO CORPORATION
Dept. D-11, Cincinnati, Ohio

Without obligation on my part, send me your new FREE catalog and complete details of your liberal 30-day FREE trial offer. This is NOT an order.

Name.....
Address.....
Town.....State.....

Special offer and prices prevail only when dealing direct with factory by mail.