

TRANSMITTING TUBES

RADIO NEWS

AND

SHORT WAVE RADIO

SHORT
WAVE
TIME
TABLE

AUGUST

Start your Vacation
with a
TRANSCCEPTOR



25¢
U. S. AND
CANADA



For Radio Vibrators MALLORY Is the Accepted Standard

Mallory progressiveness in vibrator design and manufacture has developed new standards of vibrator performance. That's why Mallory-made vibrators are standard equipment on America's most popular automobile radio receivers—and in 6 volt and 32 volt household sets.

What's more, Mallory ingenuity has created new standards of vibrator practice for service men everywhere.

Mallory Replacement Vibrators made universal service an actuality. More than 3,000,000 automobile radios can now be serviced with a handful of Mallory Replacement Vibrators. They save time, inventory—stock investment. They are dependable in service—and easy to install.

For prompt, efficient, profitable servicing, use Mallory Replacement Vibrators. It *pays*—and you have the word of thousands of service men for that!

**BUILD YOUR
 BUSINESS WITH
 MALLORY**

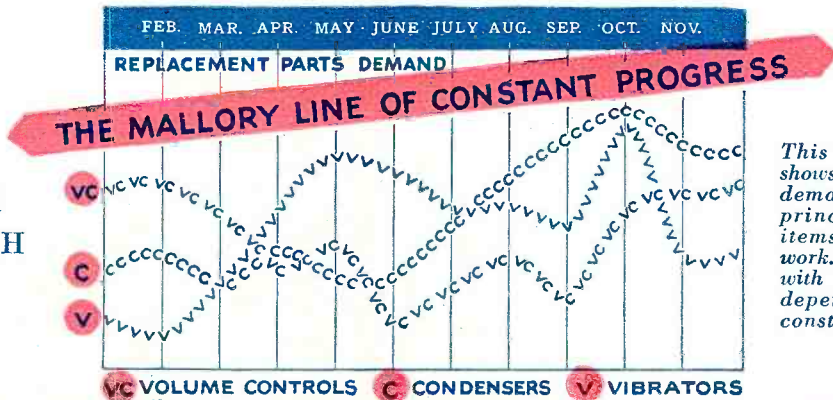

This composite graph shows the trend of service demand for the three principal replacement items in daily service work. Check your needs with the demand—and depend on Mallory for constant progress.



P. R. MALLORY & CO., Inc.
 INDIANAPOLIS INDIANA
 Cable Address—Pelmallo





High Fidelity Station tests them all! - Chooses the SCOTT for Truest Tone Beauty!

ALL THE BEAUTY OF THE OVERTONES

ALL THE MAGIC OF DISTANT LANDS

PROOF and MORE PROOF—

Proof—every day that when you own a SCOTT you have at your command the finest performance in the world—regardless of price! Tested by celebrated musicians and opera stars! Tested in almost every country in the world! And NOW—tested in one of the country's leading radio stations*—the SCOTT is again chosen as the peer of all receivers. WHY? Ask yourself this vital question when considering your new radio receiver! WHY did SCOTT tone have the most magnificent realism of all the one hundred and fifty receivers?

There under the impartial scrutiny of those engineers in the most gruelling comparison test yet devised, the SCOTT alone—of all receivers tested—captured all the marvelous beauty of the overtones which were broadcast—all the overtones audible to the human ear.

HEAR ALL THE PROGRAM!

When your receiver misses the overtones you miss half the beauty of the program—all instruments tend to sound alike. Science shows that *fundamental* notes from voice, violin, trombone, oboe, etc., are all identical—it's the *overtones alone*, or secondary tones, which enable you to tell one instrument from another.

Put your finger up to one ear. Shut off the sound. What you hear doesn't sound complete—you say "there's something missing." Look through a screen. Hold a sieve up to the light. Everything beyond is just the same—but colors are not so pleasing, faces are dimmer. It is the same with your radio. Every day you turn it on for entertainment—for local programs, programs a thousand miles away, programs from Europe, Asia, South America! These programs are for you! The stations have been designed for you! Get the full beauty they have to offer you! More and more stations are raising the fidelity of their broadcasts—and more and more are going "High Fidelity"—*broadcasting the music as it is being played and as it was meant to be heard*—with all the ephemeral and powerful expression that was written into it—with all the enthralling 16,000 cycle overtone range, wherein lies

*Name of station upon request.

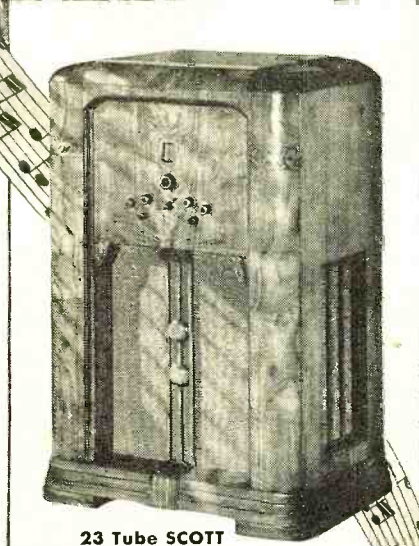

23 Tube SCOTT with Warrington Console

Volume Range Expander—restores expression necessarily cut in broadcasting and recording. Continuously Variable Selectivity—2 to 16 K.C. True Separate Bass and Treble Controls. 19 exclusive cabinets. Highest Useable Sensitivity—for clearest reception at prevailing noise level.



3 True Speakers
Each amplifying its full portion of the complete tone and overtone range.

the most sublime beauty of all music.

The SCOTT 16,000 cycle overtone range now offers you and your family the full enjoyment of popular music with all its original sparkle—offers you the world's really great music with all the inspirational beauty the composer himself meant for you to hear. The SCOTT does not overload one speaker with this full tonal range. In addition to the *bass and medium tone speaker* (using the sensational bass reinforcing filter) the SCOTT offers *two special true loudspeakers for the higher tones* (these additional speakers receive direct electrical impulses through the regular circuit). Be sure that any extra "loudspeakers" in the set you are considering are not merely "resonators" screwed to the sound-

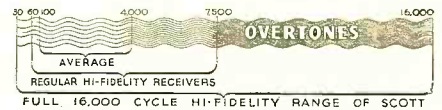

board and "vibrating" with regular tones received by the single real speaker.

Average speakers with less than 10 watts power "go to pieces", "rattle" or distort the tone when the full volume of concert music is played through them. With SCOTT 35 Watt Power you may listen to the full glory of symphonic or popular music without any distortion to the ear.

With its Highest Signal-to-Noise Ratio, its remarkable Continuously Variable Selectivity, with its exclusive Rotary Coil System and many other exclusive features, the SCOTT has made probably more verified world distance records than any other receiver in the world.

HEAR ALL THE STORY!

This is only a fraction of the magnificent story of the SCOTT. You can own a SCOTT for no more than you would pay for an ordinary good radio. A side by side comparison test is invited. Try it in your own home for 30 days. If you are not then completely satisfied that its tone is more beautifully clear, that its realism is more strikingly life-like than any other receiver, then return it—and there will be no obligation of any kind. Send — TODAY — for complete details of this extraordinary story, every word backed by page upon page of printed PROOF—PROOF of definite, vital superiorities—PROOF of unparalleled tone and distance performance in every quarter of the world—in every state in the Union! Send NOW for full facts!

FREE-SEND TODAY FOR DETAILS

E. H. Scott Radio Laboratories, Inc.
4440 Ravenswood Ave., Dept. 5N6, Chicago
I'd like to know more about the new 23-tube SCOTT. Please send me full proofs, and illustrated booklet above.

Name.....
Street.....
City.....State.....

E. H. SCOTT RADIO LABORATORIES, INC.

4440 Ravenswood Avenue, Dept. 5N6, Chicago, Illinois

630 5th Avenue, New York

115 N. Robertson, Los Angeles



Edited by LAURENCE MARSHAM COCKADAY

S. GORDON TAYLOR WILLIAM C. DORF
Managing Editor *Associate Editor*
 JOHN M. BORST JOHN H. POTTS
Technical Editor *Assoc. Tech. Editor*

JOSEPH F. ODENEACH
Art Editor

Vol. XVIII August, 1936

No. 2

Reading Guide to this Issue—

AMATEURS—3, 5, 7, 9, 10, 14, 15, 16, 17, 18, 19, 20, 22, 23, 26, 29, 30, 34
 BROADCAST FANS—2, 3, 4, 6, 7, 23, 28, 29, 31
 DEALERS—1, 3, 5, 6, 7, 8, 11, 13, 14, 19, 20, 28, 34
 DESIGNERS—4, 7, 9, 10, 14, 18, 19, 34
 DX FANS—3, 9, 12, 13, 14, 18, 20, 23, 28, 31
 ENGINEERS—3, 4, 7, 10, 14, 17, 34
 EXPERIMENTERS—3, 5, 6, 7, 9, 10, 17, 18, 21, 24, 27, 28, 29, 30, 34
 MANUFACTURERS—3, 10
 OPERATORS—4, 17, 34, 35
 SERVICEMEN—1, 3, 5, 6, 7, 8, 9, 10, 11, 14, 18, 20, 21, 24, 30, 34
 SET BUILDERS—3, 5, 6, 7, 9, 10, 18, 21, 24, 30, 34
 SHORT-WAVE FANS—3, 4, 9, 12, 13, 14, 18, 20, 23, 25, 26, 28, 32, 35
 STUDENTS—3, 4, 5, 6, 7, 8, 9, 10, 13, 14, 17, 18, 19, 21, 23, 26, 27, 28, 29, 30, 33, 34
 TECHNICIANS—1, 3, 5, 6, 7, 8, 9, 10, 14, 17, 18, 24, 30, 34

Coming Next Month

The September issue will include a constructional article on an extremely inexpensive yet surprisingly good beat-frequency oscillator. So stable are the circuits employed that frequencies as low as 2 or 3 cycles per second are obtained with no interlocking, and oscillograph studies of the wave form show complete freedom from distortion above 30 cycles. This will be the first of a group of laboratory instruments under design in the R. N. Lab—instruments of true laboratory precision yet so inexpensive that every service shop can afford them. Amateurs will find several interesting articles in the September issue on "ham" equipment, both receiving and transmitting.

1	Serviceman's Diary	<i>Anonymous</i>	67
2	Radio and Free Speech.....	<i>Samuel Kaufman</i>	69
3	What's New in Radio.....	<i>William C. Dorf</i>	71
4	Radio Aboard the "Hindenberg".....	<i>Herbert Lennartz</i>	72
5	The 5-Meter "Transceptor".....	<i>Frank Lester</i>	73
6	A Town and Country Portable.....	<i>Reginald DuBois</i>	74
7	New Permanent Magnet Speakers.....	<i>Frederick Siemens</i>	75
8	The Service Bench.....	<i>Zeh Bouck</i>	76
9	Oscillator "Freq" Meter.....	<i>John H. Potts</i>	77
10	The New "Service Twins".....	<i>John M. Borst</i>	78
11	Selling Service (Part 5).....	<i>A. A. Ghirardi & T. S. Ruggles</i>	79
12	The DX Corner for Short Waves.....	<i>Laurence M. Cockaday</i>	80
13	World Short-Wave Time-Table.....	<i>The Editor</i>	82
14	"Lab Tests" of Modern Super.....	<i>S. Gordon Taylor</i>	85
15	The "Ham" Shack.....	<i>Everett M. Walker</i>	86
16	New Amateur Transmitter.....	<i>The Staff</i>	87
17	High Efficiency Transmitter Circuit.....	<i>Frederick Siemens</i>	88
18	Installing Your Own "R" Meter.....	<i>By W2JCR</i>	88
19	Transmitting Tube Chart.....	<i>The Staff</i>	89
20	Junior Communication Receiver.....	<i>The Editor</i>	90
21	Signal Seeking Circuits.....	<i>J. van Lienden</i>	90
22	5-Meter "DX".....	<i>By W2JCY</i>	91
23	Volume Expansion and Better Quality.....	<i>The Staff</i>	92
24	Vacuum-Tube Hearing Aid.....	<i>Samuel B. Simer</i>	92
25	Homemade Code Practice Oscillator.....	<i>Gordon Fraser</i>	93
26	How to Learn the Code.....	<i>B. Breedlove</i>	93
27	Fundamentals of Electricity.....	<i>Irving J. Saxl</i>	94
28	The Radio Beginner (Part 4).....	<i>John M. Borst</i>	96
29	Experimental 9.5-Meter Station.....	<i>Robert Ames</i>	97
30	The Radio Workshop.....	<i>The Associate Editor</i>	98
31	The DX Corner for the Broadcast Band.....	<i>Broadcast DX Editor</i>	100
32	Via Short Waves.....	<i>Dorothy Love</i>	102
33	Students' Radio Physics Course.....	<i>Alfred A. Ghirardi</i>	106
34	The Technical Review.....	<i>Robert Hertzberg</i>	108
35	Captain Hall's Short-Wave Page.....	<i>Horace L. Hall</i>	110
36	QRD?.....	<i>By GY</i>	112

Published Monthly by Teck Publications, Inc., Washington and South Avenues, Dunellen, N. J.

Lee Ellmaker
President and Treas.
 B. Holcepl
Secretary

H. D. Crippen W. P. Jeffery
Advertising Management
 Virgil Malcher
 205 W. Wacker Dr., Chicago
Western Representative

EDITORIAL AND EXECUTIVE OFFICES
 461 EIGHTH AVENUE, NEW YORK CITY, N. Y.
 Entered as second class matter at the Post Office at Dunellen, N. J., under the act of March 3, 1879. Copyright, 1936, by Teck Publications, Inc., in U. S. and Canada. All rights reserved. Registration of title of this publication as a trade mark applied for in United States Patent Office. Printed in the United States of America. The contents of this magazine must not be reproduced without permission. We cannot be responsible for lost manuscripts, although every care is taken for their safety.

25c a copy. Subscriptions: \$2.50 a year, \$4.00 for two years. In Canada and Foreign Countries \$3.00 a year, \$5.00 for two years. Subscribers are notified that change of address must reach us five weeks in advance of the next date of issue.

Pages From A Serviceman's DIARY

MONDAY—Arrived early and found a customer in a big Cadillac V-16 waiting for the store to open. A hard-boiled looking dame was seated behind the wheel, apparently just having driven her husband to the railroad station—"You test tubes free, don't you?" she said, pointing to the sign on the window. "Certainly," I replied, recalling that she had once bought a twenty cent electric bulb and had it charged, "if you will give me the tubes, I shall be glad to test them." Told me they were in the auto-radio and to take them out myself. Explained that the free offer applied only to tubes brought in, but we could give them an operational test without charge. After a little hesitation, she decided to buy the free operational test. Switched on the set, a Stromberg-Carlson,—plenty of back ground noise but weak signals. Told her the tubes were probably okay and a thorough check of the entire installation would be necessary.

Watched her drive away toward another store down the street. (She'll come back—they won't do even that much for her for nothing.) Went inside and started a shop job. A dynamic speaker with an 8000 ohm field. Found the field coil open. Removed the protecting insulation paper and found a carbonized spot where an arc had developed. Unwound about 50 feet of the fine wire until I came to the break. Cleaned and resoldered the good position to the terminal. Okay!

Honk! Back Again!

Heard a honking outside—the Cadillac back again. Not quite so hard-boiled now. Asked me to drive her home, then take the car and fix the radio trouble. Boy, what a swell car to drive! But I don't like auto-radio work. Returned to the store and prepared for the job, removing from my pockets all keys, pencils and the all-too-few coins. These articles have a tendency to trickle out when crawling around steering posts, etc. Slipped on jumpers and picked up a blanket to protect the car upholstery—not mine. Went out and prepared it for the operation. Took an ohmmeter and connected one terminal to the antenna lead at the set, the other connection to the car chassis. Antenna not grounded. Traced the lead around till I found it went through the floor-board. Uttered a series of muttered but emphatic invocations, composed largely of monosyllables, then crawled under the car. Sure enough, the antenna lead was broken close to the floorboard. Made a temporary repair and checked operation. O.K.! Ran the car over to a garage and onto the rails so I could work in more comfort. Put in a new lead of heavy, rubber-covered wire. Ran it around the streets with the set operating. More trouble! Intermittent noise while running. Stopped the car, with engine going, noise stopped. Coasted down hill with motor off, noise again. Ran the car back to the garage and had the brakes adjusted. Rechecked. All O.K.

Back to the shop and found another job waiting. A Motorola installed in a Buick. Inoperative. Got a big end-wrench

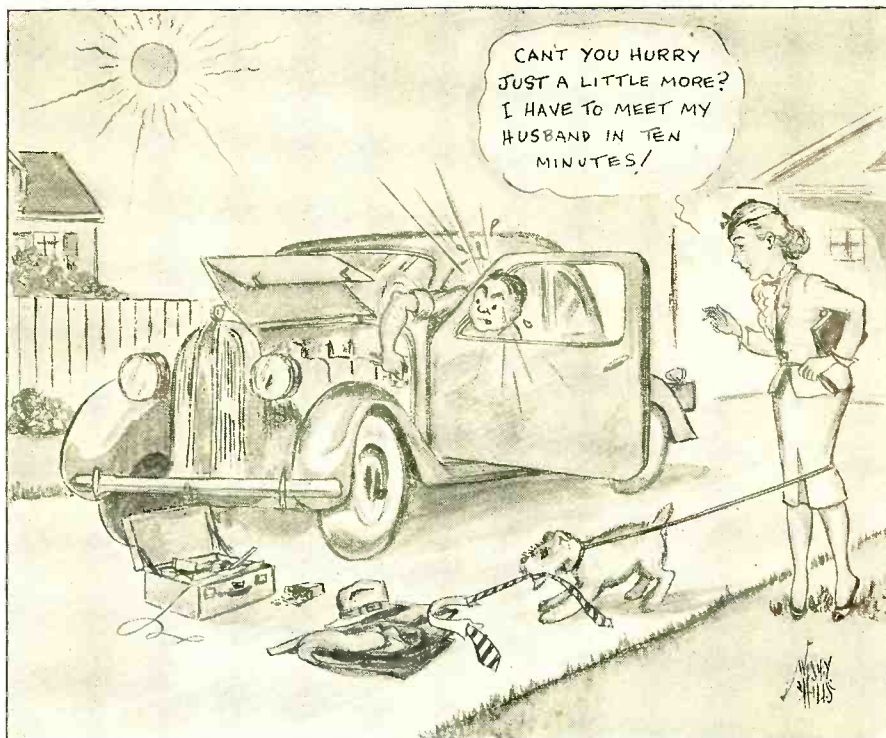

AUTO RADIO INSTALLATION AND REPAIR—PROFITABLE

While there are sometimes some rather irritating occasions in doing auto radio work the radio serviceman can make a reputation and build up a good business in both installing new sets and repairing them.

and hammer to loosen the nut on the mounting bolt. As usual, it was badly rusted. Applied a liberal dose of penetrating oil and let it percolate around the nut. Got under the hood again and managed to loosen it this time. Removed the set and checked the vibrator. Buffer condenser blown. Replaced with one of 1000 volt rating. O.K.!

Off for lunch—then out on calls. Ran over to Lou Gehrig's apartment. Mrs. Gehrig, dark-haired and lovely, with a marvelous natural peaches and cream complexion, met me at the door. "Lou's sleeping," she said, "try not to make any unnecessary noise." Wondered why she had to be so solicitous about the famous Iron Man, with an unapproached record of consecutive games played. Maybe its home care which makes such records possible. Down the hall into the living room. The radio stood near a grand piano by the window. It was a Philco 90, installed in a special cabinet. Took one look and one smell—a burnt-out power transformer. Told me she had only bought the set a few months ago from some concern in the city. Reminded her that the model was several years old, which was news, apparently, since the impression seemed to exist that it was a current type. Meanwhile

the glass-panelled door opened and Lou Gehrig appeared, in a flannel undershirt—the healthiest looking person I've seen in years. Explained the situation to him and got the order to go ahead and repair the job. Left a small midget on loan, demonstrating it while they opened a table and sat down to lunch with his parents. Pulled the chassis and went on.

Arrived at the next place, and was greeted a little too cordially. Would I mind looking at the washing machine first? It had just broken down and the washwoman was standing around doing nothing. Somewhat out of my line, but it's all in a day's work. Went down to the basement. Found a big washing machine of unknown make. Replaced a blown fuse and switched it on. No results except for another blown fuse. Tried to turn the motor by hand—jammed tight. Slipped off the belt. Motor turned freely. Opened the drain pipe and noticed a shred of cloth hanging out. Gave it a good tug and out it came. Turned the machine drive. Now O.K. Replaced the belt, put in a new fuse, threw on the power. Everything functioning normally again. What a relief to all concerned! Tackled the radio next—a Splitdorf antique. Replaced the tubes and suggested a more modern job. Made an appointment to demonstrate an all-wave receiver.

Next—Stewart-Warner all-wave. Complaint, noise. Found a defective volume control and poor contacts on band switch, requiring cleaning. Pulled the chassis for a complete shop overhaul.

Increasing Fields for the Skilled Worker in Radio Service

By Ernest Searing

On every hand there are encouraging signs of business betterment in the radio service field. Skilled, truly efficient service technicians are finding an ever-growing market from a public that is becoming increasingly exacting in its demands for radio receiver performance.

THESE records from an anonymous serviceman's diary should be of decided interest to veteran servicemen, as well as to those whose experience in the service field is more limited. Written by a man who "knows his stuff," and shot with an occasional outcropping of humor, these items provide many hints not found in text books. More of these pages will appear from time to time.

Build your business with

MALLORY

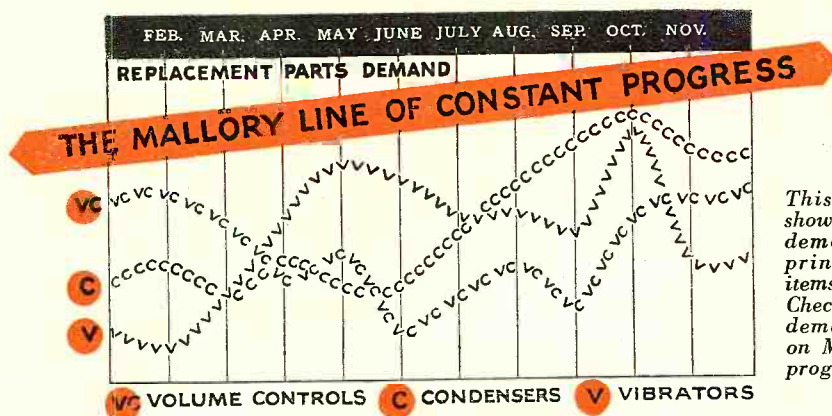

This composite graph shows the trend of service demand for the three principal replacement items in daily service work. Check your needs with the demand — and depend on Mallory for constant progress.

Study seasonal rise and fall in demand with your principal service items and peaks and valleys of service activity will iron out to a line of steady progress.

Especially — when you depend upon the Mallory Yaxley Replacement Line — Mallory Condensers, Mallory Vibrators and Yaxley Volume Controls. The Mallory Yaxley line is designed for the service man's requirements; — to enable him to give quality service, with a minimum of cash investment, yet with constant progress in building a profitable service business.

Consider the Mallory Yaxley line

Sixty-nine Mallory Replacement Condensers now fulfill *all* service needs — meeting requirements that would heretofore have necessitated literally thousands of condensers.

★ ★

A mere handful of Mallory Replacement Vibrators render universal service to over 3,000,000 auto-

Line up with Mallory — and establish for yourself — a line of constant progress.

mobile radio sets. Two out of three of *all* automobile radio vibrators now in use are Mallory made.

★ ★

In developing constant improvements in Yaxley Replacement Volume Controls, Yaxley engineering has brought about undreamed of precision in universal application to meet all service needs for over 4000 different radio receiver models.

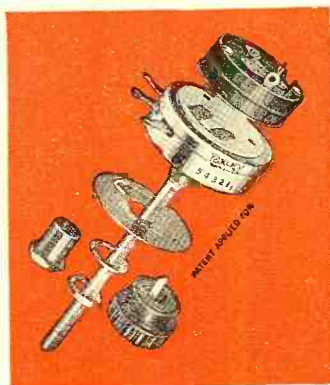

MALLORY

P. R. MALLORY & CO., Inc.
 INDIANAPOLIS INDIANA
 Cable Address — Pelmallo

YAXLEY

Radio News

August, 1936

RADIO and FREE SPEECH

The problem of whether or not radio programs are to be "censored," and if so by whom, is one of utmost importance to radio listeners, as well as the radio industry itself. Free speech is an American institution and the danger of censorship by any broadcasting czars, either commercial or governmental, is one that should be carefully guarded against.

IT is usually in presidential years that the accusations against stations for curtailing or censoring broadcast material reach new highs. And, true to form, 1936 finds loads and loads of pro and con mimeographed and neatly printed propaganda. The argument is usually about the constitutionality of the American radio setup insofar as it gives anyone (the station, the network, the Federal Communications Commission or the Federal Trade Commission) the rights to use the editorial blue pencil and shears on proposed broadcast material.

Well, we've been hearing so many references to the First Amendment in all of the free speech arguments that we reached for a copy of the Constitution to see just what our forebears set forth as our rights for liberated larynges. We're far from an authority on Constitutional Law, but, it seems to us that when the amendment was prescribed 145 years ago, no prophet among the law-makers prognosticated such a thing as radio. Nay, there is nary a link with radio and free speech in the First Amendment.

Plan New Laws

So, if you are prone to argue the point, we'll save you the trouble of

By Samuel Kaufman

reaching for a reference volume by the simple expedient of quoting the afore-said amendment, to wit: "Congress

shall make no law respecting an establishment of religion, or prohibiting the free exercise thereof; or abridging the freedom of speech or of the press; or the right of the people peaceably to assemble and to petition the Government for a redress of grievances."

For some months now, there has been activity in Congress to further bills dealing specifically with radio freedom of speech. No Government bureau has direct access to the power of censoring radio material, with the exception of the broad authority of the FCC to

observe that broadcasts are of "public service." Other Federal agencies have had a hand in re-shaping program material due to unfair trade claims by certain sponsors. But in all, these are relatively minor facts presented by the advocates of verbose liberation on the air lanes.

Political "Flats"

On a recent motor trip into the country, I passed many gasoline and service stations that had big signs along the highway to exploit their services. One of them read: "FREE AIR—WE ALSO FIX FLATS." It was only on second thought that I realized the sign

WHAT JUDGES SHALL RULE ON BROADCASTING?

If censorship of radio programs is to be allowed in America, any judicial body who undertook to make such decisions would be severely criticized by some interests, no matter what their decisions would be.





THEY GIVE THEIR VIEWS ON FREEDOM OF THE AIR

These men have definite ideas about freedom of speech and freedom of the air and their statements appear in this article. Left to right they are: Henry P. Fletcher, Anning S. Prall, Major General Harbord, Franklin D. Roosevelt, James A. Farley.

referred to automobile service; the words seemed to exactly fit the apparent policies of certain broadcasters who, while proclaiming the existence of a *free air*, were at the same time doing a swell job of fixing flat tire candidates and projects with one-sided program spots.

The first defense of a station accused of presenting a one-sided view of a public topic and refusing to grant equal facilities to an opposing party, is that the station, like a newspaper, possesses the right to exercise its own editorial judgment.

Channels Belong to Public

It is true that a broadcasting station, like a newspaper, represents a private property. *BUT* the station functions under Government license on a publicly-owned channel and its very right of way is *owned* by every citizen.

Under the title of "A Growing Threat to the Freedom of the Air!" Lee Ellmaker, president of RADIO NEWS, in the April, 1936, issue, attacked the narrow-minded viewpoint of broadcasters in failing to present both sides of controversial issues. He declared: "RADIO NEWS believes, with the great majority of radio manufacturers, radio educational institutions, servicemen and retail dealers and with the majority of listeners, for that matter, that nothing should be barred from the air which comes within the realm of decency or does not shock the public's morals or system of honor. . . . Broadcasting also should be opened to non-political public-spirited groups who are willing to operate broadcasting stations without profit. The Government, however, has not encouraged such a program. This could be done on ordinary broadcasting wavebands or even under short-wave regulations."

Campaign Brings Action

Presidential years see the most of hullabaloo about free speech and there have been just five of them (including 1936) since radio's popular acceptance. While not every alleged violation of free speech is linked to politics, the pre-campaign fuss and ado about unwarranted radio censorship may well serve as a stimulus for our lawmakers to drive home some definite bills specifically providing a code of free radio

speech to control American broadcasting.

It is generally conceded by all sides that a greater degree of free speech exists in the U.S.A. than in the rest of the world. You can say what you please, but it's no easy problem to solve and the stations are themselves in a quandary. Whenever General Harbord, Mr. Sarnoff or Mr. Paley (our chief program dictators) address a civic, community or educational group hither and yon, I always expect, and usually hear, the boast of "How free our air is," as compared to dictator-ridden Europe. Chairman Prall, of the FCC, also made the comparison a few weeks ago.

Even the American Civil Liberties Union, backers of the free speech bills in Congress, admits that the networks and stations are more liberal in their attitude than in the past. When I called at the Union's New York office, a representative mentioned the instance of Norman Thomas going on the air from Florida during a labor disturbance. The station demanded to see his talk in advance and requested certain omissions. But the Socialist leader said he would say anything he wanted to or he wouldn't go on the air at all. *He was permitted to go on!*

Big Names Undisturbed

One recent evening Dr. Morris Fishbein, of the American Medical Association, delivered a brilliant radio talk in which he attacked quack cure-alls. He said enough to make certain radio sponsors feel conscience-stricken, and it was apparent that no editorial blue pencil touched his talk.

But not all radio speakers carry the prestige of Thomases and Fishbeins. While stations would not dare to place undue limitations on the utterances of such prominent speakers, lest the wrath of unfavorable publicity befalls them, the liberal viewpoint is not the same when lesser known personalities come to the mike. The head of a consumers organization was cut off CBS right in the midst of his talk some seasons ago. And wasn't there a furor? As I recall it, one CBS executive was promptly fired for the deed when the public reaction was gauged, and the speaker was allowed to come back a second time to have his full say.

It is conceded that radio utterances must be in good taste. But who shall

gauge that taste? General Smedley Butler was once cut off the air for using "hell" and yet the word often pops up in broadcast gags and song lyrics.

The movement towards a definite freedom of the air is gaining momentum. Persons and organizations of prestige are working toward that goal, although some opposite views have been expressed by individuals in the same quest.

So much has been said in recent months on the controversial subject of free speech that space limitations permit only brief quotations herewith from some of the statements by persons prominent in broadcasting and public life.

WILLIAM S. PALEY, President of CBS. (In a statement to Chairman Henry P. Fletcher of the Republican National Committee): "It is our fixed policy not to sell time for propaganda of any sort. When we think that the public is sufficiently interested in a subject suitable for discussion over the air so that propagandists of opposing sides should be heard, we allot the time without charge. We felt that the exercise of the wisest editorial judgment we are able to bring to bear, rather than the ability of others to pay, should govern decisions as to what subjects should be discussed and what subjects lacked sufficient public interest in proportion to other things to merit discussion. I realize that it is difficult to define precisely what we mean by propaganda." (Turn to page 105)

BROADCASTING CZARS?

These two men, David Sarnoff and Wm. S. Paley (right), control the two largest broadcasting chains in America, and it has been charged that they could control what is said over the air.



WHAT'S NEW in RADIO

By W. C. Dorf

New Spider-Web Antenna

The RCA "Spider-Web" antenna comes completely assembled and soldered ready for installation. The very important feature of the new system is the fact that it can be used on all bands from 2100 to 4 meters. It is supplied in two kits both of which may be assembled together to form one unit. The main system covers the frequency range from 140 to 23,000 kc. and by adding another unit the range is increased to 70,000 kc. This high-frequency kit may be added at any time, not necessarily when the antenna is first installed. The required overall span is 38 feet with a 12-foot clearance. The action of the new antenna is that of an efficient T-type antenna over the range from 140 to 4,000 kc.

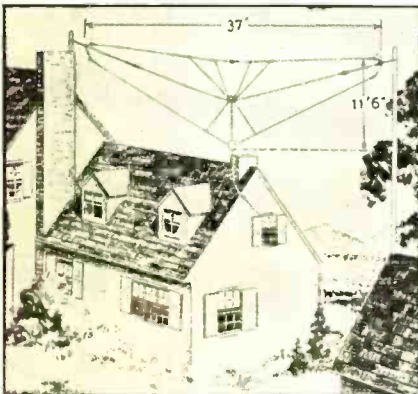

Above 4,000 kc. the operation automatically changes to that of an efficient multiple doublet all the way to 70,000 kc., with the high pickup and great noise reduction of such an antenna. Because of the addition of sufficient legs to the doublet arrangement, all the short-wave bands are covered by a special leg resonating at the particular band, thus greatly improving reception over single or double-doublet antenna.

A New Field for the Serviceman

Servicemen and dealers looking for a

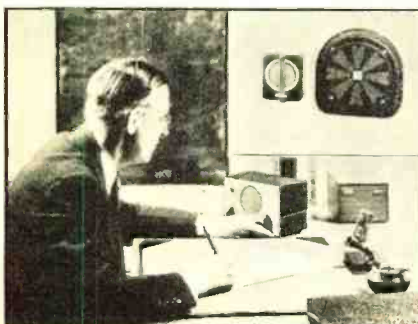

NEW BELIN APPARATUS FOR PICTURE TRANSMISSION

The equipment shown in operation, above, is a new transmitter recently installed at Malmaison, in the outskirts of Paris, for the speedy transmission of photographs by wire or radio. The cylinders upon which pictures are sent and received are shown in the fore-front of the set-up

profitable side-line will be interested in the "Belfone" two-way inter-department communication equipment produced by the Bell Sound Systems, Inc. The amplifier operates from either alternating or direct current line supply. The metal type tubes employed comprise one type 25Z6, one 25A6 and one 6F5. A crystal type loud-speaker serves as both reproducer and microphone. A 6-inch "Hyflux" permanent magnet dynamic type speaker is used where the communicating signal must cover a large room. Several of these units can be spotted at different points as in stock rooms, counter rooms, factory lofts, etc. The system is sturdily constructed to give trouble-free operation.

Striking Models Offered in 1937 Line

One of the outstanding receivers in the new RCA line is the model 10K illustrated below. It is a 10-tube, 5-band superheterodyne incorporating the new "Magic Voice" feature which eliminates the "boom" from low notes and allows only the desired controlled frequencies to radiate into the room. The tuning range of the set is from 150 to 410 and 530 to 60,000 kc. in wavelength; 2000 to 730 and 565 to 5 meters.



The tube equipment comprises three 6K7's, one 6L7, one 6J7, one 6H6, one 6F5, a "magic eye" 6E tube, one 5Z4 rectifier and one type 6L6 beam super-power amplifier tube. The set features other new developments including a high-fidelity speaker, dual-ratio tuning dial, etc.

14-Tube High-Gain P.A. System

The Webster model CPX-4P sound reproducing system delivers 30 watts power-output, is designed for 113 db. gain and uses Class A amplification to produce an



excellent audio-frequency response. It can be used with either a crystal or velocity type microphone, has a flexible input mixing arrangement for 1 to 4 microphones or phonograph pickups. The tube equipment comprises four 6C6's, two 6A6's, two 56's, four 2A3's, one 83 and one 80.

High-Fidelity Permanent-Magnet Speakers

The announcement from the Cinda-graph Corp. credits a combination of new materials and constructional design as the main factors for the high efficiency and fidelity of their new permanent-magnet, dynamic type speakers. The new line is available in 8-, 10-, 12- and 18-inch sizes. The accompanying photograph shows the side view of the 10-inch model. Probably the outstanding feature of the new speaker is in the use of a new alloy, which is called "Nipermag," for the permanent magnet. The manufacturer states that this material was found to provide flux densities of 7000 lines of force per square centimeter (Turn to page 118)

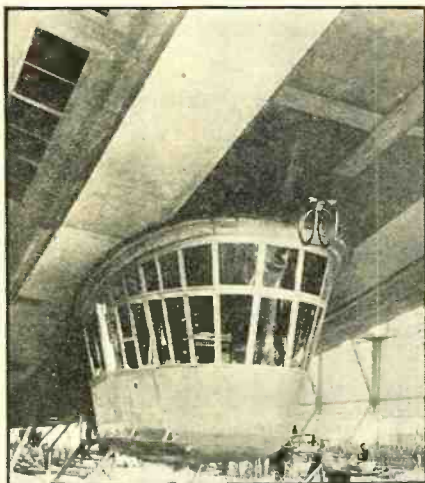

DETAILS OF EQUIPMENT

View above shows gondola holding radio equipment. Note the direction-finding loop. Three views below show Max Jordan, announcer, in the radio control room; details of the band-switching arrangement of the receiver; the Hindenburg at Lakehurst, with the NBC portable transmitter at right.

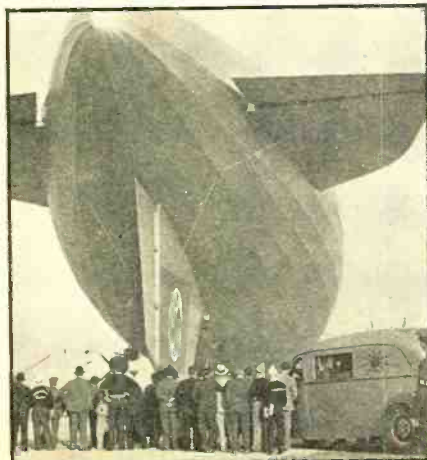
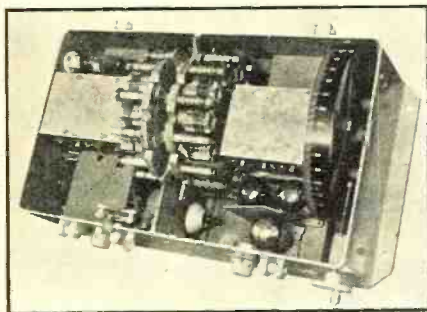

AT THE RADIO OPERATOR'S DESK

At the extreme left is the short-wave transmitter with the short-wave receiver alongside. At the extreme right is the long-wave transmitter and the long-wave receiver.

Radio Aboard The "HINDENBURG"

(LZ 129)

By Herbert Lennartz

SUCCESSFUL two-way radio communication with Chatham, Mass., was maintained by the latest zeppelin LZ129 on its second trial flight. This meant bridging a distance of 4375 miles by radio. Readers will no doubt be interested in the type of equipment employed on this latest airship. There are two transmitters, one for long waves and one for short waves, and two all-wave receivers. The aids to navigation consist of three sets of direction-finding apparatus.

The Transmitters

The long-wave transmitter can be tuned to any wavelength between 575 and 2,700 meters or 525 to 111 kc. Plate circuit modulation is employed. The power in the antenna is 200 watts for c.w. and 125 watts for telephony. The radiator consists of a two-wire antenna, 120 meters in length which can be unreeled by a motor-winch. The receiver and transmitter employ the same antenna, equipped with an automatic device which switches it over when one speaks into the microphone. As soon as the speech stops for more than half a second, the installation automatically returns to receiving conditions.

The short-wave transmitter has the same power as the long-wave transmitter and can tune from 17 to 70 meters (17,700 to 4,280 kc.). This range is divided into two overlapping bands. The antenna consists of a quarter-wave trailing wire, which is reeled out to the required length for the frequency in use.

The necessary power is supplied by

an internal combustion motor and a generator which furnishes the electrical power for the lighting of the ship, the power for the radio equipment and the heating current for the electric kitchen. The filament and plate supplies are obtained by means of the usual transformers. The necessary filters are placed in the lines in order to eliminate interference.

Two all-wave receivers are employed for reception, one to be used in conjunction with each transmitter. They are four-tube receivers employing two tuned r.f. circuits with a frequency range from 15 to 20,000 kc. subdivided into 10 bands. Switching from one band to another can be done quickly because all coils are mounted on the edge of a disk which can be rotated by hand.

The power supply for the receivers consists of a storage batteries for both A and B supply. These batteries can be charged during the flight.

Radio Compass

Three different direction-finding receivers are employed on board the airship. The first one serves for the navigation during the flight, to find the location of the ship by means of cross bearings and to follow a course indicated by beam transmitters. It has a wave-length range from 300 to 1,800 meters. Two other directional receivers are employed for landing in bad weather.

A large loop is connected to two of these receivers by means of a transformer. A small loop is coupled to the third directional receiver.

The output of the (Turn to page 115)

It's New! Take With You a "TRANSCCEPTOR"

ON YOUR Vacation

By Frank Lester

(W2AMJ)

THE transceiver, which has been popular in the 5-meter field, suffers from one serious shortcoming, which becomes objectionable as the user becomes more proficient in 5-meter technique. As the same antenna is used for both transmitting and receiving, and practically all of the other parts of the instrument likewise serve a dual purpose, some compromise in adjustment is unavoidable. This is especially true of the extremely important adjustment of antenna coupling. The best coupling for transmitting proves too "tight" for receiving and causes radiation and interfering signals. Some unimportant value of coupling must be chosen which will permit the transceiver to function in both the receive and transmit combinations; this means that the transceiver rarely gives the best performance of which it is capable.

IN an effort to preserve the highly desirable features of compactness and portability which have made the transceiver so widely accepted, the writer has designed a new 5-meter portable rig which is known as a "Transceptor." This instrument represents a logical advance in portable 5-meter practice. It was evolved from the experience gained in the building of hundreds of Lafayette transceivers. This new Transceptor, which is shown



THE TRANSCCEPTOR OPERATES ANYWHERE
The designer of this novel communications unit shown talking on 5 meters directly from a drafting board in his office to another amateur at a distant point.

in the accompanying illustrations, measures only 15 by 15 inches square by 7½ inches deep, and is therefore just a trifle larger than a portable typewriter. Unlike transceivers, it is fitted with a hinged cover which fully protects tuning controls when the unit is not actually in use. This cover, opening outward on a pair of sturdy hinges, makes a very convenient writing compartment, in which a log-book, pencils, a cheap watch, and even the necessary antenna wire may be carried. A compartment on the right side of the case houses a hand-set. When this Transceptor is closed up for carrying, it really is complete, and no additional hand-bag for a half-dozen accessories is required. It makes an ideal unit to take on the summer vacation.

The "Receive" Circuit

The case is made of black crackle finished steel, and will withstand all sorts of mechanical abuse. The Transceptor may be handled as an ordinary piece of baggage, and can be stowed away in any part of a car without suffering damage to exposed knobs, dials, binding posts, etc. It can be sat on or stood on!

Electrically, the Transceptor comprises 4 tubes in a thoroughly reliable circuit combination. In the accom-

panying circuit diagram, tube V-1, a type 30, functions as a self-quenching super-regenerating detector, operated with a separate receiving antenna. When the 3-position switch SW is thrown to the position marked "R" (receiving) transformer T-1 operates as a straight audio-amplifying transformer, working into tube V-2, also a type 30. This tube works into a class B push-pull audio, which comprises transformers T-2 and T-3 and a type 19 tube. The receiver portion of the hand-set connects directly to the secondary of output transformer T-3.

The Transmitter

When the change-over switch is thrown to "S" (transmitting), the type 19 tube V-4 operates as a unity-coupled push-pull r.f. oscillator. The microphone part of the hand-set is connected in series with a special primary on transformer T-1, which thus acts as a microphone-coupling transformer. Tubes V-2 and V-3 then function as voice amplifiers, with tube V-3 further operating as a modulator tube. The secondary of transformer T-3 is thrown in series with the B+ lead to the oscillator tube V-4, and thus modulates the r.f. output of the latter.

When the change-over switch is thrown to the (Turn to page 121)

EVERYTHING SHIPSHAPE

The inside view, from the back of the unit, showing how the batteries and hand-set fit into their compartments.

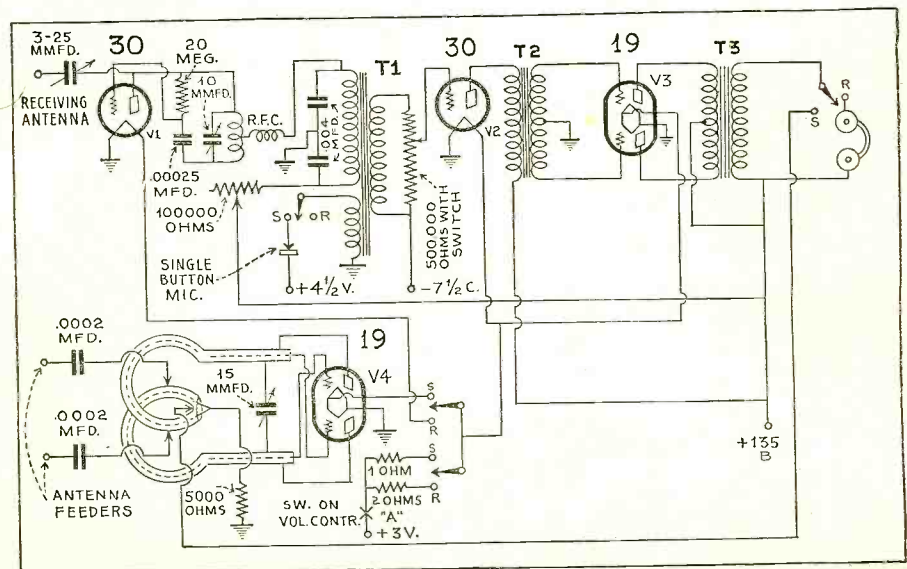
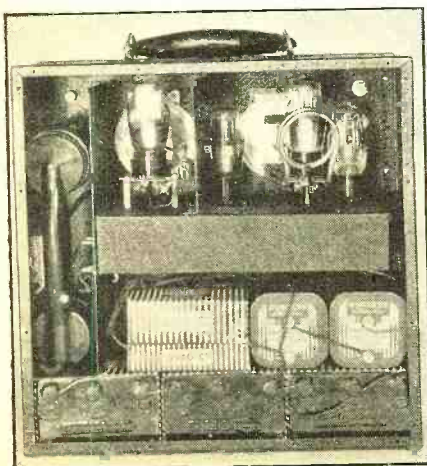

How to

TOWN and

A compact receiver which may be used wherever a.c. or d.c. lines are available. No antenna is needed, yet it will provide excellent reception even under the most adverse conditions

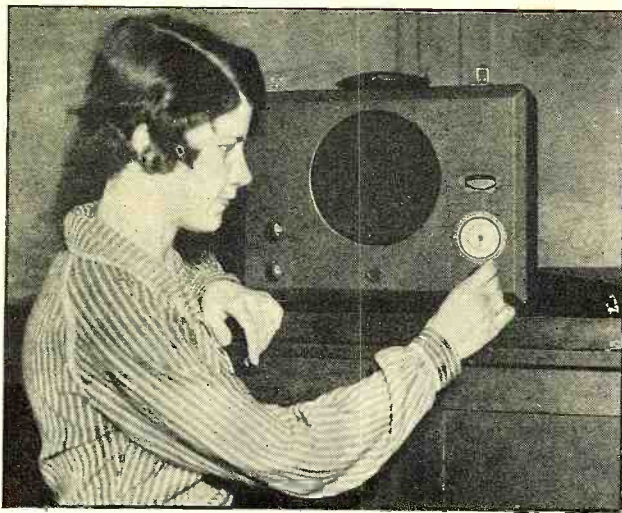

NEAT SIMPLICITY

When closed it looks like a small suitcase. With the front cover removed it is ready for business by simply plugging it into the nearest outlet.

IN designing this capable little broadcast-band receiver a number of rigid requirements were set up and kept constantly in mind:

- (1) *Real portability. This means a convenient traveling case, not too much weight, and operation without an external aerial.*
- (2) *High r.f. gain so as to work well without an aerial, in steel constructed building, and in other tough locations.*
- (3) *Exceptionally high signal-to-noise ratio.*
- (4) *Ample audio gain to bring out good response from the desired station even though its field strength be low.*
- (5) *Fool-proof 110 volts a.c. or d.c. operation; that is to say, there should be no a.c.-d.c. change-over switch and nothing to blow out regardless of which way the plug is inserted.*
- (6) *It should have sufficient undistorted output to flood several rooms with clear speech or music.*
- (7) *Easy to tune.*
- (8) *Substantial construction so as to give years of trouble-free service.*
- (9) *Last but not least, it should reproduce speech and music with a faith-*

fulness that will delight the music lover.

All these requirements constitute a

large order and for that reason a set of this kind doesn't spring up overnight. Several weeks were consumed in designing, building, and in obtaining the most satisfactory operation. Now that the design has been completed, however, this receiver can be reproduced by any experienced set builder in a fraction of the time.

The requirements as set forth were satisfied as follows:

- (1) *By using a readily-procurable portable radio cabinet, with a built-in screen aerial, which when closed looks like a high-grade suit-case.*
- (2-3) *By the use of two tuned r.f. stages and one i.f. stage instead of vice-versa.*
- (4) *By employing three stages of audio amplification.*
- (5) *By the use of transformerless rectifier circuits employing two 25Z5 tubes.*
- (6) *By the employment of two low-gain, well-stabilized audio stages driving a pair of 48 tubes in push-pull, and an*

unusually good rectifier and filter system.

(7) *By the inclusion of an illuminated airplane dial, tuning meter, and automatic volume control.*

(8) *By the selection of only high-grade materials. This receiver has been in daily use since January, 1935, and not a single unit in it has given trouble.*

(9) *By the use of a high-grade 8-inch dynamic speaker, together with the points mentioned under No. 6.*

Assuming that you purchase the cabinet as listed the chassis is made as follows: It is of 1/16 inch aluminum, 15 inches wide, 5 inches high and 5 1/2 inches from front to back, all outside dimensions. The top, front and ends are formed from a single piece with flanges on the ends as illustrated. The back is a separate piece and is attached to the rear flanges of the end pieces. The bottom end flanges are drilled for fastening the apparatus in the case. A cut-out will have to be made in the front and top of the chassis to accommodate the speaker. Although the constructor may cut the socket and other

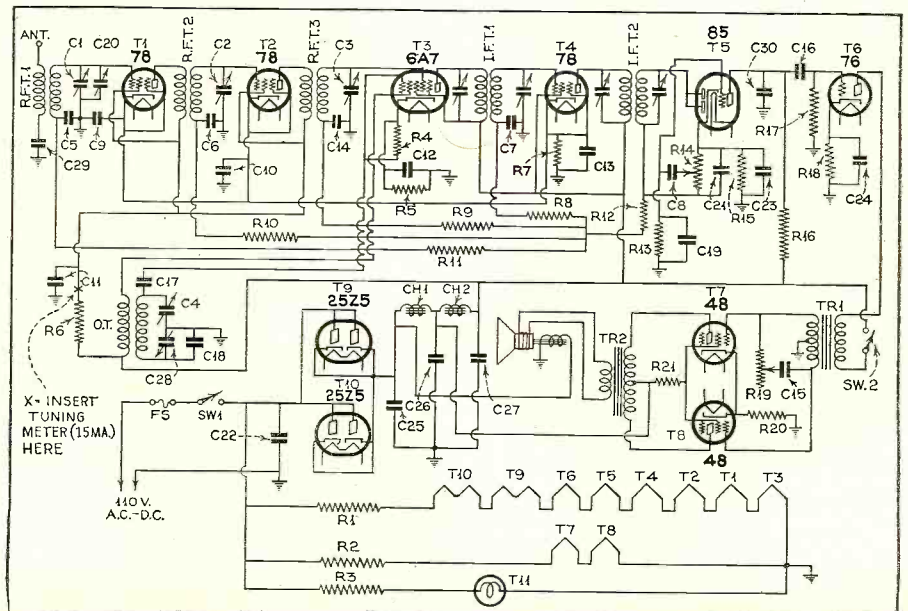
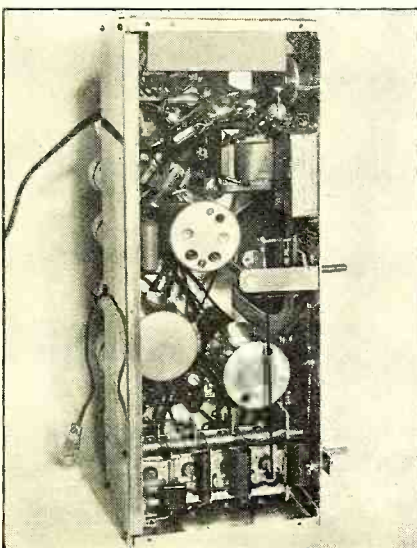

Build a COUNTRY RECEIVER

By Reginald S. DuBois

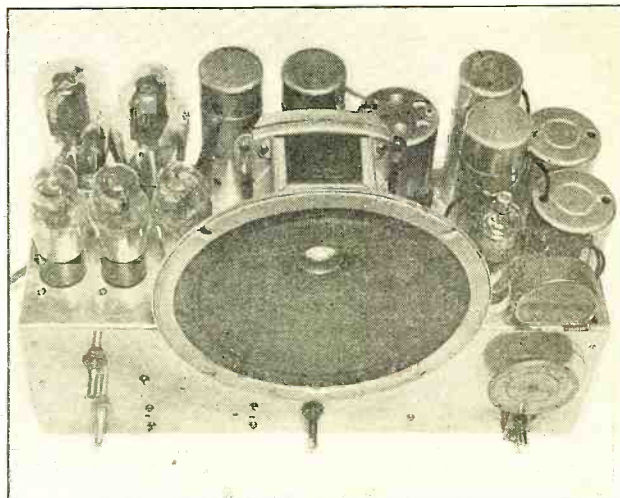

THE CHASSIS

Ten tubes provide plenty of power for strong loud-speaker reproduction, with better quality than is normally expected from portable receivers.

small holes in the base himself it is wise to let the base maker cut the speaker hole, as that is none too easy a job. The photographs clearly show the locations of the major parts.

Drill as many of the required holes as possible before mounting any of the apparatus. If the r.f. and i.f. coil cans have open bottoms their shielding will be more complete if instead of cutting out a large hole beneath the can four small holes large enough to clear the four lugs on the coil are drilled. The antenna coupler, the i.f. output and the oscillation transformer are mounted with 1/4 inch tapped brass rods and 6-32 machine screws about 1/2 inch below deck to allow room for wiring.

Practical Construction

The chassis is much easier to handle without a heavy speaker on it, therefore do as much as possible before mounting it. To obtain maximum volume without howling, the speaker is supported on rubber and held down by simple clamps as noted in the parts list. The five speaker wires are run through a rubber-grommeted hole in the base. The two resistors R1 and R3 that radiate considerable heat are mounted above deck with fibre washers top and bottom, thus leaving the interior of the base free from practically all heat-radiating parts. A panel-controlled midget condenser, C20, is shunted across the secondary of the antenna coupler, to permit precise tuning with either an outside antenna or the self-contained one. To bring about more perfect tracking, C14 was reduced to .01 mfd and a suitable decrease in the oscillator padding was made giving a noticeable gain on the tuning meter. Another set-up might present a little different problem in tracking.

It is good practice to wire the sockets first, then the r.f. and i.f. transformers, the gang condenser, tuning meter and dial bulb socket, leaving the small resistors and by-pass condensers until later. Next, wire the resistors R1 and R3 and then the tone and volume controls and the speaker. There are so many wires to be grounded that a piece of bare bus bar about two inches long and perpendicular to the base will be found useful as a ground terminal.

The power cord and switch should now be wired in, then the audio transformer and filter chokes, and the electrolytic condensers last. To guard against a.c. hum pick-up the input push-pull transformer should be placed at right angles to the filter chokes, and the control grid of T5 and the lead to the high side of the volume control shielded.

The type 48 tubes were selected as output tubes because, at low voltages, these tubes produce greater undistorted

output than any other type. If a speaker other than that specified is used, make sure that the output transformer is designed for type 48 tubes in push-pull and particularly that the primary of the transformer has low d.c. resistance. The one specified measures about 75 ohms resistance each side of the center tap.

(Turn to page 122)

New Permanent Magnet Speakers

By Frederick Siemens

IN recent years, much research work has been done in efforts to find methods of producing better permanent-magnet dynamic speakers. The development of a new magnetic alloy by the laboratory of the Continental Motors Corporation now enables the construction of a permanent magnet which is far smaller and lighter than earlier types, yet provides a flux density equal or greater than that obtainable from the average electro-dynamic type of equal size. The compactness and simplicity of the new Perm-O-Flux speaker, which employs this new alloy, are shown in the photograph.

Earlier types of permanent-magnet dynamics required large, bulky magnets. Often the sensitivity was found to be less than that of comparable electro-dynamics and the flux density tended to decrease over a period of time. The new alloy has outstanding advantages in permanence, even under the most un-

(Turn to page 105)

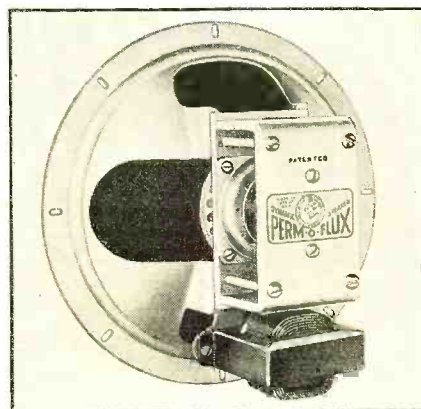

FLUX DENSITY DIMENSION RATIO

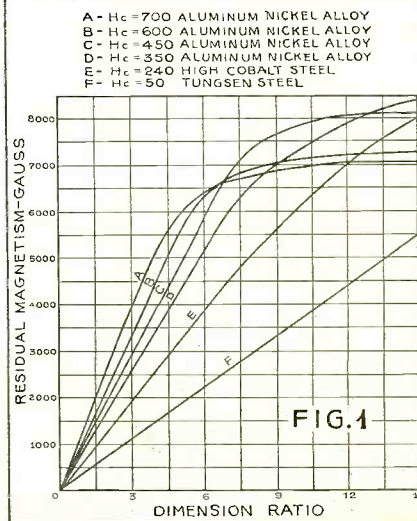

THE SERVICE BENCH

tells YOU Something about

Business Methods

...

Hum Reduction

...

Service Kinks

...

Tuning Kits



FIGURE 4

Conducted by Zeh Bouck, Service Editor

THE BUSINESS END OF SERVICING

THE principal phases of the business end of radio servicing are those of first getting the business, and then of keeping it straight—that is, systematic and orderly.

RALPH MELLON, of Pottstown, Pa., sends us a card, the front and back of which are shown in Figure 1, that has brought in business merely by overcoming the sales resistance of those who prefer to endure unsatisfactory reception rather than be without a radio for the period of repair and adjustment. Naturally, it works equally well in cases of complete breakdown.

These cards are inexpensive as they are a part of the service sales aid campaign of the makers of National Union radio tubes. National Union supplies the cards, with the serviceman's imprint in red, at \$1.25 for five hundred. The sales message in Figure 2 is printed on a penny postcard, giving a good idea of what can be done with sound equipment and an excellent way of publicizing it. Item number 1 is readily taken care of by acting as the intermediary between the "artists bureau" of a nearby broadcasting station and the customer.

With the business on hand, keeping it

FIGURE 1

**FREE
RADIO LOAN
OFFER**

▼
*No need to miss
a program!*

**NATIONAL
UNION**
RADIO TUBES
GUARANTEED NON-MICROPHONIC

Place
One Cent
Stamp
Here

**RADIO SET LOANED
FREE**

While we are repairing yours

We don't want you to miss a single moment of radio enjoyment. When we take your receiver to our shop for overhauling and repair work, we leave a set operating in your home. There is no charge or obligation for this special service. We are Qualified Radio Experts, fully equipped with modern instruments for radio tuning and repairing. Lowest prices. Every job guaranteed. Call us with confidence.

WE RECOMMEND
NATIONAL
 RADIO TUBES
 for PERFECTION

RALPH MELLON
 Certified Radio Technician
 25 KING STREET POTTSTOWN, PA.
 PHONE: 1142-M

moving and track of it is facilitated by the Goodway Radio Sales and Service organization with the tag shown in Figure 3. The reverse side of the main tag provides additional space for a record of the repair and the parts used. The name and address of the customer is written on the back side of the detachable section, which is filed in the shop. The client is requested to preserve his portion of the tag for reference in case of future trouble.

A more elaborate form is employed by the Comet Radio Service, Pittsburg, Pa. The proprietor, A. S. Isaacs, Jr., writes: "It will be observed that an invoice is attached to the service record form. We were confronted with the problem of keeping a comprehensive record of service jobs, a cost and charge record and invoice copies. A carbon is made, leaving the invoice attached. This facilitates locating both the service record and invoice copy for every job. Furthermore, a file of these forms provides a complete mailing list, a volume of trouble shooter's information, and a set of account books. The serviceman carries a pad of forms with him to each assignment, and the first seven lines are filled in as far as possible in the presence of the customer. We have found this most effective in that it creates an impression of efficiency—to which, by the way, we endeavor to live up."

This highly developed sense of order is further exemplified in the photograph in our Heading in Figure 4, showing a corner of the Comet Radio Service shop. It will be observed that Mr. Isaacs specializes in Sylvania and Radio News.

TWO FOREIGN SERVICE SHOPS

Just how the other half of the world lives and works is always of interest to most of us. Figure 5 shows the radio maintenance shop of A. C. de Barros, Georgetown, British Guiana, whose specialty is the General Electric line. It will be noted that most of the test equipment is so arranged as to be immediately demountable for portable use. The apparatus is conventional and quite adequate for

modern service work. Señor de Barros tosses a few bouquets to *Radio News*—and herewith we return the compliment.

Fada and Supreme in Belgium

There has never been any question concerning the efficiency of American radio equipment, a fact that makes it a favorite with many foreign experimenters despite the high cost imposed by import tariffs. American apparatus, notably Supreme, will be seen in the service shop (Figure 6) of Jean Schoepp, Lodelinsart, Belgium. The inclined compartment tray, just below the test panel, holds small parts, nuts, bolts, etc

THE DAYS WORK

Symposium on Hum

R. K. Wheeler, of Indianapolis, Ind., writes concerning a Silver-Marshall 728SW: "This receiver had a bad hum which varied in volume according to various settings of the volume control. On investigation it was found that the rectifier, an 82 tube, was located about one and a half inches from the volume control which was the type employing a rocking metal disk for contact. By placing a screw driver on a prong of the 82 socket and leaning it toward the volume control, the hum was increased. Apparently the metal disk of the control, which is connected to the grid of the 45 driver, was picking up the hum. Installation of a different type of control—an Electrad—eliminated the trouble."

Mr. Wheeler continues in reference to a Midwest 16 (1933 model): "Another case of hum . . . a bad one! Filter condensers checked okay as did other logical sources of trouble. Inspection of the chassis disclosed long unshielded leads running from the volume control to the sockets of the 55 and first a.f. stage in the rear of the chassis. To test these leads for hum pick-

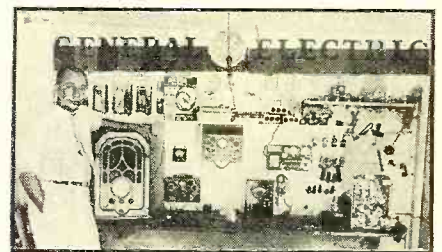

FIGURE 5

up, merely grasp them in one hand and touch the chassis with the other. This should result in a reduction of hum. The lead from the center tap of the volume control is usually the offender and should be shielded. It is not necessary to shield the entire length, about six inches of

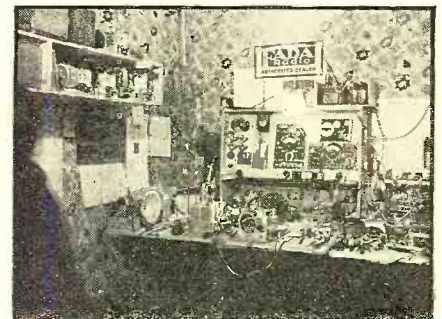
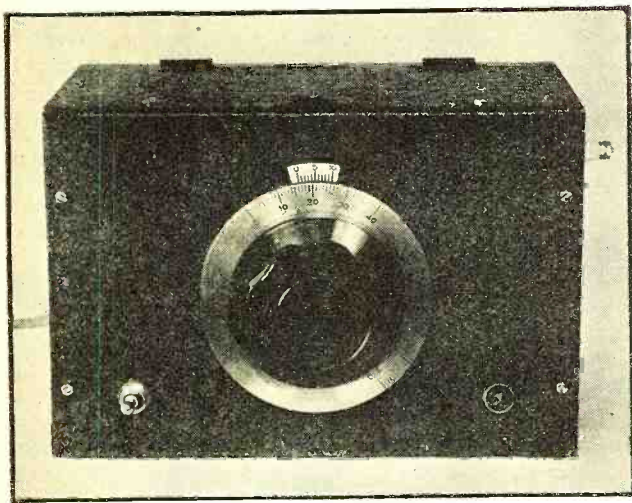

FIGURE 6

grounded braid at the volume control end being sufficient. If no tubular braid is on hand, the wire may be effectively shielded (Turn to page 104)



SIMPLE BUT EFFECTIVE

The vernier dial permits accurate readings to 1/10 of 1 degree. Once calibrated from broadcast stations by the harmonic method the calibration will be accurately maintained indefinitely.

IN response to an insistent demand for an all-wave oscillator of high frequency stability, low cost and small size, this simple instrument has been developed. The range extends from 540 kc. to 22,800 kc., which is sufficient to cover all short-wave bands from 14 meters up as well as the regular broadcast band. Through its use, the calibration of all-wave receivers may be readily checked, or one may determine immediately the frequency of an incoming signal with a high degree of precision.

A Unique Design

The circuit employed is an improved negative resistance type which extends the outstanding features of this type of oscillator to ultra-high-frequency operation. The simplicity, high stability and excellent wave-form characteristic of the negative resistance circuit described in the RCA Radiotron Company's Application Note No. 45 stimulated our endeavors to find some way of overcoming its inherent limitations, namely, failure to operate consistently at radio frequencies above 15 megacycles and weak oscillation at somewhat lower radio frequencies.

In analyzing the circuit, it was discovered that by shifting the phase of a large portion of the shunt impedances and considering other transconductance relationships, the frequency range might be greatly extended and its normal high-frequency performance definitely improved. This was confirmed experi-

mentally and the present circuit (Figure 1) illustrates an application of the new method. A detailed technical discussion will be presented in a later article which will describe a laboratory oscillator using this same basic circuit. Briefly it is done by inserting low-inductance, ultra-high-frequency chokes in the control-grid and plate circuits.

Uses Standard Parts

The instrument shown is entirely self-contained. A small transformer designed to operate from the a.c. line furnishes filament current. Since the total cathode current is but 2 ma., the other voltages required are economically supplied by a small Burgess 22½-volt type 5156 battery and a 4½-volt C battery, type 2370. Five Hammarlund plug-in coils are used to cover all the usual short-wave bands and the broadcast band. The special high-frequency coil may be wound quite simply by hand. It consists of but 5 turns of No. 20 wire spaced over 1⅜ inches on a Hammarlund coil form. The manufactured coils all have an extra winding of fine wire, which is not used in this design. A Hammarlund 140 mmfd. midget Midline variable condenser is used for tuning. It is supported by a heavy brass angle bracket as shown in the pho-

tograph. A Crowe precision vernier dial makes for ease in tuning and exact calibration. The Yaxley pilot light and bull's-eye is used as a reminder to those of us who occasionally forget to turn off the power when the instrument is not in use.

The layout as shown in the photograph should be carefully followed. The Hammarlund Isolantite tube socket is mounted slightly below the chassis, spacing washers serving to prevent any accidental shorts to the chassis. The coil socket of the same make is elevated about ¾ inch above the chassis to facilitate coil changing and decrease coil losses. The Ohmite 5.2 microhenry r.f. choke is in the control-grid circuit and the Insuline 5-meter r.f. choke is used in the plate circuit.

Simple and Compact

While a type 6C6 tube was used in this instrument, the corresponding 2.5-volt type 57 may likewise be used if a suitable filament transformer is on hand. The type 57 is capable of an even greater frequency range and output. The Insuline cabinet is 9 inches long, 6 inches high and 5 inches deep, and the chassis of the same make is 8½ by 4¾ by 1½ inches. The small stand-off insulator post serves as the oscillator output connection. For sensitive receivers, the nut and screw terminal projecting into the case will provide sufficient pickup when receiving weak signals, particularly in the short-wave ranges. If greater output is (Turn to page 117)

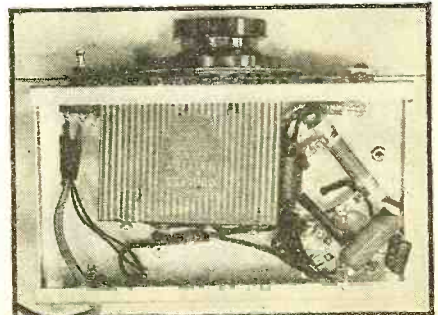
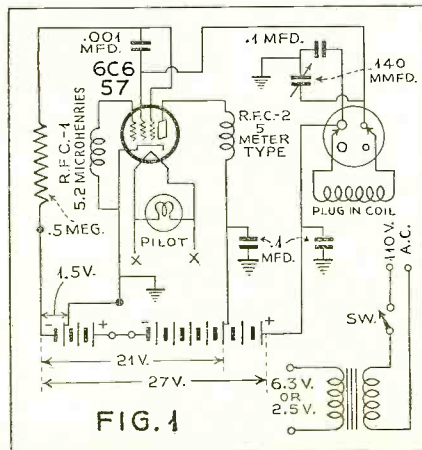
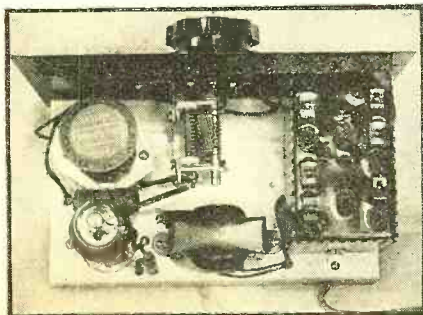



USING THE EQUIPMENT IN RECEIVER ALIGNMENT

The Wobbulator is shown at A and the oscillograph at B. The resonance curve of the receiver appears on the screen and provides an exact alignment check obtainable in no other way.

The New "SERVICE TWINS"

(Triumph Model 800 Oscillograph
and Model 180 Wobbulator)

By John M. Borst

RECEIVERS of the near future will unquestionably require better tools and higher skill on the part of servicemen and experimenters. Of these newer tools the cathode-ray oscillograph is one of the most important and useful. This is being recognized more and more by progressive set manufacturers and service organizations. One example of a complete set of instruments designed to meet this growing demand is the Model 800 oscillograph and the "Wobbulator" produced by Triumph Mfg. Co.

The oscillograph unit contains the mechanical arrangement for holding a 3-inch cathode-ray tube as well as a power supply for the tube, a linear sweep circuit and individual amplifiers for horizontal and vertical deflecting plates.

The "Wobbulator" is an accessory which is needed for obtaining the resonance curve of a receiver directly on the cathode-ray screen, thus saving the time required in tediously making a number of individual measurements and then plotting the results on paper. It

consists of an all-wave oscillator which can be "wobbled" or swept 30 kc. The same unit also serves as a regular service oscillator, modulated or unmodulated.

The circuit of the oscillograph unit is shown in Figures 1 and 2. A little explanation will no doubt be helpful to those who wish to understand the operation. The 879 tube is a high-voltage rectifier which is used to obtain the power for the cathode-ray tube. This power supply is "reversed," that is, the "hot" side is negative, R28 is the focusing control and R26 the brilliancy adjustment. R24 and R23 are screw-driver adjustments which serve to center the beam.

Amplifiers Included

V1, a 6C6 tube, is the amplifier for the vertical deflecting plates and V3 for the horizontal deflecting plates. These amplifiers can be cut out by means of the switches S1 and S3 when not needed. If S1 is set all the way to the left, 60 cycles is applied to the amplifier tube and the vertical deflecting plates. In the middle position S1 connects the "Vert" input to the amplifier; in the extreme right position directly to the deflecting plates.

S3 works in a similar way except that in the left position it connects the sweep circuit to the horizontal deflecting plates. The 885 tube and its associated resistors and condensers serve as a linear sweep circuit, the frequency being varied by means of the switch S7 and R13. It will sweep at frequencies from 20 to 20,000 per second. There are provisions to interlock the sweep circuit either with the power line, the signal on the vertical deflecting plates or any other outside source. If S6 is closed the interlocking takes place with the power line. With S6 open and S2 on "Int" the sweep circuit interlocks with the signal on the vertical deflecting plates. With S2 on "Ext" interlocking with any other signal is possible; the signal source being connected to "Sync" and "Gnd."

(Turn to page 116)

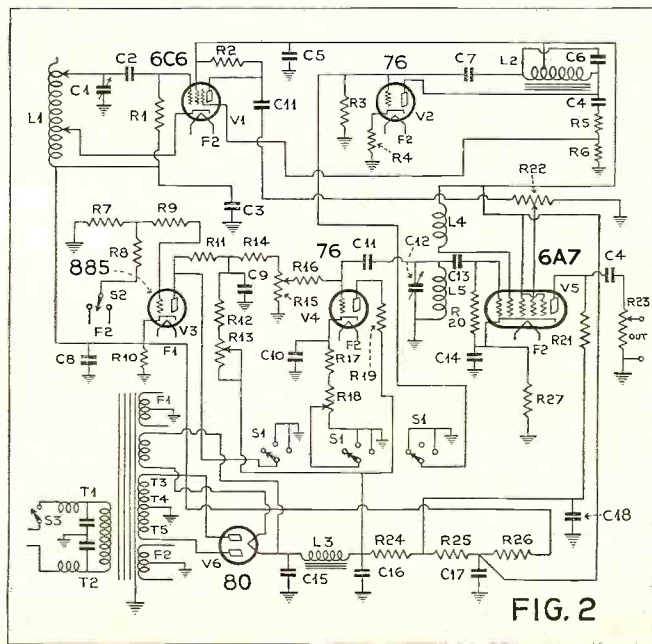
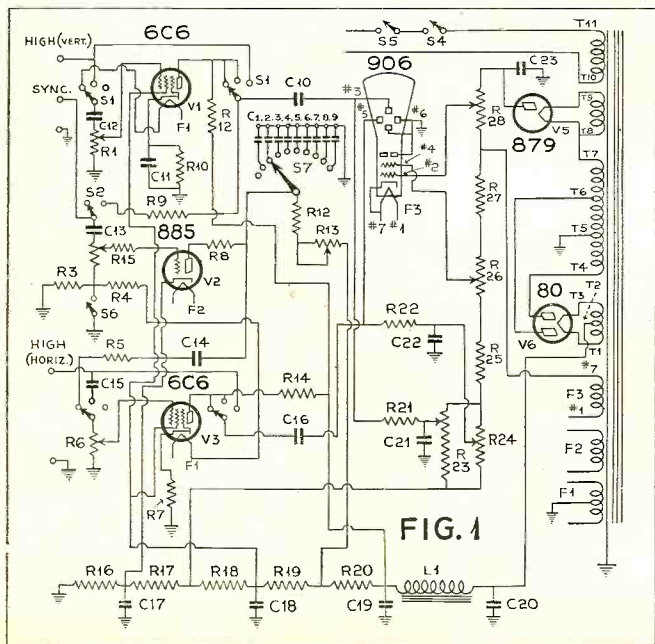

“SELLING SERVICE”

By A. A. Ghirardi
and T. S. Ruggles

Part Five

IN addition to the advertising mediums already discussed in this series, newspaper advertising, telephone-directory advertising, spot-broadcasts over local radio stations, lantern-slide ads in the local movie theatres, and even advertising through the medium of the letterhead and business card are open to radio service shops. Like all other advertising, these will produce worthwhile results only if they are carried out with intelligent regard to the numerous details that experience has shown to be extremely important.

THE practical value of local newspaper advertising for the radio service business has always been a matter of dispute—possibly because of the marked differences in the circulation, area of coverage and makeup of different newspapers. It is evident that a given small ad placed in the local newspaper of a small town will attract more attention and likely have greater pulling power than the same ad placed in the great newspaper of a large city—even though the latter has a much greater circulation. For this, and many other reasons, newspaper advertising pays out very well in some cases but may be a total loss in others. The only way you will know its actual value in your own radio service business is to test it out—and don't expect to make a fair test with less than six insertions!

Check the response as well as you

can, ask customers whether your newspaper ad was responsible for their calling on you, etc. You can secure three forms of advertising from your local newspaper. They are: (1) Display; (2) Classified; (3) Personal.

You pay for the first two—the last is free, and how much of it you get depends entirely upon your own initiative. Let us consider each one separately.

Display Advertising in Newspapers

For the average service shop, large-space display advertising is generally inadvisable. If the ad contains much copy, it will probably be a failure unless it contains an illustration. You can get the free assistance of the newspaper in laying out your advertisement and in doing the necessary art work. Or you may prefer to use some of the splendid “mats” which the leading tube manufacturers supply for reproducing “catchy” illustrations.

Make your ads “newsy” and time them. Tie them in with local and world-wide current broadcast events such as football games, political, war news broadcasts, etc. The public wants front-row seats at all these special broadcasts. Tell them how they can get them by having you check over their sets, replace tubes, sell them improved sets, etc. Vary the illustrations often but retain the same general style of treatment. Study the newspaper and magazine ads that attract your attention. Notice how they contain newsy illustrations and brief word messages.

Small-space display ads in the local newspaper are very practical for the service-man with limited funds, if well-planned and run frequently enough. The amount of space isn't so important as the frequency and regularity of your advertising message. Consistent use of small space in a good position will bring you better results than the occasional use of larger space on any other page. Do not attempt to crowd a lot of copy into the small space—nobody will be tempted to read it. It is better to have a simple ad merely calling attention to your



WHEN THE RADIO SET GOES “DEAD”

Where is the logical place for the radio set owner to look when his receiver needs repair? The local newspaper or classified telephone directory is of course the logical place to turn to. Small ads in these media should pay well for service organizations, especially in the suburbs.

name and the fact that you do good service work. Preferred position—such as on the radio program page or the sports section—costs a little more but is usually worth it. The upper right-hand corner on pages 3 or 5 is also good. Choose the paper which you feel is read most by the class of people you want to do business with—in the area you desire to serve. Don't be influenced too much by its total circulation.

Using Classified Ads

You can also advertise in the “classified advertising” section under the heading of “Radio Service”. Use copy that is short, snappy and original. “Catch” lines starting with the word *Radio* such as: RADIO SERVICE ON ALL MAKES OF SETS; RADIO SERVICE BY EXPERTS; RADIO REPAIRS at NOMINAL CHARGES, etc., followed by the shop name, address and telephone number, have proved very successful.

Personal Advertising

Everything you do that is out of the ordinary, should be written up for the newspapers as a personal news item. If you make a noise-survey in your town —If you go away on a vacation, or attend a servicemen's convention, let the personal columns carry a notice of it —with your photograph if possible. Join an active club, and volunteer your services in all community fund drives. Of course, only the owners of service

(Turn to page 124)

RADIO REPAIRS

HOME AND AUTO
by
Expert Service Men
Nominal Charges
Call W.P. 2012

KILNIE INC.
75 Mamaroneck Ave., W. P.

Authorized

RADIO

REPAIR SERVICE In Your
Own Home
M. BROOKS, 2494 BROADWAY, near 93rd St.
SC HUYLER 4-6494



NEW SOUTH AMERICAN STATION

These are the new control panels and desk for station LRU, Buenos Aires, Argentina, which may be heard transmitting on 15,290 kc. "How many of our readers have been able to pick them up successfully?" asks J. F. Edbrooke, L.P.O. for Argentina

THE forty-first installment of the DX Corner for Short Waves contains the World Short-Wave Time-Table for 24-hour use all over the world. Consult it regularly and make your all-wave set pay big dividends!

Please Use Penny Post Cards!

We realize that our Listening Post Observers are doing pioneer work in reporting and compiling information regarding the transmissions of short-wave stations and that there has been nothing to go by as to the best method for getting these reports into printed form so that everyone may have the information available in our monthly meeting place, the DX Corner for the Short Waves of Radio News. The post card system is working out so well for compilation and filing that we are asking all of our Official Observers and other Listeners to use this form. Last month about one-third of the reports were on post cards while the rest still were sent in rather rambling and enlarged style. Remem-



ber, what we want are *short concise statements about new stations or station changes*. Please remember to keep your information on stations logged specific! Do not send us long lists of the ordinary run of stations which everybody knows are on the air and which have regular short-wave transmissions with no change from month to month. To reclassify our recommendations of last month, we find that reports can be arranged in two ways instead of three, as follows: Number 1, New Stations; number 2, Station Changes.

No other information need be included on the card except the Observer's or Listener's name and address and the fact that he is either a Listener or an Observer for his territory. Standard form for this would be the following:

NEW STATIONS

W8XK, Pittsburgh, Pa., 11870 kc., daily 5 p.m. to 9 p.m., E.S.T. (Verification.)

STATION CHANGES

CB960, Santiago, Chile, moved to 9590 kc., same schedule as before. (Announcement.)

This form of reporting will guarantee an up-to-date and more workable Time-Table. We believe that our Observers will agree it takes a long time for your editor to go through 5-page letters with reports of reception on which at least 4 pages are on the standard run of stations without any change from month to month. Please, all Listeners and Observers, conform to these recommendations.

Welcome to Our Organization

The following new Listening Post Observers have been appointed for 1936:

IN THE UNITED STATES

Missouri: Robert S. Nash.
Ohio: Arthur Leutenberg.
Texas: Roy E. DeMent
Vermont: Fred Atherton.

GREETINGS FROM PORTLAND, ORE.

Harold H. Flick of that city, Official Short-Wave Observer, sends best 73's to other short-wave listeners throughout the world. He has a fine flair for picking up hard-to-get stations on his 18-tube Midwest receiver. At right is pictured his extensive antenna tower which is 70 feet high and accommodates (besides 4 antennas) a weather vane and an aircraft warning light. It was dedicated to RADIO NEWS and its DX Fraternity

The DX for the

Conducted by

Laurence

IN OTHER COUNTRIES

Greece: S. E. Stefanou.
Irish Free State: W. J. Humphries.
South Africa: L. E. Williams.

Reports of Listening Post Observers and Other Short-Wave Readers of the DX Corner

Listed in the next column is this month's consolidated reports of short-wave stations heard by our wide world listening posts. Each item is credited with the Observer's surname. This allows our readers to note who obtained the information. If any of our Readers can supply Actual Time Schedules, Correct Wavelengths, Correct Frequencies and any other Important Information (in paragraphs as recommended) the DX Editor, as well as our Readers, will be grateful for the information. On the other hand, readers seeing these reports can try their skill in pulling in the stations logged and in trying to get complete information on these transmissions. The report for this month, containing the best information available to date, follows:

EUROPE

RNE, Moscow, U. S. S. R., 12,000 kc., reported heard daily 1 to 6 p.m., E.S.T. (Westman.) This same station and location heard on 19 meters, Sunday 9 to 10 a.m., E.S.T. (Pickering.)

RV72, Moscow, U. S. S. R., 6611 kc., reported heard Sundays 4 p.m., E.S.T. (N. C. Smith.)

RKI, Moscow, U. S. S. R., 15,083 kc., reported heard Sundays up to 2 p.m., E.S.T. (Shea.)

Who has heard the new French station reported on 12,240 kc. by one listener, and on 12,260 kc. or 12,270

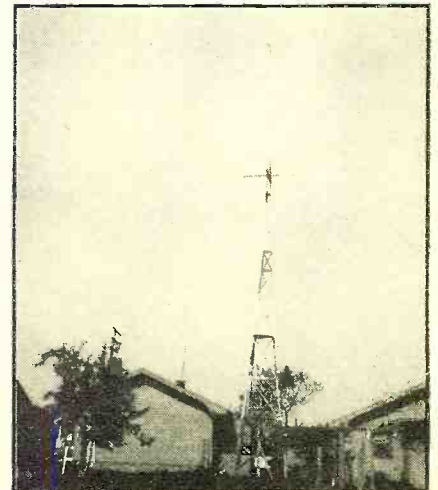

Corner SHORT WAVES

M. Cockaday

kc. by another listener? (Hartzell, Messer, Moore.) They have been reported heard 10 to 12 a.m., E.S.T., relaying French state network and also reported heard at 2:30 a.m., E.S.T. Another report says 1 to 2 a.m., E.S.T., with chimes at 2. (Cox.) (Is this the same station as that reported last month by Miller as TYB?)

SPW, Warsaw, Poland, 13,653 kc., 10 kw., reported heard Mondays, Wednesdays and Fridays 11:30 to 12:30 p.m., E.S.T. Programs in Polish, English and French. (Shea, Carville, Moore, Portmann, Yoshimura.)

CSW, Lisbon, Portugal, 9400 kc., reported heard 5 to 7 p.m., E.S.T. (DeLaet, Carville, Shea.)

Radio Belgrade, Belgrade, Yugoslavia, 6100 kc., is a new station with 2½ kilowatts power. (Styles, Stefanou.)

OER2, Vienna, Austria, 6072 kc., reported as follows: 9 a.m. to 5 p.m., E.S.T., Mondays, Wednesdays, Thursdays and Fridays. On Saturday they are on till 6 p.m., E.S.T. (Portmann, Hartman.)

LZA, Sofia, Bulgaria, 14,970 kc., reported heard testing 12:30 to 4 p.m., and also at 11 p.m., E.S.T. (Westman, Vassallo, Carville, N. C. Smith, Chambers, Styles.)

Who has heard the new Italian station on 12,825 kc., 5 to 6 p.m., with announcements by a woman and with canaries singing, etc.? (Chambers.)

PCJ, Huizen, Holland, 9590 kc., reported heard with a program for the United States 7:05 to 10 p.m., E.S.T., Wednesdays. (Oxreider, Lowe, Partner, Cindel, Rodriguez, Pickering, Coover, Howald.)

GBTT, S.S. *Queen Mary*, 13,200 kc., heard 12:30 p.m., E.S.T. (Dressler.) Also heard on 8800 kc. at 1 p.m. and on 4400 kc. at 8:15 p.m., E.S.T. (Johnson.)

GSF, Daventry, England, 15,140 kc., reported heard best 6 to 8 p.m., E.S.T. (Davis.)

GSI, Daventry, England, 15,260 kc., reported heard best 2 to 5 p.m., E.S.T. Also reported heard at 12 noon, E.S.T. (Jones, Westman.)

GSO, Daventry, England, 15,180 kc., reported heard best 4 to 5 p.m., E.S.T. (Jones, Westman, Stefanou.)

GSP, Daventry, England, 15,310 kc., reported heard best 6 to 8 p.m., E.S.T. (Jones, Chambers, Coover, Mascharrenhas, Davis, Stefanou.)

HBJ, Geneva, Switzerland, 14,535 kc., reported heard Sunday testing at 11:30 a.m., E.S.T. (Atkinson.) Also reported heard at 2:45 p.m., E.S.T. (Nosworthy, Westman, Howald.)

HBL, Geneva, Switzerland, 9595 kc., reported heard Monday 6 p.m., E.S.T. (Jones, Westman, Hynek.)

HBO, Geneva, Switzerland, frequency reported changed to 11,373 kc. and heard Monday 12:30 a.m. to 1 a.m., E.S.T. (Smith.)

DEKKA, the German dirigible *Hindenburg*, has been reported on the following frequencies: 10,290 kc., 10,335 kc., 10,500 kc., 11,040 kc., 12,550 kc. and 5820 kc. (Adams, Dressler, Hartman, Jensen, Markuson, Miller, Shea, Howald.)

DJO, Zeesen, Germany, 15,340 kc., reported heard 12:30 to 2:30 a.m. (Stevens.)

DZA, Berlin, Germany, reported heard 9670 kc., **DZB** reported heard 10,040 kc., **DZC** reported heard 10,290 kc., **DZE**, 12,130 kc. and **DZH**, 14,460 kc., 3:15 to 11:30 a.m., E.S.T. (Westman, Moore, Twomey.)

TPA3, Pontoise, France, 11,880 kc., reported heard 2 to 5:30 p.m., E.S.T. (Jones.)

TPA4, Pontoise, France, 11,720 kc., 6 to 11 p.m., E.S.T. (Jones.)

ASIA

RV15, Khabarovsk, Siberia, 4273 kc., reported heard irregularly 12 noon and 3 p.m., E.S.T. (Westman, Styles, Yoshimura.)

RAN (?), U. S. S. R., 31.5 meters, reported heard Sunday at 7 p.m. (Shea.)

PLP, Bandoeng, Java, 11,000 kc., reported heard irregularly till 11 a.m., E.S.T., when it signs off with an organ selection, "Perfect Day." (Cox.) Also reported heard Saturdays to 11 p.m., E.S.T. (Mallet-Veale.) Also heard 5:30 a.m., E.S.T., daily. (Howald, Davis, Hartzell, Moore, Williams, Gallagher, Rodriguez.)

VUB (or **VWY**), Bombay, India, 9565 kc., reported heard Mondays at 8 a.m. (Frost.)

YDB, Bandoeng, Java, 9640 kc., reported heard daily 7 to 9 a.m., E.S.T. (Rodriguez.)

PMN, Bandoeng, Java, 10,620 kc., reported heard Monday, Tuesday, Friday and Saturday 5 to 6 p.m., E.S.T. (N. C. Smith.)

ZBW, Hong Kong, China, reported heard on 8750 and 5410 kc., 2 kilowatts, from 12:30 to 2:15 p.m. and 5 to 11

POPULAR OVERSEAS ANNOUNCER
Meet announcer Walter Wellmann of the famous German "DJ" stations who says, "Short-wave friendship is the fundamental of peace". The photo was received by E. O. Braun of Providence, Rhode Island

HIGHLY PRIZED VERIFICATION

This is the "veri" card of VPD, from the station on the tiny isles in the Pacific. The card was a verification for Mr. W. C. Barron and was sent in for publication by the Vice President of the 6,000 to 12,500 Mile Club as part of their service to their official organ, RADIO NEWS

p.m., Hong Kong Time, which is 8 hours ahead of GMT. (Tynan, Wood, Davis, Frost, Sakely.) They are best heard between 8 to 10 a.m., E.S.T., Saturdays and continue on to 11 a.m. (Sakely.)

CQN, Macao, Asia, 9680 kc., 300 watts, reported heard Monday, Friday, 7-8:20 a.m. (Sholin, Gaiser, Howald.)

XGW, Shanghai, China, 10,440 kc., heard 10:15-10:30 a.m., E.S.T. (Markuson, Frost.)

HS8PJ, Bangkok, Siam, 10,965 kc., reported heard 8 to 10 a.m., E.S.T. (Tomlinson, Styles, Smith, Mallet-Veale.)

"Colombo Here," Colombo, Ceylon (no call letters as yet), 48.3 meters, starts transmitting at 12:15 p.m., E.S.T. (Mallet-Veale.)

JVH, Nazaki, Japan, 14,600 kc., reported heard at about 12:30 a.m., E.S.T. (Cox.) Also reported heard 4 to 6 a.m., E.S.T. (Snyder, Portmann, Howald.)

JVI, Nazaki, Japan, 13,560 kc., heard Wednesdays at 12 a.m., E.S.T. (Twomey, Ellsworth.)

JVM, Nazaki, Japan, 10,740 kc., is (Turn to page 84)





The DX Corner (Short Waves)

(Continued from page 81)

now heard daily, on Saturdays and Sundays 5 to 7 a.m., E.S.T. Observer Shea hears them at about 12:30 a.m., E.S.T. Observers Gallagher and Hartzell reported hearing them at 1 a.m., E.S.T.

JVN, Nazaki, Japan, 10,660 kc., reported heard 1-5 a.m. Sunday. (Twomey.) Also 4:30 p.m. to 3:25 a.m., E.S.T. (Joerger.)

AFRICA

ZTJ, Johannesburg, South Africa, 6097 kc., is on the air daily and Sunday 11:45 p.m. to 12:30 a.m., 3:15 to 7 a.m., 9 a.m. to 4 p.m., E.S.T. On Saturdays their program runs to 5 p.m., E.S.T. On Sundays they have additional time, 4 to 5 a.m., 7:55 to 10:15 a.m. and 12:30 p.m. to 3:15 p.m., E.S.T. (Mallet-Veale, Stefanou.)

CR7AA, Lorenzo Marques, Africa, 6137 kc., daily except Sunday, 12:45 to 3:15 p.m., E.S.T. On Sundays 8 to 10:30 a.m. and 12:45 to 3 p.m., E.S.T. (Mallet-Veale.)

FIQA, Tananarive, Madagascar, 50.4 meters, reported heard 9:45 to 10:30 a.m., E.S.T. (Westman.)

A new station in Djibouti, French Somaliland, Africa, on approximately 17.25 megacycles with the call F—Z. The middle letter is not sure, but it sounded like L. (Tomlinson.)

SU1CH, Cairo, Egypt, 14,020 kc., regarded as an amateur station, is owned by the Egyptian State Broadcasting Co., Sharia Eloui, Cairo, according to Observer Gaiser.

VQ7LO, Nairobi, Kenya, Africa, 6083 kc., on the air Monday, Wednesday and Friday 4:45 to 5:15 a.m., 10:30 a.m. to 1:30 p.m., E.S.T. On Tuesdays and Thursdays they are on from 4:15 to 5:15 a.m., 7:30 to 8:30 a.m., 10:30 a.m. to 1:30 p.m., E.S.T. On Saturdays 10 a.m. to 2 p.m., E.S.T., and on Sundays 10 a.m. to 1 p.m., E.S.T. (Stevens.)

CR6AA, Lobito, Angola, Africa, 7170 kc., heard Wednesdays 7:45 to 9:45 a.m., E.S.T. (Gaiser.)

NORTH AMERICA

TFJ, Reykjavik, Iceland, 12,240 kc., is now back on the air Sundays 1:40 to 2 p.m., E.S.T. (DeLaet, Messer, Stevens, Andrews, Shea, Ellsworth.)

W2XGB, Hicksville, Long Island, 6425 kc., on the air irregularly eve-

DISPLAYS HIS BRAIN-CHILDREN

Our readers already know Oliver Amlic and here they have an opportunity of seeing his two receivers, battery model on the right and new a.c. set on the left

nings 8 to 10, E.S.T., with programs and testing. Will acknowledge reports. (Howald, Gallagher, Nosworthy, Betances, Shea, Trzuskowski, Liccione, Thurn, Frost.) Observer Twomey reports them on the air Wednesdays 8:20 to 10:10 p.m., E.S.T. Observer Dressler reports they have



A SYSTEMATIC DX'ER

One of our most consistent L.P.O.'s, in finding concise information on short-wave stations, is Edward DeLaet of Dayton, Ohio, who is pictured above

stopped transmitting recently.

WMFL, 10 kw., has been using a field pick-up station which was heard by Observer Leland.

W7XBK, Tacoma, Washington, is a portable station of 2 watts, transmitting irregularly on 21,100 kc., 34,600 kc., 37,600 and 40,600 kc. (Partner.)

WQP, 13,900 kc. and **WZO**, 6725 kc., have been reported heard testing with the dirigible *Hindenburg*, 7 to 8 p.m. and 11 to 12 p.m., E.S.T. (Atkinson, Hansen, Thurn, Howald, Miller.)

W2XBJ, Rocky Point, New York, heard on 6700 kc. testing 12:15 a.m., E.S.T. (Cox.)

A station announcing as "RX" on 9 megacycles with 40 watts power has been reported by Observer Davis. Program lasts from 9 to 11:30 p.m., E.S.T., and no QRA is given. Is this a bootleg?

W4XBW, 31,600 kc., 100 watts, relays **WDOD** from 7:30 to midnight. E.S.T. (McKay.)

W9XPD, 21,600 kc., 100 watts, re-

broadcasts **KSD**, 10 a.m. to 2 a.m., E.S.T. (Nash.)

W9XOK, 35,600 kc, 100 watts, is on the air Mondays to Fridays, 2 to 3 p.m. and 9 p.m. to 10 p.m., E.S.T. (Nash.)

CFCX is the new call of **VE9DR** on 6005 kc., transmitting irregularly 8 to 10 p.m., E.S.T. (Shea, Loke.)

W9XHW, Minneapolis, Minnesota, 5.85 megacycles, rebroadcasts **WCCO**. (Saubertlich.)

W9XAA, Chicago, Illinois, 11,830 kc., transmits from 8 a.m., E.S.T., onwards. (Frost.)

XEFT, Vera Cruz, Mexico, has changed frequency to 9505 kc. They were originally on 6120 kc. Same schedule. (Carville, Partner.)

COKG, Santiago, Cuba, has been heard on about 24.25 meters Sundays 1 to 2 p.m., E.S.T. (Hill, Carville.) Is this a harmonic of their 48-meter wave?—The Editor.

CO9WR, Sancti Spiritus, Cuba, has changed frequency to 6280 kc. Their programs are from 9 to 10 a.m., 12 noon to 1 p.m., 4 to 6 p.m., and 9 to 11 p.m., E.S.T. (Pickering, Winfree.)

CMA, Cuba, heard on about 8700 kc. testing 5:30 to 6:10 p.m., E.S.T. (Davis.)

CENTRAL AMERICA

HH3W, Port au Prince, Haiti, 9595 kc., goes off the air at 8 p.m., E.S.T. (Shea.)

HIX, Trujillo, D. R., 5980 kc., transmits Sundays 7:40 to 10:40 a.m., 11 a.m. to 12:30 p.m., E.S.T. Tuesdays and Fridays 12:10 to 1:10 p.m., 4:40 to 5:40 p.m., 8:10 to 10:10 p.m. E.S.T. The rest of the week they transmit from 12:10 to 1:10 p.m., and 4:40 to 5:40 p.m., E.S.T. (Grabek, DeLaet.)

HI8Q, Trujillo, D. R., 6240 kc., reported heard 6 p.m. onwards, E.S.T. (Salazar, Hartman, Oxrieder.)

HI7P, Trujillo, D. R., 6800 kc., heard at 7 p.m., E.S.T. (Salazar.)

HIT, Trujillo, D. R., 48 meters, reported heard 6:30 p.m., E.S.T. (Salazar.)

HRD, La Ceiba, Honduras, 6235 kc., goes off the air at 11 p.m., E.S.T. (N. C. Smith, Shea, Anca.)

TGW, Guatemala City, Guatemala, 9540 kc., transmit 8 to 9 p.m. and 10 to 11 p.m. daily except Sundays. On Sundays they are on the air 1 to 5 a.m., E.S.T. (Partner, Shea.)

TGS, Guatemala City, Guatemala, 5713 kc., transmit Wednesdays, Thursdays and Sundays 6 to 8 p.m., E.S.T. (Wilkinson.)

YNLF, Managua, Nicaragua, now are on about 9760 kc., 7 to 10 p.m., E.S.T. (Wilkinson, Betances, Carville.) Observer Winfree says their frequency is 9685. Observer Oxrieder says the frequency is 9655 and Observer Shea says the frequency is 9650 kc. Take your choice.

YNA, Managua, Nicaragua, 11,935 kc., reported heard 1 to 2:45 a.m., E.S.T. (Twomey.)

HP5K, Panama City, Panama, 6005 kc., 200 watts, rebroadcasts **HP5O** daily. Reports will be welcome and will be verified. (R. H. Axtell.)

YSJ, San Salvador, El Salvador, transmit on about 13,415 kc., 4 p.m., E.S.T. (McKay, Smith.)

TIGPH, San Jose de Costa Rica, heard on 5830 kc., 1000 watts, 7 to 10 p.m., E.S.T. (Anca.) Observer Stefanou says they are on 5825 kc. at 7 p.m., E.S.T. Observer Oxrieder says they are on 5820 kc.

TIGP, San Jose de Costa Rica, now on 6385 kc., heard on the first har-
(Turn to page 114)

Modern Super Undergoes

“Lab”

TESTS

(Hammarlund “Super-Pro”)

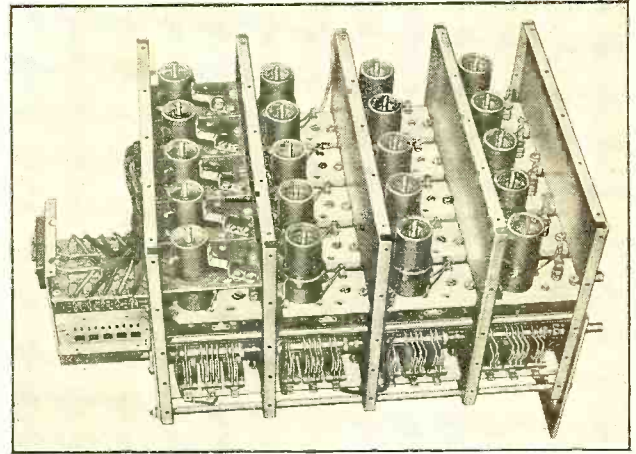

THE R.F. UNIT

The 2 r.f. stages, oscillator and detector each use a separate coil for each range. With the shield cover in position each stage is entirely shielded from the others. The band-spread system which functions on the 3 highest ranges employs different condensers for each range to maintain a constant degree of spread. This 12-gang condenser appears below the coils.

IT is seldom possible to obtain performance measurement data on a receiver, based on tests made by a completely independent laboratory which has no connection whatsoever with the manufacturer of the receiver. The information on the Hammarlund “Super-Pro” presented in this article (with the exception of Curve 4) is from such a source. The curves were plotted directly from measurements made in what is probably the best equipped measurement laboratory in the U. S. A general description of this receiver including the schematic circuit diagram appeared in RADIO NEWS last month.

The receiver is one which is generally recognized for its excellent design and study construction, both of which are interestingly illustrated in the accompanying photographs.

Curve 1 should not be confused with the ordinary sensitivity curve. It does not show the maximum sensitivity of the receiver but rather the sensitivity obtained when the signal input was adjusted to provide 6 milliwatts output with 30% modulation as against 1 milliwatt output with the modulation off, or, in other words, a signal-to-noise ratio (power) of 6 to 1. Were the measurements made without regard to noise level or on the basis of a 1 to 1 signal-to-noise ratio the sensitivity would of course appear still greater. However, it will be noted that even under the limitation imposed by the 6 to 1 ratio requirements the sensitivity averaged about 0.85 microvolt.

Curve 2 represents the selectivity characteristic of the i.f. amplifier only.

S. Gordon Taylor

The selectivity of the r.f. stages was not considered for the reason that, except in the broadcast band, preselector stages contribute little to the overall selectivity of a superheterodyne receiver. In the low-frequency r.f. range the actual overall selectivity is therefore better than indicated by these curves while in the higher ranges the selectivity is at least as great as that of curve 2. The “narrow band” curve illustrates the tuning characteristic when the i.f. coupling control on the front panel is set for maximum selectivity. The “wide band” curve was made with this control set for minimum selectivity. Any intermediate setting of this continuously variable control will provide bandwidths between the 2 extremes shown in curve 2. It will be noted that in the “selective” position the band has a total width of 10 kc. at 100 times down. In the “wide band” position the curve is widened to such an extent as to largely avoid side band cutting, thus providing a good degree of reproduction fidelity.

Curve 3 shows the a.v.c. regulation on a 2200 kc. signal with 400 cycle, 40% modulation. The performance represented by this curve is really remarkable in view of the fact that the receiver output remained constant within 2.5 db. while the signal input was varied over the extreme range from 0.1 to 500,000 microvolts!

Fidelity measurements were not included in the data obtained from the laboratory mentioned above, yet it was felt that they should be included for the benefit of readers who may be interested primarily in broadcast program reception. Measurements were therefore made by the author and the result appears in curve 4. These antenna-to-voice-coil measurements were made at a frequency of 1000 kc. with 30 per cent modulation. The receiver

(Turn to page 124)

THE ANTENNA COILS

The antenna coils for all ranges are provided with electrostatic shields between primary and secondary, as shown.

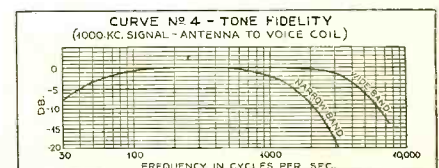
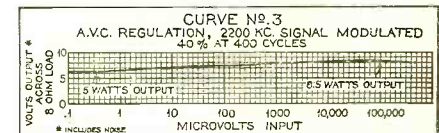
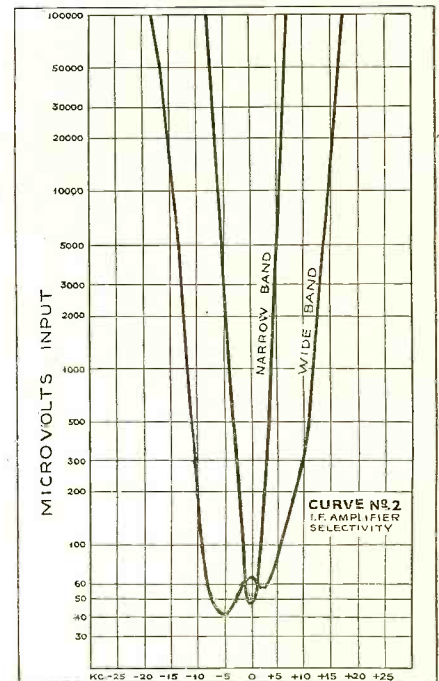
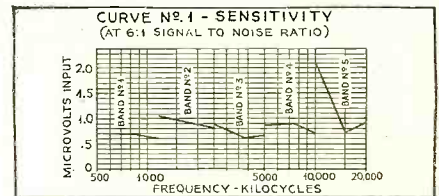
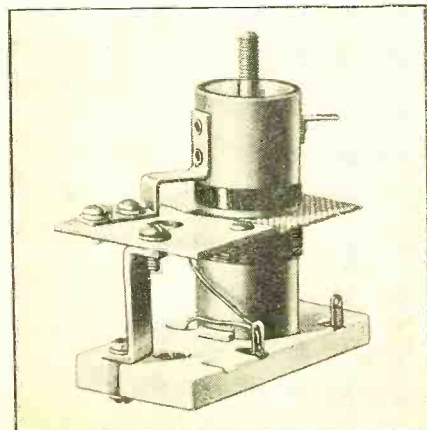



The "HAM" Shack

Conducted by
Everett M. Walker
Editor of Amateur Activities

G6QS

This is the FB Ham Shack of Stanley Roberts of Rawdon, Yorkshire, England. The r.f. circuits are shown "open" above, with the modulator and other controls in a rack below.

The PHONE C. W. Situation

ONE of the most controversial subjects in amateur radio is the allocation of frequencies for 'phone and c.w. The 'phone men have been seeking additional channels for more than two years and while the C.W. men have not made requests for additional frequencies, they naturally have sought to retain those they now have allocated to them. There are arguments to be offered on both sides, and all of them are sound.

IN reporting the amateur-phone band allocation situation, there is one important factor that should not be overlooked—'phone is becoming increasingly popular and has been for the last five years. When the present allocations were made, the number of persons using 'phone were few and the frequencies available entirely adequate. It recalls the situation that developed in the early '20s when c.w. was first making its bid for prominence and spark transmitters were on the wane. The "dyed-in-the-wool" spark men disliked to part with their deep-throated noisy equipment. They argued it was more effective than c.w.; when a station was called, it usually was raised. The reason of course was the spark transmitter was broad; it blanketed the 200-meter band and with the poor selectivity and receivers then, it couldn't miss.

But at the same time it should be pointed out there were far fewer amateurs then than now. There were less than 15,000. Also, had it not been for the inception of vacuum-tube transmitters, it would have

been impossible to operate on short or ultra-short wavelengths. Gradually, c.w. crowded out and finally spark was legislated out of the picture.

The situation of 'phone vs. c.w. is not exactly parallel to this, but there are similar points to be considered. Aural transmission in the first place is the more modern means of communication. It cannot be denied that 'phone is a technical advancement made on the c.w. transmitter. Therefore, as the c.w. man begins to grow tired of "pounding brass" one way he may expand (as far as advancing his equipment) is to install modulating apparatus and join at least occasionally, the ranks of the 'phone men.

This, naturally has resulted in the crowding of the 'phone bands which were allocated at a time when there were only a few amateurs interested in aural transmission and equipment necessary for modulation was expensive and difficult to obtain. At that time the average amateur transmitter was an ordinary oscillator. Crystal control was something quite new and crystals were expensive. Modulated oscillators were not easily operated with good quality.

Arguments on the other side of the situation however, are just about as strong. The c.w. men point out that c.w. is the backbone of amateur radio. It is necessary for the 'phone man first to become a telegraph

operator (at least to the 13 word a minute stage) before he can contemplate 'phone. Telegraph equipment alone is less expensive and, of course, does not cost as much to operate.

It would seem, however, judging the situation from the standpoint of "interest, convenience and necessity," there is need for additional frequencies for 'phone on both the 75 and 20-meter amateur bands. On both these channels, there are 100 kilocycles set aside for Class A 'phone operation. On the other hand in the 80 meter c.w. band, there are 400 kilocycles and of course, if the c.w. man chooses, he may operate his telegraph rig in the 'phone band too. On 20 meters there are 300 kilocycles set aside exclusively for c.w., and, as on 75 meters, the 100 kilocycle of 'phone frequencies are likewise open to the c.w. men.

By the time this appears in print it is quite likely something may have been done about this problem. At the Board of Directors' meeting of the American Radio Relay League last May, it was decided that the Federal Communications Commission should be requested to allocate an additional 50 kilocycles for 'phone in the 75-meter band, namely 3,850 to 4,000 kilocycles. The Canadian amateurs already have these frequencies for 'phone operation.

Furthermore the Commission will have held a series of hearings to determine the needs of various classes of radio services on all frequencies. At these hearings, however, neither individual nor group applications were to be considered, the purpose being to evaluate the service from the standpoint of need.

The 'phone men have been clamoring for a long time for additional frequencies. This, of course, has been due to the increasing interference problem on 'phone. There are, according to the Federal Communications records more than 60,000 licensed amateurs in the United States, and the number of applicants for Class A privileges is gaining rapidly as newcomers are entering the field.

THE 60-T TRANSMITTER

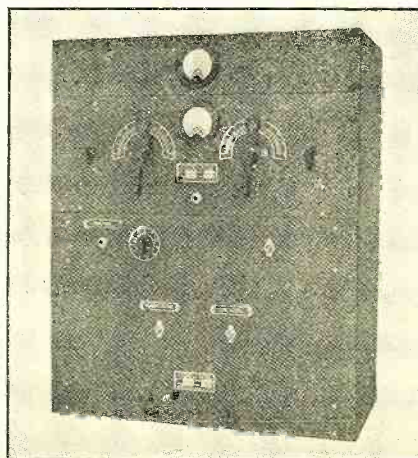

THE 200-R TRANSMITTER

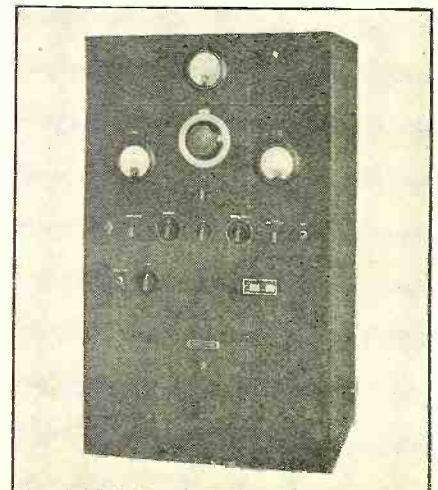

A Department for the amateur operator to help him keep up-to-date

ANOTHER recently announced transmitter is the 60-T manufactured by the Harvey Radio Laboratories of Brookline, Mass. The transmitter is designed to provide moderate power at low cost. It employs an RK-20 type tube in a crystal oscillator circuit which may be used either for c.w. or 'phone by modulating the suppressor grid. The whole transmitter is mounted in a cabinet 23 inches high, 19 inches wide and 10 inches deep.

All band operation is provided up to 14 megacycles. To facilitate frequency shift, three crystals are mounted permanently on the chassis containing the r.f. portion of the transmitter. Band switching also is provided.

For c.w. operation, 50-watts output may be obtained. For 'phone operation with suppressor grid modulation an output of 15 watts at crystal frequency may be obtained. Modulation of the suppressor is accomplished by means of a 6C6 speech amplifier driving a 41-type tube as the suppressor modulator. This unit also contains its own power supply using a type 80 tube.

The main power supply for the RK-20 is contained in a separate unit. It employs three type 83 tubes in a bridge rectifier circuit and the necessary filter apparatus. It is designed to deliver 1,000 volts at 150 milliamperes.

ANOTHER transmitter recently announced by the Harvey Radio Laboratories is the 200-R. This unit employs one of the newer type RK-28 tubes in a final amplifier circuit, which will give 60 watts output on 'phone and 200 watts on c.w. The whole transmitter is contained in a cabinet 19½ inches wide, 32½ inches high and 16 inches deep.

The top deck contains the r.f. portion of the transmitter. The RK-28 is driven by a 6A6-type tube in a crystal oscillator and a 42-type tube used only as a doubler. Operation is provided on all bands from 1,700 to 14,000 kilocycles, and the unit may be used on 10 meters when a 20-meter crystal is employed.

Like the 60-T, band switching is provided along with a combination of plug-in coils. That is, complete circuit and coil switching as well as crystal selection is provided over the three highest frequency bands, so that from four permanently mounted crystals a c.w. frequency is obtained in each band and a 'phone frequency in the 3.9 and 14.2 megacycle bands.

The suppressor grid modulator for the 200-T employs metal tubes and is designed for use with a crystal microphone. It has two stages of high-gain amplification with a 6J7 and 6C5. A 6F6 pentode supplies the 5 watts of audio power for modulating the suppressor.

Carrier control also is provided, this being accomplished by means of a special rectifier circuit which varies the carrier when connected from 6 to 60 watts along with the speech. The power supply for this transmitter delivers 2,100 volts at 250 milliamperes and is mounted at the base of the transmitter. It employs a pair of 866-type tubes and the necessary filter.

Calls Heard

By J. Vincent McMinn, 12 Edge Hill, Wellington, New Zealand, on 20 meter c.w.:
 CE3AO CE3CA CM8CK CT1OR CT1GD
 CT1AA CT1KR CT1LC CX1CB D4CSA
 D4CEF D4VRR D4SLD D4SIV D4TKP
 D4MNL D3DEN D4XCG D4RVC D4HCF
 (Turn to page 111)

New
AMATEUR
Transmitter

FIVE years ago it was practically impossible for the amateur to buy a completely assembled transmitter. As a matter of fact there were few completed receivers that met the amateur's requirements available. However, within the last few years a number of manufacturers have brought out transmitting equipment. The completely assembled transmitter is becoming more and more popular. It is welcomed particularly by the amateur who lacks the mechanical facilities to construct the modern transmitter; by the apartment-house dweller who has limited space, and by the man who lacks the free time necessary for the construction of an efficient rig.

Among the most recent of these new transmitters are the ACT-40 and the ACT-200 brought out by the RCA Manufacturing Company, of Camden, N. J. The former is a 40 watt c.w. and 'phone transmitter, and the latter is a 260 watt c.w. and 200 watt 'phone rig. Both units have many features of interest.

The ACT-40 is mounted in a 3-deck metal cabinet of standard relay rack width, namely 19 inches. Each panel is 8¾ inches high. The units are extremely compact and are designed to operate on all of the amateur bands up to 14 megacycles.

DETAILS OF CONSTRUCTION

The illustrations below show the rear view and the wiring diagram for the ACT-40 transmitter.

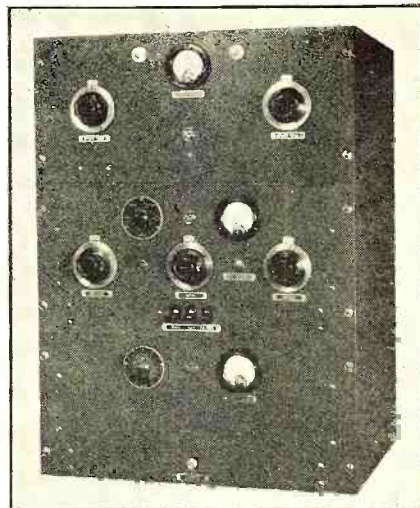
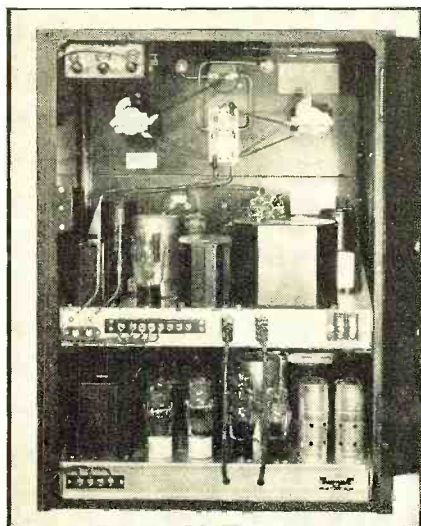

THE ACT-40 TRANSMITTER

The r.f. portion of the transmitter is mounted on the second deck and contains all of the necessary equipment for this section of the unit including the power supply. It employs a 47-type tube as a crystal controlled oscillator, an 802 as a buffer or doubler and two 801 type tubes in a push-pull final amplifier circuit. The only stage requiring neutralization is the final amplifier. All tuning controls are mounted on the front panel, the oscillator dial being at the left, the buffer in the center and the final amplifier tank circuit condenser at the right.

One interesting feature is the installation of a key-click filter in the unit. Another interesting feature is the means of using a single 0-200 milliammeter in the plate circuit of any stage or the grid circuit of the final amplifier. A four point selector switch is mounted on the front panel marked to indicate the circuit wherein the meter is connected. By operating the switch, the oscillator plate current, the buffer plate current, the amplifier grid current or the amplifier plate current may be read.

Another feature is the use of a single adjustment neutralizing device. This consists of twin condensers connected on a common insulated shaft. The adjustment is made through a hole in the front panel by means of an insulated screw driver. Once set, it need not be changed unless the tubes are changed. A switch is provided on the front panel to open the plate circuit of the final amplifier while neutralizing. Also a combination of fixed and battery bias is used to facilitate keying ahead of the final amplifier.

On the panel below is mounted the modulating equipment and its associated apparatus including the power supply for this unit. It is designed essentially for use with the popular types of crystal microphones, and therefore has a high gain. It employs two type 57 tubes in resistance-
 (Turn to page 113)

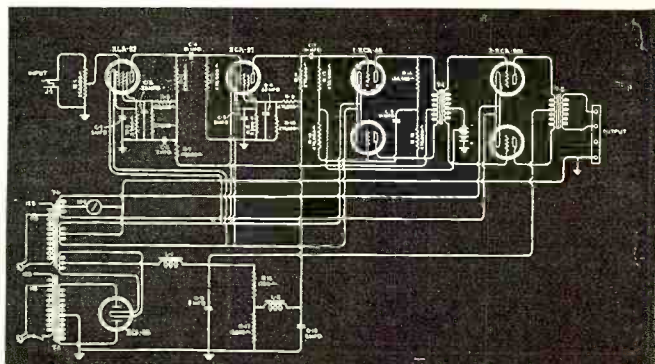
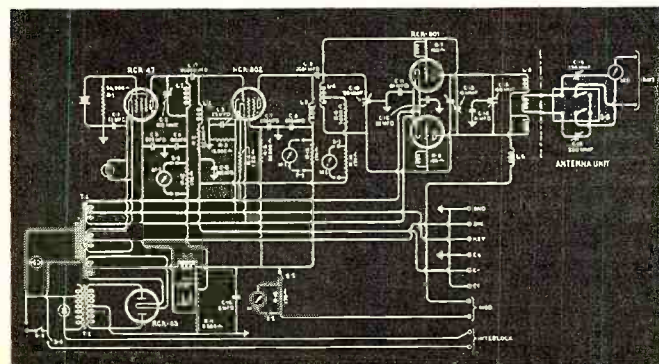

Some Notes On THE DOHERTY High-Efficiency CIRCUIT

By Frederick Siemens

RADIO-FREQUENCY amplifier stages for modulated carriers (Class B linear amplifiers) have to be designed to supply the maximum power at the modulation peak which is four times the carrier power. Most of the time the tubes are not working at full power so that there is a considerable loss in efficiency. A 50-kilowatt amplifier, with 33 percent efficiency would require a d.c. plate input of 150 kilowatts, of which 100 kilowatts would be dissipated at the anodes of the water-cooled tubes.

With Mr. Doherty's new circuit the power input for unmodulated carrier is 83 kilowatts and the dissipation only 33 kilowatts which is a considerable saving in power and permits reduction of the cooling system.

The new circuit employs two tubes (in parallel) which are connected in such a way that up to carrier power only one of them is working which will reach its peak output and efficiency at or near the carrier power. For the positive half of the modulation cycle a second tube is energized which adds its power to the first one. In this way the tubes will be used to their full efficiency a greater part of the time.

Figure 1 shows the scheme of connections. V1 represents the first tube, V2 the second one which is so biased as to prevent any current from flowing during the negative half of the modulation cycle. R represents the load, a tuned circuit which is equivalent to a resistance for the fundamental radio frequency. A network N is inserted



YOUTHFUL INVENTOR

William H. Doherty, originator of the new high-efficiency amplifier circuit which may revolutionize design of radio telephone transmitters.

between V1 and the load. This network (shown in Figure 2) is the equivalent of a quarter wave transmission line; it has the property that its impedance as measured at one end is inversely proportional to the impedance connected at the other end.

The following is what happens. Imagine that the excitation to the grids of both tubes varies from zero to twice (Turn to page 125)

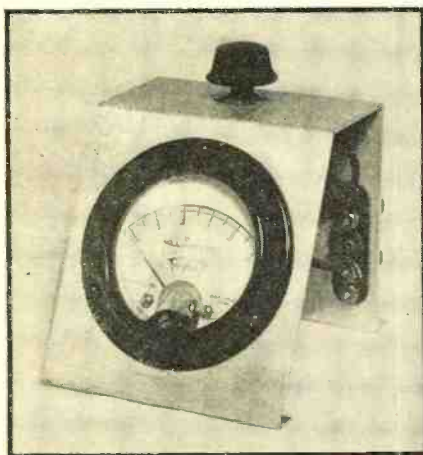

Installing Your Own "R" METER

By W2JCR

A GENERALLY admired feature of some of the most modern communication receivers is the "R" meter. Many amateurs think highly of this feature, little realizing that a simple milliammeter can in almost every case be connected into any ordinary super for this purpose, providing the receiver includes an a.v.c. system. Whether it is known as a "signal strength" meter, a "tuning" meter or an "R" meter, such a device is an extremely useful one to hams and likewise to short-wave listeners and DX'ers.

As an "R" or signal-strength meter it permits giving R reports on received stations on a much more definite basis than is the case where such reports are (Turn to page 125)

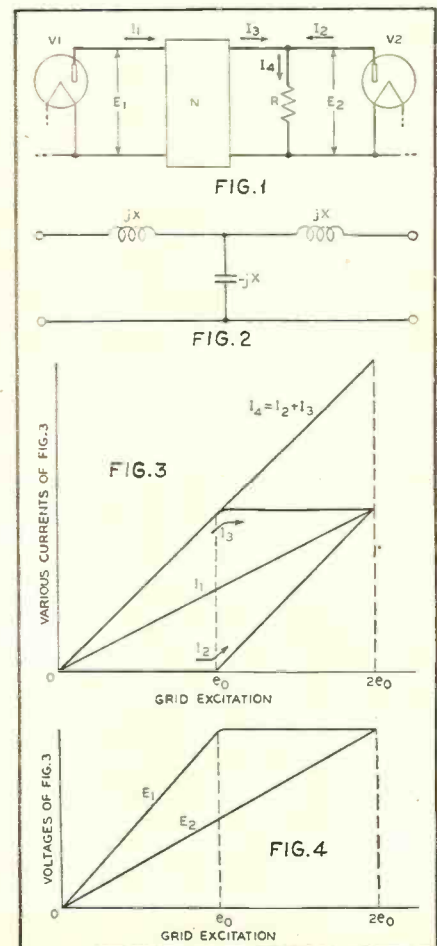
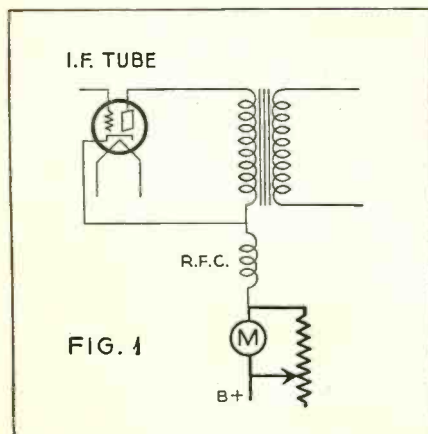

TRANSMITTING TUBE CHART

TYPE NO.	DESCRIPTION		FILAMENT		CAPACITANCES			PURPOSE	RATED VOLTAGES			RATED MA.			POWER		REQ'D. DRIVER PWR.	REC'D. GRID LEAK	
					C _{gp}	C _{gf}	C _{pf}		PLATE	GRID (NEG.)	SCR. SUPP. GRID	PLATE	GRID	SCR. GRID	PLATE DISS.	OUT-PUT			
TRIODES																			
10	THOR. FIL.	4 PIN-MED.	7.5	1.25	7.0	4.0	3.0	CLASS C AMP.	500	135			60	10	12	20	4	15000	
								CLASS B MOD.	425	50			4		12	13			
RK-18	THOR. FIL.	4 PIN-MED.	7.5	1.25	5.0	3.8	2.0	CLASS C AMP.	1000	150			85	15	40	50	3	15000	
RK-24	OXIDE FIL.	4 PIN-SMALL	2.0	.120	5.5	3.5	3.0	5M. PORT. OSC.	180	45			20		1.5	1.2			
RK-30	THOR. FIL.	4 PIN-MED.	7.5	3.25	2.5	2.7	1.0	CLASS C AMP.	1250	175			70	15	35	65	4	10000	
								CL. C MOD. AMP.	1000	200			70	15	35	50	4	10000	
								CL. B LINEAR AMP.	1000	55			42		35	14			
RK-31	THOR. FIL.	4 PIN-MED.	7.5	3.0				CLASS C AMP.	1000	50			85	15	35	50	5	3000	
								CLASS B MOD.	1250	0			20		35	70			
RK-32	THOR. FIL.	4 PIN-MED.	7.5	3.25	2.5	2.0	.7	CLASS C AMP.	1250	200			100		50	85	7	15000	
								CL. C MOD. AMP.	1000	180			100		50	65	7	15000	
RK-34	OXIDE CATH.	7 PIN-MED.	6.3	.8	2.7	4.2	2.1	CL. C OSC-AMP.	300	36			80	16	10	14	2.5	2000	
P-P DUAL TRIODE								CLASS B MOD.	300	15			30		12				
45	OX. FIL.	4 PIN-MED.	2.5	1.75				CL. C OSC-AMP.	400	200			40		10	10	3	50000	
46	OXIDE FIL.	5 PIN-MED.	2.5	1.75	(AS HI-MU TRIODE)			CLASS C AMP.	400	50			40	3	10	10	3	20000	
								CLASS B MOD.	400	0			6		10	10			
F-100	TUNGS.	SPECIAL	11.0	25.0	10.	4.0	2.0	CLASS C AMP.	2000	300			500		500	600		10000	
F-108A	TUNGS.	4 PIN-JUMBO	10.0	11.0	7.0	3.0	2.0	CLASS C AMP.	3000	350			200		175	400		15000	
150T	THOR. TUNGS.	4 PIN-JUMBO	5.0	10.0	3.5	3.0	5	CLASS C AMP.	1000	200			200	35	150	150	7	5700	
								CLASS C AMP.	2000	400			200	35	150	300	17	12000	
								CLASS C AMP.	3000	600			200	35	150	450	35	17000	
HF-200	THOR. TUNGS.	4 PIN-JUMBO	10.5	3.4	5.8	5.2	1.2	CLASS C AMP.	1500	190			175	30	150	175	25	6000	
								CLASS C AMP.	2500	280			175	30	150	300	40	8500	
203A	THOR. TUNGS.	4 PIN-JUMBO	10.0	3.25	14.5	6.5	5.5	CLASS C AMP.	1250	125			150	25	100	130	7	5000	
								CL. C MOD. AMP.	1000	135			150	50	100	100	14	3000	
								CL. B LINEAR AMP.	1250	45			106		100	42.5			
204A	THOR. TUNGS.	SPECIAL	11.0	3.85	15.0	12.5	2.3	CLASS C AMP.	2000	175			250	50	250	350		5000	
50T	THOR. TUNGS.	4 PIN-MED.	5.0	6.0	2.0	2.0	.4	CLASS C AMP.	1000	200			100	25	50	75		8000	
								CLASS C AMP.	2000	400			100	25	50	150		16000	
								CLASS C AMP.	3000	600			100	25	50	250		24000	
211	THOR. TUNGS.	4 PIN-JUMBO	10.0	3.25	14.5	6.0	5.5	CLASS C AMP.	1250	225			150	18	100	130	7	10000	
								CL. C MOD. AMP.	1000	260			150	35	100	100	14	5000	
								CL. B LINEAR AMP.	1250	100			106		100	42.5			
242A	THOR. TUNGS.	4 PIN-JUMBO	10.0	3.25	13.0	6.5	4.0	CLASS C AMP.	1000	150			150		100	125		5000	
								CL. B LINEAR AMP.	1250	100			100		100	31			
HF-300	THOR. TUNGS.	4 PIN-JUMBO	11.5	4.0	6.5	6.0	1.4	CLASS C AMP.	1500	150			250	50	200	275	40	3000	
								CLASS C AMP.	2500	250			225	50	200	450	60	5000	
354	THOR. TUNGS.	4 PIN-JUMBO	5.0	7.75	3.7	9.0	.4	CLASS C AMP.	3000	275			150		150	300		10000	
300T	THOR. TUNGS.	4 PIN-JUMBO	7.5	11.0	4.0	3.5	1.5	CLASS C AMP.	2000	300			300	30	300	450	60	10000	
								CLASS C AMP.	3000	450			300	35	300	700	75	15000	
								CLASS C AMP.	4000	600			300	35	300	950	90	20000	
500T	THOR. TUNGS.	SPECIAL	7.5	20.0	4.5	4.0	1.5	CLASS C AMP.	1000	185			500	50	500	350		3500	
								CLASS C AMP.	2000	370			500	50	500	750		7000	
								CLASS C AMP.	3000	550			500	50	500	1150		10000	
800	SEE	RK-30																	
801	THOR. TUNGS.	4 PIN-MED.	7.5	1.25	6.0	4.5	1.5	CLASS C AMP.	600	150			65	15	20	25	4.0	10000	
								CL. C MOD. AMP.	500	190			55	15	20	18	4.5	10000	
								CL. B LINEAR AMP.	600	75			45		20	7.5			
								GRID BIAS MOD. AMP.	600				50	2	20	10	2.0		
830	THOR. TUNGS.	4 PIN-MED.	10.0	2.15	9.9	4.9	2.2	CLASS C AMP.	750	180			110	18	40	55	7	10000	
								GRID BIAS MOD. AMP.	1000	200			50	2	40	15	3		
831	THOR. TUNGS.	SPECIAL	11.0	10.0	4.0	3.8	1.4	CLASS C AMP.	3500	400			275	40	400	590	30	10000	
834	SEE	RK-32																	
838	THOR. TUNGS.	4 PIN-JUMBO	10.0	3.25	8.0	6.5	5.0	CLASS C AMP.	1250	80			150	30	100	130	6	3000	
								CL. C MOD. AMP.	1000	135			150	60	100	100	16	3000	
								CLASS B MOD.	1250	0			74		100	130			
849	THOR. TUNGS.	SPECIAL	11.0	5.0	33.5	17	3	CLASS C AMP.	2000	200			300		400	450		5000	
								CLASS B MOD.	2500	130			20		400	500	7		
852	THOR. TUNGS.	4 PIN-MED.	10.0	3.25	2.6	1.9	1.0	CLASS C AMP.	3000	600			85	15	100	165	12	10000	
								CL. C MOD. AMP.	2000	500			67	30	100	75	23	10000	
								CL. B LIN. AMP.	3000	250			43	—	100	40			
TETRODES AND PENTODES																			
802	OXIDE CATH.	7 PIN-MED.	6.3	.95	0.15	12.0	8.5	CLASS C AMP.	500	100	250	+40	45	2	12	10	16	.25	15000
								SUPP. MOD. AMP.	500	90	200	-45	22	4.5	28	10	3.5	.5	15000
								CL. B LINEAR AMP.	500	28	200	0	25	0	7	10	3.5	1.8	
RK-23	OX. CATH.	7 PIN-MED.	2.5	2.0	.02	10.0	10.0	CL. C OSC-AMP.	500	90	200	0	50	6-8	40	10	18	.8	15000
								CL. C OSC-AMP.	500	90	200	+45	55	6-8	35	10	24	.8	15000
RK-25	OX. CATH.	7 PIN-MED.	6.3	.9	.02	10.0	10.0	SUPP. MOD. AMP.	500	90	200	-45	32	6-8	40	10	5.5	.8	15000
865	THOR. TUNGS.	4 PIN-MED.	7.5	2.0	.01	8.5	8.5	CLASS C AMP.	750	80	125		40	5.5	15	16	1.0	15000	
								CL. C MOD. AMP.	500	120	125		40	9	15	10	2.5	15000	
								CL. B LINEAR AMP.	750	30	125		22		15	4.5			
RK-20	THOR. TUNGS.	5 PIN-MED.	7.5	3.0	0.12	11.0	10.0	CLASS C AMP.	1250	100	300	0	80	7-10	37	40	64	1.0	15000
								CLASS C AMP.	1250	100	300	+45	92	7-10	32	40	80	1.0	15000
								SUPP. MOD. AMP.	1250	100	300	-45	43	7-10	36	40	18	1.0	15000
803	THOR. TUNGS.	5 PIN-JUMBO	10.0	3.25	0.15	15.5	28.5	CLASS C AMP.	2000		500	-30	160	16	42	125	210	1.6	5000
								SUPP. MOD. AMP.	2000		500	-50	80	15	55	125	53	1.6	5000
								CL. B LINEAR AMP.	2000		500	-40	80	3	15	125	53	1.5	
804	THOR. TUNGS.	5 PIN-MED.	7.5	3.0	.01	16.	14.5	CLASS C AMP.	1250	100	300	0	80	7	33	40	64	.9	15000
								CLASS C AMP.	1250	100	300	45	92	7	27	40	80	.9	15000
								SUPP. MOD. AMP.	1250	100	300	-50	48	7	35.5	40	21	.85	15000
RK-28	THOR. TUNGS.	5 PIN-JUMBO	10.0	5.0	.02	15.5	5.5	CLASS C AMP.	2000	100	400	0	120	10-12	75	125	160	1.8	10000
								CLASS C AMP.	2000	100	400	+45	140	10-12	60	125	200	1.8	10000
								SUPP. MOD. AMP.	2000	100	400	-45	80	10-12	85	125	60	2.7	10000
850	THOR. TUNGS.	4 PIN-JUMBO	10.0	3.25	.2	17	26	CLASS C AMP.	1250	150	175		160	35	100	130	10	5000	
860	THOR. TUNGS.	4 PIN-MED.	10.0	3.25	.08	7.75													

A Boy Scout Tests A JUNIOR Communication RECEIVER

(The Sky Buddy)

By The Editor

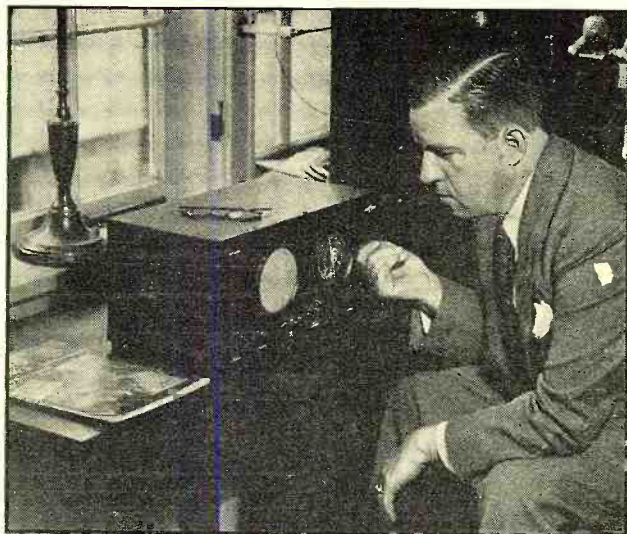

A NEAT AND COMPACT JOB

This little set, shown in the Westchester Listening Post, contains about everything that its bigger brothers have in the way of modern controls neatly arranged in a very compact unit.

THIS new set, which is a three-band receiver, tuning continuously from 540 kc. to 16 megacycles, was put through its paces satisfactorily at the Westchester Listening Post and then was loaned to Bob Molitor, W2IOM, a member of a Scout Troop, of Pelham, New York. Bob had the set for three days, during which time he used it on the amateur, short-wave and broadcast bands. His report was so well done that we are publishing it here rather than the Listening Post report.—EDITOR.

WHEN I stopped into the Westchester Listening Post, to see what was new in radio, my eye fell upon the Sky Buddy receiver which was being tested there and immediately I said to myself; 'Isn't that a little "honey"'. Mr. Cockaday let me tune it over the band and after a few moments asked me how I liked it. I replied that it seemed swell and he said, 'Bob, would you like to take it home to your station.

test it out and let me have a report on it?' I replied, 'I sure would,' and soon was hoofing it home full speed with it under my arm. I soon had it set up after reading the operating instructions which told me that band No. 1 covered a frequency from 540 kc. to 1680 kc.; band No. 2, 1680 kc. to 5.5 megacycles and band No. 3 from 5.5 megacycles to 16 megacycles. I stuck the power plug into the 110 a.c. line and connected it onto my 100-foot antenna. Of course, being interested in 40 meter c.w. I immediately turned the band switch to that range and soon had copied signals from W9WPV, W5AVN, W4DSO, W9TAD, W4DQV and XE1BQ. These all came in R9 and I was able to work (with my c.w. transmitter) a number of new contacts I had never made before. On the 20 meter

band, on c.w., I soon had copied LU5AQ, W5EXW, W6NIK, W5CQJ, K5AG, ON4LB, W6MCG, W6KYU, CM2DO, W6HCF, W5EBN. During the three days I had the set I picked up innumerable c.w. stations on the various amateur bands. On phone on the 20-meter band my first stations were W6AM, NY2AE, HI7G, HI5H, W9QI, CO6OM and one station in Sweden, SM5SX. Boy! was I pleased with it. "And also the set sure brings in Europe and South America well on the regular short-wave broadcast bands. The first evening DJJ and the British Empire stations actually shook the windows and the loudspeaker, (Turn to page 120)

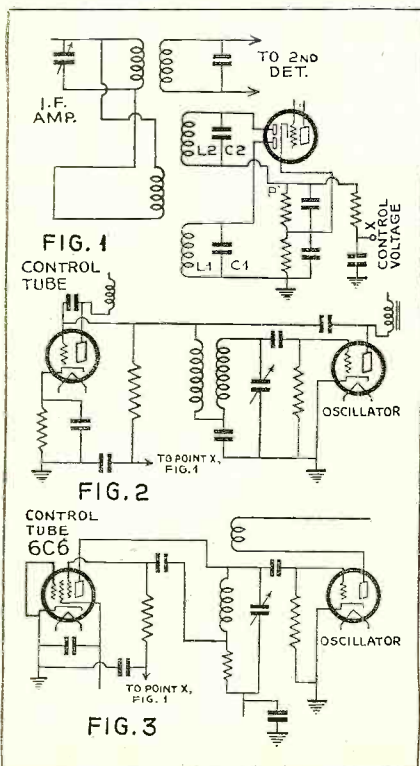

SIGNAL Seeking CIRCUITS

By J. van Lienden

THE 1936 receiver requires careful tuning if the best tone quality is to be obtained. Manufacturers have tried all kinds of systems, tuning meters, squelch systems, neon lights and the magic eye, to make the customer tune the station right "on the nose" but the majority of listeners are not using these devices to their full advantage. Consequently, most receivers never have a chance to perform at their best due to the customer's negligence; then the blame of the impaired quality comes down on the radio industry.

These facts led to the development of "signal seeking circuits" which is an arrangement that makes it impossible to be off tune. As soon as the listener tunes to within 5 kc. of a station, the automatic device slightly shifts the oscillator fre-

quency and makes the tuning nearly perfect. If two stations are 10 kc. apart and one tunes exactly between them, the receiver will automatically select the loudest one. If they are equally strong, nothing happens until the modulation percentage of one becomes more than that of the other, the oscillator will then be shifted to receive this strongest one alone.

A receiver which did these things on demonstration was shown at a lecture delivered by S. Y. White before the Radio Club of America during the latter part of 1934. Since that time others have worked on the same problem; an article appeared in the I.R.E. proceedings for October, 1935 entitled Automatic Frequency Control by Charles Travis.

This is the way the desired effect is obtained. The last i.f. stage has two transformers which may be in parallel. One of them is coupled to the second detector, the other is loosely coupled to two secondaries, one of them tuned 5 kc. above the other 5 kc. below the i.f. These two secondaries are coupled to a duo-diode tube in such a manner as to make the output equal to the difference between the two rectified outputs. For instance in Figure 1, Circuit L₁C₁ tuned to 5 kc. above the i.f. would develop a positive potential at P while Circuit L₂C₂, tuned to 5 kc. below the normal i.f., would make P negative. But these two voltages are in series and the net result will be that P becomes positive when

(Turn to page 107)

A Report of Recent 5-METER "DX"

By W2JCY

WHO says that 5-meter signals radiate outward through space without ever being reflected back to earth? The report of DX transmission and reception in this short article proves that under certain conditions long-distance transmission on 5 meters is possible, for it is now an actual accomplishment!

ON May 9th, 1936, just a little after 11 p.m. E.S.T., and until 1:05 a.m. the next morning a number of stations, in the 1st, 2nd and the 3rd districts along the Atlantic seaboard, contracted stations in the 8th and 9th districts of the Middle West, on 5 meters. These contacts were made with reports of signal strengths, ranging from R2 to R9, with signals holding up at an average of R8 to 9 during most of that time.

On that evening I had been holding a three-way contact between W2AMJ and W1EER for over an hour and when we signed off Frank Lester, W2AMJ, was surprised to hear W9PEI calling him and I was also surprised to hear W9UAQ. These were the first two contacts that we had with W9's and believe me it was a very exciting 15 to 20 minutes for all concerned. Later, both Frank and I received letters from many 8th and 9th district stations stating that we had been heard during our three-way contact and that the western stations could hardly wait for us to finish

so they could contact us.

I was delighted to make four contacts, three with W9's and one with a W8 as the accompanying QSL cards will testify to. I was also able to verify W2AMJ's transmissions as well as a western contact made by W2CLD at Rockaway Beach. I heard both sides of these conversations. I also heard western stations calling W2JNB, W2GNL and W2HRV and, during the weeks following, received 18 QSL cards with reports of hearing my station in the Central Western area. On the evening of May 8th I had been telling W2HEJ of certain researches I have been making at New York University to check up on conditions during which 5-meter DX were possible. I made a check of position

DX RECORD CONFIRMED

Below is the 56 megacycle station of W2JCY from which point the two-way contacts with the 8th and 9th Districts were made. Telegram from W9UAQ confirms the first contact which lasted for about 15 minutes. This gives your editor five districts worked on 5 meters, including first, second, third, eighth and ninth, which isn't bad—is it?



QSL'S RECEIVED AT NORTH PELHAM

A few of the confirmations received by the author of his two-way 5-meter transmissions on May 9th, with 5-meter stations in the Middle West. Four stations were worked; eleven reported hearing his signals.

and phase of the moon, temperature, atmospheric pressure, humidity and other minor conditions. By checking back through QSL cards received by various stations in 1935 for what they then considered to be long-distance transmission on 5 meters (distances of about 100 to 250 miles) I found that most of them occurred when the moon was either approaching closely to full or leaving that phase. It was also determined that a sudden drop in temperature seemed to predominate, with a decrease of humidity. Another factor checked through a number of "long distance" periods was that a low pressure area should be over the New York area with a high pressure area on the North, West and South. Working on the basis that these conditions were necessary for 5-meter DX I have been able to predict the last three real good DX periods within 24 to 48 hours.

As I say, I had been telling W2HEJ that I believed within the next 24 hours the 5-meter band would "open up" and this was verified on (Turn to page 109)

THIS COMPANY WILL APPRECIATE SUGGESTIONS FROM ITS PATRONS CONCERNING ITS SERVICE

1935-6

CLASS OF SERVICE

This is a full-rate Telegram or Cablegram unless the desired character is indicated by a suitable sign above or preceding the address.

WESTERN UNION

W. H. WHITE W. J. CARLTON J. C. WALLACE
PRESIDENT CHAIRMAN OF THE BOARD VICE PRESIDENT

SIGNS

DL = Day Letter
NL = Night Message
NL = Night Letter
LC = Deferred Cable
ML = Cable Night Letter
R = Radiogram

The Company is bound by its rates and full rates table and day letters, and the time of receipt of its messages is by STANDARD TIME.

Received at
NBK147 33 DL COLLECT 10 EXTRA=CHICAGO ILL MAY 18 254P

L M COCKADAY, RADIO NEWS=
461 EIGHTH AVE=

CONFIRMING TWO WAY FIFTY SIX MC QSO WITH W TWO JCY MAY
NINE STOP QSL WILL FOLLOW STOP SORRY TO DELAY CONFIRMATION=
AL COX W 9 UAQ 633 NORTH HUMPHREY OAKPARK ILL.

MINUTES IN TRANSIT

THE QUICKEST, SUREST AND SAFEST WAY TO SEND MONEY IS BY TELEGRAPH OR CABLE

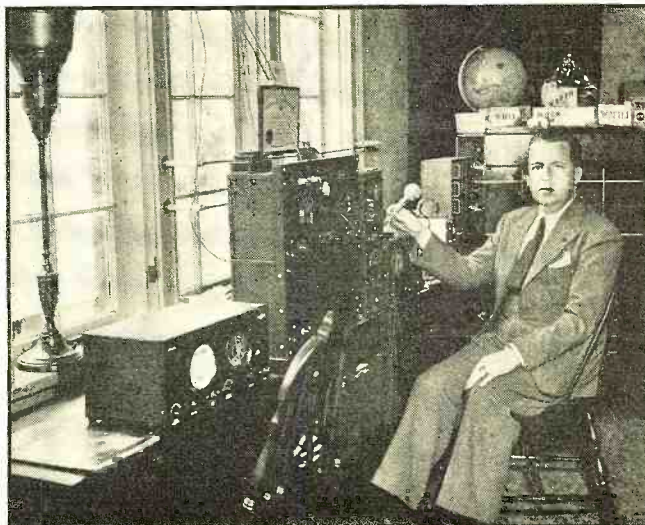

Getting Better Quality with an Expander

By The Staff

A NEW volume range-expander has been designed by Scott engineers to go with the famous Scott all-wave receiver for adding brilliancy and tone quality to even the finest broadcast programs. This unit, which is shown being installed in the illustration, can be placed in the cabinet either alongside of the chassis or at the rear. Its circuit is entirely housed, in a chromium-plated rectangular shield and may be installed in a half an hour's work by simply following the instructions that come packed with it.

The expander control may be fastened either on the front or on the side of the cabinet as it is already connected to a length of cable which is flexible and will reach around to both positions. The diagram accompanying this article shows the general methods of installation on the Scott receiver. A second cable contains two short and two long leads which are fastened to two of the

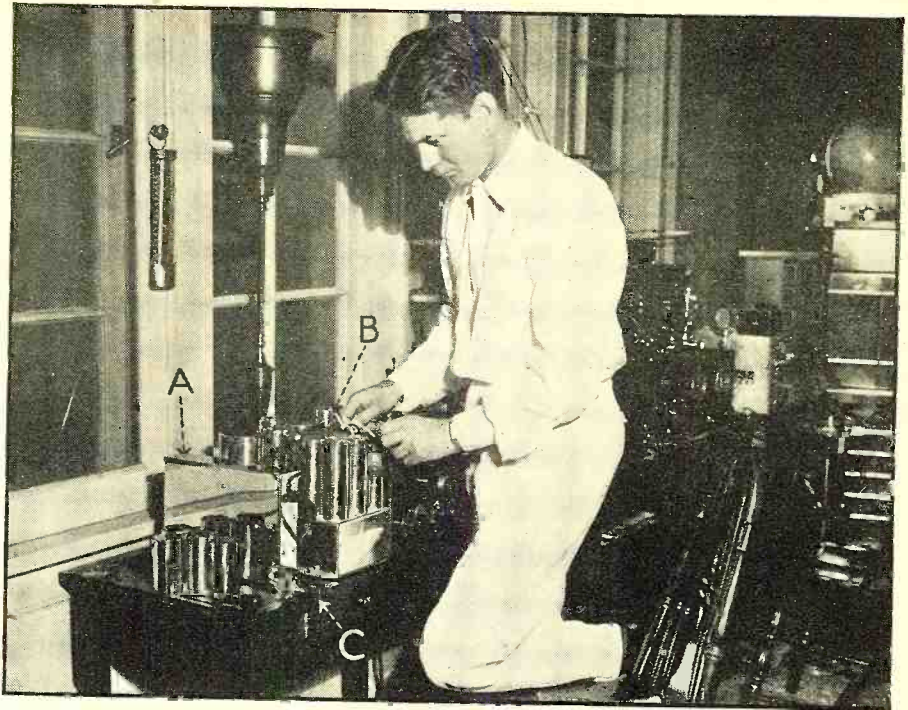

IT'S A SIMPLE JOB TO INSTALL THE EXPANDER

This illustration shows how easy it really is to connect up an expander to the set. In the photo A is the expander unit; B are the connections which are made from it to the two 6C6 tubes; C is the expansion-volume control.

6C6 tubes in the receiver. The power-supply cord of the receiver itself is inserted into a plug at the end of the third connecting cable on the expander and this plug in turn is inserted into the power unit. New tube shields, with longer slots in the side, are furnished with the expander.

The expander is equipped with spe-

cially selected and matched tubes and they only should be used with it. For replacement it is recommended that a new set for the purpose be obtained from the Scott laboratories. This does not mean that tube trouble will develop but, due to the special characteristics necessary, tested tubes will give very much better results. A set of four tubes is incorporated in the expander.

In operating the expander it will be found that different types of programs require different amounts of expansion. Speaking voices on programs require very little, with the control about one-quarter "on." Singers will be found sounding better and much more natural with the control one-half to three-quarters "on." Dance orchestras usually keep "batting away" at about an equal volume, with very few soft passages, and therefore need very little expansion. Symphony orchestras, on the other hand, have a very wide range of volume and the expander does its best work on this type of program.

(Turn to page 105)

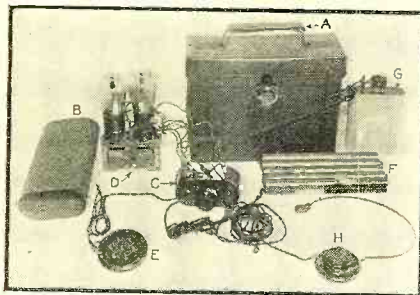

Portable

HEARING AID

By Samuel B. Simer

THE accompanying illustration shows an interesting and highly effective portable hearing aid built by Samuel B. Simer, a custom builder of hearing aid equipment. The circuit uses a straight-forward two-stage vacuum tube amplifier employing two type 30 tubes, transformer coupled.

When assembled the whole outfit fits in to the leather camera case "A". For purposes of illustration all of the parts

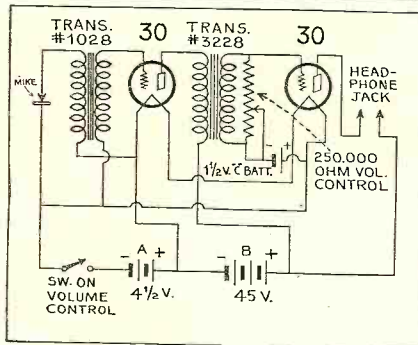

have been taken out to show the details. The can "B" is the container in which the amplifier assembly is housed. The "General" microphone input and interstage transformers are mounted side by side and their cores soldered together for security. On them is mounted a Bakelite plate and on this plate the two tube sockets are mounted. This unit "D" slips inside the can "B" and the metal cover "C", which carries the volume control R1 and the phone tip jacks, is slipped within the top of the can. In one end of the leather case a hole is cut just slightly smaller than the top of the can so that the tip jacks and the volume control knob are accessible from the outside, the can being placed horizontally in the carrying case.

The Universal single button lapel microphone "E" has its leads permanently connected to the circuit, as are also the leads from the "ribbon" type B battery "F". The

(Turn to page 106)

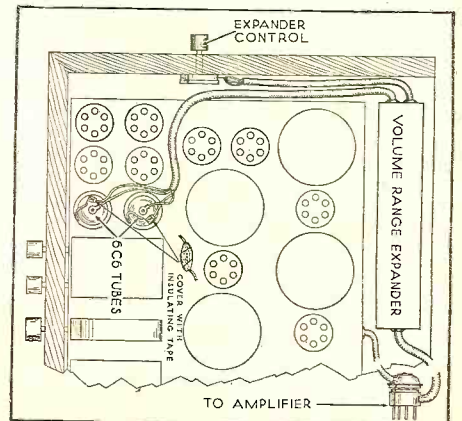

A Homemade CODE Practice Oscillator

By Gordon Fraser

FOR those who are learning or practicing the code a small vacuum-tube oscillator is unquestionably the most practical device to use because the high-pitched note which it provides is the same type of note as that heard over the air. A high-frequency buzzer is also entirely satisfactory for this purpose, but a good one costs about as much as a small vacuum-tube oscillator and there is the further drawback that unless the buzzer is a really good one it will be tricky to keep in adjustment.

The little code practice oscillator shown here has several features that recommend it to the attention of the code student. First of all, the parts are few, simple and standard and most of them will probably be found in the proverbial "junk box." Second, the only battery used is a standard 4½-volt C battery. Third, the pitch or tone of the oscillator can be continuously varied over a wide range by rotating the rheostat knob.

Variable Tone

This variable tone is an advantage for two reasons. It permits the listener to obtain a pitch that is pleasing to him and it permits the use of almost any type of audio coupling transformer. Normally a large transformer is likely to result in a very low pitch, whereas the small, cheaper transformers provide a high pitch. With the circuit employed in the oscillator shown here a transformer which is normally unsuitable for this work will be found to function very satisfactorily.

The circuit and construction is so simple that a detailed description is

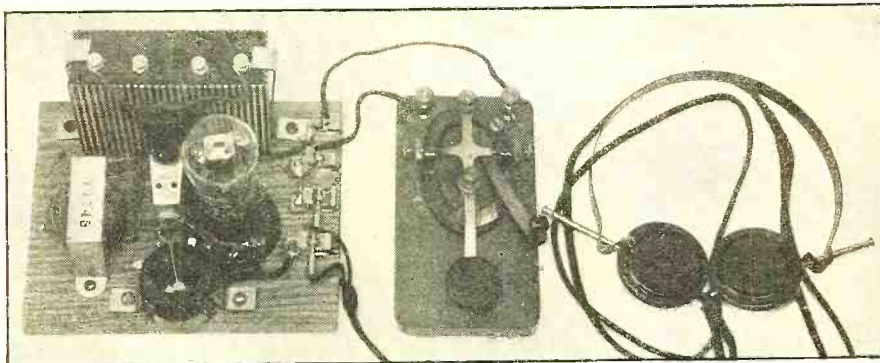
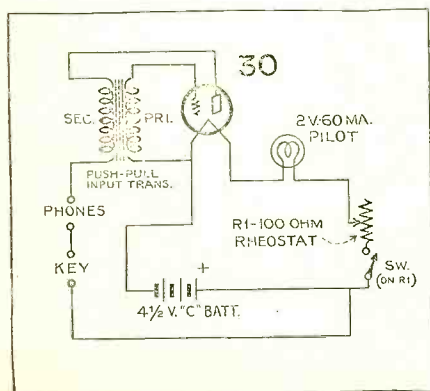

THE COMPLETE CODE PRACTICE EQUIPMENT

The home-made audio oscillator is shown at the left; the knob at the front is for adjustment of the pitch. Any standard key and headphones may be used with it

unnecessary. The illustrations make the construction of this particular model quite clear, although there is, of course, no necessity for following this particular layout.

The variable pitch is obtained by varying the filament voltage and therefore the emission of the type 30 tube. It will be noted that the tube is connected in series with the rheostat and a pilot light. But the full 4½ volts could be applied across this circuit without seriously overloading the filaments even

with a fresh battery. The rheostat is therefore inserted primarily for the purpose of tone variation. The plate return is made to the plus 4½-volt tap of the battery. This voltage is adequate for the plate supply and will provide a good loud signal in the headphones.

The pilot light is an almost essential feature of a gadget of this type, because without one it is the easiest matter in the world to forget to turn the oscillator off when practice is finished, with the result that battery (Turn to page 120)

How to LEARN The Code

By B. Breedlove

IT is fun to know the code, and those of us who possess short-wave or dual-wave receivers are missing many an evening of good solid entertainment if we do not know the International Morse code. There are new and recurrent thrills; radio signals from merchant and naval vessels in all parts of the world, weather bulletins, news flashes, time signals and oceanic services competing with the world's cable system; there are the thousands and thousands of amateur radio operators to whom most of the credit must be given for developing and opening up the shorter waves. All of these stations communicate by Morse code. Messages, some bearing on world affairs, tragedy and comedy, love and simple fellowship are buzzing out from radio stations all over the world; they are there for those of us who know the code. Though we are bound to secrecy in what we intercept (it is a serious offense and there (Turn to page 113)

A	•••••
B	•••••
C	•••••
D	•••••
E	•••••
F	•••••
G	•••••
H	•••••
I	•••••
J	•••••
K	•••••
L	•••••
M	•••••
N	•••••
O	•••••
P	•••••
Q	•••••
R	•••••
S	•••••
T	•••••
U	•••••
V	•••••
W	•••••
X	•••••
Y	•••••
Z	•••••
1	•••••
2	•••••
3	•••••
4	•••••
5	•••••
6	•••••
7	•••••
8	•••••
9	•••••
0	•••••
DISTRESS SIGNAL	•••••
PERIOD	•••••
COMMA	•••••
INTERROGATION	•••••
QUOTATION MARK	•••••
EXCLAMATION	•••••
COLON	•••••
SEMICOLON	•••••
PARENTHESIS	•••••
FRACTION BAR	•••••
WAIT SIGN	•••••
DOUBLE DASH (BREAK)	•••••
ERROR (ERASE) SIGN	•••••
END OF MESSAGE	•••••
END OF TRANSMISSION	•••••

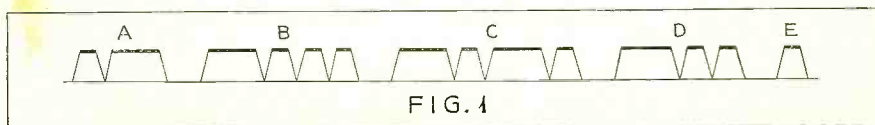



ELECTRODE POTENTIAL SERIES
(MOLAL ELECTRODE POTENTIALS REFERRED TO THE HYDROGEN ELECTRODE AS ZERO)

ELECTRODES	POTENTIAL (VOLTS)	SIGN		
		METAL TO ION	ION TO METAL	
Li-Li +	2.958	+	-	LR
Rb-Rb +	2.924	+	-	LR
K-K +	2.922	+	-	LR
Na-Na +	2.713	+	-	LR
Ba-Ba ++	2.8	+	-	LB
Sr-Sr ++	2.7	+	-	LB
Ca-Ca ++	2.5	+	-	LB
Mg-Mg ++	1.55	+	-	LB
Mn-Mn ++	1.0	+	-	LB
Zn-Zn ++	0.758	+	-	LR
Cr-Cr ++	0.557	+	-	IC
Cr-Cr ++	0.40	+	-	IC
Fe-Fe ++	0.441	+	-	LR
Cd-Cd ++	0.398	+	-	LR
Tl-Tl +	0.336	+	-	LR
Co-Co ++	0.29	+	-	LB
Ni-Ni ++	0.231	+	-	IC
Sn-Sn ++	0.136	+	-	LR
Pb-Pb ++	0.122	+	-	LR
Fe-Fe +++	0.045	+	-	LR
(Pt-H ₂)-H+	0.0	+	-	
Sb-Sb +++	0.1	-	+	LB
Bi-Bi +++	0.2	-	+	LB
As-As +++	0.3	-	+	LB
Cu-Cu ++	0.345	-	+	LR
Ti-Ti +++	0.37	-	+	IC
(Pt-OH)-O ₂	0.398	-	+	LR
Hg-Hg ++	0.799	-	+	LR
Ag-Ag +	0.800	-	+	LR
Au-Au +++	1.3	-	+	LB
Au-Au +	1.36	-	+	IC

DATA MARKED LR FROM LEWIS AND RANDALL, "THERMODYNAMICS"; LB FROM LE BLANC, "LEHRBUCH DER ELECTROCHEMIE"; IC FROM "INTERNATIONAL CRITICAL TABLES"

ORIGINAL VOLTAIC BATTERY

Figure 1, at top, shows five Volta cells connected in series. Table 2 is the electrode potential series, showing the elements and potential difference. Figure 3, below, is an exact replica of Henry's Galvanometer, made from a coil of wire and a needle supported on a string

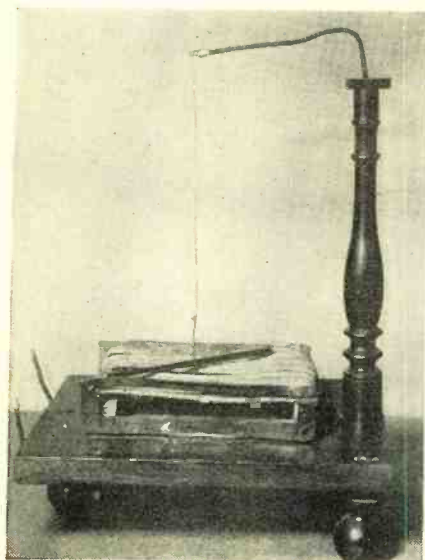

BEGINNERS: Before You Learn You Should Know Something Fundamentals

Many laymen becoming more and more interested action of radio circuits because they are not familiar Here is explained simply some of the electric

By Irving J.

WHO would ever have believed, when in 1793 Alessandro Volta, a physics professor, finished his lecture before a Pavia audience, that from such a crude device as his original arrangement voltaic cells (see Figure 1), would come a development which, if only a little further understood, would teach us about the nature of materials, the constituents of metals and fluids, the ability to build electrical equipment of vast power to run our industries, and, finally, to enable us to communicate over the entire globe by radio. A first crude arrangement of batteries—zinc and copper plates immersed in an acid solution—in its systematic investigation made possible the study of the fundamentals of electrochemistry. In consequence there came the investigation of the phenomena connected with the motion of electrical charges in gases, fluids, and solids and finally, the study of electrical charges much smaller than the others, namely—those practically free from matter—electronic physics.

It is at this point that the scientist enters the scene. In showing the common source in the diversification of general laws that allow many phenomena to appear in different lights, he creates new variations and discovers new effects that eventually become of industrial importance. It is indeed a thrilling experience to compare the phenomena of radio and electricity of today with the experiments of 100 years ago, which in their various forms look so completely different, but which at bottom are fundamentally identical with today's technique, however varied they may appear.

The Electron Theory

In the early parlance of electrical experimenters it was assumed that current traveled from *positive to negative*; it would be, perhaps, more correct to say that current travels from a higher to a lower electrical Potential. However, the flow of electric current is now believed to be in the *direction of the flow of the electrons*, as established, for instance, in radio tube phenomena.

Fundamental experiments about the mechanism of the conduction of electricity in a liquid (called an electrolyte) have been carried out as early as 1853, and the physical laws of ionization in liquids have followed since that time. As a starter, in considering the generation of electric potentials in batteries containing a fluid electrolyte, we might ask the question. How are these poten-

How Currents Flow

What is actually concerned in the passage of electricity through conducting mediums? Is it different if we screw a lamp into a light socket, or if we receive radio impulses from the ether when we have current flowing through the vacuum of our radio tubes, or if we reflect radio waves on the Heaviside layers of an atmosphere 100 miles above the earth? Just how does conduction take place?

HEARING MAGNETIC CHANGES

Figure 7. This is a replica of the original Barkhausen apparatus for demonstrating the theory of magnetism. By rotating the magnet, sounds of tiny molecular particles can be heard changing polarity

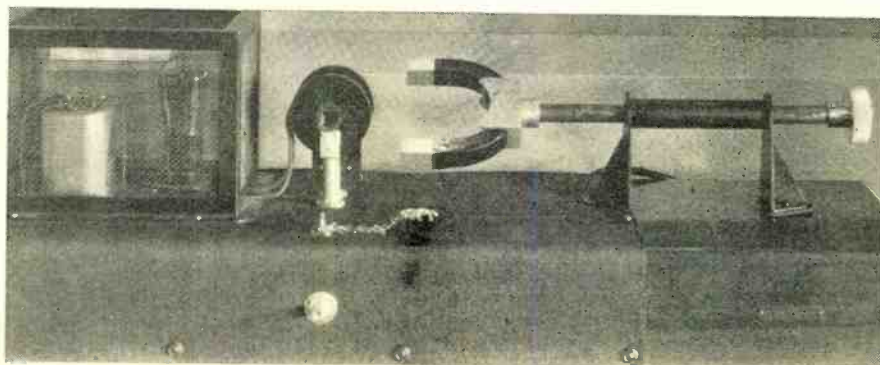

the Technical Details of Radio About the History of the of Electricity

in radio encounter difficulty in understanding the with fundamental electrical and magnetic phenomena. and magnetic actions upon which radio is based.

Saxl, Ph.D.

tials started in batteries and how is conduction accomplished? An ordinary fluid without any energy passing through it may be thought of as neutral, electrically. But the atoms of a liquid may be decomposed under the influence of an electrical potential, and the ions, resulting, will carry tiny charges through the electrolyte to the electric terminals (sometimes called electrodes). These ions may be considered as tiny little "boats" which float through the electrolyte between the electrodes starting the current flow through the battery.

The material of the electrode governs the potential difference that will be generated by the battery and there follows in Table II a list of electrode materials and their electrical characteristics in comparison to hydrogen in an electrode-potential series.

"Wandering" Electrons

While the motion of ions through fluids is one of the earliest actions of electricity to be investigated, there are a number of other phenomena that can be easily reproduced that have added considerably to increase our understanding of electrical phenomena and that have helped us to make many of the tools and machines necessary for our 20th century civilization.

The conduction of electricity through solids seems to be a much more simple than that of conduction through

ELECTRO-MAGNETIC ACTION

Figure 5. When a magnetic field invades the space taken up by an electric conductor, electric currents flow in the latter (Faraday's induction experiment)

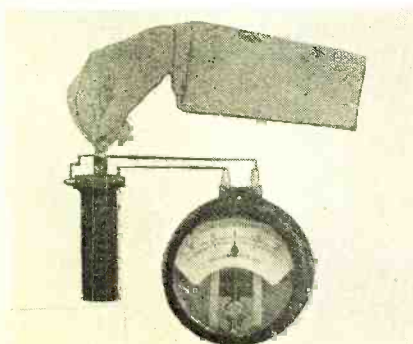

liquids. In solids, a current of electricity is believed to be a wandering of free electrons, through the atoms, in a drift tending to equalize the distribution of such free electrons. In other words, the general understanding of conduction would include the idea of the free electrons repelling each other and leaving locations in a conductor where "crowding" exists. In other words, a generator of electricity might be considered as an electron pump that produces a "crowd" of electrons at one of its terminals and they immediately drift through the conductor to the other terminal of the generator where there is a scarcity of said electrons

Magnetic Fields

Another part of electrical phenomena of importance has to do with the relation of current flow and magnetism. This refers particularly to the phenomena of electro-magnetism, the principles of which are of equal importance in the construction of huge dynamos, in the motion of the loud speaker, the galvanometer or the oscillograph, in the construction of electronic and radio apparatus, and even in the transmission of energy through space.

All these phenomena revert to the fact that flowing electricity develops a magnetic field and that changes in a magnetic field can also generate electricity. Figure 3 (Turn to page 107)

HENRY'S ORIGINAL MAGNET

Figure 8. A replica of the great Henry's largest magnet, which was made by winding silk-wrapped wire on an iron frame. It operated by passing heavy currents of low voltage through the winding and could lift a large weight

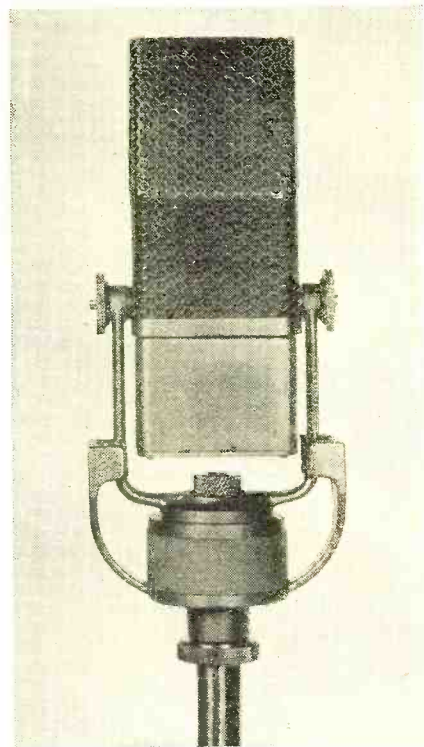
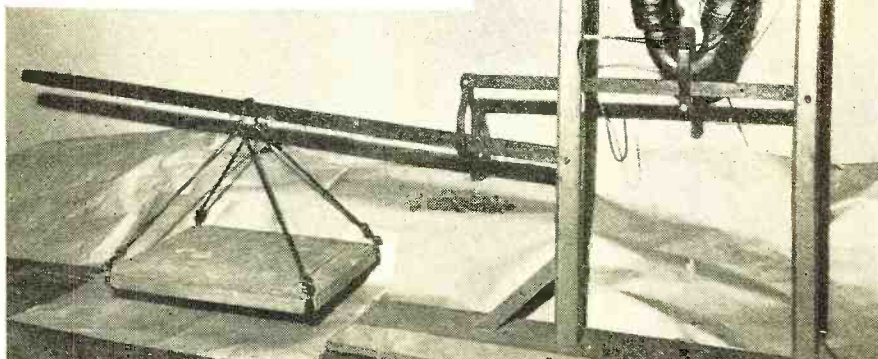

VELOCITY MICROPHONE

Figure 4. The velocity microphone built upon the principle of interaction between electric currents flowing in a ribbon and a magnetic field

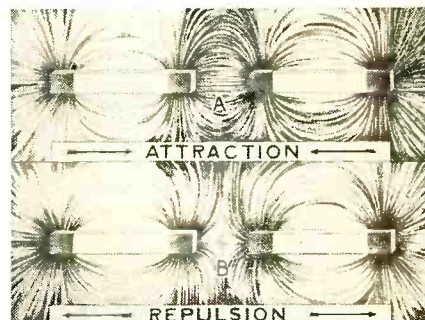

MAGNETIC FORCES

Figure 6. At A is shown attraction between two magnets placed so that opposite poles react on each other. B shows the repulsion effect between two similar poles

Practical Construction The Radio

This series of articles is presented
sire to obtain a working knowledge
have some theoretical knowledge
tical experience which is so essential

Part 4—Combination A.F.

By John M.

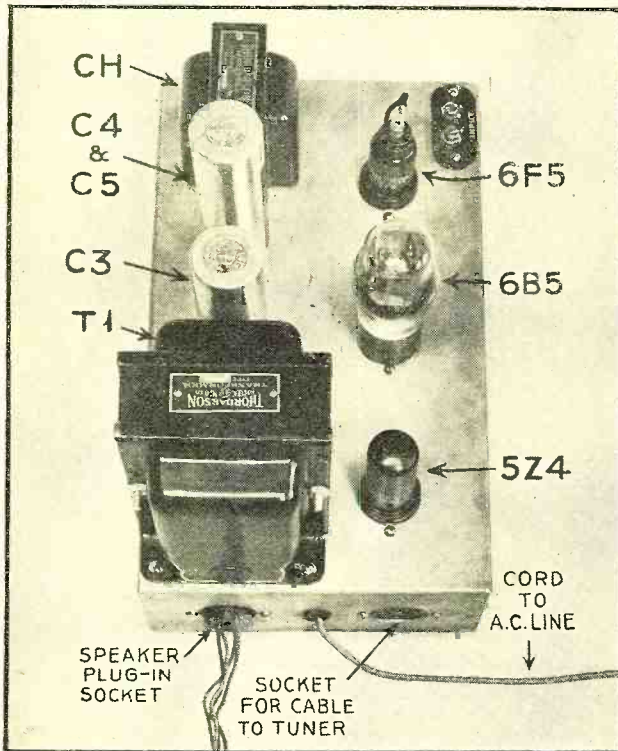

THE past three installments of this series have covered battery-operated equipment, but from now on the equipment to be described will be for operation from 60-cycle, 110-volt a.c. lighting lines.

ALL but the most simple radio receivers require direct current of several different voltages up to 300 volts and current values so large as to make batteries impractical. In order to meet this demand, the modern receiver includes a "power supply"—which turns the 110-volt a.c. into higher d.c. voltage and at the same time delivers a.c. of a few volts for the tube filaments.

This and the article next month will describe a general utility power supply and audio amplifier in one unit which can be used with the several tuning units to be described later. This unit is also an excellent audio amplifier for phonograph reproduction and it can be used with last month's battery set to obtain high-volume loudspeaker reception. The article this month will de-

scribe how the apparatus works and next month the constructional details will be given in the magazine.

The Power Supply

Obtaining d.c. from a.c. is accomplished by means of a "rectifier"—a device which conducts electricity in one direction only and was described in the first article in the May issue. For several reasons it is necessary in the case of a power supply to utilize both halves of the wave and to arrange two diode rectifiers to provide "full-wave" rectification.

Referring to Figure 1, the 5Z4 tube has been drawn upside down for convenience. The transformer winding, B, serves to heat the filament of this tube. This particular rectifier is one of the "indirectly heated" type. Its cathode consists of a tiny cylinder which is a good electron emitter when heated. The filament is inside of and heats the

cathode but does not touch it—therefore the term "indirectly heated."

Transformer winding C delivers 375 volts a.c. each side of the center-tap. On one-half of each cycle the plate P becomes positive with respect to the ground, or center-tap. A diode conducts only when the plate is positive; therefore, during this half cycle, electrons will flow from the cathode to plate P, through the upper part of winding C to ground and from ground through R6, the speaker field and the choke back to the cathode. Meanwhile, the lower half of winding C is not conducting any current.

During the next half cycle, the conditions are reversed and Q becomes positive. Consequently, electrons will flow from cathode to plate Q, through the lower half of winding C to ground and back again through R6 and the chokes. The direction of the electron flow through R6 and the chokes is the same in both cases and the result is 120 pulses of d.c. per second. If this pulsating voltage were applied to the plates of the amplifier tubes, a loud 120-cycle hum would be heard in the speaker. To smooth out the pulsating voltage and remove the hum, a filter must be used.

The power supply filter generally consists of one or more sections, each sec-

THE NEW UNIT IN OPERATION

Here the amplifier unit is shown connected to the simple one-tube receiver. The combination produced excellent loudspeaker reproduction of local broadcast programs

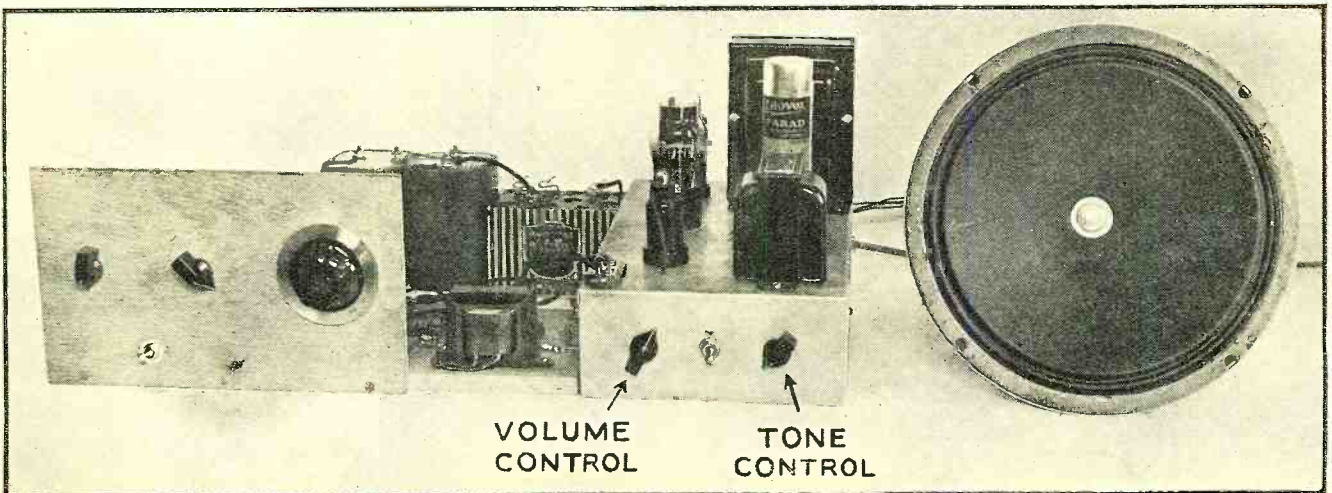

and Instruction for Beginner

for the benefit of beginners who de-
of radio, and also for those who
of the subject but lack the prac-
to thoroughly understanding radio

Amplifier and Power Unit

Borst

tion consisting of a choke in series with
the rectifier output and one or two con-
densers across the output. The first
condenser C4 serves as a reservoir. At
the peak of each voltage impulse the
condenser charges up to that peak, but
as the voltage subsides the condenser
discharges through the chokes and R6.
The net result is a partial smoothing
out of the impulses as well as the raising
of the average voltage.

The choke, CH, tends to oppose any
change in current and therefore helps
also in smoothing out the impulses. The
function of condenser C5 might best be
explained by considering that the cur-
rent passing through the choke consists
of the desired direct current plus some
undesirable 120-cycle a.c. It is the pur-
pose of C5 to remove the alternating
current by providing an easy path to
ground for it. The d.c. cannot, of
course, pass through a condenser. In
this filter the hum has been cut down
about sixty times in the first section. In
the next section the hum is cut down
again about 200 or 300 times. These
effects multiply so that the total reduc-
tion of hum in both sections is 60 x 300
or 18,000 times. Such a reduction is
more than enough. Measurements have
shown that the hum voltage across the
primary of the output transformer is
less than .1 volt, while the maximum
signal voltage across this primary is
nearly 200 volts.

A further explanation of the speaker
field is needed. This and all other
"electrodynamic" speakers require that
a current be sent through the magnet
or "field" windings. At the same time
the field can serve as a choke in the
filter, thus killing two birds with one
stone. There are, however, complica-
tions to this arrangement. The field re-
quires a certain minimum power to be
properly magnetized and consequently
the number of turns of the field must
be just right for the total current flow-
ing through it. These fields are usually
specified by their resistance as well as
the power consumption. When design-
ing the power supply, the designer must
arrange the circuit so that he makes best
use of the field's filtering property with-

out losing too much voltage in it.

More or less standard field resistances
are 1000, 1800 and 2500 ohms, which
usually require currents of 100 ma., 70
ma. and 45 ma. respectively. In our
case, the power supply unit is designed
to provide a maximum direct current of
85 ma. and so the 1800-ohm field was
most suitable. During the employment
of smaller tuning units with a total
draw of only 50 ma., including the am-
plifier, extra current can be drawn
through the bleeder resistor R6 by de-
creasing its resistance, in order to bring
up the total current drain, if this is
found necessary.

A 5-prong socket is provided for car-
rying the power to a tuner unit, although
only 4 prongs are used. The extra prong
is to prevent the error of plugging this
cable into the 4-prong speaker socket.

The Amplifier

The amplifier in this unit employs
two tubes, but it really includes three
stages, because the 6B5 consists of two

tubes and the coupling means, all within
a single bulb.

The first tube, a 6F5, is an indirectly
heated triode employing "automatic
bias" or "self-bias." The plate current
on its way to "ground" through the
cathode circuit passes through a resis-
tor, R3, with the result that a voltage
drop is developed across it and the
cathode is positive with respect to
ground by the amount of this voltage.

Since the grid is connected to ground,
the grid is thus made negative with
respect to the cathode.

The cathode resistor must be "by-
passed"; that is, an easy path for alter-
nating or voice currents must be pro-
vided by a condenser in parallel with it.
If this were not done, the amplified
signal would pass through the cathode
resistor, causing alternating voltages
across it, and the grid voltage would
vary accordingly. This variation in
cathode voltage would be in such a
direction as to oppose the original signal
and amplification (*Turn to page 117*)

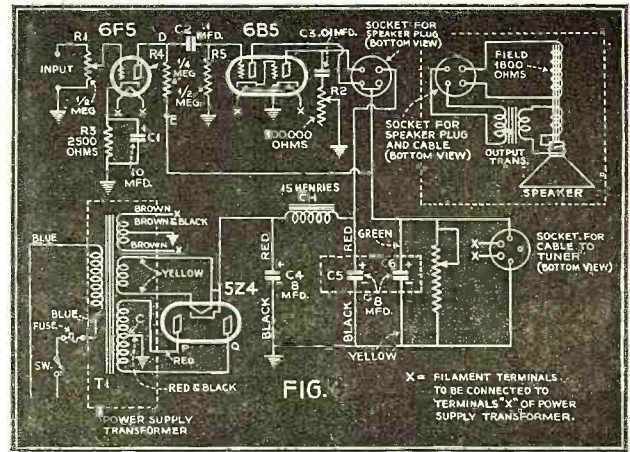

FIG. 1. THE COMPLETE SCHEMATIC DIAGRAM
The lower portion shows the power supply.
The amplifier and loudspeaker are shown above

Experimental 9.5 METER Station

By Robt. Ames

BBROADCASTERS are constantly giving
added attention to experiments on
ultra-short wave bands. For some time
now, CBS has been operating W2XDV on
the 9.5 meter band. It is a 50-watt unit
atop the WABC studios at 485 Madison
Avenue, New York.

Among phenomena being studied are the
shadow effects which the steel frames of
New York skyscrapers cast across the
ultra-high frequency band of the ether.
Besides determining signal distortion, the
transmitter is employed to find the amount
of attenuation and other transmission

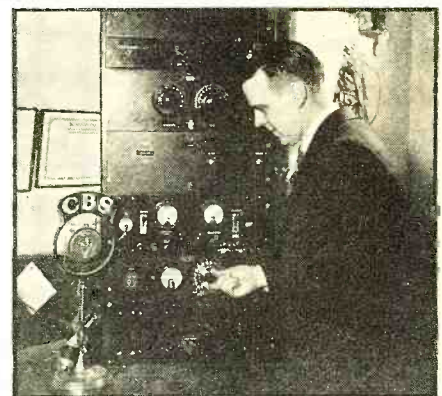

characteristics of the tiny waves in the
metropolitan zone. Also, distance tests are
being made. The general value of the
tests is said to be the use of the accumu-
lated data for television research, the very
high frequencies being the only available
channels for visual transmissions.

E. K. Cohan, CBS engineering director,
is supervising the ultra-short tests, which
are directly in charge of John Dyer.

Cash for Kinks

EVERY experimenter, from time to time, works out some simple idea or kink that could be profitably passed along to his fellow experimenters through the "Radio Workshop", a department which caters especially to the exchange of such ideas. Send your ideas to the Workshop Editor, and wherever possible include a simple but clear drawing or a photograph. All ideas published will be paid for at regular space rates.

for the job. I installed the device in a cigar box which was previously sandpapered and varnished and it gives the job a finished appearance. Experimenters who have difficulty finding a bell ringing transformer that can deliver the above voltage current, can use a standard 2 1/2-volt filament transformer obtainable at any radio store and substitute a type 27 or 56 tube.

DAN J. SPINAZZOLA,
Altoona, Pa.

"Magic Eye" Easily Installed

Any experimenter can now tune his set by eye with a cathode ray tuning indica-

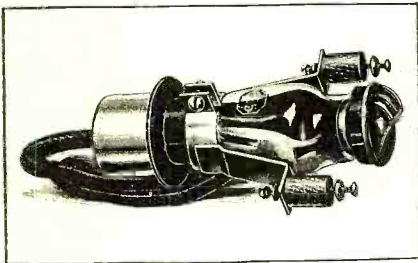

tor. RCA Manufacturing Company recently introduced a "Magic Eye" kit complete with the type 6E5 electron ray tube, connecting cable, mounting clamps and bracket assembly, bushings, mounting screws, etc. It features easy installation in receivers which employ 6.3-volt tubes. As the operation of the electron ray tube depends on the action of the automatic volume control circuit, the receiver must be one equipped with a.v.c.

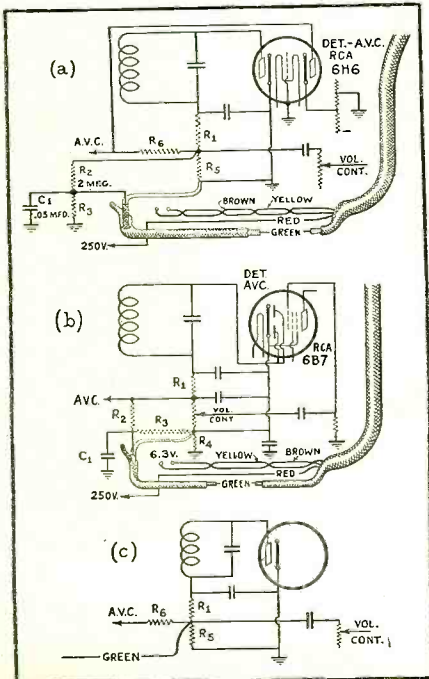

To install the device requires the drilling of but a single hole, installing three screws and making a few connections. Each kit is accompanied by an instruction sheet covering all the details. Servicemen should be interested in this new device as a profitable sideline item for modernizing radio receivers.

Figure (a) in the circuit diagram shows the connecting leads of the device to a receiver using a type 6H6 double-diode tube employed as a combination second detector and automatic volume control. Figure (b) shows the connections to a circuit utilizing a type 6B7 double-diode high-gain pentode tube and Figure (c) the connections are shown to an a.v.c. circuit using an ordinary diode tube.

Dial-Light Kink

There are many battery receivers used on farms and in districts without power lines that do not incorporate a dial light. If the set should have one, it is of the flashlight type and although it is not generally known, some of these small lamps consume current approximating that required for two or three of the 2-volt type tubes. My receiver was without benefit of any dial light, so I employed a standard 1/4-watt neon lamp of the Edison base type. The current required for this type lamp is negligible. I connected it to the 135-volt B positive side of the battery and to the ground circuit. Only one of the electrodes of a neon lamp will glow in a d.c. circuit and this side should be placed toward the dial.

FRANK J. FAULKNER,
Ogden, Utah.

Plug-In Coil Shields

One of the big drawbacks to the use of coil shields in home constructed short-

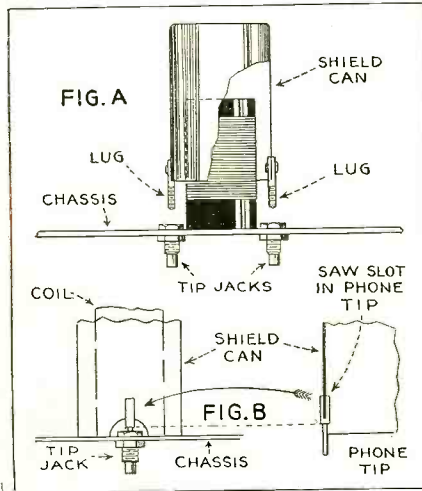

wave receivers using plug-in type coils is the difficulty of obtaining easy access to the coils. This trouble can be easily overcome by adapting the shields to either of the plug-in arrangements shown in the drawing.

In the first method, Figure A, the fastening lugs, generally machine screws eyeleted to the side of the shield can, are filed down to make a snug fit into a pair of standard tip-jacks mounted on the chassis as illustrated. If the shields do not have fastening lugs, an arrangement as shown in Figure B can be used to advantage. Two phone tips and two tip-jacks are used for this arrangement. The first thing to do is to cut 2 half circles at the bottom of opposite sides of the shield can, just high enough to clear the tip-jacks. Then prepare the phone tips by slitting them at the top for possibly 1/4 inch so they will slip over the shield in the cut-away portion as shown. To secure the tip,

solder it to the can. The rest is self-explanatory.

HARRY D. HOOTON,
Beech Hill, W. Va.

How to Make a Multi-Point Switch

Experimenters will be interested in this little kink for making a multi-point switch

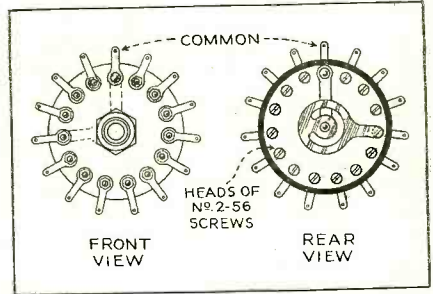

from a discarded Centralab type volume control. The accompanying sketch clearly outlines the procedure for assembling the switch and no trouble should be encountered in its construction.

The first thing to do is to remove the back plate, then loosen the lock-nut in the front, which will loosen the contact arm assembly. The metal ring that rides on the carbon resistance strip should now be cut away with wire cutters. The carbon resistance strip is broken away from its two terminal studs and lifted out. An examination of the contact arm will show that a small wheel-like fiber plug is attached to the end of this arm. This is easily poked out with a screwdriver. The arm is then replaced in the case.

The switch required for my purpose necessitated 14 taps not including the arm terminal. The number of taps or points will, of course, depend upon one's requirements. Alignment of the holes is accomplished by marking them through the hole on the contact arm from which the fiber plug was removed. The machine screws employed for the taps are size No. 2-56; one-half inch long and are inserted with the heads inside the case. On the outside of the case very small soldering lugs are inserted over the screw and they are tightened with the nuts.

STAN. ZAWACKI,
South Chicago, Ill.

Clothes Pins Make Good Spring Clips

Recently I needed some terminal clips in a hurry and having none of the standard metal clips on hand I improvised some from the ordinary spring type clothes pins as shown in the drawing and they worked out very successfully.

The metal face for the clip is cut-to-size from a piece of brass-coated shell taken from an old electric light socket. Any similar light piece of metal may be used for the purpose. A hole is drilled through (Turn to page 123)

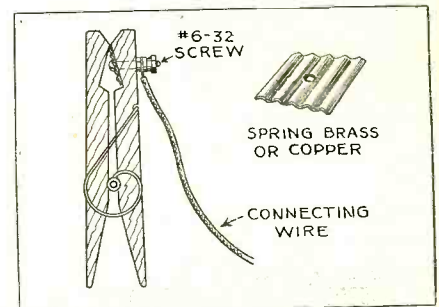

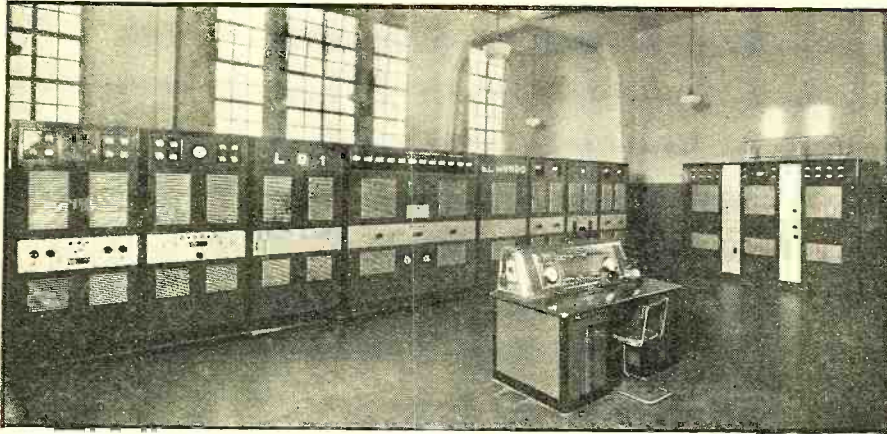

THE DX CORNER

S. GORDON TAYLOR

(For Broadcast Waves)

The Old Story

Observer Chalmers who, when he is not busy DX'ing, is one of the op's at the New Zealand station 4ZP, sends in a copy of a completely valueless report received from a U. S. listener, with the plea that some steps be taken to improve the type of reports being sent out by many listeners.

Unfortunately this report is typical of too many of the reports going out to foreign stations. Still more unfortunate, some foreign stations will verify a report of this kind. It will be noted that there is absolutely nothing in this report to serve as a basis for a verification. The report is as follows:

"Radio Station RZP

Invercargill, N. Z.

Dear Radio Friends:

I hear your broadcasts frequently and enjoy them very much. Last Saturday and Sunday, Feb. 29 and March 1, I heard your transmissions from 19.00 to 20.30 on 620 kc. or 683 meters. I enjoyed the program immensely including the musical numbers. Many things the announcer said were of much interest to me and the entire program was heard very clearly. The reception was very good and at times the volume was almost equal to that of local stations.

Please send to me a verification card showing that I have heard Radio Station 4ZP. I would also appreciate some information concerning the schedule of future programs.

With best regards and anxiously awaiting my verification card, I remain,

Sincerely yours,
D. H. _____

It is, of course, quite possible that the writer of this letter actually did hear 4ZP but it is hardly believable that if "the entire program was heard very clearly" he would refrain from mentioning the name of a single song, the time of station announcements or quote some of the remarks of the announcer which he found "of much interest to me."

It would certainly be a good thing for the DX fraternity if all stations were as scrupulous as 4ZP in demanding proof of authentic reception before granting a verification. Many of our own U. S. stations are entirely too lax in this respect and quite a number of the South American stations are notoriously careless.

The Black List

Observer Swenson of Rockford, Illinois, suggests that all stations which do not verify be black-listed. In general this would probably be a good idea. It would save much wasted time and postage. Moreover, it seems that many of the stations that do not verify fail to do so because they do not care for reports. However, this latter attitude is in many cases due to the fact that the reports reaching them do not have sufficient helpful information.

Quite a number of stations will verify only reports which include definite information on signal strength, fading, etc. Some Observers who send out good reports of this kind receive verifications from stations which ordinarily have a reputation for not verifying. The best way of obtaining verifications is to include worthwhile information of this nature. Some definite suggestions concerning the type of information which is helpful to broadcast stations will be given in Radio News in a near future issue. A committee of Observers headed by Observer Parfit is conducting an extensive investigation of this whole problem at the present time and it is expected that their report will be ready within the next sixty days.

DX Calendar

The DX broadcasts listed below are those which are expected to continue according to replies received to inquiries sent to the stations. Most of them are expected to continue throughout the summer although, of course, there may be some changes in present plans. The times given are Eastern Standard Time.

Wednesdays—

8:30—9:30 p.m. 1420 kc., KCMC Texarkana, Ark. 100 watts, (Radio News) (tips)

Thursdays—

3:30 a.m. 740 kc., KMMJ, Clay Center, Nebr., 1 kw. (tips.)

Saturdays—

12:01—12:30 a.m. 980 kc., KDKA, Pittsburgh, Pa., 50 kw., (tips)

3:15—3:30 a.m. 830 kc., WEEU, Reading, Pa. 1 kw., (tips)

Sundays—

1—1:15 a.m. 640 kc., KFI, Los Angeles, Calif. 50 kw., (tips)

1—1:15 a.m. 1420 kc., KGGG, San Francisco Calif. (Radio News) (tips)

Monthly—

1:30—2 a.m. 1060 kc., WJAG, Norfolk, Nebr. 1 kw., (tips) (2nd Friday)

2—2:25 a.m. 1420 kc., WJBO, Baton Rouge, La. .1 kw., (Radio News) (3rd Saturday)

2—4 a.m. 1420 kc. WJBO, Baton Rouge, La. .1 kw., (1st Sunday)

New Zealand DX Club

Observer Mathie, Hawkes Bay, New Zealand, submits the following notice concerning his club with the idea that some U. S. DX'ers may be interested in joining: "Membership in our club is open to all those interested in long distance reception. The entrance fee is 60c which includes the cost of a badge and a life membership certificate. The club has a membership of 1736 including 87 foreign members. American listeners interested in joining or obtaining further information should write to—The Secretary, NZ DX Club, P. O. Box 1680, Wellington, New Zealand."

New Zealand Is U. S. Radio Conscious

Observer Watson of Christchurch, New Zealand, sends in a clipping from the "New Zealand Radio Times" containing radio sales statistics which show that of the complete radio receivers imported during January 1936 the imports from the United States equal those of all other sources combined. The dollar value of chassis imported showed approximately 86% from the United States and about 63% of the tube imports were from the United States. Evidently the United States has the jump on other countries in supplying the New Zealand market.

KDKA's New Antenna

Officials of KDKA expect to increase the non-fading coverage of their station through the installation of a gigantic vertical antenna. This will consist of a slender steel mast 710 feet high which will be held in position by two sets of guys. The mast is triangular in cross-section with each side only 5½ feet wide. This mast will be supported on a single 18-inch diameter Westinghouse porcelain insulator which in turn rests on a 6-foot concrete pillar. The tower will be insulated in the middle to permit its operation as a half-wave doublet if desired and will be located at the site of the present KDKA transmitter in Saxonburg, Pennsylvania.

LRI, BUENOS AIRES

The 66.4 kw. transmitter and the control desk of "Radio El Mundo," 1070 kc. An increase of power to 75 kw. is expected shortly.

Newark News Radio Club

According to a note received from L. P. O. Bower, beginning September 1st next membership dues will be \$2.00 per year. Man and wife may obtain a joint membership for \$3.00 per year but will receive only one copy of each bulletin. Those interested in becoming members should communicate with the Club Secretary—Milton W. Fleishman, 215 Market Street, Newark, New Jersey.

New Argentina List

A new list received from the Chief of Radio Communications, Buenos Aires, is given herewith. This list is corrected to April 1st, 1936.

LS10	Buenos Aires	590	6.0
LV3	Cordoba	620	2.0
LS3	Buenos Aires	630	5.1
LS4	Buenos Aires	670	7.1
LS1	Buenos Aires	710	5.0
LV1	San Juan	730	1.0
LRA	Buenos Aires	750	15.0
(Under Construction)			
LV6	Mendoza	690	0.5
LT1	Rosario	780	5.0
LR10	Buenos Aires	790	11.1
LU2	Bahia Blanca	900	2.0
LV7	Tucuman	820	0.5
LR5	Buenos Aires	830	29.25
LT8	Rosario	840	0.5
LV10	Mendoza	1210	0.5
LR6	Buenos Aires	870	24.0
LV2	Cordoba	960	2.0
LV9	Salta	970	0.5
(Temp. suspended)			
LR2	Buenos Aires	910	11.0
LR3	Buenos Aires	950	31.0
LR4	Buenos Aires	990	16.0
LR9	Buenos Aires	1030	4.3
LT9	Santa Fe	1200	0.5
LR1	Buenos Aires	1070	66.4
(Will increase power to 75 kw.)			
LT3	Rosario	1080	5.0
LS5	Buenos Aires	1110	5.0
LV5	San Juan	1120	0.5
LR8	Buenos Aires	1150	6.2
LT5	Resistencia	1160	0.5
LS2	Buenos Aires	1190	30.0
LS8	Buenos Aires	1230	15.0
LV14	La Rioja	1240	0.5
LS9	Buenos Aires	1270	6.1
LU7	Bahia Blanca	1240	2.0
LT10	Santa Fe	1300	0.5
LS7	Buenos Aires	1310	?
(Under Construction)			
LS6	Buenos Aires	1350	4.0
LU6	Mar del Plata	1300	0.5
LR11	La Plata	1390	0.5
LS11	La Plata	1440	0.7
LT11	Parana	1470	0.5
LT7	Corrientes	1340	0.5

Notes from Readers

Observer Kaimbach (Cheektowaga, N. Y.) WMFJ no longer verifies reception, having discontinued the practice on February 1st. WSVS will remain silent from July 1st to September 1st. WBEN has a new 300-foot tower and employs 5 kw. in the daytime. My log now stands at 510 stations with 230 of these verified. Seventy-one verifications were received during the past season.

Observer Crowley (Rochester, N. Y.) would like to correspond with listeners in foreign countries. Letters should be addressed to Paul J. Crowley, 77 Canterbury Road. He guarantees to answer all letters received. He would also like to know whether any other listener can give him the correct address of station PRB-9 in Brazil.

AN IOWA LISTENING POST

Observer Barnes, Grinnell, Iowa, believes in proper equipment. Included, left to right, are a beat oscillator and "R" meter, a Wells-Gardener 7-tube, and a R. N. Tenatuner.

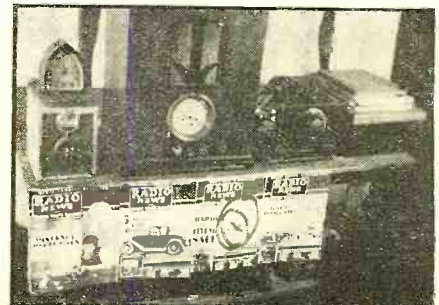



DX'ING IN MICHIGAN

An all-wave receiver, a map and a station list are the "tools" with which C. L. Riley of Pontiac, Mich., pulls 'em in.

Observer Bower (Baltimore, Md.) To obtain a verification from WCAX of Burlington, Vermont, reports must be addressed to (Observer) Henry Tyndall, Jr., 285 North Street, Burlington, Vermont, and return postage must be enclosed. WCAX does not verify directly.

Observer Schmidt (Pittsburgh, Pa.) WWSW has a new vertical antenna and a ground system consisting of 120 wires, each 200 feet long radiating fan shaped. WWSW is anxious to have reports from listeners and will verify all correct reports. My log now stands at 608 stations heard in two years, using a 10-tube t.r.f. Sparton, a 1-stage pre-amplifier and a home-made antenna tuner. Two antennas are employed, one 85-foot inverted L directed east, the other a 65-foot inverted L directed west.

Observer Gordon (Erie, Pa.) Received a verification from TTPG, 625 kc. in April as a result of reports which I forwarded last December 10th. According to the verification this station calls itself "La Voz de la Victor".

Observer Wilson (Salem, Va.) has been confined to the hospital for some time and, while not yet fully recovered, has improved to a point where he is once more taking interest in DX. We trust his recovery will be complete and rapid.

Observer Diedrich (Moline, Ill.) in a report dated June 7th states that he is still receiving Aussies and New Zealanders. They start coming in about 3:30 a.m., CST, and fade about 4:30 a.m. or earlier. Stations recently heard include 1YA, 4YA, 2HD, 4BC, 3LO, 4QG, 2BL, 2GZ, 2KY and 4BH.

Observer Swenson (Rockford, Ill.) The past season has been the best that I have experienced so far as South American reception is concerned. TA reception was likewise good. TP reception, on the other hand, was below the 1934-35 standard and the Japs were very poor.

Observer Davis (Elkhart, Texas). As was to be expected DX has fallen off radically. However, there were a few remarkably good evenings during May. The evening of May 16th, for instance, was as good as any in December or January. The South Americans were coming in so well that LS2 was heard very plainly for several minutes through our most local station WOAI. XPERA will return to the air on August 15th with increased power.

Observer Tucker (Bluff, Alaska) reports that during April (the report took over a month in transit) Australian and N. Z. stations were heard best between 8:30 p.m. and midnight, local time. Californian and Hawaiian stations were best heard from 6 to 9 p.m.

Observer Ker (Sardis, British Columbia). During this past season I have heard and verified stations on two new continents and in several new countries. The best of these are Radio Normandie, 1113 kc., and OKK on the same frequency. In South America I have verified ER1, LR4, LR5, CB138, and LS2. I jogged KZRM for the first time this season and have also verified the Cubans CMQ, CMCF, CMBN and CMON, another new country for me. My foreign log includes 54 Australians, 6 New Zealanders, 31 Japs, 5 South Americans, 2 Europeans, 2 Hawaiian and one each in Manchukuo, China and the Philippines. In addition I have 337 in the U. S., 29 in Central America and 36 in Canada, making a grand total of 555 stations on the broadcast band.

T. E. Lowe, 28 Allenby Road, Cadishead N/C, England, would like to correspond with seafaring readers whose ships travel down the Manchester Ship Canal.

Observer Mathie (Hawkes Bay, New Zealand): There are several new stations in this part of the world as follows: ZJV, 920 kc., .5 kw., Suva, Fiji Islands, Oceania; 2LV, 280 kc., power unknown, Inverell, New South Wales, Australia; 4VL, 1430 kc., .05 kw., Charleville, Queensland, Australia. Station ZHO, Hobart, (Turn to page 116)

WESTON

price reductions

save you up to

25%

DON'T DELAY...
ORDER THROUGH
YOUR JOBBER, OR
RETURN COUPON

Increasing demand for these standard, precision test units makes these big savings possible:

Model 692 ALL-WAVE OSCILLATOR
Was \$60 ⁰⁰ net Now \$45 ⁰⁰ NET
Model 669 VACUUM TUBE VOLTMETER
Was \$59 ⁶³ net Now \$45 ⁰⁰ NET
Model 780 CAPACITY METER
Was \$29 ²⁵ net Now \$22 ⁵⁰ NET
Model 687 OUTPUT METER
Was \$15 ⁰⁰ net Now \$11 ²⁵ NET



Model 692 - All-Wave Oscillator



Model 669 - Vacuum Tube Voltmeter

Weston Electrical Instrument Corporation
615 Frelinghuysen Avenue, Newark, New Jersey
Send full data on these and other WESTON test instruments.

NAME _____
ADDRESS _____



SIEGFRIED BORRIES

ROSALIND VON SCHIRACH



CONCHITA ASCANIO



Photos courtesy Philco



PAQUITA PARRA

By Dorothy Love

via SHORT WAVES

Overseas Artists and Programs

A TOUCH of nature, the poet says, makes the whole world kin. But it is short-wave radio that makes the whole world neighbors. A switch of the dial and the voluptuous voice of ravishingly beautiful Josefina Carcano sings to you from Station YV2RC, Caracas, Venezuela. Slim, tall, with a flashing smile and long raven hair, Josefina is as accomplished an actress as she is a singer. Although her songs are native melodies, and she expresses completely the allure of Latin America, her smart frocks, ensembles and suits are as brisk as you'll see strolling along Fifth Avenue any of these days.

ANOTHER of Venezuela's beauties and prime entertainment favorites is Rosario Lozada, who looks more like a sleek young American debutante than a radio star. Of medium height, Rosario has brown hair and very dark blue eyes. She parts her hair in the center, and is partial to fluffy, feminine gowns in white and pastel shades.

The South Americans are a music-loving people; making music and listening to music is their chief hobby, relaxation and recreation. There have been numerous drawbacks to broadcasting in this mountainous country, but these have been overcome by locating the transmitting towers at very high altitudes. Venezuelan time is almost exactly the same as that in the eastern part of this country, so you

don't have to stay up all night to hear their best programs.

ZIP! Your fingers barely twitch, the dial is shifted, and you have England presenting its very best for you. Perhaps it is a really important occasion, when the King himself is speaking.

One quirk which generally surprises listeners is that announcers never, never identify themselves on BBC programs. They are merely voices, and even on that great and solemn occasion when the head of the BBC himself announced King George's death, the executive was anonymous. It is part of the policy of conservatism to which the station adheres.

The American influence frequently shows up in English programs. For instance, one of Dwight Mitchell Wiley's Saturday Evening Post stories, "Grab Them by the Ears", was carefully dramatized and presented as one of the big features of GSD, GSC and GSA. "Alabamy Boun", featuring southern negro folk songs, was another program on the BBC.

Marie Burke, musical comedy star heard over the BBC in a series of programs known as "Starlight," has been in such shows as "Showboat," "Katja, the Dancer," "Waltzes from Vienna" and

"Wildflower." She is all excited about singing on the air, and says, "I am especially delighted because I know that my husband, who is at present in Australia, my brother, and my mother-in-law will listen to me." Miss Burke's husband is a New Zealander. She is preparing for a role in a new play to be named "Starlight" in honor of her broadcast.

The Yorkshire dialect and naive humor of Stainless Stephen make him one of England's favorite radio comedians. He has been broadcasting since the BBC's early days in Savoy Hill. He is considered the Will Rogers of Britain. Until last year he was a school teacher, but his engagements were so thick and fast that he felt he couldn't do justice to his teaching job, so he gave it up to devote his full time to the microphone.

"Flotsam and Jetsam," jovial comedy team, are really B. C. Hilliam (his play, "Baby Austin," was recently produced at the Strand Theatre, London) and Malcolm McEachern, respectively.

ALMOST daily America heard programs from short-wave stations at Zessen, a Berlin suburb. Friedrich Kaysler, well known German actor, announces and acts on many of these shows. He is

LEONARD HENRY AND HORACE KENNEY



SENOR ALCALA ZAMORA



MICHAEL HOGAN AND MABEL CONSTANDUROS



a heavy-set, tall man of middle age, with a solid jaw and conservative taste in clothes.

America has such girls' bands as Phil Spitalny's girl orchestra and Ina Ray Hutton's Melodears. Zessen's Ingrid plays the saxophone on many radio programs. She's young, slender, with shining chestnut hair, laughing eyes and a sunny disposition. She likes to wear dark frocks with Peter Pan collars.

Young Siegfried Borries frequently displays his violin virtuosity over the Zessen station. He is concert master and first violinist of the Berlin Philharmonic Orchestra.

In appearance Rosalind von Schirach is a real "woman of mystery." Her eyes are dark and seem to have secret depths; her rich black hair is worn drawn back, a widow's peak making her hairline interesting. She is an opera star well known on the continent, and broadcasts from the German short-wave stations.

Short Waves Growing in Popularity

By G. Wallington

According to officials of the Stromberg-Carlson Telephone Manufacturing Company of Rochester, N. Y., short-wave reception is now beyond the experimental stage. The listener is no longer content to put up with squeals and howls, the poor tone quality and noise which marked the earlier efforts in this direction. Today we have radio receivers which, under normal conditions, bring in programs from across the seas with the tone quality and fidelity of local broadcast stations. This is in part, of course, due to improvements in transmission, but by far the greatest advance has been in the forward development of the all-wave receiver. Metal tubes, improved loudspeakers with Carpinchoe leather cone support, clover-leaf assembly of coils and range switch for shorter wiring and greater efficiency—these are but a few of the recent advances which, while they have contributed to the enjoyment of standard broadcast programs, have also added tremendously to the pleasures of world-wide radio reception. With the present keen public interest in world affairs, short-wave reception is bound to continue to grow in popularity.

Television to Be a Dominant Radio Factor

By C. W. Griffin
First National Television, Inc.

World-wide advancements in the science of television and tangible indications of greatly stimulated public interest in this most modern form of broadcasting indicate an immediate and rapidly expanding market for television receivers that will far exceed the demand for sound receivers. That television will be a dominating factor in home entertainment, advertising, central transmission of motion pictures, dispensing of news and in war is fully established by that most accurate and dependable of all industrial barometers . . . front page television news in the world's press and special feature stories in national publications.

Dial Your Ship

It is now possible for the telephone operator at Central to call any radio-telephone-equipped ship afloat. A special dialing apparatus emits a series of musical tones in rapid succession which forms a code. Each ship's equipment responds only to one combination. This causes the bell to ring and the operator answers like any ordinary telephone call.

THE BIGGEST OPPORTUNITY IN RADIO TODAY

\$ \$ SOUND \$ \$



Webster-Chicago Model C-10.

3-Stage, 10-Watt Amplifier. Mixes microphone and phonograph. 2-Button carbon microphone—stretched duraluminum diaphragm—banquet stand—25-foot cable. High grade 3" D.C. Dynamic Speaker. (System handles one or two speakers.)

SOUND EQUIPMENT

Sensational Expansion This Year . . .
Volume Growing by Leaps and Bounds
. . . New Uses Found Every Day

National Union believes this field should gravitate to the radio service dealer. Now is the time to get started. National Union makes it easy for you to go into this business by furnishing equipment on National Union deals, requiring minimum outlay of cash. Further, National Union will help you learn the business; how to sell, how to rent, how to expand, how to explore the possibilities, just the same way that they did in helping service dealers build up service work. Don't delay—Get into sound now!

National Union Radio Tubes are Handled and Recommended by More Service Dealers Than Any Other Make.

THE ROAD TO BETTER BUSINESS

- 1. Full guarantee on highest quality radio tubes.
- 2. Cut price business not solicited.
- 3. Price Protection.
- 4. N. U. jobber stocks are complete...No hunting for odd types.
- 5. Timely business building aids.

FREE System on NATIONAL UNION Deal

OTHER NATIONAL UNION OFFERS

In SOUND EQUIPMENT items available include 17-watt portable system, 10-watt mobile system, phonograph pickup and turntable, etc.

In SERVICE EQUIPMENT items available include tube testers, analyzers, oscillographs, signal generators, modulators, meters, etc.

In SHOP EQUIPMENT items available include stock cabinets, coats, display signs, etc. All items available free on attractive National Union deals.

THE NATIONAL UNION WAY

Through National Union's help, radio service dealers everywhere have been able to set up better equipped shops to do better work; also to obtain merchandise helps that produce more customers. National Union has constantly put the latest advances in scientific equipment as well as modern selling aids within reach of the service dealer. The National Union deal calls for a dealer deposit which is rebated when the specified number of tubes have been purchased. Over 50,000 completed deals. Every service dealer should investigate.

Act Now! Send Coupon!
Let National Union Help You!

See Your National Union Jobber.
Write for Complete Information.

National Union Radio Corporation
570 Lexington Ave., New York City

Please send me more information on

..... Free offer for Webster-Chicago Sound System C-10.

..... Free offer for.....

Dealer's Name.....

Address.....

City..... State.....

THERE'S A GOOD JOB FOR YOU IN RADIO

We Will Train You Quickly to Qualify

The servicing of modern radio receivers requires experts—men trained for this work are needed everywhere.

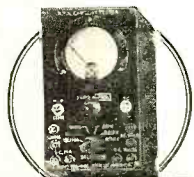

FREE

OF EXTRA COST
This time-saving trouble-finder and circuit analyzer included.

RADIO OFFERS BIG OPPORTUNITIES

Your possibilities of making money are limited only by your ability and skill. There is no room for the soldering iron "guesser". But you must be trained—the sooner you begin the quicker you'll cash in.

LEARN AT HOME

We will train you at home to service and repair radio receivers of all types. Invest for future success in R.T.A. training.

NO EXPERIENCE NEEDED

You need no previous experience in Radio. We show you how to make money almost from the start. Hundreds of men are enjoying the rewards of R.T.A. training.

Full details of this great opportunity FREE are explained in a helpful book that is

Send for it today. It will be mailed at once.

RADIO TRAINING ASS'N. OF AMERICA
Dept. RN68 4525 Ravenswood Ave., Chicago

Tune with Your Eye

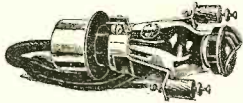

An "RCA Cathode Ray Kit," easily installed on any receiver having Automatic Volume Control, makes your set tune like a '36 model. Kit, including tube, socket, escutcheon, cable, everything needed, only \$3.00. Stock No. 9688.

New RCA Spiderweb Antenna

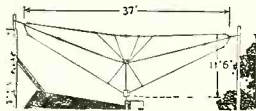

Gives improved pick-up on all bands with noise-reduction on short waves. Functions as a T from 140 to 4,000 kc., multiple tuned doublet 4000 kc. to 23 megacycles. Completely assembled, soldered, \$8.95. Stock No. 9685. Kit extending range to 70 mcs., \$1.50. Stock No. 9689.



See your dealer or write to Parts Division

RCA Manufacturing Co., Inc.
Camden, New Jersey
A Service of Radio Corporation of America

THE SERVICE BENCH

(Continued from page 76)

by winding any convenient wire around the lead for several inches, and grounding one end of the wire.

"Moral: All that hums is not due to faulty condensers!"

S. Solway, of the Ansol Radio Service, Monticello, New York, continues the discussion on hum with the case history of a

Zenith 430-440

"The complaint is oscillation and motor-boating at high volume, accompanied with abnormal hum. All voltages check normal. In every instance we have encountered, the trouble has been cured by replacing the 8 m.f. filter condenser bolted on the underside of the top of the chassis pan. Abnormal hum has also been experienced with the

G. E. A—53

"The set is also inoperative. Check the .5 m.f. cathode by-pass condenser for the 6K7 tube. The leads have been found to short to the filament prong in several instances."

A Corrosion Tip

"My service territory is in the heart of an oil and gas field. The gas which the majority of people burn is raw and untreated, and the fumes are very corrosive. Upon the advent of all-wave receivers, we began to experience trouble with the multiple-band switches. After a short time, the switches would become very noisy, and occasionally completely dead on some bands. The difficulty, of course, was due to corroded switch points. Installing new switches helps for a while—but it is some job on many of the designs. I have tried my present treatment for about two years and it has been successful in every instance.

"I first clean the switch points with crocus cloth—a very fine abrasive. Work this cloth under all points, taking care not to spring or bend the contacts. I then pack the switch with a non-flowing electric motor grease. I use Singer electric motor lubricant. Pack the points heavily—don't be afraid to smear it on. This treatment will permanently stop corrosion and does not affect the operation of the receiver adversely in any way. On the contrary, the switch action is rendered beautifully quiet and smooth."—C. R. Garst, Service Department, Singer Store (Atwater-Kent Radios), Borger, Texas.

This idea should be equally applicable to receivers operated for long periods in the presence of salt sea air. A good tip for the serviceman in preparing clients' receivers for a summer vacation at the seashore!

SERVICE BRIEFS

Charles L. Schultz, of Brazil, Indiana, sends us the following notes from his radio case book: "Low volume with a Crosley Show Box was caused by corrosion of the power terminal strip. Sandpapering both sets of connections and tightening the connecting screws returned the volume to normal. Distortion on several sets was traced to pitch flowing from overheated transformers into the speaker plug, cutting out one tube of a push-pull amplifier.

Offering:-

A Complete Amusement, Advertising & Sound Service to Fire Co's, American Legion Posts, Auxiliaries, Lodges, Carnival and Park Management's.

1.—Booking Agency for Radio & Diversified Entertainers.

2.—Amplifier or Public Address Service for Platform Entertainment.

3.—Sound Truck Service for Advertising Purposes (range 2 miles.)

4.—Talking Motion Pictures for Outdoor Use.

Our Prices are Considerably Lower than has been asked in the past for this type of work.

Think of the Goodway, when in need of anything in sound (because) our business is "Sound."

Goodway Public Address & Sound Systems
196 Duke Street Phone 219-J. Ephrata, Pa.

FIGURE 2

"When a phonograph pickup has low output, suspect the rubber dampers. These become hard, or rotten, after a year or so, and should be replaced. A temporary replacement on some makes can be effected by packing small pieces of ordinary rubber bands into the recess. (Damping rubbers should also be suspected in case of rattle.—Ed.)

"Blowing of the rectifier tube every month or so—with no other complaint—was caused by a faulty socket. Since the socket replacement over two years ago, the receiver has not had a new rectifying tube.

"Try putting some pitch from a convenient transformer on your finger tip to hold that nut when starting it in a tight place." (Ye editor has been using chewing gum for this purpose for well on twenty years.)

SERVICE NOTES

The first volume of "An Hour a Day With Rider" has just come to your Service Editor's desk. It is an excellent job, and, there being little doubt that subsequent numbers will maintain the standard set by the initial volume on resonance and align-



A set needs carefully-made tubes to reproduce tone accurately, and in volume. Tung-Sol tubes qualify. They are mechanically right—the kind upon which a service organization can stake its reputation.

TUNG-SOL

Tone-flow radio Tubes

Tung-Sol Lamp Works, Inc.
Radio Tube Division
NEWARK, N. J.

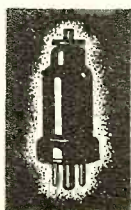

Repair	NO	1350
The Goodway		
RADIO Sales and Service		
RADIO SPECIALISTS		
Phone 219-J. Earle C. Good, Mgr.		
Duke Street Ephrata, Pa.		
Name of Set	_____	
Serial No.	_____	
Tubes	_____	
Accessories	_____	
Customer's Description of Trouble	_____	
Trouble Found	_____	
Parts Used for Repairs	Price \$	_____
Labor Charges \$		
Total Charges \$		
Repair Memo	_____	
Name of Set	NO	1350
Parts for Repairs	_____	
Labor Charges	_____	

FIGURE 3

ment, the series is heartily recommended to the radio serviceman. To the serviceman who will admit that he is a little hazy on some aspects of inductive and capacitative reactance in relation to resonance, or perhaps on some of the finer points in the actual practice of tuning and alignment, this book provides an excellent, self-teaching text. To the serviceman satisfied with his technical knowledge and practical expertness, we still recommend

this little volume as a refreshing course. In either case, you will find the hour spent with this book highly interesting—and should you experience the least difficulty in assimilating its contents, don't blame the book. It is merely *prima facie* evidence that you need it!

The tube manufacturers, notably RCA and National Union, are offering attractive arrangements to servicemen for promoting the inclusion of cathode ray tuning indicators in receivers manufactured before this device was available. The RCA kit includes a type 6E5 tube, socket, cable, clamp and bracket assembly, escutcheon and miscellaneous hardware. The National Union kit is designed around their 6G5 tube, and also includes a series of two special post cards for sales promotional work.

An Expander Unit

(Continued from page 92)

After a short time the required amount of expansion will be found easy to arrange for as the listener gains experience. On the short waves also, additional audio volume can be obtained by increasing the expansion and much better general short-wave reception can be obtained through the use of this unit.

Even though the set for which this receiver is designed has very wonderful tone quality, the addition of the expander to the receiver installed at our Westchester Listening Post gave us the most beautiful and realistic radio reception of high-quality programs that anyone could wish for and the naturalness of reproduction obtained just made listeners sit breathless, without saying a word.

We have said nothing about the technical operation of the circuit because the general subject of expanders and how they work may be found in an article on page 663 of the May 1936 issue of RADIO NEWS. After reading this, if there are any points needing further clarification, the manufacturers tell us that they will be very glad to answer any requests for additional information if it is sent to them in care of this magazine.

Permanent Magnet Speakers

(Continued from page 75)

favorable conditions.

For battery sets, multi-speaker installations, auto-radio systems and other applications where power drain for field excitation is objectionable, the permanent-magnet type of speaker offers incontestable advantages. In extension speaker installations, even when the speaker field of the electro-dynamic type is used as a part of the filter system, the high voltage leads require special precautions in wiring to reduce the fire hazard. The permanent magnet type greatly simplifies installation problems under such circumstances. Possible distortion of the voice coil or cone from heat dissipated in the field of electro-dynamics is likewise avoided in this type of speaker.

The new alloy is composed of aluminum, nickel, cobalt and iron. As applied to the Perm-O-Flux speaker, it is designed to give a flux density of 10,000 to 14,000 lines per square centimeter. In the electro-dynamic type, it is indicated that a flux density 10,000 lines per square centimeter is required to meet present day trade requirements.

In Figure 1, the dimension ratio is given by the manufacturers for various values of residual magnetism for tungsten steel, cobalt steel and aluminum nickel alloy and well illustrates the superiority of the new alloy over the other metals represented.

The Perm-O-Flux speaker should prove of decided value to manufacturers, engineers and servicemen in its simplification of many of the problems now facing the industry.

And Still They Come

Owensboro, Ky.—A new metal tube, the 6B8, was announced by the Ken-Rad Corporation. This tube is similar to the 6B7. This marks the last of double-purpose tubes to be duplicated in metal envelopes. Who said it couldn't be done?

Radio and Free Speech

(Continued from page 70)

HENRY P. FLETCHER (in a statement to Paley): "I believe your policy 'not to sell time for political broadcasts until after the regular party conventions next summer' will leave in the minds of the American public the distinct impression that you are either exercising an unwarranted degree of censorship or that you fear punitive action by the Federal Communications Commission. It seems to me that the services of the great radio chains should be as non-partisan and free from Government domination as are great news services like the A. P., U. P., International News, etc., and give both sides an absolutely equal break."

WILLIAM S. PALEY (in rebuttal with Fletcher): "There is nothing in the Federal Communications law which would allow the Commission to act from partisan political motives, and, if it did so act, its judgments would very promptly be reversed by the Federal courts. Moreover, if this company were subject to such domination by any political party as is implied by you, the American people would be served so shabbily that I should lose all interest in the conduct of this business. We shall distinguish between the President as President and Franklin D. Roosevelt as a candidate for office."

HENRY P. FLETCHER (back to Paley): "I think our correspondence plants the issue squarely before the American people and I am willing to leave it to their calm and unbiased judgment whether or not on the record thus made your system is or is not exercising censorship of the air."

The excerpts quoted above must not be accepted as the complete arguments of Paley and Fletcher, which all started when CBS permitted a broadcast of the President's message to Congress at the special night session, the evening hours presumably being chosen to reach the greatest possible radio audience. The quotations will, however, demonstrate just how different viewpoints on censorship can be.

The Philco Radio & Television Corporation has been very active in furthering the cause of free speech on the air. The broadcasts of that firm presented over CBS by Boake Carter reflect that policy. A statement from Philco on the series, quoted in part, follows: "The American public is entitled to uncensored expression of opinion, so that it may use its own judgment and draw its own conclusions. Philco has never exercised or will exercise any censorship over him (Carter) whatsoever. The comments and opinions expressed by him on the air are his and his alone."

DAVID SARNOFF and **GENERAL HARBORD** (in the RCA Annual Report): "Radio has become a more important medium than ever for the presentation and discussion of public questions. NBC facilities have been made available for the presentation to the American public of different sides of important subjects. The only requirements have been timeliness and importance of the subjects discussed, and their presentation by responsible spokesmen. NBC endeavors to maintain American standards of good taste, of fair play and of free speech on the air."

DAVID LAWRENCE (Editor of the *United States Daily*, in a forum conducted on CBS by Boake Carter): "I believe in the freedom of the air, because I believe in freedom of speech and the freedom of the printed word. Radio is no different from any other medium of thought expression, except in a mechanical sense."

WILLIAM GREEN (President, American Federation of Labor, in the Carter forum): "For reasons which are quite clear, the Government should control the issuance of licenses, apply rules and regulations, and exercise such supervision as may be necessary in order to provide for orderly procedure and prevent confusion."

JAMES A. FARLEY (Postmaster General, in the Carter forum): "The Communications Act of 1934 assures freedom of the air, and specifically prohibits censorship by governmental authority."

GEORGE HENRY PAYNE (Member of FCC, in Carter forum): "I do not think it is proper censorship to censor speeches or such material as news comments, with the purpose of favoring any political party or political candidates or to coerce anyone speaking in an editorial capacity."

PRESIDENT ROOSEVELT (in a message to the American Broadcasters Association, as quoted by Farley in the Carter forum): "I have previously expressed my great faith in the American system of broadcasting. Recent events have increased rather than diminished that faith. Censorship has not and cannot invade the ether waves. It is not the American way."

FREE RADIO CATALOG

This big, all-inclusive catalog is yours for the asking. It lists thousands upon thousands of items—anything and everything in radio for hams, experimenters, service men and dealers. Whatever your needs may be—a 4 or 24 tube receiver, all-wave and short wave mantels and consoles; parts; tubes; kits; accessories; amateur equipment; P.A.

—they can be comfortably and economically filled while you sit in your easy chair at home. You will find nationally known, nationally advertised merchandise at lowest **WHOLESALE** prices—backed by a guarantee of Wholesale Radio Service Co., Inc., the largest radio institution of its kind in the world.

FOR EVERYONE

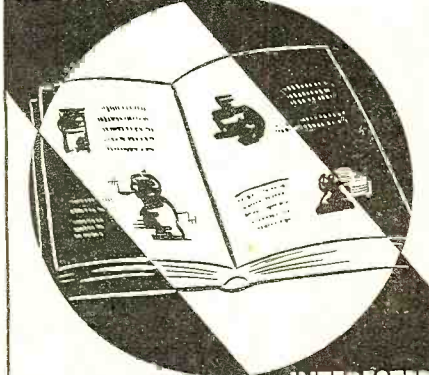

This convenient catalog will serve as a handy reference book and shoppers guide to radio. It is thorough—complete—and it brings the world of radio to your door. Back of it all is a competent organization of experienced radio engineers and service men, whose services are available at all times in helping you with your radio problems.

INTERESTED IN RADIO

Be sure to get a copy of this helpful catalog for your own use. You will enjoy the assurance of knowing that every single item carries the guarantee of **WHOLESALE RADIO SERVICE CO., INC.** You will like our service, too—the fastest, most dependable service in the field. Five huge, conveniently located branches bring over nite service to most parts of the country—and these five branches are brought to you in the pages of this catalog.

MAIL THIS COUPON TODAY

Wholesale Radio Service Co., Inc.
Dept. H-2
100 Sixth Avenue, New York, N. Y.

Please RUSH catalog by return mail.

NAME.....

ADDRESS.....

TOWN.....STATE.....

WHOLESALE RADIO SERVICE CO.
NEW YORK, N.Y.
100 SIXTH AVE.
CHICAGO, ILL. 901 W. JACKSON BLVD.
ATLANTA, GA. 430 W. PEACHTREE ST. N.W.
BRONX, N.Y. 542 E. FORDHAM RD.
NEWARK, N.J. 213 CENTRAL AVE.

RADIO PHYSICS COURSE

ALFRED A. GHIRARDI

Lesson 53. Resonance

In a resonant circuit, the currents existing at any two frequencies equally above and below the resonant frequency are not equal, since the *net reactance* increases faster below the resonance frequency than it does above the resonance frequency, as shown by the dotted line in Figure 1. Here the inductive reactance of a 300 microhenry tuning coil employed in a standard broadcast receiver, and the capacitive reactance of the tuning condenser set at .0001 microfarads and connected in series with it, are plotted against the frequency. The net reactance at each frequency is given by the dotted line. Note that there is one point at about 920 kc.

built up across the inductance and condenser may become so great at resonance, that the condenser may be punctured. This is especially liable to happen in radio transmitting circuits.

If it is desired to keep the circuit in tune as the frequency of the impressed e.m.f. is decreased (wavelength increased), as in the case of the tuned circuits in radio receivers, either the inductance or the capacitance must be increased. If the frequency of the applied e.m.f. is increased (wavelength decreased), either the inductance or capacitance must be decreased. It can be seen that every circuit containing capacitive reactance and inductive reactance will be in tune for some particular frequency. This *resonance frequency* may be determined by using formula (20) in Lesson 52.

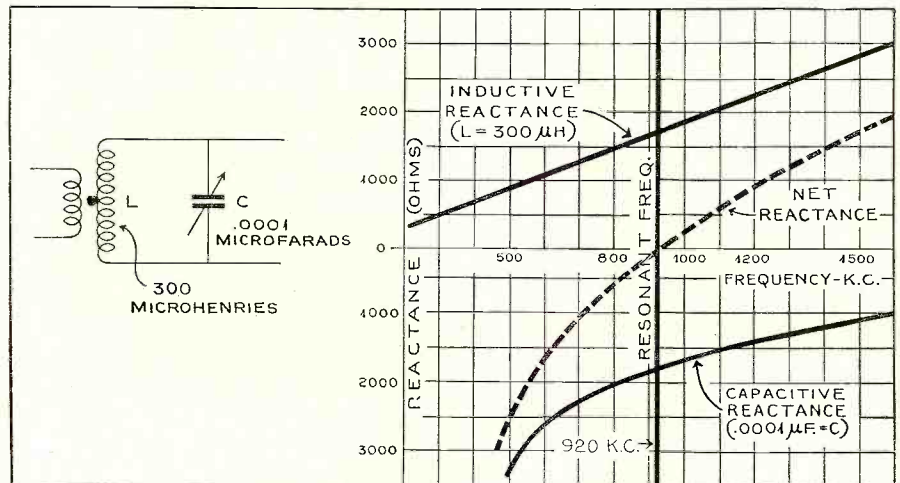

Fig. 1. Curves showing how the inductive, capacitive and net reactances in a variable tuned circuit vary as the resonant frequency is approached, reached, and passed.

where the reactances equal each other and the dotted curve of net reactance passes through zero. This is the resonant frequency to which the coil and condenser are tuned for that particular setting of the tuning condenser.

The effects in a series circuit may be summed up as follows: "When a series circuit is in resonance, the current and the e.m.f. are in phase; the current is a maximum; the impedance is a minimum; the voltages across the condenser and inductance are equal and opposite in signs and greater than the total voltage across the combination. In some cases, the voltage

If the inductive element has an iron core, the inductance and consequently the inductive reactance, will vary with the current through it as the strength of the magnetism in the iron core approaches and passes through its saturation value. Thus, with a saturated core condition of this kind, a circuit may be in tune when a certain voltage is impressed and certain current flows, and be out of tune when the applied voltage is above or below this value, even though the frequency remains the same. This principle is applied in the design of some forms of line-voltage stabilizers used with radio receivers.

Hearing Aid

(Continued from page 92)

4½ volt battery which supplies the tube filaments and microphone is one of the special type available from dealers in hearing aid equipment. The terminals of this battery take the form of small sockets into which a 2-prong connecting plug fits. The cord of the Trimm featherweight headphones is equipped with tips to plug in to the tips jacks on the top of the can.

When assembled in the carrying case the battery "F" is placed horizontally in the bottom of the case and the metal can on top of this battery. The battery "G" is slipped into one end of the case in a vertical

position. After this has been done there is surplus space left on top in which the microphone and headphones may be placed when the instrument is not in use. While in use the microphone may be clipped on to the outside of one end of the case or on to one's clothing. For this purpose the microphone comes supplied with a clip on the back similar to a fountain pen clip.

In view of the scarcity of published designs of portable hearing aid equipment the above description and illustrations should be of considerable interest to those who have some knowledge of radio construction and who desire such a device for their own use or for use by afflicted friends or relatives. For anyone who desires to duplicate this equipment it is of interest to know that all of the parts employed are

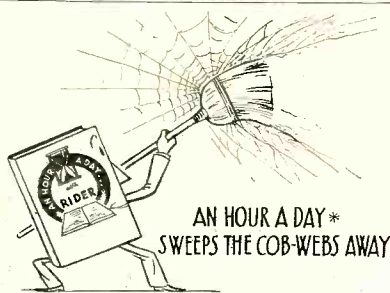

AN HOUR A DAY* SWEEPS THE COB-WEBS AWAY

... Away from your technical attic

SPEND

"An Hour a Day with Rider on RESONANCE AND ALIGNMENT"

... And the second of this series is just off the press

"An Hour a Day with Rider on D.C. VOLTAGE DISTRIBUTION IN RADIO RECEIVERS"

Will prove to be just as much of an aid, for it tells you how D.C. voltages are fed to different parts of a set and how the various resistances are calculated. The price? Just half a dozen dimes.

... And another way to do some technical cobweb sweeping is to find out from

JOHN F. RIDER'S THE CATHODE-RAY TUBE AT WORK

How the use of the oscillograph will enable you to get more sets through your shop in a day. The new edition has 332 pages, and more illustrations than ever and costs but \$2.50.

... By the way, have you All Six Rider Manuals?

BUY THEM FROM YOUR JOBBER

* with RIDER

NEW AND UP-TO-DATE REPLACEMENT VIBRATOR GUIDE NOW READY FOR DISTRIBUTION STOP WHERE SHALL WE SEND YOUR COPY ADVISE
UTAH RADIO PRODUCTS COMPANY—CARRINGTON
P. S. NEW SPEAKER CATALOG JUST CAME IN STOP HAVE COPY OF THIS RESEKVED FOR YOU ALSO
TEAR OUT THIS AD—PIN TO YOUR LETTERHEAD AND MAIL TO DEPT. R. N.
FOR COMPLETE DETAILS AND FREE CATALOG

UTAH RADIO PRODUCTS CO. CHICAGO, ILL. URPC 820 RNS CHICAGO ILLINOIS

standard parts with the exception of the can and its cover. The battery "G" is not generally available but in its place any other form of 4½ volt battery could be employed.

Mr. Simer has stated his willingness to answer any questions which readers may have concerning this instrument and letters addressed to him in care of RADIO NEWS will be promptly forwarded.

Signal Seeking Circuits

(Continued from page 90)

the received signal is too high in frequency. P will become negative when the signal is too low in frequency. When the tuning is exact the two voltages are equal and P is at zero potential. Thus the mistuning is translated into a positive or negative control voltage.

The control voltage is now fed back to a control tube which will vary the oscillator frequency in accordance with the control voltage. There are several ways of doing this. Figure 2 shows the method employed by Mr. White. It has been known for some time that a triode with a choke in the plate circuit reflects back into the grid circuit as a poor condenser. Connecting a condenser between grid and plate, making the tube degenerative, increases the effect. Now this tube, acting as a condenser, is connected across a part of the oscillator tuning circuit. When the grid-voltage of the control tube is changed, the reflected capacity changes too and thereby readjusts the oscillator frequency.

Another system is shown in Figure 3. In this case, the grid is coupled to a resistor in the tank circuit of the oscillator, while the plate is directly connected to the high side of the tank circuit. The voltage on the grid is then 90 degrees out of phase with the plate voltage; the plate current is also 90 degrees out of phase with the plate voltage. The tube then acts as a reactance. The magnitude of the reactance can again be varied by the grid voltage.

Improvements in the design will surely be made in the future. It is expected that the system will prove very useful on short waves, where it will avoid one type of "fading" which is really nothing else than fluctuations in the oscillator frequency. The automatic circuit would keep the oscillator in tune and avoid this trouble.

The reader is warned that this is not a "gadget" that can easily be added to any set. For proper results it must be built into the receiver design.

Electricity

(Continued from page 95)

shows one of the earliest experiments ever attempted in this line. In its beautiful simplicity and clarity, consisting of a coil of wires, a suspended magnetic needle and two nails as contacts, it is indeed an example of the method of thinking and experimenting fundamentally and of far-reaching results even with meager means. The galvanometer referred to is a design of the great American physicist, Joseph Henry, who investigated, with this type of equipment, the phenomena of electro-magnetic induction one year before Faraday observed and published the same results. This suspension galvanometer was based upon the fact, discovered by the physicist Oersted in 1819, that a magnetic needle is influenced by a current of electricity. Current flowing through a coil in this galvanometer deflects the magnetic needle suspended on a thread above it, the needle being attracted with a certain force toward the magnetic meridian. It requires a definite force to deflect it from its original position. This force is a function of the amount of electric current flowing,

(Turn to page 117)

An Ideal Receiver!

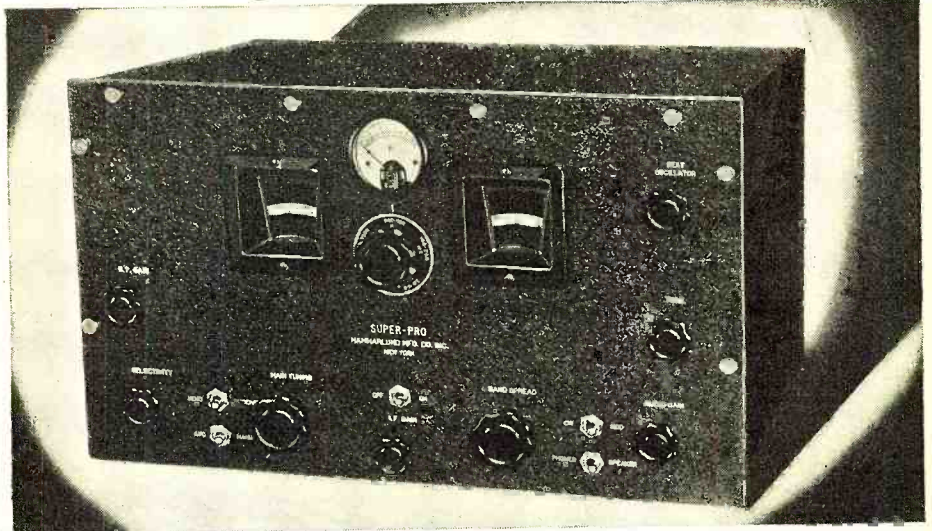

The Hammarlund "Super Pro"

IN the nation's leading research laboratories, on the air fields, in "ham" shacks, on scientific expeditions, in naval and war departments, coast-to-coast broadcast systems, foreign commercial and government services—everywhere—where the most exacting equipment must be used, Hammarlund "Super Pros" have been unanimously approved and promptly installed! "Super Pros" receive such decided acclamation, for they have every grand, important feature demanded by experts—truly the "ideal receiver." One such feature is the electrostatically shielded input. Then there is that uncanny, exclusive Hammarlund five-band switch, remarkably positive and smooth in action. The unique variable selectivity system affords continuous variation from 1/3 to over 3 times critical coupling. Another fea-

ture is the special 12-gang band spread condenser. That cleverly designed "Super-Pro" crystal unit permits selectivity from a knife-like point for C.W. to a wider degree for practical phone reception. And there are dozens of other outstanding features winning new admiration every moment. The "Super-Pro" reaches new performance standards that you've always wanted! The complete story of this "ideal instrument" appears in a profusely illustrated bulletin. Write for your copy today!

MAIL COUPON FOR FULL DETAILS!

HAMMARLUND MFG. CO., Inc. RN-8
 424-438 W. 33rd St., New York
 Check here for complete data on the new Hammarlund "Super Pro."
 Check here for 1936 Hammarlund General Catalog.

Name.....
 Address.....



Learn
TALKING PICTURE PROJECTION
SOUND RECORDING
TELEVISION-RADIO



Quality for Good Jobs
 Learn in Los Angeles. Practical instruction. Newest equipment. Master training courses. 30,000 graduates. Earn room and board while learning. Coach R. R. fare allowed to L. A. Send coupon for Catalog.

NATIONAL SCHOOLS - LOS ANGELES
 Dept. RN-8, 4000 S. Figueroa St.
 NAME.....AGE.....
 ADDRESS.....
 CITY.....STATE.....

HANDEE

Tool of 1001 Uses

Does away with slow hand work. Plugs in any light socket, A. C. or D. C. 110 v. 13,000 r. p. m. For home, shop or take to job. Uses 200 different accessories... grinds... polishes... routs... drills... cuts... carves... sands... saws... sharpens... engraves.



Order on our Ten-Day Money-back Trial... or send for FREE Catalog.
\$10.75
 And up Postpaid, 3 accessories FREE. Send order today. Chicago Wheel & Mfg. Co., 1101 W. Monroe St., Dept. AB, Chicago, Ill.

See at your Dealer's
New CRAFTSMAN Project Book
 "Pleasure and Profit with a Handee." Easy work-in-progress for making many interesting and unusual projects 25c, stamps or coin.



NATIONAL

**HRO JUNIOR
SUPERHETERODYNE**

The HRO Junior is a superheterodyne receiver, outstanding for its excellence and low price. It is designed expressly for those who are interested in world-wide short wave reception, and who demand the performance of a commercial-type receiver, but do not require the highly specialized features that necessarily increase the cost of a receiver designed expressly for two-way commercial service.

A nine tube circuit (including two stages of preselection and two stages of I. F. with air dielectric trimming condensers), a precision built tuning condenser, separate shielded coils, and strict adherence to National's high standard of quality permits the attainment of unsurpassed selectivity and sensitivity. Laboratory calibration of each coil range, plus the unique easy-reading tuning dial (no perplexing intermingled tuning scales) provides an accurate means for logging and locating stations. Fast or slow tuning is accomplished by the clever arrangement of the tuning drive mechanism. Only one knob is used—no unhandy double or two position knobs.

For those desiring the specialized features of a crystal filter, S meter and amateur band spread, we recommend the standard HRO.

Write for an illustrated description of both receivers.

NATIONAL CO., INC.
MALDEN, MASS.

DEGREE IN 2 YEARS
Radio
Engineering

Complete Radio Engineering course in 96 weeks. Bachelor of Science Degree. Radio (television, talking pictures and the vast electronic field) offers unusual opportunities for trained radio engineers. Courses also in Civil, Electrical, Mechanical, Chemical, Aeronautical Engineering; Business Administration and Accounting. Low tuition, low living costs. World famous for technical two-year courses. Those who lack high school may make up work. Students from all parts of the world. 53rd year. Located in picturesque hill and lake region of northern Indiana. Enter September, January, March and June. Write for catalog. 1686 College Ave., Angola, Ind.

TRI-STATE COLLEGE

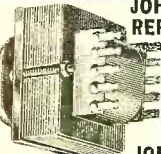

**JOHNSON UNIVERSAL
REPLACEMENT TRANSFORMER**

Guaranteed equal to original. First-quality, new stock, correctly engineered and carefully made by skilled workmen.

Radio & Neon Transformers Rebuilt
Quality work fully guaranteed. Jobbers, Dealers, Servicemen. Save money with Johnson Universal Replacement and Rebuilt Transformers. Write for our FREE low Price-list.

JOHNSON TRANSFORMER CO.
2206 N. Western Avenue Chicago, Illinois.

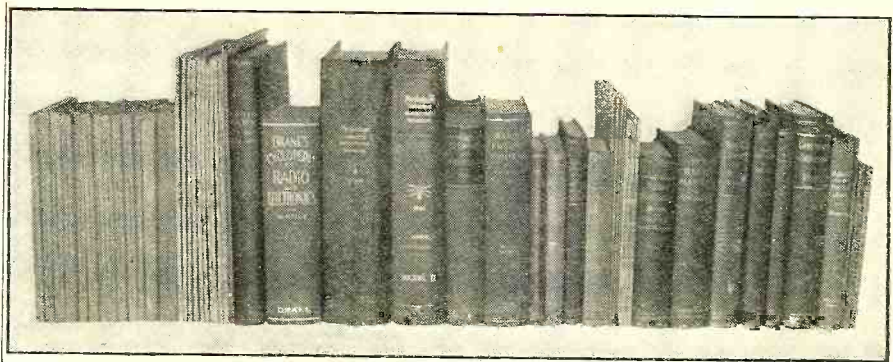

THE TECHNICAL REVIEW

CONDUCTED BY ROBERT HERTZBERG

Radio Operating Questions and Answers, by A. R. Nilson and J. L. Hornung. Sixth Edition. McGraw-Hill Book Co., 1936. This is a book containing answers to various questions such as the inspector will ask at license examinations for radio operators. It covers all types of operators' requirements such as radio telegraph, telephone, amateur, aircraft, etc. The new edition has been brought up-to-date by the addition of 100 new questions. Chapters are rather elaborate so that they answer most questions that would be asked in regard to modern equipment. Such things as changing the frequency of broadcast transmitters, the proper values for T-pads, etc., are described in detail.

The following is a sample question and answer: Question 417. Are amateurs subject to state or municipal regulations? Ans. Amateur stations are not subject to state or municipal regulations from a communication standpoint. States and municipalities can make and enforce regulations affecting amateur stations in safeguarding health, enforcing electrical wiring codes, and abating nuisances.

Wireless Servicing Manual, W. T. Cocking, published by Iliffe and Sons, Ltd., London, 1936. The attitude of a serviceman is somewhat as follows: Here is a receiver which once worked right, it has a defect now. Which is the quickest way for me to find this defect? Obviously, the location of parts and the design are all right, else the receiver would not have operated well when it was new. Authors of books on servicing never seem to catch this attitude; their suggestions are too much taken up with design errors which are not of value in service work, although it is good for the serviceman to understand them.

The book by Mr. Cocking is excellent in itself and should be useful to servicemen, experimenters and designers. It covers the discussion of all types of defects which may be found in modern receivers. The chapters on hum instability and motorboating are especially well written. Furthermore he suggests an improved method of oscillator alignment in supers, eliminating the "rocking". An appendix gives a complete list of socket connections of European and American tubes.

On Resonance and Alignment, published by John F. Rider, 1936. This is one of a series of booklets under the general title: An Hour a Day with Rider. It is a book of 91 pages which deals exclusively with the alignment of different types of receivers, including those which have variable i.f. transformers.

The first chapter deals with the general theory of resonant circuits. Then follow chapters on alignment procedure, alignment and neutralization of t.r.f. receivers,

the alignment of i.f. amplifiers, oscillator alignment, r.f. and detector alignment. The last named chapter also discusses cathode-ray methods of alignment. This volume should be a valuable guide to servicemen and would-be servicemen.

**Review of Articles Appearing in
May, 1936, Issue of the Proceedings
of the Institute of Radio
Engineers**

Reducing Disturbances in Radio Signals, by Edwin H. Armstrong. The inventor's own description of frequency modulation, the most talked-of development in radio engineering circles of recent years.

Television in Germany, by Hubert Gibas. A rather sketchy outline, not at all as inclusive as its title indicates. Tells very little about transmitters, but illustrates and briefly describes half a dozen receivers of obvious complexity and high cost. The present service is experimental and the received images are still not acceptable from the commercial standpoint.

Blind Landing for Airplanes, by K. Baumann and A. Ettinger. Great simplification of the required equipment and control of the landing maneuvers from the ground are advantages claimed for this new system.

An Urban Field Strength Survey at 30 and 100 Megacycles, by R. S. Holmes and A. H. Turner. This paper describes an extensive survey made in the Philadelphia-Camden area of the field strength from an ultra-high-frequency transmitter. Interesting and significant data were obtained.

Modulating the Magnetron Oscillator, by Janusz Groszkowski and Stanislaw Ryzko. Magnetron oscillators are efficient generators of ultra-high-frequency power, but are difficult to modulate. The authors propose a method of modulation making use of an additional electrode placed in the tube.

Effective Resistance of Closed Antennas, by V. I. Bashenoff and N. A. Mjasoedoff. This paper discusses the most desirable dimensions for closed antennas. It reveals that the great losses are the dielectric losses in the earth and nearby objects and it gives formulas for calculating this component.

**Review of Contemporary
Literature**

Broadcast Coverage, by Raymond F. Guy. Electronics, May, 1936. Like newspapers, broadcast stations must prove the size of their audiences. Methods of measurement, influence of the soil and the frequency, and other considerations are discussed in this article.

An A.C. Operated Beat Oscillator, by S. J. Haefner and E. W. Hamlin. Electronics, May, 1936. Details of a low cost laboratory-type instrument, built of standard parts and capable of delivering half a watt at frequencies from 40 to 15,000 cycles with very low distortion.

A 50-Watt Audio Amplifier-Modulator with Beam Output Tube, by George Grammer. QST, June, 1936. The new 6L6 further proves its versatility. This article tells how it is adapted for amateur transmitting purposes. Also in the same issue is an article by Frank W. Edmonds on the use of this tube as a crystal oscillator.

Electric Wave Guides, by G. C. Southworth. Bell Laboratories Record, May, 1936. Highly interesting experimental work being conducted with hollow pipes as power-conductors for the ultra high frequencies is described in this paper.

Magnetic Circuit Calculations, by H. H. Friend. Radio Engineering, May, 1936. A review of the principles of calculating magnetic circuits, a subject of timely interest in view of the recent advent of new magnetic alloys.

Applying Predistortion to Broadcasting, by Lorne F. Jones. Communication and Broadcast Engineering, May, 1936. The possibility of improving the signal-to-noise ratio on the ultra-high frequencies by "predistortion" in the transmitter is described at length in this article. Improvements corresponding to an increase of 530% in transmitter power are claimed.

What the Europeans are Doing, by L. M. Clement. Broadcast News, April, 1936. The marked differences in radio receivers, tubes and listening tastes between American and European publics are explained by a man who has just completed a four-year stay on the continent.

Types of Condensers and Their Applications. Aerovox Research Worker, April, 1936. This excellent article discusses the various condensers employed in a typical modern radio receiver and indicates the types generally considered best for each task.

Free Bulletins

Resistor Replacement Catalog

An 18-page catalog devoted to fixed and variable resistors and replacement volume controls has been brought out by the Wirt Company. It also describes a very handy wooden cabinet for storage of resistors and small parts. To obtain a copy of this catalog free of cost, write to RADIO NEWS, 461 Eighth Avenue, New York City.



Modulation Booklet

Bulletin 11CC of the United Transformer Corporation is an eight-page folder containing a technical description of the principles of controlled carrier modulation transmission, with data on the construction of an actual transmitter employing the idea. Amateurs interested in this folder can obtain a copy free of charge by writing to Radio News, 461 Eighth Avenue, New York City.

New Instrument Catalog

The Clough-Brengle line of precision engineering instruments including cathode-ray oscillograph, signal generators, multi-meter, etc., is thoroughly illustrated and described in a new 8-page folder. Radio engineers and wide-awake servicemen will find this of interest and value. Copies are obtainable free of charge from Radio News, 461 Eighth Avenue, New York City.



Special P. A. Catalog

A 48-page rotogravure catalog describing the complete Lafayette line of public-address amplifiers, and accessories has just been brought out by Wholesale Radio Service Co., Inc. Copies are obtainable free of charge from Radio News, 461 Eighth Avenue, New York City.

Amateur Radio Booklet

Many short-wave listeners who have become interested in amateur radio through listening-in on the "ham" wave bands wonder how they can get on the air themselves. They can learn by reading the booklet "Amateur Radio as a Hobby," issued by the New York Wireless School. Copies are obtainable free of charge

from RADIO NEWS, 461 Eighth Avenue, New York City.

RADIO NEWS Booklet Offers Repeated

For the benefit of our readers, we are repeating below a list of valuable technical booklets and manufacturers' catalog offers, which were described in details in the February, March, April, May, June and July, 1936, issues. The majority of these booklets are still available to our readers free of cost. Simply ask for them by their code designations and send your requests to Radio News, 461 Eighth Avenue, New York, N. Y. The list follows:

- F1—Catalog of Radio arts. The National Co., Inc. Free.
- Mh1—Sound Equipment catalog. Inter-World Trading Corp. Free.
- Mh2—Radio Parts catalog of Bud Radio, Inc. Free.
- Mh3—Amateur Equipment catalog of Wholesale Radio Service Co., Inc. Free.
- Mh4—Tube Tester Booklet of Supreme Instruments Corp. Free.
- A2—"Your Future in Radio", 32 page book of Sprayberry Academy of Radio. Free to readers seriously considering a modern education in radio.
- A3—Radio Capacitor catalog of Solar Mfg. Co. Free.
- My1—Information on a new antenna system. Technical Appliance Corp. Free.
- My2—Condenser bulletin of Cornell-Dubilier Corp. Free.
- My3—Free. Instructive bulletins on measuring resistance and proper use of resistors to extend meter ranges. Aerovox Corp.
- My4—Free. Folders on Polyiron core coils. Aladdin Radio Industries, Inc.
- My5—1936 condenser catalog. Sprague Specialties Co. Free.
- Je1—Sound Equipment Catalog of the Webster Co. Free.
- Je2—Radio Parts Catalog of Allied Radio Corp. Free.
- Je3—Transmitter Bulletins of the Collins Radio Co. Free.
- Je4—Radio Supply Catalog of Wholesale Radio Service Co., Inc. Free.
- Je5—Spring Radio Catalog of Radolek Co. Free.
- Jy1—Tube Engineering Bulletin on Harmonic Analysis of Modulation. Ken-Rad Corp. Free.
- Jy2—Free Tube Chart of the Raytheon Production Corp.
- Jy3—Public Address Catalog of Operadio Mfg. Co. Free.
- Jy4—Latest Radio Parts Bulletins Utah Radio Products Co. Free.
- Jy5—Commercial Refrigeration Booklet of the Frigidaire Corp. Free.
- Jy6—Short-Wave Catalog of Harrison Radio Co. Free.

5-Meter DX

(Continued from page 91)

the next night of May 9th. At the moment of writing this report conditions are again pulling into line and I am waiting for the next few evenings to see if our prognostications on the basis of these factors are invariable.

At present writing, W2AMJ and I are collaborating with fellow amateurs on 5 meters in the 8th and 9th districts, in determining just how many stations East and West were heard and verified. A letter from Dr. Krynski of Chicago, W9SQE, furnishes us with the first verified list of eastern stations heard on 5 meters in Chicago. This list was verified by W9TLQ, W9PEL, W9AI, W9LBP, W9WNE, W9UOV, and W9HPP. The eastern stations heard follow: W1CE, W1DVO, W1ZE, W1BJE, W1EER, W1HRZ, W1IYX, W1SS, W1JJK, W1DZE, W1DK, W1FHN, W1EYM, W2COL, W2JCY, W2BRO, W2LAG, W2AMI, W2JBK, W2GNT, W2HWC, W2IIN, W2IJJ, W2AZI, W2IGG, W2DTE, W2EFM, W2DNL, W2BVC, W3EPN, W3FTW, W3EFU, W3EUY, W3NU, W3CTG, W3FNU, W3EP, W3HG, W3KW, W3GAH and W3AYG. On this end, stations in the West that were verified as being heard in New York by W2AMJ, W2CLD, W2JCY and others, are the following: W9SQE, W9TLQ, W9LWI, W9UOV, W9TMD, W9UVZ, W9AI, W9PPP, W9HPP, W8UAQ, W9PEL, W9WUZ, W9AHC, W8CDI, W8DQR and W8NSS. During the same evening many 1's and 3's were also heard by us in the 2nd district.

One of the first verifications of the fact that the 2nd and 9th districts had made actual contacts was confirmed in New York by the visit of W9TRD, publisher of the Call-book, who happened to be in Chicago and listening on 5 meters while the contacts were being made. On the following Friday he came to New York and gave a short talk on the 5-meter weekly broadcasts from W2DKJ, confirming the transmissions and telling how excited the boys out in the 9th district were over the accomplishment which, by the way, establishes a new record in two-way 5-meter communication. We have been told that the previous record was held by G5BY, a pioneer 5-meter experimenter of Great Britain.

RADIO SERVICING "In the Car"

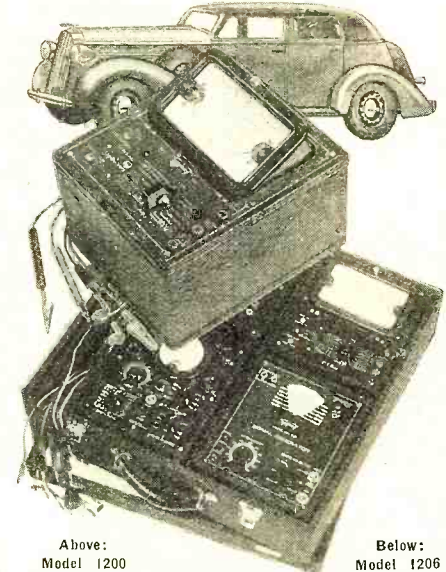

Above: Model 1200 Volt-Ohm-Milli-ammeter Dealer Net. \$21.67
Below: Model 1206 The Master Unit Test Set, Complete. Dealer Net \$84.33

Practically all makes of auto radio sets today are accessible for "in the car" servicing. Triplett Master Units are just the instruments for this work.

Small, light, compact, each Master Unit can be handled right where it is needed, doing the job easier and quicker.

The Triplett Master Unit Test Set is the most popular tester among radio servicemen. It is a complete portable laboratory with the testers that the professional serviceman needs in his daily work. Each instrument can be purchased separately and the entire laboratory thus built up over a period of time.

DEALER NET	
Model 1210-A Tube Tester	\$20.00
Model 1220-A Free Point Tester	10.00
Model 1231 All Wave Signal Generator, D.C.	26.67
Model 1232 All Wave Signal Generator A.C.	26.67
Model 1204 Leatherette Carrying Case with Dismountable Cover	6.00
Model 1207 (same as Model 1206 except has A.C. Signal Generator No. 1232)	84.33

See Your Jobber. Write for Catalogue.



TRIPLETT ELECTRICAL INSTRUMENT CO.
158 Harmon Dr., Bluffton, Ohio

Without obligation please send me—
 _____ More information Master Unit Test Set.
 _____ New 1936 Catalogue.

Name.....
 Address.....
 City..... State.....

Build the "RADIO NEWS" Beginner's RECEIVERS



Radio Set Builders! Build the efficient, economical Beginner's Receivers described in the Radio Beginner Course running regularly in "Radio News" Magazine. Write for FREE parts lists as specified by Radio News, for Simple Diode Receiver (May); Triode V. T. Receiver (June); One-Stage Audio Amplifier (July); Audio Amplifier-Power Supply Unit. Construct these successful kits using ALLIED matched, selected parts. You'll like our fast, friendly service, our high quality merchandise, our money saving prices.

RADIO'S LEADING SUPPLY GUIDE

Write for the new 1936 Spring and Summer ALLIED Radio Catalog. 136 pages packed with 10,000 parts to cover every radio need; Complete lines of standard dependable Amateur, Set-Builder, Service and Public Address equipment; dozens of kits, tools, books, sets, etc. For service, quality, and low price—order from the new ALLIED Catalog. Send for this great book—it's free for the asking!

10,000 Radio Parts

ALLIED RADIO

833 W. Jackson Blvd., Dept. M
Chicago, Ill.

- Send me Parts List for.....
- Send me your Free Radio Catalog.

Name.....

Address.....

AT LAST! THE PERFECT CODE TEACHER! NEW MASTER TELEPLEX

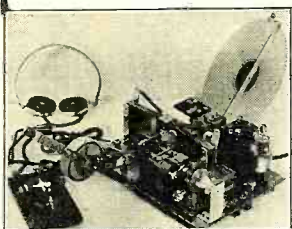

For beginners, experienced operators, and schoolrooms. The sure easy way to learn code and to step up your speed. This amazing new instrument will record your own sending on double row perforated paper and repeat it back to you at any speed you desire. 10,000 words can be recorded on one tape.

NO BATTERIES NO WINDING ALL ELECTRIC
It is the same in principle, and in operation is equal to the Wheatstone Perforator and Transmitter, which cost over \$1,000.

BUY IT OR RENT IT
Send for Folder RN, 8, which tells you how to get the use of this instrument without buying it. No obligation. We furnish complete course and personal instruction with a money-back guarantee. Low cost, easy terms. Write today for information.

"HAM" SPECIAL STANDARD TELEPLEX
A highly efficient code teacher using heavy specially prepared waxed paper tape, having two rows of perforations. Write for Free folder
We are the originators of this type instrument
TELEPLEX CO.
72 Cortlandt St. New York City
The New Master Teleplex
"The Choice of Those Who Know"

NOTICE Regarding TELEVISION!

● Pictures go on the air experimentally this month from Big new television stations. Study the facts. Great new book, "TELEVISION WITH CATHODE RAYS", which required 5 years to write, will be ready for distribution on June 5th. Written by Arthur H. Huloran. Price \$2.00 per copy, which includes FREE one-year monthly supplement service mailed to you each month. Send check or money order to: Pacific Radio Publishing Co., P. O. Box 3278, San Francisco, U. S. A.

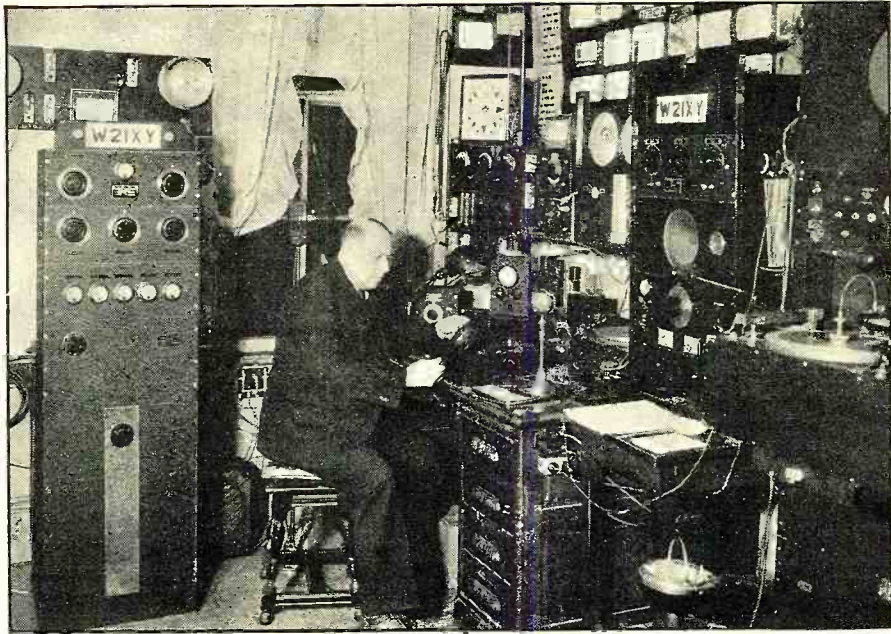

CAPT. HALL'S PAGE

DURING the last month there has been some very fine long distance reception and the 14 megacycle amateur band has in fact been spell-binding. The Japanese short-wave broadcasting stations' afternoon (4 to 5 p.m.). Special U. S. listeners transmissions are always heard but not with the clarity and volume of their early-bird broadcasts.

THE Island of Java is ably represented by its daily radio broadcasts transmitted over PLP, 11 meg. and YDB, 9.65 meg. We have always heard the former station with far greater signal strength than the latter. Have you heard the woman announcer on these stations?

One cannot say that the Hong Kong station has been coming into the eastern part of the United States with any degree of regularity but when they are heard the program often consists of re-broadcasts of the Davenport station's programs. This Chinese station is continuing to be listed in the DX group; possibly with the change in season it will be heard more regularly.

Just as soon as we tune in a station located below the Rio Grande it is immediately associated with the Spanish language. But the owner-operator of VP3MR, 7.08 meg., Georgetown, British Guiana, informs us that the "King's English" is ALWAYS spoken. British Guiana is the only British possession in South America. Programs sponsored by "Ferrol" are heard regularly over this station, and reports are earnestly requested. Tune for VP3MR from 6 to 10 p.m. and on Sundays 9 a.m. to 11 a.m. Correspondence in connection with the station should be addressed to: Station VP3MR, Georgetown; Demerara, British Guiana, and those in reference to the "Ferrol" programs should be addressed: "The Manager, Bookers Drug Store, P. O. Box No. 17, Georgetown, Demerara, B. G."

There always will be short wave fans who consider the Australian stations—DX. Possibly due to our receiving equipment or antennas, the VKs have rarely if ever failed to come through whenever tuned for. VK2ME, 9.59 meg., Sydney, will be operating on a new schedule beginning this month. If you are tuning over the dials on Sunday morning (12 a.m.) try for this station, as from that hour until 2 a.m. (and then later 4.30 to 8.30 a.m.) VK2ME transmits very fine programs. VK3ME, 9.51 meg., Melbourne, will adhere to their

announced schedule, viz., Monday to Saturday (inclusive) 4 to 7 a.m. The same identical "roll" always associated with VK3LR's 9.58 meg., transmissions has now become "part and parcel" of the Suva station's signals. VPD, 13.07 meg., Fiji Islands, has been a daily visitor. Arriving on the air at 12.35 a.m. and broadcasting a program of recordings followed by a news bulletin, tuning in this station arouses a thrill even with the old timers in the game.

Short-wave listeners throughout the world must have derived many a thrill from the Hindenburg's signals. At first it was rather confusing to determine whether the giant liner was tuned in direct or from one of the outlets of the German short-wave system, as several of the programs originating aboard the Zeppelin were re-broadcast over DJC and DJD. On several occasions the ship was heard transmitting on 10.29 meg., but as it neared the United States they dropped in frequency and 5.80 meg. was the one in use. Hundreds of ship-to-shore telephone conversations were carried out on this frequency with WQO, 6.75 meg., Rocky Point, acting as the land contact.

A South American station heard on 6.12 meg., and announcing as HJ4BP, Medellin, Colombia, has been very active on Sunday mornings about 2 a.m.

ZLT, 11.05 meg., Wellington, New Zealand, VLK, 10.52 meg., Australia, and GBP, 10.77 meg., Rugby, are heard daily around 2 a.m., in a three-way round the world hook-up.

To use the parlance of the street, reception of Ethiopia is now "washed up", therefore verifications from that part of the world are both rare and now unattainable. Time was when the "E" stations were fairly easy to "catch" and the fan who failed to write for a veri then—will find it difficult to obtain one now.

Experimenters have discovered in past years that when the European stations shift to the higher frequencies, long antennas, which are so satisfactory on the

25, 31 and 49 meter bands, do not, perform as well as on the 19, 16 and 13 meter channels. If this proves to be the case attach a short piece of wire to the aerial post of your receiver. It need not be more than seven or eight feet long. On these higher frequencies a make-shift antenna frequently gives better results and at the same time eliminates much of the man made interference. We may remark in passing that this type of "aerial" need not be out-doors.

Calls Heard

(Continued from page 87)

D4AKK EA3BP EA3DL EA1AW EA5BS
EA4AV EA3CZ EA3EV EA7AI ES2D
F3BJ F3LE F8GK F8SAA F8PZ F8RS
F8KJ F8ER F8DC F8WB F8VY F8NR F8NE
G5TZ G5QA G5LI G2AO G2DV G5WP G6BS
G6NX G5RL G6CV G2ZO HAF8C HAF4K
HB9AY HB9J HB9AT HB9BD I1ZZ I1WV
I1TKM J5CC K5AG LY1J OE1CM OE1FP
OE7JH OH3NP OH7NF OK2RM OK2KU
OK2HX OK3VA ON4HM ON4HC ON4VW
ON4FK ON4FE ON4VK OZ2M PA0AW
PA0WHS PY1DI PY2QD SM5SX SM5SC
SM7YN SM7YG SM5UU SPIDE SPIGZ
SPIBA SUIWM SUIKG SV1K U2NE U5AE
U3QE UZAZ U9MF U3VB U3AG UE3EL
UK1CC VE1ET VE2CA VE2GA VE4AL
VP1VB XE2GQ XE2CG XE2ZZ XE2BH
XU3DF YT7VN.

On 20 meter 'phone: EA5BE EA5BC EA2BT
EA7AI F8OV F8DC G5ML K6JLV K6GAS
KA1ME NY2AE ON4VK T12RC VE5JB
VE3EO VE5HI VE3DB VE5OT VE5HA
VE5DK VE5BY W1GJX W1FTJ W1YI
W1DNL W1ARC W2AGA W2LHI W2FDA
W2HFS W2JNE W2FF W2DX W3CRG
W3BSY W3KHY W3CEI W3BDI W3ABN
W3CC W3APO W3EOZ W3GNO W3BMR
W4CFO W4ANZ W4AT W4OC W4AH
W5ACF W5EXL W5YW W5BAT W5EUC
W6BYW W6BAY W6LY W6GAT W6LHF
W6AH W6FGR W6SJ W6HCE W6UT
W6BWE W6CFJ W6HOE W6GAL W7MD
W7IF W7BUH W8IK W8JN W8CBX
W8LPI W8FC W8IKI W9OC W9UVC
W9DUM W9ITS W9VZ W9RUK W9CWN
W9MRH W9IZY W9VZ W9KFA W9PIY
W9OLY W9IQ W9SZY W9GIC W9DGY
XE1Q XE1G OA4AK.

On 40 meter c.w.: CT1LZ D4YBF D4SPP
D4VYG D4XBG EA1BD EA1BU EA5AQ
EA5CG EA5AU EA1AW EA5CK EA5AE
F3HJ F3HG F8LC F8RS F8PK F8GG
F8AD G6JW G5TP G2AV G5JM G5XC
HB9X KA9JO LU4AA OEGMP ON4POM
ON4GB OZ7KG PAOWV SM6UA SPIFU
SPIFD SPIAU SVIK USAZ UK3AH UK5AA
VQ8AG VE3AGM XU3ZC XU6SW Y1IM.

On 40 meter 'phone: EA1AS EA2BH
EA7CA.

By T. Lunn, Dunedin, New Zealand; on 20-
meter 'phone: CO6OM K6BAZ OA4R TI2RC
XE1G NY2AE W2AIO W5AHK W5VA
KA1AJ W6SJ W6TTH W6LLO W6BYH
W6KSO W9LD W5ATB W6FZR W9BJ.

On 20 meter c.w.: YL4AA SU2AZ G5YG
HB9AT HB9AQ K6LOS VE4OG LU2AM
LU1EP OK1BC VE5IQ VR2FF OA4J LU8DI
W9VOG W9MNU W9FHR W9AHH W9IWI
W8KKL W8BKW W8BQJ W7FDR W7CWN
W6EYC W6HFB W6NHC W6OAR W6JWL
W6JPW W6KQH W6KOL W6FOY W6AM
W6NDC W6DYM W4ARY W4EF W4DZH
W3QT W3EJM W1ARC W1ADM W1OZ.

By W. J. Thomas 3d, 676 Fourth Street, N. E.,
Washington, D. C., on 20 meter 'phone: VE2HY
VE1DC W4FK W9MEL W9HCV W4YC
W9SZH W3ACF W9OQE W9GIC W9DNP
VE1CI W4SA W9BBU W9ZD W9CHI
W9DIP W9IMZ W9VXZ W9GOI W4HT
W9BOI W9AXM W9PGO W4LD W4ANO
W9SBB W9CCV W5ACF W4DOY W8EBN
VE2GT W9BRX W8UD W9MFH W9CHI
W9EPI W3DXT W5IBB VP3BG W9FAV
VE1CF CO2FL W1GIX CO7CN NY2AE
W5BCO W9RGF W9BEZ W9JND W9RNX
W9QI W9SBL VE1EF VE1BA.

Making Short-Wave Improvements

By W. H. Hollister

Due to the high percentage of noise, short-wave enthusiasts in the past have been held to a comparatively small percentage of the radio public. To really popularize short-wave receivers, engineers have been concentrating on ways and means of making an all-wave receiver so that Mr. Jones can take friend wife on his shopping tour for the new radio.

NEW

Again
McMURDO SILVER
ENGINEERING
BRINGS YOU A
TOTALLY NEW AND
PERFECT RADIO

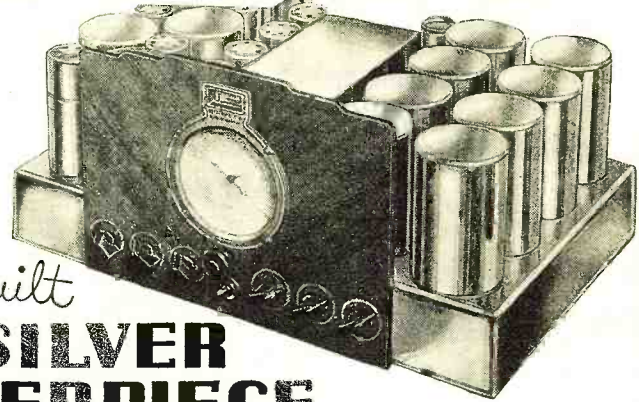

Custom Built SILVER MASTERPIECE

In the new MASTERPIECE you will find new inventions, new features galore. From stem to stern it's a totally new radio. More than that, it's the perfect radio, ready to be truly custom built to your exact desires and needs. At last you can get a superb radio especially made to bring you perfect reception in your own home. No longer need you be satisfied with just a fine radio, for now you can have the perfect radio built expressly for you, ready to make your dreams of perfect reception come true.

The MASTERPIECE is totally new. It's new in design, new in construction, and utterly new in the results it brings you. Here at last is the perfect radio, years in advance of its time, ready to give you reception you've hardly even dared dream could ever be possible.

Truly Custom Built for You

Your MASTERPIECE will be truly custom built for you as though it were the only one ever to be made. To your exact specifications and needs, it will be precisely aligned, adjusted, and finally peaked to give you perfect reception. World famous engineers will now build your radio just as you want it, to bring you just what you want.

New Features

Developments of the last few weeks that lift radio out of mediocrity, that jump over years of compromise results, lift the MASTERPIECE to entirely new conceptions of what radio can be. Be it distance, be it selectivity, be it quietness, be it ease of operation, or be it tone so glorious as to send the shivers dancing up and down your spine—all this is now yours in your own truly custom built MASTERPIECE. Every known and proven engineering development, and gobs of entirely new features, bring you in the MASTERPIECE a radio utterly without compare—literally, the perfect radio.

McMURDO SILVER CORPORATION Div. of G.P.H. Inc.
3352 N. Paulina St. Chicago, Ill.

\$34.00 Puts It in Your Home

A new budget plan brings you your own special MASTERPIECE truly custom built for you for only \$34.00 down, with the balance spread over twelve small monthly payments. Through this plan, you need no longer deprive yourself of superb radio reception. It can be yours for only \$34.00 down, and paid for as you delight in the ring-side seat it gives you to the billion dollar show of world wide radio.

Try It For 30 Days!

You can try your own special MASTERPIECE for thirty whole days if you want to. You can test it any way you want to, compare it with ordinary radios, make it prove to you that it will bring you distance, tone, freedom from interference you never dreamed was possible. If it fails to PROVE its complete superiority, you may return it undamaged for refund of your deposit.

SEND TODAY
for Complete
Description
of the
PERFECT RADIO

McMURDO SILVER CORPORATION
3352 N. Paulina Street, Chicago, U. S. A.

- Send Free "Blue Book" giving complete specifications of new MASTERPIECE with details of 30-DAY TRIAL.
- Send details of new \$34.00 Budget Plan of Easy Payments.

Name.....
Address.....
City..... State.....

You Save Money By Subscribing Now!

We want to eliminate the slack summer subscription period as much as possible—so we're making a special inducement! For the first time in years, we offer our readers two years of RADIO NEWS for only \$3—a saving of 50% over the regular newsstand cost of 24 issues! (Canada and foreign \$4.) Think of it! You save \$3 by placing a subscription—and sending it now! If you are already a subscriber, we will extend your present subscription. Remember, this offer applies only during the summer months—so send in your remittance today!

Radio News, Dept. 368-A, 461 Eighth Ave., New York, N. Y.



A BETTER SERVICE BUSINESS FOR YOU

Chances are ten to one that **YOUR** business **CAN** be made better, more efficient, **MORE PROFITABLE.**

You **CAN** get better jobs. You **CAN** expand to do all types of work quicker and easier. You **CAN** learn to merchandise your business to greater advantage.

Enthusiastic letters from many Sprayberry graduates offer convincing proof. I have helped them on the road to success. I honestly believe I can help you. Certainly, as a serviceman, you owe it to your business future to mail the coupon today and **GET THE FACTS** about Sprayberry's Practical Mechanics of Radio Service. It may be the turning point in your business career. You have nothing to lose—much to gain.

SPRAYBERRY ACADEMY OF RADIO
(F. L. Sprayberry, President)

2546 University Place, N. W., Washington, D. C.

Without cost or obligation, please send your book "PUTTING PROFITS AND EFFICIENCY INTO SERVICING."

Name

Street

Address

RN-8-36

SPRAYBERRY'S PRACTICAL MECHANICS OF RADIO SERVICE

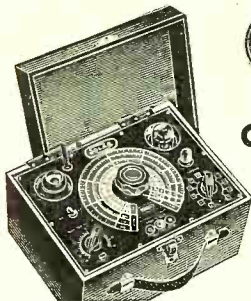

Precision CAPACITOR ANALYZER

Capacity, power factor, leakage, resistance, directly on the panel. Highly sensitive No. 6B5 cathode ray tube used for balancing. Dials color-coded to match settings. A refined and extended Wien bridge, instantly usable in shop and field. Two models, low priced.

QUICK as a WINK!
write for full details

SOLAR MFG. CORP.

599-601 BROADWAY

NEW YORK CITY

ELECTRO-VOICE



HUM FREE Velocity Microphones

For high-fidelity P.A. work, the **ELECTRO-VOICE V-2** meets every requirement. Its wide, flat response gives a naturalness of reproduction, rarely found in other types. Feedback is greatly reduced and hum pick-up eliminated through ingenious design. Incorporates many other desirable features such as the locking grille, internal shock-proof assembly and 20' well shielded cable. Performance, appearance, simplicity of operation and value merge in the **ELECTRO-VOICE Model V-2**. Try one on your next installation. List price: \$35.00, other models, \$25.00 to \$75.00 list.

See Your Jobber or Write for Catalogue

Electro-Voice Mfg. Company, Inc.

338 E. Colfax Ave. South Bend, Ind., U. S. A.

Export Office: 15 Laight St., New York, N. Y.

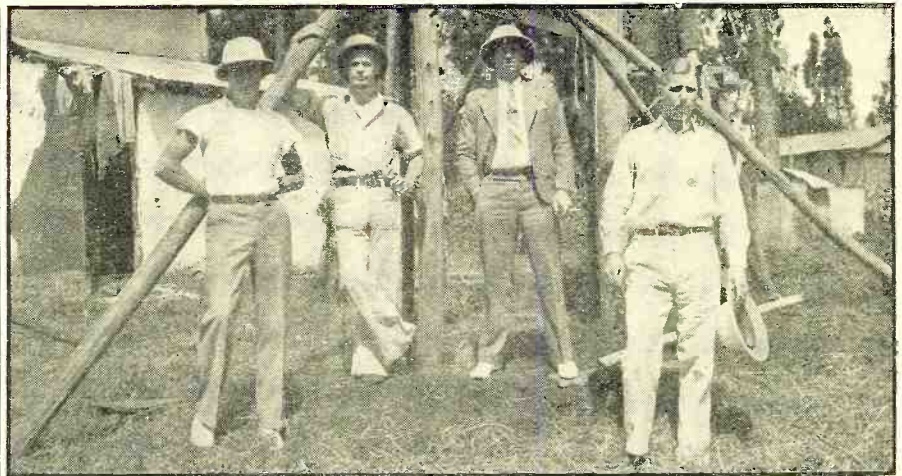

QRD? QRD? QRD?

CONDUCTED BY GY

SOMETHING like the old story of the kid who yelled "wolf" was enacted a short time ago when two vessels sent out radio alarms and had rescue vessels racing through the night to render assistance. Both vessels had rudder trouble during a heavy gale and were worried, but after the gale died down a bit they found that they could get along without help from the oncoming rescuers. We admire these skippers for having braved the possible ridicule of their fellows rather than lose their ships.

SOMETIMES we wonder if any of our hints to the radioman who is looking for a job are ever taken. Well, here is another one. Pan-American Airways got FCC approval to erect two aviation radio stations on the New York seacoast. These are the first steps in the opening up of a transatlantic airways service, which is expected to begin shortly. Work is to begin immediately on the towers. One is to be at Port Washington and the other on Eastern Long Island. Now let's see how many of youse guys will gallop over for these openings.

Well, the U. S. Navy boys who put up the radio station at the U. S. Legation in the Ethiopian Capital certainly had their experiences and will soon be coming home again. Photo, in heading shows the crew.

So the boys out in St. Louis are also stepping out to gain better wages, etc. Members of station WIL, Radio Division, Local Union No. 1, I.B.E.W., went out on strike and although harassed by scabs, managed to win by getting better working conditions and by having another operator added to the staff of the station. And under the resolution advising their official organ, "The Electrical Worker" of the outcome of the strike, they add this paragraph: "Be it still further resolved that we request all locals of I.B.E.W., their memberships, and all fellow operators, not affiliated, to please be advised that every commercial broadcasting station in St. Louis is 100% closed shop under L.U. No. 1, and that we stand ready to give and receive cooperation." Which goes to prove that cooperation is still the keynote of success.

Well, the boys down at ARTA National Office headquarters tell Ye Ed that they have almost affiliated with the CTU. In a national ballot cast, the majority of the paying members decided for this connection. But the reason for the "almost" is, according to the statement by President Haddock of the ARTA, that "we have not officially consummated affiliation pending a clear statement from International President Powers of the CTU on two questions raised. These were: 1. The further prosecution of the Mackay Radio matter and

the future success of the National Labor Relations Board decision ordering reinstatement of the locked out point-to-point brothers at San Francisco. 2. Retention of Broadcast by CTU. President Powers stated that he would have to refer the question of the Mackay matter to his General Executive Board for their advice and comment before he would be able to take a more definite stand than he had taken heretofore. He stated that he can expect written answers from his Board within a week after they are presented, possibly earlier. Therefore, these questions await his reply. Meanwhile we are refraining from consummating affiliation officially until we have had a reply from him that is satisfactory."

Powers' stand on the Broadcast Jurisdiction is the same as stated in the referendum ballot which has been voted upon and has carried. He stated that he is concerned with organizing and improving the conditions of the Broadcast Technicians, and that he will take the question before the next A.F.L. convention, if necessary, to guarantee the Broadcast Technicians the right of proper organization and, through this, improvement in their conditions.

This, then, is the affiliation of and about which many words have been written and spoken. There is no doubt but that it would be of great benefit to the ARTA organization because of the weight it can throw in the matter of cooperation, not only during trouble with shipping owners, but also from the standpoint of advice and guidance. Their greater experience in these matters will be of invaluable assistance in helping the ARTA along the right road towards arbitrating a problem instead of high-handed and hot-tempered rushing into a situation. We therefore endorse this policy and, with hopes for its immediate counsel, ge... 73... GY.

Ultra-Short Waves Open Up Radio and Television Fields

By C. W. Horn

Just when we feel we can sit back and reflect on what we have accomplished,

there appears a new problem which requires intensive fundamental research and study. This is true in the case of ultra-high frequencies which, because of their quasi-optical properties, offer many new possibilities in radio communication. We have all read of some of the achievements already made, especially in reference to the rather low power used. What will be the result when we find ways and means of using some real power on these frequencies? It will mean the development of new tubes, new circuits and new methods of creating oscillations.

The result of all this work is not in the few additional radio circuits we can establish, but in the many by-products which will eventually come into existence. Just as the first vacuum tube oscillator was considered a great advance in the art of radio communication, but which in itself created entire new industries, so will the development of ultra-high frequency apparatus create new possibilities and uses that will perhaps outweigh the communications angle.

We already know that these frequencies will be utilized in the transmission of television and many communication needs, but few of us can foretell the tremendous possibilities of these ultra-high frequencies in fields other than communications. We know that these high frequencies are useful in the medical profession and are being carefully studied by research men in that field for the creation of artificial fevers, internal heat, etc. I feel quite sure that the value to mankind of the so-called "by-products" which will be uncovered in this new portion of the radio spectrum will exceed any past records.

Amateur Transmitter

(Continued from page 87)

coupled circuits which in turn feed into a pair of 45-type tubes which serve as drivers for a pair of 801 tubes in a push-pull Class B modulator circuit. As a pair of these tubes will provide nearly 80 watts of audio power, more than sufficient modulating power is available.

The power switches are mounted on the r.f. unit and interconnected to the modulator unit by means of plugs. One switch is provided for filament control and another for plate circuits. Battery bias is used for the 801 Class B tubes, the batteries being mounted conveniently on the chassis. The front panel contains a plate current meter reading the current of the Class B tubes, a gain control which is a 1/4-megohm resistor connected across the microphone input plug also mounted on the front panel.

The third unit is the antenna coupler and is mounted logically at the top of the transmitter. It is ingeniously designed to provide coupling for almost any type of antenna. It may be used with a resonant transmission line, a single wire non-resonant line, current or voltage fed antennas. Two variable condensers controlled from the front panel are used for either series or parallel tuning of feeders. A switch is mounted at the rear of the panel for changing the variable condenser connections. A 0-2.5 ampere radio-frequency ammeter reads antenna current.

The ACT-200 employs a number of features contained in the ACT-40 and in addition has a high-powered amplifier using a pair of 838 tubes in Class C r.f. stage and a pair of 838s as modulators along with the necessary power equipment. The driver or exciter unit is the same as the ACT-40

transmitter. This is link coupled to the 838s which are used in the final amplifier. The whole transmitter is mounted in a metal cabinet which stands 52 inches high, 19 inches wide and 15 inches deep.

The units from the bottom up are the high voltage power supply, the high powered modulator, the exciter, the high-powered r.f. amplifier and the antenna coupler. Both grid and plate circuits are tuned in the final amplifier by means of two controls on the front panel. In addition a meter is provided in the plate circuit of the tubes. Coils are available for operation on 20, 40, 80 and 60 meters.

The power supply employs four type 866 rectifiers in a full-wave rectifier circuit and includes equalizing reactors, filter condensers and transformers. A special winding on the plate transformer furnishes power for both the final amplifier and the plate circuits of the pre-amplifier unit which is not contained in the main cabinet.

The modulator unit in addition to containing the two 838 tubes also contains two 245s which serve in push-pull as drivers for the modulators. The advantage of employing 838s in this class service is that no grid bias voltage is required. The input of the driver stage is connected to the external pre-amplifier by means of a 500 ohm line. The output of the Class B modulation transformer is designed for a 3300 ohm load.

The pre-amplifier uses two 6C6 tubes in cascade and two 76s in push-pull, and is designed to be placed on the operating desk alongside the receiver. It contains the gain control and the jack for the microphone.

Learn the Code

(Continued from page 93)

are severe penalties for divulging the contents of radio messages) we are at liberty to "eavesdrop" all we want.

"But," you say, "it takes a lot of study and it's hard to learn the code. I could never do it." And that is where you are wrong. During the war Great Britain turned out high-speed operators in less than a month's training. There is a right and wrong way, a pleasant and an unpleasant way, to learn the code.

Most of us make the mistake of thinking of the code in terms of "dots and dashes"; unknowingly we separate the dots from the dashes, we break into its component parts a character that should be thought of as a whole. Forget the dots and dashes, and in their place think of dits and dahs; think of the sound of each character as one complete unit—a, for instance, becomes *dit dah*. I've been pounding away at the International Morse code for years, and if I were asked offhand to give the number of dots and dashes in a certain code character, I'd find it necessary to stop and think. But if I were called upon to hum a character I'd do so without the slightest hesitation.

Each letter of the alphabet has a separate and distinct sound of its own. Very good code can be produced by whistling, or on any wind instrument of the orchestra. As a novelty it is often the practice at radio operators' conventions to pass out wooden whistles with which it is possible to blow good code, readable blocks away. So, with this simple music lesson we start out to learn the code.

The International Morse code shown here-with is the accepted radio code. Now, we'll make a copy of the code, but instead of putting down dot-dash for a we'll draw two little tents, one short and one long (Figure 1); and every time we see this group in our future study of the code, we'll think of it as *dit dah*, repeating it in our minds and verbally droning the signal out on our lips. A sharp staccato dit is followed by a longer dah (about 3 times as long as the dit). These sounds can be made distinctly with the tongue and lips, and hummed over a few times it doesn't take long for us to know without a doubt that the familiar little tune of dit dah can be nothing but the letter a.

Next comes b, which we put on paper as one long tent and three short ones, *dahhh-dit-dit-dit*. The writing of the characters as short and long tents helps to prevent us from learning the groups as dots and dashes; instead, it gives us the impression of sound.

Each character follows with equal ease and simplicity. Practice each letter from A to Z

(Turn to page 120)

THE SYLVANIA TECHNICAL MANUAL



IS GOING GREAT GUNS!

Every day from every corner of the world . . . more orders are coming in for the New Sylvania Technical Manual. And no wonder! Radio men have discovered that here is a real VALUE! Look at some of the subjects covered in this book:

1. 141 tube types listed with important circuit application information given on each type.
2. Characteristics on all types completely up-to-date. This includes all standard types of metal tubes.
3. Section on circuits has been increased to include 13 typical radio receiver and amplifier circuits which show proper use of the most popular types of tubes now being employed.
4. Curve data on ballast tubes for battery sets.
5. A 50% increase in contents.
6. The convenient pocket size has been retained in spite of the large increase in material.

Don't miss this value! Send 15c for the New Technical Manual Now!

Hygrade Sylvania Corporation, makers of Sylvania Radio Tubes and Hygrade Lamps. Factories at Emporium, Pa.; Salem, Mass.; and St. Mary's, Pa.

SYLVANIA THE SET-TESTED RADIO TUBE

Hygrade Sylvania Corporation Emporium, Pa.	RN-86
Please send me the new Sylvania Technical Manual. I enclose 15c in stamps.	
Name.....	
Address.....	
City.....	State.....

NEW Extension Auto Speaker

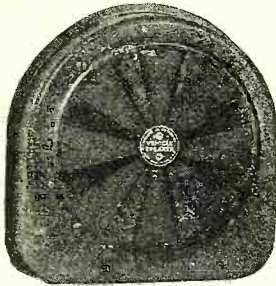

Model 930 for Camping, Touring, etc.

- 8" Nokoil Speaker gives electro dynamic performance yet draws no current from battery.
- Cabinet easily taken apart to make proper connections to the universal transformer which matches all tubes.
- Any service man can easily and inexpensively furnish proper length cord and plug-in connection for automatically disconnecting car speaker and connecting extension speaker.

Here is a big Summer Item

Our special low price enables you to make it **\$9.30** a great leader. LIST

Write for further particulars, complete catalog and name of your nearest distributor.

WRIGHT-DECOSTER, Inc.

2255 University Ave., St. Paul, Minnesota

Export Dept.: M. Simons & Son Co., New York
Cable Address: "Simonrice."

Canadian Office:
Wright-DeCoster, Inc., Guelph, Ontario

NOW - BETTER VALUE THAN EVER!



No. 405A

New Price

\$8.75

(Was \$9.95)

DEPENDABLE OHMMETER

Save money on this wonderful eight range instrument! Ohmmeter 0-1000 and 0-100,000 ohms. measures less than $\frac{1}{4}$ ohm.
D'Arsonval moving coil meter, guaranteed accuracy of 2%.
Voltmeter scales 0-2.5, 0-25, 0-125 and 0-750. Milliamperes ranges 0-2.5 and 0-125. Complete with case and self-contained batteries. See it at your jobber's.

→ IMPORTANT ANNOUNCEMENT ←

Bulletins on our new Multitester No. 410 are now ready. Get the facts about this instrument at once! You will be amazed at the many improved features, as well as its low price. Write Dept. RN-8.

RADIO CITY PRODUCTS CO. 88 Park Place, New York City

The Kit that Requires the Least Time to install

You want the "eye" directly over the dial. Because of the small overall size of the connector and mounting foot which can be rotated, the most difficult space requirements are met.

Because it installs directly from the back and can be adjusted instantly from the back, you can work fast and conveniently.

Meets Underwriters' requirements.

Bezel gives most effective brilliancy to sector.

Many servicemen making excellent profit installing this job.

No. 206FECHB
"Mystic Eye"
Outfit as illustrated with 24" cable and complete instructions (less tube)...LIST PRICE. \$1.15



Write Today for Catalog Sheets



ALDEN PRODUCTS CO.
Dept. RN-8 715 Centre St.
BROCKTON, MASS.

The DX Corner (Short Waves)

(Continued from page 84)

monic, also 12,820 kc., from 9 p.m. E.S.T., onward. (DeLaet.) Observer Frost says they are on 6316 kc. Observer Betances reports hearing them on 6380 kc. Observer Oxrieder reports them moving about in frequency. Take your pick.

TI1AF, Aliboila, Costa Rica, 14,955 kc., reported heard Thursdays 3 to 3:45 p.m., E.S.T. (Hartzell.)

SOUTH AMERICA

HJ1ABE, Cartagena, Colombia, 6115 kc., reported heard 11 a.m. to 12:30 p.m., 4 to 5 p.m., E.S.T. (Loke.)

HJ1ABJ, Santa Marta, Colombia, 6006 kc., reported heard till 10:40 p.m., E.S.T. (Pickering.) Observer Oxrieder says they have changed frequency to 6025 kc.

HJ1ABP, Cartagena, Colombia, 9600 kc., reported heard varying in frequency. (Moore, Pickering, Nelson, Jr., Anca, Smith, Vassallo, Hartshorn, Messer.) Observers Oxrieder and Partner say the frequency is 9615 and 96,100 kc. Observer Partner also says they are sometimes heard on 6560 kc. Observer Hartzell says they are on 9625 kc. Maybe they can't make up their minds what frequency to "sit" on.

HJ3ABD, Bogota, Colombia, 6050 kc., reported heard Sundays at 8:45 p.m., E.S.T. (Rodriguez.) Observer Davis says they are heard till 12:10 a.m., E.S.T.

HJ3ABX, Bogota, Colombia, 6122 kc., reported heard at about 10:15 p.m., E.S.T. (Salazar, Rodriguez, Oxrieder.)

HJ4ABP, Medellin, Colombia, 6135 kc., reported heard 6 to 10 p.m., E.S.T. (Loke.)

HJ4ABE, Medellin, Colombia, 6092 kc., reported heard 11 a.m. to 12 noon and 6 to 10:30 p.m., E.S.T. (Loke.) Observer Miller says their frequency is 6095.

HJ5ABC, Cali, Colombia, 6150 kc., 150 watts, reported heard 11 a.m. to noon, and 7 to 10 p.m. (Moore.) Observer Loke reports they are on the air also Sundays 12 noon to 2 p.m., E.S.T.

HJ5ABD, Cali, Colombia, has changed frequency to 6085 kc. (Oxrieder.)

HJU has changed frequency to 9510 kc., with the same schedule as previously. (Atkinson, Hartman, Amos, Williams, Partner, Coover, Joerger, Sauberlich.) Observer Lopez says they are on the air Wednesdays and Fridays 12 a.m. to 2 p.m. and 8 to 11 p.m., E.S.T.

The Pareira station sends out verification cards with the call HJ4ABC plainly shown on them, according to short-wave listener Schram.

YV2RC, Caracas, Venezuela, 6110 kc., reported heard same schedule as time-table. (Nelson, Jr., Carville.)

YV11RB, Bolivar, Venezuela, reported heard on 6545 kc. (Oxrieder.)

LRU, Buenos Aires, Argentina, 15,920 kc., transmits news in Spanish at 7 a.m., E.S.T., daily. (Masuda.) Observer Shea reports hearing them at 5 p.m., E.S.T. Observer Mascarenhas says they are on the air till 2 p.m., E.S.T. Other Observers hearing them are Markuson and Williams.



A STAUNCH R.N. SUPPORTER
Come on, gang, and meet C. O. Thompson of New South Wales, Australia, who divides his interest between amateur activity and short-wave reception with time off for carefully reading RADIO NEWS

LRX, Buenos Aires, Argentina, is now transmitting on 9640 kc. with 5 kw. power, 7 to 11 p.m. (Andrews, Harris, Hansen, Partner, Williams, Howald.)

LSX, Buenos Aires, Argentina, 10,350 kc., reported on the air between the hours of 6:30 and 11 p.m., E.S.T., irregularly. (Snyder, Chambers, Shea, Jones, Harris, Williams.)

CB960, Santiago, Chile, now on 9590 kc., between GSC and HJ1ABP. (Gallagher.)

CEC, Santiago, Chile, 10,670 kc., heard Mondays and Thursdays 7 to 7:16 p.m., E.S.T. (Harris, Lopez, Twomey, Dressler.) Also heard with another station synchronized on 10,250 kilocycles.

PRF5, Rio de Janeiro, Brazil, 9500 kc., reported heard 4 to 4:45 p.m. and as late as 8:45 p.m., E.S.T. (Rodriguez, Nosworthy, Cindel, Frost.)

OCEANIA

VK3ME, Melbourne, Australia, now on 9510 kc., 4 to 7 a.m., except Sun-

L. P. O. FOR CALIFORNIA

The business-like Listening Post inhabited by Bernard L. Wood, Official Observer for California for RADIO NEWS. The set is a 7-tube Airline, equipped with a doublet antenna



day. (Pickering, Joerger, Moore, L. Jones.) Observer Oxrieder says they are on 9495 kc.

VK6ME, Petrh, Western Australia, 31.28 meters, 500 watts, started broadcasting in July. (N. C. Smith, Amlie, Styles.)

VK2ME, Sydney, Australia, 9590 kc., heard transmitting at 1 a.m., E.S.T., onwards. (Dressler.) Observer Joerger reports hearing them at 4:20 a.m., E.S.T. Observer Stefanou reports hearing them at 3 a.m., E.S.T.

VK3LR, Lyndhurst, Australia, 9580 kc., reported heard 12:30 to 1 p.m., E.S.T. (Moore.) Observer Ellsworth says he has heard them at 7:15 a.m., E.S.T. Observer Hartshorn reports hearing them 7:23 to 7:45 a.m., E.S.T.

VK3ZX, Australia, 41.1 meters, reported heard 3 a.m., E.S.T. (Portmann.)

VK9MI, Australia, 49.8 meters, reported heard testing 4 p.m., E.S.T. (Styles.)

VPD, Suva, Fiji Islands, reported now on 13,110 kc. at 1:30 a.m., E.S.T. (Pickering, Moore, Miller, Chambers, Tomlinson, Ellsworth, Wood.)

KZRM, Manila, P. I., 9990 kc., re-lays KZRM at 5 to 7 a.m., E.S.T. (Gallagher, Andrews, Hartner, Masuda, Sholin.) Observer Frost has heard them at 11 to 12 p.m., E.S.T. This station has also been reported heard on 6140 kc.

KIO, Kahuku, T. H., 11,680 kc., heard rebroadcasting KGMB 11:30 p.m. to midnight. (Jordan.)

Readers Who Are Awarded "Honorable Mention" for Their Work in Connection with This Month's Short-Wave Report

Vincent W. Thurn, Bernard J. Wood, J. F. Snyder Jr., Oliver Amlie, Jack Frost, A. E. MacLean, Ed McKay, Luiz Fosca, J. Evan Puyenbroek, Robert S. Nash, Roy E. DeMent, James Rice Jr., F. Sutton, M. J. Markuson, W. J. Humphries, Fred Atherton, S. E. Stefanou, Anatol Kabatoff, L. E. Williams, Werner Howard, John Hartshorn, F. Bjargmundsson, Flavio C. Mascarhenas, Sydney Cakeland, Charles E. Hansen, Douglas C. Atkins, Bruce Holmgren, Louis Kuslan, George C. Sholin, Gil Harris, Peter McGinn, Howard Sauberlich, Clarence Hartzell, G. W. Twomey, L. M. Jensen, Joe Tanaszi, C. H. Skatzes, Robert W. Winfree, Melton & Gilpin Amos, Edward DeLaet, Isaac T. Davis, Arthur Inimicke, Albert Pickering, Lewis W. Jones, Earl P. Hill, Thaddeus L. Grabek, Gerald Liccione, Thomas P. Jordan, Jose Rodriguez R., Thomas F. Tynan, Juan Manuel Salazar, Fred Cox, J. L. Atkinson, J. Wendell Partner, Caleb A. Wilkinsin, Howard Adams Jr., Anton J. Cindel, Fred C. Lowe Jr., Robert F. Gaiser, Arthur B. Coover, Frank Andrews, Chester A. Joerger, H. R. Smith, Kenneth Dressler, Edgar J. Vassallo, R. C. Messer, Lewis Miller, R. B. Oxrieder, R. Stevens, Louis Horwath Jr., Wade Chambers, Pierre A. Portmann, Frank Sakely, Shokichi Yoshimura, George J. Ellsworth, Fletcher W. Hartman, George L. Loke, K. G. Schram, Jerry M. Hynek, Manuel E. Retances, G. C. Gallagher, Jose L. Lopez, R. H. Tomlinson, Frank Nosworthy, James E. Moore Jr., S. F. Carville, H. Francis Shea, L. C. Styles, H. Westman, H. Mallet-Verle, N. C. Smith, Augusto Anca, Stuart LeLand, J. V. Truskowski, Tomonobu Masuda, Manno Nelson Jr., Theodor B. Stark.

Radio Aboard the "Hindenburg" (LZ 129)

(Continued from page 72)

three receivers is connected to two indicating instruments. Each instrument has three pointers and each pointer is controlled by one of the three receivers. When the airship lands the ground crew of the airport operates three radio transmitters which give complete directions for grounding the ship, releasing the grab-lines, etc.



Model PA-417A

- STRICT DEALER POLICY
- FULLY LICENSED
- TIME PAYMENT PLAN

WEBSTER-CHICAGO offers you today's finest in P.A. systems at thoroughly competitive prices. WEBSTER-CHICAGO has earned its reputation for building outstanding

WEBSTER-CHICAGO

Manufactures a complete line of synchronized public address systems, sound equipment, amplifiers and accessories of all kinds.

Incorporating every known improvement . . . for best and enduring performance, and for simplified, damage-proof operation.



17 WATT...PORTABLE... SPARKLING BRILLIANCE

SYSTEM INCLUDES:

- Dual Diaphragm Crystal Microphone
- 4 Stage Amplifier Using 6 Tubes (furnished)
- Dual Input Mixing System
- One or Two 12" D.C. Dynamic Speakers

trouble-proof sound equipment—the kind every service dealer likes to sell and recommend. See your Jobber. See for yourself that WEBSTER-CHICAGO merchandise does not cost more.

The Webster Company
Section AU6
3825 West Lake Street, Chicago, Ill.

Write for catalogue.

Without obligation please send me
 More information on Model Pa-417A.
 Send complete catalogue.
 Name.....
 Address.....
 City..... State.....

"COSMAN 4"

5 Band Switch Type Receiver

- No Plug-in Coils
- Continuous Band-spread
- Uses 2 New Metal Tubes
- Dynamic Speaker

Just the receiver for the "Ham", or short wave enthusiast. Incorporates all recent developments in its design. Provides a continuous tuning range of from 15 to 550 meters. NO SKIPS. Uses 2-6K7's, 1-43 and 1-25z5 tubes. Absolutely no plug-in coils are required for operation. Simply throw switch to any desired band.

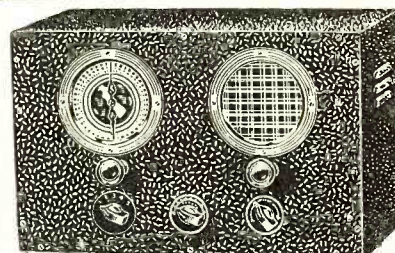

Complete kit of parts with instructions, less tubes and cabinet..... \$10.50
 Wiring and Testing..... \$2.50
 Set of Matched Sylvania Tubes..... 2.25
 All Metal Crystallized Hinged Cabinet..... 2.25

Paramount 4-Tube Portable Battery Super



No. AA. Complete with tubes and batteries..... \$18.95

A sensational new type of instrument. Light and compact. Carry it anywhere with you like a camera; on the golf course, hunting camp, fishing trip, on the train or in your automobile. Batteries and antenna are self contained. Has both shoulder strap and handle. Tunes from 170 to 550 meters. Extremely low battery drain. Uses 1-1AA, 1-1E4, 1-1A6 and 1-1F48 tubes. Size 9 1/2" x 8 1/2" x 4 1/2".

"Buddy Two" A.C.-D.C., S.W. Receiver

Operates on either A.C. or D.C. Makes use of 1-6J7 METAL TUBE, and 1-2A7 as a combined rectifier and pentode output tube. Furnished with four plug-in coils which tune from 15 to 200 meters. Additional coils to extend the tuning range of the "Buddy" down to 95 meters and up to 2000 meters are also available.

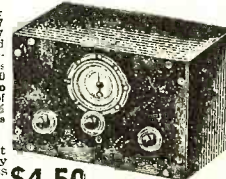

No. B2U Complete kit of parts for "Buddy 2" receiver, less tubes and cabinet..... \$4.50
 Wiring and Testing, Extra..... \$1.25
 Set of Matched Sylvania Tubes..... 1.95
 Crystallized Metal Cabinet..... .95
 Extra Set of Coils, 9 1/2-21 and 200 to 2000 Meters..... 1.75

TRY-MO RADIO CO., Inc., 85 Cortlandt St., N. Y. C.
 POWERTONE ELEC. CO., Inc., 179 Greenwich St., N. Y. C.

Ken-Rad Radio Tubes

THE KEN-RAD CORP., Inc., Owensboro, Ky.

Correspondence Courses in
RADIO and ELECTRICAL ENGINEERING
 ELECTRICAL ENGINEERING Covers complete electrical field. Most modern course. So simplified anyone can grasp quickly. Prepares you for better future. LOW COST.
 RADIO ENGINEERING Ultra-modern course in radio, public address, photo-electric work. Trains you to be super-service man, read vacuum tube technician. Diploma given. Tuition only \$25, either course. Deferred payment plan.
FREE! Send name quick for free copies of school catalogs, student magazines, etc. SEND NOW.
 Lincoln Engineering School, 857-K So. 37th St., Lincoln, Nebr.

"MIDGET" AUDIO COMPONENTS

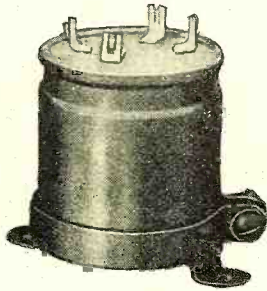

by
AMERTRAN
35 Standard Designs

Suitable for -80 db. to 0 db. operating levels. Shielded electromagnetically and electrostatically. Useful frequency range 20 to 20,000 cycles. Average weight, 3/4 oz. Cubic content, 2 1/4 cu. in.

These "Midget" Audio Components are manufactured to the usual careful specifications and quality standards indicative of all Amertran products.

Send for Bulletin 1003 which gives complete data on these remarkable units. It is also chock full of interesting information.

AMERICAN TRANSFORMER COMPANY

177 EMMET ST. NEWARK, N. J.

Send for Both

FREE

① POLITICAL P. A. SALES BULLETIN

② 136 PAGE CATALOG

RADIO'S LEADING SUPPLY GUIDE

Send for both! A punchy, sales-promoting Political P. A. Bulletin timed for the coming campaigns—and a great 136-page Radio Catalog featuring everything in Radio—sets, parts, books, tools, etc. Send for both—they're FREE and they're Hot! Write today.

ALLIED RADIO

833 W. Jackson Blvd. Dept. M
Chicago, Ill.

Send me your FREE Political P. A. Bulletin

Send me your FREE 136-Page Catalog

Name.....

Address.....

The DX Corner

(Broadcast Band)

(Continued from page 101)

Tasmania, is at present on 860 kc. instead of 820 kc.

Observer Chalmers (Invercargill, N. Z.): Please advise your DX readers that our station 4ZP does not verify chain programs or relays of church services. 4ZP is on a chain with 4YA on Wednesdays and Saturdays, 7:45-10 p.m. N. Z. time. H17G, on 20-meter amateur phone, sends out an excellent QSL card. Those hearing this station can obtain a card by sending a report to H. H. Gosling, Calle Cesar, Nicolas Penson, Santo Domingo, D. R.

Observer Jurd (Queensland, Australia): Australian 4TO shifted from 1170 kc. to 1080 kc. beginning March 12th. The Townsville Radio Listeners League of which I am Vice President and Publicity Officer is doing a good job in clearing up sources of man-made static. We have just completed our "detector" for locating interference and hope in the near future to make Townsville a much better place for radio reception. As a result of my request for correspondence which was published in the DX Corner of the February issue I received such a bundle of correspondence from America that I am afraid I shall have to engage a private secretary to help deal with it. Letters came from nine different states, all short-wave or broadcast band LPO's. I note that in the January issue several Observers reported the new Australian station 4QN. This was quite impossible as this station up to March 1st had not even been on the air for test purposes.



OBSERVER MEEHAN

Fortunately "Mort" Meehan of Elizabeth, N. J., is a much better DX'er than photographer. The wall behind the receiver is covered with veris, many of them foreign, but evidently they didn't impress the camera. The receiver is a Philco 16B.

The New Service Twins

(Continued from page 78)

This instrument alone will serve many purposes in radio work, including the observation of wave forms in amplifiers, frequency comparison, tracing of hum, checking modulation, measurement of r.f. or a.f. voltage, etc. When the tube is used without an amplifier, the sensitivity is approximately 28 volts r.m.s. per inch. With the amplifier full on and at audio-frequencies, the sensitivity is about .7 volt r.m.s. per inch.

To test its utility and versatility the oscillograph was put to work at various jobs in the Radio News Laboratory. For instance, a recheck was made of the harmonic distortion of the Radio News Amplifier (described in the February issue) and the amount of hum measured—a recheck which revealed that an output tube was below par.

Next the wave form of the standard audio oscillator used in the Lab was checked. For some time there had been a question as to whether it still retained its undistorted output. The test revealed that the wave form was good only as long as the grid-current of the oscillator tube did not rise above a certain value. So in the future, it is only necessary to observe this limitation in order to be assured of a sine wave.

Testing Wave Form

A beat-frequency oscillator under development in the Lab sounded fine but the oscillograph showed the wave form to be far from perfect. By a series of changes, checking with the oscillograph after each change, a sine wave was obtained. The only other way of determining wave form would be by means of a harmonic analyzer.

The r.f. oscillator described elsewhere in this issue was another instrument checked with the oscillograph. It, too, showed a nearly sine-wave output, almost entirely free from harmonics.

Measurements of audio frequency was performed successfully by means of Lissajous figures. The beat-frequency oscillator could be calibrated in this way. Previously there had been some discussion on how to do it with the help of tuning forks, pitch pipes or a piano, but the oscillograph proved the most practical and also more accurate.

Aligning Receivers

One of the most important applications of the cathode-ray tube is the aligning of receivers by means of the "Wobulator". The schematic of this instrument is shown in Figure 2. Briefly, it consists of an oscillator which works at 840 kc. heating with another oscillator which can be tuned. The 840 kc. oscillator, a section of the 6A7, is being varied 30 kc. (15 kc. either way)

by means of the relaxation oscillator V3, a type 885 tube, and the control tube, V4, a 76. The frequency of the relaxation oscillator can be interlocked with the 60 cycle power supply. The instrument supplies a signal which always sweeps 30 kc.

The variable oscillator, V1, can be modulated by the tube, V2. There are switches for cutting in and cutting out the modulation or the sweep.

When oscillograph, receiver and "Wobulator" are properly adjusted the oscillograph will show four peaks. Two of them are narrower than the others. The narrow ones, the "beacons," are obtained on the backstroke of the "Wobulator" and since the backstroke is so much faster than the forward stroke, these peaks appear compressed. One of the other peaks can now be centered on the screen, as in Figure 3. This is the normal resonance curve. The alignment of the receiver can then proceed, the result of each change being observed on the screen.

The distance between the beacons is more than 30 kc., so, in order to obtain a scale in kc. the image should be adjusted so that there are 6 divisions of the celluloid scale (this is supplied with the oscillograph) between two points X which are somewhat inside the beacons. Each division then represents 5 kc.

The "Wobulator" and the "Oscillator" were tried out in the Radio News laboratory by connecting them to a selective superheterodyne. The curve obtained proved to be quite narrow but unsymmetrical. Readjusting the i.f. trimmers resulted in increased sensitivity and selectivity, and a symmetrical curve. The foot of the curve appeared to be 15 kc. wide but the top was very sharp. This shape could be changed to something resembling a rectangle of about 12 kc. width by "staggering" the i.f. circuits. There was, of course, a loss in sensitivity when doing this. Instability in the receiver was also definitely shown during this test.

These tests leave no doubt as to the wide scope of usefulness of these two instruments in the laboratory, test room or service shop.

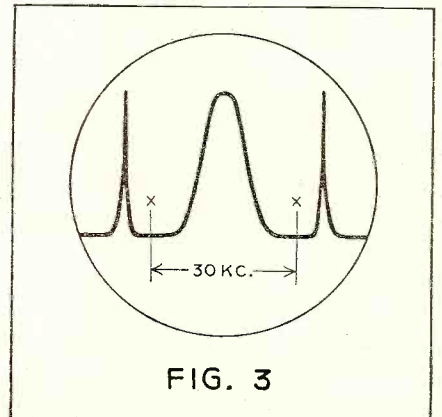

FIG. 3

Electricity

(Continued from page 107)

It can therefore be calibrated in amperes (or multiples or fractions thereof) and will measure current.

It is indeed a long way from this original experiment of interaction between an electric current and a magnetic field to the construction of a modern string galvanometer or a velocity microphone, such as is shown in Figure 4, but the principle involved is the same. In this microphone thin ribbons are suspended within the magnetic field. But "cutting" the lines of force in the magnetic field, electric current is developed in these ribbons as they move, which current is conducted by wires to the amplifier equipment—giving us hundreds of thousands of times the energy output of the original sound wave that moved the metal ribbon in the magnetic field.

This idea of cutting magnetic lines of force by a conductor is shown in Figure 5, in which the magnet is shown being inserted into a coil of wire. A magnet, as is known, is surrounded by what we call a magnetic field, such as is shown in Figure 6 at A and B, which at the same time show also the interaction of two magnetic fields upon each other. The coil, connected to a milliammeter, reads up to 20 milliamperes on each side of the scale. During the time the magnet is inserted, the milliammeter is deflected in one direction. If it is then held motionless, no current flows in the milliammeter. If the magnet is pulled out, the milliammeter shows current flowing in the opposite direction. The quicker we move the magnet, the stronger the needle is deflected; if we move the magnet very slowly, the deflection is minimized.

We see here that the electric current in addition to being proportionate to the force of the magnetic field (which we can readily see by inserting a stronger magnet in comparison with a weaker), is also determined by the factor of motion. The more lines of force cut per time unit, the stronger is the electromotive force developed in the conductor.

If we represent the magnetic flux in the closed magnetic field with the mathematical designation Φ_m , the total electromotive force, E (the voltage), will be the greater the bigger is the change of this flux per time unit, or to put it in clear mathematical form, $E = -\mu \frac{d\Phi_m}{dt}$, where μ is the factor of magnetic permeability.

This equation is one of the two famous equations of James Clerk Maxwell, which he developed mathematically in 1817. Simple as it appears, it has become of fundamental importance in electrical engineering. Its influence can be followed through the entire electromagnetic spectrum. It classifies, on one side, radiation in open space, such as radio waves, and is still valid down to electromagnetic waves of very short wavelengths, such as infra-red and visible light. It reaches its limitation only in atomic dimensions, where it no longer applies to empirical facts.

While the modern atomic and subatomic theories can no longer utilize directly the classical laws shown in Maxwell's equations or the theory of electrical dissociation, it is these wonders which have made possible radio and its allied sciences—based upon Maxwell's theories.

In Figure 7, for instance, is shown a most interesting apparatus designed by Professor Barkhausen showing the present theory of magnetism. A bar of steel placed in the center of the coil is magnetized and demagnetized by a moving horseshoe magnet near it, as shown at the right side of the picture. Various test bars are inserted in the coil. The latter is coupled to an amplifier which finally operates a loudspeaker. Thus any sudden change in the status of magnetization of the bar within the coil will be made audible.

If we bring the magnet near the bar at the right side, the magnetism within this core is not only changed continually, but at a certain point of approach of the permanent magnet to the iron bar a number of sudden clicks are heard in the loudspeaker. These clicks are sharper and must be made with a closer position of the magnet, the harder is the iron core. A soft magnet will give clicks that do not sound as hard and metallic. They occur also at a greater total distance of the magnet. The clicks are the result of turning around the tiny "processes" in the magnetic substance.

The clarity shown in the early experiments of Faraday can be found here again, except that the line of investigation has shifted from the exploration of visible, physical phenomena to research in this region which is beyond the reach of the most powerful microscopes. Here is indeed a clear example of how the methods for exploring the principles of electricity have shifted from gross material facts to the investigation of those phenomena that are not only descriptive but that try to get down to the fundamentals of matter itself. From the work with Henry's original magnet, which was sufficiently powerful so that the force of attraction produced had to

be measured with an arrangement of levers similar to a decimal scale of present-day construction (see Figure 8) to hearing the click of the individual molecule that elastically jumps into the polarity line-up of the sub-microscopic groups surrounding it, we have a completion of similar and original trains of thought. However, the tendency of physical research has shifted from the investigation of average action, of a main effect distributed around a Maxwell curve, to the investigation of the individual phenomena, the electron, the individual positron and neutron and the subjective action of a single iron molecule.

Osc. "Freq." Meter

(Continued from page 77)

desired, a 4-inch length of wire may be bent around the output terminal and curved over near the coil winding.

Lower frequencies may be covered by using simple, single-winding coils. No other changes will be required. The circuit is readily adaptable to band-spreading and to operation at much higher frequencies, if suitable chokes are used.

In spite of the fact that this oscillator uses a small tuning condenser (a "low C" circuit) its stability is nevertheless excellent, as indicated by the following description of tests made at W2JCR. The model shown in the photographs was turned on cold and turned to zero beat with the crystal-controlled carrier of WEA-F, 660 kc. During the following ten minutes the oscillator drifted very slowly through a range of only 200 cycles. At the end of this ten-minute period the oscillator was again tuned to zero beat and for the two hours following did not vary more than 60 cycles. At the end of this test the oscillator was turned off and everything was left without change until the following morning. When the oscillator was again turned on cold it was found to be 240 cycles off resonance but at the end of a ten-minute period had again arrived at a point within a few cycles of zero beat.

The foregoing test—and this test was borne out by numerous others—indicates that the maximum frequency variation encountered from a cold start was less than 300 cycles when tuned to a frequency of 660,000 cycles (660 kc.), or one part in 2200.

The stability of this oscillator can be still further improved by employing a "high C" tuning circuit. In the present model a wide tuning range was required for universal operation. However, if the constructor desires to use the oscillator in some particular ranges, as in covering the relatively narrow amateur bands, a fixed shunt capacity of at least 100 mmfd. could be employed. The fixed capacity value could be selected to provide the coverage or amount of band-spreading desired. The Harmlund plug-in coils have provision for mounting adjustable tank capacities within the coil. Either their type APC air condensers or type 1BT mica compression condensers fit these mounting holes. The former are available in capacities up to 100 mmfd. and the latter in capacities up to 220 mmfd., both with screw-driver adjustment. This plan cannot be used in the very high-frequency range because with such high capacity the inductance required would be too small to permit stable oscillation.

The Radio Beginner

(Continued from page 97)

would be reduced. The large by-pass condenser, C1, provides a very easy path for alternating currents and so practically nothing will be fed back to the grid.

The resistance coupling consists of the combination R4, C2 and R5. The plate current of the 6F5 passes through R4 and causes alternating voltages across it. Since the point E is held at a fixed potential (+300 volts), the voltage at D fluctuates. The ideal way of coupling would be to connect the grid of the next tube to D and the cathode to E, but unfortunately this is impractical, because the high plate voltage at D would likewise be applied to the 6B5 grid. C2, R4 and C6 may be considered in parallel with R5, with the result that the greater part of the signal voltage is also across R5. There is not much loss in the condenser coupling through C2 and C6 if the condensers are large enough. C6 is always large enough, but C2 has to be chosen so that its reactance is low compared to the resistance of R5. The reactance varies with frequency, so the calculation has to be made for the lowest frequency which has to be amplified.

On the other hand, C2 cannot be too large or a loud signal may make the grid of the 6B5 positive for a very short time. When this happens, the condenser C2 will be charged, making the grid negative and "blocking" the tube. The charge leaks off through the resistor R5. The

(Turn to page 123)

HAIL... THE NEW



Pocket D. C. VOLT-OHM-MILLIAMMETER-Model 735



DEALER PRICE \$10.80

- ★ Accurate to 2%
- ★ Molded Case
- ★ Selector Switch
- ★ With Test Leads and Two Alligator Clips

A SENSATIONAL DEVELOPMENT AT A SENSATIONAL PRICE

Here is the handy, general purpose instrument you have always wanted. . . . Precision built, D'Arsonval movement. . . . Accurate. . . . At the unbelievable price of \$10.80.

Slips in the coat pocket, provides all the D.C. measurements required by the radio serviceman. The selector switch makes operation as simple as the larger multimeters.

Reads D.C. 15-150-750 volts at 1000 ohms per volt; 1.5-15-150 Milliamperes; 5-1000 low ohms; 0-100,000 high ohms at 1.5 volts.



READRITE METER WORKS
815 College St., Bluffton, Ohio

Please send me more information on the Ranger-Examiner

Name

Address

City State



So Small!

MIDGET CAN Electrolytics



Ideal for crowded assemblies. • Smaller cans . . . larger capacities. Twice the capacity of former 1" dia. can units, for better filtering. Or height cut in half, for space-saving. • Hermetically sealed for longest life. Inverted mounting. Color-coded leads. • And so inexpensive!

Write for latest catalog covering complete line of condensers and resistors; also sample copy of monthly Research Worker.

ALEROVOX CORPORATION
78 Washington St. Brooklyn, N. Y.

You, too. Can become a **RELIABLE SPEED RADIO OPERATOR**
(LEARN AT HOME)

THE Candler System is the QUICK, EASY way to learn—whether you're a beginner or an amateur. Candler gives you the SHORT CUTS—its simplified system makes it EASY TO LEARN. The Junior Course for beginners—the Advanced Course for HIGH SPEED TELEGRAPHING. Gain more speed by following Candler principles of coordination—essential to High Speed Telegraphy. It's like playing a game—with the Candler System you learn scientifically! It teaches you SOUND SENSE quickly—Automatically. You will be astounded at your immediate progress—and marvel at the SPEED and ACCURACY that will soon be yours. Big FREE BOOK tells you the quickest way to become a FAST, RELIABLE Radio Operator. Don't delay—send for your copy TODAY.

TED McELROY,
Official Champion Radio Telegraph Operator of the World, Says:
"The Candler System is the quickest, easiest way I know of to become a top-notch Radio Telegraph Operator."



CANDLER SYSTEM CO.
Dept. N-3, Asheville, N. C.

MAC KEY AT \$7.95
finest speed key built

MAC OSC at \$3.95 ac/dc oscillator. Tone control.
MAC CORD \$1.00 navy spfn speed key cord.
MAC MARINE receiver 550-850 meters. r u into?
Few deluxe MAC KEYS at \$15.00 fm me di. Wri me.

T. R. McELROY, 23 Bayside St., Boston, Mass.
If u hv Mac Key wri me for xny ipt & dsrb inf.

RAYTHEON
TRADE-MARK
4-PILLAR RADIO TUBES

WHAT'S NEW IN RADIO

WILLIAM C. DORF

(Continued from page 71)

for the 8-inch model and as high as 13,000 lines for the 18-inch model. For the voice coil a special quartz-silicate ribbon has been developed; they also call attention to a new centering device in place of the conventional "spider" construction. A new polyfibrous material is used in the con-

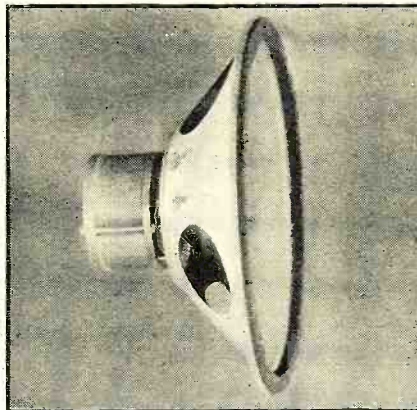

struction of the cone and the contour of the cone surface itself is made to conform to the exponential curve. Another feature of the speaker is in the "infinite baffle." The reproducer is designed to operate with the back completely enclosed.

Midget A. F. Transformers

A tiny audio-frequency transformer having an average net weight of only 3¼ ounces and measuring 1¾ inches in diameter by an overall height of 1¼ inches has just been announced by the American Transformer Company. It is especially applicable to small size, light-weight amplifiers for aircraft and portable service. The transformer is designed to have a fre-

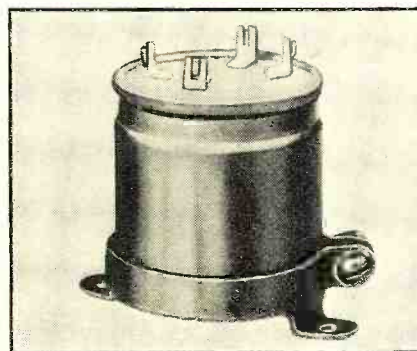

quency response uniform within close limits from 20 to 20,000 cycles. They are available in 35 standard designs for mixing, line-matching, line-to-grid, interstage, plate-to-line and audio reactor circuits. In addition to midget audio transformers, Amertran also offer small size audio-reactors, filter reactors, and plate-filament transformers.

New Wire-Wound Low-Ohmage Resistors

Economically priced, completely insulated wire-wound ½ and 1 watt resistors similar in size and appearance to the IRC metallized units have just been introduced by the International Resistance Company. They are available in values of 0.25 to 500 ohms for the ½ watt unit and 0.5 to 2000 ohms for the 1 watt resistor, respective measurements ⅝ inch and 1½ inches. Known as type "BW" resistor, it consists

of wire wound on a textile core of small diameter, to which wire leads are clamped under pressure for permanent contact and

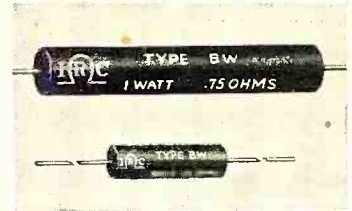

molded at high pressure in a special phenolic compound.

Tube Tester

The Readrite model 430 tube checker can test all glass, metal-glass and metal tubes for value and shorts under actual load conditions. A unique shadow type a.c. meter for line voltage adjustment is a feature of the instrument. The meter is direct reading with a good-bad scale. Testing is extremely simplified, requiring only four operations. Removable cover

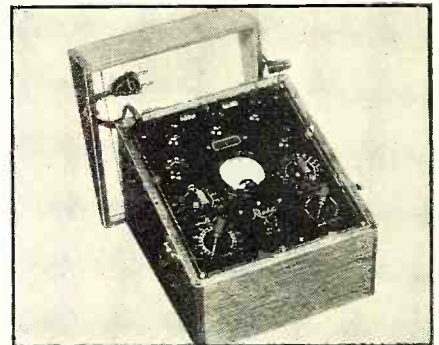

makes the instrument equally satisfactory for counter or portable use.

Announcing a New Switch

The Central Radio Laboratories have developed a new switching device for use in radio circuits where a low-loss, low capacity multi-section switch is required. It employs an Isolantite base to which are attached double-biting clips with low contact resistance. It is sturdily constructed to be free from all looseness or rocking. The switch is available in a multiplicity of types and can be supplied to meet individual requirements.

Two-Band Table Model

Sensitivity and selectivity are emphasized in this Sentinel a.c. operated table model receiver. It employs 5 tubes, covers both

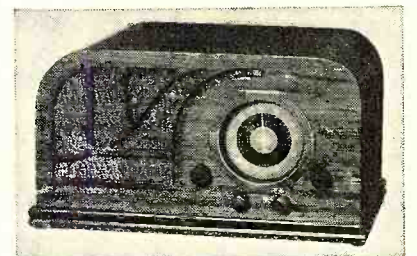

the standard broadcast band and police calls, has a large airplane type dial and makes an ideal set for installation in a bookcase.

Latest Auto Receiver

Illustrated below is the Howard 6-tube motor car set. This is a single-unit job

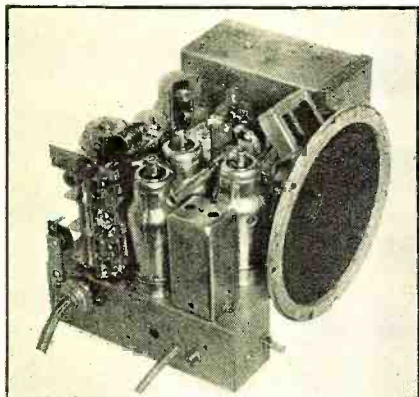

with receiver, power supply using a Mallory synchronous vibrator, and dynamic type speaker mounted on the one chassis. It has 2½ watts power output, incorporates variable tone control and adjustable antenna compensator, has rubber-mounted tuning condenser and is designed for easy installation and servicing. Special instrument panel controls are available to harmonize with the new automobiles.

Tube Checker

The Jackson tube tester model 435A has a large direct reading meter 3¾ inches in diameter, can test all tubes in present day use and is designed to take care of new tubes that may be introduced in the future.

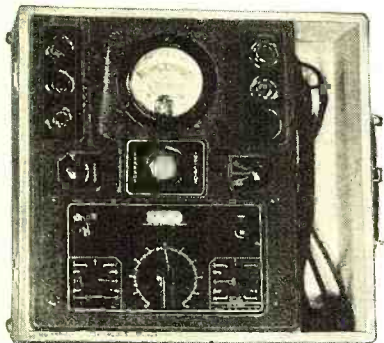

It incorporates a neon short and leakage testing circuit.

Extension Speaker

There are many occasions such as picnics, outings, etc., where an extension speaker operating from a motor car set, would be a welcome accessory to the festivities. To meet just such requirements Wright-DeCoster, Inc., has just brought out the model 930 automobile extension speaker, an 8-inch "Nokoil" permanent-magnet dynamic type reproducer requiring no exciting current. The cabinet housing the speaker is made of steel to withstand rough handling. It comes equipped with a



universal transformer to match all types of output tubes.

Volt-Ohm-Milliammeter

Servicemen and dealers looking for a universal testing instrument will be interested in hearing of the Triplett model 1200

combination volt-ohm and milliammeter with separate a.c. and d.c. meters. It incorporates a tilting feature for adjusting the instrument to proper alignment for correct readings. A.c. and d.c. voltage ranges provided are 0-10, 50, 250, 500 and 1000 volts; direct current ranges 0-1, 10,



50, and 250 ma. and resistance ranges, 1500 ohms, 1.5 and 3 megohms.

A New Transmitting Tube

The Taylor Tube Company introduces a new transmitting triode type T-55 for



ultra short-wave operation. It is designed to operate efficiently as low as 1 meter and provides 55 watts plate dissipation. The manufacturer calls attention to the use of carbon anodes, and of lava insulators which have a resistance of many million ohms to prevent losses at the higher frequencies.

Characteristics

- Filament Voltage.....7.5 Volts
- Filament Current.....3.25 ampere
- Maximum Plate Volts1250
- Maximum Plate Current.....125 Ma.
- Plate to Grid.....2.5 MMid.
- Grid to Filament.....1.7 MMid.
- Amplification Factor.....25
- UX250 Envelope
- Nonex Glass

Compact P. A. System

The portable 17 watt sound-system shown herewith is offered by the Webster Company. It is equipped with a desk-type crystal microphone, a 12-inch dynamic type speaker and features a mixing input circuit, high-gain, high-fidelity and a connection arrangement for an additional speaker. It operates from 110 volt, 60
(Continued on page 126)

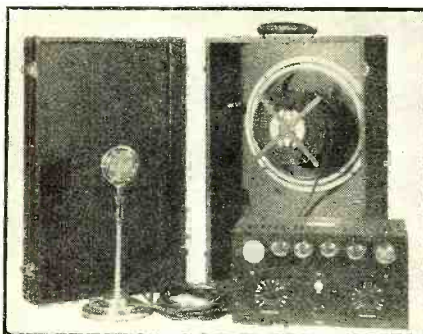

SAVE UP TO 50% DIRECT FROM MIDWEST FACTORY
Whole World Your Radio Playground
WITH NEW 1937 Super Deluxe
AIR TESTED MIDWEST



Only **MIDWEST** gives you **14 TUBES**
5 WAVE BANDS
11 to 2150 METERS
AUTOMATIC BAND SELECTION
SILENT VISUAL TUNING
AUTOMATIC AERIAL ADAPTION
SCORES OF OTHER FEATURES
and
30 DAYS FREE TRIAL

only **\$39.50** WITH NEW AUDITORIUM TYPE SPEAKER

TERMS AS LOW AS **10¢ A DAY**

EVERYWHERE, radio enthusiasts are praising this amazingly beautiful, bigger, better, more powerful, super selective ALL-WAVE 14-Tube 5-Band Radio. It will outperform \$100 to \$200 sets on a side-by-side test. Before you buy any radio, write for the new FREE 40-page 1937 Midwest catalog. **50 ADVANCED 1937 FEATURES** Scores of marvelous Midwest features, many of them exclusive, explain Midwest glorious tone realism, brilliant performance, and thrilling ALL-WAVE 5-band reception. Five tuning ranges make it easy to switch instantly from American programs . . . to Canadian, police, amateur, commercial, airplane and ship broadcasts . . . to fascinating foreign programs. No Middlemen's profits to pay. You buy at wholesale prices, direct from factory...saving 30% to 50%. You get 30 day's FREE trial...as little as 10c a day pays for your Midwest. You are triply protected with a One-Year, Foreign Reception, and Money-back Guarantees.



I AM PROUD OF MY MIDWEST... A REALLY FINE RADIO!
.....Richard Dix

MAIL COUPON TODAY for **Free 30-DAY TRIAL OFFER and 40-PAGE FOUR-COLOR Free CATALOG**

MIDWEST RADIO CORP.
Dept. B-11, Cincinnati, Ohio

Without obligation on my part, send me your new FREE catalog and complete details of your liberal 30-day FREE trial offer. This is NOT an order.

Name _____
Address _____
Town _____ State _____

GET ON THE LIST FOR THESE CATALOGS

WHOLESALE BUYERS' GUIDE OF
Hot Shot
Burstein-Applebee Co's Hot Shot
REFRIGERATION ELECTRICAL

Here are the four big catalogs sent to every Burstein-Applebee customer this year. Each catalog is brim full of latest information and lowest wholesale prices on Radio, Electrical and Refrigeration Equipment. Write today—get on the list.

BURSTEIN-APPLEBEE CO.
1012-14 McGee St., Kansas City, Mo.

CONTINUE YOUR EDUCATION
... do not allow adverse circumstances to deprive you of college training . . . intensive home-study instruction of college calibre in **RADIO ENGINEERING** will ensure you a future with professional status . . . prospectus upon request. Dept. R-2.
School of Communication Engineering
38-40 Park Place, Newark, N. J.

★ SUPER-SKYRIDER
★ ULTRA-SKYRIDER
★ SUPER-SEVEN
★ SKY BUDDY

★ America's leading Short Wave Receivers — ruler's of the Air!
 Short wave listeners everywhere are using these outstanding super-sensitive receivers to pull in any signal they want — with all the convenience of a standard broadcast receiver!
 No cumbersome plug-in coils — Iron Core I. F. Transformers — Micro-Vernier Dials — Electro-Mechanical Band Spread — Metal Tubes — these Case Hallicrafter engineered sets have all the features you've been looking for — at a price you can afford to pay. You don't know what real short wave reception can be until you've tried these receivers.
SEE THEM AT YOUR JOBBERS
 or Write **COMMUNICATION DIVISION of the Hallicrafters, Inc**
 MARION, INDIANA

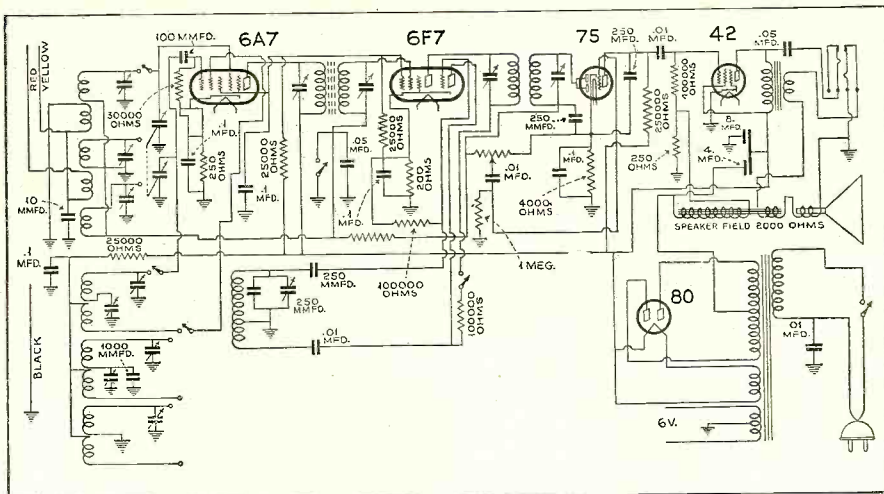

Communication Receiver

(Continued from page 90)

which is only 5 inches in diameter, seems to handle the 3 watts output of the 42 tube with very little distortion.

"After my first excitement had died down a little bit I took a peck inside the receiver and noticed the set used a 6A7 tube as the first detector-mixer, a 6F7 tube as the beat oscillator—first i. e. a 75 diode detector-a.v.c., a 42 tube as the output with an 80 type tube as the rectifier. "In regard to calibration, I found that the

band-spread was very good as on 80 meters every division represents 3.13 kc.; on 160 meters every division is 1.8 kc.; on 40 meters every division equals 4.6 kc. and on 20 meters every division equals 8 kc. The automatic volume control can be cut in-and-out, with a switch, as can the beat-frequency oscillator which also has a pitch control for varying the beat note. This is excellent for c.w. There is also a phone jack in which a pair of phones can be plugged for headphone reception. Provision is made for using a doublet antenna or for a long single wire antenna. I have found the sensitivity excellent and the selectivity was also O.K.

During the three days I had the set in my shack I sure had a lot of fun with it and seemed to be able to pull in about anything I went after, in the way of c.w. or phone reception, and it sure looks nice sitting there so compact and easy to handle.

Learn the Code

(Continued from page 113)

just as you like; let the numerals go until you have mastered the alphabet. Hand the printed dith dahs over to some fellow sufferer and have him skip around and call out characters for you to respond to in song. It's pleasant, like doing a cross-word puzzle, and you'll find yourself repeating the signals over and over, whether you be president of Amalgamated Mushrooms or Johnny Clerk; and you both can expect and get just as much ultimate pleasure out of knowing the code as the rest of us.

You don't have to have telegraph keys, buzzers, oscillators and batteries to learn the code. Start today and make your voice the buzzer and your lips and tongue the key. In this manner the characters, diths and dahs, are more quickly and lastingly impressed on the brain and the sound is conveyed with directness and realism to the ears. Later on if you like, you can equip yourself with a telegraph key and buzzer or oscillator. If you use the dot-and-dash method you'll find yourself counting the number of dots and dashes to make the characters, and if you have to hesitate, see it in your mind's eye, take your mental pencil and point out each dot and dash, you'll find yourself greatly hampered and soon you'll give up in disgust at your slow progress.

Perhaps by now you are settling down to copy all the code you hear. All right, good, but tune until you can find some slow signal. They're there, especially between 8000 and 9000 kilocycles on your receiver dial. Just listen without trying to put anything on paper. After a moment you'll single out individual characters. Try listening for some predetermined letter and confine your efforts to recognition of that particular sound. You'll find that in a remarkably short time you can recognize that selected character without any trouble at all. Just watch the individual characters; never mind the words and sentences, they'll come later. It's not work, it's fun; get a group together—father, son, and all the youngsters and oldsters in the neighborhood, a boy scout troop—it doesn't matter, but do get in line for the fun you can get out of such little and pleasant effort.

from one to three months, depending on the amount of use. It is desirable from the standpoint of battery life to keep as much of the resistance of the rheostat in the circuit as possible. It so happens that as the rheostat resistance is increased, the oscillator tone frequency increases and the current consumption decreases. This is a fortunate combination, because most code learners prefer a high-pitched tone and in adjusting the rheostat to provide this the battery current consumption decreases automatically.

This little oscillator is also excellent for i.c.w. when used in conjunction with a transmitter operating on the 5-meter band. It may be coupled to a microphone transformer by simply connecting the input winding of the microphone transformer in series with the key. When used this way the oscillator is working into only 200 ohms and as a result of the poor impedance match, it may not be capable of properly modulating the transmitter, due to lack of sufficient gain in the speech amplifier. In that event the oscillator can be coupled direct to the grid of the first speech-amplifier tube by simply connecting a .1 mfd. condenser between the oscillator plate and the grid of this speech amplifier tube. This provides a better impedance match and therefore a greater transfer of energy from the oscillator to the speech amplifier. Another alternative if it is desired to couple through the microphone transformer is to add a 22½-volt battery in the oscillator plate circuit. This provides enough additional "hop" to compensate for inadequate gain in the speech amplifier.

S. W. Station List

(Continued from last month)

AFRICA

ANGOLA

Location	Call	Meters	Kc.	Class
Lobita	CR6AA	41.80	7,177	B, P

BELGIAN CONGO

Leopoldville	OPL	14.97	20,040	P
Leopoldville	OPM	29.59	10,140	P

CANARY ISLANDS

Santa Cruz, Tenerife	EA8AB	41.71	7,210	B
----------------------	-------	-------	-------	---

EGYPT

Abu Zabal	SUV	29.84	10,055	P
Abu Zabal	SUX	38.13	7,867	P
Abu Zabal	SUZ	21.72	13,811	P

Code Oscillator

(Continued from page 93)

mortality runs high. With the pilot light to act as a reminder to turn the oscillator off when not in use, the single 4½-volt C battery should last

Be a TELEVISION EXPERT

LEARN TELEVISION with RADIO-NOW!

Great opportunity for experts in this amazing new industry. Recent developments in radio make television a certainty NOW. We teach you by our "on the job" method Radio and Television from beginning to end in our marvelously equipped labs and studios. You actually operate thousands of dollars worth of expensive equipment. You get expert instruction and skillful guidance by radio-television specialists.

Demand for Television Experts

Television now perfected and ready for the market ON THE NEXT BIG BUYING WAVE. Business leaders predict new system television will require thousands of relay and broadcasting stations. Ultra-short waves will permit eighty thousand television stations in America alone.

GET IN NOW and "build up" with the world's next billion-dollar industry.

6 MONTHS THROUGH PRACTICAL TRAINING

Qualifies for radio-phonograph license (1st Class). Complete up-to-the-minute training on modern "workable" television equipment including the new cathodray. Practical experience in studio control room. Transmitter operation of Television Station W9XAL. Employment and while training and upon graduation. Write for free book "Pictures On the Air" NOW!

S. Q. NOEL, Pres. First National Television, Inc.

Dept. D-8 Power & Light Bldg., Kansas City, Mo. Without obligation, send me postpaid FREE Illustrated Book—"Pictures On the Air", telling about new opportunities in television. I am 17 years or older.

Name _____
 Address _____

Buy Direct From the Manufacturer AND SAVE BIG MONEY!

WRITE FOR FREE CATALOG FOR Radio Sets • Parts • P.A. Amplifiers

We Specialize in Manufacture of

AMPLIFIER SYSTEMS

REMINGTON RADIO & ELECTRIC CORP. 106 N 7th Ave. New York, N. Y.

ETHIOPIA			
Location	Call	Meters	Kc. Class
Addis Ababa	ETA	16.42	18,270 P
Addis Ababa	ETB	25.09	11,935 P
Addis Ababa	ETD	39.37	7,620 P
Addis Ababa	ETG	51.02	5,880 P

KENYA			
Location	Call	Meters	Kc. Class
Nairobi	VQ7EO	49.32	6,083 B

MADAGASCAR			
Location	Call	Meters	Kc. Class
Tananarive	FU	50.45	5,946 B

MOZAMBIQUE			
Location	Call	Meters	Kc. Class
Lourenço Marques	CR7AA	48.89	6,136 B
Lourenço Marques	CR7AA	84.67	3,543 B

MOROCCO			
Location	Call	Meters	Kc. Class
Rabat	CNR	23.38	12,830 B
Rabat	CNR	37.34	8,035 B

SOUTHERN RHODESIA			
Location	Call	Meters	Kc. Class
Bulawayo	ZEB	45.52	6,590 P
Bulawayo	ZEB	49.02	6,120 P
Salisbury	ZEA	45.52	6,590 P
Salisbury	ZEC	50.00	6,000 B

UNION OF SOUTH AFRICA			
Location	Call	Meters	Kc. Class
Johannesburg	ZTJ	49.20	6,098 B
Kliphoeuveld	ZSS	15.88	18,890 P

ASIA			
CHINA			
Location	Call	Meters	Kc. Class
Hong-Kong	ZBW	34.29	8,750 B
Hong-Kong	ZBW	55.45	5,410 B
Macao	CON	49.37	6,073 B
Nanking	NGOX	31.58	9,500 B
Shanghai	NGBA	15.92	21,550 B
Shanghai	NGBB	16.86	17,790 P
Shanghai	NGBD	31.31	9,580 P
Shanghai	NGO	39.58	7,580E, P
Shanghai	NGR	26.00	11,540 P
Shanghai	NGW	28.79	10,420 P
Shanghai	XQAJ	53.00	5,660 B

DUTCH EAST INDIES			
Location	Call	Meters	Kc. Class
Bandjermasin	YDV2	92.88	3,330 B
Borneo			
Makassar, Celebes	PNI	34.18	8,775 P, B
Bandoeng, Java	PLE	15.93	18,830 P
Bandoeng, Java	PLG	18.81	12,950 P
Bandoeng, Java	PLP	27.27	11,000 P, B
Bandoeng, Java	PLV	31.86	9,415 P, B
Bandoeng, Java	PMA	15.51	19,345 P, B
Bandoeng, Java	PMB	14.56	20,610 P
Bandoeng, Java	PMC	16.55	18,135 P
Bandoeng, Java	PMN	29.24	10,260 P, B
Bandoeng, Java	PMY	58.03	5,170 B
Bandoeng, Java	YDA5	49.02	6,120 B
Sourabaya, Java	YDB	31.12	9,640 B
Tandjongpriok, Java	YDA	49.67	6,010 B
Tandjongpriok, Java	YDA	98.68	3,040 B
Medan, Sumatra	YBF	30.21	9,930 P
Medan, Sumatra	YBG	28.76	10,430 P
Medan, Sumatra	YBJ	24.61	12,190 P
Medan, Sumatra	YDU2	63.69	4,710 B
Medan, Sumatra	YDU3	57.03	5,260 B

FEDERATED MALAY STATES			
Location	Call	Meters	Kc. Class
Kuala Lumpur	ZGE	48.92	6,132 B
Singapore	ZHI	49.85	6,018 B

FORMOSA			
Location	Call	Meters	Kc. Class
Tyureki	JIA	19.05	15,750 P
Tyureki	JIB	28.48	10,535 P
Tyureki	JIC	50.93	5,890 P

INDIA			
Location	Call	Meters	Kc. Class
Bombay	VUY (VUB)	31.36	9,565 B
Calcutta	VUC	49.10	6,110 B
Colombo, Ceylon		49.26	6,090 B
Kirkee	VWV	17.16	17,380 P
Kirkee	VWV	33.43	8,975 P

FRENCH INDO-CHINA			
Location	Call	Meters	Kc. Class
Saigon	FZR3	18.50	16,214 P
Saigon	FZS	16.38	18,310 P
Saigon	FZS2	25.02	11,991 P
Saigon	F31CD	31.51	9,520 P

IRAQ			
Location	Call	Meters	Kc. Class
Bagdad	YID	67.11	4,470 B

JAPAN			
Location	Call	Meters	Kc. Class
Kagoshima	JBK	32.89	9,120 P
Kemikawa-cho	JVK	22.04	13,610 B, E
Kemikawa-cho	JYR	38.07	7,880 B
Kemikawa-cho	JVS	30.49	9,840 B, E
Kemikawa-cho	JYT	19.04	15,760 B, E
Nazaki	JVA	15.86	18,910 P, B
Nazaki	JVB	16.49	18,190 P, B
Nazaki	JVC	15.75	19,050 P
Nazaki	JVD	18.92	15,860 P
Nazaki	JVE	19.16	15,660 P

Location	Call	Meters	Kc. Class
Nazaki	JVF	19.21	15,620 P
Nazaki	JVG	20.12	14,910 P, B
Nazaki	JVH	20.55	14,600 P, B
Nazaki	JVI	22.12	13,560 P, B
Nazaki	JVL	23.73	11,660 P, B
Nazaki	JVM	27.93	10,740 P
Nazaki	JVN	28.14	10,660 P
Nazaki	JVO	28.92	10,375 P, B
Nazaki	JVP	39.95	7,510 P
Nazaki	JVQ	40.16	7,470 P, B
Nazaki	JVT	44.44	6,750 P, B
Nazaki	JVU	51.81	5,790 P, B
Nazaki	JVV	52.36	5,730 P, B
Nazaki	JZD	17.74	16,910 P
Nazaki	JZE	23.04	13,020 P
Nazaki	JZF	35.29	8,500 P
Nazaki	JZG	47.39	6,330 P

MANCHUKUO, MANCHURIA			
Location	Call	Meters	Kc. Class
Kanjoshi	JZA	19.13	15,680 P
Kanjoshi	TDD (JZC)	51.46	5,830 P
Kanjoshi	TDE (JZB)	29.81	10,065 P
Dairen	JDY	30.23	9,925 P
Dairen	JDZ	52.54	5,710 P

SIAM			
Location	Call	Meters	Kc. Class
Bangkok	HJSJ	37.41	8,020 P
Bangkok	HSP	16.91	17,740 P
Bangkok	HSP2	31.12	9,640 B
Bangkok	HSP2	31.58	9,500 B

SIBERIA			
Location	Call	Meters	Kc. Class
Irkutsk	RSZ	34.21	8,770 P
Khabarovsk	RV15	35.00	8,570 B
Khabarovsk	RV15	70.21	4,273 B
Sverdlovsk	ROI	54.64	5,490 P
Sverdlovsk	RSN	55.15	5,440 P

STRAITS SETTLEMENTS			
Location	Call	Meters	Kc. Class
Penang	ZHJ	39.32	7,630 B
Penang	ZHI	49.34	6,080 B

The Transceptor

(Continued from page 73)

transmitting position, it also opens the filament to the receiving tube V-1, thus preventing additional modulation of the transmitter by incoming signals. Resistors are provided in the filament circuit to compensate for the slight voltage differences that occur between the receiving and transmitting circuit combinations. A 500,000-ohm potentiometer connected across the secondary to transformer T-1 operates as a volume control in the receive position, and as a microphone "gain" control in the transmit position. A separate 100,000-ohm variable resistor in the plate circuit to tube V-1 functions as a regeneration control.

As the front view of the Transceptor indicates, separate tuning controls are provided for transmitter and receiver tuning. It is therefore possible to adjust the transmitter for maximum efficiency on any frequency and then to cover the entire band with the separate receiver control. That this is a huge improvement over ordinary transceiver operation will be readily evident to any person who has had experience with instruments of the latter type.

The inside view of the Transceptor shows the neat and simple distribution of the various parts. The hand-set is shown in its own special compartment at the left, with tip jacks provided for quick connection. There are no loose cords of any kind hanging from the front panel to interfere with the tuning manipulations. The left section of the chassis contains the receiver tube V-1 and its own tuning system comprising a space-wound coil, and a tiny 10 mmfd. variable capacitor; beyond the partition (to the right) are tubes V-2, V-3 and V-4, and the heavy copper tubing, comprising the tank circuit of the push-pull oscillator. In the schematic diagram the dotted lines indicate insulated wire pulled through the tubing. This insulated coil represents the grid inductor, while the copper tubing is the plate inductor. Snap clips attached to the tank coil are run through fixed condensers to a pair of binding posts on the front panel for eventual connection to any of the usual types of 5-meter antenna. The audio units and assorted fixed resistors and capacitors are placed on the under-side of the chassis. The dry cells required for filament, grid, plate and microphone current supply fit snugly inside the bottom of the case.

The Transceptor illustrated, is a 2-volt battery model. Another model, which is undergoing completion, will use the identical mechanical layout with the 2-volt tubes replaced by tubes of the 6.3-volt series.

This Transceptor has undergone thorough field tests and has proved to be exceptionally successful in all respects. Its mechanical construction and electrical design will appeal instantly both to the experienced 5-meter operator who has wrestled with ordinary transceivers, and to the beginner who wants to get started on 5-meters with a versatile instrument of low cost.—Frank Lester, Engineer, Wholesale Radio Service.

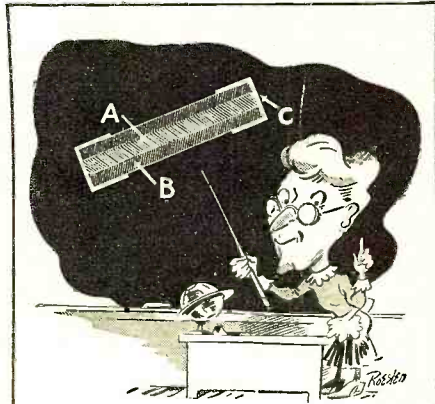

The ABC of Sturdy Resistors

- A.** Center core of resistance material is surrounded by a dense shock-proof ceramic, providing strength and protection against humidity.
- B.** Cone and jacket are fired together at 2500 degrees F. into a single, solid unit, hard and durable as stone.
- C.** Pure copper covers the resistor end for wire lead contact. Contact to the resistance material is at the extreme ends only, providing uniform resistance and load distribution over entire length. End contacts do not short circuit part of resistance as in other types.



Every Radio Service Man should be a member of the Institute of Radio Service Men

Centralab

MILWAUKEE, WIS.

British Centralab, Ltd. | Canterbury Rd., Kilburn | London N. W. 6, England
 Centralab | 68-70 Rue Amelot | Paris, France

The New

BELphone

for

A COMPLETE INTRA-DEPARTMENT COMMUNICATING SYSTEM

as little as \$39.50

RADIO MEN! Here's a real opportunity for real profits. Write today for full details.

BELL SOUND SYSTEMS, Inc.
 61-68 East Goodale Street | Columbus, Ohio

RADIO ENGINEERING

RCA Institutes offers an intensive course of high standard embracing all phases of Radio. Practical training with modern equipment at New York and Chicago schools. Also specialized courses and Home Study Courses under "No obligation" plan. Catalog Dept. RR-36.

RCA INSTITUTES, Inc.

75 Varick St., New York | 1154 Merchandise Mart, Chicago
 Recognized Standard in Radio Instruction Since 1909.

Save Dollars on Radios

30 DAY TRIAL

Many models to select from. Factory prices. A. C. - D. C. All Wave, farm, car and new metal tube models. Public Address and Communication System. Send for new 1936 bargain catalog free.

Autocrat Radio Company
 3855 North Hamilton Avenue
 Dept. 500 | Chicago, Illinois

BRUSH Spherical Microphone



For remote pickup, "P.A.," commercial interstation and amateur use. Low in price... but built to Brush's traditionally high mechanical and electrical standards. Wide frequency response. Non-directional. No diaphragms. No distortion from close speaking. Trouble-free operation. No button current and no input transformer to cause hum. Beautifully finished in dull chromium. Size only 2 1/2 inches in diameter. Weight 5 oz. Output level minus 66 D.B. Locking type plug and socket connector for either suspension or stand mounting at no extra cost. Full details, Data Sheet No. 13. Free. Send for one.

BRUSH Lapel Microphone



For after dinner and convention speakers, lecturers, etc. Gives great mobility. The smallest, lightest microphone on the market. Size 1 1/2 x 1 1/4 x 3/8. Weight with coat attachment less than 1 oz. Special internal construction and rubber jacketed outer case insure quiet operation. No interference from breathing noises, etc. Typical Brush sound cell response and trouble-free operation. Details on request.

BRUSH DEVELOPERS COMPANY
 1890 E 40th St. CLEVELAND, O.
 MICROPHONES • MIKE STANDS • TWEETERS • HEAD PHONES • LOUD SPEAKERS

CORNISH WIRE CO., Inc. \$6.75
 30 Church Street, New York City

NOISE-MASTER
 For quiet, noise free reception (both shortwave and broadcast) have a "NOISE-MASTER" installed by a qualified service man. Stick to antenna products designed by specialists. Complete literature on request.

PASS CODE EXAMS
 You can do it easily by learning with INSTRUCTOGRAPH Code Teacher, the most practical way to learn accurately, and improve speed. Practice at your convenience, at any speed desired. Choice of two models. Buy or Rent. Send post-card for complete details now—
Instructograph Company
 Dept. NR-8
 912 Lakeside Place, Chicago, Ill.
 Representatives for Canada-Toronto Radio College of Canada, Ltd., 863 Bay St.

RADIOS.. SAVE UP TO 50%

Deal Direct! Factory Prices. Many models to select from! AC-DC, All-wave, Fern, Car and new Metal Tube Models. Your name and address on postcard brings you NEW to price 1936 Bargain Catalog in color FREE. Get details of 30-DAY TRIAL plan and Agent-Cler presentation.

Goldentone Radio Co., Dept. 299, 8780 Grand River, Detroit, Mich.

RADIO ENGINEERING

broadcasting, aviation and police radio, servicing, marine radio telegraphy and telephony, Morse telegraphy and railway accounting taught thoroughly. Engineering course of nine months' duration equivalent to three years of college radio work. School established 1874. All expenses low. Catalog free.

Dodge's Institute, Oak St., Valparaiso, Indiana

Town and Country Receiver

(Continued from page 75)

As the chassis of this receiver is grounded to one side of the line an external ground connection must not be used. The antenna circuit is insulated from the line by the stopping condenser C29, and is therefore entirely safe to handle.

Although broadcast stations can be used in aligning the tuned circuits a service oscillator is to be preferred. If an a.c.-d.c. type is used, do not use the ground connection.

Align the i.f. transformers first. To do this, remove the clip from the antenna and clip it onto any part of the chassis. Connect the output of the test oscillator between the first detector control grid and chassis. Tune the service oscillator to 175 kc. and adjust the signal input until the tuning meter swings only slightly to the right of its normal no-signal position. Now adjust four condensers in the two i.f. transformer shields for greatest swing of the meter. Begin with the fourth, counting from left to right on the circuit diagram, (Figure 1) and work back to the first. Check over the adjustments twice more and then proceed to the r.f. and oscillator adjustments.

Tune the service oscillator to 1400 kc. and connect to the antenna terminal and chassis. Adjust the trimmer condensers, one of which will be found on each section of the gang con-

- C14—Acratest tubular paper condenser, .01 mfd., 200 volt
- C15—Acratest tubular paper condenser, .006 mfd., 200 volt.
- C17, C21—Acratest moulded mica condenser, .0002 mfd.
- C18—Acratest moulded mica condenser, .00065 mfd.
- C19—Acratest moulded mica condenser, .001 mfd.
- C20—Hammerlund Star midget variable condenser, 20 mmfd.
- C23, C24—Aerovox electrolytic condenser, 10 mfd., 25 volts, d.c.
- C25, C26—Edison cardboard electrolytic condenser, 175 volts (working voltage) C25 being 24 mfd. and C26 16 mfd.
- C27—2 Edison cardboard electrolytic condensers in parallel 8 mfd., 175 volts
- C28—Acratest compression type padding condenser, 94-419 mfd.
- C29, C30—Mica condensers, .002 mfd.
- CH1—Acratest heavy duty filter choke, 100 ohms, 150 ma.
- CH2—Acratest midget filter choke, 200 ohms, 50 ma.
- IFT1, IFT2—Gen-Win i.f. transformers, 175 kc.
- OT—Sickles oscillation transformer 175 kc (for .000365 mfd. condenser)
- R1—Electrad type A 10 watt, 100 ohms, cut down to 91 ohms
- R2—Power cord resistor, 140 ohms
- R3—Acratest, 12,000 ohms, 10 watt
- R4—Acratest, 18,000 ohms, 1/4 watt
- R5—Acratest, 300 ohms, 1/2 watt
- R6, R15—Acratest, 2000 ohms, 1/2 watt
- R7—Acratest, 200 ohms, 1/2 watt
- R8, R9, R10, R11, R12—Acratest, .5 meg., 1/4 watt

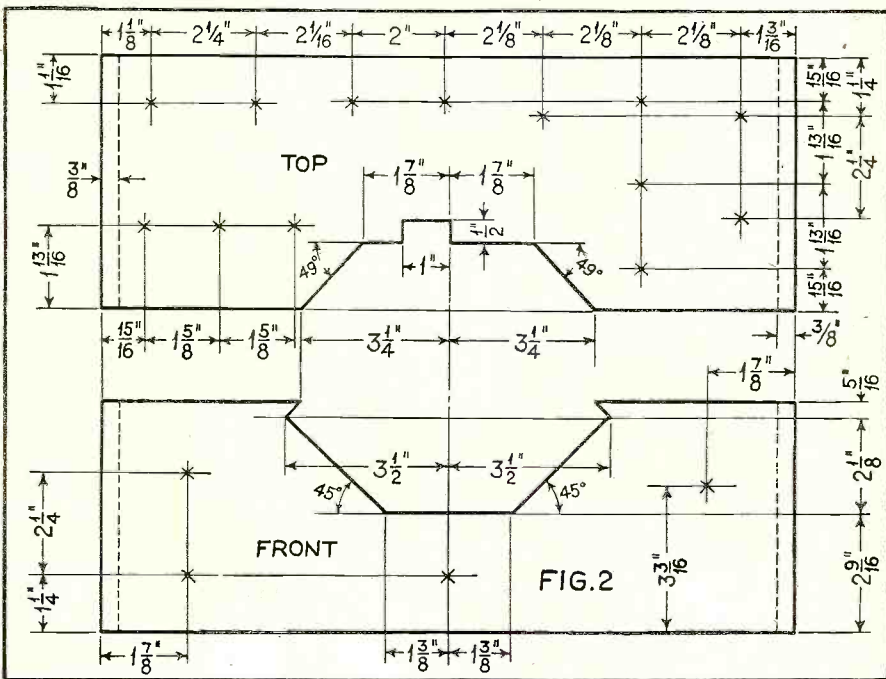

denser, until maximum swing of the tuning meter occurs about twenty divisions from the end of the dial. The trimmer across the first section of the gang condenser should be set at minimum capacity as the panel-controlled midget condenser C20 acts as trimmer for this section.

Next set the service oscillator to 600 kc. Adjust only the oscillator padding condenser C28, at the same time turning the dial of the receiver back and forth through the signal until the greatest swing of the tuning meter is obtained. Repeat the 1400 kc. adjustment of the oscillator trimmer to compensate for any change caused by adjustment of C28.

It might be mentioned that every one who has heard this little receiver in operation has made some very complimentary remarks. The stations come swishing in with plenty of power and when tuned to greatest swing of the meter the background noise is suddenly quieted due to the a.v.c. action. There is real satisfaction in operating a receiver with two tuner r.f. stages ahead of the first detector, especially as there is not a squeal in this set.

Parts List

- C1, C2, C3, C4—General Instrument variable condensers—4-gang—.000365 mfd. with 3/8 inch shaft, all sections alike
- C5, C6, C7, C9, C10, C11, C12, C13—Acratest tubular paper condensers, .1 mfd., 200 volts
- C8, C16, C22—Tubular paper condensers, .05 mfd., 600 volt

- R13—Acratest, 60,000 ohm, 1/4 watt
- R14, R19—Centralab volume controls, with switch; .5 meg., taper #6
- R16—Acratest, .25 meg., 1/2 watt
- R17—Acratest, 38,000 ohm, 1/4 watt
- R18—Acratest, 2500 ohms, 1/2 watt
- R20—Acratest, 200 ohms, 1/2 watt
- R21—Acratest, 1500 ohms, 1 watt
- RFT1—Sickles antenna transformer
- RFT2, RFT3—Sickles r.f. transformers Sw1—On-off switch (on volume control)
- Sw2—Silent tuning switch (on tone control)
- T11—Dial bulb, 6 volts, .1 ampere, with bracket
- TR1—Acratest input push-pull transformer—large core
- TR2—(Supplied with speaker)
- 1 Readrite tuning meter
- 1 Aluminum chassis
- 1 Ansley suit-case type cabinet 15 1/2 in. long, 11 inches high, 6 inches deep, inside dim.
- 1 8-inch Magnovox dynamic speaker with 2000-ohm field, equipped with output transformer for push-pull 48 tubes and hold-down hardware
- 1 Airplane dial 2 3/8 inches outside diameter
- 1 Pointer knobs
- 1 tuning knob
- 4 Aluminum tube shields
- 10 Eby wafer sockets
- Fs—2 amp. auto fuse and holder
- 1 Mueller No. 45 clip for aerial
- 1 roll of push-back hook-up wire
- Miscellaneous hardware, including machine screws, nuts, washers, rubber grommets, variable condenser cushion mounting assembly, etc.

The Radio Beginner

(Continued from page 117)

larger C2 and the larger R5, the longer it will take before the charge has disappeared and the tube is working again. The values must be chosen so as to make the blocking time very short. In the example of Figure 1, it will be one-twentieth of a second.

The story of the 6B5 is much too long to be told in this article. The tube was chosen because it does its work well and because it requires the simplest circuit. It is best to consider that it consists of two coupled triodes. The bias for the tubes is developed automatically inside the tube.

The power tube drives the speaker voice coil

- C3—Aerovox tubular paper condenser, type 484, .01 mfd., 400 volts
- C4—Aerovox dry electrolytic condenser, type GL, 8 mfd., 525 volts
- C5, C6—Aerovox dual dry electrolytic condenser, type GGL, 8-8 mfd., 525 volts
- R1—Electrad volume control, type 203, 500,000 ohms
- R2—Electrad tone control, type 242, 100,000 ohms
- R3—IRC carbon resistor, 2500 ohms, 1/2 watt
- R4—IRC carbon resistor, 1/4 megohm, 1/2 watt
- R5—IRC carbon resistor, 1/2 megohm, 1/2 watt
- R6—Electrad variobm, 25,000 ohms, 75 watts
- T1—Thordarson power transformer, type T7062
- CH—Thordarson power choke, type T1607, 15 henries, 85 ma.
- Wright-DeCoster 10-inch dynamic speaker, model 820-B (speaker field 1800 ohms, transformer primary 7000 ohms)
- 1 four-prong, 1 five-prong, 1 six-prong and 2

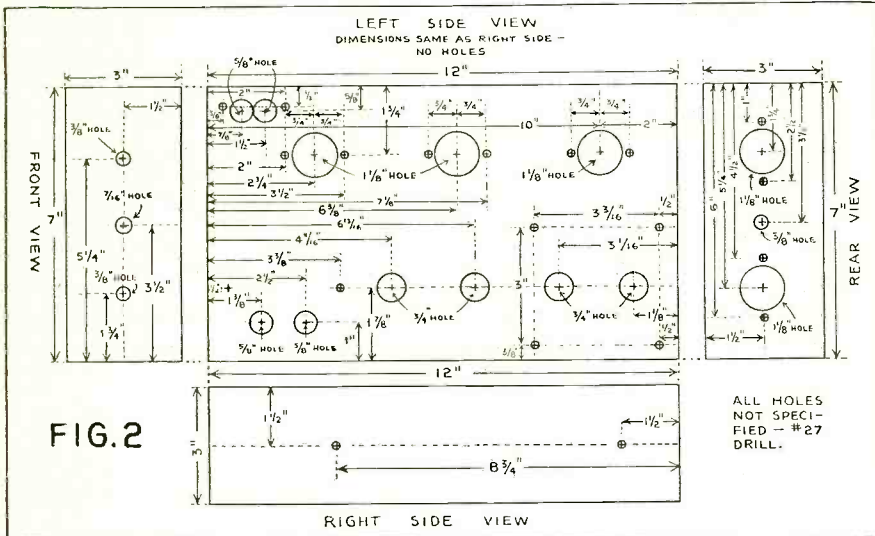

through a transformer. The voice coil consists of a few turns of heavy wire and therefore offers a relatively low resistance. For efficient operation this must be matched to the higher output resistance of the tube. The output transformer, included in the speaker, performs this function.

The next installment will give constructional data on this unit; also a discussion of the tone control (C3 and R2). For those who wish to acquire the parts for this unit, a parts list follows. The drilling specifications of the chassis are given in Figure 2.

Parts List

- C1—Aerovox electrolytic condenser, type PR50, 10 mfd., 50 volts
- C2—Aerovox tubular paper condenser, type 484, .1 mfd., 400 volts

- octal wafer type sockets. Mounting centers 1 1/2 inch
- ICA cadmium-plated steel chassis 12 x 7 x 3 inches high, type 1527, blank or drilled
- SW1—ICA toggle switch, type 1230
- 2 ICA bakelite pointer knobs, type 1155
- 1 ICA terminal strip marked "INPUT," type 2417
- E ICA fuse mounting, type 2340
- 1 Littelfuse 2 amp. fuse
- 2 lug terminal strips, each having 2 terminals
- 1 small grid-clip (for metal tubes)
- 1 rubber grommet for 3/8-inch hole
- 1 line plug and 5 feet of line cord
- Bolts, nuts, washers, soldering lugs, push-back wire
- 1 6F5 tube
- 1 6B5 tube
- 1 5Z4 tube

The Radio Workshop

(Continued from page 99)

the plate and one of the jaws of the clothes pins as shown. A No. 6-32 machine screw is inserted and secured by a nut, and to this is attached a flexible connecting lead.

If used for storage battery clips, the face plate should be made from lead or lead-coated metal.

J. M. NIGHSWANDER,
Eugene, Oregon.

Better Trained Servicemen Needed

By Arthur G. Mohaupt

The ever increasing complexity of radio-receiver circuit systems has practically wiped out the "attic set builder" type of radio mechanic in the service field. The wide use of dual-purpose tubes, the application of various types of automatic volume-control methods, together with the multi-range tuning systems used in modern radio sets, calls for more knowledge and skill than the mere ability to turn the screwdriver or wield the soldering iron. A deeper acquaintance is needed with the inner workings of these circuit networks together with a thorough training in radio

trouble-shooting and repair methods such as is offered by the Radio Training Association of America.

P.A. Demands Now Becoming Greater Than the Supply

By D. H. Wright

The rapid strides made by sound before the depression will appear as a snail's pace compared to what we are about to witness. The morning the theatres awoke to the fact that they had to have sound we worked night and day to take care of their orders. Schools are now rubbing their eyes and when they wake to the fact that they must have centralized sound no night and day work will supply the demand.

Service Work on a Higher Plane

By Leslie Muter

Radio service work has reached the position where it is vitally important to the future progress of the radio industry. The new all-wave receivers, as well as many other advances in the radio field, will place service work on a much higher plane and will preserve this business for the properly trained and fully equipped serviceman. Proper radio service, with fully equipped and thoroughly trained servicemen, is essential to maintain the public interest in broadcasting, which also determines the progress of the radio industry.



H. H. NIETZKE PRES. OF CREI

SPARE TIME

is the

BEST TIME

To Plan Your Future!

CREI technical training gives every man the opportunity to get ahead. UNTRAINED men are simply eliminating themselves from better jobs and better pay. Be a success NOW... start training now—ABILITY is always recognized.

PRACTICAL RADIO ENGINEERING

—is the "shortest cut" to success! A thorough training in all phases of Radio Engineering, including Broadcast Transmission and Control Engineering. Enrollments now being accepted for one-year Residence School... start the Home Study Course anytime.

SERVICE AND PUBLIC ADDRESS ENGINEERING

A new CREI course for Service men, teaching theory plus the principles of design and the latest works in vacuum tubes, circuits, acoustics and the treatment of auditoriums. Send today for illustrated literature and full details.

WRITE FOR 48-FREE! PAGE ILLUSTRATED CATALOG

CAPITOL RADIO ENGINEERING INSTITUTE

Dept. RN-8
Washington, D. C.—14th & Park Road
New York City—29 Broadway



MILLION TUBE TESTER

FEATURES

1. Emission
2. Metal Tubes
3. Shorts Hot
4. Leakage Hot
5. Resistance
6. Electrolytics
7. By-Pass Condensers
8. Neon Alignment



MODEL CN
\$9.95
NET

Here's what the Service Men say about the New Million Tube Tester! "Most valuable purchase of test equipment we made during the last year." "It shows up weak tubes better than any expensive tester."

If your jobber cannot supply you—order direct—20% deposit required on C. O. D. orders. Tear out this ad and send it to us NOW for complete information!

MILLION RADIO AND TELEVISION LABORATORIES

363 W. SUPERIOR ST., CHICAGO, ILL.

MAKES USE OF YOUR BUMPER AS AN AERIAL
F&H AUTO BUMPER AERIAL
 COMPLETELY SOLVES THE AUTOMOBILE AERIAL PROBLEM



LIST PRICE \$2.45
 Complete with Lead-In

ANNOUNCING OUR NEW PRODUCT
 DESIGNED ESPECIALLY TO PROVIDE AN AERIAL FOR COUPES AND CARS HAVING ALL STEEL TURRET TOPS. The F & H Bumper Aerial can be installed in a few minutes time by just removing the two rear bumper bolts and inserting the two F & H Bumper Aerial Insulating Bolts in their place, putting the square spacer insulators between, thereby completely insulating the rear bumper from the body of car. The bumper then serves as a very effective aerial. As you will note from the picture above, the F & H Bumper Aerial Insulating Bolts come complete with a shielded lead-in which is simply run along the frame channel of car to the radio.

NO MORE UNDER-CAR AERIALS
 TO SHORT OUT OR TEAR OFF. Once the F & H Bumper Aerial Insulator Bolts are installed insulation is permanent and you may rest assured that it will not short out or give trouble as the bumper insulators are out of the way of mud and slush. And in that the lead-in and bumper insulators are out of the path of flying rocks and gravel, they cannot be put out of commission by the elements of road travel. The F & H Bumper Aerial Bolts are of double strength nickel steel. The insulators and bolt bushings or sleeves, are of special material having exceptional insulating qualities and strength. Thus, your bumper is thoroughly and permanently insulated yet placing it securely in its usual position. The F & H Bumper Aerial Insulators and bolts are especially designed to fit Chevrolet and Ford. However, they will also fit many other cars.

THE GREATEST IMPROVEMENT OF ALL TIMES IN CAR AERIALS
 The F & H Bumper Aerial is superior to any type of automobile aerial on the market and for turret top cars and coupes, it is without a doubt the only practical type. In view of the large size and heavy chrome plating of the conventional bumper on the present day automobile its electrical conductivity and pick-up as an aerial is exceptionally good. This is also due to its ideal position as it is FULLY EXPOSED to the radio waves being away from the steel body of the car and at the FARTHEST POSSIBLE point from the noise-making ignition system.

If dealer cannot supply, order direct. The tremendous demand necessitates filling your order in the position in which it is received. Shipment will be made in as few days as possible.

DEALERS—DON'T BE LATE!
 This aerial will quickly take the place of all others. Standard dealers secure discounts apply as follows: in lots of three 33 1/3% discount, net each \$1.63; in lots of six 40% discount, net each \$1.47. F. & H. RADIO LABORATORIES, Dept. 93, Fargo, N. Dak.

Selling Service

(Continued from page 79)

shops in small towns can get free publicity of this kind.

Telephone Directory Advertising

Many successful service shops swear by advertising placed in their local telephone directory under "Radio." Their argument is that other forms of advertising may or may not reach the prospect just when he is in need of service. By the time his radio set does develop trouble, ads may be forgotten, cards may be lost and the set owner instinctively refers to the classified section of his phone book. Your local telephone directory is unquestionably an excellent medium—it catches most of those prospects who have poor memories—and how many of us haven't? Ads of this kind are usually 1 inch high, and either of single column or full page width. Boldness and simplicity are the things to strive for—the ad must pop right out of the page. The business manager of the Telephone Company will be glad to assist you in laying out an effective ad.

Radio Station Advertising

Advertising on the programs of local radio stations is an opportunity that far too few servicemen take advantage of. The most practical way to use radio advertising is through commercial "spot" announcements one or two minutes in length. The cost may run somewhere around \$5 to \$10 per minute. Continuity can be obtained free from your station or from tube manufacturers. If permissible a "blind" tagged on to the end of a good broadcast announcement may pull best—for example:

"We wish especially to request all our listeners to let us know if they had good reception during this past program. Please write, addressing _____, care of this station."

Advertising in Local Theatres

In small towns, lantern slide advertising messages, flashed on the screen between reels have some value. However, many movie patrons are annoyed by this form of advertising which is more or less boring because it is usually overdone.

Dress Up Your Stationery

Even your business cards and letterheads should be designed so that they will pay for themselves in advertising value. If possible, illustrate them with an effective monogram, and make them distinctive but do not say too much on them. Remember that good business stationery costs very little more than poor stationery, but is many times more valuable.

More and more progressive business concerns are adopting the "family resemblance" idea—letterhead, envelope and business card in matched units. The subject of servicemen's stationery has been covered adequately in many past issues of this magazine. *Alfred A. Ghirardi, author of Modern Radio Servicing, T. S. Ruggles, specialist in direct mail advertising.*

Lab. Tests

(Continued from page 85)

was adjusted to provide a 10 volt signal across a normal output load at 400 cycles, then the variations in output voltage were noted as the modulation was varied throughout the range of 30 to 7500 cycles. The first series of measurements were made with the selectivity control in the front panel set for maximum selectivity (narrow band). Measurements were then repeated with this control set for medium selectivity (wide band). In both cases the tone control was left at its minimum setting; i.e., the position for maximum fidelity.

From these curves it is seen that the fidelity is far better than that of the average broadcast receiver and a fairly close approach to the RMA standard of "High Fidelity". In the narrow band

position, which is the position normally used for communication work, audio frequencies were sharply attenuated above about 2000 cycles. This does not in any way interfere with the understandability of speech but it does effectively reduce much of the static and other noise incidental to the reception of weak signals.

Image-frequency selectivity is an important consideration in the case of any receiver designed to operate at the higher frequencies and it is in this connection that the use of two efficient preselector stages offers a distinct advantage. The independent laboratory tests of the "Super-Pro" included measurements of this type and showed that at 20 megacycles the signal-to-image ratio was 178 to 1. At 350 kc. this figure reached the amazing value of 2,818,000 to 1. Additional measurements were made at the midpoint of each of the five ranges produced the following ratios: 800 kc.—398,000 to 1; 1.8 mc.—100,000 to 1; 3.8 mc.—35,480 to 1; 7.5 mc.—7,943 to 1; 15 mc.—1413 to 1. These measurements were made with the i.f. selectivity control set for maximum selectivity and with the signal input modulated 50% at 400 cycles. Gain controls were adjusted to give a 2 to 1 signal-to-noise ratio with minimum input signal for a 5-volt output. Interpreted in terms of actual use these figures mean that repeat points are never encountered on the lower frequency ranges and even on the high frequency ranges it is seldom indeed that interference would be suffered from a station operating on the "image" of the desired signal. Even at 15 megacycles, for instance, the interfering signal would have to put into the receiver a signal 1400 times greater than the desired signal in order to provide an equal output.

These curves really tell a remarkable story of the extent to which receiver development has progressed. They represent a receiver which definitely offers more sensitivity than can be used even in locations where the noise conditions are excellent, and selectivity adequate to meet all present-day requirements except in the extremely crowded amateur bands and to take care of the unusual situation encountered there this receiver is available equipped with a quartz crystal filter.

The flexibility of control, the ease of tuning and the extreme accuracy of calibration are further features of the receiver which space does not permit discussing in this article, but further attention will be given to these points in an article next month describing the "on the air" tests conducted at the RADIO NEWS Listing Posts.

Changes in Amateur Licenses

Washington, D. C.—The Federal Communications Commission, has modified the requirements for the examination for amateur radio operators. The applicant now must be able to send and receive plain language messages at a minimum speed of 13 words per minute. Previously the speed was 10 words per minute.

HOW TO make more money IN RADIO SERVICING

Hundreds of money-making ideas tested and used successfully by the leading servicing organizations in the country. Practical up-to-the-minute dope on test instruments, test methods, repair methods, etc., etc. the only book in the world that explains everything you need to know about modern radio servicing. It's the Serviceman's Book of Knowledge. To get it together with the handy Radio Supplement Book there are over 1500 pages crammed full of data you can use today. Read "Selling Service" by Ghirardi and Ruggles in June Radio News.

A. A. Ghirardi's "MODERN RADIO SERVICING" and Supplement "RADIO FIELD SERVICE DATA" \$5.00

SEND TODAY! RADIO & TECHNICAL PUBL. CO. 45 Astor Place, N. Y. C. Dept. RN-86

TRI-JAY B-PASS CONDENSER GUARANTEED

Full Capacity—No Leakage—Full Voltage
FREE TO JOBBERS AND DEALERS

Send for TRI-JAY SAMPLE CARD containing 3 condensers and descriptive literature. Send to SERVICE MEN on receipt of 10c to cover mailing. **WRITE TODAY.**

TRI-JAY PRODUCTS CO.
 4440 Elston Ave. Chicago, Ill.

Doherty Circuit

(Continued from page 88)

the carrier voltage. The voltage E1 of the first tube will grow proportional to the excitation and then the limit is reached. For the rest of the cycle the voltage remains constant at its maximum. The voltage E2, across the load will also increase linearly, but up to carrier strength it will be only one-half of E1. Then the second tube, V2, begins to add power to the circuit, which results in an increase in impedance of R and a decrease of the load on V1. So, besides adding power from V2, V1 also will deliver more power due to the lower load. The result is that E2 and the power and the total current increase linearly with respect to the excitation voltage. At the peak of the modulation cycle V2 is delivering half of the power.

Figure 3 and 4 show the variations of the currents and voltages of both tubes plotted against grid-excitation. The network N causes a phase shift of 90 degrees. In order to bring the excitation of the second tube in the proper phase, it is necessary to interpose a second network N2 in the grid circuit of V1 or V2. The circuit then becomes as in Figure 5.

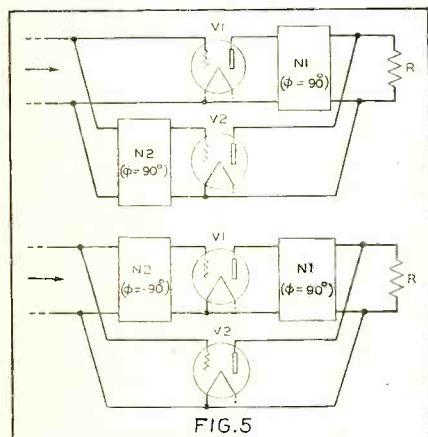

FIG. 5

Extensive tests have shown that the system is very successful and that the power varies in proportion to the excitation voltage due to the unusual properties of the network N.

"R" Meter

(Continued from page 88)

dependent on the ear alone—a fact well enough recognized to make further comments necessary. Some of the other advantages which are less widely recognized are perhaps even more important.

It likewise constitutes a check on the proper operation of a receiver.

The milliammeter may be connected in one or more of the i.f. stages which are controlled by the a.v.c. system. At W2JCR the practice is to connect it only in one i.f. stage and a meter having a range of 0-1 ma. is employed with a shunt rheostat directly across the meter as shown in Figure 1 and in the photograph. The meter need not have

such a low range, but in any event the range should be less than the current drawn by the tube circuit in which it is connected. The rheostat has the effect of reducing the meter sensitivity and is adjusted until the meter shows full-scale deflection with no signal tuned in. This is desirable because it makes the whole scale of the meter useful and signal readings will therefore be larger than would be the case if only part-scale deflection was obtained with no signal tuned in.

If the only milliammeter available is one having a range higher than the current drawn by a single tube, then it may be placed in a plate circuit of two a.v. controlled i.f. tubes so that both will draw their current through the meter. In any case the meter should be connected on the supply side of any filters which may be incorporated in the plate circuits of these tubes, otherwise the leads to the meter may introduce instability or may tend to detune the i.f. circuits.

Figure 1 illustrates the method of connecting the meter and its shunt in the plate supply lead of one or more i.f. stages. In this case the i.f. circuit includes a filter consisting of an r.f. choke and a by-pass condenser.

It is also possible to connect such a meter in the cathode circuit instead of the plate circuit, but this has the disadvantage that both screen and plate current will flow through the meter. On the other hand, it has the advantage that one side of the meter will be at ground potential. Which of these methods of connection to use can be determined in any individual instance by experiment.

The meter employed in the unit shown in the photograph is a Triplet milliammeter with a scale marked off in 50 divisions and equipped with a knife-edge pointer. This latter is an unnecessary refinement and was included for the purpose of making some rather accurate measurements in connection with a study of day-to-day variations in the signals of certain commercial stations.

On an all-wave receiver with which this meter is frequently used, strong local signals retard the meter as much as 95 percent of its scale, while the weakest audible signals provide a definitely readable degree of retardation. Less expensive meters will serve very nicely. In fact, the inexpensive "tuning" meters now on the market can be employed, although they have the disadvantage that their scales are relatively limited in length and also their sensitivity is such that it is usually necessary to connect them in two tube circuits.

The value of the shunt rheostat employed depends on the sensitivity of the meter used and on the internal resistance of the meter. A 100-ohm rheostat will be satisfactory, although if an 0-1 ma. meter is employed adjustment will be a little more convenient if the rheostat is 25 or 50 ohms.

Finally, the same meter may be used with more than one receiver by wiring a closed-circuit jack into the circuit of each receiver. The meter can then be plugged into whichever receiver is in use at the moment.

GENERAL ELECTRIC

AUTO RADIO

WITH METAL TUBES



It's MORE Fun To Ride With Music

Just drive in and see this remarkable G-E Metal-tube Auto Radio. It's easily installed in any make of car. You have the choice of steering post or instrument panel control. Your nearest G-E Radio Dealer will gladly arrange a demonstration. **\$49.95**

GENERAL ELECTRIC

The Original Metal-tube Radio APPLIANCE AND MERCHANDISE DEPT. GENERAL ELECTRIC COMPANY BRIDGEPORT, CONN.

Again...



ADVANCES IN MICROPHONE ENGINEERING

1 New! EXTERNAL INPUT TRANSFORMER

(Cable type Model LGP) NOW ENABLES USE OF LOW IMPEDANCE MICROPHONE WITH AMPLIFIERS HAVING HIGH IMPEDANCE INPUT

Up to 2000' of cable can be used Hum trouble is entirely eliminated by special balanced windings. Extra heavy case will withstand mechanical abuse. Not to be confused with ordinary input transformer

AMPERITE EXTERNAL INPUT TRANSFORMER, PLUG IN TYPE L.G.P. AMPERITE EXTERNAL INPUT TRANSFORMER Model LGP List \$5.00

P.S. For jobs using cables no longer than 325 we will recommend Amperite Velocity Model RB-H (200 ohms) with high impedance input.

2 New! DUAL-IMPEDANCE MICROPHONE

FOR LOW OR HIGH IMPEDANCE AMPLIFIERS

Can be used with high impedance input with cable lengths up to 125' or low impedance input with cable lengths up to 2000'. MUST PLUG IN THE PROPER CABLE as shown in diagram. NO DEAD WINDINGS OR TAPS—therefore, maximum efficiency for low or high impedance connection

*Again? Yes, Amperite was first to use Nickel Aluminum Magnets... first with a successful "taper" velocity... first with a high impedance velocity... first to bring velocity type microphone within reach of all.

AMPERITE Company 561 BROADWAY, NEW YORK.

AMPERITE Velocity MICROPHONE

TROUBLE - SHOOTING Gadget

Buy this ingenious service-men's reminder and time-saver. Take it with you on all your service calls. **25c** Radio Tech. Publ. Co. 45 ASTOR PLACE, NEW YORK CITY. Dept. RN-86

FIRST FOR 1937 HETRO SUPERADIO XII

The all feature radio

- 12 Tubes
- 7-2100 Meters—5 Bands
- Metal Glass—Metal Tubes
- Simplified Robot Tuner
- AVC Electric Eye
- Variable Selectivity
- Variable Sensitivity
- Beam Push Pull Audio

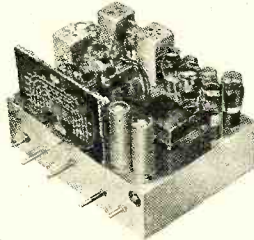

• And—Fill in the coupon below and find out for yourself how this startling custom-built receiver can give you everything you want in a Radio Receiver! The Price? So low it will surprise you.

HETRO ELECT. IND. INC.
4611 Ravenswood Ave., Chicago, Ill., U. S. A.

Hetro Electrical Industries, Inc.
4611 Ravenswood Ave., Chicago, Ill., U. S. A.

Without obligation on my part send me the free booklet describing the Hetro Superadio XII and your SPECIAL 10 DAY OFFER.

Name.....
Street.....
City..... State.....

★ BUILD YOUR OWN ★

ALL-STAR TRANSMITTER

FREE CIRCUIT AND PARTS LIST

Anyone with a soldering iron, screw driver and a pair of pliers can build this transmitter. It can be used on 10, 20, 40, 80 and 160 meters. Bands changed in a few seconds. Designed by engineers. Built from standard parts, stocked by us.

Write for our free catalog

CAMERADIO

601-3 GRANT ST., PITTSBURGH, PA. 30 TWELFTH ST. WHEELING, W. VA.
Established 1919

SAVE \$3.00
By Subscribing for
RADIO NEWS Today!
(See Adv. On Page 111)

Manufacturers of
VITREOUS TRANSMITTING GRID LEAKS
VOLUME CONTROLS · POWER RHEOSTATS

Write for Complete Free Catalog
ELECTRAD, Inc.
175 Varick Street, New York

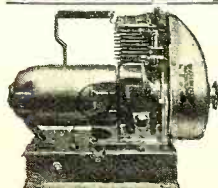

KATO LIGHT JR.
Complete light plant at price everyone can afford.
LIST PRICE
6 v. 150 watt DC... \$59.95
12 v. 200 watt DC... 62.00
32 v. 300 watt DC... 65.00
110 v. 300 watt DC... 69.00
110 v. 300 watt AC... 84.00
Profit for dealers.
Kato Engineering Company
Mankato, Minn., U. S. A.

What's New

(Continued from page 119)

cycle supply. The amplifier uses 6 tubes with three 2A5's in the power output stage.

New Line of A.F. Transformers

Ferranti Electric, Inc. announces a new series of audio transformers and reactors known as "Ultra High Fidelity—series B."

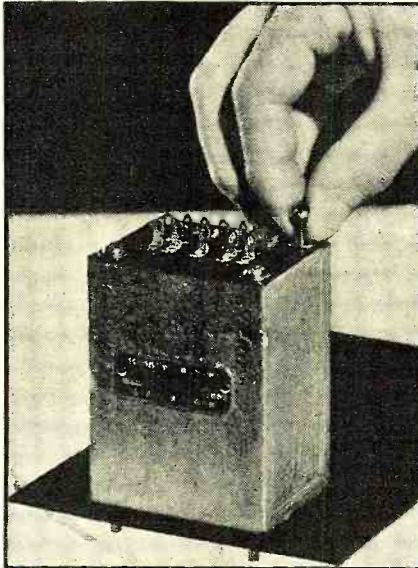

The frequency response curve shows plus or minus 1½ db. from 30 to 16,000 cycles. The transformers are fitted with electrostatic shields between windings and are designed for extremely low-insertion loss.

Sectional Rack with Professional Appearance

Radio amateurs, experimenters, laboratory men and sound engineers will be interested in the sectional standard constructional rack introduced recently by the Insuline Corp. of America. The fundamental units are a heavy steel base measuring 20

Read Classified Advertising—It Pays

Advertisements in this section twenty cents a word for each insertion. Name and address must be included at the above rate. Cash should accompany all classified advertisements unless placed by an accredited advertising agency. No advertisements for less than 10 words accepted. Objectionable or misleading advertisements not accepted. Advertisements for these columns should reach us not later than 3rd of 2nd month preceding issue. **TECK PUBLICATIONS, INC.**
461 Eighth Ave. New York, N. Y.

A.C. Auto Generators

TURN scrap into money. Autopower shows you how easily and economically auto generators can be converted into A.C. or D.C. generators and D.C. motors, 2 to 1000 volts; for sound, radio, power, light, or welding. No previous experience necessary—complete information all in new book, with simple instructions and illustrations. Endorsed by thousands. Only \$1.00 postpaid. Autopower, Inc., 414-A S. Hoyne Ave., Chicago.

Correspondence Courses

USED Correspondence Courses and Educational Books sold or rented. Inexpensive. Money-back guarantee. Write for Free Catalog listing 4000 bargains. (Courses Bought.) Lee Mountain, Pfsgh, Alabama.

BIG BARGAIN Catalogue Courses 10c. Hanfing, P-799 Broadway, New York.

Patent Attorneys

PATENTS—Advice and booklet free. Highest references. Best results. Promptness assured. Watson E. Coleman, Patent Lawyer, 724 9th Street, Washington, D. C.

PATENTS. Instruction "How to Establish Your Rights" and form, "Evidence of Conception" sent Free! Lancaster, Alvine & Rommel, 414 Bowen Building, Washington, D. C.

Patents and Inventions

INVENTIONS COMMERCIALIZED. Patented or unpatented. Write Adam Fisher Company, 278 Enright, St. Louis, Missouri.

Radio

GENUINE Philco parts and tubes. Wholesale Catalog sent free on request. Williams Philco, Inc. 800 S. Adams St., Peoria, Illinois.

Wind Driven Lights

ELECTRIC LIGHTS—WIND DRIVEN—You build them. Write, Wind Motor Electric, Brainerd, Minnesota.

INDEX TO ADVERTISERS

Aerovox Corp.	118	Midwest Radio Corp.	119
Alden Products Co.	114	Million Radio & Television Lab.	123
Allied Radio Corp.	110, 116	National Company, Inc.	108
American Transformer Co.	116	National Radio Institute	Back Cover
Amperite Corp.	125	National Schools	107
Autocrat Radio Co.	121	National Union Radio Corp.	103
Bell Sound Systems, Inc.	121	Pacific Radio Pub. Co.	110
Brush Development Co., The	122	RCA Institutes, Inc.	121
Burstein-Applebee Co.	119	RCA Manufacturing Co.	104
Cameradio Co.	126	Radio City Products Co.	114
Candler System Co., The	118	Radio & Technical Publishing Co.	124, 125
Capitol Radio Engineering Inst.	123	Radio & Television Institute	128
Central Radio Laboratories	121	Radio Training Ass'n of America	103
Chicago Wheel & Mfg. Co.	107	Radolek Co., The	127
Classified Advertisements	126	Raytheon Production Corp.	118
Cornell-Dubilier Corp.	128	Readrite Meter Works	117
Cornish Wire Co., Inc.	122	Remington Radio & Electric Corp.	120
Coyne Electrical School	127	Rider, John F.	106
Dodges Institute	122	School of Communication Engineering	119
Electrad, Inc.	126	Scott Radio Labs, Inc., E. H.	65
Electro-Voice Mfg. Co., Inc.	112	Silver Corp., McMurdo	111
F & H Radio Laboratories	124	Solar Mfg. Corp.	112
First National Television, Inc.	120	Sprayberry, F. L.	112
General Electric Co.	125	Standard Transformer Corp.	Inside Back Cover
Goldentone Radio Co.	122	Sundt Engineering Co.	128
Hallicrafters, Inc.	120	Teleplex Co.	110
Hammarlund Mfg. Co.	107	Tri-Jay Products Co.	124
Hetro Electrical Industries	126	Trimm Radio Mfg. Co.	128
Hygrade-Sylvania Corp.	113	Triplet Electrical Instrument Co.	109
Instructograph Co.	122	Tri-State College	108
Johnson Transformer Co.	108	Try-Mo Radio Co., Inc.	115
Kato Engineering Co.	126	Tung-Sol Lamp Works, Inc.	104
Ken-Rad Corporation, Inc., The	115	Utah Radio Products Co.	106
Lincoln Engineering School	115	Webster Co., The	115
McElroy, T. R.	118	Weston Electrical Instruments Corp.	101
Mallory & Co., Inc., P. R.	Inside Front Cover, 68	Wholesale Radio Service Co.	105
		Wright-DeCoster Co., Inc.	114
		Zephyr Radio Co.	128

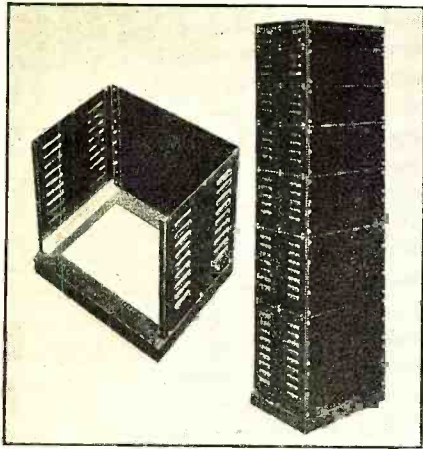

by 15¾ by 2½ inches and a top cover in the form of an inverted tray 20 by 14¾ by 1¼ inches. Each section consists of 2 louvered end plates, a back plate, a front panel and a pair of angles. As many sections as desired may be stacked to provide all the advantages of a standard rack and panel assembly, but with the added advantage that a rack, or framework, is not required and additional sections may therefore be added at any time. A screw-driver is the only tool required in assembly and the finished job is sufficiently rigid to meet the most exacting requirements. Panels are 19 inches long and are available in 11 different heights from 3½ inches to 21 inches, with end and back plates to match. All parts are finished in baked black crinkle.

New Power Tube

The Taylor type 814 transmitting tube is designed for high efficiency with low



driving power for efficient operation on all bands from 10 to 160 meters.

Characteristics

Filament.....	10 Volts-4 Amps
Maximum Plate Volts.....	200C
Maximum Plate Current.....	300 ma
Plate Dissipation.....	200 Watts
Class C Output.....	500 Watts
Amplification Factor.....	12
Grid to Plate.....	13 mmfd

Fuses for Radio Sets

By E. V. Sundt

It seems certain that practically all the new metal tube radio sets will be required by the Underwriters' Laboratories to have fuses either in the primary or secondary of the power supply. Fuses must be accessible, but covered to prevent accidental shocks. The cover must be so designed that a tool is required to remove it. Only Underwriters approved fuses must be used. Fuses are also highly important in sets using mercury vapor rectifiers and should be installed by the conscientious serviceman when not factory equipped.

Attractive Combination Set

The new Wholesale Lafayette 7-tube portable combination phonograph and radio receiver can operate from either alternating or direct current supply. Travelers and summer vacationists should be especially interested in a set of this type. The receiver has a three-band tuning range from 560 to 18 meters. The tube equipment comprises one 6A8, one 6K7, one 75, one 43, one 25Z5, one 2Z3, and one 50A2MG. A specially constructed Fab-

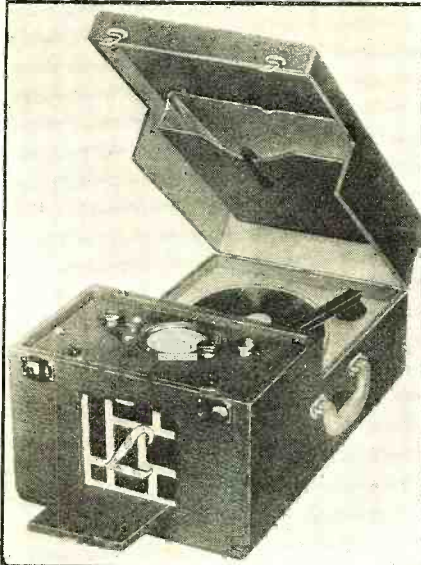

ricoid covered carrying case houses the radio chassis, loud speaker, phono turntable, motor and pick-up and a compartment for a dozen records.

Dual Impedance Velocity Microphone

This new microphone introduced by the Amperite Corp, can be used directly with either a high or low impedance input. The manufacturer advises that it is accomplished without any loss in efficiency by using a specially designed transformer. The microphone is changed to low (200 ohms)

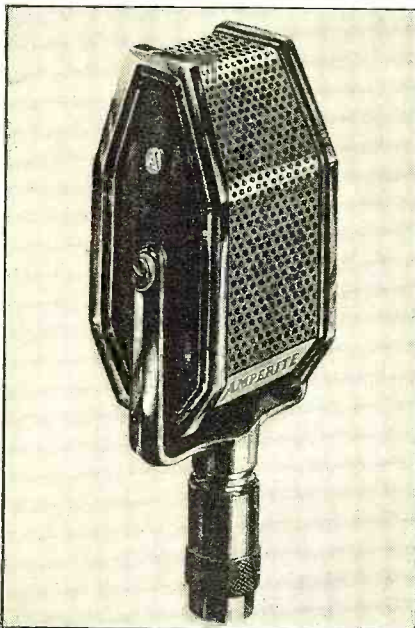

or high impedance automatically by plugging in the proper connector plug.

Six-Tube, Three-Band Super

The new RCA model 6-T-2 receiver has a tuning range from 540 to 18,000 kilo-

Train for
RADIO
IN 12 WEEKS AT COYNE

The great Coyne shops in Chicago have a world-wide reputation for training ambitious fellows for this big-pay field in only 12 weeks. Then help you by giving you lifetime employment service. By my new plan you can take advantage of their wonderful method of learning-by-doing NOW.

SEND TODAY FOR DETAILS OF MY "Pay-Tuition-After-Graduation" Plan

Train for Radio in 12 weeks on real Radio, Sound and Television equipment. **Send the coupon today.** If you are short of money I'll send you all details of my finance plan. If accepted, you won't have to start paying tuition until **five months from the date you start school**, and then you'll have 18 months to complete your payments. Send for **Big Free** illustrated Book telling all about **COYNE** and how **many** **earn** while **learning** and **training** you can get there without book study or useless theory. *H. C. Lewis*

COYNE ELECTRICAL SCHOOL
500 S. Paulina St., Dept. C6-3K, Chicago, Ill.

MR. H. C. LEWIS, President

500 S. Paulina St., Dept. C6-3K, Chicago, Ill.

Send me the **BIG FREE** illustrated Book on **RADIO** with details of your "Pay-Tuition-After-Graduation" Plan.

NAME..... AGE.....
ADDRESS.....
CITY..... STATE.....

PUBLIC ADDRESS SALES PROMOTER
With List Prices

JUST OFF THE PRESS!

Another Radolek "Profit-builder" for you! A complete "Public Address Salesman". All prices are shown at your list selling prices. Show this book to your customers—it clinches the sale and protects your profits. Beautiful illustrations—complete descriptions. 5 to 60 watts. Everything in P. A.

Repair Parts Profit Guide

The new Radolek 1937 Radio Guide is completely revised—right up to the minute—everything in radio—at the right prices. Over 10,000 Repair Parts—a complete selection of Receivers, Amplifiers, Tubes, Tools, Books, Instruments—always in stock—ready for speedy shipment to you. You need this big Radio Parts Catalog. It's Free! Send for it.



MAIL THIS COUPON!

RADOLEK

605 W. RANDOLPH ST., CHICAGO

Send the Radolek Profit Guide Free
Send the P. A. Sales Promoter Free

NAME.....
ADDRESS.....
Serviceman? Dealer? Experimenter?

FAST Selling

ELECTROLYTICS

Nothing short of championship quality could be responsible for the fast selling record established by the JR Series of C-D Electrolytics.

**SPACE SAVERS
MONEY MAKERS
HANDY ASSISTANTS!**

The convenient compactness and multiple capacity combinations of the JR Series, makes it possible to use them in any circuit and in the tightest corners. Doubly sealed against the damaging effects of high temperatures and excessive humidity conditions, they are supplied with color-coded terminal leads and handy mounting feet.

Try them on your next job! Convince yourself of their possibilities by using them!

Carried by all C-D authorized distributors. Complete details contained in Catalog No. 131A, supplied on request.

CORNELL-DUBILIER CORPORATION
4387 BRONX BOULEVARD
NEW YORK, U.S.A.

MAGIC Senco Tuning Wand

• Easy to adjust any transmitter or receiver. An accurate instrument for the odd timer—a short cut method for the new experimenter.

• Increases or decreases inductance with a wave of the hand.



ONLY \$1.00

• Bright NEON LIGHT indicates relative strength of R.F. fields of transmitters, resonance, etc. 10 inch neon filled tube so constructed to increase inductance of a transmitter or receiver when left cap is placed inside the coil and decreases inductance when right cap is inserted. Sensitive tube illuminates when placed near the transmitter tank coil. COMPLETE \$1.00 POSTAGE PREPAID. Guaranteed.

SUNDT ENGINEERING COMPANY
4256 Lincoln Ave. Chicago, Ill.

SAVE \$\$\$ on RADIOS

BUY DIRECT 30 day trial

Buy at factory prices. 30 models to choose from. AC-DC. All-wave. Farm, Car and Metal Tube models. Send postcard for NEW 1936 Bargain Catalog FREE. Get details of 30 day TRIAL plan and Agent-User proposition. Also ask for our NEW Parts Catalog.

ZEPHYR RADIO CO. Dept. 218
11702 Livernois, Detroit, Mich.

PAPUA
KNOW WHERE IT IS?

Even here among tropical jungles will be found Trimm Featherweight headsets.

Available at all good ham stores.

TRIMM RADIO MANUFACTURING CO.
1770 W. Berteau Ave., Chicago, Ill.

Get into RADIO

REAL JOBS REAL PAY

Earn While Learning at Home!

Television, Photo Electric Cells, Public Address

Many R-T-1 Trained Men make up to \$75 a week and more in full-time radio jobs—\$5-\$15 in spare time alone. More trained men needed. Learn at home by quick, easy, endorse

PHILCO CROSLY ZENITH GRUNOW and 46 other mfgs. endorse R-T-1

Write for big Opportunity Book FREE. **RADIO AND TELEVISION INSTITUTE, Inc.** 2150 Lawrence Ave., Dept. 4-C, Chicago, Ill.

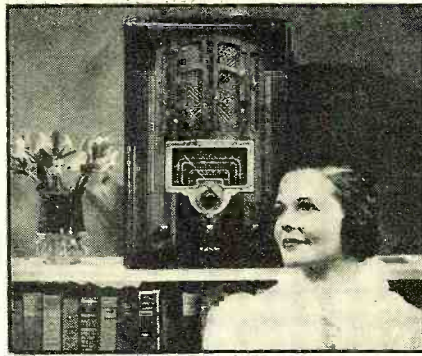

cycles. Metal type tubes are employed throughout and include a type 6A8 as a combination detector and oscillator, a 6K7 for the i.f. stage, a 6H6 as a second detector and a.v.c. tube, followed by a 6F5 for the first audio stage and a 6F6 in the power output stage. The type 5Z4 is used for rectification. This receiver is designed to provide 4.5 watts output and features the new edge-lighted dial, music-speech control and automatic tone compensation.

Lapel Microphone

One of the recent additions to the Brush line of crystal microphones is the new lapel unit weighing less than one ounce



and measuring only 1 1/2 by 1/4 inches across by 3/8 inch thick. Special cushioning of the internal parts and the use of a protecting rubber jacket on the case are employed to insure quiet operation. The specifications show its output level to be minus 72 db.

Service "Quacks" Passé

By Arthur Moss

The future of service work offers a very attractive living for individuals with proper technical training and experience. The end of the so-called "quack doctor" of radio sets is close at hand. The experienced serviceman who has the necessary technical knowledge and the proper tools with which to carry on his profession finds that there is no necessity for charging anything but a fair price for his knowledge and labor. Manufacturers have wherever possible cooperated so that definite information is available showing the application of standard products to the service field. Test equipment has been designed specifically to fill the needs of the serviceman in his every day routine. The consumer who after all is the most important cog in the wheel is beginning to have confidence in the serviceman, who can efficiently pursue his calling and on account of his efficiency and the test equipment he has, does not have to charge more than a fair price for the time he expends on a service call.

Printed by Art Color Printing Company, Dunellen, New Jersey, U. S. A.

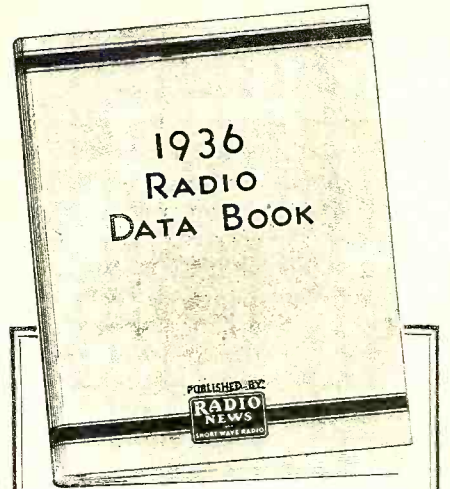

FREE

1936 Radio Data Book Given Free to Readers Placing Subscription for 5 Months Radio News at \$1

Even a casual glance at the partial list of contents given below will prove, beyond a doubt, that the 1936 Radio Data Book is one of the most useful radio volumes ever published. It is a large 8" by 11" book—with over 120 illustrations, charts and hook-ups—crammed full of worthwhile information. Get your free copy now by placing a subscription for 5 issues of RADIO NEWS.

Partial List of Contents

Here are a few of the dozens of articles: Disk vs. Cathode Ray Television Systems—Description and Characteristics of Metal Tubes—S-W Reception Aids and Charts—S-W Circuit Design—Constructional Details on S-W Receivers—Amateur Transmitters, Receivers and Transceivers—Transmitting Tubes—Broadcast Receivers—S-W Converter—Trap-Circuit Tenatuner—DX Converter—Cathode-Ray Oscillographs—P. A. Systems—Service Sales Tips—Engineering Design—Hints and Kinks—and plenty of other worthwhile information. Mail the coupon with your remittance today!

Radio News

Radio News, Dept. 368
461 Eighth Ave., N. Y. C.

Enclosed find \$1 (Canada and Foreign \$1.25) for five issues of Radio News. Send me the 1936 Radio Data Book without cost.

Name.....
Address.....
City.....State.....

Free COMPLETE TRANSFORMER REPLACEMENT CARD FILE

COMPLETE DATA ON
ALL THE TRANSFORMERS
AVAILABLE—TYPES,
COSTS, etc. - FOR ANY
REPLACEMENT JOB
**IT IS THE
SERVICE MAN'S
BEST FRIEND!**

Mr. Service Man, how would you like to have a handy card file, where, under the name and model number of the receiver, right at your finger tips, you could find complete information and prices on all types of transformers available for any replacement job!

That's what you get with the New Stancor Replacement Guide! No more searching and hunting through pages of catalogs to find the right transformer! All the information you need is right there on a single alphabetically filed card available at instant notice.

And it's FREE to users of Stancor Transformers. Just send in a Stancor Box Top with the coupon below and your Stancor Replacement Guide goes forward to you immediately. As the supply is limited we can offer only one to a service man. Without the box top, send 25c to cover mailing cost. Hurry! Send for this Stancor Replacement Guide today. It will save you time and money!

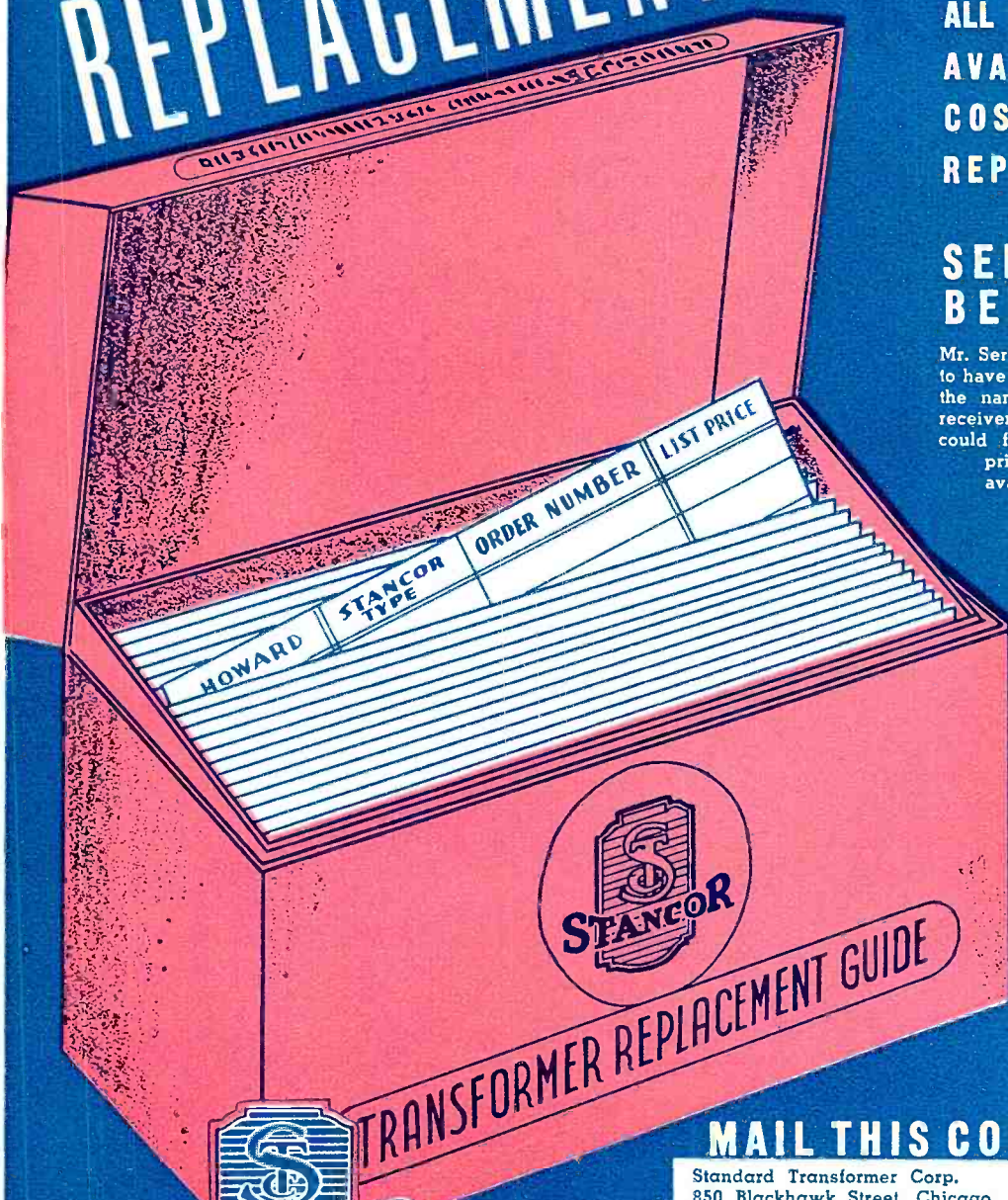

TRANSFORMERS

**FREE
MAIL THIS COUPON TODAY!**

Standard Transformer Corp.
850 Blackhawk Street, Chicago, Ill.

Gentlemen:

Please send my Stancor Transformer Replacement Guide at once.

- I am enclosing Stancor Box Top
 I am enclosing 25c in stamps

Name

Address

City State

I will send you a Lesson Free



J. E. SMITH, President, National Radio Institute, Washington, D. C.—the man who has directed the training of more men for the Radio industry than any other man in America.

to show how easy it is to learn at home in spare time to fill a

Good Radio Job

Clip and mail the coupon. I'll send you a FREE lesson. I'll show you that Radio is fascinating; that I give you practical money-making information, easy to learn, easy to put into use. See for yourself why many men with less than a grammar school education and no Radio experience are now making good money as Radio Experts. Get the facts about Radio's spare time and full time job opportunities. Mail the coupon now.

Many Radio Experts make \$30, \$50, \$75 a week. Get Ready Now for Jobs like these

Broadcasting stations employ engineers, operators, managers, and men for other jobs that pay up to \$5,000 a year. Radio factories employ testers, inspectors, foremen, engineers, servicemen, salesmen, buyers, and pay up to \$6,000 a year. Radio dealers and jobbers employ servicemen, salesmen, buyers, managers, and pay up to \$75 a week. There are many opportunities to have a spare time or full time Radio service business of your own. Radio is picking up. It's a big business—big enough to absorb many more well trained men—and it's growing bigger all the time. Get ready for Radio. Be a Radio Expert. I'll train you at home in spare time.

Many make \$5, \$10, \$15 a week Extra in Spare Time While Learning

Nearly every neighborhood needs a good spare time serviceman. Find out how I help you cash in—how I start sending you Extra Money Job Sheets the day you enroll, for doing Radio repair jobs common in most every neighborhood. How, when you get underway, I send you much more information for servicing sets and for doing other spare time jobs for extra money. My Training is famous as "The Course That Pays for Itself." Many make \$200 to \$1,000 while learning.

Short Wave, Loud Speaker Systems, Television, Auto Radio, etc., included

New Radio developments are continually making new opportunities. Loud speaker systems, police, auto and aviation Radio, are recent new uses that have been found for it. Television promises many good jobs soon. Television is leaving the laboratory in an impressive way. One million dollars is being spent on two stations. Television receiving sets are being designed and built. New opportunities—many of them—are right ahead. Get full information about how I train you at home in spare time to be a Radio Expert. My 50-50 method of training—half with printed and well illustrated lessons, half with Radio equipment I furnish as part of my training—gives you broad practical experience—makes learning at home interesting, fascinating, practical.

You Must Be Satisfied

I make an agreement with you in writing—if you are not entirely satisfied when you finish my Course, with the Lesson and Instruction Service I have given you, every penny you have paid me for tuition will be refunded.

Get a Sample Lesson and my book on Radio's Opportunities

Mail coupon now. I'll send my book "Rich Rewards in Radio" and a FREE lesson at once. Find out about Radio's spare time and full time opportunities; read what others who have taken my Course are doing and making. Read the sample lesson, decide for yourself whether my training is clear, interesting, practical. This offer is open to any ambitious fellow over 15 years old. There is no obligation. Act at once. Mail coupon in an envelope or paste on a 1c postcard.

J. E. SMITH, President
National Radio Institute, Dept. 6HR
Washington, D. C.



SET SERVICING

Spare time set servicing pays many N.R.I. men \$5, \$10, \$15 a week extra. Full time men make as much as \$30, \$50, \$75 a week. Almost every community offers trained men opportunities to enter this profitable field.

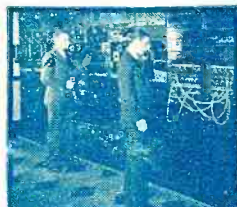

BROADCASTING STATIONS

employ managers, engineers, operators, installation and maintenance men for jobs paying up to \$5,000 a year. The larger stations employ as many as 20 to 60 men. Over 600 Broadcasting Stations now in operation.



LOUD SPEAKER APPARATUS

Installing, servicing Loud Speaker Systems in auditoriums, for sporting events, political rallies, in schools, factories, etc., is another growing money-making field for which N.R.I. will train you.

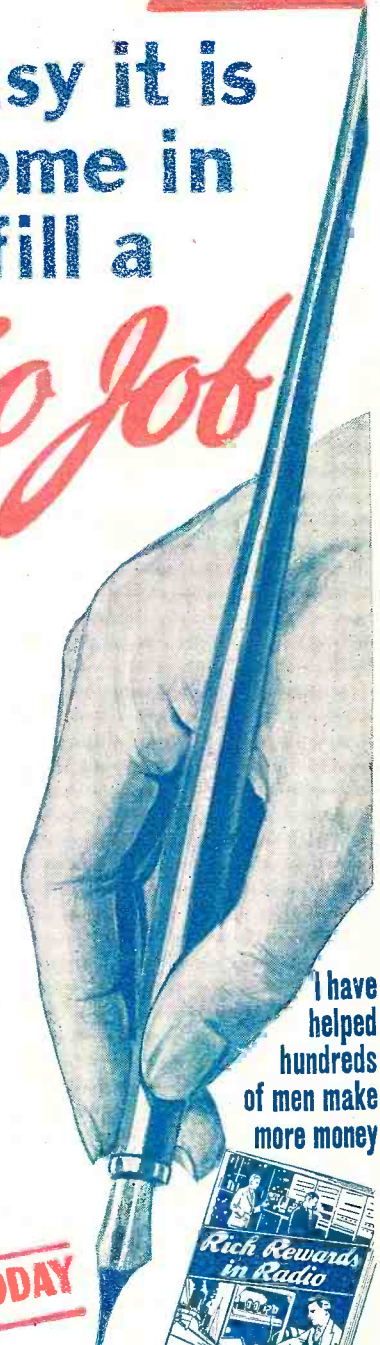

I have helped hundreds of men make more money



MAIL THIS TODAY

Good for FREE SAMPLE LESSON and BOOK on RADIO'S OPPORTUNITIES

J. E. SMITH, President
National Radio Institute, Dept. 6HR
Washington, D. C.

Dear Mr. Smith: Without obligation send me the Sample Lesson and your free book about spare time and full time Radio opportunities, and how I can train for them at home in spare time.
(Please write plainly)

NAME.....AGE.....
ADDRESS.....
CITY.....STATE..... 14X1

The Tested Way to BETTER PAY

(If you do not want to cut this cover, simply write us on a post card)