

RADIO COMBINE ATTACKED!

RADIO NEWS

AND
SHORT WAVE RADIO

APRIL

SHORT
WAVE
TIME
TABLE



Pepping Up

“DISTANCE” RECEPTION

*Build this
PRESELECTOR
See Page 586*

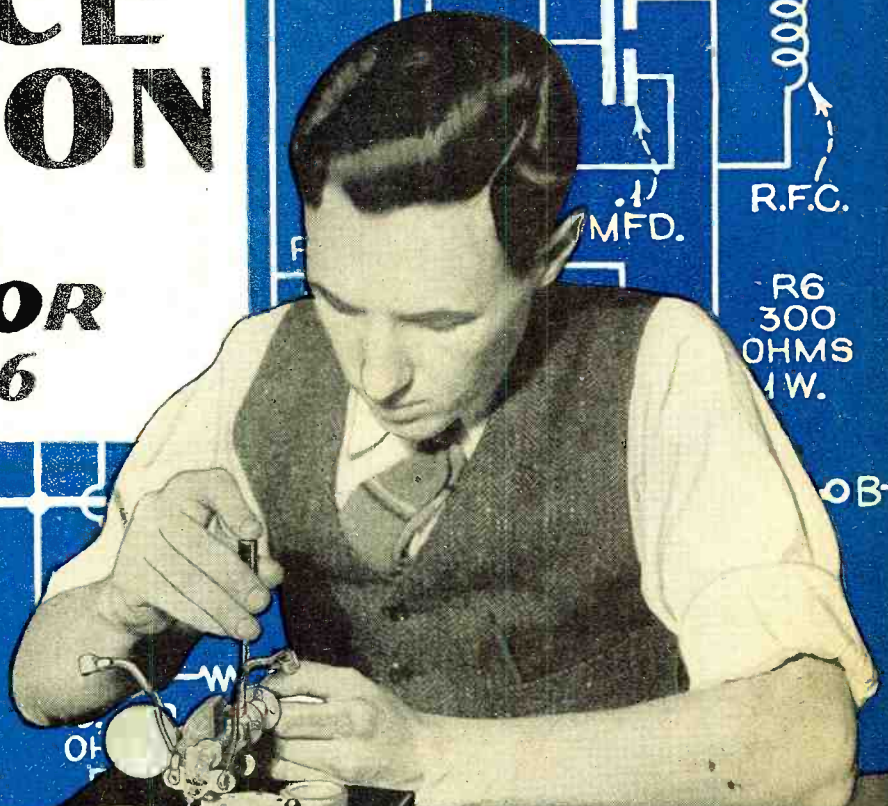

25¢
U.S. AND
CANADA



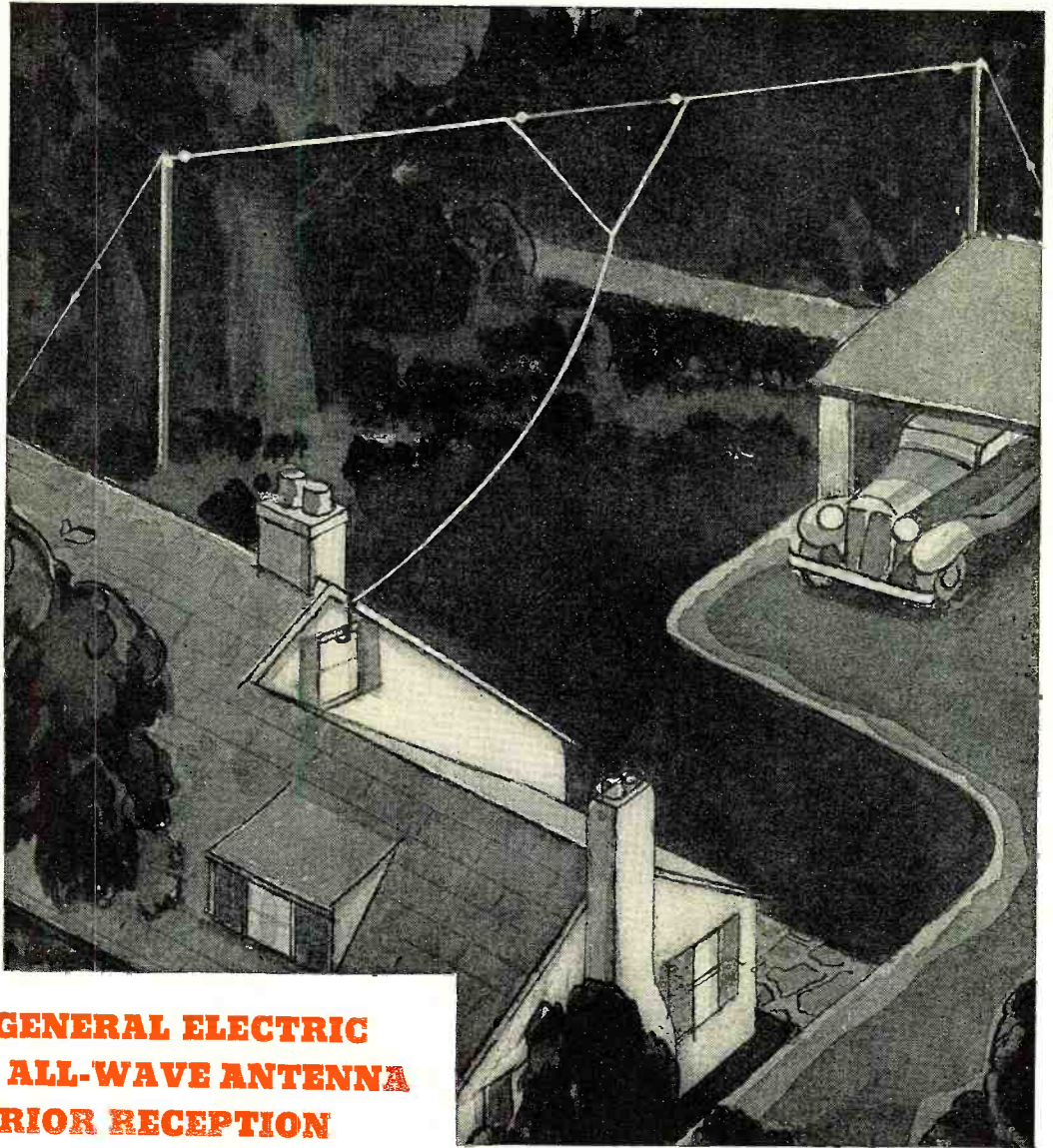

**INSTALL A GENERAL ELECTRIC
"V-DOUBLET" ALL-WAVE ANTENNA
FOR SUPERIOR RECEPTION**

DIRECTIONAL CHARACTERISTICS

The "V-doublet" Antenna System is ideally suited to take full advantage of directional effects. When the antenna system is placed at right angles to the direction of the incoming signal, the signal will come through at maximum energy. When the antenna span points towards a known source of local interference, it decreases the pick-up of noise from that source.

**EXCELLENT SENSITIVITY ON ALL
SHORT-WAVE FREQUENCIES**

The "V-doublet" is very broadly peaked in the short-wave band. The tapered "V" section couples the antenna to the transmission line in a manner that permits the transfer of signal energy over a wide frequency range, without favoring any particular short-wave frequency.

A specially constructed receiver-coupling transformer affords proper *electrical matching* for modern radio receivers equipped with antenna coils having a relatively large number of turns in the primary circuit.

BALANCED TRANSMISSION LINE

Short-wave signals intercepted by the "V-doublet" are fed to the receiver through a balanced, twisted-pair, transmission line. Since the transmission line serves only to transfer signals from the doublet to the receiver it minimizes "man-made" static which originates from the house wiring system and external electrical apparatus, including even ignition systems of passing automobiles.

**DOUBLET FOR SHORT-WAVE—
T TYPE FOR STANDARD BROADCAST**

In the reception of standard broadcasts, the G-E "V-doublet" Antenna System is automatically converted from its "V-doublet" form to one approximating the conventional "T" type arrangement. This change-over is accomplished automatically by the special circuit employed in the receiver-coupling transformer.

EASY TO INSTALL

The "V-doublet" All-wave Antenna Kit, consisting of the doublet wires, glass strain insulators, and transmission line is assembled and packed ready for installation. It's easy to install, requiring only two points of suspension over a 50-foot span.

PRICE - - Model KV-10 - - \$5.00

Available at your local
General Electric Radio Dealer

GENERAL  ELECTRIC

THE ORIGINAL METAL-TUBE RADIO
APPLIANCE AND MERCHANDISE DEPARTMENT
GENERAL ELECTRIC COMPANY
BRIDGEPORT CONNECTICUT



WHEN YOU HEAR the Japanese Shamisen then You'll *Know* why

SCOTT FOREIGN RECEPTION Thrills its Owners

Across the sombre expanse of the deep Pacific—through 8000 miles of the lambent dawn—the Japanese giant awakens! JVT—Tokio! With its directional antenna aimed for America! Comes in as you open up the controls of your new 23-Tube SCOTT High Fidelity Radio.

You hear strange culture, stange mixture! Baseball, cherry blossoms, wild music of street festivals—stringed shamisen—koto harp—shakuhachi flute. An ancient nation mellowing the old, infusing the new!

Your SCOTT brings it all to you—with such dialing precision, with such bullet-direct selectivity, with such freedom from inherent noise and with such a fidelity of tone that owners in 146 countries have filled the files of the SCOTT Laboratories with thousands of unasked-for letters of overwhelming praise.

**THE YEAR 'ROUND—
'ROUND THE WORLD**

Not only France, Germany, England, Spain—but Russia, Java, Indo-China, Japan, Australia, the Argentine and dozens of foreign stations are heard regularly with the SCOTT.

Built not only for the DX performance which has given it world leadership, but built for the future! The SCOTT Full Range Hi-Fidelity Receiver is fully two years ahead. The only receiver with a high fidelity overtone range provably from 30 to 16,000 cycles. The SCOTT captures these thrilling overtones—the singing silver harmonics of the Japanese shamisen—the thundering largos of the mightiest organ. You lose half the beauty of the program if your radio misses the overtones—for it is the overtones alone which enable the human ear to distinguish one instrument from another.

MORE EXCLUSIVE FEATURES

These are some of the features which make such astounding superiority possible—and where else can you find their equal?—
—Highest Useable Sensitivity
—less than 1 microvolt. Made



A personal message to every home owner from Mr. E. H. Scott

"I have complete confidence that once you have heard the new 23-tube SCOTT you will never be satisfied to own any other radio for your home. From A to Z, I know the unparalleled standards of precision engineering which go into the building of every SCOTT. As a DX enthusiast myself, I know what an almost unbelievable difference custombuilding makes in really satisfying foreign reception, to say nothing of reception in the domestic bands. I know, too, the unbounded enthusiasm of thousands of distinguished SCOTT owners in 146 countries over the entire globe, personages such as Arturo Toscanini, Baron de Rothschild, Guy Lombardo, the Sultan of Johore, Ted Husing, the Prince of Hyderabad and hundreds more.

"So I am naturally anxious to have you hear the SCOTT when considering your new radio. It is only fair, of course, that you hear it at our risk. So I say this:—Let us install the new 23-Tube SCOTT in your own home for 30 days trial. If not long before that time is out it does not bring into your home more foreign stations with more entralling volume, more dependable regularity, more beautifully clear true tone than you ever dreamed possible, you may return it and your money will be promptly refunded. SCOTT receivers are built to render the finest performance in the world, from the torrid equator to the frigid poles."

practical by the highest signal-to-noise level.

Bullet-Direct Selectivity—continuously variable 2 to 16 KC. Enabling you to pierce powerful adjacent wave length stations for more foreign and domestic stations.

Double A.V.C.—keeps world programs at practically invariable volume.

Short Wave Station Locator—beat frequency oscillator instantly locates foreign stations.

Highest Strictly Class "A" Power—35 watts. For undistorted programs at concert volume. 5 times the average undistorted power.

Full Range Hi-Fidelity—30 to 16,000 cycles—twice the tonal range of other high fidelity radios—a fact we can prove in any comparative test. Retains the identifying overtones of voice, violin, clarinet, saxophone, oboe and trombone.

More Important Performance Features—including True Bass Control, Separate Treble Control, Shadow Meter Tuning, 23 High Efficiency Tubes—Completely Shielded.

NATIONWIDE INSTALLATION

Nineteen exclusively designed cabinets. Five year guarantee. 30-day home trial anywhere in the United States. Strictly custombuilt. Nationwide installation service. You can own the custombuilt SCOTT Full Range Hi-Fidelity Radio for no more than you would pay for any good radio.

Every sensational claim backed by VERIFIED printed PROOF. Send TODAY for the fully illustrated 20-page book, "PROOF of Consistent Foreign Reception"—one of the most thrilling stories ever recorded in the history of Radio.

E. H. SCOTT RADIO LABORATORIES, INC.
4440 Ravenswood Avenue, Dept. 5F6, Chicago, Illinois

When in New York visit our beautiful permanent Salon at 630 Fifth Avenue, Rockefeller Center



SEND COUPON

TODAY - DETAILS ARE FREE

E. H. SCOTT
RADIO LABORATORIES, INC.
4440 Ravenswood Ave., Dept. 5F6, Chicago.

Send "94 PROOFS" of the SCOTT'S superior tone and DX performance and particulars of 30-day home trial anywhere in U.S.A.

Name.....
Street.....
City.....State.....



Edited by LAURENCE MARSHAM COCKADAY

S. GORDON TAYLOR
Managing Editor

WILLIAM C. DORF
Associate Editor

JOHN M. BORST
Technical Editor

JOHN H. POTTS
Assoc. Tech. Editor

JOSEPH F. ODENBACH
Art Editor

Vol. XVII April, 1936

No. 10

Reading Guide to this Issue—

- AMATEURS—1, 4, 5, 6, 9, 11, 12, 13, 14, 15, 26, 28
- BROADCAST FANS—2, 3, 4, 16, 18, 21
- DEALERS—1, 2, 4, 8, 10, 14, 15, 20, 22, 23, 26
- DESIGNERS—4, 9, 11, 14, 15, 26
- DX FANS—4, 5, 16, 17, 18
- ENGINEERS—6, 7, 9, 11, 14, 15, 26
- EXPERIMENTERS—4, 5, 6, 7, 9, 11, 12, 14, 15, 26, 28
- MANUFACTURERS—2, 15
- OPERATORS—13, 27
- SERVICEMEN—1, 2, 4, 5, 8, 9, 10, 11, 12, 14, 15, 18, 20, 22, 23, 26, 28
- SET BUILDERS—4, 5, 8, 9, 11, 12, 14, 15, 22, 23, 26, 28
- SW FANS—4, 5, 6, 13, 14, 15, 18, 19, 20, 25, 26
- STUDENTS—1, 4, 5, 6, 7, 8, 9, 11, 12, 14, 15, 22, 23, 24, 26, 28
- TECHNICIANS—1, 4, 5, 8, 9, 10, 11, 12, 22, 23, 26, 28

Coming—

The best way to learn radio is by doing! The most competent radiomen have, almost to a man, started their careers by actually building simple radio equipment, gradually progressing to more complicated construction with their knowledge and ability growing apace. To assist those who wish to adopt radio as a hobby or a vocation, the May issue will contain the first of a series of articles which will describe the construction and operation of a series of receivers starting with the simplest type and following through to the more complicated modern types of receivers. Not only will these articles provide all of the information necessary to construct the models described but, in addition, they will explain the fundamental principles involved in the operation of each. If among your friends, there are any who are interested in developing their knowledge of radio you will do them a favor by bringing this series to their attention.

1	Serviceman's Diary.....	Anonymous	579
2	Editorial.....	Lee Ellmaker	580
3	New Broadcast Studios.....	Merle S. Cummings	583
4	What's New in Radio.....	William C. Dorf	585
5	How to Build an All-Wave Preselector.....	Henry Dobrovolny	586
6	Radio 600 Feet Underground.....	The Editor	588
7	Seeing in the Dark.....	Victor Hall	589
8	Selling Service (Part 3).....	A. A. Ghirardi and T. S. Ruggles	590
9	Servicemen's Output Meters (Part 2).....	John Strong	592
10	P. A. Profits in Low-Cost Sound System.....	M. N. Beitman	593
11	Solutions of Transmission Problems (Part 1).....	Frederic Siemens	594
12	Making Your Own Relays.....	Merrit L. Perkins	595
13	The "Ham" Shack.....	Everett M. Walker	596
14	The 5-Meter Range Beckons (Part 2).....	S. Gordon Taylor	598
15	5-Meter Car Radio (Part 2).....	Laurence M. Cockaday	600
16	BB Station List (Central and South Americas).....	John M. Borst	601
17	The DX Corner for the Broadcast Band.....	S. Gordon Taylor	602
18	Test Report on 24-Tube Super.....	L. M. Cockaday and S. G. Taylor	605
19	The DX Corner for Short Waves.....	L. M. Cockaday	606
20	World Short-Wave Time Table.....	The Editor	608
21	Backstage in Broadcasting.....	Samuel Kaufman	612
22	The Service Bench.....	Zeh Bouck	614
23	Servicemen's Contest Awards.....	The Contest Editor	616
24	Students' Radio Physics Course.....	Alfred A. Ghirardi	620
25	Captain Hall's Short-Wave Page.....	Horace L. Hall	622
26	The Technical Review.....	Robert Hertzberg	624
27	QRD?.....	By GY	626
28	The Radio Workshop.....	William C. Dorf	628

Published Monthly by Teck Publications, Inc., Washington and South Avenues, Dunellen, N. J.

Lee Ellmaker
President and Treas.

B. Holcepl
Secretary

H. D. Crippen W. P. Jeffery
Advertising Management

Virgil Malcher

205 W. Wacker Dr., Chicago
Western Representative

EDITORIAL AND EXECUTIVE OFFICES

461 EIGHTH AVENUE, NEW YORK CITY, N. Y.

Entered as second class matter at the Post Office at Dunellen, N. J., under the act of March 3, 1879. Copyright, 1936, by Teck Publications, Inc., in U. S. and Canada. All rights reserved. Registration of title of this publication as a trade mark applied for in United States Patent Office. Printed in the United States of America. The contents of this magazine must not be reproduced without permission. We cannot be responsible for lost manuscripts, although every care is taken for their safety.

25c a copy. Subscriptions: \$2.50 a year, \$4.00 for two years. In Canada and Foreign Countries \$3.00 a year, \$5.00 for two years. Subscribers are notified that change of address must reach us five weeks in advance of the next date of issue.

Pages From A Serviceman's DIARY

WEDNESDAY—Arrived a little late and rushed to the phone, which was already ringing with monotonous insistence. Recognized the worried, hesitant voice of Dr. G— "Please come over right away. There is something I must see you about before I leave for town." Jumped into the car immediately. The doctor is an ideal customer. Knows that special service is worth a special price—buys lavishly and pays promptly. Wondered what might be wrong. The overhaul job on his Stromberg and record-changer was finished only last week. Stepped on the gas and pulled up alongside the entrance to his white Colonial home in less than ten minutes. Before I could get out of the car he appeared in his doorway and called out reassuringly, "Don't bother to bring in your apparatus."

Troubles! Troubles!

After we were seated in the library, the doctor leaned forward and said apologetically, "I hope I haven't called you here about something which may be incurable. It isn't the radio's fault. My trouble is"—he paused momentarily—"announcers! During every program one of the pests stands ready to break in with a sales talk which I must suffer through or jump up and shut off the set until he has finished. My secretary keeps salesmen out of my private office. My servants see that they do not disturb me at home, at least in person. Now it's up to you to find a way so I can listen to the radio without this constant annoyance."

"What you want, then, is an *announcer squelcher*," I said. "De Forest had an arrangement with a photo-cell actuating a relay for this purpose. He used a flash-light trained on the light cell, but that is unnecessarily complicated. RCA had a voice coil, short-circuiting switch on the Radiola 67 to reduce the interstation noise, but one had to push the tuning knob to make it work. Suppose I rig up an arrangement so you can sit in your armchair, push a button and reduce the announcement to a whisper. You can then tell when it is over. Push another button and the program will return to its original volume."

"That's the idea!" the doctor exclaimed. "Go to it."

Went back to the store and got a pear-shaped, push-button switch and wired it with 16 feet of silk-covered twisted pair. Returned and tried connecting it so as to short-circuit the voice coil. Speech reduced

THESE records from an anonymous serviceman's diary should be of decided interest to veteran servicemen, as well as to those whose experience in the service field is more limited. Written by a man who "knows his stuff," and shot with an occasional outcropping of humor, these items provide many hints not found in text books. More of these pages will appear from time to time.



OH! FOR THE LIFE OF A HARASSED SERVICEMAN

Torn breeches, wild dogs and jumpy nerves are only a few of the conditions that the serviceman has to deal with besides his technical problems in making refractory radio receivers work right.

in volume, but still a little too loud. Tried resistors in series with the voice coil and found 1000 ohms about right. Speech coming through faintly but understandable. Connected the switch cable so the resistor could be short-circuited out by pushing the red button and the program restored to normal volume when the black button was pressed. Ran the switch over to the doctor's easy chair. O.K.!

Discussed the job back at the store, contending that if everybody had such a contraption sponsors would put on better programs. My argument was that the present system of long-drawn-out sales talks antagonized the manufacturers' best customers and caused ill-will. Subtler methods, such as Major Bowes uses, would entertain listeners and the advertising would not be so offensive.

Work Amidst Difficulties

Next—A new customer, up the hill. Radiola 18, installed in bookcase. (This model never seems to wear out.) Found open grid-suppressor, causing weak reception. Socket contacts weak. Wanted to take it to the shop, but no go. Owner asleep and had left word that the set must be fixed in her house. Maid cautioned me not to make unnecessary noise. Spread cloths on the floor and started to work. Removed knobs and screws and slipped chassis out of cabinet. Just then two Scotch terriers came bounding in. Shooed them away from the soldering iron and patted their heads to keep them quiet. One seemed to have a rather sedate disposition and merely ambled over to the other side of the room to await developments. The younger animal was pretty frisky. Thought I wanted to play. Jumping around, the pup suddenly knocked over the envelope containing the knobs and screws for set. One knob started to roll along the floor. I went after it but the pup beat me to it, taking the knob in its mouth and running into the next room.

Then dropping the knob the animal stood panting with head cocked over on one side and the stubby tail wagging, until I made a grab for the knob. Too late again! This time the exasperating canine picked up the knob and dived under a settee. Meanwhile the other dog started barking. I got down on my hands and knees and crawled slowly toward the knob. Decided the best plan appeared to be to catch the dog and knob simultaneously, so I made a sudden quick dive under the settee. Victorious at last! About this time, the other dog decided to become an active party in the proceedings and obtained a tight grip on my pants, tugging and growling. As I attempted to repulse the attack from this quarter, in sailed the lady of the house, in negligée. "What is the meaning of all this disturbance?" Struggled to my feet and told her I was trying to keep her radio from going to the dogs! She chased the animals into another room and I finished the job in peace. Off to lunch and a much-needed rest.

Started off the afternoon with a shop overhaul job on a Stromberg 642, replacing volume controls, cleaning condenser rotor contacts and tube prong contacts of sockets, tightening drive-shaft screws on tuning dial hub, cleaning all ground contacts on by-passes and testing filter condensers for leakage. (Turn to page 615)

A SQUELCH CIRCUIT

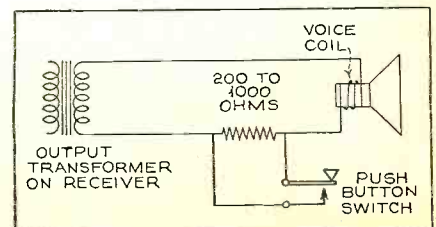

A Growing Threat to the

By Lee Ellmaker,



CONTROVERSIAL issues, which by necessity arise during political campaigns such as we will have during the coming summer, may seriously tax the strength and endurance of the radio broadcasting set-up as it now exists. We have in these United States a condition whereby two men can dictate what goes over the air waves to this nation. And it should be remembered that these two men are in this radio broadcasting business for a profit. Their futures as business men depend upon their having the favor of such licensing machinery as exists under a partisan government at Washington. At present they are the sole judge of what constitutes "freedom of speech" over air bands which have been granted to them without cost.

Entire Industry at Stake

The entire radio industry, as represented by manufacturers, dealers and servicemen, may be jeopardized by any questionable move by these two broadcasting systems.

These conditions should not exist. For a century and a half in America the freedom of speech has been held inviolate. The most partisan of the American press feels that it is mandatory to print both sides of a question, confining their own comment to the editorial pages.

Freedom of speech as well as freedom of the press is guaranteed by our Constitution. Under the present national broadcasting set-up, freedom of speech is not guaranteed. The whim of a Paley or a Sarnoff might throw its whole system of communication for the dissemination of news and facts into the backyard of any political buccaneer. If this should be done, and present indications are that these two great broadcasting czars keep their ears tuned to the listening "sounding board" at Washington, then the whole struc-

ture of radio in its physical aspects, and that is the one we are interested in, is strained and may be broken.

The radio industry, outside of the two great broadcasting systems, exists because of the sale of radio receivers, the sale of parts for radio receivers and the servicing of sets in the home. If there is not a broad-visioned non-partisan and non-influenced person or persons in charge of determining just what should be broadcast and what should not be broadcast, the interest of the people in radio will fade out and disappear. This should not and cannot be.

Partisan Censorship Dangerous

RADIO NEWS believes, with the great majority of radio manufacturers, radio educational institutions, servicemen and retail dealers and with the majority of listeners, for that matter, that nothing should be barred from the air which comes within the realm of decency or does not shock the public's morals or system of honor.

With this as a rule, there should be no question as to what devious means might be employed to muzzle free expression by anyone as long as the air, belonging to the people, is parcelled out without cost to any commercial radio broadcasting combine or combines. That broadcasting stations, licensed as private, profit-making institutions to use the nation's wavebands exclusively, have the right to commercialize the air, owned by the people, should be enough. No radio licenses should extend to the point where the holders thereof should enjoy the sole or even partial right to determine who is to broadcast or what is to be said on the air.

On controversial issues, both sides should be given the opportunity, if they are willing to pay the carrying charges, to state their views whether they employ facts or fallacies, because, after all, the ordinary householder

Freedom of the Air!

President, RADIO NEWS

spends his own money for radio, believing that he or she has both the right and the ability to select their own particular choice of programs. They don't want to have expressions of their own will fettered by the narrow view of any broadcasting executive.

It may be that the government is playing too prominent, though hidden, a part in this radio control. It is true that there must be some centralized authority so that wavebands will not conflict and so that reception can be perfected to the nth degree, but that is as far as this man's government should be able to go.

There are laws a-plenty in existence to keep truly objectionable statements or other obnoxious material off the air. Once issued, no license should be revoked by any government official body except for some cause which would break down a logical scientific set-up of waveband control, such as the misuse of power or some other real but technical regulation.

Scope Should Be Widened

Broadcasting also should be opened to non-political public-spirited groups who are willing to operate broadcasting stations without profit. The government, however, has not encouraged such a program. This could be done on ordinary broadcasting wavebands or even under short-wave regulations. There is a vast field for educational, labor, religious or even veteran broadcasting which could be developed soundly, on a non-profit basis, but which might mean an even greater mechanical development for radio, a larger field for set making, servicing, etc., than now.

A commodity is worth what you can get for it. During the past year broadcast advertising rates have increased with nothing to prevent station owners from doubling them if future traffic will bear it.

President Roosevelt in all his utterances

has claimed that the national wealth of this country, which is represented by our water power, should not be exploited in private enterprises. Whether this policy in electricity has come too late, to be of much value, is a question. But it is not too late to prevent the radio wavebands from being exploited by a few, for their own personal benefit, under licenses which cost them nothing. It may be that the great publicity of the air waves and the possibility of one political party receiving the lion's share of this has had something to do with the closing of the official eye to the exploitation of this great national radio resource.

Future Must Be Guaranteed

We don't want to go into this from any other angle, however, than its effect on the large set makers of this country (and the small ones, too), the radio servicemen and the radio retail outlets as well as radio manufacturers of parts. And we must keep in mind the fact that if there is to be any future of this industry, for the youth of the United States, they must not get the impression that the future is sewed up in the pockets of those who happened to be on the "in" when the broadcasting licenses were parcelled out.

This is a grave question and it must be faced at once before the radio industry becomes shackled and forbidden to move by virtue of the lack of "freedom of speech and expression" over the nation's broadcasting systems.



PRECISION ENGINEERING WORKS WONDERS *for* SERVICE MEN



Mallory Condensers are manufactured under
U. S. Patents 1710073, 1714191, et al.

Now... 69
MALLORY
REPLACEMENT
CONDENSERS
give universal application

You'll appreciate how precision engineering helps service men when you see how these Mallory Condensers offer practical universal mountings for both carton type and round can condensers—

- how precision engineering develops absolute protection against humidity
- how precision engineering makes practical smaller sizes with greater efficiency
- how precision engineering has with 69 condensers provided the complete answer to the condenser problems of over 29,000 service men.

And you will appreciate just how precision engineering counts for you when you read the new Mallory Service and Replacement Manual which gives in detail the universal application of these Mallory Condensers in every day service work.

Have you received your copy? If not, write us today, on your business letterhead.

Cellophane separators —
Etched anodes —
Stitched anode leads —

— of course, all important improvements pioneered or developed by Mallory are incorporated in Mallory Condensers wherever they add to quality.

P. R. MALLORY & CO., Inc.
INDIANAPOLIS INDIANA
Cable Address — Pelmallo

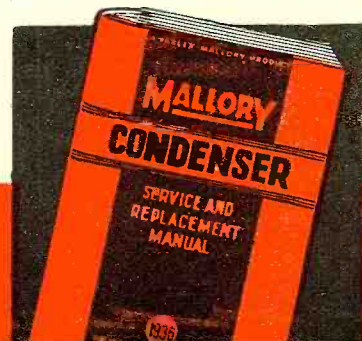

Radio News

April, 1936

New Styles In

BROADCAST STUDIOS

In accordance with the latest trends in modern architecture and acoustics, American broadcasters are building new studios to house their air programs with a view to improving pick-up, to making the artists feel more at home, and at the same time providing for a growing demand on the part of the public to see and hear productions as they are being broadcast

THE networks and the large individual stations throughout the United States are investing heavily in modernized and enlarged studio quarters. It was natural that, following recent trends in programs and technical equipment, appropriate studio settings for the physical presentation of broadcasts should be provided. While it is true that the decorative features of a broadcasting studio have no direct bearing on what the listener thinks of the station's offerings, the new and attractive type of program chambers prove their worth as a psychological factor in getting the best out of entertainers' endeavors. Also, with the growing trend for visible audiences in the key cities, stations are eager to provide surroundings as pleasing to the eye as they hope their programs are to the ear.

While studio improvements have been made at many stations in recent weeks, the two outstanding ventures in broadcasting halls are in Hollywood and Chicago. Hollywood has been growing in importance as a radio talent center since the exodus of big names from the East due to lucrative talking-picture offers for the headliners of the air.

Hollywood Studios

NBC, long feeling the need for more modern studio facilities in the Cinema Capital, took over the old Consolidated Film Industries Studio on Melrose Avenue. Or rather, they took over what was left of the building. The structure was largely destroyed by fire several years ago. Now as the network's West

By Merle S. Cummings

Coast studios, the building has been made fireproof and earthquake proof. The broadcasting chambers, of modern design, have been constructed according to the principles followed in New York's Radio City.

The structure's exterior is modern, coinciding with the interior. Air-conditioning, sound-proofing and other technical features of Radio City were applied to the building. O. B. Hanson, the network's chief engineer, designed the project which was built under the supervision of Gordon Strang, construction engineer, and E. J. Tyler, installation engineer. Besides the main building housing three studios and administrative offices, there is a second smaller structure which has been converted into a single studio exclusively for auditions. Neighboring the new studios are the RKO and Paramount movie lots.

Two stories in height, the main building is 140 feet long and 75 feet deep. The exterior is of white stucco,

with chromium and black metal trim added to the decorative scheme. A large vertical neon sign of black and chrome is over the entrance. The annex building is of similar design.

Studio Layout

The two principal studios are on the second floor of the main building. These are known as Studios A and B and are patterned after Studio 8-G of Radio City, along theatrical lines. Studio A accommodates 276 persons as on-lookers while Studio B can take care of 210 guests. Studio D is in the center of the main

AWAITING THE FIRST NOTE ON A FIRST NIGHT
Scene on the stage in the new Hollywood NBC Studio, where the artists and performers, as well as the audience, tensely awaited the opening strains of the inaugural program



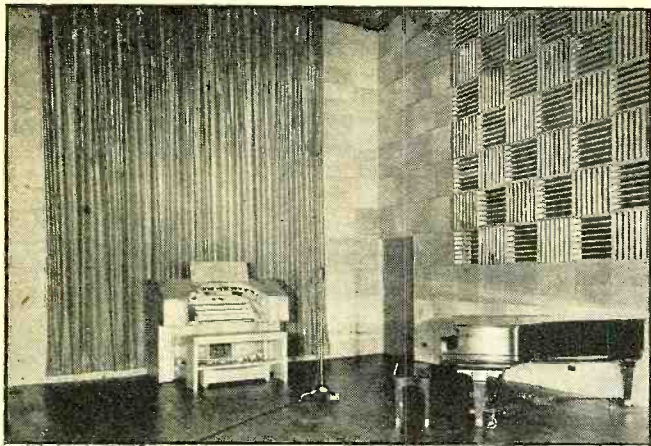

ACOUSTIC PERFECTION IN MODERNISTIC SETTING

No musical instruments are harder to reproduce perfectly than the organ and the piano. This new Studio at WGN, Chicago, introduces the eye and ear to new possibilities



HOLLYWOOD STUDIOS IN A NEW DRESS

The main Hollywood broadcasting center of NBC is the most modern in technical layout and appearance and in keeping with the surroundings, down to the last palm tree

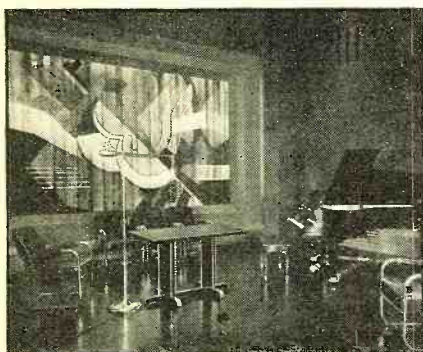

WGN'S NEW LAYOUT

The illustration above shows Studio Number 2. Below are: Studio Number 10 and a nook in the artist's private dressing room

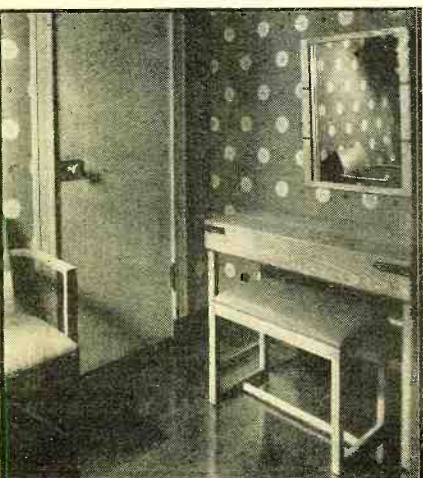
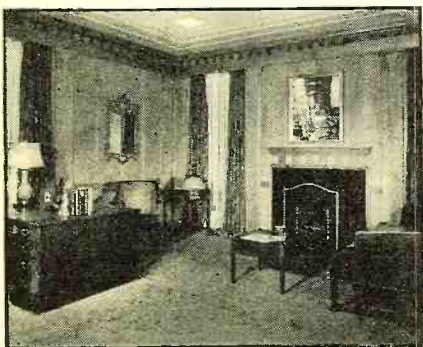

floor while Studio C is in the adjoining smaller building. Dressing rooms, clients' rooms and various executive offices are attractively laid out.

Chicago also has come to the fore along with Hollywood as a talent center. Hence, it is not surprising to find the station owners making heavy investments in new studio accommodations. The most elaborate new studio venture of the Windy City was the opening of the \$600,000 building of Station WGN on Tribune Square. This 50-kilowatt station, one of the most prominent in the Midwest, is a point of origin for several programs on the schedule of the Mutual Broadcasting System.

Modern Interior

The building exterior is Gothic while the interior is modern. The structure includes six studios—each with a control room. There are also four clients' rooms, three observation rooms, one main control room, dressing and lounging rooms, a sound effects laboratory, a transcription chamber, a music library and various offices and work rooms. Prizes totaling \$5,000 were offered in a competition of interior designs. Out of 189 submitted

plans, the first award went to Ernest A. Grunsfeld, of Chicago, who was retained to supervise the execution of his designs and decorations for Studio One. This studio, the main attraction of the building, is the largest radio studio in the country, outside of New York.

The Large Auditorium

Studio One is 70 feet long and 65 feet wide with 538 opera chairs placed in permanent rows and tiered from the front of the house to the rear providing clear views of the production platform for every guest. The concert stage is large enough to accommodate an entire symphony orchestra. There are two glass-walled booths on either side of the platform. The lower left booth is for engineering controls while the one above is for lighting controls which yield special effects as programs are presented. The upper and lower-right booths are for clients and guests. A public-address system, enabling the studio guests to hear the programs exactly as they go on the air, is also provided. A projection room, completely equipped, provides for the showing of talking pictures in this auditorium (*Turn to page 637*)

A REAL STAGE SETTING FOR AIR BROADCASTS

This is the main Studio Number 1 at WGN, seating an audience of 538 persons. The control, monitoring and announcing rooms, totally enclosed in glass, are seen at the right and left of the stage

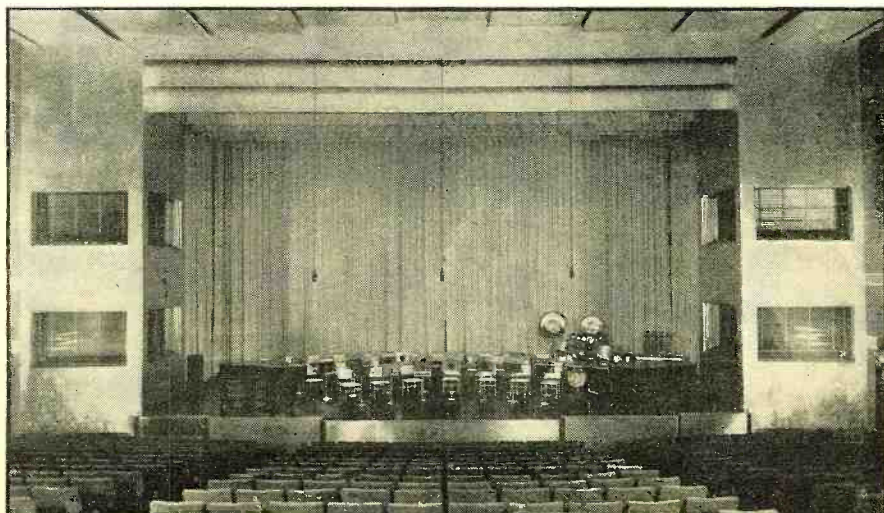

WHAT'S NEW in RADIO

Every radio man wants to know about new receivers, new amplifiers, new tubes and new equipment and the following pages give you information on such developments

By W. C. Dorf

Interference Eliminator

The "Filtrad" interference eliminating device made by the Automatic Electrical Devices Co., is designed to suppress radio interference at its source. It is applied directly to the motor or electrical equipment creating such radiations and is made to absorb and dissipate the interference, before it has an opportunity to interfere with radio reception. The instrument can be had in different current ratings and in different mounting styles to meet every type of installation.

Crystal Microphone with a Good Frequency Characteristic

The new Turner "Mu-X" multi-crystal type microphone is available in single or push-pull types and are designed to provide natural reproduction with a high output level. These new microphones can be had in many models, differing only in number and arrangement of the crystals. Response curves rate the microphone basically flat from 40 to 7000 cycles with a slightly rising characteristic from 7000 to 10,000 cycles. This series of micro-

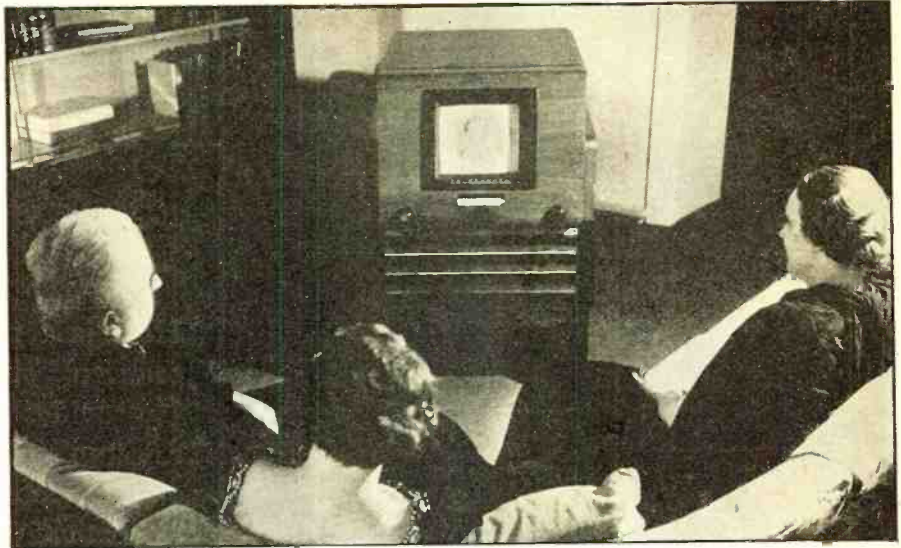

WHAT A TELEVISION RECEIVER FOR THE HOME LOOKS LIKE

In spite of the denial, by the officials of various radio companies working on television, that this art is not "just about to be released to the public," there is actual evidence of feverish activity along this line and that receivers suitable for home-vision reception have been developed.

phones is particularly suited to studio requirements for broadcasting or recording.

Attention, Servicemen and Dealers

The Supreme Instruments Corp. makes the announcement that their new model 491 theater, P.A., and radio analyzer supersedes the type 391 instrument. The outstanding developments in the new instrument include a completely internal, resistance-measuring power supply; both point-to-point and selective analysis (socket) testing methods and a multi-range meter.

A New Development in Attenuators

A notice has just been received from Electrad, Inc., that their attenuators, types TN, LN and U are now replaced by the new type BN control. The new unit is designed for greater and true logarithmic attenuation and lower noise level. They are available in standard resistance values from 15 to 10,000 ohms.

High-Fidelity Receiver

The photograph below shows the new 20-tube Lincoln Symphonic receiver. The feature of the set is the use of a double system of intermediate-frequency amplifiers, one channel being used to produce a very narrow filter allowing high sensitivity and selectivity for DX reception and the other channel designed to pass all of the musical frequencies. The complete



equipment consists of a 12-tube self-powered tuner, an 8-tube audio amplifier and a pair of matched speakers. The large airplane type dial is calibrated on all frequencies from 16 to 2000 meters. This dial is equipped with a band-spread pointer plus a dual-speed planetary reduction dial drive. Additional features include a manually controlled, filtered bass amplifying circuit, 30-watt power output, 2 r.f. pre-selector stages and low noise level. In order to eliminate cabinet resonance the Lincoln engineers have developed what they call a "Free Floating Speaker Resonator". This is a separate assembly on which the speakers are mounted and completely insulated from the cabinet by means of heavy layers of hair felt.

Effectively Demonstrating a New 16-Tube Set

The photograph shows Mr. Malcomb Woodman of Wholesale Radio Service Co., Inc., demonstrating the new Lafayette 16-tube all-wave superheterodyne. This display model is enclosed in a specially built plate glass case, the r.f. tuner section, the

(Turn to page 632)



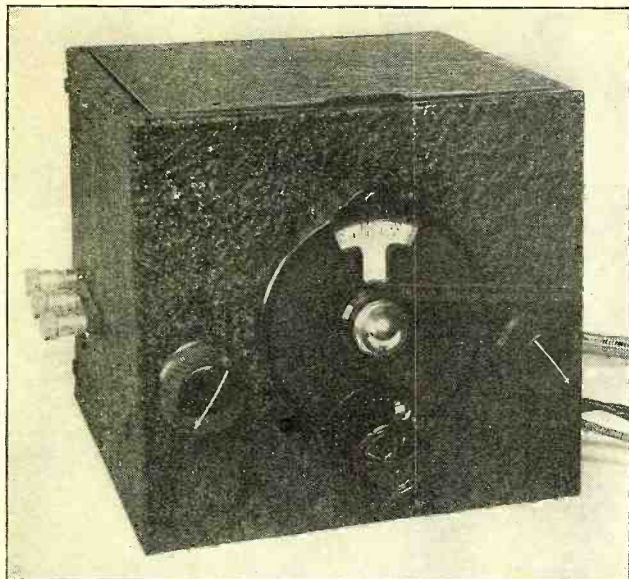

AN EXTRAORDINARY DISTANCE-GETTER

Front view of the completed preselector which in tests showed a veritable "kick like a Missouri mule".

THE trend in designing highly sensitive receivers has been more and more during the past two years in the direction of more preselection and pre-amplification. A favorable signal-to-noise ratio requires that a relatively high signal voltage be applied to the converter tube. Unless this is done, maximum usable sensitivity cannot be obtained, regardless of the amount of amplification provided at the intermediate frequencies.

A NUMBER of receivers during the past year or so have incorporated two stages of two tuned r.f. ahead of the converter and these circuits have definitely proven the distinct advantages offered by a high degree of pre-amplification. In many cases DX'ers and short-wave listeners are using superheterodyne receivers which do not have sufficient pre-amplification. Naturally, they do not feel that they can afford to discard the receivers, but on the other hand, they are interested in obtaining maximum usable sensitivity. A good preselector offers the solution of this problem and it is the author's intention to describe here a preselector which can be constructed at home and which has

proven highly successful with both t.r.f. and superheterodyne receivers.

Heretofore, most preselectors have employed a single regenerative r.f. tube and as a result have for the most part been cranky in operation and extremely critical so far as antenna coupling is concerned. If antenna absorption or improper design resulted in the inability to bring the tube up to a point of active regeneration, such preselectors have resulted in actual loss of signal strength at the particular frequencies where this condition obtained.

For this and other reasons it is important that the functions of amplification and regeneration be handled by two separate tubes. In this way the amplifier tube always functions as an amplifier so that increased signal voltage is obtained at all frequencies. Then, when still further sensitivity is required for weak signals, the regeneration provided by the separate tube is brought into play to provide an extremely high degree of additional amplification as well as decidedly improved selectivity.

The input circuit shown in Figure 1 can be used only with ordinary "L" type antennas with a single lead-in wire. It is flexible, however, and can readily be

ARRANGEMENT OF THE PARTS

The three illustrations below show quite clearly the placing of the various parts used.

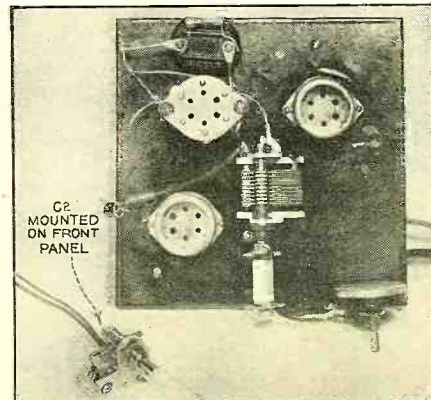
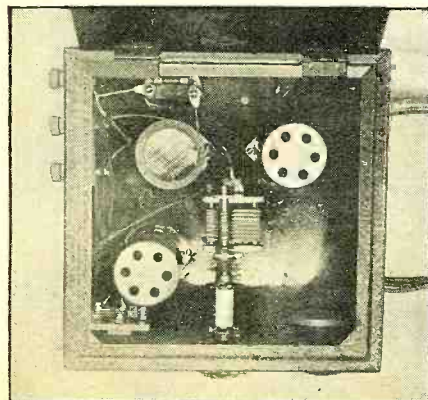

Kicking Up

*with
A Home-Built, All-*

Here is a compact unit which may be connected ahead of any type of receiver. It provides an additional stage of tuned r.f. amplification, with a separate regenerative tube to provide still further amplification when needed. Plug-in coils permit its use in any wavelength range.

adjusted for special antenna systems, as will be described later. Since the rotor of C2 is grounded, it can be mounted on the front panel.

Unless certain precautions are taken a regenerative r.f. stage is apt to develop undesirable characteristics, especially when coupled to a regenerative receiver. One of these precautions is to insulate the rotor of the tuning condenser C1 from the chassis and dial. R2 and C3 were also found essential for maximum isolation. A metal cabinet solves the shielding problem most adequately. A tube of the 58 or 6D6 type is used as the amplifier to prevent cross-modulation. The regenerative tube may best be a 6C6 or a 57.

Neat and Compact Unit

The National cabinet was selected because of its neat appearance and to avoid constructional difficulties. Before taking it apart a $\frac{1}{4}$ -inch hole is drilled in the exact center of the front panel and then the small holes for mounting the dial. Figure 2 and the photos present the essential details for locating and drilling the holes for the regeneration control, antenna condenser, binding posts, and output and supply leads.

The tuning condenser, C2, is fastened to a piece of victron, (bakelite will do), and this assembly is mounted on two pillars so that the rotor will be insulated

DX

Wave Preselector

By
Henry Dobrovolny

Amateur Station W7CKB

from the sub-base. The half-inch bushings supplied with Hammarlund sockets were just the right height for lining up the condenser shaft with the bushing of the tuning dial. After locating the holes for the two screws used for mounting the tuning condenser, the cabinet is taken apart and the sub-base removed.

Short Leads Stressed

If the layout in Figure 2 is approximated the r.f. leads will be quite short and the efficiency of the coil will not be impaired by the shielding. The components beneath the sub-base should be arranged so that the important leads will be short, and all the r.f. grounds should be made at one point on the sub-base. Heavy copper wire should be used to connect this ground point to the ground post. If the heater current for two tubes would overload the power transformer in the main receiver, mount a small filament transformer in

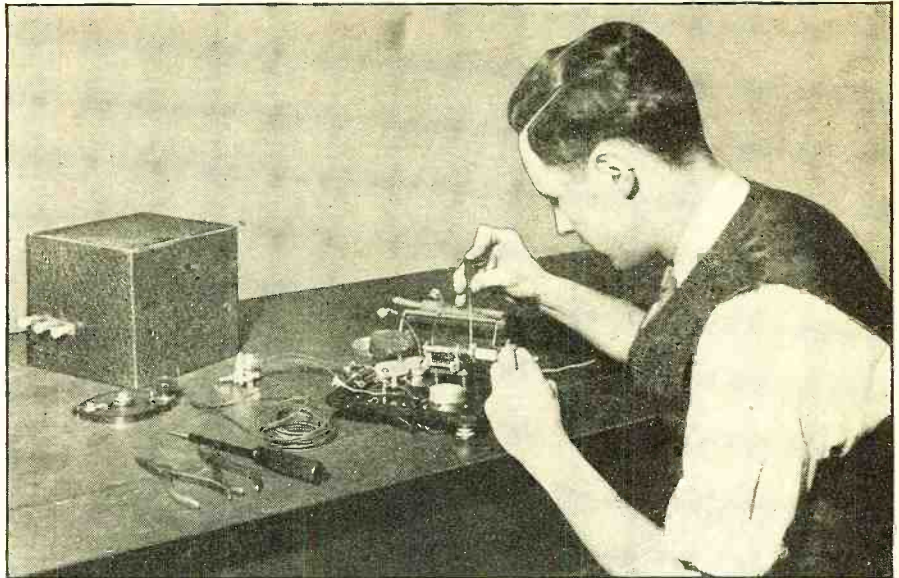

YOU CAN BUILD THIS PRESELECTOR AT HOME

Only a few ordinary household tools are necessary to put together this valuable adjunct to your present receiver. The whole thing can be assembled and wired in a couple of hours' in the cellar workshop or even on the kitchen table.

the space indicated by dotted lines in Figure 2.

The Hammarlund plug-in coils were selected because of their efficiency and reasonable price; nevertheless, there is no apparent reason why the constructor should find it difficult to wind his own coils, or to adapt other makes or types.

A choke-capacity coupled output is

WIRING AND ASSEMBLY
The two diagrams below give the details for hooking up the preselector as well as the placement for the various parts that go into it.

indicated in Figure 1, but if the receiver input is designed for antenna systems with two lead-in wires, that is, if it has a separate and insulated antenna coil, leave out the connection between points marked E and F, connect C7 as shown by the dotted line and connect the output leads to E and F. A twisted pair may then be used for the output leads, but they will have to be as short as it is possible to make them. With the choke-capacity coupled output it will usually be found desirable to use a shielded lead. In that case, a single-conductor cable of the low-capacity type with a 1/2-inch outside diameter should be used. By connecting one end of the shield to the ground post of the receiver and the other end to the ground point of the pre-selector, the shield will serve as the ground and B-lead. The B plus lead may be connected to any point on the filtered side of the receiver's plate supply, where a voltage between 150 to 250 volts is obtained.

Operating Instructions

The operation of this pre-selector is very simple. While "fishing" for signals little or no regeneration should be employed, C2 is set for maximum capacity, and the circuit (Turn to page 637)

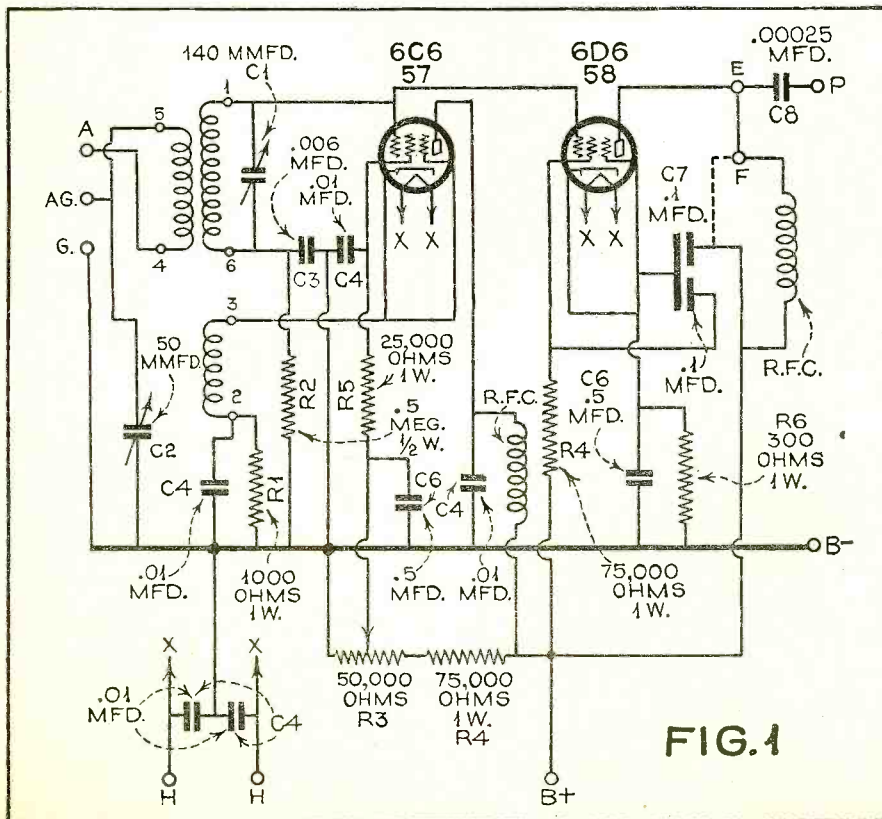

FIG. 1

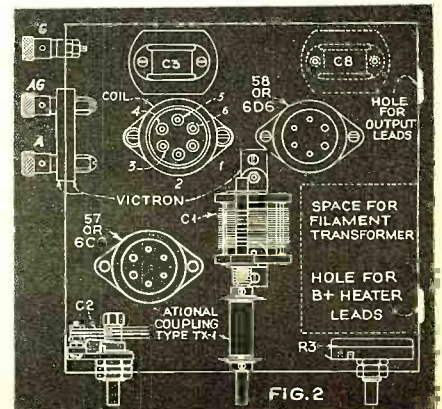

FIG. 2

Some Interesting

600 FT

What scientists found out about ultra-short-waves when they descended into the depths of one of the world's most wonderful tunnels, drilled through the underlying strata of rock under the East River

By The Editor

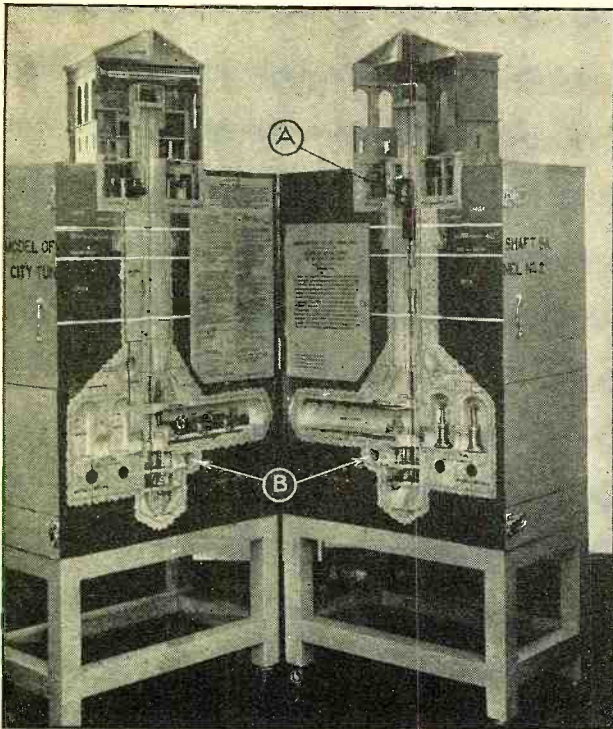

MODEL OF THE TUNNEL SHAFT

This is a fore-shortened model of shaft 9A, where the tests were made. The arrow A points to the elevators, whereas the arrows B indicate the entrance to the tunnel along which further tests were conducted

THE ability of 5-meter signals to penetrate almost 600 feet of solid rock, down into the depths of one of the world's deepest tunnels, was recently demonstrated by a group of scientifically minded engineers picked from the personnel of the Headquarters Troop of the 131st Cavalry, the staff of the School of Commerce, New York University, the Engineering Bureau of the Board of Water Supply of New York City and the editorial staff of RADIO NEWS. The tests were made in New York City Tunnel No. 2, at Shaft 9A, at a point where the signals would

have to descend through almost 600 feet of solid rock to the level of the tunnel. Two-way communication was held between a party located in the engineering office building, 110 feet from the head of the shaft (which is covered by a steel building) and the exploring party as it made its way down in the huge elevator to the bottom of the shaft. Tests made later between the two parties, directly along the tunnel, indicate that the 5-meter waves were absorbed by the rock walls at a distance of approximately 750 feet, horizontally, where there was no wiring running through the tunnel. This is the distance at which signals faded out. However, tests in the opposite direction in the tunnel, through which there was an electric cable running, indicated that the

short radio waves will travel along guided by the wires to much greater distances.

These results were really surprising to all concerned when it is considered that the signals had to go down through the shaft where there are over 1000 tons of ferrous metal lining the shaft walls.

Used Portable Units

One of the transmitters was a portable job using two 76 tubes (as oscillator and speech modulator) with only 250 volts on the plates. In this unit was incorporated a simple super-regenerative receiver. This equipment is shown in use in the lower photograph. It was this unit which was carried through the tunnel through water almost knee-deep, and set up in the really complete darkness. An interesting point during the test was when three members of the party took up a position in the tunnel between the two transmitters while they made their way from one station to another. At this time the signals dropped from a clear understandable volume to almost a whisper and did not come in loud and clear again until the three human bodies had passed the transmitter and gotten out of range.

The Fixed Station

The other transmitter and receiver was a semi-portable job and was mounted on a wooden platform at the juncture of the tunnel and the vertical shaft. This transmitter, shown in use in the tunnel and pictured at the top of the page, was more powerful and used a 6A6 tube as oscillator with another 6A6 tube as a Class B modulator. The receiver was a superheterodyne. This transmitter-receiver unit was made available for the tests by Dr. C. C. Clark of the School of Commerce.

The purpose of the tests were to find

TALKING ALONG THE TUNNEL

The small portable 5-meter transmitter that was carried along the passage in holding the two-way tests underneath that part of the tunnel extending under the river up to Westchester



Radio Tests

UNDERGROUND

out if radio transmitters could be used in the shaft and along the tunnels in place of telephones during construction work.

Organizing Expedition

The exploring party was organized by Mr. Latimer M. Spoley, chief operator of the radio section of the communications platoon of the 101st Cavalry of New York and owner of amateur station W2ASF. Lt. Pierce P. Hurley Jr. (of the same military organization) headed the party, which consisted of the two already mentioned as well as Mr. Herman J. Vanholten and Mr. Walter E. Lawson, Mr. Nathaniel Bernstein, manufacturer of the transmitter, and L. M. Cockaday, editor of RADIO NEWS, and Herman Young, photographer. The whole party donned hip-boots and extra-warm clothing to withstand the chill and cold at this great depth. Of course, permission to enter the tunnel for the tests was obtained through the courtesy of Mr. Walter E. Spear, Acting Chief Engineer of the Board of Water Supply and Mrs. Charles M. Clark, Department Engineer of the City Aqueduct Department of the Board.

The tunnel is 17½ feet in diameter and has a capacity of 700 million gallons of water per day. It is 20 miles long and was built for the better distribution of the existing water supply for New York City. The shaft of the tunnel where the tests were made, a model of which appears above, is located on the waterfront of Queens and the tests in the tunnel were 600 feet down from the surface, directly under the East River in the direction of the far end running up into Westchester County.

First 5-Meter Tests

While these tests are not the only ones that have been made underground they are significant because they were made using 56 megacycle waves which were previously believed to have been incapable of passing large objects. Another reason is that they were made through a greater thickness of rock than previous tests. One of the tests in the tunnel was made around a bend in the tunnel and this seemed to make no difference in the transmission and reception. There was no actual sight-line between the two stations during that particular test. If the waves do not bend it may be that they were reflected from the walls of the tunnel at the curve. A floodlight flashed through the tunnel during this same test did light up the other party somewhat due to this type of reflection.



SEMI-PORTABLE RIG MOUNTED ON TUNNEL PLATFORM

Another "flashlight" picture of the engineers at the fixed station in the main tunnel. Underneath the platform a swift stream of "seepage" water ran continuously

Our readers may also remember tests made some time ago in the depths of Mammoth Cave, Kentucky, where radio signals penetrated more than 400 feet of solid rock to get down to the

expedition in the cave. Still other tests have been made from submarines diving several hundred feet below the surface of the ocean. Tests have also been made in coal mines (Turn to page 625)

SEEING in the DARK

By Victor Hall

HOW man is now enabled to see in the dark by means of a new electron-image tube was demonstrated recently before the American Association for the Advancement of Science by Drs. George A. Morton and V. K. Zworykin of the RCA Laboratories.

The assembled scientists witnessed the projection of motion pictures focused on the tube, which converted light rays into electrons. The electrons sped through the tube and reproduced the pictures in enlarged form on a screen in its further end. Then continuing the demonstration a dark-glass filter was placed in the beam of the motion-picture projector. All visible light rays were stopped dead, yet, with what to the average person would appear sheer magic, the electron image tube continued to reproduce the enlarged pictures with hardly (Turn to page 620)

OPERATES ON BLACK LIGHT

The new electron-image tube which converts invisible light-rays into electrons and back again into a picture

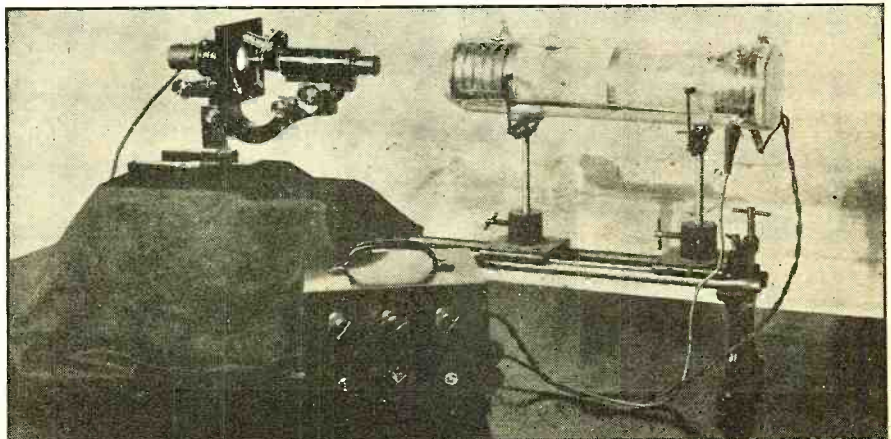



CLEVER "SICK TUBE" WINDOW DISPLAY

Here is an unusually attractive and clever window display that has been used with great success by the service shop of Paul Butler & Chall McCall of Wilkesburg, Pa. The trim cost about \$25.00. During the two weeks it was in, Butler & McCall more than doubled their tube business and collected the names of many good prospects for sets and appliances.

THERE was a time when a radio serviceman could pick up clientele if he merely put up a sign outside his shop and printed some common "business-cards" which he circulated among the residents of his local neighborhood. But competition has changed all that!

TODAY, a serviceman must know something about the many advertising and sales-promotion methods that are open to him, and learn to use them intelligently, if he expects his business to have a steady and healthy growth. True, if his business is already so large that his advertising runs into considerable volume he will undoubtedly profit, in the long run, by hiring the services of professional advertising counsel, but even so, he should familiarize himself with the fundamental principles and methods of sales-promotion for his own personal information.

The first and second articles in this series (which appeared in the December and February issues of RADIO NEWS), reviewed the practical selling methods which are open to the radio sales and service shop, and considered Counter Selling, Outside Canvassing, Special Check-up Services, and Telephone Selling. We continue on from this point.

Every day, alert servicemen are proving that there are many different "good" ways in which to advertise their service. But while all of them have merit, because of the different conditions under which servicing businesses are operated, they are not all "good" to the same degree for all servicemen. Some servicemen find direct-mail advertising very much worth while. Others cannot make it pay, but find that door-to-door canvassing works wonders for them. Still others find that certain forms of sales-promotion work, best, only at certain seasons of the year, etc. You will have to do a little careful experimenting to find out which ones work best for you.

Since display advertising is applicable to any service business operating from a store, and has generally proved to be a very effective and comparatively inexpensive method of advertising and for bringing in new business, we will consider it now.

Display Advertising

By display advertising is meant advertising in which the attention and interest of the prospect are captured by a display or demonstration of the product or service which are to be sold to him. The best type of display is one that has action, and which demonstrates, as well as calls attention to, your service. Demonstration of the product is essential in any kind of selling. Radio service work may not be quite as easy to demonstrate as some definite radio products, but servicemen with imagination have found many interesting and effective means for doing it.

Naturally you will have a store-front and sign that are attractive in appearance. But it's what you put in your window that is responsible for pulling the passer-by inside. Always remember—the public likes to be entertained! So put a radio "show" in your window—avoid the more usual show cards and display pieces—try to "dramatize" your story—use showmanship!

Tube Window Displays

For example, a Pennsylvania tube dealer made up the fairly inexpensive window display illustrated here, drama-

A DISPLAY THAT SELLS RECEIVER CHECK-UPS AS WELL AS TUBE TESTS.

Why stop at testing tubes? When a tube replacement customer enters your store, sell him more than a tube check-up—test his tubes and also his complete Radio Set. Here's an attractive display by National Union Radio Corp. that helps to put this idea across! It's an excellent example of a silent promotional display that will work for you all day—and every day in your shop.

"SELLING

Display advertising is a powerful yet that every serviceman can use in his able outlet for the full expression of for creating new ideas. If any service—and carry out to completion an idea for really succeeds in bringing in more a new interest in his business from that

By A. A. Ghirardi

Part

tizing the idea of "First Aid to Sick Radio Tubes". From 3 to 6 o'clock from Monday to Friday, and from 3 to 9 P.M. on Saturday, an attractive girl dressed as a Red Cross nurse tested tubes in the window. The rest of the window was filled with various piles of old tubes, labelled, "We have howled our last time," "We made a lot of noise," "Free Burial for Dead Tubes," etc. Under a sign "Radio Tube Cemetery" there was a "coffin" filled with worn-out tubes. The public was invited to guess the number of tubes in the coffin and win a valuable prize. This window display has "action," and if an attractive girl is used, also has "human interest". It more than doubled the dealer's tube business during the two weeks it was used and, in addition collected a number of good prospects for sets and electric appliances. A good, unusual idea like this can be used more than once at sufficiently long intervals.



SERVICE"

inexpensive business-building medium shop. Furthermore, it makes an admirable whatever inventive genius he may possess man wants a real thrill, let him originate a novel window or store display that customers, work and profits! He'll take day on and become more successful!

and T. S. Ruggles

Three

Another enterprising dealer has three elaborate tube-testing panels in use, not because he needs that many, but simply to impress his prospects. A man testing tubes at one of the panels is placed in the window (along with appropriate display signs) so that they are visible from the street. This display brings in a lot of tube business for this shop.

Cathode-Ray Window Displays

From time to time you can always make a display of your servicing equipment, within the limitations of your window space. Better still, keep a repairman at work in the window if you can. Put up a sign describing what the different pieces of equipment are and what they do. The Cathode-ray oscillograph is proving to be an excellent medium for this purpose, for at last the many interesting things which go on in a radio set can be made visible—and in an extremely fascinating way that never fails to attract attention and interest the public. Sets can be aligned, distortion can be demonstrated, sound wave-forms can be shown, etc.

A window display of this type that has proved its worth is shown in the

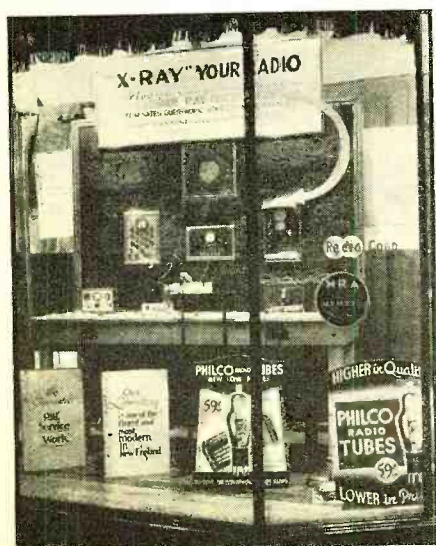

accompanying illustration. The man at work, and the antics of the oscillograph attracted hundreds of people each day so that the entrance to the store was practically jammed all the time. As a result a considerable amount of service work, and some set sales were realized. The names of many interested prospects were also obtained.

Don't leave one display up too long in your window. After it reaches the point of "diminishing returns", its effectiveness decreases rapidly. If you find that a particular display pulls exceptionally well, re-run it at a later date. Two separate runs are better than a lengthy display, as the novelty of the idea wears off.

The posters and displays furnished by manufacturers are usually worth using for short periods between your own novel displays, even though they impart no real individuality to your service and window. One unusual display supplied by a prominent tube manufacturer, sells the customer the idea of having his entire set tested as well as his tubes. Why stop at testing the tubes only—why not try to sell your complete service? By a unique construction, a rack is provided on top of this display, where the dealer can place an actual set, as shown in the accompanying illustration.

OSCILLOGRAPH WINDOW DISPLAY GREAT ATTENTION GETTER

Your cathode-ray oscillograph used properly in a window display will never fail to attract the attention of the public and interest them in your shop. This is the splendid business-getting display used by World Radio Corp., of Boston, Massachusetts. A neat service bench was moved intact into the display window and the attention of passers-by directed to the modern service facilities of the shop by the large attractive sign and arrow pointing to the oscillograph—with the catch-phrase, "X-RAY YOUR RADIO". A serviceman was kept at work at the bench aligning receivers.



A PARTS DEPARTMENT THAT IS A REAL ASSET
A neat, systematic arrangement for your parts department will prove to be a real asset to your shop, for it makes your customers feel that you are well-equipped and will render them intelligent service. Notice the neat display of parts, 6-point check-up service, etc., in this parts department of the World Radio Corporation of Boston.

Inside Displays

Make sure that the inside of your shop is laid out so as to properly "merchandise" the services you have to offer (or the merchandise you have to sell). Don't be afraid to "show-off" your business and your shop. It should look clean, business-like and modern. Don't let old sets, parts and other junk lie around. Display your test equipment as prominently as possible. Make it impressive—it will inspire your customers' confidence in your technical knowledge and ability. It pays to build an impressive, modern test panel—it will do as much to sell your service as anything else. So many excellent test panels and benches have been shown in Zeh Bouck's Service Bench section in past issues of RADIO NEWS that it is not necessary to show additional examples here.

Your shop should demonstrate what you have to sell by displaying it right in front of your customers—so they don't have to look for it! If you sell sets, arrange them so the customers see them as soon as they enter your door—and so they first see the ones you are most interested in selling. Provide chairs for your prospects while you are demonstrating your sets.

If you sell only parts and service, arrange everything systematically on shelves, and in view. The accompanying illustration shows how one serviceman accomplished this objective in the parts department of his shop. Notice how clean, orderly and systematic everything looks—you'd surely expect to get intelligent service in a shop like this one!

Set a stage for your work! One service dealer, just for effect, has his walls literally lined with tube cartons. He sells an average of 1000 tubes a month!

You can probably find additional opportunities for (Turn to page 636)

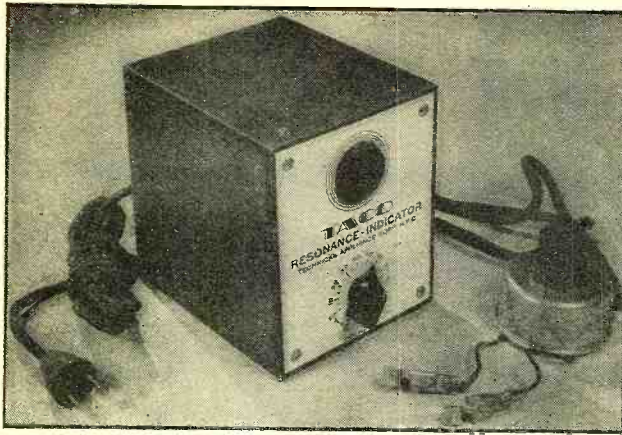

SERVICE UNIT OF WIDE UTILITY

A Serviceman's STUDY of Output Meters

By John Strong

Part Two

IN addition to the output meters described last month, a novel and interesting type, the Taco Resonance Indicator, has just been announced by the Technical Appliance Corporation. The unique circuit employed in this device is shown in Figure 1. The indicator is the 6E5 "Magic Eye." A 6H6 duodiode is used as a rectifier and voltage-doubler to supply the proper voltages to the 6E5 elements. The input tube is likewise a 6H6, acting as a diode tube voltmeter, and is mounted on a small support which may be placed close to the circuit under test so that short connecting leads may be used. The reactive effects of long leads are thereby minimized. The parts values were not obtainable from the manufacturer and are therefore omitted in the schematic diagram.

A Home-made Model

Another unusually simple and inexpensive output indicator of the neon-tube type, supplied by Blan the Radio Man, is shown in one of the accompanying photographs.

Those who have an extra 1 ma. meter on hand can construct a simple output meter at negligible cost, using the circuit shown in Figure 4. A small "bread-board" model constructed in the RADIO NEWS Laboratory is shown in the photograph. The resistors used are 1-watt carbon type. This simple circuit is so arranged that the meter may be used for its normal d.c. applications in addition to functioning as an output meter. By connecting to terminals *DC* and *LO*, it is a milliammeter with a full-scale deflection for 1 ma. Using *DC* and *INT*, it becomes a d.c. voltmeter giving a full-scale reading for approximately 15 volts, and connecting to *Hi* extends the voltmeter range to 50 volts.

Figures 2 and 3 indicate various meth-

ods of connecting output meters. Figures 2A and 2B are applicable to any output meter of medium or high input impedance and voltage range. In this category are most of the neon bulb devices, except as noted in the preceding article, as well as the copper-oxide rectifier and "Magic Eye" types. Figure 2C may be used if the output meter has high sensitivity. The step-up transformer used in the RCA device adapts their neon tube indicator (shown last month) to this form of connection. Most copper-oxide rectifier types used without multipliers and tube voltmeters may likewise be so employed.

Figure 3 shows two additional meth-

ods which may be employed only with output devices having high input impedance, such as tube volt-meters, cathode-ray tubes or the Taco Resonance Indicator described above. The form of connection of Figure 3A obviates the need of a blocking condenser and keeps the output meter at low d.c. potential. This method is applicable only to Class A amplifiers.

Using the Meter

Figure 3B is an excellent method of connection for receivers employing a.v.c. This is a typical a.v.c. circuit, with the audio and i.f. circuits omitted for simplicity. An impressed signal on the diode rectifier causes an increase of current in R1. The resulting voltage drop across R1 causes point *a* to become negative with respect to ground. The a.c. components are filtered out by C1, R2C2 and R3C3, applying only the negative d.c. bias to the grid of the controlled tube. When the output meter is connected as shown, this voltage is indicated. Since this system is actuated by the carrier frequency, modulation is not required, and will not affect the aligning process. Most test oscillators give a much sharper signal when unmodulated, which enables more precise alignment. Since a high degree of attenuation is not required with this form of connection, proper alignment is simpler, particularly at high frequencies where the attenuators of many types of test oscillators are not efficient. The output meter shown in Figure 4 does not have a sufficiently high input resistance for this form of connection. However, if the 1 ma. meter is shunted to give full-scale deflection for 8-10 ma., it may be connected in the plate circuit of one of the tubes controlled by the a.v.c. system and the same advantages obtained. A diagram (*Turn to page 636*)

BLAN OUTPUT INDICATOR

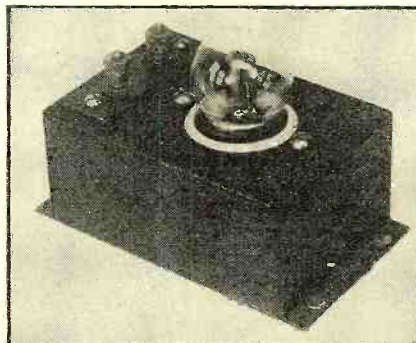

HOME-BUILT OUTPUT METER

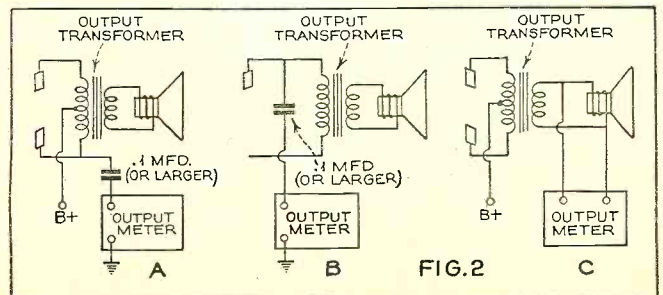
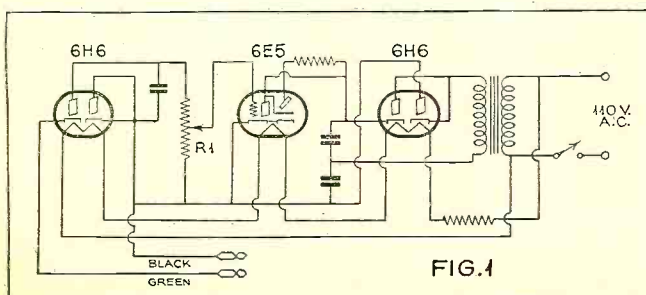
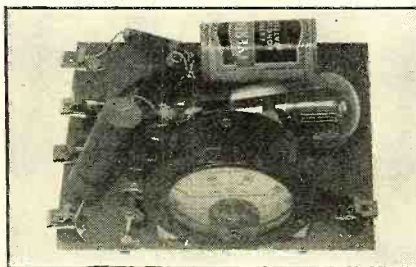

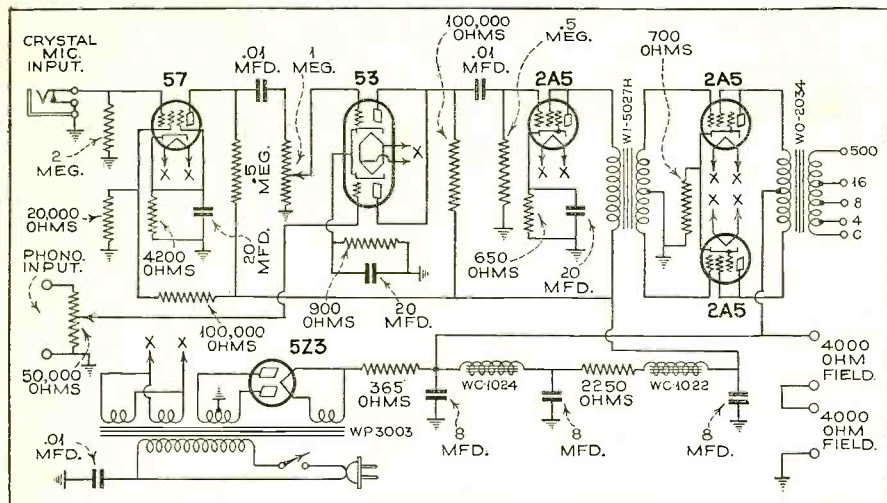

Break Into P. A. PROFITS

with this Low-Cost Sound System

By M. N. Beitman

BROADCASTING "OPPORTUNITIES"

It should be shouted from the housetops for the benefit of servicemen, that real money can be made by the application of P. A. systems to the problems of public life in our own home towns and cities. This is true in the case of both permanent installations for schools, restaurants, churches, clubs, etc., and rental for publicity

THE universal popularity of high-quality, low-output microphones of the crystal and velocity types has resulted in a heavy demand for high-gain amplifier units. Engineering difficulties originally encountered in developing such an amplifier on a single compact chassis have been overcome.

AN unusually successful high gain amplifier of the new type is represented by the "Knight" 15-watt unit which is especially designed for use with either crystal or high impedance type velocity microphones. This quality amplifier, engineered by the Allied Radio Corporation, is distinguished for its advantageous layout of parts, for a number of unique circuit developments, and for its low cost.

The output stage uses two 2A5 tubes connected as push-pull triodes, self-biased, in a class AB circuit. The rating given by tube manufacturers to this type of 2A5 arrangement is 15 watts and the preceding stages employed in

this design are ample to fully excite the output stage with the microphones mentioned. The amplifier has an extraordinarily low hum level, at all times better than 25 db. below zero level.

The complete sound system, of which this amplifier is the heart, is illustrated by the accompanying photographs. It consists of the high gain amplifier, either a crystal or velocity microphone mounted on an attractive floor stand with suitable shielded cable, and two giant Knight dynamic speakers obtaining their field excitation from the am-

plifier, each equipped with a 30 foot connecting cable.

In designing the system, special attention was given to making it versatile in application. The input of the amplifier is arranged for ribbon-velocity or crystal microphones, and may be easily adapted for carbon microphone use. Almost any type of phonograph pickup may be employed and radio input may also be used. The output transformer has taps at 4, 8, 16 or 500 ohms. The lower output impedances may be used in various combinations with a number of standard dynamic speakers. The 500 ohm output is employed for coupling to a line when the speakers are placed some distance away from the amplifier. It is evident that these flexible input and output provisions will meet practically all low-power public address requirements that may arise.

The amplifier is housed in a steel case of black crystalline finish, of sturdy construction (Turn to page 636)

THE COMPLETE INSTALLATION

Here is a self-contained, public-address system ready for installation at only a few hours' notice. The cord running out of the picture to the right, from the amplifier, is the microphone cord. The microphone itself is pictured at the top of this page.

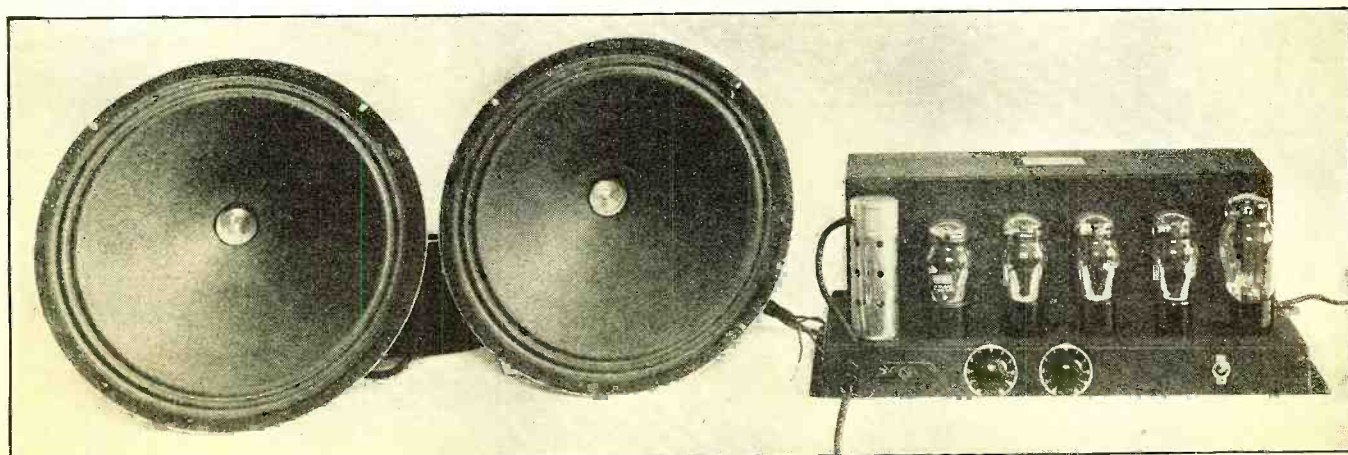

Some Standard Solutions of TRANSMISSION PROBLEMS

Refreshing your mind on some simplified solutions of problems of electrical transmission of energy from one circuit to another as applied in impedance matching, etc.

Frederic Siemens

Part One

THE increasing use of public-address systems and apartment house radio installations in which a number of loudspeakers are operated from a single amplifier, or radio receiver, makes it necessary for the practical man concerned with design and installation to know something of transmission theory. For the most part, this theory is simple enough to be readily assimilated so that it can be easily applied to practical problems in which an approximate solution, only, is necessary. The consideration of actual cases in which detailed analysis is necessary may become somewhat involved due to the lack of perfection of physical apparatus. Fortunately, modern equipment, for the most part, approximates perfect equipment sufficiently close that in quick solutions necessary for system layout, the actual equipment can be considered perfect. In the following there is outlined for reference some well-known transmission formulas in general use by engineers concerned with transmission.

It is well known that a generator will deliver maximum power to a load when the impedance of the load is *equal in magnitude and opposite in phase* to that of the generator. This can easily be shown as follows:

Impedance of generator	=	$X + JY$
Impedance of load	=	$A + JB$
Current flowing	=	I
Generator voltage	=	E
Here J	=	$\sqrt{-1}$

The current flowing in the circuit due to (E) is given by:

$$I = \frac{E}{Z} = \frac{E}{(X + A) + J(Y + B)}$$

The power delivered to the load is then: $P = AI^2$

$$AI^2 = \frac{AE^2}{[(X + A) + J(Y + B)]^2} \quad (1)$$

The vector quantity in the denominator consists of a real and an imaginary component. The magnitude is determined by the square root of the sum of the squares of the real component and the imaginary component. Using only the magnitude of the vector (1) becomes:

$$P = \frac{AE^2}{(X + A)^2 + (Y + B)^2} \quad (2)$$

Now in order to find the maxima or minima of any expression it is customary to differentiate it with respect to the variable quantity and equate to zero. Since in (2) one of the variables is A, we may differentiate the right-hand side with respect to A. This gives:

$$\text{and: } \frac{2E^2A(X + A)dA}{A^2 = X^2 + (Y + B)^2} \quad (3)$$

Since B is also a variable, we must also differentiate (2) with respect to B and equate to zero. This results in:

$$\frac{2E^2A(Y + B)}{Y} = -B \quad (4)$$

Substituting (2) in (3) we have:

$$\begin{aligned} A^2 &= X^2 \text{ or} \\ A &= X \end{aligned}$$

That is, maximum power will be delivered to a load of (A + JB) when the reactance of the generator is equal and opposite to that of the load (i.e. at resonance) and when the resistance of the generator is equal to the resistance of the load.

This solution can also be had, without recourse to the Calculus, by a simple consideration of fundamentals. First, it is obvious that if the generator impedance consists of resistance and inductance in series, that more power can be delivered to the load when the inductance of the load is resonated by a series condenser. That is when:

$$Y = -B$$

Then the impedance of the whole series circuit will be purely resistive. The optimum load conditions may be determined by trial. Thus let:

$$A_1 = \frac{X}{2}$$

Then:

$$I_1 = \frac{2E}{3X}$$

And:

$$P_1 = I_1^2 A = I_1^2 \frac{X}{2} = \frac{4E^2}{9X^2} \times \frac{X}{2} = \frac{2E^2}{9X}$$

Next let:

$$A_2 = X$$

Then:

$$I_2 = \frac{E}{2X}$$

And:

$$P_2 = \frac{E^2}{4X}$$

Again let:

$$A_3 = 2X$$

Then:

$$I_3 = \frac{E}{3X}$$

And:

$$P_3 = \frac{2E^2}{9X}$$

Obviously:

$$\begin{aligned} P_2 &> P_1 \\ P_2 &> P_3 \\ P_1 &= P_3 \end{aligned}$$

It is already obvious that a maximum lies near (X = A) and this process can be continued by choosing values of a closer to X until sufficient points are obtained to plot a curve of power (P) as a function of the load impedance (A). It will be found that the curve would have a maximum at:

$$X = A$$

Plotting a curve to obtain maxima or to estimate area, by means of counting squares or using a planimeter rather than depending on a purely mathematical analysis, is usually the surest way of arriving at the correct solution of the problem for the person not mathematically inclined. Fortunately most of the problems that the practical engineer must face are readily solved in this manner. It is often possible to obtain an absurd solution of a problem by correct mathematical treatment. Thus, as a simple example let:

$$X = A$$

Multiplying by sides by A:
 $AX = A^2$

Subtracting X^2 from both sides:
 $AX - X^2 = A^2 - X^2$

Factoring:

$$X(A - X) = (A - X)(A + X) \text{ or} \\ X = A + X$$

Now this solution is absurd, although no error is at once apparent in the algebraic manipulation. The defect lies in the interpretation, and is due to the fact that extraneous roots often result from squaring and taking square roots, or in factoring. In such cases it is the usual practice to test the solution in the original equation and to neglect those roots that do not satisfy it. The point that we wish to make, here, is that *good judgment must be used* both in solving a problem and in the interpretation of its solution, rather than blind analysis.

Now consider the impedance-matching transformer. If this is a perfect transformer of impedance (*Turn to page 615*)

Making Your Own RELAYS

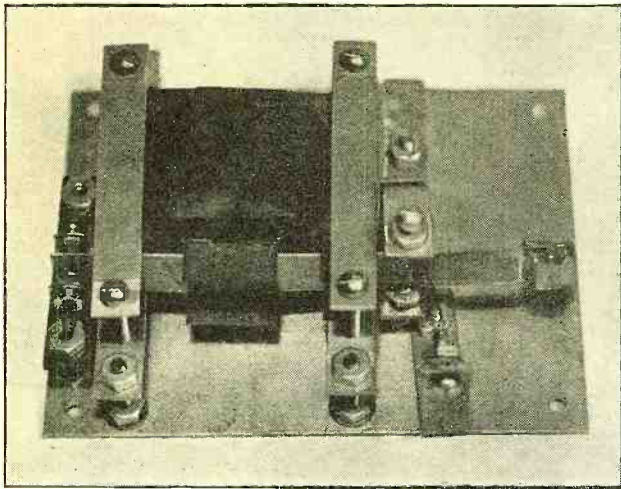

This example of one of the relays made by the author from an old transformer is described in detail and the construction details are shown on this page. Under test it operated dependably on 0.8 ma.

By Merrit L. Perkins

EXCELLENT relays, including those which will be actuated by a current of 1 milliampere, can be easily made from the windings and core of an audio transformer or choke. Only a few common tools are required and the materials are easily obtainable. The work does not require skill and if carefully done the relay will give excellent results. This is largely due to the very efficient electromagnet formed by the transformer core and coils.

It is not intended to describe here any particular relay but rather to explain the general principles of design that they may be applied to any relay that the experimenter wishes to construct. To do this a given relay will be taken and particular parts of its design and their modifications explained. A sensitive relay capable of closing on currents of slightly less than 1 milliampere is chosen because it is the type that most experimenters will wish to build and also because it is the most difficult type to construct. A transformer with "E" type core is the most common type and therefore will be used in the relay described here.

The electromagnet assembly consists of the core, coil and mounting. The transformer is taken apart and the core and coil assembled with all of the "E" laminations in one position. The "I" laminations are not used in this assembly. The core is well designed and adds greatly to the efficiency of the electromagnet by providing a good path for the magnetic flux. With a given core and armature arrangement and spring

tension the sensitivity of the relay depends on the number of ampere-turns of the coil.

If the resistance of the circuit is very high and the current small, as in the plate circuit of some vacuum tubes, highest sensitivity is obtained with the greatest number of turns of fine wire. In most circuits the amount of current to be carried and the amount of resistance that may be introduced into the circuit limit the size of wire. An audio transformer secondary will carry at least 5 ma. and the primary 10 to 15 ma. continuously. If the current is intermittent, as in a keying relay, more current may be carried safely. The maximum current depends entirely on the heating of the windings. Ordinarily currents will be well within the maximum limits, but in certain cases, as when the windings are paralleled this matter must be watched.

Construction Details

If the relay is to close on the smallest current through the windings, they should be connected in series. If it is to close on the least voltage across the windings they should be connected in parallel. This choice adds greatly to the value of such relays in experimental applications.

The electromagnet assembly is best mounted by means of clamps made from non-magnetic material. However, other means may be employed if desired.

The armature should be made from material that is a good carrier of magnetic flux. For most purposes ordinary

sheet iron is entirely satisfactory. Soft iron is much better than hard iron. In small relays a single strip of heavy sheet iron such as No. 20 is satisfactory. For heavy relays extra strips the length of the pole pieces may be riveted on or the left-over "I" laminations may be used. Figure 1 shows the arrangement of core, armature and contacts; the manner of mounting is illustrated in the photograph.

In delicate relays where only a little tension is used on the armature it is desirable to counter-balance the armature to minimize the effect of vibration. A weight made of solder is satisfactory for this use. The armature should be balanced in all positions.

Mounting the Armature

A simple yet good bearing may be made by soldering a piece of hard steel wire, a little longer than the width of the armature and sharpened to a point on each end, to the armature. These points rest in deep center-punch marks in the ends of two screws which are adjustable and can be locked in place by means of locknuts; this is illustrated in Figure 2.

Springs may be taken from old automobile tire valve insides. The spring may be held in place by a rivet made from No. 12 wire and riveted to the armature (as shown in Figure 3). It should project about one-eighth inch from the bearing.

The stiffness of the spring is important. If the spring is too flexible the relay will open on (*Turn to page 639*)

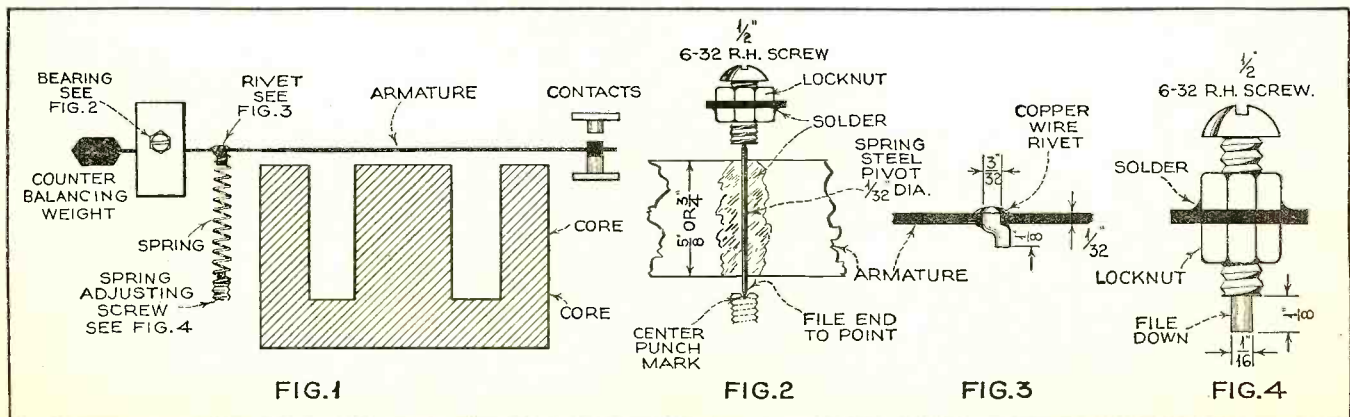

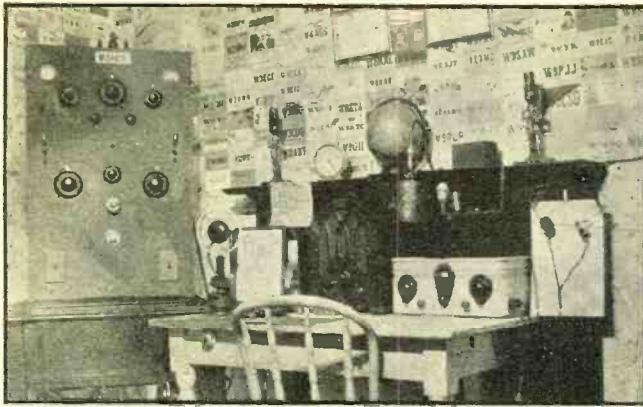

A PENNSYLVANIA HAM SHACK
The station of C. L. Gibson, W8MHE,
at Natrone, Pennsylvania, who is also
a C.S.C.G. member.

The "HAM" Shack

Conducted by
Everett M. Walker
Editor for Amateur Activities

Overhauling AMATEUR EQUIPMENT

THIS is the season of the year when the amateur begins to think of summer-time activity, of overhauling his equipment, and sometimes of other things besides radio. Whether these possibilities have been considered or not, the amateur station once a year needs a good going-over, and the late spring and summer are the ideal times of the year to do it. DX on most of the lower frequencies (below 14,000 kilocycles) is at a low ebb, and receiving conditions are frequently

severely punctuated with static. By saving rebuilding and overhauling for this time of the year, none of the "cream" of the radio weather is lost, and the transmitter may be put in shape to better battle the QRM in the fall and winter to come.

THERE are basically two types of amateurs—those who experiment all the time, continually trying everything new that comes "down the pike" and those who operate year in and year out without making any changes in their equipment. In this latter category we have the traffic handlers and the "rag chews." Their philosophy is "leave well enough alone." But even for this group, the necessity for overhauling cannot be accentuated too much. Surprising as it may seem, the writer has known amateurs who have allowed the same rig to stand without change for three and four years.

This amateur game is developing so rapidly, it seems difficult to believe that any one could allow his transmitter to remain in a static condition for so long, but nevertheless, they do. There is no criticism to be found with this practice, but it does

seem that a little doctoring here and there would have to result in some improvement. It might be in greater output, appearance or stabler and more efficient operation.

Any program of overhauling should logically begin with the antenna. In most cases it has just come through a hard winter. In the north there were heavy snows, sleet storms and lots of ice. These have a habit of collecting on antenna wires, and, unless the wire is of the non-stretch variety, they add considerably to the pulling that sometimes will draw it out of resonance. Believe it or not, a 3,500 kilocycle antenna (about 132 feet) will stretch as much as two feet in a year, particularly if soft drawn wire is used. While this difference in length is not so important with some types of antennas (such as the Zeppelin, where 5 or 6 per cent deviation from half-wave length may be tolerated), with voltage fed systems such as matched impedance lines, twisted pairs, etc., the resonant point is rather critical and the stretching will be enough to throw the whole system out of kilter.

Replace Antenna

Therefore, it would be wise to replace the antenna wire. It might be suggested too, that wire of the non-stretch variety be substituted. There are several kinds available, the most common is copper plated steel wire. The stretching factor of such wire is negligible as far as radio antennas are concerned. Neither is efficiency impaired because of the "skin-effect" of r.f. currents.

In addition, all antenna connections should be resoldered, and, where glass or porcelain bushings are used to bring the feeders into the shack, they should be cleaned. Guy wires on antenna poles should be tightened, and those which have rusted replaced. Ropes should be replaced, and it will pay to tar them.

Improve Xmitter

So much for antennas; now for transmitters. The last few years have brought so many new developments both in equipment and circuit design, that it is difficult to keep pace. New tubes have been developed that lessen the number required for a given amount of power in a transmitter; new exciter units have been designed that facilitate greater flexibility and band switching equipment has been made available. In view of these developments it is possible now to build a transmitter that may be operated on all but the ultra-high frequencies (above 56 megacycles) and even these may be covered with some of the latest types of equipment. It no longer is necessary to have a separate transmitter for different bands as it once was; either changeable coils or switches may be installed that facilitate all-band operation with a single unit.

For instance, a typical all band transmitter might be something like this: A 53 or 6A6 type tube as oscillator and frequency multiplier, a 210 or 801 buffer stage

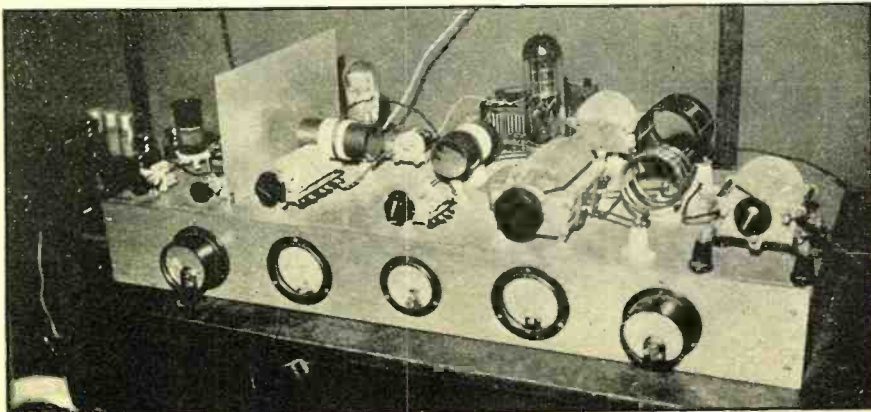
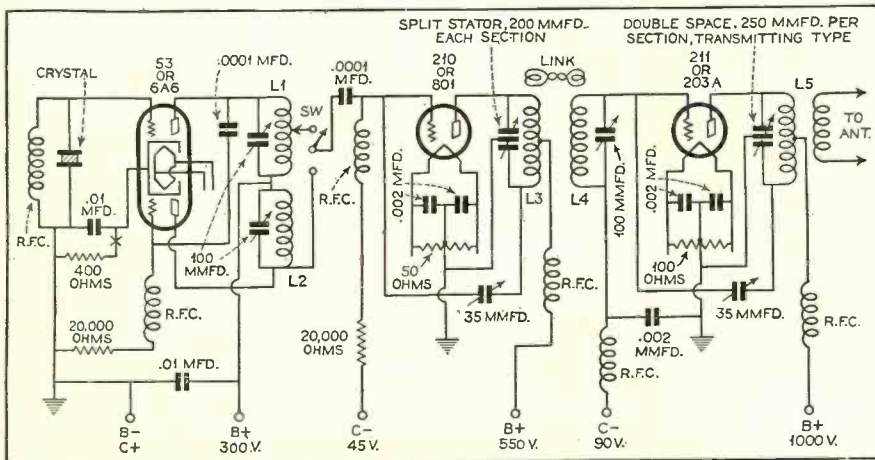

A Department for the amateur operator to help him keep up-to-date

and a 203A or 211 final amplifier. Such a transmitter may be operated on all frequencies ranging from 1,800 to 28,000 kilocycles. In an experimental model plug-in coils and semi-bread board construction were used, but the layout lends itself well for standard rack and panel mounting. With it, it is possible to jump from 1,800 to any other band in about thirty seconds; to use 'phone with either grid or high level plate modulation or C.W. merely by switching or plugging in the necessary coils, crystal or amplifier.

To Use Any Band

With a variety of crystals, each in a separate holder, it is possible to operate on any band. In the experimental transmitter two crystals were used, one at 1,995 kilocycles and the other at 7,100, and with these operation is possible on 1,995 or 3,990 kilocycles with one and on 7,100, 14,200 and 28,400 with the other, thus facilitating five band operation. This necessitates two crystal coils, each tapped one-quarter the total number of turns from the plate for fundamental operation; two doubler coils, one for 75 meter operation and the other for 20 meters; four sets of buffer plate and amplifier grid coils each with separate links and five tank coils for the final amplifier. All are of the plug in type, although coil switching arrangements could be used in all cases if desired.

To operate the transmitter on the 1,800 kilocycle band the necessary oscillator coil is plugged in, and the plate coil of the doubler section of the 53 oscillator is removed from the circuit. This disconnects the plate voltage from the second triode section. If tapped coils are used in this circuit, it will be necessary to provide a switch to cut this unit out of the circuit. The exciter control switch is connected to the oscillator coil tap by means of the single-pole-double-throw-switch; the 1800 buffer tank, amplifier grid and plate coils are plugged in the circuit. To shift the transmitter to the 75 meter 'phone band, the oscillator coil of course is the same; the doubler coil is inserted in the second 53 triode plate circuit; the exciter switch is connected to

(Turn to page 630)

COIL DATA					
BAND	L1	L2	L3	L4	L5
1.8 MC.	65 TURNS ON 1 1/2" FORM, No. 22 TAPPED	—	55 TURNS 2" No. 18	55 TURNS 2" No. 18	45 TURNS 3" No. 14
3.5 MC.	SAME AS FOR 1.8 MC.	25 TURNS 1 1/2" No. 18	28 TURNS 2" No. 18	28 TURNS 2" No. 18	34 TURNS 2 1/2" No. 12.
7 MC.	44 TURNS 1 1/2" No. 18 TAPPED	—	22 TURNS 2" No. 14 SPACED	22 TURNS 2" No. 14 SPACED	46 TURNS 2 1/2" 3/16" DIA. COPPER TUBING
14 MC.	SAME AS FOR 7 MC.	7 TURNS 1 1/2" No. 18 SPACED	10 TURNS 2" No. 12 SPACED	10 TURNS 2" No. 12 SPACED	9 TURNS 2" 1/4" DIA. COPPER TUBING
28 MC.					3 TURNS 1/4" COPPER TUBING, WIDELY SPACED

THE TAP FOR L1 COILS IS 1/4 THE NUMBER OF TURNS FROM THE PLATE END.

6R7 TUBE

A NEW metal tube, type 6R7, recently released, is a double-diode-triode with characteristics resembling those of type 85. While the 6Q7 provides a triode section with a high amplification factor, the 6R7 has a triode with a relatively low amplification factor and a lower plate resistance so it can be transformer-coupled to the next audio stage.

Yet the new tube is not the exact equivalent of the 85. The difference is shown in the accompanying table of comparative characteristics.

Less signal is required on the grid of the 6R7 than on the grid of the 85, for a given output. The power output is somewhat less but still sufficient for most output stages.

The diode units are independent of the triode and of each other, and can be used either in parallel or for separate functions in accordance with present practice.

Figure 1 shows the socket connections of the 6R7, which are the same as those of the 6Q7. Figure 2 shows a family of plate characteristics. (Technical information for this article was obtained through the courtesy of R.C.A. and Raytheon engineers.)

TABLE I

Heater voltage (a.c. or d.c.)	6.3	6.3 volts
Heater current	0.3	0.3 amp.
Max. overall length	3 1/4	inch
Max. Diameter	1.5-1.6	inch
Base	small octal 7-pin	small 6-pin

Triode Section—Class A Amplifier

Plate voltage	250 max.	250 volts
Grid voltage	-9	-20 v.
Plate current	9.5	8 max.
Amplification factor	16	8.3
Plate resistance	8500	7500 ohms
Mutual conductance	1900	1100 micromhos
Load resistance	15000	20000 ohms?
Max. power output	280	350 milliwatts

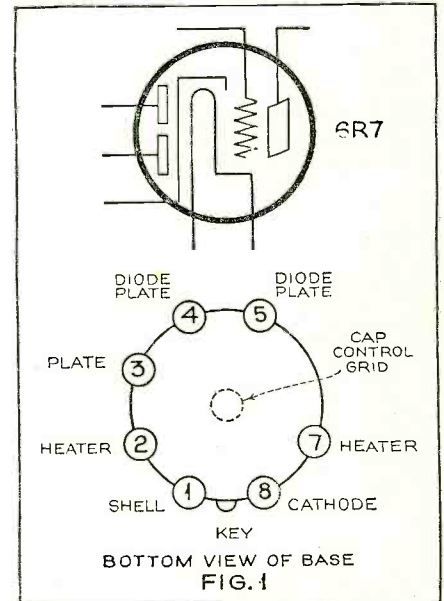
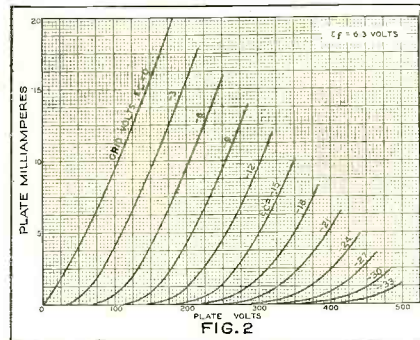

OFTEN HEARD FROM TOKIO Miss Chiyono Cugita, who has contacted more than one hundred American radio hams and is Japan's only YL operator. She uses her brother's transmitter and also works Australia, South America and Siberia.



The 5-Meter PICKING A

The following review of the latest of interest to experienced fans, as well described have been put through RADIO NEWS 5-meter Listening Posts tive. An introductory discussion last tions involved in selecting a receiver and for assuring the best results in ultra h.f.

By S. Gordon

Part

BEFORE proceeding with the descriptions of individual receivers it is well to point out that no consideration was given to super-regenerative receivers in which the super-regenerative detector is the first tube. Several years ago, while radio was going through its "growing pains," one of the greatest sources of annoyance were regenerative receivers. The radiation from these "bloopers" caused interference in other receivers, sometimes for miles around. From the standpoint of radiated interference, the super-regenerative circuit is far worse than old-time regenerative receivers and RADIO NEWS feels that it should discourage their use.

Several super-regenerative receivers are described here, but it will be noted that each one has an r.f. tube ahead of the super-regenerative detector. Whether or not the r.f. circuit is tuned, the presence of a tube between the antenna and the detector reduces radiation to a negligible value.

The order in which the receivers are described in this article has no bearing whatsoever on their relative merits.

Lafayette "Acorn" Superhet

Figure 1 shows the circuit of this 6-tube receiver and the photographs below the circuit show front and inside views. A type 954 acorn pentode is employed in the tuned r.f. stage, and another 954 serves as both the first detector and oscillator. This is the so-called "autodyne" converter system made practical by the use of a very low-frequency, resistance-coupled intermediate amplifier which consists of two stages with 6D6 tubes. Sensitivity is controlled by varying the first detector screen voltage. Volume is controlled by means of a potentiometer in the grid circuit of the power amplifier tube. The output connections provided are suitable for use of either headphones, a magnetic speaker, or a dynamic speaker with a suitable coupling transformer.

Power supply may be obtained either from batteries or from a separate power supply unit.

Separate tuning controls are provided for the r.f. and detector stages and plug-in coils are used to permit coverage of any portion of the range below 10 meters. Any type of antenna may be employed, as the isolated antenna primary permits the use of double-wire feeders, or an antenna having a single lead may be used by grounding one end of the primary.

The receiver is available only in built-up form, laboratory tested and ready for use. Another model which differs from this only in that a 6D6 and a 6C6 are employed in place of the acorn tubes is available in kit form for the home constructor. Both are produced by Wholesale Radio Service, Inc.

Peak Model Q-5 Superhet

This receiver is designed for the use of either 6-volt or 2½-volt glass tubes. The schematic circuit, Figure 2, shows the types. The first tube is the combination first detector and oscillator (autodyne), the sensitivity of which is varied

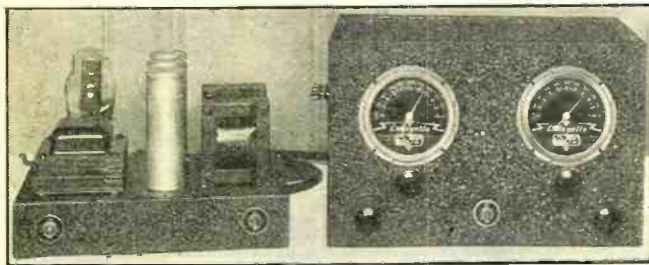
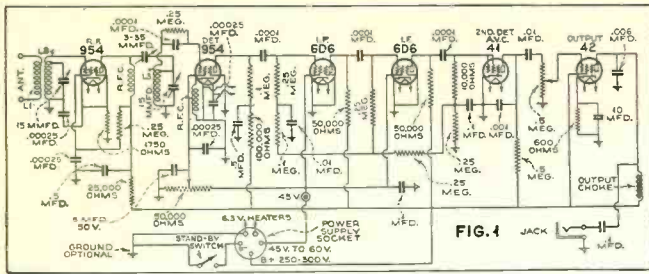

LAFAYETTE SUPERHETERODYNE

Figure 1. Separate tuning controls for the preselector and detector stages insure exact tuning, with maximum selectivity and sensitivity. The inside view is shown below. Either a separate power unit or batteries may be used for the power supply. The power supply is a special Lafayette unit designed for use with this receiver

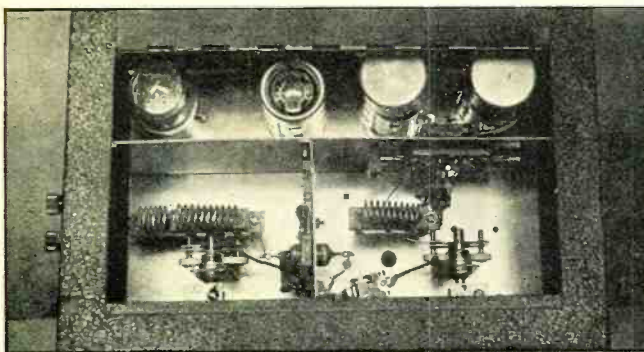

"PEAK" MODEL Q-5 SUPERHETERODYNE

Figure 2. The front and inside views are shown above; the schematic diagram below. One of its features is adjustable antenna coupling. Batteries or a separate power unit may be employed, or this receiver may be used as a companion to the Peak X-4, five-meter transmitter, in which case the transmitter power supply will also operate the receiver

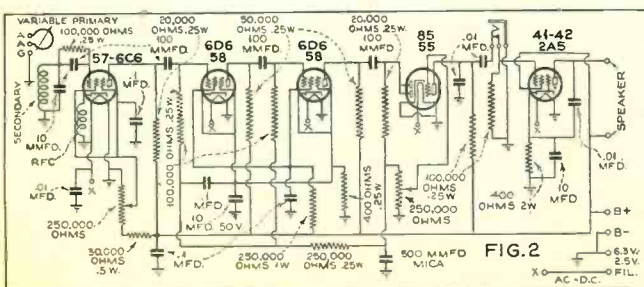

Range Beckons RECEIVER

ultra-high-frequency receivers will be as to the novice. All of the receivers rigorous "on the air" tests in the and all have been found highly effective month covered the general considerable suggestions on suitable antennas reception, especially 56-60 megacycles

Taylor

Two

by means of the potentiometer in the screen-grid circuit. The output of this tube feeds into a 2-stage resistance-coupled i.f. amplifier. The second detector and first audio amplifier functions are performed by an 85 tube (or 55), the audio output of which is resistance coupled to the power tube. A dynamic or magnetic speaker may be employed in the output and must be capable of carrying the plate current for the power tube. A headphone jack is provided in the input circuit of the power tube and audio volume is controlled by means of the potentiometer in the triode grid circuit of the 85 second detector.

Adjustable inductive coupling is provided in the antenna coil, suitable for use with either single- or two-wire antennas. Power supply may be obtained from batteries, from a separate power supply unit or from the power supply for the Peak X4 transmitter in cases where these two pieces of equipment are used together.

The receiver is supplied in built-up form, with plug-in coils covering the 2.5-, 5- and 10-meter amateur bands. The maker is the Eastern Radio Specialty Co.

Knight-Jones Ultra H.F. Receiver

The circuit of this 4-tube super-regenerative receiver is shown in Figure 3. A study of the circuit discloses that it is a highly-refined type consisting of a tuned r.f. stage and super-regenerative detector employing 954 and 955 "acorn" tubes, respectively. A 6C5 is employed to provide the low-frequency quenching voltage upon which super-regeneration is dependent. The 955 detector is transformer-coupled to a 6F6 metal power tube. The receiver is intended primarily for use in headphone reception but will nevertheless provide satisfactory loudspeaker volume on the great majority of signals.

One unusual feature of this circuit lies in the use of regeneration in the tuned r.f. stage. This regeneration is controlled by means of a potentiometer in the screen circuit. Detector regeneration and the quenching voltage are simultaneously controlled by a second potentiometer. The two tuned circuits are individually controlled by airplane dials. Plug-in coils are used to cover the various ranges below 10 meters. Either batteries or a separate power supply may be employed.

The receiver is sold in kit form and is merchandised by the Allied Radio Corporation.

R.T.L. Type PR Receiver

The circuit of this Radio Transceiver Lab receiver is shown in Figure 4 with the front and inside views immediately above. Five tubes are employed, including the rectifier in the built-in power supply. The tuned preselector stage employs a variable- μ tube with the antenna coupled direct to the grid through a small variable capacity. (Turn to page 636)

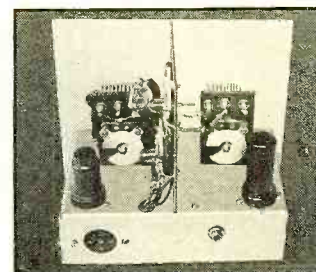
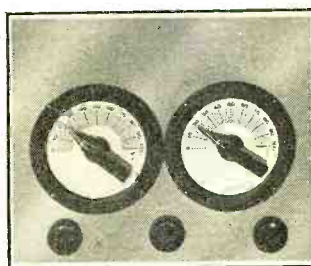
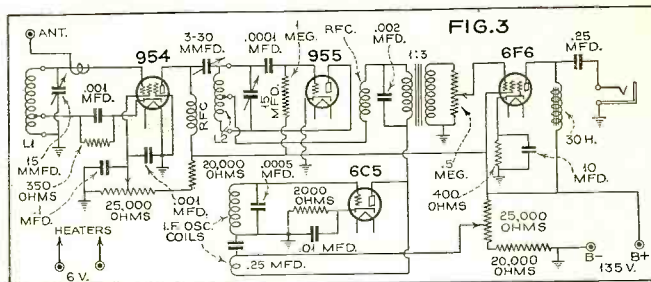

KNIGHT-JONES SUPER-REGENERATOR

Figure 3. A regenerative r.f. stage is used ahead of the super-regenerative detector, both employing "acorn" tubes

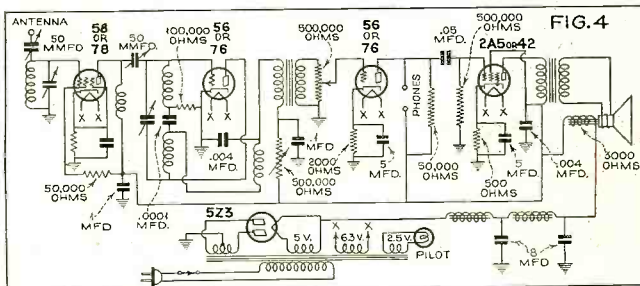
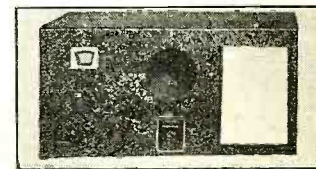
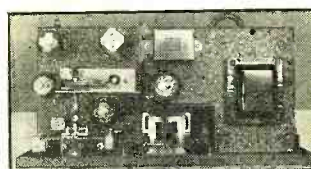

R.T.L. SUPER-REGENERATOR

Figure 4 (above). Includes dynamic speaker and power supply

CUSTOMBUILDERS SUPER-REGENERATOR

Figure 5 (below). Model shown is for battery operation, but is also available with built-in power supply

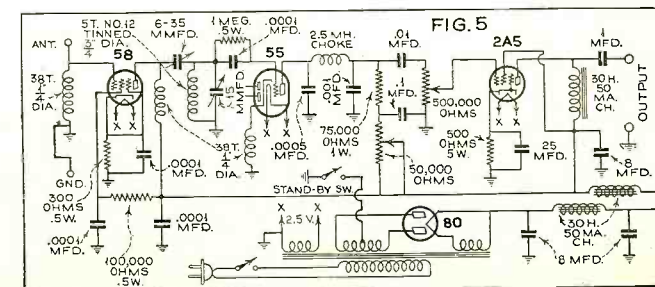
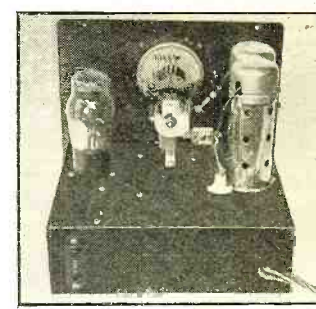
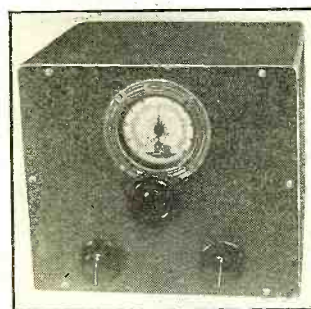

Build Your Own 5-METER Car Radio

An intriguing pastime for 5-meter amateurs is the operation of a transmitter and receiver of midget design in their cars. This article describes the receiver

By Laurence M. Cockaday

Part Two

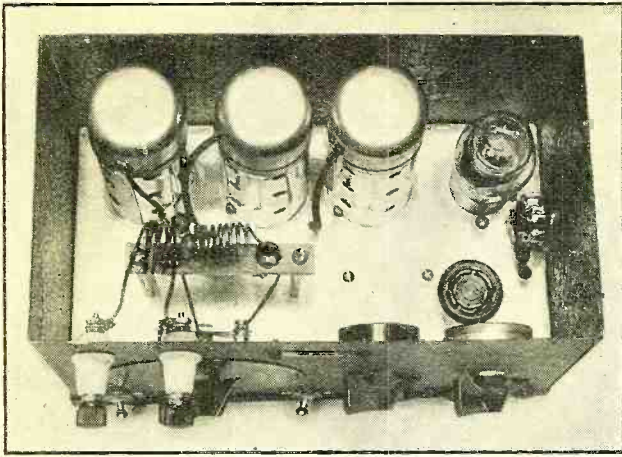

BIRDSEYE VIEW OF THE RECEIVER

Looking down on the autodyne receiver for portable mobile work discloses the arrangement of the parts in the top compartment and on the front panel. This view was taken with the top lid removed

A COMPLETE midget 5-meter transmitter was described last month, in the March issue of this magazine. It can be built at home and installed in your own car. This month we give the constructional details and the wiring diagram for making the 5-tube superheterodyne receiver which is built in a similar "twin" cabinet.

THIS receiver, for use with the 5-meter car transmitter, is a really easy job to make. It was designed and built by Tony Landry (W2IRT) in his spare time and has given him exceptional results for reception of 5-meter phone and i.c.w. signals. In fact, he has been able to receive with it, over very much greater distances than is necessary for communication with his transmitter. The receiver is also a nice mechanical design and can be used at home for a regular 5-meter station, if desired, as it takes only a few minutes to remove it from the car and hook it up on the operating table at a permanent station.

The receiver utilizes 6 tubes in an autodyne "superhet" circuit, using resistance-coupled r.f.s. The coils are home-made and full winding instructions for making them are given in the wiring diagram. The coil L2 is shown in the top photograph as a 1/2-inch diameter coil, but since the photograph was taken it has been changed to a 5-turn, 3/4-inch coil and seems to work out still

better with a larger size. The first tube, which serves as a combination oscillator and detector, is a 6C6. The two r.f. stages use 6D6 tubes while the output detector is a 76 triode tube. Mr. Landry prefers to use the set in a car with headphones (to exclude noises while he is driving along the road) but shown in the circuit is an additional output tube, connected by a switch, for amplifying the signals so that a loudspeaker may also be used. The extra socket for this tube is also shown in the top photograph. A D.P.D.T. switch can be used to change from headphones to loudspeaker. The electrical constants for all of the parts used in building this receiver are given in the diagram. All of them may be standard parts and the only things that are home-built and "Special" are the two coils L1 and L2.

Construction Details

The set is constructed in a metal cabinet of the same dimensions as that used in the transmitter. Its size is 5 1/2 inches by 6 inches by 12 inches. A metal chassis is suspended at about an inch and a quarter up from the bottom end. The photographs, herewith, show the constructional details for the parts mounted in the top section and also for

those mounted below deck.

Looking at the top photograph we see the four tubes (in a row) in the same order as shown in the wiring diagram. Directly in front of these are the coils and their mounting. The coil L1 is fastened directly to the antenna posts, while the coil L2 is mounted on pin jacks, on a metal strip supported by two metal posts fastened to the sub-base. Looking at the front panel; on the left, at top, are the antenna posts. Below that is a tuning dial and farther below that is the filament snap switch and a switch for turning on the audio amplifier stage filament current. At the right are the two resistors for controlling volume and oscillation. Below these are the pin jacks for connection to the batteries.

Uses Autodyne Circuit

Going back to the wiring diagram, it will be noticed that the tuning condenser is a small midget of 15 mmfd. The conventional grid leak and condenser are used for coupling to the grid of the first tube. Notice that the r.f. choke is incorporated in the cathode-to-ground lead. Two of the grids are connected together and brought over to the resistance control (Turn to page 621)

CONSTRUCTION BELOW DECK

This view of the receiver shows the placing of the parts beneath the sub-base, with the bottom cover removed

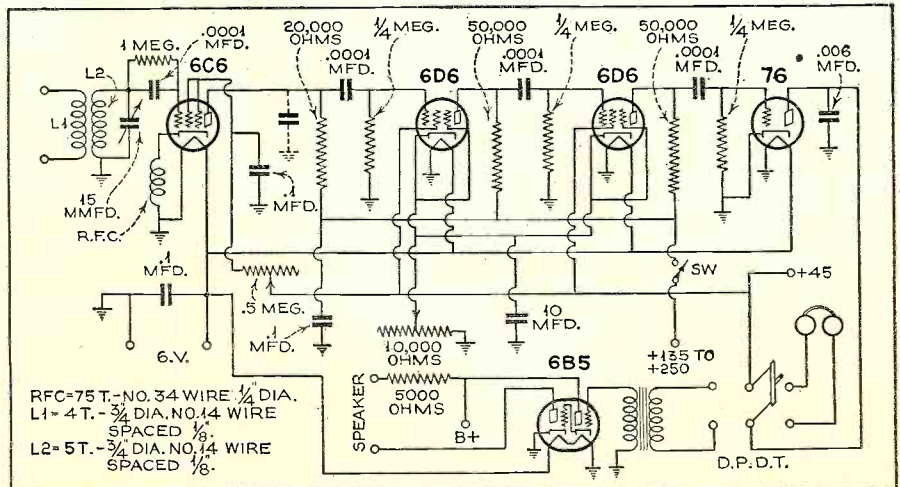
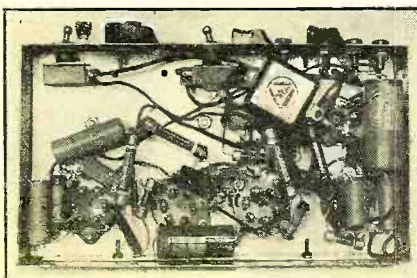

AMERICAN STATION LIST

CENTRAL and SOUTH AMERICA

(Exclusive of the United States)

Compiled by John M. Borst

CENTRAL AMERICA				Call	Location	kc.	kw.	Call	Location	kc.	kw.
COSTA RICA				PRA7	Ribeirao Preto, Sao Paulo	670	—	CD136	Magallanes	1360	0.1
Call	Location	kc.	kw.	PRG5	Santos, Sao Paulo	670	0.75	CB137	Temuco	1370	0.1
TIFA	San Jose	614	0.03	PRA6	Sao Paulo	690	5.0	CB138	Santiago	1380	5.0
TIPG	San Jose	625	1.0	PRA2	Rio de Janeiro	720	—	CB139	Valparaiso	1390	1.0
TIVL	San Jose	859	0.0075	PRD2	Rio de Janeiro	780	1.0	CB140	San Antonio	1400	0.1
TIJJ	Alajuela	1430	0.0075	PRG2	Sao Paulo	800	10.0	CC141	Concepcion	1410	0.1
				PRH8	Rio de Janeiro	830	5.0	CC143	Talca	1430	0.1
				PRB9	Sao Paulo	840	—	CB144A	Santiago	1440	0.1
				PRJ3	Rio de Janeiro	860	2.5	CB144B	Santiago	1440	0.1
				PRB7	Rio de Janeiro	900	0.5	CB144C	Santiago	1440	0.15
				PRC4	Amparo, Sao Paulo	930	0.05	CB144D	Santiago	1440	0.1
				PRA8	Recife, Pernambuco	930	5.0	CB146	San Felipe	1460	0.1
				PRC7	Bello Horizonte, Minas Gerais	930	—	CB150	Santiago (Under construction)	1500	10.0
				PRB2	Curitiba, Parana	930	0.25				
				PRF4	Rio de Janeiro	940	10.0	COLOMBIA			
				PRF3	Sao Paulo	960	5.0	HJ3ABH	Bogota	1005	2.0
				PRC6	Rio de Janeiro	980	—	HJ3ABD	Bogota	1100	0.5
				PRB6	Cruzeiro de Sul, Sao Paulo	1000	—	HJ3ABE	Bogota	1200	1.0
				PRH3	Sao Paulo	1020	—	HJ4ABE	Medellin	1230	0.3
				PRC8	Rio de Janeiro	1080	0.25	HJ1ABA	Barranquilla	1330	0.5
				PRE7	Sao Paulo	1090	—				
				PRA9	Rio de Janeiro	1100	1.0	ECUADOR			
				PRG4	Jaboticai, Sao Paulo	1160	0.25	HC2JSB	Guayaquil	1070	0.04
				PRC2	Porto Alegre, Rio Grande do Sul	1160	3.0	HC2ET	Guayaquil	1160	0.3
				PRD9	Sorocaba, Sao Paulo	1160	0.05	HCJB	Quito	1200	0.03
				PRD8	Nitheroy, Rio de Janeiro	1160	—	HC2ROZ	Guayaquil	1210	0.25
								HC2JB	Guayaquil	1250	0.05
				PRG9	Sao Paulo	1200	—				
				PRA5	Sao Paulo	1240	5.0	PARAGUAY			
				PRE3	Rio de Janeiro	1260	10.0	ZP15	Villarrica	700	0.01
				PRG7	Jahu, Sao Paulo	1270	—	ZP4	Asuncion	736	0.5
				PRB4	Santos, Sao Paulo	1270	1.0	ZP1	Asuncion	810	0.1
				PRG3	Rio de Janeiro	1280	10.0	ZP9	Asuncion	920	1.5
				PRE2	Rio de Janeiro	1320	—	ZP7	Asuncion	1050	0.1
				PRC5	Belem, Para	1330	0.1	ZP5	Asuncion	1360	0.015
				PRD7	Sorocaba, Sao Paulo	1330	0.5	ZP13	Asuncion	1429	0.015
				PRF8	Bahia	1330	0.05				
				PRB3	Juiz de Fora, Minas Gerais	1340	0.25	PERU			
				PRD4	Araraquara, Sao Paulo	1340	0.25	OAX4A	Lima	750	1.5
				PRE8	Rio de Janeiro	1360	10.0	OAX4E	Lima	1000	0.2
				PRF9	Porto Alegre, Rio Grande do Sul	1410	—	OAX4F	Lima	1080	0.06
				PRF6	Bahia	1410	0.5	OAX4J	Lima	1100	0.13
				PRG8	Bauru, Sao Paulo	1410	—	OAX4H	Lima	1150	0.05
				PRE5	Uberaba, Minas Gerais	1460	0.25	OAX4B	Lima	1200	0.35
				PRC9	Campinas, Sao Paulo	1460	—	OAX4C	Lima	1350	0.03
				PRA4	Bahia	1460	0.5	OAX6B	Arequipa	1400	0.06
				PRD5	Rio de Janeiro	1460	1.0	OAX4C	Lima	1429	0.06
				PRF2	Rio Claro, Sao Paulo	1480	—	URUGUAY			
				PRE9	Fortaleza, Ceara	1480	—	CX2	Montevideo	570	—
				PRB8	Mogy das Cruzes, Sao Paulo	1480	0.05	CX4	Montevideo	610	1.0
				PRD3	Taubate, Sao Paulo	1480	0.05	CX6	Montevideo	650	10.0
								CX8	Montevideo	690	1.0
								CW9	Montevideo	720	0.12
								CX10	Montevideo	730	1.0
								CX12	Montevideo	770	1.0
								CX14	Montevideo	810	5.0
								CX16	Montevideo	850	10.0
								CX18	Montevideo	890	1.0
								CW19	Rocha	920	0.05
								CX20	Montevideo	930	2.0
								CX22	Montevideo	970	0.25
								CW23	Salto	1000	0.25
								CX24	Montevideo	1010	2.5
								CW25	Durazno	1040	0.5
								CX26	Montevideo	1050	2.0
								CW27	Salto	1080	0.25
								CX28	Montevideo	1090	3.0
								CW29	Mercedes	1120	0.05
								CX30	Montevideo	1130	0.5
								CW31	Salto	1160	0.25
								CX32	Montevideo	1170	0.5
								CW33	Florida	1200	0.75
								CX34	Montevideo	1210	0.5
								CW35	Paysandu	1250	0.25
								CX36	Montevideo	1250	0.25
								CW37	Colonia	1280	0.025
								CX38	Montevideo	1290	0.5
								CW39	Paysandu	1320	0.1
								CX40	Montevideo	1330	0.5
								CW41	San Jose	1360	0.05
								CX42	Montevideo	1370	1.0
								CW43	Lavalleja (Under construction)	1400	—
								CX44	Montevideo	1410	0.2
								CX46	Montevideo	1450	1.5
								CW47	Canelones	1480	0.1
								CX48	Montevideo	1490	1.5
								VENEZUELA			
								YV4RC	Sabana Grande, D. F.	750	—
								YV1RC	Caracas	960	5.0
								YV9RC	El Valle	1010	—
								YV11RMO	Maracaibo	1034	—
								YV7RMO	Maracaibo	1153	—
								YV3RC	Caracas	1200	0.25
								YV6RV	Valencia	1350	0.35



HAMBURG'S GRAND STUDIO
It is here that the main programs heard from the 100 kw. Hamburg station on 904 kc. originate. Many of these programs are also relayed by other German stations.

Photo—Courtesy L.P.O. Tomlinson

THE DX CORNER

S. GORDON TAYLOR
(For Broadcast Waves)

THE complete schedule of Federal Communication Commission frequency check broadcasts is given in this department this month. This should be extremely helpful to DX'ers who are not members of DX clubs and who, therefore, have not heretofore had complete information on this revised schedule. It will be noted that these broadcasts now take place the second week of each month instead of the first week.

Notes from Readers

Unfortunately, the fact that the F.C.C. monitor schedule is included in this department this month does not leave space for the regular notes gleaned from the monthly reports from our Official Listening Post Observers. This is most regrettable but an effort will be made to make up for it next month.

Correspondence Wanted

The following L.P.O.'s desire correspondence; J. S. Phillips, Selwyn College, Cambridge, England, would like to correspond with DX'ers in America. A. R. Jurd, Livingstone Street, West End, Townsville, Queensland, Australia, would also like to correspond with American listeners. Harold Mendler, 3154 Coney Island Avenue, Brooklyn, New York, invites correspondence from foreign DX'ers. These three L.P.O.'s guarantee to answer all letters received.

DX CALENDAR

Below are given lists of special and periodic DX broadcasts which are scheduled up to April fifteenth. The initials following an item indicate the organization to which the program is dedicated and where a RADIO NEWS special has been arranged for by an Observer, his name is given in the schedule.

Don't fail to tune in the RADIO NEWS specials on this list and as many others as possible—and above all, don't fail to report to each station tuned in, giving them as much information as you can concerning their signal strength, fading, quality, etc. Practically all of these stations verify reports and where verifications are desired it is always desirable to enclose return postage.

Hours shown are Eastern Standard Time and are all a.m. unless otherwise indicated.

SPECIALS

Day	Hour	Kc.	Call	State	Kw.	Club
March						
1	2-3	1310	CJLS	N.S.	.1	NNRC
	3-3:30	630	CKOV	B.C.	.1	CDXR
	3	1050	KNX	Calif.	50	NNRC
	3-4	1150	XEFL	Mex.	.25	URDXC
	3-4	1200	CHAB	Sask.	.1	CDXR
	3-4	1220	KWSC	Wash.	.1	CDXR
	4-4:30	630	CKOV	B.C.	.1	NNRC
	4-5	1220	KWSC	Wash.	.1	NNRC
	5-5:30	1240	KGKO	Texas	.25	NNRC
4	3-5:10	1400	WIRE	Ind.	.5	CDXR
5	4:30-5:30	1200	CKNX	Ont.	.05	CDXR
6	2-3	1290	KDYL	Utah	1	CDXR

7	5-6	1370	WMFO	Ala.	.1	NNRC
	7-8	1210	WSBC	Ill.	.1	NNRC
8	2-4	1420	WJBO	La.	.1	CDXR
	4-4:30	630	CKOV	B.C.	.1	NNRC
9	12:45-1:45	1130	KSL	Utah	50	R. News Jensen
	2:2-2:20	1420	WJBO	La.	.1	R. News Golson
	2-3	1250	CMKC	Cuba	.15	CDXR
	2:30-4:30	1320	KID	Idaho	.25	NNRC
	3-4	1370	KFRO	Texas	.1	NNRC
10	2-3	1530	WIXBS	Conn.	1	NRC & CDXR
	3-3:30	1210	CKBI	Sask.	.1	NNRC
	3-4:30	1260	IZM	N.Z.	.05	URDXC
	10-10:30	1170	WCAU	Penna.	50	R. News Cleaver
11	2:30-3	1370	WHBQ	Tenn.	.1	NNRC
	6-6:30	1270	WOOD	Mich.	.5	CDXR
14	2:30-3:30	923	PRF4	Brazil	10	NRC
	4:40-5	1420	KCMC	Ark.	.1	R. News Halsey
	5-6	1370	WMFO	Ala.	.1	NNRC
	7-8	1210	WSBC	Ill.	.1	NNRC
15	3:01-3:30	630	CKOV	B.C.	.1	CDXR
	3:30-4:30	1370	KFRO	Texas	.1	CDXR
	4-4:30	630	CKOV	B.C.	.1	CDXR

A SOUTH AFRICAN DX CORNER

The combination radio-bookcase built by H. Stopford King and installed in his home, Port Elizabeth, Cape Province, South Africa. The receiver employs twin speakers and is designed for quality reproduction of local programs, as well as DX.



Official RADIO NEWS Broadcast Band Listening Post Observers

United States

- Alabama: Ray Wood
- Arkansas: James Halsey
- California: Frank D. Andrews, Roy Covert, Bill Ellis, Henry Evansmith, Randolph Hunt, Walter B. McMenemy, Radio Fellowship, George C. Sholin, Warren E. Winkley.
- Connecticut: Fred Burleigh, James A. Dunigan, Stanley Grabowski, Joseph J. Mazel.
- District of Columbia: Geo. Day Coakley, Jr.
- Illinois: Herbert H. Diedrich, H. E. Rebensdorf, D. Floyd Smith, Donald C. Truax
- Indiana: Earl R. Roberts
- Kansas: Dudley Atkins III, T. R. Grosvenor, Vernon Rimer
- Louisiana: Wilbur T. Golson, Aubrey V. Deterly
- Maine: Danford Adams, Floyd L. Hammond, Roger Williams
- Maryland: William L. Bauer, Louis J. McVey, William Rank, Frank Zelinka
- Massachusetts: William V. Beal Jr., Walter C. Birch, Russell Foss, Simon Geller, Warren C. Reichardt, Evan B. Roberts
- Missouri: M. F. Meade
- Minnesota: Floyd Biss, Walter F. Johnson
- Mississippi: Mrs. L. R. Ledbetter
- Montana: R. W. Schofield
- Nebraska: Bud Crawford
- New Jersey: Robert F. Gaiser, Morton Meelian
- New York: Jacob Altner, Murray Buitekant, Ray Geller, Edward F. Goss, John C. Kalmbach Jr., Harry E. Kentzel, Maynard J. Lonis, Harold Mendler, Robert C. Schmarler, R. H. Tomlinson, William Wheatley
- North Dakota: O. Ingmar Ojeson
- Ohio: Stan Elcheshen, A. J. Parfitt, Donald W. Shields
- Oregon: David Hunter
- Pennsylvania: Robert W. Botzum, Robert H. Cleaver, Harry M. Gordon, Edward Kocsan, Francis Schmidt, Joseph Stokes, Paul V. Trice
- Rhode Island: Spencer E. Lawton
- South Dakota: Mrs. A. C. Johnson
- Texas: Isaac L. Davis, E. L. Kimmons
- Vermont: Henry T. Tyndall Jr.
- Virginia: C. C. Wilson
- West Virginia: Clifford Drain

Foreign

- Alaska: S. A. Tucker
- Australia: Albert E. Faull, George F. Ingle, Aubrey R. Jurd
- Canada: Bernard J. Clancy, John W. Ker, Ernest W. Law, Philip H. Robinson
- Cuba: Rafael Valdes Jimenez
- England: R. T. Coales, F. R. Crowder, Charles E. Pellatt, J. S. Phillips
- Japan: A. T. Yamamoto
- New Zealand: Alexander N. Chalmers, L. W. Mathie, R. H. Shepherd, Eric W. Watson
- Philippine Islands: George Illenberger
- South Africa: A. E. Lyell
- Switzerland: Dr. Max Hausdorff
- Turkey: A. K. Onder

	4-5	1300	WHAZ	N. Y.	.5	CDXR
	4-6	1310	WTRC	Ind.	.1	NNRC
18	2:30-3	1370	WHBQ	Tenn.	.1	CDXR
19	2-3	830	WRUF	Fla.	5	CDXR & GDXXC
20	1-2	1150	CMHI	Cuba	.1	URDXC
	5-6	1010	CHML	Ont.	.05	CDXR
21	5-6	1370	WMFO	Ala.	.1	NNRC
	7-8	1210	WSBC	Ill.	.1	NNRC
22	1-5	1380	CMXB	Cuba	.5	URDXC
	2-4	1420	WJBO	La.	.1	CDXR
	3-5	1450	CFCT	B.C.	.075	CDXR
	4-4:30	630	WGBF	Ind.	.5	CDXR
	4:30-5	630	WGBF	Ind.	.5	NRC
23	1-2	1250	CMKC	Cuba	.15	IDA
25	2:30-4	1200	KADA	Okl.	.1	NNRC
	6-6:30	1270	WOOD	Mich.	.5	CDXR
26	2-3	1370	WOC	Iowa	.1	NNRC

ITALY'S IIFI

This 20 kw. station at Florence is frequently heard in the Eastern U. S. at 1-2 a.m. on 610 kc. The gigantic antenna tower is shown at the left.

Photo—Courtesy L.P.O. Tomlinson

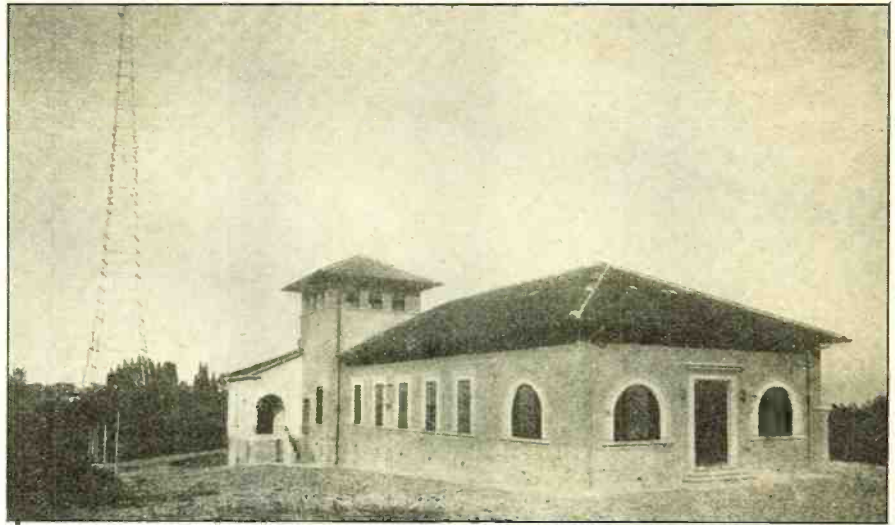

28	5:30-6 5-6 5-6 7-8	1310 WRAW 820 7HO 1370 WMFO 1210 WSBC	Penna. .1 Tasm. .1 Ala. .1 Ill. .1	MCDXE IDA NNRC NNRC
20	12-3 3-3:30 3-4	1420 WPAR 630 CKOV 640 WOI	W. Va. .1 B.C. .1 Iowa .5	CDXR CDXR CDXR
April				
1	2-2:30	1310 WEBR	N. Y. .1	CDXR
4	4:30-5:30 5-6 7-8	1200 CDNX 1370 WMFO 1210 WSBC	Ont. .05 Ala. .1 Ill. .1	CDXR NNRC NNRC
5	2-3 3-4 3-4 3-5	1310 CJLS 1150 XEFL 1200 CHAB 1450 CFCT	N. S. .1 Mex. .25 Sask. .1 B.C. .075	URDXC CDXR CDXR
6	3-5:10	1400 WIRE	Ind. .5	NNRC
8	2:30-3	1370 WHBQ	Tenn. .1	NNRC
9	2-3	1270 CMKC	Cuba .15	NNRC
10	4:20-4:40	1210 WMFG	Minn. .1	R. News W. Johnson
11	5-6 7-8	1370 WMFO 1210 WSBC	Ala. .1 Ill. .1	NNRC NNRC
14	3-3:30	1210 CKBI	Sask. .1	NNRC
15	2:30-3	1370 WHBQ	Tenn. .1	CDXR

PERIODIC

The times shown for the following stations are, so far as could be determined, correct at the time of preparation. However, the hours of these periodic broadcasts are shifted frequently and it will probably be found that some of them will have changed hours by the time this appears in print.

Daily—	
7:30 a.m.	1050 kc., KFBI, Abilene, Kansas, 5 kw. (tips)
8:30 p.m.	1310 kc., WTRC, Elkhart, Ind., .1 kw (tips) (exc. Sunday)
Tuesdays—	
2:30-3 a.m.	900 kc., KSEI, Pocatello, Idaho, 25 kw
Thursdays—	
12:30-1:15 a.m.	1390 kc., KLRA, Little Rock, Ark., 1 kw. (MCDXE) (tips)
2-2:15 a.m.	1300 kc., KFAC, Los Angeles, 1 kw. (tips)
8:45-9 p.m.	1420 kc., KCMC, Texarkana, Ark. 1 kw. (Radio News) (tips)
11-11:15 p.m.	1010 kc., CKCK, Regina, Sask., .5 kw. (tips)
Fridays—	
8 p.m.	1320 kc., WORK, York, Pa., 1 kw. (NRC) (tips)
8:45-9 p.m.	1530 kc., W9XBY, Kansas City, Mo. 1 kw. (tips)
Saturdays—	
12:01-12:30 a.m.	980 kc., KDKA, Pittsburgh, Pa., 50 kw., (tips)
10-10:15 a.m.	830 kc., WEEU, Reading, Pa., 1 kw. (tips)
Sundays—	
12:30-12:45 a.m.	1420 kc., KGGG, San Francisco, Calif., 1 kw. (Radio News) (tips)
12:45-1 a.m.	640 kc., KFI, Los Angeles, Calif., 50 kw. (tips)
12:45-1 a.m.	1250 kc., WTCN, Minneapolis, Minn., 1 kw. (tips)
12:45-1 a.m.	1400 kc., WIRE, Indianapolis, Ind. .5 kw. (tips)
12:45-1 a.m.	1470 kc., WLAC, Nashville, Tenn., 5 kw. (tips)
1-5 a.m.	1210 kc., TGW, Guatemala, Gua., 10 kw.
2 a.m.	730 kc., CJCA, Edmonton, Alberta 1 kw.
2-5 a.m.	1380 kc., CMBX, Havana, Cuba, .25 kw.

Consolidated Foreign "Best Bets"

Following is a list of the foreign stations being heard by Official Observers in different sections of the U. S. and Canada. Wherever either an asterisk (*) or a number appears in a column it indicates that the station has been heard in the section represented by that column. The numbers represent the approximate local time when the station is heard. Heavy numbers represent p.m. and light numbers a.m.

This list is made up from observers' reports as follows: Column 1 (New England)—Observers Hammond, Tyndall Jr., Foss, Reichardt; Column 2 (New York)—Observers Geller, Buitekant, Goss, Tomlinson, Kentzel, Kalmbach, Louis; Column 3 (Pennsylvania, Maryland, Virginia)—Observers Botzum, Rontzahn, Trice, Schmidt, Gordon, Marshall, Bauer, Wilson, Brus, Kocsan; Column 4 (Illinois, Minnesota, North Dakota)—Observers Rehensdorf, Smith, Diedrich, Johnson, Oleson; Column 5 (Mississippi, Kansas, Arkansas, Texas)—Observers Ledbetter, Kimmons, Grosvenor, Halsey, Rimer; Column 6 (California, Alberta, British Columbia)—Observers Sholin, Ker, Clancy.

Kc.	Call	1	2	3	4	5	6									
546	HAL	1	1					740	Munich	2	1	*				
550	2CR			5				740	2BL	5	5					3
560	MTCY						4	749	Marseille	5	5	2				1
565	Athlone	5		*				750	KGU	9	4	3	5	3		
570	2YA	5			3		2	750	LR7	5	6					3
574	Stuttgart	7	1					750	JOBK-1	1						
580	3WV	5						750	7NT	6						3
583	Grenoble PTT	2						758	Katowice	1						
590	LS10	2			2			757	Scottish Regional	6						
592	Vienna	1	2					770	JOHK	5					4	3
601	SBD	2						770	3LO	5						
601	CNR	2	1					776	Toulouse-Muret	5	6					
610	IIFI	2	1					780	JOPK	2	1	*				4
610	2FC	5						785	Leipzig	2	1	*				
620	Brussels I	2	1					790	LR10	6	8					
625	TIPG	9	9	2	8		1	790	JOGK	5						4
625	JOJK						3	790	4YA	5	5			4	4	2
629	LKT	2						795	Lwow	1	5					
630	LS3			9			3	795	EAJ-1	7	5					
630	3AR	5					3	800	HIX		*	2	5	3		
638	Prague	1	1					800	4QG	5			*			2
640	5CK	5					3	804	West Regional	6	5	*				
648	Lyon-la-Doua	5	1					810	CX14	5						
650	IYA	5	5	5	3	4	3	810	JOCK-1	2	2	3				3
658	Cologne	1	1					814	Milan	6	7					
660	XGOA					4	4	815	PRA-6	8	8	2	2			1
668	North Regional	6		*				830	JOJK	5	6		*			3
670	LS4	8	8			4		830	3GI	1	1					
670	2CO	5			4		3	840	CMQ	1	1					7
677	Sottens	5	5					841	Berlin	8						
682	HJN	5	5					850	TIEP	8						
695	Paris PTT	5	5					850	CX16	8						
710	LS1		1					850	JOFK	5						3
713	HRO	4	9					850	5RM	2	*	1	*			
720	3VA	5			3	5	3	859	Strasbourg	5						
730	SCL	5						868	Paris-Agen	8	8			7		
731	EAJ-5	3						870	LR6	5	*	*				3
731	Tallinn	2						870	JOAK-1	1						
735	JOSK						3	870	2GB	2	*	*				

KDKA'S DX TIPS BROADCAST

These weekly broadcasts are known the world over and here is where they originate. The photo shows none other than Joe Stokes, doing his stuff at the "mike".





A PENNSYLVANIA LISTENING POST

Observer Trice on the job in his listening post at Sharon. A Majestic 59, at the extreme right, and the home-built short-wave receiver on the desk, are his main stand-bys.

1095	EAJ-7	5	5	-	-	-	-	-
1104	11NA	2	-	-	-	-	-	-
1104	Madona	1	4	-	-	-	-	-
1110	2UV	5	-	-	4	-	-	3
1113	Radio-Normandie	2	2	2	-	-	*	M
1113	OKK	1	2	2	-	-	-	-
1120	4BC	5	-	-	4	-	-	3
1122	HAE	1	5	-	-	-	-	-
1131	SBH	2	-	-	-	-	-	-
1132	PRD-8	8	-	-	-	-	-	-
1140	11TO	2	5	2	-	-	-	-
1140	2HD	5	-	-	-	-	-	-
1149	London National	-	-	*	-	-	-	-
1149	West National	-	-	*	-	-	-	-
1149	North National	-	-	*	-	-	-	-
1150	LR8	8	9	-	-	-	-	-
1153	YV7RMO	-	1	-	-	-	-	-
1158	Kosice	1	-	-	-	-	-	-
1167	Monte Ceneri	4	-	-	-	-	-	-
1170	4TO	5	-	-	4	-	-	3
1175	JOCK-2	-	-	-	-	-	-	3
1176	Copenhagen	6	2	-	-	-	-	-
1180	3KZ	5	-	-	4	-	-	3
1185	Nice-Corse	5	5	-	-	-	-	-
1190	LS2	8	8	3	*	2	1	-
1190	2CH	5	-	-	-	-	-	-
1195	Frankfurt	2	1	3	-	-	-	-
1204	Prague II	1	-	-	-	-	-	-
1213	Lille	5	5	*	-	-	-	-
1215	TGW	-	9	3	-	-	-	-
1220	PRE3	-	8	-	-	-	-	-
1220	4AK	-	-	-	-	-	-	3
1222	11TR	5	*	1	-	-	-	-
1230	LS8	-	8	-	-	-	-	-
1230	2NC	5	-	-	-	-	-	3
1231	Gleiwitz	2	2	-	-	-	-	-
1240	WKAQ	-	-	6	*	1	-	-
1249	Juan-les-Pins	4	-	-	-	-	-	-
1258	Kuldiga	2	-	-	-	-	-	-
1267	Nurnburg	2	1	-	-	-	-	-
1270	PRB-4	-	7	-	-	-	-	-
1270	LS9	-	8	-	-	-	-	3
1270	2SM	5	-	-	-	-	-	3
1280	3AW	5	-	-	-	-	-	-
1282	PRG-3	-	8	-	-	-	-	-
1285	Dresden	1	1	-	*	-	-	1
1290	WNEL	-	-	-	-	-	-	-
1294	Klangenfurt	5	-	-	-	-	-	-
1294	Linz	-	1	-	-	-	-	-
1512	SBC	2	1	-	-	-	-	-
1320	KGMB	-	*	-	-	5	-	1
1321	HAE-2	1	1	-	-	-	-	-
1330	Stettin	-	1	-	-	-	-	-
1339	Montpellier	-	6	-	-	-	-	-
1339	Lodz	1	-	-	-	-	-	-
1348	Konigsberg	1	1	-	-	-	-	-
1348	Paris-Ile de France	2	-	-	-	-	-	2
1380	CMBX	-	-	-	-	-	-	2
1380	4BH	-	-	-	-	-	-	3
1393	Lyon	5	5	-	-	-	-	-
1402	SCF	2	-	-	-	-	-	-
1410	2KO	2	-	-	-	-	-	3
1411	SCW	2	-	-	-	-	-	-
1420	3XY	5	-	-	-	-	-	-
1438	HAE-3	5	-	-	-	-	-	-
1440	4IP	5	-	-	-	-	-	3
1456	Paris-Eiffel Tower	2	-	-	-	-	-	-
1460	7UV	5	-	-	-	-	-	3
1492	Nimes	2	-	-	-	-	-	-

F. C. C. Monitor Schedule

Following is the latest schedule received from the Federal Communications Commission. Each of these stations is on the air for 20 minutes,

beginning with the time shown. All hours are a.m.

Second Monday of Each Month

E.S.T. a.m.	Freq.	Call	Location	Watts
2:00	1310	WLNH	Laconia, N. H.	100
1420	WJBO	Baton Rouge, La.	100	
2:10	1210	WBRB	Red Bank, N. J.	100
1500	WBHB	Selma, Ala.	100	
2:20	1420	WMAS	Springfield, Mass.	100
1300	WIOD	Miami, Fla.	1000	
2:30	1500	WWRL	Woodside, N. Y.	100
1200	WJBW	New Orleans, La.	100	
2:40	1430	WOKO	Albany, N. Y.	500
1370	WMBR	Jacksonville, Fla.	100	
2:50	1200	WCAX	Burlington, Vt.	100
1500	WPOI	Bristol, Tenn.	100	
300	1290	KTRH	Houston, Texas	1000
1310	WMBO	Auburn, N. Y.	100	
1420	WNRA	Muscle Shoals, Ala.	100	
3:10	1370	WOC	Davenport, Iowa	100
1220	WCAD	Canton, N. Y.	500	
1210	WMFN	Clarksdale, Miss.	100	
3:20	1270	KWLK	Decorah, Iowa	100
1500	WMBQ	Brooklyn, N. Y.	100	
1430	WNBR	Memphis, Tenn.	500	
3:30	1210	KFPW	Fort Smith, Ark.	100
1310	WMFF	Plattsburg, N. Y.	100	
580	WDBO	Orlando, Fla.	1000	
3:40	1420	KABC	San Antonio, Tex.	100
1370	WQDM	St. Albans, Vt.	100	
1320	WSMB	New Orleans, La.	500	
3:50	1200	KADA	Ada, Okla.	100
1500	WHEF	Kosciusko, Miss.	100	
4:00	560	KFDM	Acumout, Tex.	500
1280	WCAP	Asbury Park, N. J.	500	
1440	KLS	Oakland, Calif.	250	
1370	WAGF	Dodhan, Ala.	100	
4:10	1420	WHDL	Olean, New York	100
1310	KCRJ	Jerome, Ariz.	100	
1200	KMLB	Monroe, La.	100	
4:20	1370	KLUF	Galveston, Tex.	100
550	WDEV	Waterbury, Vt.	500	
1100	KGDM	Stockton, Calif.	1000	
1500	WDNC	Durham, N. Car.	100	
4:30	1310	KROC	Rochester, Minn.	100
1210	WFAS	White Plains, N. Y.	100	
1370	KGAR	Tucson, Ariz.	100	
1420	KALB	Alexandria, La.	100	
4:40	1200	WBNO	New Orleans, La.	100
4:50	1370	KRE	Berkeley, Calif.	100
1420	WJBR	Gastonia, N. Car.	100	
5:00	1450	KIEM	Eureka, Calif.	500
1120	WGCM	Mississippi City, Miss.	100	
5:10	1210	KDON	Del Monte, Calif.	100
1310	WTAL	Tallahassee, Fla.	100	
5:20	1420	KUMA	Yuma, Ariz.	100
5:30	1200	KWG	Stockton, Calif.	100
5:40	1320	KGMB	Honolulu, Hawaii	1000

Second Tuesday of Each Month

2:00	1210	WBAX	Wilkes-Barre, Pa.	100
2:10	1370	WDAS	Philadelphia, Pa.	100
2:20	1210	WBBL	Richmond, Va.	100
2:30	1310	WFBG	Altoona, Pa.	100
2:40	1210	WMBG	Richmond, Va.	100
2:50	1310	WEBR	Buffalo, N. Y.	100
3:00	1500	KGFK	Moorhead, Minn.	100
1420	KFIZ	Fond du Lac, Wis.	100	
1200	WLVA	Lynchburg, Va.	100	
3:10	1260	KPAC	Port Arthur, Tex.	500
1210	WOMT	Manitowoc, Wis.	100	
1370	WBTM	Danville, Va.	100	
3:20	550	WKRC	Cincinnati, Ohio	1000
1430	WHEC	Rochester, N. Y.	500	
3:30	1010	WNAD	Norman, Okla.	1000
1420	WMBC	Detroit, Mich.	100	
1370	WRAK	Williamsport, Pa.	100	
3:40	1210	KFVS	Cape Girardeau, Mo.	100
900	WTAD	Quincy, Ill.	500	
1310	WJAC	Johnstown, Pa.	100	
3:50	1120	WTAW	College Station, Tex.	500
1430	WBNS	Columbus, Ohio	500	
4:00	1370	WBNY	Buffalo, N. Y.	100
1210	WCOL	Columbus, Ohio	100	
1390	KOOS	Marshfield, Ore.	250	
4:10	1310	WBRE	Wilkes-Barre, Pa.	100
1240	KLFM	Minot, N. Dak.	250	
1370	WPAV	Portsmouth, Ohio	100	
1500	KPO	Wenatchee, Wash.	100	
4:20	1420	WPAR	Parkersburg, W. Va.	100
1310	KRAM	Shreveport, La.	100	
1200	WCLO	Janesville, Wis.	100	
1120	KPIO	Spokane, Wash.	100	
4:30	570	WSYR	Syracuse, N. Y.	250
1270	KGCA	Decorah, Iowa	100	
610	WJAY	Cleveland, Ohio	500	
1420	KORE	Eugene, Oregon	100	
4:40	1500	WNBF	Binghamton, N. Y.	100
1370	KFJM	Grand Forks, N. D.	100	
1200	WHBC	Canton, Ohio	100	
900	KGHU	Ketchikan, Alaska	100	
4:50	1310	WGH	Newport News, Va.	500
1420	KRLH	Midland, Tex.	100	
1390	WHK	Cleveland, Ohio	100	
1260	KGVO	Missoula, Mont.	1000	
1500	WWSW	Pittsburgh, Pa.	100	
5:00	1340	WSPD	Toledo, Ohio	1000
1310	KMED	Medford, Ore.	100	
1210	WSAY	Rochester, N. Y.	100	
5:10	1420	KNET	Palestine, Tex.	100
940	WAVE	Louisville, Ky.	1000	
1370	KAST	Astoria, Ore.	100	
5:20	1370	KWKC	Kansas City, Mo.	100
1240	WXYZ	Detroit, Mich.	1000	
1210	KFJJ	Klamath Falls, Ore.	100	
5:30	1420	KIDW	Lamar, Colo.	100
1450	WGAR	Cleveland, Ohio	500	
5:40	1310	KGCX	Wolf Point, Mont.	100
1200	WCAT	Rapid City, S. Dak.	100	
1380	KQV	Pittsburgh, Pa.	500	

Second Wednesday of Each Month

2:00	1420	WFMF	Daytona Beach, Fla.	100
2:10	1200	WAIM	Anderson, S. Car.	100
2:20	1310	KVOL	Lafayette, La.	100
2:30	1370	WBHQ	Memphis, Tenn.	100
2:40	1240	WKAQ	San Juan, P. R.	1000
2:50	1310	WSJS	Winston-Salem, N. Car.	100
3:00	1420	KABR	Aberdeen, S. Dak.	100
1200	WFAM	South Bend, Ind.	100	
3:10	1370	WMFD	Wilmington, N. Car.	100
1290	KLCN	Blytheville, Ark.	100	
3:20	1210	WPAX	Thomasville, Ga.	250
1310	KFPL	Dublin, Tex.	100	
570	WKBN	Youngstown, Ohio	500	
3:30	1500	WRDW	Augusta, Ga.	100
1230	KGEX	Springfield, Mo.	500	
1420	WELL	Battle Creek, Mich.	100	
3:40	1350	WQBC	Vicksburg, Miss.	1000
1200	KFXJ	Grand Jct. Colo.	100	
1320	WADC	Tallmadge, Ohio	1000	
3:50	1500	KPLC	Lake Charles, La.	100
890	KARK	Little Rock, Ark.	250	
570	WOSU	Columbus, Ohio	750	
4:00	1420	WGFC	Albany, Ga.	100
1270	KFJZ	Fort Worth, Tex.	100	
4:10	1210	WHBU	Anderson, Ind.	100
1250	WLB	Minneapolis, Minn.	1000	
4:20	1310	WBBO	Marquette, Mich.	100
1430	KSO	Des Moines, Iowa	500	
4:30	1200	WMPG	Lapeer, Mich.	100
1370	WHLB	Virginia, Minn.	50	
4:40	1310	WEXL	Royal Oak, Mich.	100
1420	WIMB	Ironwood, Mich.	100	
4:50	1310	KEXR	Oklahoma City, Okla.	100
1210	WTAX	Springfield, Ill.	100	
5:00	1200	KFJB	Marshalltown, Iowa	100
1370	New	Evanston, Ind.	100	
5:10	1020	WDZ	Tuscola, Ill.	100
5:20	1370	KELD	Eldorado, Ark.	100
5:30	1210	KDLR	Devils Lake, N. Dak.	100

Second Thursday of Each Month

2:00	1370	WSVS	Buffalo, N. Y.	50
2:10	1210	WKOK	Sunbury, Pa.	100
2:20	1310	WRAW	Reading, Pa.	100
2:30	1210	WCOL	Jamestown, N. Y.	50
2:40	1310	WTBL	Philadelphia, Pa.	100
2:50	1410	WHIS	Bluefield, W. Va.	250
3:00	570	KGKO	Wichita Falls, Tex.	250
1200	WQPO	Cincinnati, Ohio	100	
3:10	880	WQAN	Seranton, Pa.	250
1310	KFYO	Lubbock, Tex.	100	
1370	WGL	Ft. Wayne, Ind.	100	
4:20	1420	WLEU	Erie, Pa.	100
3:20	1500	KGPI	Corpus Christi, Tex.	100
1210	WBUB	Poyette, Wis.	100	



L.P.O. OLESON, AMBROSE, NORTH DAKOTA

South America is a long haul from North Dakota but Observer Oleson proudly displays the "veri" from "Radio Excelsior" above his radio—side by side with his L.P.O. certificate.

3:30	1370	KGFL	Roswell, N. Mex.	100
1410				

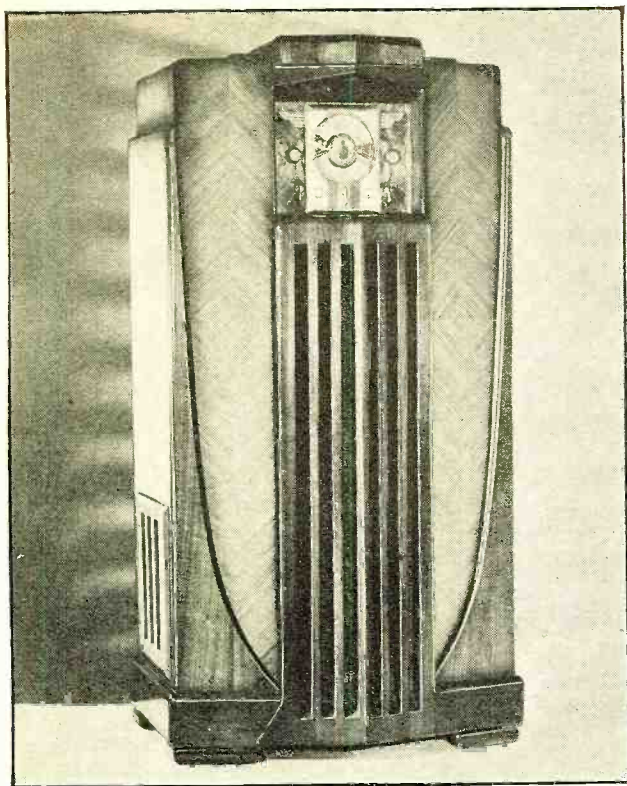

THE SET INSTALLED IN ITS CABINET

This is the 24-tube receiver, tests on which were conducted in the RADIO NEWS Listening Posts and described in this short article for the benefit of our DX listeners. Notice the loudspeaker grills on the front and sides to allow for diffusion of the sound waves.

In an article last month the authors briefly described the new Midwest "Royale" 24-tube all-wave superheterodyne and included a detailed discussion of the function of the 24 tubes employed. Since that time "on the air" tests of this new de luxe receiver have been carried on at the authors' Listening Posts in New York City and Westchester with results as given in the present article.

DURING tests on this receiver special attention was paid to logging short-wave broadcast stations, but some time was also spent in testing reception of amateur phone signals on the various amateur bands, regular reception in the broadcast band and also on other services such as aviation, police, etc.

So far as the miscellaneous and amateur services are concerned it will suffice to say that police and aviation stations were logged in considerable numbers, including a great number in the Middle West and East and a few more distant. Amateur phone stations logged on the 20-, 75- and 160-meter amateur bands were distributed in every amateur district in the United States and Canada and included a sizable number of foreign amateurs in Mexico, Central America, South America, England, France and Belgium. The most distant of these were heard on the 20-meter band.

On the broadcast band a number of West Coast stations were logged as well as others in Canada, Mexico and Cuba.

The concentration of attention on short-wave broadcast stations during the

test resulted in an excellent list of stations heard, as shown at the end of this article.

The receiver was easy to tune and the flexibility of operation provided by having a number of controls directly on the front panel was found to be distinctly advantageous. The receiver covers the unusually wide range of 4½ to 2400 meters. This is divided into 6 ranges and each range is completely calibrated on the illuminated dial face. This is even carried to the extent of including the call letters of the more powerful broadcast stations in addition to the frequency calibration of the broadcast range.

The tuning control is one of the two-speed type, the normal position being used for broadcast and long-wave tuning. In the short-wave ranges slow-motion tuning is obtained by simply "pulling out" on the tuning control knob. In this position the speed is so low that "hairtrigger" tuning is avoided. In addition to the usual tuning, volume and band-switching controls are several others on the front panel of the Royale. One, which has been named the "micro-attenuator," provides for varying the degree of selectivity and fidelity. This lever also controls the "off-on" switch. In the extreme left position the receiver power supply is cut off. Advancing this lever a few degrees turns on the power and if left there the receiver will be in its most broad-band condition. As the lever is advanced in a clockwise direction the tuning becomes more selective until it finally reaches the high-gain, high-sensitivity position where the tuning has been sharpened to an extent where the selectivity is greatest for DX reception.

Controlled High-Fidelity

The tone control is glorified with the name "Fidel-A-Stat"—and it really is a super tone control, as it provides a wide range of tone adjustment. In one position it accentuates the bass response, then as it is turned in a clockwise man-

ner an even balance of bass and treble is obtained; turning it still further, the treble becomes accentuated and the bass is attenuated. Thus in the "in-between" range any degree of tone blending may be obtained.

Just below the dial are two push-buttons. If the left-hand one is pressed, while tuning the receiver, a heterodyne whistle will be heard as each station is passed. This serves as an excellent aid in tuning in weak signals. The other push-button completely silences the receiver when it is pressed, thus serving as an interstation noise eliminator. In fact, by this means, a desired station may be tuned in by watching the "tuna-lite." This is an illuminated spot on the dial which dims as a station is tuned in. With the "silent tuning" button pressed, a station is tuned until this light is dimmed, then the button is released and the station will be heard fully tuned in.

Every one of these controls actually serves the purpose for which it is intended and each one makes an important contribution to the ease and pleasure found in operating this receiver.

Space does not permit a comprehensive discussion of all of the operating features, but this test report would most certainly be incomplete if special emphasis were not placed on the unusually fine quality of reproduction and tremendous output volume demonstrated in the tests. At no time was it possible to turn the volume on full. The rated output is 40 watts, which is far in excess of that which can be used in an ordinary room. It is, nevertheless, advantageous because it insures a surplus of power at all times to meet any volume demands and to absolutely insure against overloading in any portion of the circuit. In the matter of tone quality the reproduction of speech and music is impressive, particularly to those who have a keen sense of music tone values.

Short-Wave Stations Logged During Tests

GSI	21530	Davenport, England
GSG	17790	Davenport, England
W2XAD	15330	Schenectady, N. Y.
W2XE	15270	New York, N. Y.
GSI	15260	Davenport, England
FYA	15245	Pontoise, France
PCJ	15220	Huizen, Holland
W8XXK	15210	Pittsburgh, Pa.
DIB	15200	Zeesen, Germany
GSF	15140	Davenport, England
HVJ	15121	Vatican City
PSD	15070	Rio de Janeiro, Braz.
DJI	14460	Zeesen, Germany

(Continued on page 638)

Test Report on 24-TUBE All-Wave Super

By L. M. Cockaday and S. G. Taylor



DX CORNER REPRESENTATIVE

Away up there in Alberta, Canada, Arthur E. MacLean watches over the short waves, with an eagle eye for new stations. He uses an RCA Victor 6-tube model 128 receiver, with a double-doublet antenna and a copper coil buried in the ground.

THE thirty-seventh installment of the DX Corner of Short Waves contains the World Short-Wave Time-Table for 24-hour use all over the world.

Our Readers Vote for "EST"

The vote for the method for designating what standard of Time for reports, taken last month among our Readers, turned out to be overwhelmingly in favor of Eastern Standard Time (EST) and so we are asking all Observers and other Listeners reporting stations to the Short-Wave DX Corner to observe this decision in sending in their reports.

To save a lot of wasted effort for our editors it would be best if our Observers use a standard form for their reports of new stations or station changes. We have found a system of paragraphs, in exactly the following procedure, most convenient: "W2XAF, Schenectady, N. Y., 31.4 meters, 9530 kc., daily 4 p.m. to midnight, E.S.T."

In other words, use one paragraph to an item and indicate whether data is from a veri, an announcement, or other source. Also include station slogan, power, owner and address if available.

Your DX Logs Welcome

Please keep on sending in your information on any S.W. stations that you hear during the coming month, getting them in to the short-wave DX Editor by the 20th



of the month. In this way you share your "Best Catches" with other Readers and they, in turn, share with you, making for improved knowledge on short-wave reception. Also send in any corrections or additions that you can make to the Short-Wave Identification Charts, including Station Addresses, Station Slogans, Station Announcements, and any Identifying Signals the stations may have.

Welcome to Our Organization

The following new Listening Post Observers have been appointed for the year 1936.

IN THE UNITED STATES

Colorado: T. B. Mechling.
 Connecticut: Harold R. Smith.
 Idaho: Melton and Gilpin Amos.
 Indiana: Earl R. Roberts, Henry Spearing, Ted Stark.
 Iowa: E. R. Webb.
 Kansas: C. W. Bourne.
 Maine: H. Francis Shea.
 Maryland: Wm. J. Thomas III.
 Massachusetts: Edward J. Dailey, Jr., Gilbert L. Harris.
 Nebraska: John Havranek.
 New Jersey: A. Kosynsky, Robert F. Gaiser.
 New York: Alvin H. Behr, E. Scala, Jr.
 North Dakota: Ray N. Putnam.
 Oklahoma: Wade Chambers.
 Pennsylvania: Leon Stabler.
 Texas: Earl P. Hill.

IN OTHER COUNTRIES

Cuba: Jose L. Lopez.
 Egypt: Aram Ishkanian.
 Japan: Shokichi Yoshimura.
 New Zealand: Eric W. Watson.

Reports of Listening Post Observers and Other Short-Wave Readers of the DX Corner

Listed in the next column is this month's consolidated reports of short-wave stations heard by our wide world listening posts. Each item is credited with the Observer's surname. This allows our readers to note

TWO NEW OBSERVERS

At right: Captain Ian Cleveland Morgan of Montreal, Canada recently appointed Official Observer for RADIO NEWS. He has heard 250 stations, in 49 countries, in 1936. His DX Corner is located on the slopes of Mount Royal, Montreal, and his summer Listening Post on the shores of Lake of Two Mountains.

At left: Meet Charles Marvin of Detroit, Michigan. He is an old ex-ham and now Observer for the DX Corner. He uses a Patterson PR-10 receiver and an inverted L antenna.

The DX

for the

Conducted by

Laurence

who obtained the information. If any of our Readers can supply Actual Time Schedules, Correct Wavelengths, Correct Frequencies and any other Important Information the DX Editor as well as our Readers will be grateful for the information. On the other hand, Readers reading these reports can try their skill in pulling in the stations logged and in trying to get complete information on their transmissions. The report for this month, containing the best information available to date follows:

EUROPE

GSL, Daventry, England, 6110 kc., reported heard 7 to 8 p.m. E.S.T. (Costes.)

GSI, Daventry, England, reported heard on 15260 kc. at 2 p.m. E.S.T. (Schumacher) and on 17790 kc., heard evenings in South Australia. They play notes on bells (Lower), reported 6 to 6:15 p.m. E.S.T. (Butcher.)

DIQ, Berlin, Germany, reported variously on 10290 kc., 10260 kc. and 10285 kc. Heard 4:30 to 8 p.m. E.S.T. (Howald, Lee, Dickes, Gavin.)

DJH, Zeesen, Germany, 14460 kc., reported heard 12 noon to 2 p.m. (Williams, Chambers.)

DJI, Zeesen, Germany, 9675 kc., 40 kw., reported heard 5 to 7 p.m. E.S.T. (Winand, Styles, Cristoph, Brewer, Dickes, Libby, Akins, T. Smith, Munz.)



Corner SHORT WAVES

M. Cockaday



DJJ, Zeesen, Germany, 10042 kc., reported heard 1 to 5 p.m. E.S.T. (Mallet-Veale, Marshall, Gavin, Styles, Kemp, Partner, Munz, Hammersley, Libby.)

DJL, Zeesen, Germany, 15110 kc., 5 kw. (Styles.)

DJM, Zeesen, Germany, 6079 kc., reported heard 3 to 5 p.m. E.S.T. (Betances, Hammersley, Shea, Libby, Bower, Partner.)

DJN, Zeesen, Germany, heard 6:30-8 a.m. E.S.T. (Howald.)

DJP, Zeesen, Germany, 10042 kc. (Hammersley) also reported on 11855 kc. (Styles.)

DJR, Zeesen, Germany, 15340 kc., 50 kw. (Hammersley, Chambers, Styles.)

DJT, Zeesen, Germany, 15360 kc., reported heard 12 noon to 2 p.m. E.S.T. (Libby, Hammersley, Chambers.)

DZA, Berlin, Germany, reported heard on about 9690 kc., with an experimental program starting at 6:15 p.m., E.S.T. (Bower.)

CT1AA, Lisbon, Portugal, has changed its frequency to 9650 kc. to avoid interference from I2RO (Schumacher, Sand, Partner, Colburn, Winand.)

CSL, Lisbon, Portugal, 48.78 meters, 1/2 kw., reported heard 7:14 to 9:24 a.m., E.S.T. (Styles.)

CT2AJ, Sao Miguel, Azores, 4002 kc., reported heard Saturdays 5 to 7 p.m., E.S.T. (Hynek.)

EA8AB, Tenerife, C.I., reported heard on 41.6 meters. (Miller.)

PCJ, Eindhoven, Holland, has a new transmitter of 60 kw. power. (Styles.)

IRM, Rome, Italy, 9830 kc., reported heard 6:45 a.m., E.S.T. (Howald.)

I2RO, Rome, Italy, reported heard with very strong signals on all three frequencies during the afternoon, E.S.T., as shown in Time Table.

(Harris, Goldman, Holmgren, Brewer, Rheiner, Hunter, Cremona, Howald, Butcher, Zarn, Wickes, Dailey, Craft, Bixley, Mraz.)

LKJ1, Jeloy, Norway, is soon to be increased in power to 25 kw. (now 1 kw.). Best heard at Alberta, 11:30 a.m. to 2 p.m. (Baadsgaard.) Reported heard 5 to 8 a.m. and 11 a.m. to 5 p.m. (De Laet). Have an English program on Sundays 8 to 9 a.m.

RV59, Moscow, U.S.S.R., 6000 kc., has an English program, Mondays, Wednesdays and Fridays, 4 to 5 p.m., E.S.T. (Marshall.)

RKI, Moscow, U.S.S.R., reported heard on 15040 kc. at 8 a.m., E.S.T.

IN THE INDIAN FORESTS

Jungle tribes in mountain fastnesses beyond Bombay, who sleep with their cattle in a common hut, listening to one of their songs broadcast over the short waves. They first claimed it was "bad magic" but now they must have their short-wave programs.

BOOSTING NORTH DAKOTA

Meet O. Ingmar Oleson, Official Observer for Short Waves, for North Dakota, a listener who goes after DX in a business-like style.

(Shea), also reported at 7520 kc., 6:30 a.m., E.S.T. (Howald). Reported heard 1:30 to 11:30 a.m. (Sholin, N. C. Smith.)

ASIA

RIO, U.S.S.R., 10170 kc., reported heard 12 p.m. to 2 a.m. (Messer, Hull), also reported 10 a.m. (Gallagher.)

RAU, Tashkent, U.S.S.R., 19.85 meters heard Sundays at 6 a.m., E.S.T. (N. C. Smith.)

RV15, Khabarovsk, U.S.S.R., 4273 kc., reported heard 7 p.m. to 5 a.m., E.S.T. (Howald, Craft, Watson.)

RIR, Tiflis, U.S.S.R., 10080 kc., heard phoning RNE daily 7 to 10 a.m., E.S.T. (Roberts.)

XGW, Shanghai, China, reported heard Saturdays, Sundays and Mondays, 3:30 a.m. and up to 11 a.m. E.S.T. (Howald.)

ZCK, Hong-kong, China, is still heard on 8750 kc. with 250 watts power, Mondays and Thursdays, 4 to 7 a.m. E.S.T. and on other days 6 to 10 a.m. E.S.T. On Saturdays they are on to 10:30 a.m. E.S.T. (Andrews, Marshal.)

F3LCD (or F3ICD) Saigon, French Indo China, is soon to be broadcasting regularly. They have been heard testing, now, on 31.5 meters. Kindly get schedule, proper call and frequency. (Turn to page 610)

Short-Wave Broadcasts in English

OSWALD F. SCHUETT, President of the Short-Wave Institute of America, sends us the following information on news broadcasts, on the Short Waves, in the English language.

Country	Call Letters	Time—E.S.T.
Germany	DJN, DJB	4:30 a.m.
France	FYA	4:45 a.m.
England	GSB, GSF	5:15 a.m.
France	FYA	7 a.m.
Germany	DJN, DJB	7 a.m.
England	GSF, GSG	8 a.m.
Germany	DJA	8:45 a.m.
Italy	I2RO	10:45 a.m.
Germany	DJA	11:15 a.m.
England	GSB, GSE	11:30 a.m.
England	GSB, GSD	1 p.m.
Italy	I2RO	1:30 p.m.
Germany	DJC, DJD	2 p.m.
France	FYA	2:30 p.m.
Germany	DJA, DJD	4 p.m.
Spain	EAQ	5:15 p.m.
England	GSB, GSC	5:25 p.m.
Italy	I2RO	6 p.m.
Spain	EAQ	6:30 p.m.
England	GSA, GSC	7:45 p.m.
France	FYA	8 p.m.
Germany	DJC	8:15 p.m.
England	GSL, GSC	11 p.m.
France	FYA	11:20 p.m.



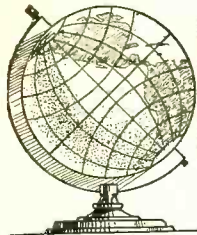

WORLD SHORT WAVE TIME-TABLE



(Continued from the Previous Page)

Hours of transmission for the World's Short Wave Broadcast Stations

Main table containing station names, call letters, frequencies, cities, and transmission schedules across various time zones.

A-Thursday, Sunday
C-Monday, Wednesday, Friday
D-Daily
E-Tuesday, Thursday
F-Friday
G-Tuesday, Thursday, Saturday
I-irregularly
K-Monday, Friday
L-Wednesday, Saturday

M-Monday
N-Monday, Wednesday, Thursday
P-Except Tuesday, Wednesday
R-Thursday, Friday, Saturday
S-Sunday
T-Tuesday
Th-Thursday
V-Sunday, Wednesday

W-Wednesday
Xth-Except Thursday
Y-Sunday, Monday
Z-Tuesday, Friday
AC-Monday, Thursday, Saturday
AE-Tuesday, Friday, Sunday
AG-Tuesday, Sunday
AH-Monday, Wednesday, Saturday

AL-Except Monday, Sunday
AM-Monday, Thursday
AN-Tuesday, Saturday
Sa-Saturday
XA-Except Saturday, Sunday
XM-Except Monday
NS-Except Sunday
XX-Tuesday, Thursday, Friday
XY-Except Tuesday, Sunday



The DX Corner (Short Waves)

(Continued from page 607)

JVP, Nazaki, Japan, 7510 kc., heard Mondays and Thursdays, 4 to 5 p.m. E.S.T. (Libby, Marshal, Winand).

JVT, Nazaki, Japan, 6750 kc., reported heard 11 p.m. to 1:45 a.m. E.S.T. (Craft).

JVN, Nazaki, Japan, 10660 kc., reported heard Mondays and Thursdays, 11 a.m. to 6 p.m. E.S.T. at various times regularly (McDonagh, Gallagher, Arickx, Marshal, Dodge, Sahlbach, Craft, DeMarco).

YBG, Medan, Sumatra, is a government station occasionally used for broadcasting (Hardeman).

PMA, PLE, PLV, PMC are all government phone transmitters at Bandoeng, Java, occasionally used for broadcasting (Hardeman).

PNI, Makasser, occasionally tests on broadcasting (Hardeman).

PMY, Bandoeng, Java, is the 0.6 kw. transmitter of the Bandoeng Radio Club heard 4:30 to 10:30 a.m. and 5:30 to 7:30 p.m. E.S.T. (Hardeman).

YDA, Batavia, Java, may be heard testing, irregularly, on 49.67 meters, instead of their old frequency of 98.68 meters. They are using 10 kw. (Hardeman).



GREETINGS FROM INDIA

Terry A. Adams, Official L.P.O. for India, sitting at a receiver in his DX Corner from which he receives short-wave signals from all over the world.

YDB, Sourabaya, Java, are now operating on 31.1 meters with 1 kw. power, instead of 67.11 meters. They relay the program of YDA (Hardeman).

YDA5, Bandoeng, Java, is now operating on 120 meters, instead of 49.02 meters (Hardeman).

YDE2, Solo, Java, is now operating on 62.37 meters, with 0.1 kw. power (Hardeman).

The four above mentioned stations are NIROM stations of the Java chain and all have the same time schedule—5:30 to 10 a.m. E.S.T. daily (on Saturdays to 11:30 a.m.) and 6 to 7 p.m. E.S.T. daily (Hardeman).

PLP, Bandoeng, Java, is a government phone station on 27.25 meters, relaying YDA programs on Sundays. They utilize 3 kw., with the antenna beamed to Celebes, Hawaii and California (Hardeman).

PMN, Bandoeng, Java, is a government phone station on 29.24 meters, utilizing 3 kw. power and relaying YDA daily from 5:30 to 10 a.m. E.S.T., with the antenna beamed on Sumatra and Holland (Hardeman).

PLV, Bandoeng, Java, 9415 kc., reported heard on Tuesdays and Thursdays, 10 to 10:30 a.m. E.S.T. (Ned Smith, Van der Veen).

AFRICA

The Ethiopian stations are on an irregular telegraph and telephone schedule as follows:

ETA, Addis Ababa, 18270 kc., 16.42 meters, 3.5 kw. (Hull, Scala).

ETB, Addis Ababa, 11955 kc., 25.09 meters (Zarn, Scala, Hull, Bourne).

SHORT-WAVE DX CORNERS

At left: Sutton Myers, enthusiastic listener of Earlham, Indiana, at his 7-tube Midwest receiver.

At right: DX Corner of Harry G. Dage Jr. His receiver is an Alan 3-tube prize-winner.

ETD, Addis Ababa, 7620 kc., 39.37 meters (Hull, Scala).

ETG, Addis Ababa, 51.02 meters (Hull, Scala).

The address of the above Imperial Ethiopian stations is: Akaki, Ethiopia, Africa (Scala).

ZUD, location unknown to the observer, reported heard between 8675 and 8700 kc., working ZTN, 10:30 a.m.-11 a.m. E.S.T. Who knows who this is? (Omstead).

SUV, Cairo, Egypt, 10050 kc., reported heard 4-5 p.m. E.S.T. (Gavin).

SUZ, Cairo, Egypt, 13820 kc., reported heard 11:30 a.m. E.S.T.

CR7AA, Lourenco Marques, Mozambique, 6136 kc., reported heard daily, 12:45-3 p.m. and Sunday 8-10:30 a.m. E.S.T. (Williams).

ZE1JR, Rhodesia, is a 20-meter amateur, testing with music and frequently heard (Hull, Havranek).

ZSR, Capetown, South Africa, heard on about 9000 kc., 4:15-4:30 p.m. E.S.T. (Kentzel).

AUSTRALASIA

ZLT, Wellington, New Zealand, 11050 kc., heard at about 3:30 a.m. and from 5-6 a.m. E.S.T. (Marshal, Roberts).

VK3ME, Melbourne, Australia, has changed frequency from 9510 to 9490 kc., and they are heard daily except Sunday 4-8 a.m. E.S.T. (Craft, Dodge, Brewer, Winand, Duignan, Kosynski, Behr, Loke, Watson, Gallagher, Sholin, Gray).

NORTH AMERICA

TFJ, Reykjavik, Iceland, 12235 kc., 24.5 meters, reported heard 1:45-2 a.m. E.S.T. and on Sundays with an English program 8-9 a.m. E.S.T. (Webb, Shea, Akins, Baadsgaard, Craft).

NX2Z is the call of the Hochstetter-Farland Danish Expedition in Greenland. The transmitter is 1400 watts heard on 14010 kc. in the 20 meter band on about HKIZ's frequency reported heard 1-5 p.m. and 7:30-8:20 p.m. (Quinn, Kemp, Jensen, Messer, Yeager).

CHNX is the new call of VE9HX, Halifax, N. S. on 6110 kc. (Styles).

W3XAL, Bound Brook, New Jersey, is well heard on 16 meters in South Africa (Williams). They are reported on the air daily from 9 a.m. to 5 p.m. E.S.T.

W2XE, New York, New York, 21520 kc. reported heard 10-11 a.m. E.S.T. (Boatman).

WXE, Anchorage, Alaska, reported heard 7:30-9:30 p.m. E.S.T. (Howald).

KFI on the broadcast band now carries a DX program "Around the World with Frank Andrews" giving short-wave DX tips at 12:30 a.m. E.S.T. (Howald).



W2XAF, Schenectady, New York, 9530 kc. is reported as the star station in South Africa. It is heard R9 and can be heard 200 yards away from the loudspeakers (Mallet-Veale). The American stations heard best in Belgium: **W2XAF**, **W2XAD**, **W1XK**, **W8XK**, **W1XAL**, **W9XF**, **W8XAL**, **W2XE**. (Arickx).

W8XAI is a new station on 31.6 megacycles, 9.6 meters heard 7:30 a.m.-12 N. (Amas).

W4XB, Miami, Florida, 6040 kc. is heard Saturday mornings 2-6 a.m. with a DX program (Goldman, Sahlbach, Harris).

W1JOM, Roxbury, Massachusetts, is the new call and location of Listening Post Observer Millen of that city. He is on 5 meters and 160 meters.

W7XBK located in the state of Washington is a new 7-meter experimental station (Millen).

EXXA, Mexico City, Mexico, reported heard on the following frequencies 6130 kc., 6170 kc., 6180 kc., 6182 kc. and 6190 kc. They are evidently testing from 10-11 p.m. E.S.T. (Winand, T. Smith, Trice, Shea, Dickes).

XEMS, Merida, Yucatan, Mexico, 8160 kc. reported heard 9-9:55 p.m. E.S.T. (Betances).

XEUW, Mexico City, Mexico, is now on a frequency of about 6065 to 6060 instead of the previous frequency of 6020, reported heard at 8 a.m. (Roberts).

XEBT, Mexico City, Mexico, 6000 kc., 50 meters, 1 kw. reported heard very well in Jerusalem (Frost).

CMA3, Havana, Cuba, is now broadcasting regularly on 24.52 meters. Look for their complete schedule and frequency (Messer, Tolpin).

CO9JQ, Camaguey, Cuba, is reported on 8665 kc. instead of their old frequency from 8-8:45 p.m. E.S.T. (Wilson, Dickes, Libby, Hill, Sahlbach).

HI1S, Puerto Plato, D. R., 6420 kc. reported heard early evenings testing. Also 6:40 a.m. and from 10-11:15 p.m. (Dunn, Hynek, Kemp, Adams, Hammersley, Bower, Gavin).

The name of Santo Domingo, D. R. has been changed to Ciudad Trujillo, D. R. (Messer).

HI5N, Trujillo, D. R., 6135 kc. reported heard 10:30 p.m. E.S.T. (Gavin).

HIX, Trujillo, D. R., 5980 kc. reported heard Sundays 7:40-10:40 a.m. On Tuesday and Friday 11:40-12:40 p.m. and 4:40-5:40 p.m. and 8:10-10:10 p.m. E.S.T. The rest of the week they are on the air 11:40 a.m.-12:40 p.m. and 4:40 p.m.-5:40 p.m. E.S.T. (Wilkinson).

HIL, Trujillo, D. R., 6500 kc., 46 meters, reported heard daily 12 N-2 p.m. and 6-8 p.m. E.S.T. (Dickes, Betances, Wilkinson).

HI6F, Trujillo, D. R., reported heard on the 40-meter band 8-9:30 p.m. E.S.T. (Harris). They are soon to be on 6630 kc. with music on Sundays using the call letters HIT (Betances).

HI4V (or **HI4B**) Santiago, D. R., reported heard on 6450 and on 6470 kc. early evening between 5 and 8 p.m., and also at 12:40 a.m., E.S.T. (Roberts, Gavin, Houghton).

HIZ, Trujillo, D. R., 6315 kc. reported heard 1-2 p.m. and 4:30-11 p.m. E.S.T. (Gaiser).

HIH, San Pedro de Macoris, D. R., 6796 kc. reported heard on the air (Turn to page 618)

The "SUPER-PRO"

AMATEUR-PROFESSIONAL RECEIVER

THE new Hammarlund "Super-Pro" Receiver more than fulfills the exacting demands of the seasoned professional and amateur operator. It fairly bristles with distinctive features. Among these are: Electro-statically shielded input; two stages of tuned R. F. on all bands; four air-tuned I. F. transformers; continuously variable selectivity; three audio stages; silver-plated five-band switch; visible tuning meter; separate power supply unit; separate grid bias supply; send-receive switch; speaker-phone switch; A. V. C.-Manual switch; C.W.-Modulation switch; standard and rack type panels and heavy gauge cadmium-plated steel chassis.



TUNING UNIT

The tuning unit, illustrated at the right, is an engineering triumph of compactness and precision. It includes the main tuning and band spread condensers and their respective dial assemblies, the band change switch, and all antenna coupling, R. F. and H. F. oscillator coil assemblies. Only 8 leads from this unit to chassis assembly.

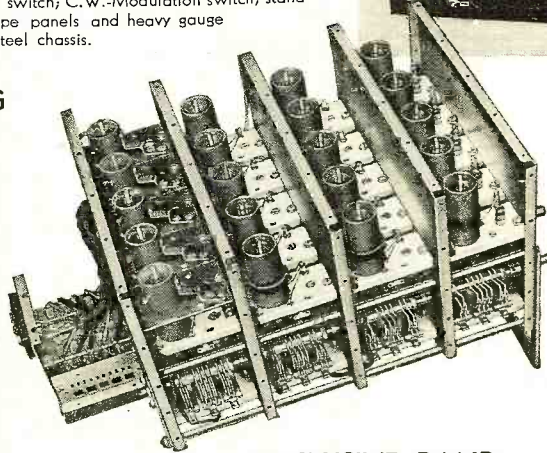

CONTROL PANEL

The precision controls include: accurately calibrated tuning dial in kilocycles and megacycles; band spread tuning dial (both illuminated); five-band switch; audio frequency gain; radio frequency gain; intermediate frequency gain; selectivity; beat frequency and tone control. The main tuning dial is accurately calibrated in megacycles in ranges of 2.5 to 5; 5 to 10; and 10 to 20, and in kilocycles from 540 to 1160 and 1160 to 2500. This dial is equipped with an ingenious mechanical shutter which operates in conjunction with the band change switch, making visible only the frequency band in actual use. The high frequency ranges each have a two-to-one frequency range, which puts the three amateur bands at the same setting of the main tuning dial.

EXCLUSIVE BAND-CHANGING SWITCH

The band-changing switch is a radical departure from switches commonly used for this purpose. Its design incorporates the well-known knife switch principle actuated by eccentric cams. Specially designed bakelite sections with silver-plated phosphor bronze knife blades, gradually slide into silver-plated phosphor bronze spring clips forming a 6-point positive contact. This switch operates backward or forward and not only controls the tuning coverage of the 20 mc. to 540 kc. range in five bands, but also automatically connects the proper band spread condensers to each of the three high frequency circuits and short circuits all coils not actually in use.

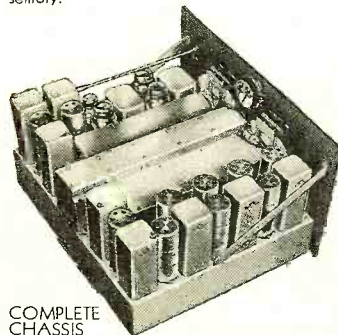

COMPLETE CHASSIS

Write Dept. RN-4 for Complete Details

HAMMARLUND MANUFACTURING CO.

424-438 W. 33rd Street, New York

Now The Perfect CODE TEACHER!

The NEW Master Teleplex

For beginners, experienced operators, and schoolroom. The sure easy way to learn code and to step up your speed. This amazing new instrument will record your own sending on double row perforated tape and repeat it back to you at any speed you desire. 10,000 words can be recorded on one tape.

No Batteries No Winding All Electric
It is the same in principle; and in operation is equal to the Wheatstone Perforator and Transmitter, which cost over \$1,000.

Buy It or Rent It

Send for Folder RN. 4, which tells you how to get the use of this instrument without buying it. No obligation. We furnish complete course and personal instruction with a money-back guarantee. Low cost, easy terms. Write today for information.

TELEPLEX CO.

72 Corlandt St. New York City
The New Master Teleplex—"The Choice of Those Who Know"

YOU WANT YOUR OBSOLETE SET ANALYZER OR TUBE CHECKER Modernized

WRITE FOR OUR PLAN

MENTION MODEL NUMBER OF YOUR OLD INSTRUMENT

MODERNIZATION DIVISION DEPT 'N'

PRECISION APPARATUS CORPORATION
821 EAST NEW YORK AV., BROOKLYN, N. Y.



TED HUSING



LEFT:
RUTH LYON

ADELE
RONSON



"BUCK ROGERS"
(MATTHEW CROWLEY)

Backstage in Broadcasting

By
Samuel
Kaufman

TED HUSING, star CBS sports announcer, has been assigned a commercial spot in which he holds the featured spotlight himself. The Wildroot Company is sponsor of the Monday series presenting Ted as a raconteur. Husing promised to range far from the field of sports and, instead, will deal with comments on personalities and events observed in his many years in radio. The Charioteers, Negro quartet, and Teddy Wilson, pianist, are also heard on the Wildroot feature.

LENOX RILEY LOHR is the new head man at NBC. The successor to the presidency of the network subsidiary of RCA is a graduate engineer who is also noted for achievements as a soldier, instructor, editor and author. He gained considerable attention for his successful management of the Century of Progress Exposition in Chicago. His election to the NBC post followed the resignation of Merlin H. Aylesworth who remains identified with NBC in the newly created post of vice-chairman of the board. Mr. Aylesworth asked to be relieved of the responsibilities of the presidency due to his increased duties assumed by his election to the chairmanship of the Radio-Keith-Orpheum Corporation board of directors. Mr. Lohr came to NBC at the time five additional West Coast stations joined the

chain, thus giving the company two complete coast-to-coast networks, "keyed" respectively by WJZ and WEAJ, New York.

A NOVEL means of weaving a variety program together has been effected in the NBC "Cinema Theatre" presented Wednesday nights. The period consists of a typical show in a de luxe movie theatre—overture, newsreel, stage show, feature picture and a comedy or "short." The idea is a clever one and is accredited to C. L. Menser, NBC Central Division production manager. Betty Winkler and Sidney Ellstrom head the cast of the weekly drama which constitutes the "feature picture." Ruth Lyon, soprano, and Charles Sear, tenor, headline the "stage show." Al Short conducts the orchestra.

IN a recent issue we commented on numerous instances of stellar programs on different stations at the same time. One of the outstanding examples of this was Eddie Cantor's and Leslie Howard's CBS competition to the Major Edward Bowes Amateur Hour of NBC. Lehn & Fink, the sponsors of both the Cantor and Howard shows, apparently feeling the futility of bucking the smash-hit Bowes program, moved the two half-hours to earlier Sun-

day spots. But, alas! The well-intentioned switch put Cantor on exactly the same time as Jack Benny's NBC offering. Upon his return to New York, Cantor readily admitted that he felt it wise to switch to another spot in view of the tremendous following enjoyed by Major Bowes. Regarding his new competition with Jack Benny, Eddie commented that he feels he can hold more listeners against him than against Bowes and, in addition, the new time will permit many of the Bowes followers to listen to him prior to switching to the amateurs.

NO name in broadcasting has remained a more consistent hit than Paul Whiteman. Radio's "King of Jazz" is now starred on the 45-minute NBC Sunday feature sponsored by the John B. Woodbury Company. Supplementing the famous Whiteman orchestra is the following batch of vocalists: Bob Lawrence, Ramona, Johnny Hauser, Durelle Alexander and The King's Men. The Whiteman troupe also boasts of its individually-famous instrumentalists. The guest star technique the conductor utilized on his recent Kraft series still prevails on his new offerings. Harry Richman led the parade of invitation performers on the Woodbury series

RIGHT: EUNICE STANDISH
GATES AND MAJOR BOWES

LENOX RILEY LOHR



AT RIGHT: RAMONA

SIX "CANTORS"
AND EDDIE CANTOR





STELLA

with Morton Downey on the second program, and it is understood that names of this calibre will continue to occupy the choice guest spots.

THE popular adventure series, "Buck Rogers in the 25th Century," which deals with such gadgets as rocket ships, hypnotic ray machines and disintegrators, is on a revised CBS schedule under the new sponsorship of the Cream of Wheat Corporation. The series is now heard Mondays, Wednesdays and Fridays. Matthew Crowley, who originated the title role in 1932, is back on the program replacing Curtis Arnall who portrayed the hero for many intervening seasons. Wilma Deering, the leading feminine character, continues to be portrayed by Adele Ronson, popular radio actress.

FRED WARING and his Pennsylvanians—a smash radio hit for several consecutive seasons on CBS—is now on a new schedule whereby both NBC and CBS carry the feature. The Ford and Lincoln dealers of America continue as his sponsors. His CBS offering continues on Tuesday nights but it has been cut from one hour to thirty minutes. His NBC offering, also a half-hour, is on a Friday schedule. The new arrangement makes Waring's offerings available over a total of 154 stations. There are 93 transmitters in the CBS chain and 61 in the NBC hook-up. The glee club remains a highlight of the broadcasts. The vocal offer-
(Turn to page 639)

"MOLLY GOLDBERG"



just out!

1936

Allied Radio

CORPORATION
833 W. JACKSON BLVD.
CHICAGO

WORLD-WIDE SETS
TUBES-ACCESSORIES
REPLACEMENT PARTS
SERVICEMEN SUPPLIES
TESTING EQUIPMENT
LABORATORY EQUIPMENT
AMATEUR EQUIPMENT
EXPERIMENTERS PARTS
S.W. APPARATUS
PUBLIC ADDRESS

U.S. LEADING SUPPLY GUIDE

Allied Radio

CORPORATION

833 W. JACKSON BLVD., Chicago

FREE MAIL THIS COUPON

ALLIED RADIO CORP. Dept. M.
833 W. Jackson Blvd., Chicago

Send me your FREE NEW SPRING AND SUMMER 1936 Radio Catalog.

Name.....

Address.....

QUALITY recommends

Condensers by

WET... DRY
PAPER
MICA... TRIMMER

SOLAR

Please Write for Details

SOLAR MFG. CORP. 599-601 Broadway
New York City

"HAM" SPECIAL Standard Teleplex

A highly efficient code teacher using heavy specially prepared waxed paper tape, having two rows of perforations. Write for Free folder "R.R.A." DEALERS - Correspondence invited with dealers for protected territories.

We are the originators of this type instrument

TELEPLEX CO.
72 Cortlandt St., New York City

Instrument with tapes prepared by expert and complete course of lessons, all for \$11.95

THE NEW "Rebroadcaster"
EXPLORER

Makes Any Radio an All-Purpose Amplifying System.

A complete audio-modulator oscillator of extremely flexible design. With microphone, short wave set, or phonograph pick-up attached to its input, it rebroadcasts as its output a powerful tunable broadcast band signal to aerial terminal of any radio receiver—for amplification by the entire receiver, and reception at full speaker capacity. Attach your short wave set using 1 or more tubes and bring in foreign stations never heard before—on the broadcast receiver with tremendous volume!

Uses: for Public Address, radio-phonograph installations, short wave conversion, as experimental "ham" S.W. transmitter, beat oscillator for all-wave receivers, etc. Many amazing features! **Net Price, Only \$8.95** less tube. **Kit-\$7.95.** Send now for **FREE Literature.**

RIM RADIO MFG. CO., 695 Grand St., Brooklyn, N.Y.

INVENTORS

TIME COUNTS

In applying for patents. Don't risk delay in protecting your ideas. Send sketch or model for instructions or write for **FREE BOOK** "Patent Guide for the Inventor," and "Record of Invention" form. No charge on how to proceed. Prompt, careful, efficient service.

CLARENCE A. O'BRIEN and HYMAN BERMAN
3091 Adams Building Washington, D. C.
Registered Patent Attorneys Before U. S. Patent Office

To Give FACTORY-TYPE SERVICE

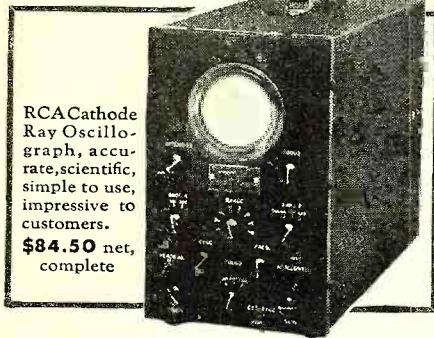

RCA Cathode Ray Oscillograph, accurate, scientific, simple to use, impressive to customers. \$84.50 net, complete

To make it possible for service men to use the same instrument used in factories for peaking I. F. transformers, checking distortion, etc., we offer the RCA Cathode Ray Oscillograph. Entirely self-contained, including power supplies. With RCA Test Oscillator and RCA Frequency Modulator you can offer complete factory service; or use it as a modulation indicator for your amateur transmitter, etc. See it at your RCA Parts Distributor's.



OSCILLOGRAPH

RCA Parts Division, RCA Mfg. Co., Inc.
Camden, N. J. An RCA Subsidiary



A BETTER SERVICE BUSINESS FOR YOU

Chances are ten to one that YOUR business CAN be made better, more efficient, MORE PROFITABLE.

You CAN get better jobs. You CAN expand to do all types of work quicker and easier. You CAN learn to merchandise your business to greater advantage.

Enthusiastic letters from many Sprayberry graduates offer convincing proof. I have helped them on the road to success. I honestly believe I can help you. Certainly, as a serviceman, you owe it to your business future to mail the coupon today and GET THE FACTS about Sprayberry's Practical Mechanics of Radio Service. It may be the turning point in your business career. You have nothing to lose—much to gain.

F. L. SPRAYBERRY

2548 University Place, N.W.
Washington, D. C.

Without cost or obligation, please send your book "PUTTING PROFITS AND EFFICIENCY INTO SERVICING."

Name.....

Street.....

Address.....

RN-4-36

**SPRAYBERRY'S PRACTICAL
MECHANICS OF RADIO SERVICE**

THE SERVICE BENCH

tells YOU Something about

Service Shops

...

Actual
Servicing

...

Service Sales

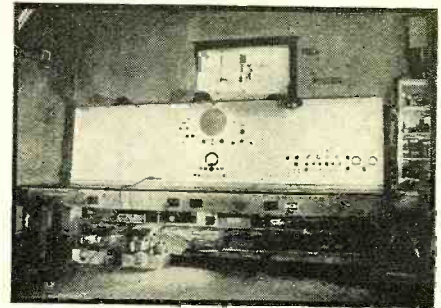

SERVICE SHOP OF
DENNY RADIO SERVICE

Conducted by Zeh Bouck, Service Editor

THIS MONTH'S SERVICE SHOP

THIS month's heading shows the elaborate service shop designed and constructed by R. J. Denny, Jr., of St. Louis, Mo. The elaborateness is fully justified by the utility of the layout and its sales promotional possibilities. According to Mr. Denny, no inconsequential proportion of his success is due to the impression this service laboratory makes upon his customers, and the equipment enables him to live up to the promise of efficient servicing implied in its appearance. The bench, approximately ten feet long, is sturdily constructed, and the rear panel is of sheet aluminum—which, its designer confesses, would have been an extravagance were it not for the eye appeal that has won him many clients. All the usual equipment is present, including a universal speaker that can be connected to any amplifier, regardless of output impedance or connections and field requirements. All usable voltages, a.c. and d.c., are obtainable through the power lines, suitable rectification and a motor-generator unit. Adequate lighting and plenty of room contribute to the ease and efficiency of service work. Such refinements as soldering iron "coolers" have been incorporated in the bench, and we have written to Mr. Denny for more dope on this—to pass on to our readers.

THE DAY'S WORK

Roger H. Hertel, manager of Hertel's Radio Store, Clay Center, Nebraska, and a familiar contributor to this department, sends us the following notes from his service records:

Atwater Kent, 465Q

"The complaint is distortion, apparently in the loudspeaker, symptomatic of a driving pin loose or unsoldered in a magnetic speaker. It is naturally most troublesome on high volume. However—*don't touch the speaker*. The chances are the difficulty is in the 8 mfd. electrolytic by-pass condenser—with the probability of an open. This condenser, a tubular, is connected from the speaker plug to ground—in other words, across the B supply."

Atwater Kent, 165

"The set cut out between 800 and 550 kc. Trouble: The red and blue antenna leads were connected together. Break the connection and connect the aerial to the blue lead only."

Majestic, 160

"Dead and no plate voltage. This trouble is very common and can usually be traced to a .1 mfd. condenser in an i.f. transformer can. My recommendation is to disconnect the high voltage leads from the transformers and test the condensers before looking elsewhere for trouble."

Majestics, Models 1411, 12 and 13

"Low volume, fading and noise. Outside of this the set is okay. The trouble is in the volume control, even though this component may check satisfactorily on a cursory examination. Replace the control with a new one. In an emergency, the 6D7 tube can be replaced with a 6C6."

Kolster, Model 6D

"The customer complained of laborious tuning—a stiff dial. The difficulty is due to friction between the dial pulley and the panel. This can be corrected by inserting any convenient sort of a spacer, such as a shingle nail cut off about 1/4 inch from the head, between the top shielding and from the front panel. This springs the panel far enough to permit easy action of the dial pulley."

Zenith, 4V31

"A common complaint is noise—which the serviceman will immediately recognize as the vibrator feeding through to the speaker. Peculiarly enough, this is due to the antenna and ground leads being too close together. Where splices are made in these leads, they should be well taped and spaced at least one inch. Vibrator noise from this source is usually accompanied with low signal strength."

U. S. Radio, Apex and Clarion

"A trouble common to these sets is oscillation. A reasonable amount of alignment alone will not correct the trouble, with such of these receivers as have a set-screw and nut holding the moving con-

SERVICE SHOP CONTEST

RADIO NEWS is offering this month five new cash prizes of \$10.00, \$5.00, \$4.00, \$3.00 and \$2.00 each for photographs and descriptions of Service Shops. We and our readers are as much interested in seeing *where* you work as in knowing how you work. Elaborateness will *not* be the deciding factor. Ingenuity and neatness will count higher. Send in your Service Bench photo. Describe your equipment and anything unusual you have done with it in four hundred words or less. All material used will be paid for, whether prize-winning or not. Address contributions to, yours for better servicing—

—The Service Contest Editor

denser plates in place on the shaft. Loosen the lock-nut securing the bolt in the center of the back plates on the condenser assembly. Tighten the bolt, retighten the lock-nut, and realign. The trouble is a bad connection to ground through the bolt. Be sure to make the proper electrical contact, but watch out for shorting the rotor and stator plates during the operation."

Traveler

"The complaint is noise. In all models that have a heavy bus-bar coupling on the r.f. coils, look for faulty insulation on the bus-bar loop coupling coil. Remove this loop and insulate with spaghetti."

Tube Tips

"I have a new 89D Supreme tube tester. This tester has a hot short test, but occasionally the short does not show up—par-

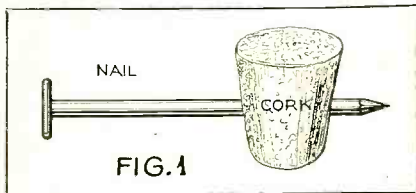

ticularly those of the intermittent variety. I use a rubber cork with a nail driven through it to form a handle (Figure 1) as a gentle hammer or mallet. Tapping the

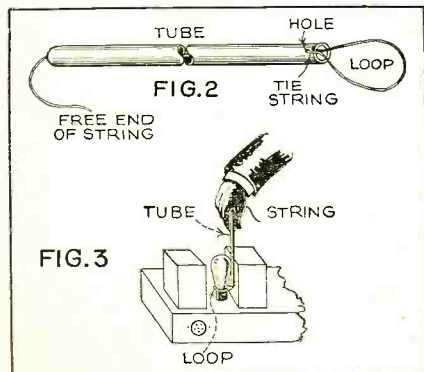

tube will often show up this baffling type of short.

"Another idea of mine, which I find most useful, is a gadget to remove tubes and vibrators from auto-radio sets—or (Turn to page 617)

Transmission Problems

(Continued from page 594)

ratio (K) and with its secondary terminated in a resistance (R), the primary will present an impedance of:

$$Z_1 = \frac{R}{K}$$

That is, the transformer could be replaced with a resistance:

$$\frac{R}{K}$$

without in any way affecting the load impedance connected to the generator.

All of which means that the transformer serves to increase or decrease the load impedance in accordance with its impedance ratio. From this it is easily shown that for usual cases, of a complex impedance load, the best ratio of transformer to couple the generator to the load is one in which ratio of primary turns to secondary turns is equal to the square root of the ratio of the generator impedance to the load impedance.

Serviceman's Diary

(Continued from page 579)

Drove over to the 3 o'clock appointment, a Victor 9-54 combination, about as easy to push around as a Mack truck with a dead motor. Complaint, radio squeals, phonograph doesn't work, sorry we ever bought it, could have bought today a better set for one-tenth the money, and words to the same effect ad infinitum. Found set operating fairly well below 1000 kc. but unstable. Slight i.f. oscillation and considerable r.f. oscillation, particularly above 1000 kc. Readjusted r.f. feed-back condenser—no effect. Checked voltages. First detector plate read 160 volts; much too high. Removed chassis, speaker and power unit to shop. Located open 1000-ohm section in voltage divider, the cause of the abnormal voltages. Replaced. Removed gang condenser, realigned and neutralized i.f. Replaced condenser and realigned r.f. circuits. Found spider support broken in speaker cone. Repaired with piece from another defective cone, a delicate job, but the customer can't wait for a replacement cone. Put aside for cement to set and moved on to next call.

This one proved to be a Zenith 52, customer complaining that reception was noisy on all the big stations. Trouble was obvious, noise being noted when the station selector was revolved. Set had been in storage for two years and corrosion of gang condenser contacts resulted. Removed chassis for shop repair and proceeded to the next on the list.

Found a good old Victor R-32 waiting at the next place, an easy set to work on and not subject to fading to any appreciable extent. The complaint was that the stations sounded muffled and noisy. Told the customer before taking the speaker out of the cabinet that we would find the center cut out of the cone, that same would have to be replaced.

FREE TO SERVICEMEN

This package of VALUABLE Service Data PRACTICAL Sales Helps



For a limited time only

To enable a larger number of servicemen to become familiar with the advantages of RADIO MANUFACTURERS SERVICE, we will send FREE to any serviceman . . . on receipt of the coupon below filled out . . . a sample copy of one of the recent mailings of service information and service selling aids.

These are being sent out regularly each month from R.M.S. headquarters to every member of this nationwide service organization, absolutely FREE. In fact, membership in R.M.S. is entirely free—no dues or charges of any kind. Over 15,000 members and still growing! Send in the coupon . . . see what you have been missing! Full details of Radio Manufacturers Service will also be sent you.



RADIO MANUFACTURERS SERVICE

Send in this coupon TODAY!

Date.....

R. M. S. Headquarters
Tioga & C Sts., Philadelphia, Pa.

Please send, without obligation to me, FREE sample of R.M.S. mailing and full information on Radio Manufacturers Service.

NAME.....

ADDRESS.....

OCCUPATION.....

Never Before!
DUAL CHANNEL OPERATION!

Bring the Station in on the **TUNING CHANNEL** for maximum Sensitivity and Selectivity
 —then Switch it over on the **TO NE CHANNEL** for Maximum TONE!

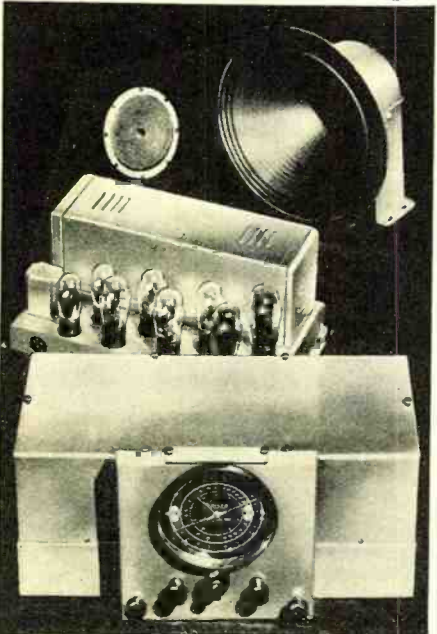

Dual Channel Operation accomplishes the impossible! A super Selective and Sensitive receiver with SUPERLATIVE TONE! By the flip of a switch you change from a sharp intermediate TUNING CHANNEL to a broad intermediate TONE CHANNEL!

THE NEW 20-TUBE
Lincoln
 SYMPHONIC

"The Finest Radio for Fifteen Years"
MAIL THIS COUPON!

Lincoln Radio Corp.
 154 E. Erie Street
 Chicago, Illinois

Mail me FREE complete details on the NEW DUAL-CHANNEL "Lincoln Symphonic."

Name.....
 City..... State.....

Servicemen's PRIZE CONTEST

Announcement of Awards

Zeh Bouck

Service Editor

THIS month's prize of \$10.00 goes to Edward M. Scribner, of Scribner Brothers, Schoharie, New York, a familiar contributor to the *Service Bench*—for originality and enterprise! While the main idea was conceived for the promotion of good will and publicity and direct financial return during the Xmas-New Year holidays, it is equally applicable to Easter—and this issue of RADIO NEWS reaches

hardware stores, two drug stores, a department store that is impregnable to mail-order competition, one hotel, a liquor store, several restaurants, the usual number of garages and filling stations and a radio service shop and store. Its inhabitants are justly proud of their central school (completely wired for sound and radio, by the way) and the "Stone Fort" that bears marks of Indian warfare. A motion picture theater with modern and comfortable seats is always well filled by devotees of the talking screen. There are two cemeteries—and many a stone marks the resting place of those who have contributed to the history of the county, state and country.

In other words, it is a typical American village, populated by typical American people—surrounded by typical hills and farm lands.

What one serviceman can do—another can.

Citizens, typically proud of their community, donated chimes, supplementary to the organ in the Methodist Church. The

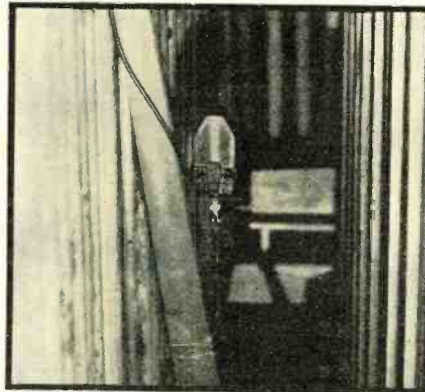

FIGURE 1

you in just plenty of time to negotiate a similar set-up. The secondary idea incorporated in Mr. Scribner's contribution is an all-year-round tip!

A Carillon in Every Village!

The village of Schoharie, N. Y., is not a large one. The population is a bit over one thousand. It boasts of a Main Street, with the usual complement of local and chain stores. A block back, toward the historic Schoharie Creek, is a residential section, fringed with stately maples—and evergreens that flaunt a note of color throughout the winter. There are two

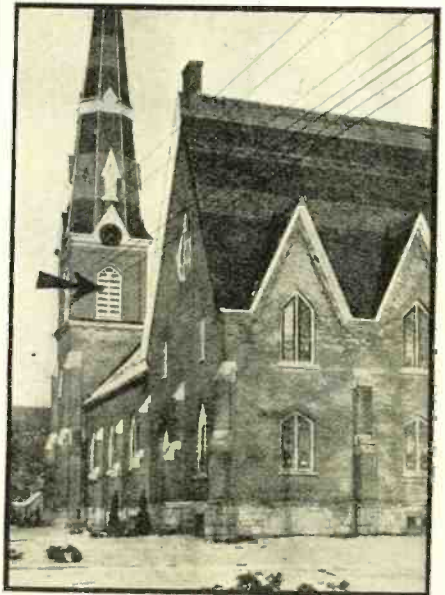

FIGURE 3

idea of amplifying these chimes, with the organ music, and broadcasting the music through a conventional public-address system so that it might be heard over the entire village for the Xmas week, was conceived, and ably executed, by a local radio man—Edward M. Scribner. The job was contracted for at regular rates—less a reduction in consideration of the yuletide spirit, and good will. The rest of the story is best told in the accompanying photographs.

Figure 1 shows the installation of the Amperite ribbon microphone among the organ pipes, and adjacent to the chimes in the loft. Figure 2 shows the organist,



FIGURE 2

TRI-STATE COLLEGE

Radio Degree in 2 Years
Engineering

Complete Radio Engineering course in 96 weeks. Bachelor of Science Degree. Radio (television, talking pictures and the vast

electronic field) offers unusual opportunities for trained radio engineers. Courses also in Civil, Electrical, Mechanical, Chemical, Aeronautical, Architectural Engineering; Business Administration and Accounting. Low tuition, low living costs. World famous for technical two-year courses. Those who lack high school may make up work. Students from all parts of the world. Located in picturesque hill and lake region of northern Indiana. Enter January, March, June, September. Write for catalog. 1646 COLLEGE AVE. ANGOLA, IND.

Frank Rickard, seated at the console. He wears earphones for monitoring, and he himself constitutes the principal operator and sole "mixer." There is no volume control on the chimes, and the mike is so located that overload and blasting are impossible. However, the volume of the organ is controlled in the usual manner, and by wearing earphones a nice balance between the pipes and chimes is readily secured.

The church itself is shown in Figure 3, an arrow marking windows covering loud-speakers. Three Wright-deCoster speakers are mounted in the belfry, facing the vanes most favorable for sound distribution over the village. One of these is shown in Figure 4. Aside from the idea itself, the arrangement is altogether conventional, and can be duplicated by any serviceman hav-

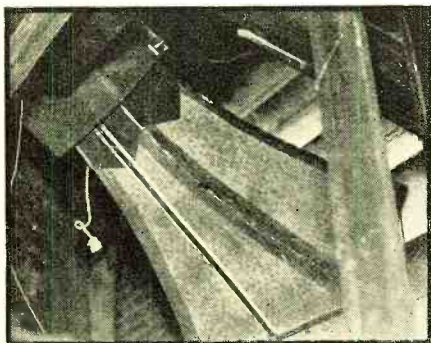

FIGURE 4

ing medium- or high-power P.A. equipment—from 15 electrical watts up. An output of 30 watts were employed in the layout illustrated and the organ with chimes—sounding for all the world like the Rockefeller carillon on Riverside Drive, New York City—were clearly heard, and enjoyed, over the entire village. More exactly, the music was pleasurable audible over a radius of better than 1/2 mile—and carried with the wind Xmas and New Year greetings far into the hills.

This advent was acclaimed with considerable publicity in urban newspapers—in Schenectady, some 30 miles away—as well as in local publications. Needless to say, the Scribner service and set business has not suffered!

Another evidence of enterprise on the part of Scribner Brothers is indicated in

Amateur Contest On Stage This Week

The second in a series of Amateur contests will be the attraction at Conery's Schoharie Theatre Friday night at 8:30 in addition to the screen attraction. Arrangements have been made through the courtesy of Scribner Bros. for use of their amplifying equipment for this contest which is sponsored by Kilts and Guernsey Food Market and the theatre.

The screen attraction stars Margaret Sullivan in "So Red The Rose" with featured players including Randolph Scott, Walter Connolly, Janet Beecher

FIGURE 5

the clipping of Figure 5. This is an all-year-round stunt, and takes advantage of the publicity being given amateur hours and the universal interest in them. An amateur hour, sponsored by a progressive local merchant, is given a Major Bowes flavor with the use of a mike and adequate electrical

CONTEST NEWS

THE original intention of this department was to end the Serviceman's Sales Promotion Contest with the March number of RADIO NEWS. However, interest has been such that the contributions have continued to pour in, and we can do no other than continue it for this issue, particularly when the prize-winning sales plan for this month is so appropriate to Easter, with an added suggestion for all-year-round sales idea! The next contest on schedule—as you will note in another part of this magazine—is for photographs and descriptions of service benches. This will be followed with prizes for the best stories on how the cathode ray oscilloscope has built up the radio service business! After that—who knows? Perhaps another sale promotion contest!

—The Contest Editor

sound distribution. The clipping tells most the story—the cash register the rest!

The Service Bench

(Continued from page 615)

from any tight place where it is difficult to obtain a grip with the fingers. All that is required is a bit of string and a piece of tubing—metal or bakelite—as shown in Figure 2. The tube is "lassoed" as shown in Figure 3—saving time, knuckles and cussing."

SERVICE NOTES AND SALES HELPS

Your Service Editor will probably never cease to emphasize the desirability of an attractive business card. A minor item, to be sure, but the successful business is built about a collection of minor items conceived and executed in such a manner as to appeal to customers. An attractive card is illustrated in Figure 4. We pass this on to our readers for three reasons—first, it carries a terse sales message requiring exactly eight words. Second, it is neat, and slightly "ritzy" despite the fact that it is set up with standard type fonts available at most local printers. Third and last, but by no means least, it serves a double purpose more effectively than the ordinary name-and-address card. While it may be used in the introductory manner of the usual business card, it is an excellent reminder, thumb-tacked under the cover or inside the cabinet of a radio set.

Radio Servicing

75 Cents Plus Parts
Free Inspection

... Call ...

EARL (Skeet) HALL

6-4294

FIGURE 4

The parts manufacturers are doing more and more in the way of service sales promotion for the serviceman. National (Turn to page 640)



How
one service shop
licked 4
tough problems

HOW WOULD YOU DO IT?

Case No. 1 Stuck on a set with an unfamiliar QAVC circuit. They spent long hours tracing trouble and studying manuals in vain. Finally they turned to MODERN RADIO SERVICING and there on page 473 found a complete description of this very QAVC circuit. With that they located the trouble in ten minutes and soon had the set working perfectly.

Case No. 2 A low-priced a.c.-d.c. midget had some kind of "tunable hum" trouble they had never run across before. MODERN RADIO SERVICING gave them the causes and remedies on pages 628 to 630, and the hum was completely and quickly eliminated by simply connecting a 0.001 mfd. condenser from one side of the power line to ground. Hours were saved!

Case No. 3 Two previous service men had completely given up on an Amrad Model 7100 troubled with intermittent reception. But this shop turned first to RADIO FIELD SERVICE DATA (Supplement to MODERN RADIO SERVICING), and there on page 33 of the "Case History" section found that "leads shorting in the cabled wiring" might be the trouble. The book was right—and the customer delighted—to say nothing of the service men!

Case No. 4 This shop had two good technicians, but neither one had the "selling knack", and their advertising never seemed to "pull". In MODERN RADIO SERVICING they found a 59-page chapter that gave them scores of practical, tested tips on selling and advertising. They tried out a few and now their only problem is catching up with the orders!

Here's the one book that has everything you need to know

MODERN RADIO SERVICING

by Alfred A. Ghirardi

1300 pages, 706 illustrations.
Together with 240-page
Supplement

\$5

RADIO & TECHNICAL PUBL. CO.

45 Astor Place, N. Y., Dept. RN-46

Enclosed please find \$5 for your Introductory Combination Offer of both books postpaid (\$5.50 foreign).

Please send free descriptive literature.

Name.....

Address.....

Occupation.....

What kind of information do you need most? Test instruments? Latest test methods? Latest repair methods?

Case Histories? Sales and Advertising?

READ "SELLING SERVICE" BY Ghirardi and Ruqqles in Feb. Radio News

-GO TO 10th & MAIN - RADIO TROUBLE THERE

CALLING all Servicemen!

When "Squad-car" Centralab is at the wheel things happen. He stands for no foolin'. Out goes that noisy control on its ear . . . and a smooth, efficient CENTRALAB RADIOHM preserves the peace.

The best pacifier for noisy receivers, servicemen agree, is a Centralab Radiohm . . . and . . . a mere handful will service practically any set ever made . . . and make it work "better than ever before."

Every Radio Service Man should be a member of the Institute of Radio Service Men

Centralab

Milwaukee, Wis.
RADIOHMS FIXED RESISTORS
WAVECHANGE SWITCHES

NEON OSCILLOSCOPE KIT

Radio amateurs—Experimenters will want this for viewing and demonstrating wave form, for making resonance and r.f. indicators and audio oscillators. Many other uses too. Neon oscilloscope tube is brilliant and has long life. Complete kit only \$2.00 includes tube, clips, mirror and motor shaft adapter. Write for folder or see at your jobber — or order now from

\$2.00 Net
 Prepaid with Tube, Clips, Mirror and Motor Shaft Adapter

SUNDT ENGINEERING COMPANY
 4256 Lincoln Ave. Chicago, Ill.

(Affiliate of Littelfuse Labs. Makers of Instrument Fuses—Radio and Auto Fuses—High Voltage Fuses—Aircraft Fuses—Fuse Mountings.)

RADIO ENGINEERING

RCA Institutes offers an intensive course of high standard embracing all phases of Radio. Practical training with modern equipment at New York and Chicago schools. Also specialized courses and Home Study Courses under "No obligation" plan. Catalog Dept. RN-36

RCA INSTITUTES, Inc.
 75 Varick St., New York 1154 Merchandise Mart, Chicago
 Recognized Standard in Radio Instruction Since 1909.

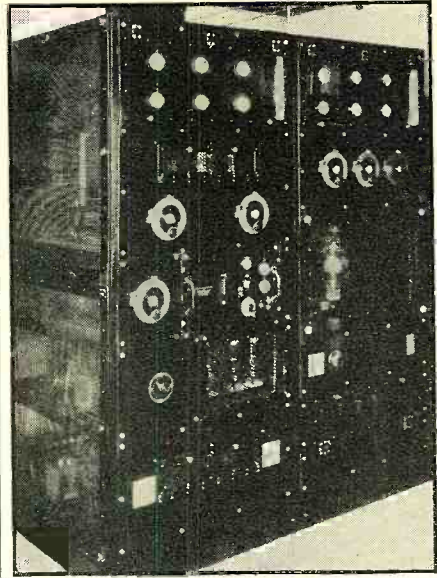

The DX Corner
 (Short Waves)

(Continued from page 611)

Sundays, Mondays, Thursdays and Saturdays 12:10-2 p.m. and 7:10-9 p.m. E.S.T. (Gaiser, Stabler).

HI9B, Santiago, D. R. 6-50 kc. reported heard 5-10 p.m. E.S.T. and also shortly after 10 a.m. E.S.T. (Marshall, Sand, Chambers, Leutenberg).

HI8A, Trujillo, D. R., 6600 kc. and also on about 6740 kc. irregularly (Betances).

HI5M, Trujillo, D. R., 6150 kc. reported heard at noon and early evening (Betances).

HH2K, Port-au-Prince, Haiti, 5920 kc. reported heard 7:40-8:40 p.m. E.S.T. They speak the French language (Messer, Belanger).

HH2S, Port-au-Prince, Haiti, 5920 kc. reported heard 8-10:30 p.m. and sometime up until 5 p.m. (Sahlbach, Butcher, Chambers, Hammersely).

VRO4, Kingston, Jamaica, heard on about 11650 kc. (Wilson).

HH2T, Port-au-Prince, Haiti, 11570 kc. reported heard testing (Brewer).

CENTRAL AMERICA

YNVA, Managua, Nicaragua, 8640 kc. reported heard 8 to 10 p.m. (Roberts).

TI5HH, San Ramon, C. R., 550 kc., 200 watts reported heard afternoons and evenings (Anca).

HRN, Tegucigalpa, Honduras, now reported on 5910 kc. instead of the old frequency of 5875 kc, 500 watts in the antenna, 5:30 to 7 p.m., 7:30 to 9 p.m. also 12 noon to 1 p.m. E.S.T. On Sundays they are on from 2:30 to 4:30 p.m. (Danforth, Graham, Quinn, Nosworthy, Sands).

HIY, Honduras, 6350 kc. reported heard testing at 8:05 p.m. (Jacobs).

HIW, Honduras, 11040 kc., reported heard 7 to 8 p.m., E.S.T. (Akins, Jacobs).

HP5F, Colon, Panama, 6080 k.c., reported heard daily except Sunday 1:45 to 3 p.m., E.S.T. and 9 p.m. to 12 midnight E.S.T. On Sundays they are reported on the air 12:45 to 1:30 a.m. and 6 to 8 p.m. E.S.T. (Hynek, Butcher, Anca). Observer Partner reports them daily 11:45 to 1 p.m. and

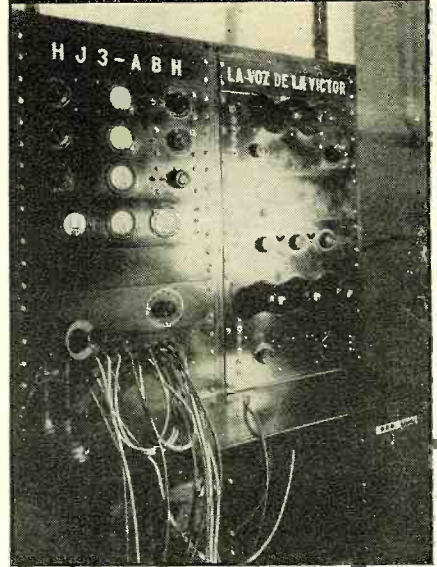

THE EQUIPMENT AT HJ3ABH
 At the left is the 1200-watt, short-wave transmitter, operating on 5970 kc. and above are the line amplifier panels.

7:45 to 10:30 p.m. and on Sundays 4 to 6 p.m. E.S.T.

HP5J, Panama City, Panama, 9590 kc., reported heard 11:45 to 1 p.m. and 7 to 11 p.m. E.S.T. (Anca, Wilkinson, Butcher, Loke).

SOUTH AMERICA

VP3MR, Georgetown, British Guiana, 7080 kc., reported heard Sundays 8 to 10 a.m.; Mondays 3 to 4 p.m.; Wednesday, Thursdays and Saturdays 5 to 7 p.m. E.S.T. (Hull, Shea, Brewer, Colburn, Trice, Dunn).

PZH, Paramaribo, Dutch Guiana, 6990 kc., reported heard irregularly evenings (Butcher).

HJU, Buenaventura, Colombia, 9110 kc., reported heard 8 to 12 p.m., E.S.T. (Trice, Kentzel, Nosworthy, Gallagher, Hull, Craft, Sahlbach).

HJ1ABD, Cartegena, Colombia 7281 kc., reported heard 8 to 10 p.m. (Stabler).

HJ1ABE, Cartegena, Colombia, 6115 kc., has a DX broadcast on Mondays at 11:10 p.m. E.S.T., (Jones).

HJ1ABJ, Santa Marta, Colombia,

THEY ARE "NEAT" IN ARIZONA
 This is the Listening Post of I. F. Wolpe of Phoenix, Arizona. His receiver is an Airline model 7D and he uses a doublet antenna pointed N.W.-S.E.





JUST ONE DAY'S VERIFICATION MAIL AT W8XK

Miss Eleanor M. Hicks, correspondent of Station W8XK at Pittsburgh, receives her daily mail, to begin her task of classification and verification.

6006 kc., reported heard to 11 p.m. (Foshay).

HJ2ABD, Bucaramanga, Colombia, reported heard on 6450 kc., 6451 kc., and 6457 kc., from 8 to 10 p.m., using the same call letters as the station at Pereira on 6080 kc. (Betances, Shea, Byrnes).

HJ4ABE, 5930 kc., Medellin, Colombia, is to use lower power soon, while their regular transmitter is moved outside the city limits. (Butcher, Colburn, Brewer, Hamilton).

HJ4ABD, Medellin, Colombia, reported heard on 5750 kc., 5760 kc., 5770 kc., 1 kw. 10:20 a.m. to 12 noon and 5:20 to 11 p.m. (Gavin, Sand, Betances, Wilkinson, Butcher, Foshay, Winand, Miller).

HJN, Bogota, Colombia, reported heard 5940 kc., 4960 kc., and 5970 kc. 8 to 11 p.m. E.S.T. (Gavin, Betances, DeMarco, Dickes, Anca, Bower, Partner).

HKF, Bogota, Colombia, 6150 kc., reported heard testing evenings (Betances).

HJ4ABP, Medellin, Colombia, 6135 kc., reported heard (Chambers).

YV8RB, Barquisimeto, Venezuela, 5880 kc., reported heard 6 to 10 p.m. E.S.T. and 12 to 1 a.m. E.S.T. (Millen).

YV9RC, Caracas, Venezuela, 7795 kc., heard calling CQ 8:10 p.m. E.S.T. (Betances).

YV12RM, Maracay, Venezuela, 6300 kc., reported heard 8 to 11 p.m. E.S.T. (Dunn, Cristoph, Miller, Sholin, Houghton, Winand, Bremer, Betances, Danforth, Anca, Dickes).

LSN2 (or **LSN3**) Buenos Aires, Argentina, 9890 kc., reported heard 5:50 p.m. E.S.T. (Millen, Wilson, N. Smith, de Laet, Chambers, H. Smith).

LRU, Buenos Aires, Argentina, 15280 kc. (or 15290 kc.) 5 kw., reported heard 7 to 10 p.m. (Marshal, Hull, Sholin, Butcher).

LRX, Buenos Aires, Argentina, 9580 kc., reported heard testing and relaying LRI 7 to 7:45 p.m. E.S.T. (Hessler).

LRI, Radio Mundo, Buenos Aires, Argentina, reported heard on about 15.2 meters 11:25 p.m. to 12:07 a.m. E.S.T. (Hyde).

ZP10, Asuncion, Paraguay, 8100 kc., reported heard 8 to 9 p.m. E.S.T. (Marshal).

Who is the station on about 17780 kc., heard around 5 to 6 a.m., an-

nouncing "Republique de 'Par-argooay'?" Station talks French and says repeatedly "Hallo Bear-lin" (Dailey, Lower, Yeager).

OCI, Lima, Peru, reported heard at 3:30 p.m. E.S.T. on 18680 kc. (Smith) LPO Gavin says they are on 10970 kc. and he reports them at 4 p.m. E.S.T.

HCK, Quito, Ecuador, 5885 kc., reported heard Tuesday 9 to 9:45 p.m. (Smith).

HCJB, Quito, Ecuador, now announces their frequency as 8773 kc. Reported here 12 noon to 2 p.m. on Monday and Thursday and 6 to 7 p.m. E.S.T. Also irregularly from 2 to 5 p.m. and 7 to 11 p.m. E.S.T. (Trice, Dodge, McDonagh, Chambers).

KKH, Kahuku, Hawaii, 7520 kc., reported heard at 2:52 a.m. (Messer, Wilson).

KIO, Kahuku, Hawaii, 11710 kc., heard testing evenings (Costes).

Readers Who Are Awarded "Honorable Mention" for Their Work in Connection with This Month's Short-Wave Report

- E. Scala, Jr., Gilbert L. Harris, Robert F. Gaiser, C. W. Bourne, Shokichi Yoshimura, Earl P. Hill, Leon Stabler, Wade Chambers, R. N. Putnam, Alvin H. Behr, A. Kosynsky, John Havranek, Edward Dailey, Jr., Wm. J. Thomas III, H. Francis Shea, E. P. Webb, Ted Stark, Melton Amos, Gilpin Amos, Harold R. Smith, T. B. Meehling, L. C. Styles, Eric Butcher, H. Kemp, G. C. Gallagher, George C. Sholin, Harry E. Kentzel, Walter L. Chambers, Jerry M. Hynck, Sydney G. Millen, Norman C. Smith, Harold F. Lower, R. C. Messer, W. H. Boatman, W. E. Frost, Charles B. Marshall, Jr., Edgar J. Vassallo, Caleb A. Wilkinson, J. Herbert Hyde, Manuel E. Betances, Walter W. Winand, Werner Howald, A. B. Baadsgaard, George C. Atkins, M. Keith Libby, Harold W. Bower, Orval Dickes, A. T. Hull, Edward De Laet, George J. Munz, Morgan Foshay, Malcomb L. Gavin, R. S. Houghton, Paul J. Mraz, Salvatore G. De Marco, L. H. Colburn, Hen. F. Polm, Frank Nosworthy, Bill Schumacher, L. D. Brewer, J. Wendell Partner, Paul E. Byrns, U. L. Jacobs, Fred M. Craft, R. W. Sahlbach, Ted Smith, Ned Smith, H. Mallet-Veale, Rene Arickx, L. T. Lee, Jr., Arthur Hamilton, Paul V. Trice, George Danforth, Forrest W. Dodge, Harlan E. Wykoff, L. M. Jensen, Thomas R. Dunn, Gabriel M. Costes, Roy L. Christoph, A. W. Quinn, Clayton D. Sands, M. Michaelson, E. W. Watson, A. Belanger, George L. Loke, L. F. Miller, Louis Horvath, Jr., Robert B. Hammersley, Augusto Anca, Arthur B. Coover, J. Edwin Wilson, Hank G. Wedel, R. H. Graham, Norman Smith, Maynard J. Lonis, Franz Huszar, H. H. Parker, Stuart Leland, George W. Yeager, Paul Dreibelis, George Danforth, Yvon O. Johnson, Richard Tears, Albert Augustine, Sam Tolpin, Robert Herman, Milton Prashaw, Bruce Holmgren, Eddie C. Zarn, Frank Andrews, Earl R. Roberts, James S. Nicholls, John C. Kaimbach, Jr., A. J. Umlauf, Oliver Anlie, John H. Sanders, A. B. McDonagh, Dr. Max Hausdorff, Richard Nassar, W. G. Umstead, R. Grimany.

"WESTON Instruments
 put more money in my pocket"

"My '665' Analyzer has served me for almost three years (since it was first introduced) and it's good for years to come. I don't have to buy a new analyzer for the metal tubes. That saves me a good sum. And it's the most dependable instrument. Look how WESTON designs and builds."

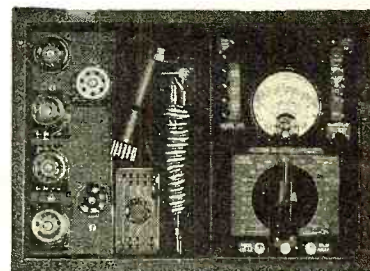

Exclusive Socket Selector—saves time—and removes obsolescence factor from the analyzer.

Quality wire-wound resistors—insure accurate readings under all temperature and humidity conditions.

The world-famed WESTON 301 Meter—sensitive and sturdy—stands the gaff and remains accurate.

Exclusive open-circuiting pin jacks—permit quick insertion of meter for current measurements, without disturbing circuit.

Full wave bridge type rectifier—accurate over wide frequency limits.

And this name WESTON is on instruments used in laboratories the world over . . . the finest procurable.

The above statement from a WESTON owner merely confirms the reports from users everywhere. WESTON Instruments cost far less because they are built to serve for years. The coupon will bring complete information.

WESTON ELECTRICAL INSTRUMENT CORPORATION
 615 Frelinghuysen Avenue, Newark, N. J.
 Send bulletin on Weston Radio Instruments.

Name.....
 Address.....
 City.....State.....



BE INDEPENDENT!

Make up to \$120 a week as a Radio Dealer!

RADIO FREE!

Have your own independent business!

• Men and women make up to \$120.00 a week in their SPARE TIME acting as exclusive PER-WAL Radio Agents. It's easy, congenial and interesting work, and leads to an established well-paying business of your own. Complete sales outfit FREE. All PerWal radios sent you on 30 days FREE TRIAL. We set you up in business!

This is a legitimate business proposition, whereby you can sell radio receivers at WHOLESALE PRICES. It's backed by a highly rated manufacturer who has spent 20 years in the radio business. Get your own 8 Tube Console Radio with World-Wide reception FREE!

TEAR OUT THIS AD NOW, write your name and address in the margin and mail to us for EXCLUSIVE PER-WAL RIGHTS.

PER-WAL
RADIO AND TELEVISION CO.
 Dept. RN-4
 166 West Jackson Boulevard
 CHICAGO, U. S. A.



RADIO PHYSICS COURSE

By **ALFRED A. GHIRARDI**

972 pages. Over 500 illustrations
856 Review Questions. Price \$4

FREE CIRCULAR

Radio & Technical Publishing Co.,
 45 Astor Place, New York. Dept. RN-46

- Please send my copy at \$4.00.
- Please send free literature.

NAME.....
 ADDRESS.....

5 METER RECEIVER

SUPER REGENERATOR WITH SUPERHET SELECTIVITY

Non-Radiating—Extremely Sensitive—Only \$24.00 in tubes.
 Write for Information

Custombuilders
 113 W. 57th St., New York City

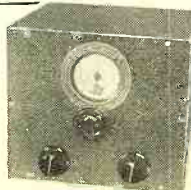

RADIO PHYSICS COURSE

ALFRED A. GHIRARDI

Lesson 51. Resonance

IF the values of inductance and capacitance in an a.c. circuit are such that the inductive reactance is equal to the capacitive reactance, then $X_L - X_C = 0$ and the formula for impedance becomes:
 $Z = \sqrt{R^2 + (X_L - X_C)^2} = \sqrt{R^2 + 0^2} = R$

This is the condition of resonance. At resonance the total opposition to the current flow is simply equal to the resistance of the circuit, and the maximum current therefore flows through it. At resonance there is neither lag nor lead. The phenomenon of resonance may be illustrated very simply by the following experiment:

Experiment: Connect a 10- or 15-microfarad condenser, a low-resistance variable inductor of at least .5 henry, and an incandescent lamp bulb all in series across a 110-volt, 60-cycle, alternating-current electric light line as shown at (A) in Figure 1. For the condenser, several ordinary 1- or 2-mfd. filter condensers of the type commonly used in radio receivers may be connected in parallel. For the inductance coil, wind from 750 to 1000 turns of No. 18 double-cotton-covered wire on a cardboard tube 3 inches in diameter and about 12

the inductance of the coil by moving the iron core in or out of the coil. At a certain position of the iron core the inductance will be such that the lamp will glow brightly, showing that the inductive reactance of the coil and the capacitive reactance of the condenser are equal and neutralizing each other as shown at (B) of Figure 1, so that the current flowing is determined only by the total ohmic resistance of the coil, lamp and condenser. If it is possible to change the frequency at this time, the lamp will grow dim, showing that resonance exists for this particular value of inductance and capacitance only at one particular frequency. If now the inductance is varied again by adjusting the iron core, the circuit may be brought to resonance at the new frequency.

The foregoing experiment illustrates the application of series electrical resonance in a circuit to adjust it for maximum current when a constant e.m.f. is applied. It is evident that the circuit could be brought to resonance for a given frequency either by varying the inductance or the capacitance or both. The process of making this adjustment is called *tuning*. In radio receivers the radio-frequency amplifier stages

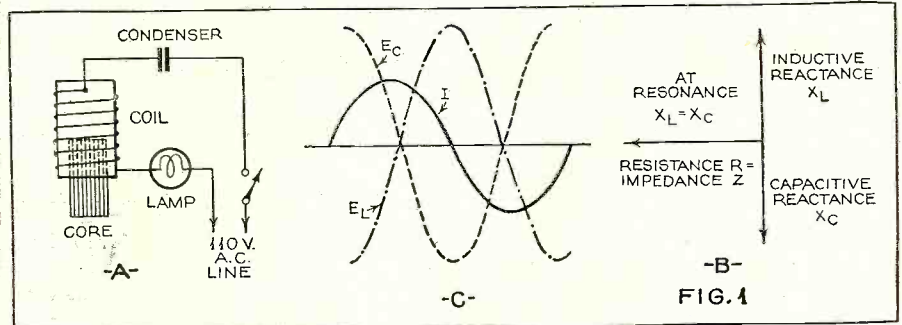

Figure 1. Effects of resonance in a series circuit.

inches long. A core of soft iron or silicon steel which just fits the tube is also used.

When either the inductance coil or the condenser are short-circuited out of the circuit by connecting a short piece of wire across their terminal, the lamp gets brighter, showing that both the inductive reactance and the capacitive reactance have been reducing the current. Now with the short-circuiting wire removed, slowly vary

are tuned to the frequency of the incoming voltage impulses of the station it is desired to hear, by turning the tuning knob or dial. This turns the rotor plates of the variable tuning condensers so as to adjust the capacitance to the proper value. The inductance is usually made fixed, although some receivers have been marketed in which the tuning capacitance was fixed and the tuning inductance was variable.

New Tube for Seeing in the Dark

(Continued from page 589)

noticeable loss in clarity. It was explained that the tube was then functioning "in the dark", entirely on "black light" or infra-red rays, which were all that could reach the tube through the filter.

The new device, which is sensitive to ultra-violet as well as infra-red rays, known as "black light," makes electrons behave exactly as light rays and marks a great advance in the use of electron lenses. Its large photoelectric cathode allows the efficient employment of large-diameter, high-power optical lenses.

The amazing similarity of the new system to optical systems was shown. The images were focused by electrostatic instead of optical means, and the produced images possessed a degree of definition quite comparable to that obtained by photography. This new electron-optical system inverts the image, as in the case of a glass-lens optical system. In the electron-image tube,

electrostatic lenses play the part of glass lenses. Focusing of the image is accomplished by varying the electrostatic lenses by means of a potentiometer, and, to carry the analogy one step further, the scientists have even corrected the tube for various distortions, just as is the lens of a camera.

The experiment has already captured the interest of experts in microscopy who see in the device a tool to extend their research in minute living organisms, which are now observable by means of intense light or stains, that often kill the germs they seek to study. By means of the new device, sensitive to infra-red rays, whose illumination reveals details of tissue and cell structure not readily viewed by visible light, it is foreseen by some that the use of stains may be obviated, and the natural development of heretofore baffling cells brought within the field of human vision.

In converse use, the electron-image tube opens the possibility of seeing through atmospheric haze, which seriously handicaps visible light by reflection from water particles but does not impose limitations in the same degree on infra-red light waves. For such use, the RCA scientists also demonstrated an "electron telescope" which makes use of the light-gathering properties of optical systems, plus the infra-red and ultra-violet favoring characteristics of the electron-image tube.

Car Radio

(Continued from page 600)

which is .5 megohms with a .1 mfd. by-pass condenser to ground. The chassis is used as a general ground for the various points so designated in the diagram. The first plate-coupling resistor is 20,000 ohms, the second and third ones are 50,000 ohms each. All of the other grid resistors are 1/4 megohm. The cathode variable resistor, for the first and second 6D6 tubes, is returned to ground for controlling volume. A 10 microfarad condenser by-passes this part of the circuit for both of these tubes.

The receiver operates very well on 135 volts B and up to 250 volts B. It is used with a 6-volt storage battery. (In fact the car battery was used in this instance.) The detector operates with 45 volts on the plate as shown. The r.f. choke can be built by winding 75 turns of No. 34 insulated wire on a wooden or glass peg (or a bakelite tube) 1/4 inch in diameter. If wood is used it should be boiled in paraffin first to exclude moisture.

Referring to the top view photograph, again, it will be noted that the first three tubes are shielded. This is not necessary to such an extent with the detector as the whole can is fitted with lids, top and bottom, which will act as a shield for this circuit. The chassis itself is connected, with four bolts, to the outside rectangular frame and if lock-washers are used, fairly good ground is obtained in this way.

Looking at the bottom view it will be seen that the resistors and condensers used in the circuit are mounted in such a way that they form the shortest path between the two points that they are to be connected to. In 5-meter work, in general, it is quite important that connections be as short as possible due to the extremely high impedance even short lengths of wire offer to frequencies of the order of 56 to 60 megacycles.

The receiver can be used with a short length of wire installed in the car roof as an antenna or it can be used with the transmitting antenna, with a switching arrangement for changing over from "transmit" to "send." Mr. Landry tells me that for DX work he gets the best results by using a steel fishing pole which he can extend out the back window when he wants to work "distance." The fishing pole can be folded up and packed away in very small space when not in use.

The receiver is operated by tuning the main dial over the band slowly with the volume control turned part way on for suitable volume while the oscillator adjustment dial is kept in position just beyond the oscillating point. It will be remembered that the autodyne circuit uses the single tube as a detector and oscillator in onc. This would not be a very efficient circuit on the higher wavelengths but on ultra-short waves, using a wide-band resistance-coupled i.f. amplifier it seems to work out quite efficiently giving great sensitivity. (Mr. Landry would be glad to have anyone write to him c/o Radio News regarding any problems or other questions of construction our readers might like to ask.)

RADIO programs have dramatized adventures of all types, but it seems that the new Mutual Broadcasting System feature based on the careers of soldiers of fortune is a rather new idea. The series stars Tex O'Reilly, a real soldier of fortune, whose thrilling adventures have taken him to all parts of the world in far from ordinary assignments. The programs, definitely aimed at male audiences (this means that the women will certainly listen in), are sponsored by the Axton-Fisher Company. The dramatic cast will be predominately male. Enoch Light's orchestra and Craig McDonnell, vocalist, share the spotlight with the adventure dramatizations.

Insulating the Control Grid of Metal Tubes

NEW YORK—The water-like phenolic insulating material which isolates the control grid from the metal tube-shell has come in for extra attention. It was found that many types of phenolic materials used here caused a noticeable reduction in the Q of the tuning coil. Engineers of the Raytheon Laboratories have carried out tests with all available insulating material which resulted in the development of a new wafer insulator which has the mechanical strength of the old types but insulating properties nearly as good as ceramic insulators.

WHEN SELECTING YOUR SERVICE-TEST EQUIPMENT

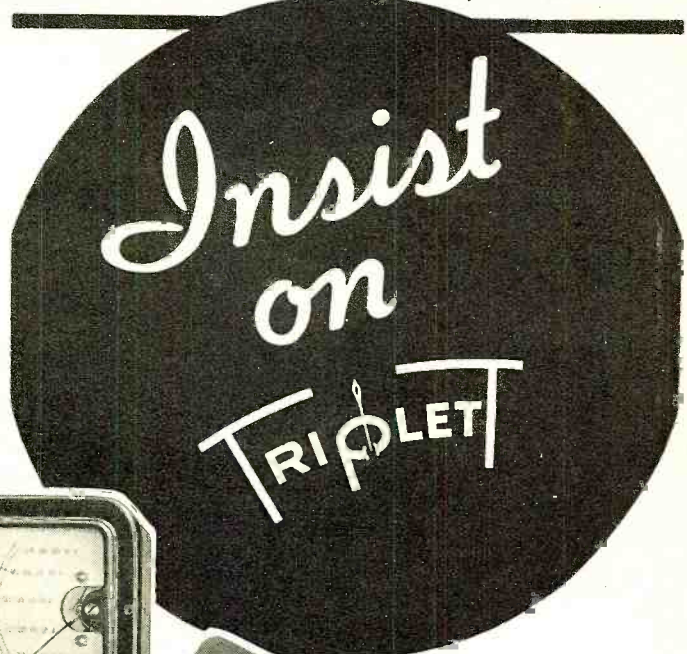

TRIPLETT TWIN. Used as standard equipment in No. 1200 Volt-Ohm Milliammeter Unit.

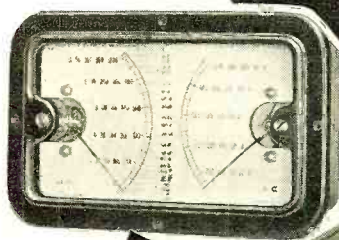

Master Unit Model 1200 Volt-Ohm Milliammeter.

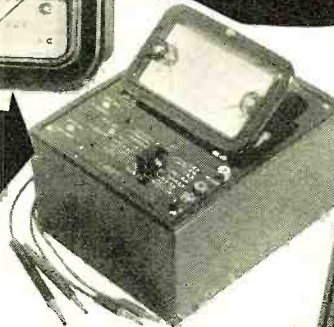

MASTER UNIT TEST SET. Model 1206

A complete servicing laboratory consisting of four separate units. Each can be purchased separately.

Model 1206 complete

Dealer Net Price—\$82.67

See your jobber



Triplet Electrical Instrument Co.
154 Harmon Drive, Bluffton, Ohio
Please send me complete information on Model 1206. Send New 1936 Catalog.
Name
Address
City

Insure Your Success for Life!

National Schools, Los Angeles, offer full instruction in Electricity, Television, Radio, Talking Pictures and Commercial and Broadcast Operating. National's all-inclusive course qualifies you for a successful, profitable future in the actively growing fields of Electricity, Radio and Television. Training meets U. S. Govt. license requirements. Earn room and board while learning. Coach R. R. fare allowed to L. A.



MAIL THIS COUPON

NATIONAL SCHOOLS—LOS ANGELES
Dept. RN-4, 4000 Figueroa St.

NAME
ADDRESS
CITY STATE

JUST STARTING

TO BUILD A NEW "RIG"?
WE STOCK ALL
RADIO EQUIPMENT
FOR TRANSMITTER
REQUIREMENTS
LICENSED RADIO AMATEURS
AT BOTH OF OUR STORES

Our catalog on request only to those living in Pennsylvania—Ohio—W. Virginia.

CAMERADIO

601-3 GRANT ST., PITTSBURGH, PA. 30 TWELFTH ST. WHEELING, W. VA.
Established 1919

RAYTHEON
4-PILLAR GLASS AND ALL-METAL RADIO TUBES

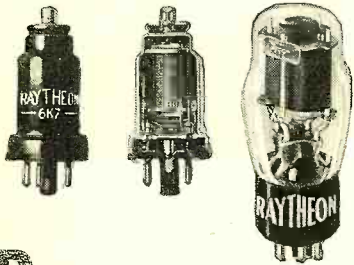

"Radio will elect the next President"

CARRY ON WITH RAYTHEON!

The Raytheon Line is complete ... 4-Pillar Glass, "G" Type and All-Metal Tubes ... Raytheon's 1936 Sales Campaign will help you sell tubes ... at a PROFIT!

Visit with Raytheon at Booth 15, in the 4th Annual National Convention and Radio Trade Show, Hotel Sherman, Chicago, Ill. March 27, 28 & 29.



TECHNICAL DATA CHART
Raytheon has distributed hundreds of thousands of the previous 8 editions. The NEW NINTH EDITION will be off the press soon! This chart gives all the important characteristics of types formerly listed; includes information on all the new tubes and other valuable reference data — it's NEW! It's UP-TO-DATE! It's FREE!

Headquarters for Tube Information

RAYTHEON PRODUCTION CORP.

- 30 EAST 42ND STREET NEW YORK, N. Y.
- 55 CHAPEL STREET NEWTON, MASS.
- 445 LAKE SHORE DRIVE CHICAGO, ILL.
- 555 HOWARD STREET SAN FRANCISCO, CAL.
- 415 PEACHTREE STREET N. E. ATLANTA, GA.

RAYTHEON PRODUCTION CORPORATION
Dept. D-2, 30 East 42nd St., New York, N. Y.

Please send NEW 9th Edition Tube Chart, FREE!

Name PLEASE PRINT

Address

City



Capt. Hall's

SHORT-WAVE PAGE

WE have at last delved into the ultra-high frequencies and are doing some patient tuning on the 28 meg. band, which, by the way, has become extremely interesting and active within the last few weeks. Although the stations heard are all experimental (or amateurs), we believe that this is an up-and-coming band. In our location we have found that best results are obtained between 9 a.m. and 3 p.m. on Sunday. We have been given to understand that the first skip on these frequencies is 2000 miles.

ONE of the best heard American amateurs operating on 10 meters is W5CBS, with CO2FA, Havana, running a close second. VP5PZ was about R7-8 whenever heard.

If you have a receiver that is capable of taking in 31.6 megs., try for W2XDV. This is the Columbia Broadcasting System's 50-watt station. Its schedule times of broadcasts are: Week days, 6 to 10 p.m., and Saturdays and Sundays, 1:30 to 6 p.m. and 7 to 10 p.m. The quality of W2XDV is excellent and there is absolutely no interference on this frequency from motors or atmospherics. More frequent announcements would be appreciated.

A powerful radio center is scheduled for construction in Igarka, in the Far North. It will be able to establish direct communication with Moscow, Yakuti and wintering stations on the Taimyr Peninsula. The center will also serve air lines and meteorological stations in the north. The number of radio broadcasting stations in the U. S. S. R. now total sixty-seven, with an aggregate capacity of 1600 kilowatts. The cities in which broadcasting stations are to be built include Alma-Ata, capital of Kazakistan, and Staninbad, capital of Tajikistan.

Harry Lange, Moscow, U. S. S. R., informs us of the time difference between here and Moscow as erroneously shown in many of the printed time charts. "Instead of Moscow being two hours earlier than London, it is three hours. When it is 8 a.m. in New York it is 1 p.m. in London and 3 p.m. in Berlin and 4 p.m. in Moscow. Another point. Please tell short-wave fans that Russia ceased to exist eighteen years ago and that this is the Union of Soviet Socialist Republics. Letters with 'Russia' on them are frequently returned to the sender. They do not like this designation at all. Heard W2XAF and W8XK. Why they want to put advertising on the short-waves for listeners living in foreign countries I cannot understand."

A letter from the Penang Wireless Society informs us that the call letters of their 49-watt short-wave broadcasting station

are ZHJ, "J" for Jubilee. The wavelength is 49.3 meters or 6080 kc. The hours of transmission are 6:40 to 8:40 a.m., E.S.T.

W2XAF, 9.53 megs., Schenectady, New York, has been very active of late. Conducting test programs from 4 to 6 p.m., E.S.T., they possibly are causing our foreign listeners considerable consternation. Between 5:45 and 6:30 p.m., W2XAF is sometimes busily engaged contacting HJU, Colombia, or PRF5, Brazil. The American station is utilizing 25 kw. power at present but expect to get up to 40 kw. some day. Reports should be addressed to General Electric Co., 1 River Road, Schenectady, New York, U. S. A.

Frank Andrews, "Round the Radio World News" commentator on KFI, Los Angeles, informs us that HRN, 5.87 megs., Tegucegalpa, Honduras, will broadcast a remote-control description of National Lottery drawings on the first Sunday of each month at 11 a.m., E.S.T. Church services are broadcast at 8:30 a.m., and of course we all listen to the "Appreciation Hour" from HRN every Sunday at 9 p.m. During this last-mentioned special letters from listeners are read and all announcements are in English.

HCJB, "The Voice of the Andes," Quito, Ecuador, now broadcasting on 8.33 megs., wants to increase their power to 1 kw. Mr. Clarence W. Jones, owner-operator, informs us: "The time has come when HCJB must have a new transmitter to replace the old one, which has been functioning nightly for four years." HCJB broadcasts four gospel messages in Spanish and one in English each night. The schedule is: Tuesday to Saturday, 7 to 10:30 p.m. HCJB broadcasts simultaneously on three waves. For South America and international reception, 36 meters; for Ecuador, 73 meters, and for Quito local reception, 308 meters!

Many listeners have recently contented themselves with the logging of the multitude of new stations that have sprung up almost overnight in South America, Mexico and the British West Indies.

HJU, owned by the National Railroads of Colombia, has been drifting from kilo-

cycle to kilocycle but did settle down on 9.10 meg. long enough to be logged. Although this station made their initial appearance before the new year, it was not until a short time ago that their signals reached listeners in the eastern portion of the United States. HJU is heard several nights a week from 8:30 to 11:30 p.m.

XEAW is the Mexican station operating on 6.02 meg. that really verifies reception reports. This station's slogan is "El Eco de Sotavento des de Vera Cruz." XEAW has been frequently heard on Sunday morning from 3 to 3:45 a.m. with special programs intended for English-speaking listeners. Their QSL card is very beautiful. Address reports to: Independencia 98, Vera Cruz, Mexico.

On 5.98 meg. from 6 to 10 p.m., HJ2ABD, Bucaramanga, Colombia, radiates an exceptionally strong signal, considering the low power employed at present. Within a few weeks their 1 kw. outfit will have arrived from the United States and then HJ2ABD will certainly go places! This station has a very original verification card.

CEC, Santiago de Chili, will verify all correct reports that are sent to: Cia. International de Radio, S. A. Calle Neuva York 52, Santiago de Chili. This station is owned and operated by a subsidiary of the International Telephone and Telegraph Co. of New York.

HH2S, 5.91 meg., Port-au-Prince, Haiti, has been heard sending several special broadcasts, between 3 and 5:30 a.m. Reports were requested to be sent to P. O. Box 103. Announcements were given in French, Spanish and English. We are still awaiting a QSL from this station for a report sent several months ago.

We wonder how many of the late (or should we say early?) dial twisters are hearing a station on 7.6 meg. whose program originates in the studios of Dr. Brinkley's station, XEAW, Mexico. Heard on Sunday mornings between 4 and 5 a.m. The signal strength is R7-8.

The well-known amateur, HI7G, informed many of his contacts that the name "Santo Domingo" no longer existed, as that city had been renamed Tuijillo in honor of the President of the Dominican Republic.

HI5X, whose "voice" is coming into the United States with startling regularity will verify reports when sent to: Walter L. Fox, Box 127, Tuijillo, R. D. Just wait until you see his extremely clever card.

NX2Z, an amateur located at Latitude 76-2 N and Longitude 19-4 W, East Greenland, was heard regularly for several days and then dropped out of the picture. Add Greenland to your list of countries heard.

THE Saturday matinees of the Metropolitan Opera Company were made available to NBC listeners this season without a sponsor. This didn't effect the quality of the programs but it did make a difference in the NBC cashier's till. However, the network capitalized on the Metropolitan in another manner. The Sherwin-Williams Company stepped in to sponsor a new series labeled "Metropolitan Auditions of the Air" which was supervised by the opera company with Edward Johnson, manager of the "Met," as a commentator. The basic idea was to bring to the public, on a Sunday schedule, a series of regular opera auditions. These auditions have always been withheld from the public. Talent heard on the series is distinctly not of the "amateur" type, the auditions being open even to professionals with merit. The auditions committee of the opera company select the most promising vocalists for the broadcast auditions.

Stability

...holds the secret of unfailing accuracy of the HIGH-FIDELITY ALL-WAVE WORLD-WIDE

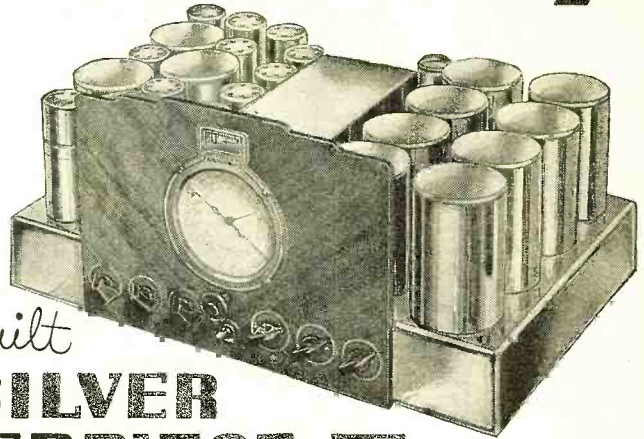

Custom Built SILVER MASTERPIECE IV

From the first moment your fingers touch the dial of a Custom-Built MASTERPIECE IV, you will marvel at its amazing flexibility... at the astonishing ease with which the calibrated controls may be adjusted for the utmost in tone perfection, selectivity, sensitivity, noise elimination and distance range. But only time and continued use can bring you a full realization of the vital difference between the MASTERPIECE IV and other all-wave receivers—that stability which is the secret of its unfailing accuracy in duplicating, at will, any previous performance without the slightest variation.

Finest Laboratory Construction

Custom-designed, custom-built, every set laboratory adjusted to the most exacting precision standards... this champion distance-getter, this superb musical instrument, brings you every worthwhile feature of advanced radio engineering—many of them exclusive in the MASTERPIECE IV. Truly, it has every right to be termed the "Rolls Royce" of Radio!

New Tube Equipment

1936 MASTERPIECE IVs are equipped with eight-pin sockets which take either the new octal-based glass or metal tubes. New 19-tube equipment gives a total of 27 separate tube functions. The MASTERPIECE IV gives you air tuning and trimming of all r.f., oscillator and

i. f. circuits—one secret of its unequalled stability and outstandingly superior performance.

New Low Prices... Easy Terms

The new perfected MASTERPIECE IV is now offered at the lowest price in its history. New, liberal time-payment plan enables you to enjoy it NOW... and pay for it out of income. Check the coupon for details.

Try it for 30 Days

Try the new MASTERPIECE IV for 30 days in your own home or laboratory, under your own reception conditions. If it fails to PROVE its ability to outperform any other all-wave receiver, at any price, return it to our laboratory undamaged and get your money back.



SEND TODAY for FREE "Blue Book of Fine Radio"

McMURDO SILVER CORPORATION
3352 N. Paulina Street, Chicago, U. S. A.

Send Free "Blue Book" giving complete specifications of MASTERPIECE IV with details of 30-DAY TRIAL.

Send details of new Budget Plan of Easy Payments.

Name.....

Address.....

City..... State.....

McMURDO SILVER CORPORATION Div. of G.P.H. Inc.
3352 N. Paulina St. Chicago, Ill.

CODE TEACHER

It's easy to learn the code with the Instructograph. Book of Instructions shows you how to study to best advantage. For Rent—on attractive terms. Rental paid may be applied toward purchase price if desired. For Sale—cash or terms. Just send post-card to—

INSTRUCTOGRAPH COMPANY, Dept. NR-4
912 Lakeside Place Chicago, Ill. Toronto

Representatives for Canada
Radio College of Canada, Ltd., 863 Bay St.

JOBBERS • SERVICEMEN

Write for FREE 1936 Catalogue!

Covering — Replacement Parts • Ham Parts • Short Wave Parts • Amplifiers and Kits • Experimenters Parts • Accessories.

BOND RADIO COMPANY
11702 Livernois Ave., Dept. 21K, Detroit Mich.

RADIO ENGINEERING

broadcasting, aviation and police radio, servicing, marine radio telegraphy and telephony, Morse telegraphy and railway accounting, taught thoroughly. Engineering course of nine months' duration equivalent to three years of college radio work. School established 1874. All expenses low. Catalog free.

Dodge's Institute, Oak St., Valparaiso, Indiana

OHMITE AMATEUR HANDBOOK

NEW RESISTOR HEADQUARTERS

24 pages of ingenious tables and charts tell how to choose voltage dividers, bleeder resistors, filament rheostats, etc., without difficult calculations or formulas. Complete data on band-switching. Price 10c from your jobber or Ohmite Mfg. Co., 4840 Flournoy St., Chicago.



AT THESE PRICES

- * Model 430 Tube Tester...\$18.00
- * Model 710-A Set Tester...\$16.50
- * Model 720-A Point-to-Point Tester \$15.00

All prices are Dealer's net.

MODEL 554-A NEW READRITE ALL-WAVE SIGNAL GENERATOR

1. Uses plug-in coils.
2. Five coils supplied covers range from 100-20,000 kc.
3. Uses 2 No. 30 tubes for perfect attenuation.
4. Calibration curves supplied with each instrument.
5. Complete with tubes, batteries and other necessary accessories.

If you want a real surprise in performance, try this Signal Generator. Compare it point for point with any Signal Generator, regardless of price.

OTHER READRITE PRODUCTS

Readrite manufactures all types of testers used for servicing radio sets, including: Oscillators, Set Testers, Tube Testers, Resistance, Continuity and Capacity Testers, Point-to-Point Testers and inexpensive Indicating Meters.



MAIL COUPON NOW!

Readrite Meter Works
415 College St., Bluffton, Ohio

I am interested in

Please send me your new 1936 Catalogue

Name.....

Address.....

City..... State.....



THE TECHNICAL REVIEW

CONDUCTED BY ROBERT HERTZBERG

Handbook of Chemistry and Physics, Twentieth Edition; Charles D. Hodgman, Editor-in-chief; Chemical Rubber Publishing Co., 1935. It seems hardly necessary to introduce the reader to this handbook, but for those who may not be acquainted with it, a review of the contents follows. One can divide the contents into three main subjects: mathematics, chemistry and physics.

The mathematical part contains a collection of formulas pertaining to algebra, geometry, trigonometry and calculus. Then there is a complete selection of mathematical tables: logarithm tables in four and five places, logarithms of the trigonometric functions. There are separate tables for angles written in the sexagesimal system, the decimal system and angles measured in radians. Then there are additional tables of the natural trigonometric functions, natural logarithms, hyperbolic functions, compound interest tables, tables of powers and roots.

The chemistry section consists of over 900 pages and it is not possible to mention all its tables. They contain several tables of the elements, tables of organic and inorganic compounds which list the names, chemical formulas, chemical and physical characteristics of compounds. Besides there are numerous other tables.

The physics section is a compilation of tables and laws of physics. So, for instance, there are tables of the coefficient of thermal expansion, of specific heat, melting point and boiling points, critical constants of gases, etc. In the electrical section one finds spark-gap voltages for different spacings of electrodes, specific inductive capacity, dielectric strength, resistivity of conductors, and many other tables. An alphabetical listing of units and laws of physics and chemistry is particularly useful.

Popular Television, by H. J. Barton Chapple, Pitman Publishing Corp., 1935. This book tells in relatively simple language how television apparatus works and what one may expect from it in the near future. It gives an explanation of different systems used in Europe and America. There are, for instance, descriptions of the image dissector tube of Farnsworth and the iconoscope of Zworykin. Several other types of scanning, using discs and mirrors, are explained. Similarly, the reader is introduced to the problems of synchronization, radio transmission, etc. The book will prove very interesting reading for the intelligent layman as well as those professionally interested, but it does not claim to be a guide to building television equipment.

Wireless Telegraphy Notes for Students, by W. E. Crook, Pitman Publishing Corp., 1935. According to the preface, the book is intended as a notebook for students who prepare themselves for the "Air License for

Wireless Telegraph Operators" in England. It is not intended as a textbook but as an accompaniment to suitable textbooks.

The book should be of value to radio operators, experimenters, amateurs and servicemen. It gives briefly the definition of units and statements of the laws of electricity, magnetism and radio circuits. The information is given without unnecessary verbiage. As one might expect, the book stresses the problems of aviation radio and gives but little attention to telephony. Chapters on direction finding and on the elimination of interference from the motor are included.

Your Invention, by Elmore B. Lyford, Radio and Technical Publishing Co., 1935. This book fills a definite need for those who have an idea or invention which they believe to be patentable but do not know how to proceed.

The author discusses the best procedure from the inception of the idea to the final granting of the patent and even beyond this, he gives advice on marketing the patent. Trademarks and copyrights are also covered in the book. The subject is covered extensively and tells the inventor all about patent searches, what is patentable, how to select a patent attorney, what it costs to get a patent, etc.

Review of Articles Appearing in the January, 1936, Issue of the Proceedings of the Institute of Radio Engineers

The Broadcast Antenna, by A. B. Chamberlain and W. B. Lodge. It is stated in this paper that the conventional broadcast antenna supported by two towers is definitely outmoded by the single vertical radiator. Data on efficiency, base voltage, base loss, practical design considerations and cost are given.

Some Comments on Broadcast Antennas, by Ralph N. Harmon. A modified antenna system is suggested which combines a high-angle suppressor with a vertical constant phase and current antenna. It is shown that the modified system cancels the high angle lobe of radiation and increases the non-fading range.

A Critical Study of the Characteristics of Broadcast Antennas as Affected by Antenna Current Distribution, by G. H. Brown. This paper examines the action of broadcast antennas with various current distributions in an endeavor to determine the combinations which are most likely to be useful.

Input Resistance of Vacuum Tubes as Ultra-High-Frequency Amplifiers, by W. R. Ferris. Tubes which require no measurable grid input power when operated at low frequencies have been found to take

serious amounts of power at ultra-high frequencies. A physical picture of the effect, a simple theoretical derivation and experimental proof with conventional tubes are given.

Analysis of the Effects of Space Charge on Grid Impedance, by D. O. North. Until recently, it has been convenient to refer to the vacuum tube as an "inertialess" device, but this term does not apply at the ultra-high frequencies. In this paper, previous theory of transit-time phenomena in high-vacuum diodes is extended and augmented to provide an explanation of the high-frequency behavior of high- μ amplifiers with parallel plane electrodes. It is shown how the theory can be applied quantitatively to many commercial tubes of cylindrical design.

Review of Contemporary Literature

Laces of Alternating Current (two parts). The Aerovox Research Worker, November and December, 1935. These articles attempt to clarify the entire theory and application of a.c. principles to readers (i.e., amateurs, service men and experimenters), with limited mathematical knowledge. Excellent review material for the man who hasn't wrestled with vectors and formulas for several years and now finds himself somewhat puzzled by commonly used networks and the like.

High-Speed Motion Pictures, by Charles T. Burke. The General Radio Experimenter, January, 1936. The study of repetitive motion in machinery at high speeds is extremely interesting. This article describes the latest Edgerton power stroboscope for taking pictures with flashes of light that last only from five to ten one-millionths of a second.

Some Measurements on Iron-Cored Tuning Coils, by K. Kascke. The Wireless Engineer (London), January, 1936. The difficulties that have so far handicapped the extensive use of iron-cored coils in Great Britain are discussed. Some new types of coils, described in this article, are expected to overcome the existing limitations.

A Sensitive Output Meter, by Frank R. Dickinson. Service, January, 1936. Description of a home-built output meter making use of the vacuum-tube voltmeter principle and intended for service work.

Crystal Filter Design, by W. W. Waltz. Radio Engineering, January, 1936. Theoretical considerations of crystal filter application, worked out from the mathematical standpoint. For engineers and students.

A Logarithmic Cathode-Ray Resonance-Curve Indicator, by S. Bagno and Martin Posner. Radio Engineering, January, 1936. An improved and more accurate method of making selectivity measurements with the aid of the cathode ray tube.

A Tube-Controlled Motor, by Paul B. King, Jr. Electronics, January, 1936. Description of a synchronous motor with electronic connection between field coils, forming a mechanically coupled, variable frequency oscillator of many interesting uses in the laboratory.

Free Bulletins

Condenser Replacement Manual

The 1936 Mallory Condenser Service and Replacement Manual is a valuable 96-page book, full of useful information. It lists replacement condensers for thousands of receivers and includes a general catalog section for reference purposes. Because of the cost of this book, it is offered free of charge only to legitimate servicemen and dealers who write their requests on

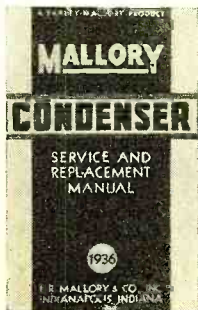

their regular letterhead or billhead. Requests should be addressed to RADIO NEWS, 461 Eighth Avenue, New York City.

"Your Future in Radio"

"Your Future in Radio" is the title of an elaborate 32-page book describing the course of technical instruction offered by the Sprayberry Academy of Radio. Copies of this fine piece of

literature are free to persons seriously interested in acquiring a modern education in every phase of radio theory and practice. Send your request to RADIO NEWS, 461 Eighth Avenue, New York City.



Radio Capacitor Catalog

A new type of condenser catalog, especially arranged for quick and easy consultation, has been brought out by Solar Manufacturing Corporation. It contains eight large pages, attractively printed throughout in black and blue. It lists a complete line of wet and dry electrolytics and paper, mica and trimmer condensers, also contains an illustrated tabulation of replacement dry electrolytic condensers for all popular receivers. To obtain a copy free, write to RADIO NEWS, 461 Eighth Avenue, New York City.

RADIO NEWS Booklet Offers Repeated

For the benefit of our new readers, we are repeating below a list of valuable technical booklets and manufacturers' catalog offers, which were described in detail in the October, November, December, 1935, and January, February and March, 1936, issues. The majority of these booklets are still available to our readers free of cost. Simply ask for them by their code designations and send your requests to RADIO NEWS, 461 Eighth Avenue, New York, N. Y. The list follows:

- O1—Dial Bulletins, issued by Crowe Name Plate & Mfg. Co. Free.
- O2—Carbon Resistor folder, published by Ohio Carbon Co. Free.
- O3—Muter Catalog of "Candohm" wire-wound resistors. Free.
- O4—Cardwell condenser catalog. Free.
- N1—Resistors folders, issued by Eric Resistor Corporation. Free.
- N2—Latest resistor catalog of Electrad, Inc. Free.
- N3—Folder on resistance bridge, issued by the Muter Company. Free.
- N4—Free code charts, offered by Dodge's Institute. Free.
- D1—Yaxley Replacement Manual. Free to servicemen and dealers, only.
- D2—Latest Sound Equipment Bulletin of Webster Co. Free.
- D3—Catalog of Resistors and Condensers, of the Aerovox Co. Free.
- D4—Free booklet on servicing instruments. Radio Products Co.
- Ja1—1936 Allied Radio Corp. Catalog—114 pages listing radio receivers, service and amateurs' parts, P.A. equipment, etc. Free.
- Ja2—Radio Parts Catalog, of Insuline Corporation of America. Free.
- Ja3—Book Circulars of Alfred A. Ghirardi. Free.
- Ja4—Latest Wholesale Radio Service Co. Catalog—listing receivers, sound equipment, amateur and service replacement parts, etc. Free.
- F1—Catalog of Radio Parts. The National Co., Inc. Free.
- Mh1—Sound Equipment catalog. Inter-World Trading Corp. Free.
- Mh2—Radio Parts catalog of Bud Radio, Inc. Free.
- Mh3—Amateur Equipment catalog of Wholesale Radio Service Co., Inc. Free.
- Mh4—Tube Tester Booklet of Supreme Instruments Corp. Free.

600 Ft. Underground

(Continued from page 589)

in the past with portable radio equipment. It is true it is rather interesting to see just what can be expected of transmission and reception with antennas located down as far as possible beneath the surface of the earth when everyone acquainted with 5-meter phenomena knows that one of the greatest benefits in aiding efficient transmission and reception at these frequencies is obtained when the antennas are as high as possible above the surface of the earth. It is rather unfortunate that further tests in the New York City tunnel will probably never be made again with more powerful transmitters and more sensitive receivers, as the tunnel is to be placed in service and will be soon carrying its load of 180 million gallons of water into lower Long Island at the rate of 1000 million gallons daily.

Learn Electricity In 3 Months at Coyne



I'll Finance Your Training

Learn to Earn \$30, \$40 and \$50 a week and up Or Go In Business For Yourself Where Many Make Up To \$5000.00 and More A Year

Are you dissatisfied with your job? Are you out of a job because you lack specialized training? Is your future uncertain? Then let me show you an amazingly easy way to get into Electricity, where there are many opportunities to make \$30-\$40-\$50 and up a week, or where many start a business of their own and make up to \$5000 a year and do it with very small capital to start. Mail the coupon today and I'll send you my big free book along with all details of my plan to help deserving fellows get a training even if they haven't got much money.

Train Now--Pay Tuition Later

My great new plan enables many students to get their training first—then pay tuition in small monthly payments—starting 5-months from the date they start school or 2-months after their required training period is over—send today for all details of this amazing plan.

Not a Correspondence School

We train you—not by correspondence—but by actual work on our mammoth outlay of actual equipment. We train you in house-wiring by having you do it as it is done outside—not just by reading about it. The same applies to armature winding, power plant operating, motor installations, automotive work and hundreds of electrical jobs. That's how we give you a practical training at Coyne.

Not Books - - Actual Work

At Coyne you "Learn by Doing"—not from books—and you can start any time. We train you to work with your head and hands on the kind of electrical apparatus you will find "out in the field." Age, lack of experience or advance education no drawback. Our students range from 16 to 40 years of age. Coyne gives you Free, a Life Scholarship which enables you to return at any time for instruction on new apparatus which we are continually adding to our course. We give you Free Lifetime Employment Service after graduation.

Earn While You Learn! Many of our students work part-time to help pay living expenses. If you need part-time work to help pay your living expenses while training, we'll do our best to get it for you.

Send Coupon Now for big Free Book and full details of my "Pay Tuition After Graduation" Plan.

COYNE ELECTRICAL SCHOOL
500 S. Paulina St., Dept. 46-81, Chicago, Ill.

SEND NOW FOR FULL DETAILS!

H. C. LEWIS, President
Coyne Electrical School, Dept. 46-81
500 S. Paulina St., Chicago, Ill.
Please send me big Free Book and details of "Pay-Tuition-After-Graduation" Plan.

Name.....
Address.....
City.....State.....
Mail in envelope or paste on a postcard

**the SUPER SKYRIDER
is COMPLETE!**

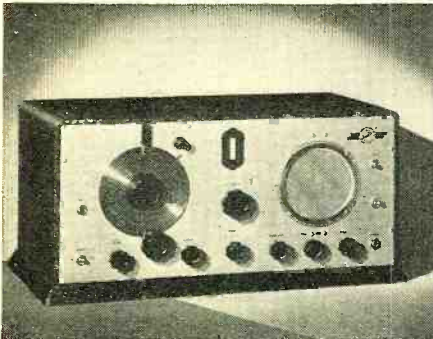

7.5 to 550 Meters Coverage

The Super Sky Rider at \$89.50 is all anyone needs for short wave reception. It covers the radio spectrum with unsurpassed efficiency including the standard broadcast band and the recently active 10 meter band.

It's modern and complete, with a convenient band switch (no cumbersome plug in coils), controlled Crystal Filter Circuit, 9 Metal Tubes with their superior performance characteristics, Built-in Speaker and Power Pack, Iron Core I.F. System—and a dozen other exclusive Hallicrafters features. For complete short wave reception, see the Super Sky Rider. It's today's radio's greatest value. Mail the coupon for complete details.

MAIL THIS COUPON

the hallicrafters

3001-V. Southport Ave., Chicago, Ill.

Please send me complete information on the 1936 Super Sky Rider and name of nearest Jobber where it can be seen.

Name.....

Address.....

City..... State.....

for PERFORMANCE

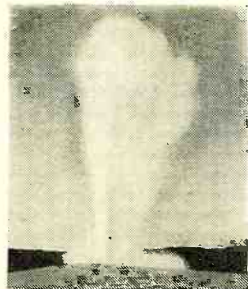

Old Faithful Geyser—
A consistent performer since the Stone Age

**AMERTRAN
TRANSFORMER PRODUCTS**

You cannot expect performance in radio reception unless you use Quality products. That is why we say there can be no substitute for quality. That is why engineers and amateurs alike prefer AmerTran transformer products when they want consistent performance in their amplifier and transmitter circuits.

If you have not already received your copy of the 32-page Audio Bulletin, we suggest that you write us immediately. It is fully illustrated and contains useful information. Ask for bulletin 1002.

**AMERICAN
TRANSFORMER COMPANY**
177 EMMET ST., NEWARK, N. J.



QRD? QRD? QRD?

CONDUCTED BY GY

WE are still receiving many requests for information as to the easiest methods of passing the U. S. Government exams for licenses and again we must say that the most practical method, although perhaps not the easiest, would be to take a course in radiotelegraphy with one of the recognized schools.

WE often wonder at the past history of many of the ops who come into the Buzzer Room of any of the locals of the ARTA. To sit there and hear the various discussions which come up would give one the impression of college education, travel sophistication or great readers of the classics. The language employed shows good English training and constant educational environment, the well-turned phrases and explicit explanations denote high regard for clear understanding. And yet with it all there is an atmosphere of something lacking which might be station-in-life, future prospects or whither-are-we-bound-from-here attitude. Of course, we cannot blame them, as their lot is one continual ship after the other, one new boss after another, and new shipmates continually. This is all right for those who are always searching for something new, something different, but there are a few who have families, folks or friends with whom they would like to remain for long stretches of time, and we wonder why is it not possible to be able to swap shore billets for seagoing berths from time to time to keep every one happy. There are men on shore duty who would like a few months at sea and who are qualified to handle a watch, and vice versa. We believe the millennium would be reached when this is accomplished and we hope that in the very near future this thought will come to those in the proper position to make this adjustment.

Through underground channels we have been advised that the ARTA is right now sitting on a powder keg in regards to a general strike. It seems that the long-shoremen out on the blue Pacific have been having some difficulty with their bosses known as the "shipping Tycoons" (apologies to whom) and are liable to call a strike which will, if all stories are straight, paralyze everything. The ops will give them support in consideration of the aid they themselves had received from the other unions; which is only fair, say we. But, what is the outcome gonna be? We hope that the boys hold off that threat-

ened imbroglio until after this goes to print, 'cause imagine our embarrassment.

A bit late, but nevertheless acceptable, we hope, is the report made by President Haddock of the ARTA to the National Convention. The progress that has been made since the first convention meeting on September 4th, 1934, is shown in an increase of membership from 1546 to 2502, or a 62% growth. Now there are sixteen full-time representatives of the Association as compared with seven at that time. And the number of men employed for organizational work is triple that of last year. As an investment, the ARTA with only the small output of \$55,829.90 for organization has netted for radio communication workers in salary increases the sum of more than one million dollars annually. The ARTA has accomplished a strong organization of radiomen, overcome the fear of losing earnings as a result of discrimination against individuals, established a definite prestige among fellow workers, and have won the admiration of employers. These are just a few of the many advantageous gains made for the previous year and Mr. Haddock feels that greater gains will be made for the present one. We hope so, is our most earnest wish.

Because every one else is doing it, we suppose that we'll also have to publish the statement made by R. R. Beal of the RCA that "Television still has a long way to go before it will be ready for general home service, and any reports that RCA is about to market television receivers is absolutely without foundation. When RCA announced its three-point development program last spring, it was estimated that it would require twelve to fifteen months to build a transmitter and a number of experimental receivers necessary to carry out the field tests. We are still engaged in that preliminary phase of the project and obviously cannot be in a position to contemplate commercial service in the near future." And "that is that," if you believe it, to all you guys who are going to be on the ground floor of this noble art of the future. Well, cul O.M.'s till the next time. 73's. GY.

The DX Corner (Broadcast Band)

(Continued from page 604)

Second Friday of Each Month		
2:00	1210	WGNV Chester Twp., N. Y. 100
2:10	1500	WGNW Brooklyn, N. Y. 100
2:20	1210	WGBB Freeport, N. Y. 100
2:30	1370	WABY Albany, N. Y. 100
2:40	1200	WNRI Newport, R. I. 100
2:50	1500	WSYB Rutland, Vt. 100
3:00	1370	KICA Clovis, N. Mex. 100
	1210	WEBQ Harrisburg, Ill. 100
3:10	1420	WACO Waco, Texas 100
	1310	WLBC Muncie, Ind. 100
3:20	760	WVW St. Louis, Mo. 100
	1500	WKBB E. Dubuque, Ill. 100
	1200	WIBX Utica, N. Y. 100
3:30	1260	KUOA Fayetteville, Ark. 100
	1370	WHDP Calumet, Mich. 100
	1420	WAGM Presque Isle, Me. 100
3:40	1310	KIUJ Santa Fe, N. Mex. 100
	1210	WJW Akron, Ohio 100
	1290	WNBZ Saranac Lake, N. Y. 100
3:50	1420	WMBH Joplin, Mo. 100
	1500	WJBK Detroit, Mich. 100
	1370	WHDO Augusta, Me. 100
4:00	1210	KIUL Garden City, Kansas 100
	1310	WCMI Ashland, Ky. 100
4:10	1420	WLBK Kansas City, Kans. 100
	1070	WCAZ Carthage, Ill. 100
4:20	1210	WMFG Hibbing, Minn. 100
	1330	WTAQ Green Bay, Wis. 100
4:30	1370	KIUP Durango, Colo. 100
	1420	WPAD Paducah, Ky. 100
4:40	1500	KNOW Austin, Texas. 100
	1310	WEMP Milwaukee, Wis. 100
4:50	1200	KGDE Fergus Falls, Minn. 100
5:00	1420	KIUN Pecos, Tex. 100
5:10	1200	KGEK Sterling, Colo. 100
5:20	1370	KMAC San Antonio, Texas 100
5:30	1200	WIL St. Louis, Mo. 100
5:40	1370	KGFG Oklahoma, City, Okla. 100

Second Saturday of Each Month		
2:00	1200	WMFR High Point, N. Car. 100
2:10	1370	WMFO Decatur, Ala. 100
2:20	1210	WSOC Charlotte, N. Car. 100
2:30	1310	WTJS Jackson, Tenn. 100
2:40	1210	WSIX Nashville, Tenn. 100
2:50	1310	WROL Knoxville, Tenn. 100
3:00	1500	KOTN Pine Bluff, Ark. 100
	560	WQAM Miami, Fla. 100
3:10	1370	KWYO Sheridan, Wyo. 100
	1310	WCLS Joliet, Ill. 100
	1420	WPRP Ponce, Porto Rico 100
3:20	1240	KGCU Mandan, N. Dak. 250
	1200	WHBY Green Bay, Wis. 100
	1290	WNEL San Juan, P. R. 500
3:30	1440	KXYZ Houston, Texas 1000
	1500	WKBV Richmond, Ind. 100
	1310	WAML Laurel, Miss. 100
3:40	1260	KRGV Weslaco, Tex. 500
	1200	WJBL Decatur, Ill. 100
	1370	WPFH Hattiesburg, Miss. 100
3:50	1500	KNEL Brady, Texas 100
	630	WGFB Evansville, Ind. 500
	1420	WEED Rocky Mount, N. Car. 100
4:00	1210	KVSO Ardmore, Okla. 100
	1310	WDFP Flint, Mich. 100
	780	KFQD Anchorage, Alaska 250
4:10	1370	KONO San Antonio, Tex. 100
	1500	WKIB Muskegon, Mich. 100
	1200	KVOS Bellingham, Wash. 100
4:20	1310	KTSM El Paso, Tex. 100
	1420	KRLC Lewiston, Idaho 100
4:30	1210	KWEA Shreveport, La. 100
	1370	KUJ Walla Walla, Wash. 100
4:40	1420	KCMC Texarkana, Ark. 100
	1500	KRNR Roseburg, Ore. 100
4:50	1210	KWTN Watertown, S. Dak. 100
	1370	KVL Seattle, Wash. 100
5:00	1420	KGFF Shawnee, Okla. 100
	1310	KIT Yakima, Wash. 100
5:10	1200	KBTM Paragould, Ark. 100
	1370	KRKO Everett, Wash. 50
5:20	1370	KPRO Longview, Tex. 100
	1310	KGEZ Kal spell, Mont. 100
5:30	1200	KFXD Nampa, Idaho 100
5:40	1310	KXRO Aberdeen, Wash. 100
5:50	1210	KGY Olympia, Wash. 100
6:00	1310	KINY Juneau, Alaska 100

A New German Transmitter

BRESLAU, GERMANY—A new station is being erected at Reichenbach in Silesia. This station will have a power of 5 kilowatts and will be synchronized with the station Gleiwitz.

Heilsberg Rebuilt

KONIGSBERG, GERMANY—The power increase of the radio station at Heilsberg has been accomplished and the station is now operating with a power of 100 kilowatts, using a special fading-reducing antenna.

- 17 WATTS UNDISTORTED OUTPUT
- SYNCHRONIZED COMPONENT PARTS
- FLOOR CRYSTAL MICROPHONE 25 FT. CABLE
- FIELD EXCITATION FURNISHED FOR 2 SPEAKERS
- SYSTEM AVAILABLE ONE OR TWO 2" SPEAKERS



MODEL PX-417

Strict Dealer Policy. Time Payment Plan. Fully Licensed.

WEBSTER-CHICAGO

manufactures a complete line of synchronized public address systems, sound equipment amplifiers and accessories of all kinds.

This equipment makes an ideal system for permanent installations in halls, churches, schools, etc., where crowds not exceeding 3,000 people are to be handled. Like all WEBSTER-CHICAGO sound systems it is completely synchronized and all parts are properly matched to deliver the ultimate in results.

Model PX-417 consists of the following units: The new WEBSTER No. 1242 dual diaphragm crystal microphone, which is unquestionably the ultimate in the diaphragm type of microphone, mounted on a floor stand with 25 feet of cable. Two No. 2601 speakers with connecting cords and cables. These speakers are 12" electro-dynamics with specially designed cones and heavy voice coils for public address systems. They have wide range reproductions to handle the amplifier range.

H.G.-417 Amplifier is a four stage advanced design using the following tubes: 1-57, 1-53, 3-2A5, 1-52Z3. Mixes two inputs. Gain at 400 cycles 105 DB. the hum level 25 DB below zero level. Tapped output transformers.

System is also available with one speaker. Can be purchased as a portable unit in carrying case.

Prices are surprisingly low. Write for details. See your jobber.

FREE "A Short Course in Sound Engineering."

Webster-Chicago is now preparing a limited edition on the above. Every sound man, jobber dealer service man will want one of these up-to-date pamphlets covering engineering and sales details. If you wish one, send in your name. Printing will be limited to those desiring this information.

The Webster Company
Section A6
3225 W. Lake St.
Chicago, Illinois

Please send me more information on Model PX-417.
Please enter my name for copy of "Sound Engineering"
Name.....
Address.....
City..... State.....



Mr. E. H. RIETZKE President, CREI



OPERATORS! AMATEURS!

WHO WISH TO BECOME ENGINEERS!

You can't "bluff" your way in Radio today! You've got to have the necessary *technical training* to cope with the more intricate developments that are occurring daily. CREI offers all ambitious, experienced Radiomen the necessary training that enables you to be a more valuable man to yourself—and to your boss. That's why radio engineering will pay you rich dividends.

PRACTICAL RADIO ENGINEERING

Many leading radio men owe their success to CREI. A thorough home study course that covers every phase of Radio Engineering. Well-balanced in essential mathematics... theory... practice... and practical engineering problems. For EXPERIENCED radiomen who realize that training is not only important but NECESSARY!

New 48-Page Illustrated Booklet

FREE!

Right now—WRITE NOW for this interesting catalog that tells pictures and describes our courses, school, faculty and equipment. Yours for the asking.

SERVICE AND PUBLIC ADDRESS ENGINEERING

A newly developed course... not for beginners, but for the better type of serviceman who sees the need for Technical Training. Practical right from the beginning and priced within reach of all. Teaches theory plus the principles of design, so that the TRAINED serviceman does better work in less time and earns more.

CAPITOL RADIO ENGINEER NG INSTITUTE

14th and Park Road Dept. RN-4 Washington, D. C.



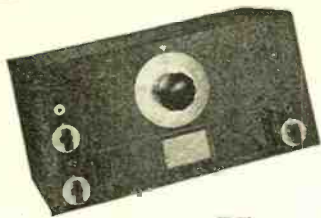

New!
HRO JUNIOR
Communications Type
SUPERHETERODYNE

For those who have coveted the superlative performance of the communications-type HRO receiver, but who do not require its extreme versatility, a Junior model is offered. The circuit details of both receivers are identical in every respect, but the lower priced model has been greatly simplified by omitting the crystal filter and the S-meter, and by designing coils for "continuous bandspread" only.

Although these omissions do not greatly restrict its usefulness, they make it possible to price the HRO Junior at a very attractive figure.

Whether your interest is in international broadcasts or in amateur communications, we believe you will find these remarkable receivers ideally suited to your needs. The coupon below will bring an illustrated description of both.

NATIONAL COMPANY, INC.,
Malden, Mass.

Gentlemen: Please send me your descriptive folder on the Standard HRO and the HRO Junior.

Name

Address

R.N.-4-36



The RADIO WORKSHOP

Items of interest for beginners, experimenters and radio constructors.

Conducted by The Associate Editor

Concrete Foundation for My Antenna Mast

The irresistible urge to try something different, especially in the way of antennas, is one of the principal characteristics of the radio amateur.

In order to facilitate a quick change-over to different type aerial systems when experimenting with antennas, I rigged up a mounting for my antenna mast as illustrated in the accompanying diagram A, B. A cube of concrete, measuring 2 feet in each dimension, is embedded in the earth with the top surface level with the ground. This block contains three 1-inch iron eye-bolts about one foot long. The mast is mounted on a wood block 18 inches square

once it is in the vertical position it will not fall over in the opposite direction as is usually the case when a wood mast is buried in the earth.

The mast described in the May, 1935, issue of RADIO NEWS, page 666, is excellent for use with this mounting. The usual precautions as to guying, etc., should be observed.

HARRY D. HOOTON,
Beech Hill, West Va.

Improving the Output Stage in the Browning 35

The type 6B5 tube proves an excellent output tube for receivers which employ a single 42 in the power stage. In order to change over from the 42 to the 6B5, all that is necessary is to short circuit the bias resistor. The drain on the power supply is practically the same and the replacement

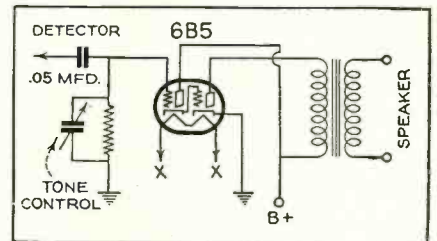

tube requires the same output impedance as the type 42. The result is better quality and higher output (4 watts). This change has been tried on a Browning 35 receiver and found to work very satisfactorily and can of course, be used with equal success in other receivers that use the type 42.

JOHN BORST,
New York, N. Y.

An Electronic Interrupter

An interesting application of a vacuum tube is shown in the accompanying drawing, in which a regenerative circuit with grid-leak omitted, is utilized to operate a relay which in turn operates its secondary circuit periodically. The rate at which the circuit is interrupted is regulated by the tuning condenser of the oscillator and of course is limited by the sensitivity of the relay. The amount of amplification depends on the relay as well as on the type of tube used. Using the 30 tube, with two stages of transformer-coupled amplification, I had sufficient power to operate a relay, rated at 3 ma. at 3 volts, over a variety of speeds. The tuning unit may be from an old broadcast receiver or made

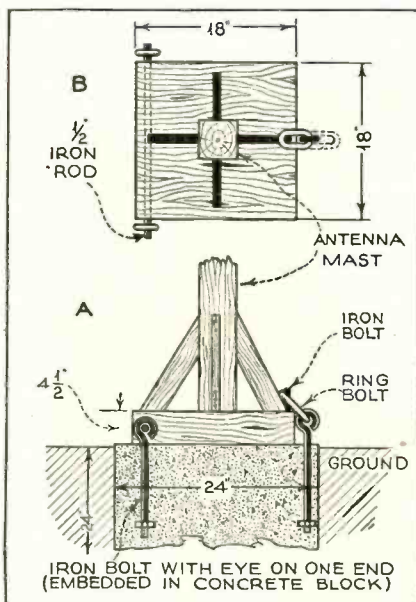

by 4½ inches thick and is securely held in place by four 2- by 4-inch braces. A hole is bored through one end of the block and a ½-inch steel rod 2 feet long is placed in this hole, the ends protruding to form "hinges" when used in conjunction with the eye-bolts as shown. A short bolt or rod is placed in the center at the opposite side and with the ring-bolt locks the mast in the vertical position.

The chief advantage gained by the use of this mounting is the ease with which the mast can be raised or lowered. One man, with the help of a long ladder, can easily raise a 20- or 30-foot support, and

up of some similar combination of apparatus that will cause the tube to "motorboat" when in a circuit of this sort.

This apparatus may be used for flashing signals, for operating ratchet movements

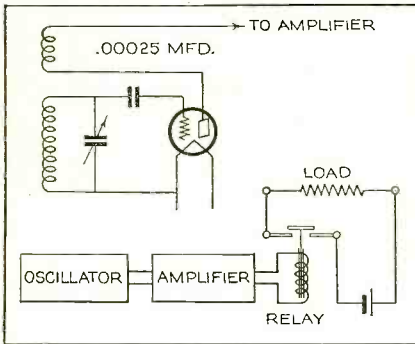

in place of the customary motor-driven cam or in any circuit where an intermittent current is desired.

JOHN W. DEELEY,
Springfield, Mass.

New Low-Loss Amateur Tube

A type 10 tube with a low-loss ceramic base is now being produced by the Hygrade Sylvania Corp. The standard type 10, with bakelite base, has often proved unsatisfactory for high-frequency work,



due to r.f. losses through the base. The use of a ceramic base should reduce the losses to a negligible factor and the tube should be particularly valuable for amateur use. The operating conditions and characteristics of the new tube are the same as the standard type 10.

Home-Made Bone Conductor

Having been so successful in converting my hearing-aid earpiece to bone conduction with improved volume and better tone for my particular hearing loss, I am taking this opportunity to pass the idea on to others who are hard of hearing.

To make this home-made bone conductor, simply take a single headphone

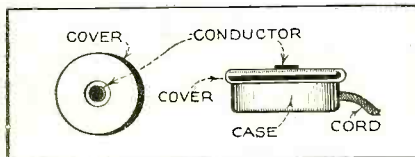

(matched, of course, to the hearing aid) and scrape off the enamel from the center of the diaphragm. Next, solder a small piece of iron or copper rod approximately $\frac{3}{16}$ or $\frac{1}{4}$ inch in diameter by about $\frac{1}{4}$ inch in height so that it just protrudes above the earpiece cover, and can be set against the bone back of the ear.

J. WILLIAM DAY, JR.,
Daytona Beach, Fla.

Frequency Drift in Receivers

I agree with Mr. Hertzberg (page 720, RADIO NEWS, May, 1935) that much so-called "fading" of signals is due to temperature changes inside of the receiving set.

I have serviced two or three short-wave supers in which this trouble was very bad and the following observations should be of interest.

First let us see how a small change in frequency of the oscillator will affect the output. Suppose we have a signal of 6000 kc. which does not vary; our intermediate amplifier is tuned to 456 kc. Let us assume that the local oscillator changes its frequency by $1\frac{1}{2}$ per cent. (One and one-half per cent of 6456 kc. (the frequency at which the oscillator must be set in order to receive the 6000 kc. signal) is 96.84 kc. Since the beat frequency will change by the same amount as that of the oscillator the change will be 96.84 kc. out of 456 kc. or over 20 percent.

If the super has any selectivity at all, this frequency shift would be enough to tune out the signal altogether. However, most oscillators are not likely to change as much as $1\frac{1}{2}$ percent unless the set has been poorly designed. Yet, as the above explanation shows, even a very small change will cause considerable fading.

I find that there are two chief causes for drifting both very difficult to remedy after the set is built. One is lack of stability in the oscillator; the other is poor design and placement of parts. Lack of stability may be caused by losses in the oscillator circuit, a poor tube, not enough voltage or, as is usually the case, too low resistances in the plate and grid circuits. In one of the supers mentioned above I improved the stability considerably by using a 50 mmfd. grid condenser in the oscillator and by making the grid resistor as high as possible, consistent with absence of blocking. Both of these sets were poorly designed; the builder had placed the two 45 tubes rather close to the oscillator section of the tuning condenser. Result: the heat from the tubes caused the condenser plates to expand, detuning the oscillator. Stations tuned in at good volume began to fade after 15 or 20 minutes until they could no longer be heard. I could hardly change the design of the set, so I did the next best thing: I let the set warm up for about 20 minutes and then adjusted the oscillator and intermediate amplifier for maximum performance and from then on obtained stable operating conditions.

When building a new super, pay particular attention to the layout of the parts, keeping all tubes a good distance from the oscillator tuning condenser. If you have a set already in use and experience frequency drift, try adjusting the trimmer on the oscillator section of the tuning condenser after the set has had time to warm up.

HARRY D. HOOTON,
Beech Hill, W. Va.

Ribbon Microphone

The latest Universal ribbon or velocity type microphone measuring only $4\frac{3}{4}$ by $2\frac{3}{4}$ by 1 inch in thickness is applicable to all-around radio use, including P.A. work, broadcast studios, amateur activities, etc.

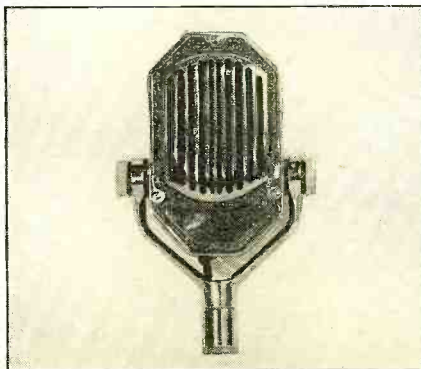

Learn RADIO from REAL RADIO ENGINEERS!



Kendall Clough
Chief Engineer,
Clough-Bremde Co.
E. E. Gramer
Chief Engineer,
Standard Transformer Co.
Karl E. Hassel
Chief Engineer,
Zenith Radio Corp.
H. C. Yitko
Chief Radio Engineer,
Grunow Radio
F. D. Whitten
Service Manager, Philco
Radio & Television Corp.
Dr. C. M. Blackburn
Radio Engineer,
P. R. Mallory & Co.

**Train Now at Home
for Good Pay. Spare-
Time and Full Time
Jobs that Pay up to**

\$ 75 a week

If you're dissatisfied with small pay—and an uncertain future—here's an opportunity that's too good to miss. Get my big FREE book, "RADIO'S FUTURE AND YOURS." This book tells how you can learn at home under the supervision of factory engineers, to make more money almost at once in Radio—how to make Radio your life's work, or use it to pick up \$5 to \$20 a week extra in your spare time.

MORE OPPORTUNITIES THAN EVER BEFORE

Radio is still forging ahead. 1935 was its biggest year. Over 3 million new sets sold. Over 30 million dollars paid for service alone in 1935. Where only a few hundred men were employed a short time ago, thousands are employed today. And where a hundred jobs paid up to \$75 a week—there are thousands of such jobs today—many paying even more. New full time jobs and spare time jobs are being created all the time. Get my book and see how easy you can get started.

"SHOP TRAINING" FOR THE HOME

R-T-I Training is different. It comes to you right from the heart of the Radio Industry—right out of the factories where Radio sets and other vacuum-tube devices are made. It was planned and prepared and is supervised by big radio engineers IN these factories—by men appointed for the purpose. R-T-I will train you as the Radio Industry wants you trained.

TELEVISION, PHOTO ELECTRIC CELLS, PUBLIC ADDRESS SYSTEMS INCLUDED

Radio service work is plentiful but it's only the starting point in R-T-I Training. From there you'll go through the whole field of Radio and Electronics. You will learn about every new development, including Television

MAKES \$600 IN ONE MONTH

Herbert B. Thomson, Gorman, Texas, started making money with 12 lessons finished. He says, "Because of my R-T-I Training I made \$450 in September and over \$600 in October 1935. I pay to be R-T-I Trained."

so you'll be ready when Television breaks. You'll also learn the big money subjects such as Aviation and Auto Radio; Public Address Systems; how to handle Photo Cells; Sound Picture Recording, Etc.

BIG MONEY IN AUTO AND POLICE RADIO WORK

W. H. Carr, 402 N. 16th St., Kansas City, Kans., R-T-I student, has charge of 35 radio equipped Police and Fire Department cars. He gets \$200.00 a month and free auto, gas, oil, etc. He says, "If I had not taken your course I would not be able to hold this job!"

4 WORKING OUTFITS FURNISHED

Start almost at once doing part time radio work. I furnish 4 outfits of apparatus that you build into test equipment with which you can do actual jobs and earn extra money. My Training pays its own way, and you get your money back if not satisfied. Age or lack of experience is no handicap.

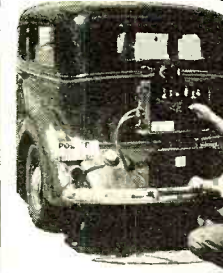

FREE BOOK

Find out why R-T-I Trained men get "Quick Results" and "Big Results." Send for "Radio's Future and Yours" today. It tells about Radio's amazing opportunities. It describes my approved training—what R.T.I. students are doing and making. It gives the names of 50 firms who endorse and recommend R-T-I. It's FREE.

Ray D. Smith
President Radio and Television Institute

Dept. 44, 2150 Lawrence Ave., Chicago

MAIL COUPON FOR FREE BOOK

RAY D. SMITH, President
Radio and Television Institute (R-T-I)
2150 Lawrence Ave., Dept. 44
Chicago, Ill.

Without obligating me, send FREE Book about spare-time and full-time Radio opportunities and how I can train for them at home.

Name.....
Address.....
City..... State.....

**GREAT PLANS AHEAD FOR
NATIONAL UNION RADIO
SPECIALISTS! TIE UP NOW!**

QUALITY MERCHANDISE

FREE INSTRUMENTS

BUSINESS BUILDERS

CHARTS · DATA

GET DETAILS NOW!



**NATIONAL UNION RADIO CORP. of N. Y.
570 Lexington Avenue, New York, N. Y.**

Send circular telling me what I can
get from National Union and where!

Name _____
Street _____
City _____ State _____

The "Ham" Shack

(Continued from page 597)

the plate of the frequency multiplier; the 75-meter coils are plugged in in the remaining three circuits. A similar procedure to that for 1800-kc. operation is followed for putting the transmitter on 7100; and the doubling procedure for 14,200-kilocycle operation. To operate the transmitter on 10 meters, everything is the same as for 20 meters, excepting the final tank coil, which uses the final amplifier as a doubler. This arrangement is not as efficient as exciting the final amplifier at 28 megacycles, but will give adequate output for reliable work at this frequency. As a matter of fact with slightly more than 130 watts input more than 70 watts output was obtained.

This transmitter is cited to show what may be done with some old equipment and a few new ideas. The tubes used are not new; many of them have been the standard of many years. However, during the last year a number of new tubes have been introduced that offer lots of food for thought for the amateur contemplating modernizing his transmitter. For instance, there are the 802, RK24 and RK25, the RK28 and the 803. These tubes are pentodes of different power ratings, and offer even greater flexibility in transmitter layout. The higher powered ones require small amounts of excitation, thus reducing the number of tubes needed for all band operation and provide for suppressor grid modulation at reduced outputs. For example, the 53 unit such as used in the transmitter above will provide enough driving power for either an RK28 or 803, giving C.W. outputs of about 200 watts.

The experimental amateur prefers to have his transmitter mounted breadboard fashion so he may get at the various components and make changes. Breadboard construction can be made to look neat if a little care is used. A method of construction where meters are mounted on a small panel and by-pass condensers and resistors hidden under the "board" can be made to appear pleasing to the eye. For the man who likes a "commercial job" there are now available a number of types of relay-racks. Also there are metal bases or blank chassis, panels and a variety of fixtures. Cost of such equipment has been greatly reduced in the last year, so that it is possible to obtain an excellent frame and the trimmings for the average medium powered transmitter for about \$25. For the man who is looking for appearance, this is a small amount. For those who do not want to invest so much in a mechanical feature, an excellent substitute may be made from wood—using 2 by 4s for uprights, etc.

Next we have the receiver. The man who "rolls his own" is perhaps in a better position to modernize, but whether it be a home-made job, or a commercial model, there is nothing like a good over-hauling to put a set back into shape. The modern super-heterodyne can get out of adjustment without it being noticed by the operator, except possibly by increased interference. Regardless what kind of receiver you have, now is the time to give it a good servicing. Borrow an oscillator if you haven't already got one and tune it up from antenna stage through intermediate frequency to detector. It will be surprising to see how some receivers can get out of adjustment, particularly those with compression type trimmers in the i.f. stages.

The procedure for realigning a set is simple and perhaps known to most "hams." A good oscillator with modulator and out-

put meter should be obtained. The i.f. should be aligned first. This is done by tuning the calibrated oscillator to the i.f. frequency and connect the output to the grid of the first detector or converter tube. Then merely adjust all i.f. circuits for maximum output on the output meter. If a crystal filter is used, a great deal more care is necessary. It is essential to have the i.f. stages tuned to crystal frequency in order to get the most out of the filter. Attenuation of the test oscillator through the crystal circuit may be used in determining this frequency. The crystal also may be put in an oscillatory circuit to determine its oscillating frequency. However, as a warning, this method is not advised except only to approximate the crystal filter frequency because a crystal in an oscillatory circuit will operate at a difference frequency than when the same crystal is used in a filter circuit. There may be as much as five kilocycles difference.

After the i.f. is aligned, the pre-selector stage, the first detector and oscillator circuits should be checked. For this purpose the output of the oscillator should be connected to the antenna terminal of the receiver. The frequency of the oscillator then is set for each band, the receiver covers, and adjustments made in the trimmers to obtain the greatest output.

Now about renovating the receiver. Perhaps one of the most important innovations in the last year was the introduction of the iron core intermediate frequency transformer. This unit offers tremendous possibilities to the ham. With these units it is possible to greatly decouple circuits affording greatly improved selectivity with little sacrifice in sensitivity. The inherent feature of such transformers is the high gain afforded, thus making possible less coupling with proportionally the same output as with air core transformers. Of course, this added selectivity is not what the short wave or broadcast listener wants, but it is ideal for ham practice. With such arrangements it is possible to peak the middle 1,000 cycles of a signal quite sharply, so that the interference of signals on adjacent channels is reduced. This is effective in phone work, where frequencies above 1,000 cycles are not necessary to the intelligibility of the voice, although if the same unit were used for aural broadcasting, the quality would be pronounced as "bad" because of the chopping of side bands. However, this does not mean that iron core transformers may not be used for broadcast reception, as it is possible with tighter coupling to obtain the necessary broad tuning to give adequate frequency response.

Another important feature of the receiver is the antenna. This is too often neglected. Frequently, a small antenna is used, which is adequate for local reception on the lower frequencies, or a long antenna is used which has the unfortunate ability to pick up interference from every conceivable type of electrical appliance and automobiles. Why not put up a good doublet for reception? It will greatly reduce man-made interference and give better reception on weaker signals. We have pointed out before the value of a good antenna in these columns. Briefly, the sensitivity of a receiver is limited only by the inherent noise input in the first tube of the set. Therefore, by tuning the antenna circuit or using one that is designed for a given frequency, the input voltage of a weak signal to the grid of the first tube may be increased beyond the input level to the same grid of the "rush" resulting in greater sensitivity. This, of course, improves reception. Also, it will be found that a doublet helps selectivity, particularly if regeneration is used in the radio frequency amplifier stage.

There are a number of different types of doublet antennas available for reception. Most of these use twisted pair feeders. The one important thing to remember is to match the line with the input of the receiver. A twisted pair normally has an impedance of about 70 ohms, while the input circuit of most receivers is between 300 and 500 ohms. Therefore, it is necessary to use a transformer to obtain the proper match. A direct line match may be obtained by using parallel feeders such as those used for transmitting with from four to six inch spacing. The impedance will vary in proportion to the spacing and the size of the wire used. Six inch spacing with number 12 wire will give about 600 ohms. Transposed feeders using any of the standard blocks will give a line of about 400 ohms. Such lines may be fed directly to the input of the receiver without a matching transformer.

These are merely some ideas on antennas, transmitters and receivers which it is hoped will provide food for thought for the "ham" preparing for rebuilding and over-hauling this spring and summer.

Calls Heard

By Wheeler T. Thompson, Betty Lewis Apartments, Fredericksburg, Va., on 20 meter 'phone:

DESIGNED FOR SET BUILDER PUBLIC ADDRESS SYSTEM AND
SERVICE MAN STOP LARGE SAFETY FACTOR STOP UTAH REPLACEMENT TRANSFORMERS CHOKES STAY REPLACED STOP SEND
FOR DETAILS

UTAH RADIO PRODUCTS CO.

TEAR OUT THIS AD—PIN TO YOUR LETTERHEAD AND MAIL TO DEPT. R. N.
FOR COMPLETE DETAILS AND FREE CATALOG

URPC 820 TWS—CHICAGO ILL.



"AN HOUR A DAY WITH RIDER"

Want to Know What That Is?

ASK YOUR JOBBER ABOUT IT

JOHN F. RIDER, Publisher
1440 B'way., New York, N. Y.

CORWICO

NOISE MASTER
ANTI-WAVE ANTENNA

For quiet, noise-free reception (both shortwave and broadcast) have a "NOISE-MASTER" installed by a qualified service man. Stick to antenna products designed by specialists! Complete literature on request.

List Price **\$6.75**

CORNISH WIRE CO., Inc.
30 Church Street, New York City

Ken-Rad
Radio Tubes

THE KEN-RAD CORP., Inc., Owensboro, Ky.

ECONOMY CODE MACHINE--\$12

Learn code easily, at your convenience—and economically. Famous Instructograph principle. Complete with choice of 5 tapes, and Book of Instructions. Delivered postpaid anywhere in U. S. A. Send postcard for full details.

Instructograph Co., Dept. NR. 2.
912 Lakeside Place Chicago, Ill.

Be a TELEVISION EXPERT

LEARN TELEVISION with RADIO—NOW!

Fine opportunity for experts in this amazing new industry. A NEW business in a NEW era offers NEW opportunities for big salaries! You learn Radio and Television from beginning to end in our marvelously equipped labs and studios. You actually operate thousands of dollars worth of expensive equipment. You get expert instruction and skillful guidance by radio-television specialists.

Demand for Television Experts

Television now perfected and ready for the market ON THE NEXT BIG BUYING WAVE. Business leaders predict new system television will require thousands of relay and broadcasting stations. Ultra-short waves will permit eighty thousand television stations in America alone.

GET IN NOW and "build up" with the world's next billion-dollar industry.

6 MONTHS THOROUGH, PRACTICAL TRAINING

Qualifies for radio-phonograph license (1st Class). Complete up-to-the-minute training on modern "workable" television equipment including the new cathode-ray. Practical experience in studio, control room. Transmitter operation of Television Station W9XAL. Employment and while training and upon graduation. Write for free book "Pictures On The Air" NOW!

FREE FOLDER

S. Q. NOEL, Pres. First National Television, Inc.
Dept. D-4 Power & Light Bldg., Kansas City, Mo.

Without obligation, send me postpaid FREE Illustrated Folder "Pictures On The Air", telling about new opportunities in television. I am 17 years or older.

Name _____
Address _____

VE3FW, VE2VE, VE1CW, K4SA, X1U, OA1B, CO4QY, CO2AN, CO2WZ, CO2SV, G2GF, VE4GO, VE1CO, VE2AP, X1G, VE4LL, K6BAZ, H17D, H17G, CO2HY, F8DR, VT2CD, K4VGH, HP1A, CO2RA, T13AV.

On 40 meter phone: LU5CZ.
By N. C. Smith, Forge House, High Street, Footh Cray, Sidcup, Kent, England, on 20 meter phone: W3BFH, W3MD, F8DR, VP9O, W8NQC, W3EOZ, W1CTZ, W8HFW, LU1EX, OK3VA, LA1G, SU1CH, W9DTB, W3EHY, LU9EA, W4AGX, K4DDH, W1HCM, W1IMG, VE2HK, K4SA.

On 20 meter C.W.: YU7QA, YM4AF, U3JE, FM8CR, U4AG, SU5NK, ZB1H, VK3KP, LU4DQ, SU1KG, CE7AA, K5AF, HB9J, VQ4CRM, W8DHC, FT4AF, VE1IW, VK2HF, ZL2CI, VK2PV, VK5WK, ZL4BT, VK2IK, VK2IP, VK2EL, VK2VQ, VK3MR, W9FM, CX1CG, W1BXC, LU1EP, VE1HG, U2NE, W3EAH, W2CNJ, W2DTB, VP2BX, W4YC, W2MJ, W3HN, PY9AH, W8LIR, W6CXW, W2CJX, W2IKZ, CE3CR, W2MB, W3BKZ, W9JFB, W1AQT, VE1EP.

On 40 meter C.W.: HB9M, U3DI, EA1AM, OA2RS, W8CNZ, W5EHM, SP1IG, W1ZZC, ZL2LB, Y1ITW, OH1NW, OZ5P, OK1KM, ZL3BJ, LA1R, LU1AB, SM5UM, YU7QA, U3VL, W3ENB, W3ABT, W1FPL, W2HNR, W1DUK, W2DOB, W1HRJ, W2EVI, W1HGJ, W8OE, W2EYB, W9FM, W8GQB, W9TB, VE2QD, LA4U, W3SI, SM7UR.

On 40 meter phone: HB9AY, CT1JW, CT11P, CT1HR, EA4AK, EA5BS.

By Harry Wolf, Camp VERDE, Ariz., on 20 meter phone: W1B1Q, W1KK, W2BIT, W2BSD, W2BYP, W2CRT, W2EUG, W2GG, W2FHS, W2HVI, W2ICU, W2UG, W2UK, W3ABF, W3APA, W3BFH, W3FEU, W3RA, W4AXO, W4ALG, W4BX, W4CAF, W4COG, W4EF, W4FK, W4UP, W4YC, W5AFK, W5AHJ, W5AKI, W5AOP, W5AXA, W5ANU, W5BEE, W5BDB, W5BGT, W5CEL, W5DLC, W5DNV, W5DRR, W5EBP, W5EDX, W5FJ, W5GLC, W5SF, W5UN, W6BOY, W6BUY, W6BWF, W6BWZ, W6FAH, W6EFR, W6ETX, W6FOX, W6FZI, W6FZR, W6HCE, W6LRO, W6MVR, W6UT, W7ABH, W7AF, W7AFD, W7APD, W7BCL, W7BI, W7BFS, W7FD, W7FP, W8BOL, W8CVO, W8DHD, W8DLD, W8DFU, W8HAF, W8HEO, W9A1K, W9ARK, W9AWJ, W9AS, W9BEZ, W9BIY, W9BTP, W9BXC, W9CFE, W9CPM, W9CUP, W9DEF, W9DG, W9GFO, W9JZA, W9LVJ, W9NGL, W9NTY, W9NGZ, W9OKA, W9OTP, W9PDI, W9PIL, W9PIV, W9PTC, W9RUK, W9RUW, W9SGM, W9TPC, W9VPM, W9ZD, CO2HY, CO2SE, CO8YB, H15X, K6LJB, CA, VE3BK, VE3PA, VE4CY, VE4NI, VE5DK, VE3VH, VF9BE, X1G, X1AJ, X2CK, X2FM.

On 75 meter phone: W6ABY, W6AGJ, W6ANU, W6ATX, W6AVN, W6BGL, W6BMD, W6BPV, W6BUY, W6BY, W6COG, W6CNA, W6CRX, W6DTX, W6EAN, W6EFR, W6ELW, W6ETE, W6FGO, W6GZU, W6HAR, W6HBY, W6HCL, W6HLT, W6HOE, W6HUX, W6JCI, W6JFO, W6JIW, W6JY, W6JRD, W6KCE, W6KMC, W6KMD, W6KSE, W6LKG, W6MNL, W6QF, W6TO, W5AOT, W5CA, W5CD, W5CPC, W5DUM, W5FAP, W7BJS, W7COO, W8CSN, W8JKA, W9BFT, W9BXC, W9EYV, W9KOU, W9MGV, W9NMH, W9OKA.

By Aram Ishkanian, Radio House, Elwi St., Cairo, Egypt, on 20 meter phone: W9LD, W2HFS, W2AEB, W2AMD, W3BFH, W2AM, W5BDB, W5ZA.

RADIO NEWS Sponsors New Opportunity for Code Practice at Home

RADIO NEWS takes pleasure in publishing the following schedule of code transmissions in the United States especially for those who wish to learn the code over the air. All one has to do is to tune in to the proper frequency as specified at the proper time and day and start copying the special code transmissions for practice. A daily schedule is given for the present month (beginning March 1st and ending April 1st). In the first column is the time (a.m. or p.m.); in the second column are the symbols, E, C, M and P (where E is used for E.S.T., C for C.S.T., M for M.S.T. and P for P.S.T.); in the third column are the call letters of the transmitters of amateur members of the Guild and the fourth column contains the frequencies of transmission in all cases, except where otherwise noted. Each CSCG transmitting station will begin his program at stated time by sending "CSG" 6 times, followed by his station call repeated 3 times, slowly. At intervals of 5 minutes, he will repeat "CSG" 6 times and his call letters 3 times. All who listen to CSCG programs are requested to write a card to the transmitting station telling him how his signals come in and, if possible, sending him copies of transmissions.

MONDAY

8:30 A.	E.	WIAMH	56,100-3536 1/2
10:00 A.	E.	W3AEJ	3785
4:00 P.	E.	N1FNM	3510
5:00 P.	P.	W7WE	3637-7274
6:00 P.	E.	N1DUZ	3638
6:00 P.	E.	W8MHE	3830
6:00 P.	E.	W8EZ	3598
6:30 P.	C.	W9LKK!	3757
6:30 P.	E.	W2HCP	3786
7:00 P.	E.	W3AEJ	3783
7:00 P.	C.	W9SFT	3855

LOW PRICE Precision Instruments

All-Wave Signal Generator



MODEL 82—net \$19.90

EVERY MODERN FEATURE: Large direct reading 8 1/2-inch dial—all-wave continuously variable from 90 kc to 20 Mc—long life self-contained batteries—new type "Band-Spread" tuning with 6 separate inductors—triple shielding—ladder-type constant impedance attenuator—modulated, unmodulated, and 400-cycle audio outputs—employs 2 type '30 tubes in separate audio and radio frequency generating circuits. Write for full description of this and the 2 other C-B r-f signal generators.

Point-to-Point Analyzer



MODEL 85 UNIMETER \$24.90

A low cost set analyzer and all-purpose component tester with a big, easy-to-read 5-inch fan-type meter. Ranges: 0-15-150-750 v d.c. and a.c., 0-1.5-15-150 ma d.c., and ohms scales 0-100, 0-20,000, and 0-2 meg. Low ohms range is new shunt type with maximum battery drain only 2.5 ma. Hand calibrated in the C-B Standardization Laboratory. Write for new bulletin.

See This Modern Equipment at your CLOUGH-BREngle Jobber

MODEL CRA Cathode-Ray Oscilloscope, net \$84.50
 MODEL OM Frequency Modulated R-f Signal Generator (built-in r-f sweep unit), net..... 57.75
 MODEL 79 Beat-Note Audio Oscillator, net 51.90
 MODEL OC Precision R-f Signal Generator, net 32.90
 MODEL UC Vacuum-Tube Voltmeter, net 34.85
 MODEL UD Power Level Indicator, net 24.60

Complete description of the full C-B line may be secured from your jobber, or write the factory.

Write Today for Complete Literature



Enclose 25c if a copy of "Cathode-Ray Testing and Analysis" is desired.

The CLOUGH-BREngle CO.
1136 W. Austin Ave., Chicago, U.S.A.

Send complete literature on the new C-B Line for 1936.

Name.....
 Address.....
 My Jobber is.....

WHAT'S NEW IN RADIO

WILLIAM C. DORF



Left: Resistance element baked on Bakelite ring.

Right: Mechanism showing shoe in contact with ring.

Not FRICTION-less but Friction-RIGHT

The very fact that you can feel the contact as you turn the shaft of an Electrad Volume Control is the best sign of its electrical quietness. There are no gaps to cause stuttering or noise.

The single moving part—the contact shoe—moves on a carbon resistance element permanently baked to a warp-and-wobble-proof Bakelite ring. This mechanical simplicity means fewer parts to wear, less chance for trouble.

The more an Electrad is used, the smoother and quieter it gets, because the direct contact is self-polishing and self-cleaning.

Every Electrad Volume Control is noise tested at the factory and is fully guaranteed. Try one on your next service job. Write Dept. RN4 for new catalog.



RESISTOR SPECIALISTS

Featuring—Quiet Carbon Volume Controls, Vitreous Resistors, Truvalt Resistors and Power Rheostats.

Fewer service call backs on TUNG-SOL tubes...because they're set and circuit tested before they leave the TUNG-SOL factory.



TUNG-SOL

Tone-flow radio Tubes

TUNG-SOL LAMP WORKS, INC.
Radio Tube Division
SALES OFFICES: Atlanta, Boston, Charlotte, Cleveland, Chicago, Dallas, Detroit, Kansas City, Los Angeles, New York.
GENERAL OFFICE: Newark, N. J.

(Continued from page 585)

twin speakers and the a.f. power-pack section are mounted in the same positions they would occupy in the regular wood cabinet.

Newest Adapter

The Alden No. 965M1 octal tube testing adapter permits the new Raytheon type 6X5 metal full-wave rectifier tube to be

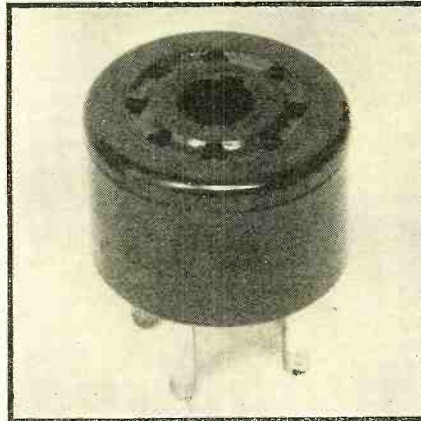

checked in the 84 socket of any tube tester. This adapter can also be used to replace the type 84 with the 6X5 in any receiver.

Modernize Your Analyzer

With this Bud 8-prong analyzer plug and adapter kit it is possible to bring your analyzing equipment up-to-date so as to take care of metal tubes. The equipment comprises one 8-prong analyzer plug wired with five feet of 9 conductor cable; with

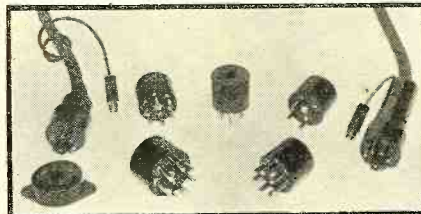

cable plug on other end; an 8-prong socket which is to be wired into your analyzer and five associate adapters. The method for locking the adapter to the plug is simple and "fool-proof".

Announcing a New Line of Replacement Condensers

The new Mallory line of replacement condensers incorporate several practical features which will be immediately apparent to the serviceman. Designed in accordance with present-day space requirements, the new units are smaller, but of right size to meet practically all applications. They offer convenient universal



mounting features for both the carton and round can type condensers and they afford protection against humidity.

Build Your Own Transmitter

Both the veteran amateur and the novice who has just received his license, will be interested in the following announcement concerning the new All-Star transmitter kit. This professional appearing rack-and-panel unit has been designed and laid-out so that no amateur should have trouble in its construction. Only standard parts that are available from local dealers are employed. The various chassis come already drilled and the detailed building instructions include photographs and helpful constructional data. The transmitter can be

(Continued on next page)

The "Ham" Shack

(Continued from page 631)

8:00 P. E. W8MCP 3580

TUESDAY

8:15 A. E. VE3UU 3865
3:30 P. C. W9TE 7012
4:00 P. E. N1FNM 3510
6:00 P. E. W8MHE 3830
6:00 P. E. W8EEZ 3598
6:30 P. C. W9LKK 3757
7:00 P. M. W9HHW 7276
7:00 P. M. W6IQY 7090
7:30 P. C. W8HKT 3750
8:00 P. C. W5CPV 7149
8:00 P. E. W8MCP 3580
8:00 P. M. W7DBP 3607

WEDNESDAY

6:00 A. C. W5DDC 7200
10:00 A. E. W3AEJ 3785
3:30 P. C. W9TE 7012
4:00 P. E. N1FNM 3510
5:00 P. P. W7WE 3637-7274
6:00 P. E. W6MHE 3830
6:00 P. E. W8EEZ 3598
6:30 P. C. W9LKK 3757
6:30 P. E. W2HCP 3785
7:00 P. E. W3AEJ 3785
7:00 P. C. W9SFT 3585
7:00 P. M. W9HHW 7276
8:00 P. M. W7DBP 3722

THURSDAY

8:15 A. E. VE3UU 3865
3:30 P. C. W9TE 7012
6:00 P. E. W8MHE 3830
6:00 P. E. W8EEZ 3598
6:30 P. C. W9LKK 3757
6:30 P. M. W6IQY 7090
8:00 P. M. W7DBP 3607

FRIDAY

10:00 A. E. W3AEJ 3785
3:30 P. C. W9TE 7012
5:00 P. P. W7WE 3637-7274
6:00 P. E. W8MHE 3830
6:00 P. E. W8EEZ 3598
6:00 P. E. N1DUZ 3638
6:30 P. C. W9LKK 3757
6:30 P. E. W2HCP 3785
7:00 P. E. W3AEJ 3785
9:30 P. E. W4BHR 3867

SATURDAY

8:15 A. E. VE3UU 3865
8:30 A. E. W1AMH 56, 100-3536 1/2
6:00 P. E. W8MHE 3830
11:50 P. P. W7WE 3637-7274

SUNDAY

8:15 A. E. VE3UU 3865
10:30 A. E. W3EEV 3628
10:30 A. C. W5DDC 7200
11:00 A. E. W8KGM 3807
1:00 P. P. W7WE 3637-7274
6:00 P. E. W8MHE 3830
7:00 P. ED. W2HJZ 3577
7:00 P. C. W9LUS 3631
8:00 P. M. W7DBP 3722

EBY

Specializes in Quality

Binding Posts
Tip Jacks
Male Plugs
Female Plugs
Low-Loss Sockets
A-C Switches
Tap Switches
Terminal Strips
Short Wave Switches
Moulded Sockets
Electric Eyes

Write for Latest Bulletin

HUGH H. EBY Inc.
 2066 Hunting Park Ave.
 PHILADELPHIA, PENNA.

SAVE \$\$\$ on RADIOS

BUY DIRECT **30 day trial**
 Buy at factory prices. 30 models to choose from. AC-DC. All-wave. Farm, Car and Metal Tube models. Send postcard for NEW 1936 Bargain Catalog FREE. Get details of 30 day TRIAL plan and Agent-User proposition. Also ask for our NEW Parts Catalog.

ZEPHYR RADIO CO. Dept. 214
 11705 Livernois, Detroit, Mich.

LES
 Correspondence Courses in
RADIO and ELECTRICAL ENGINEERING

ELECTRICAL ENGINEERING Covers complete electrical field. Most modern course. So simplified anyone can grasp quickly. Prepares you for secure future. **LOW COST!**
RADIO ENGINEERING Ultra-modern course in radio public address, photo-electric work. Trains you to be super-service man, real vacuum tube technician. Diploma given. Tuition only \$25, either course. Deferred payment plan. Send name quick for free copies of school catalogues, student magazines, etc. **SEND NOW!**
FREE!
 Lincoln Engineering School, 857-F So. 37th St., Lincoln, Nebr.

FREE!

1936 RADIO DATA BOOK
 with
5 Issues Radio News At \$1

Here is your opportunity to get a copy of the tremendously popular 1936 RADIO DATA BOOK. It is 8" by 11", has over 120 illustrations and is bound in a sturdy, green ripple cover.

There are chapters on: Television, Metal Tubes, Short-Wave Reception Aids, Short-Wave Circuit Design, Amateur Radio, Broadcast Radio Receivers, Servicing and Sound Equipment, Engineering Design, Radio Experimenting and Broadcast and Short-Wave Station Lists.

Even a casual glance at the above condensed list of contents will prove, beyond a doubt, that the 1936 RADIO DATA BOOK is one of the most useful books ever published! You can get it FREE by placing a new or renewal subscription for the next 5 issues of RADIO NEWS at the low price of \$1. (Canada & Foreign \$1.25.) The supply is limited—so send your remittance today!

Dept. 364

RADIO NEWS
 461 Eighth Ave. New York, N. Y.

used on 20, 40, 80 and 160-meter bands, the change over to the various bands requiring only a few seconds. With the initial working unit it is possible to begin with a 40-watt c.w. rig and expand as fast or as gradually as you wish by adding

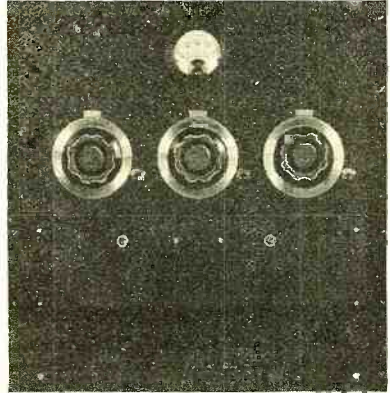

other units, such as a modulator for phone work, power amplifier to provide 500 watt output, etc. Additional information on this new transmitter can be had by writing to the magazine, attention of this department.

Gas-Engine Generator for Unelectrified Farms

Designed as a low cost generating unit, the Sentinel "FarmPowr" develops current to operate lights, radio, charge batteries, drive washing machines and

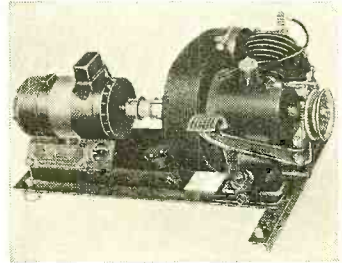

similar electrical equipment. For the farmer who already has a gas engine, the "FarmPowr" Model B can be supplied; this consists of the generator only for pulley drive. Undoubtedly, there is a vast market for this power unit among the thousands of rural homes not yet electrified.

A New Instrument for Laboratory and Shop Use

The Supreme model 89D DeLuxé tube tester is enclosed in an attractive quartered oak cabinet with sloping panel and convenient accessory compartment. It has a full-vision English reading tube scale, a



neon tube leakage test and in addition is equipped with both neon and English reading condenser testing circuits, d.c. voltmeter ranges up to 1250 volts and five ohmmeter ranges up to 20 megohms. (Turn to next page)

THESE SPLENDID BOOKS
FREE

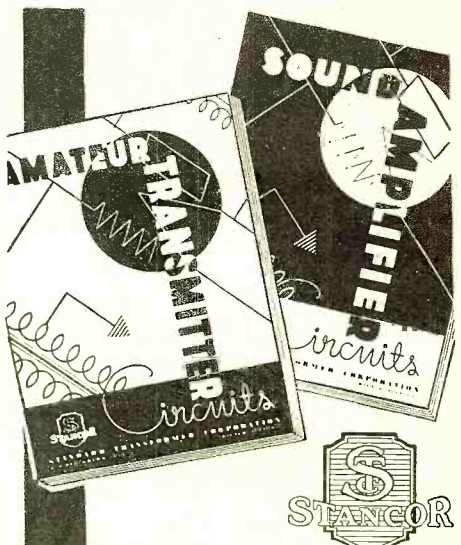

THINK of it! 2 books full of invaluable information, to be had for just the mailing costs! One with 20 complete transmitter designs including 12 tested transmitter RF section designs and 8 modulator and speech amplifier designs. Circuits, complete parts specifications, inductances, etc., all included. Outputs ranging from a little fellow all the way up to the big ones comparable to the best broadcasters. Ten complete designs for public address amplifiers in the other book. It includes one for every purpose, from 3 Watts to 30 Watts output, tried and tested designs that you can build, with complete parts list for each.

These books should be in every amateur's technical library. They are invaluable for reference purposes. Just 22 cents in stamps, to cover postage, brings them both to you, or get them from any standard distributor. Send for your copies today.

STANDARD TRANSFORMER CORPORATION
 856 Blackhawk St., Chicago, Illinois

MAIL THIS COUPON!

STANDARD TRANSFORMER CORP.
 Dept. D. 856 Blackhawk St., Chicago.

I am enclosing 12c for Transmitter Manual
 I am enclosing 10c for Amplifier Manual

Name.....

Address.....

City..... State.....

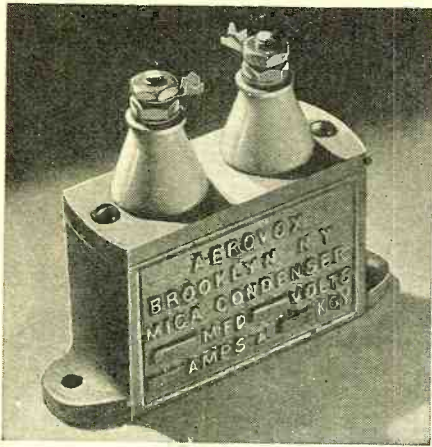

HEAVY-DUTY Mica CONDENSERS



Here's a neat unit rated at 7000 volts for that transmitting circuit of yours. • From this high-voltage type, down to the tiny "postage stamp" molded bakelite unit, the AEROVOX line includes thirteen types of mica condensers for every standard need. • Send for new 1936 catalog covering complete line of condensers and resistors. Also sample copy of Research Worker.



78 Washington St. Brooklyn, N. Y.

FREE



New SPRING CATALOG FREE!

Right up to the minute! Every last minute price change! Every latest development! All leading manufacturers represented! What more can anyone ask from a catalog? You'll find a large selection of Lafayette Public Address Equipment . . . amplifiers from 3½ to 100 watts for every conceivable occasion, complete systems, portable and mobile. There are auto radios, aeri-als, parts and accessories while a big section is devoted to receivers from 4 to 24 tubes. Remember—NO non-essentials; only fast selling profit-making summer sellers! Be sure to get your copy today—just address Dept. RN-46.

NEW LAMB NOISE SILENCER

We carry all the parts for this new development . . . at lowest WHOLESALE prices.



Headphone Attachment

A device called the "Auriton," produced by the Amplivox Labs., permits headphones to be connected to the output of the receiver without requiring any wiring changes. When the phones are plugged into the device it automatically cuts out the loud-



speaker. The big advantage of a device of this type is that one can listen on headphones late at night without disturbing other members of the family. It is also helpful to the hard of hearing.

Class A Prime Amplifier

One of the outstanding amplifiers in Radolek's new line of sound systems is the 12-tube, 40-watt, high-gain P.A. amplifier illustrated below. It is designed to provide 135 db. gain at 1000 cycles, and a frequency characteristic flat within 1 db. from

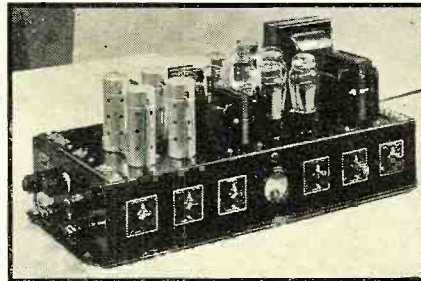

40 to 9000 cycles. Featuring simplicity of operation and installation, it has mixing and fading facilities, universal output impedance arrangements and input connections for four crystal or velocity microphones, phono pick-up or radio input.

Attractive 7-Tube Console

Metal tubes are used throughout in the new RCA-Victor model C7-6 all-wave superheterodyne. Covering all frequencies



from 540 to 18,000 kc., the set is equipped with an improved 12-inch speaker, a dual-speed tuning control and other features. Its power output is 5 watts.

Pre-Amplifier

A two-stage resistance-coupled pre-amplifier with metal type tubes has just been brought out by the Bell Sound Systems. The unit employs two 6F5's and one type 5Z4 rectifier. The rated overall gain is 60

db., the input is of high impedance for use with crystal or velocity microphones,

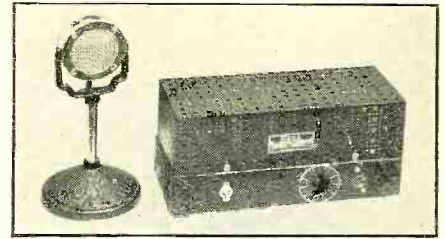

and the output provides for 200 and 500 ohm lines.

5-Tube Table Type Set

This is the new Emerson model 117 dual-wave band superheterodyne receiver, frequency range from 7500 to 540 kc. It

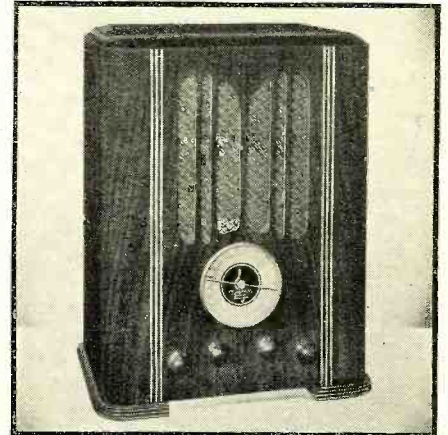

has 3 watts power output and incorporates a code interference trap circuit, automatic volume control, diode detection, etc.

New Oscillator Converter

The Clough-Bregle Model 81 frequency-modulator unit is designed to convert any standard oscillator into a frequency modulated instrument for use with a cathode-

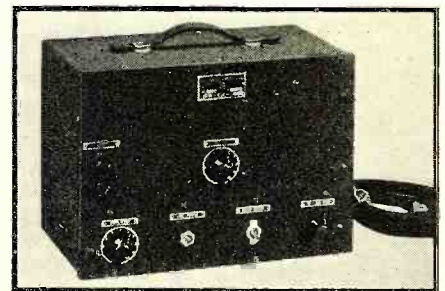

ray oscillograph. It employs the "fixed-sweep" principle to produce a selectivity curve accurately calibrated in frequency width. The output of the oscillator is connected to the input of the Model 81 unit whose frequency modulated output is in turn connected to the receiver under test, which means that no alteration or wiring changes are required in the oscillator.

Multi-Crystal Microphone

The Astatic model K2 crystal microphone is made up of two units connected in multiple, a big advantage in materially lowering the impedance, therefore reducing line losses. The output level of the microphone is approximately minus 64 db. It is non-directional and is recommended for use in broadcasting stations, high-fidelity P.A. systems or wherever quality reproduction is required.

Handy Fuse Unit

The new Littelfuse No. 1069 extractor fuse post takes the standard 3 AG type

**Remarkable Value!
DEPENDABLE "RCP"
MULTITESTER**



only **\$13.95**

**Complete and
GUARANTEED**

KIT - \$10.65

This piece of equipment is worth many times its price to the up-to-the-minute service man. It has been most enthusiastically praised by users for its accuracy and convenience. Has 2000 ohms per volt sensitivity, 3 range ohmmeter, 1/2 ohm to 2 million ohms; 4 range voltmeter, microammeter and milliammeter. Compactly designed, complete with self-contained batteries. Examine it and you'll be convinced that the value is really remarkable! See your jobber or write us for further details.

Write Dept. RN-4 for Test Bulletins

**RADIO CITY PRODUCTS CO.
88 Park Place, New York City**

RADIO COURSES

RADIO OPERATING: Prepare for Gov't License Exam. • **RADIO SERVICING:** Including Short Wave • **AMATEUR CODE** • New Course in **ELECTRONICS:** Day and Evening Classes—Booklet Upon Request

NEW YORK Y.M.C.A. SCHOOLS
7 W. 63rd Street, New York City

RADIOS..SAVE UP TO 50%



Deal Direct: Factory Prices. Many models to select from: AC-DC, All-wave, Farm, Car and new Metal Tube Models. Your name and address on postcard brings you NEW 12-page 1936 Bureau Catalog in color FREE. Get details of 30-DAY TRIAL plan and 3-cent-User proposition.

Free Catalog
Goldentone Radio Co., Dept. 256,
8780 Grand River, Detroit, Mich.

FREE!

**"23 Lessons In Radio"
With
5 Issues of
RADIO NEWS at \$1**

We still have a very limited supply of the famous book "23 Lessons In Radio" on hand. No further reprints will be made. If you want a copy, we advise you to send for it immediately! "23 Lessons In Radio" covers the fundamentals, including elementary radio theory, radio tubes, principles and construction of receivers, converters and transmitters, standard radio symbols, the amateur field, and many other important items. Get your copy now—it's FREE with a new or renewal subscription for 5 issues of RADIO NEWS at \$1. (Canada and Foreign \$1.25.) Send your remittance today, to:

Dept. 364A

**RADIO NEWS
461 Eighth Ave.
New York, N. Y.**

fuse, it is shockproof insulated and will extract the blown fuse when the knob is unscrewed. It is especially suited for loads

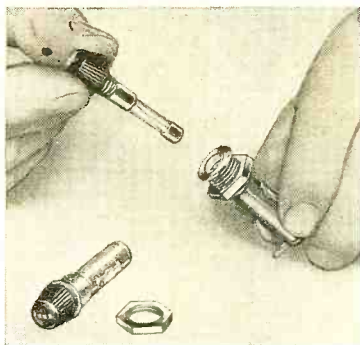

of less than 5 amperes 110 volts, in the primary circuits of power supplies.

New Tubes for Old

Many an owner of a radio receiver, reading about the advantages of the new metal tubes, has wondered if he cannot use these new tubes in his old set. However, equivalents of the older types of glass tubes are not found among the regular metal tubes. But now the replacement of glass tubes in old sets is possible. The Arcturus Company has made available thirteen new metal tubes which are electrically equivalent to the most popular glass types: 24, 27, 51 (35), 55, 56, 57, 58, 75, 77, 78, 80, 82 and 2A6. These tubes are to be known as the 24-Coronet, 27-Coronet, etc. The new metal tubes have the octal 8-prong bases. In order to use the tube without making any alteration in the wiring of the set, adapters have been made by the same company. The adapter fits into the regular socket and the tube is inserted into the adapter. The height of the tube plus the adapter is less than that of the original glass tubes.

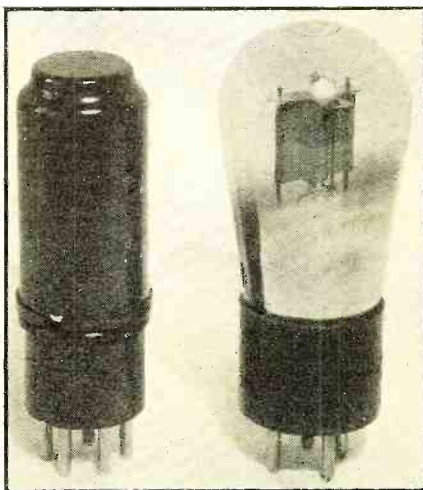

When such replacements are made, the shields on r.f. tubes are no longer needed. The number of prongs on the metal tube is one more than that of the original tube. This extra prong is connected to the shell of the tube. The adapter has its internal connections so arranged that the shell is tied to the cathode, which is satisfactory in nearly all cases.

Rectifiers which have their filament at high voltage can, of course, not be treated in this way. Therefore, the adapters for these tubes make no connection to the shell.

Dealers and servicemen will find the modernizing of receivers a profitable undertaking. When the demand is demonstrated, additional types will be made available.

**"YOUR NEW
BOOK SURE HAS
THE ANSWERS"**



**GET YOUR FREE
COPY OF SERVICE
HINTS TODAY. IT WILL
IRON OUT A LOT OF TOUGH SPOTS.**

• Short cut solutions . . . new ways to solve everyday problems . . . questions on circuit and receiver troubles . . . Sylvania's new volume of SERVICE HINTS has all the answers!

Hundreds of successful service men wrote this book . . . sent in their solutions to tough problems they have solved. Sylvania compiled them into this second volume of SERVICE HINTS . . . and it's yours without any charge whatever.

Don't wait. Send today for your copy of SERVICE HINTS, Volume 2. It will put you in line for more and better service jobs. Simply fill out the coupon below . . . and you'll get your copy of Service Hints in a few days.

Hygrade Sylvania Corporation. Makers of Sylvania Radio Tubes and Hygrade Lamps. Factories at Emporium, Pa., Salem, Mass., and St. Mary's, Pa.

SYLVANIA
THE SET-TESTED RADIO TUBE

**Hygrade Sylvania Corporation
Emporium, Pa.** RN-4

Please send me free, without obligation, Volume 2 of Sylvania's "Service Hints".
 Experimenter Amateur Call.....
 Serviceman Employed by dealer
 Independent

Member Service Organization.....

NAME.....

ADDRESS.....

CITY.....STATE.....

NAME OF JOBBER.....

ADDRESS.....

KNIGHT 15 WATT HIGH GAIN CRYSTAL SOUND SYSTEM

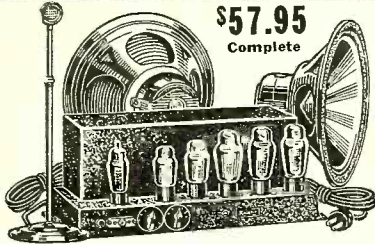

\$57.95
Complete

A newly designed high quality full 15 watt high gain sound system for crystal microphone reproduction. Offered at our unbeatable low price. Amplifier features 4 high gain stages; input for phono and mike; separate "mixer" volume controls; built-in field excitation; universal output; push-pull 2A5 Class "AB" power stage, etc. Complete system includes: 1-Knight 15 Watt Amplifier; 2-12 inch Knight Dynamic Speakers with 30 ft. cords; 1-Shure Crystal Microphone with 25 ft. cable; 1-microphone floor stand; Raytheon tubes.

- H9913 Complete Crystal Sound System..... **\$57.95**
- H9915 Amplifier Only, less tubes..... **\$23.85**
- H9914 The Knight 15 Watt High Gain Sound System as described above, but with an Arapette RB-H Velocity Microphone instead of the crystal type..... **\$68.95**

ALLIED RADIO
833 W. JACKSON BLVD., CHICAGO

- Enclosed find \$57.95 for Complete 15 Watt System.
- Enclosed find \$23.85 for Amplifier Only.
- Enclosed find \$68.95 for 15 Watt Velocity System.

Name.....

Address.....

THE COMPLETE CONDENSER LINE FOR SERVICING



1910-1936

Many servicemen have established a most profitable business on the keynote of C-D prime quality condensers.

A quality product, established for more than twenty-six years, backed by an iron-clad guarantee.



A complete line of capacitors carried by the nation's leading distributors.

Get your local C-D distributor to point out the salient features of this famous condenser line. Also ask him to give you a copy of the latest 1936 catalog.

CORNELL DUBILIER CORPORATION
4387 BRONX BOULEVARD
NEW YORK U.S.A.

P.A. Profits

(Continued from page 593)

measuring 17 $\frac{3}{4}$ inches long, 6 $\frac{3}{4}$ inches wide, and 8 $\frac{1}{2}$ inches high. It provides an unusually high gain of 104 decibels to insure more than enough gain to permit the direct use of a crystal or a high impedance velocity microphone without a pre-amplifier.

The applications of this sound system are numerous. Its many features make it well-adapted for profitable sales or rentals for use in auditorium, church, hospital, theatre, and school installations.

In looking over the schematic circuit diagram, it will be noted that four audio stages are employed. A type 57 tube is used in a high-gain microphone pre-amplifier stage. A type 53 tube is used as a voltage amplifier and a novel electronic mixer. For this application the plates of the two triode sections are tied together, while the grids are coupled to two dissimilar sources. The grid of one section is connected to the output of the 57 stage, and the input voltage is controlled by means of a one megohm potentiometer. The second grid is connected to the phonograph pickup input terminals. By means of these two potentiometers controls the microphone and phono inputs may be mixed and blended in any desired proportion.

The next stage is used as a voltage amplifier and driver and employs a 2A5 tube connected as a triode. This tube in turn is coupled through a specially designed transformer to a pair of 2A5's in a class AB arrangement. The plate voltages and field current is obtained from a conventional, well filtered full-wave rectification circuit using one 5Z3 tube. The fields are connected in series across the high voltage, acting as a bleeder and stabilizing the output voltage.

All in all, this sound system is one which will meet the requirements of a great majority of P. A. installations and should therefore be of interest to dealers and servicemen who are active in this field, especially where low cost is an important factor.

Picking a Receiver

(Continued from page 599)

The super-regenerative detector is one of the self-quenching type, the quenching action being obtained through the proper selection of grid-leak tickler and plate voltage values. Regeneration (and super-regeneration) are controlled by a variable resistor in the detector plate circuit. Two audio stages provide ample loudspeaker volume.

The power supply and 5-inch dynamic speaker are built into the cabinet. The two tuning condensers are ganged for single control. The 50 mmfd. compression-type interstage coupling condenser also serves as a trimmer condenser in aligning the two tuned circuits. This tuning arrangement provides the simplicity of control of the ordinary super-regenerative receiver but, due to the r.f. stage, offers the advantage of greater selectivity, and of freedom from radiation of interference. This receiver is also available in built-up form. It is produced to cover the 5-meter band but can also be supplied to cover the 30-40 megacycle experimental range.

"Custombuilders" Super-Regenerative Receiver

Figure 5 shows the schematic circuit, with the front and rear views. An r.f. buffer stage is used, not so much for additional sensitivity as to prevent radiation from the super-regenerative detector circuit. The choke input circuit permits the use of either a single or double antenna lead. The super-regenerative detector is a 55 tube. This is a duo-diode-triode but only the triode section is used. This particular tube was selected because of its unusually low input capacity. The super-regenerative circuit is an extremely simple one, in which regeneration is obtained through the insertion of a choke in the cathode lead to provide the necessary grid-plate coupling. Regeneration is controlled by means of the variable resistor in the detector plate circuit. The choke L5 and condensers C7 and C8 serve as a filter to keep the r.f. out of the audio circuits. The detector is resistance coupled to the 2A5 output tube, the output of which is suitable for the use of either headphones or a magnetic speaker, no D.C. current being present. Volume control is accomplished by means of the potentiometer in the grid circuit of the power tube.

The receiver is designed primarily for use in the 5-meter range but coils are also available for the 2 $\frac{1}{2}$ and 10 meter ranges. The model shown in the photographs is for battery operation but is also available with built-in power supply. It might be added here that the selectivity of this receiver is distinctly better than that normally provided by a super-regenerative receiver with no preselector stage. The reason for this unusual degree of selectivity is not ap-

parent but was definitely noticeable during the "on the air" tests. This receiver is available only in built-up form and is produced by "Custombuilders."

Part Three of this series of articles will present information on available ultra-high frequency transmitters.

Output Meters

(Continued from page 592)

for this latter application was shown last month.

The cathode-ray oscilloscope with a linear sweep circuit is an output meter de luxe. A discussion of its application is beyond the scope of this article but is given in service notes on receivers and in previous articles in this magazine.

The following points should be observed in all aligning procedure.

Use an accurately calibrated test oscillator, particularly for i.f. alignment.

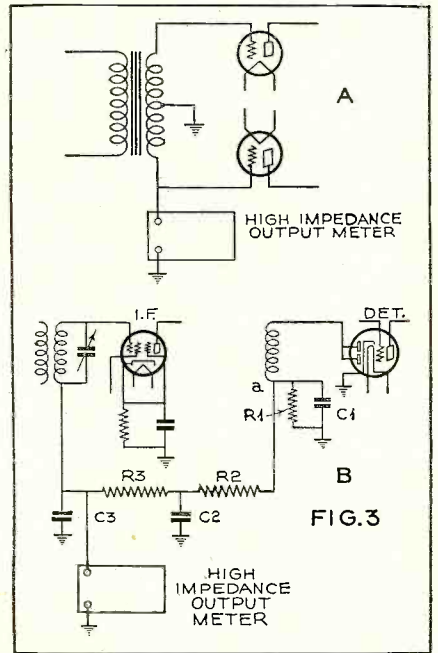

Make certain whether the i.f. transformers are designed to have a flat top or a peaked characteristic.

Don't align any receiver until it is thoroughly warmed up.

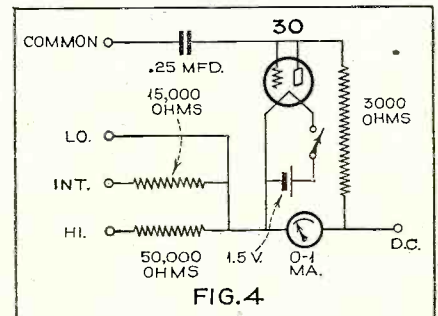

Be sure and check the image repeat point on short wave bands.

Recheck the input stage alignment with the customer's antenna connected.

Selling Service

(Continued from page 591)

placing your promotional displays in stores in your neighborhood. Simple showcards announcing your service, if placed in a few electrical stores, garages, hardware stores, vacant stores, etc., pull in quite some business. If necessary, offer the store owners a small fee or commission for displaying your sign and referring all service business to you.

Broadcast Studios

(Continued from page 584)

studio. The smaller studios, all embodying distinctive features, include a speaker's chamber with the trappings of a luxurious lounge to offset mike-fright, an organ room and a small announcer's studio for the presentation of news flashes and various program cut-ins.

An unusual feature for a radio station is a plant for the manufacture of electrical transcriptions.

As this article is being written, finishing touches are being applied to the three additional studios of NBC in Chicago. These three chambers supplement the previous NBC space of 65,000 square feet previously utilized atop Merchandise Mart. It is quite likely that the three new studios will be in use at the time this article reaches print.

When the initial Chicago studios were opened in 1928, only two were needed. Two years later, the quarters were moved to the Merchandise Mart where first six and later eight studios were opened. The Chicago staff, exclusive of artists, exceeded 300 persons. A portion of space in Merchandise Mart was left unfinished for future expansion and it is this space that the new studios occupy. The new units are each 17 by 30 feet in size with adjoining control rooms and storage space. The storage compartments are an innovation in studio design yielding facilities to stow chairs, drums and other equipment that is unsightly when not in use. Echo chambers, similar to those in Radio City, have also been constructed. There is also a new pipe organ chamber 12 by 30 feet in size.

It should be noted that this trend toward studio expansion and modernization has also been effective in New York, despite the previously constructed or acquired auditorium-sized presentation chambers. The Columbia Broadcasting System now operates three Radio Playhouses in the Times Square area in addition to its modernized studio suite at its headquarters building on Madison Avenue. The three CBS radio playhouses were formerly known as the Little, Avon and Hudson Theatres. NBC, despite its own huge auditorium studio, utilizes the Hippodrome Theatre for the Tuesday "Jumbo" program. And WOR, the Newark station serving as the metropolitan New York outlet for Mutual Broadcasting System programs, has taken over the Times Square Studios atop the New Amsterdam Theatre Building formerly occupied by NBC.

From London, too, comes news of studio expansion by the British Broadcasting Corporation. In order to meet new demands of program development, new studios have been erected at Maida Vale, London. The main premises were originally designed to house one of the largest skating rinks in the world. The total floor area of the five new B.B.C. studios and their associated listening rooms is over 17,000 square feet. The building also includes recording rooms—presumably for the Blattnerphone rebroadcasts on the Empire short-wave stations—a suite of offices and a staff restaurant.

The largest Maida Vale studio—Number One—has a floor area of 72 by 110 feet. Studios Two and Three, are of the same size and shape—70 by 43 feet. Zig-zag wall panels—similar to those recently introduced at the CBS New York studios are employed in one of the British radio chambers. Two smaller studios are designed for dance bands or other musical groups.

Many experimental features were applied in the new British studios. But they are recognized as methods already used in the U.S.A. For example, there is no structural connection between the studios and the buildings. It is the principle known here as the "box-within-a-box" method. Special emphasis in design has been placed on acoustical properties.

It is apparent that all improvements in studio facilities should lead to still better program fare.

Kicking up DX

(Continued from page 587)

tuned approximately to the center of the band to be explored. Since C2 affects the tuning its best setting for each coil-range should be determined, noted, and duplicated after the signal of a desired station has been tuned in on the receiver. Then, the dial of the pre-selector is adjusted for maximum volume.

Receiving conditions and the preferences of the operator will determine whether or not regeneration should be used. Adjusting the regeneration control to the best setting will increase the sensitivity and selectivity to a surprising degree. The tuning becomes quite critical and it is good practice to tune for maximum volume after each adjustment of the regeneration control. Every regenerative set has a few peculiarities of its own, and a little patience and practice may be necessary to fully realize the advantages of r.f. regeneration. In general the considera-

I'LL SEND MY FIRST LESSON FREE

It shows how EASY it is to learn at home to fill a GOOD JOB IN RADIO



Clip the coupon and mail it. I will prove to you that I can train you at home in your spare time to be a RADIO EXPERT. I will send you my first lesson free. Examine it, read it, see how clear and easy it is to understand. Then you will know why many men with less than a grammar school education and no technical experience have become Radio Experts and are earning more money than ever before as a result of my training.

MANY RADIO EXPERTS MAKE \$30, \$50, \$75 A WEEK

In about 15 years, the Radio Industry has grown to a billion dollar industry. Over 300,000 jobs have been created by this growth, and thousands more will be created by its continued development. Many men and young men with the right training—the kind of training I give you in the N. R. I. Course—have stepped into Radio and quickly increased their earnings.

GET READY NOW FOR JOBS LIKE THESE

Broadcasting stations use engineers, operators, station managers and pay up to \$5,000 a year. Manufacturers continually employ testers, inspectors, foremen, engineers, servicemen, buyers, for jobs paying up to \$6,000 a year. Radio operators on ships enjoy life, see the world, with board and lodging free, and get good pay besides. Dealers and jobbers employ servicemen, salesmen, buyers, managers, and pay up to \$75 a week. My book tells you about these and many other interesting opportunities to make more money in Radio.

MANY MAKE \$5, \$10, \$15 A WEEK EXTRA IN SPARE TIME WHILE LEARNING

The day you enroll I start sending you Extra Money Job Sheets which quickly show you how to do Radio repair jobs common in most every neighborhood. Throughout your training, I send you information for servicing popular makes of sets! I give you plans and ideas that have made good spare time money for hundreds of fellows. My Training is famous as "the Course that pays for itself."

TELEVISION, SHORT WAVE, LOUD SPEAKER SYSTEMS INCLUDED

There's opportunity for you in Radio. Its future is certain. Television, short wave, loud speaker systems, police Radio, automobile Radio, aviation Radio—in every branch, developments and improvements are taking place. Here is a real future for men who really know Radio—men with N. R. I. training. Act now to get the training that opens the road to good pay and success.

YOU GET A MONEY BACK AGREEMENT

I am so sure that N. R. I. can train you satisfactorily that I will agree in writing to refund every penny of your tuition if you are not satisfied with my Lesson and Instruction Service upon graduation.

FREE 64-PAGE BOOK OF FACTS

Mail the coupon now. In addition to the sample lesson, I send my book, "Rich Rewards in Radio." It tells you about the opportunities in Radio, tells you about my Course, what others who have taken it are doing and earning. This offer is free to any ambitious fellow over 13 years old. Find out what Radio offers you without the slightest obligation. ACT NOW! Mail coupon in an envelope or paste on a 1c postcard.

J. E. SMITH, President
National Radio Institute, Dept. 6DR
Washington, D. C.

I have helped hundreds of men make more money



MAIL THIS NOW!

J. E. SMITH, President
National Radio Institute, Dept. 6DR
Washington, D. C.

I want to take advantage of your offer. Without obligating me, send me your Free Sample Lesson and your book, "Rich Rewards in Radio." (Please Write Plainly.)

NAME.....AGE.....
ADDRESS.....
CITY..... STATE....."R"

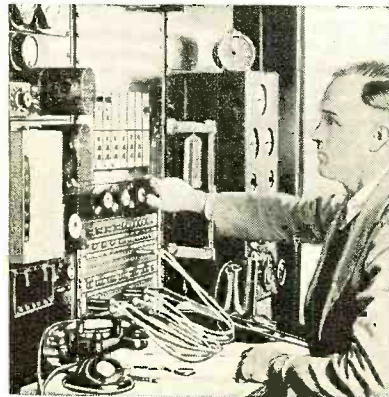

You Get PRACTICAL EXPERIENCE with Radio Equipment I GIVE YOU

I'll show you how to use my special Radio Equipment for conducting experiments and building circuits which illustrate important principles used in such well-known sets as Westinghouse, General Electric, Philco, R. C. A., Victor, Atwater Kent and others. You work out with your own hands many of the things you read in my lesson books. This 50-50 method of training makes learning at home easy, interesting, fascinating, intensely practical. You learn how sets work, why they work, how to make them work when they are out of order. Training like this shows up in your pay envelope—when you graduate you have had training, and experience—you're not simply looking for a job where you can get experience.

Here's Proof



\$75 in One Week



Does Police Radio Work

"One week my business netted \$75.00 on repairing alone, and there were sales to be added. I have only you to thank for it. In my estimation, N. R. I. is the best home-study school in the United States." — R. S. LEWIS, Box 314, Pittsfield, Ill.

"I am doing the work on the Radio ears of the Police Department of West Seneca township. This is not a full-time job, but averages about \$25 a week. Besides this I am working as assistant manager in a local Radio store and average \$20 a week on this job. J. M. TICKNOR, 111 Edison Street, Buffalo N.Y.



\$5,000 on Repair Work Alone

"I am doing around a \$5,000.00 business in repair work alone, not counting the new Philco Radio sales." — C. D. THOMPSON, R. F. D. 2, Troy, Alabama.

The Tested Way to BETTER PAY

Train Now for New RADIO Opportunities



Get Into a Line Where There's Action—Every Day—And a Payday Every Week—You Be the Boss!

Analyzer & Resistance Tester—Latest Design—Yours Without Extra Cost

now while hundreds are looking for work where there isn't any, the radio service field can use trained men. With the proper training and the necessary equipment, you can enter this field and make a comfortable living. We include with our course this modern set analyzer and trouble shooter without any extra charge. This piece of equipment has proved to be a valuable help to our members. After a brief period of training, you can take the set analyzer out on service calls and really compete with "old timers." We show you how to wire rooms for radio—install auto sets—build and install short-wave receivers—analyze and repair all types of radio sets—and many other profitable jobs can be yours. Teaching you this interesting work is our business and we have provided ourselves with every facility to help you learn quickly yet thoroughly. If you possess average intelligence and the desire to make real progress on your own merits, you will be interested.

ACT NOW—MAIL COUPON

Start this very minute! Send for full details of our plan and free booklet that explains how easily you can now cash in on radio quickly. Don't put it off! Write today! Send now!

RADIO TRAINING ASSN. of AMERICA
Dept. RN-64, 4525 Ravenswood Ave., Chicago, Ill.

Gentlemen: Send me details of your Enrollment Plan and information on how to learn to make real money in radio quick.

Name.....

Address.....

City..... State.....

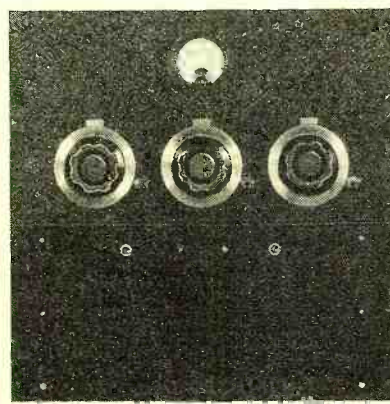

It's Easy to Build the ALL-STAR TRANSMITTER

ANYONE with screw driver, pliers and soldering iron, and only a kitchen table to work on, can build the efficient ALL-STAR TRANSMITTER.

Photographs and Diagrams Make Assembly Easy

Drilled chassis and detailed instructions, including photographs, enable you to build without laborious drilling or machining. Instruction Sheet gives step-by-step procedure, with 21 photographs and 8 diagrams. Complete constructional data and diagrams, 25c postpaid, or FREE with foundation units.

Specified Parts Stocked by Jobber

Specified parts approved by the designers are stocked by your jobber, and made by these sponsor-manufacturers—THORDARSON ELEC. MFG. CO.—HAMMARLUND MFG. CO.—CORNELL-DUBILIER CORP.—TRIPLETT ELEC. INST. CO.—OHMITE MFG. CO.—L. F. JOHNSON CO.—CROWE NAME PLATE CO.

See Your Jobber or Write

BUILD YOUR OWN **ALL-STAR HEADQUARTERS**
TRANSMITTER 222 W. Adams St. Chicago.

tions applicable to a regenerative detector also apply to a regenerative r.f. stage except that oscillation is undesirable even for CW reception. By using a separate tube to furnish regeneration the voltages applied to the electrodes of the regeneration tube become unimportant, as long as maximum regeneration can be obtained. Nevertheless, for a smooth control of regeneration, oscillation will occur too readily with the coils specified, and commercially manufactured plug-in coils especially designed for a regenerative r.f. stage are not available. Therefore, if this control seems too critical, the tickler coil can be adjusted by removing turns until oscillation will just take place with the antenna connected, C2 in the best position and the regeneration control full on. To adjust the input for special antenna systems with two lead-in wires disconnect C2 from AG, connect the antenna leads to A and AG, and then remove turns from the primary until oscillation is obtained over the entire tuning range of the coil at maximum screen-grid voltage. The turns should be removed from the top of the winding, that is, from the end connected to terminal No. 5.

Parts List

- C1—Hammarlund midget condenser type MC-140M, 140 mmfd.
- C2—National midget condenser type SSS-50, 50 mmfd.
- C3—.006 mfd. mica condenser
- C4—.01 mfd. mica condenser (5)
- C6—.5 mfd. paper condenser (2)
- C7—.1 mfd. paper condenser (2)
- C8—250 mmfd. mica condenser
- R1—1,000 ohms, 1 watt metallized
- R2—500,000 ohms, 1/2 watt metallized
- R3—50,000 ohms potentiometer
- R4—75,000 ohms, 1 watt metallized (2)
- R5—25,000 ohms, 1 watt metallized
- R6—300 ohms, 1 watt metallized
- RFC—Hammarlund r.f. choke type CH-8 (2)
- 1 set of 4 Hammarlund 3-circuit, 6-prong plug-in coils
- 2 Hammarlund tube shields, type TS-50
- 3 National Steatite 6-prong sockets
- 1 National dial, type B
- 1 National cabinet, type C-SRR (plain)
- 1 National coupling, type TX-1
- 2 1/2" x 2" pieces of vitron (any low-loss insulation from 1/16" to 3/16" thick will do)
- 3 binding posts
- 1 3/16" x 1/2" x 3" piece of bakelite, for mounting the tuning condenser

24-Tube Super

(Continued from page 605)

HJ5ABE	14120	Cali, Colombia
RV59 (RNE)	12000	Moscow, U. S. S. R.
KKQ	11950	Kahuku, Hawaii
FYA	11890	Pontoise, France
W8XK	11870	Pittsburgh, Pa.
GSE	11860	Daventry, England
W2XE	11830	New York, N. Y.
I2RO	11810	Rome, Italy
W1XAL	11790	Boston, Mass.
DJD	11770	Zeesen, Germany
GSD	11750	Daventry, England
PHI	11730	Huizen, Holland
CJRX	11720	Winnipeg, Canada
FYA	11720	Pontoise, France
HJ4ABA	11710	Medellin, Col.
CEC	10670	Santiago, Chile
JVN	10660	Nazaki, Japan
EAQ	9860	Madrid, Spain
I2RO	9635	Rome, Italy
CT1AA	9600	Lisbon, Portugal
HBL	9595	Geneva, Switzerland
W3XAU	9590	Philadelphia, Pa.
GSC	9590	Sydney, Australia
W1XK	9580	Daventry, England
DJA	9570	Millis, Mass.
DJN	9560	Zeesen, Germany
W2XAF	9540	Zeesen, Germany
VK3ME	9530	Schenectady, N. Y.
GSB	9510	Melbourne, Australia
COCH	9510	Daventry, England
HJU	9428	Havana, Cuba
YNVA	9000	Buenaventura, Colombia
HCJB	8657	Managua
HBP	8333	Quito, Ecuador
JVT	7797	Geneva, Switzerland
TIEP	6750	Nazaki, Japan
HC2RL	6710	San Jose, Costa Rica
TIRCC	6668	Guayaquil, Ecuador
HIL	6550	San Jose, Costa Rica
YV6RV	6500	Santo Domingo, D. R.
HJ1ABB	6520	Valencia, Ven.
TIPG	6447	Barranquilla, Col.
HIZ	6410	San Jose de Costa Rica
CJRO	6315	San Domingo, D. R.
YV3RC	6160	Winnipeg, Canada
W8XK	6150	Caracas, Venezuela
COCD	6140	Pittsburgh, Pa.
W2XE	6130	Havana, Cuba
GSL	6120	New York, N. Y.
W3XAL	6110	Daventry, England
W9XF	6100	Bound Brook, N. J.
CRCX	6090	Chicago, Ill.
W9XAA	6090	Toronto, Canada
HP5F	6080	Chicago, Ill.
DJM	6080	Colon, Panama
	6079	Zeesen, Germany

TRIMM

The **ONE** name of dependable quality in headsets. Designed and built by master craftsmen, using only the finest materials and workmanship.

TRIMM
Radio Mfg. Co., 1770 W. Berletau Ave., Chicago, Ill.

INDEX TO ADVERTISERS

Aerovox Corp.	634
Alden Products Co.	640
Allied Radio Corp.	613, 636
All-Star Headquarters	638
American Transformer Co.	626
Bond Radio Co.	623
Brush Development Co., The	639
Cameradio Co.	621
Candler System Co., The	639
Capitol Radio Engineering Inst.	627
Central Radio Laboratories	618
Classified Advertising	639
Clough-Bregle Co.	631
Cornell-Dubilier Corp.	636
Cornish Wire Co., Inc.	631
Coyne Electric School	625
Custombuilders	620
Dodge's Institute	623
Eby, Inc., Hugh H.	633
Electrad, Inc.	632
First National Television, Inc.	631
General Electric Co.	Inside Front Cover
Goldentone Radio Co.	635
Hallcrafters, Inc.	626
Hammarlund Mfg. Co.	611
Hygrade-Sylvania Corp.	635
Instructograph Co.	623, 631
Ken-Rad Corp., Inc., The	631
Lincoln Engineering School	633
Lincoln Radio Company	616
McElroy, T. R.	639
McGraw-Hill Book Co., Inc.	640
Midwest Radio Corp.	Back Cover
Million Radio & Television Lab.	640
Mallory & Co., Inc., P. R.	582
National Company, Inc.	628
National Radio Institute	637
National Schools	621
National Union Radio Corp. of N. Y.	630
New York Y.M.C.A. Schools	635
O'Brien, Clarence A.	613
Ohmite Mfg. Co.	623
Per-Wal Radio & Television Co.	620
Philco Radio & Television Corp.	615
Precision Apparatus Corp.	611
RCA Institutes, Inc.	618
RCA Manufacturing Co.	614
Radio City Products Co.	635
Radio Products Co., The	Third Cover
Radio & Technical Publishing Co.	617, 620, 640
Radio & Television Institute	629
Radio Training Association of America	638
Radolek Co., The	639
Raytheon Production Corp.	622
Readrite Meter Works	624
Rider, John F.	631
Rim Radio Mfg. Co.	613
Scott Radio Labs., Inc., E. H.	577
Silver Corp., McMurdo	623
Solar Mfg. Corp.	613
Sprayberry, F. L.	614
Standard Transformer Corp.	633
Sundt Engineering Co.	618
Teleplex Co.	611, 613
Trimmm Radio Mfg. Co.	638
Triplet Electrical Instrument Co.	621
Tri-State College	616
Tung-Sol Radio Tubes, Inc.	632
Utah Radio Products Co.	630
Webster Co., The	627
Weston Electrical Instruments Corp.	619
Wholesale Radio Service Co.	634
Wright DeCoster Co., Inc.	640
Zephyr Radio Co.	633

You Can Become a Fast, Capable RADIO OPERATOR at Home

With CANDLER Scientific Sound System That Trained Champion McElroy

McELROY says: "If you want to learn code quickly so you can read it like print, or increase your code speed, send for CANDLER BOOK OF FACTS. It contains the secret of my success."

FREE—1936 BOOK OF FACTS
Contains McElroy's own story and other valuable information. A card will do. No obligation.

CANDLER SYSTEM CO.
Dept. N-4 Asheville, N. C.



Beginner or old timer, to be a good operator, you need:

MAC KEY @ \$7.95 finest semi-automatic key built. Or JUNIOR MODEL @ \$4.95 a low priced "speed key" guaranteed; MAC OSCILLATOR @ \$3.95 AC/DC 1,000 cycles code practice. "Mac" items sold with emphatic money back guarantee.

T. R. McElroy, 23 Boyside St., Boston, Mass.
If you have a Mac Key write me now for my ipt & dsrb inf—Mac

Read Classified Advertising—It Pays

Advertisements in this section twenty cents a word for each insertion. Name and address must be included at the above rate. Cash should accompany all classified advertisements unless placed by an accredited advertising agency. No advertisements for less than 10 words accepted. Objectionable or misleading advertisements not accepted. Advertisements for these columns should reach us not later than 3rd of 2nd month preceding issue. **TECK PUBLICATIONS, INC.**
461 Eighth Ave. New York, N. Y.

A.C. Auto Generators

TURN scrap into money. Autopower shows you how easily and economically auto generators can be converted into A.C. or D.C. generators and D.C. motors. 2 to 1000 volts for sound, radio, power, light, or welding. No previous experience necessary—complete information all in new book, with simple instructions and illustrations. Endorsed by thousands. Only \$1.00 postpaid. Autopower, Inc., 414-A S. Hogue Ave., Chicago.

Agents Wanted

AGENTS: Stick-on-Window Sign Letters. 500% profit. Write today. Metallic Letter Co., 422 N. Clark, Chicago.

Correspondence Courses

USED Correspondence Courses and Educational Books sold or rented. Inexpensive. Money-back guarantee. Write for Free Catalog listing 4000 bargains. (Courses Bought.) Lee Mountain, Pisgah, Alabama.

LEARN RADIO. \$1.00 per lesson. All subjects. Revolutionary successful individual method. Equipment loaned and rented. University Expert Instructors. Information free, or send \$1.00 for first lesson. Missouri Technical School, 3907-H North 25th, St. Louis.

Patent Attorneys

PATENTS. Instruction "How to Establish Your Rights" and form, "Evidence of Conception" sent Free! Lancaster, Allwine & Rommel, 414 Bowen Building, Washington, D. C.

PATENTS—Advice and booklet free. Highest references. Best results. Promptness assured. Watson E. Coleman, Patent Lawyer, 724 9th Street, Washington, D. C.

Patents and Inventions

INVENTIONS COMMERCIALIZED. Patented or unpatented. Write Adam Fisher Company, 278 Enright, St. Louis, Missouri.

Radio

ARMY-NAVY gives free Radio Operators' training for service on Ships, Aircraft. Salary, expenses paid. Information pamphlet, how to apply, 20c. Continental, Box 314V, Indianapolis, Ind.

Radio Instruction

AMATEUR LICENSES, complete training, \$1.50 weekly. Resident and correspondence courses. Students licensed this month: W2JAN, W2JBD, W2JCU, W2JDI, W2JBO, W2JDR, K2JGS, W2JGV, W2JGX, W2JGY, W2JHF, W2JHV, W2JIE, W2JIL, W2JHW. New York Wireless School, 1123 Broadway, New York.

Wind Driven Lights

ELECTRIC LIGHTS—WIND DRIVEN—You build them. Write, Wind Motor Electric, Ridgway, Montana.

- | | | |
|--------|------|-----------------------|
| HH2S | 6070 | Port-au-Prince, Haiti |
| W8XAL | 6060 | Cincinnati, Ohio |
| W3XAU | 6060 | Philadelphia, Pa. |
| GSA | 6050 | Daventry, England |
| W1XAL | 6040 | Boston, Mass. |
| DJC | 6020 | Zeesen, Germany |
| XEUW | 6020 | Veracruz, Mexico |
| COCO | 6010 | Havana, Cuba |
| XEBT | 6000 | Mexico City, Mex. |
| HJ1ABJ | 6000 | Pereira, Colombia |
| HJ2ABC | 5985 | Cucuta, Col. |
| HIN | 5980 | San Domingo, D. R. |
| XECW | 5975 | Xantocam, Mexico |
| HJ4ABE | 5930 | Medellin, Colombia |
| YV8RB | 5880 | Barquisimeto, Ven. |
| HRN | 5875 | Tegucigalpa, Hond's |
| YV8RMO | 5850 | Maracaibo, Ven. |
| YV2RC | 5800 | Caracas, Ven. |
| T15HH | 5500 | San Ramon, C. R. |
| RV15 | 4273 | Khabarovsk, Siberia |

Backstage

(Continued from page 613)

ings of Rosemary and Priscilla Lane, Stella and the Fellows, Johnny Davis, Poley McClintock and others are additional vital contributions to the program.

GERTRUDE BERG, author and star of NBC's erstwhile "House of Glass" series has won the applause of listeners by bringing back "The Goldbergs" to microphone life. Although considerable time lapsed since the script act was last heard, there was every indication that the series retained all of its old popularity when it was resumed—this time on CBS—on a daily, except Saturday and Sunday, schedule. The series is sponsored by the Colgate-Palmolive-Peet Company. The same sponsor also moved the Beauty Box Theatre series of operettas over to CBS on a Saturday night schedule. And a third feature of the firm, "The Gang Busters," is a series of crime dramas, emphasizing law enforcement, the script coming from the pen of the versatile Phillips Lord who had considerable experience with the idea on his former NBC Chevrolet series. The Lord dramatizations are heard Wednesdays.

Home-made Relays

(Continued from page 595)

much less current than is required to close it. This effect will be accentuated if the contacts stick. If the spring is too stiff the armature will move slowly from one contact to the other as the current increases. If a spring of the proper stiffness is not available the point where the spring bears against the armature or the spacing between the armature and the poles of the magnet can be adjusted. Two light springs working in opposition may be used to obtain the same effect.

The adjusting screw can be made by filing down about one-eighth inch of the end of a machine screw. (See Figure 4.) If a nut is put on the screw before filing any damage to the threads will be removed when the nut is taken off.

If the relay is to open and close rapidly the armature should not be too heavy and the spring tension should not be too light. In cases where the spring tension is great enough it may be desirable to eliminate the counterweight.

When the contacts are connected directly to the armature the spring carries the current. The bearings should not carry current. Stranded wire carries the current in case of insulated contacts.

The stationary contacts also act as stops for the armature. Contacts may be obtained from automobile supply stores. The contacts used on gas engines with make and break ignition are good.

The author will be glad to hear from experimenters who build this type of relay and may be addressed in care of RADIO NEWS.

Radio in Czechoslovakia

PRAGUE, CZECHOSLOVAKIA—The number of licensed radio receiving sets in Czechoslovakia showed an increase of 7.6 percent during the first half of 1935. On June 30, 1935, there were 746,353 licensed radio receiving sets of which 741,474 had paid the prescribed monthly fee of 10 crowns.

BRUSH Spherical Microphone



For remote pickup, "P. A." commercial interstation and amateur use. Low in price... but built to Brush's traditionally high mechanical and electrical standards. Wide frequency response. Non-directional. No diaphragms. No distortion from close speaking. Trouble-free operation. No button current and no input transformer to cause hum. Beautifully finished in dull chromium. Size only 2 1/2 inches in diameter. Weight 5 oz. Output level minus 66 D. B. Locking type plug and socket connector for either suspension or stand mounting at no extra cost. Full details, Data Sheet No. 13. Free. Send for one.

BRUSH Lapel Microphone



For after dinner and convention speakers, lecturers, etc. Gives great mobility. The smallest, lightest microphone on the market. Size 1 1/2 x 1 1/4 x 3/8. Weight with coat attachment less than 1 oz. Special internal construction and rubber jacketed outer case insure quiet operation. No interference from breathing noises, etc. Typical Brush sound cell response and trouble-free operation. Details on request.



New! PROFIT GUIDE

JUST OFF THE PRESS!

- 164 Pages
- New Items
- New Prices



The Radolek New 1936 Profit Guide is the most complete Radio Parts Catalog ever published. Completely revised—right up to the minute, bringing you everything in Radio—at the right prices. Every page brings you extra profits! Contains over 10,000 Individual Radio Repair Parts—hundreds of new items—a complete new selection of Receivers, Amplifiers, Tools, Tubes, Books and Instruments. Everything you need—always in stock—ready for prompt shipment to you. You need this Big Radio Parts Catalog—it's FREE. Send for it!

RADOLEK

MAIL THIS COUPON!

Radolek—583 W. Randolph—Chicago

Send The Radolek Profit Guide Free.

Name.....

Address.....
Serviceman? Dealer? Experimenter?

Now—a high-powered—

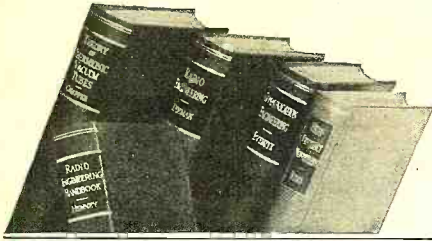

Radio Engineering Library

—especially selected by radio specialists of McGraw-Hill publications.

—to give most complete, dependable coverage of facts needed by all whose fields are grounded on radio fundamentals.

—available at a special price and terms.

These books cover circuit phenomena, tube theory, networks, measurements, and other subjects—give specialized treatment of all fields of practical design and application. They are books of recognized position in the literature—books you will refer to and be referred to often. If you are practical designer, researcher or engineer in any field based on radio, you want these books for the help they give in hundreds of problems throughout the whole field of radio engineering.

5 volumes, 2981 pages, 2000 illustrations

1. Everitt's COMMUNICATION ENGINEERING
2. Terman's RADIO ENGINEERING
3. Chaffee's THEORY OF THERMIONIC VACUUM TUBES
4. Hund's HIGH-FREQUENCY MEASUREMENTS
5. Hendry's RADIO ENGINEERING HANDBOOK

10 days' examination. Special price. Monthly payments. \$26.00 worth of books cost you only \$23.50 under this offer. Add these standard works to your library now; pay small monthly installments, while you use the books.

SEND THIS ON-APPROVAL COUPON

McGraw-Hill Book Co., Inc.
330 W. 42nd St., New York, N. Y.

Send me Radio Engineering Library, 5 vols., for 10 days' examination on approval. In 10 days I will send \$2.50, plus few cents postage, and \$3.00 monthly till \$23.50 is paid, or return books postpaid. (We pay postage on orders accompanied by remittance of first installment.)

Name.....
Address.....
City and State.....
Position.....
Company..... RN 4-36

Get Your Copy
of the
1936 RADIO DATA BOOK
Now!
(See Page 633)

Service Men JUST
CHECK THESE FEATURES!
NEW MILLION
Tube Tester



- ★Emission Type
- ★Metal and Glass Tubes
- ★Neon Short Test
- ★0.10-50-500V D. C. at 1000 ohms per V.
- ★0-5000 ohms
- ★0-1-10-100 M. A.
- ★0-2 megohms
- ★.01 to 3.0 microfarad
- ★Line Voltage Adjustment and Test
- ★3" x 7" x 10" overall
- ★Weight 7 pounds

\$26.95 Net

RADIO AND TELEVISION

MILLION LABORATORIES

381-99 WEST SUPERIOR STREET, CHICAGO, ILL.

The Service Bench

(Continued from page 617)

Union's window display is shown in Figure 5—an eye catcher that performs a dual function in putting over a profitable idea and at the same time providing counter or shelf room for small merchandise, such as tubes, or a midget receiver. This display can be obtained from your N. U. distributor free of charge with the purchase of twenty-five tubes.



FIGURE 5

The International Resistance Company is offering, on a similar free basis, the IRC Resisto-Chest illustrated in Figure 6 with the purchase of \$14.00 worth of resistors (serviceman's net price \$8.23). It is made of multi-ply board, and provides for the systematic arrangement of other small parts in addition to resistors.

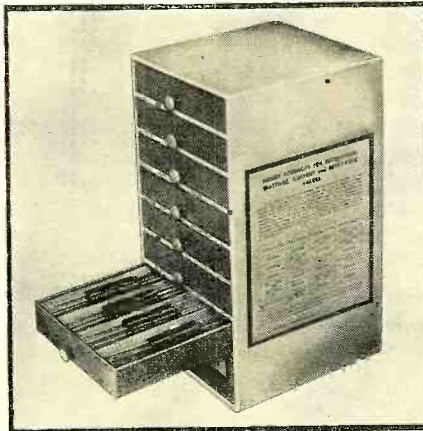

FIGURE 6

Servicemen! Take advantage of these aids—and many others offered to you by manufacturers. They are designed to help you build up a better business!

Anti-Noise Ruling in Hamburg

HAMBURG, GERMANY—The police of the city of Hamburg has notified residents of the city that it will prosecute all persons who violate the ordinance against disturbing the peace by loud radio receivers.

Printed by Art Color Printing Company, Dunellen, New Jersey, U. S. A.

And the Answer to the demand for a quality Magnetic



is the "Hyflux"

- High Efficiency
- Wide frequency range
- Permanent dust proofing
- Rugged construction

Write for Complete Details, Specifications, Prices

WRIGHT-DECOSTER, Inc.

2255 University Ave. St. Paul, Minn.
Export Dept.: M. Simmons & Son Co.
Cable Address: SIMONTRICE, New York
Canadian Office: Wright-DeCoster, Inc., Guelph, Ont.

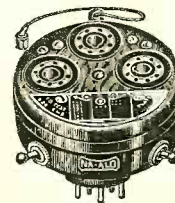

NEW 1936 CATALOG

available shortly. Write today and get your name on our mailing list for this new catalog and the latest authorized information on testing and analyzing the new Octal and Metal Tubes, the new Octal Analyzer Plus, Sockets, Adapters, Grid Caps, etc. 950 GEM on left checks all metal tubes in type 36 sockets of your tube tester. List price \$6.50.

ALDEN PRODUCTS CO.
Dept. RN-4 715 Centre St.
Brockton, Mass.

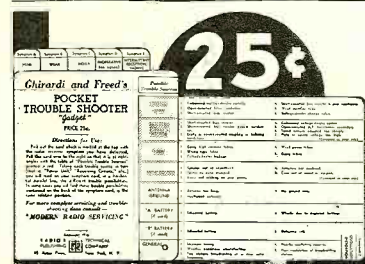

25¢

Ghirardi and Freed's POCKET TROUBLE-SHOOTER

(For Service Men)

The handiest gadget ever invented for servicemen. Gives 275 specific remedies for all types of symptoms and every possible trouble source. Take it with you on all your calls—as a reminder, it saves hours of wasted time and no end of "headaches".

Send Coupon Today

RADIO & TECHNICAL PUBLISHING CO.
45 Astor Place, N. Y. C., Dept. RN-46
 Enclosed find 25c for one of Ghirardi and Freed's Pocket Trouble-Shooters.

NAME.....
ADDRESS.....
OCCUPATION.....

Thousands of Modern
SERVICEMEN are Saying:
**"HAVE YOU SEEN
 DAYRAD'S LATEST?"**



**DAYRAD INSTRUMENTS GIVE YOU
 MORE VALUE PER DOLLAR INVESTED**

The new DAYRAD PATENTED INDEX SYSTEM is just one example of DAYRAD'S consistent leadership. Our Engineering and Research facilities are tremendous. All leading Tube Manufacturers cooperate with us closely. We are always aware of new developments months (sometimes years) before they go on the market. Hence each instrument is engineered from these future requirements. Compare DAYRAD INSTRUMENTS on all points before you buy—precision, price, range, quality of materials, engineering excellence. Get our Catalog by mailing the coupon.

ALL WAVE SIGNAL GENERATOR

\$31.75
COMPLETE

SERIES 36

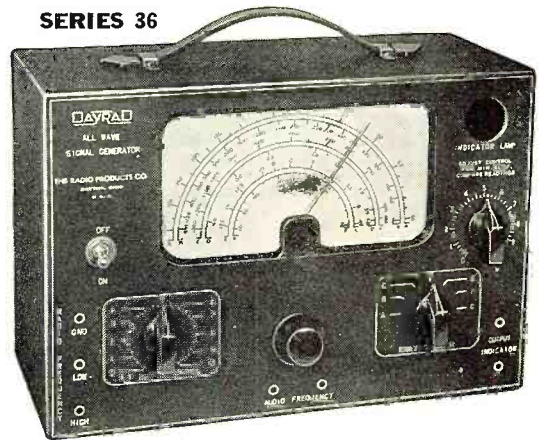

Frequencies to cover all bands—60 K. C. to 60,000 K. C. 5 meters. Six Fundamentals. Self contained Neon Type Output Indicator built in. Extremely wide range makes it adaptable for a great variety of uses and offers untold profit possibilities. Case finished in attractive black crystal. Size: 10 x 7 x 4 1/2". Weight: 10 lbs. Tubes included.



SERIES 20

**DAYRAD TUBE TESTER
 with patented INDEX SYSTEM**

Complete. Size 12 x 11 x 5 1/4". Weight: 9 pounds. Walnut carrying case. Simple as A-B-C to operate. Speeds up testing operations 75%. Tests metal tubes, all octal base and is flexible enough for future use. Reveals faults in from 20% to 30% more tubes!

\$31.75

Both of these DAYRAD INSTRUMENTS are explained in great detail in the new DAYRAD CATALOG. Also full description of other money-making, time-saving DAYRAD INSTRUMENTS. Get your copy of this big catalog without cost or obligation. Mail the coupon at right TODAY!

Genuine DAYRAD INSTRUMENTS are made by
The RADIO PRODUCTS COMPANY
 Subsidiary of BENDIX AVIATION CORP.

126 Sunrise Place

Dayton, Ohio

MAIL COUPON FOR CATALOG OF FACTS



THE RADIO PRODUCTS CO.
 126 Sunrise Place, Dayton, Ohio

Please send at once and without obligation your Catalog of DAYRAD RADIO SERVICE INSTRUMENTS containing full information on the patented INDEX SYSTEM and the two Instruments shown above.

Name..... Street.....

City..... State.....

My Jobber's Name.....

**MAIL COUPON FOR
 LATEST CATALOG**

See us at IRSM
 SHOW, Chicago,
 March 27, 28, 29—
 Booth 30. Register at booth
 and win an instrument!

Again... MIDWEST RADIO

Proves Its Leadership!

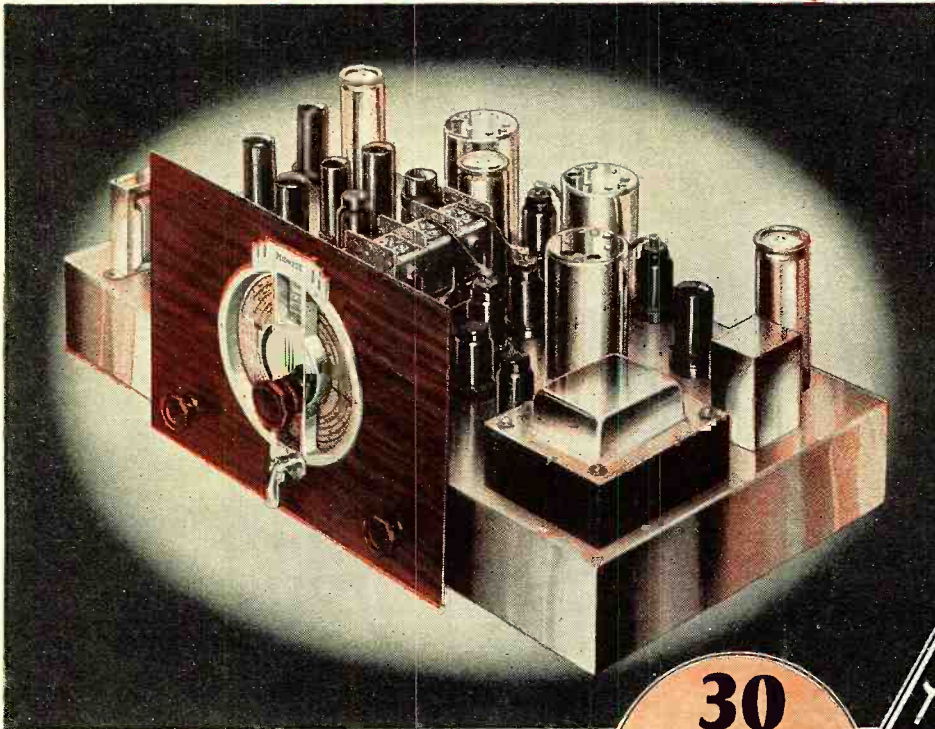

with a
MARVELOUS NEW

14-Tube
FIVE WAVE BAND,
WORLD WIDE SET
9 TO 2400
METERS

DEAL DIRECT WITH LABORATORIES
SAVE UP TO 50%

30
DAYS
FREE
TRIAL

\$39.50
with New
AUDITORIUM TYPE
SPEAKER
(LESS TUBES)

EASY
PAYMENT
TERMS

ONCE again, Midwest demonstrates its leadership by offering the world's most powerful Super DeLuxe 14-METAL Tube 5-band radio. It is a master achievement... today's most highly perfected, precisely built, laboratory adjusted set. It is a radio-musical instrument that will thrill you with its marvelous super performance... glorious new acousti-tone... crystal-clear "concert" realism... and magnificent foreign reception. Before you buy any radio, write for FREE 40-page 1936 catalog. Learn about the successful Midwest Laboratory-To-You policy that saves you 30% to 50%... that gives you 30 days FREE trial. This super radio will out-perform \$100 and \$200 sets on a side by side test. It is so powerful, so amazingly selective, so delicately sensitive that it brings in distant foreign stations with full loud speaker volume, on channels adjacent to powerful locals. The 14 tubes permit of advanced circuits, make it possible to use the tremendous reserve power, and to exert the sustained maximum output of the powerful new tubes.

50 SENSATIONAL ADVANCEMENTS

Scores of marvelous Midwest features, many of them exclusive, explain Midwest glorious tone realism, super performance and thrilling world-wide 5-band reception. They prove why nationally known orchestra leaders like Fred Waring, George Olsen, Jack Denny, etc., use a Midwest in preference to more costly makes. Five tuning ranges make it easy to parade the nations of the world before you. You can switch instantly from American programs... to Canadian, police, amateur, commercial, airplane and ship broadcasts... to the finest and most fascinating programs from Europe, Africa, Asia, Australia South America... 12,000 miles away.

Acousti-Tone V-Spread Design (U. S. Design Patent No. 96750)
The V-Front Dispersing Vanes established a new radio style overnight. They spread the beautiful lace-work of the "highs" throughout the room in a scientific manner... directing the High Fidelity waves uniformly to the ear. Now, get complete range of audible frequencies... achieving glorious new acousti-tone... assuring life-like crystal-clear "concert" realism.

No middlemen's profits to pay. You buy at wholesale prices, direct from Laboratories... saving 30% to 50%. You can order your 1936 Midwest radio from the new 40-page catalog with as much certainty of satisfaction as if you were to come yourself to our great laboratories. You save 30% to 50%... you get 30 days' FREE trial... as little as \$5.00 down puts a Midwest radio in your home. Your are triply protected with a One-Year Guarantee, Foreign Reception Guarantee, Money-back Guarantee.



Ted Weems Enthusies Over Foreign Reception
"After comparing many radios, I can truthfully say that my Midwest out-performs other sets costing almost twice as much. In all my experience, I have never heard such life-like reproduction. My Midwest surpasses all my expectations, and in my opinion, is the finest radio receiver obtainable."
TED WEEMS.



Send for FREE 40-page four-color catalog. It pictures the complete line of beautiful 1936 Midwest Acousti-Tone V-Spread consoles and chassis... in their natural colors.

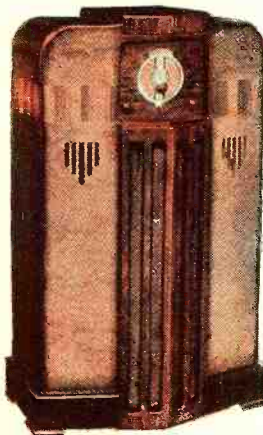

MAIL COUPON TODAY for

Free 30-DAY TRIAL OFFER
and 40-PAGE FOUR-COLOR Free CATALOG

MIDWEST RADIO CORPORATION
Dept. 11-L, Cincinnati, Ohio

Without obligation on my part, send me your new FREE catalog and complete details of your liberal 30-day FREE trial offer. This is NOT an order.

User-Agents Make Easy Extra Money Check Here for details.

Name _____
Address _____
Town _____ State _____
 Check if interested in a Midwest All-Wave Battery Radio

MIDWEST RADIO CORP.
DEPT. 11-L CINCINNATI, OHIO U.S.A.
Established 1920 Cable Address MIRACO All Codes