

**AUTOMOBILE**

**RADIO**

DOUBLE

# **RADIO NEWS**

**MAY  
25 Cents**

*and  
Radio Call Book Magazine  
and  
Technical Review*

**Treasure Hunting  
by Radio**



**A Publication Devoted to Progress and Development in Radio**

**Experimental Research  
Service Work  
Engineering  
Industrial Application**

**Short Waves  
Broadcasting  
Television  
Electronics**

**Electrical Measurements  
DX Reception  
Set Building  
Amateur Activity**

# You Asked Us for this Valuable Book

And Now We Make This New Offer:

**"23 Lessons In Radio"**

**FREE**

With

**5 Issues of Radio News for \$1**

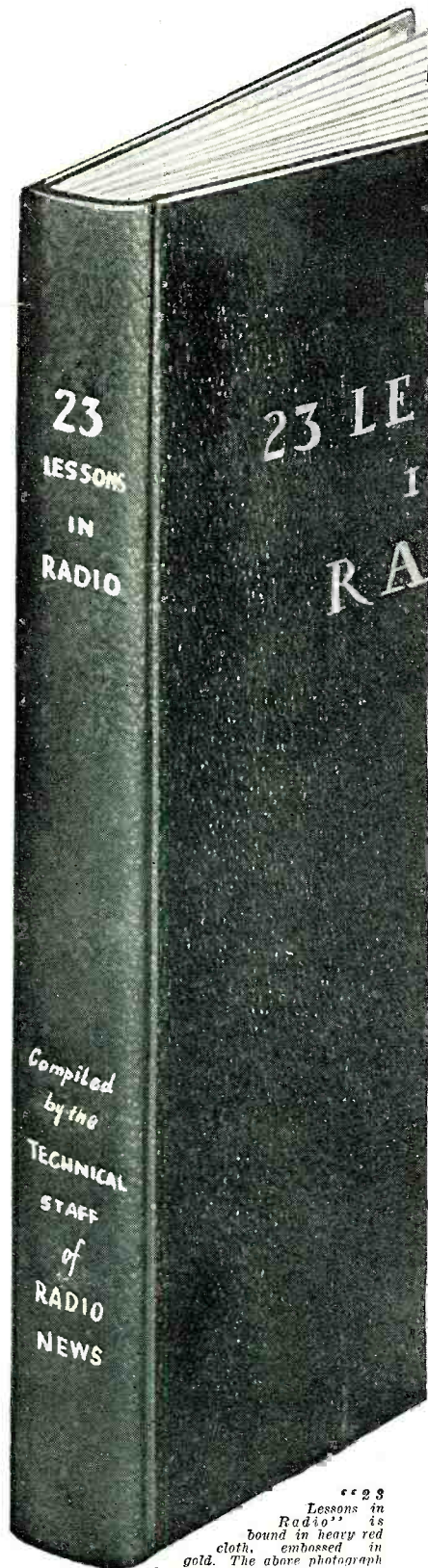

THE response to our January advertisement offering this well-known, cloth-bound reference book free with *Radio News* was so gratifying that we are again offering it to our readers. And, for the first time, we make it possible to obtain this book with a short-term subscription.

Those just beginning radio training—young men needing a reference book containing the fundamentals of radio—more experienced men wanting dope on the essentials—all will find "23 Lessons in Radio" of special value.

You—the readers of *Radio News*—have induced us to reoffer this book, and we are pleased to present it to you free with a short-term subscription.

## A Foundation for All Radio Men

All radio men know the tremendous value of a good background in this field. To be well grounded in the first essentials is the kernel which develops success!

"23 Lessons in Radio" furnishes this background. It is written in clear, concise language and contains innumerable illustrations, charts and schematic diagrams. Just for example, the first few lessons are an exposition of radio principles, and they tell how to build, step by step, a complete 5-tube radio receiver. Later lessons include instructions for building a short-wave converter for this same receiver.

There is a chart explaining the standard radio symbols used in schematic diagrams—a chart of the International Morse Code—and a thousand other things which make this book a thoroughly comprehensive training for the radio set builder, the experimenter, the service salesman and the dealer.

## What Do You Want To Know About Radio?

Here are a few of the subjects covered in "23 Lessons in Radio":—Elementary radio theory;—How the detector tube works;—Construction of a 2-stage audio-frequency amplifier;—How the radio-frequency amplifier works;—How to build a short-wave converter which enables you to listen to police reports, amateur stations, and other short wave stations;—Principles of transmitting and receiving;—Standard radio symbols;—How to build a 3-stage resistance coupled audio-frequency amplifier;—Breaking into the amateur game;—How to build a code test outfit;—Circuit, construction and operating details of a low-power transmitter;—How the vacuum tube works;—How to analyze receiver circuits;—and many other outstanding radio features.

## Take Advantage Of This Special Offer

"23 Lessons in Radio" is not for sale anywhere! But, by subscribing to *Radio News* for a period of 5 months at the special price of \$1 you will receive this great book free! Simply fill out the coupon below and send it to us with your remittance of \$1. We will immediately mail you a cloth-bound copy of "23 Lessons in Radio" and your first issue of *Radio News*.

## Mail This Coupon Today For Your Free Copy!

### RADIO NEWS

222 W. 39th St., N. Y. C., N. Y.

Enclosed please find \$1. Send my copy of "23 Lessons In Radio" by return mail and enter my subscription for the next 5 issues of Radio News. If renewal subscription check here .

Name.....

Address.....

City.....State.....

Are you a Serviceman  Engineer

Dealer  Experimenter

Radio Technician

Canada and Foreign \$1.50 5A

"23 Lessons in Radio" is bound in heavy red cloth, embossed in gold. The above photograph is actual size.



# BE A RADIO EXPERT

## Many Make \$50 to \$100 a Week

### I'll Train You at Home in Your Spare Time for RADIO · TELEVISION · TALKING MOVIES

J. E. Smith, President, National Radio Institute, the man who has directed the Home-Study training of more men for the Radio Industry than any other man in America.



#### Set Servicing

Spare-time set servicing pays many N.R.I. men \$200 to \$1,000 a year. Full-time men make as much as \$65, \$75, and \$100 a week.

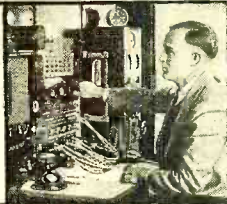

#### Broadcasting Stations

Employ trained men continually for jobs paying up to \$5,000 a year.



#### Ship Operating

Radio operators on ships see the world free and get good pay plus expenses. Here's one enjoying shore leave.

#### Aircraft Radio

Radio is making flying safer. Radio operators employed through Civil Service Commission earn \$1,620 to \$2,800 a year.

If you are dissatisfied with your present job, if you are struggling along in a rut with little or no prospect of anything better than a skinny pay envelope—clip the coupon NOW. Get my big FREE book on the opportunities in Radio. Read how quickly you can learn at home in your spare time to be a Radio Expert—what good jobs my graduates have been getting—real jobs with real futures.

#### Many Radio Experts Make \$50 to \$100 a Week

In about ten years the Radio Industry has grown from \$2,000,000 to hundreds of millions of dollars. Over 300,000 jobs have been created by this growth, and thousands more will be created by its continued development. Many men and young men with the right training—the kind of training I give you in the N. R. I. course—have stepped into Radio at two and three times their former salaries.

#### Get Ready Now for Jobs Like These

Broadcasting stations use engineers, operators, station managers, and pay up to \$5,000 a year. Manufacturers continually employ testers, inspectors, foremen, engineers, service men, buyers, for jobs paying up to \$6,000 a year. Radio Operators on ships enjoy life, see the world, with board and lodging free, and get good pay besides. Dealers and jobbers employ service men, salesmen, buyers, managers, and pay up to \$100 a week. My book tells you about these and many other kinds of interesting Radio jobs.

#### Many Make \$5, \$10, \$15 a Week Extra in Spare Time Almost at Once

The day you enroll with me I send you instructions which you should master quickly for doing 28 jobs common in most every neighborhood, for spare-time money. Throughout your course I send you information on servicing popular makes of sets! I give you the plans and ideas that have made \$200 to \$1,000 a year for N. R. I. men in their spare time. My course is famous as the course that pays for itself.

#### Television, Short Wave, Talking Movies, Money-Back Agreement Included

Special training in Talking Movies, Television and Home Television experiments. Short Wave Radio, Radio's use in Aviation, Servicing and Merchandising Sets, Broadcasting, Commercial and Ship Stations are included. I am so sure that N. R. I. can train you satisfactorily that I will agree in writing to refund every penny of your tuition if you are not satisfied with my Lesson and Instruction Service upon completion.

#### 64-page book of Information FREE

Get your copy today. It's free to all residents of the United States and Canada over 15 years old. It tells you where Radio's good jobs are, what they pay, tells you about my course, what others who have taken it are doing and making. Find out what Radio offers you without the slightest obligation. ACT NOW!

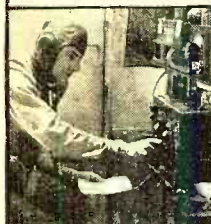

#### Talking Movies

An invention made possible by Radio. Employs many well trained Radio men for jobs paying \$75 to \$200 a week.



#### Television

The coming field of many great opportunities is covered by my course.



## Special Free Offer

Act now and receive in addition to my big free book, "Rich Rewards in Radio," this Service Manual on D.C., A.C., and Battery operated sets. Only my students could have this book in the past. Now readers of this magazine who mail the coupon will receive it free. Overcoming hum, noises of all kinds, fading signals, broad tuning, howls and oscillations, poor distance reception, distorted or muffled signals, poor Audio and Radio Frequency amplification and other vital service information is contained in it. Get a free copy. Mail the coupon.

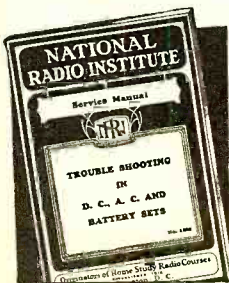

THIS COUPON IS GOOD for One FREE COPY OF MY BOOK

mail it now

J. E. SMITH, President  
National Radio Institute, Dept. 3 ER  
Washington, D. C.

Dear Mr. Smith: I want to take advantage of your Special Offer. Send me your two books, "Trouble Shooting in D.C., A.C. and Battery Sets" and "Rich Rewards in Radio." I understand this request does not obligate me.

Name.....Age.....  
Address.....  
City.....State..... "M"

S. GORDON TAYLOR  
Technical Editor

WILLIAM C. DORF  
Associate Editor

JOHN M. BORST  
Ass't Tech. Editor



HOWARD S. PEARSE  
Associate Editor

SAMUEL KAUFMAN  
Broadcast Editor

JOS. F. ODENBACH  
Art Editor

Edited by LAURENCE M. COCKADAY

VOLUME XIV

May, 1933

NUMBER 11

## CONTENTS

(Cover Design by Morey)

S. O. S. By Frank Petraglia.....	PAGE 647	Grid Glow Tubes By M. J. Brown.....	PAGE 658
Prospecting for Treasure By Irving J. Saxl.....	PAGE 650	An A.C.-D.C. Miniature Receiver By H. G. Cisin.....	PAGE 660
Mathematics in Radio By J. E. Smith.....	PAGE 653	Two New Tubes By J. van Lienden.....	PAGE 662
Modernistic Broadcasting By Samuel Kaufman.....	PAGE 654	Short-Wave DX Reception (Part 2) By W. H. Reeks.....	PAGE 664
DX Receiver Design (Part 3) By C. H. Long.....	PAGE 656	Graphs and Charts (Part 8) By John M. Borst.....	PAGE 666

## RADIO CALL BOOK SECTION

Broadcasting Stations in the U. S. By the Staff.....	PAGE 668	Testing a Commercial S.W. Super (Part 2) By the Staff.....	PAGE 676
The DX Corner By the Staff.....	PAGE 670	Modern Auto Radio By S. G. Taylor and J. M. Borst.....	PAGE 678
What Tube Shall I Use? (Part 5) By Joseph Calcaterra.....	PAGE 672	Service Data for Servicemen By the Staff.....	PAGE 680
I.F. Transformer Design By A. A. Webster.....	PAGE 674	The Technical Review By Joseph Calcaterra.....	PAGE 681

## DEPARTMENTS

The Service Bench.....	PAGE 684
With the Experimenters.....	PAGE 686
Backstage in Broadcasting.....	PAGE 688
Latest Radio Patents.....	PAGE 690
Students Radio Physics Course.....	PAGE 692
What's New in Radio.....	PAGE 694
QRD.....	PAGE 696

Published Monthly by Teck Publications, Inc., Washington and South Avenues, Dunellen, N. J.

### OFFICERS

Lee Ellmaker, *President*  
Warren P. Jeffery } *Vice Presidents*  
Huston D. Crippen }  
Paul Diffenderfer, *Treasurer*  
Abner Germann, *Secretary*

EDITORIAL AND EXECUTIVE OFFICES  
222 WEST 39th STREET, NEW YORK CITY, N. Y.

Entered as second class matter at the Post Office at Dunellen, N. J., under the act of March 3, 1879. Copyright, 1933, by Teck Publications, Inc. All rights reserved. Title Registered at the U. S. Patent Office. Printed in the United States of America. The contents of this magazine must not be reproduced without permission. We cannot be responsible for lost manuscripts, although every care is taken for their safety.

25c a Copy, \$2.50 a year,  
\$3.50 in Canada, \$3.50 in  
Foreign Countries. Sub-  
scribers are notified that  
change of address must reach  
us five weeks in advance of  
the next day of issue.

# SCOTT TAKES 20,000-MILE CRUISE TO GIVE RADIO ANOTHER HARD TEST

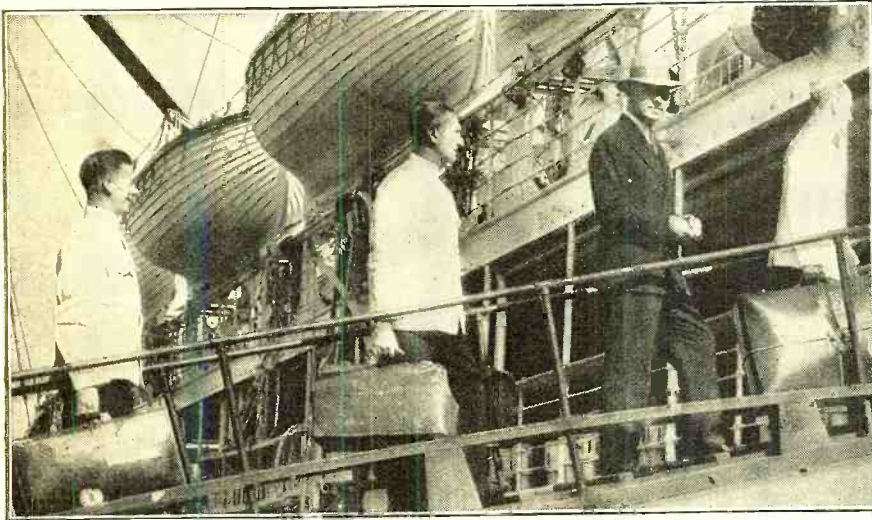

E. H. Scott, designer and builder of the famous Radio Receiver bearing his name, boards the SS. Maunganui to start 20,000-mile cruise.

## WORLD-WIDE RECEPTION GUARANTEE BASED ON CONSISTENT PERFORMANCE

Backing the Scott All-Wave Deluxe Radio with a positive guarantee of consistent world-wide reception, with loud speaker volume, of foreign stations 10,000 miles or more distant, was not justified by scientific laboratory tests alone. Rather such tests, under actual owner-operated conditions, as the reception in Chicago of every program broadcast from VK2ME and VK3ME in Australia (9,500 miles distant) throughout an entire year's time, were considered more conclusive. Likewise were the more than 19,000 verified foreign reception logs submitted by Scott owners within a six months' period contributory to the

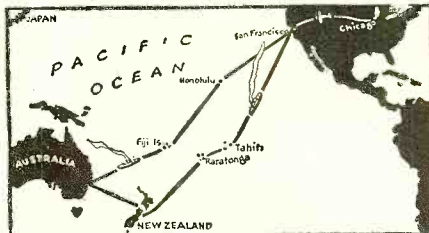

Here is the route of E. H. Scott's long cruise, undertaken to test reception under most difficult conditions.

maker's decision to back his receiver with such a startling warranty. On his present 20,000-mile experimental cruise Mr. Scott will cover many localities where radio reception is extremely difficult. He is wholly confident that even in these so-called "dead spots" his set will function perfectly for him as it is doing for many owners in places where radio reception was always before considered impossible.

### WORLD-TRAVELING RECEIVER

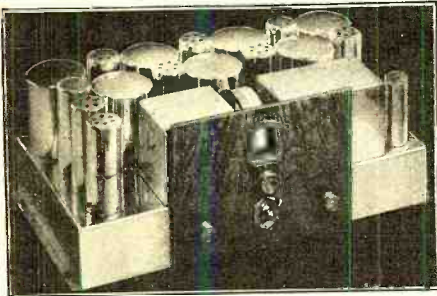

This Scott All-Wave Deluxe Radio which Mr. Scott is using on his research trip is an exact duplicate of the custom-built sets sold to discriminating buyers. It receives broadcasts on all wave lengths between 15 and 550 meters. Of true one-dial type, it uses no trimmers or auxiliary tuning dials, and has no plug-in or tapped coils or other old-fashioned wave band-changing devices. It is equipped with automatic volume control, visual tuning, static reducer, and every new scientific betterment of proved value. Despite its tremendous distance range, high selectivity, absolutely natural tone, and general excellence, it is sold at a remarkably moderate price.

## Research To Prove Perfection Of Scott All-Wave Deluxe

E. H. Scott, whose genius created the marvelous SCOTT ALL-WAVE DELUXE RADIO, sailed recently on an adventurous 20,000-mile voyage to give his receiver still another series of gruelling reception tests.

Thousands of miles from any land the SS. Maunganui plows her way down the trackless Pacific enroute to New Zealand. Her passengers are gay as they gather in the luxurious Grand Salon each evening. They enjoy an excellent dance orchestra's rhythms. The tunes come from a loud-speaker that reproduces the music of orchestras six or seven thousand miles away, back in "the States."



E. H. SCOTT

To E. H. Scott, and the world's-record-shattering receiver which he designed and builds, must go all the credit for this exceptional feat. But bringing music, daily news flashes and other radio treats to the Maunganui's company is but a small part of the thorough research Mr. Scott is carrying on during his cruise to test his receiver. From his experimentation with the Scott All-Wave Deluxe, which is his most important piece of baggage, will come new inspiration and still further justification of the consistent world-wide reception guarantee under which this radio known as "The World's Finest Receiver" is sold.

The radio-wise will watch with interest for final reports of Mr. Scott's research. They confidently expect news of the breaking of still more reception records as one outgrowth of this long trek.

## ENTHUSIASTIC OWNERS CONTINUE TO LAUD PERFORMANCE OF ALL-WAVE DELUXE

Letters expressing perfect satisfaction with the marvelous Scott All-Wave Deluxe Radio pour into the Scott Laboratories daily. Here are excerpts from a few recent ones: "Most sensitive radio I have ever seen," SGP, Ala. . . . "Nothing finer in tone—in fact, perfect in every way," FW, Calif. . . . "Stations all the way from Berlin to Tokio and Australia," . . . JBT, Conn. . . . "Foreign reception every day. France best—Rome, England, Germany and Spain come in very good," RPH, Conn. . . . "Tone cannot be improved—it is already perfect," GL, N. Y. . . . "Australia with the volume of a local station," Dr. HPC, N. Y. . . . "Amazed at results—would not take \$500 in exchange for it," JLI, Pa. If you would

like such a set—the ultimate in radio ability—why not send NOW for all details regarding it?

### SEND COUPON AT ONCE!

E. H. SCOTT RADIO LABORATORIES, INC.  
4450 Ravenswood Ave., Dept. N-53, Chicago, Ill.

Send me all details regarding the SCOTT ALL-WAVE DELUXE RADIO, including technical data, performance proofs and prices. This is not to obligate me.

Name .....

Address .....

Town..... State.....

# The Editor—to You

IN presenting the series of articles on long-distance receiver design for the broadcast band, RADIO NEWS feels that it is giving a service available through no other agency. The installment in this issue gets down to actual construction details and the ability of the receiver has been proven to bring in stations to the central part of the United States from Australia, China, Japan, Europe and other distant lands, on the broadcast band.

\* \* \*

BEFORE this series was presented, the Editors made a careful search for individuals who claimed such outstanding reception and finally decided upon Mr. Long to do this work. Accordingly, when the design was completed the Editors arranged with the National Radio Institute to have three graduate radiotricians of the Institute go to Mr. Long's laboratory and actually sit in at a session of broadcast DX listening, to verify the results accomplished with the finished set. So the three graduates presented themselves on the evening of February 25, 1933, to listen in. Printed below are the three reports made by these men to our Editors:

\* \* \*

"ALONG with a party of two others, we presented ourselves to Mr. Long, and he showed us a series of verification letters from the following stations: 4BC, Brisbane, 750 watts; 3LO, Melbourne, Australia, 300 watts; 4MK, MacKay, Queensland, 100 watts; 7LA, Lancaster, Tasmania, 200 watts; 5AD, Adelaide, S. Australia, 300 watts; 2YA, Wellington, New Zealand. JOAK, JOCK, JOHK and JOGK, all 10 kw., Japanese, and COHB, China, at 1 kw.

"At our listening post it was about 2:30 a.m. before anything began to come in. QRN was rising to a very high level. I stepped over to the machine and picked up a strong signal which turned out to be HJN, Bogota, Colombia, South America. The time was 2:30, strength about R8. CMJK or CSMJA, Cuba, came in R5. Later at 4:15 a.m. we received 2YA, Wellington, New Zealand. Mr. Long demonstrated the sensitivity and selectivity of the machine. He tuned in WABC, New York, with good volume with only a four-inch antenna. We used the loudspeaker throughout the entire evening and believe we could have done much more if the QRN had not been so strong. Between 2:30 and 6:30 a.m. we picked up the carriers of nearly all the Australian stations."—H. E. Gamble, St. Joseph, Mo.

\* \* \*

"ON the night of February 25, Mr. Gamble, Mr. Wheat and myself sat in on a DX session with Mr. C. H. Long of Winston, Missouri. Mr. Long's receiver is the only receiver I have lis-

tened to that will bring in transpacific stations on the regular broadcast band with loudspeaker volume. The receiver is extremely selective (less than 10 kc.) and has tremendous sensitivity. There must have been a tropical storm off the Pacific coast, as the static was terrible. I am sending a list of stations received distinctly and with plenty of volume, while I was listening. HJN, Bogota, Colombia, South America, 684.9 kc., at 2:30 a.m.; 2YA, Wellington, New Zealand, 719 kc., at 4:15 a.m.; 4QG, Brisbane, 760 kc., at 5:00 a.m.

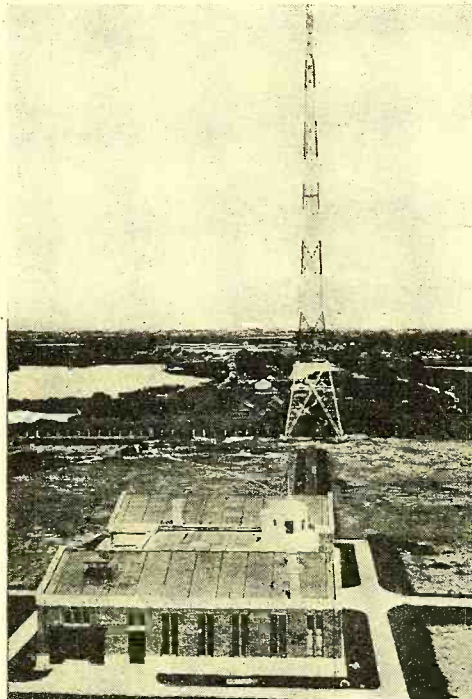

"We heard other Australian stations, but the static was so bad we could not catch all the call letters. Mr. Long showed me letters of verifications he received from Australia, New Zealand and other foreign countries. Station 4TO, Townsville, Australia, 1170 kc., reports that Mr. Long was the first to receive their station in the United States. Station 2UW, Sydney, Australia, 1125 kc., reports likewise."—Chester Lee Walker, St. Joseph, Mo.

\* \* \*

"I SAT in on a DX program at Mr. C. H. Long's home in Winston on the night of February 25, 1933, and heard the following stations: HJN, Bogota, Colombia, at 2:30 a.m., frequency 684.9, aerial watts 2000; 2BL, Sydney, Australia, at 4:55 a.m.; 4QG, Brisbane, Australia, 5:00 a.m.; 2BL, Sydney, Australia, at 5:15 a.m.; CMJA, Cuba, 790 kc., 3:49 a.m.; 2YA, Wellington, New Zealand, 4:15 a.m.; 2BL, Sydney, Australia, 4:45 a.m. Also heard JOAK and JOHK, Japan, shortly after 3:55 a.m., but extremely weak. The night was

clear, locally, but there was a lot of static which made reception noisy. Mr. Long has many letters that he showed me from foreign stations verifying program reception. Mr. Long's set is sensitive and very selective. We received Pacific Coast stations with a one-inch-long antenna. All of the stations were heard on the loudspeaker. Mr. Long's set has eleven tubes, and all the stations were heard on the broadcast band between 200 and 550 meters."—R. O. Wheat, St. Joseph, Mo.

\* \* \*

THE photograph reproduced on this page shows the station layout of a new broadcaster at Nanking, China. The call letters are XGOA and the transmitter has a power of 75,000 watts and transmits on a frequency of 680 kc. The transmitter is of Telefunken design. We are wondering whether any of our readers have been able to pick up their signals.

\* \* \*

So many of our readers have requested information on DX clubs and associations that we have made a survey of this field and find that there are a number of these clubs in which membership is invited. We list a few of them below:

\* \* \*

INTERNATIONAL Short-Wave Club, with headquarters at Klondyke, Ohio, U. S. A. This organization started in October, 1929, with a membership of three. It claims membership, now, all over the world and publishes a monthly bulletin entitled "The International Short-Wave Radio," containing short-wave information collected from members all over the world. The president of this club is Arthur J. Green.

\* \* \*

THE New England Radio Club, Worcester, Massachusetts, is composed of members residing principally in New England, but its roster has extended to reach all parts of the United States and Canada. Twice a month a DX "tip" sheet is mailed to members from September to May and once a month during the summer. The club frequently goes on the air over WTAG. The officers are: President, Roy Sanders, and Executive Secretary, Frederick L. Rushton.

\* \* \*

TRANSCONTINENTAL DX club, Hawthorne, New Jersey. This club is open for membership to sincere DX listeners and its members correspond with each other. The president is Ralph H. Schiller.

*Sturcell Lockaday*



### The Leader in Short-Wave Activities

*I heartily congratulate RADIO NEWS on taking the leadership in the field of short-wave reception. I feel that its policy in presenting to readers the latest information on receiving equipment and in preparing, in the DX Corner, an actual time-table of transmissions of the world's best-heard short-wave stations is a progressive one. In the past the listener has been handicapped by lack of knowledge of when to listen for particular short-wave transmissions. This new feature, I feel, will develop into an item of greatest importance to the short-wave fan.*

*L. A. Hammarlund*

Hammarlund Mfg. Co.

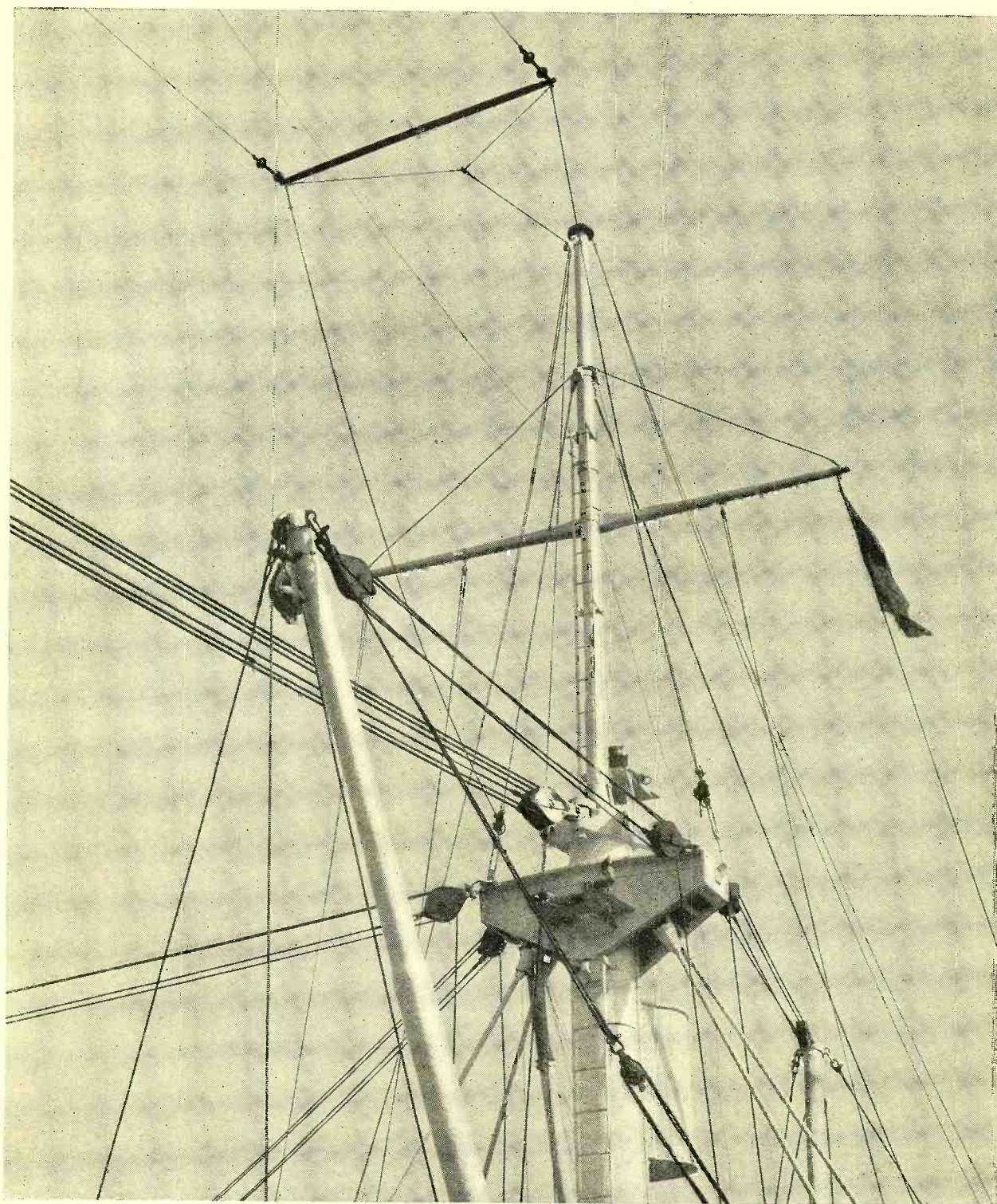

### A Symbol of Safety at Sea

*Flying high in the ship's rigging is that symbol of communication with the outside world, the wires, insulators and spreaders of the radio antenna, giving to passengers and crew alike a feeling of reassurance that in whatever emergency, help can be called and a speeding vessel sent on its mission of rescue. The radio operator, therefore, becomes the "high priest" of mercy and should be well trained in the seeming mysteries of radio procedure, maintenance and operation of his equipment. He is indirectly responsible for the safety of every man aboard.*



# Radio News

VOLUME XIV

May, 1933

NUMBER 11

## S. O. S.

Being a true story of the predicament in which a "green" operator found himself on his first trip to sea. And although he came through with flying colors he admits that a little more attention to details while studying for the job would have prepared him for any emergency

"EVER been to sea before?"

"No sir," I answered, with appropriate brevity (my sea experience until then had been confined to ferry-boats and excursions up the Hudson).

"You mean to say this is your first trip?" the Captain stared hard at me.

"Yes sir, but . . . I shall be able to handle everything all right. I'm a licensed, first class operator," I hastened to reassure him.

"This is a hard run—no trip for a greenhorn operator. Suppose you get seasick, what then? Well . . . think you can get the weather reports alright? We want plenty of weather reports on this run."

"Yes sir," again.

"Alright, sign here." And I signed on. "Here's the key to the wireless room. Remember those weather reports and let me know of any important changes."

I stumblingly made my exit from the Captain's cabin and found the "shack" situated, together with my private cabin, on the well-deck forward amidships. One port of the shack looked aft, the other starboard to the sea. With trembling hands I opened the door into ship-station KEKL and now I must confess that I was perhaps the greenest operator that ever crossed the threshold of a wireless room. I felt myself in the clutches of a nightmare as I surveyed, for the first time, the five square feet of induction coils, rheostats, meters and what not to which I had been assigned.

What accounted, I suppose, for my presence on board the *S. S. Saguache*, a 4,000-ton freighter bound for remote Scandinavian ports, was the fact that I had been hired in an emergency. Not another

By Frank Petraglia

single operator in town. Otherwise I would have made my first trip at sea in the usual manner, as "Junior"

on some passenger ship and so would have left all the worrying to the chief operator. But as I entered the room, I can tell you I felt like a "bundle of sparks sitting on a barrel of dynamite." In fact, if you ask me how in the world I managed to pass the Government tests I will tell you—the Question and Answer book did the trick. (I had been lax, I realize, in studying my course at the radio school.)

So within an hour of receiving my assignment I dashed with grip in hand, Question and Answer book, enthusiasm and all into Pier 18, East River, then up the *Saguache's* gangplank and after ducking booms, cables, derricks and open hatch holes, presented myself panting and perspiring to her Master, Captain Bendetti. It was then that he, eyeing my beardless 20-year-old physiognomy, asked

the momentous question, "Ever been to sea before?"

Here I was stepping into the door of KEKL and glancing in alarm at my first impression of coils, switches, and equipment, my first thought was a hope that it was all in good order and after about an hour looking around, after hanging up my newly acquired commercial license on a nail in the wall, I found that I was supreme master of a two k.w. quenched-spark transmitter, high-wave receiver with honeycomb attachment, Navy type control panel, typewriter, etc. I was in a blue funk!

The fun began for me as the *Saguache* plied her way to sea through the waters of Manhattan; Captain and mates keeping a sharp lookout on the bridge. Seamen raising booms as the rumble mingled with whistling

### 27 Survivors Of Ocean Wreck Tell Thrilling Story

Crew Of American Liner *Saguache* Braves Storm And Darkness To Save Lives Of Those Aboard Sinking *Roedelheim*—Two Perish When Life Boat Is Smashed—Another Epic Added To Sea Annals

Battered by enormous seas and tossed about by gale winds most of the 18 days, she had been out of Emden, Germany, with a cargo of pulp for Boston and New York, the *Roedelheim* was in a helpless condition on Sunday, Jan. 6, about 500 miles off Cape Race. She was taking water fast and the pumps could not cope with the situation. Cracking in the middle, the vessel threatened to break up at any minute.

After a desperate fight to save his ship, Captain Dietrich Ziegler, veteran of the sea for 24 years, himself sent out the first distress signal. The day was cloudy. There were high seas and furious winds. At 1:30 p. m. Frank Petraglia of New York, "Sparks" aboard the *Saguache* received a message from the *Roedelheim* stating that the ship was not yet sinking, but that it was making water fast.

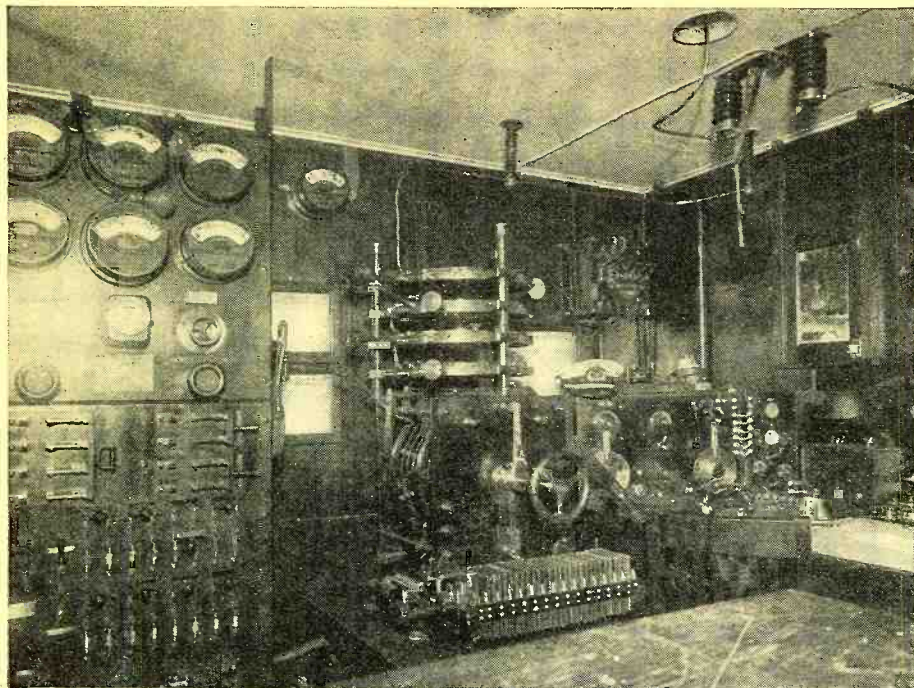

A MAZE OF INSTRUMENTS, SWITCHES, WHEELS AND GADGETS  
*The view that confronted the author's inexperienced eyes as he entered the "wireless" room of the first ship he took to sea as an operator*

November breezes. In the radio shack your greenhorn wireless operator, already dubbed "Sparks," wondered how to start up his set to give his TR to a coast station. With nose stuck into "First Principles of Radio Telegraphy," I finally gathered enough courage to push the generator button. Following book rules, I extended a shaky hand to the transmitter panel, turned the generator rheostat to increase armature speed to raise the indispensable e.m.f. Then I set the wave, coupled the oscillation transformer as I pressed the key, when—CRACK! CRASH! Well, what was that? Investigation revealed that the headphones, plugged into the amplifier, were resting on the oscillation transformer. Two amplifier tubes were blown. I finally replaced them (only one spare tube is left—and 3500 hundred miles to go!).

All set again, with pounding heart and shaking fist I called Tuckerton. (It took a long time to tune WSC in through the harbor QRM.) Tuckerton takes my TR. At the key, KEKL sounded like a glass-fisted Chinaman afflicted with delirium tremens. And that was for the first night out.

#### *Just One Thing After Another*

Other similar disconcerting experiences followed. I didn't get a weather report accurately until the third day out, although I got plenty of comment from the bridge. Captain Bendetti, already prepared for the worst, apparently, took it easy with me, for which I was indeed grateful.

On our first day at sea, after missing NAA Weather on the daily broadcast, I was told to get a time tick. I tuned in the tick well enough, but got my minute count mixed up. As you know, five sixty-second ticks are sent in succession, but it is a bit difficult to get the order of them accurately on first trial. After I had muffed the first three, the second mate, who was taking my confused signals on the bridge end of a speaking tube, came bursting into the shack, grabbed the earphones from my head and checked the last two minutes himself.

When I went to the upper deck to replace two sets of antenna insulators, the Bo'sun and seamen who assisted me in lowering the "L" type apparatus, asked me when I was going to make up "press." I had heard before that saying "static" was generally a good excuse. So I offered it as the reason why they had gone without their daily news that day. But on noticing my bewilderment with the insulator replacement job, their suspicions became fact and one of them spoke up: "Is this your first trip, Sparks?" However, on the first day out, after sleepless nights, I managed to tune in WII for press. Yes, the hot spots came in rapid but, fortunately, descending series. A little more attention to my training at school while I was taking my course would have saved

me all the grief and embarrassment.

A particularly tough assignment came when I had to get a radio bearing. Calling VCT, the government station at Newfoundland, I gave up after a half hour's pounding at the key. "Try again," I was ordered. Again I tried, breaking all radio regulations, unknowingly, by making continuous three and perhaps five-minute calls. VCT never answered. But I was enlightened when a ship called me, saying: "VCT has been calling you for the past half-hour. Tune him on CW." He might just as well have said "tune him on XYZ." Well, sir, I threw condensers, coil and ticker into so many juxtapositions that I couldn't possibly miss—allowing for time, of course. VCT, when I got him, lectured me briefly. He knew my trouble.

All of which certainly sounds like a sad commentary which does me not the least credit. My mistake was all on the side of enthusiasm, without intensive application to thorough training when it was well within my grasp. I had merely muddled through a really fine and comprehensive and practical school course. Had I completely mastered the training given me while a student of wireless, I would have been, without doubt, a

competent man for my job. Considering the responsibility attached, I was, on that first ship, recklessly gambling with the life safety of myself and thirty-two others. Reckless it certainly was—and perhaps criminally so.

Of course, I had to go through with it, regardless of regrets which made themselves felt immediately. I worked double time and overtime, both with the apparatus and my "First Principles," to make up for lost time. The *Saguache*, however precariously guided by her radio, finally reached the Baltic. Copenhagen, Stockholm, Gutenberg and Helsingfors occupied us a month. The trip across had been high, wild and furious, with regard to weather. We rocked and pitched the limit on every day of the fourteen-day run. Large doubts, of course, often crept into my mind, but seeing how the others on board took the weather nonchalantly, I dismissed my attacks of chicken-heartedness as due to lack of familiarity with the sea's moods. Only I used to have the hardest time walking straight. It took a while to acquire "sea legs." I was highly qualified, and lucky, in just one thing—I never got seasick.

The highlights of that dramatic voyage came on the homeward stretch. Practically since our first day out from Copenhagen (the last port) we encountered mountainous seas and terrific gales—harmful babies whistling along at a gentle pace of ninety miles an hour. For days we rocked and pitched without let-up; waves swelled to tremendous height and broke down on our decks with a shattering force which often brought a pale look into many a seaworthy face on board.

#### *The Antenna Cracks Up*

I constantly feared the antenna might be blown away. My fears were justified when the antenna broke loose at the lead-in. In that rough and rocking weather I had to go to the upper, open bridge deck and mend the trouble while risking being swept unceremoniously over the side.

It was on our eighth day out when I picked up signals from a vessel in distress. Fortunately for the smitten ship, the weather was the calmest we had had so far. I had just come into the shack after putting down a substantial meal, and stretched out with a politician's sense of comfort, to work off the effects of a satiated appetite. I had a half hour yet before I would tune in to exchange TR's and weather reports with ships nearby. There were always a half dozen "ops" on the air, so it was no trouble to keep the bridge supplied with weather reports of conditions about. Coast station broadcasts do not cover the mid-Atlantic areas, therefore ships depend on direct interchange for information. This gave us "ops" a chance for exercise at the key. Consequently the unofficial broadcast at noon was a lively half-hour of maritime and fra-

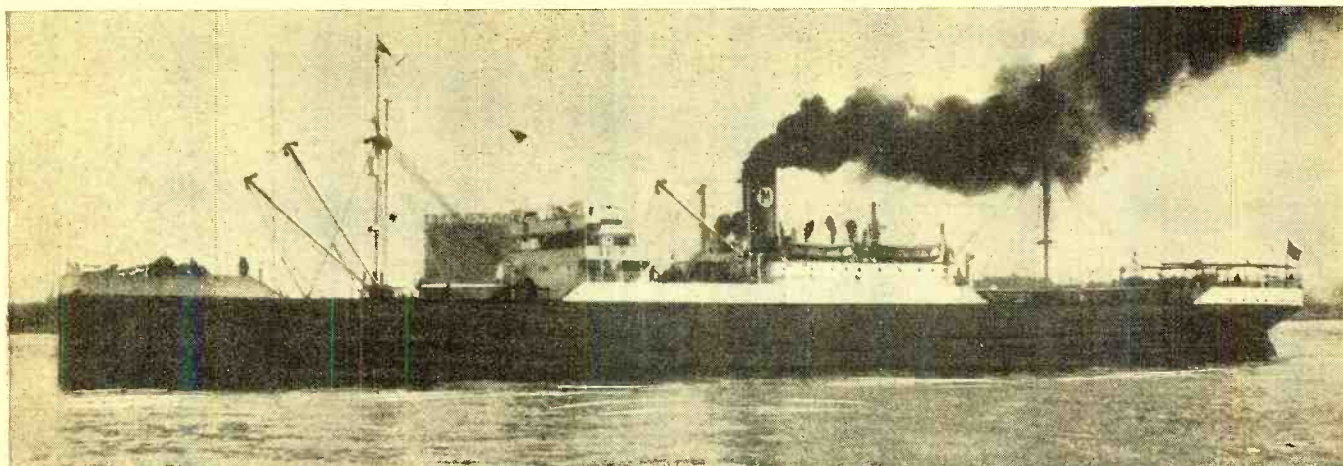

STEAMING DOWN THE HARBOR ON AN EVENTFUL VOYAGE

*The casual observer on the shore, seeing the author's ship passing downstream, could give no thought to the adventure lying in store for the officers and crew of this vessel as it glided along smoothly with belching funnel. But to the operator on his first trip its amazing array of derricks, machinery and unaccustomed activity produced the thrill felt once in a lifetime*

ternal exchanges. The company out there was congenial and international. English, French, Spanish, German and Japanese—to mention only a few—participated in the "WX."

I sat a while idly, then turned on my receiver switch, tuned on 600. The boys should be warming up by now, I thought. Without reading the signals, I heard just one operator on the air. They're making a late dinner of it, I concluded.

But the dramatic answer to the situation suddenly struck home with all the force of a bat clipping off a homer.

I listened with muscles taut and ears intent to the hoarse dots and dashes of a rasping spark note as it spelled out fateful words revealing the critical situation:

"We are making only four knots against strong head wind, but are proceeding to your position. Should take about five hours to reach you. Are you badly water-logged?"

The words fell on what seemed a long, dead silence. With careful slowness the spark note called again, and I got both ships' letters: DDHH de KOTN.

"SPARKS" QUARTERS

*A simple bunk, a typewriter desk and crowded walls serve as "home" for weeks at sea*



KOTN sent QSU?—to ascertain whether his communication had been received. But again, silence, in which I pictured every operator who had heard sitting closer to his receiver, generator running and hand to key, ready to be of assistance.

There must have been many sighs of relief when DDHH, equipped, as I found later, with a half kw. spark transmitter, slowly and feebly answered:

"Please repeat slowly."

Realizing we must be nearby, since the signals of both ships came in strong, I snatched at the opportunity to get our position while KOTN repeated his message to DDHH, and then I dashed up a flight of stairs to the bridge. Bursting into the pilot-house, I explained my heated entry with: "There's a sinking ship nearby. Let me have our position report." The captain waved to the second mate, who immediately went to his charts and wrote down Lat. . . . Long. . . . As I darted down the stairs, the captain called out after me:

"Get her correct position and find out what condition she's in."

Returning to the earphones, I found KOTN midway in the repetition of his message to DDHH. I waited until DDHH had sent him an "R." Meanwhile I grabbed up my copy of the International Call Book to identify the ships. DDHH was the S.S. *Rodelheim*, a German freighter. KOTN was an American freighter.

On Deck for the Rescue

When DDHH gave KOTN a "wait" signal, I called the American ship. I shot back with a speedy, curt "K." I asked for the *Rodelheim's* position, saying we might be nearer to her. When he gave me the position, I could see there was a difference of a few degrees in the readings, so I figured that couldn't be much, counted in miles. Then I gave KOTN the *Saguache's* noon TR, and he came back quickly with:

"You're nearer to DDHH. Inform your captain."

DDHH, apparently having difficulty with the English language, called KOTN and spelled out with painful slowness:

"Maybe we hold out but pumps no good, but cannot save ship—come quick."

Captain Craft was standing in the doorway of the shack. I handed him the *Rodelheim's* position.

"They're not far off. You sure this is the correct position?"

I gave him also the *Rodelheim's* last communication.

"Tell them we're steering our course towards them and should be alongside in two hours."

KOTN then stood by as I called DDHH. Understanding he was having difficulty, I transmitted very slowly. I told him we were nearer, the time required, and even added superfluous words of encouragement—"coming full steam ahead."

Preparations on board the *Saguache* began immediately. All hands were called on deck. Steam was gotten up for the winches. The crew was arranging ropes and ladders to have them in readiness. The steward came to inquire of me how large a company of unexpected guests we would have so that he might get up adequate supplies of food and hot coffee.

However, I immediately called (Continued on page 691)

# LATEST METHODS FOR USING PROSPECTING

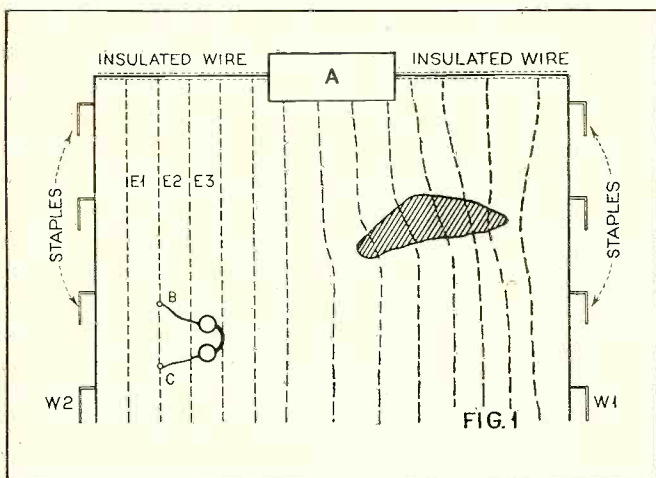

THE EQUI-POTENTIAL METHOD

Figure 1. Diagram illustrating system for locating buried metal by plotting equi-potential lines of force with a buzzer and headphones

FROM the ancient alchemistic "gold-makers" to the atom-splitting scientists of today, gold has exerted a great influence upon mankind. It was probably the first metal known to prehistoric man, as it existed in its glittering metallic state in streams and seams in the naked rock.

But it is not always gold in the form of the yellow metal that is sought by prospectors of today. There are other sources of natural supply, other minerals that pay lavishly if they are discovered. Oil, mineral ores, as well as sunken "loot," are hidden below the almost unknown crust of our earth. Their lure has spurred man on to conquer the depths of the oceans with special diving equipment, to suffer the hardships of the icy north and the perils of the impenetrable jungles. The quest for gold drove the Spanish conquerors over the unknown water desert. In all ages the quest for gold has enslaved adventurous spirits of men, whether it is a gold rush like the era of the forty-niners or other forms of gold prospecting more appropriate to 1933.

Everything in the way of scientific equipment has been put at the disposal of the gold seekers. All the methods of technical approach have been used in the hunt for gold. Now comes radio and adds to this everlasting strife for gold new

*So many hundreds of letters have the last six months on the possibility minerals by radio methods that we the field of geophysical applications article for RADIO NEWS. Described methods, including electrical, strictly with the necessary data for making*

By Irving J.

methods of prospecting, new possibilities which, though only a beginning, give justified hope for greatly expanded exploration of hidden treasures below our feet. There are various methods for approach to this problem, all of which depend upon some fundamental physical characteristic of the material which we may not notice directly with our eyes.

What do we know of the interior of this earth, a globe with almost eight thousand miles of diameter? We have not even scratched its surface! Yet geological and geophysical methods have substituted the guesswork and the "magic" methods of medieval divining. Rocks are shattered with heavy blasts of dynamite and the waves through the different layers of the ground are recorded with sensitive seismographs, while the actual time of explosion is transmitted by radio impulses sent out simultaneously with the initial charge. The weight of large amounts of heavy deposits make the torsion balances of Eötvoës swing lower and magnetic minerals influence the compass needle.

The investigating methods, however, which at present are the center of the interest of men controlling the heavy investments of the mining industry, are moving more and more toward the electrical exploration of the ground, particularly the high-frequency part of it—radio and its various frequencies—as a means to determine subterranean formations and strata. It will be easier to understand the new methods of radio exploration if we first discuss briefly the more classical methods that have been used in electrical prospecting. All methods of electrical prospecting are based upon the fact that the homogeneity of the field of electromagnetic power lines is immediately disturbed if a body lies within this field which has different electrical constants than the surrounding medium.

## THE ULTRA-SHORT-WAVE TRANSMITTER FOR PROSPECTING

Figure 3, at right, the diagram for the 1.6 meter transmitter used in prospecting with ultra-short-waves. Figure 4, at left, illustrates the method of mounting apparatus on a panel and gives a picture-wiring diagram for connections

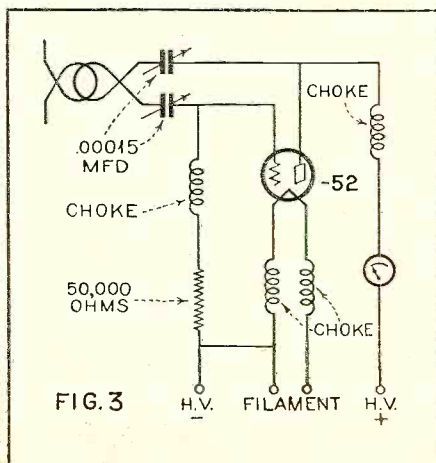
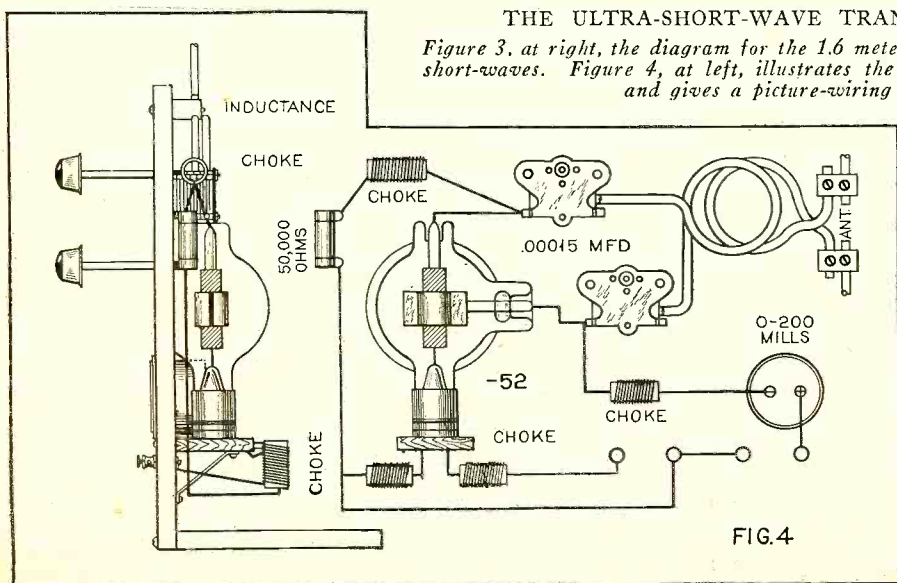

# ELECTRONIC APPARATUS IN FOR TREASURE

come to our editorial offices during of exploring buried treasure, oil and have asked Dr. Saxl to investigate and report his findings in an exclusive below are his findings with the several radio and other inductive systems, and operating these devices

**Saxl, Ph.D.**

This change of continuity can be detected by various methods, using alternating or direct current fields.

Take, for example, Figure 1. A source of vibratory current (a buzzer) A, is connected to two bare copper wires, W1 and W2, through an insulated cable. These wires are connected to the ground with bare copper staples, S. Salt solution is poured around the copper staples so as to insure the proper contact with the ground.

If we then take a pair of headphones and connect the terminals to two metal rods, we can push these rods into the ground in such a way that no signal is heard in the headphones. This gives the lines of equal potential, E1, E2, E3, etc.

Between points B and C no sound will be heard, because both points have the same potential (equipotential), as they are both the same distance from the opposite lines of staples in a homogeneous field. In this way a number of equipotential lines can be drawn, and if the ground is homogeneous (that means, if it has equal conductivity in all parts to a reasonable distance below the surface), then the equipotential lines will go parallel to the wires W1 and W2. These lines can be staked out or drawn on a surveyor's map. But now something unforeseen happens. We enter the right part of the field, approaching the bare copper wire W1, and we find that we can reach silence in our earphones, not by plugging the metal rods into the ground in a way so that the line drawn through both contacts is parallel to the wires, but that we have to insert our metal rods so that their connections means a *considerable angle to the first equipotential lines*. The lines of force shown in the right part of Figure 1 indicate clearly that they are deflected and drawn within a certain area. What is the cause of this?

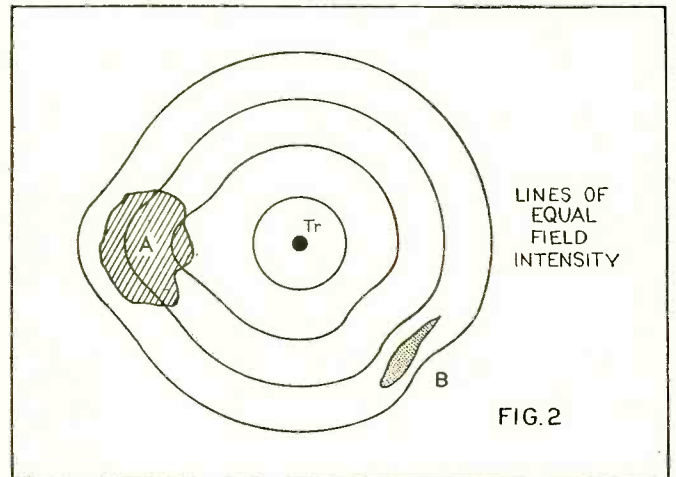

THE FIELD DISTORTION METHOD

Figure 2. Locating buried metal or oil by plotting field intensity lines from a transmitter with a portable receiver

Electromagnetic impulses travel along such lines as build the least resistance against their propagation. If there is a body in the path of the lines of force, through which these lines of force can pass easier than through a resisting medium, then they will be drawn toward this body and will go partly through it.

This is the result shown by the appearance of the lines of force in the right part of Figure 1. A body of good conductivity—for instance a metal—is lying in the part of these lines and they have been bent from their straight path so as to pass through this body.

Suppose a body of considerable metal content—gold, zinc, iron ore, etc.—is buried at this point. It will be readily detected because the lines of force will draw toward this body, as indicated. It is from the appearance of such lines of force that the experienced geophysicist can judge of deposits of higher electrical conductivity.

The opposite to this is also possible. If we have a body that is practically an insulator of electricity, as, for example, mineral oils, then the lines of force, trying to avoid the body of high insulation, prefer to go through the surrounding territory rather than to pass straight through the oil field. Oil

THE ULTRA-SHORT-WAVE RECEIVER AND WIRING DIAGRAM

Figure 8, below, the schematic wiring diagram of the ultra-short-wave receiver. Figure 9, at right, gives a recommended construction for setting up this apparatus in conjunction with the two-stage audio frequency amplifier

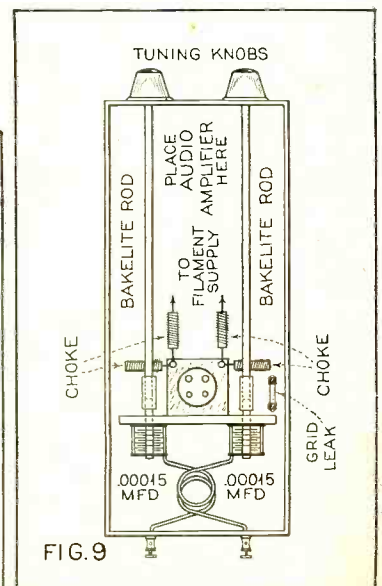
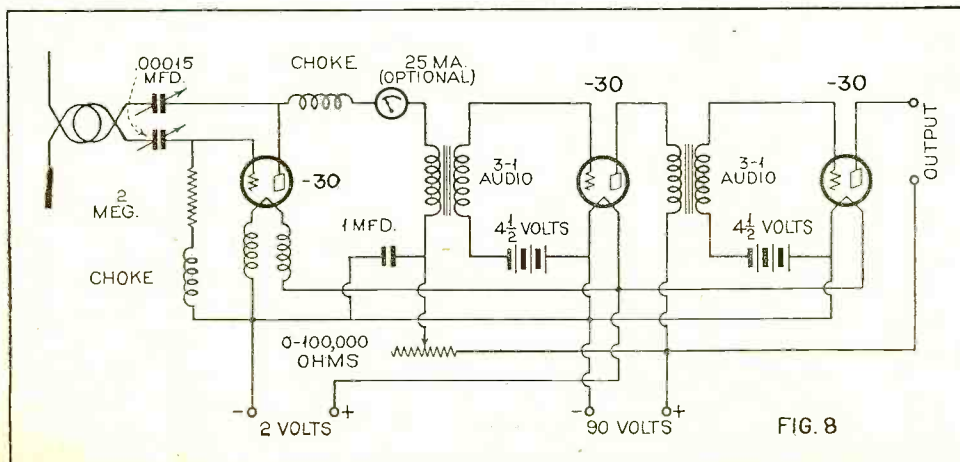

beds of high electrical resistance are often imbedded in wet, salt deposits, which are a good conductor of electricity. The sudden change from a good conducting body to such insulators is a sharp one and can be noticed at a considerable distance.

**Field-Strength Measurements**

This type of investigation can be adapted for the survey of large areas by using radio waves, as, for instance, standard signals radiated from portable radio transmitters. Radio waves, as is well known, propagate along two different paths. One is radiated into the sky, and eventually, as important for the short waves used in long-distance communication, is reflected by the Heaviside layer back to the earth. The other is the ground wave, which is essential for experiments of this type. We know, from the erection of regular radio transmitting stations and the survey of field strength in various locations, that this field strength is dependent upon the composition of the ground to which the receiver is connected. The ground wave propagates with greatest difficulties through desert areas, while a good conducting body like the salt water of the ocean attenuates it much less. Based upon field-strength measurements of this type, survey of greater regions has been made.

For prospecting with a portable transmitter, field-intensity measurements are taken with reference to the standard signal generated. Drawing lines of equal field intensity from such a transmitter shows, as can be seen in Figure 2, that the lines of equal field intensity seem to be bent forward by a body of good conductivity. This may be a lake, an underground stream, a metallic deposit or an ore deposit, as shown at A. Or they may bend back out of the way over deposits of high resistance, as shown at B. In such cases, we would judge that very dry sand or perhaps an oil deposit would be found at B.

While these methods, and many variations of them, are important for the general survey of larger areas and big deposits, the actual location of the individual structure of the deposits and of smaller findings can best be made by different methods.

**POTENTIOMETER-BALANCED CIRCUIT**

Figure 11. Suggested circuit for a balanced system using a potentiometer instead of a slide wire

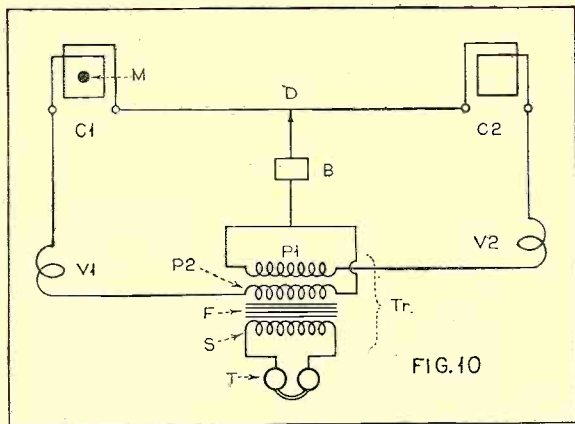
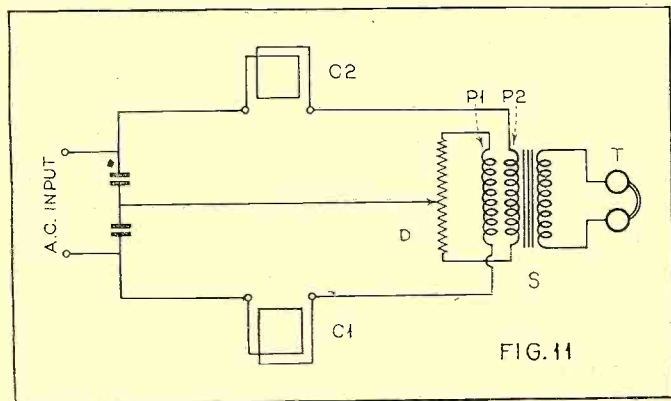

**AN INDUCTIVE EXPLORING UNIT**

Figure 10. Suggested circuit for a balanced method using two loops to be carried with the apparatus for the ground to be worked

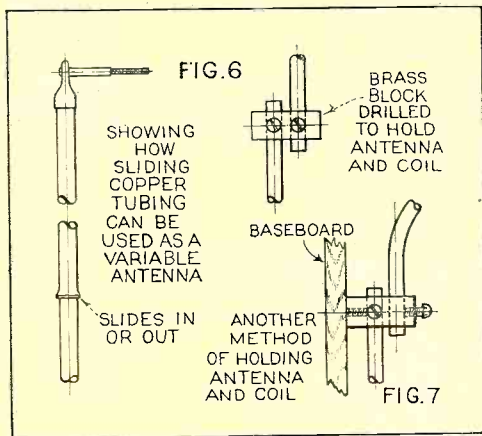

**ANTENNA MOUNTING DETAILS**

Figure 6 shows the details of the copper tubing antenna and the method of mounting. Figure 7 shows details for supporting the antenna and coil

While the equipotential method and its variants investigate the field around the bodies of different dielectric properties, the newer short-wave methods use the subterranean body itself as an agent for its determination.

Generally speaking, the resistance of the ground to the propagation of electrical waves becomes greater the higher the frequency of these waves becomes. However, this statement must not be too broadly generalized. After all, only a certain percentage of the energy is absorbed, and if it is possible to send a concentrated beam of high intensity short-wave radio waves into the ground, it can penetrate to a considerable depth. We must not expect, however, that a sharply focused beam of ultra-short waves will pass through the ground just like a transparent medium. But, if the short waves are strong enough, they can penetrate to a reasonable depth. Bodies in their way will eventually deflect them and reflect them so that if a receiver sensitive enough is carried over the ground a reflected wave will be received from below the ground. The problem of using these waves in prospecting centers around the point of making the short-wave transmitter of sufficiently high power and the receiver of sufficiently high sensitivity—both working on a very high frequency.

Considerable work in this line has been done by Mr. Joseph I. Heller of New York. His equipment consists primarily of a 75-watt transmitter working at about 1.6 meters. The transmitter and the receiver have identical circuits, the only real difference being that, following the detector in the receiver, several stages of a.f. amplification are introduced. Figure 3 shows a wiring diagram of his transmitter.

Figure 4 shows a layout of the outfit as it appears from the tube side as well as a picture wiring diagram of connections. The chokes consist of 15 turns of No. 20 wire, double-silk-covered, wound on a bakelite form with 1/2 inch diameter. The coil is one single turn of wire of 1/4-inch copper tubing. The loop is 3 1/2 inches in diameter. Specific data for the size of condensers and resistors used in (Continued on page 702)

**A BEAT-OSCILLATOR SYSTEM**

Figure 12. This circuit operates by heating two frequencies to produce a beat note which varies as metallic objects come within its field

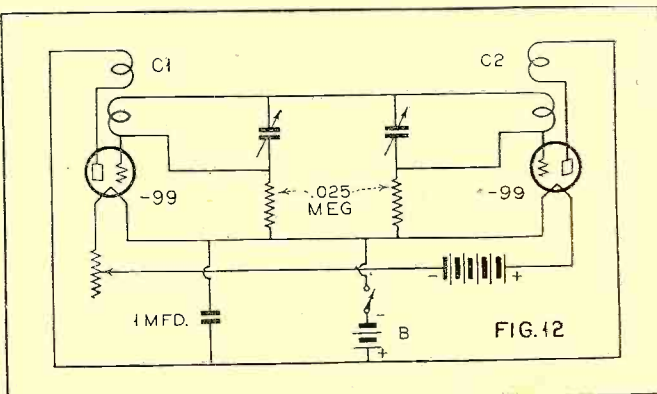

# Mathematics in Radio

## Calculus and Its Application in Radio

By J. E. Smith\*

Part Twenty-one

**T**HE study of calculus is not complete unless one has taken the time to investigate the meaning of the integral calculus. This subject is often considered of more interest to the radio student than the differential calculus, because, as it will be shown in greater detail later, the handling of the mathematics appears to be more easily accomplished.

We are constantly appreciating that the symbol "f" which appears so often in the radio magazines and technical publications must be of increasing importance, and it is essential to us that the fundamentals of this interesting subject be realized. The symbol which represents the sign of integration is in the form of a distorted "S," and can be taken as a simple indication of a process of mathematics which we can all readily understand.

The student is already familiar with the fact that subtraction is the inverse operation of addition, and that division is likewise the inverse operation of multiplication. Now, the integral calculus may be said to be the inverse operation of the differential calculus.

Using the methods of the integral calculus, which will be outlined in these pages, will be an aid to prove more conclusively many of the fundamental relationships which are encountered in the theory of radio circuits. The average and effective or root-mean-square values of currents and voltages are more precisely determined, and also power relationships, efficiencies and the more complicated structures of wave analyses are studied by this interesting method.

There is a fundamental reason for the operations performed in mathematics, and a logical sequence is followed which can be readily understood. It is true that the subject requires patience and practise, but this is also true for any other worth-while occupation, and the student will profit greatly by using mathematics in his work.

Standard elementary forms for integrating various types of expressions have been prepared for students, and they will be shown to bear a close relation to the forms which were included in the study of the differential calculus. It will be noticed that the letter "c" is included in the following formulas, and the significance of this, which is referred to as the "constant of integration," will be explained.

### Standard Elementary Forms

- (1)  $\int dx = x + c$                       (2)  $\int a dv = a \int dv$   
 (3)  $\int v^n dv = \frac{v^{n+1}}{n+1} + c$  (when "n" does not equal -1)

In order to study these elementary forms a little more thoroughly, let us investigate the following expression:

(a)  $y = x + c$   
 Let us assume that  $c = 0$ , then  
 if  $x = 0$ , the corresponding value of  $y = 0$   
 $x = \pm 1$ , " " " "  $y = \pm 1$   
 $x = \pm 2$ , " " " "  $y = \pm 2$   
 $x = \pm 4$ , " " " "  $y = \pm 4$

Let us assume that  $c = +2$ ; then  
 if  $x = 0$ , the corresponding value of  $y = 2$   
 $x = \pm 1$ , " " " "  $y = 3$  or  $1$   
 $x = \pm 2$ , " " " "  $y = 4$  or  $0$   
 $x = \pm 4$ , " " " "  $y = 6$  or  $-2$

Let us assume that  $c = -2$ ; then  
 if  $x = 0$ , the corresponding value of  $y = -2$   
 if  $x = \pm 1$ , the corresponding value of  $y = 1$  or  $-3$   
 if  $x = \pm 2$ , the corresponding value of  $y = 0$  or  $-4$   
 if  $x = \pm 4$ , the corresponding values of  $y = 2$  or  $-6$ .  
 The values of  $y$  for the three assumed values of  $c$  are shown plotted in Figure 1.

Let us differentiate the following expression:

- (a)  $y = x + c$   
 $\frac{dy}{dx} = \frac{d}{dx}(x) + \frac{d}{dx}(c)$

But we have learned that the derivative of a constant is zero, thus (b) becomes:

- (c)  $\frac{dy}{dx} = 1$

This expression can be written in another form, which is referred to as its differential form; thus, from algebra, (c) becomes:

- (d)  $dy = dx$

Let us place the integral sign before each side of the above expression. It will be remembered that algebra teaches us that such an operation is permissible. Therefore, (d) becomes:

- (e)  $\int dy = \int dx$

From the above table of standard elementary forms for integration, we have:

- (f)  $\int dy = y + c_1$   
 and  $\int dx = x + c_2$

Thus, (e) becomes:

- (g)  $y + c_1 = x + c_2$   
 But  $c_1$  and  $c_2$  can be of any constant value, and (g) can become:  
 (h)  $y = x + c$

It will be remembered that it was stated that integration was the inverse operation of differentiation. This is proven in the above analyses, for when (a) was differentiated, (d) was obtained, and when (d) was integrated (h) was obtained, which is the original expression under consideration. It can be seen that the integration of (e) would refer to an infinite number of lines, some of which are shown in Figure 1. Thus, it is essential for the time being to always consider the constant of integration "c." Further use of this constant is made when the conditions of the problem are more precisely stated.

### Examples

In order that the student will obtain practice in the use of integration, the following examples are included.

- (I) Integrate the following:  
 (a)  $\int x^2 dx$                                       (c)  $\int 5y dy$   
            $2 dx$                                       (d)  $\int 5m^2 z^3 dz$   
 (b)  $\int \frac{2 dx}{3x^2}$

To indicate the method, let us take example (b):

$$\int \frac{2 dx}{3x^2}$$

This is of the forms  $\int a dv$  and  $\int v^n dv$  where  $a = \frac{2}{3}$ ,  $dv = dx$  and  $n = -2$ . Performing the various steps, we have

$$\int \frac{2 dx}{3x^2} = \frac{2}{3} \int \frac{dx}{x^2} = \frac{2}{3} \int x^{-2} dx$$

NOTE: From the study of logarithms, (Cont'd on page 701)

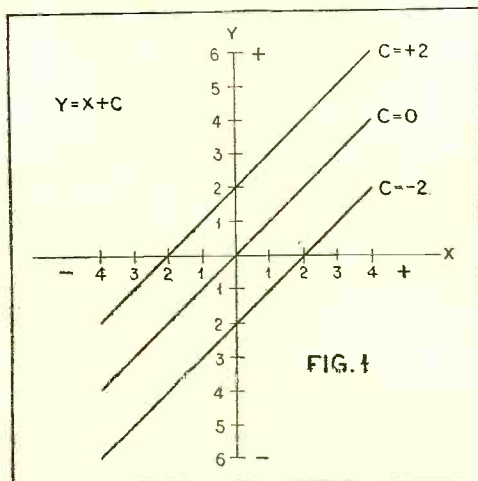

FIG. 1

\* President, National Radio Institute.

# WCAU IN PHILADELPHIA, PA., MODERNISTIC



—IN THE MODE MODERNE

*Above, the main reception room of the new station WCAU, showing its modernistic and artistic layout. Below, the main studio for accommodating over 100 performers. The windows are for observers and the control room operator*



*Worthy of description is this new of building designed especially for a radio modernistic in design and architecturally of note. The station operates on a clear to DX listeners, who should be able to located many thousands of miles away. trol is of the most recent design and the laid out with a special view to housing*

**By Samuel**

**O**NE of the most modern and elaborate radio studio and transmitter layouts in the United States has recently been built for Station WCAU, of Philadelphia.

The new studios are housed in an especially constructed nine-story building at 1622 Chestnut Street. Columbia executives claim that this is the first completed building in the United States originally designed for broadcasting purposes. Both the exterior and the interior of the structure are pleasingly modernistic in design. All furnishings and equipment have been given a futuristic appearance by the decorators. In some respects the WCAU studios resemble the famed British Broadcasting Corporation studios in Broadcasting House, London. The 50-kilowatt station, owned by the Universal Broadcasting Company, is the Philadelphia outlet of the Columbia Broadcasting System. Many programs that originate in WCAU's ultra-modern studios are being routed over the CBS chain. With the anticipated augmentation of network programs from Philadelphia, WCAU will be, in effect, a joint key station of the CBS along with WABC, of New York.

Four floors of the new structure are used for studios, control rooms, audition rooms and offices. RCA-Victor equipment has been used throughout the studios as well as for the transmitter building at Newton Square.

Velocity microphones are used in the studios. The introduction of these ribbon pick-up devices was the cause of giving all WCAU performers special training in using the sensitive,

### THE MASTER CONTROL ROOM

*Various control equipment in this room are situated with a view to easy access from the main control desk, as seen below*

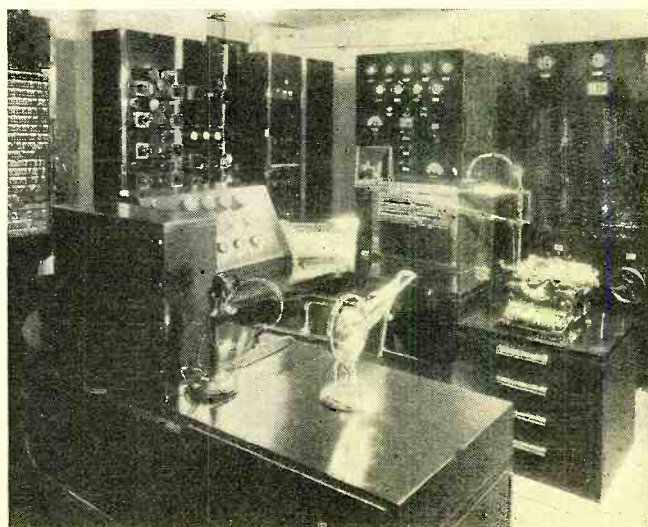



# INAUGURATES A NEW ERA IN BROADCASTING

*50-kilowatt station housed in a new type transmitter. The studio building, also designed for this special purpose, is worthy channel and will therefore be interesting pick it up on their receivers although The equipment for transmission and convarious rooms in which it is located are the apparatus and make for efficient service*

## Kaufman

two-way instruments. WCAU is believed to be the first transmitter in the United States to use this new type microphone, exclusive of all others.

There are seven studios in the building which range in size from a speaker's chamber of small size to huge studios two stories in height to accommodate large symphonic groups. Studio A, the largest, can accommodate over 100 performers. Visitors can view the broadcasts through double-paned windows on the upper floor. From the studio floor, proper, the audition windows seem to be located on balconades, but, actually, the windows are on the floor above.

Experiments have been conducted to have the acoustical properties of the studios as perfect as possible for broadcasting purposes. Zigzagged walls have been constructed to break up and deflect the sound. A perforated chromium-plated metal was utilized in their construction, permitting the sound to seep through and be absorbed in a special composition base. Special care was also taken with the placement of the velocity microphones.

The WCAU engineers have applied a new acoustic principle of "live" and "dead" ends in the studios. From one-half to two-thirds of each studio, depending entirely upon size, is built of sound-absorbing material to form a "dead" end. Here microphones are set to pick up every part of the program originating in the "live" portion of the studio. The walls in the "Live" end reflect the sound waves (Continued on page 699)

### THE MAIN TRANSMITTING ROOM

*The panels of the 50-kw. transmitter, with John Leitch, technical supervisor, at left; Charles Miller, chief engineer, seated, and Albert Gegenbach at right*

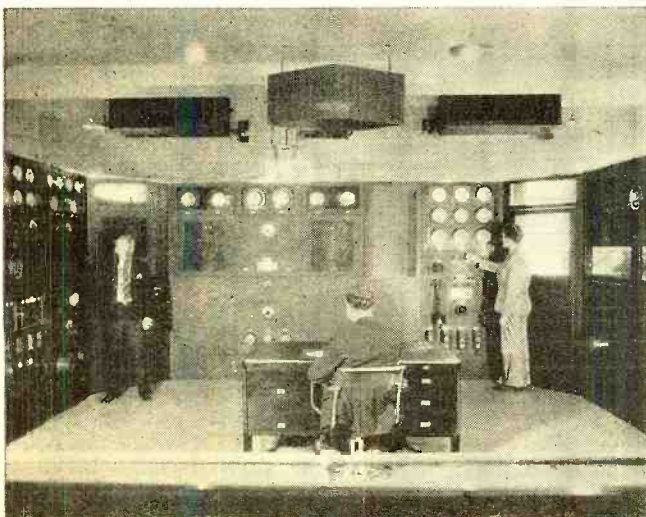

### A SCENE IN THE STUDIO

*Above, the Savitt String Quartette giving a performance. Notice the station call letters worked into the floor decorations. Below, the power room, showing the motor generators in the foreground, with the power transformers in the caged space at the rear*



# Design Principles of Long-Distance Receivers

## for the Broadcast Band

*Suggestions on DX design given in the two preceding articles are exemplified in the author's receiver, with which he regularly tunes in Japan and Australia. This article and those to follow will provide complete constructional details*

By C. H. Long  
Part Three

THOSE who have followed this series of articles, the first and second of which appeared in the March and April issues, respectively, may be interested in the description of a receiver embodying the various features laid down.

The receiver to be described is the writer's personal receiver, developed after more than two years of extensive experimentation in an effort to develop a broadcast-wave receiver of outstanding DX ability. Many circuits and plans have been tried and discarded in favor of the circuit finally adopted and developed. The receiver will really bring in the overseas Australian, New Zealand and Japanese broadcast-wave stations here in the central U. S. A. (Missouri) so that their programs can be enjoyed. Even the smaller stations, such as 4TO (150 watts) and a number of others, can frequently be received (possibly 15 or 20 times during a season) so that their programs can be enjoyed. Naturally, they can be heard much more often than this.

A glance at the features embodied in the receiver will be instructive. First, there is provision for the tuning of the antenna system, necessary for true efficiency, by either of two different methods, inductive or direct tuning with variometer. The practical maximum of energy transfer from the antenna to

the grid of the first tube is provided for over the entire scale. The first tube is a triode -30 in order that the all-important noise level of this tube may be held at the lowest possible value with reference to amplification. The fundamental circuit is the superheterodyne, in order to meet effectively and simply the necessary selectivity and sensitivity requirements. The sensitivity of the receiver is such that any signal receivable can, without employing regeneration be brought to full speaker volume. On the quietest winter day at midday in the country, far from man-made static, the prevailing noise level can be brought to good speaker volume, but when the aerial is disconnected, the set immediately becomes quiet. This shows

that the usable sensitivity is unusually high, especially when it is borne in mind that, by careful attention to details and the use of a filter stage between successive amplifying stages (a feature developed by the author and so far as known not previously used for the purpose and in the manner to be described), the noise level of the receiver is exceptionally low.

The filtering system referred to, whereby successive amplifying stages are separated by a filter stage, named by the author the A.F.A. (Amplifying, Filter, Amplifying) system, is a special feature of this receiver and is responsible in no small way for its exceptional

**A Real DX Record**  
MR. LONG has established an enviable record in broadcast band reception from TransPacific stations. Summarizing comments taken from letters of verification which he has received from various over-seas stations shows that he was the first fan in the United States to report reception of programs from Australian stations 2CO, 4TO and 2SM; the first to report Australian stations 5CK and 4BH from East of the Rocky Mountains; and the first from Missouri to report Australian stations 3BO, 2UE, 2UW, 2HD, 3DB and 4BK. With verifications received from 26 Australian stations, including those mentioned above (all reception obtained on receivers of his own design and construction), it is apparent that the receiver described here, which is Mr. Long's latest "brain child," should be well worth the consideration of experimenters and DX fans.

FIGURE 1. THE SCHEMATIC CIRCUIT DIAGRAM

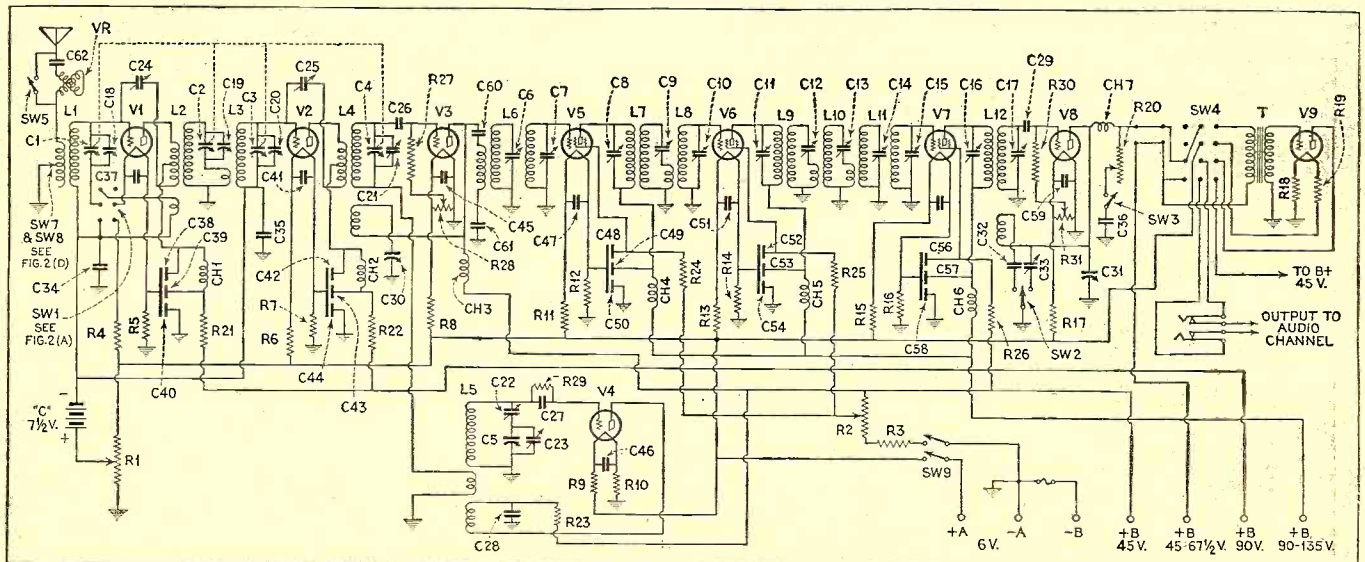

performance. This i.f. system results in a striking reduction of tube and other noises, contributes greatly to rendering the amplifying stages non-regenerative (a necessary condition for low noise level and good tone), and adds greatly to the selectivity without undue cutting of sidebands.

The high order of sensitivity of the receiver remains usable under actual operating conditions, since the selectivity, obtained through a total of 16 tuned, low-loss circuits, excluding the oscillator, or 17 in all (see circuit diagram), is of a similar high order. With absolutely stable and non-regenerative amplifying stages, this selectivity is obtained without any noticeable cutting of sidebands. The receiver features double regeneration under full control at a low noise level, which, though not needed to boost an already more than adequate sensitivity, is invaluable in increasing selectivity. By applying regeneration to the first and second detectors (without raising the noise level, since the radio-frequency gain is retarded a corresponding amount), the side bands may be cut and the selectivity increased to the point where it becomes effective in even reducing small static interference. Unless regeneration is pushed to the very limit, the frequencies necessary to the intelligibility of speech are sufficiently retained and speech can be readily followed, due to the flat-topped, steep-sided tuning curve.

The receiver features an unusually thorough job of by-passing and confining of all radio-frequency currents to their proper paths, which adds materially to the quietness and stability of operation. With an intermediate frequency of 175 kilocycles, image-frequency interference is rendered impossible by the four circuits tuned to signal frequency. Provision is made for obtaining the correct amount of gain preceding the first detector, or mixer, for best overall results. Though not generally recognized, this is a matter of much importance in superheterodyne design, if the ultimate in long-range reception is sought. Too much gain here raises the noise level unnecessarily and too little causes the signals to be lost in the noise of the first detector. Moreover, the proper amount of gain va-

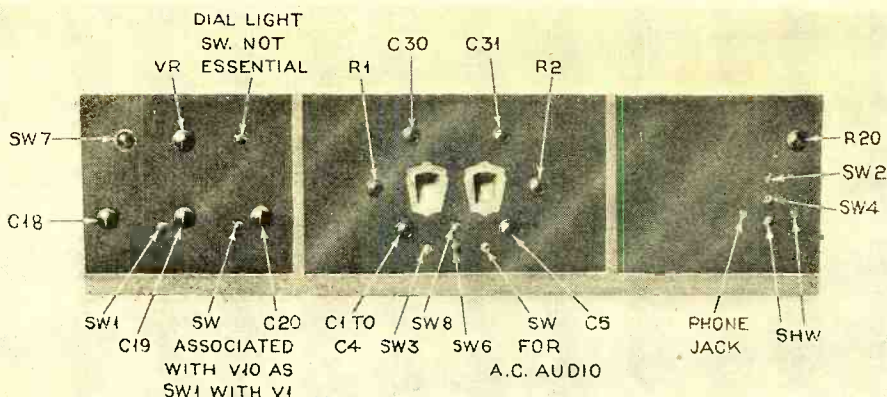

THE RECEIVER AS SEEN FROM THE FRONT

The author designed the receiver to be housed in a cabinet with three front doors. In all ordinary use only the center panel need be accessible, but for the utmost in DX work the end doors of the cabinet may be opened to allow access to the other two panels. The switch and jack on the right, marked SHW, are for a separate short-wave tuner and are not a part of the receiver described here. The switch SW at the left controls an extra stage of r.f. amplification between the first and second stages shown in Figure 1. This extra stage is an exact duplicate of the first stage (V1 and its circuits) and the switch SW functions in the same manner as SW1. This stage was omitted in Figure 1, as it does not offer any particular advantage

from a superheterodyne to a tuned radio-frequency receiver without change in tuning, and vice versa. For ordinary reception the signal-frequency section is quite sufficient and affords single-control operation. Dual tuning controls that track to within 3 kilocycles or better over the entire scale are provided and are necessary for highest efficiency when both sections of the receiver are made highly selective. A tone control is provided. A stage of audio especially designed and exclusively for headphone use, with a switch, SW4, to cut it in or out, as desired, is included on the tuner chassis.

While the receiver described here possesses unusual distance-getting ability, it is equally good for all general use. Its tone, sensitivity and selectivity leave nothing to be desired on any strength signal. Nor is the tuning difficult, as might be imagined, judging by the controls provided, as only the two tuning controls and the two volume controls are commonly used.

The chassis was designed to be enclosed in a cabinet with only the center panel ordinarily exposed when the receiver is in operation, but with doors opening on the side panels so that access might be had to them when desired. The physical size of the tuner will perhaps surprise some. This size was adopted in order to secure the practical maximum of efficiency. For the benefit of those with whom space is an important consideration, it may be mentioned that experiments have shown that the tuner length may be reduced to three feet by reducing the intermediate-frequency coil size to 1 1/2 inch i.d. throughout and crowding all parts closer together, with only a slight decrease in efficiency. By using still smaller coils throughout, the length of (Continued on page 704)

CIRCUIT DETAILS

Figure 2. (A) Alternative method of connecting SW1. (B) Details of connections to SW6, which permits simple changeover from superheterodyne to t.r.f. and vice versa. (C) An alternative arrangement of (B). (D) Details of connections for switches S7 and S8. These may be single-pole, double-throw switches. (E) Optional series-parallel filament circuit connections for 6-volt battery

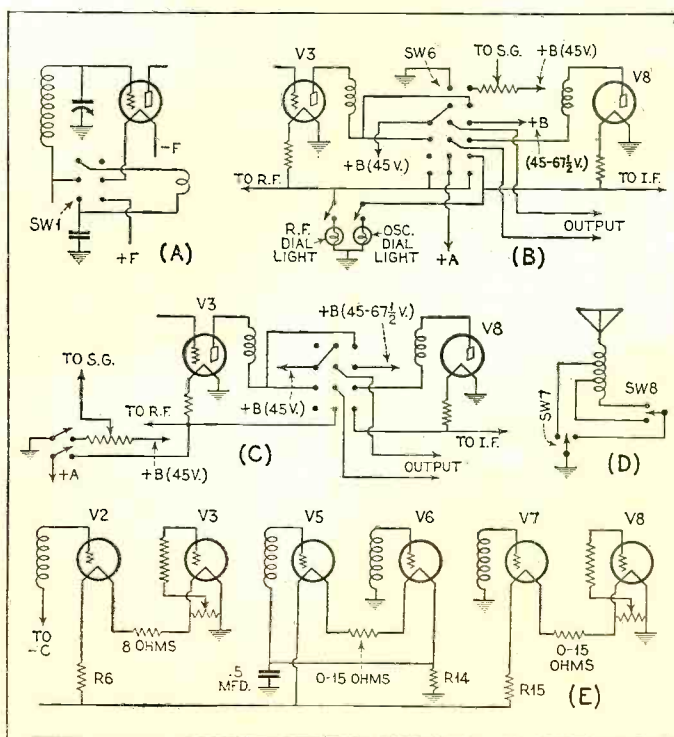

# OTHER EXPERIMENTAL APPLICATIONS OF THE GRID-GLOW TUBE

*Experimenters and control engineers will find these additional uses of the versatile grid-glow tube interesting and helpful. They show how the tube may be employed to operate a control relay by changing capacity, by voice currents, by light or dark, by electric surges, as well as by timed impulses*

**T**HE grid-glow tube is essentially an "on" and "off" relay of distinctive characteristics. There are three active electrodes in the tube; a grid, an anode, and a cathode. The main flow of current through the tube is passed in the form of a glow discharge from the positive anode to the negative cathode. The grid can prevent the main glow from starting, but once it is started it cannot stop it. This fact makes the tube particularly suited for alternating-current operation. Current is passed only during the half cycle when the cathode is negative and the anode is positive and therefore the grid-cathode voltage must be of a proper potential to start the tube at the beginning of each conducting half cycle for the tube to be on continuously. Therefore, if the grid voltage is decreased after the glow has started during the conducting half cycle of an alternating current wave, the tube will continue to glow through that half cycle but will not start during the succeeding cycles. A magnetic relay in the cathode circuit of the tube forms a connecting link between the tube circuit and the device being controlled.

A convenient and flexible arrangement for a grid-glow tube experimental circuit is shown in Figure 1. Two variable condensers are used in series across the 440-volt transformer that supplies voltages to the grid-glow tube. They form a condenser potentiometer, and since the grid is connected to the common connection between the two condensers, its voltage with respect to the cathode varies when the capacity of C1 or C2 is changed. The voltage change will be such that as C2 is increased the grid-cathode voltage is lowered and as C1 is increased the grid-cathode voltage is raised. As has been previously explained, a voltage of the proper value

By M. J. Brown

between the grid and cathode will permit the grid-glow tube to start; any values less than this will tend to prevent the tube from starting. Therefore, as C1 is increased the tube tends to start and an increase in C2 tends to prevent the tube from starting.

The circuit shown in Figure 1 may be made sensitive to very small capacities. If any small capacity is placed in parallel with either of the condensers, the effect will be the same as though the capacity of the condenser itself was increased. A circuit utilizing this effect is shown in Figure 2. In this arrangement a metal plate about 6 inches square is connected to the grid of the grid-glow tube. The capacity of the plate itself will tend to operate the tube, but the glow can be prevented by adjusting C2 to the proper value. The adjustment of C2 will depend upon the size of the plate and the length of the lead to it. With an arrangement of this sort, the grid-glow tube can be made to operate as the hand is brought near the plate.

Another very interesting demonstration of the extreme sensitivity of the grid-glow tube uses a modification of the circuit in Figure 1. A wire is attached to each side of the variable condenser C1 as shown in Figure 3. These wires are extended out parallel to each other and about 1/2 inch apart. As a flame is brought in contact with them a current will flow through the flame. If the values of C1 and C2 are adjusted properly, the tube will glow and the relay will close. In commercial practice, a modification of this circuit is being used as a safety device for domestic oil burners. If the fuel does not ignite after the oil burner ignition and motor have been started, the grid-glow tube will bring the oil burner to a safe

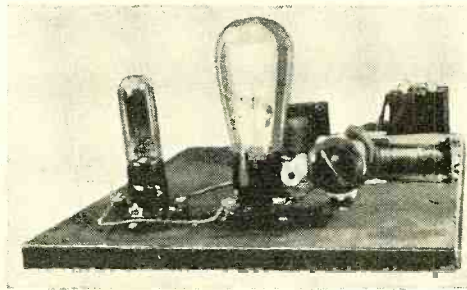

THE LIGHT RELAY

Figure 11. This is a laboratory set up for controlling apparatus with light impulses

### SOME EXPERIMENTAL RELAY CIRCUITS FOR THE GLOW TUBE

Figure 1, at left, is a fundamental circuit showing two variable capacities used to balance the grid-glow tube. If either is thrown off balance, the relay immediately operates. Figure 2, center, is a circuit that will be set in operation by approaching the hand to the metal plate. It has been used in store windows to control turn-tables and other machinery for displaying articles for sale. The plate is attached to the inside of the window and the onlooker operates it by holding up his hand. Figure 3, at right, is a control circuit for shutting off an oil burner if the flame goes out

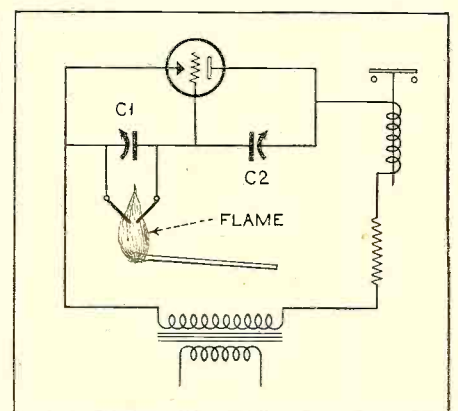
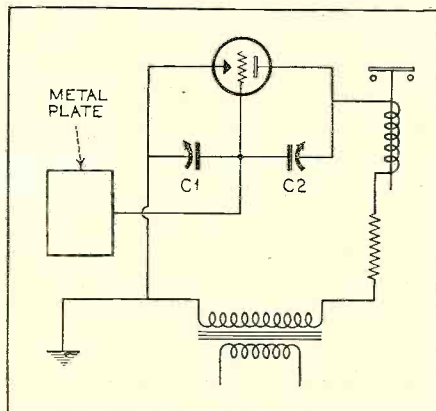
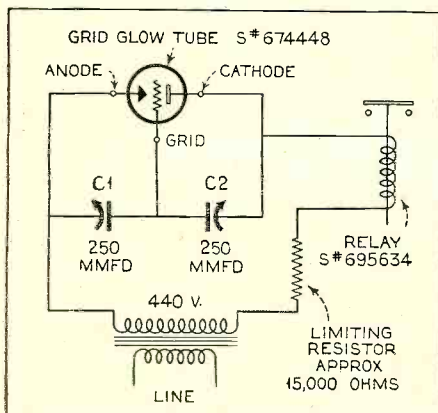

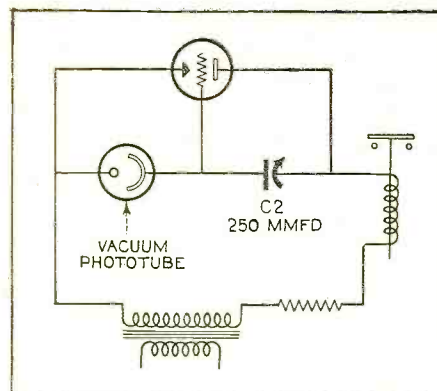
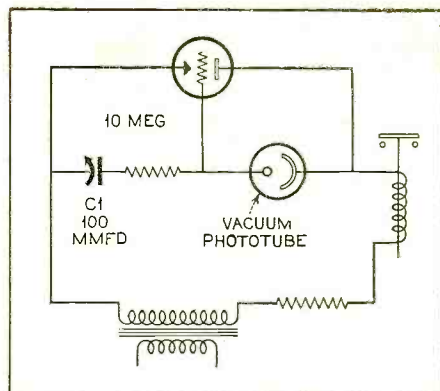
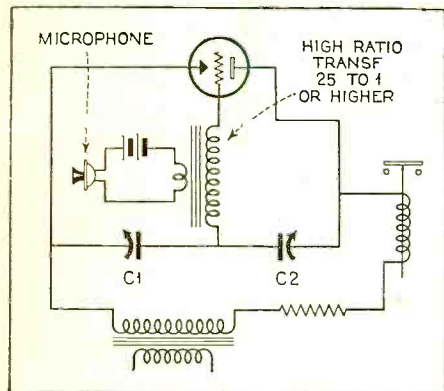

OTHER EXPERIMENTAL CONTROL CIRCUITS

Figure 4, left, is a circuit operated by voice signals. Figure 5, center, is a light sensitive circuit that operates by darkness. Figure 6, right, another light sensitive circuit that operates through light impulses

condition by shutting off the motor and fuel. Should the flame go out, accidentally during operation, the ignition will be brought on again and if the flame fails to start in a certain period of time after this, the motor and ignition will be shut down.

Another circuit that may be used for laboratory work and demonstration purposes is shown in Figures 4 and 10. It is essentially a sound relay. The condensers C1 and C2 are adjusted so that the grid-cathode voltage is only a few volts short of the starting value. As words are spoken into the transmitter an induced voltage is built up in the secondary of the modulation transformer, which adds to the voltage already present, thus giving a potential from the grid to the cathode sufficient to start the grid-glow tube. When used with a circuit-selection relay such as used on automatic-telephone systems, this arrangement can be made to pick out any given circuit according to the number of words spoken into the microphone. Each word will cause one impulse to be sent to the relay. The number of impulses determines the circuit to which the relay contact arm moves. This can be used to control model trains—to make them start, stop and reverse by the spoken word.

Because of the very small currents required to operate the grid-glow tube, it can be readily adapted to photo-tube work. The phototubes are put into the same relative positions as the condensers and resistors of the circuit previously discussed.

A phototube is, in effect, a variable resistance and when used

in series with other resistances or with capacities across a constant voltage source, the voltage across the phototube will be proportional to its resistance. The resistance of a phototube varies from approximately one to several hundred megohms, depending on whether the tube is illuminated or dark. Due to the high voltages used in grid-glow tube circuits, only vacuum phototubes can be used. The gas in a gas-filled tube would be ionized at these voltages and the ultimate destruction of the sensitive material in the phototube would result.

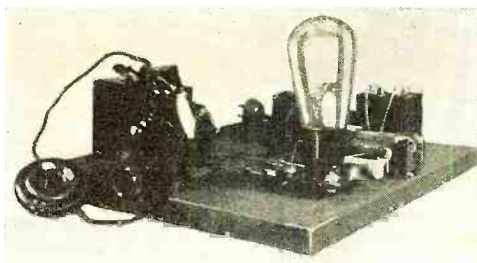

USED AS SOUND RELAY

Figure 10. This is a laboratory set up for using the glow tube as a sound relay. The circuit is shown in Figure 4

Figure 5 shows a phototube, grid-glow-tube circuit in which the grid-glow tube is normally glowing but is extinguished when the phototube is illuminated. The phototube, being a rectifier, requires that proper polarity of the electrodes be observed in making connections.

Another phototube, grid-glow-tube combination, using a phototube in the anode circuit is shown in Figures 6 and 11. The grid-glow tube in this circuit is normally not glowing but may be made to glow if the phototube is illuminated.

Many interesting experiments and applications may be made of these extremely simple phototube circuits. They may be used to count small articles, they may be made to turn lights off-and-on at the approach of daylight and dusk respectively, they can be used to detect smoke and any other similar duties that suggest themselves.

The well-known phenomena of ionization by high-frequency currents is demonstrated by making low-pressure gas-filled tubes glow in Tesla coil circuits or on radio transmitter high-frequency circuits. These can be suc- (Continued on page 700)

THREE SPECIALIZED CIRCUIT USAGES

Figure 7, at left, shows a schematic diagram of a control unit for operating on high-frequency currents. Figure 8, at center, is a control circuit for a high voltage transmission line. Figure 9, at right, shows a circuit using the grid-glow tube as a time delay switch of great flexibility, in which the delayed time may be adjusted for a fraction of a second up to values as great as a few minutes

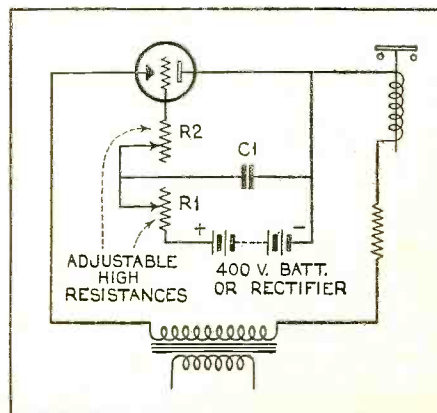
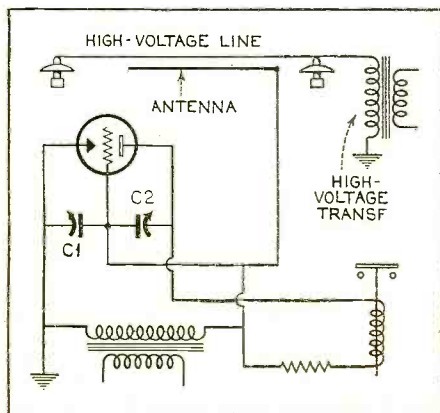
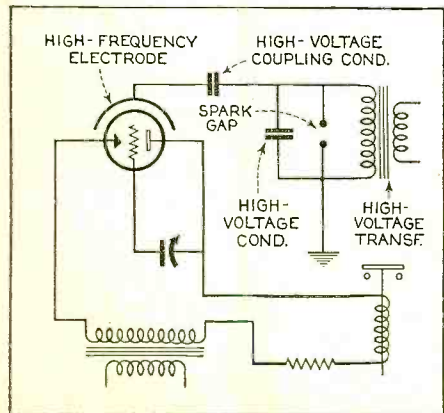

## How to Build an A.C.-D.C.

# MINIATURE RECEIVER

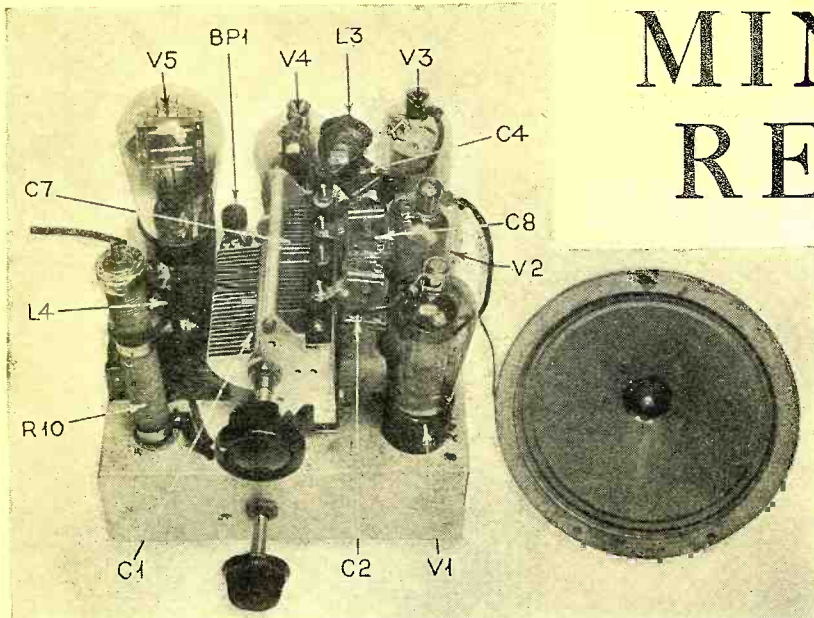

THE CHASSIS

The aluminum chassis is only 6 inches wide, 5½ inches deep and 2 inches high. Its small size permits it and the 5-inch speaker to be fitted into a small carrying case which the builder may select to best fit his particular requirements

Complete details are given on the construction of a small portable receiver which draws its power from any 110-volt line, works with or without an antenna and is truly portable

By H. G. Cisin

**T**HE Senior "Pal" Portable is an extremely compact four-tube and rectifier set, powerful enough to operate a loudspeaker. It can be operated on either a.c. or d.c., without changes whatsoever in the wiring.

Everyone can use a portable set of this type. For the traveling salesman it provides an ideal, inexpensive and restful form of recreation after a hard day on the road. It makes no difference whether the "knight of the grip" travels by motorcar or by train. This receiver is light enough and compact enough to go along with him.

For the business man, making a trip between two distant cities, such a receiver should prove as necessary and as profitable as his portable typewriter. Stock market reports, important news of the day and even some frivolous entertainment are always on tap.

Many of the leading theatrical people now consider the portable radio as an indispensable part of their traveling equipment. Accompanied by this ever-present source of entertainment, they no longer have reason to dread the long hours of waiting between trains in some dismal, one-horse town. Instead, the portable is plugged into the nearest electric light socket and, with a few turns of the knob, they are soon listening to a snappy jazz band, performing at a gay night club miles away. Many of the stars, including Eddie Cantor and Al Jolson, are said to be enthusiastic owners and boosters of portable radios.

The "Pal" portable can be carried on every pleasure trip. It is invaluable for the summer bungalow, the tourist camp or the country home. At boarding school and at college, it serves as a true "personal" set. Invalids and convalescents in hospitals and nursing homes can also use it to great advantage. By turning a knob, volume may be reduced so as not to disturb others. Moreover, a simple adapter may be used to permit the employment of earphones instead of speaker, if so desired.

Even for the home this little receiver has its important uses. When the big set becomes temperamental and suddenly stops playing in the midst of an important program, the portable will imme-

diately take care of this emergency. When the young folks want to use the large receiver in the living room to get the latest dance music, mother and father can take the "Pal" to any other room in the house and listen to the opera—unless father prefers to tune in a prize-fight.

Servicemen can use it to check up the erratic performance of sets which are giving trouble. When the big set has to go back to the shop for repairs, the little one serves as an excellent substitute.

Many radio dealers who formerly thought of the radio business solely in terms of "midgets" are now thoroughly convinced that the portable radio is an excellent sales stimulator and a new and ready source of profits. A number of wide-awake dealers are adding considerably to their incomes by renting portable sets to hotels, clubs, institutions and to private individuals.

Without a doubt, the evolution of the modern portable has been accelerated by the vogue for the midget set. The "craze" for midgets compelled engineers and designers to turn out smaller and more efficient radio parts. Radio-frequency coils, variable condensers and other components were reduced in size and increased in efficiency and accuracy. Midget dynamic speakers and permanent-magnet speakers of improved tone quality were developed.

### HOUSING THE RECEIVER

The author's suggestion for a neat case with handle on top for carrying

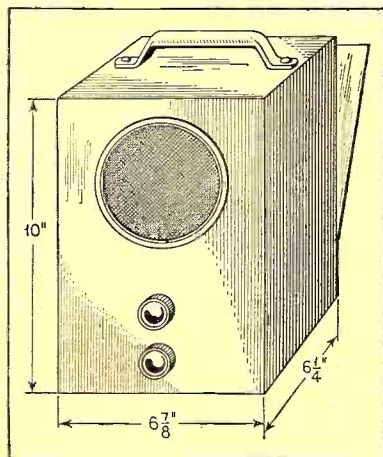

The author conceived the idea of employing the new cathode-heater 6.3-volt tubes in an a.c.-d.c. circuit as soon as these tubes were announced. After some experimentation he produced a novel circuit along these lines, using a -37 tube as a rectifier by tying plate and grid together and with filaments of all tubes in series. He immediately made a patent application covering the various features of this circuit.

The next step was to apply the new circuit in a practical portable receiver. It is believed that the receiver described here is the first really practical universal a.c.-d.c. portable receiver made available for home construction. It is a truly modern set, which can be plugged into any lighting socket—either a.c. or d.c.—thus eliminating the expense and the weight of the batteries. Direct current is still standard in many localities, but the "Pal" portable works just as well on this type of current as on a.c.—without any circuit changes.

Very often the author receives letters

from fans wanting to know whether they may have his permission to build and sell sets incorporating some of his patented circuits. These new circuits, if they are covered by patents or by patents pending, are made available to the amateur set builders, for experimental purposes only. This is the case with the circuit of the Senior "Pal" portable, on which there is a patent pending. In publishing this circuit, the author retains all rights which may be granted under the patent. However, any fan or home set builder may build one of these sets for himself or he may even build a few for his friends. In order to produce these commercially, however, a license must be obtained.

An important feature of the receiver lies in the fact that the power transformer has been eliminated, thus cutting down the cost for parts. The tubes used are of the quick-heating, cathode type. The filaments of the 5 tubes are in series and the line voltage is reduced to the correct filament voltage value by means of a suitable series resistor. Since cathode type tubes are used, the series arrangement of the filaments does not affect the amplifying properties of the circuit, and moreover, there is no possibility of hum from the filament circuit. Other characteristics of these tubes also make them very desirable for portable use. They are rugged and their filament current is only .3 ampere. Since they are connected in series, this value (.3 ampere) represents the total filament current drain.

A tuned radio-frequency circuit is employed having one stage of tuned r.f., an untuned second r.f. stage, a tuned detector using grid-leak rectification and a single audio stage. Variable- $\mu$  -39 type pentode tubes are used in the two r.f. stages and the detector. The antenna coupler is lateral-wound with Litz wire and combines high efficiency with great accuracy. Impedance coupling is used between the r.f. stages. A tuned impedance is used to couple the second r.f. stage and the detector. Both the secondary of the antenna coupler and the impedance are tuned by sections of a small two-gang variable condenser. Resistance coupling is used between the detector and the audio output stage. This stage uses a -38 type output pentode. This tube permits the use of a pentode screen-grid tube as an audio amplifier, giving high gain without distortion, with low signal input. Furthermore, the -38 works exceedingly well with a

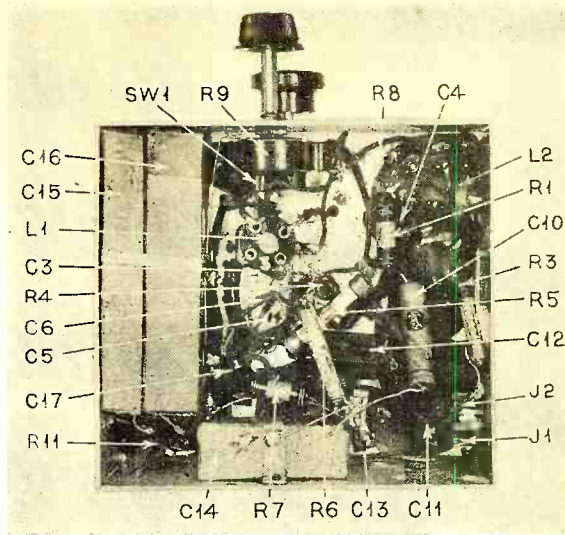

UNDER THE CHASSIS

*Looks a little complicated, but its really easy to assemble and wire if the buidler uses a little forethought in following a logical sequence in his work*

plate voltage as low as 90 volts, and this characteristic is highly advantageous where the maximum available voltage happens to be 110 instead of 115 volts.

Rectification is obtained through the use of a -71-A tube, by tying the plate and grid together, thus making the tube into a two-element half-wave rectifier. Since the filament current drain of the -71-A tube is slightly less than that of the other tubes, this is equalized by shunting the filament terminals of the -71-A with a 50-ohm resistor. Hum is eliminated through the use of a small audio choke, by-passed at either end by cardboard type electrolytic condensers.

The circuit presents a number of other interesting features. Provision is made for any one of four aerial arrangements. First, it is possible to use simply a piece of stranded wire about ten to fifteen feet in length, with no other aerial or ground. Second, conventional aerial, and ground to a water pipe or radiator may be used. Third, the electric light line may be used as an aerial by connecting two of the three binding posts together, with a ground wire connected to the ground post. Fourth, the electric light line may be used as a ground in connection with a short aerial. Naturally, the first method is the most convenient, and this is the one which is used most frequently. To prevent short circuits, the negative side of the line is not grounded to the chassis, but is brought out to a binding post through a .0005 mfd. condenser.

Volume is controlled by means of a potentiometer in the cathode return circuit of the two r.f. pentodes. A smooth, even control is obtained. The voltage-reducing resistance in the filament circuit is an adjustable 300-ohm wire-wound resistor, adjusted to about 280 ohms by means of the sliding contact.

**Construction Data**

The chassis is only 6 inches by 5½ inches by 2 inches high. Light-gauge aluminum, say 14 to 16-gauge, is the most suitable. This may be obtained drilled for the sockets and the audio choke mounting.

The parts on top are mounted first. The dual variable condenser is mounted at the front, as shown. The five wafer type sockets are mounted. If a tube shield is used, the shield base for socket V1 should be fastened at the (Continued on page 698)

**THE SCHEMATIC CIRCUIT DIAGRAM**

*The rectifier (V5) and filter are in the circuit at all times, thus d.c. and a.c. supplies may be used interchangeably—the receiver doesn't know the difference*

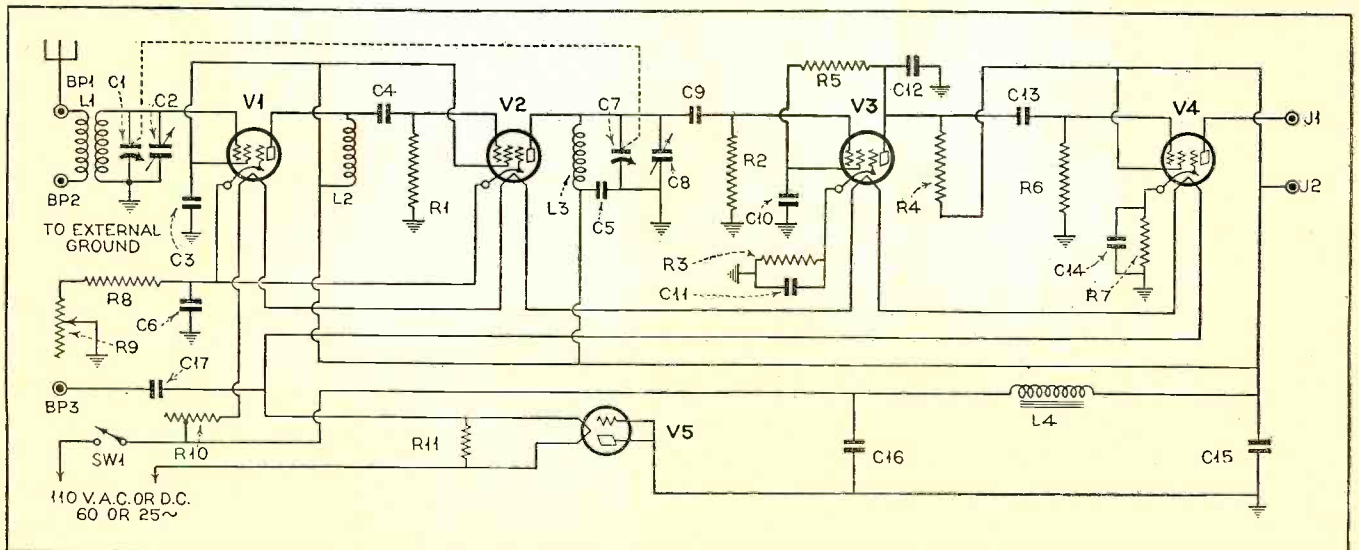

TECHNICAL DATA AND CIRCUIT DESIGN FOR

# TWO NEW TUBES

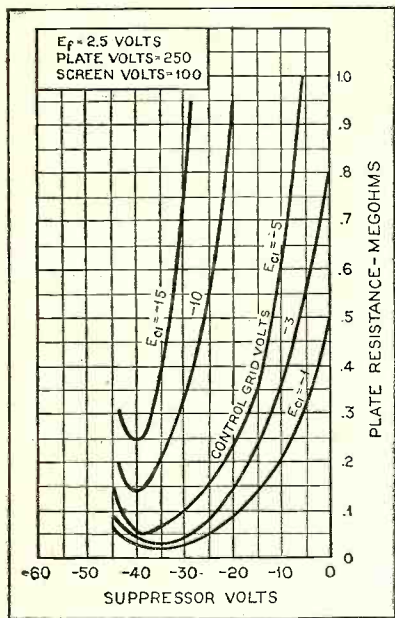
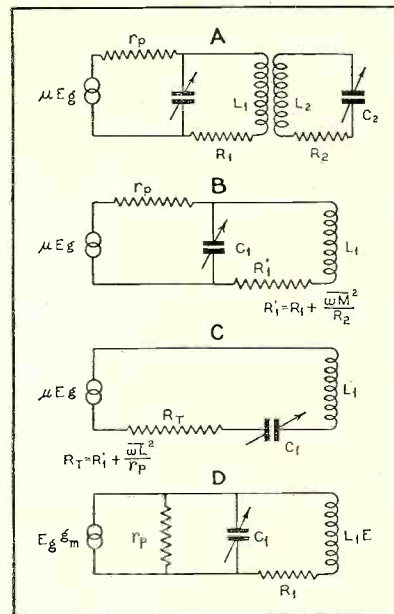

PLATE RESISTANCE CHARACTERISTICS

Figure 1. When the suppressor voltage of the type -58 tube is varied from zero to -40 volts, the plate resistance decreases. This action is opposite to that of the screen grid tube when the grid bias is varied

The type -58 tube is suitable for some entirely new uses, one of them, automatic tone control, being fully described in this article. The design of the circuit for the type -46 tubes, used as Class B amplifiers, is also explained

By J. van Lienden



FUNDAMENTAL CIRCUITS AND EQUIVALENTS

Figure 2. Circuit B is equivalent to circuit A, and so is circuit C. The resistance values then become as indicated above. Circuit A is reduced to its equivalent series circuit at C by means of well-known formulas

WITH the type -58 tube it is now possible to control fidelity simultaneously with sensitivity; thus automatic volume control becomes an automatic tone control at the same time. This application will be discussed in the following paragraphs. Another tube, the type -46, when used as a Class B amplifier, needs a special input transformer. The theory of design of this transformer, as well as the determination of the proper load impedance, is also discussed below. (Preliminary data on these tubes appeared in the July and August, 1932, issues of RADIO NEWS.)

It is anticipated that the improved quality of modern receivers will ultimately make manual tone control unnecessary. For distance reception, however, a suppression of high-frequency noises such as tube hiss will still be required. It is desirable that the change from high quality, low sensitivity (for local stations) to high sensitivity, modified quality, shall be accomplished automatically. This eliminates one control and pre-

vents improper use of it by the listener. Automatic fidelity control appears possible without the use of physical resistances, by making use of the variation in plate impedance produced by a change in grid bias. By connecting the plate and cathode of a tube across a tuned circuit, a change of plate will alter the selectivity curve and will suppress or admit side bands.

Examining the characteristics of the -24 type tube, it is seen that the plate resistance,  $r_p$ , increases as the grid bias increases. If such a tube were connected across a tuned-plate circuit, the selectivity would be greatest with the volume control set for minimum sensitivity, which is opposite to the desired effect.

Figure 1 shows the variation of plate resistance,  $r_p$ , with a change in suppressor voltage, while the control-grid bias remains fixed. The curves show a decreasing plate resistance when the suppressor voltage is varied from 0 to 40 volts negative. This effect is in the right direction for selectivity control and may be utilized for the

### ATTENUATION VERSUS FREQUENCY

Figure 3. These curves show how the higher frequencies are attenuated for different plate resistance values. For these curves, circuit D (Figure 2) was used. The intermediate frequency was 175 kc.,  $R_1$  135 ohms,  $L_1$  4.72 millihenries and  $C_1$  175 mmfd.

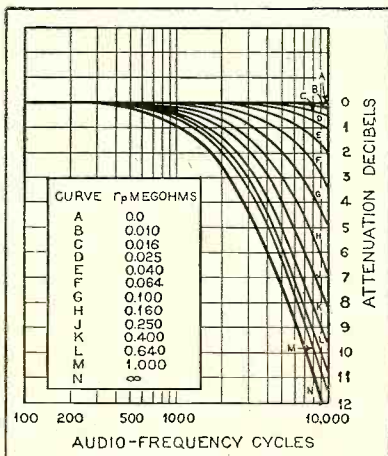

### OVERALL RESPONSE VARIATION

Figure 4. A test heterodyne showed a variation from curve 1 to curve 2 for zero suppressor volts to -38. Only one stage was fidelity-controlled and the transformer was not especially designed for it

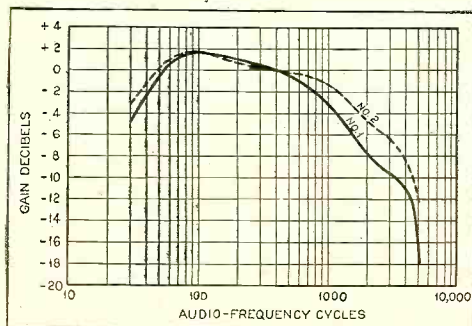

### FINDING CORRECT LOAD

Figure 5. This family of curves serves to determine the best load from the standpoint of maximum power output. The best load varies, and depends also on other conditions as described in the text

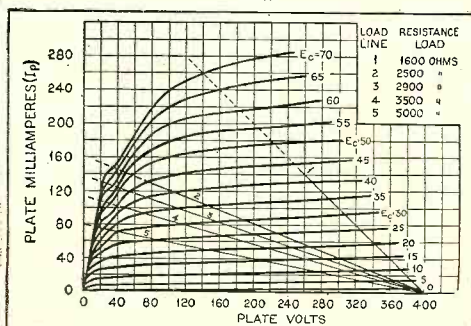



automatic control of these functions by connecting the suppressor to the a.v. resistor supplying variable control-grid bias for the i.f. or r.f. tube of a receiver.

A change of suppressor voltage from 0 to 40 volts negative with a control-grid bias of 3 volts negative produces a 64-to-1 change in mutual conductance and, simultaneously, a change in plate resistance from .8 to .05 megohm.

The extent of the signal attenuation as the effect of both the change in mutual conductance and the change in load impedance because of the variation of  $r_p$  can be derived from the circuits shown in Figure 2.

**The Effect of  $r_p$  Variation on Stage Gain**

Figure 2 (A) shows the conventional circuit, which may be resolved into the equivalent circuits in Figure 2 (B) and (C). Let  $Z_\infty$  denote the impedance of the circuit in Figure 2 (C); then it can be shown mathematically that

$$\frac{Z_\infty}{Z} = 1 + \frac{Z_\infty}{r_p}$$

If  $Z_1$  and  $Z_2$  denote the impedances of the same circuit for  $r_{p1}$  and  $r_{p2}$ , then

$$\frac{Z_2}{Z_1} = \frac{1 + \frac{Z_\infty}{r_{p1}}}{1 + \frac{Z_\infty}{r_{p2}}}$$

Assuming for  $Z_\infty$  a value of 200,000 ohms, the change in  $Z$ , for  $r_{p1} = 50,000$  ohms and  $r_{p2} = 800,000$  ohms, is 4 to 1. The attenuation change is then  $4 \times 64$  (the change due to the  $g_m$  change) = 256. This change is of the same order as would result from the change in  $g_m$  by variation of the control-grid bias. For a  $Z_\infty$  of 600,000 ohms, the ratio of impedances would be 7.4 to 1. Thus a stage of controlled fidelity would provide in addition about the same control of sensitivity as is obtainable from the usual grid-bias volume control.

To examine the possibility of side-band attenuation in a parallel tuned circuit, consider circuit D, Figure 2. When  $r_p$  is infinite, the resonance curve is that of the circuit alone. For finite values of  $r_p$ , it will be reflected into the circuit as an increased series resistance. The attenuation of a non-resonant

frequency at a particular value of  $r_p$  is proportional to the ratio of the impedance  $Z_0$  at resonance and the impedance  $Z$  at the non-resonant frequency.

The resonant impedance, when  $R$  is small compared to  $\omega L_1$ , is

$$Z_0 = \frac{R}{\omega_0 L_1}$$

Let  $R = R_1 + \frac{r_p}{\omega_0 L_1}$

then, by substituting,

$$Z_0 = \frac{R_1}{\omega_0 L_1} + \frac{r_p}{\omega_0 L_1}$$

At a non-resonant frequency,  $Z$  can be shown to be equal to

$$\frac{Z}{Z_0} = \frac{1 - \left(\frac{\omega_0}{\omega}\right)^2}{1 + \frac{\alpha^2}{\omega^2}}$$

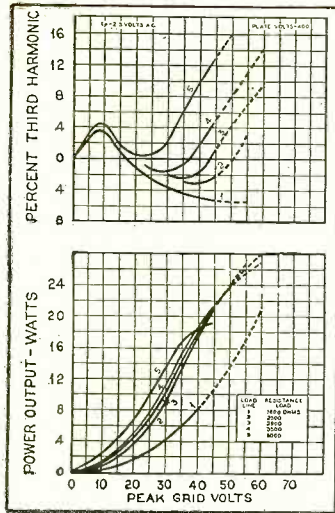
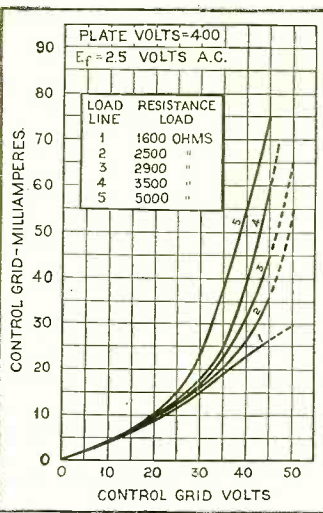

**EFFECT OF DIFFERENT LOADS**

Figure 6 (left). The most desirable of the 5 loads from the standpoint of third harmonic distortion and power output can be determined from these characteristics. The part of the distortion curves below zero represents a third harmonic 180 degrees out of phase with the one above zero. Figure 7 (right). The choice of the load also involves consideration of the grid current which the tube will draw. This is shown here for the five loads considered in the text

where  $\alpha = \frac{R_1}{\omega L_1} + \frac{\omega L_1}{r_p}$  and  $\frac{\omega_0}{\omega}$  = the ratio of the resonant

to the non-resonant frequency. The relative attenuation of the side bands from 0 to 100,000 cycles either side of resonance can now be determined from the above equations.

The attenuation obtainable is the larger, the lower the resonant frequency; this follows from the presence in the formula of the ratio  $\frac{\omega_0}{\omega}$ . For instance, for a frequency 10 kc. off

resonance the attenuation at 1000 kc. is 4.4 db., while the attenuation at 175 kc. is 13.4 db. In order to obtain the same degree of control at broadcast frequencies as at intermediate frequencies, a greater number of r.f. stages is needed. Application of fidelity control to a superheterodyne therefore will be logically confined to one of the i.f. stages, since little will be gained from the simultaneous control of a r.f. stage.

Consider a coupled intermediate-transformer circuit, having both primary and secondary tuned to resonance, as shown in circuits (A) and (B) in Figure 2. The sharpness of the selectivity curve is a function of  $R_1$ ,  $R_p$ ,  $R_2$  and  $M$ . The gain per stage will be maximum at critical coupling, when

$$\omega M = R \left( R_1 + \frac{\omega L_1}{r_p} \right)$$

(Continued on page 703)

**DRIVER PLATE CHARACTERISTICS**

Figure 8 (left). A family of plate curves for the type -46 tube used as a driver for two similar tubes in a Class B circuit. Figure 9 (right). The required load resistance with the corresponding power output and a.c. peak grid resistance is here plotted for a 300-volt and 400-volt B supply

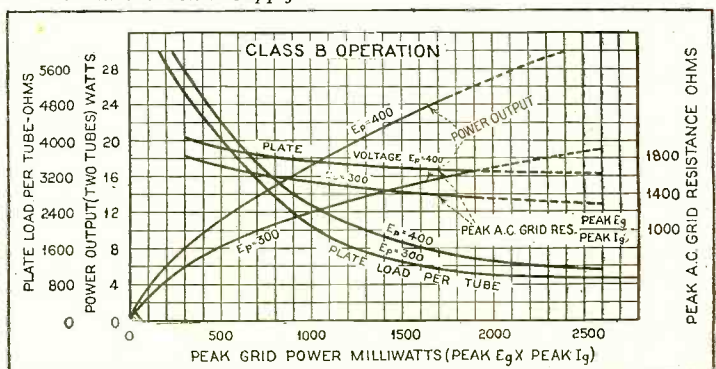
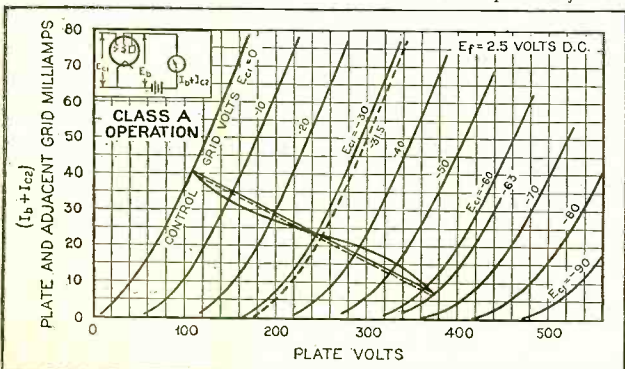

# SOME PERTINENT INFORMATION ON Short-Wave **DX** Reception

*On these two pages our readers will find a comprehensive discussion of some of the remaining fundamentals for DX reception on the short-wave bands. The material presented is that necessary information that would take the DX fan months of actual experience to gather*

**T**HE effects of sunrise and sunset on s.w. transmission presents an interesting study. Conclusions based on observations of stations VK2ME and VK3ME in Australia operating on approximately 9590 kc. (31.28m.) are that maximum results are obtained in Chicago from shortly before sunrise until one or two hours after sunrise, regardless of the time of year. Even on considerably lower frequencies such as F3ICD in Saigon, French Indo-China, on 6,110 kc. (49.1 m.) and RV15 in Khabarovsk, Siberia, on 4,280 kc. (70.1 m.), marked improvement is apparent near the hour of sunrise. A similar effect is observed at sunset from stations in Europe operating on the 12,000 kc. (25 m.) band, marked improvement in reception from G5SW, 12RO and Pontoise, France, being observed from about one or two hours before sunset until shortly after sunset. The Heavyside layer, being lower in daylight and higher when darkness prevails, has a tendency to cause a signal from Australia to be deflected earthward in America at sunrise and a signal from Europe to be deflected earthward at sunset, the angle of declination being reversed in the two instances.

A member of the Chicago Short-wave Radio Club after a close study of the effects of the moon on short-wave radio reception has concluded that reception slowly improves from the first quarter to the full moon, reaching the peak during the full moon period and rapidly dropping off with the approach of the last quarter. The conclusions were based on continued observations during the various lunar periods extending over a period embracing seasonal positions of the earth.

## *Atmospheric Conditions*

Undoubtedly short-wave radio reception is affected by atmospheric conditions but it does not necessarily follow that stormy or unsettled weather is unfavorable for good results from distant stations. Very frequently transmissions from Australia, Europe and South America are intercepted in Canada and the United States during the height of a thunder and lightning storm with excellent volume and audibility, impaired only by the direct interference caused by the individual flashes of lightning. According to repeated observations, wet weather appears to improve reception considerably in many cases. This is probably especially true where the storm is more or less localized, as when unsettled weather conditions extend over a vast area distant reception generally is partially impaired or totally ruined.

Although it is generally understood that short waves are more dependable for long distance communication than long waves, it should not be concluded that short waves can be intercepted with 100 percent consistency. The English and American stations engaged in commercial telephony for trans-Atlantic traffic, as well as the ship-to-shore stations, can not rely upon any one frequency for any certain hours with abso-

lute dependability. In many instances, especially when an international broadcast is in progress, two or more short-wave stations operating on entirely different frequencies are used in parallel to insure the best possible reception. If the short waves fail to hold up, long-wave transmitters operating on 60 kc. (5000 m.) with as much as 1,000 kilowatts power are used.

The power used by a short-wave station does not govern whether or not it will be heard in some remote locality. Unlimited power and the most efficient receiver will not necessarily result in a signal being intercepted. The famous little station NRH (now T14NRH) using only 7½ watts power has been heard in many countries with good volume. Stations HKA, PRADO and other 50-watt stations and VRY with 120 watts have been heard with much volume in many sections of the earth. In a single trans-

**By W. H. Reeks**

## *Part Two*

mission of only two hours duration HKA was heard in Canada, the United States, Mexico, Cuba, Venezuela, Peru, England, France and New Zealand, which is considered a record for the power used. VK2ME in Sydney with a power of 12 kilowatts and VK3ME in Melbourne using 4 kilowatts are often heard with clarity and volume almost equal to that of local broadcast stations whereas PLV in Bandoeng, Java, on practically the same frequency and using 60 kilowatts and operating at about the same hour is heard in Chicago generally with poor volume and almost always with rapid fading. Undoubtedly the governing factors in these cases are the locations and the directions from which the signal is received. Possibly the nature of the earth's surface over which the signal passes affects the strength of the signal to some extent, since transmission over water is generally more satisfactory than transmission over land due, in part, to the reflecting characteristics of water. Vast forests, such as those of Siberia, have a tendency to absorb radio transmissions. This absorption is considerably less on the higher frequencies.

## *Foreign Announcements*

Realizing that their programmes are reaching the ears of thousands in many lands who might not be familiar with the language of the country where the transmission originates, short-wave stations in a great many cases adopt a signal that establishes beyond peradventure the identity of their station. As an aid in identifying station call letters, the alphabet and first ten or twelve numerals of some of the more important languages, such as Spanish, French and German, should be memorized. Since many of the commercial and experimental stations sign off with the International Morse Code, it is to a listener's advantage to be familiar with that code.

Most stations welcome reports of reception from their listeners, especially the experimental stations transmitting musical programs. Many listeners are equally interested in receiving confirmations of their reception from the various stations. A request for such verification should include date of reception; frequency or wave length; details of program items with the actual time of musical selections, songs, announcements, etc., given in local time, time at place of origin of transmission or, preferably, Greenwich Mean Time (G.M.T.) Volume or audibility expressed in the R system and readability expressed in the QSA system; quality of modulation; kind of receiver; temperature; barometric pressure; whether rising or falling barometer and general weather conditions; conditions of ground; official hour of sunrise or sunset if reception is effected just before or after these times are other details of interest which may be included. An International Postal Reply Coupon is necessary in most cases, if a reply is desired. Stations do not all require a complete log of reception or the actual identification of even a single selection, since in many cases either no transmission log is maintained or no reference is made to the log when verifying a report. Other stations are very particular on this point, however. Nor is it necessary to comply with the other conditions suggested, although the order given here constitutes a good report and is of value to the station owner.

Until recently G5SW required a coupon from the British Broadcasting Corporation's journal, World-Radio, properly filled out. It was also necessary to enclose sixpence and, in the case of overseas listeners, an International Postal Coupon. However, the requirements for verification from G5SW for overseas listeners have been revised and they now call for, in addition to the report of reception, only a self-addressed envelope and sixpence, equivalent to 12c in American money. Stamps should not be sent. Reports to other stations (outside of the United States) should, however, be accompanied by an International Postal Reply Coupon. They may be purchased at Canadian and United States post offices at 9c each and may be exchanged in any country of the Postal Union for a postage stamp or postage stamps representing the postage on a single-rate foreign letter; they are valid for two months (six months in relations with over-sea countries), exclusive of the month of issue.

## *Scrambled Speech*

The commercial stations as a rule do not verify telephonic transmission not intended for general public reception, since such communication is classified by international treaty as correspondence of a private nature of which the unauthorized reception by any chance intercepting listener is in violation of the secrecy provisions of the International Radio Convention.

In such instances where the highest pos-

sible degree of secrecy is desired or must be exercised a special device known as a "demodulator" is employed which causes the speech and music to become "scrambled," the high notes being turned into low ones and the low notes into high ones, making the voice unintelligible. Special receiving apparatus is required to "unscramble" this "inverted modulation," the inverted notes resuming their original positions. No wonder that when listeners hear this strange jargon they are convinced that they are receiving emissions from Chinese stations or else begin dismantling their receivers in order to locate the cause of the distortion in their sets!

One of the most interesting considerations in connection with the interception of foreign short-wave radio emissions is the difference in time between the respective locations of transmitter and receiver. As "the iron tongue of midnight hath toll'd twelve" and the final stroke of famous Big Ben is being broadcast to the world over G5SW, ushering in a new day, Chicagoans will have heard it 6 hours earlier, the day before it was broadcast, while Australians will have tuned it in just after 10 o'clock in the morning of the same day.

Distance alone does not govern difference in time. There is a difference in time between New York and Sydney, Australia, a distance of over 10,000 miles, of 15 hours; and between New York and Wellington, New Zealand, a distance of less than 9,000 miles, of 16½ hours. At 9:00 a.m. in Chicago it is 1:00 a.m. in Sydney the next day, a difference of 16 hours. Though Los Angeles, California, is 1,170 miles closer to Sydney than is Chicago, yet the difference in time is 18 hours; Honolulu, Hawaii, is over 4,000 miles closer but there is a difference of 20½ hours. A less difference in mileage may result in a much greater difference in time. Samoa is separated from Suva, Fiji Islands, by only about 700 miles but by 23½ hours, Samoa being on one side of the International Date Line and Suva on the other.

### International Date Line

The International Date Line, also known as the Admiralty Date Line or Shippers' Date Line, is an arbitrary line curving east and west of the 180th Meridian in such a manner as to lie always in the ocean. This is the official starting point of every day, every year, every century. From here day speeds Westward at about a thousand miles an hour along the Equator. Day first dawns on the Chatham Isles with its population of a couple of hundred shepherds and fishermen, about 400 miles southeast of Wellington, New Zealand.

*(All of this may sound complicated. However, this need not worry readers as the time chart printed in the March issue provides a simple guide to the time in any part of the world.—The Editors.)*

Those unfamiliar with short-wave radio reception are often of the opinion that a great number of tubes incorporated in a complicated circuit utilizing expensive components is a major requisite for the interception of transmissions from distant stations. Experimenters in various localities of America have listened to Australian programs with good volume using a set employing only two tubes in a simple circuit. Of course, for greater amplification a receiver utilizing more tubes is to be recommended but it does not always follow that the most elaborate and expensive set with many stages of amplification will give the best results. Some listeners prefer a superheterodyne circuit employing about a dozen tubes while others choose a regenerative circuit, preferably with one stage of radio-frequency ahead of a regenerative detector followed by two stages of audio frequency, possibly with push-pull in the output, making only four or five tubes in all. Though the appli-

cation of alternating current has eliminated battery problems and the trouble and expense involved, nevertheless some of the most critical listeners continue to recommend battery-operation for quiet and more satisfactory reception on the high frequencies. This, however, appears to be largely a matter of individual choice.

### Short-Wave Tuning

As has already been inferred, tuning for distant short-wave stations should not be fashioned after the casual tuning of local broadcast stations. Short-wave radio receivers, covering as they do a wide range of frequencies, must of necessity tune sharply. This is readily realized when one stops to

## Can You Answer These?

**T**HE questions presented below are considered important problems in the reception of distant signals on a short-wave set. Mr. Reeks' series of two articles throw light on these questions.

1. *What natural phenomena governs short-wave transmission?*
2. *What are the best times to listen-in?*
3. *What wavelengths furnish the best results?*
4. *What is "skip distance"?*
5. *What is the heaviside layer?*
6. *How is time reckoned?*
7. *How may foreign "announcements" be recognized?*
8. *How may reception be verified?*
9. *What sets may be used?*
10. *What is the relation between frequency and wavelength?*
11. *Where to tune for stations.*
12. *What are "phantom" harmonics?*
13. *How can one reckon distance?*
14. *How may one recognize a station?*
15. *What is the international date line?*
16. *How does day and night affect reception?*
17. *What is "scrambled" speech?*

consider that a standard receiver designed for reception only of the wavelengths between 200 and 550 m. used for regular broadcast purposes covers a band of only 955 kc., from 1,500 to 545 kc., whereas a short-wave receiver designed to operate from 14 to 200 m., usually with a system of plug-in coils or change-over switches utilizing different coils for different bands, must cover 19,920 kc., from 21,420 to 1,500 kc. Of course, band-spreading devices may be obtained giving greater separation on certain bands of frequencies. The amateurs almost universally adopt some means of spreading on narrow congested bands allotted them, without which reception often would be out of the question. Though 10-kilocycle separation is considered exceedingly selective on the regular broadcast channels, such separation is practically impossible on the extremely high frequencies with even the best short-wave receiver. A selective receiver is usually re-

quired to separate PCJ, Holland, on 9,585 kc. and W1XAZ on 9,570 kc., a difference of 15 kc., or DJA, Zeesen, Germany, on 9,560 kc. from either W1XAZ with a difference of 10 kc. or W2XAF on 9,530, a difference of 30 kc. On the 6,120-kc. (49-m.) band 10-kc. separation is not so difficult. It should be noted that for the 955 kc. equivalent to the 350 m. comprising the broadcast band the average is 3.675 m. per 10 kc. and that one m. is, on the average for this range, 2.73 kc.

Compare these results with 955 kc. near 14 m. 21,420 kc. is equivalent to 14.006 m. and 20,465 kc., a difference of 955 kc., is equivalent to 14.659 m., a difference of .653 m. as compared with a difference of 350 m. for 955 kc. on the broadcast band. Though 10 kc. represents 5 m. on the band of 375 m., on the 14-m. band 10 kc. is about six one-thousandths of a meter. Thus it is seen that the same results should not be expected on short-waves where a 10-kc. separation might be only four one-thousandths, or less, of a meter as on the broadcast band where 10 kc. equals anywhere from 1.3 m. to 11 m.

### Frequency vs. Wavelength

It is often necessary for the short-wave listener to convert kilocycles to meters or meters to kilocycles. A convenient rule to remember is that kilocycles divided into 300,000 is the equivalent in meters and meters divided into 300,000 is the equivalent in kilocycles. For example, 300,000 divided by 1,500 kc. equals 200 m. and 300,000 divided by 200 m. equals 1,500 kc. The exact figure is 299,820 but 300,000 is accurate enough for all general purposes and is much more easily remembered.

Frequencies are often stated in megacycles, a megacycle being 1,000,000 cycles or 1,000 kc. Thus 10 megacycles equals 10,000 kc. or 30 m. A kilocycle is, of course, 1,000 cycles.

### Harmonic Radiation

Listeners frequently come across the perplexing situation of hearing stations on short waves that are known to broadcast only on the regular band between 545 and 1,500 kc. These "phantom" short-wave stations are harmonics radiated by the broadcast stations and although they are generally considered a nuisance, especially when one undergoes the aggravating experience of listening most intently for perhaps fifteen minutes, expecting to hear a foreign tongue, misses the announcement due to static or fading, stands by for another quarter hour or more only to find out it is a harmonic of a nearby broadcast station, nevertheless they may be used to good advantage in calibrating a short wave receiver. Take for example a station operating on 1,500 kc. (200 m.). Its second harmonic would fall on 3,000 kc. (100 m.), its third on 4,500 kc. (66.67 m.), its fourth on 6,000 kc. (50 m.), and so on. Suppose a station is heard on a roughly estimated frequency of 9,090 kc. (33 m.) and upon checking up its correct frequency is found to be 1,280 kc. (234.2 m.). The nearest harmonic to 9,090 kc. would be the seventh harmonic, equivalent to 8,960 kc. (33.48 m.).

Harmonics must be whole multiples of the original frequency. There can be no harmonic before the second, which is double the frequency or one-half the wavelength, the third being triple, the frequency of the fundamental or one-third the wavelength, and so on.

At the present time much of the short-wave radio broadcasting of the world is of an experimental nature. For this reason it is impossible to draw up a list of the world's short-wave stations that can be presented to the listener with any assurance that it will not be partially out of date within a short time.

# MODERN RADIO PRACTICE IN USING GRAPHS *and* CHARTS

*Calculations in radio design work usually can be reduced to formulas represented as charts which permit the solution of mathematical problems without mental effort. This series of articles presents a number of useful charts and explains how others can be made*

**A**LTHOUGH the resistance of copper wire can be found in wire tables, if the conductor is another substance this problem becomes one of finding the specific resistance and involves some calculation. And there are several ways of expressing the specific resistance, which is a confusing idea to many.

The chart of Figure 1 enables one to determine the resistance of a wire of any material listed, when the cross-sectional area and the length are known. When a given resistance is required, the accompanying chart is useful in finding the correct length of resistance wire needed.

The resistance, R, of a wire is found from the formula

$$R = \frac{lk}{A}$$

Where A = the cross-sectional area of the wire  
l = the length of the wire  
and k = the specific resistance of the conductor.

### Unit of Resistivity

In America, the specific resistance is usually given in ohms per mil foot, and, consequently, A is then measured in circular mils and the length in feet. However, sometimes the specific resistance is given in ohms per centimeter cube; if the same formula is to be used, the quantities A and l must then be measured in square centimeters and centimeters respectively.

For the convenience of those who may have to work with other units, some equivalents have been placed on the chart along the regular divisions. So, for instance, on the A scale, the cross-sectional area is measured off in circular mils, in square millimeters and in gauge numbers. To illustrate the use of the chart, let us take an example. Suppose it is required to find the resistance of 10 feet of German silver of number 22 B. & S. gauge. Draw a line from the division point marked "German silver" on the k scale and the point on the l scale marked 10 feet; note the intersection on the turning scale. A

By John M. Borst  
Part Eight

line drawn from this point through the division marked 22 intersects the resistance scale at 3.1 ohms, which is the answer to our problem.

When the resistance is known, but the length of the wire has to be found, the same work may be done backwards. Beginning with the wire size and the resistance, connect the respective values on the R and A scale, with a straight line, and note the intersection on the turning scale. Then draw a line from this point to the division point on the k scale, indicating the material in question. The intersection at the l scale indicates the length of wire needed.

In some cases, when long wires have to be employed, it is necessary to read the l and R scales on the "B" side. The relations will always hold as long as you read both R and l on the "A" side or both on the "B" side.

For the benefit of those who must work with other units than the ones used in Figure 1, we list the following equivalents:

- 1 microhm per centimeter cube equals 6.0153 ohms per mil foot
- 1 ohm per mil foot equals .16624 microhms per centimeter cube
- 1 circular mil equals .0005065 square millimeters
- 1 square millimeter equals 1972 circular mils
- 1 foot equals .3048 meters and 1 meter equals 3.2809 feet.

The simplest charts are always the most successful! When a formula in more than two independent variables has to be solved graphically and the system of parallel scales is used, it is always necessary to draw two constructional lines for each individual computation.

This method of graphical calculation does not permit the solution of a three-independent-variable-equation in one operation unless a network is used for the center scale. The latter method is not so easy to read, but sometimes it is the only one possible. In one of the future issues of RADIO NEWS we shall give the theory of this method and illustrate the principles with a useful example.

A simplification of the chart in (Continued on page 700)

MATERIAL	OHMS PER MIL-FOOT
ADVANCE	293.5
ALUMINUM, PURE	15.8
ALUMINUM WIRE	15.7
ALUMINUM BRONZE	53.3
ARGENTAN	171.5
BRASS, 90.9 COPPER, 9.1 ZINC	21.9
BRASS, 65.8 " 34.2 "	27.8
BRONZE	107
CALIDO	601.5
CLIMAX, NICKLE STEEL	524
CONSTANTAN	295
COPPER, ANNEALED STANDARD	9.6
COPPER, ELECTROLYTIC	9.4
COPPER, HARD DRAWN	9.65
COPPER IRON	24.6
EXCELLO	550
FERRO NICKLE	162.5
GERMAN SILVER	199
GOLD	13.25
IDEAL	295
IA IA, SOFT	284
IA IA, HARD	302
IRON, VERY PURE	53.3
IRON, SOFT STEEL	71
IRON, HARD STEEL	275
IRON, CAST, SOFT	448
IRON, CAST, HARD	590
KRUPP METAL	512

MATERIAL	OHMS PER MIL-FOOT
LEAD, PURE	119
LEAD-BISMUTH	381
MANGANESE-COPPER	601.5
MANGANIN	249,445
MERCURY	567
MOLYBDENUM, HARD DRAWN	29.5
MOLYBDENUM, ANNEALED	25.3
MONEL METAL	246
NICHROME	595
NICHROME II	662
NICKLE, ELECTROLYTIC	41.7
NICKLE, COMMERCIAL WIRE	59.7
NICKLE STEEL	177
PHOSPHOR BRONZE	46.7
PLATINUM, DRAWN	61.4
PLATINUM-IRIDIUM	190.4
PLATINUM-RHODIUM	127
RHEOTAN	268
ROSE'S METAL	398
SILVER, ELECTROLYTIC	8.86
SUPERIOR	525
TANTALUM	8.80
THERLO	281
TIN	63.3
TUNGSTEN	26.35
WOOD'S METAL	312
YANKEE SILVER	199
ZINC	32.4

TABLE OF SPECIFIC RESISTANCE

# Resistance of Round Wire

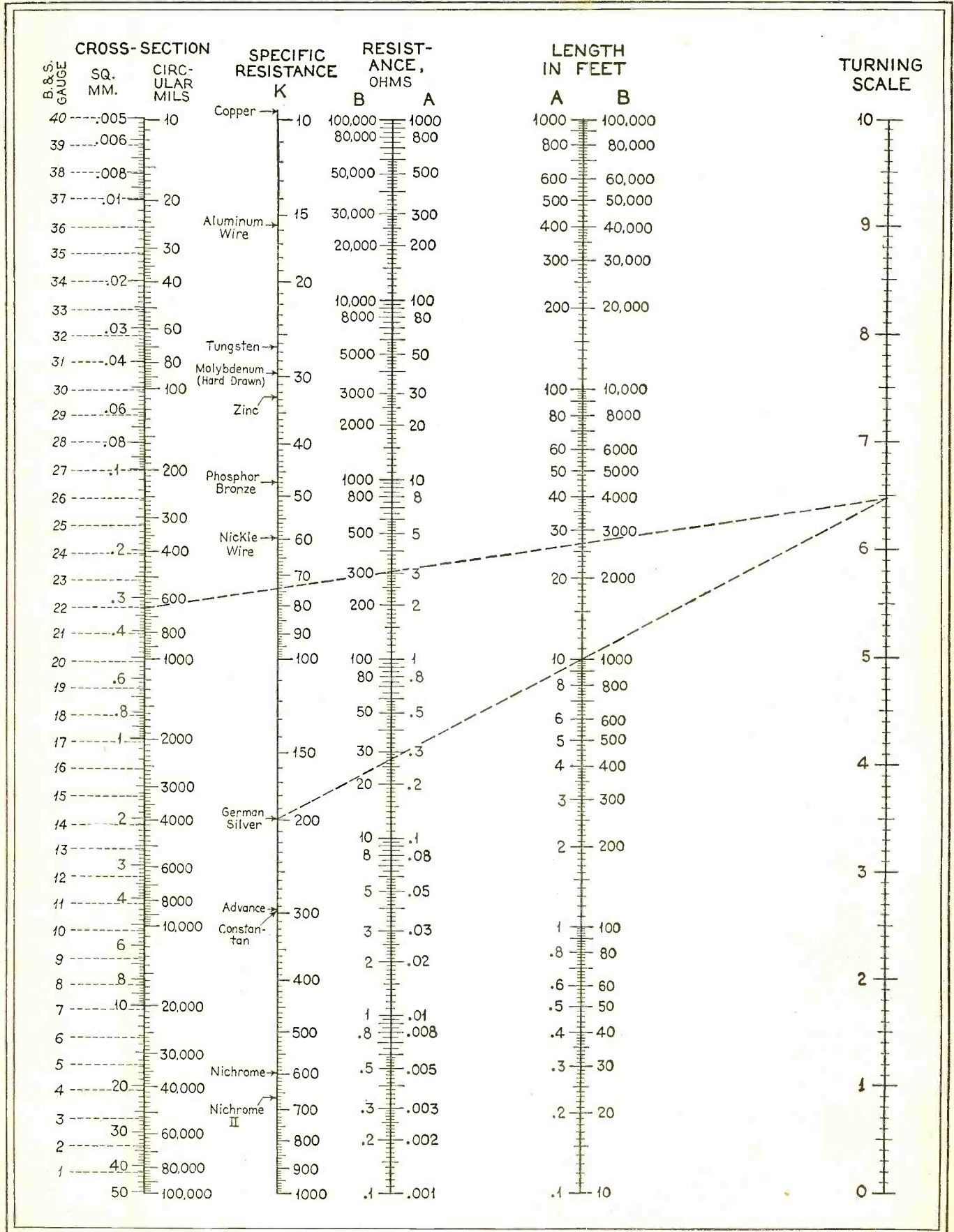

THIS CHART WILL SAVE YOU TIME AND TROUBLE

Figure 1. The equation used is  $R = 1k/d$ , where  $k$ , the specific resistance, is expressed in ohms per mil foot. For example, a German silver wire, 10 feet in length and of No. 22 B. & S. gauge, has a resistance of 3.1 ohms

# Radio Call Book Section

Conducted by S. Gordon Taylor and John M. Borst

## Broadcasting Stations in the U. S.

Alphabetically by Call Letters, Location, Frequency and Power

Call	Location	Kilocycles	Watts	Call	Location	Kilocycles	Watts	Call	Location	Kilocycles	Watts
KABC	San Antonio, Tex.	1420	100	KGGF	Coffeyville, Kansas	1010	500	KTHS	Hot Springs National Park, Arkansas	1040	10,000
KALE	Portland, Ore.	1300	500	KGGM	Albuquerque, N. Mexico	1230	500	KTM	Los Angeles, California	780	1,000
KARK	Little Rock, Arkansas	890	250	KGHF	Pueblo, Colorado	1320	500	KTRH	Houston, Texas	1120	500
KASA	Elk City, Okla.	1210	100	KGHI	Little Rock, Arkansas	1200	100	KTSM	San Antonio, Texas	1290	2,500
KBPS	Portland, Oregon	1420	100	KGHL	Billings, Montana	950	2,500	KTSA	El Paso, Texas	1310	100
KBTM	Paragould, Arkansas	1200	100	KGIR	Butte, Montana	1360	500	KTW	Seattle, Washington	1220	1,000
KCMC	Texarkana, Ark.	1420	100	KGIW	Trinidad, Colorado	1420	100	KUJ	Walla-Walla, Wash.	1370	100
KCRC	Enid, Oklahoma	1370	250	KGIX	Las Vegas, Nevada	1420	100	KUMA	Yuma, Arizona	1420	100
KCRJ	Jerome, Arizona	1310	100	KGIZ	Grant City, Missouri	1500	100	KUOA	Fayetteville, Arkansas	1390	1,000
KDB	Santa Barbara, Calif.	1500	100	KGKB	Tyler, Texas	1500	100	KUSD	Vermillion, S. Dakota	890	500
KDFN	Casper, Wyoming	1440	500	KGKL	San Angelo, Texas	1370	100	KVI	Tacoma, Washington	570	500
KDKA	Pittsburgh, Pennsylvania	980	50,000	KGKO	Wichita Falls, Texas	570	500	KVL	Seattle, Washington	1370	100
KDLR	Devils Lake, N. Dakota	1210	100	KGKX	Sandpoint, Idaho	1420	100	KVOA	Tucson, Arizona	1260	500
KDYL	Salt Lake City, Utah	1290	1,000	KGKY	Scottsbluff, Nebraska	1500	100	KVOR	Tulsa, Oklahoma	1140	5,000
KECA	Los Angeles, California	1430	1,000	KGMB	Honolulu, Hawaii	1320	250	KVOS	Colorado Springs, Colo.	1270	1,000
KELW	Burbank, California	780	500	KGMP	Elk City, Oklahoma	1210	100	KWCR	Bellingham, Washington	1200	100
KERN	Bakersfield, California	1200	100	KGNF	North Platte, Nebraska	1430	500	KWEG	Cedar Rapids, Iowa	1210	250
KEX	Portland, Oregon	1180	5,000	KGNO	Dodge City, Kansas	1210	100	KWJ	Shreveport, Louisiana	1210	100
KFAB	Lincoln, Nebraska	770	5,000	KGO	San Francisco, Calif.	790	7,500	KWJ	Stockton, California	1200	100
KFAC	Los Angeles, California	1300	1,000	KGRS	Amarillo, Texas	1410	1,000	KWJ	Portland, Oregon	1060	500
KFBB	Great Falls, Montana	1280	2,500	KGU	Honolulu, Hawaii	750	2,500	KWK	St. Louis, Missouri	1350	1,000
KFBI	Abilene, Kansas	1050	5,000	KGVO	Missoula, Montana	1200	100	KWK	Kansas City, Missouri	1370	100
KFBK	Sacramento, California	1310	100	KGW	Portland, Oregon	620	1,000	KWKH	Shreveport, Louisiana	850	10,000
KFBL	Everett, Washington	1370	50	KGY	Olympia, Washington	1210	100	KWLC	Decorah, Iowa	1270	100
KFDM	Beaumont, Texas	560	1,000	KHJ	Los Angeles, California	900	1,000	KWSC	Pullman, Washington	1220	2,000
KFDY	Brookings, S. Dakota	550	1,000	KHQ	Spokane, Washington	590	2,000	KWWW	Brownsville, Texas	1260	500
KFEL	Denver, Colorado	920	500	KICA	Clovis, New Mexico	1370	100	KXA	Seattle, Washington	760	500
KFEQ	St. Joseph, Missouri	680	2,500	KICK	Red Oak, Iowa	1420	100	KXL	Portland, Oregon	1420	100
KFGQ	Boone, Iowa	1310	100	KID	Idaho Falls, Idaho	1320	500	KXO	El Centro, California	1500	100
KFH	Wichita, Kansas	1300	1,000	KIDO	Boise, Idaho	1350	1,000	KXRO	Aberdeen, Washington	1310	100
KFI	Los Angeles, California	640	50,000	KIDW	Lamar, Colo.	1420	100	KXVZ	Houston, Texas	1420	250
KFIO	Spokane, Washington	1120	100	KIT	Yakima, Washington	1310	100	KVA	San Francisco, Calif.	1230	1,000
KFIZ	Fond du Lac, Wisconsin	1420	100	KJBS	San Francisco, Calif.	1070	100	KVW	Chicago, Illinois	1020	10,000
KFJB	Marshalltown, Iowa	1200	250	KJR	Seattle, Washington	970	5,000	WAAB	Boston, Massachusetts	1410	500
KFJI	Klamath Falls, Oregon	1210	100	KJRN	Blytheville, Arkansas	1290	50	WAAF	Chicago Illinois	920	500
KFJM	Grand Forks, N. Dakota	1370	100	KLO	Ogden, Utah	1400	500	WAAM	Newark, New Jersey	1250	2,500
KFJR	Portland, Oregon	1300	500	KLPM	Minot, North Dakota	1240	250	WAAT	Jersey City, New Jersey	940	300
KFJZ	Fort Worth, Texas	1370	100	KLRA	Little Rock, Arkansas	1390	1,000	WAAW	Omaha, Nebraska	660	500
KFKA	Greeley, Colorado	880	1,000	KLS	Oakland, California	1440	250	WABC	New York, New York	860	50,000
KFKU	Lawrence, Kansas	1220	500	KLX	Oakland, California	880	500	WABI	Bangor, Maine	1200	100
KFKX	See KYW			KLZ	Denver, Colorado	560	1,000	WABO	See WHEC		
KFLV	Rockford, Illinois	1410	500	KMA	Shenandoah, Iowa	930	1,000	WABZ	New Orleans, Louisiana	1200	100
KFLX	Galveston, Texas	1370	100	KMAC	San Antonio, Texas	1370	100	WACO	Waco, Texas	1240	1,000
KFMX	Northfield, Minnesota	1250	1,000	KMBC	Kansas City, Missouri	950	1,000	WADC	Tallmadge, Ohio	1320	1,000
KFN	Shenandoah, Iowa	890	1,000	KMED	Medford, Oregon	1310	100	WAGM	Presque Isle, Maine	1420	100
KFOR	Lincoln, Nebraska	1210	250	KMJ	Fresno, California	1210	100	WAIU	Columbus, Ohio	640	500
KFOX	Long Beach, California	1250	1,000	KMLB	Monroe, Louisiana	1200	100	WALR	Zanesville, Ohio	1210	100
KFPL	Dublin, Texas	1310	100	KMMJ	Clay Center, Nebraska	740	1,000	WAMC	Anniston, Ala.	1420	100
KFPM	Greenville, Texas	1310	15	KMO	Tacoma, Washington	1330	250	WAPI	Birmingham, Alabama	1140	5,000
KFPW	Fort Smith, Arkansas	1210	100	KMOX	St. Louis, Missouri	1090	50,000	WASH	Grand Rapids, Michigan	1270	500
KFPY	Spokane, Washington	1340	1,000	KMP	Beverly Hills, California	710	500	WAWZ	Zarephath, New Jersey	1350	250
KFQD	Anchorage, Alaska	1230	250	KMTR	Los Angeles, California	570	500	WBAA	West Lafayette, Indiana	1400	500
KFR	San Francisco, Calif.	610	1,000	KNOW	Austin, Texas	1500	100	WBAX	Harrisburg, Pennsylvania	1430	1,000
KFRU	Columbia, Missouri	630	500	KNX	Los Angeles, California	1050	25,000	WBAL	Baltimore, Maryland	1060	10,000
KFS	San Diego, California	600	1,000	KOA	Denver, Colorado	830	12,500	WBAP	Fort Worth, Texas	800	50,000
KFSG	Los Angeles, California	1120	500	KOAC	Corvallis, Oregon	550	1,000	WBAX	Wilkes-Barre, Penn.	1210	100
KFUL	Galveston, Texas	1290	500	KOB	Albuquerque, N. Mexico	1180	10,000	WBBC	Brooklyn, New York	1400	500
KFUO	Clayton, Missouri	550	1,000	KOCW	Chickasha, Oklahoma	1400	500	WBBL	Richmond, Virginia	1210	100
KFVD	Los Angeles California	1000	250	KOH	Reno, Nevada	1380	500	WBMM	Chicago, Illinois	770	25,000
KFVS	Cape Girardeau, Mo.	1210	100	KOIL	Council Bluffs, Iowa	1260	1,000	WBRR	Brooklyn, New York	1300	1,000
KFWB	Hollywood, California	950	1,000	KOIN	Portland, Oregon	940	1,000	WBZ	Ponca City, Oklahoma	1200	100
KFWF	St. Louis, Missouri	1200	100	KOL	Seattle, Washington	1270	1,000	WBCN	Bay City, Michigan	1410	500
KFWI	San Francisco, Calif.	930	500	KOMA	Oklahoma City, Okla.	1480	5,000	WBEN	Buffalo, New York	900	1,000
KFXD	Nampa, Idaho	1200	100	KOMO	Seattle, Washington	920	1,000	WBEO	Marquette, Michigan	1310	100
KFXF	Denver, Colorado	920	500	KONO	San Antonio, Texas	1370	100	WBHS	Huntsville, Alabama	1200	100
KFXJ	Grand Junction, Colo.	1200	100	KOOS	Marshallfield, Oregon	1370	100	WBIG	Greensboro, N. Carolina	1440	1,000
KFXM	San Bernardino, Calif.	1210	100	KORE	Eugene, Oregon	1420	100	WBIS	See WNAC		
KFXR	Oklahoma City, Okla.	1310	250	KOY	Phoenix, Arizona	1390	500	WBMS	Hackensack, New Jersey	1450	250
KFY	Lubbock, Texas	1310	250	KPCB	Seattle, Washington	650	100	WBNX	New York, New York	1350	250
KFYR	Bismarck, N. Dakota	550	2,500	KPJM	Prescott, Arizona	1500	100	WBOQ	See WABC		
KGA	Spokane, Washington	1470	5,000	KPO	San Francisco, Calif.	680	5,000	WBOW	Terre Haute, Indiana	1310	100
KGAR	Tucson, Arizona	1370	250	KPOF	Denver, Colorado	880	500	WBRC	Birmingham, Alabama	930	1,000
KGB	San Diego, California	1330	1,000	KPPC	Pasadena, California	1210	50	WBRE	Wilkes-Barre, Penn.	1310	100
KGBU	Ketchikan, Alaska	900	500	KPO	Wenatchee, Washington	1500	50	WBRO	Needham, Massachusetts	920	500
KG BX	Springfield, Missouri	1310	100	KPRC	Houston, Texas	920	2,500	WBT	Charlotte, N. Carolina	1080	25,000
KGZ	York, Nebraska	930	1,000	KQV	Pittsburgh, Pennsylvania	1380	500	WBTM	Danville, Virginia	1370	100
KGCA	Decorah, Iowa	1270	100	KQW	San Jose, California	1010	500	WBZ	Boston, Massachusetts	990	25,000
KGCR	Watertown, S. Dakota	1210	100	KRE	Berkeley, California	1370	100	WBZA	Boston, Massachusetts	990	1,000
KGCU	Mandan, North Dakota	1240	250	KREG	Santa Ana, California	1500	100	WCAC	Storrs, Connecticut	600	250
KGCX	Wolf Point, Montana	1310	250	KRGV	Harlingen, Texas	1260	500	WCAD	Canton, New York	1220	500
KGDA	Mitchell, South Dakota	1370	100	KRND	Los Angeles, California	1120	500	WCAE	Pittsburgh, Pennsylvania	1220	1,000
KGDE	Fergus Falls, Minnesota	1200	250	KRLD	Dallas, Texas	1040	10,000	WCAH	Columbus, Ohio	1430	500
KGDM	Stockton, California	1100	100	KRMD	Shreveport, Louisiana	1310	100	WCAJ	Lincoln, Nebraska	590	500
KGDY	Huron, South Dakota	1200	100	KROW	Oakland, California	930	1,000	WCAL	Northfield, Minnesota	1250	1,000
KGEF	Los Angeles, California	1300	1,000	KRSC	Seattle, Washington	1120	100	WCAM	Camden, New Jersey	1280	500
KGEK	Yuma, Colorado	1200	100	KSAC	Manhattan, Kansas	580	1,000	WCAP	Baltimore, Maryland	600	250
KGER	Long Beach, California	1200	1,000	KSCJ	Sioux City, Iowa	1330	2,500	WCAT	Asbury Park, N. J.	1280	500
KGEV	Fort Morgan, Colorado	1200	100	KSD	St. Louis, Missouri	550	300	WCAT	Rapid City, S. Dakota	1200	100
KGEZ	Kalispell, Montana	1310	100	KSEI	Pocatello, Idaho	890	500	WCAU	Philadelphia, Penna.	1170	50,000
KGFF	Shawnee, Oklahoma	1420	100	KSI	Salt Lake City, Utah	1130	50,000	WCAX	Burlington, Vermont	1070	50
KGFG	Oklahoma City, Okla.	1370	100	KSO	Des Moines, Iowa	1370	250	WCAY	Carthage, Illinois	1440	250
KGFI	Corpus Christi, Texas	1500	250	KSOO	Sioux Falls, S. Dakota	1110	2,500	WCBA	Allentown, Penn.	1080	5,000
KGFL	Los Angeles, California	1200	100	KSTP	St. Paul, Minnesota	1460	10,000	WCBD	Zion, Illinois	1370	250
KGFK	Moorhead, Minnesota	1500	50	KTAB	San Francisco, Calif.	560	1,000	WCBS	Baltimore, Maryland	1370	250
KGFL	Raton, New Mexico	1370	50	KTAR	Phoenix, Arizona	620	1,000	WCBS	Springfield, Illinois	1210	100
KGFW	Kearney, Nebraska	1370	100	KTAT	Fort Worth, Texas	1240	1,000	WCBS	Minneapolis, Minnesota	810	50,000
KGFX	Pierre, South Dakota	630	200	KTBS	Shreveport, Louisiana	1450	1,000	WCBS			
KGGC	San Francisco, Calif.	1420	100	KTFI	Twin Falls, Idaho	1240	500	WCBS			

Call	Location	Kilocycles	Watts	Call	Location	Kilocycles	Watts	Call	Location	Kilocycles	Watts
WCDA	New York, New York	1350	250	WILL	Urbana, Illinois	890	500	WORK	York, Penna.	1000	1,000
WCFL	Chicago, Illinois	970	1,500	WILM	Wilmington, Delaware	1420	100	WOS	Jefferson City, Missouri	630	500
WCCU	Brooklyn, New York	1400	500	WINS	New York, New York	1180	500	WOV	New York, New York	1130	1,000
WCKY	Covington, Kentucky	1490	5,000	WIOD	Miami, Florida	1300	1,000	WOW	Omaha, Nebraska	590	1,000
WCLO	Janesville, Wisconsin	1200	100	WIP	Philadelphia, Penna.	610	500	WPOW	Fort Wayne, Indiana	1160	10,000
WCLS	Joliet, Illinois	1310	100	WIS	Columbia, S. Carolina	1010	1,000	WPAD	Paducah, Kentucky	1420	100
WCOA	Pensacola, Florida	1340	500	WISN	Milwaukee, Wisconsin	1120	250	WPAP	See WQAO		
WCOE	Meridian, Mississippi	880	1,000	WJAC	Johnstown, Penna.	1310	100	WPAP	See WPRO		
WCOD	Harrisburg, Penn.	1200	100	WJAG	Norfolk, Nebraska	1060	1,000	WPCC	Chicago, Illinois	560	500
WCRW	Chicago, Illinois	1210	100	WJAR	Providence, Rhode Isl.	890	500	WPCH	New York, New York	810	500
WCSC	Charleston, S. Carolina	1360	500	WJAS	Pittsburgh, Penna.	1290	2,500	WPEN	Philadelphia, Penna.	1500	250
WCSD	Portland, Maine	940	2,500	WJAX	Jacksonville, Florida	900	1,000	WPFB	Hattiesburg, Mississippi	1370	100
WDAE	Tampa, Florida	1220	1,000	WJAY	Cleveland, Ohio	610	500	WPG	Atlantic City, N. J.	1100	5,000
WDAF	Kansas City, Missouri	610	1,000	WJBC	La Salle, Illinois	1200	100	WPHR	Petersburg, Virginia	1200	250
WDAG	Amarillo, Texas	1410	1,000	WJBI	Red Bank, New Jersey	1210	100	WFOR	See WTR		
WDAH	El Paso, Texas	1310	100	WJBK	Detroit, Michigan	1370	50	WPRO	Providence, Rhode Isl.	1210	100
WDAS	Philadelphia, Penna.	1370	250	WJBL	Decatur, Illinois	1200	100	WPTF	Raleigh, North Carolina	680	1,000
WDAY	Fargo, North Dakota	940	1,000	WJBO	New Orleans, Louisiana	1420	100	WOAM	Miami, Florida	560	1,000
WDBJ	Roanoke, Virginia	930	500	WJBT	See WBBM			WOAN	Scranton, Pennsylvania	880	250
WDBO	Orlando, Florida	580	250	WJBU	Lewisburg, Penna.	1210	100	WQAO	New York, New York	1010	250
WDEL	Wilmington, Delaware	1120	500	WJBW	New Orleans, Louisiana	1200	100	WQBC	Viicksburg, Mississippi	1360	500
WDEV	Waterbury, Vermont	550	500	WJBY	Gadsden, Alabama	1210	100	WQDM	St. Albans, Vermont	1370	100
WDGY	Minneapolis, Minnesota	1180	1,000	WJDX	Jackson, Mississippi	1270	1,000	WQDX	Thomasville, Georgia	1210	100
WDOD	Chattanooga, Tennessee	1280	2,500	WJEF	Hagerstown, Maryland	1210	100	WRAK	Williamsport, Penna.	1370	100
WDRC	Hartford, Connecticut	1330	500	WJEM	Tupelo, Mississippi	990	500	WRAM	Wilmington, N. Carolina	1370	100
WDSU	New Orleans, Louisiana	1250	1,000	WJEQ	Williamsport, Penna.	1370	100	WRAW	Reading, Pennsylvania	1310	100
WDZ	Tuscola, Illinois	1070	100	WJJD	Mooseheart, Illinois	1130	20,000	WRAX	Philadelphia, Penna.	1020	250
WEAF	New York, New York	660	50,000	WJJS	Gary, Indiana	1360	1,250	WRBL	Columbus, Georgia	1200	100
WEAN	Providence, Rhode Isl.	780	500	WJMS	Ironwood, Michigan	1420	100	WRBN	Roanoke, Virginia	1410	250
WEAO	Columbus, Ohio	570	750	WJR	Detroit, Michigan	750	10,000	WRC	Washington, D. C.	950	500
WEBC	Superior, Wisconsin	1290	2,500	WJVS	Alexandria, Virginia	1460	10,000	WRDO	Augusta, Maine	1370	100
WEBO	Harrisburg, Illinois	1210	100	WJTL	Oglethorpe Univ., Ga.	1370	100	WRDW	Augusta, Georgia	1500	100
WEBR	Buffalo, New York	1310	250	WJW	Akron Ohio	1210	100	WREC	Memphis, Tennessee	600	1,000
WEDC	Chicago, Illinois	1210	100	WJZ	New York, New York	760	30,000	WREN	Lawrence, Kansas	1220	1,000
WEEL	Boston, Massachusetts	590	1,000	WKAQ	San Juan, Porto Rico	1240	1,000	WRHM	Minneapolis, Minnesota	1250	1,000
WEEU	Reading, Pennsylvania	830	1,000	WKAR	East Lansing, Michigan	1040	1,000	WRJN	Racine, Wisconsin	1370	100
WEHC	Enory, Virginia	1350	500	WKAV	Lacoria, New Hampshire	1310	100	WRNY	New York, New York	1010	250
WEHS	Cicero, Illinois	1420	100	WKBE	Joliet, Illinois	1310	100	WROL	Knoxville, Tennessee	1310	100
WELL	Battle Creek, Michigan	1420	50	WKBC	Birmingham, Alabama	1310	100	WRR	Dallas, Texas	1280	500
WENC	Americus, Ga.	1420	100	WKBF	Indianapolis, Indiana	1400	500	WRUF	Gainesville, Florida	830	5,000
WENR	Chicago, Illinois	870	50,000	WKBH	La Crosse, Wisconsin	1380	1,000	WRVA	Richmond, Virginia	1110	5,000
WEPS	See WORC			WKBI	Cicero, Illinois	1420	100	WSAI	Cincinnati, Ohio	1330	1,000
WERE	Eric, Pennsylvania	1420	100	WKBN	Youngstown, Ohio	570	500	WSAJ	Grove City, Penna.	1310	100
WESG	Elmira, N. Y.	1040	1,000	WKBS	Galesburg, Illinois	1310	100	WSAN	Allentown, Penna.	1440	250
WEVD	New York, New York	1300	500	WKBV	Connersville, Indiana	1500	100	WSAR	Fall River, Mass.	1450	250
WEW	St. Louis, Missouri	760	1,000	WKBW	Buffalo, New York	1480	5,000	WSAZ	Huntington, W. Virginia	580	500
WEXL	Royal Oak, Michigan	1310	50	WKBZ	Ludington, Michigan	1500	100	WSB	Atlanta, Georgia	740	5,000
WFAA	Dallas, Texas	800	50,000	WKFI	Greenville, Mississippi	1210	100	WSBC	Chicago, Illinois	1210	100
WFAB	New York, N. Y.	1300	1,000	WKJC	Lancaster, Penna.	1200	100	WSBT	South Bend, Indiana	1230	500
WFAM	South Bend, Indiana	1200	100	WKRC	Cincinnati, Ohio	550	500	WSEN	Columbus, Ohio	1210	100
WFAN	Philadelphia, Penna.	610	500	WKY	Oklahoma City, Okla.	900	1,000	WSFA	Montgomery, Alabama	1410	500
WFAS	White Plains, N. Y.	1210	100	WKZO	Kalamazoo, Michigan	590	1,000	WSIN	Springfield, Tennessee	1210	100
WFBC	Greenville, S. Carolina	1200	100	WLAC	Nashville, Tennessee	1470	5,000	WSJS	Winston-Salem, N. C.	1310	100
WFBE	Cincinnati, Ohio	1200	250	WLAP	Louisville, Kentucky	1200	250	WSM	Nashville, Tennessee	650	50,000
WFBG	Altoona, Pennsylvania	1310	100	WLB	Minneapolis, Minnesota	1250	1,000	WSMB	New Orleans, Louisiana	1320	500
WFBP	Syracuse, New York	1360	2,500	WLCB	Muncie, Indiana	1310	50	WSMK	Dayton, Ohio	1380	200
WFBM	Indianapolis, Indiana	1230	1,000	WLBK	Kansas City, Kansas	1420	100	WSOC	Gastonia, North Carolina	1210	100
WFBT	Baltimore, Maryland	1270	500	WLBL	Stevens Point, Wis.	900	2,000	WSPA	Spartanburg, S. Carolina	1420	250
WFDK	Flint, Michigan	1310	100	WLBW	Erie, Pennsylvania	1260	1,000	WSPD	Toledo, Ohio	1340	1,000
WFDF	Rome, Georgia	1500	100	WLBZ	Bangor, Maine	620	500	WSUI	Iowa City, Iowa	880	500
WFEB	Manchester, N. H.	1430	500	WLEY	Lexington, Mass.	1370	250	WSUN	See WFLA		
WFI	Philadelphia, Penna.	560	500	WLIB	See WGN			WSVS	Buffalo, New York	1370	50
WFIW	Hopkinsville, Kentucky	940	1,000	WLIT	Philadelphia, Penna.	560	500	WSYB	Rutland, Vermont	1500	100
WFLA	Clearwater, Florida	620	500	WLOE	Boston, Massachusetts	1500	250	WSYR	Syracuse, New York	570	250
WFOX	Brooklyn, New York	1400	500	WLS	Chicago, Illinois	870	50,000	WTAD	Quincy, Illinois	1440	500
WGAL	Lancaster, Pennsylvania	1310	100	WLTH	Brooklyn, New York	1400	500	WTAG	Worcester, Massachusetts	580	500
WGAR	Cleveland, Ohio	1450	1,000	WLVA	Lynchburg, Virginia	1370	100	WTAM	Cleveland, Ohio	1070	50,000
WGBB	Freeport, New York	1210	100	WLW	Cincinnati, Ohio	700	50,000	WTAQ	Eau Claire, Wisconsin	1330	1,000
WGBC	See WNBR			WLWL	New York, New York	1100	5,000	WTAR	Norfolk, Virginia	780	500
WGBF	Evansville, Indiana	630	500	WMAC	See WSYR			WTAW	College Station, Texas	1120	500
WGBI	Scranton, Pennsylvania	880	250	WMAL	Washington, D. C.	630	500	WTAX	Springfield, Illinois	1210	100
WGCM	Mississippi City, Miss.	1210	100	WMAQ	Chicago, Illinois	670	5,000	WTBO	Cumberland, Maryland	1240	250
WGCP	Newark, New Jersey	1250	250	WMAS	Springfield, Mass.	1420	100	WTEL	Philadelphia, Penna.	1310	100
WGES	Chicago, Illinois	1360	1,000	WMAZ	Macon, Georgia	1180	500	WTFI	Athens, Georgia	1450	500
WGH	Newport News, Virginia	1310	100	WMBC	Detroit, Michigan	1420	250	WTIC	Hartford, Connecticut	1060	50,000
WGL	Fort Wayne, Indiana	1370	100	WMBD	Peoria, Illinois	1440	1,000	WTJS	Jackson, Tennessee	1310	250
WGLC	Glens Falls, N. Y.	1370	50	WMBF	See WIOD			WTMJ	Milwaukee, Wisconsin	620	2,500
WGM	See WLB			WMBG	Richmond, Virginia	1210	100	WTOC	Savannah, Georgia	1260	500
WGN	Chicago, Illinois	720	25,000	WMBH	Joplin, Missouri	1420	250	WTRC	Elkhart, Indiana	1310	50
WGR	Buffalo, New York	550	1,000	WMBI	Chicago, Illinois	1080	5,000	WTSL	Laurel, Mississippi	1310	100
WGST	Atlanta, Georgia	890	500	WMBO	Auburn, New York	1310	100	WVAE	Hammond, Indiana	1200	100
WGY	Schenectady, New York	790	50,000	WMBQ	Brooklyn, New York	1500	100	WWJ	Detroit, Michigan	920	1,000
WHA	Madison, Wisconsin	940	750	WMBR	Tampa, Florida	1370	100	WWL	New Orleans, Louisiana	850	10,000
WHAD	Milwaukee, Wisconsin	1120	250	WMC	Memphis, Tennessee	780	1,000	WWNC	Asheville, N. Carolina	570	1,000
WHAM	Rochester, New York	1150	5,000	WMCA	New York, New York	570	500	WWRL	Woodside, New York	1500	100
WHAS	Louisville, Kentucky	820	25,000	WMIL	Brooklyn, New York	1500	100	WWSW	Pittsburgh, Pennsylvania	1500	250
WHAT	Philadelphia, Penna.	1310	100	WMMN	Fairmont, West Virginia	890	500	WVVA	Wheeling, West Virginia	1160	5,000
WHAZ	Troy, New York	1300	500	WMPD	Lapeer, Michigan	1500	100	WXYZ	Detroit, Michigan	1240	1,000
WHB	Kansas City, Missouri	860	500	WMSG	New York, New York	1350	250				
WHBC	Canton, Ohio	1200	10	WMT	Waterloo, Iowa	600	500				
WHBD	Mount Orab, Ohio	1370	100	WNAC	Boston, New York	1230	1,000				
WHBF	Rock Island, Illinois	1210	100	WNAD	Norman, Oklahoma	1010	500				
WHBL	Sheboygan, Wisconsin	1410	500	WNAX	Yankton, South Dakota	570	1,000				
WHBQ	Memphis, Tennessee	1370	100	WNBF	Binghamton, New York	1500	100				
WHBU	Anderson, Indiana	1210	100	WNBH	New Bedford, Mass.	1310	250				
WHBY	Green Bay, Wisconsin	1200	100	WNBO	Silver Haven, Penn.	1200	100				
WHDK	Calumet, Wisconsin	1370	250	WNBW	Memphis, Tennessee	1430	500				
WHDH	Boston, Massachusetts	830	1,000	WNBX	Carbondale, Penna.	1200	10				
WHDL	Tupper Lake, New York	1420	100	WNBZ	Springfield, Vermont	1260	250				
WHEB	Portsmouth, N. H.	740	250	WNCI	Saranac Lake, New York	1290	50				
WHEC	Rochester, New York	1440	500	WNCJ	Newark, New Jersey	1450	250				
WHEF	Kosciusko, Mississippi	1500	250	WNOX	Knoxville, Tennessee	560	1,000				
WHET	Troy, Alabama	1210	100	WNYC	New York, New York	570	500				
WHFC	Cicero, Illinois	1420	100	WNOI	New York, New York	1190	50,000				
WHIS											

# The DX Corner



SHORT-WAVE DX listeners who saw last month's issue of the DX'ERS CORNER expressed their appreciation and gratitude for this new department in no uncertain terms. As was mentioned, RADIO NEWS has equipped a short-wave listening post in Westchester County, New York, with the finest type of long-distance short-wave receiver equipment as pictured above. With this equipment a log of short-wave best bets, as printed below from actually received programs, will be made a monthly feature. The log gives the best received stations, hourly, from 5 o'clock in the morning to 12 midnight, Eastern Standard Time. A space has been left for filling in local time for each division. Spaces have also been left for your own dial settings for each station you can pick up.

## Short-Wave "Best Bets"

Wavelengths in Meters			Call Letters	Dial Settings	Wavelengths in Meters			Call Letters	Dial Settings
49.6			GSA	.....	25.6		FYA	.....	
49.6+			W1XAL	.....	30.4		EAQ	.....	
49.9+			VE9DR	.....	31.2+		CT1AA	.....	
50.0+			HVJ	.....	31.3		GSC	.....	
2 P.M.	Eastern Standard Time	Local Time			31.3+		W1XAZ	.....	
30.4			FYA	.....	31.3+		DJA	.....	
31.2+			VK2ME	.....	31.4+		W2XAF	.....	
31.5			VK3ME	.....	48.8+		W8XK	.....	
6 A.M.	Eastern Standard Time	Local Time			49.1+		YV1BC	.....	
25.5			GSD	.....	49.1+		W9XF	.....	
31.2+			VK2ME	.....	49.5		W3XAU	.....	
31.3			GSC	.....	49.6		GSA	.....	
31.3+			W1XAZ	.....	49.9+		VE9DR	.....	
31.5			VK3ME	.....	7 P.M.	Eastern Standard Time	Local Time		
19.6			FYA	.....	25.2		W8XK	.....	
30.4			J1AA	.....	25.6		VE9JR	.....	
31.3+			W1XAZ	.....	31.3		GSC	.....	
8 A.M.	Eastern Standard Time	Local Time			31.3+		W1XAZ	.....	
16.8			W3XAL	.....	31.4+		W2XAF	.....	
19.6			FYA	.....	48.8+		W8XK	.....	
19.7			DJB	.....	49.1+		YV1BC	.....	
23.3			RABAT	.....	49.1+		W9XF	.....	
25.4			I2RO	.....	49.3+		W9XAA	.....	
31.2+			VK2ME	.....	49.5		W3XAU	.....	
31.3+			W1XAZ	.....	49.6		GSA	.....	
9 A.M.	Eastern Standard Time	Local Time			8 P.M.	Eastern Standard Time	Local Time		
16.8			W3XAL	.....	25.2		W8XK	.....	
19.6			FYA	.....	31.3+		W1XAZ	.....	
19.7			DJB	.....	31.4+		W2XAF	.....	
25.3			GSE	.....	48.8+		W8XK	.....	
25.6			VE9JR	.....	49.1+		YV1BC	.....	
31.3			GSC	.....	49.1+		W9XF	.....	
31.3+			W1XAZ	.....	49.3+		W9XAA	.....	
49.9+			VE9DR	.....	49.5		W3XAU	.....	
10 A.M.	Eastern Standard Time	Local Time			50.0		HKO	.....	
16.8+			W3XAL	.....	51.0		HJ2ABA	.....	
19.7			W8XK	.....	9 P.M.	Eastern standard Time	Local Time		
19.7			DJB	.....	25.2		W9XK	.....	
25.3			GSE	.....	31.3+		W1XAZ	.....	
25.6			VE9JR	.....	31.4+		W2XAF	.....	
31.3			GSC	.....	31.4+		W2XAF	.....	
31.3+			W1XAZ	.....	45.3		PRADO	.....	
49.9+			VE9DR	.....	48.0		VKPR	.....	
11 A.M.	Eastern Standard Time	Local Time			48.8+		W8XK	.....	
16.8+			W3XAL	.....	49.1+		YV1BC	.....	
19.7			W8XK	.....	49.3+		W9XAA	.....	
19.7			DJB	.....	49.5		W3XAU	.....	
25.2			FYA	.....	50.0		HKO	.....	
25.2			W8XK	.....	51.0		HJ2ABA	.....	
25.3			GSE	.....	10 P.M.	Eastern Standard Time	Local Time		
25.4			I2RO	.....	31.3+		W1XAZ	.....	
31.3+			W1XAZ	.....	31.4+		W2XAF	.....	
49.9			VE9CJ	.....	45.3		PRADO	.....	
49.9+			VE9DR	.....	48.8+		W8XK	.....	
12 NOON	Eastern Standard Time	Local Time			49.1+		W9XF	.....	
19.7			W8XK	.....	49.5		W3XAU	.....	
25.2			FYA	.....	11 P.M.	Eastern Standard Time	Local Time		
25.4			I2RO	.....	31.3+		W1XAZ	.....	
31.3+			W1XAZ	.....	48.8+		W8XK	.....	
49.5			W3XAU	.....	49.1+		W9XF	.....	
49.9			VE9CJ	.....					
49.9+			VE9DR	.....					
1 P.M.	Eastern Standard Time	Local Time							
19.7			W8XK	.....					
25.2			FYA	.....					
25.5+			DJD	.....					
30.4			EAQ	.....					
31.3			GSC	.....					
31.3+			W1XAZ	.....					
49.3			W9XAA	.....					
49.5			W3XAU	.....					
5 P.M.	Eastern Standard Time	Local Time							
19.7			W8XK	.....					
25.2			FYA	.....					
25.4			EAQ	.....					
25.6			VE9DR	.....					
30.4			I2RO	.....					
31.2+			CT1AA	.....					
31.3			HBL	.....					
31.3+			GSC	.....					
31.3+			W1XAZ	.....					
31.3+			DJA	.....					
31.5			OXY	.....					
38.4			HBP	.....					
48.8+			W8XK	.....					
49.1+			YV1BC	.....					
49.1+			W9XF	.....					
49.3+			W9XAA	.....					
49.5			W3XAU	.....					
49.9+			VE9DR	.....					
50.0			RV59	.....					
6 P.M.	Eastern Standard Time	Local Time							
25.2			W8XK	.....					

### Station Locations

Wavelengths in Meters	Call Letters	City	Country
16.8	W3XAL	Bound Brook, N. J.	
19.6	FYA	Pontoise, France	
19.7	W8XK	Pittsburgh, Pa.	
19.7	DJB	Zeesen, Germany	
23.3		Rabat, Morocco	
25.2	FYA	Pontoise, France	



Wavelengths in Meters	Call Letters	City Country
25.2	W8XK	Pittsburgh, Pa.
25.3	GSE	Daventry, England
25.4	I2RO	Rome, Italy
25.5	GSD	Daventry, England
25.5	DJD	Zeesen, Germany
25.6	FYA	Pontoise, France
25.6	VE9JR	Winnipeg, Canada
30.4	J1AA	Japan
30.4	EAQ	Madrid, Spain
31.2+	VK2ME	Sydney, Australia
31.2+	CT1AA	Lisbon, Portugal
31.3	HBL	Geneva, Switzerland
31.3	GSC	Daventry, England
31.3+	W1XAZ	Springfield, Mass
31.3+	DJA	Zeesen, Germany
31.4+	W2XAF	Schenectady, N. Y.
31.5	VK3ME	Melbourne, Australia
31.5	OXV	Skamleback, Denmark
32.3		Rabat, Morocco
38.4+	HBP	Geneva, Switzerland
45.3	PRADO	Riombamba, Ecuador
48.0	VKPR	Fort Williams, Ont., Can.
48.8	W8XK	Pittsburgh, Pa.
49.1+	YV1BC	Caracas, Venezuela
49.1+	W9XF	Chicago, Ill.
49.3+	W9XAA	Chicago, Ill.
49.5	W3XAU	Philadelphia, Pa.
49.6	GSA	Daventry, England
49.6+	W1XAL	Boston, Mass.
49.9	VE9CJ	New Brunswick, Can.
49.9+	VE9DR	Montreal, Can.
50.0+	HVJ	Vatican City
50.0+	HKO	Medellin, Colombia
50.0	RV59	Moscow USSR
51.0	HJ2ABA	Tunja, Colombia

**VE9GW Off Air**

Our latest report on VE9GW, a favorite station, in the past, with American listeners, is off the air indefinitely. But another station in New Brunswick, VE9CJ, has been reported at different times.

**VE9DR's Daily Programs**

This Canadian station, which relays CFCF in Montreal is now coming in nearly all day long with a strong signal on 49.97 meters, although last month they were slightly off this wavelength for a week or so. They dropped down to the wavelength shown above and have been on that wave since.

**Those Broadcast Harmonics**

Many short-wave fans are reporting the reception of American stations on the short waves and have confused the short-wave relay stations of these same stations with the harmonic radiation of the long-wave stations. Many reports are received that WCAU in Philadelphia is heard on about 51 meters, and this is the fourth harmonic of WCAU on the regular broadcast band. It should not be confused with the real short-wave broadcast of W3XAU on 49.5 meters. KDKA has been reported as heard slightly below 51 meters during the late afternoon and evening. This is also a harmonic, and the nearest short-wave broadcast from Pittsburgh to this frequency is W8XK on 48.86 meters. Other stations in the broadcast band whose harmonics have been picked up are WBEN of Buffalo on about 47.5 meters, which is its seventh harmonic, as well as many points on the dial for station WIOD in Florida.

**FYA Broadcasts in English**

At certain times in the afternoon Pontoise has a broadcast for a short period in English, and so far listeners may have mistaken this station at those times for an English station, because the announcer's voice has quite an English accent and he speaks English perfectly.

**Short-Wave Programs on Sundays**

There are many special features on the air on the short waves on Sundays that make this time, when many fans are at leisure, a good one for listening. In the United States, station W1XAL will often be heard on 49.6+ with an interesting resumé of DX listening data dispersed with musical programs relayed from a Boston station. Another American station heard almost exclusively on Sundays is W9XAA, with special features. The African station at Rabat, Morocco, can be heard early Sunday morning from 7 to

10 a.m., E.S.T., and Sunday afternoon from 1 to 4 p.m., E.S.T. The Australian station, VK2ME, is on the air Sundays as early as 5 a.m. and continues to noon, E.S.T., with a special program. Station HVJ, Vatican City, is reported on the air Sundays for a short period after 5 a.m., E.S.T. The Geneva station in Switzerland is usually audible on Sunday for about three-quarters of an hour, starting at 5 p.m. with special announcements from the League of Nations, usually in French, Spanish, and sometimes in English and Italian. This station is usually tied up with HBP at 38.4+ meters at the same time. HBL may be heard at many other times during the day on code, so that lis-

land; DAN, Norddeich, Germany; DIS and DFH, Germany; DJC and DJD, Zeesen, Germany, as well as FYA (otherwise known as Pontoise or Radio Colonial), France, and once in a while EAQ, Madrid, Spain. Also on Sundays on about 25.5 meters can often be heard symphony concerts from Koenigs-wusterhausen, Germany (believed to be station DIQ). It seems that a number of German stations transmit on this or very nearby wavelengths, and, due to their infrequent announcements of call letters, it is hard to say just what station is transmitting at given times.

**The Canadian Zone Broadcasts from GSA and GSB**

Last month station GSB was hooked up with GSA instead of the former hook-up of GSC and GSA for the British Empire Broadcasting Systems service to the Canadian zone. On March 12th GSA and GSB started transmitting from 6 p.m. to 8 p.m., E.S.T., rather than from 8 p.m. to 10 p.m., E.S.T. It was announced over the station that this change of two hours earlier had been requested by Canadian and West Indies listeners and will be continued until further notice as an experiment to see if an improvement in reception is obtained. This would bring Big Ben's tolling voice at 6 o'clock (striking eleven times) and at 8 o'clock (striking once), as Greenwich Mean Time is five hours earlier.

**Maurice Chevalier's Double?**

A number of people have commented on the style of speaking and the voice of the regular announcer on the Moroccan station at Rabat, saying that he sounded like the well-known screen actor, Maurice Chevalier, and that he is a cheerful and witty fellow.

**CT1AA Heard Well**

The amateur broadcasting station CT1AA, located at Lisbon, Portugal, has been coming in strong and with very good tone quality here in the eastern part of the United States on Tuesdays and Friday afternoons from about 5 to 7 p.m., E.S.T. They sign on and off with two falling notes on an auto horn repeated twice.

**W1XAZ Increases Schedule**

The short-wave Westinghouse station, W1XAZ, can now be heard on 31.38 meters practically all day long and evening.

**Try This One**

The Japanese station at Kemikawa, J1AA, has been reported by a few listeners. If you are a "dyed-in-the-wool" fan, you might try for them, as this would be a real accomplishment in receiving. Their wavelength is 30.4 meters, about the same as EAQ, Madrid.

**Have You Heard DJC?**

Another German station reported as being received, that probably is a sister station of DJA, DJB and DJD, is DJC, which has been heard on 49.8 meters.

**Send Us in Your Logs**

It may be that a number of expert short-wave listeners in the United States will hear many more stations than we have listed in our Best Bets for the Month. If you hear them and can log them successfully, we would be glad to have you send them in to us, pointing out their call letters, location, wavelength and the times between which they are heard. Also any changes or deviations from the listed Best Bets that you are able to find during the month will be appreciated. We are particularly anxious to hear from readers on the Pacific Coast and from the southern areas of the U. S. Our readers in Canada, Mexico, Central and South American countries are also invited to send in their logs.

**Short-Wave DX Listeners, Attention!**

**T**his is the second installment of this department and we wish our readers to know that it is still in the experimental stage. Do you like it? If so just drop a card or letter to the DX Editor, care of RADIO NEWS, giving your suggestions and comments. If the response from readers is sufficient to warrant its being continued, it will be enlarged and made more complete as time goes on.

You can help to make it more perfect and more useful by mentioning in your letter to the DX Editor the stations you receive most favorably on the short waves, giving, wherever possible, the call letters, location, wavelength or frequency and the periods the stations are on the air. It would be advisable to mention in your letter any peculiarities of transmission that might help to identify the foreign station, such as their method of signing on or off, languages used, any station signals, like the tooting of horns, ringing of bells, or the ticking of a clock, etc. If you keep a log of foreign station reception it would be of invaluable aid to us in presenting this information in the coming DX CORNER. Later on RADIO NEWS is to select a number of proficient RADIO NEWS listening posts from amongst its readers who respond to this request and who show their ability in keeping a several months' accurate log of stations. If our readers will co-operate with the DX Editor in this way, we feel we can have the finest DX department possible and one that should be of great value to DX short-wave fans the world over.

teners who are interested in practicing code can get it easily. Another interesting bit of reception that can be accomplished on the short waves on Sundays is to listen to the European stations engaged in broadcasting relays from Europe to America for the chain networks in this country. A survey of the local chain programs, as published in newspapers, will often bring to light a number of rebroadcasts of this nature running from about 11 o'clock in the morning well on through the afternoon. Short-wave fans will find that if they listen at these times on wavelengths between 25 and 33 meters they may be able to pick up a number of the short-wave rebroadcasting stations in Europe. It is then quite an interesting feat to compare the direct reception with the rebroadcasts from the chains. Some of the European stations that have been engaged in this work are the following: GBC, Rugby, Eng-

# What Tube Shall I Use?

*Many considerations are involved in selecting the r.f. tubes to be used in the design of a new receiver. The author points out a number of these and presents a list of r.f. tube characteristics in handy tabular form*

**T**HE main functions of the radio-frequency amplifier tubes and circuits of a receiver are to amplify the weak signal currents brought in by the antenna circuit to a sufficiently high level to operate the detector efficiently and to provide the necessary selectivity to tune in a desired station to the exclusion of other undesired broadcast stations.

One consideration is to select tubes capable of handling the signal voltages which are to be fed to them. To accomplish this the tubes must be provided with suitable grid-bias voltages sufficient to prevent a positive grid swing and still not great enough to carry the operating range off the straight portion of the tube characteristic.

The selectivity of the receiver is governed largely by the number of tuned circuits used and by the operating characteristics of the tubes.

To obtain good selectivity it is important that the input or grid-to-filament resistance of the tube be kept at a high value, since this resistance is connected across the tuning condenser of the tuned circuit. The higher this resistance, the lower is the equivalent series resistance introduced in the tuned circuit and the better the selectivity and sensitivity.

Low input resistance will be produced in a tube which normally has high input resistance by operating the tube at the wrong part of its characteristic curve, and this must be guarded against in designing the circuit. If the grid bias on the tube is not negative enough to prevent the grid from swinging positive, grid current will flow when the grid swings positive and the input resistance will be reduced to a low enough value to cause serious losses in sensitivity and selectivity and troublesome distortion.

On the other hand, if the tube is operated with too high a grid bias, detection is apt to take place with consequent poor amplification.

When a tube is closely coupled to a tuned secondary circuit, the sensitivity will be high, but the selectivity will suffer to some extent due to the increase in effective circuit resistance caused by the close coupling.

If the coupling is decreased, better selectivity will result because of the decrease in effective circuit resistance produced by loose coupling.

## Part Five

**By Joseph Calcaterra**

It might be well to mention here that it is important to distinguish between the real and apparent selectivity of different receivers. Extremely sensitive sets are often apparently less selective than less sensitive receivers because they are capable of amplifying the weaker signals to a point where they interfere with the desired signal. If the sensitivity of such a receiver is adjusted down to the level of the less sensitive receiver, however, it is often found that the more sensitive receiver which apparently was less selective actually has greater real selectivity than the less sensitive set.

Proper shielding of the radio-frequency and detector stages is very important in obtaining selectivity, since the direct pick-up by the circuits and wiring of the detector or intermediate-frequency stages will often nullify the most elaborate precautions taken in the design of the radio-frequency stages.

The type of tubes and the design of the circuits used in the radio-frequency amplifier are determined largely by the amount of amplification required at any particular location to boost the average field strength of signals received in that locality to the signal strength required to efficiently operate the detector of the receiver. The frequency, number and power of stations which come in strongly at a given locality determine the amount of sensitivity and selectivity which must be designed into a receiver and influence the choice of tubes and circuits to be used.

To obtain the best radio reception, free from objectionable noise and interference, a field strength of from 5,000 to 10,000 microvolts per meter is recognized as a satisfactory signal with average conditions of prevailing static and interference.

Receivers can be designed to have a sensitivity which provides fair reception with signal field strengths of a few microvolts per meter, provided noise conditions are not very bad. If the noise field strength approximates signal field strength at any given locality, however, no amount of radio-frequency amplification will result in a satisfactory signal, since the radio-frequency amplifier will amplify noises and other disturbances along with the signal.

The most important factors affecting the sensitivity of a receiver are the amplifying abilities of the tubes used in the

**TABLE IX**  
TYPE NUMBERS OF SIMILAR TUBES MADE BY DIFFERENT MANUFACTURERS

RADIO NEWS TYPE NUMBERS	401	-01A	-12A	-22	-24	-24A	-26	-27	-30	-32	-34	-35	-36	-37	-39	-99
ARCTURUS	-	101 A	012 A	122	-	124	126	127	-	-	-	551	136 A	137 A	139 A	099
CECO	-	201 A	112 A	222	224	-	226	227	230	232	234	235	236	237	239	199
CUNNINGHAM	-	CX-301A	CX-112 A	CX-322	C-324	C-324A	CX-326	C-327	CX-330	CX-332	CX-234	C-335	C-336	C-337	C-339	CX-299
DeFOREST	-	401 A	412 A	422	-	424	426	427	430	432	434	435	436	437	439	499
GOLD SEAL	-	65X-201A	65X-112A	65X-222	65Y-224	-	65X-226	65X-227	65X-230	65X-232	65X-234	65Y-235	65Y-236	65Y-237	65Y-239	65X-199
KELLOGG	401	-	-	-	-	-	-	-	-	-	-	-	-	-	-	-
KEN-RAD	-	UX-201A	UX-112 A	UX-222	UY-224	-	UX-226	UY-227	UX-230	UX-232	UX-234	UY-235	UY-236	UY-237	UY-239	UX-199
NATIONAL UNION	-	NX-201A	NX-112 A	NX-222	NY-224	-	NX-226	NY-227	NX-230	NX-232	NX-234	NY-235	NY-236	NY-237	NY-239	NX-199
PILOT	-	P-201A	P-112 A	-	P-224	-	P-226	P-227	-	-	-	-	-	-	-	P-199
RAYTHEON	-	ER-201A	ER-112 A	ER-222	ER-224	-	ER-226	ER-227	ER-230	ER-232	ER-234	ER-235	ER-236	ER-237	ER-239	ER-199
RCA RADIOTRON	-	UX-201A	UX-112 A	UX-222	UY-224	UY-224A	UX-226	UY-227	RCA-230	RCA-232	RCA-234	RCA-235	RCA-236	RCA-237	RCA-239	UX-199
SPEED	-	201 A	112 A	222	224	-	226	227	230	232	234	235	236	237	239	199
SYLVANIA	-	SX-201 A	SX-112 A	SX-222	-	SY-224	SX-226	SY-227	SX-230	SX-232	SX-234	SY-235	SY-236	SY-237	SY-239	SX-199
TRIAD	-	T-01 A	T-12 A	T-22	T-24	-	T-26	T-27	T-30	T-32	T-34	T-35	T-236	T-237	T-239	T-199

NOTE: THE ABOVE CHART SHOWS TYPE NUMBERS OF DIFFERENT MANUFACTURERS FOR SIMILAR TYPES OF TUBES. TUBES OF DIFFERENT MANUFACTURERS SOMETIMES DIFFER SOMEWHAT FROM GENERALLY ACCEPTED CHARACTERISTICS OF A GIVEN TYPE OF TUBE. FOR ACCURATE DATA ON TUBE CHARACTERISTICS OF ANY GIVEN MANUFACTURER, CONSULT HIS TUBE CHARACTERISTIC CHARTS OR BULLETINS.

TABLE X  
R.F. AMPLIFIER TUBES

RADIO NEWS GENERAL TYPE DESIGNATION	FILAMENT OR HEATER RATING		NUMBER OF ELECTRODES NOTE *	CATHODE TYPE	SCREEN GRID		NEGATIVE GRID BIAS VOLTS BETWEEN-			PLATE VOLTS	PLATE CUR. MA.	A.C. PLATE RESISTANCE OHMS	MUTUAL CONDUCTANCE MICRO-MHOS	RATED VOLT. AMP. FACTOR MU	PRACTICAL VOLTAGE AMPLIFICATION AT BROADCAST FREQ.	INTERELECTRODE CAPACITIES IN MMFDS. BETWEEN-			BASE TYPE	TUBE DIMENSIONS		AVER. LIST PRICE
	VOLTS	AMPS			VOLTS	MA.	G & -F	G & FIL. C.T.	G & CATH.							G & P	G & CATH.	P & CATH.		L	D	
<b>GROUP 1: A.C. TUBES: "A" "B" AND "C" SUPPLY FROM A.C. LIGHTING LINES</b>																						
-35	2.5	1.75	4	HEATER	75	-	-	-	1.5	180	5.8	350,000	1100	385	50-100	.01	5	10	UY	5 1/4"	1 13/16"	\$1.60
					90	-	-	-	3.0	250	6.5	350,000	1050	370	50-100							
-24				"	75	-	-	-	1.5	180	4.0	400,000	1050	420	50-100							1.00
-24A	2.5	1.75	4	"	90	-	-	-	3.0	180	4.0	400,000	1000	400	50-100	.01	5	10	UY	5 1/4"	1 13/16"	1.60
					90	-	-	-	3.0	250	4.0	600,000	1025	615	50-100							
-27	2.5	1.75	3	"	-	-	-	-	6.0	90	2.7	11,000	820	9	9							
					-	-	-	-	9.0	135	4.5	9000	1000	9	9							
					-	-	-	-	13.5	180	5.0	9000	1000	9	9							
					-	-	-	-	21.0	250	5.2	9250	975	9	9							
-26	1.5	1.05	3	FIL.	-	-	-	-	5.0	90	3.8	8600	955	8.2	8.2							
					-	-	-	-	8.0	135	6.3	7200	1135	8.2	8.2							
					-	-	-	-	12.5	180	7.4	7000	1170	8.2	8.2							
401	3.0	1.0	3	HEATER	-	-	-	-	4.5	90	3.7	10,750	930		10.0							
					-	-	-	-	7.5	135	5.3	9520	1050		10.0							
					-	-	-	-	10.5	180	7.2	9330	1070		10.0							
<b>GROUP 2: D.C. STORAGE BATTERY TUBES: "B" AND "C" SUPPLY FROM DRY BATTERIES OR "B" AND "C" ELIMINATORS</b>																						
-22	3.3	.132	4	FIL.	45.0	-	1.5	-	-	135	1.5	850,000	350	300	25-50	.025	3.5	12	UX	5 1/4"	1 13/16"	4.50
					67.5	-	1.5	-	-	135	3.3	600,000	480	290	25-50							
-12A	5.0	.25	3	"	-	-	4.5	-	-	90	5.2	5600	1500	8.5	8.5							
					-	-	9.0	-	-	135	6.2	5300	1600	8.5	8.5							
-01A	5.0	.25	3	"	-	-	4.5	-	-	90	2.5	11,000	725	8.0	8.0							
					-	-	9.0	-	-	135	3.0	10,000	800	8.0	8.0							
<b>GROUP 3: D.C. TUBES FOR AUTO. OR D.C. DISTRICT USE: "B" AND "C" SUPPLY FROM DRY BATTERIES OR "B" AND "C" ELIM.</b>																						
-39	6.3	.3	5	HEATER	90 †	-	-	-	3 ††	90 †	4.4	375,000	960	360	50-100	.007	4	10	UY	4 1/16"	1 9/16"	2.75
					90	-	-	-	3 †	135	4.4	540,000	980	530	50-100							
					90	-	-	-	3 †	180	4.5	750,000	1000	750	50-100							
-36	6.3	.3	4	"	55	-	-	-	1.5	90	1.8	200,000	850	170	50-100	.01	4	9	UY	4 1/16"	1 9/16"	2.75
					67.5	-	-	-	1.5	135	3.0	300,000	1050	315	50-100							
-37	6.3	.3	3	"	-	-	-	-	6.0	90	2.6	11,500	780	9.0	9.0							
					-	-	-	-	9.0	135	4.3	10,000	900	9.0	9.0							
<b>GROUP 4: LOW VOLTAGE (DRY CELL) D.C. TUBES: "B" AND "C" SUPPLY FROM DRY BATTERIES</b>																						
-34	2.0	.06	5	FIL.	67.5	1.1	3 †	-	-	67.5	2.7	400,000	560	224	25-50							
					67.5	1.1	3 †	-	-	90.0	2.7	500,000	580	290	25-50							
					67.5	1.0	3 †	-	-	135	2.8	600,000	600	360	25-50							
					67.5	1.0	3 †	-	-	180	2.8	1,000,000	620	620	25-50							
-32	2.0	.06	4	"	67.5	-	3	-	-	135	1.4	1,150,000	505	580	25-50	.02	6	11	UX	5 1/4"	1 13/16"	2.30
-30	2.0	.06	3	"	-	-	4.5	-	-	90	1.8	13,000	700	9.3	9.3	6.0	3.5	2	UX	4 1/4"	1 9/16"	1.60
-99	3.3	.063	3	"	-	-	4.5	-	-	90	2.5	15,500	425	6.6	6.6	3.3	2.2	2.5	UX	3 1/2"	1 1/16"	2.50

NOTE: THE ABOVE ARE AVERAGE GENERALLY ACCEPTED CHARACTERISTICS. THE CHARACTERISTICS OF SIMILAR TUBES, MADE BY DIFFERENT MANUFACTURERS WILL VARY IN SOME CASES, AND THEIR SPECIFICATIONS SHOULD BE CONSULTED IN DESIGNING CIRCUITS FOR PARTICULAR MAKES OF TUBES.  
 NOTE\*: THIS REFERS TO ACTUAL ELECTRODES, AND NOT TO NUMBER OF TERMINALS OR PRONGS.  
 NOTE†: RECOMMENDED VALUES FOR D.C. DISTRICT OPERATION.  
 NOTE‡: GRID BIAS VOLTAGE SHOULD NEVER BE REDUCED BELOW THIS MINIMUM VALUE AND SOME MEANS MUST BE USED TO PREVENT ADJUSTMENT BELOW THIS VALUE.

radio-frequency stages, the set-up ratios used in the coupling transformers and the efficiency of the circuits and component parts in reducing losses to a practical minimum.

Since radio-frequency amplification is primarily concerned with voltage amplification and involves comparatively low power-handling requirements, it is important, in order to get best results with a minimum expenditure, to use tubes having a high amplification factor.

The rated voltage amplification factors usually given in charts of screen-grid tube characteristics are the values used in calculating the performance of the tubes and are not a direct measure of the practical voltage amplification obtainable with such tubes.

The voltage amplification of screen-grid tubes depends only upon the load impedance and mutual conductance when the load impedance is appreciably lower than the plate resistance of the tube, which is the condition usually found in screen-grid tube circuits designed for broadcast frequencies. The voltage amplification of screen-grid tubes may be calculated approximately when the load impedance and the mutual conductance of the tube is known, by multiplying the value of the load impedance in ohms by the value of the mutual conductance in mhos. In making this calculation, be sure to convert the value of the mutual conductance, which is usually given in micromhos to mhos by dividing by 1,000,000.

From this relation, the importance of using a high value of load impedance in radio-frequency amplifier circuits employing screen-grid tubes is obvious.

In general, properly designed radio-frequency transformers are preferable to impedance-capacity for interstage coupling of screen-grid tubes, especially in cases where a high-impedance B supply device may cause oscillation below radio frequencies. Where impedance coupling is used, however, the coupling condensers should have a capacity of .0005 mfd. and the best arrangement of circuits is to use a good radio-frequency choke coil in the plate circuit and a tuned coil in the grid circuit.

The transformers required for radio-frequency stage coupling are the same for both the standard screen-grid tubes and the super-control screen-grid tubes.

**Effects of Interelectrode Capacities**

The inherent capacities between the various elements or electrodes of the tube, usually referred to as the interelectrode capacities of the tubes, have a rather important bearing on the operating efficiency and stability of the circuits in which they are used. In general, the lower these capacities are, the less trouble will be experienced with them.

The most important interelectrode capacity is that existing between the plate and control-grid electrodes of the tube. In the usual three-electrode tubes, this capacity ranges between 3 and 10 mmfds. and is large enough to cause trouble from oscillation due to feedback, unless steps are taken to counteract its effects. Neutralizing and oscillation suppressor circuits are designed to overcome such tendencies toward oscillation in radio-frequency stages using three-electrode tubes which have high plate-grid capacities. (Continued on page 695)

# *An Improved* I. F. Transformer Design

*"Hams" and set builders have encountered much difficulty in obtaining highly selective i.f. transformers. Here is a new one, now available to experimenters, which under test proves to be a close approach to the ideal*

By A. A. Webster

**T**HERE seems to be a mistaken, yet common, notion that modern tubes provide so much gain as i.f. amplifiers that a little loss here and there is not of great significance. This might be true if there were not always some unavoidable losses. There are plenty without adding other losses which are avoidable. With *efficient design* and tubes of the -58 type, a two-stage i.f. amplifier can be made to provide all the gain that can be employed effectively. Even this amount of gain seldom can be taken full advantage of, because it is more than adequate to get down to the noise level in even the most favorable locations. Likewise, two stages will provide ample selectivity to meet all normal requirements—even for DX'ing during the early evening when the locals are in fully swing.

In the writer's opinion, the only real justification for using more than two i.f. stages is when super-selectivity is required. An example of the gain possible, when using -58 tubes in an i.f. amplifier, is demonstrated in the operation of the latest Hammarlund i.f. transformer pictured here. Under actual measurement, a single stage using this transformer shows a gain of exactly 200. Two stages would, therefore, provide a gain of  $200 \times 200$ , or 40,000, but in actual practice this gain can only be obtained by resorting to unusually complete shielding and thorough filtering in control-grid, screen-grid and plate leads. In an experimental model of this transformer the writer learns that gains of as much as 259 were found possible in a single stage, although at the cost of a considerable loss in selectivity. The Hammarlund engineers therefore deemed it advisable to so lower the coupling between coils as to limit the gain to 200. This resulted in a degree of selectivity approaching maximum for the coils employed and had the important advantage that mutual inductance was lowered to a point which permitted the tuning of one coil to be practically independent of the other. To anyone who has had to juggle the tuning of one coil of a transformer against that of the other, in lining up intermediate stages which employed dual-tuned circuits, the extent of this advantage will be readily realized. This transformer has just recently been introduced. It is available to home set builders and experimenters, as well as manufacturers, and is held up as an example of good design because it represents a combination of excellent features for which the writer and many other experimenters have been waiting.

The curves of Figure 2 show the selectivity provided by one, two, three and five-stage amplifiers employing these transformers. It should be borne in mind, in studying these curves, that they represent the selectivity characteristic of the i.f. stages alone and not the overall selectivity of the entire receiver. Adding the selectivity of the re-

ceiver input circuit, the overall selectivity characteristic for two i.f. stages would provide excellent selectivity. What is equally important, they offer a corresponding degree of sensitivity, even without resorting to amplification ahead of the first detector. This is the combination used in the latest improved model of the Comet "Pro" receiver. Unfortunately, the writer has been unable to obtain the operating characteristic curves on this new receiver for presentation here, but the curves on the earlier model which appeared some months ago in *RADIO NEWS* left little to be desired; yet those on the newest model would show better selectivity and better sensitivity due to the use of the new transformers and the -50 series tubes.

The improved sensitivity and selectivity characteristics of these transformers are extremely important, but they have another outstanding feature as well. This is found in the use of air-dielectric tuning condensers across both coils. These condensers may be seen in one of the illustrations, one at each end of the transformer assembly. They are so mounted that their slotted shafts project out through the shield ends, making them easily accessible for screw-driver adjustment when the transformers are mounted on the receiver chassis. The advantages of air-dielectric condensers for i.f. tuning are numerous, both electrical and mechanical. The electrical improvement is found in their lower power factor and in permanency of adjustment, when compared with the mica-dielectric adjustable condensers usually employed for this purpose. The capacity of mica condensers, for instance, varies considerably with changes in humidity and temperature—enough to materially reduce both the sensitivity and selectivity of the receiver. Also the sensitivity and selectivity would suffer even more than this, due to moisture absorption and its attendant electrical losses.

A striking example of the relative effect of humidity on air-tuned transformers as compared with transformers tuned by mica dielectric condensers of the usual type is shown in Figure 3. This illustration is made from figures supplied by one of the largest independent testing laboratories in the country. The test procedure consisted of obtaining 10 transformers, tuning them exactly to a given frequency under normal air conditions of low humidity, then subjecting them to 100 percent humidity for 24 hours and checking their frequency again immediately after removal from the humidity box. The transformers were all identical and were of the type described in this article, except that in five the condensers were of the highest grade mica compression type. The other five were standard, using the air dielectric condensers.

A study of Figure 3 discloses that the humidity caused the mica-condenser tuned trans-

## THE NEWEST I.F. TRANSFORMER

*Figure 1. This transformer, described in detail in this article, combines high gain with an unusual degree of selectivity and permanence of tuning adjustment*

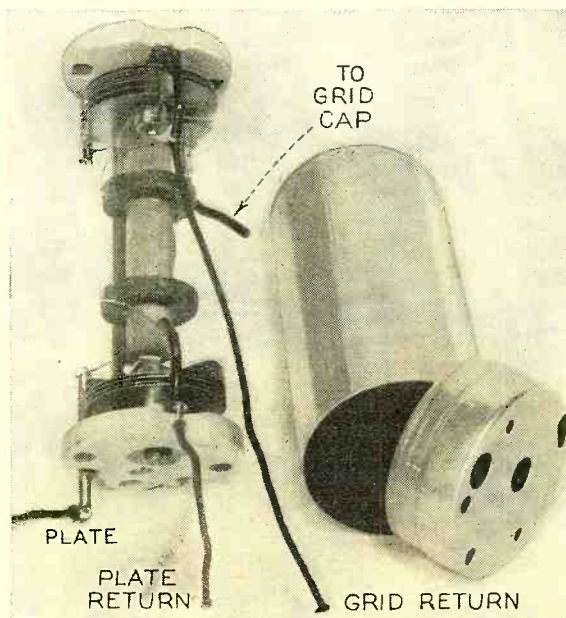

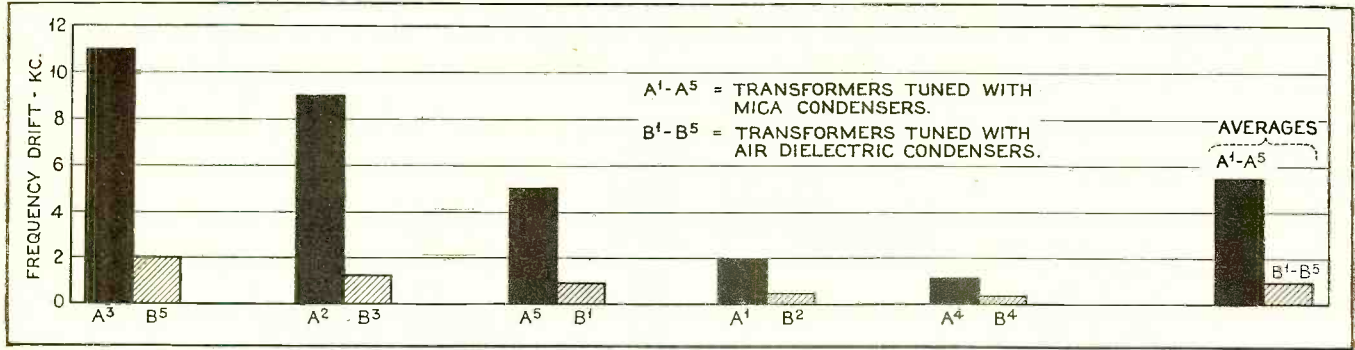

EFFECT OF HUMIDITY ON TUNING ADJUSTMENT OF I.F. TRANSFORMERS

Figure 3. In these tests ten transformers were used, five tuned by air condensers and five by high-grade compression type mica condensers. The frequency of each was accurately measured before and after 24-hour exposure to 100% humidity. This illustration shows the detuning effect of humidity on each of the transformers and the average change in the air-condenser tuned transformers as compared with the average for the mica-condenser tuned units. To facilitate comparison the transformers (of each type) showing the greatest change are paired (A3, B5), etc.

formers to shift an average of 5.6 kilocycles in resonant frequency, whereas the air-condenser tuned transformers suffered a frequency shift of only .9 kilocycle. The greatest shift of any one transformer was in the case of A3, and amounted to 11 kc. The greatest shift in the air-condenser tuned transformers was 2 kc. in the case of B5.

Referring to Figure 2, Curve A (one-stage i.f. amplifier), it will be seen that a shift of .9 kc. in tuning results in such an extremely small loss as to be negligible. A shift of 5.6 kc., on the other hand, will provide a response 13 times down. This latter shift would not be particularly important if all the i.f. tuned circuits shifted alike, because the oscillator beat frequency could be changed proportionately, but Figure 3 shows that the shift is far from uniform. The result is that one transformer using mica condensers might shift as much as 10 or 11 kilocycles and another as little as 1 or 2 kc. The intermediate amplifier would be decidedly out of alignment, with the result that the overall selectivity characteristic for even a one-stage amplifier would broaden out tremendously and sensitivity would be greatly reduced. Using air condensers, which according to tests show a maximum drift of 2 kc., the transformers could at the worst get only slightly out of line.

So much for the electrical advantages; now for the mechanical features. The condensers incorporated in the new transformer assembly each consist of 9 plates, 5 on the rotor section and 4 on the stator. Two of the plates in each section are circular, while the other 5, 2 on the stator and 3 on the rotor, are the usual semi-circular plates. The four circular plates are always interleaved and added to the minimum capacity of the other 5 plates, provide a total minimum capacity of 56 mmfd. The semi-circular plates provide a variable capacity of 36 mmfd. This variation is practically linear over a 180-degree revolution, as in the ordinary midjet variable condenser. Thus the adjustment of the condensers is far less critical than is the adjustment of mica dielectric condensers, because in this latter type practically the total variable capacity is lumped in a small fraction of a revolution of the adjustment screw, at the point where the condenser approaches maximum compression.

Also readjusting the screw to the same position does not always produce the same capacity with the mica condensers, whereas with the air condensers a given adjustment will always provide the same capacity value.

Due to the compact design, the air condensers included in the Hammarlund transformers have such closely spaced plates that the overall height of the transformer shield is only 1/2 inch greater than the older type transformers which employed mica condensers, the diameter remaining the same.

The primary and secondary coils in each transformer are exactly alike and are wound with double-silk-covered "Litz" to an inductance of 1.25 millihenries each. The coils are of the small lattice-wound type and are assembled on a wood dowel. The use of "Litz," together with the shape factor and type of winding, results in a coil of exceptional efficiency having a radio-frequency resistance of but 32 ohms at 465 kc. This corresponds to a Q of 115 or power factor of .0087, which accounts for the high order of sensitivity and selectivity. Both the coils and dowel are wax impregnated to prevent changes in power factor or inductance with changes in humidity.

The transformer is assembled on a rigid brass upright, terminating in the Isolantite end panels on which the tuning condensers are mounted. The dowel on which the coils are mounted is securely supported in a vertical position, and the leads from the coil windings to the corresponding condensers are thus made short. The primary or plate coil is the lower one. Its "high" end is connected to the condenser stator, and one of the supporting members of the stator is extended down through the Isolantite end and the shield bottom to provide a direct connection for the plate lead from the tube. The "high" lead from the grid coil is brought out through a hole in the shield wall, directly opposite the tuning condenser and level with the grid cap of the tube. This arrangement of connections is such that the exposed plate lead between transformer can and tube socket terminal need not be longer than 1 inch, and the grid lead from transformer can to tube shield need not be more than 1/2 inch.

This provision for short leads is of the utmost importance, because long leads result in undesirable feedback and (Continued on page 699)

SELECTIVITY CHARACTERISTICS

Figure 2. These curves show selectivity of 1, 2, 3 and 5-stage i.f. amplifiers employing the new transformers. Adding the tuning effect of a receiver input circuits, this selectivity would be further improved, the degree depending on the number of tuned input circuits

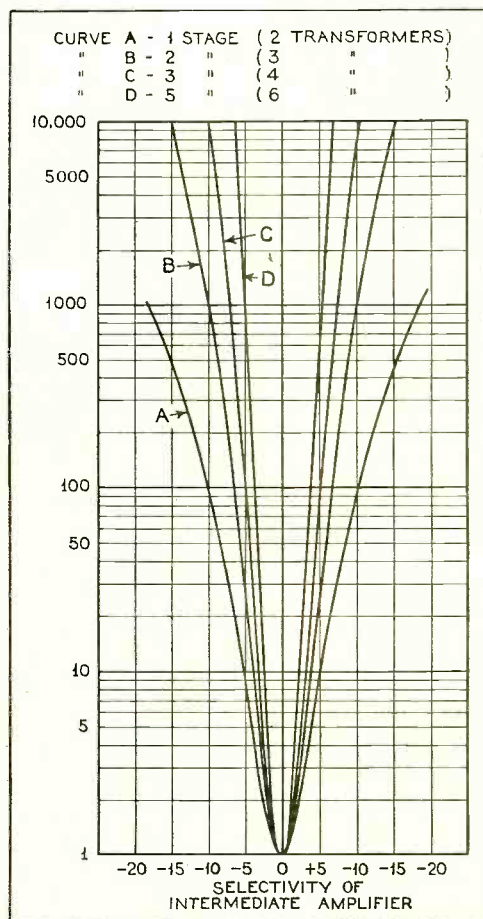

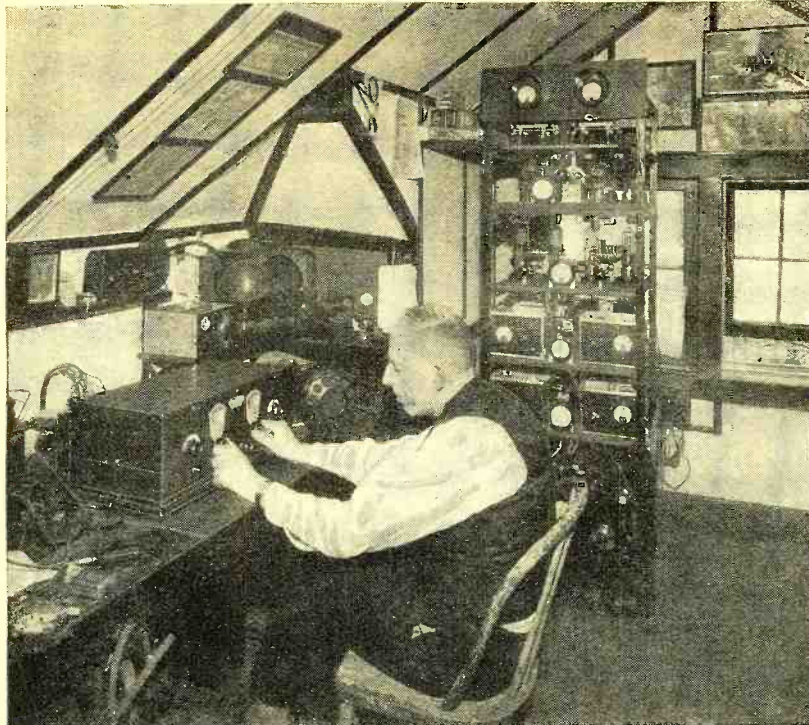

TESTING THE RECEIVER

*The new receiver being put through its paces by W. H. Hollister, the designer. Mr. Hollister, for many years a design engineer, has also been keenly and actively interested in amateur radio. He is therefore thoroughly familiar with the rigid requirements for both commercial and amateur receiver equipment. Adding to this background his recent years as producer of Lincoln laboratory-built receivers, he is unusually well qualified to design and produce a receiver to meet these requirements*

## Operating Tests on New Commercial Type S-W Super

*This article constitutes a report on operating tests of the new R-9 short-wave superheterodyne, conveying some idea of the practical value of the numerous special features offered in this receiver*

### Part Two

**A**n opportunity has been found to make operating tests on the new Lincoln R-9 commercial type superheterodyne short-wave receiver. These tests were conducted both in the RADIO NEWS testing station in Westchester County and in apartment locations in New York City.

The tests tended to emphasize the advantages of a number of the features described last month. The system of band-spread tuning, for instance, was found extremely effective. This would, of course, be expected on the amateur bands, but on the short-wave broadcast bands as well it greatly simplified tuning. Last month it was explained that a band-spread tuning control offers a tuning range of approximately ten divisions for every single division on the main oscillator dial. This means that stations which on the main tuning dial are one degree apart (or on many all-wave receivers would be less than one degree apart) are separated by nine or ten degrees on the band-spread dial of the R-9.

A striking example of this is found in tuning on the lower end of the broadcast band (the range of this receiver extends up into the lower part of the broadcast band). Setting the input tuning control and the main oscillator tuning control to bring in a 200-meter station with the band-spread dial on zero, the ten channels from 1500 kc. to 1410 kc. were tuned in on the band-spread dial alone. The settings of the band-spread dial for each channel was as follows:

Kilocycles	B. S. Dial
1500	0
1490	9
1480	19
1470	27
1460	38
1450	47
1440	57
1430	67
1420	79
1410	89

Compare this dial spread with the dial spread obtained with the ordinary broadcast-band receiver and the elimination of critical tuning is at once apparent. On the short waves, around 25 meters, the more common stations which with an ordinary short-wave receiver all crowd into an area of about three divisions on the dial, are spread over 38 dial divisions in this receiver, as follows:

Station (morning transmission)	Location	B. S. Dial
8XK	Paris	25.5
GSE	Pittsburgh	36.
I2RO	London	37.5
	Rome	46.
	Paris	63.

(afternoon wavelength)

This spread effect has an important advantage other than taking the difficulty out of tuning. It permits adjustment for exact resonance to the transmitting carrier. On many other short-wave receivers it is extremely difficult to get this quality because it is almost impossible to adjust the tuning dial with sufficient accuracy.

The provision in this receiver to cut the automatic volume control in or out at will by means of the switch was found to be a great asset. In listening to short-wave broadcasting the automatic volume control is left in the circuit in order to compensate for fading which would otherwise be encountered. But when tuning for weak amateurs, better results are obtained with the automatic volume-control switch in the "off" position. This is explained by the fact that where two amateur transmitters are working on very close frequencies, if one happens to be a local and the other a weak one, it is quite possible that the weaker one would not be heard because the powerful local signal in such close proximity would tend to activate the automatic volume-control system and thus decrease sensitivity to a point which would not permit the weak station to be heard. This, of course, does not happen where stations are separated by as much as 10 kc., but in the amateur bands in many cases the separation between two signals does not exceed more than a fraction of a kilocycle.

In the reception of c.w. signals automatic volume control does not have the same advantages that it does in the reception of music or speech. While it tends to compensate for fading of c.w. signals, this fading is not so troublesome. On the other hand, if the transmitting frequency is unstable, the use of the automatic volume control does have the advantage that it will to a certain extent compensate for swinging signals. So that even in c.w. reception the automatic volume control does sometimes come in handy.

In contemplating the preparation of a report on the actual reception tests conducted with this receiver, the writers are rather stumped in describing the reception in such a way as to convey a definite idea of the results procured. It is of course simple enough to say (and this is true) that stations were tuned in from almost every part of the globe, but any moderately good short-wave receiver could qualify for the same report. By this we mean that it is no trick at all to bring in short-wave broadcast programs from London, Paris, Rome, Madrid, etc. The actual difference between an excellent receiver and a moderately good one lies more in *how a station is received rather than the bare fact that it was received*. Even reporting on the volume of reception is rather unsatisfactory because of the great day-to-day variation in the signal strength of short-wave transmitters. Thus one day it may be possible to bring in several of the European stations with more than adequate volume even on a mediocre receiver, whereas the next day the very best receiver might not be capable of bringing in the same stations with volume equalling that of the previous day.

During the tests all of the stations mentioned above were received as well as numerous South American stations. Australia was heard, coming in well. Any number of commercial phone stations were heard on all wavelengths, as were also the commercial code transmitters from all over the world.

So many stations were heard, in fact, that it would be a waste of space to try to tabulate them all. Perhaps the test can be summed up by saying that just about everything that can be heard was heard.

During the tests, both in the Westchester laboratory and in the apartments in New York City, stations in Rome, London, Madrid, Paris and Germany were brought in with excellent volume, at times closely approximating reception of local broadcast stations, both in point of volume and in quality. In Westchester, the test station is located in the basement of a private house. So tremendous was the volume of European stations, that it was no trick at all to close the basement up completely, go up to the second floor and there hear the programs distinctly.

During the New York City tests, one obstacle was found which, in the case of many receivers, would be almost unsurmountable. It so happens that within the immediate vicinity of the apartment house in question there are several amateur transmitting stations which on many short-wave superheterodynes just about obliterate reception on the lower part of the 49-50 meter short-wave broadcast band, due to the image-frequency repeat points of the 40-meter "ham" stations appearing within the 49-50 meter range. But inasmuch as the R-9 has a separately tuned signal oscillator, it is possible to tune in the 49-50 meter broadcast stations on their repeat points rather than on their regular setting of the oscillator dial. This is, of course, an old trick, but it has the advantage of providing a degree of image-frequency selectivity not obtainable in short-wave superheterodynes having a single tuning control, unless such receivers include two or more tuned circuits ahead of the first detector to provide a relatively high degree of selectivity at the input.

Lest the idea be conveyed in the foregoing, that the selectivity is not all that it might be, it is well to mention here that selectivity is excellent in this receiver. Actually, by cutting down on the length of the apartment-house antenna to a length of approximately 75 feet overall, the image-frequency interference was substantially reduced without resorting to the use of the upper settings of the oscillator tuning dial.

So far as the adjacent channel selectivity is concerned, it was found possible to cleanly separate short-wave broadcast stations which on some receivers run together enough to make their programs practically indistinguishable. Take the case of the Caracas and Chicago stations, operating on 49.10 and 48.18 meters respectively. They cannot only be readily separated, but a dead spot can actually be found between them. This was found true even at times when Caracas was strong and Chicago was extremely weak, a regular occurrence at certain times of the day in the vicinity of New York City.

The ease of tuning, due to the band-spread feature of this receiver, made it a pleasure to tune in and listen to the police and airport stations, both of which operate on bands that are extremely crowded. Police stations from all over the country were heard strong, as was also the almost continuous procession of reports on airplane positions and the other aviation phone traffic, far and near.

To summarize, it may be said that just about every type of (Continued on page 683)

**T**HIS report on results obtained with this new receiver is based on tests made by the RADIO NEWS staff, under the direct supervision of Laurence M. Cockaday and S. Gordon Taylor.

AN INTERIOR VIEW

The overall shield cover has been removed, disclosing the simplicity of the layout

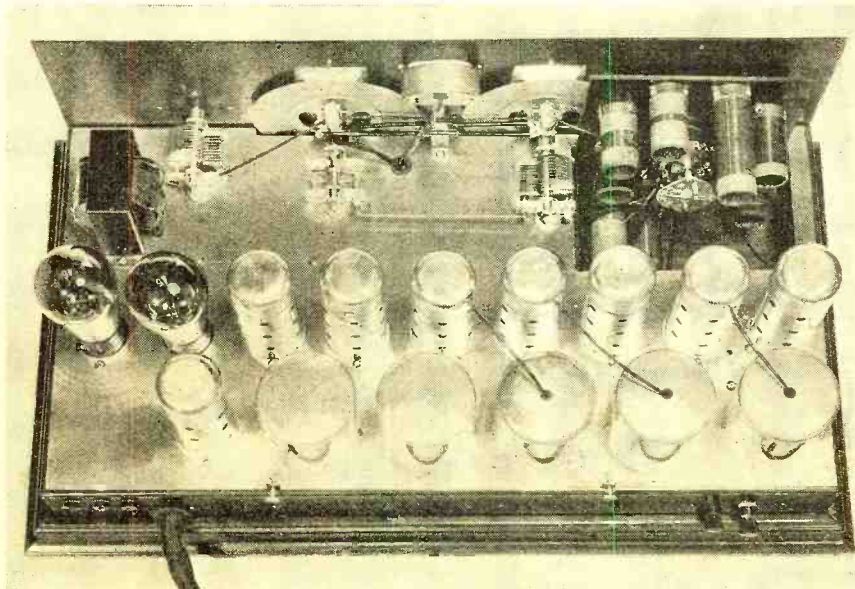

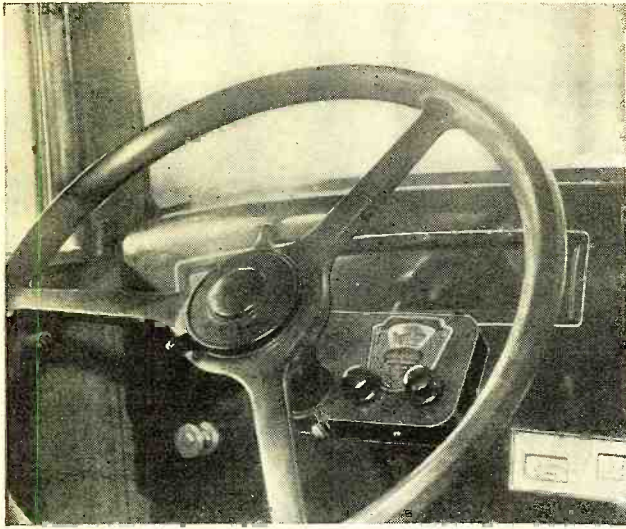

#### TUNING CONTROL READILY ACCESSIBLE

Figure 2. The tuning control with its illuminated scale is directly before the driver and within easy reach. Tuning is accomplished without taking too much attention off the road

THE general public and even that part of the public particularly interested in radio lacks appreciation of the effectiveness of modern automobile radio receivers. Vast strides have been made in motor-radio development during the past year or two, but for some reason the motoring public has not been well informed on this subject. It was believed, therefore, that a real service could be provided if the Laboratory Staff of RADIO NEWS were to put such a receiver through its paces and pass the results on to readers. The necessary arrangements for such an operating test were then completed and the tests carried on. The results are given in this article.

A regular stock model of the Motorola was obtained and the complete installation made in an Essex car by the Automotive Radio Engineering Service, a New York City concern which makes a specialty of Motorola sales and installation. These arrangements assured an installation that was standard in every way.

#### THE RECEIVER INSTALLED

Figure 1. Chassis and speaker are mounted on the car side of the bulkhead where they do not interfere with the driver, passengers or other equipment. Cables and other connections to the dash are bonded together and grounded where they come through the bulkhead. This is one step in eliminating ignition noise

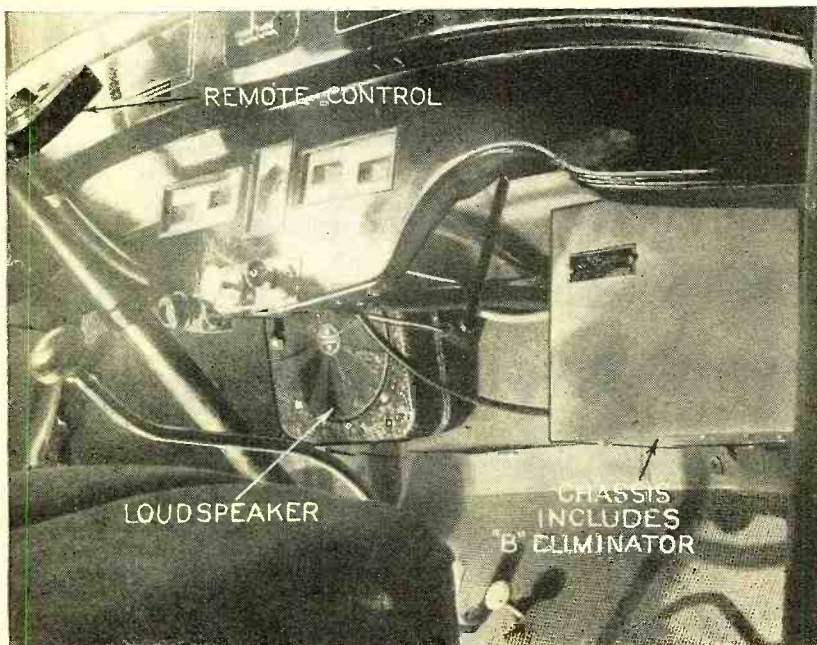

# Operating Tests On A Modern Auto-Radio

Some time ago a technical description of a modern automobile radio set was presented under the head of "Modern Auto Radio." The present article covers results obtained in operating tests of this receiver

By S. G. Taylor and J. M. Borst

The first idea of the operating characteristics of the receiver was obtained during the preliminary check-up on the floor of the installation shop. This shop is located on the ground floor of a large steel-framed garage building in the hollow at 61st Street and West End Avenue. In spite of this unfavorable location, particularly the shielding effect of the steel construction, all of the local stations were brought in with more than adequate volume and with very little noise. What little noise was picked up was not contributed by the electrical system of the car, the engine of which was left running. It seemed to be made up entirely of noise picked up from electrical equipment operating in other parts of the building—in other words, the type of man-made static always present in such locations.

Before leaving the shop the various details of the installation job were gone over. Many of these are shown in the accompanying photographs which were made during the process of installation. These photographs, incidentally, show just where the equipment was located in the car and the method of installing the antenna under the roof's upholstery. The installation itself follows along the general lines described in past articles of RADIO NEWS. The noise-eliminating system includes the usual spark suppressors and bypass condensers, the effective grounding of the conduit, etc.

A rather striking impression was obtained as the car was driven out of the shop to the street. Upon leaving the building the background noise disappeared completely, leaving the station program absolutely free from interference. This was not so much due to the fact that the car was farther from the source of interference as to the automatic volume control. Upon leaving the "shadow" of the steel structure the field signal strength was naturally much greater, with the result that the sensitivity of the receiver was immediately reduced by the action of the automatic volume control—reduced to a point at which the receiver was no longer susceptible to the local noise.

#### Effective A.V.C. Action

From the installation shop the car was driven up West End Avenue to 72nd Street and then north on Riverside Drive. In this short drive one runs the gamut of field strength variation. Going up West End Avenue, the street is buttressed on both sides by manufacturing buildings and farther on by massive steel-framed apartment houses, but turning into Riverside Drive, conditions become excellent, due to the unobstructed sur-



roundings. With auto-radio sets of earlier design, the changing conditions were made noticeable by variable but relatively low signals, with a decided jump in signal strength upon swinging into the Drive. In the present instance, however, the volume remained uniform through this kaleidoscopic change in field strengths.

Along the Drive, where it was possible to amble along and concentrate more or less on the radio, attention was given to the question of tone quality. Ordinarily, with an auto installation one makes allowances for imperfections in tone quality, expecting considerably less than would be demanded from a good home receiver. But during these tests it can be said without hesitation that the quality of reproduction was superior to that of many receivers used in homes today. The adaptation of the speaker and audio-frequency characteristics of the receiver to the peculiar acoustical properties of the automobile, as explained in the article last month, has proven highly effective, as evidenced by this test.

Further observations, during this and subsequent trips, permitted a careful test of all of the features that might be required in an ideal automobile radio installation, including selectivity, sensitivity, ease of tuning, action of the automatic volume control, elimination of ignition noise and the general noise-level characteristic of the receiver itself.

The first real indication of the sensitivity of the receiver was encountered accidentally. While driving along one night, the receiver was tuned to what was believed to be the proper setting for the local station WEA. After enjoying the program for several minutes, we were considerably surprised to find that, instead of being WEA, the station to which we had been listening was WSM of Nashville, Tennessee. This station was heard with such volume and clarity that we were not aware, until we heard the announcement, that it was not WEA. This proved so interesting that in the few moments left before our arrival at our destination a little "fishing" was done and produced XER, Villa Acuna, Mexico, with as good volume as we had been getting on WSM.

**Real DX Reception**

On the evening of October 25, 1932, the car was parked on Riverside Drive and fifty minutes was spent in tuning to see what could be brought in. Naturally, in this length of time we could not get calls on all stations heard, but among those whose calls were heard were WLW, Cincinnati; WGN, Chicago; XER, Mexico; WGY, Schenectady; WCCO, Minneapolis, and WHAS, Louisville. In addition to these, other distant stations were tuned in. The frequencies of these stations were given, together with the assumed location: 560 kc., Philadelphia; 610 kc., Philadelphia; 630 kc., Canada; 680 kc., North Carolina; 690 kc., Canada; 730 kc. (Spanish program), Cuba; 770 kc., Chicago; 840 kc., Canada, and 870 kc., Chicago.

On November 5th an occasion was found to try early-morning reception. The test was started at 1:20 a.m. and continued until 2:25 a.m. During this time the majority of stations were, of course, off the air, but among those brought in and definitely identified by hearing their call letters were WBBM, Chicago; WILL, University of Illinois; KOA, Denver; KFI, Los Angeles; WFIW, Hopkinsville, Kentucky; WCFL, Chicago; WOMT, Wisconsin, and WLY, Lexington, Kentucky. KGO of San Francisco was also heard but not at the right time to hear an announcement. This was also true of KNX of Hollywood, California. These two latter stations were fading badly, but KFI was much more steady and was received with ample volume to be heard outside the car.

It is true that the average automobile owner is not particularly interested in attempting to bring signals in from across the continent, but the high degree of sensitivity shown in these tests guarantees a variety of programs while driving, even in the most remote corners of the United States. It follows that a receiver which, in New York, can bring in West Coast stations at night, will certainly provide a daytime range sufficient for all practical purposes. To sum the matter up, this radio, although operated in an automobile and in spite of the limitations imposed in the way of (Continued on page 695)

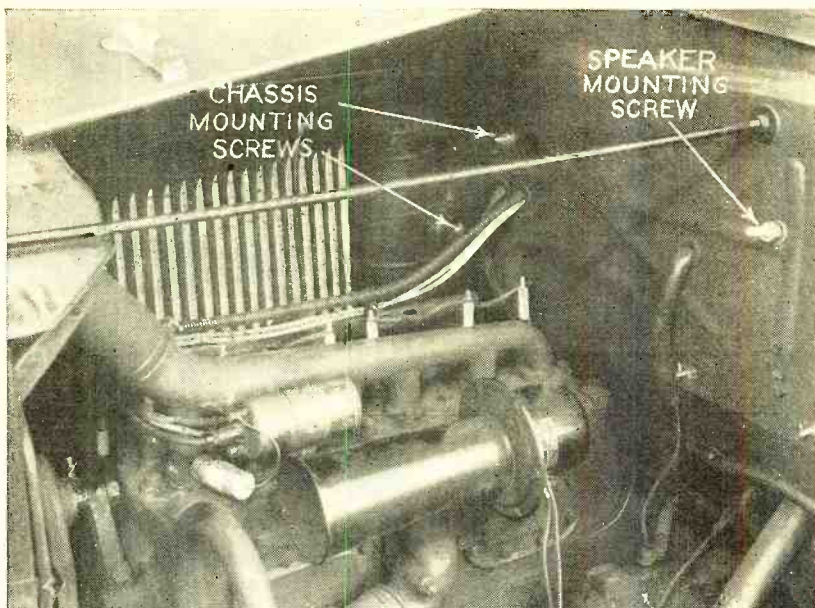

**THE IGNITION SUPPRESSION EQUIPMENT**

Figure 3. The spark plug suppressors are seen on top of the engine block. In the foreground is one by-pass condenser, beside the high-tension coil. Note the shielding of the two leads running from the ignition coil to the switch on the instrument panel. The shielding of these leads is important for quiet operation

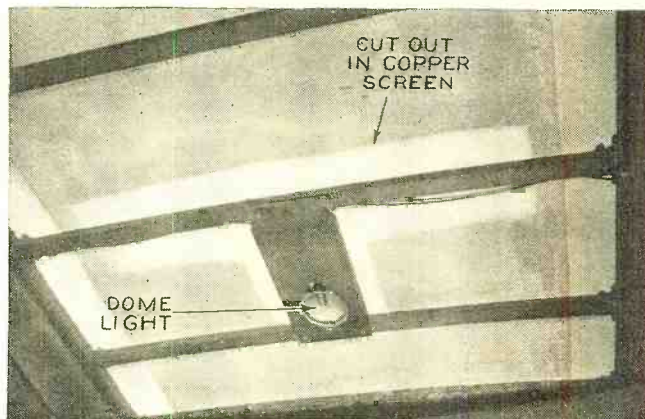

**THE ANTENNA**

Figure 4. This view shows the roof of the car, looking from the front, with the upholstery removed. Note the way the copper screen is cut away from the dome light and its wiring. This is helpful in eliminating noise pick-up from the car wiring

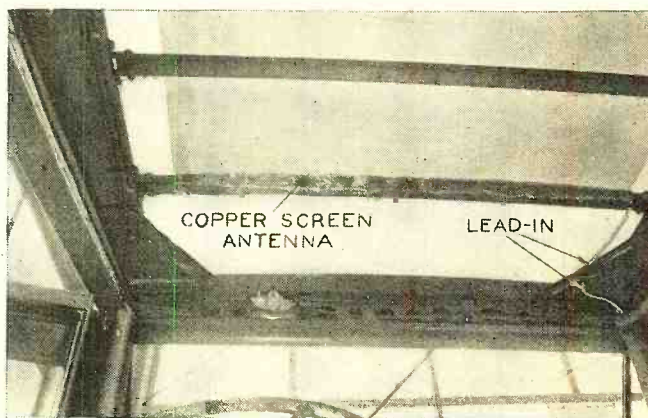

**THE ANTENNA LEAD**

Figure 5. The copper screen antenna is anchored by wrapping around the front cross stay. The lead-in wire is soldered to the screen and is carried down inside the front corner post of the car. Thus, when the upholstery is replaced, the antenna and its lead are both completely concealed and protected from damage

# Service Data for Servicemen

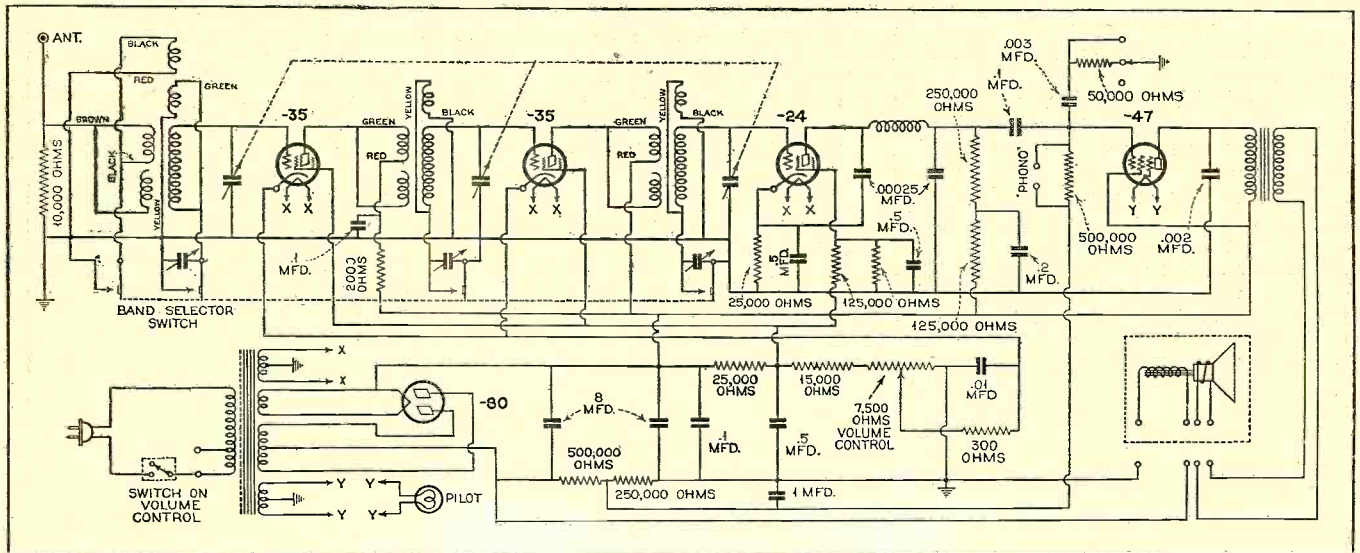

FADA, MODELS 61 AND 66 ("KX")

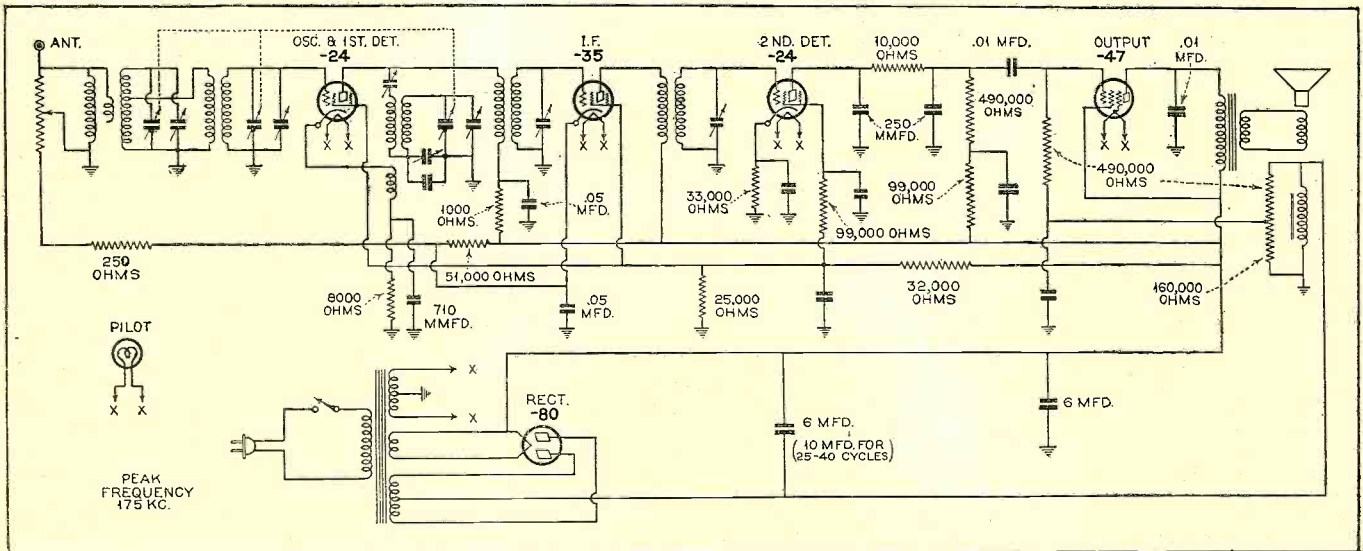

PHILCO, MODELS 51 AND 51-A, SUPERHETERODYNE

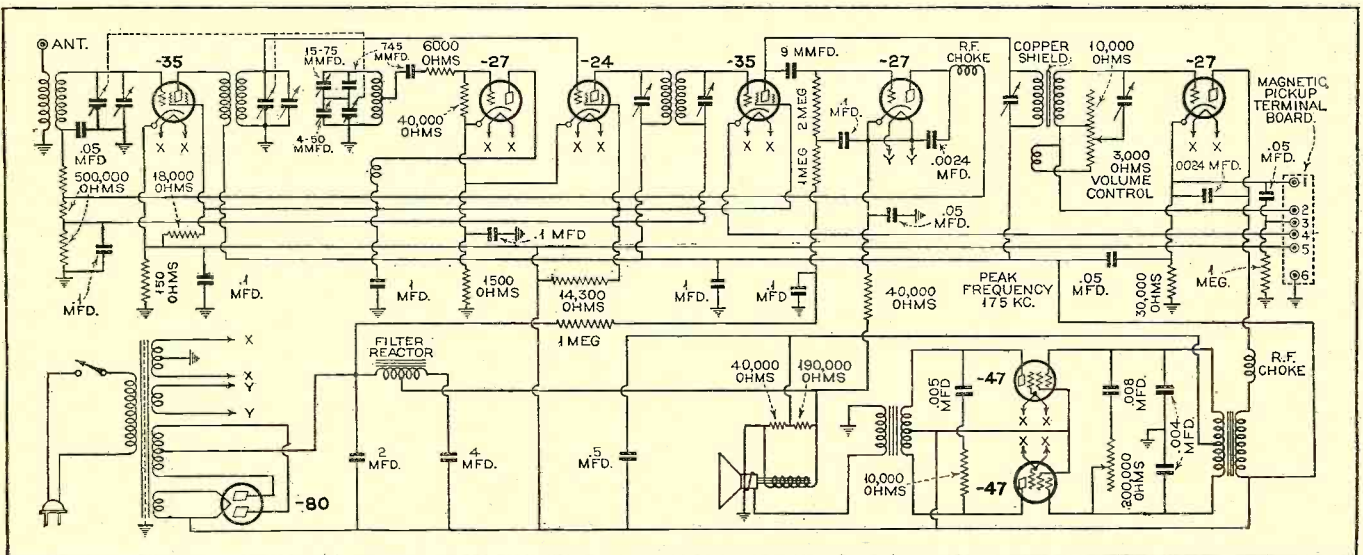

RCA-VICTOR, MODEL R-21, SUPERHETERODYNE

Compiled from J. F. Rider's Perpetual Trouble Shooter's Manual.

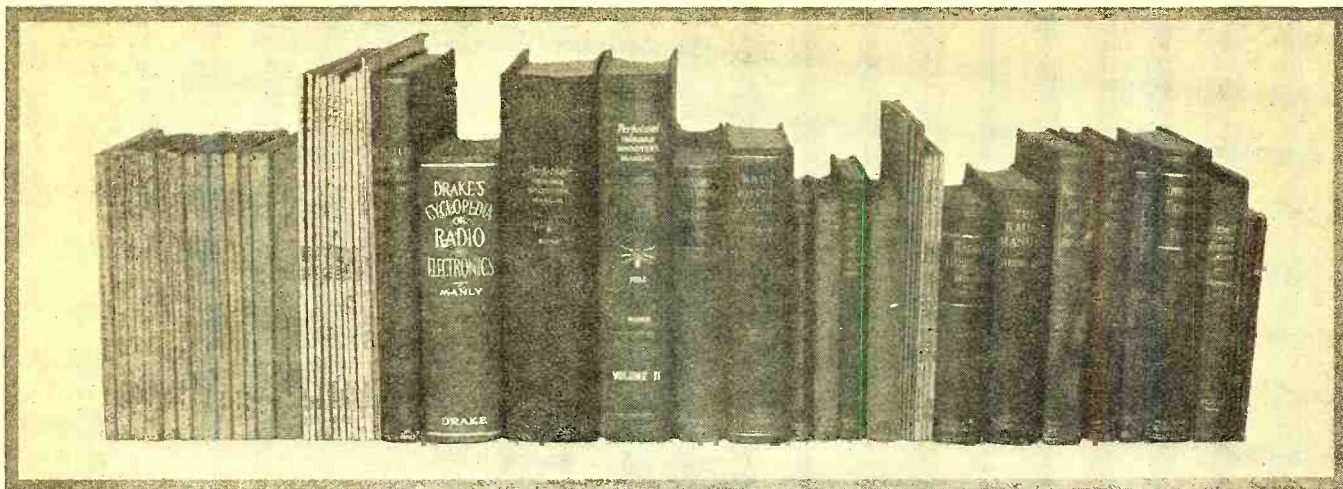

# Technical Review

## RADIO SCIENCE ABSTRACTS

*Radio engineers, laboratory and research workers will find this department helpful in reviewing important current radio literature, books, Institute and Club proceedings and free technical booklets*

Conducted by

Joseph Calcaterra

*Photocells and Their Application*, by V. K. Zworykin and E. D. Wilson; second edition. John Wiley & Sons, 1932. The second edition has been enlarged to include new information on subjects relating to the photoelectric art. Practical information on photoelectricity is so scarce that this book will no doubt be a welcome addition to the library of the engineer and experimenter interested in this subject.

The contents of the volume include the history of photoelectric phenomena, the theory of photo-emission, photo-conduction and photo-voltaic action, the properties of the cells now on the market, laboratory methods of manufacture and a discussion of applications, including amplifier circuits. A little over half of the book is concerned with the cell itself, the other half with the application. It is indispensable that the reader shall have an adequate understanding of radiant energy and the photo-emissive effect, so we find a chapter devoted to these subjects at the beginning of the book. The text contains but few mathematical equations, which makes the book worth while for a large group of readers. The first part is especially valuable to those who wish to understand the so-called "new physics." If one has had his physics training quite some time ago, one's mental picture of the structure of matter needs modifications in order to understand the working of photo-cells and vacuum tubes.

*NRI Advanced Course: Sound Pictures and Public-Address Systems*. The course consists of 15 lessons with the following titles:

- 1PA—Power Supplies for Power Audio Amplifiers
- PA—Pick-up Devices; Speech Input Analysis
- 3PA—Impedance-Matching Networks, Pads and Volume Controls
- 4PA—Transmission Lines; Volume Indicators; Monitors
- 5PA—Acoustics of Buildings
- 6PA—Outdoor P.A. Systems
- 7PA—Design of Outdoor Public-Address Systems
- 8PA—Indoor Public-Address Systems

- 9PA—Design of Indoor Public-Address Systems
- 10PA—Analysis of Photophone, Vitaphone and Movietone Systems
- 11PA—Studio Sound Shooting; Part I
- 12PA—Studio Sound Shooting; Part II
- 13PA—Sound Picture Theatre Equipment
- 14PA—Trouble-Shooting Sound Motion Picture Equipment
- 15PA—Control and Operation of S.P. and P.A. Systems

These fifteen lessons contain a wealth of practical information on the design, installation and operation of sound equipment. After the student has learned the fundamental principles, of microphones, power supplies, tubes, speakers, etc., the course continues with three concrete examples of P.A. system designs. One is for a ball-park, one for a convention hall and one for an apartment house, with several program channels. Finally, coming to the sound-picture field, he learns the working of the equipment used in the studios and the duties of the sound technicians. Theatre equipment and the problems of the projectionist are discussed in the last three lessons.

### *Review of Articles in the February, 1933, Issue of The Proceedings of the Institute of Radio Engineers*

*The Required Minimum Frequency Separation Between Carrier Waves of Broadcast Stations*, by P. P. Eckersley. The various factors of distribution of power, response characteristics of the ear, and the frequency characteristics of transmitter and receiver equipment, as they effect interference over the broadcast frequency range are discussed in this paper. The changes in allocation of frequencies and design of receiving and transmitting equipment to minimize this type of interference are considered.

*Supervisory and Control Equipment for Audio-Frequency Amplifiers*, by Harry Sohön. This paper describes a new type of peak voltmeter which serves as a level indicator for audio-frequency amplifiers. The use of this type of level indicator eliminates the possibility of failing to indicate a condition which might result in distortion in the amplifier when an r.m.s. or average voltmeter type of level indicator is used. An automatic control circuit which reduces the amplification of a special amplifier when the output voltage reaches a certain amount is also described.

*A Practical Analysis of Parallel Resonance*, by Reuben Lee. This article shows a comparatively simple method of solving parallel resonance problems by the vectorial method, with perhaps a better indication of the physical phenomena involved. Examples of the practical application of the analysis are given.

*Graphical Methods for Problems Involving Radio-Frequency Transmission Lines*, by Hans Roder. This paper explains how, using the simple premise that resistance and leakage conductance of the line can be neglected in radio-frequency transmission lines, simple graphical methods can be used for the determination of currents, voltages and impedances along a transmission line. The application of elliptical and circle diagrams is explained.

### *Review of Contemporary Literature*

*A "Low-Hum" Vacuum Tube*, by J. O. McNally. Bell Laboratories Record, February, 1933. This article describes the theory, construction and characteristics of the new Western Electric No. 262-A vacuum tube, especially designed with exceptionally low hum characteristics for use with very high gain a.c.-operated audio-frequency amplifiers.

*Light-Weight Transformers for Aircraft*, by D. W. Grant. Bell Laboratories Record, February, 1933. This article discusses the

factors which determine the size and weight of transformers and coils for audio amplifier and power supply use in airplanes and outlines the results of the intensive research which has been done to reduce both the size and weight of such units.

*Abbé Lemaitre on Cosmic Rays.* Science, Jan. 20, 1933. Prof. Einstein gave his blessings to the theory proposed by Abbé Georges Lemaitre that cosmic rays are birth cries of the universe and the radiations from the super-radioactive primeval matter that existed when the universe was young.

*A Contribution to Vowel Theory,* by L. E. Travis and A. R. Buchanon. Science, Jan. 27, 1933. The authors have performed experiments to determine whether new frequencies can be created by the oral and nasal cavities or whether all frequencies making up a vowel were present at the source of sound (the vocal chords). The former seems to be the case.

*Electronic Devices for Industrial Control,* by F. H. Gulliksen. Electrical Engineering, February, 1933. A discussion of the advantages of electronic relays above other types. Three examples of typical applications are described.

*The Wunderlich Tube,* by Norman E. Wunderlich (obtainable from Arcturus Radio Tube Co., Newark, N. J.) This pamphlet shows the practical application of the Wunderlich tube in several commercial receivers. The circuits of the receivers are given, together with explanatory text and values of electrical constants. This information should be sufficient for the engineer or manufacturer to duplicate the performance of the described sets.

*Recent Developments in Mica Condensers,* by A. E. Thiessen. General Radio Experimenter, January, 1933. This article gives important information on a new line of inexpensive, low-loss mica condensers having many of the features, such as stability of calibration, temperature compensation usually found only in expensive, precision-standard types of units.

*A New Coil Form.* General Radio Experimenter, January, 1933. This is a catalog description of the features and characteristics of the new General Radio moulded porcelain, ribbed, low-loss coil form for use by laboratories, amateurs and experimenters. For quick-change circuits a plug-in arrangement is provided when required.

*Grid-Current Compensation in Power Amplifiers,* by W. Baggally. The Wireless Engineer and Experimental Wireless, February, 1933. A discussion of the distortion effects produced by grid-current flow and the most suitable methods of preventing or overcoming such effects.

### Review of Technical Booklets Available

1. *Wholesale Radio Parts and Sets 1933 Spring and Summer Catalog No. 54.* A catalog of 152 pages, issued by the Wholesale Radio Service Co., one of the oldest mail-order houses. The catalog contains illustrations, descriptions, specifications, list and net prices of a variety of radio parts, tools, replacement items, receiver chassis, complete sets, public-address systems and electrical merchandise required by dealers, servicemen, set builders, amateur and commercial operators, experimenters and engineers.

2. *1933 R.F. Parts Catalog.* An 8-page folder containing specifications on the line of Hammarlund variable and adjustable condensers, r.f. transformers, sockets, shields and miscellaneous parts for broadcast and short-

*Non-Linear Valve Characteristics,* by C. S. Bull. The Wireless Engineer and Experimental Wireless, February, 1933. This article explains a method showing how the frequencies in an input signal are added and subtracted by a curved tube characteristic. Simple rules are given for determining the effective combination of frequencies, and modulation rise, cross modulation, detection, modulation, and high-frequency mixing are considered in detail.

*Defamation—Broadcast as Publication by Station.* Air Law Review, January, 1933. A summary, statement and list of cases bearing on the responsibility of broadcast stations for defamatory matter transmitted by radio stations.

*Sixth Annual Report of the Federal Radio Commission to the Congress of the United States for the Fiscal Year 1932.* A complete report on the organization, functions, activities, rulings, etc., of the various divisions of the radio branches of the government.

*Atmospherics in Australia,* by G. H. Munro and L. G. H. Huxley. Commonwealth of Australia, Radio Research Board report No. 5, Bulletin No. 68. A detailed report on atmospherics giving a complete description of the instruments and methods used and the results obtained in the study.

*A Direct-Current Amplifier with Good Operating Characteristics,* by A. H. Taylor

### Free Technical Booklet Service

THROUGH the courtesy of a group of manufacturers, RADIO NEWS offers to its readers this Free Technical Booklet Service. By means of this service, readers of RADIO NEWS are able to obtain quickly and absolutely free of charge many interesting, instructive and valuable booklets and other literature which formerly required considerable time, effort and postage to collect. To obtain any of the booklets listed in the following section, simply write the numbers of the books you desire on the coupon appearing at the end of this department. Be sure to print your name and address plainly, in pencil, and mail the coupon to the RADIO NEWS Free Technical Booklet Service. Stocks of these booklets are kept on hand and will be sent to you promptly as long as the supply lasts. To avoid delay, please use the coupon provided for the purpose and enclose it in an envelope, by itself, or paste it on the back of a penny postcard. The use of a letter asking for other information will delay the filling of your request for booklets and catalogs.

wave receivers, complete short-wave receivers and transmitting variable condensers.

4. *A 15 to 200-Meter Comet "Pro" Superheterodyne.* A description of the outstanding features of the Hammarlund-Roberts high-frequency superheterodyne designed especially for commercial operators for laboratory, newspaper, police, airport and steamship use.

5. *A 1933 Volume Control, Fixed and Variable Resistor Catalog.* This 12-page catalog, issued by Electrad, Inc., gives data on standard and special replacement volume

and George P. Kerr. The Review of Scientific Instruments, January, 1933. This article contains a complete discussion of some generally overlooked points regarding the tube characteristics which must be considered in the design of high-quality amplifiers for special purposes.

*Electron Tubes in Radio City Theatres.* Electronics, February, 1933. Enumeration and description of the many uses to which electronic devices have been put to make possible the smooth-running effects produced in these theatres is given in this article.

*Relays for Electronic Devices.* Electronics, February, 1933. This article gives operating characteristics and valuable information on the selection of relations used in operating heavy-duty circuits from sensitive circuits such as light-sensitive units. The operating characteristics and applications of a number of commercial relays are given.

*Gaseous Discharge Tubes for Radio Use,* by John F. Dreyer. Electronics, February, 1933. A description of the characteristics of gaseous discharge tubes when used as visual tuning indicators in radio receivers is given in this article. Circuit diagrams for most efficient operation are included.

*The Madrid Conference,* by K. B. Warner. QST, February, 1933. A report of the Madrid Conference with special reference to the effect of the conference on amateur radio, and a discussion on how the aims of radio amateurs were attained.

*Suppression of Noise in Radio Receivers,* by Edgar Messing. Radio Engineering, February, 1933. A discussion of the theory and application of q.a.v.c. (quiet automatic volume control), giving the history, development, circuits and operating characteristics which have made this feature so popular in modern receivers.

*Roll Your Own.* Radio Retailing, February, 1933. A survey of the market for automobile radio, including a list of cars which are antenna-equipped for use with a radio and the methods used by a number of dealers to merchandise receivers for auto-radio use.

### How to Get Copies of Articles Abstracted in This Department

The abstracts of articles featured in this department are intended to serve as a guide to the most interesting and instructive material appearing in contemporary magazines and reports. These publications may be consulted at most of the larger public libraries, or copies may be ordered direct from the publishers of the magazines mentioned.

RADIO NEWS cannot undertake to supply copies of these articles. They are NOT included in the RADIO NEWS Free Technical Booklet Service.

controls, Truvolt adjustable resistors, vitreous wire-wound fixed resistors, voltage dividers and other resistor specialties and public-address amplifiers (using new tubes). Many revisions and additions to the Electrad 1932 line are included.

6. *Line-Voltage Control.* Characteristics and uses of a real voltage regulator and complete chart showing the correct Amperite recommended by set manufacturers for their receivers. Also tells how to improve your customers' sets and make a profit besides.

7. *Rich Rewards in Radio.* This 64-page book is filled with valuable and interesting information on the growth of radio and the opportunities existing in the fields of radio manufacturing, radio servicing, broadcasting, talking pictures, television, public-address

systems and commercial station operation on land and sea, for men who are trained to fill the many jobs created by radio and allied industries. The book also contains information on the home-study courses in radio and allied subjects offered by the National Radio Institute. This book is available only to RADIO NEWS readers who are over 16 years of age and who are residents of the United States or Canada.

9. *Catalog of Fixed, Metallized and Precision Resistors.* This 16-page catalog gives specifications of the International Resistance Co. 1933 line of metallized, wire-wound and precision wire-wound resistors, motor-radio suppressors, handy servicemen's kits, valuable data and list of free bulletins available on the building of servicemen's test equipment.

10. *Information on the Suppression of Motor-Radio Noises.* This useful folder of the International Resistance Co. gives complete information on how to overcome motor-generator, ignition-coil, interrupter and spark-plug noises in automobile radio installations.

16. *RMA Standard Resistor Color Code Chart.* A handy post-card-size, color-code chart designed by the Lynch Mfg. Co. to simplify the job of identifying the resistance values of resistors used in most of the standard receivers. It also contains a list of the most commonly used values of resistors with their corresponding color designations. A complete catalog of Lynch products is included.

18. *Volume Controls, Fixed Resistors, Motor-Radio Spark Suppressors and Power Rheostats.* A 1933 catalog containing descriptions, specifications and prices of a complete line of Centralab standard, special and replacement volume controls for receivers, amplifiers, public-address systems and talkie installations, fixed resistors, motor-radio spark suppressors, wire-wound rheostats and potentiometers. Details are given on how to obtain, without charge, a copy of the 64-page Centralab volume control guide for servicemen.

25. *Transposition Noise-Reducing Antenna System.* A description, with technical data, on a new antenna system, perfected by the Lynch Mfg. Co., which is effective in eliminating the majority of electrical noise interference on broadcast, short-wave and amateur reception. It is especially suited for application on all-wave receivers which have heretofore given unsatisfactory results because of objectionable interference on the shorter waves.

29. *Practical Radio Engineering.* This 32-page booklet gives the details on the courses offered by the Capitol Radio Engineering Institute of Washington, D. C., to fit the requirements of professional radiomen, radio servicemen, operators and technicians, who are ambitious to get into the higher-paid positions in radio, reserved for those with advanced training. Three types of courses are offered: (1) an intensive 9-months' full-time resident course requiring regular attendance at classes; (2) a home-study course which can be mastered entirely at home and (3) a combination home-study and post-graduate resident course consisting of the regular home-study course followed by 10 weeks' practical training at the school with regular full-time attendance at classes. (Please do not write for this catalog unless you are interested in taking up a course on radio.)

30. *Shielded "Noise-Reducing" Antenna System for Broadcast Waves.* A description of a new Lynch low-cost, impedance-matching system of unique design—including

impedance-matching transformers for the antenna and for each receiver—which now makes possible the use of a shielded transmission line of any length, without loss of signal strength. This system is designed for the elimination of "man-made" electrical interference on the broadcast frequencies. It is easy to install and provides for using several receivers on a single aerial. It offers many opportunities for profitable jobs to dealers and servicemen.

34. *Serviceman's Replacement Volume-Control Chart.* A revised complete list, in alphabetical order, of all old and new receivers, showing model number, value of control in ohms and a recommended Electrad control for replacement purposes. Contains specifications for over 2000 different receiver models. A handy chart which should be in every serviceman's kit.

37. *Servicemen's and Dealers' 1933 Testing and Trouble-Shooting Instruments.* A 16-page handbook and catalog giving details on diagnetometers, set analyzers, tube testers, oscillators, ohmmeters and other testing instruments and accessories made by the Supreme Instruments Corp. It also contains details of blue-prints and kits by means of which any serviceman can build any of these instruments at a saving, and a self-payment plan which enables responsible servicemen to pay for these instruments while using them.

39. *Radio Servicing and Radio Physics.* A 4-page folder which describes two of the most complete, easily understood and inexpensive books on every phase of radio. The books are written by A. A. Ghirardi and Bertram M. Freed and should be in the libraries of every radio student, experimenter and serviceman. The fact that they are used as standard texts by many radio schools and that chapters have been reprinted in RADIO NEWS Magazine is an indication of their value.

40. *Resistor Indicator.* A description of an instrument designed by the International Resistance Co. to enable servicemen and other radio men to determine the exact resistance value of a defective resistor without the use of meters, wiring diagrams or specifications. (Continued on page 699)

### S.W. Super

(Continued from page 677)

service operating on short waves was brought in during the relatively brief tests. Whether the transmission was broadcast, amateur or commercial, it all fell prey to this receiver.

In last month's article photos were shown of the complete receiver, including the power supply unit and auditorium type electrodynamic speaker. This month the inside view is shown, with the metal shield cover removed. When in position this shield is attached to the metal front panel and to three sides of the metal chassis, providing a most complete overall shield, and at the same time keeping dust off the tuning condensers, coils and other critical parts.

The extremely clean-looking layout of the parts on the chassis is particularly noteworthy. The tubes are all lined up according to the sequence in which they function in the circuit. This brings the first detector and oscillator to the right end of the receiver (looking at it from the rear, as in the photograph), where they are close to the coils. The coils are mounted in a circle, with the wave-changing switch in the center. This makes for short leads in the tuned circuits with consequently low losses.



### NU 201AA HAS NON-PARALYZING PROPERTIES

In line with the National Union policy of continually producing outstanding quality tubes older types are constantly subject to experimentation with an idea of improvement, if possible. As a result of this developmental work, the NU 201AA has been produced. Engineering data on this improved type follows:

The mutual conductance of the 201AA is approximately 12% higher than the mutual conductance of the 201A, and so a corresponding increase in sensitivity in a radio set will be brought about by the use of the 201AA. If four or five of these tubes are used, there will be a noticeable increase in sensitivity. Due to the increase in mutual conductance and slightly higher plate current, the 201AA should read somewhat higher on a tube tester than does the type 201A. The 201AA should not be as critical in its filament voltage requirements as is the 201A. The 201A employs a thoriated tungsten filament and such filaments when operated at a voltage less than rated voltage becomes paralyzed. The 201AA employs an oxide coated filament and consequently is not critical with respect to filament voltage. It is probable that the life of the 201AA will be greater than the life of the 201A. Your jobber can supply this new NU 201AA.

**N.U. JOBBER STOCKS ARE COMPLETE!**  
All types at all times for your convenience.

### THANKS MR. DUBUQUE!

Unsolicited testimonials from live wire service organizations are always appreciated! Says Mr. John Dubuque of Snohomish, Washington: "Received my National Union Radio Service Manual and will say I am well pleased with it. . . . Wish to commend your policy toward the serviceman and will add that this policy coupled with the outstanding excellence of the tubes you manufacture is sure to bring continued success."

### BASE CONNECTION FINDER



This handy dial chart, printed in four colors, coat pocket size, tells you pin connections quickly, simply. A twist of the outer dial and the data appears. Send six (6) National Union carton tops or 25c in stamps for your copy!

This is the National Union carton top.

### FREE SHOP EQUIPMENT!

It is the objective of National Union at all times to assist the service man to fully equip his shop with fine modern instruments and data. Free. You should join the thousands who are getting equipment the easy National Union way.

**TWO SERVICE MANUALS:** by John F. Rider. Free with small tube purchase. No deposit.

**READRITE TUBE TESTER:** Free with small tube purchase. Small deposit.

**OSCILLATOR AND OUTPUT METER:** Free with small tube purchase and small deposit.

**THE UNAMETER:** Most modern Tube Tester. Free with tube purchase and deposit.

**HICKOK OHM CAPACITY VOLTMETER:** Free with tube purchase and deposit.

**BENCH KIT:** Handy parts box. No deposit.

NATIONAL UNION RADIO CORP. OF N. Y.  
400 Madison Avenue, New York City RN5

Sirs: I am interested in following equipment: Readrite Tube Tester  Oscillator & Output Meter  Volume I  Volume II  Unameter  Ohm Capacity  Bench Kit   
NAME.....  
ADDRESS.....  
CITY.....STATE.....

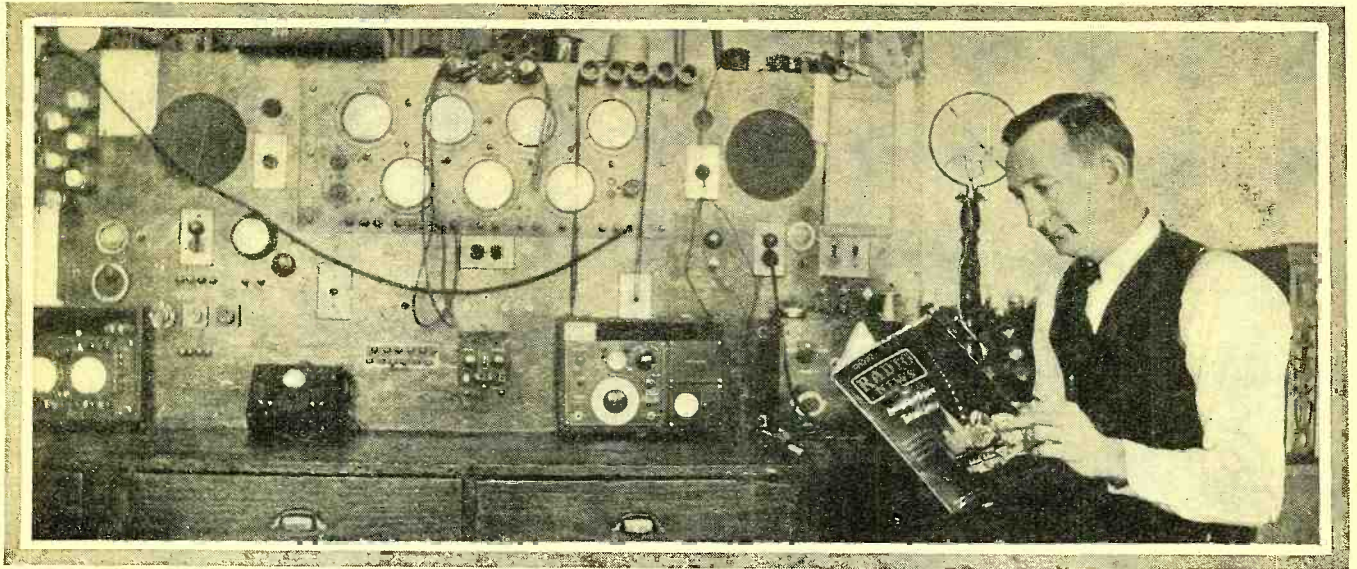

# The Service Bench

*Making Your Correspondence Build Business—Collecting Outstanding Bills, Follow-Up Sales Letters, Letterheads; A Model Service Bench; Double Ground Connections*

**C**ORRESPONDENCE is an intimate part of every business, including that of radio sales and servicing. The success or failure of a commercial enterprise may often be directly attributed to the manner in which its mail contacts are maintained. We have considered, at various times in the Service Bench, sales letters and other postal contacts with customers. Sporadically we have picked successful letterheads, here and there, from our service correspondence, with which to emphasize the desirability for attractive stationery. Similarly, several pages in the RADIO NEWS book for servicemen—"How to Make Money in Radio Servicing"—are devoted to the finer points of salutation, argument and signature. However, many requests from our readers for individual assistance in letter composition indicate that our previous treatment of the subject has been either inadequate or so distributed as to be inconveniently referable, and so we take pen in hand to do a more thorough job.

By far the greater part of the serviceman's correspondence will be of so individual a nature that even the most elastic sort of a form letter can give no satisfactory suggestion as to thought and wording. On the other hand, there are some letters which fall into definite classes, and in writing these it may be desirable to follow closely examples recommended by careful consideration of the factors involved. Among these are dunning letters, that inevitable *Old Man of the Sea*, perched on the shoulders of every legitimate business.

A letter requesting payment of a bill is a pound of cure—and it may not always work. The ounce of prevention is—doing a job on a cash basis. However, there are instances where credit must be extended, and such cases are bound to result in debts of varying degrees of badness. The purpose of a dunning letter is twofold—first to request payment of the account due, and second, to maintain friendly relations with the customer. The latter may require considerable diplomacy. Nobody likes to be asked for money, and it is particularly disagreeable

## Conducted by Zeh Bouck

when one owes it legitimately. It is one of the many anomalous psychological facts that we bear a grudge against the person to whom we are in debt. In these times there is a tendency toward leniency in such matters, and dunning communications may well be

we assume that this matter has escaped your attention, and we are enclosing a duplicate. "How is the receiver working? Our work is guaranteed, and we are not satisfied until you are. Do not hesitate to call upon us for radio service at any time—day or night."

"Yours very sincerely, \_\_\_\_\_"  
If this is unproductive, we follow it up in two weeks' time with—

"My dear Mr. Jones: We have not heard from you in reference to our requests for payment covering repairs made on your radio receiver some time back.

"Are you in any way dissatisfied with the work? It is our sincere endeavor to do a good job at a reasonable price, and if there is anything wrong, we should appreciate hearing from you.

"May we expect a check—or a letter—within the next few days?"

"Yours sincerely, \_\_\_\_\_"  
In the next step, we still mask our real opinion of the customer, bearing in mind the fact that his radio will go bad again some day, and stretch our diplomacy a little more toward the limit of perfect elasticity.

"My dear Mr. Jones: It occurs to us that it may not be convenient for you at the present time to settle your account for radio repairs some months ago. We desire to cooperate with our clients and customers in every possible way, and shall be glad to extend you any reasonable credit.

"However, we should greatly appreciate it if you would make a part payment now, or indicate to us when you think it will be possible to clear our books on this item."

"Sincerely yours, \_\_\_\_\_"  
If a week's time elicits no response to this letter, it is obvious that the customer is not overburdened with a sense of honor, and diplomacy may be profanely hurled to the winds. A customer of this sort will probably be no better in the future, and is therefore not worth holding. A bird in hand is worth two in the bush, so take the chance that you may be able to scare him into settling the present debt with the following letter—

"Dear Mr. Jones: As you have ignored

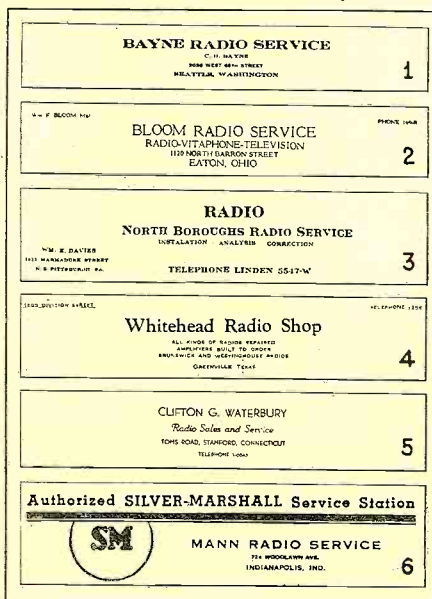

FIGURE 1

graded in six degrees of importunateness. The first is the simple invoice. If not paid within thirty days it should be followed with a statement. If this is ignored, we try step number three—

"My dear Mr. Jones: We sent you a statement on \_\_\_\_\_ covering recent repairs to your radio receiver. As we have not heard from you at the present writing,

our many requests for payment of your account, long overdue, we shall be forced to turn the matter over to our attorney unless check is received within one week. We hope you will not force us to this drastic action which will necessarily be rather expensive for both of us.

"Yours very truly, \_\_\_\_\_"

The philosophy of the dunning letter should impress itself on the serviceman in reverse English. The serviceman himself may be pressed for payment of one or more accounts at a particularly inconvenient time. The path of least resistance is to ignore the bills and statements until payment is possible. The effect on your creditors, however, will be exactly the same as that which impels you to write the dunning letters suggested above. It is highly detrimental to credit, good will and ease of mind. If you, yourself, cannot pay a bill when it is due, write to your creditor and frankly tell him so. He will respect your confidence, wait patiently, and probably extend you additional credit. A letter of this kind will avoid many unpleasant situations for all concerned—

"Gentlemen: In reference to your invoice dated \_\_\_\_\_, we regret that circumstances beyond our control make it impossible for us to meet payment at the present time.

"We hope, however, to be in position to send you our check by \_\_\_\_\_, and beg your indulgence until then.

"Thanking you for past favors, and assuring you of our appreciation in the present instance, we are,

Yours sincerely, \_\_\_\_\_"

If it is possible to make a part payment, do so, and modify the letter accordingly. It is an art to owe money gracefully!

Various sales letters have been suggested in the Service Bench from time to time. Almost invariably these will be printed, multi-graphed and mimeographed. It is rarely practicable to prepare these in their most attractive and compelling form of individually typed letters. However, one sales letter that can be typed without imposing too great a burden on the serviceman's stenographic facilities is the follow-up sent out, say six months after service job. Such a letter should suggest the possibility of a check-over in somewhat the following style—

"My dear Mr. Brown: It is half a year since we last serviced your radio. While we left your receiver in A-1 condition, the chances are that by now it might need a check-up. The change may have been so gradual that it may be noticed by the owner, in casual operation, only subconsciously as a slight dissatisfaction with programs, and fewer hours of listening.

"Why not critically check your receiver, yourself, this evening? Has the tone the same rounded, mellow volume it used to have? Is the volume control noisy as you change volume? Do you experience any more local interference on those hard-to-get distant stations? Is the receiver as sensitive to weak stations as it was directly after we finished servicing it? Is reception of these stations as quiet as before?

"If, after these critical tests, you decide the set is not quite up to snuff, why not drop us a line—or better yet, call us on the phone. As usual, there will be no charge for inspection. You pay us only for what we do in the way of adjusting and repairing your radio.

"Yours sincerely, \_\_\_\_\_"

### The Letterhead

Business letters should, of course, be typed. Typewriters can be purchased at such reasonable prices—particularly very excellent rebuilt machines—that there is no good excuse for the up-to-date serviceman not possessing one. If the name of the sender is typed at the conclusion of the letter, his signature, in ink, should be penned above.

The persuasive force of any letter will be

curtailed by unattractive stationery. Similarly it will be enhanced by a presentable letterhead. It is a link in the argument—and should not be a weak one. In many instances the reaction of the recipient will be influenced by the appearance and quality of the letterhead—particularly where it forms the major or only source of contact. This does not mean that you should go in for five-dollar-per-ream paper stock and embellish with an engraved or lithographed head. An excellent water-marked bond stock can be had for as low as \$1.50 for 500 8½ by 11 sheets, and, as we have pointed out in the past, any modern printer has a selection of very attractive type fonts.

Figure 1 shows a new collection of letterhead suggestions taken at random from our recent files. Samples 1 through 4 are readily available in hand-set type and linotype. Your printer will readily identify and approximate these types. Sample 5 is unusually neat and effective, and attains its quiet distinction through the use of one of three similar new fonts—Vogue, Futura or Kabel. Number 5 illustrates the desirable embellishment of a cut. These trade-mark cuts are usually furnished free of charge by the manufacturer to his dealer, representative or serviceman.

It is a good idea to have the letterhead set up so that it can also be used on half-size sheets—5½ by 8½—as in samples 1 and 5. These smaller sheets can be used as invoices and statements, as well as for short letters.

## THIS MONTH'S SERVICE BENCH

Our lead picture this month illustrates the service bench of Dave Whitehead, proprietor of the Whitehead Radio Shop, Greenville, Texas—notably Mr. Whitehead himself reading RADIO NEWS (presumably the Service Bench). The bench itself—which trails out of the camera's view on the left—is twelve feet long. A thirty-five-inch height provides ample drawer room and space for storage batteries, etc. The test equipment is built up around a Jewel test panel, type 25, and is supplemented by an excellent collection of oscillators, output meters, resistor and capacitor testers and a preheater. Facilities for rural servicing include complete voltage supplies for battery sets.

A turntable provides an excellent quick check on audio channels, through the two dynamic speakers which are arranged, with various field and input circuits, to cover a multitude of requirements. The portable equipment includes a Dayrad oscillator and tube checker, as well as a Jewell analyzer.

Dave Whitehead pushes his business through efficient servicing and local publicity. The turntable and the mike can be switched to a speaker in front of the Radio Shop, for the edification of Greenville, Texas, while his Austin service car exacts a maximum amount of attention with a minimum of gas on the streets of that metropolis.

## ALL IN THE DAY'S WORK

There are several instances in the course of radio servicing where a separate ground connection to either the receiver or power-pack chassis is desirable—such as occasional obstinate cases of hum, and when revising the antenna input circuit for the use of a transposed transmission-line lead-in. Such grounds are usually made by securing the lead under any convenient machine screw—more often than not without benefit of lug or solder.

The illustration of Figure 2 shows how Frank W. Bentley, Jr., of Missouri Valley, Iowa, makes a workmanlike job of it, in

(Continued on page 703)



## COMPACT service kit for Point-To-Point testing

Dealers and service men who have seen this new combination of Weston Standardized Service Units have voiced their enthusiasm. Those who have used it are agreed that it combines all those desirable features which minimize call backs and promote profits.

Within a rugged carrying case, Weston has mounted a Model 663 Volt-Ohmmeter, a Model 664 Capacity Meter and a Model 662 Oscillator. The kit is complete for Point-To-Point servicing of all types and makes of receivers. It provides the accuracy and dependability for which Weston is known the world over.

Complete data on all of the Weston-Jewell Radio Instruments is yours for the asking. Just fill in and mail the coupon. Weston Electrical Instrument Corp., 615 Frelinghuysen Avenue, Newark, N. J.

For those who prefer the Analyzer Method, the Weston Service Kit containing Oscillator, Tube checker and Analyzer is recommended.

## WESTON-JEWELL Radio Instruments

WESTON ELECTRICAL INSTRUMENT CORPORATION  
615 Frelinghuysen Ave, Newark, N. J.

Please send me further information on Weston-Jewell Service Equipment.

Name.....

Address.....



# With the Experimenters

*Hints on Dual Speaker Installation, Tone Modulation of Amateur Transmitters, How to Taper Resistors, Simple Stand-Off and Lead-in Insulators*

## Installing Dual Speakers

In view of the present popularity of dual speakers a helpful hint may not be amiss. When two or more speakers are to be operated on the same baffle, or adjacent baffles, they must be properly phased; i.e., all cones must move out and in together, otherwise there will be interference and decreased volume on the lower tones. It is also an advantage to connect the voice coils in parallel because of their mutual impedance effects. (The builder should use an output transformer to match this combination.)

It is comparatively simple to check dual speakers to see if they are properly phased. First, connect both speakers together just as they will be operating from the amplifier and turn on the field current. Now apply a d.c. voltage of from fifty to one hundred volts direct to the primary of the output transformer (B batteries are o.k.) (Caution: Never apply this voltage on the voice coil directly.) At the instant this connection is made each cone will move either out or in and then move back to a neutral position. In case the cones do not move together reverse the voice coil leads or the field leads until the initial movement of both cones is in (or out) at the instant voltage is applied.

PAUL E. CHAMBERLAIN,  
Franklin, Ohio.

## Tone Modulation

While chopper or buzzer modulation is forbidden, tone modulation is not taboo in the last stage of a separately excited transmitter. Grid modulation has been pretty thoroughly forgotten since phone work has made more people familiar with Heising modulation.

Our old friend the code practice outfit or audio frequency oscillator (circuit A) may be connected (see circuit B) so that it will

Conducted by  
**S. Gordon Taylor**

modulate the power amplifier without necessity for auxiliary apparatus or B supply. The oscillator plate voltage is obtained from

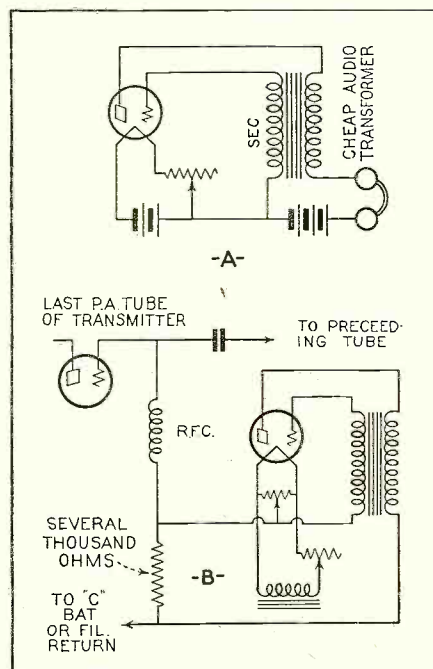

the voltage drop across the grid biasing resistor, or C battery.

A separate source of filament supply for the oscillator is necessary, and this source

will determine the type of tube used for modulation. If a 2.5 volt supply is handy use a -27 or a -45 tube, etc. The oscillator tube does not have to be even nearly as large as the power amplifier tube since it is grid, not plate, modulation.

The oscillator should be made to work separately by hooking a pair of phones and B battery in the plate circuit and the outfit adjusted until the desired tone is obtained. This may be accomplished by varying the filament current. If the oscillator fails to give a tone, reverse either the primary or secondary leads.

Properly adjusted, this will give a ten or fifteen percent modulation and a pleasantly distinctive and readable tone to the transmitter which is less tiresome than pure d.c. and much superior to the gutturalness of incompletely filtered plate supply.

While the oscillator may be connected directly across the C battery (if used), if it is connected across a resistance it will give a pleasant 1,000 cycle tone in the receiver when the key is down, allowing the operator to hear his own signals.

F. C. EVERETT, W8CMY,  
Dalta, Ohio.

## A Tapered Resistor Kink

Where a tapered variable resistance is required, it is sometimes difficult to find one on the market which provides just the desired degree of taper. This is especially true of resistors having the so-called "right-hand" taper. It is therefore of interest to know that a linear variable resistance can be adapted for this latter purpose by the simple expedient of shunting it with a fixed resistor of suitable value.

In combining resistors in this way, almost any desired degree of reversed taper can be obtained by combining different fixed and variable resistance values. The taper is determined by the ratio of the fixed value to



the maximum value of the variable resistor. The higher this ratio, the more gradual will be the change at the high-resistance end of the range and the steeper the drop at the low-resistance end. The attached curves show the tapered effect obtained for six different ratios of fixed to variable resistance values. The taper for any combination of values can be calculated from the formula:

$$R = \frac{KX}{(KX + 1)} A$$

where "A" is the value of the fixed resistor,

ways be greater than the total resistance desired. To determine the resistor values which will provide a combination equal to the desired total resistance is a relatively simple matter. Suppose, for instance, a taper such as that represented by the curve C2 is desired in a radio circuit which calls for a 10,000-ohm tapered resistor. We know that to obtain the taper C2 a ratio of 1 to 10 is required in the values of the fixed and variable resistors. We also know that if a 10,000-ohm fixed resistor were used the total resistance of the combination, as indicated

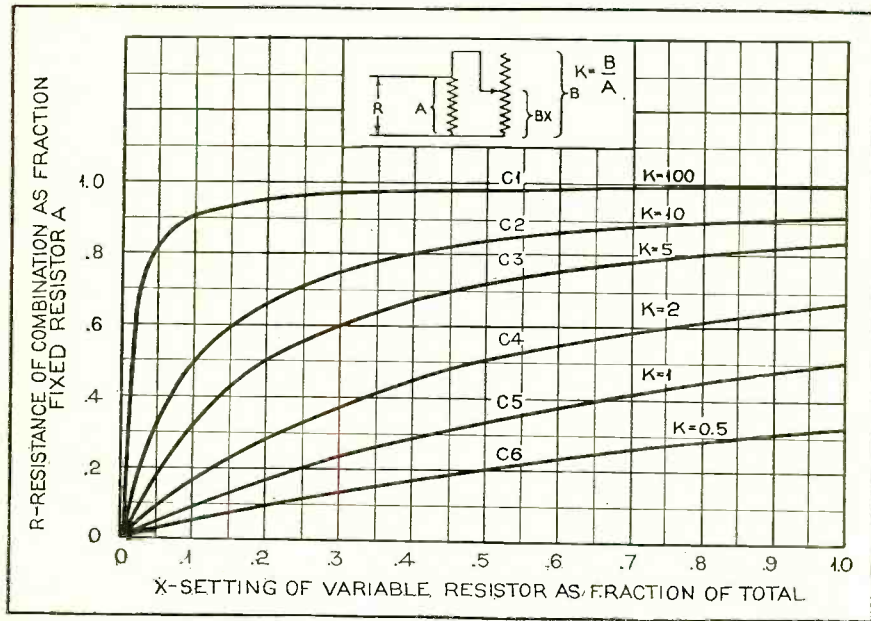

"B" the maximum value of the variable resistor, "X" the fractional part of the variable resistor in circuit, as .1, .2, .3, etc., and

$$K = \frac{B}{A} \quad (\text{BX will represent the effective resistance of the variable leg of the circuit.})$$

It is the value of the fixed resistor that primarily determines the maximum overall resistance of the combination. The overall value is, of course, always lower than that of the fixed resistor—which is another way of saying that the fixed resistor selected will al-

by this curve, would not be 10,000 ohms, but would be approximately 91% or 9100 ohms. The fixed resistor value (A) is there-

$$A = \frac{100}{91} \times 10,000$$

This gives a value of 10,989 for the fixed resistor, which means that a fixed resistor of 11,000 ohms would be used with a variable resistance having a total of 110,000 ohms. (A 100,000-ohm variable resistor would serve the purpose closely enough.)

### Insulators

Stand-off insulators are relatively inexpensive, but they are not always available when one wants them. With very little effort and practically no expense one can make them in a short time. An ordinary insulator

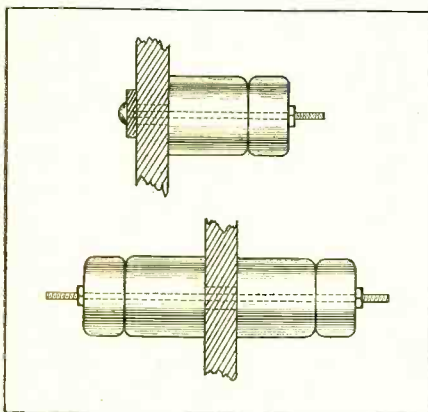

made of white porcelain used generally for electric wiring is used. The nail can easily be removed by cutting off the head or prying loose the little holder at the bottom. It is mounted by boring about a half-inch hole in the board on which it is to be placed and a small piece of bakelite cut to fit underneath

as shown in the accompanying diagram. If the entire insulator is used, it will be about 1 3/4 inches high. In this case the bolt should be about 3 inches long, depending upon the thickness of the board. Different heights can be had simply by using the lower piece which gives 1 1/2 inches or just the upper part which gives 5/8 inch. These insulators will give very good service, because they are exceptionally sturdy. Because these insulators are always available, one need not be delayed in any construction work.

Lead-in insulators for antennas or transmitter feeders are often a problem. The sketch shows how two of the above insulators can be used to good advantage. One is placed on each side, and a bolt with threads on both ends runs all the way through. The hole in the wood need only be slightly larger than the bolt. In mounting, care should be taken that the bolt does not touch the wood.

ALONZO WIERENGA,  
South Haven, Mich.

### Simple Lead-in Insulators

Efficient insulators for the antenna lead-in or feeders may be made from old dials and long brass bolts. A hole is cut, either in the wall or in a board under the window, of a diameter slightly smaller than the dial to be used. The dials are drilled in the

(Continued on page 701)

Check Tubes  
EASIER  
QUICKER  
BETTER



### Tester No. 406

Checks All Types of Tubes  
by Exclusive Readrite Test

WHILE low in price the No. 406 Tester accepts and rejects tubes as efficiently and satisfactorily as testers costing many times more. That's why dealers and service men are so enthusiastic about it! With the Readrite Tester No. 406, you can test all tubes released up to the present time. Contains new wiring and socket for taking care of new small 7-prong tube as well as larger 7-prong tube. This new tester with 7-prong socket is specially designed for testing all new-type tubes. Connects to A.C. supply line. A push button provides two plate current readings for determining the conductance and worth of a tube. Another new feature applies the same test to rectifier as well as to all other types of tubes. A separate push button provides for testing both plates of '80 type tubes.

### Illuminated Meter Dial

Wide range in readings is made possible by a simplified single scale meter. It is connected in tip jacks. A small protecting fuse is attached also. A pilot light, located directly beneath the meter, is used to illuminate the dial. Both lamp and fuse are easily renewed. This tester is an ideal companion to the Readrite No. 1000 Tester for testing voltages, milliamperes, resistances, continuities, short circuits, capacities.

Only \$15. Net to Dealer

List \$25.00

Your jobber can supply you. If not, order direct. We will ship the No. 406 Tester directly to you—when remittance accompanies your order at dealer's net price, \$15.00. Mail the coupon now—get complete information!

Readrite  
Meter Works

52 College Ave.,  
Bluffton,  
Ohio

Mail for Details NOW

READRITE  
METER WORKS  
52 College Ave.,  
Bluffton, Ohio

Gentlemen:  
Please send information about Readrite No. 406 Tester. Also catalog of other servicing instruments.  
Name.....  
Street Address.....  
City..... State.....

# Make MORE MONEY in RADIO with R.T.A. Professional TRAINING

Home study with R. T. A.—plus lifetime membership in our large, powerful association of radio service men—brings you up to date on all improvements in radio, television, sound engineering, and keeps you among the real money-makers in this expanding field. Unless you have this high-type professional training you will find it hard to get out of the poorly paid "tinkerer" class.

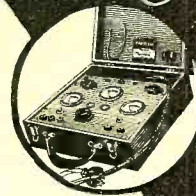

### NEW TYPE SET ANALYZER INCLUDED

As part of R. T. A. training you get this up-to-the-minute Set Analyzer and Trouble Shooter. After a few easy lessons you are ready to use it for immediate money-making, competing with "old-timers" without fear. With this wonderful piece of equipment, backed by R. T. A. professional training, you need have no fear or worry over the future. Even though there should never be a new radio set constructed—or not another improvement in radio made—there are enough sets now in service that need frequent attention to assure you good money as an accepted Radio-technician.

### START MONEY-MAKING QUICKLY

R. T. A. Training is especially designed—and given you by one of the outstanding teachers of radio technology in the world—to get you into the profitable end of radio quickly. It is not empty theory, but practical, down-to-earth work that makes you a money-maker in this immense field in the shortest possible time. Don't delay your start toward success! Write at once for all details about R. T. A. training. The Coupon below brings FACTS—astonishing ones that may open up a new, depression-proof future for you.

## MAIL COUPON NOW!

RADIO TRAINING ASS'N. OF AMERICA,  
4513 Ravenswood Ave., Dept. R.N.A 5, Chicago, Ill.

Send me all the FACTS about R. T. A. professional training, together with information about the opportunities existing for R. T. A. Radiotechnicians today.

NAME .....

ADDRESS .....

### NATIONAL STEWART WARNER

Scott  
BOSCH  
LINCOLN  
Hammarlund  
SILVER-MARSHALL

OWNERS

In increasing numbers  
CLAIM BETTER RECEPTION  
with the NEW noise-free

## LYNCH

Short Wave Antenna System

Complete Kit.....\$5.00

At All LYNCH Jobbers and Dealers

If your Jobber, Dealer or Serviceman cannot supply you, order direct from us. Sent post-paid, with instruction Booklet, upon receipt of \$5.

Free Descriptive Folder upon request.

LYNCH MANUFACTURING CO., Inc.

711RP—General Motors Bldg., New York, N. Y.

Makers of the Famous Metallized Resistors

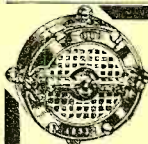

## UNIVERSAL

Protected Diaphragm  
Type  
1933 MODEL "BB"

Damage proof diaphragm protection is now added to the superdependability of Model BB performance. Brand new ahead-of-the-times design. Double-weight, in-built ruggedness. The new 1933 Model BB offers a new conception of what microphone values can be. No advance in prices. Model BB still sells at \$25.00 list.

UNIVERSAL MICROPHONE CO., Ltd.  
424 Warren Lane, Inglewood, Calif., U.S.A.

Personal inter-views with broad-cast artists and executives



VICE-PRESIDENT CURTIS

# Backstage in

By Samuel

JESSICA DRAGONETTE, Morton Downey, Richard Gordon, Dave Rubinoff, Harry Horlick, Rudy Vallee, John S. Young and Earl Benham (representing Ed Wynn), recently flew to Washington from New York to receive gold cups from Vice-President Charles Curtis as first awards in the nation-wide radio poll conducted by the United American Bosch Corporation. The awards were made on the steps of the Capitol and then the party was taken to the National Press Club for luncheon. Following the luncheon, the winners were received by President Hoover at the White House. The contest was conducted through ballots appearing in newspapers. In the singers' groups, Downey won the first men's award and Miss Dragonette won first place in the women's division. Vallee came to the fore as the leading orchestra conductor. Ed Wynn led the comedians and Rubinoff carried honors in the instrumental division. John S. Young won first place in the announcers' division. The actors' cup was snatched by Richard Gordon, who enacted the rôle of "Sherlock Holmes" on the air. Harry Horlick's A. & P. Gypsies won the cup in the miscellaneous features group.

strumental music. Nat Shilkret, of radio and recording fame, conducts the 35-piece orchestra heard on the program.

ROARK BRADFORD'S famous story, "John Henry," is the basis of a new dramatic series recently launched over the CBS.

## Our "Uncle

Many radio executives believe that the reign of the comics has passed and that some new type of program will take the lead in listener popularity. . . . When Kate Smith appeared at the Paramount Theatre, New York, her broadcasts were picked up right from the stage where they were worked into her theatrical routine. . . . Tom Howard, screen and stage comic, went floppo on the Chesterfield programs, lasting but a few weeks. . . . Numerous persons flocking to New York to try to crash the big gates of radio would do better if they stayed at home and got some experience over their local station. . . . Phil Cook won wide comment for his feat in broadcasting a full hour's dramatic program, taking all the fifteen parts himself. . . . Rumor has it that the microphone will not be very welcome at the big baseball games and outdoor fights this Spring and Summer, the sporting magnates being again worried by the

EDWIN C. HILL, the New York newspaperman who leaped to the fore in 1932 as a radio news commentator, is now starred on a new commercial series, known as "The Inside Story," sponsored by the Socony-Vacuum Corporation. The programs are heard over CBS each Friday. On each program, Hill presents a prominent personality whose activities have been recorded in front-page headlines. Hill's wide contacts and friendships assure him of a long list of prominent guest speakers on his programs. These include statesmen, economists, athletes, scientists, musicians and persons of almost every other occupation. Hill stages his interviews and accompanying dramatizations against a background of vocal and in-

JUANO HERNANDEZ



GRETA KELLER



KEN MURRAY



NAT SHILKRET





PRESENTS BOSCH CUPS

*Chatty bits of news on what is happening before the microphone*

# Broadcasting

## Kaufman

The programs, billed as "John Henry—Black River Giant," follow the exploits of the fabulous Negro strong man of Mississippi. An innovation in the series is that two episodes are presented each Sunday evening instead of but one. A half-hour interval, during which another program goes

on the air, separates the two parts of the story. Juano Hernandez, formerly of the Theatre Guild, plays the rôle of "John Henry."

**T**HE team of Keller, Sargent and Ross, recent headliners of the British Broadcasting Corporation, have launched a new commercial series over the CBS. The broadcasts are heard Tuesday and Thursday evenings. The team consists specifically of Greta Keller, Joe Sargent and Stuart Ross. Miss Keller is a Viennese dramatic performer and singer. She met Sargent and Ross, an American vocal and piano team, while the latter two were in Europe. They combined their talents, and the trio set forth on what proved to be a very successful tour of Europe.

**R**ADIO, still on the alert for prominent stage names, has snatched Ken Murray from the footlights and is now featuring him on the Royal Vagabonds programs over NBC, Wednesday evenings. He is co-starred with Robert Russell Bennett, composer and arranger, who directs the musical part of the broadcast proceedings. Ward Wilson, impersonator, recently starred on the series, retains a prominent rôle in the new programs. Helen Charleston, vaudeville actress, plays straight parts for Murray. Just before taking over his radio contract, Murray completed a personal appearance tour with Mary Brian, screen star. He, too, has appeared in the talkies and may be remembered for his rôles in "The Crooner" and "Ladies of the Jury."

**A** COMBINATION musical and comedy program featuring Vincent Lopez and his orchestra and The Two Doctors, Pratt and Sherman, was recently launched over NBC under the sponsorship of the Real Silk Hosiery Mills. The programs are heard Sun-

(Continued on page 696)

## "Sam" Says

*bogey that radio hurts the box-office. . . . NBC scored a big radio scoop in scheduling the only address by George Bernard Shaw in New York. . . . Goodman and Jane Ace, the "Easy Aces," recently had their radio contract renewed for four years. . . . Morton Downey's migration to the NBC on a commercial program did not interfere with his continuing with CBS on a sustaining schedule. . . . Jack Pearl is one of the latest radio stars to be signed by the talkies. . . . There is an influx of imitators on the air, and the surprising thing is that some of the imitations are better than the originals. . . . Amos 'n' Andy recently made their first visit in two years to New York and spent considerable time in Harlem gathering local color for their broadcasts. . . . Broadcast stations and networks are cutting down on expenses in every possible way, anticipating a big drop in total income this year.*

VINCENT LOPEZ



HARRY RESER



ANNETTE HANSHAW



SIGMUND SPAETH

*The Season's Big Radio Sensation!*

# 16-TUBE only \$39.95

**ALL-WAVE** Completely Assembled with Large DUAL SPEAKERS

TUBES EXTRA

A bigger, better, more powerful, more selective, finer toned radio than you've ever seen before. Offered at an amazingly low price direct from the big Midwest factory. One complete 16-tube chassis with one dual-ratio dial. . . . new Super-Heterodyne circuit with a range of 15 to 550 METERS. . . . No trimmers. . . . No plug-in coils. . . . Large acoustically matched Dual Speakers. . . . New CLASS "B" PUSH-PUSH Super Power Amplifier with six times the power of ordinary tubes. . . . Full band AUTOMATIC VOLUME CONTROL. . . . COLOR-STAT Multi-Wave Band Selector. . . . OMIT TUNING SILENCER. . . . Full FLOTTING VARIABLE CONDENSER. . . . Absolute tone fidelity. . . . Image Frequency Suppressor. . . . Fractional Microvolt Sensitivity. . . . Two Full Wave Rectifiers, including the new Mercury type. . . . DUAL POWERED—two separate power transformers.

**30 DAYS FREE TRIAL**

TERMS as low as \$5.00 DOWN

## Deal Direct with Factory!

You buy DIRECT FROM THE MAKERS. No middlemen's profits to pay. Absolute guarantee of satisfaction or money back. You try any Midwest 30 DAYS before you decide to keep it. Then, if you wish, you can pay in small monthly amounts that you'll scarcely miss. Mail coupon for full details or write us a postal.

## MIDWEST RADIO CORP.

Dept. 213 [Est. 1920] Cincinnati, Ohio

MIDWEST RADIO CORP.  
Dept. 213,  
Cincinnati, Ohio.

Send me SPECIAL USER-AGENTS PROPOSITION

Without obligation on my part send me your new 1933 catalog, and complete details of your liberal 30-day free trial offer. This is NOT an order.

Name.....  
Address.....  
Town..... State.....

# FREE—104-Page Radio and Short-Wave Treatise



The new Winter, 1933 edition of our Radio and Short-Wave Treatise, Nov. 26 has just come off the press—104 solid pages of useful information, radio, short-wave programs and illustrations. Positively the greatest book in print—NOT JUST ANOTHER CATALOG. Contains a large editorial section with valuable information not found anywhere else. PARTIAL LIST OF CONTENTS: Fundamental Principles of Radio—Ohm's Law—Discussion of New Tubes—Constructing a "Triple-Twin" Amplifier—All about Superheterodynes—Eliminating Man-Made Static—Constructing a Two-Tube Short-Wave "Globe-Trotter" Receiver—\$3.00 Prize suggestions—Radio Kinks, etc.

100 New Hook-Ups  
1000 Illustrations

WRITE TODAY. ENCLOSE 4 CENTS FOR POSTAGE. TREATISE SENT BY RETURN MAIL.

## RADIO TRADING COMPANY

92 PARK PLACE NEW YORK

**TRIMM FEATHERWEIGHT THE BETTER HEADPHONE**

You are interested in performance for your Short Wave Set or Hard of Hearing Installations. Guess the world over say the TRIMM FEATHERWEIGHT phones do improve their reception. Write for information.

**TRIMM RADIO MFG. CO.**  
"Earphone Specialists"  
1528-38 Armington Ave., Chicago, Ill.



Who? Why the values in Federated Purchaser's big new radio catalogue. New low prices on replacement parts, parts for set-builders, sets, amplifiers, tubes, meters and everything else in radio.

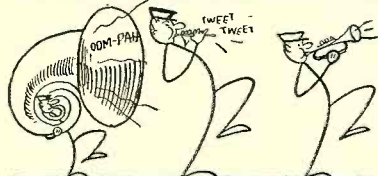

Lower prices are sweet music to everyone. Our prices are lower than ever before. Savings on every item and bigger profits for you.

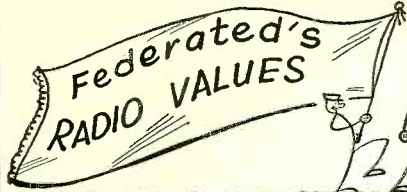

And best of all, whether you live in the north, south, east or west in the U. S. A. there is a Federated branch near enough to give overnight shipping service. All of these branches carry a complete stock. The addresses of these branches are listed below:

**Federated Purchaser Inc.**

Main Office, 25 Park Pl., Dept. C, New York, N. Y.

Chicago, Ill., 1331 So. Michigan Ave.

Phila., Pa., 2909 N. Broad St.

Atlanta, Ga., 631 Spring St. N. W.

Newark, N. J., 273 Central Ave.

Jamaica, L. I., 9226 Merrick Rd.

Bronx, N. Y., 534 E. Fordham Rd.

Send for the BIG VALUE SPECIAL Catalog.

**INVENTORS PATENT YOUR IDEAS**

Write for Free Book, HOW TO OBTAIN A PATENT and RECORD OF INVENTION—or send drawing or model for examination. MAIL COUPON TODAY!

**MILLER & MILLER REGISTERED PATENT ATTORNEYS**

1638 Woolworth Building, Dept. H, New York

206 EARLE BUILDING, WASHINGTON, D. C.

Please send me your Free Book, "How to Obtain a Patent," and your "Record of Invention Form."

Name.....

Address.....

**PATENTS TRADE MARKS COPYRIGHTS**

"Little Ideas May Have Big Commercial Possibilities"

PROTECT THEM BY PATENTS

Send for our Free Book, "HOW TO OBTAIN A PATENT" and "Record of Invention" blank.

Prompt Service—Reasonable Charges—Deferred Payments.

HIGHEST REFERENCES

**VICTOR J. EVANS & CO.**

Registered Patent Attorneys—Established 1898

622EE Victor Building, Washington, D. C.

**EXTRA MONEY!**

Hundreds of radio Service Men are making extra profits regularly by using Sprayberry Data Sheets—a unique NEW service by one of radio's best known engineers. Sheets tell exactly how to rewire old standard receivers (A. K., Majestic, Sparton, etc.) for modern tubes and circuits—also how to land these profitable jobs. New sheets monthly. Service only \$3.50 a year. Satisfaction guaranteed—a sure tonic for business. Send check or M. O. or write for free details. (Plans for rewiring any set or tube analyzer only \$1.)

**F. L. SPRAYBERRY** 132 Bryant St., N. W., Washington, D. C.

**WORLD-WIDE TWO TUBE SHORT WAVE RECEIVER**



12,500 Mile reception record established! Tunes from 10 to 200 meters. Gets foreign broadcasts, police calls, airplanes, amateurs, etc.—direct COM-PILETE KIT (no drilling) with clear instructions to build this remarkable 2 tube receiver. Dry cell or AC Model. Send \$1.00. Balance C.O.D. Satisfaction Guaranteed! Free Short Wave Catalog N-S.

Harrison Radio Co., 142 Liberty Street, New York City

# Latest Radio Patents

A description of the outstanding patented inventions on radio, television, acoustics and electronics as they are granted by the United States Patent Office. This information will be found a handy radio reference for inventors, engineers, set designers and production men in establishing the dates of record, as well as describing the important radio inventions

By Ben J. Chromy\*

1,875,837. RADIO RECEIVING APPARATUS. HAROLD A. WHEELER, Great Neck, N. Y., assignor to Hazeltine Corporation. Filed July 7, 1931. Serial No. 549,149. 12 Claims.

1. In a superheterodyne radio receiver, means for rejecting the "image" frequency, which comprise an input transformer, a tuned radio-frequency circuit including the

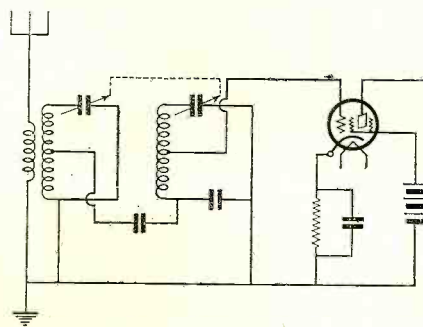

secondary of said transformer, a second tuned radio-frequency circuit, and means connecting said tuned radio-frequency circuits, said last-mentioned means including a connection to a portion of the first tuned circuit which is at node potential relative to currents of the "image" frequency.

1,874,865. ACOUSTIC COMBINING SYSTEM. HAROLD H. BEVERAGE, Riverhead, N. Y., assignor to Radio Corporation of America, a Corporation of Delaware. Filed Nov. 17, 1928. Serial No. 320,017. 9 Claims.

1. The method of diversity reception of audible signals transmitted on a single high-frequency carrier which includes collecting the desired radiated signal energy at a plurality of spaced points, separately detecting the collected energies, separately translating the detected energies into sound energy, so directing and repeatedly reflecting the sound energies that they are thoroughly mixed, more or less independently of the initial audio-frequency phase, transforming the resulting sound energy into electrical energy, and utilizing the electrical energy.

1,873,715. PIEZO-ELECTRIC ACOUSTIC DEVICE. ALEXANDER MEISSNER, Berlin, Germany, assignor to Telefunken Gesellschaft für Drahtlose Telegraphie m. b. H., Berlin, Germany, a Corporation of Germany. Filed July 26, 1928, Serial No. 295,491, and in Germany Sept. 17, 1927. 2 Claims.

1. An electroacoustic device comprising in



combination, an arched vibratory diaphragm, a plurality of piezo-electric elements connected to opposite ends of said diaphragm, whereby mechanical vibrations applied to the surface of said arched diaphragm are converted into tangential stresses, which stresses are exerted upon said piezo-electric elements to produce piezo-electric reactions in accordance therewith.

1,861,571. AMPLIFIER CIRCUIT. LEWIS M. HULL, Boonton, N. J., assignor, by mesne assignments, to Radio Corporation of America, New York, N. Y., a Corporation of Delaware. Filed Dec. 23, 1926. Serial No. 156,677. 3 Claims.

1. An electrical amplifier circuit comprising a four-electrode vacuum tube including a plate, a cathode, and two grid electrodes; an input circuit connected between said cathode and one of said grid electrodes; an output circuit connected between said plate and said cathode and including a plate coil; a source of plate potential, an auxiliary coil connected between said cathode and the second of said grid electrodes, whereby a compensating voltage is impressed upon said control grid through the interelectrode capacity between said grids; a capacity of little impedance to alternating current between said plate and auxiliary coils and a tuning condenser connected between said plate and said second grid electrode.

1,873,236. VOLUME CONTROL FOR RADIO RECEIVERS. HAROLD A. WHEELER, Jackson Heights, N. Y., assignor to Hazeltine Corporation, Jersey City, N. J., a

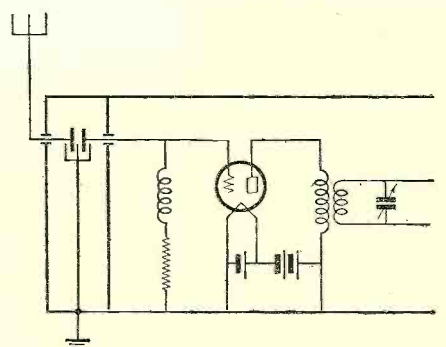

Corporation of Delaware. Filed Sept. 22, 1928. Serial No. 307,688. 1 Claim.

A radio receiving system including an antenna circuit, a vacuum tube circuit electrically shielded therefrom, a capacitive coupling device having three co-operative elements enclosed in a metallic casing, two of said elements being connected in the two said circuits, respectively, and the third element being connected to said casing and adjustably associated with said other two, whereby the electrostatic or electromagnetic transfer of energy between said circuits can be adjusted from a maximum value to a substantially zero value.

\* Patent Attorney, Washington, D. C.

S. O. S.

(Continued from page 649)

DDHH and got all details. She was irreparably damaged by a split amidships, carried thirty-one men, all of whom would have to be transferred to the *Saguache*. The captain, I later learned, was the man at the wireless key. (This is a custom generally observed on smaller foreign vessels.) His great difficulty was due to two reasons: one, his limited knowledge of English; the other, the fact that he could neither transmit nor receive above a speed of twelve words a minute. With his second mate at his side to do the interpreting for him, the Captain carried on bravely the twofold responsibility of master and wireless operator.

But as luck would have it, again a jinx. For, after two hours on the choppy seas in our cruising towards the *Rodelheim*, we simultaneously with the two English vessels arrived at the given position, only to find the *Rodelheim* nowhere in sight!

What the captain's remarks to me were at this point, I won't say. It seemed, naturally, that I had copied the position sent by DDHH incorrectly. But the two other vessels substantiated, by their presence on the scene, my contention that DDHH must have sent the wrong position. Getting DDHH immediately, he explained in part this fiasco which seemed a vile joke.

"My position perhaps inaccurate. Could not take good observation due to cloudy weather today," he said.

What a predicament! He gave another position, one nearby. His signals did seem a bit stronger now, so I judged that while we missed him, we must be closing in on the scent, at any rate. This I explained to Captain Bendetti, insufficient as it was in a practical way. Captain Bendetti took the new position and recharted his course. "Tell the *Rodelheim's* skipper we'll keep up the search for him. Tell him, too, to fire a rocket if he's got any."

At this point the two English vessels gave up what seemed a vain search. One of them called DDHH and informed him: "Since your correct position cannot be determined, we cannot continue in search for you and are obliged to resume our course."

Within a few minutes he received the same news from the other ship. I figured that this turn of events must have struck the *Rodelheim's* captain-operator like a thunderbolt. He merely sent an "R." I reported what had taken place to Captain Bendetti.

"We'll cruise around until we get them, although it looks like a wild-goose chase," he remarked.

So the good ship *Saguache*, commanded by a determined sea-salt, kept on. It was near 4 p.m. and getting dark. Night was setting and the winds were blowing with renewed strength—a gentle reminder that old boy gale wind was not far behind. It seemed the *Rodelheim's* crew would be sure "goners" if the seas should again be lashed up to storm weather.

Well, God was in His heaven, and all was right with the *Rodelheim's* destiny that day, for in the tense situation on which hinged the lives of thirty-one men, the *Rodelheim's* captain, with all due respect to him for finally extricating himself and his crew from that tough spot, finally got a brilliant idea. Why he didn't get it sooner, under the circumstances, is hard to explain.

But I jumped for joy when he sprang the idea on me. Imagine! He asked me whether I would take a radio bearing by his compass! Jumping jimminy crickets!!

Did I take a radio bearing? Man, I tackled that suggestion like a bulldog. I kept up an uninterrupted succession of long

dashes for fully three minutes to make no mistake in the bearing. DDHH gave me it: N 51 E. I shut down my generator and rushed to the bridge all but shouting Eureka!

"Why, he must be just over the horizon," said Captain Bendetti, immediately giving new instructions for steering to the third mate, who was at the pilot-wheel.

It was now 4:30 p.m., and the galley bell announced grub-time. We all caught a bite, captain and crew, while the third mate steered in the hopeful new direction. And just about the time that we reached pie and coffee in our evening meal, Captain Bendetti, rising and looking out through the salon porthole, spied a ship on the horizon. "There she is, boys!" he called out, while I gave full due credit to the fine magic of the radio compass.

In a half hour we were at the *Rodelheim's* side. Lifeboats were launched from the *Rodelheim's* decks and the men rowed against the mounting waves to our side. As soon as they had clambered up the wooden ladder lowered for them, they were rushed into the engine room, where the messmen poured out coffee from a big pot and supplied the German crew with sandwiches in the way of more substantial fare. The time of the rescue, I forgot to mention, was middle January, and, of course, very cold. The boys from the *Rodelheim*, and our own men who had patiently stood by on deck, all had a bad case of frozen mittens. The *Rodelheim's* men had had enough time to change to their good clothes, and had rescued other of their personal belongings. Beer bottles containing genuine Deutschland Pilsner turned up after a while.

With the crew safe aboard, the *Saguache* resumed her original course. The stricken vessel was left to drift at the mercy of the waves. At the Captain's orders, I sent out a navigation warning, indicating the *Rodelheim's* position, condition, etc. I invited the *Rodelheim's* captain into KEKL, and soon we were talking shop.

But other business was in order, in which I continued to get "broken in." Messages poured in and out of KEKL. Captain Bendetti handed me a sixty-word message in code, reporting the happenings to the Moore McCormick S.S. Line, the ship's owners. The *Rodelheim's* captain wrote out several messages in German, destined for Bremerhaven, the home port. And I certainly appreciated the opportunity for all the practical experience in handling a mass of traffic. By that time I had already been on board the *Saguache* nearly two months; I had familiarized myself rather well in most things relating to my job. Only then, of course, did the position of radio operator take on the pleasurable interest which I had anticipated but poorly prepared for in my training-course days.

Our arrival in Portland, Me., was the occasion for some local festivity. News had preceded us, and the rescue incident had become front-page news. Reporters, photographers and a large portion of the Portland citizenry met the ice-laden "rescue ship" as the tugs pulled her into dock. Various fraternal organizations had the entire *Saguache* crew, from captain down to messman, as honored guests. We were treated to a box at a local theatre, and, if you please, were spotlighted as we were introduced to the theatre audience who had, of course, heard a great deal about us from the daily papers. Autograph hunters were also in evidence and almost became a problem, however pleasant. But a ship's business is serious, and soon we

(Continued on page 693)

RCA INSTITUTES

Recognized Standard in Radio Instruction Since 1909

Technical Training Courses in Radio and Associated Electronic Arts

GENERAL COURSE. Extensive training in all branches of the radio industry. Excellent for beginner or experienced man. Graduate well fitted to cope with practical radio engineering problems.

SOUND ENGINEERING embracing Television Fundamentals, Public Address Systems, Recording, Sound Motion Pictures. Electronic Tube Applications.

BROADCAST TRANSMISSION in all its aspects including Studio and Control Room Operation.

RADIO SERVICING including Broadcast Receivers, Home Talkies, Rudiments of Television.

COMMERCIAL RADIO OPERATING—Aircraft, Marine and Police Alarm Systems.

Resident Schools at New York & Chicago

EXTENSION COURSES for HOME STUDY under new "no obligation" plan, with privilege upon graduation of 2 weeks' intensive practical training without charge at either Resident School.

Mail Coupon for Illustrated Catalog.

**RCA INSTITUTES, INC.,**  
Dept. RN 5  
75 Varick Street, New York, N. Y.  
1154 Merchandise Mart, Chicago, Ill.

Please send with no obligation to me:  
( ) Illustrated catalog and information about resident school courses.  
( ) Information about extension courses for study at home, together with illustrated catalog.

Name.....Age.....  
Address.....  
City.....State.....

FREE!

AN IMPORTANT NEW IRC SERVICE HELP

If your name isn't on the IRC mailing list, better get it there—quick! Beginning with April the makers of the famous IRC Metallized and Power Wire Wound Resistors and Motor Radio Suppressors will issue one of the finest, most useful helps ever prepared for the radio service man—a monthly publication known as the "IRC SERVICE CALL." Far from being a mere "puff sheet" this little magazine will contain more interesting, more helpful information than you'd imagine could be packed between two covers. You'll not only read it and enjoy it BUT YOU'LL PROFIT FROM EVERY ISSUE.



IRC RESISTORS

Drop us a line on your business stationery—today. Don't miss it!

International Resistance Co.

2006 Chestnut St., Philadelphia, Pa.  
In Canada, 74 Wellington St., W. Toronto, Ont.

FORDSON

announces a new and better midget radio AT THE LOWEST PRICES EVER QUOTED!

THE NEW SIX TUBE Goldentone \$9.95 TRADE-MARK

Superheterodyne For six tube chassis With automatic volume control and dynamic speaker

Mass production enables us to quote the lowest prices. Buy direct from manufacturer. Save up to 50%.

WE REFUSE TO BE UNDERSOLD! FREE CIRCULAR GIVING COMPLETE INFORMATION FORDSON RADIO MFG. CORP. 11701 Livernois Ave. Detroit, Mich.

# Radio Physics Course

## LESSON SEVENTEEN—PERMANENT MAGNETS

**M**ANY theories have been developed to attempt to explain the various magnetic actions. One popular explanation, called the "molecular theory of magnetism," assumes that each molecule in a magnetic substance is itself a tiny magnet with a north and south pole. When the substance is not magnetized, all of the molecules are supposed to be arranged in rather haphazard positions as shown in (A) of Figure 1, with the poles neutralizing each other so that no manifestations of magnetism are observed outside of the body. The process of partly magnetizing the magnetic substance consists in bringing it under the influence of a magnetic force so that some of the molecules are turned around to one direction as shown at (B) of Figure 1. At (C) all of the molecules have been turned around and the bar is completely magnetized. They then work together as one magnet, since the combined forces of the separate molecules all act in the same direction.

It must be admitted that this theory of magnetism is supported by many facts which can easily be proved experimentally. For instance, heating or jarring a magnet weakens it greatly, since both of these processes make it easier for the molecules to move back to the haphazard position of (A) in Figure 1. When a magnet is rapidly magnetized and demagnetized it becomes heated, thus indicating that friction exists due to the motion of the molecules. If a magnet is broken in the middle, opposite poles are found on either side of the break. Careful measurements indicate that substances undergo a series of changes in length when being magnetized. In general, the substance first expands and later contracts. This latter phenomenon of contraction is known as "magneto-contraction." The difference between permanent magnets and temporary magnets is due to the fact that in the hard steel used for permanent magnets there is greater friction between the molecules. After the molecules are turned around during magnetizing, this friction prevents them from turning back easily. If a piece of iron be placed in a magnetic field, the amount of magnetization increases as the strength of the inducing field increases. At last a condition is reached where all of the molecules have been turned around as shown at (C) of Figure 1. The iron is then said to be magnetically saturated, because all of its molecules have been completely turned around and its magnetism cannot be further increased. The ease with which a magnetic steel saturates is in many cases a determining factor as to whether it will be used for a particular device. As we shall see later, the electron theory of magnetism goes a bit further in explaining the nature of the causes of magnetism in terms of the molecular currents and structure of the atom.

### Aging Permanent Magnets

In many practical applications, it is essential that the flux density of a permanent magnet shall remain as constant as possible for long periods of time. Examples of such cases are the permanent magnets in moving-coil ammeters and voltmeters, the brake magnets of electric watt-hour meters, and the magnets in earphones, loudspeakers and phonograph pick-up units. A permanent magnet becomes gradually weaker with age.

\* Radio Technical Pub. Co. Publishers' Radio Physics Course.

By Alfred A. Ghirardi\*

The strength falls off sharply soon after it is magnetized and then decreases at a very much slower rate. The loss of strength is hastened by excessive jarring or heating of the magnet. The loss of magnetic strength is caused by a structural rearrangement of the molecules of the steel, some of them going back to their haphazard positions. It is possible to artificially "age" permanent

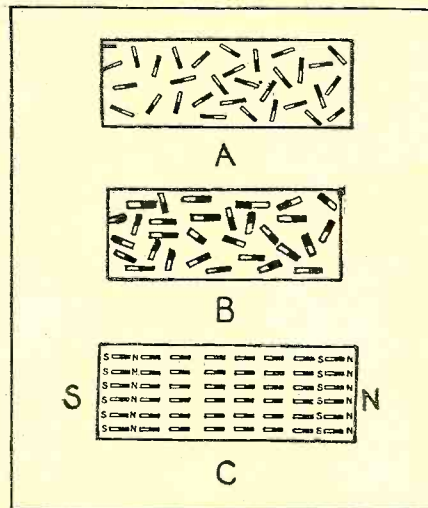

Figure 1. The molecules are represented like tiny bar magnets in (A) unmagnetized iron; (B) partly magnetized, (C) completely magnetized (saturated) iron

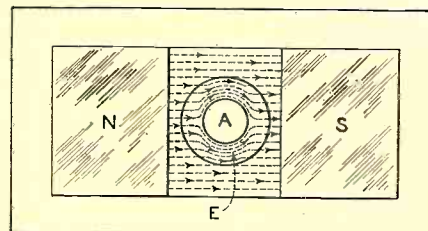

Figure 2. Magnetic screening effect of an iron enclosing case

magnets by heating them to suitable moderate temperatures below the point where the steel would be softened. This is called "aging" because it is an artificial and quick method of bringing the magnetic strength down to the nearly steady value which a long period of years would naturally accomplish. The aging process is used extensively in the manufacture of permanent magnets for electrical measuring instruments, etc. Magnets are aged by heating them to 100° C. for about 12 hours.

### Permanent Magnet Steels

Originally, permanent magnets were made of tempered high-carbon steel. The demand for permanent magnets having a greater permanency and constancy than these magnets provided led to the use of alloyed steels. (An alloy is a simple mixture of the two or more metals. The metals do not enter into chemical combinations with each other.) It was found that certain alloys of iron and tungsten, and iron and chromium, had these

desirable properties. Tungsten magnet steel is now used almost exclusively for the permanent magnets in high-grade electrical indicating instruments.

Recently it was found that alloys of iron and cobalt could be made having greater permanency or higher coercive force than the tungsten alloys. The *coercive force* of a magnetic material is a measure of the amount of applied opposing magnetizing force required to completely demagnetize the sample and completely remove any residual magnetism. It is therefore a measure of the permanence and the merit of a steel intended for permanent magnets. Tungsten magnet steel usually contains about 6 percent tungsten and 0.55 to 0.80 percent carbon, the remainder being iron.

Chromium magnet steel contains about 2 percent of chromium, 1 percent carbon and 97 percent iron. An alloy of cobalt and iron must be added to chromium steel to make it useful for permanent magnets.

Cobalt magnet steel is of two types. Low cobalt steel has about 9 percent chromium, 0.8 to 1.0 percent carbon and 9 to 20 percent cobalt. High cobalt or "Japanese steel" contains 35 percent cobalt, 3 to 4 percent tungsten, 1 to 2 percent chromium and 0.8 percent carbon. Cobalt steel has come into general use in electro-magnetic phonograph pick-ups because of the large air gaps which have been employed in these devices. The size and weight of a suitable tungsten magnet to furnish adequate intensity of magnetism under these conditions would be too great.

Cobalt steel magnets are superior (bulk for bulk) to tungsten steel magnets. Since cobalt is an expensive metal, a 35 percent cobalt steel must be used in moderation where economy is concerned. The object to be attained is to produce permanent magnets of suitable strength and dimensions at a reasonable price. With this end in view, it is usual to employ magnet steel containing 9 to 15 percent of cobalt, although 35 percent is used in some cases.

In pick-ups having short air gaps, tungsten steel with its lower reluctance or resistance to magnetism, and its higher flux density, is used on account of its relative cheapness.

A special alloy steel has been developed for making permanent magnets of low cost, having a magnetic flux density of 20,000 lines per square inch in the air gap. This is used in loudspeakers. The magnetization and remagnetization of permanent magnets will be studied in connection with electro-magnets. The reader is referred to the sections on electrical measuring instruments, earphones, loudspeakers and phonograph pick-ups for illustrations of actual application of permanent magnets in radio equipment. Permanent magnets used in electrical apparatus are usually cadmium plated to prevent rusting. This gives them a dull silvery appearance.

### Magnetic Screens

There is no material which will insulate magnetism; that is, entirely stop the lines of magnetic force. Magnetism will go through air, wood, brass or any other non-magnetic substance, but of course not as easily as it goes through iron or steel. The method for protecting or screening any device from the effects of a steady magnetic field is to use a soft iron enclosure that completely encircles the device as shown in Figure 2. The iron enclosure E offers a good

path for the lines of force to go through it, thus leaving the inner region A free from the field. This principle is used for enclosing certain measuring instruments to shield them from the effects of external stray magnetic fields. The enclosure must be made thick, so as to offer a very good path for the lines of force. A thin sheet-iron enclosure is worthless as a screen for strong magnetic fields.

**Experiment:** The shielding action of a magnetic ring or enclosure can be illustrated by placing an iron ring between the two poles of a horseshoe magnet as shown in Figure 2. Iron filings sprinkled over a thin sheet of paper placed over the magnet poles and ring will show by their position that the region inside the ring is free of magnetism. If a brass ring is substituted and the experiment is repeated, the lines of force will be found to go directly through the brass and empty part inside as though it were not there at all, for it is a non-magnetic substance.

When the field is rapidly changing in strength or direction, it is common to screen an object located in it by enclosing the object in a non-magnetic shield of copper or some other good electrical conductor. In this case the energy of the field is absorbed by making it induce electric currents in the shield. This type of shielding is used around the coils in radio-frequency amplifiers, etc., and will be discussed more in detail later.

Choke coils and transformers used in radio equipment are usually enclosed in soft iron cases, but in most instances these cases are so thin that they do not act as magnetic shields to any great extent. This can be proved by connecting a pair of earphones to the secondary winding of an audio transformer and moving the transformer around in the vicinity of a power transformer operating from the 110-volt, 60-cycle a.c. line. Any stray field around the power transformer will induce a voltage in the audio transformer winding and will be heard in the earphones as a low-pitched hum. The more stray field there is around the power transformer, the louder the hum will be.

## S O S

(Continued from page 691)

were heading out for our home port, New York. A thirty-six-hour run, and we were lodged in Pier 18, where we had started from.

The *Saguache* trip had been for all on board, and myself particularly, a "whopper." Still, I did not make another trip with the ship. I thought, in spite of the sentimental feeling which I had developed, that I really preferred to continue on my search of experience—and, possibly, adventure—by venturing into blue tropical waters, since the Atlantic was still raging with winter's fury. But on the *Saguache* I got my "sea legs" as an operator. It gave me that most important thing—practical experience. Perhaps I would have in that time benefited more fully had I been better prepared when setting out. But I came through (with noticeable grief), and I think Captain Bendetti, at the end, gave me the benefit of the doubt. What I certainly gained was a real appreciation of the great responsibility of the wireless operator's job. A parrot-like study of the Question and Answer book is, I see now in retrospect, an act of criminal carelessness. For, in crucial situations, the operator's job becomes one involving the safety of human life itself.

Wireless has increased a thousandfold the margin of safety on which a ship may traverse oceans. It is the operator's duty to guarantee that margin of safety by being fully prepared for his job.

# Here Is News

We have perfected a new portable Sound Amplifying device that promises to make history in this field. Wherever seen, it has been enthusiastically received.

## BIG NEW FEATURES

**EASIER TO HANDLE** than any portable ever was before.

**TUBES, ALL VITAL PARTS, PROTECTED** by removable screen.

**NOTICEABLY BETTER TONE QUALITIES**—better than anything heretofore possible in an amplifier. Set it up in competition and you have cinched the job.

Can be used with either phonograph, microphone or radio input, has variable impedance output; all controls on the front panel, all parts readily accessible; terminals fully protected; fine appearance, a very professional looking job that will help you get business. VERY attractively priced. You want the facts on this.

Write for Bulletin on the New Model "K"

**THE WEBSTER COMPANY**  
3825 West Lake St., Chicago, Illinois

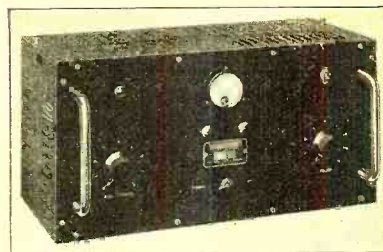

Rear View, Screen Removed

**\$5,000 WILL BE PAID TO ANYONE WHO PROVES THAT THIS** is not the actual photo of myself showing my superb physique and how the Ross System has increased my own height 6 ft. 3 3/4 inches.

Hundreds of Testimonials. Clients up to 45 years old gain from 1 to 6 inches in a few weeks!

**NO Appliances—No Drugs—No Dieting**  
**ROSS SYSTEM NEVER FAILS. Fee Ten Dollars Complete**  
Convincing Testimony and Particulars 5 cents stamps.  
Allow time for return mail across the Atlantic  
G. MALCOLM ROSS, Height Specialist  
Scarborough, England. (P. O. Box 15)

FIRST IN 1907  
FIRST TO-DAY

**SUPPRESSED KNOWLEDGE OF THE AGES**

Hidden, denied, but not lost, is the miraculous wisdom of the ancients. Their methods of mental power in achieving **SUCCESS and MASTERY IN LIFE** are available TO YOU. Write for a FREE copy of the "Wisdom of the Sages" and learn how to receive this rare knowledge. **MAKE YOUR LIFE ANEW.**  
SCRIBE N.S.P.

**ROSICRUCIAN BROTHERHOOD**  
SAN JOSE CALIFORNIA

## COMET "PRO"

**T**HE "PRO" is COMPLETE. No extras to buy. Built-in power-pack. Band-spread tuning at all frequencies. Four sets of coils (included) cover all bands from 20,000 kc. to 1,500 kc.

The only short-wave receiver using I.F. transformers tuned by AIR-dielectric, Isolantite-insulated condensers. Has greatest sensitivity and selectivity. Peak efficiency can not be affected by weather or atmospheric conditions.

Razor-like sharpness of the I.F. amplifier, in connection with a new tuned beat-frequency oscillator, gives the improved "PRO" a remarkable degree of "single-signal" selectivity. A quartz filter is readily adaptable.

For greater output and complete elimination of hum, the new 2 A5 three-watt heater-type pentode is used in the output stage.

The above are exclusive features. Standard features include electron-coupled oscillators; band-spread tuning on all amateur, police, transport and similar bands; uniform 1/4-microvolt sensitivity and 10-kilocycle selectivity throughout the range; high signal-to-noise ratio; phone or loudspeaker operation; adaptable for either transmission line or standard antenna system.

Built to professional standards, for exacting services regardless of cost, the "PRO" is used by armies, navies and commercial companies all over the world, and gives faultless performance every day in the year.

- COMPLETE
- LOWEST FINAL COST
- GREATEST SELECTIVITY
- SINGLE-SIGNAL RECEPTION
- "AIR-TUNED" TRANSFORMERS
- BAND-SPREAD TUNING
- PROFESSIONAL STANDARDS

These new Hammarlund Air-Tuned I.F. Transformers are available for replacement in former COMET models, or for markedly improving other superheterodynes.

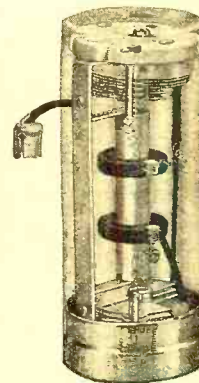

For Better Radio  
**Hammarlund**  
PRECISION PRODUCTS

HAMMARLUND MANUFACTURING CO.,  
424-438 W. 33rd Street, New York, N. Y.

..... Check here for booklet describing the "PRO" in detail. .... Check here for folder on new Air-tuned I.F. Transformers. .... Check here for General Catalog "33".

Name.....

Address.....

.....RN-5

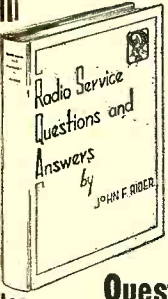

**1/2 Cent per Question and Answer**

**A NEW BOOK! Just Out.**

**RADIO SERVICE Questions and Answers**

**By John F. Rider**

This is Volume 1 of a series. Here are the answers to many of the every day perplexing service problems. Have you any questions about:

- alignment
- neutralization
- oscillation
- selectivity
- use of oscillators
- condenser replacement
- resistor replacement
- vacuum tubes

you will find complete and detailed answers in this volume—written in the usual clear and concise Rider style. Here is a book which you should have in your library. . . . It will never be obsolete.

Sold with a Money Back Guarantee. 160 pages. Type set. Bound in canvas.

**PRICE: \$1.00 POSTPAID**

---

**RADIO TREATISE CO., INC.**  
1440 Broadway, New York, N. Y.

Here is \$1.00. Send me Rider's "Radio Service Questions and Answers" Volume 1. This will be mailed postpaid.

Please Check one of the following:

..... I have Rider's Manual

..... I do not have Rider's Manual

Name.....

Address.....

City..... State.....



FREE!

Our new Catalog is just off the press. Use it as your guide for buying every radio part you want at the lowest price obtainable anywhere. SERVICE-MEN & DEALERS will find this catalog a priceless directory for their every need. Every item advertised is carried in stock, thus assuring you PROMPT DELIVERY. SEND FOR YOUR COPY TODAY

**TRY-MO RADIO CO., INC.**  
DEPT. R5, 85 CORTLANDT ST., NEW YORK

**AUDIO AND POWER TRANSFORMERS**  
OF EVERY DESCRIPTION

**BUY DIRECT FROM THE MANUFACTURER AND SAVE BIG MONEY!**

**SET AND AMPLIFIER MANUFACTURERS - DEALERS - SERVICEMEN... WRITE FOR OUR FREE CATALOG. Containing LOWEST PRICES QUOTED**

Highest Type Distributors and Sales Representatives Should Contact Our SALES-DEPARTMENT.

MANUFACTURING DIVISION OF THE  
**REMINGTON-RADIO-ELECTRIC CORP.**  
121 N. WEST 17th St. NEW YORK N. Y.

THE MOST COMPLETE LINE OF CONDENSERS AND RESISTORS FOR EVERY RADIO USE

AEROVOX

Write for Complete Catalog free of charge  
**AEROVOX CORPORATION**  
78 Washington Street Brooklyn, N. Y.

# What's New in Radio

*A department devoted to the description of the latest developments in radio equipment. Radio servicemen, experimenters, dealers and set builders will find these items of service in conducting their work*

**By The Technical Staff**

## Photo-electric Cell

*Description*—The new Electronic photo-electric cell is of the dry-disc type. It has numerous industrial and commercial applications and should also have wide appeal to the radio experimenter. It is a compact cell measuring 2 3/8 inches in diameter by 1 inch thick and is equipped with two connection prongs

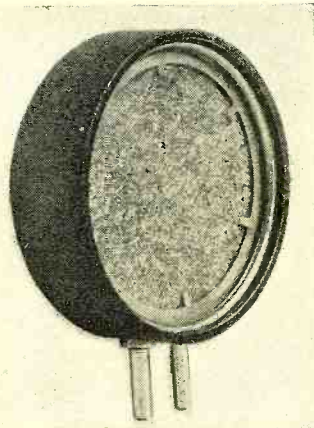

to fit the standard UX type radio tube socket. This type of cell transforms light directly into electrical energy without the use of batteries or other source of e.m.f. It is stated that this cell is capable of generating from 5 to 7 milliamperes current in direct sunlight. Neither climatic conditions nor exposure to strong light affect the cell's efficiency.

*Maker*—J. Thos. Rhamstine, 510 E. Woodbridge, Detroit, Mich.

## Transformers

*Description*—Announcement is made by this company of a complete line of audio and power transformers. The unit "A" in the illustration is a universal-purpose, universal-mounting power transformer, especially suited to laboratory and experimental work, besides being adaptable to audio am-

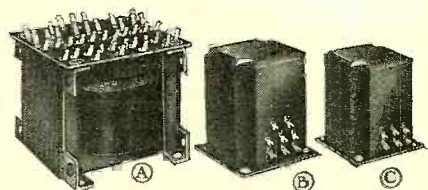

plifier and radio receiver requirements. The primary is tapped at 100, 112 and 125 volts, 50-60 cycle a.c., with output high voltages of 900, 850, 750, 650, and 550 volts at 125 milliamperes, windings center-tapped. The filament windings are: 5 volts, 3 amperes; 2 1/2 volts, 3 amps.; 2.5 volts, 12 amps.; 1.5 volts, 3 amps., all center-tapped. Additional filament secondaries not center-tapped are available at: 1.5 volts, 6 amps.; 5 volts, 3 amps. The transformer can be used with -80, -82 or the -83 type rectifiers. The universal output transformer "B" is encased in a hermetically sealed, copper-shielded cast-iron case. It is equipped with two center-tapped primary windings for use with the general-purpose power amplifying tubes in single,

parallel, push-pull or push-push circuits. The secondary windings are: 4000, 2000, 500, 200, 15, 8, 4, 2, 1 1/4 ohms. The universal input transformer "C" is enclosed in the same type of case as the output unit. It has three primary windings, 200 ohms tapped at 100 ohms; 3000 ohms tapped at 500 and 200 ohms, and a third primary winding to match the impedance of a radio tuner plate circuit. The secondary matches the grid impedance of an input tube and is provided with taps to match 500 and 200-ohm transmission lines.

*Maker*—Transformer Mfg. Div. of the Remington Radio and Electric Corp., 123 W. 17th Street, New York City.

## Power Amplifier

*Description*—The model 6056R four-stage Class B power amplifier is adaptable to permanent or portable public-address requirements. It weighs only 31 pounds and measures 18 1/2 inches long by 9 inches wide by 7 7/8 inches high, which makes it especially suitable to sound-truck installation. The amplifier is designed to provide a maximum undistorted power output of 26 watts. The following

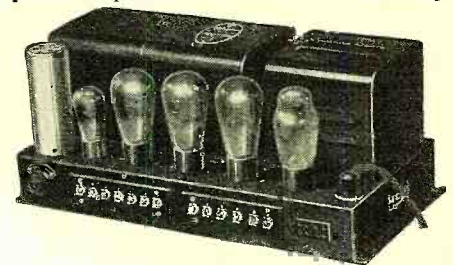

type vacuum tubes are employed: one -35, one -56, one -45, two -46 and one -83 type rectifier. The amplifier can supply two d.c. speaker fields of 2500 ohms at 9 watts each. It is equipped with a master volume control and the input and output impedances are variable.

*Maker*—Webster Electric Co., Racine, Wis.

## Tube Checker

*Description*—This model 677 tube checker for counter use should prove popular as an aid to vacuum-tube sales. It is so designed that the prospective customer can read with complete understanding the condition of his vacuum tube as indicated on the "tube-worth meter" by the designations "satisfactory," "doubtful" or "unsatisfactory." This large meter has a colored multi-arc scale, to indicate the quality of tubes of each type.



An a.c. voltmeter is provided for insuring the proper operating voltages in the tester, and there are neon lamps to indicate all possible tube shorts. The instrument is provided with 35 sockets, which take care of all

*(Continued on page 703)*



# Modern Auto Radio

(Continued from page 679)

antenna pick-up, actually provides better reception from distant stations than does the average home radio receiver.

As for selectivity, the receiver under test can be rated as at least "good." Extreme selectivity is not desirable in an automobile radio. It is deemed better to broaden the tuning slightly so that the tuning process will be somewhat less critical. In the home, one can take time and pains to tune with a high degree of exactitude, but in a moving car this is not so simple. Moreover, in an automobile the radio is used solely for its entertainment value and there is little necessity for trying to reach out for distant stations operating on channels adjacent to powerful locals. This should not be taken to mean, however, that the tuning of the Motorola was found to be broad. In fact, WLW was tuned in one channel away from the most powerful local, WOR, with only slight interference from the latter.

The operation of the receiver is simplicity itself. There are only two knobs on the remote control unit, which is mounted on the steering post under the wheel. One of these is the tuning control, the other the volume control. Backlash has been reduced to a satisfactory degree. While there is a slight amount present, a condition that is unavoidable where a mechanical type of remote control is employed, it is not sufficient to cause any great inconvenience, even when tuning in distant stations.

Automatic volume control is an extremely useful feature, as will be realized by anyone who has driven a car equipped with a receiver not having this feature. In this latter case, it is necessary to constantly vary the adjustment of the volume control, and even then it is impossible to maintain constant volume. The a.v.c. system employed in this receiver closely approaches perfection. All except distant stations come in with approximately the same volume for a given setting of the volume control. Thus if it is desired to tune from one station to another, it is accomplished without touching the volume-control knob at all.

The elimination of ignition noise and other interference originating in the electrical system of the car involves considerations in both the receiver itself and in the installation. During the tests there was no interference from the operation of the car, and the behavior of the receiver was as good in every respect while the car was in operation as when the car was standing still. This statement is made without reservation.

The only internal noise found was a slight "frying" noise encountered when the receiver volume control was turned up "full," as it is when tuning for West Coast stations. This noise arises in the B eliminator portion of the circuit, but is so slight and so seldom encountered that it scarcely deserves mention except that it is the purpose of this article to give a complete story of the results obtained. The fact that KFI can be clearly heard above this noise will give the reader a good indication of its extremely low value.

In closing, it may be well to say a few words about the installation itself. During the installation process a photographer was on hand to obtain views of the various details of the installation job. These photographs and their captions tell the story. Figure 1 shows how completely out of the way the chassis and speaker are mounted. Due to the position which was necessary for the camera to take, part of the floor in front of the seats has been omitted so that actually there is much more foot room than appears in this picture. The loudspeaker is so far above the foot controls that it cannot interfere with the driving of the car. The

chassis is likewise in a position which does not interfere with the passenger riding in the front seat. The remote tuning control may be seen at the upper left, together with the two cables running up the steering post by means of which the remote unit is connected to the chassis. Figure 2 shows the close-up of the tuning-control unit as viewed through the spokes of the steering wheel. Figure 3 shows the engine, with the suppressors and one by-pass condenser. Another by-pass condenser is connected in the generator circuit, but does not show in the photograph. Figures 4 and 5 show the details of the antenna installation.

## What Tube?

(Continued from page 673)

### Shielding in Screen-Grid Circuits

In multi-stage radio-frequency amplifiers using the various types of screen-grid tubes, the need for neutralizing of the interelectrode capacities or the introduction of suppressor methods for controlling oscillation has been eliminated by the use of the screen grid.

It is very important, however, in order to obtain stability of operation and the unusual amplifying ability of these tubes, to take the following precautions or the efficiency of the tubes will not be realized. Each stage must be completely and effectively shielded and all components of each stage must be enclosed in the shields of their respective stages.

To reduce undesirable coupling in the external circuits to an absolute minimum, radio-frequency filters consisting of suitable combinations of resistances or chokes and condensers should be connected in all plate, control-grid and screen-grid leads of each stage. It is especially important to keep the impedance of the circuit from screen grid to ground as low as possible by the use of a high-quality, fairly large by-pass condenser.

In most cases, though not in every instance, it is desirable to use a metallic shield to enclose the screen-grid tubes. This shield should extend down the entire length of the tube, including the base, and should be connected to the ground circuit.

### Cross-Modulation and Modulation Distortion

One of the important developments in radio-frequency amplifier tubes has been the super-control screen-grid tube. These tubes are primarily designed for radio-frequency and intermediate-frequency amplifier use and are very effective in reducing cross-modulation and modulation distortion over the entire range of received signals. The design features of these tubes are such as to permit easy control of a large range of signal voltages without the use of local-distance switches or antenna potentiometers. The super-control feature makes the tubes especially adaptable for circuits incorporating automatic volume control.

The super-control feature is obtained in such tubes by using a non-uniform construction of one or more of its electrodes. In most of these tubes, a non-uniform winding is used for the control grid and sometimes also for the screen grid.

At low negative grid-bias voltage, the effect of non-uniform turn spacing on the



## The Most Useful "Tool" in the Service Man's Kit!

**M**ORE than 10,000 users of last year's Electrad Hand Book called it "Great!" But the 1933 edition (now ready) is GREATER!!

It is bigger, more convenient, and contains new and more complete data on all resistors (including carbons) and volume controls for all receivers.

Last year's Hand Book is now out of date. You need the new 1933 edition. \$1 brings it to you, with three supplements as issued.

Mail your dollar NOW to Dept. RN-5. Money refunded if not satisfied after 10 days' trial.

175 Varick St., New York, N.Y.  
**ELECTRAD**  
INC.

## Compact 5-Tube AC and DC RADIO



Plays Anywhere

**\$11.95**

Complete with Tubes

NOTHING ELSE TO BUY!

Sensational value! Gets long distance, police calls, with volume and beautiful tone. Built-in aerial and dynamic loudspeaker. Plays on any 110-120 volt AC or DC current, 25, 50, and 60 cycle. Guaranteed one year.

### 1933 MIDGET

AC Only **\$9.95**

R. C. A. Licensed 4-tube set. Gets police calls and distant stations as well as locals. Worth double our price.

Complete with Tubes

Send \$2 Deposit with order; balance C. O. D. Satisfaction Guaranteed.



**BANNER RADIO CO., Dept. R-5**  
1356 S. Michigan Ave., Chicago, Ill.

## Learn Radio in 10 Weeks

PAY for TRAINING AFTER YOU GRADUATE!  
GET DETAILS OF MY AMAZING OFFER!

Prepare for jobs in Radio Broadcast, Talking Pictures, Television, by ten weeks of practical shop work in the great Coyne Radio Shops, on real machinery and equipment. You don't need advanced education or experience. Free Employment Service for life. Many earn while learning. Mail coupon today for free book which tells you how hundreds of others have become successful Radio men after taking my training.

**COYNE RADIO SCHOOL, H. C. LEWIS, Pres.**  
500 S. Paulina Street, Dept. 53-8C, Chicago, Ill.

Send Free Radio Book and facts. Tell how I can pay for my course on easy payment plan after I graduate.

Name.....  
Address.....  
Town..... State.....

plate current is the same as if it were uniformly spaced. As the grid-bias voltage is made more negative, however, the current from those areas of the cathode covered by the closely wound grid turns is gradually cut off. When this condition occurs, only that area of the cathode under the relatively open turns is effective. During this increase of negative grid voltage, the plate current and mutual conductance characteristic curves follow a shape which minimizes the factors responsible for cross-modulation and modulation distortion. The mutual conductance characteristic also varies smoothly throughout its entire range, affording remarkable ease of volume control.

### Super-Control Screen-Grid Pentodes

The screen-grid pentodes of the -34 and -39 types represent the highest development in radio-frequency amplifier tubes. These tubes are similar to the types -35 and -51 super-control screen-grid tubes except that another element or electrode, called a suppressor grid, has been added.

It has been found that the suppressor grid, up to recently used only in output pentode tubes, has a very useful application in screen-grid tubes designed for radio-frequency amplification. It provides greater selectivity, more stable operation over a wide range of plate and screen-grid voltages, a higher plate resistance at high plate voltages and much more stable operation at low plate voltages when the plate voltage approaches the same value as the screen-grid voltage. It can be used more satisfactorily than the usual screen-grid tube at low plate voltages. It also provides greater uniformity of screen-grid current which makes it possible to use a series resistor from the high-voltage tap on the power supply for obtaining the required screen-grid voltage.

It is possible to operate this tube with low plate voltage equal to the recommended screen-grid voltage and thus use the same voltage tap on the power supply for both screen-grid and plate voltages.

This feature of high efficiency at low plate voltages makes the super-control screen-grid type of tube especially adapted for use in automobile receivers because of the savings in bulk and expense obtained by the smaller B battery requirements. It is also specially useful in receivers designed for operation from d.c. lines where the plate voltages available are limited.

Because of the elimination of cross-talk with super-control screen-grid tubes, it is possible to use a longer antenna with receivers employing these tubes; and by providing a stronger signal, to reduce the amplification required, by suitable volume control; or by using fewer stages. This results in eliminating the tube "hiss" and noise which comes of operating tubes at maximum output.

### Screen-Grid Voltage

On standard screen-grid tubes the positive voltage for the screen-grid should always be obtained from a tap on the B supply voltage divider rather than by using a series resistor connected between the screen grid and the high-voltage tap of the power supply unit, because of the wide variation in screen-grid current with different screen-grid tubes of the same type. A very desirable way to obtain the screen-grid voltage is by connecting the screen grid to the movable arm of a potentiometer whose resistance element is connected across a section of the voltage divider, sufficient to provide the necessary adjustment of screen-grid voltage. This method can be used as a volume control with all screen-grid tubes except for the super-control types such as the -35 and -51 tubes.

When the potentiometer method is used with battery tubes using dry batteries as the

source of B supply, some provision should be made for opening the potentiometer circuit across the batteries when the set is not in use, to prevent a constant drain on the batteries.

### Volume Control

With battery tubes, using dry batteries for the B supply, the most effective and desirable method of volume control is to use a variable high resistance in the plate leads of the radio-frequency tubes. When a B supply unit is used for the plate supply, however, it is much more desirable to use a variable high resistance connected across the primary winding of the radio-frequency transformer preceding the detector stage or an antenna volume control.

For standard screen-grid tubes, some variation of the screen-grid or grid-bias voltage in combination with an antenna control constitutes an effective means of volume control.

In the case of super-control screen-grid tubes, the best method of volume control consists of varying the control-grid bias by means of a potentiometer connected across the voltage divider, with the cathode lead to the movable arm, or by means of a variable resistor connected in the cathode lead. In these tubes the screen-grid voltage should remain nearly constant.

In using the grid-bias method to control volume with the super-control screen-grid tubes, it is important to provide means for preventing the grid bias from ever becoming lower than the recommended minimum, as excessive plate currents will result in poor operation and damage to the tube.

To prevent overloading, distortion and too heavy drains of plate currents and lowered tube efficiency and life, it is important that the recommended values of filament, plate, grid-bias and screen-grid voltages be used at all times.

### "Backstage"

(Continued from page 689)

day nights. On each program, Lopez is featured in one of his well-known piano solos. The vocalists heard on the program from time to time include Arthur Beddoes, Johnny Morris and Louis Bring. Dr. Pratt and Dr. Sherman, whose nonsensical chatter has been broadcast for years, head the cast of dramatic performers, presenting comic skits.

THE oldest continuous NBC network feature, the Clicquot Club Eskimos, recently inaugurated a new type program featuring Albert Kennedy "Rosey" Rowswell, humorist; Annette Hanshaw, blues singer, and an augmented orchestra under the direction of Harry Reser, the conductor who has piloted the Eskimos throughout their radio career. Miss Hanshaw appears on this series under the name of Gay Ellis. Although retaining the well-known banjo tone which has characterized the Cliquot Eskimos' music for several years, Reser has increased the number of strings and reassembled the orchestra to obtain a softer and fuller type of music.

NBC's famed "Tune Detective," Sigmund Spaeth, who has the knack of making musical education entertaining, was born in Philadelphia in 1885, the seventh son in a minister's family of eleven. He studied at Germantown Academy and Haverford College and served on the faculty of Princeton University. During his school days, Spaeth's activities were largely centered around music. After coming to New York, he obtained a job with a music publisher, reading proof on Victor Herbert operettas.

## ?QRD?

A column devoted to  
the commercial operator  
and his activities  
Conducted by GY

TO reduce the clerical work, save expense and to give the amateurs a break, the FRC has recently ordered that all licenses for amateurs be valid for a period of three years from the date of issue, instead of the former one year. All Hams are rejoicing over this bit of luck, as it protects them against any radical changes in control over the longer period. The Hams have done much toward the building up of the short waves for commercial use and they should be given any leniency which is in the power of the Commission.

Dear GY: . . . In a short time now I'm going up to take that all-important second-class exam. and I'm pretty confident of passing it. What worries me is my first berth. I've a pretty good idea of the major duties of operating, but outside of sending and receiving and maintaining equipment, what do I do? Such as helping the Captain? What uniforms do I have to use? What discipline am I under when addressing a superior officer, and do I salute and say "Sir" or "Aye, aye, sir"? What is the usual length of the watch? . . . Another important thing is, what is my chance of getting a job, and what salary should I ask for? (Signed) C. L.

Dear C. L.: First off, pass the exam, and second, get the job! After that everything will come to you easy if you have paid good attention to your studies. If you haven't, you might as well give up now!

Speaking in the amateur vein, it has come to our knowledge that a Carnegie Tech. student had received a rather tough problem in calculus which he just wasn't able to work out. After tinkering with it for a few hours, he yelled for help via his amateur transmitter. A little while later the solution came back from the University of Texas, in Austin. There is no getting away from it, but necessity is the mother of invention.

As all heroes are modest, nothing much was learned of the harrowing experiences of Henry W. Lothian, Op on the ill-fated S.S. *Exeter City*, which recently took a nose dive into Davy Jones' locker out in midocean. He was honored by the V.W.O.A., over station WOR, with a presentation of the Scroll of Honor. We, who have been through something of what he was up against, can fully appreciate and understand the anguish, the tortures of waiting for a reply, the straining of all muscles as slowly the dial is turned for the faintest sound to indicate that someone had received the SOS. That is the time when it takes a man to stand by his post, to tell his shipmates not to worry, to take the responsibility that is thrust upon him in a manner befitting a real man and a seasoned operator. Here's long life to you, OM, and may the powers that be give you smoother sailings and happier ports.

Most of the monitor holder-downers in the broadcast stations are ex-brass pounders. It is with a thought of "a word to the wise is sufficient" that we suggest that before applying for a position as a monitor man

that, not only the back of the ears be washed, but the inside of the loving-cup handles be taken into consideration for the bawth. Heavy tests have been going on in these stations to make sure that monitor men have perfect hearing ability. A program can be "shot to pieces" if the gadget behind the dial isn't getting the high and low notes put out properly. To monitor a program properly or to arrange persons and musical instruments before the mikes so as to get from them a harmonious and well-modulated tonal quality requires the ability to hear with equal facility in all frequencies of the voice. An audiometer is used, and the hearing ability on all frequencies from 64 to 8192 cycles is charted and recorded in decibels or "sensation units." The right ear as well as the left one is tested. What a tough break it would be if a chappie was cockeyed on his ears, eh? And would we then call him cockeared?

Well, the "shindig" of the V.W.O.A. is over and quiet reigns around the Crystal Ballroom of the Hotel Taft in N'yoick once again. Now that the smoke has cleared away, we must say that the only trouble with the V.W.O.A.'s cruises are that they are not undertaken often enough. Talk was plentiful! Beauty was plentiful and a goodly crowd was there. Can more be said? Oh, yes, and that dinner was something to write home to the folks about. We could write pages about that affair, but the aforementioned should be sufficient to let those who didn't attend this cruise feel sorry enough so that reservations will now be made for the next annual cruise.

An opening for ops is the new service that has been started by WMCA. It is now possible for persons on the dock to communicate with persons on board an incoming liner as it is coming to its berth. A radio op, using a portable set, is on the dock with the crowd, to transmit and receive communications to and from the ship at Quarantine. The arrangements have been completed at Pier 59 and will be extended to the other piers as soon as the radio equipment can be installed. The reception of the service at its inauguration indicated it would be popular also for the exchanging of salutations between incoming ocean travelers and those awaiting them.

Here's something for us to worry about—or should we! Word comes to our ears that 'way over yonder in Vienna a beer pump was found to be the cause of the static that was ruining reception for the people thereabouts. Upon questioning, the owner of the beer garden admitted that he knew his pump was causing the interference and his purposes in letting it run was to make the people come to his place after they were tired of listening to messed-up broadcast programs.

Shipmate Harry Chetham writes in to say that his mail must be sent to the new police station at Union Square, Somerville, Mass., if you wish him to get it. Also, Jimmie McLunes and Elgar St. Clair are with him, to see that everything is shipshape. . . . The V.W.O.A. would like to know the whereabouts of J. B. Milkiewitz, who was formerly with Mackay. . . . Airways sends in greetings via F. C. Justice, who holds down the station out in Des Moines, Iowa. Let's hear from Howell Jones, who is now out in Los Banos, P. I., holding down a land job for the U. S. Navy. . . . Well, keep writing, gang, and let us hear about yourselves. Also, we are still answering questions on what's new, what is and what will be—if we can catch up with ourselves, so cheerio and 73's. . . . GY.

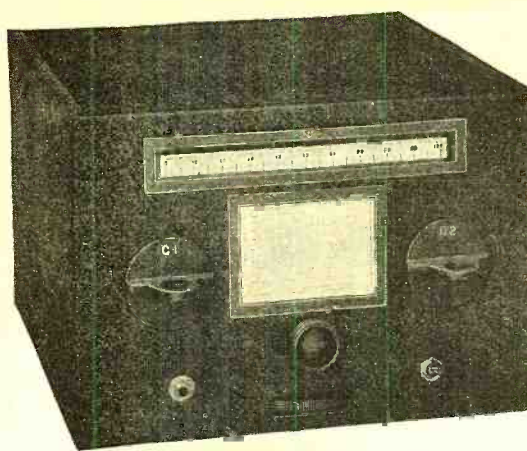

**FB-7 Specifications**

**THE CIRCUIT** . . . 7 tubes; one 57, two 24's, two 58's, one 59, and one 59 . . . Electron Coupled Oscillators . . . Separate Oscillator for CW beat frequency giving "semi-single signal" of "outset" tuning . . . High efficiency Litz wound I.F. Transformers . . . Class A Power Pentode Output . . . R-39 Coil Forms with grounded metal shield handles . . . Band Spread Coils available for 20, 40, 80 and 160 meter amateur bands, each covering 100 full dial divisions . . . Standard coils for continuous coverage from 20 MC to 1500 KC . . . No frequency drift . . . Double Shielding . . . May be used with either conventional antenna or "doublet" with transposed transmission-line lead-in.

**THE CHASSIS** . . . Single Control Tuning. (No trimmers.) . . . Full Vision Dial with SFL 270° condenser . . . Front-of-panel coil changing, without disturbing shielding . . . CW Beat Oscillator Switch on panel . . . Front-of-Panel Switch for "cutting" B voltages during transmission . . . Phone Jack, connecting ahead of final audio stage . . . Calibrated Volume control located under tuning knob, for one-hand operation—gain control calibrated in R units . . . All fixed adjustments, such as I.F. peaking, accessible from top without removal of chassis from cabinet.

**NATIONAL  
FB-7 SHORT-WAVE RECEIVER**



**THE  
FB 7  
NEW SHORT-WAVE  
SUPER FOR AMATEURS  
AND S.W. BROADCAST  
RECEPTION**

This new 7-tube short-wave super-heterodyne, designed originally for amateur phone reception, with professional design details, offers the short-wave broadcast listener and the experimenter exceptional distance, selectivity, stability and tone quality in the reception of short-wave broadcasts. From such a receiver, National-built, one expects remarkable performance, and gets it. With its strictly single control tuning, front-of-panel coil changing, full vision dial and single hand control of tuning and volume, the National FB-7 gives you a simplicity and convenience of operation heretofore not available at such a reasonable price.

**Made for AC Operation**

The FB-7 is designed to be operated by filament transformer and B-batteries, or the National 5887 or 5880 Short-Wave Power Units. Where the maximum undistorted power output is desired for short-wave broadcast reception, the National 5897 Power Unit is recommended, which furnishes voltages sufficient to drive the type 59 power output pentode at full rating. R.C.A. Licensed.

**Send in COUPON today**

**NATIONAL COMPANY, Inc.**  
61 Sherman St., Malden, Mass.

Gentlemen: Please send me your new catalogue sheets giving full description of the new FB-7 Short-Wave Super, and your new Short-Wave Parts. I enclose 6¢ in stamps to cover mailing costs.

Name.....  
Address.....  
RN-5-33

**100 PAGE COAST TO COAST RADIO ACCESSORY CATALOG AND PUBLIC ADDRESS AMPLIFIER SYSTEMS TREATISE WHOLESALE PRICES**

**3 STAGE HIGH GAIN 250 PUSH-PULL 13 WATT OUTPUT MICROPHONE-PHONO-RADIO AUDITORIUM or SOUND TRUCK PUBLIC-ADDRESS-AMPLIFIER**

MANUFACTURED BY WESTINGHOUSE ELECTRIC MFG. CO. Tubes Required 2-56, 2-250, 2-261

**\$19.50 LESS TUBES \$26.50 WITH GENUINE RCA TUBES**

**BRAND NEW! FULLY GUARANTEED!**

Specifications: INPUT: To Universal 500,000 ohm potentiometer connected to grid of first 56 Tube (high impedance pick-ups, radio tuner or pre-amplifier plate outputs require no special input transformer); GAIN: 62 D.B. (at 2000 cycles); OUTPUT: 400-1000 Ohms—connect to primary of an output transformer; SIZE: 17 1/2 in. long, 12 1/2 in. wide, 7 1/2 in. tall.

**13 Watt AMPLIFIER, with SIX 13 Watt AMPLIFIER, with SIX GENUINE RCA TUBES, and IN-GENUINE RCA TUBES, and INCLUDING your choice of ONE CLUDING your choice of TWO WRIGHT DE COSTER or \$33.50 WRIGHT DE COSTER or \$33.50 Jensen Dynamic Speakers, Jensen Dynamic Speakers, \$38.50 Special Output Transformer. MATCHES VOICE COILS of from 2 to 16 Dynamic Speakers. (Required with either of two P. A. Systems herewith advertised.) Rating: Primary 1000-4000 ohms, secondary 500 ohms 15-7 1/2 3/4 ohms.....\$3.95 200 Ohm Single or Double Button "MIKIE" INPUT TRANSF.....\$1.75**

**COAST-TO-COAST RADIO CORPORATION**  
123 N. WEST 17TH STREET  
NEW YORK, N. Y.

**You Can Become a Fast, Capable RADIO OPERATOR at Home**

FREE—C. S. Code Guild Sked. Daily C. S. practice programs on amateur bands. FREE short wave press schedules. Learn to copy px from Candler trained ops, sending out of principal px stations. Amazing results in short time. FREE ADVICE IF "STUCK". Write Candler. No obligation. Junior Course for beginners. Advanced Course for ops with speed of 10 wpm or over who want to get in 30 to 45 wpm class and copy behind. Also Radio Typing Course. Save time and money by sending for FREE BOOK today.

CANDLER SYSTEM CO., Dept. 15  
6343 So. Kedzie Ave., Chicago, Ill.

**World's Only Code Specialist**

*"Candler training enabled me to copy 56 1/2 w.p.m. for the all-time record."—H. McElroy, Official Champion Radio Operator of the World, 46 Everdeen St., Boston, Mass.*

**PERSONAL**

Need an extra wad of rent or gasoline money? Improve the sets you service. Plug Amperites the way the smart service boys do. Reuben Gordon, 2504 Bronx Pk. E., New York, averages \$90 per month on Amperites alone. Amperite Corporation, 561 B'way, N. Y.

# AERO INTERNATIONAL

## ALL WAVE 11-TUBE SUPER-HETERODYNE DE LUXE

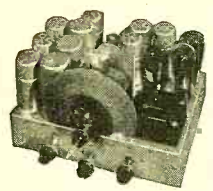

Completely Assembled  
With 2 Matched Full  
Dynamic Speakers . . . \$29.75

At Last! World wide reception at a sane price, 15 to 550 meters. Besides the regular broadcast band it brings in foreign programs, amateurs, police calls, ships at sea and aeroplanes. One dial control. No plug in coils. Latest super-phonetic tubes.

### AERO 4-TUBE MIDGET



\$10.95 less  
tubes \$2.95

The lowest priced quality Midget Receiver on the market today. Very selective, brings in long distance like local stations.

Aero 5-tube Midget . . . \$11.90  
Aero 6-tube Superheterodyne Midget . . . \$18.50

### AERO WORLD WIDE



1-Tube SHORT WAVE  
SET for Headphone  
\$5.95 . . . Operation

Listen in DIRECT to London, Paris, Berlin, Buenos Aires and other broadcasting stations throughout the world via short waves. Your ordinary receiver cannot tune in these low wave stations. WORLD-WIDE RECEIVER gets 15 to 500 meters. Aero 2-Tube Short Wave Set \$8.75. The same as above set but it has 1 stage of Audio Frequency added to it.

Write today for Your FREE copy of our CATALOGUE

**CHARLES HOODWIN CO.**

4240 Lincoln Ave. Dept. E-30 Chicago

## LEARN AT HOME TO BE A Good Radio Operator

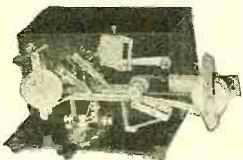

It's Easy

with  
The NEW  
MASTER  
**Teleplex**  
Code Teaching Machine

Pleasant, interesting work. No experience necessary. We guide you step by step—furnish you Complete Code Course and lend you The New Master Teleplex. Teleplex has instructed more students in the code in the past ten years, than all other systems combined. It is the only instrument ever produced that will record your own sending in visible dots and dashes, and then repeat it to you audibly on headphones. Used by U. S. Army and Navy, R. C. A., A. T. & T. Co., and others. Get started NOW. Low cost, easy terms. Write for folder RN-5 giving full details.

**TELEPLEX COMPANY**

76 Cortlandt St. New York, N. Y.

## Get Into the Toy Business

As Our Manufacturer



Earn Money casting our new hollow Toy Soldiers, Indians, 5 and 10c Automobiles, Ashtrays, etc. NO EXPERIENCE required as we furnish full instructions with moulds and cooperate in selling, also buy goods we need. A rare opportunity for these times for men with small capital so if you mean strictly business write at once for full details as 1933 Wholesale Season is Now Starting.

**METAL CAST PRODUCTS CO.**

Dept. 12 1696 Boston Road, New York

Heavy Duty Peerless 11-inch Dynamic P.A. Speakers, complete with 110 volt rectifier or field coil of any impedance. Output transformer also included. Wholesale Dealers' Price \$3.75.

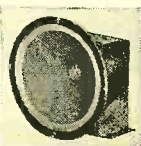

**MELLAPHONE CORP.**  
Rochester, N. Y.

## A Miniature Set

(Continued from page 661)

same time this socket is mounted. The audio choke L4 is mounted next. Then the three bending posts, BP1, BP2 and BP3, are fastened in place. All three posts must be carefully insulated from the chassis. Resistor R10 is mounted in an upright position as illustrated. This should also be carefully insulated from the chassis deck. The coil L3 is fastened to the side of condenser section C7. Fixed condenser C4 and resistor R1 may also be soldered in place.

The chassis is now turned upside down and components are mounted on the under side. Where parts are likely to interfere with the wiring, as in the case of condenser C14, as much of the wiring as possible should be completed before mounting that particular part. The locations of the various parts are clearly indicated on the under-side view. The antenna coupler L1 is mounted on top of the triple fixed condenser (C3, C5, C6). Other parts may be located as near as possible to the components with which they function, but they should all be kept safely away from the metal chassis, to prevent any possibility of short-circuiting.

The wiring should be carried through in a methodical manner, using a flexible hook-up wire. The entire filament circuit wiring should be completed first. Next the grids and screen grids, then plates, cathodes, bypass condensers and all remaining wiring. Wiring should be completed in a short time, as it presents no difficulties whatsoever.

### Parts List

- BP1, BP2, BP3—Eby insulated binding posts
- C1, C7—Cardwell dual midway "feather-weight" variable condensers, .00035 mfd. each section, type 407CS
- C2, C8—Trutest equalizing condensers, 3 to 35 mmfd.
- C3, C5, C6—Aerovox triple section metal case condenser, .1 mfd. each section, type 260-31
- C4—Aerovox .00025 mfd. mica condenser, type 1467
- C9—Aerovox .0001 mfd. mica condenser, type 1460
- C10—Aerovox .01 mfd. cartridge condenser, type 281
- C11—Aerovox .5 mfd. cartridge condenser, type 281
- C12, C17—Aerovox .0005 mfd. mica condenser, type 1460
- C13—Aerovox .01 mfd. mica condenser, type 1455
- C14—Aerovox 2 mfd. dry electrolytic condenser, cardboard container type P5-2
- C15—Aerovox 8 mfd. dry electrolytic condenser, cardboard container type Pr-8
- C16—Aerovox 4 mfd. dry electrolytic condenser, cardboard container type P5-4
- J1, J2—Amphenol four-prong socket (only two prongs used for speaker connections)
- L1—"Find-all" antenna coupler
- L2—"Find-all" r.f. choke
- L3—"Find-all" impedance coil
- L4—Trutest 20-henry (small size) audio filter choke
- R1, R2, R6—I.R.C. (Durham) 1-meg., 1-watt metallized resistors, type F-1
- R3—I.R.C. (Durham) 10,000-ohm, 1-watt metallized resistor, type F-1
- R4, R5—I.R.C. (Durham) 500,000-ohm, 1-watt metallized resistor, type F-1
- R7—I.R.C. (Durham) 1500-ohm, 1-watt metallized resistor, type F-1
- R8—Electrad 150-ohm flexible resistor, type 2GB150
- R9—Electrad 5000-ohm tapered volume control potentiometer, type R1278-P, with switch SW1
- R10—Electrad Truvolt 300-ohm, 50-watt adjustable resistor, type C3

- R11—Electrad 50-ohm flexible resistor, type 2GB50
- V1, V2, V3—Eveready Raytheon type ER-239 r.f. pentodes, five-prong Amphenol sockets
- V4—Eveready Raytheon type ER-238 output pentode, five-prong Amphenol socket
- V5—Eveready Raytheon type -71-A tube, four-prong Amphenol socket
- 1 roll Corwico solid-core Braidite hook-up wire
- "Find-all" 5-inch cone midget magnetic speaker
- Aluminum chassis, 5½ inches by 6 inches by 2 inches high, 16-gauge
- 4 screen-grid clips
- 2 knobs, one for volume control, one for tuning condenser

## S. A. Stations

(Continued from page 669)

Call	Location	K.C.	K.W.
PRAP	Pernambuco	706	3
PRAG	Porto Alegre	706	3
PRAA	Rio de Janeiro	750	1
PRAE	Sao Paulo	815	1
PRAF	Para	842	.25
PRAJ	Juz de Fora	857	.2
PRAC	Rio de Janeiro	857	.5
PRAN	Curitiba	887	.05
PRAS	Santos	887	1
PRAD	Pelotas	920	.05
PRAB	Rio de Janeiro	937	.5
PRAY	Mogy das Cruzes	1000	.05
PRAR	Sao Paulo	1006	.5
PRAI	Ribeirao Preto	1070	.01
PRAQ	Belle Horizonte	1090	
PRAZ	Franca	1110	.05
PRAK	Rio de Janeiro	1153	1
	Campinas	1170	.02
PRAX	Rio de Janeiro	1364	1

### CHILE

CMAB	Santiago	625	1
CMAI	Santiago	681	1
CMAF	Santiago	717	1
CMAZ	Santiago	750	1
CMAG	Valparaiso	785	.05
CMAC	Santiago	833	1
CMAE	Santiago	862	1
CMBH	Valparaiso	869	.02
CMAR	Santiago	923	1
CMBE	Santiago	1016	.25
CMBO	Santiago	1027	.02
CMBK	Valparaiso	1045	.02
CMAQ	Santiago	1110	1
CMAT	Valparaiso	1153	.02
CMAH	Santiago	1158	1
CMAK	Santiago	1200	.25
CMAS	Rancagua	1239	.01
CMAJ	Valparaiso	1249	.05
CMAA	Santiago	1304	.02
CMBF	Santiago	1304	.02
CMBJ	Santiago	1344	.02
CMBA	Rancagua	1388	.01
CMBC	Rancagua	1448	.01

### PARAGUAY

ZP3	Asuncion	1000	.285
ZP1	Asuncion	1135	1
ZP4	Asuncion	1275	.15
ZP5	Asuncion	1465	.15

### PERU

OAX	Lima	790	1.5
OA4M	Lima	1428	.012
OA6U	Arequipa	1764	.02

### URUGUAY

CX6	Montevideo	650	1
CX10	Montevideo	730	1
CX12	Montevideo	770	.5
CX14	Montevideo	810	1
CX16	Montevideo	850	
CX18	Montevideo	890	.25
CX20	Montevideo	930	2
CX22	Montevideo	970	.25
CX24	Montevideo	1010	1
CX26	Montevideo	1050	2
CX30	Montevideo	1130	.25
CW30	Tucuariembo	1140	
CX32	Montevideo	1170	.2
CW32	Salto	1180	.03
CX34	Montevideo	1210	.5
CW34	Salto	1220	.05
CX36	Montevideo	1250	.25
CW36	Salto	1260	.03
CX38	Montevideo	1290	1
CW38	Salto	1300	.03
CX40	Montevideo	1330	1
CW40	Paysandu	1340	.03
CX42	Montevideo	1370	.5
CX44	Montevideo	1410	.02
CW44	Paysandu	1420	.03
CX46	Montevideo	1450	1
CW46	Tucuariembo	1460	.02
CX48	Montevideo	1490	.05

### VENEZUELA

YV1BC	Caracas	960	
-------	---------	-----	--

## Station WCAU

(Continued from page 655)

to the microphones in the "dead" end of the broadcasting chamber.

An unusual type of timepiece was ordered by WCAU engineers for the new studios. The timepieces (which are three-minute clocks) mounted on the studio walls alongside standard electric clocks, have but a single hand. The single hand of the device makes one complete revolution in three minutes and it automatically starts and stops three minutes before and at the end of each quarter hour. The fifteen-minute interval is the standard radio broadcast time unit. Three colored lights are mounted on the wall near the clock. The lights are synchronized with the clock to show the minutes remaining as each program draws to a close. This timing is of especial importance to announcers and production men.

The new building was officially dedicated on February 10, with an elaborate broadcast which was piped to the entire Columbia chain. Noted network artists and broadcasting executives went to Philadelphia for the occasion and a brief address from Washington by President Hoover was included in the dedicatory program. The artists included Morton Downey, Tom Howard, Mary Garden, Helen Kane and the Vincent Travers and Meyer Davis orchestras. Boake Carter was master of ceremonies. An address by Dr. Leon Levy, president of WCAU and secretary of the CBS, was heard.

Dr. Levy, the thirty-seven-year-old head of WCAU, has also gained prominence in American broadcasting circles for his work in developing the huge CBS chain. He is a native Philadelphian and an alumnus of the University of Pennsylvania. During the World War he was a junior lieutenant in the United States Navy. He entered the radio field in 1925 and was elected president of WCAU in 1926. The following year he was elected secretary-treasurer and director of the CBS.

John G. Leitch is technical engineer in charge of operation. He supervised all of the construction work of the new building and transmitter. Gabriel Roth, of Philadelphia, designed the new studios, and Robert Heller, of New York, made the decorations. Stan Lee Broza is the program director.

Even the control rooms in the studio building have modernistic furnishings. An unusual feature of the master control room is the presence of a 1000-watt transmitter for emergency purposes.

WCAU's 50-kilowatt transmitter is located in the suburbs of Philadelphia, on Bishop Hollow Road, Newton Square. The transmitter building, like the studio structure, is modernistic in design. The transmitter utilizes a 500-foot vertical antenna, similar in appearance to the one utilized by WABC at Wayne Township, New Jersey.

In order to prevent airplane accidents on account of the unusual height of the antenna, a 24-inch revolving, observation aeronautical beacon has been installed on top of the transmitter building. In addition, the antenna has been painted in alternate sections so that it can be more easily seen over a great distance.

The well-known short-wave sister station, W3XAU, is also located at Newton Square. This is a 1000-watt outfit which relays the same programs as WCAU on short waves.

At the time of the new studios' dedication, a total of eighteen broadcasts per week were "piped" to the CBS. While it is expected that many more Philadelphia programs will become available to the nation's listeners via this powerful transmitter and the CBS chain, it is unlikely that Philadelphia will supplant New York as the key Columbia outlet.

## Transformer Design

(Continued from page 675)

instability. If shielded wire is used for the leads, in order to eliminate undesirable coupling effects, losses are introduced due to the fact that the lead and the grounded shield constitute a highly inefficient condenser. Inasmuch as this capacity is in parallel with the coil, it has the effect of partially offsetting the low-loss properties built into the tuning condenser. What is more, even a two-inch shielded lead will vary in capacity, due to humidity changes, enough to alter tuning of the circuit in which it is included.

With the transformer described here it will be seen that not only is the transformer itself a well-designed and highly efficient one, but it simplifies efficient receiver construction. With tubes placed as close as possible to the transformer can, to provide short leads, and with provision for properly filtering and bypassing of the tube circuits, all of which are well understood in standard practice, it would be difficult to construct an inefficient i.f. amplifier. And with these provisions there would be no occasion to use more than two stages. The possible exception to this might be in meeting some special receiver requirements, where far more than normal selectivity may be required.

## Technical Review

(Continued from page 683)

fications of the receiver circuit. This small, handy instrument should be in every serviceman's kit.

### 41. How to Build the Economy "Eight."

A folder prepared by Wholesale Radio Service Co. giving constructional information, diagrams, list of parts, etc., of an efficient 8-tube receiver which can be built from a kit which sells for \$13.75. Servicemen and set builders can put in their spare time to advantage building and selling these sets.

May, 1933

RADIO NEWS Free Technical Booklet Service  
222 West 39th Street  
New York, N. Y.

Gentlemen: Please send me, without charge, the booklets or folders I have filled in below:

Numbers.....

- Serviceman in Business for Myself
- Serviceman Employed by:  Manufacturer,  Jobber,  Dealer,  Service Organization
- Radio Engineer
- Experimenter
- Laboratory Technician
- Dealer
- Jobber
- Professional or Amateur Set Builder
- Licensed Amateur
- Station Operator

I am a  subscriber  newsstand reader.

I buy approximately \$..... of radio material a month.

Name.....

Address.....

City..... State.....

PLEASE USE PENCIL AND PRINT, IN FILLING IN COUPON

## THE NEW SHALLCROSS A.C. Utility Meter

No. 685

### CAPACITY

.0005 Mfd. to 10 Mfd.

### INDUCTANCE

.5 Henrys to 10,000 Henrys

### RESISTANCE

25 ohms to 5 megohms.

A.C. voltage ranges

0-10-125-500-1000

1000 ohms per volt.

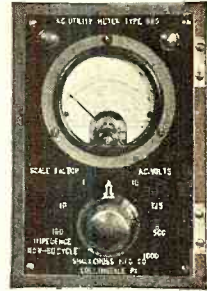

This instrument is very easy to build. The important parts required are a 1-milliamperere A.C. (rectifier type) meter and the SHALLCROSS Resistor Kit No. 685 with meter scale.

Send 6¢ in stamps for Bulletin 685-D describing this useful test instrument.

Shallcross Mfg. Company  
ELECTRICAL SPECIALTIES  
700 PARKER AVENUE  
Collingdale, Pa.

## RADIO OPERATING RADIO SERVICING



Prepare for the new Government Radio Operating license examinations; Radio Operator, Marine and Broadcasting. Also Radio Amateur Telegraph and Telephone. Resident courses. Write for booklet

"Opportunities In Radio"

West Side YMCA Trade & Technical Schools  
17 West 63rd Street New York City

## EARN MONEY AT HOME

YOU can make \$15 to \$50 weekly in spare or full time at home coloring photographs. No experience needed. No canvassing. We instruct you by our new simple Photo-Color process and supply you with work. Write for particulars and Free Book to-day.

The IRVING VANCE COMPANY Ltd.  
265 Hart Building, Toronto, Can.

## SERVICEMEN! GET THIS FREE CATALOG



88 Pages—Over 2000 Items—Headquarters for "hard-to-get" replacement parts. Ham supplies. Lowest Prices.

Baltimore Radio Corp.  
N725 Broadway, N. Y. C.

# OHIOHM SPARK SUPPRESSOR SETS

for eliminating ignition interference on **AUTO-MOBILE RADIOS**



Enjoy radio at its best in your automobile. Service men and dealers will find this a made-to-order market for them.

Ohiohm Spark Suppressor Sets are furnished for 4, 6 and 8 cylinder cars. Condensers designed to withstand unusual conditions of temperature and vibration. Suppressors immune to accumulation of dirt and protected against shorting.

Also **OHIOHM RESISTORS** for all radio receivers

**THE OHIO CARBON CO.**  
CLEVELAND OHIO

## SERVICE MEN!



Send for our new 1933 Catalog... Just off the press. Everything in replacement parts. Tubes, Batteries, Latest Sound Systems, Automobile Sets, and Electrical Supplies. 6000 different items at lowest wholesale prices. Prompt, reliable service. Send for this big FREE Catalog today. You need it.

**ALLIED RADIO CORP.**  
833 W. Jackson Blvd., Chicago, Ill.

Please send me **FREE** your new 1933 catalog.

Name.....  
Address.....  
City..... State.....

## LEARN IN LOS ANGELES Radio-Television

**TALKING PICTURES & ELECTRICITY**  
In just a few years, Radio has become one of the world's leading industries. Talking pictures have brought new life and opportunity to the Movies. Now, Television is here with a promise of growth and activity so great it cannot be estimated. Come to Los Angeles and learn these fascinating Trades. Times are getting better. The worst of the depression is over. Thousands of new jobs will call for Trained Men. Let National help you.

**Special New Course—Radio Broadcast Technician**  
Given to students who enroll immediately. We broadcast over our own station. You learn to operate all kinds of latest equipment.

**EARN Room and Board**  
75% of our students are earning their living expenses while attending school now. We help you get a job. If you are short of money, write and explain your problem. We also allow your Coach Railroad Fare to Los Angeles. Send for Free Book

**NATIONAL RADIO & ELECTRICAL SCHOOL**  
Dept. RNS-4006 So. Figueroa St., Los Angeles, Calif.  
Please send me your big Free Book on Television, Talking Pictures, Radio and Electricity. Also details of R. R. fare offer.  
Name.....  
Address.....  
City..... State.....

## Graphs & Charts

(Continued from page 666)

Figure 1 is shown in the chart on Figure 3. The main chart was not made in this form because it requires a special tool to use it. Its simplicity, however, is so surprising that many of our readers may wish to make one.

In Figure 2 are shown two parallel lines which carry two different scales each. Therefore there are four variable quantities—a, b, c and d—measured off along two lines. A pair of division points of scales a and d are connected by a line PQ, and a pair of points

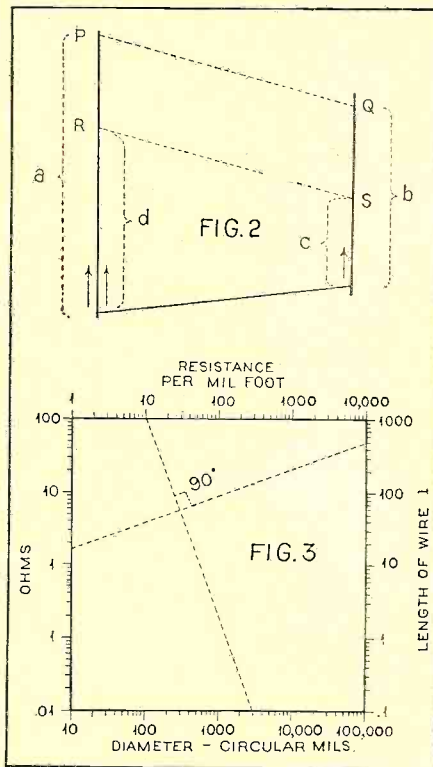

on the scales b and c are connected by a line RS, parallel to PQ. Then it is obvious that PR and QS are equal, and therefore

$$a - d = b - c$$

If a, b, c and d have been measured off on a logarithmic scale with the same modulus, then the relation between the four variables become

$$\log a - \log d = \log b - \log c \text{ or } \frac{a}{d} = \frac{b}{c}$$

This formula is of the same general form as the one shown earlier in this article.

When using a chart of this type, one must draw the two parallel constructional lines with a pair of triangles or with a parallel ruler. This difficulty can be avoided when the scales b and c are measured off on two lines which form a square, with the lines a and d. This is shown in Figure 3.

The relation between the four variables is now the same as in Figure 2 if the constructional lines are drawn perpendicular to each other. An easy way of using the chart is to mark two lines, perpendicular to each other, on a sheet of celluloid. The sheet can then be moved over the scales until three of the intersections of these lines with the scales correspond to the given values; the desired fourth quantity will then be found at the fourth intersection.

It is obvious that this method may be extended to more complicated formulas by making the figure a rectangle, but not a square, and by using a different modulus for the variables.

## Grid Glow Tubes

(Continued from page 659)

cessfully applied as a control of the grid-glow tube. The grid of the tube is connected through a condenser to the cathode thus preventing the tube from glowing under normal conditions. If high-frequency currents are allowed to pass through the gas in the tube, there will then be ionization, causing the grid to lose control and current will therefore flow from the anode to the cathode. This demonstrates the possibilities of using the grid-glow tube as a high-frequency relay. The circuit of a high-frequency relay is shown in Figure 7. The electrode external to the tube may be a band of tinfoil or metal around the glass. The oscillating system, that produces the high-frequency current, consists of a high-voltage transformer, a condenser and a gap. A coupling condenser excludes the commercial-frequency currents and voltages from the external electrode around the tube.

A high-voltage relay circuit is shown in Figure 8. An antenna that is located adjacent to the high-voltage line picks up a voltage by capacity coupling to this line. The voltage thus induced in the antenna is applied to the grid of the grid-glow tube. When a high voltage exists on the line, the grid-glow tube will glow, when no voltage is present the tube will be out. This serves as a high-voltage relay eliminating the use of a potential transformer. It should be noted that the action here is purely a relaying action and no quantitative measurements are made of the voltage or current in the line.

Time delay relays have been designed in many forms but few of them are as flexible as the type shown in Figure 9. The grid-cathode voltage in this circuit is furnished by the battery which slowly or rapidly charges the condenser C1 depending on whether the resistance R1 is small or large. When the condenser C1 becomes charged to the breakdown voltage of the grid-cathode gap in the tube, the main glow starts and the condenser is drained of its charge, rapidly or slowly, depending on whether R2 is large or small. By adjusting R1 the time interval between glowing periods may be made any desired value, and by adjusting the resistor R2 the time that the glow tube is "on" can be set. A high-grade paper or mica condenser, with low leakage, should be used. For time delays of a minute or two the value of C1 should be about 1 mfd. and the rheostats should be the variable 0 to 10-megohm type similar to those used for volume control on radio sets. The battery voltage should be about 350 volts. A good rectifier having negligible reverse-current flow (vacuum tube, mercury-vapor tube, or copper-oxide, bridge-circuit rectifier) can be used instead of the battery. A filter circuit is unnecessary.

The author wishes to express his appreciation of the assistance and cooperation of Messrs. D. D. Knowles, T. Draper and C. R. Smeltzer of the Westinghouse Electric and Manufacturing Co. in work on the circuits described.

## The Result of the Convention at Madrid

MADRID—The world radio conference here which was concluded recently, brought, besides many other important decisions, a change of the width of the broadcast band. The long-wave band, which used to cover from 160-225 kc. (1875-1340 meters), has now been widened to 265 kc. (1131 meters). The shorter wave-band could not be changed because it is too close to the "distress call" wave.

# Mathematics in Radio

(Continued from page 653)

it will be remembered that the following analyses is true:

$$\begin{aligned} 10^2 &= 100 \\ 10^1 &= 10 \\ 10^0 &= 1 \\ 10^{-1} &= .1 \\ 10^{-2} &= .01 \end{aligned}$$

Therefore,  $\frac{1}{10^2} = \frac{1}{100} = 10^{-2} = .01$ , and this

shows why  $\frac{1}{x^2}$  has been taken equal to  $x^{-2}$ .

Continuing, and remembering that  $\int v^n dv = \frac{v^{n+1}}{n+1}$

+ c, we have:

$$\int x^{-2} dx = \frac{2}{3} \left[ \frac{x^{-1}}{-1} + c \right] = -\frac{2}{3} \left[ \frac{1}{x} + c \right]$$

Answer.

Additional standard elementary forms are included as follows:

NOTE: Many of the examples here are taken from the following textbook, "Elements of the Differential and Integral Calculus," by W. A. Granville, published by Ginn and Company, New York.

- (4)  $f(du + dv - du) = f du + f dv - f du$
- (5)  $f \sin v dv = -\cos v + c$
- (6)  $f \cos v dv = \sin v + c$
- (7)  $f \tan v dv = \log \sec v + c$
- (8)  $f \cot v dv = \log \sin v + c$

Additional exercises are included for practice.

Integrate the following:

- (II) (a)  $\int (2x^2 - 5x^2 - 3x + 4) dx$
- (b)  $\int x^4 dx$
- (c)  $\int y^3 dy$

# With the Experimenters

(Continued from page 687)

centers and one placed on each side of the hole, connected by the bolt. The lead-in

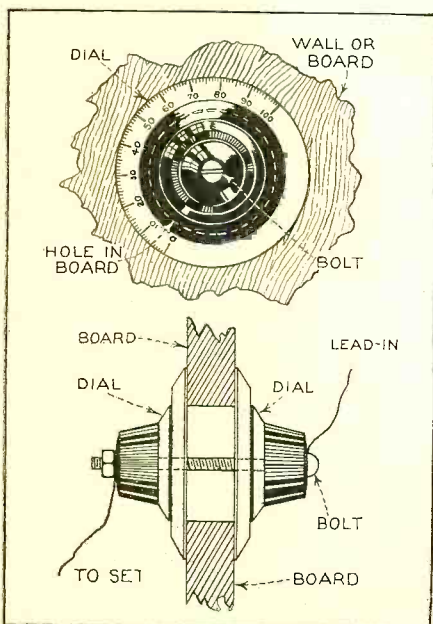

wires are then connected to the ends of the bolt, making a neat lead-in job.

HORACE B. GOSS,  
Essex, Conn.



## SERVICE MEN! GET YOUR COPY OF THIS RADIO BARGAIN BOOK!

Radio Servicemen who work for Profit and not for fun know that it pays to buy from WHOLESALE! For 12 years we have been guided by one policy—"Highest Quality at Lowest Prices." This policy has enabled us to become the world's largest organization of its kind and to give you values greater than ever!

### GREATEST VALUES IN OUR HISTORY!

Our new, 1933 Catalog is now ready for you . . . with the greatest array of values in our history. More than 10,000 Radio Bargains are listed in this 152-page Wonder Book! Anything and everything in Radio at prices which will enable you to do business profitably. Every Serviceman needs this "Directory of Radio Values!"

### EVERY LATEST DEVELOPMENT!

All the latest equipment of foremost manufacturers is listed. SETS, TUBES, SPEAKERS, REPLACEMENT PARTS, KITS, etc. Then there are featured sections on LAFAYETTE RECEIVERS, TRUTEST PARTS, PUBLIC ADDRESS; SHORT WAVE SETS, CONVERTERS, COILS and EQUIPMENT! No matter what you want we have it at prices which are amazingly low!

Get Your Free Copy by Sending the Coupon . . . NOW!



Wholesale Radio Service Co.  
100 Sixth Ave., New York, N. Y.  
Dept. N-53.

Gentlemen: I WORK FOR PROFIT--NOT FOR FUN. Please send me your 1933 Catalog of Radio Bargains.

Name.....

Address.....

Town..... State.....

**WHOLESALE  
RADIO SERVICE CO.  
100 SIXTH AVE.  
NEW YORK, N.Y.**



### AD-A-SWITCH is the Emergency Control!

With a skeleton stock of CLAROSTAT AD-A-SWITCH Controls over 70% of volume control replacements can be handled.

#### because

- one control can serve either for plain or switch type—
- the shaft is completely insulated from the contact arm—
- the combined length of shaft (with the mounting bushing) is 1 1/4"—sufficient to take care of most requirements—
- Standard Ad-A-Switch Controls are available in all tapers and electrical characteristics.
- AD-A-SWITCH is recognized and adopted as the only emergency Control rendering maximum service with minimum investment.

A helpful VOLUME CONTROL and RESISTOR GUIDE is available upon request. "AD-A-SWITCH" was originated by Clarostat

**CLAROSTAT Mfg. Co.**  
285-287 N. 6TH ST. BKLYN. N.Y.

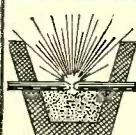

### 200 STUNTS

Electric Fun with 110 volts! How to make arc lights and furnaces, motors, obedient lights, alarms, and 195 other practical, mysterious and amusing devices. Book clearly explains how to do each stunt. Post-paid \$1.

CUTTING & SONS 53 B ST., CAMPBELL, CALIF.

## 2 GREAT BOOKS

THAT WILL BRING YOU MORE MONEY

No radio man should be without a pair of pliers or a copy of "Radio Servicing Course"—the one indispensable book on servicing by Ghirardi & Freed.

Radio schools everywhere use A. A. Ghirardi's "Radio Physics Course" as the textbook for their courses. You too can learn all about radio from it—at home! Complete! Easily understood! Up-to-date!



Send Now for FREE Folder

### MAIL THIS COUPON AT ONCE!

RADIO TECH. PUB. CO., Dept. R.N. 5,  
45 Astor Place, New York City.

We will send you a free illustrated circular describing the contents of these books in detail. Write your name below.

Name.....

(Write your street address, City and State in margin.)

### AUTOCRAT AUTO RADIO 6 TUBE

Quality—Tone—Selectivity & Power

Complete \$29.40—includes set, remote control, suppressor kit, tubes, mounting brackets, dynamic spk., antenna. Set only \$10.78. Also 4-5-6-Tube Midgets with latest tubes at low prices. Dealers wanted. Write today.

**AUTOCRAT RADIO CO.**

3855 N. Hamilton Ave., Dept. RN, Chicago, Ill



**New**  
—a Set-tested  
**AERIAL ELIMINATOR**  
Goes Right Inside Your Receiver

**\$1**  
An F. & H. Capacity Aerial Eliminator equals average 75-foot aerial, 50 feet high. Gives greater sensitivity and volume on both local and DX stations. Does away with outdoor aeriels, poles, guy wires, spoiled woodwork, lightning hazards, etc. No light socket connection, or current used in operation. Chosen for U. S. Naval Hospital use. Installed for any set by anyone in a moment. Concealed inside—permits moving set anywhere at will. Each tested on 1127-mile reception. At 8,000 dealers—or send coupon and \$1.00 or mark for C.O.D.

Complete  
POSTPAID

**F. & H. RADIO LABORATORIES**  
Dept. 21, Fargo, N. D.

Send one F. & H. Capacity Aerial for \$1.00 enclosed. Cash, Check or Money Order (C. O. D. if preferred). If after three days trial I am not satisfied you agree to refund my money. Check here if interested in our Dealer Proposition ( ).

NAME.....  
ADDRESS.....  
CITY.....STATE.....

**Information Wanted**

RADIO NEWS is considering the publication of a "Radio Scrap Book". Would you personally be interested in such a reference book, containing a list of short and long wave stations of the world with space for pasting special articles, QSL cards, etc.?

Send us a postcard telling the type of book you want us to publish and what reference data you would like us to include. Mail it to:

**CQ. Radio News**  
222 W. 39th St. New York, N.Y.

**YOUR DOLLAR IS Worth More at NUSSBAUM'S**

**Genuine BRUNSWICK SHORT WAVE CONVERTER**



Attach to your present radio for short wave reception... **\$6.95** Complete with TUBES Regular \$98.95

hear Rome, London, Police Calls, etc.

**Extraordinary Value! Genuine I. C. A. CONQUERER 6 TUBE**



Short and long wave radio for European and local reception... complete sets of coils for all wave bands from 14 meters up.

Complete with tubes and full set of S. W. coils, less speaker. **\$29.95**

**FOR AC, DC, AND BATTERY CURRENT**

Including power pack. Regular \$84.00

**RADIO INSURANCE**  
Cash refund within 24 hours if you are not entirely satisfied with your purchase.

**NUSSBAUM'S**  
61 Cortlandt St.  
New York City, N.Y.  
MAIL ORDERS PROMPTLY FILLED

# Treasure Prospecting

(Continued from page 652)

this apparatus are given in Figure 3. The single-turn loop coupled to the transmitter is connected to an antenna of a doublet type. Both sides of the antenna should be exactly the same length. They can be constructed, for example, of copper or brass rods which slide into each other so that they can be elongated. Each side of the antenna should be one-quarter of the wavelength used.

The best way for adjusting the antenna to the right value is through actual experiment. Readings should be taken of the signal picked up by the receiver, then after switching off the high voltage of the transmitter, the length of the antenna should be varied, and the transmitter turned on again. This process should be repeated until a maximum signal is received. Bakelite extension handles should be used on the tuning condensers.

Figure 5 is a front view of the panel on which all the apparatus are mounted. Figures 6 and 7 show how the antenna coupling coil is mounted against the inductance.

While these short radio waves are still relatively much too big to result in any appreciable reflection from the average size reflector, a certain focusing over shorter distances is possible with a plain parabolic reflector.

The doublet is placed for this purpose in the focus point of the plain parabolic reflector, which is, for instance, of sheet metal. While a real focusing of ultra-short waves can only be expected from wavelengths in the order of centimeters, a certain directional effect can be noticed from this type of outfit, which makes it possible to direct the main beam of radiation toward the ground.

The idea is that part of the radiation is reflected by ores with metal content, and is thus brought back to the receiver located some distance away, or that some parts of the deposits eventually act as resonators and thus radiate a secondary wave.

The receiver circuit is similar to the transmitter, as shown in Figure 8. It differs from the transmitter in that it contains -30 tubes instead of the -52 type tubes used in the transmitter. The diagram is self-explanatory. Types -12 and -99 tubes can be used instead of the -30 type tube, however, if desired. A constructional diagram is given in Figure 9. While the foregoing covers the investigation of areas which are relatively large, we will now discuss the equipment for the location of smaller metallic objects.

Time and again hints have been spread

about hidden treasures below the ground, and once in a while an actual discovery is made. While great care must be taken in the critical consideration of these rumors, only a very small percentage of which may be based upon actual truth, the fact remains that treasures have been again and again discovered. Almost every community has its rumor of hidden treasure.

Now these objects have usually only a relatively small volume. For instance, a pot of gold pieces would not equal even one cubic foot of gold at the most. To discover such pieces, methods must be resorted to which are better suited. All of these methods can more or less be traced back to the inductance balance which was invented as early as 1841 by Dove. The principles of its appearance, after it was perfected in 1879 by Hughes, is shown in Figure 10.

In principle, it consists of the following: The transformer, Tr, has two primary coils, one exactly like the other, but wound oppositely, as shown in the diagram as P1 and P2. The technical expression for this is "differential-wound transformer." In the exact center of these two windings, alternating current is supplied, for instance, from the buzzer, B. As any lines of force induced

## INDEX TO ADVERTISERS

Aerovox Corp.	694
Alden Products Co.	704
Allied Radio Corp.	700
Amperite Corp.	697
Autocrat Radio Co.	701
Baltimore Radio Corp.	699
Banner Radio Co.	695
Candler System Co., The	697
Capitol Radio Engineering Inst.	704
Central Radio Laboratories	703
Clarostat Mfg. Co., Inc.	701
Coast-to-Coast Radio Corp.	697
Coyne Electrical School	695
Cutting & Sons	701
Classified Advertising	703
Electrad, Inc.	695
Evans & Co., Victor J.	690
F & H Radio Laboratories	702
Federated Purchaser, Inc.	690
Fordson Radio Mfg. Corp.	691
Hammarlund Mfg. Co.	693
Harrison Radio Co.	690
Hoodwin Co., Chas.	698
International Resistance Co.	691
Irving-Vance Co., The	699
Lynch Mfg. Co., Inc.	688
Mellaphone Corp.	698
Metal Cast Products Co.	698
Midwest Radio Corp.	689
Miller & Miller	690
National Co., Inc.	697
National Radio & Electrical School	700
National Radio Institute	641
National Union Radio Corp.	683
Nussbaum's	702
Ohio Carbon Co., The	700
RCA Institutes, Inc.	691
Radio Technical Pub. Co.	701
Radio Trading Co.	689
Radio Training Ass'n of America	688
Radio Treatise Co., Inc.	694
Radolek Co.	703
Readrite Meter Works	687
Remington Radio & Electric Corp.	694
Rim Radio Mfg. Co.	704
Rosicrucian Brotherhood	693
Ross, Malcolm G.	693
Scott Radio Labs., Inc., E. H.	641
Shallcross Mfg. Co.	699
Silver, Inc., McMurdo	Fourth Cover
Sprayberry, F. L.	690
Teleplex Co.	698
Trimm Radio Mfg. Co.	689
Try-Mo Radio Co., Inc.	694
Universal Microphone Co., Ltd.	688
Webster Co., The	693
West Side Y.M.C.A. Radio Inst.	699
Weston Electrical Instruments Corp.	685
Wholesale Radio Service	701

### MAY, 1933

Technical Information Coupon  
RADIO NEWS Laboratory  
222 W. 39th Street  
New York, N. Y.

Gentlemen:

Kindly supply me with complete information on the attached question:

- I am a regular subscriber to RADIO NEWS, and I understand this information will be sent me free of charge.
- I am not yet a subscriber to RADIO NEWS.
- I wish to become a subscriber to RADIO NEWS, and enclose \$2.50 to receive the magazine regularly for one year, and to receive this valuable technical information service free of charge.

Name.....  
Address.....



in the iron core, F, of the transformer from one winding, P1, would be counteracted by the other winding, P2, an electromagnetic force can be induced in the secondary, S, only if part of the field near these coils or a "prolongation" of them, the big coils, C1 and C2, is distorted.

The coils C1 and C2 consist of 125 turns of double-silk-covered enamel wire, No. 24. They are three feet square and no metal is to be used in making their base.

If, for example, one part of the winding is brought out in the form of the coil, C1, and a small metal piece, M, is within this coil, while in the equivalent coil, C2, there is no metal piece, the equilibrium of this Hughes bridge will be distorted and a sound signal will be induced in the secondary, S, of the transformer, which can be heard in the telephone, T.

Once silence has been attained by moving the slide-wire contact, D, between the coils C1 and C2 and by calibrating the distance of the service coils V1 and V2, the slightest change in inductivity around the field of one of the coils will immediately start considerable noise in the earphones. An improved type of Hughes inductance balance which uses a potentiometer, D, for establishing equilibrium is shown in Figure 11.

In one of my earlier articles I have already shown how beat notes can be produced by slightly detuning one part of two almost equal oscillators.

In Figure 12 such an instrument is shown schematically. Instead of the differential-wound transformer that was used in the wiring diagrams of Figures 10 and 11, we have here two almost equal oscillating circuits in which -99 type tubes are used and all the individual parts are shielded. The field coils C1 and C2 may be wound of No.

22 d.s.c. wire on fibre or wooden forms about 15 inches square. The coils must be wound in the same direction.

For avoiding the necessity of carrying the batteries or the apparatus, a task which heretofore often made it necessary to have the equipment carried by two or more investigators, all the instruments can be mounted in an automobile. The exploring

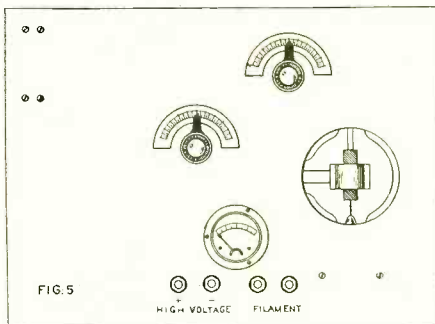

coils are mounted on a hinged frame which, when in use, protrudes from the running-board of the car. The driver or the operator carries the earphones on his head and directs the car over the terrain to be studied. A difference of conductivity under the ground can be readily located with this type instrument, whether it is caused by hidden treasure, by buried pipe lines, by an underground stream, etc.

## What's New in Radio

(Continued from page 694)

the tubes now on the market. There are spare sockets for four, five, six and seven-prong tubes, ready to connect to the terminal board whenever new tubes become available.

Maker—Weston Electrical Instrument Corp., Newark, N. J.

## The Service Bench

(Continued from page 685)

three steps, from right to left. The brass cap from the carbon of an old dry-cell is the main contribution to the idea. The flange



is cut away, leaving a flat disc, with machine screw and nut. The disc may be sweated to any desired flat surface or merely soldered neatly around the edge.

## Two New Tubes

(Continued from page 663)

The effect of  $R_2$  upon the primary resistance is a function of the percentage of critical coupling. In view of this effect, the extent of non-resonant frequency attenuation is proportional to the ratio of  $Z_0/Z_1$ , which in

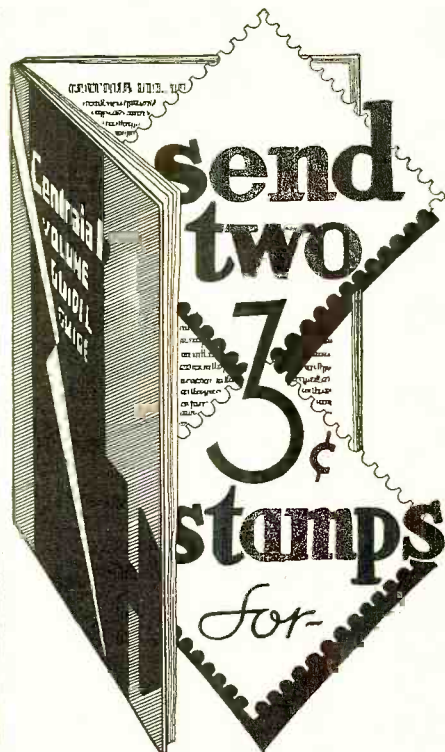

## the New 50c Centralab Volume Control Guide

Thousands of these new Guides are now doing signal service... in helping servicemen to do a more efficient and satisfactory replacement job... with, of course, added profits.

Send for the Centralab Guide on your stationery Address Dept. B

**Centralab**  
CENTRAL RADIO LABORATORIES, Milwaukee

## Read Classified Advertising—It Pays

Advertisements in this section twenty-six cents a word for each insertion. Name and address must be included at the above rate. Cash should accompany all classified advertisements unless placed by an accredited advertising agency. No advertisements for less than 10 words accepted. Objectionable or misleading advertisements not accepted. Advertisements for these columns should reach us not later than 1st of 2nd month preceding issue. **TECK PUBLICATIONS, INC.** 222 West 39th St. New York, N. Y.

### Correspondence Courses

USED Correspondence Courses and Educational Books sold or rented. Inexpensive. Money-back agreement. Catalog listing 3000 bargains—FREE. (Courses bought). Lee Mountain, Piscola, Alabama.

### Inventions

INVENTIONS, COMMERCIALIZED. Patented or unpatented. Write, Adam Fisher Mfg. Co., 278 Enright, St. Louis, Mo.

### Microphones

SENSATIONAL MICROPHONE VALUE—Universal Model "Y"—Experimenters Single-button, waltz model type. 200 ohms. Pure Gold Spot Center Diaphragm. Only \$2.00, including valuable 1933 General catalog with diagrams. Universal Microphone Co., Ltd., Inglewood, California.

### Patents

PATENT Your idea now. Send for free book, "How to Obtain a Patent," and free "Record of Invention Blank." In business since 1898, specializing in patent matters, we have successfully served thousands of inventors. Little ideas may have big commercial possibilities. Delays are dangerous in patent matters—act at once and protect your ideas. Reasonable fees. Convenient terms. Write us today. Victor J. Evans & Co., 649 E. Victor Bldg., Washington, D. C.

PATENTS—Advice and booklet free. Highest references. Best results. Promptness assured. Watson E. Coleman, Patent Lawyer, 724 9th Street, Washington, D. C.

PATENTS, TRADE MARKS—All cases submitted given personal attention by a member of the firm. Information and booklet free. Lancaster, Alvine & Rommel, Suite 414, 815 15th St., N. W., Washington, D. C.

### Pocket Radios

GUARANTEED "Pocket Radio," \$2.00. Catalogue, 10c. Neil Tasker, Shamokin, Pennsylvania.

### Song, Poem Writers

SONG WRITERS WANTED Now. 50-50 Plan. Indiana Song Bureau, Salem, Indiana.

### Radio Instruction

CANADA'S OLDEST and best equipped radio school offers complete course covering Radio, Television, Sound Amplification, etc. Approved by leading radio manufacturers. No duty or exchange to pay. Radio College of Canada, Limited, 310 Yonge St., Toronto.



The Most Complete and Up-to-date Radio Parts Guide Ever Compiled

FREE To Radio Servicemen, Engineers and Mfrs.

Learn what's NEW IN RADIO! Get our Heibold suggestions for making more PROFITS from Radio Service Work! SAVE MONEY by getting our new WHOLE-SALE PRICES! The NEW RADOLEK PROFIT GUIDE contains in addition to the largest selection of standard Replacement Parts, dozens of Diagrams, Charts and Tables which you have need for every day and it is FREE for the asking if you will enclose your business card or letterhead with the coupon below and mail to

**THE RADOLEK CO.**

231 Canal Station CHICAGO

Clip this Coupon

Send Me the New Radolek Profit Guide.

Name.....  
Address.....  
City.....State.....  
Do You do service work? Yes  No   
Do You operate from Shop  or Home   
What Testing Equipment have You?.....  
What Experience or Training?.....

# SERVICEMEN.... Here Are Your Latest Needs

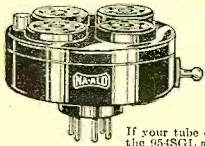

**Get this Adapter to Modernize Your Tube Checker**  
950XYL Universal Tube Checking Adapter tests over 80 NEW TUBES. No wires—no leads—no jacks—very simple to operate—Circuit diagram and directions chart listing over 80 NEW TUBES with spaces for recording readings of these and future tubes supplied with all orders.  
List Price \$6.00

If your tube checker has no filament-voltage switch, the 954SGL adapter must be used on the base of the 950XYL.  
954SGL—UY top—UX bottom—with C. G. lead. List Price \$1.25

**Equip Your Analyzer With This Plug and Bring It Up to Date**  
DIAGRAMS AND DIRECTIONS SENT FREE WITH ALL ORDERS.  
907WLC Famous Ni-Alc Latch Lock Analyzer Plug with Twin C. G. Handle and five feet of 8 wire cable attached.  
907WLC (as described) List Price \$5.50  
907WLC (as illustrated) List Price \$3.50

The 907WLC basic plug fits the 59 seven prong tube socket. For UX 4 hole sockets, the 974DS adapter is snapped onto the plug; for UY 5 hole sockets, the 975DS is used; for six contact sockets, the 976DS and for the new small size 7 contact sockets, as used for the 2A7, 2E7, etc., tubes the 977DS adapter is required. All of the above four: 974DS, 975DS, 976DS and 977DS Associate Adapters. List Price \$1.25 each

**Replace Your Obsolete Sockets With These Latest Composite Sockets**

- 456E replaces sockets requiring a 1-3/8" panel hole and 1 1/2" mounting hole spacing—receives 4, 5 and 6 prong tubes—Filament circuit common—all others isolated—has nine contacts. List Price \$6.00
- 477E matches above but receives both the 59 type 7 pin tube and the new small size 7 pin tubes like the 2A7, 2E7, 6A7 and 6B7. List Price \$6.00
- 477E similar to 477E but for receiving regular 7 prong tubes only. List Price \$4.10
- No. 456 5 and 6 hole socket .50
- No. 477 Regular and small 7 socket .50
- No. 437 Regular 7 pin tube socket .35
- No. 438 6 contact socket .25
- No. 425 9 contact socket .25
- No. 424 4 contact socket .25

**Treat Your Output Meter to This Adapter**  
This 9PL Output Meter Adapter contacts the plate prong of 4, 5, 6 and 7 prong tubes whether having a small or regular base—Insulated for use in the new close fitting shielded sockets and equipped with a serviceable 5 foot lead. 9PL. List Price \$3.00

**Here's the Quickest, Lowest Cost Method of Modernizing Your Analyzer**

965DW Enables any analyzer which can test 24 circuits to test the new 8 prong tube circuits.  
965DW List Price \$2.50 965DSW Same with locking stud. List Price \$2.50.  
975DW Enables any analyzer which can test 24 circuits to test the 7 prong tube circuits.  
975DW List Price \$3.00. 975DSW Same with locking stud. List Price \$3.00

Send for free catalog sheets showing all kinds of sockets, plugs, connectors, coil forms, etc., or send a dime for the Ni-Alc Adapter Data Sheets showing diagrams of over 300 different adapters including directions for modernizing the set analyzers, new tube connections, etc.

**ALDEN PRODUCTS COMPANY**  
715 Centre Street  
Dept. "N" Brockton, Massachusetts

turn depends upon the departure from resonance as expressed by

$$\left[ 1 - \left( \frac{\omega_0}{\omega} \right)^2 \right]^2$$

$$\alpha = \frac{R_1}{\omega L_1} + \frac{\omega M}{r_p}$$

where  $R_1 = R_1 + \frac{\omega M}{R_2}$

For a given resonance curve and assuming that  $r_p$  is infinite, the ratio of  $Z_o/Z$  decreases as  $R_1/L_1$  becomes greater. This results in a broad resonance curve which limits the attainable attenuation. Sharpness of primary resonance is therefore a requisite for a large attenuation by means of  $r_p$  variation. This can be obtained by making the coupling substantially less than critical.

Figure 3 shows computed and measured values illustrating these effects. A representative i.f. transformer having loose coupling and the following primary circuit characteristics was employed in obtaining the data: Resonant frequency, 175 kc.; inductance, 4.72 millihenries; capacitance, 175 microfarads; resistance,  $R_1$ , 135 ohms and resonant impedance  $Z_o$ , 200,000 ohms. From Figure 3 it is evident that primary circuit attenuations of the order of 3 to 4 db. are obtainable at 3000 or 4000 cycles within the normal range of  $r_p$  variation.

Figure 4 shows the performance curve of a superheterodyne receiver having one r.f. stage and two i.f. stages, one of the latter being fidelity controlled. In this case the variation in overall response is shown to be 3 db. (at 3000 cycles) and 6 db. (at 5000 cycles).

The range of attenuation may obviously be increased or decreased by the choice of appropriate transformer couplings and impedances. The transformer used for these tests were not designed especially for this purpose and consequently the results do not illustrate the maximum possibilities of the described circuits.

low value of leakage reactance is required in the grid circuit to avoid excessive amplification of small amounts of higher-frequency distortion components.

The use of an input transformer with less step-down ratio will accomplish two things: it will reflect the plate circuit of the driver as a greater resistance in the grid circuit, thus cancelling a part of the third-harmonic distortion. It also causes the grid circuit to be reflected into the driver plate circuit as a lowered load resistance. More power is obtained with a lower load for the driver, but the second-harmonic distortion from the driver is increased.

Usually not more than 2 percent second-harmonic distortion can be tolerated from

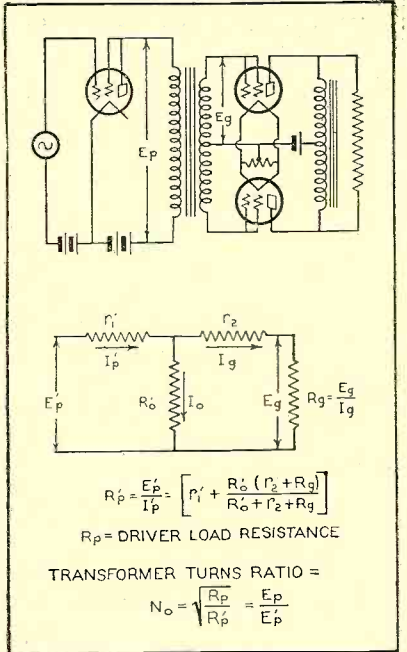

FIGURE 10. CLASS B CIRCUIT

### The Application of the -46

Figure 5 represents the plate-voltage, plate-current curves of the tube. Load lines have been drawn for 5 different loads. In Figure 6 the power output and third-harmonic distortion of these loads are plotted against peak signal voltage. From these curves it is seen that load 3 gives maximum power output and less distortion than any of the other loads for the maximum signal voltage (45 volts). For lower voltages (below 37 volts), load 4 might be more suitable.

Briefly stated, the lower the power of the driving source and the smaller the maximum signal voltage delivered to the Class B tubes, the larger will be the value of load impedance required for maximum output with minimum distortion and vice versa.

Thus far we have not considered the effect of the impedance in the grid circuit. Considering the effect of the plate load on the grid characteristics, loads 4 and 5 of Figure 5 cause higher grid current than loads 3 and 2. The difference between loads 3 and 2 is not great enough to determine the load. (See Figure 7.)

There is still another factor which has an appreciable effect on the choice of the proper load. With a resistance in the grid circuit, the third-harmonic distortion (due to the upward curvature of the grid-current curve) appears in the plate circuit in opposite phase to the distortion caused by the upward curvature of the plate-current curve. Distortion measurements with resistances of 41 ohms, 221 ohms and 521 ohms in series with each grid lead show that an appreciable reduction in distortion results from the resistance in the grid circuit. It should be noted that leakage reactance will shift the phase and prevent cancellation of the distortion voltage. Also, the impedance of the leakage reactance is higher for higher frequencies. A

the driver tube. This generally requires a load on a triode driver tube of 3 to 4 times the plate resistance of the tube. A load somewhat lower can be used with a push-pull driver.

Figure 8 shows the load line for the grids of the type -46 Class B tubes (and transformer losses) reflected on the plate characteristics of a type -46 tube used as the driver. The load line is curved, due to the curvature of the grid-current curve. The input-transformer ratio, from primary to one-half the secondary, was 2.44 to 1.

The peak power output multiplied by the peak transformer efficiency gives the power available at the grids of the Class B tubes. From this and the characteristics in Figure 5 a suitable load can be chosen.

In order to facilitate the choice of plate load which will give maximum power with approximately 5 percent total distortion, curves have been made showing the approximate values of the plate load, power output and peak grid resistance versus peak grid power (see Figure 9).

The peak grid power is equal to the product of maximum, instantaneous grid voltage to the maximum, instantaneous grid current.

The plate load per tube is one-fourth of the load resistance effective from plate to plate of the output tubes.

### DX Receiver Design

(Continued from page 657)

the chassis may be reduced to two feet, but with an appreciable sacrifice of efficiency. If the builder desires the utmost in results, he will do well to adhere to the larger dimensions.

**have you heard...**

- **ABOUT** the **FIRST Residence School for Practical Radio Engineering** offering thorough **Practice and Theory, without requiring 4 years of college engineering?**
- **ABOUT** the **new complete residence course PLUS the famous home study plan, which enables the student to study intensively at home with follow-up laboratory work on actual equipment?**
- **ABOUT** the **finest working equipment and capable staff of instructors?**

Send for **NEW CATALOG** Just Off the Press

**CAPITOL RADIO ENGINEERING INST.**  
14th and Park Road, Washington, D. C.  
Dept. R.N.-5

**The New EXPLORER**  
**SHORT WAVE**  
**Receivers and Kits**

Announcing the 1933 EXPLORER series of receivers and kits, designed to provide world-wide short wave reception with utmost economy of cost and operation.

- One Tube Receiver—\$5.00; Kit—\$4.25
- Two Tube Receiver—\$6.50; Kit—\$5.50
- Three Tube Receiver—\$8.95; Kit—\$7.50

Receivers shipped with beautiful walnut-finish, hinged cover cabinets at \$1 additional.

Any receiver or kit sent C.O.D. on receipt of \$1. Wave length range, 15 to 210 meters. Adaptable for broadest band reception. Despite their remarkably low price, the EXPLORER receivers use only standard parts of the highest quality. Designed in every respect for greatest efficiency, they incorporate carefully worked out refinements of circuit and design to assure real sensitivity, and plenty of reserve power for exploring the world from your own easy chair.

For complete description and information **SEND POSTAGE FOR FREE CATALOG**  
**RIM RADIO MFG. CO.** 695 Grand Street  
Brooklyn, N. Y.

# Keep Apace With Radio

## Read Radio News Every Month!

EVERY radio man recognizes the importance of keeping abreast of new developments in radio. Month by month the panorama is changing—new ideas spring up—new circuits are created—new tubes are designed—new stations are licensed—new, hitherto-impossible feats are accomplished!

In order to keep apace with radio, you need a thoroughly reliable, comprehensive publication. *Radio News* fills this need for tens of thousands of radio men. You can't afford to miss a single issue!

### Free Technical Service

If, at any time, you come across a problem in radio work that you cannot solve for yourself, simply clip the coupon for free technical information included in every issue of *Radio News*, attach it to a letter stating your particular problem, mail it to *Radio News*, and you will receive the desired information *absolutely free of charge*.

### Free Books for Subscribers

In line with its policy of giving its subscribers the greatest amount of value, authoritative reference books on various phases of radio are given *free* with subscriptions. Keep up with radio—subscribe to *Radio News* now—and pick your choice of any one of the books offered on this page—they will be sent *free* with a 5-month subscription for \$1 or an 11-month subscription for \$2.

***This Coupon Is For Your Convenience  
Mail It At Once!***

RADIO NEWS  
222 West 39th St.  
New York, N. Y.

Enclosed find \$..... Enter my subscription for ..... issues of *Radio News* and send me a free copy of ..... (If renewal check )

Name.....

Address.....

City..... State.....

Canada & Foreign, \$1.50—5 issues.  
Canada, \$2.50; Foreign, \$3—11 issues.

5B



## Any One of These Books Free With a Subscription for Radio News

### Radio Experimenters' Hand Book

Every radio fan should have a copy of this new 136-page book. It has chapters on: Electrical Measurements; Resistance, Inductance and Capacity Measurements; Design of Radio Components; Circuit Design; Short-Wave Essentials; Photo-Electric Cell Applications; Shop Notes; Antenna Experiments; Experimental Circuits in Radio and Electronics; and Miscellaneous Radio Experiments. You need this book at your work-bench!

### 101 Radio Hook-Ups

To the experimenter, student, serviceman or fan, this book offers a strong appeal. It includes circuits highly popular among experimenters and others who prefer to "roll their own," circuits of short-wave receivers and transmitters, hook-ups of various auxiliary devices, including audio amplifiers, power supply units and servicemen's test equipment, and a large number of circuits of standard manufactured receivers.

### How to Make Money in Radio Servicing

This 130-page book was written by Zeh Bouck especially for *Radio News*. It gives real, practical suggestions for profits in radio servicing and contains information on the following subjects: Equipment; Contacts; Advertising and Publicity; Circularization; Service Procedure; The Service Salesman; Off-Season Business; Service Sidelines; The Business End of Servicing; How to Buy; and Keeping Up-to-Date. For profits—read this book!

# Radio News

222 West 39th Street

New York, N. Y.



# McMURDO~SILVER

## THE ONLY CUSTOM-BUILT RECEIVER OFFERED FOR 10 DAY TRIAL

No strings to this offer. Try the Masterpiece 10 days. Keep it if you like it . . . or send it back for prompt refund.

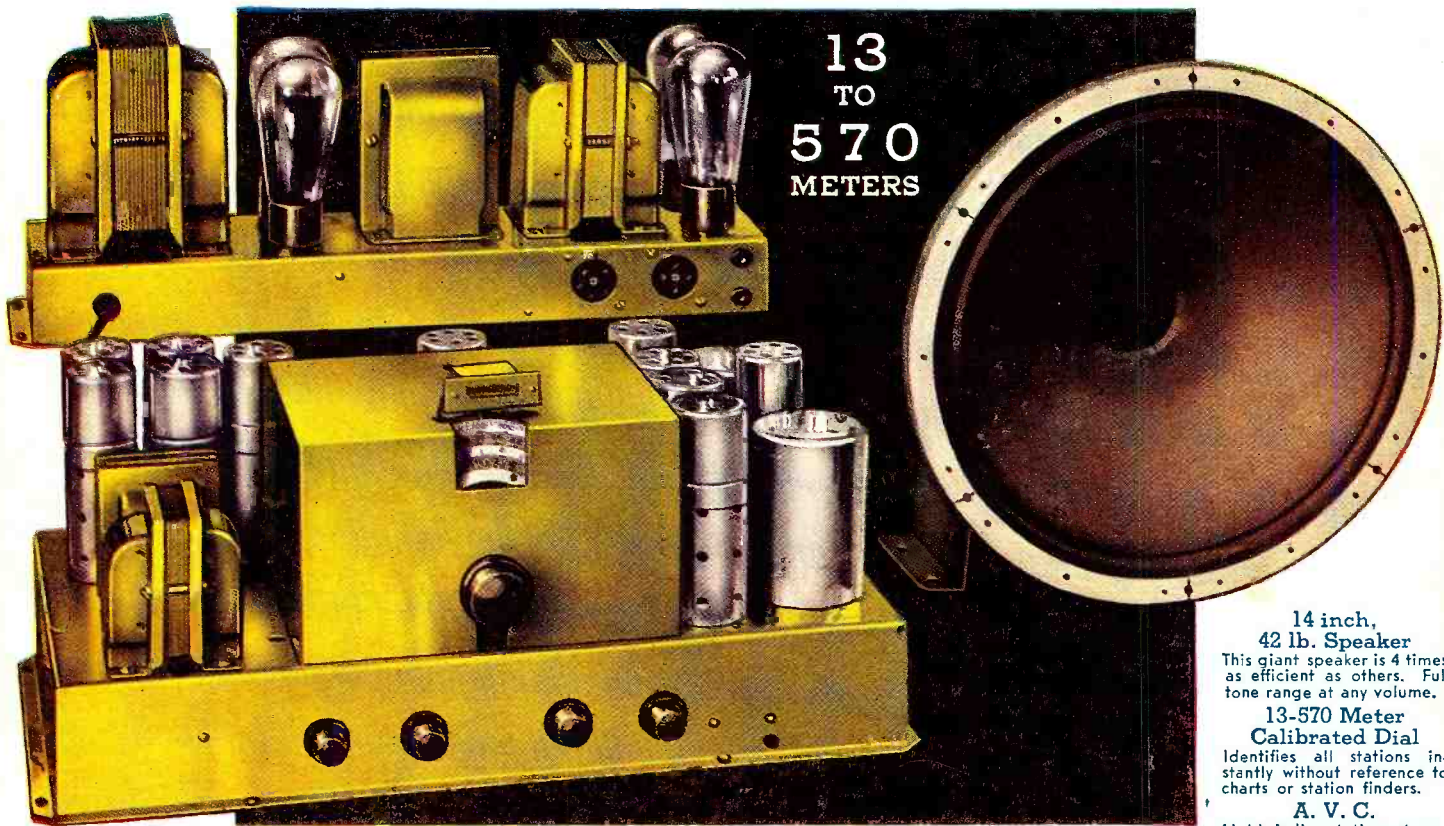

13  
TO  
570  
METERS

14 inch,  
42 lb. Speaker  
This giant speaker is 4 times as efficient as others. Full tone range at any volume.

13-570 Meter  
Calibrated Dial  
Identifies all stations instantly without reference to charts or station finders.

A. V. C.  
Holds fading stations at constant volume.

Manual and Automatic Tone Control  
Gives any desired interpretation of musical programs at any volume.

Meter Tuning  
Permits micrometrically accurate tuning.

Noise Squelch Circuit  
Cuts out all inter-station noise at the turn of a knob.

Audio-Beat Oscillator  
The throw of a switch makes very low-power foreigners easy to find.

Individual Curves  
Personally made by myself on your own set, which they accompany.

Accurately Logged  
On at least 3 European or Asiatic stations in final test.

**N**OW is the best time for European reception. But, you don't want to spend your money for an All-wave receiver until you KNOW, beyond all doubt, that the receiver you intend to buy will *fully* meet your expectations, and will actually give you the reception you hope to get. You are right. You should not be asked to gamble. Yet the Masterpiece is the only receiver you can buy, *without* gambling. The Masterpiece is the *only* custom-built radio in the world whose maker *knows* it to be so fine that he dares offer it to you for a ten day free trial in your own home, with only *you* to be the judge if it is satisfactory in every way before you decide it's the set you want. Good? The Masterpiece has got to be good to justify such a guarantee!

This is the most daring offer ever made by a maker of custom-built receivers. 10 day free trial! 10 days in which to prove to yourself, by any kind of test you can conceive of, right in your own home, that The Masterpiece is the finest All-wave receiver made today.

London, Paris, Berlin, Madrid, Lisbon and other foreigners are coming in at their best now—with excellent volume and clarity. You want to hear these stations clearly, distinctly . . . each word, each note sharply defined . . . exactly as though you were there. Hear them *that* way with The Masterpiece—on trial!

Send 6c in stamps for my 16-page book giving complete technical description of the Masterpiece and its many new and outstanding operating and performance features. Full details of my offer will be included. Please use the coupon from this announcement.

McMURDO SILVER INC.  
1130 W. Austin Ave., Chicago.  
Six cents in stamps enclosed. Send me your book giving full technical details and performance facts on The Masterpiece.  
Name .....  
Street .....  
Town..... State.....

**McMURDO SILVER INC.**  
1130 West Austin Avenue  
Chicago, U. S. A.