

AIDS FOR THE DEAF

RADIO NEWS

**December
25 Cents**

**New
"Wire-Less"
Antenna**

**Servicemen's Data
80 Meter Transmitter
200-2000 Meter Super**



LEWIS & CLAY

SM AROUND the WORLD with the All-Wave SILVER-MARSHALL 726SW

In the 726SW there is available a combination of the very latest and most modern superheterodyne broadcast and short-wave designs on one chassis.

In the 200 to 550 meter band, the 726SW is a nine-tube vario-mu pentode superhet employing nine tuned circuits. One precedes the '51 r.f. stage, a second is before the '24 first detector, and another with the '27 oscillator. The two tuned circuits ahead of the first detector, coupled with the '51 vario-mu tube, absolutely eliminate all cross-talk or image frequency interference. The two-stage i.f. amplifier, using '51 tubes, has a total of six tuned circuits (three dual tuned transformers) which definitely assures uniform and absolute 10 kc. selectivity at short or long waves.

A '27 second linear power detector feeds a compensated push-pull '47 pentode audio stage delivering from 5 to 7 watts undistorted power output, and in turn feeds a specially compensated electro-dynamic speaker unit.

The broadcast sensitivity ranges from less than one-half to seven-tenths of one microvolt per meter—so great that every station above the noise level can be tuned in easily. The selectivity is absolute 10 kc., and in any large city distant stations on channels adjacent to locals can be readily tuned in. From 60 to 100 different stations can be logged almost any night in any fair location.

The short-wave end of the 726SW is the dream of old—a true eleven-tube superhet using "double-supering" on not one, but two, intermediate frequencies. Yet it has but one dial—plus a non-critical trimmer! For short-waves, a '24 first detector and '27 oscillator ganged together are added by a turn of a switch, which selects between short-wave and broadcast band reception. A second selector switch chooses between four ranges (from 10 to 200 meters) at will—and all without a single plug-in coil.

The sensitivity, selectivity on short-waves are exactly equal to the broadcast band—giving thousands of miles of range.

Tubes required: 2-'24's, 3-'27's, 3-'51's, 2-'47's, 1-'80.

726SW All-Wave Superheterodyne, complete as described above, wired, tested, licensed, including S-M 855 electro-dynamic speaker unit. Size 20½" long, 12" deep, 8½" high. To be used on 110-120 volt, 50-60 cycle AC power. Price \$139.50 LIST.

SILVER-MARSHALL, Inc.
6405 West 65th Street • Chicago, U. S. A.
Canadian Division: SILVER-MARSHALL of CANADA, Ltd.
75 Sherbourne Street, Toronto
Export Office: 41 Water Street
New York City, U. S. A.



All in the 726SW

- Nine-Tube Broadcast Super
- Eleven-Tube Short-Wave Super
- Built-In Coils
- Pentodes in Push-Pull
- Three Vario-Mu Tubes
- Sensitivity Between .45 and .7
- Selectivity Absolute 10 kc.
- 10½" Electro-Dynamic Speaker

SILVER-MARSHALL, Inc.
6405 W. 65th Street, Chicago, U. S. A.

Please send me full details on the S-M 726SW (enclosed you will find 2c).

Please send me FREE your new General Parts Catalog.

Name

Address

Train *with* R.T.A. *for* Radio Service Work

Important and far-reaching developments in Radio creates sudden demand for specially equipped and specially trained Radio Service Men.



*This excellent
set analyzer
and trouble
shooter included
with our course
of training*

MANY skilled Radio Service Men are needed now to service all-electric sets. By becoming a certified R. T. A. Service Man, you can make big money, full time or spare time, and fit yourself for the big-pay opportunities that Radio offers.

We will quickly give you the training you need to qualify as a Radio service man . . . certify you . . . furnish you with a marvelous Radio Set Analyzer. This wonder instrument, together with our training, will enable you to compete successfully with experts who have been in the radio business for years. With its help you can quickly diagnose any ailing Radio set. The training we give you will enable you to make necessary analysis and repairs.

Serving as a "radio doctor" with this Radio Set Analyzer is but one of the many easy ways by which we help you make money out of Radio. Wiring rooms for Radio, installing and servicing sets for dealers, building and installing automobile Radio sets, constructing and installing short wave receivers . . . those are a few of the other ways in which our members are cashing in on Radio.

As a member of the Radio Training Association, you receive personal instruction from skilled Radio Engineers. Upon completion of the training, they will advise you personally on any problems which arise in your work. The Association will help you make money in your spare time, increase your pay, or start you in business. The easiest, quickest, best-paying way for you to get into Radio is by joining the Radio Training Association.

This amazing Radio Set Analyzer plus the instructions given you by the Association will transform you into an expert quickly. With it, you can locate troubles in all types of sets, test circuits, measure resistance and condenser capacities, detect defective tubes. Knowing how to make repairs is easy; knowing what the trouble is requires expert knowledge and a Radio Set Analyzer. With this Radio Set Analyzer, you will be able to give expert service and make big money. Possessing this set analyzer and knowing how to use it will be but one of the benefits that will be yours as a member of the R. T. A.

Write for No-Cost Membership Plan

We have worked out a plan whereby a membership enrollment need not cost you a cent. Our thorough training and the valuable Radio set analyzer can be yours. Write at once and find out how easily both of these can be earned.

Now is the time to prepare to be a Radio Service Man. Greater opportunities are opening up right along. For the sake of extra money in your spare time, bigger pay, a business of your own, a position with a future, get in touch with the Radio Training Association of America now.

Send for this No-Cost Membership Plan and Free Radio Handbook that will open your eyes as to what Radio has in store for the ambitious man. Don't wait. Do it now.

RADIO TRAINING ASSOCIATION OF AMERICA
Dept. RNA-12 4513 Ravenswood Ave. Chicago, Ill.

Fill Out and Mail Today!

RADIO TRAINING ASSOCIATION OF AMERICA
Dept. RNA-12, 4513 Ravenswood Ave., Chicago, Ill.
Gentlemen: Send me details of your No-Cost Membership Enrollment Plan and information on how to learn to make real money in radio quick.

Name.....

Address.....

City..... State.....

S. GORDON TAYLOR
Technical Editor

WILLIAM C. DORF
Associate Editor



RAYMOND J. KELLY
Associate Editor

JOS. F. ODENBACH
Art Editor

Edited by LAURENCE M. COCKADAY

VOLUME XIII

December, 1931

NUMBER 6

CONTENTS

(Cover Design by Morcy)

Radio in the African Jungle By Clyde de Vinna.....	PAGE 459	Radio Equipment on the DO-X By Myron Eddy.....	PAGE 478
W.A.B.C.'s New "Wire-less" Antenna By Frederick Siemens.....	PAGE 462	Power Transformer Design for the Home Experimenter By George E. Fleming.....	PAGE 480
Controlling Trains with Light Rays By Irving J. Saxl.....	PAGE 464	RADIO NEWS Designs a New Amateur Transmitter By Nat Pomcranz.....	PAGE 482
Telephony on a Light Beam By E. E. Free.....	PAGE 466	Poland Inaugurates Long-Wave Super- Power Broadcasting By J. Plebanski.....	PAGE 484
The Vacuum Tube Aids the Deaf By S. Gordon Taylor.....	PAGE 468	An Economical Eleven-Tube Superhetero- dyne Design By W. A. Smith.....	PAGE 485
A 200-2000 Meter Receiver Design By McMurdo Silver.....	PAGE 469	The International Six By Allan C. Bernstein.....	PAGE 487
Assembling Your Own Home Recorder By S. M. Riccobono.....	PAGE 471	Reducing Noise in Talking-Picture Film By Barton Kreuzer.....	PAGE 489
Solution of the City Antenna Problem By John M. Borst.....	PAGE 473	Mathematics in Radio By J. E. Smith.....	PAGE 491
Marine Radio Telephony By Andrew R. Boone.....	PAGE 475		
Latest Example of Tuned R.F. Design By Glen H. Browning.....	PAGE 476		

DEPARTMENTS

With the Experimenters.....	PAGE 492
The Service Bench.....	PAGE 494
Service Data for Servicemen.....	PAGE 497
Radio Physics Course.....	PAGE 498
Radio Science Abstracts.....	PAGE 501
Latest Radio Patents.....	PAGE 503
Backstage in Broadcasting.....	PAGE 505
What's New in Radio.....	PAGE 506
News and Comment.....	PAGE 508

Published Monthly by Teck Publishing Corporation, Washington and South Avenues, Dunellen, N. J.

OFFICERS

Lee Ellmaker, *President*
 Warren P. Jeffery } *Vice Presidents*
 Huston D. Crippen }
 William Thompson, *Treasurer*
 Wesley F. Pape, *Secretary*

EDITORIAL AND EXECUTIVE OFFICES

350 HUDSON STREET, NEW YORK CITY, N. Y.

Entered as second class matter at the Post Office at Dunellen, N. J., under the act of March 3, 1879. Copyright, 1931, by Teck Publishing Corporation. All rights reserved. Title Registered at the U. S. Patent Office. Printed in the United States of America. The contents of this magazine must not be reproduced without permission. We cannot be responsible for lost manuscripts, although every care is taken for their safety.

\$2.50 a year, \$3.50 in Canada,
\$3.50 in Foreign Countries.
Subscribers are notified that
change of address must reach
us five weeks in advance of
the next day of issue.

I will train you at home



Here's Proof

to fill a **BIG PAY** Radio Job!

If you are earning a penny less than \$50 a week, send for my book of information on the opportunities in Radio. It is free. Clip the coupon NOW. Why be satisfied with \$25, \$30 or \$40 a week for longer than the short time it takes to get ready for Radio.

Radio's growth opening hundreds of \$50, \$75, \$100 a week jobs every year

In about ten years Radio has grown from a \$2,000,000 to a \$1,000,000,000 industry. Over 300,000 jobs have been created. Hundreds more are being opened every year by its continued growth. Many men and young men with the right training—the kind of training I give you—are stepping into Radio at two and three times their former salaries.

You have many jobs to choose from

Broadcasting stations use engineers, operators, station managers and pay \$1,200 to \$5,000 a year. Manufacturers continually need testers, inspectors, foremen, engineers, service men, buyers, for jobs paying up to \$7,500 a year. Shipping companies use hundreds of Radio operators, give them world-wide travel with board and lodging free and a salary of \$80 to \$150 a month. Dealers and jobbers employ service men, salesmen, buyers, managers, and pay \$30 to \$100 a week. There are many other opportunities too. My book tells you about them.

So many opportunities many N. R. I. men make \$200 to \$1,000 in spare time while learning

The day you enroll with me I'll show you how to do 28 jobs, common in most every neighborhood, for spare time money. Throughout your course I send you information on servicing popular makes of sets; I give you the plans and ideas that are making \$200 to \$1,000 for hundreds of N. R. I. students in their spare time while studying. My course is famous as the course that pays for itself.

Talking Movies, Television, Aircraft Radio included

Special training in Talking Movies, Television and home Television experiments, Radio's use in Aviation, Servicing and Merchandising Sets, Broadcasting, Commercial and Ship Stations are included. I am so sure that I can train you satisfactorily that I will agree in writing to refund every penny of your tuition if you are not satisfied with my Lessons and Instruction Service upon completing.

64-page book of information FREE

Get your copy today. It tells you where Radio's good jobs are, what they pay, tells you about my course, what others who have taken it are doing and making. Find out what Radio offers you, without the slightest obligation. ACT NOW!

J. E. SMITH, President
National Radio Institute Dept. INR
Washington, D. C.

Our Own Home

Pioneer and World's Largest Home-Study Radio training organization devoted entirely to training men and young men for good jobs in the Radio industry. Our growth has paralleled Radio's growth. We occupy three hundred times as much floor space now as we did when organized in 1914.



\$500 extra in 6 months

"In looking over my records I find I made \$500 from January to May in my spare time. My best week brought me \$107. I have only one regret regarding your course—I should have taken it long ago."

HOYT MOORE
R. R. 3, Box 919,
Indianapolis, Ind.,



Special Offer

Service Manual on Trouble Shooting in Radio Sets Sent Free

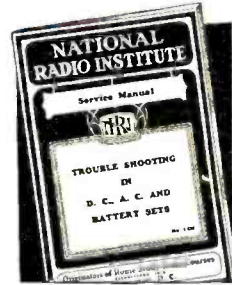

Act now and receive in addition to my big free book "Rich Rewards in Radio," this Service Manual on D. C., A. C., and Battery operated sets. Only my students could have this book in the past. Now readers of this magazine who mail the coupon will receive it free. Overcoming hum, noises of all kinds, fading signals, broad tuning, howls and oscillations, poor distance reception, distorted or muffled signals, poor Audio and Radio Frequency amplification and other vital service information is contained in it. Get a free copy by mailing the coupon below. ACT NOW.

I will give you my new 8 OUTFITS of RADIO PARTS for practical Home Experiments

You can build over 100 circuits with these outfits. You build and experiment with the circuits used in Cruesley, Atwater-Kent, Eveready, Majestic, Zenith and other popular sets. You learn how these sets work, how to make them work. This makes learning at home easy, fascinating, practical.

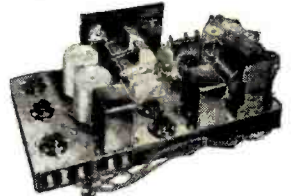

I am doubling and tripling the salaries of many in one year and less. Find out about this quick way to

BIGGER PAY



FILL OUT AND MAIL THIS COUPON TODAY

J. E. SMITH, President
National Radio Institute, Dept. INR
Washington, D. C.

I want to take advantage of your special offer. Send me the two booklets "Rich Rewards in Radio" and "Trouble Shooting in D. C., A. C. and Battery Sets." This request does not obligate me and no salesman will call.

Name.....
Address.....
City..... State.....

Lifetime Employment Service to all Graduates

The Editor—to You

EXPERIMENTALLY inclined readers are finding great interest in the series of articles in RADIO NEWS on transmission and reception with quasi-optical radio waves. Those ultra-short waves in the neighborhood of a few inches in length that behave similarly to light rays. Letters are coming in to the editors from individuals in many countries asking where they may obtain the micro-ray tubes for this purpose. These tubes have not as yet been released for ordinary consumption, but it is interesting to note that a number of experimenters find they get good results with various types of standard receiving tubes in which the filament, grid and plate are geometrically assembled. One of the most popular tubes is the old-style type -99 tube which can be made to oscillate at slightly over 60 centimeters wavelength when used as a Barkhausen oscillator. The voltage of the filament is to be increased somewhat higher than the normal operating voltage and the plate and grid voltages are approximately the usual voltages used as described in a former article. Some experimentation by the user will obtain results that will familiarize him with this new principle. These tubes may be used for both transmission and reception. Any "hard" three-element tube with symmetrical layout can be used for this purpose, however.

* * *

THE opening up of this new field of wavelengths with transmission characteristics so similar to light waves, at once suggested another field of experimentation. The quasi-optical waves enable telephony to be carried on on radio waves that resemble light. The question brought up by the Editorial staff was this: "Why not consider the feasibility of telephone transmission over actual light waves?" While this is not an absolutely new development in the laboratories, it is believed to be a new field for amateur experimentation.

* * *

DURING the last year or so a number of experimenters, Zworykin, Taylor and others, have successfully transmitted voice and music signals over modulated light-beams and although this apparatus has been somewhat complicated, it was believed that further simplification would make possible a device by means of which anyone could experiment along these lines.

In the present issue of RADIO NEWS you will find on page 466 a complete article that shows how you can construct a light-wave telephone to transmit and receive audible signals over a beam of light that is so faint that it is practically invisible in daylight. These light beams may be condensed through lenses and reflected from mirrors, bent around corners and picked up with photoelectric light-sensitive devices and changed again into sound waves by apparatus consisting almost wholly of radio parts and accessories.

SUCH a system may be used for secret transmission, as the signals cannot be picked up by a radio set and the beam can be projected in a narrow ray that is focused only on the receiver where the signals are to be received. It is possible that this new technique may be developed into a usefulness for short-distance transmission that will release a number of actual radio channels now being employed for this purpose. At any rate, experimenters can transmit over distances with these light waves without requiring the Government license that is required with true radio.

* * *

RADIO men will be interested in the first exclusive description of the radio equipment on the DO-X, by Lieut. Eddy, Director of Radio, Aeronautech Institute. His description includes wiring diagrams of the short and long-wave transmitters and receivers, incorporating many new design features.

* * *

THE cover design of this issue depicts a unique antenna system, recently installed in the new WABC station. Read the article telling about this new and radical development in antennas, as described by Frederick Siemens.

* * *

POLAND now has a new high-wave, super-power broadcasting station, similar to the design suggested in a recent series of articles by Lieut. Wenstrom. This station is so powerful that it gives crystal receiver reception throughout the nation and may be picked up anywhere in Europe with a single-tube set. This is one way of reducing the cost of receiving apparatus and at the same time obtaining direct coverage for broadcasting over a wide area.

* * *

IT is also interesting to know that there is an article in this issue describing a new 200-2000 meter receiving set that would work out excellently with Lieut. Wenstrom's idea.

* * *

CAN you telephone from a ship?

* * *

YES, it can be done; there are now a number of ocean liners equipped for telephone conversation with either Europe or the United States. Of course, radio telephony plays the main part in the ocean link which connects up with the land wires in the regular manner.

* * *

JOHN M. BORST describes an antenna system that, although relatively new, has been tried out and proven for use by the city dweller. This system includes the use of a community antenna on an apartment house by means of which all apartments may be suitably supplied with broadcast programs. The use of the new system depends largely on a new multicoupler unit and the system eliminates the unsightly scramble

of many antennas installed haphazardly on the roofs of our city dwellings. There has been some talk about legislation controlling the erection of antennas on roofs and some such system as this may be the logical answer to the problem. Not only being unsightly, scrambled antennas very often constitute actual fire hazards as well as producing poor reception results for the listener-in.

* * *

ON PAGE 476, Glen Browning, the famous co-designer of a popular line of receiving sets, the well-known Browning-Drake, now describes a new receiver to be known as the MB-32. Upon checking over the design, our technical staff believes that it will be even more famous than any of the previous models, including the MB-30, which is now in use in many hundreds of RADIO NEWS readers' homes.

* * *

CONTROLLING trains by radio is the subject of Dr. Irving J. Saxl's latest contribution. He tells of the latest European devices employing light-sensitive cells and radio circuits for signaling to trains and for preventing accidents due to the "human" element on the part of engineers. Trains equipped with this device would stop safely in case of danger even if the engineer should fall asleep or be taken ill suddenly.

* * *

C. A. JOHNSON, of the New York University Science Department faculty, begins, next month, a series on electric wave filters that should not be missed by a single one of our engineer readers. The complete series will take up every phase of filter design, both for radio-frequency and audio-frequency work, including practical data on this subject and the mathematical concept of all filter work.

* * *

OUR circulation manager tells me that our little instruction book, "23 Lessons in Radio," is going over "big." You know, we are presenting it with new two-year direct subscriptions. It is easy to read, for it is written in non-technical language. Here is the first letter received from a new subscriber: "I have just received '23 Lessons in Radio.' I expected it to be much harder to understand than it turned out to be. You have put Radio in a form that even a child can understand in learning the first principles. I have just finished a three-months' course in radio at one of the best radio schools in the South. Let me thank you for this little handbook, as it is the best one I have seen for learning fundamental principles."

CHAS. A. MOORE.

* * *

You should have a copy.

* * *

Sawmell Lockaday

Big Pay Jobs for Trained RADIO Men

5000

Service Men Needed

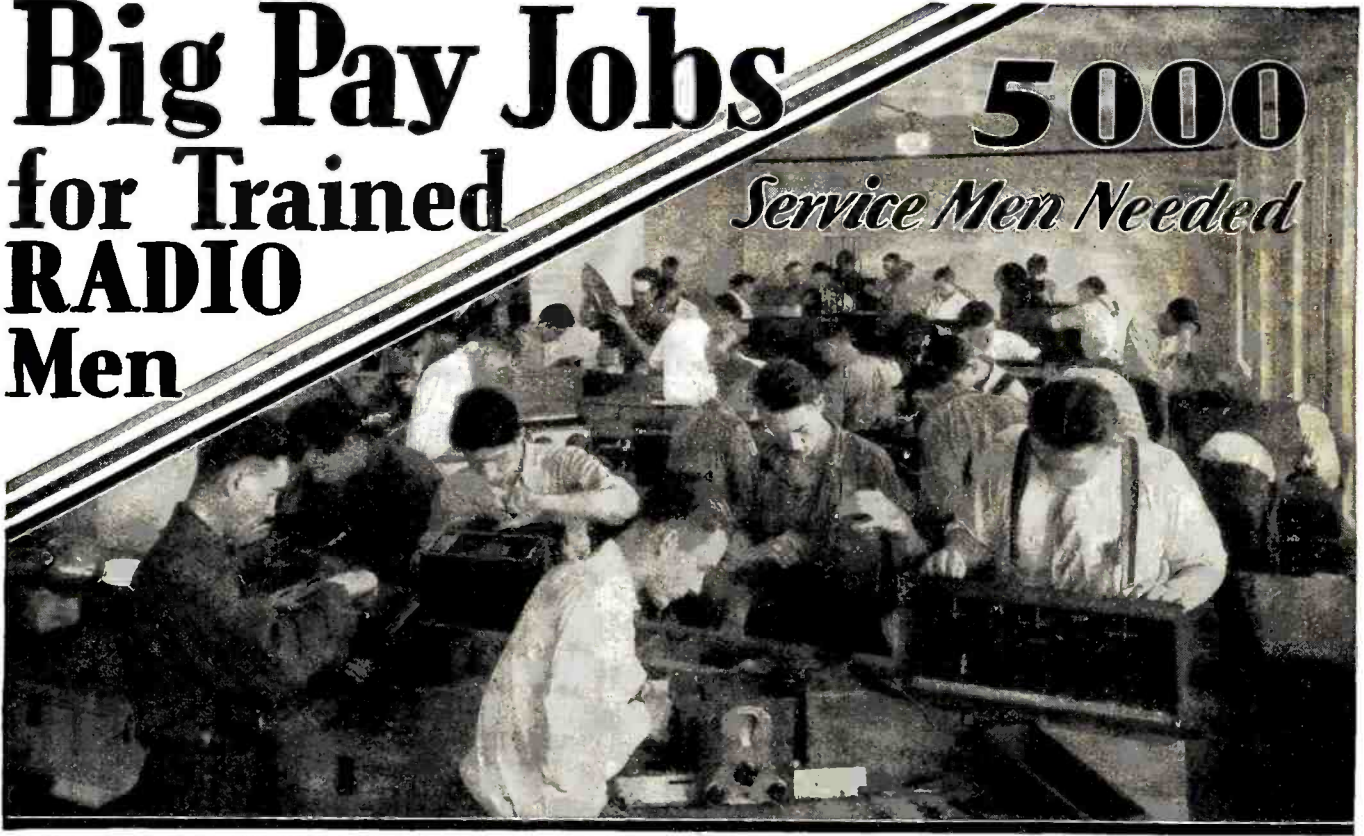

ACTUAL PHOTOGRAPH OF STUDENTS WORKING IN SERVICE DEPT. OF COYNE RADIO SHOPS

LEARN RADIO~TELEVISION TALKING PICTURES AT COYNE

TEN WEEKS of SHOP TRAINING on RADIO EQUIPMENT

Dissatisfied with your job? Not making enough money? Then let me show you how to prepare for a real job and how to make real money, in RADIO—one of the fastest growing, biggest money-making trades on earth.

JOBS LEADING TO BIG PAY

Scores of jobs are open—jobs as Designer, Inspector and Tester—as Radio Salesman and in Service and Installation work—as Operator or Manager of a Broadcasting Station—as Wireless Operator on a Ship or Airplane—with Talking Picture Theatres and Manufacturers of Sound Equipment—with Television Laboratories and Studios—fascinating jobs, offering unlimited opportunities to the Trained Man.

PRACTICAL Shop Training

Come to Chicago and prepare for these jobs the QUICK and PRACTICAL way—BY ACTUAL SHOP WORK on ACTUAL RADIO EQUIPMENT. Some students finish the entire course in 8 weeks. The average time is only 10 weeks. But you can stay as long as you please, at no extra cost to you. No previous experience necessary.

Broadcasting — Television Sound Equipment

In addition to the most modern Radio equipment, we have installed in our Shops a complete model Broadcasting Station, with sound proof Studio and modern Transmitter with 1,000 watt tubes—the Jenkins Television Transmitter with dozens of home-type Television receiving sets—and a complete Talking Picture installation for both "sound on film" and "sound on disk." We have spared no expense in our effort to make your training as COMPLETE and PRACTICAL as possible. Mail the coupon for full particulars!

Free Employment Service TO STUDENTS

After you have finished the course, we will do all we can to help you find the job you want. We employ three men on a full time basis whose sole job is to help our students in finding positions. And should you be a little short of funds, we'll gladly help you in finding part-time work while at school. Some of our students pay a large part of their living expenses in this way. Get all the facts!

COYNE IS 32 YEARS OLD

Coyne has been located right here in Chicago since 1899. Coyne Training is tested—proven by hundreds of successful graduates. You can get all the facts absolutely free. JUST MAIL THE COUPON FOR A FREE COPY OF OUR BIG RADIO AND TELEVISION BOOK.

H. C. Lewis, Pres. **Radio Division** **COYNE ELECTRICAL SCHOOL** **500 S. Paulina Street Dept. 91-8C Chicago, Illinois** **Founded 1899**

H. C. LEWIS, President
Radio Division, Coyne Electrical School
500 S. Paulina St., Dept. 91-8C, Chicago, Ill.

Send me your Big Free Radio, Television and Talking Picture Book. This does not obligate me in any way.

Name.....
Address.....
City.....State.....

Save up to 50%



Complete Line of Consoles

The Midwest Lowboy, the Highboy and the DeLuxe consoles are beautiful, artistic, designed for even the finest homes. Never before have sets of such style, beauty and quality been offered at Midwest's sensationally low prices.

Sensitivity Plus

"Eleven tube Super-Het working fine; selectivity unparalleled—fidelity excellent—sensitivity amazing. Logged 129 stations in one week. WTMI Milwaukee comes in without noise throughout the day. I think that's sensitivity plus."

Wm. V. Quinn, Cosmeant, Ohio.

Certainly Likes the Midwest

"I am well pleased with the 11-tube Midwest. It is all that you represented it to be and more. My first Radio was a Midwest, purchased from you about ten years ago."

V. Albers, LaJunta, Colo.

**30
DAYS
FREE
TRIAL**

Deal Direct With Enormous MIDWEST Factory--Save the Difference

Midwest—now in its twelfth successful year—saves you all the middlemen's profits. You pay just one small factory profit, giving you a better radio for much less money than you can ever hope to get in any retail store. The users of Midwest Radios like them and know they get better value for their money. Hundreds upon hundreds, who bought Midwest sets years ago, are now re-ordering our latest Super-Heterodyne, Screen Grid radios equipped with Pentode Tubes, Variable-Mu Tubes, Automatic Volume Control, Police Short-wave arrangement, and all the new 1932 features. The new Midwest 11-tube, introduced a little over ninety days ago, is going over like "wild fire."

Hear the World's Greatest Programs

The amazing new sensitivity of the 1932 Midwest Super-Heterodynes makes you "master of the air." Stations on either coast—yes, and users even report foreign stations—come in clear and loud. You'll marvel at the improvement in radio reception as revealed in the performance of the beautiful new Midwest high-power radios offered at sensationally low direct-from-factory prices. You'll be amazed at Midwest values when you order your set and compare it with those for which your neighbors have paid double Midwest prices. And you can buy these magnificent new advanced 1932 radios for as little as \$5.00 down.

Think of buying an 11-tube Screen Grid, Super-Heterodyne with Pentode Tubes, Variable-Mu Tubes and all the latest 1932 improvements for only \$37.50—completely assembled, with especially matched large dynamic speaker.

Big Beautiful Catalog FREE

Send for the Midwest Catalog today. Don't buy a set until you see how much we can save you. Fill out and mail the coupon on opposite page right now. You'll be amazed when you get our catalog and learn how little it costs for a powerful new Midwest Super-Heterodyne with all the latest 1932 features.

20 Great MIDWEST Features!

1. Two Pentode Tubes in Push-Pull.
2. Variable-Mu Tubes.
3. Automatic Volume Control.
4. Short-Wave Police arrangement.
5. Balanced Unit. Super-Heterodyne.
6. Eleven Tubes.
7. Built-in Aerial.
8. Pre-Selector.
9. Electro-Dynamic Speaker. Large size.
10. Tone Control and Static Modulator.
11. Eleven-Tuned Circuits.
12. Great Distance Range.
13. Full Vision Dial.
14. Sharp Selectivity.
15. Chassis. Auto body steel.
16. Life-Like Tone.
17. Built-in Extra Light Socket.
18. Low Current Consumption.
19. Six Screen Grids.
20. Phonograph Connection.

Free Catalog describes these and other features in detail.

MIDWEST RADIO

On 11 Tube Radio

only
\$37.50
COMPLETELY ASSEMBLED

With Specially Matched Large Dynamic Speaker

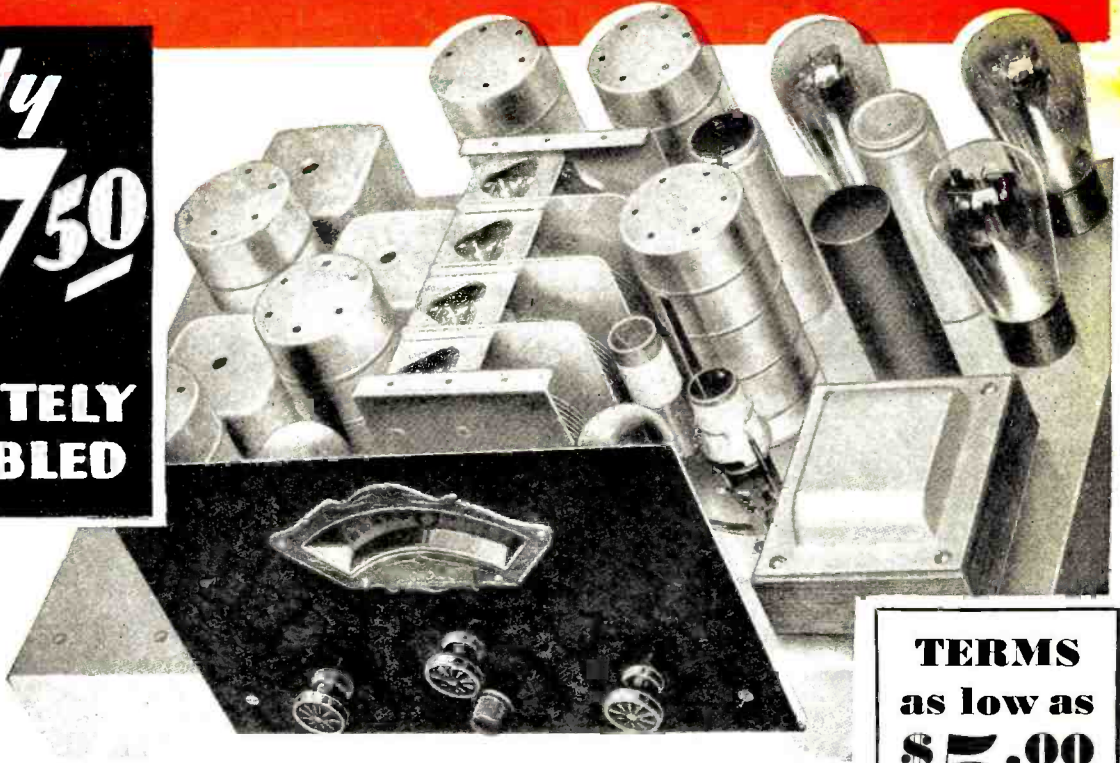

TERMS as low as \$5.00 Down

In buying direct from the Midwest factory you not only save the middlemen's profits, but you can buy on convenient easy monthly payments. The big new Midwest catalog shows the world's greatest values in new high-power Super-Heterodynes. Don't buy a radio of any kind until you get your copy. Clip and mail the coupon right now!

ELEVEN TUBE SUPER-HETERODYNE

Push-Pull Pentode, Variable-Mu, Screen-Grid, Automatic Volume Control

RADIO FANS! Just what you've been looking for! A powerful new 11-tube radio at an unbelievably low price. And what a radio! Two Push-pull pentode power output tubes with twice the power and four times the sensitivity of ordinary 45's—and Multi-Mu tubes, together with a -24 first detector, gives you SIX SCREEN GRIDS. These six screen grids, together with the -27 oscillator, second detector, first A.F. and automatic volume control—the -80 tubes—make a total of ELEVEN TUBES, with reception equal to fifteen ordinary tubes—in a perfectly balanced, non-oscillating, non-radiating, Super-Heterodyne Eleven-Tuned circuit with real Automatic Volume Control that holds those powerful locals down to the same volume as the distant stations and counteracts that annoying fading on weak stations.

The use of a band-pass or pre-selector stage, together with Multi-Mu tubes, makes this radio actually surpass 10 K.C. selectivity. Absolutely eliminates those noisy singing "birdies" and annoying cross talk. You'll be positively amazed and delighted when you see this sensational new set, hear the beautiful mellow cathedral tone—know what it means to have that pin-dot selectivity and unequalled sensitivity. And the price—only \$37.50, completely assembled, with large dynamic speaker.

Be convinced . . . TRY IT 30 DAYS BEFORE YOU BUY. Don't send a penny. Mail coupon right now for big new catalog, amazing FREE trial offer and complete details.

CORP. Dept. 17
Cincinnati, O.

RUSH THIS COUPON FOR AMAZING FREE TRIAL OFFER AND BIG BEAUTIFUL CATALOG

Midwest Radio Corp.
Dept. 17, Cincinnati, Ohio

Enclose Special "User Agent" proposition.

Complete details about the powerful new 11-tube super-heterodyne outfit. This is not an order, and I am not obligated.

Name.....
Address.....
Town.....
State.....

WANTED

\$20 to \$35 a week men who want to earn \$50 to \$75 a week and more

TODAY—more than any time before in the history of the great Radio Industry—Manufacturers, Broadcasting Stations, Sound Picture and Television concerns, and others—are on the lookout for men capable of being promoted to their more responsible jobs.

They can get all the men they want for their ordinary work—jobs that pay \$20 to \$35 a week or less. Which, of course, is one reason why these jobs don't pay better wages—almost any man can do the work.

But for their better-paying jobs—those jobs that pay \$50 to \$75 a week and up—well, it's different. Here brains, not muscle, are required. Here knowledge, not guess work, is necessary. Here men capable of some day being promoted to still better-paying jobs are needed.

This big demand for men of this type has been brought about by the amazingly rapid expansion of the Radio field. Because of dozens and dozens of new, and almost revolutionary, developments, hundreds and hundreds of big-pay jobs have been created almost over-night.

Radio work is no longer limited to the building and servicing of Radio sets.

It now includes such other things as Sound Pictures, Public Address Systems, Radio in Industry, Radio in Aviation, Radio aboard ship (for operating mechanisms of different kinds, and even for running the ship itself), telephotography, Television, etc.—everything, in fact, that makes use of the vacuum tube or photo-electric cell.

Radio devices, today, are operating great machines formerly operated by man—are grading by color or size such manufactured articles as cigars, paper, silks, etc.—are counting people or automobiles as they go by any given point—are turning on and off lights in our big factories or on our city streets—are operating airplanes in the air—directing ships at sea from stations on land—creating music more perfect than played by our best masters—and doing a thousand other things not dreamed of a few years ago.

To know Radio is to know the principles of all of these things.

And to such men the great Radio Industry offers many wonderful opportunities—steady work at good pay, NOW—and an early advancement to still better-paying jobs, as a future.

But no ordinary knowledge of Radio will do. To qualify for these better-paying jobs—men

must know the theory and practical application of all Radio devices—old and new, and they should be able to teach other men some of the things they know.

That means they must be "trained".

As few men can afford to get this training at some College or University, the Radio and Television Institute, of Chicago, was organized to train men at home—no matter where they live—in their spare time—easily and quickly—and at a cost of only a few cents a day.

The Radio and Television Institute is the ONLY Institution of its kind whose Course of home-training is actually supervised by an Advisory Board of outside business men,—all highly paid engineers and executives,—each actively connected with some large Radio concern. It is, too, the ONLY Radio School to be endorsed by some fifteen of our largest and most progressive manufacturers of Radio and Television equipment. These public endorsements were given to guide ambitious men who seek a future in Radio. These manufacturers want all such men to know that the Radio and Television Institute has their unqualified approval, and their hearty support, in its work of training men, through spare-time home-study, for the many better-paying jobs that exist today in Radio . . . Sound Pictures . . . and Television work.

Radio and Television Institute home-training prepares men, easily and quickly, for these better-paying jobs. It is the ONE recognized connecting link between ambitious men and a splendid future in Radio.

To the man, then, who is earning \$20 to \$35 a week NOW—and who would like to earn \$50 to \$75 a week or more—regardless of whether or not he is doing Radio work today—we say in all honesty—"we think we can help you." Just mail the coupon below for full particulars of our plan and a free copy of the new Opportunity Book.



Radio—first an experiment—then a plaything—now a giant industry—the fastest growing industry the world has ever known—offering thousands of wonderful opportunities to ambitious men.

≡ RADIO AND TELEVISION INSTITUTE ≡
DEPT. 849 2130 LAWRENCE AVENUE, CHICAGO

Please send me a copy of your Opportunity Book and full particulars of your plan for helping men into good pay positions in the Radio field.

Name.....

Address.....

City..... State.....



A Wealth of Authoritative Data

Nothing could be more misleading than the familiar statement that the days of the radio experimenter are passé. Today radio experimentation is going on at a rate never before attained—but it is now being carried on for a useful purpose rather than purely as a hobby. Many of the early amateur experimenters and research workers have been absorbed into the industry itself in various capacities, including executives, engineers, laboratory workers, production men, sales, and servicemen. They are now turning their early training in radio to profit both for themselves and for the industry. Today they have far better tools to work with and better apparatus and design for experimentation than at any previous period in radio's history. They, as well as other thousands of new recruits to the ranks of modern radio experimenters, are making progress in transmission and reception, television, sound recording, physical research and many other allied fields.

The up-to-date radio experimenter and researcher, be he professional or amateur, finds in RADIO NEWS a wealth of authoritative information and data that he cannot afford to miss.

Mr. Eduardo Selby

President,
Silver-Mar-ball, Inc.



The Tom-Tom; Radio's Jungle Competitor

INTER-TRIBAL communication in the African hinterland is limited to signals beaten on drums such as this. The natives doubted the effectiveness of the radio communication system, described in the story on the opposite page, because, to them, communication signals were definitely associated with loud noise—"the louder the noise the greater the distance-carrying ability."

Radio News

VOLUME XIII

December, 1931

NUMBER 6

RADIO In The African Jungle

Another page is added to radio history—and to American amateur history—in this story of short-wave radio as employed to maintain communication with civilization from an expedition moving in the African interior

By Clyde de Vinna

WHEN our company was sent to film a picture in the heart of Africa, some means of communication between headquarters and the various field units had to be maintained. Short-wave radio was selected as the means of communication, and as the expedition was necessarily limited to a small number of persons, we could not afford to take along a radio operator. I was selected, because of my interest in the amateur short-wave branch of modern science, to be the radio operator of our safari.

From the remote places visited it was one of my duties to keep in daily touch with the expedition's temporary headquarters in Nairobi, British East Africa, and in some cases with the studios at Culver City, 12,000 miles away, as well as the New York office.

Personnel

When we left America our party included 20 people, and this number was augmented to forty whites at certain stages of the safari, what with the addition of professional British hunters and guides, and additional white men, who acted as technicians in handling the necessarily elaborate motion-picture equipment, camp managers, and so on. In addition we enrolled an army of native porters for carrying goods, cooking, personal service, etc. I mention these particulars to give some idea of the elaborate formation of the safari, which was said to be the longest and largest ever organized in Africa. We carried a quarter of a million dollars in equipment to these remote places, and altogether lived a rather complicated and varied life, if primitive in some of its essentials.

In addition to my regular work, the radio required considerable time, but was nevertheless a source of much interest, as radio enthusiasts will understand.

The expedition was directed by W. S. Van Dyke, with whom

I had formerly traveled to the South Seas a couple of times, to Alaska, the Canal Zone and other places while making motion pictures. The players, Harry Carey, Duncan Renaldo and Edwina Booth, and one native, a big M'Kamba whom we adopted, were the actors of the expedition. The others included electricians, property men, grips, and "sound" technicians, as well as a personnel of eight in the camera department.

The first consideration in selecting a radio outfit was performance, and this had to be sharply related to portability and endurance. Operating as we were, far from a place where parts may be replaced, I had to rely on the ruggedness of the original equipment to an unusual degree.

I chose an M-1 type transmitter and receiver, made by Heintz and Kaufman, of San Francisco, which is a portable set standard with the U. S. Navy. It works on a frequency of 4000 to 30,000 kilocycles both for sending and receiving. The power was derived from a two-cycle, single-phase gas-electric generator. The entire outfit weighed three hundred pounds and could be broken up into packages weighing from 40 to 60 pounds for convenience in carrying.

Three Waves Used

The main object of our installation was to maintain regular schedules with Nairobi, regardless of our location. This was quite a problem, inasmuch as nearly as great difficulty is encountered in working short distances with short-wave apparatus as in trying for extreme distance. Fading, swing, and other disturbing phenomena are more prevalent at short distances than at longer ones; and during our work recourse was had to three of the bands—14,000, 7000 and 3500 kilocycles—according to what best suited prevailing conditions. The distance from Nairobi varied from forty to approximately one

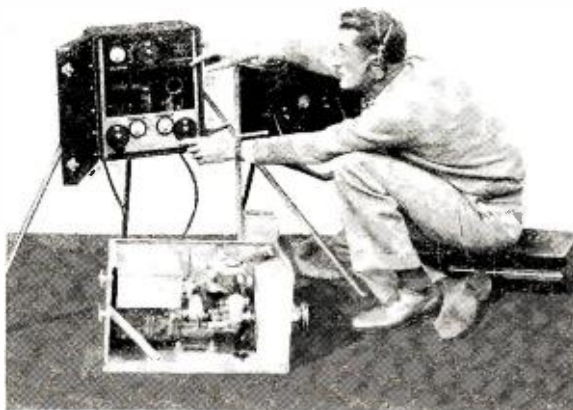

CLOSE-UP OF THE TRANSMITTER

The short-wave transmitter is clearly shown and to the right and partly concealed is the receiver. Both were especially designed for this expedition



M-G-M Photos

KEEPING THE GRID LEAKS DRY

Excessive moisture offers one of the greatest obstacles to jungle radio. Here is the author, in what proved to be a somewhat characteristic pose, wiping moisture off the grid leaks before putting the equipment into operation

thousand miles, and communication was maintained throughout the trip, regardless of weather and other adverse conditions.

The man handling the Nairobi end was Mr. Sydney Pegrume, an amateur there, VQ4CRE, who did remarkably good work on his low-powered set. Our regular schedule was kept at 16:00 GMT, with extra sessions fitted in, according to demand.

During the period of our safari we handled approximately six hundred messages, totaling perhaps 18,000 or 20,000 words. The Nairobi connection was the first consideration throughout the trip, taking precedence over any efforts at distance or other experimental work.

However, we also made connection with amateurs in practically all parts of the world during our spare time—this being carried on, of course, along recognized amateur lines. Many interesting contacts were made with amateurs in different nations: South Africa, France, Spain, Germany, England, Belgium, Denmark, Czechoslovakia, China, Malay States, Borneo, Philippines, Russia, Mexico and the United States.

Governments Cooperate

Radio is now fostered under an enlightened policy in most of the African governments, and we were specially licensed by the Kenya, Uganda, Belgian Congo and Tanganyika governments to handle traffic to and from Nairobi. I take this opportunity to say that these governments showed us great courtesy and cooperation.

As to operation: All work was done in the wavelength bands set aside for use by amateurs, according to the Washington Conference. The bands used most were the 7000 kilocycle and the 14,000 kilocycle bands—or 40 and 20-meter bands, respectively. The 7000 kc. band works best for moderate distances, and during the early morning, while the 14,000 is best for extreme distance and in the evening.

The early evening and early morning proved the best hours for receiving. From about 5 p.m. to about 7 p.m. the 40-meter signals come in well from the east. From about 8

p.m. to 10 p.m. the "European gang" on 20 meters (14,000 kilocycles) came along; and from 10 at night until around 2 a.m. the United States "bunch" on 14,000 kc. came in excellently. Then there began a fade-out until daylight, and from then until 8 a.m. or so the U. S. bunch on 40 meters came in very well again. This represents about the average condition, the time given being that for the parts of Africa in which we happened to be working.

Static an Obstacle

Stations on the east coast of the U. S. and those in the Philippines came in best, considering distance. Some of the east coast stations, both on 20 and 40 meters, were extremely reliable. The Philippine bunch was as regular as clockwork every evening, although static sometimes got too bad to read them.

There was considerable heat lightning in Africa, and also a frequency of thunder showers in a land where clouds are always present along the rim of the sky. There are also frequent atmospheric disturbances due to the great changes in

temperature from day to night. Lightning always causes interference, my experience showing that this is more the case on the 40-meter band than the 20, and most of all on the 80. As a rule, the higher the wavelength, the greater the interference from lightning.

"Blind spots" were also occasionally encountered. A possible explanation of this is the presence of great bodies of metallic ore. At times this condition gave considerable difficulty in keeping up the average work. Conditions in different



MODERN "SHOOTING" IN THE JUNGLE

The author, chief camera man and radio operator of the expedition, setting up his camera for a "shot" of local color. The natives are of an African pigmy tribe

parts of the country vary to a great extent, both in reception and transmission, and it was difficult to maintain any sort of standard when shifting about from place to place.

My confidence in our "outfit" was justified by events, as there was remarkably little technical trouble under the conditions encountered, and deterioration was slight. My most serious single difficulty, and one that threatened to put the radio out of commission and thus leave the expedition considerably handicapped, was the failure of the generator while we were on the Victoria Nile, near the Nile's source and quite remote from other means of communication.

Following a period of overheating, the generator was overhauled, and upon being reassembled the output dropped to about two-thirds normal.

Emergency Power Supply

Fortunately, the equipment for producing lights in the jungle, operating our electric refrigerating plant and other equipment, is extensive. I was enabled to commandeer a new generator of a different type which arrived "on location" at this time, having come by native dug-out canoe and cross-country portage. This new generator was adapted to run from our Kohler lighting plant. Since then, the gasoline motor rig has been used only when away from the Kohler plant, or in emergencies.

The greatest items of deterioration were the dry batteries used in the receiver, which had to be replaced, usually, once a month. In fact, that is about the only item of deterioration about the set. The storage batteries lasted well indeed, and I could see no change in any of them during the ten months of use.

The spares I carried consisted of two transmitting tubes, six receiving tubes, several insulators and a quantity of wire for antennas, transmitting grid leaks, transmitting grid and blocking condensers, two receiving grid leaks, and earphones and earphone plugs.

The chief mechanical difficulty I encountered was with the gasoline engine. It required a good deal of attention, particularly if the gasoline was not of the best quality, which, of course, was often the case. Gasoline was carried in great quantity with the expedition—we had a lighting generator which alone consumed 12 to 15 gallons an hour when in use.

Damp weather occasioned a certain amount of trouble with



COMBINING BUSINESS WITH PLEASURE

Harry Carey, moving picture star, adds another potential trophy to his collection—under the somewhat critical gaze of the overdressed natives

the receiver, giving rise to noise through corrosion. This was easily remedied by drying and cleaning.

There was no trouble with the transmitter, with the exception of grid leaks—a rather unusual condition, but a troublesome one, probably due to humidity.

My greatest physical difficulty when reaching a new location was the erection of the antenna. One of my native assistants, whom I named "Grid Leak," had become quite expert at getting the wires clear of trees and brush. The aerial problem was of but little moment when considering only the Nairobi schedule, as I usually had power to spare from almost any sort of a set-up—but when attempting DX work, the location of the antenna was of extreme importance.

Since necessity is the mother of invention, I worked out one improvement in the Zeppelin type of antenna which may be of interest to others who have to consider portability and save time as well. The improvement consisted of a set of detachable feeders!

The Zeppelin type of antenna proved to be about the most satisfactory for general use. The mast furnished with the set is perhaps more convenient, but not as efficient, so a "Zepp" was made up in a permanent form, and an arrangement made whereby it could be readily reeled up for portability. For the benefit of the general reader, the Zepp rig consists of a length of wire suspended (usually horizontally), called the radiator or "sky wire." This is coupled to the set by a pair of wires known as "feeders." One wire of this set is fastened to one end of the radiator; the other wire parallels it, but is not connected to anything at the top, simply being fastened to an insulator. It is quite necessary to the operation of the Zepp that these two wires be held parallel to each other and at a non-variable distance of a few inches apart—any swinging or changing of their relative positions acts to the detriment of the antenna. In ordinary cases of set installation the feeders are run down from the radiator to the set and fastened permanently, being spaced by insulating strips, every three feet or so, along the length.

Antenna Problems in Field Service

Carrying the set around, however, results in each installation having a different aerial condition—the sky-wire is at a different slant, or the feeders have to run at a different angle than the last time; a delay and difficulty in getting the optimum setting. The detachable feeders snap on quickly, and regardless of the placement of the radiator, come down to the transmitter in the same evenly spaced way that they did at the last location.

Because the Zepp is designed for half-wave operation on about 42 meters, the radiating portion (Continued on page 510)

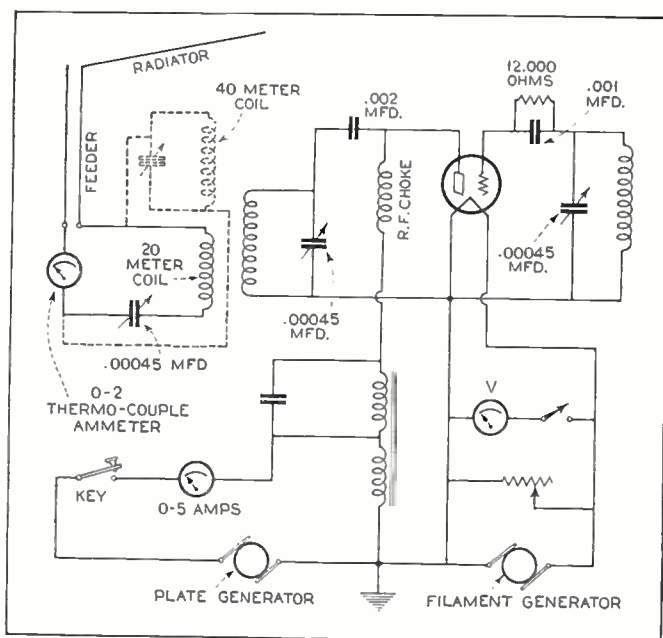

THE TRANSMITTER CIRCUIT

Plug-in coils were used to permit both the 20-meter to 40-meter bands to be worked

WABC's New "Wire-less" Antenna

In spite of the tremendous progress made in almost every phase of the radio art, broadcast antenna design remains substantially the same as when broadcasting started. Now station WABC breaks the ice with a radical innovation, the results of which will be watched with interest

By Frederick Siemens

MOTORISTS traveling the highway along the Pequannock River, passing through the township of Wayne, New Jersey, have been wondering recently what is the purpose of a huge, odd-shaped steel tower that raises its slender form to a height of 665 feet. "It cannot be an aerial," they have been heard to say, "because the aerial wires are missing. Is it a dirigible mooring mast? Or is it a power line transmission tower? It does not look like anything we have seen before."

Actually, it is the outstanding feature of the new 50,000-watt broadcasting transmitter of station WABC, the key station of the Columbia Broadcasting Company. This gigantic tower, which weighs 340 tons, is an antenna. It is a "wire-less" antenna. The tower, which has the appearance of standing on its head, rests on a porcelain base which insulates it from the ground. Its steel base is only 18 inches in diameter, although it is 27 feet wide at the widest portion, 280 feet above the ground. Its top end, which thins down to a slender steel spire, resembling the top of the Chrysler Building, is actually higher than most of New York City's giant skyscrapers. Some idea of the height is gained from the fact that, at its top a panorama view covering a radius of approximately 36 miles is obtainable on a clear day. The new antenna, which is designed to reduce the radiation of the sky wave, by changing its angle of propagation, is a vertical antenna in itself which radiates the transmitting energy as a half-wave system. The mast is guyed at the widest part, somewhat below center height, by four cables similar to those used in supporting suspension bridges. These cables are broken up into short lengths by large insulators to prevent them radiating at their frequencies within the broadcast band.

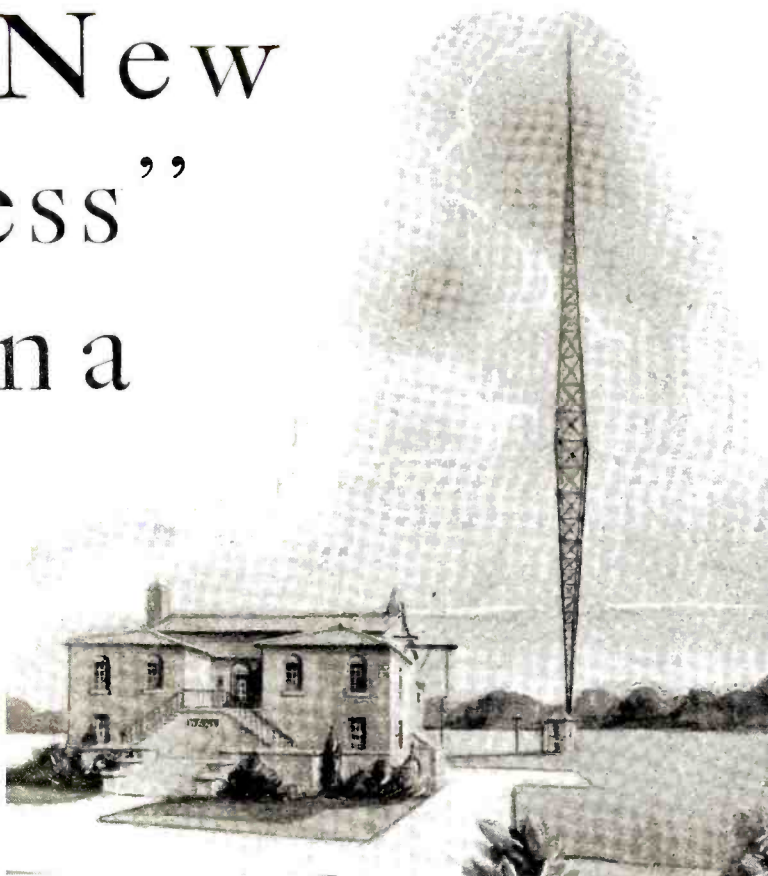

THE NEW WABC

The new 50,000-watt station which will serve as the New York key station for the Columbia chain. The 665-foot mast is the vertical, half-wave antenna which dispenses with wires entirely except for guys. This novel antenna is expected to provide higher efficiency and eliminate the hazards of sleet and wind

The tower antenna is connected with the transmitter in a near-by building by a feeder line 350 feet long, running between the station house and the antenna coupling "shack" which can be seen in the illustrations.

"The antenna itself," Mr. Cohan, technical director of the Columbia System, told the writer in an interview, "represents an investment of \$100,000. The antenna system is the outstanding feature of the new transmitter. We felt justified in making the expenditure for what was obviously an experiment for the simple reason that up to now there has been little change and improvement in antenna design, whereas considerable progress has been made in other broadcasting branches.

"The theoretical advantages indicated for the new antenna justify the undertaking. While it is still too soon to have sufficient quantitative data on which to draw conclusions, the tests thus far seem to bear out the original theory and are very gratifying."

Problems of High Power

It was in October, 1929, that the Federal Radio Commission granted a construction permit for the new WABC 50,000-watt transmitter. With the construction permit in its possession, the key Columbia outlet sought locations in several towns in Long Island and New Jersey. Objections arose from residents in all of the towns the station desired to locate in. Radio listeners feared that the nearness of a powerful station would tend to drown out other stations and might cause interference. Columbia engineers contested these



LOOKING DOWN FROM NOWHERE

This shows one of the guy wires as viewed from the mast. The monstrous insulator in the foreground gives some idea of the insulation problems involved. Insulators below are provided to keep the natural frequency of the wires well above the transmitter frequency in order to avoid absorption and possible re-radiation

arguments—but to no avail. In rapid succession, the towns of Columbia Bridge, New Jersey; Jones Beach, Long Island, and Island Park, Long Island, were crossed off the WABC list of desired locations.

With several successive renewals of the construction permit, ground was finally broken for the transmitter in Wayne Township, New Jersey, a suburb of New York, approximately twenty miles from the Columbia Broadcasting System studios on Madison Avenue and East Fifty-second Street, New York. The new transmitter went on the air with early morning test programs late last summer and early in the autumn. The outlet conveyed the regular program schedule of the Columbia chain.

Hope to Reduce Fading

The new transmitter is a Western Electric 107-B, 50-kilowatt unit. Columbia engineers then thought that great transmission improvements could be obtained by the erection of the half-wave vertical type of antenna system. This will prevent, it is believed, most of the fading experienced with ordinary transmitting antennas due to reaction between the upper radiation of the sky-wave and the ground wave.

The transmitter building is fifty feet wide, sixty-six feet deep and thirty feet high. The structure is within a few thousand feet of the Pequannock River and the soil was found to possess an unsatisfactory construction quality. With the river bed six feet under the surface of the soil, coupled with a quicksand condition, it was found necessary to build a huge concrete and steel mat, suitably anchored, upon which to construct the transmitter building. Mr. Cohan stated to this writer that it might be literally said that the transmitter building "floats."

Difficulties were not found in the subsoil condition alone. The network engineers, searching through old records, discovered that the river overflowed at times. To prevent any damage, if the overflow recurred, the transmitter building is surrounded by a watertight wall six feet in height—the highest point the overflow ever reached. Throughout the structure, the outside walls are 12 inches and 18 inches thick. In structural qualities, the transmitter building is similar to a fortress.

The lower of the building's two floors is divided into a generator room, a transformer room, a fan room, a boiler room, a spare tube room, and a workshop. The upper floor contains the main transmitter room, speech input room, 600-meter room, and the water control room. The upper floor, in addition, houses the transmitter office, a foyer, a kitchen and shower baths.

Unique Sighting Plan

A rotating air beacon is situated atop the transmitter building as an airplane guide. The beacon was officially approved by the Department of Commerce. The tall antenna mast will not be topped by a beacon, but the entire structure is studded with electric lights to prevent any aircraft accident. The lights on the antenna mast are generated by a motor generator in the



"THE INSIDE STORY"

Looking down one corner of the structure, from half way up. The only means of ascent is the ladder with its safety cage of metal hoops. However, with no wires at its top there is little need for attendants to climb the mast after it is once finished

antenna coupling house. The lights and the generator are at the mast potential.

In conjunction with the Bell Telephone Laboratories, Mr. Chamberlain, Columbia's chief engineer, designed improved speech input equipment for the new WABC outlet.

To assure good transmission, every piece of metal in the transmitter building is grounded, every door knob, lock and hinge and window latch, virtually every nut and bolt is grounded.

Although owned by the Columbia Broadcasting System, Station WABC is operated under the subsidiary name of Atlantic Broadcasting Company. The former 5000-watt transmitter of the station was located at Cross Bay Boulevard, Broad Channel, Long Island. The station, before acquisition by the Columbia chain, was owned by Alfred H. Grebe & Company,

radio manufacturers. The station's original location was at the Grebe plant in Richmond Hill, Long Island.

According to Mr. Cohan, the Columbia short-wave station, W2XE, will be moved to Wayne Township at an early date. The CBS television station, W2XAB, atop the Columbia building in New York, will remain at its present location for the time being.

Booster Station

Shortly before the new transmitter took the air officially the Federal Radio Commission was asked by WABC for a modification of its construction permit to erect an experimental "booster" station at the corner of New York Avenue, G and 15th Streets, N.W., Washington, D. C. The completion date of the "booster" station was re- (Continued on page 512)

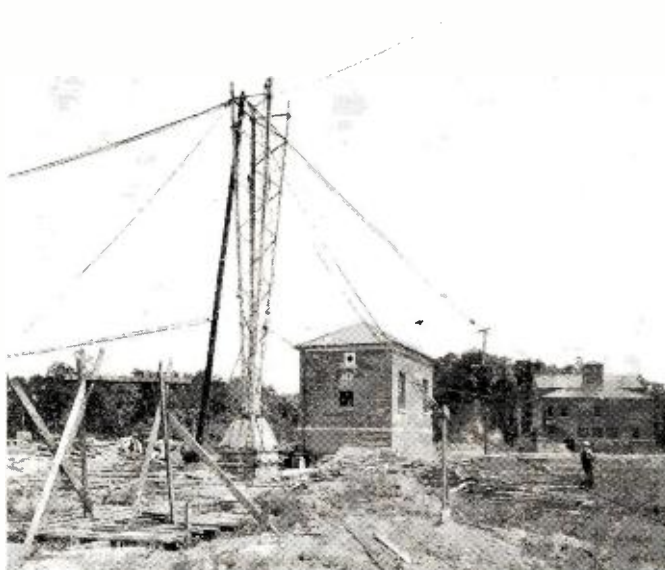

THE ANTENNA UNDER CONSTRUCTION

The base, which is concealed by the wood planking, is of porcelain to effectively insulate the antenna from ground. It is called upon to bear the entire 340-ton weight of the mast

Controlling Trains

Using Photo-Cells

How the radio science has developed an and traffic control, that increases greatly apparatus and light-sensitive devices

By Irving J.

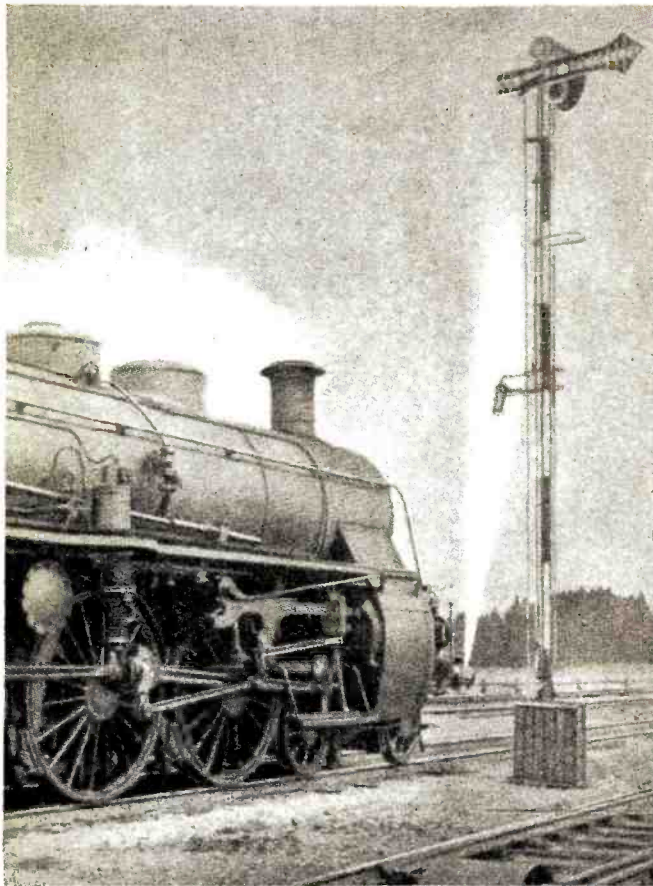

CLEAR TRACK AHEAD

The projector, at the front end of the locomotive, making "light contact" with the mirror on the signal posts, and receiving back a signal that indicates "all clear"

EXPRESS trains, weighing thousands of tons and moving at top speed, can be controlled automatically from the road; they can be stopped and various orders can be transferred to them with a new device which is based upon the tremendous strides the radio sciences have taken.

Train control, heretofore primarily dependent on the human element, the locomotive engineer, can now be performed with an automatic device. Using this new system, train signals influence an optical arrangement carried on the locomotive. A light-sensitive selenium cell receives these signals on the train. They are amplified in a low-frequency amplifier and are fed into relays which operate the air brakes, give orders to the engineer, check the road signals and perform other functions.

Tiny Electrons Control Massive Trains

The radio sciences have added a new chapter in a field where the influence of the minute electron did not at first seem striking. Now, with this optical train control, it is impossible for the engineer to run over signals without recognizing them. The signal is reported upon the locomotive, and, if proper action is not taken within a limited time, which can be set in advance, the signal automatically turns on the brakes. In this way, rain, hail, storm or other adverse conditions which might influence the control by a human are no longer hazards, thus making possible safer, quicker and better traveling.

Rumors are present that the above type of train control will be applied to the fast-moving trains between Chicago and New York. In Germany, application of this system has already been made and this equipment is being built for the roads of Munich-Regensburg and Berlin-Elsterwerda.

The system, invented by Dr. Baeseler, consists principally of a projector mounted upon the locomotive and mirrors mounted on the signal posts along the tracks. If the signal is closed, the rays coming from the projector are reflected back by the mirror and fall upon a light-sensitive selenium cell near the projecting lens.

This optical system has the advantage of being free from inertia and friction of mechanical contacts, and the strain that might be put thereon by the moving trains. Magnetic systems of train control require a spacing, between the contact on the train and the signal, of not more than about 7 inches. This new optical system, however, works at a distance of 15 feet or more. In addition, it makes possible for the first time the transmission of a variety of signals with the same apparatus. It can transmit acoustical and optical signals to the locomotive which automatically control safety devices, pull the brakes, etc. With the same apparatus a number of different selenium cells can be used alone or in combination. It uses inexpensive equipment and standard radio parts which can easily be replaced should it be necessary.

For influencing an ordinary light-sensitive cell upon a locomotive any type of light on the road would be sufficient. Why, therefore, does the engine

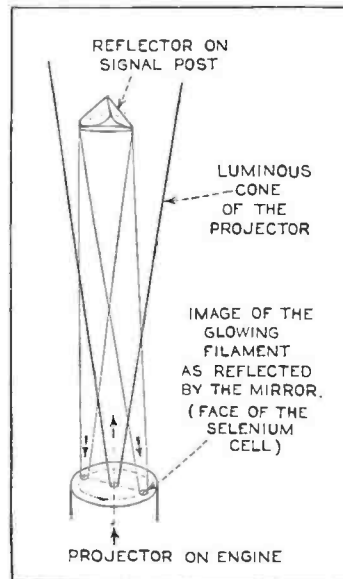

HOW THE BEAM IS PROJECTED

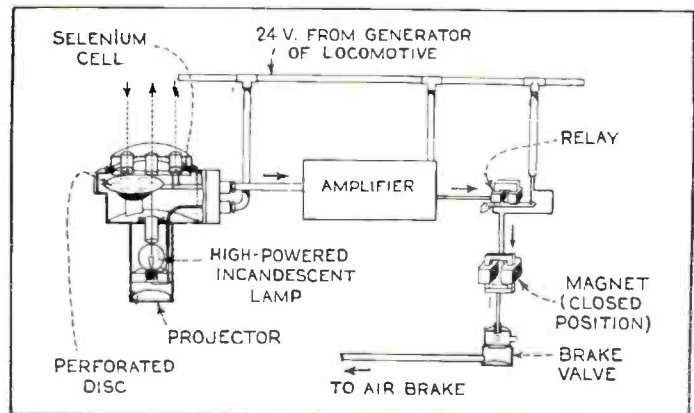

CIRCUIT OF THE TRAIN CONTROL

Diagrammatic sketch of the complete system mounted on the front of the locomotive. At the left is the projector and receiver connected to the amplifier and relays which control the air-brake valve

with Light Rays

and Vacuum Tubes

optical method for train signaling, speed the safety factor of railroads. Radio play a large part in this new art

Saxl, Ph.D.

carry its own illuminating device? It is because any stray lights could operate the selenium cell and possibly show an incorrect signal. For this reason the new system uses a special kind of light which does not occur in nature. Moving before the path of the light beam coming from the projector is a perforated disc which is rotated at a constant speed. Thus the beam of light coming from the projector is interrupted regularly, producing an intermittent current of illumination. Oscillating signals of about 600 cycles arrive at the light-sensitive cell; therefore, after the rays are reflected upon it an alternating current is produced in the circuit in which the cell is placed. After primary amplification these signals are fed into an audio transformer. Naturally only the alternating current applied thereon is transformed and lead to the next stage amplifier. Meanwhile the direct current, which might be superimposed on the alternating current, is excluded from amplification and cannot influence the relays attached to the last stages of amplification. Thus, accidental illumination from bright, constant light sources, as for instance the sky, is automatically eliminated from interfering with the train control. Resonating circuits of this type of frequency, which is produced by the scanning disc and specially

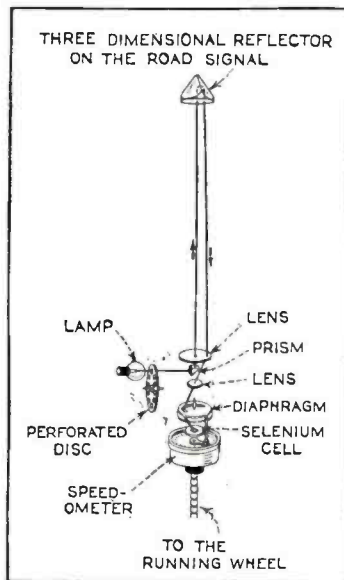

DETAILS OF THE SPEED CONTROL

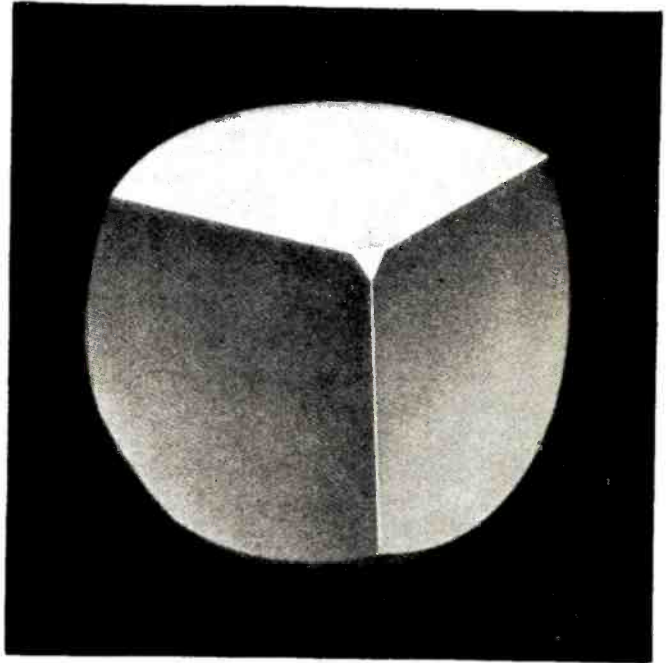

THREE-DIMENSIONAL REFLECTOR

Due to a simple physical law, light rays falling upon the under surface of this odd-shaped glass pyramid are reflected back to their origin. This reflector is a feature of the new system

colored lights with cells sensitive for only a limited range of light spectrum, increase the selectivity of this system.

Connected with the moving arm of the signal is the special mirror which reflects the light coming from the engine back to the sensitive cells of the receiver. These cells have a specific working surface smaller than a dime. The train moves at, say, 60 miles an hour; it vibrates. This vibration causes changes in the relative positions of signal and train—but still the signal has to fall back to a place very near the light source. No ordinary mirror would be able to perfect this kind of reflection and to maintain it with all the hardships it has to undergo in all kinds of rough weather and railroad treatment.

A reflector which will stand up under these conditions has been invented by Professor Dr. Straubel, head of the Zeiss works at Jena. The reflector consists of a triangular glass pyramid, as shown in one of the accompanying illustrations. Any light ray falling in the opening of this pyramid is reflected three times from the sides of the pyramid and projected back to the point from which it came. The construction of this three-dimensional reflector is based upon physical laws similar to those applied in the construction of prism binoculars. Reflection takes place on the sides, thus making it unnecessary to apply any silver to the surface. This compact glass body stands up under all kinds of atmospheric and mechanical conditions. No metal is used which could change its shape or reflecting surface after a certain period of use. And last but not least, this reflector makes it possible to do what no ordinary mirror could perform—to reflect any light ray to its source *regardless of the angle of incidence.*

Provides Double Check on Signals

The mirror moves with the arm of the railroad signal. If the signal is closed, the mirror reflects the light upon a cell which, in its last stage, operates a relay which gives the message to the engineer. If the signal is open, another cell is activated and delivers the message that the road is open and the signal is working properly. Thus the optical train control not only delivers orders to the train, but also checks the signals on the road as to their working condition.

The selenium cell consists (Continued on page 541)

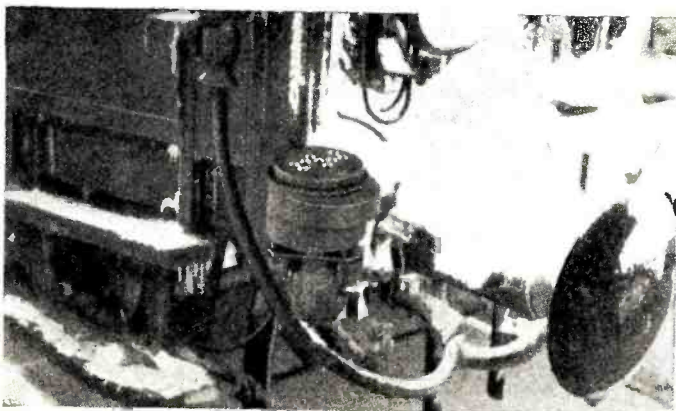

AFTER THE BLIZZARD

The projector on the engine is kept free from snow or ice by either electric or steam heat. The holes on the receiver indicate the number of signals that can be passed to this train

Telephony on

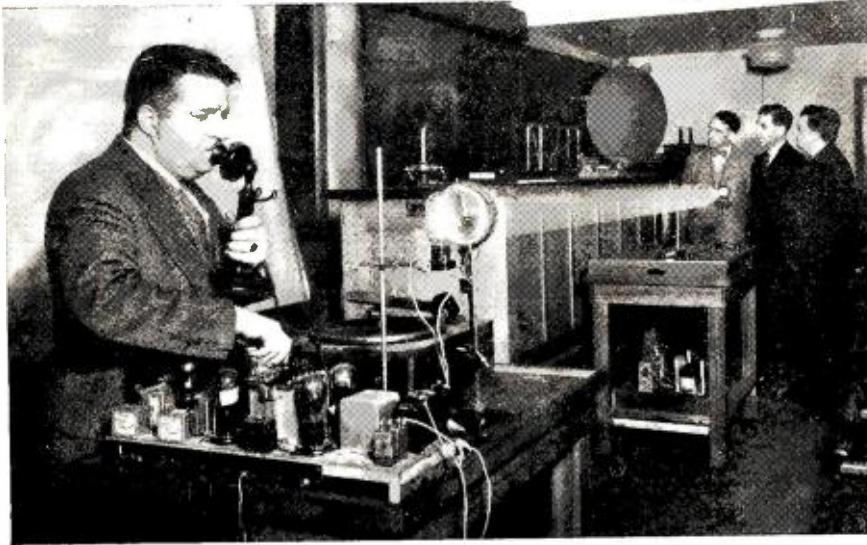

THE LIGHT BEAM TELEPHONE AT NEW YORK UNIVERSITY
Laurence M. Cockaday demonstrates to his class students how the light-beam telephone works and how it might be used for commercial or industrial purposes. The transmitter is on the left; the receiver and loudspeaker on the right

THE first successful invention of Alexander Graham Bell when he was developing the telephone was a device for sending speech over a light beam. The idea of using wires came later. And now modern radio science promises to go back to Bell's abandoned light-beam telephone; not, it is true, with any idea of replacing the telephone but for some important purposes which the ordinary telephone cannot fulfil.

Tugboat captains in a crowded harbor, for example, must communicate with each other at present either by flag signals or in some similarly crude and awkward way. Radio is a possibility, but would jam the ether with too many messages. Amplified sound, like the gigantic loudspeaker systems now used to communicate between aircraft and the ground at landing fields, would fill the harbor similarly with a din which nearby residents scarcely would regard as permissible. A simple and practicable outfit for light-beam telephony would solve the whole problem. Two captains wishing to communicate with each other would need only to turn the lenses of their transmitting and receiving telescopes in the same sight-line and talk to each other to their hearts' content, with no interference whatsoever with anyone else.

Another probable use for such outfits is in construction work in the field, especially where gangs of men may be scattered for miles along a mountainside or a river bank, moving each day and yet with a strong desirability of keeping in easy touch

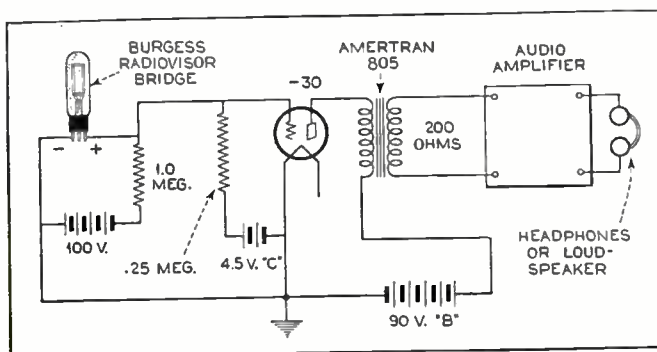

A TYPICAL RECEIVING CIRCUIT
The circuit shows all necessary receiving apparatus, using the Burgess radiovisor selenium bridge as the light-sensitive unit. Other photo-electric devices, such as the new Weston photronic cell, may be used as well.

A new field for radio Amateurs developed is radio over the still Radio servicemen needs of business or the telephony or distribution these needs the light-beam

By E. E.

with each other and with headquarters. At present the only practicable system is to string temporary telephone lines, something which is always expensive, often difficult and sometimes impossible. If stations could be selected in sight of each other, the light-beam telephone would solve these difficulties also; since sending lamps could be erected at convenient points and receiving outfits carried as easily as a suitcase by each party of workers.

Aircraft communication is another future field for such communication methods. Radio, it is true, has been perfected, for such purposes, to a degree which would have been deemed impossible a decade ago, yet it still has limitations. If many communications are desirable simultaneously, as between the units of an air fleet in formation, radio is likely to exhaust its available channels just as would happen were radio used for harbor traffic. That light-beam telephony ever would replace radio, altogether, for aircraft use is improbable, since it would have its own limitations also. As an adjunct, however, it is likely to be invaluable.

Police cars on a search for criminals, scouts in war time,

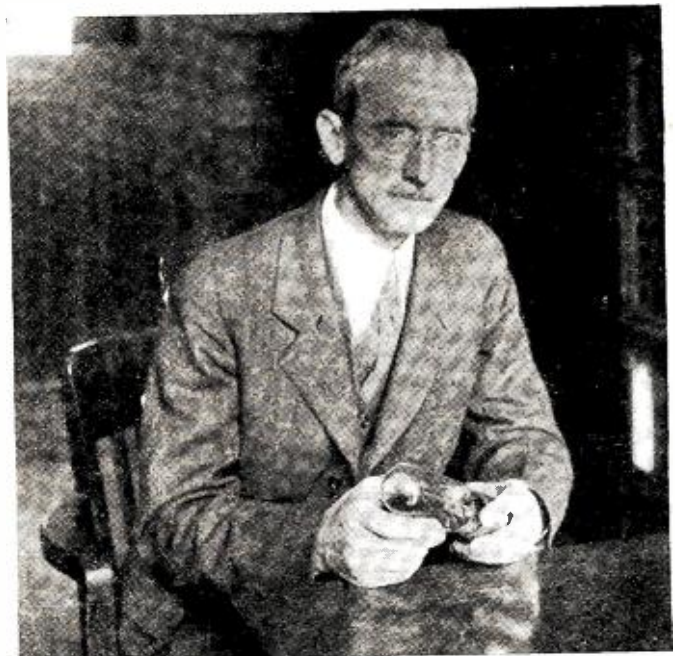

HE HELPED MAKE SYSTEM POSSIBLE

Dr. D. McFarlan Moore invented, years ago, glow discharge lamps containing neon and other gases, forms of which are now used in recording sound motion pictures, and for many other purposes for which lamps that can be modulated with sound waves are needed

a Light Beam

amateurs and servicemen. short-wave radio. Here shorter waves of light. continually encounter public for special kinds of of programs. Some of telephone will fill

Free, Ph.D.

explorers penetrating into unknown country or confronted by hostile natives, even business men in separate offices, visible to each other like the different buildings of a factory, all would have real and important uses for a simple outfit capable of talking over a light beam just as Bell did successfully so many years ago. Someone ought to work out the details for making and using such outfits, and the task seems to be made to order for radio amateurs. The technique and apparatus, with only a very few simple exceptions, are those of radio. Rewards of reputation and possibly of money are likely to be considerable. Best of all, here is a public service for the benefit of everybody; an appeal to which radio amateurs never failed to respond.

The fundamental principles of light-beam telephony are simple and well known. Recently Dr. John B. Taylor of the General Electric Company telephoned across the Hudson River



A PORTABLE TRANSMITTER

Two years ago Dr. John Bellamy Taylor, of the General Electric Company, demonstrated before the New York Electrical Society this portable light-beam telephone. The transmitter is in the case at the left; the receiver at the focus of the mirror at the right

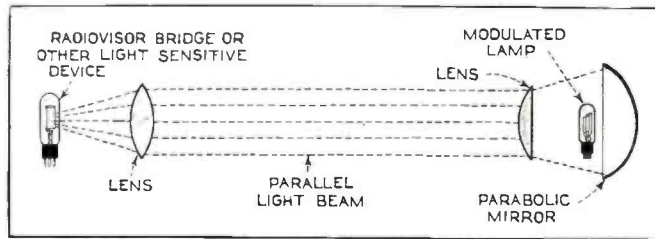
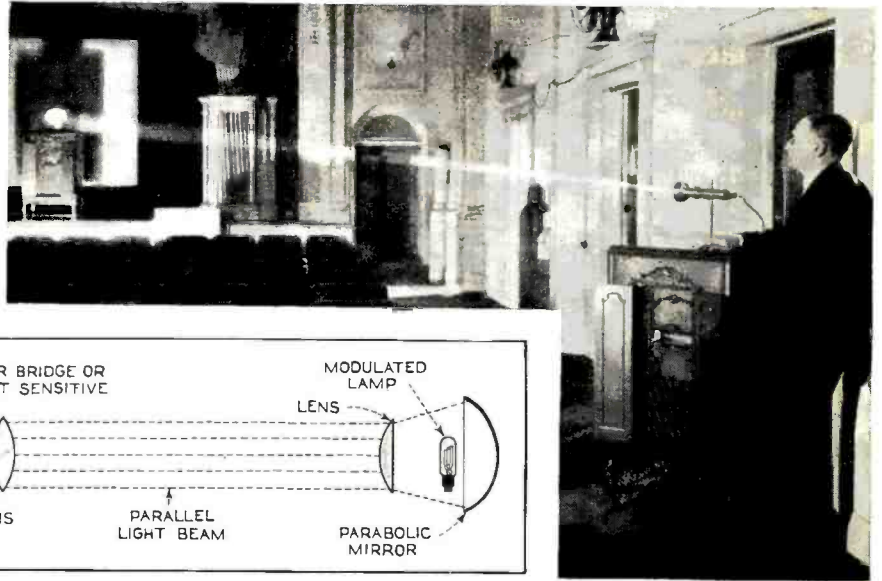

THE OPTICAL BEAM SYSTEM EMPLOYED

Dr. V. K. Zworykin (above) demonstrating a light-beam telephone across an auditorium. The diagram (left) indicates a simple optical system; the modulated lamp, a mirror and lens at the right, a condensing lens and light-sensitive cell at the left

at New York City with one form of such a device. Other experiments have been made, it is announced, by the Westinghouse interests and by Dr. V. K. Zworykin of the RCA-Victor Co. and others. Anyone can set up a talking light beam on a laboratory basis. What now is necessary is to work out all the details of best practical operation; to make the outfits simpler, cheaper and more fool-proof; to put the device on its feet as a really practical one; just the same activities, in fact, which the radio amateurs carried out so successfully a few years ago with short-wave radio.

Extension of communication into the realm of light waves is a natural "next step" to the development of micro-wave radio. As has been described in RADIO NEWS in recent months, the extremely short radio waves, now producible by the microtubes operating on the Barkhausen principle, provide radio-wave beams which already have many of the properties of light beams. They can be reflected from mirrors, concentrated by lens-like metallic structures or by actual lenses of insulating materials, made into beams resembling, in all ways, the light beams of searchlights. On these light-like radio beams messages may be modulated as on radio waves of any other type. All that the true light-beam telephone (Continued on page 537)

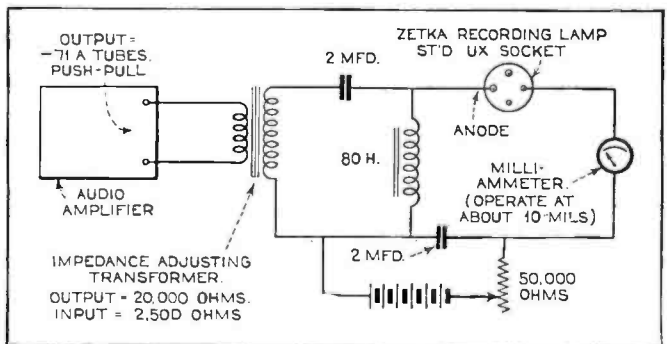

A TYPICAL TRANSMITTING CIRCUIT

The sound-picture recording lamp shown in this circuit is only one of many devices by which sound impulses may be modulated on a light beam. The neon lamps used in television experiments also work admirably, driven much as they are for television

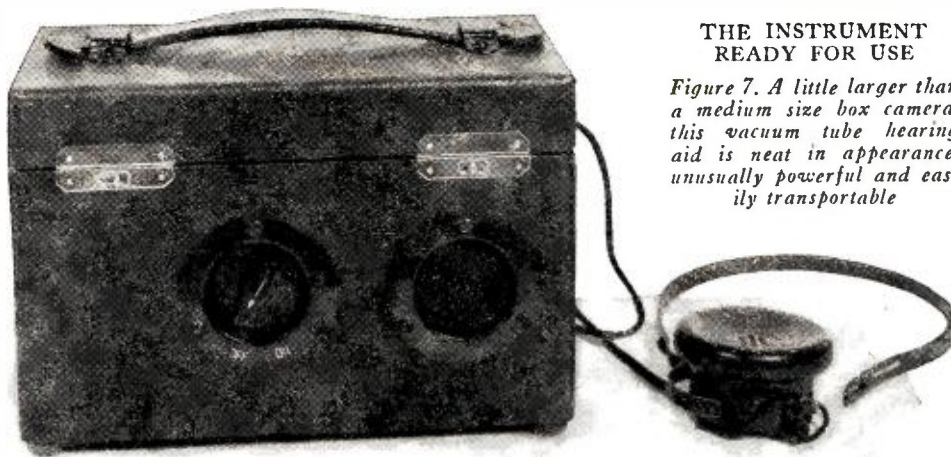

THE INSTRUMENT
READY FOR USE

Figure 7. A little larger than a medium size box camera, this vacuum tube hearing aid is neat in appearance, unusually powerful and easily transportable

The Vacuum Tube Aids the Hard-of-Hearing

Many are unaware of the important rôle being played by the vacuum tube in providing a substitute for partially lost hearing. It is used as the basis of one of the most powerful and effective hearing aids, as described here

By S. Gordon Taylor

THE variety of electrical devices now on the market to aid the hard-of-hearing divide themselves into two general classes which we "telephone" type and the "vacuum tube" type. The telephone type consists, in its simplest form, of an earpiece, a battery and a volume control for varying the sensitivity. In its more complex form this type of hearing device may include two, three or four microphones instead of one, the purpose of these extra pick-ups being to provide increased sensitivity and greater volume of sound.

This telephone type of equipment was discussed in some detail in Dr. Saxl's article, last month, as were also the technical requirements for the specific

may designate as the sensitive microphone,

type of hearing aids. as the Vactuphone and is manufactured by the Globe Techno-

apparatus to be used by the deaf.

The present article will be confined to a description of one of the vacuum-tube hearing aids. The particular unit discussed is known as the Vactuphone and is manufactured by the Globe Techno-

lian Corporation, which, with the Western Electric Company, are the pioneers in the vacuum-tube hearing-aid field. The basic idea of including a vacuum tube in equipment of this nature is, of course, to provide increased amplification. The vacuum tube itself is capable of multiplying sound anywhere from five to nine times and in addition the coupling transformer employed between the microphone and the tube provides additional voltage amplification so that the overall sound increase obtainable through using (Continued on page 528)

LAST month it was pointed out that electrical aids for the hard-of-hearing can be logically—and profitably—merchandised by radio dealers and by radio servicemen whose entrée to private homes places them in a unique position to contact the deaf whose abnormal sensitiveness in many cases prevents them from visiting a store in search of a hearing aid. Any question as to whether radio dealers are the logical market outlets for such equipment should be dispelled by a study of one type of instrument, as described in this article. It is, in effect, regular amplifier equipment which radio men can understand and sell more intelligently than any other type of retailer.

—The Editors.

THE "WORKS"

Figure 3. As will be seen in the view at the right, compactness is attained through rigid elimination of waste space Figure 4. Left. When not in use the headphones nest on top of the sub-cover and the head-band fits inside the outer cover, making the device entirely self-contained

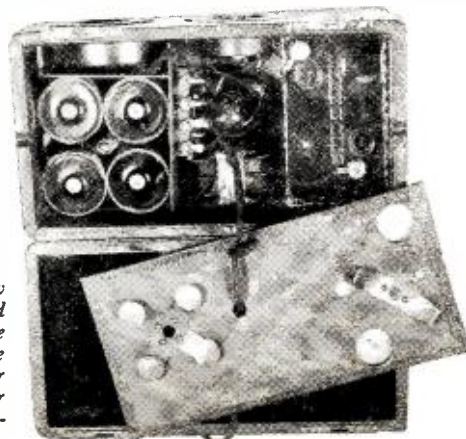

And Now— A 200-2000 Meter Broadcast Receiver Design

America is now producing a combination broadcast and long-wave receiver, primarily for export and for domestic airport use, but incidentally in preparation for possible long-wave American broadcasting as proposed by Lieutenant Wenstrom in his recent articles in RADIO NEWS

By **McMurdo Silver***

IT is well known that the design problems for European broadcast receivers differ quite considerably from those encountered in this country, since European broadcast stations operate in the range of 200 to 550 meters, as do those in America, but in addition many of the most important stations operate in the 1000 to 2000-meter range, with a few even falling in the 600 to 1000-meter range. Very little attention has been paid to these problems in this country in the past, and in consequence exports of American broadcast receivers to Europe have been less than they might easily have been, due to the limited frequency range of standard American receivers. Such exports of American receivers to Europe as have existed are a tribute to their marked superiority, since only because of outstanding superiority would Europeans buy radios capable of bringing in only part of their stations.

May Find Use in U. S.

Today the proposal of super-power long-wave broadcasting for this country makes 200-2000-meter receiver design details of immediate interest. Also, the development of long-wave aircraft transmission has produced a definite need for good receivers covering the range of 200 to 2000 meters for reception of aircraft weather information and other transmissions. A description follows of a superheterodyne receiver covering the two bands of 200 to 550 and 1000 to 2000 meters.

Essentially, the S-M 773 airport and European receiver is an eight-tube superheterodyne employing a dual or Siamese pre-selector circuit between the antenna and the screen-grid first detector, an extra stable oscillator which employs a type -27 tube with iso-

lated tank tuning circuit, two stages of 115 kc. i.f. amplification employing type -51 tubes, a second linear power detector of the -27 type feeding two type -45 tubes in push-pull, and a type -80 rectifier in the a.c. power supply circuit. At this point it is well to mention, since European and particularly British power sources are not particularly standardized, it is necessary, if such a receiver

is to be at all universal in application, that it must be adapted to operate from 110 to 125-volt or 220 to 250-volt power lines of frequencies ranging between 25 and 60 cycles. This has been provided for in a universal power transformer having two primaries, chosen at will by changing only two connections under the chassis. When these primaries are in parallel, as they leave the factory, the set will operate on 110 to 125-volt, 25 to 60-cycle power sources, or even down to 100 volts. When connected in series, the set will operate from 200 to 250-volt, 25 to 60-cycle power lines and, in fact, even down to 200 volts quite satisfactorily. The filter system is universal in that it is amply effective at any power line frequency between 25 and 60 cycles. Hence the receiver is universal for any source of a.c. power found in Europe or the British Isles.

Band Switch

The receiver is illustrated in Figures 1 and 2, while its circuit diagram appears in Figure 3. It is single control in operation, that is, one-dial tuning, plus a wave change switch selecting between the 200 to 550 and 1000 to 2000-meter bands, a volume control and on-off switch, a tone control and a jack for a phonograph pick-up.

Before considering the mechanical design of the receiver, it may be well to review a few of the design problems encountered and the manner in which they were solved.

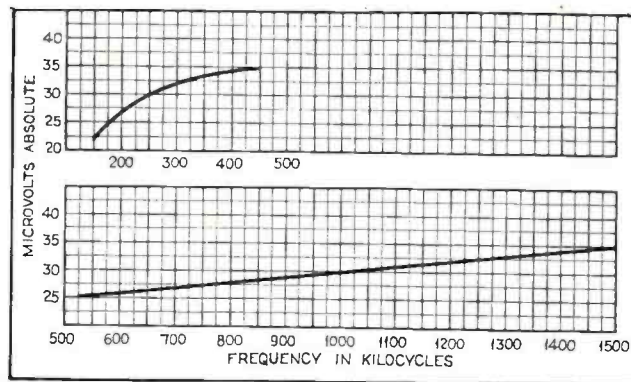

THE SENSITIVITY CURVES

Figure 4. The relative field strength required at different frequencies to provide a given output. The rising characteristic in the 200-550-meter range offers the advantage of higher sensitivity toward the low frequency end where programs are best and the noise level lowest

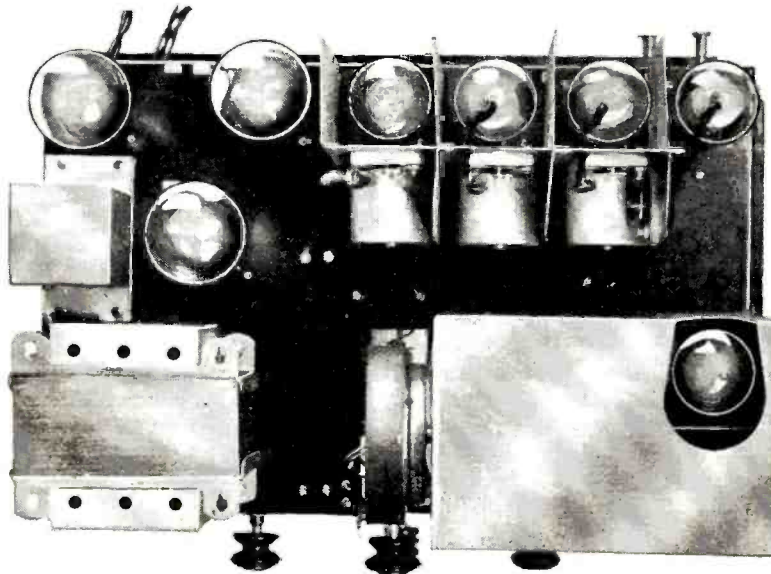

THE 200-2000-METER RECEIVER

Figure 1. A superheterodyne which employs single-tuning control and other advanced features found in our present broadcast and short-wave receivers

*President, Silver-Marshall, Inc.

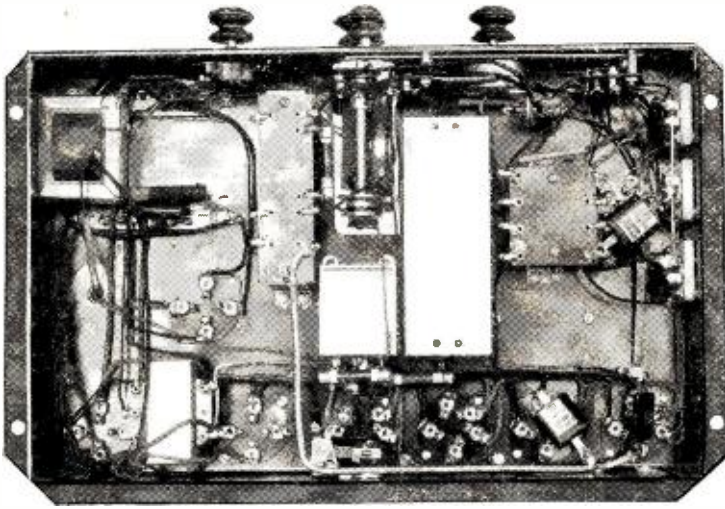

UNDERNEATH VIEW OF CHASSIS

Figure 2. Location of the various parts described in the text is shown, particularly the dual-band coils and their switching arrangement

The receiver being intended primarily for export sale, it was permissible to employ either the tuned r.f. or superheterodyne system. Inasmuch as the receiver was being designed in the United States, it was felt that it should be representative of the latest American engineering developments, and since it was going into foreign markets where national prejudice is a factor, it would have to be very definitely superior to anything there available if this prejudice was to be overcome and a good volume of sales realized. Further, with the number of stations operating in Europe, a sensitive receiver of the t.r.f. type would be hopelessly unselective, and it was therefore felt that the superheterodyne system was necessary to give adequate selectivity. In the matter of sensitivity, the necessity of shifting r.f. circuits for the two frequency bands to be covered involved relatively complicated switching in a t.r.f. circuit which would introduce stability problems definitely limiting the overall gain. In a superhet this could be avoided, since all

the switching could take place at one gain level, in the oscillator and input circuits, the i.f. amplifier remaining undistorted.

175 Kc. Not Suitable for I.F.

The choice of an intermediate amplification frequency did not allow consideration of the standard American frequency of 175 kc., since this fell in the band to be covered by the long-wave portion of the set, the range of which must be from 1000 to 2000 meters, or 300 to 150 kc. Exactly the same problems of image-frequency interference and i.f. harmonic feedback were present, however, as in a standard American design, and as the image interference problem is the more serious of the two, the highest possible intermediate frequency had to be chosen. Analysis indicated that 115 kc. was the best possible choice, since from an image-frequency interference standpoint, it was ideal for the 1000 to 2000-meter band, and still satisfactory for the broadcast band. From an i.f. harmonic feedback standpoint, 115 kc. is just as good as 175 kc. for the broadcast band—maybe even a little better, while for the longer wave-band only its second harmonic, or 230 kc., actually falls in the band, and it is not particularly serious, since at this frequency strays are much less bothersome and strong than at 700 kc., for instance.

As a modern superheterodyne utilizes a relatively powerful oscillator, with a strong second harmonic, it is apparent that for a considerable portion of the long wave-band the oscillator second harmonic will fall in the broadcast band, and will serve to heterodyne broadcast band stations if they are allowed to reach the first detector with any magnitude. (The long-wave oscillator covers the range of 150 kc. plus 115 kc. to 300 kc. plus 115 kc., or 265 kc. to 415 kc., so that its second harmonic range is 530 to 830 kc., or almost the entire lower third of the 550 to 1500 kc. broadcast band range.) A high degree of pre-selection is therefore required in the long-wave band, in order to insure that no undesired low-wave signals shall reach the first detector grid. To provide this, a dual pre-selector having two tuned circuits is placed between the first detector and antenna, and while this is not unusual, the actual effective selectivity of the combination is. The long-wave selector coils are wound with "Litz" wire, in universal (Continued on page 514)

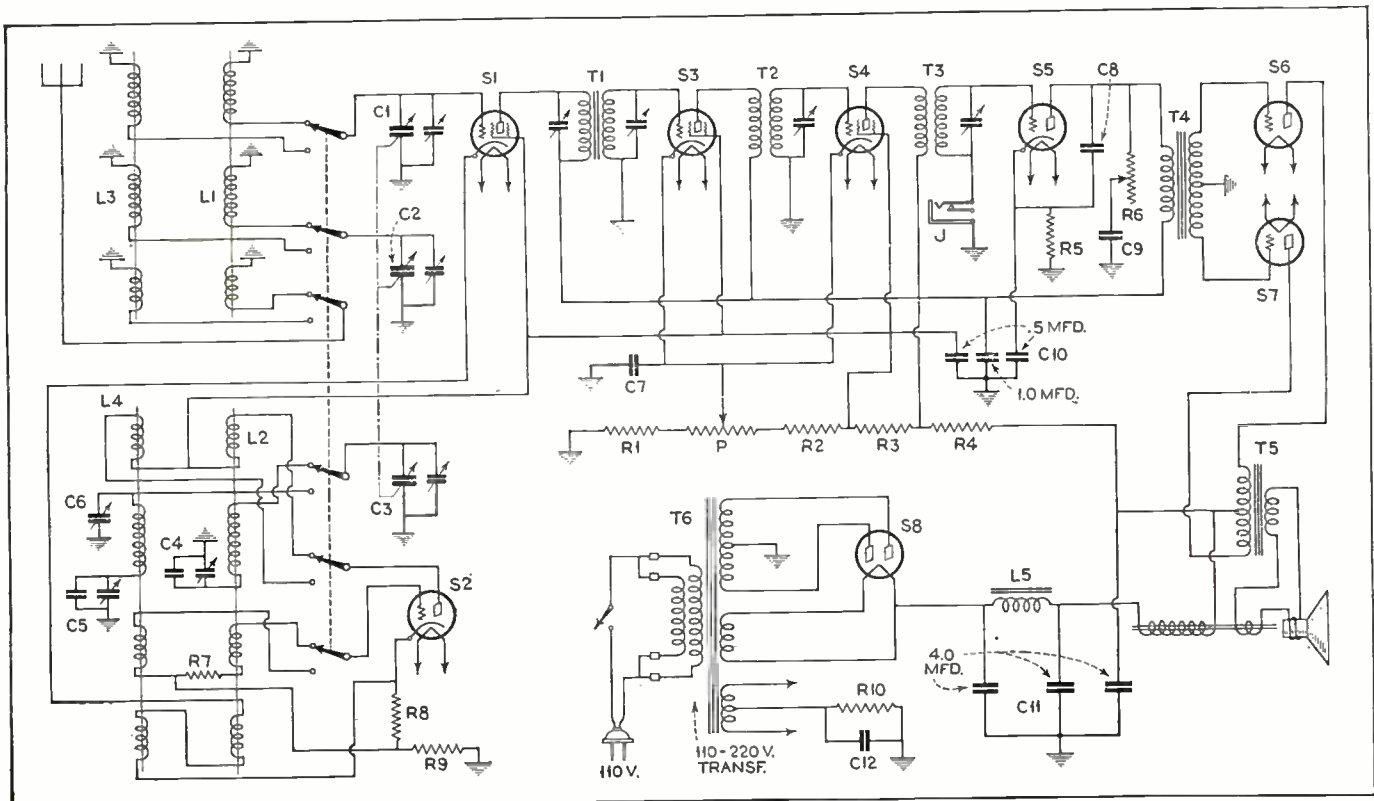

Figure 3. Both the 200-550 and the 1,000-2,000-meter ranges are covered by the same tuning condensers. The i.f. amplifier is tuned to 115 kilocycles for reasons explained in the article

Assembling Your Own **HOME RECORDER**

Phonograph records of the baby's voice or the voices of others of the family constitute an interesting complement to the family picture album. Here the author explains the theory of recording and reproduction—and describes equipment which is easily assembled by anyone with even a fair knowledge of radio

DURING the past year considerable experimental work has been done with home recording equipment and now it is possible to obtain surprisingly good results with a few inexpensive parts available at most radio stores. After installing these few parts you can record your favorite radio features or the voices of your family and friends. Occasionally a personal message can be recorded and mailed to friends and relatives living out of town. This makes a very good impression on the uninitiated. At a house party a great deal of fun may be had by recording some of the "talent" present and playing it back immediately after recording. The recording of long-distance short-wave broadcast programs should prove to be another interesting feature. There are many other stunts and applications that the individual will find well worth the few dollars spent on the equipment.

There is really nothing complicated in recording at home, providing one devotes a little time in deciding on which is the most satisfactory hook-up to use with the particular equipment he has on hand.

By S. M. Riccobono

The purpose of this article is to discuss some of the important things about recording and to pass on in-

formation obtained by the writer in experimenting with home recording equipment.

Before we can talk about recording we must have a fairly good idea of the electrical pick-up as used for reproducing records (see Figure 1). An electrical pick-up is made up essentially of a permanent magnet with a coil suspended between the poles. The needle is secured to a small armature which sets in the field of the coil and is swung on a pivot. When the pick-up is riding on a record, the lateral variations on the record cause the needle to vibrate and this in turn vibrates the armature. Movement of the armature between the poles produces a corresponding variation of the magnetic flux set up by the permanent magnet. This flux is diverted through the armature and in turn through the coil. The a.c. voltage induced in the coil coincides, theoretically, with the wave form on the record in frequency, form, and intensity. The voltage across the pick-up coil can be impressed on the input of an

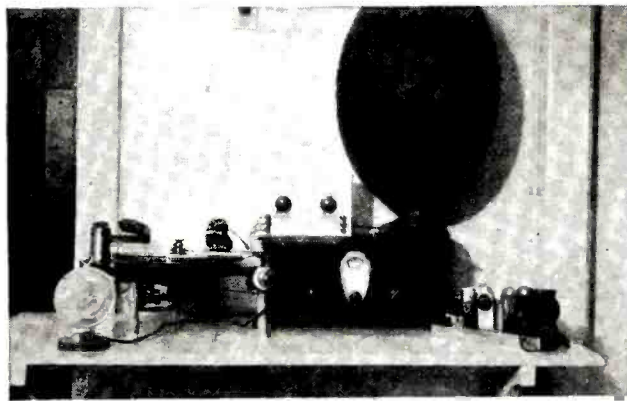

THE HOME RECORDING SET-UP

Equipment for recording on ungrooved aluminum discs. Left to right are shown: a double-button microphone; a Pacent 78 r.p.m. electric turntable, above which are a Pacent pick-up and a Presto cutter with its lead screw; a radio tuner and an audio amplifier. The aluminum box houses the microphone controls

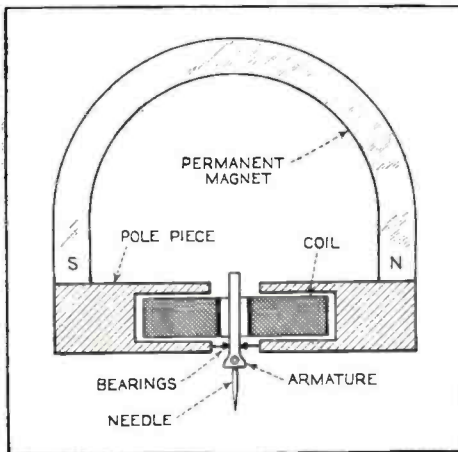

DRAWING OF PICK-UP

Figure 1. The vibration of the armature, which carries the needle, causes a variation in magnetic flux, inducing an a.c. voltage in the coil

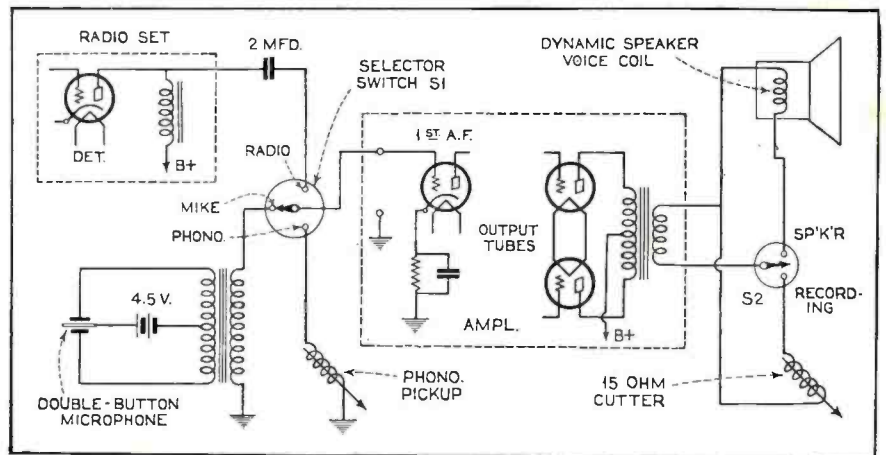

CIRCUIT FOR HOME RECORDING AND REPRODUCTION

Figure 2. A simple switching arrangement permits radio programs, microphone output or phonograph records to be reproduced through the loudspeaker or either the radio or microphone outputs to be recorded

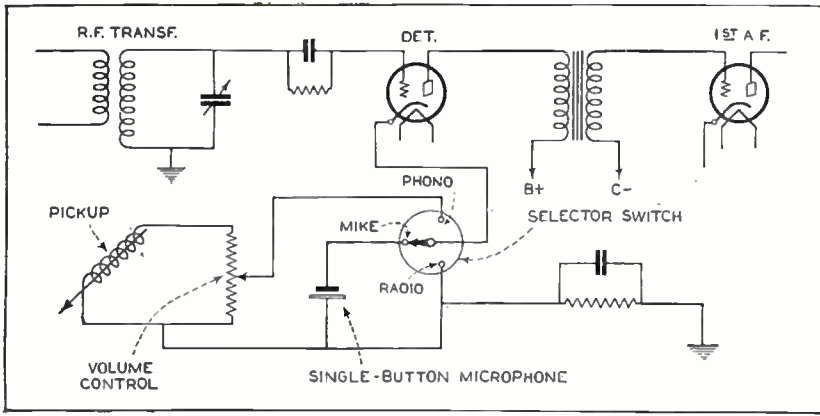

THE RADIO SET AS THE RECORDING AMPLIFIER

Figure 3. Instead of using a separate amplifier for recording, as in Figure 2, the audio end of a radio set may be used, if connected as shown here

audio amplifier and amplified in the conventional manner.

For recording, the process is reversed. The input to the amplifier may be obtained from a radio set or a microphone. The electrical pick-up or cutter is connected at the amplifier output in place of the loudspeaker. The a.c. voltage at the amplifier output is fed to the coil in the cutter and this in turn drives the needle. If the cutter is now permitted to ride on a blank record, the mechanical vibrations of the needle will modulate the record grooves, thus permanently recording the signals.



RECORDING AT AMATEUR STATION W2TI

One corner of the author's amateur station where he records short-wave foreign broadcast programs. Several types of pick-ups and cutters are provided for experimental work

At the present time three types of discs are available for home recording, as follows:

- 1—Pregrooved aluminum disc.
- 2—Ungrooved aluminum disc.
- 3—Pregrooved celluloid disc.

In using the pregrooved type of aluminum disc the cutter rides on the spiral groove and the stylus modulates the grooves when electrical sound energy is fed into the cutter. The audio-frequency range that can be recorded on this type of disc is limited, and the surface scratch during play-back is of considerable magnitude.

With the ungrooved type of aluminum disc the grooves are cut and modulated simultaneously. This is accomplished by having the cutter ride on a lead screw which is driven by the vertical shaft on the phonograph motor. For recording a hard steel needle is used and for play-back a special fiber needle replaces the cutting stylus.

Recording with pregrooved celluloid records is accomplished in the same manner as mentioned above for the pregrooved aluminum records except that a short, stocky, blunt-pointed needle is used for recording and reproducing. Comparing the two types of pregrooved records, better quality of reproduction and less surface scratch is obtained with the celluloid disc. However, the main disadvantages are: short life of the recording, due to the resilience of the material, and the inability to record audio frequencies above 300 cycles.

Although it is possible to use the cutter for reproducing records by

properly connecting it to the amplifier input circuit, it is recommended that an electromagnetic pick-up intended for that purpose be used.

Because of the reasons mentioned above the rest of this article will be confined to a discussion of recording with the ungrooved aluminum records only.

Needle Pressure

The average pick-up has a pressure at the needle point of $4\frac{1}{2}$ ounces. This is not sufficient for recording, therefore additional weight must be added. Experiments conducted with different values of weight at the needle point show that best results are obtained when as much weight as possible is placed on the head. In conducting these tests a phonograph motor having an exceptionally high torque was used. Further investigation,

using several different makes of motors on the market, showed that very few of them maintained a fairly constant speed with two pounds of weight on the cutter. In order to pull a two-pound cutter the motor should have a torque of about 35 ounce-inches when turning at 78 r.p.m. The minimum weight for good recording was found to be $1\frac{1}{2}$ pounds. If less than this value is used the results will be relatively poor and the record can only be played a few times before the recording is entirely destroyed.

An Ideal Set-up for Recording

An ideal set-up for recording should consist of an amplifier having at least two stages of a.f. amplification, with a gain of 35 db. or higher; two electrical pick-up units, one for reproducing and the other for recording; a radio tuner; a double-button microphone, and a 78-r.p.m. motor. These are hooked up as shown in Figure 2. By referring to the diagram you can see that we have three sources of input to the amplifier; i.e., radio, microphone, and pick-up. Any one of these can be used simply by manipulating the single-pole, three-point selector switch, S1.

Going to the output circuit, we have a pair of output tubes in push-pull, a step-down transformer having a 15-ohm secondary to couple to the voice coil of a dynamic speaker, and a 15-ohm cutter. For reproducing, we (Continued on page 520)

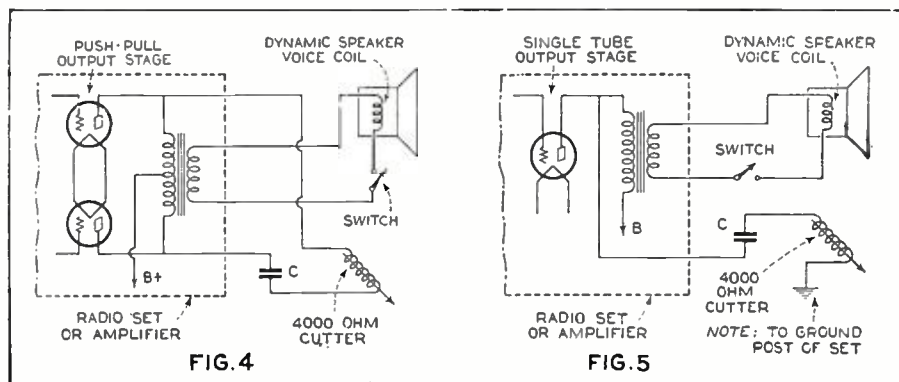

USING A HIGH-IMPEDANCE CUTTER HEAD

Figure 4. If a high-impedance cutter is fed by a push-pull stage, the connections are as shown here. The cutter connections shown in Figure 2 are for low-impedance cutters only. Figure 5 shows connections for a high-impedance cutter when a single output tube is used in the amplifier

One Solution of The City Antenna Problem

With the increasing trend toward apartment house living the antenna problem is becoming really serious, both in the poor radio reception and in the disfigurement of the buildings. The group antenna system described here offers one solution of the problem

By John M. Borst

IN his effort to utilize all available space, the city dweller has made his roof almost a perfect imitation of the wire entanglements of the Western Front—and sometimes nearly as dangerous. This is because in the city most radio listeners are handicapped by the lack of room for the erection of an efficient antenna, particularly in apartment houses where antennas for perhaps fifty or more families must be confined to a single roof.

Recently a new system has been developed by Messrs. Amy, Aceves & King, which does away with all this trouble. The multicoupler antenna system permits the connection of up to 30 receivers on a single antenna. The different receivers may be tuned to the same or to different stations without any interaction.

The installation of this system in apartment buildings, hotels, hospitals, etc., provides a profitable side line for the wide-awake radio installation or service man. One type of system is simple enough to be easily installed in finished buildings and thus owners of practically all existing buildings of these types become potential sales prospects.

Helps to Rent Apartments

In these days of depression, when so many apartments are empty, the progressive landlord who takes advantage of the latest conveniences will be able to secure tenants more readily than the building owner who is backward. The servicemen, when approaching a landlord, can show him how this installation is relatively inexpensive and at the same time will make money for him by attracting desirable tenants, both because of the improved appearance of the building and because of the radio convenience to the tenant.

New apartment houses going up should logically be equipped with it. A special type of multicoupler system has been designed for installation during construction. In this system all wires are run in conduit and the tenant

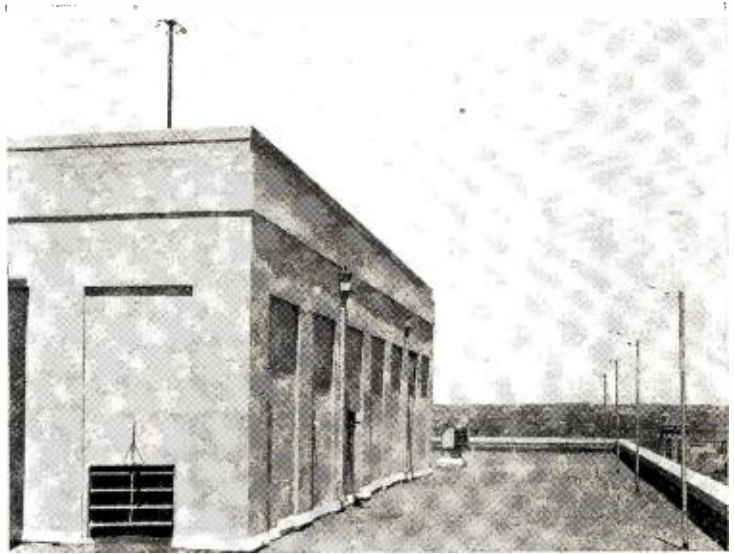

A MODERN ANTENNA SYSTEM

The ten antennas shown here will operate up to 300 radio sets. It does not require a vivid imagination to appreciate the improvement in appearance over the same roof if tenants were forced to erect their own individual antennas—and the improvement in reception conditions is equally marked

has aerial and ground connections right in his apartment, just as he gets his power today.

An antenna erected right in among many others is inefficient, for each conductor in the field takes a little of the available signal energy, leaving that much less for its neighbors. A maze of wires on an apartment roof absorbs so much power that a substitute, such as an indoor aerial, often actually works better than a regular aerial on the roof. But inside aeri- als and socket power antennas when used in the city have the drawback that they tend to pick up too much noise of the "man-made static" type. The connection of more than one radio receiver in one ordinary antenna has been tried, but the sets affect each other's tuning.

No Tubes Used in New Antenna System

Another and even more serious feature in locations where each family in an apartment house erects its own antenna lies in the fact that haphazard erection often results in one antenna sagging until it makes contact with others on the same roof. Not only does this cause trouble in the radio sets attached to these antennas but when the wind blows, causing the troublesome antenna to make and break contact with others, resulting clicks will be picked up by every antenna on the roof.

Complicated systems have been designed to take care of these difficulties. In hotels and hospitals, for instance, a master receiver is put in the building and the output is wired to loudspeakers in each room—or three or four receivers may be used to provide a selection of programs. Such centralized radio systems are highly satisfactory for use in these types of buildings, but are obviously unsuited for apartment houses or other multi-family dwellings.

The multicoupler system described here does not use any tubes, yet it brings to each tenant the same results he would obtain from a really good outdoor aerial. There is nothing that needs adjustments or replacements, so that there is no upkeep expense after the system has been installed.

There are two types of multicoupler systems available: the "open" type and the "conduit" type. The open type is to be installed in finished buildings and the wires are run either outside the building or in an elevator shaft or ventilating flue. The conduit type is

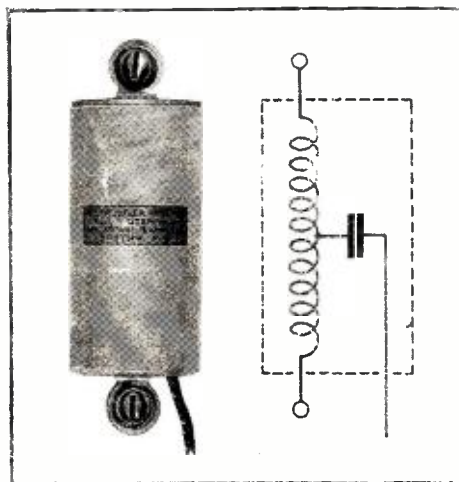

THE MULTICOUPLER

Figure 1. The multicoupler unit in its metal housing. Its schematic circuit is at the right

used for buildings in process of erection, where it will usually be installed by the electrical contractors at the same time as the electric wiring.

An outside type of the open multicoupler system consists of an efficient antenna with a down-lead along the side of the building. On its way down a multicoupler unit is connected in series with the riser, or lead-in, at each apartment, as shown in one of the accompanying views and in Figure 2. This device consists of a center-tapped inductance and a condenser, connected as shown in Figure 1. The receiver is connected to the center tap through the small condenser. Both the condenser and the coils are in one metal container of cylindrical shape. The value of L and C are so chosen that the natural wavelength is outside the broadcast band.

Interaction Limited

Because of the high reactance of the condenser in series with the receiver the energy it can take from the line is limited. A receiver which is tuned to a signal has a high resistance for that particular frequency. When it is detuned the resistance is decreased, but the current will still be limited by the high reactance of the condenser. As the currents through the receiver and the condenser are out of phase, the difference in current drawn off between a tuned and an untuned receiver is relatively slight. This is a fact borne out by actual measurement.

The complete technical story is found in an article by the co-inventors in the May, 1931, issue of *Projection Engineering*. After deriving the propagation constant per section it is explained that the attenuation per section can be calculated. However, this calculation is complicated and may not produce an accurate result because it has been assumed that the signal is picked up only by the antenna, but actually the down-lead will pick up additional signal voltages and these will vary in different locations in such a way as to make accurate calculation entirely out of the question. Similarly the losses in the line depend on the proximity of metals, and they, too, cannot be predicted. It is therefore necessary to get quantitative data by experimentation.

In an apartment house in New York City the signals were measured on different floors and also compared with those picked up by an individual antenna. At the 14th floor the gain was 18 decibels when using the multicoupler. At the 9th floor the average gain was 14 decibels. Other measurements were made to check up on the voltage distribution and the relative volumes of the same signal at different outlets. The maximum vari-

ation of the same signal on different floors did not exceed 5 decibels.

In the conduit type of wiring, as used in new buildings, the antenna down-lead is run in rigid conduit, together with a common ground wire. Such a circuit introduces additional distributed capacity. The effect of this distributed capacity can be neutralized by putting loading coils in the line in the same way as telephone lines are loaded with "Pupin" coils.

At the ground end of either the open or conduit type systems a terminal resistance must be connected between each down-lead and a good ground.

The antenna used with the multicoupler system should be approximately 75 feet long and supported at least 20 feet above the building at the free end. The end where the lead-in is connected should be at least 8 feet above the building so that one may walk under it. The antenna should be kept away from metal objects and at least 6 feet from another antenna running parallel with it, if the building is large enough to require more than one.

Lightning Protection

It seems to be necessary to point out that the prevailing practice of having the antenna proper and the lead-in in two pieces is a bad one. The antenna and lead-in should be one piece of wire down to the first necessary break; in this case that will be the first multicoupler. An approved lightning arrester should be mounted at the head of the down-lead. The antenna wire does not have to be broken for this lightning arrester, but instead another wire should be spliced to it.

The down-lead should be supported at top and bottom by strain insulators so as to take the weight off the antenna. It should be run as close as possible to the windows through which the leads are to be carried. This down-lead must be kept away from the building at least three inches by stand-off insulators located a few inches below the multicoupler. To insure the installation against rusting, the metal supports of these stand-off insulators should be of galvanized iron or brass. They are to be fastened into the brick wall, using a Rawl plug in a 1/4-inch hole drilled 3/4 inch deep. The hole should be drilled in the brick and not in the mortar between the bricks.

Usually a group of apartments directly above one another are connected to one riser, another vertical group to a second riser, and so on. A maximum of 30 multicouplers, connected to 30 receivers, may thus be connected in series if an antenna of at least 75 feet in length is used. For buildings of 15 stories or less two down-leads (Continued on page 540)

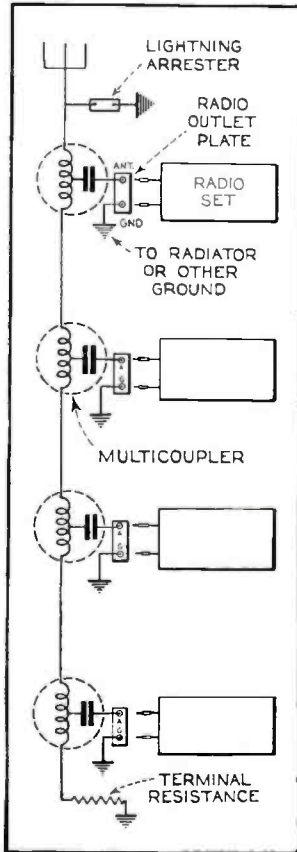

AN "OPEN" SYSTEM INSTALLATION

Figure 2, left. Here only four extensions of the open type system are shown. Actually up to thirty radio sets may be operated from a single antenna. At the right is seen an actual installation

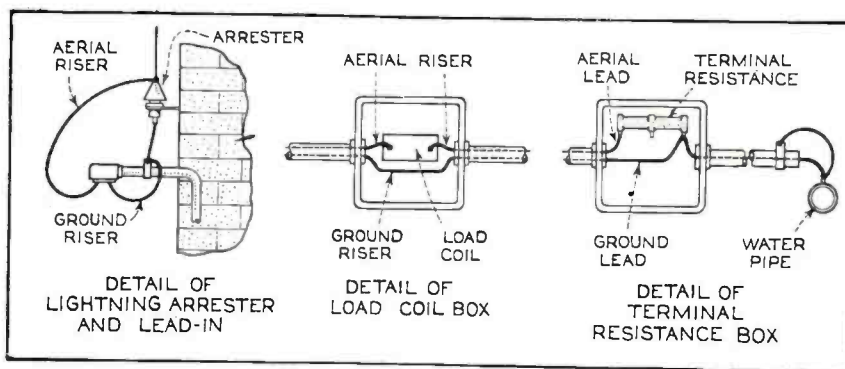

DETAILS OF CONDUIT TYPE INSTALLATION

Figure 3. When installed during the construction of a building all wiring is commonly placed in rigid conduit, with parts and connections in standard outlet boxes

Marine Radio Telephony

It appears that the telephone, aided by radio, knows no limitations. Not only can one now call a person on another continent, he can actually talk to voyagers in mid-ocean, as demonstrated by the actual tests described here

By Andrew R. Boone

FORMAL telegraph blanks no longer provide the sole means for conveying messages from round-the-world travelers to friends at home. Now they may speak into an ordinary telephone transmitter and the radio combined with land wires will carry their voices to any city on any continent.

In the flexible use of the sea telephone demonstrated aboard the round-the-world liner *Belgenland* may be seen the beginning of a basic change in marine communication. Although radio as a means of communication between ships and the shore and between ships at sea is commonplace, voice communication by radio between a liner and a shore subscriber marks a decided advance step in the science.

To what extent the marine radio telephone will cut into the use of code cannot be forecast. Since direct communication by voice eliminates the mechanics of the written message and permits instant Socratic discussions at low cost, it promises to find widespread use. The range of the marine radiotele-



THE RADIO TELEPHONE AT SEA

Mary Elizabeth Shirk, one of the round-the-world voyagers, talks to her friends in Glen Ridge, New Jersey, while on the Pacific, one day out of Panama

phone became world wide for the first time through the *Belgenland* installation.

From south seas and cooler waters of the Pacific passengers talked with Europe and the United States as easily as you may phone cross-lots to a neighbor. Early in the voyage Captain William A. Morehouse, while off the Florida coast, talked with people in Buenos Aires, 5000 miles away. Another officer chatted from the Caribbean with his wife in Liverpool. Mary Elizabeth Shirk, 12-year-old Glen Ridge, N. J., youngster, talked with her playmates in Glen Ridge while a few hundred miles off Panama in the Pacific.

As the round-the-world radiotelephone works both ways, one can easily reach passengers on the other side of the world. Mrs. William O. Smith, in St. Paul, (Continued on page 518)



ON BOARD THE S. S. BELGENLAND

The radio telephone equipment which permits passengers to telephone from the ship to their homes no matter what ocean they may be on at the time



BROADCASTING FROM MID-OCEAN

Professor Einstein (with Mrs. Einstein) was able to broadcast while at sea, via ship-to-shore radio telephone. Land lines then carried the program to the broadcast stations

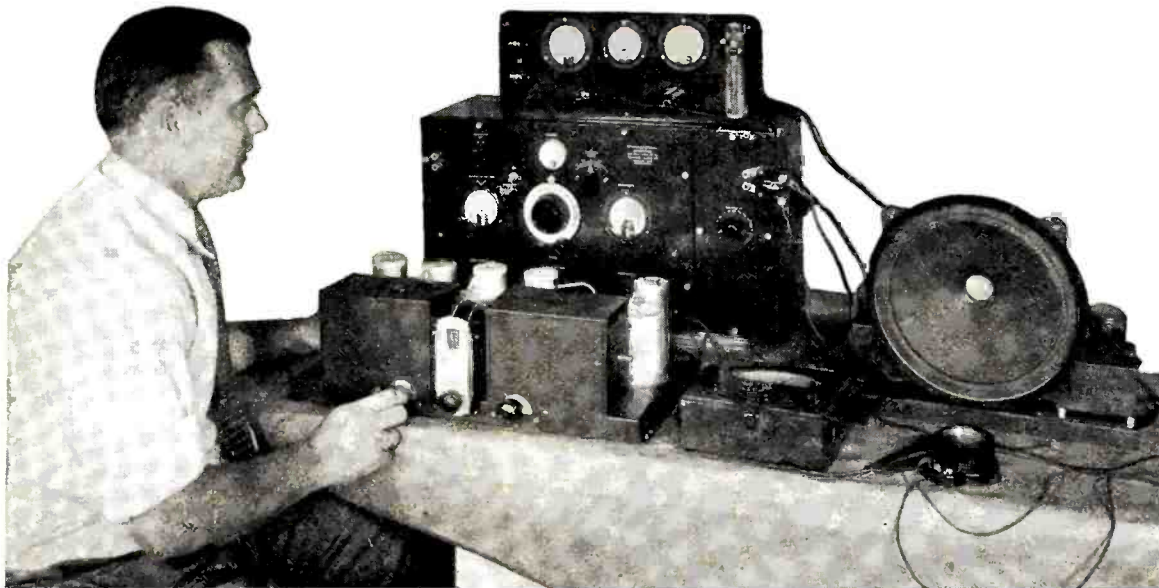

MEASURING THE PERFORMANCE OF THE RECEIVER

The receiver surrounded by laboratory equipment employed in making measurements used in plotting some of the curves presented in this article and the one to follow

The Latest Example of Tuned R.F. Design

The author needs no introduction to readers, as his name is almost a household word in radio circles. In this article, and another to follow next month, he describes some of the outstanding features of a new receiver, in the design of which he has been collaborating

By Glenn H. Browning

Part One

THE radio-frequency tuner type MB-30, described last year in RADIO NEWS, was so well received by those demanding quality, sensitivity and selectivity that further research and development was undertaken in order to produce a radio set which would be as fine a product as could be built with the more modern apparatus and knowledge now available.

The complete set, to be known as the MB-32, was designed in two separate units, a radio-frequency tuner and a speaker-amplifier combination. This division is obviously an advantageous one, for not only can the hum be practically eliminated

from such a separation of apparatus, but the radio-frequency tuner may be employed separately as a radio pick-up for public-address systems, hotels, theatres and other purposes.

The next question that had to be solved was the selection of circuits for both the radio-frequency end and the audio amplifier. Time was taken up in analyzing, constructing and testing various radio-frequency amplifiers. Double detection (superheterodyne) systems were worked out, as well as various tuned-radio-frequency amplifiers. It was finally decided to use a combination of the band-selector, band-amplifier developed by Dr. Frederick K. Vreeland, an untuned "leveling"

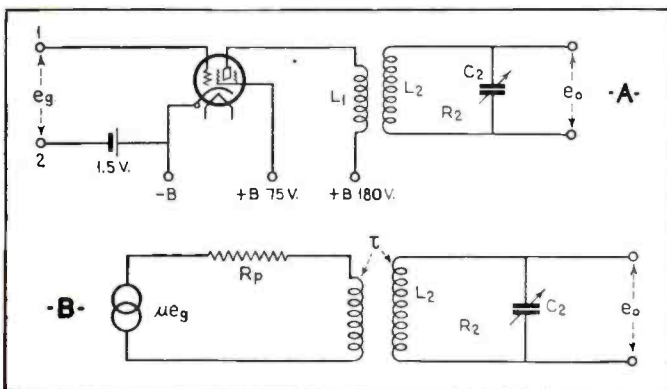

EXPERIMENTAL MULTI-MU TUBE CIRCUIT

Figure 2. (a) A one-stage r.f. amplifier used in obtaining actual operating data on type -35 tubes and (b) its mathematical equivalent used in calculating the theoretical characteristics of the circuit

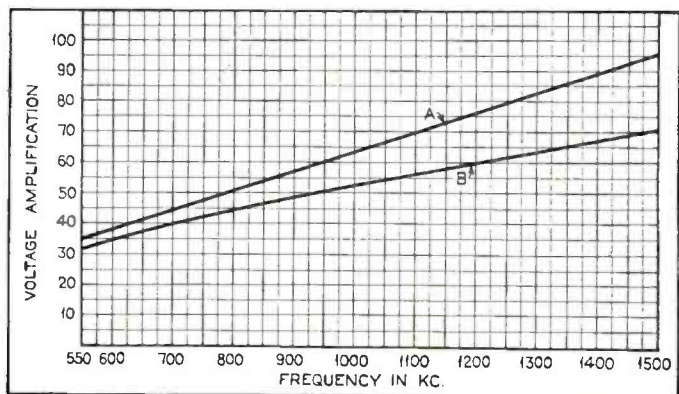

CHECKING THEORY WITH PRACTICE

Figure 3. (a) The calculated gain with the circuit of Figure 2. (b) The actual measured gain. This latter curve shows the necessity for design features which will increase the amplification at lower frequencies

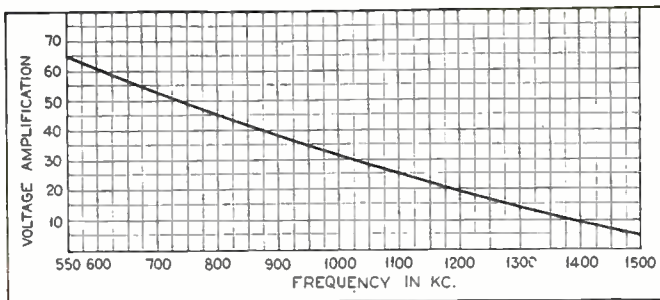

GAIN CURVE OF THE UNTUNED STAGE

Figure 5. The high gain at the lower frequencies overcomes the reverse condition in the associated tuned stages

stage and two stages of tuned band-width radio-frequency amplification as shown in Figure 1. This, apparently, was in many ways superior to the other tuners, for with double detection the quality was somewhat impaired by the first detector and the lining up of the condensers, one of which controlled the frequency of the oscillator, would be extremely difficult in production. With the chosen combination the selectivity could be made easily within 10 kc., the sensitivity made practically constant over the frequency range of from 550 to 1500 kc., and the quality as near perfect as could be desired.

Every few years the vacuum tube industry presents the radio engineer with new tools to work with. The introduction of the heater type of a.c. tube marked a milestone long to be remembered, while the screen-grid tube made possible a gain in sensitivity of at least ten times, with a slight gain in selectivity. In November, 1930, a new type of screen-grid tube was discussed at a meeting of the Institute of Radio Engineers. This tube, called a variable-mu screen-grid tube (type -35 or -51), was the invention of H. A. Snow and subsequently developed by Ballantine at the Boonton Research Laboratories.

Multi-mu Tubes Used

This variable-mu tube had certain desirable characteristics, especially in view of the present broadcast congestion. It is not within the scope of this article to discuss at length the -35 tube; however, the tube has characteristics which will tolerate strong signals without overloading. Thus, when it is used as a radio-frequency amplifier,



THE RECEIVER MOUNTED IN A CONSOLE

The main chassis includes only the r.f. tuner. The a.f. amplifier, loudspeaker and power supply are combined in a second unit. This use of two separate units reduces the hum level and makes the tuner more adaptable to public address and centralized radio installations

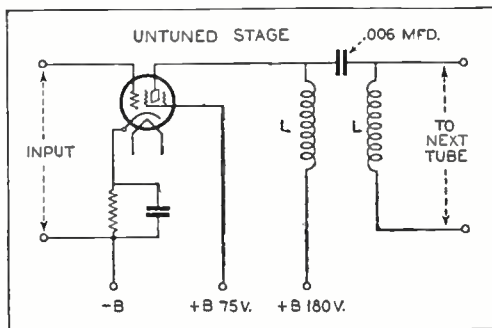

AN UNTUNED R.F. STAGE

Figure 4. Tuned r.f. stages normally provide more amplification at the higher end, so an untuned stage was designed with reverse characteristics

local signals are not usually of sufficient magnitude to make the tube automatically become a detector, causing cross talk, cross modulation and hum on the carrier, due to modulation of the tubes. Thus, preliminary experimentation showed these tubes to be apparently more quiet in operation in addition to other desirable characteristics, consequently data concerning their performance in a one-stage tuned r.f. amplifier was first calculated and then determined by laboratory experiments.

Figure 2A shows the circuit in this process. As the tube is being employed as an r.f. amplifier, it may be represented, for calculation purposes, as a generator whose voltage is the amplification factor times the input signal, in series with the plate resistance of the tube. (Continued on page 522)

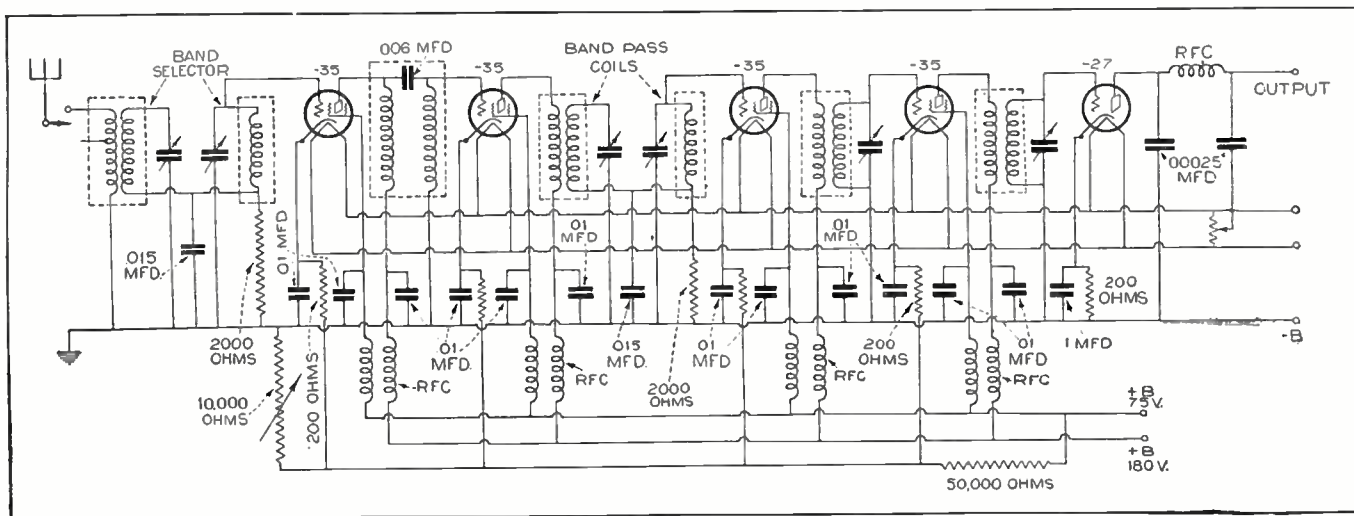

THE CIRCUIT OF THE R.F. TUNER

Figure 1. Band-pass tuning is accomplished by a band-selector input to the first tube and band-pass coupling between the second and third tubes. A fixed coupling transformer following the first tube serves to maintain high sensitivity level at the longer wavelengths

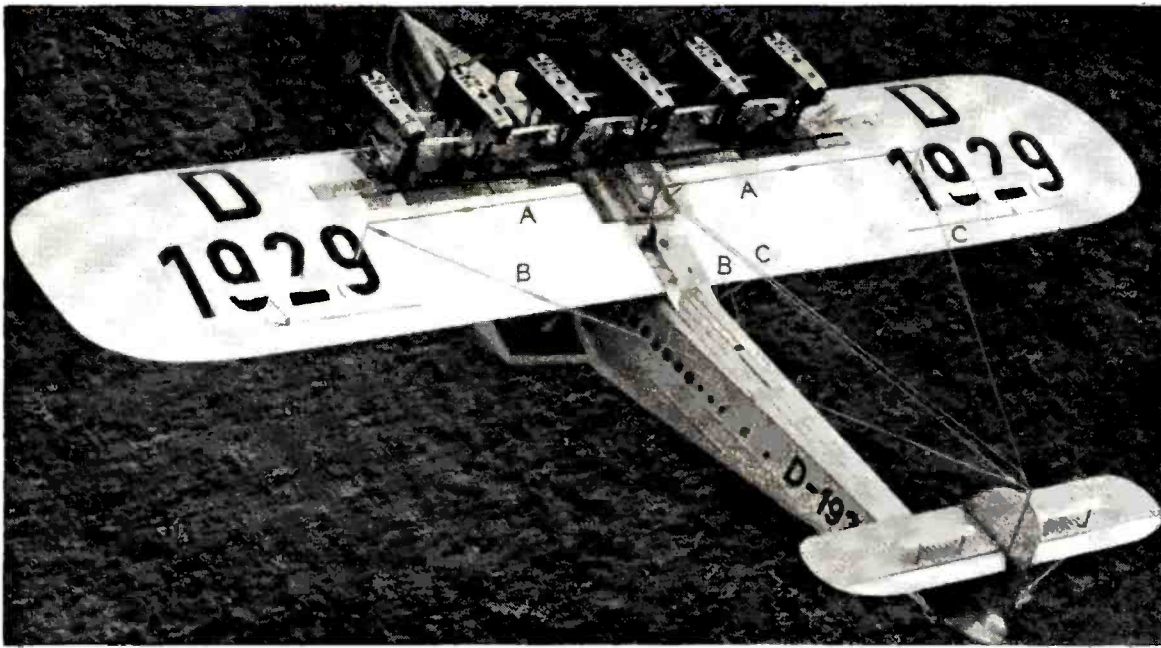

THE DO-X ANTENNA SYSTEM

A dipole antenna (A-A) is used for short-wave transmission and reception. For 600-meter work either one of the two V-shaped antennas (B-B or C-C) is used. These two are employed together for wave-lengths above 600 meters. Combined, they have an effective length of 200 feet

RADIO EQUIPMENT on the DO-X

Radio is extensively employed on the DO-X for communication purposes, but its most important function is in its aid to navigation and safety. Details of the installation are given in this exclusive article

THE DO-X carries more radio equipment than any other plane in the world. It carries both a long-wave and a short-wave transmitter; a long-wave, a short-wave, and a broadcast receiver; a radio-compass with receiver; both a wind-driven and an engine-driven generator; two dynamotors; a battery and four aerials. One radio officer operates all this equipment and he literally has his hands full every minute the plane is in the air. This operator is a "Debeg" employee and all radio equipment except the radio-compass is standard Lorenz equipment as used by the Debeg Company on German aircraft.

The installation scheme has been carefully worked out so that most of this equipment is accessible within the restricted area of the main radio room. This is a small compartment located about midships just aft of the pilot's compartment and adjacent to the captain and navigator. The radio-compass loop is mounted outside on the starboard bow. The control wheel and receiver for this loop is in the barroom (Mr. Volstead, take notice), below, which has been built into the forward part of the fuselage or boat hull, just aft of the bow. Here the exhaust is not so loud as to require helmet type headphones, ordi-

*By Myron Eddy, U.S.N. Ret.**

nary headphones with a special steel spring headband being used instead.

Passengers in this compartment are welcome to headphones for broadcast programs. Passengers may also send private messages. Weather reports are copied and posted. The entire radio situation is comparable to that aboard an ocean liner—and the DO-X is just that—an ocean air-liner de luxe.

The antenna system is most unique. As the seaplane is all metal, it constitutes an ideal counterpoise. There are two fixed aerials besides the radio-compass loop—a dipole and a doublet—for use either while moored or in the air. After the take-off, a third antenna is trailed down.

For the dipole there is a hollow mast installed amidships. This mast is about 8 feet in height and the antenna passes straight through the wing from the radio compartment, to the mast top, divides and goes out toward each wing tip to 3-foot stub masts, mounted so as to give a flat top span along the wing of 50 feet. The dipole mast is guyed to the wings to obviate undesirable vibration. The dipole antenna is for transmitting and receiving short waves.

The doublet type antenna is made in two open V sections. These are formed by stringing antenna wire from each

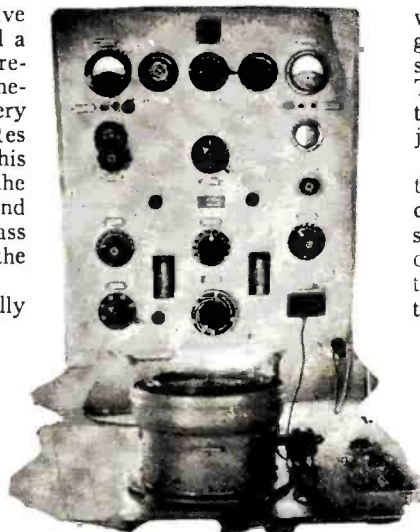

THE RADIO COMPASS

The DO-X does not have to depend on bearings provided by shore radio compass stations, but is equipped to take its own bearings. This shows the equipment panel and compass

*Director of Radio, Aeronautech Institute. Author of "Aircraft Radio."

stub mast to the tail and back to the dipole mast. The stub masts on top of the wings support and insulate this wire from the wing surfaces, while a regular strain insulator is used for the ends attached to the vertical stabilizer aft. One section of this aerial is used for both transmitting and receiving on 600 meters. Both sections switched together have an effective length of about 200 feet, and this latter arrangement is used when working on wavelengths above 600 meters.

The Long-Wave Antenna

The trailing antenna is reeled out by hand from a reel that is counterbalanced to facilitate quick withdrawal in case of a sudden landing. A lead "fish-tail" or streamlined weight securely attached to the end of the antenna causes it to trail aft as well as down. The length of this antenna is varied according to the wavelength used. About 450 feet is usually the maximum length of antenna paid out before the reel is locked, and this length antenna is for maximum radiation at 2200 meters. The loop antenna used with the radio-compass or direction-finder is the ordinary ship's type (Telefunken), about 3 feet in diameter.

The radio power supply is most complete. The system assures a suitable source at all times for both transmission and reception. A special 2-cycle, 12-horsepower gas engine is geared to a d.c. generator delivering up to 30 volts to a 24-volt lead type storage battery and a 4-volt battery used for filament supply. There is also a wind-driven generator which is kept regulated at a constant speed irrespective of flying speed by its two-bladed (Telefunken) propeller. This generator is not mounted in any of the plane-engine

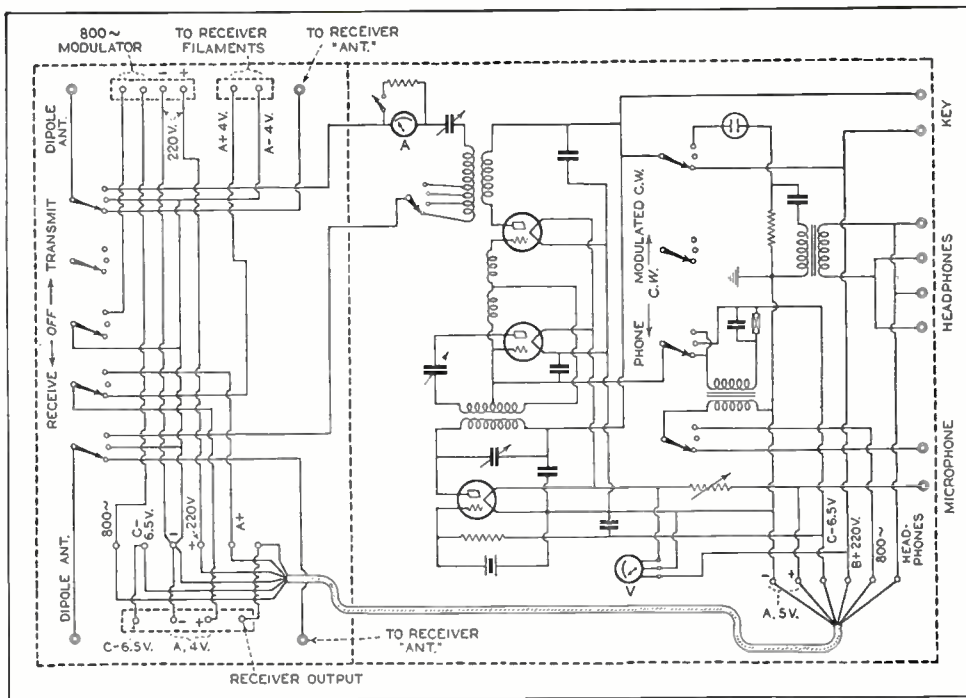

THE 27-80 METER TRANSMITTER

Figure 1. 'Phone, c.w. and modulated c.w. are provided for. Modulated telegraphy employs an 800-cycle note from an external generator



THE SHORT-WAVE RECEIVER

For short-wave reception a compact, plug-in coil receiver is used. The circuit diagram is shown in Figure 3

propeller slip-streams, so does not generate any power except when the seaplane is in flight.

Both the engine-driven and the wind-driven generators have four armature windings, one delivering 165 watts at about 30 volts d.c. to charge the storage battery, one delivering 15 watts d.c. at 220 volts for the modulator tubes, one giving 370 watts d.c. for the plate and still another furnishing 5 watts a.c. at 800 cycles for modulated continuous-wave telegraphy. Two dynamotors are also available as substitutes for this generator. These run from the 24-volt storage battery mentioned. These dynamotors also have four windings altogether, the three besides the 24-volt input being the same as those

on the generators except that the one used with the short-wave transmitter supplies 250 volts for the plate circuit. The rated output of each of the generators and dynamotors is 555 watts.

The Transmitters

The short-wave transmitter, Figure 1, is of the master-oscillator, power-amplifier type, crystal controlled. Its input is 30 watts; antenna output, 5 watts. There is one German type R.E. 134 tube used as an oscillator and 2 used as amplifiers. The filament voltage is 4, the plate voltage 250. The wavelength can be changed to six different values, ranging from 35 to 74 meters, by using a different crystal for each wave setting. The range of this set as installed on the DO-X has been shown to be as high as 4500 miles when using 35 meters and transmitting from the water.

The long-wave composite transmitter, Figure 2, is a 120-watt set. Either c.w., phone or i.c.w. can be used. Magnetic modulation is employed with the latter two. Radio telegraphy wavelengths from 600 to 2200 can be used and a distance of 500 miles at 600 meters and 1600 miles on 2200 meters has been worked by the DO-X on this last trip. The (Continued on page 530)

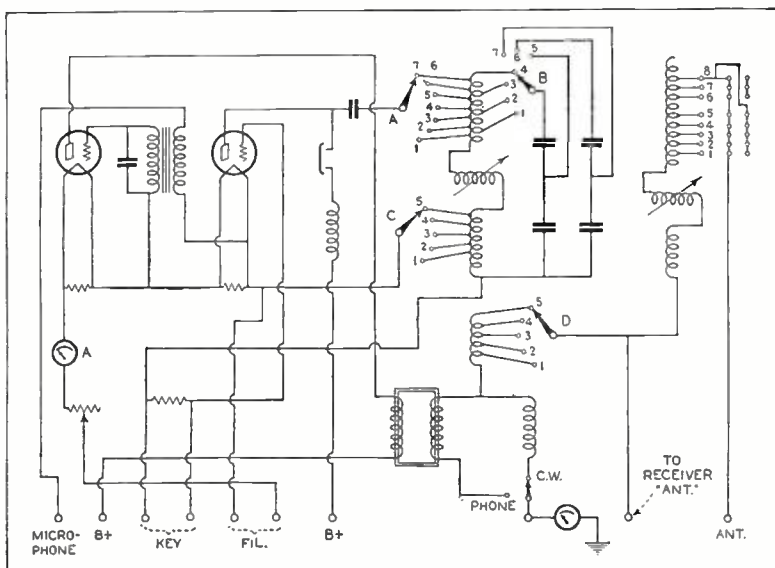

THE LONG-WAVE TRANSMITTER

Figure 2. Long waves from 580 to 1300 and 1800 to 2300 meters are covered by this transmitter, employing c.w., i.c.w. or 'phone

Power Transformer Design for the Home Experimenter

The author gives relatively simple formulas by means of which it becomes a simple matter for even the novice to design power transformers to fit his individual radio requirements. A practical example of the application of the formulas is also given

By George E. Fleming

THE experimenter and the custom set-builder frequently face the necessity of obtaining a power transformer to fill a certain need. Not being able to buy it over the counter, in the same way that he buys chokes and condensers, he either must be satisfied with a substitute, which is rarely satisfactory either from a financial or electrical point of view, or he must build his own.

The design and building of a small transformer are not difficult in any way, but the majority of textbooks so confuse the subject with obscure formulas that one is discouraged in attempting to dig out the necessary information. However, all that is really necessary to know about the design can be covered in a few empirical formulas that are easy to understand. After all, a small transformer is just an iron core with wire wound upon it, so if we can determine the amount of iron to use, and the number of turns and the proper size of wire, we have covered the subject fairly well.

Transformers, generally, are divided into two distinct types, the "core" type and the "shell" type. Figure 1 shows a typical lamination of the core type. It will be noticed that the dimension A is equal to the sum of the dimensions B and C. This is because the winding, in this type of transformer, is all placed on the center leg of the core, and the magnetic path divides between the other two legs equally. An additional piece is shown at the bottom of the illustration, which only serves to complete the magnetic path, and if it were possible to wind the wire on the center leg with this piece in place it might well be a part of the lamination, instead of a separate piece.

The shell type transformer differs from the core type in that there is no center leg to the core, and all dimensions are equal. Figure 2 shows a typical lamination of this type. The windings in this instance, instead of being on the center leg, are on one or both of the outside legs. Sometimes the primary is placed on one leg in this type of transformer, and the secondary on the other leg, and again in high-voltage transformers of this type the secondary is sometimes split in two parts, half of which is wound on each leg. These variations do not, however, in any way alter the principle on which the transformer operates, nor the computation of its various parts.

Volts-per-turn

Volts-per-turn of wire in a transformer is a function of primary wattage. The primary wattage is the sum of the wattage of the various secondaries, plus approximately ten

per cent. for core loss. This may be expressed

$$W_p = W_{s1} + W_{s2} + W_{s3} + \frac{W_{s1} + W_{s2} + W_{s3}}{10} \quad (1)$$

where W_p represents primary watts and W_{s1} , W_{s2} , etc., the wattage of the individual secondaries. (The wattage of any one secondary is the voltage multiplied by the amperage, considered in phase.)

$$E = \frac{\sqrt{W_p}}{50} \quad (2)$$

where E is the volts-per-turn. This formula applies to 60-cycle supply, and a core of the "core" type.

$$E = \frac{\sqrt{W_p}}{83} \quad (3)$$

Again E is volts-per-turn. This formula applies to 25-cycle supply and a core of the "core" type.

$$E = \frac{\sqrt{W_p}}{25} \quad (4)$$

This formula applies to 60-cycle supply and a core of the "shell" type.

$$E = \frac{\sqrt{W_p}}{41} \quad (5)$$

This formula applies to 25-cycle supply and a core of the "shell" type.

It will be noticed that only two frequencies are considered above. A transformer designed for one frequency can always be used on a frequency *higher* than that for which it was designed, so we may use 25-cycle design for any frequency from 25 cycles up to 60, and 60-cycle design for 60 cycles and higher. With, of course, some loss of power. It will be noticed also that the volts-per-turn is a fraction unless the primary wattage is very high.

Turns-per-volt

Since the volts-per-turn solution of any of the preceding formulas is usually a fractional term, it will be more convenient to change it to "turns-per-volt" in computing the number of turns in the various windings. This may be done by inverting the fraction and dividing as indicated. For instance, if the solution of any one of the formulas should give us $E = \frac{1}{4}$, the turns-per-volt will be four. (We will use the term "Tv" to indicate turns-per-volt in any following formula.)

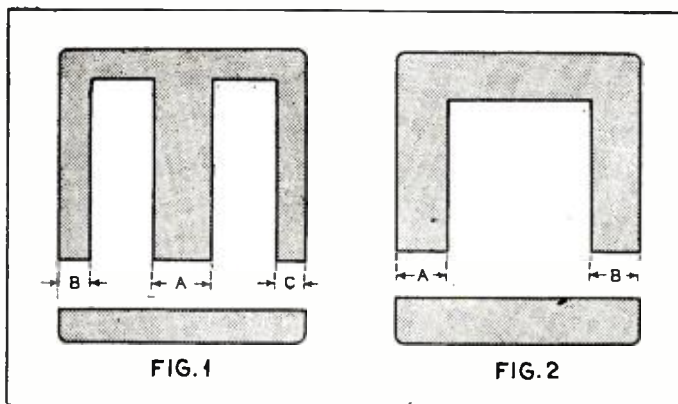

TYPES OF LAMINATIONS

Figure 1. A lamination for a "core" type core. Note that the dimension A is equal to the sum of dimensions B and C.
Figure 2. A lamination for the "shell" type core. In this type dimensions of the two legs are equal

We have found that we now have a value of turns-per-volt, or T_v , so it follows that the total number of turns in any individual winding is the voltage across that winding times turns-per-volt, or

$$N = V \times T_v \quad (6)$$

where N is the total number of turns in the individual winding, V is the voltage across the winding, and T_v is turns-per-volt.

Size of Wire to Use

It is customary to use wire with an area of 700 circular mils to 1000 circular mils per ampere, depending on the ventilation of the transformer. If at all in doubt, it is best to use a wire too large rather than one too small, so use 1000 circular mils in all computations. Appended to this article will be found a wire-size table, giving all necessary information about the sizes of wire most frequently used in transformer design.

Size of Core

The size of the core in a transformer is always the area, in square inches, of a cross section of the leg of the core on which the winding is placed. In the core type this is the center leg, and in the shell type, either of the outside legs. To make this clearer, the area in square inches is the dimension A in Figure 1, times the height of the stack of laminations. As the dimension A decreases, the height of the stack will, of course, increase, and vice versa.

The number of laminations necessary to give a stack of a certain height will be the necessary height divided by the thickness of one lamination. (This is not literally true, for in practice we do not, as a rule, compress the pile to its smallest possible dimension, but for practical purposes it is true.)

Having defined the "cross-section" of the core, let us see how we determine the necessary cross-section to use.

$$A = \frac{E \times 100,000,000}{4.44 \times F \times B} \quad (7)$$

where A is the area in square inches, E is the volts-per-turn solution of one of the formulas (2), (3), (4) or (5). F is the frequency of the supply current and B is the number of lines of magnetic force per inch. With the vast majority of steels on the market we may use 50,000 lines per inch, so we will adopt that as standard. With very high-grade steel, or in transformers that are large, such as lighting-line transformers, this might be increased, but again it is best to err on the side of designing our transformer too well rather than too poorly. Using 50,000 lines per inch, we can reduce the formula to

$$A = \frac{E \times 100,000,000}{13,320,000} \quad (8)$$

where F is 60 cycles, or

$$A = \frac{E \times 100,000,000}{5,550,000} \quad (9)$$

where F is 25 cycles.

Since the frequencies usually encountered are 60 cycles and 25 cycles, these formulas may be further reduced to—

$$A = E \times 7.50 \quad (8a)$$

where A is the area, E is volts-per-turn, and the frequency is 60 cycles.

$$A = E \times 18 \quad (9a)$$

where the frequency is 25 cycles.

Design of a Typical Transformer

Figure 3 is a schematic drawing of a transformer such as might be used in the design of a receiver. To make the foregoing mathematical discussion clear, we will fully design this transformer.

The first step we will take is to determine the primary wattage, by the method outlined in

WIRE TABLE					
SIZE B.&S.	DIAMETER		AREA	TURNS PER INCH	
	ENAM.	D.C.C.	CIRC. MILS.	ENAM.	D.C.C.
8	.1307	.1413	16510.	7.7	7.0
9	.1166	.1252	13090.	8.6	7.9
10	.1041	.1118	10380.	9.6	8.9
11	.0927	.1006	8234.	10.8	9.9
12	.0828	.0902	6530.	12.1	11.0
13	.0740	.0812	5178.	13.6	12.1
14	.0659	.0733	4107.	15.2	13.6
15	.0589	.0655	3257.	17.0	15.1
16	.0526	.0592	2583.	19.1	16.7
17	.0469	.0536	2048.	21.5	18.2
18	.0419	.0487	1624.	23.9	20.2
19	.0373	.0446	1288.	26.8	22.2
20	.0334	.0408	1022.	30.1	24.3
21	.0297	.0368	810.1	33.7	26.7
22	.0265	.0335	642.4	37.7	29.2
23	.0238	.0308	509.5	42.3	31.6
24	.0213	.0283	404.0	47.1	34.4
25	.0191	.0261	320.4	52.9	37.2
26	.0170	.0240	254.1	59.1	40.1
27	.0153	.0219	201.5	66.2	43.1
28	.0135	.0205	159.8	74.1	46.2
29	.0122	.0192	126.7	83.3	49.2
30	.0108	.0179	100.5	92.2	52.5
31	.0097	.0168	79.70	103.4	55.8
32	.0087	.0158	63.21	115.6	58.9
33	.0077	.0150	50.13	129.3	62.1
34	.0069	.0143	39.75	144.9	65.3
35	.0062	.0136	31.52	162.3	68.4
36	.0055	.0130	25.00	181.8	71.4
37	.0049	.0124	19.83	202.4	74.3
38	.0044	.0119	15.72	227.7	77.1
39	.0039	.0115	12.47	252.5	79.8
40	.0034	.0112	9.888	280.1	82.3

the discussion of formula (1). We have four secondaries, one of them 400 volts, 100 milliamperes, for the plate current supply of the receiver. As 100 milliamperes is .1 ampere, the wattage of this winding is 40. In this connection it might be well to note that with full-wave rectification, while the total voltage is 800 volts, current is being drawn from only one side of the secondary at a time, or more literally, as the current rises in one side of the secondary, it falls in the other side, so in our computations we treat this as one secondary with 400 volts across it. The second secondary is 2.5 volts, 10.5 amperes, for lighting the tube filaments. The wattage of this secondary is 26.25 watts. The third secondary is used to light the power tubes, and the wattage is 7.5. The last secondary is to light the rectifier, and the wattage is 10. Substituting these values in formula (1), we have

$$W_p = 40 + 26.25 + 7.5 + 10 + \frac{40 + 26.25 + 7.5 + 10}{10} =$$

92 watts neglecting the very small fraction.

The next step is to determine the volts-per-turn by one of the formulas, (2), (3), (4) or (5), depending upon which one fits our case. Let us assume that our line voltage is 110 volts, 60 cycles, and that we desire to use a core type core. In this case we will use formula (2). Substituting, we have

$$E = \frac{\sqrt{92}}{50} = \frac{192}{1000} \text{ or } .192$$

since the square root of 92 is 9.6 to the nearest decimal.

To obtain the necessary number of turns to use for each winding, (Cont'd on page 517)

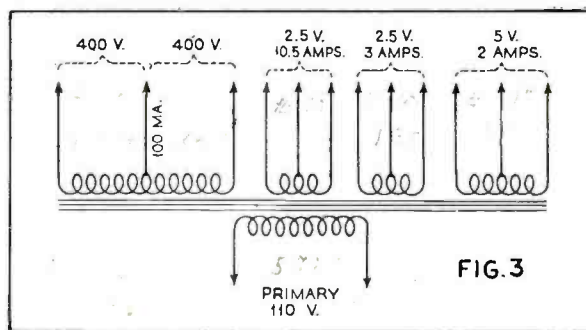

A TYPICAL POWER TRANSFORMER
Figure 3. The design details for windings and core of this transformer are completely worked out in this article

Radio News Designs a New Amateur Transmitter

This series of articles will provide complete constructional data on the new transmitter being installed in the RADIO NEWS laboratory. This month the description covers the basic, single-tube circuit, which in itself is a highly efficient transmitter. Next month the power supply, and in following months the transmitter, finally winding up as a full-fledged, crystal-controlled, multi-tube transmitter for c.w. and phone will be described

THESE articles are primarily meant for that class of radio amateurs who have absorbed a working knowledge of transmitting circuits and operating by experimenting with the usual 210 transmitter and now wish to step into a higher powered class. The transmitter to be described has been designed for use in amateur communication and short-wave experimental work in the laboratories of RADIO NEWS, under the call letters W2RM.

The beginner in the transmitting end of radio has always been urged to start with a low powered 210 transmitter. This practice is to be commended. It benefits the beginner inasmuch as it eliminates the possibilities of damage being done to expensive equipment and other things which can happen when inexperienced hands are used. It is a boon to the transmitting fraternity in general since it does away with high-power signals which are liable to cause excessive interference while the beginner is learning the rudiments of operating.

By Nat Pomeranz*

Some really good work has and is being done with the "seven and a half watter." Twenty meters with its penchant for carrying low-power signals has rewarded many with long distant two-way communications. But the results are far too inconsistent with the conditions now prevalent. The amateur bands are crowded and fair power is needed for reliable work. The transmitter being described is an ideal one for those who have received a working knowledge of low power work as well as those who are contemplating a new, medium powered outfit.

The fundamental idea of this article and of those which are to follow is to develop, step by step, a really fine transmitter. The circuit herein described will not be the one which will be embodied in our completed transmitter but the parts will all be used. The plans are simple enough. We start off with a three decker transmitter frame of ample size to permit the installation of our final equipment. The top shelf will hold equipment which, for the time being, will be connected up as a self-excited oscillator using

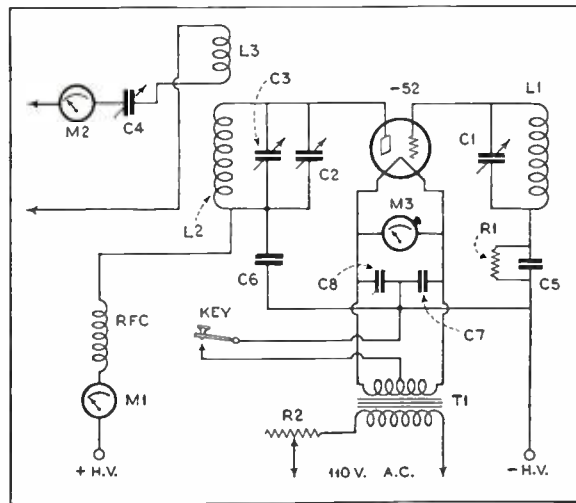

THE TRANSMITTER CIRCUIT

Figure 1. The tuned-grid-tuned-plate circuit is employed with a so-called "high C" plate circuit, employing relatively high capacity and low inductance to provide more stable signals

*U. S. N. R., W2WK-W2APD

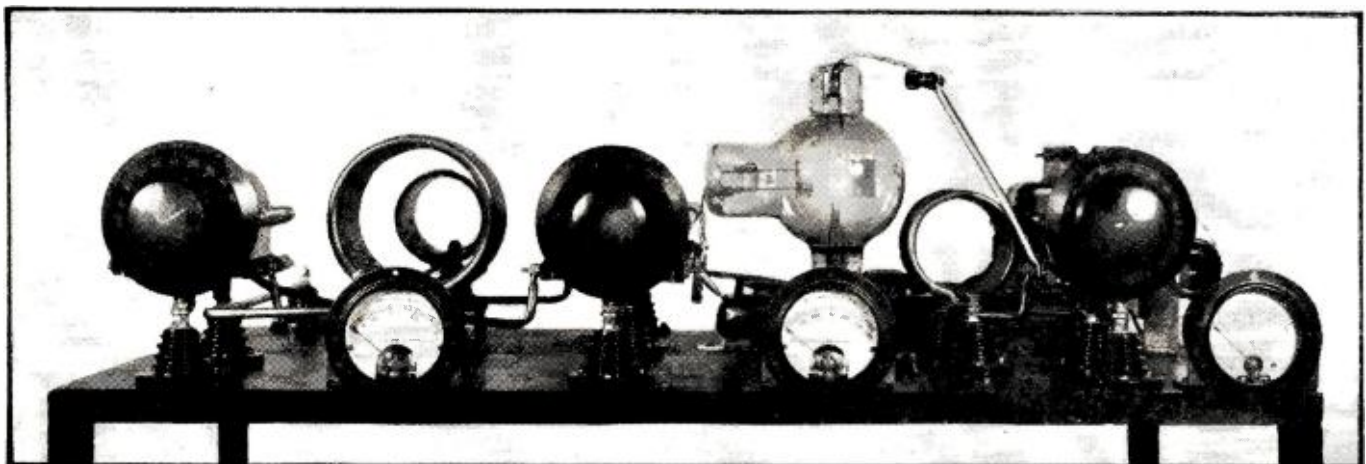

THE FRONT VIEW

With this arrangement all parts are in plain view while operating. Note the porcelain insulators used for mounting all high-frequency circuit parts. These not only provide excellent insulation, but also keep parts up in the open.

the well-known tuned-grid-tuned-plate circuit and employing a type 552 tube, rated at 75 watts. The construction of this will be described in the present article.

In forthcoming issues will be found constructional data on building a power supply on the bottom shelf giving approximately 1500 volts of properly filtered, rectified alternating current. As we go along, we will add a crystal oscillator and a buffer-amplifier stage. Then, with a few changes, our self-excited oscillator will become the final amplifier stage of our crystal controlled transmitter. Descriptions of a three stage speech amplifier with a separate power supply and a modulator will complete the job. These ideas will be described in the order named. Finally, we will have a general discussion on the proper type of transmitting antenna and we will probably evolve down to the one which is most widely used, the "zepp." Tuning and operating hints as well as general information will also be included.

We have, first, to consider the choice of the oscillator tube. Many amateurs that have been contacted seem to be of the opinion that the 50-watter is a much better tube to use than its larger brother, the 552. This, in practical experience, has been found to be untrue. The 552 type tube, with its irregular shape and low capacity arrangement of leads has been found to make for much better connections in a transmitter where short leads are desirable. The 50-watt type tube necessitates the use of a socket where all leads are bunched. The t-g-t-p circuit is not easily adaptable to a 50-watter or even to a 210. Disregarding the physical make-up of the 552, its internal construction is such as to leave little desired for all around amateur purposes. Its low internal capacity makes it the ideal thing for the 14 megacycle band as it does on the 7 megacycle band. On 3.5 or 1.7 megacycles, the tube is found to be as near perfect as wanted.

Another point which concerns the tube is the power to be used on it. It seems to be a general belief that where a tube of this type is used, 2000 volts must be put on its plate. In practical experience it has been found that voltages between 1000 and 1500 showed no appreciable de-

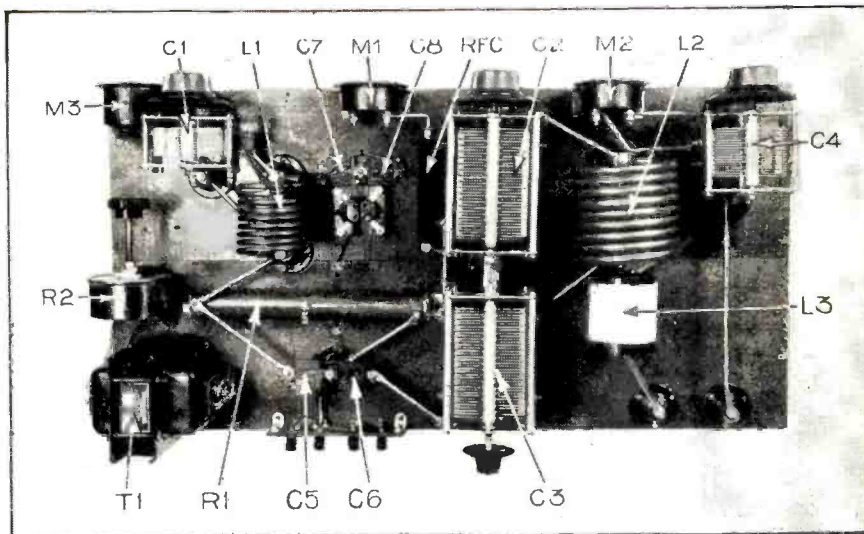

THE LAYOUT

This view shows the location of all parts and the "wiring," which is really copper tubing. All parts are lettered to correspond with those in the parts list at the end of this article

crease in signal strength over the 2000 volt power. Reports from reliable stations contacted showed that the signal received when using but 1000 volts on the plate was better than when using 2000 volts because the lower power signal was more clean-cut and consistent. Then again a better d.c. note can be procured from a tube which is being under-run in power than when the rated voltage is used.

MOST amateur transmitting equipment is designed with low cost as the primary consideration. True, efficiency comes in for a good share of attention, but is likely to be sacrificed at points to keep costs low. In designing a new transmitter for use in experimental transmission work in the RADIO NEWS laboratory, it was decided to strive for efficiency above all else, keeping costs down at the same time to the minimum required for best operating results. It is felt that a transmitter such as this will be of intense interest to a great many amateurs who now have low-power transmitters, but who have gone far enough in the game to feel the need of greater power and more careful design. The complete description of the transmitter will therefore be given, in the form of constructional and operating articles, of which this is the first.

—The Editors.

The writer has also found that a self-excited oscillator works best when the least current is drawn by the plate of the tube for a given plate voltage. The oscillator being described should draw no more than 90 milliamperes when the antenna is connected, and using 1000 volts on the plate. With the antenna, a drain of from 30 to 40 milliamperes should be expected. The methods to be employed in tuning this transmitter so that low current drains can be procured will be described in a later issue.

In 1928, Mr. Ross A. Hull, on a short visit from Australia, introduced the high capacity tank circuit, (Continued on page 525)

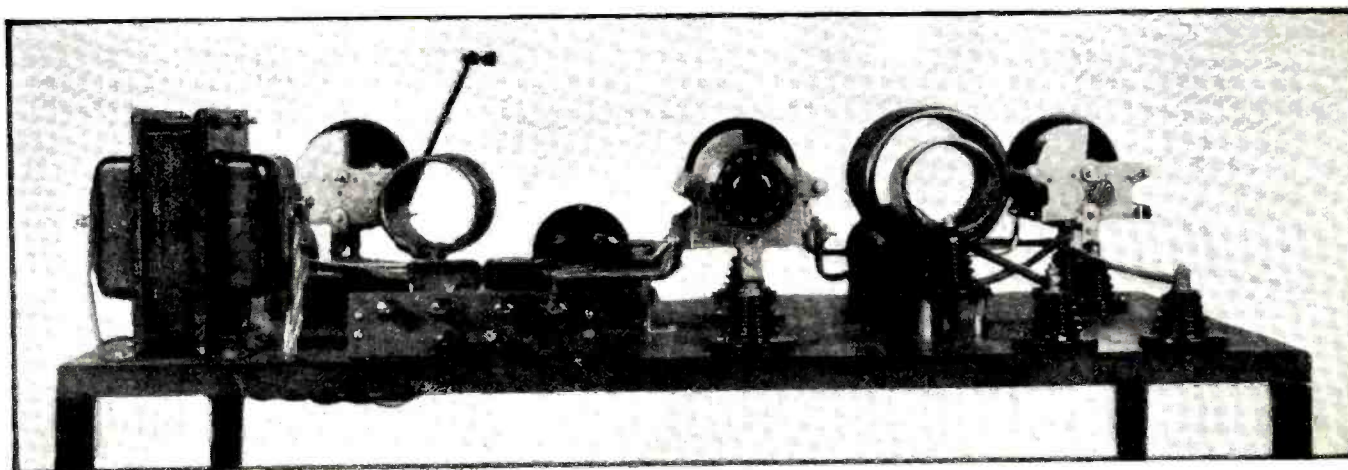

VIEWED FROM THE REAR

All power connections and the transformer are grouped at one end, remote from the antenna and plate circuits. The filament and voltmeter circuits are wired with twisted pair, run underneath the shelf.

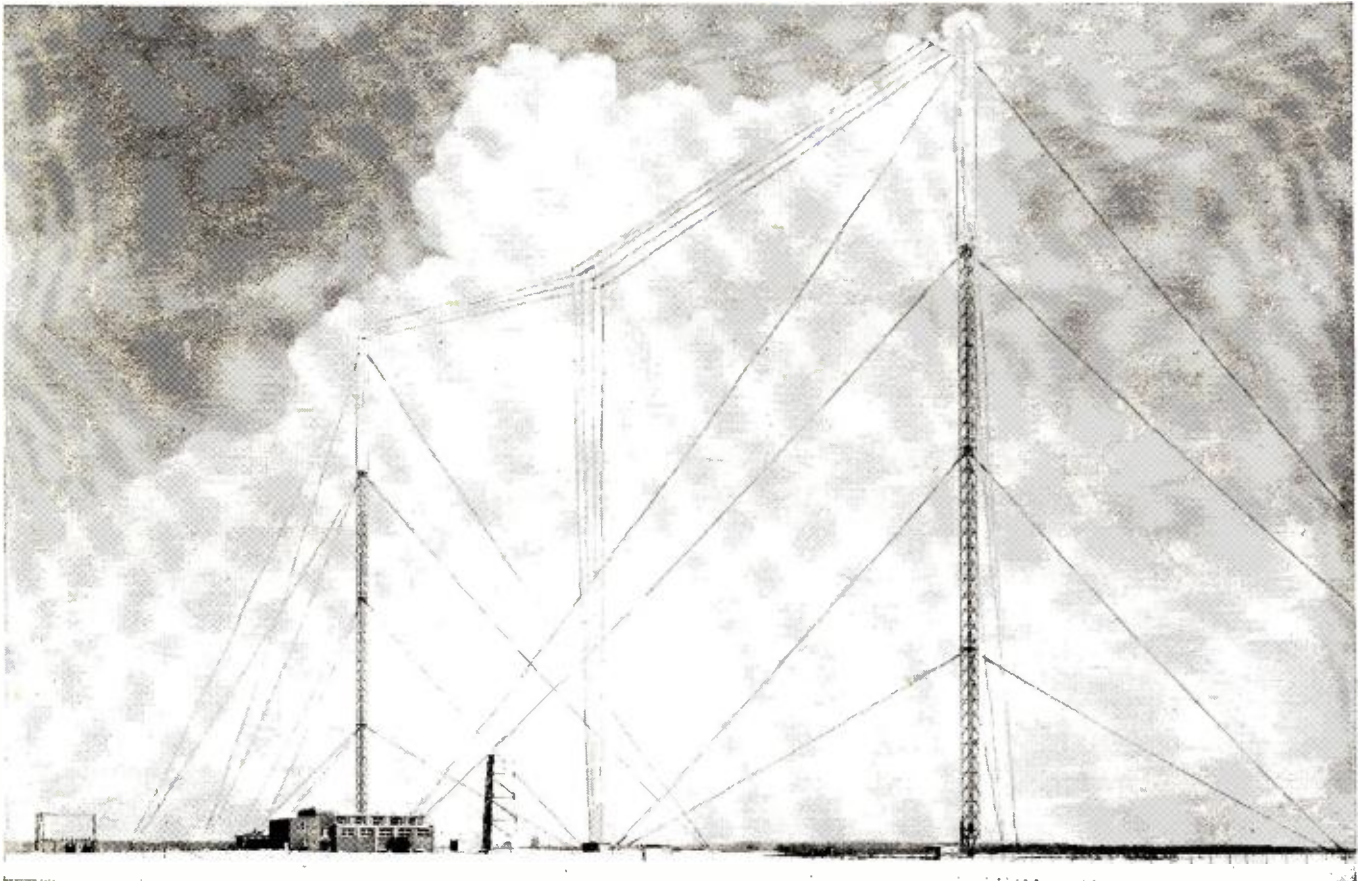

MODERN TOWERS OF BABYLON

From this gigantic antenna, radio signals are being flung to millions of listeners' earphones on crystal sets throughout the whole of Europe. It will be noticed that the antenna is "T" connected with the four-wire lead-in dropping down at the center to the antenna house

Poland Inaugurates *Long-Wave* *Super-Power* Broadcasting

A powerful new transmitter recently constructed, along the line of Lieut. Wenstrom's proposed single-coverage station for the United States, has been giving Europe non-fading reception with simple sets

By J. Plebanski

THE new Polish broadcasting station, one of the most powerful in the world, has recently been built, about 165 miles from the Polish city of Warsaw, which gives Polish listeners in adequate reception on a crystal set. The new station is built along the lines of super-power high wavelength, the antenna rating of the station being 120 k.w. of unmodulated antenna energy. When voice or music signals are impressed on the modulation apparatus, the power immediately increases up to 160 k.w. It is recorded by listeners all over Europe as coming in like a local station without fading or variation.



VIEW OF TRANSMITTER ROOM

The new 160-kw. transmitter is housed according to the latest European design, with a central control bench overlooking all of the transmitter panels

The antenna is carried by two huge steel masts, 650 feet high. Electrical measurements show an effective antenna height of about 400 feet. The actual radiated power, according to these calculations, is thus more than 100 k.w., with a radiation resistance of approximately only 11 ohms. The complete antenna resistance lies between 12 and 13 ohms. This is a figure not met at present in any other broadcasting station in Europe.

The new Warsaw station operates on a wave length of 1414 meters or approximately 212 kilocycles and is of the low-powered modulation type with a number of
(Continued on page 523)

An Economical Eleven Tube Superheterodyne Design

The author describes a new set incorporating many novel features in engineering practice and design. On account of the practical economies employed he nicknames it the ideal "Hard Times" set

SINCE the advent of the "mantel" receiver, the trend has been toward lower cost until the climax recently reached in the midget type of set, consisting of a single or two-gang condenser, three active tubes and a rectifier. Anticipating that the pendulum of public opinion will soon trend toward the larger, more selective receivers of better tone quality, it has been the writer's aim in this design to construct a receiver where results will be satisfactory from every standpoint, regardless of the amount of apparatus required. Recent high-speed production and low raw material cost have reduced the costs of all components used in radio set design.

In this new superheterodyne, the Midwest eleven-tube model consists of two push-pull pentodes, two type -27 audio tubes in resistance-coupled amplification, one type -27 tube used as

By W. A. Smith*

study of practically every system of automatic volume control, during which the various systems were set up and actually tested out in actual operating condition, a circuit was evolved which produced maximum sensitivity, together with "even" selectivity characteristics.

Ordinarily, with automatic volume control, a signal of uniform level is fed into the audio amplifier and the only manual control required would be in the audio-frequency amplifier to deliver the volume at a certain level. This is usually done satisfactorily, but in all such controls there is liable to be either overloading or a lack of sensitivity. During this work the writer cast about in his memory for a dual control similar to the cathode-antenna control where a potentiometer with a grounded rotor is connected between the cathode of the first

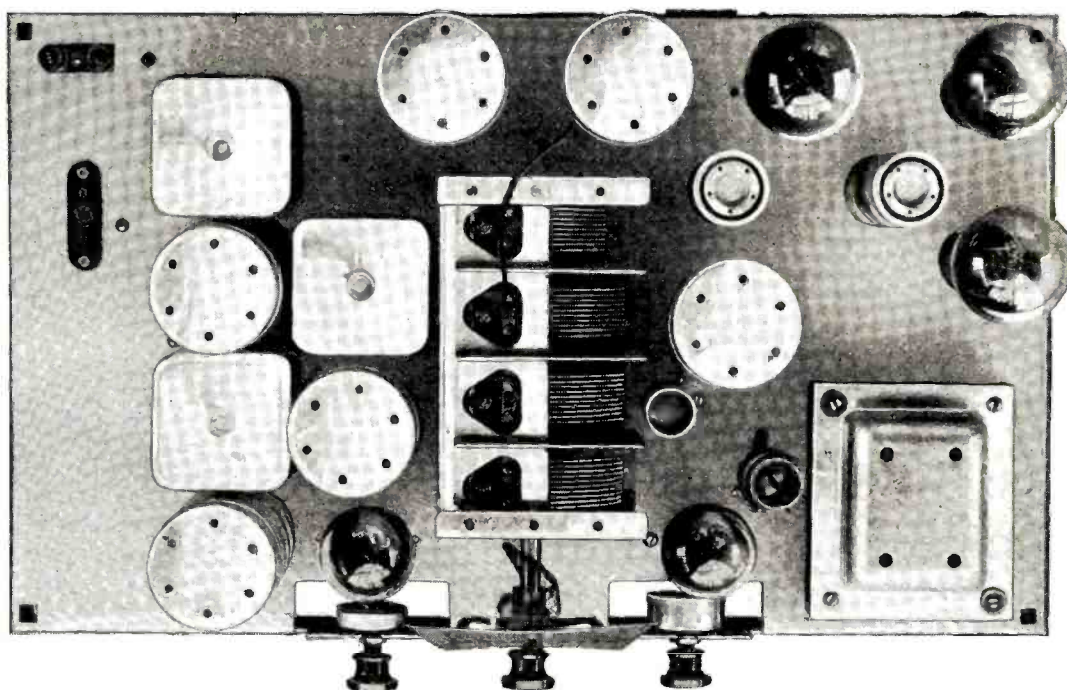

TOP VIEW OF THE RECEIVER

The utter simplicity of this design is shown in this photograph. Notice that the four-gang condenser is mounted centrally so that short connections may be brought out to the tubes and the shielded coils. The two pentodes are shown in the upper right with the power transformer directly in front

a combined automatic volume control and detector tube, one variable-mu tube in the intermediate-frequency amplifier and one -24 screen-grid tube. The first detector is a type -24 tube and a variable-mu type -35 tube is used in the radio-frequency amplifier. A type -27 is employed as the oscillator tube. The rectifier is a type -80 tube.

One of the novel features of the receiver is the special automatic volume control used in the circuit. After a complete

tube and the antenna post in such a way that as the cathode bias is increased the antenna circuit becomes shunted with a lower and lower resistance, with the same movement of the control. Unfortunately, the cathode control is not satisfactory in an audio amplifier, and of several audio-frequency controls tried, none was satisfactorily applicable to this idea.

The writer then developed the circuit shown in Figure 2. The operation of this circuit depends upon the fact that grid current flows whenever a too-strong signal is fed through a powerful amplifier. A microammeter inserted in the grid

*Chief Engineer, Midwest Radio Corp.

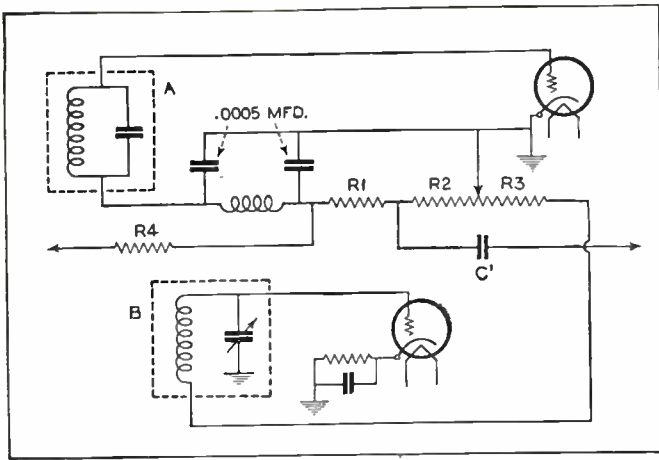

NOVEL VOLUME REGULATOR

Figure 2. Shows Mr. Smith's version for an automatic volume-control circuit in which R1 is the grid-current limiting resistor, R2 is the audio-voltage resistor, R3 is the resistance inserted in the tuned circuit "B," and R4 is the audio-choke resistor. The placing of the circuits "A" and "B" are also indicated in Figure 1

return of the third or fourth tube of almost any powerful receiver may show currents as high as 100 or more microamperes. This is evidence of overloading, but this same grid current may be harnessed and controlled to produce the results desired in automatic volume control in the following manner. First, a resistor may be placed between the grid return and the cathode of the tube and this current will then flow through the resistor. The signal frequency will therefore appear across this resistor. There will also appear a certain amount of direct current, which is due to the rectification of the signal energy, and if the signal is modulated by an audio frequency this component will also appear.

By using special filter circuits these three voltages may be separated and directed as follows: The signal frequency may be shunted to ground while the audio component may be directed to the grid of the audio amplifier and the direct current may be al-

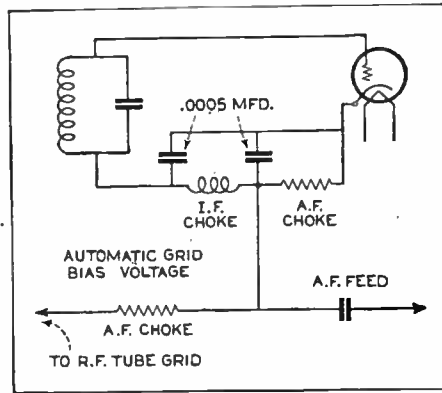

VOLTAGE FILTER CIRCUIT

Figure 3. Circuit designed by the author for dividing voltages due to overloads in a radio-frequency amplifier

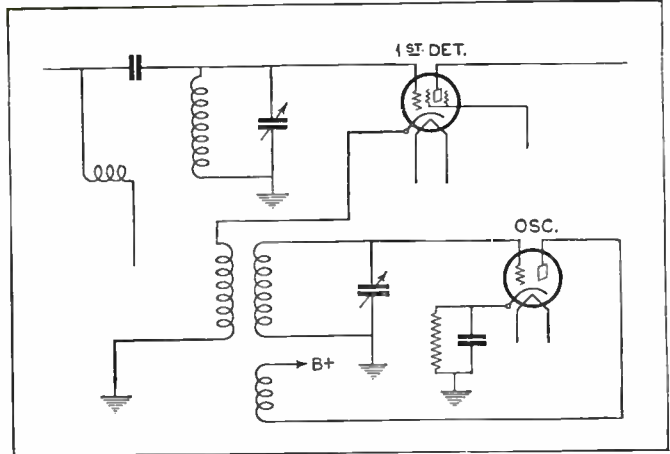

OSCILLATOR CIRCUIT

Figure 4. This is the oscillator circuit which is coupled between the cathode and filament of the first detector tube

lowed to act independently as a subtraction from the grid bias on these tubes. (See Figure 3.)

It will also be noted that when the potentiometer contact is at the right end of the resistance, the automatic control is set at a maximum and the audio-frequency voltage is also a maximum.

It will be noted that when the potentiometer contact is at the left, its resistance is inserted in the tuning circuit and the efficiency of circuit "B" is very low indeed. This cuts out any further amplification in both the audio and the radio-frequency stages and results in silence in the loudspeaker. The arrangement also permits the use of a large antenna without objectionable overloading from local stations and therefore permits increased sensitivity that goes with a larger pick-up.

The I.F. Amplifier

In designing the intermediate-frequency amplifier a two-stage, six-circuit schematic was laid out consisting of fully shielded high-gain units with only sufficient spread for the complete audible wave-band. The curve obtained on this amplifier is a flat, slightly (Continued on page 536)

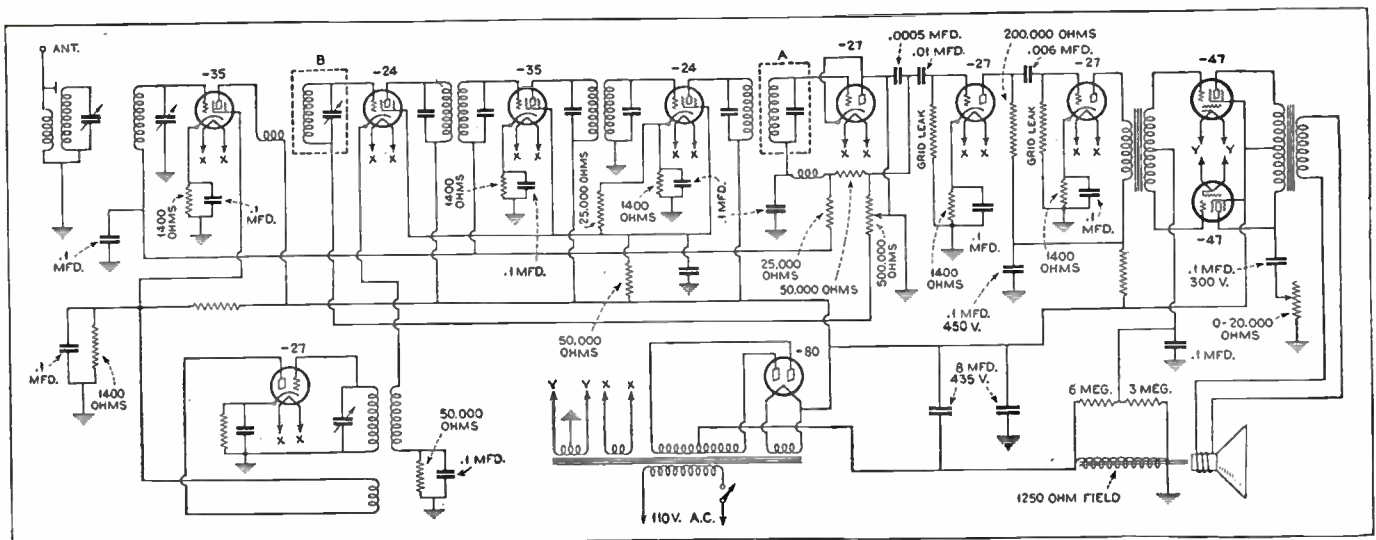

CIRCUIT DIAGRAM OF THE ELEVEN-TUBE "SUPER"

Figure 1. This drawing gives all the connections for the new receiver, incorporating many new features, such as the novel oscillator coupling, a "different" automatic volume-control and two pentode tubes working in push-pull

The International Six

An Unusual Receiver for Home Construction

Here is presented the full constructional data on a receiver which combines variable- μ r.f. amplification with a direct-coupled audio amplifier. The design and advantages of this receiver were described last month

By Allan C. Bernstein

Part Two

LAST month's article gave a complete description of the theory in back of the International Six. Now we will give constructional details for all those who desire to build this unusual receiver. The only special parts are the coils and chassis and these are now on the market. It is advisable to buy these items, as their construction is rather difficult. Best results may not be obtained with home built coils even though the directions are carefully followed unless the builder has an oscillator for lining up the completed set of four coils. However, for those who have the proper equipment, the coil specifications are given.

The four coils are wound on bakelite tubes $1\frac{1}{4}$ inches in diameter and $2\frac{3}{4}$ inches long. In $\frac{1}{4}$ inch from one end, two $\frac{1}{8}$ inch holes are drilled on opposite sides of each tube to accommodate the mounting bracket. The secondary winding is started $\frac{5}{8}$ inch up from the end. This consists of 110 turns of No. 30 enameled wire. The lower end is fastened to a lug on the lower end of the tube, and the grid end fastened to a lug near the top of the tube. The four coils should look like Figure 5A.

Now take one of the coils, and wind a single layer of celluloid one-half inch wide around the lower end of the secondary. On top of this wind 20 turns of No. 26 S.S.C. wire. Make sure both windings are in the same direction. Fasten the lower end of the primary to the same lug as the lower end of the secondary. Fasten the upper end of the primary to an independent lug on the lower end of the tubing. Paint the primary with a thin coating of collodion. This serves to keep the winding in place; as no other means are used, this must be done carefully. This completes the antenna coupler as shown in Figure 5B.

The forms for the chokes to go inside the r.f. coils are built up of bakelite washers. Fifteen washers are needed, altogether for these chokes, all $1\frac{1}{16}$ inch thick with $3\frac{1}{16}$ inch holes drilled through their centers. Nine washers should be $11\frac{1}{16}$ inch in diameter, three $1\frac{1}{8}$ inch in diameter, and three 2 inches in diameter. The 2-inch washers are drilled as shown in Figure 6. Five washers are riveted together to make each form, as shown in Figure 7.

The forms are wound in layers with No. 37 enameled wire, the turns spaced with white cotton thread approximately the same diameter as the wire. 425 turns are wound in even layers. The ends are passed through the smaller holes in the

top washer, and brought out to lugs at the edges. The lug attached to the inner lead is fastened by one of the screws that holds the blocking condenser. This is the plate terminal. The other end of the choke is the B+ terminal.

Be careful to wind each choke in the same direction as the coil secondaries. The small end of the choke should fit snugly inside the grid end of the tubing. Push the choke down till the big end of the choke form fits flush against the top of the tube. The large lug under one end of the blocking condenser is bent over and soldered to the grid lug. All three interstage couplers are alike, as shown in Figure 1 last month.

The importance of winding these coils exactly as specified cannot be overemphasized. The chokes must have a certain distributed capacity, and this will only be obtained if the specifications

are exactly followed as to size and kind of wire, number of turns, dimensions of the form, etc. The placement of the forms inside the secondary is also important. If the secondaries are all wound exactly alike, little trouble will be experienced later in lining them up with the oscillator.

The sub-panel mounting strip runs the length of the chassis, beneath it, near the rear of the set as shown in the bottom view photograph last month. All parts shown on it, in Figure 8, are mounted before the strip is attached to the chassis. Notice especially the placement of the lugs under various screws and nuts, and the four mounting brackets. The soldering lugs all go in the same direction. The in-

ner electrolytic condenser is insulated from the mounting strip. The sub-panel sockets are next mounted underneath the chassis, with the filament terminals toward the front of the set. On heater type tubes, the filament terminals are those opposite the isolated terminal. On four-prong tubes the filament terminals are the two with the larger holes. All tubes except the rectifier are shielded. The bases of the shields are mounted with the same screws used to mount the sockets.

The coils are mounted next. Lay out the four coils in order on a table, with the antenna coil to the left. Solder a five-inch length of shielded wire to the antenna terminal of this coil, an eight-inch length of black wire to the ground terminal and a two-inch length of black wire to the grid terminal. Next, solder eight-inch lengths of yellow wire to the

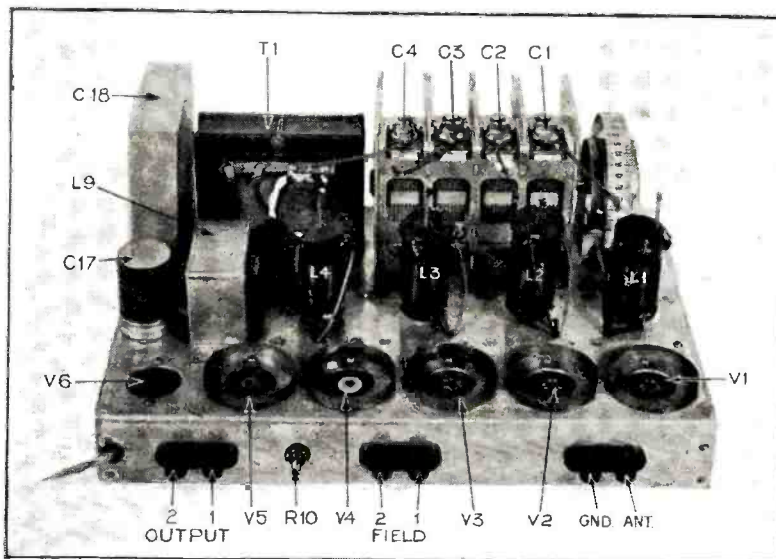

THE CHASSIS PARTIALLY WIRED

Figure 9. Positions of all parts on top of chassis and part of wiring are shown here. Note how coil leads are carried down through chassis

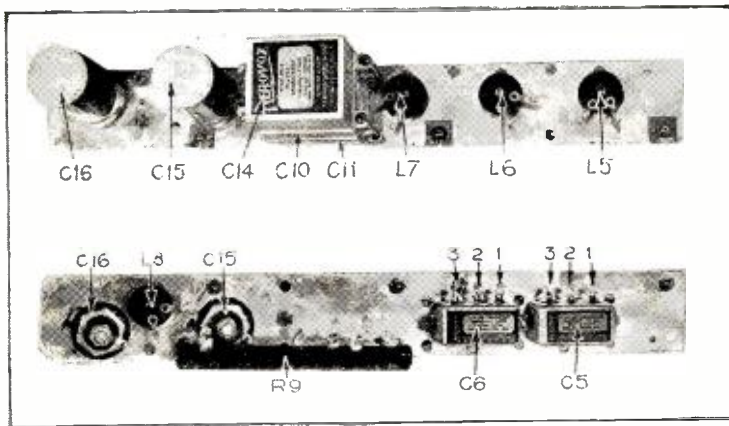

THE SUB-PANEL ASSEMBLY

Figure 8. All parts on the sub-panel are mounted, as shown here, before it is installed in the chassis

plate terminals of each of the other coils, two-inch lengths of black wire to the grid terminal, eight-inch lengths of black wire to the ground terminal and twelve and four-inch lengths of red wire to the B+ terminals. Now mount the antenna coil at the left end of the chassis, facing the set from the front.

Mount the r.f. coils next, as shown in Figure 9. Drill small holes in the center of the top of each coil shield, to allow the grid leads to pass through. Then place the shields in position over the coils. Nuts are used to fasten all but two of the mounting screws. These two are very short screws, and go into the tapped holes.

Mounting the Parts

The drum dial, variable condenser, power transformer, and 2-microfarad filter condenser are mounted along the front of the chassis. Put lugs under each of the variable condenser mounting bolts. Then mounting the choke and 4-microfarad electrolytic condenser C17 will complete the top of the chassis as it is shown. The volume control is mounted on the front flap, and the hum-bucking potentiometer and three binding post strips on the rear flap. The parts have now all been mounted on the sub-panel mounting strip or on the chassis. Some of the wiring, as shown in Figures 9 and 10, is done before these two parts are fastened together. Since much of it is in inaccessible places, the complete wiring of the set is given in that order which makes for the simplest assembly.

(1) A.C. cord enters set through hole in rear flap, passes along side flap to the switch, then through a hole to transformer terminals 11 and 12. Break one lead where it passes the switch, and connect the two ends to the switch terminals. Tape the cord where it enters the chassis at the rear. (2) Transformer terminals 4 and 5 same route as a.c. cord to filaments of -51 and -24 tubes. (3) Transformer terminals 2 and 3, same path to -45 filaments. (4) Transformer terminals 6 and 7 to filament of -83 socket. (5) Transformer terminals 8 and 10 to -83 socket, plate and grid.

All the above leads have been made

with twisted-pair wires. Now pass the two red leads from the choke and the two yellow leads from the condenser through the hole provided for that purpose.

Next (6), splice one of the wires going to the -88 filament and connect to it one red lead from the choke and one yellow lead from the condenser. Then tape this joint very carefully. (7) Connect the other yellow lead from the condenser to the ground lug on the electrolytic condenser, C17. (8) Connect the other red lead to the insulated lug on the electrolytic condenser C17. (9) Transformer terminal 9 to 15, then through hole and grounded to lug under nearest mounting bolt (black). (10) Transformer terminal 1 to the same lug (black).

Checking Wiring Saves Future Grief

Now mount the sub-panel strip by the four small brackets, keeping the filament wiring between the strip and the sockets. Incidentally, this is a good time to check up the previous wiring, since if any mistakes have been made, it will be easier to correct them before the sub-panel mounting strip is in position.

Now continue the wiring. (11) Center terminal C17 around end of strip to center terminal C15 (black). (12) Center C17 around outside to output 1, then to field 2 (black). (13) Choke L8 to plate of -45 socket (black). (14) Other end of L8 to output 2 (black). (15) .00025 condensers C12, C13 connect from both ends of L8 to the most convenient mounting bolt. (16) Plate of -24 to grid of -45 (black). (17) Screen of -24 to L.W. resistor 4 (black). (18) One end of R8 to cathode -24. (19) Other end R8 to lug under nearest mounting bolt. (20) Cathode -24 through wiring hole to top of C11 (black). (21) Top of C10 and C14 to lug A (black). (22) Lower end C11 to center R10 (red). (23) Ends of R10 to L.W. 2, 3 (black). (24) L.W. 2 to bottom C10 (black). (25) Yellow leads from coils L2, L3, L4 to plates of V1, V2, V3. (26) Black leads from coils L1, L2, L3 to lugs D, C, B, respectively. (27) Black lead from L4 to bottom C10. (28) Cathodes V1, V2, V3 to L5, L6, L7 (black). (29) Cathode V1 to C5, terminal 1 (black). (30) Screen V1 to C5, terminal (Cont'd on page 532)

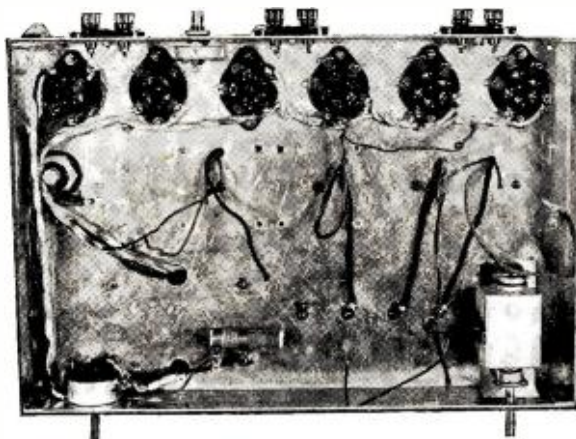

PRELIMINARY WIRING

Figure 10. Part of the wiring is completed, as shown here, before the sub-panel is put in place. All wiring details are given in text

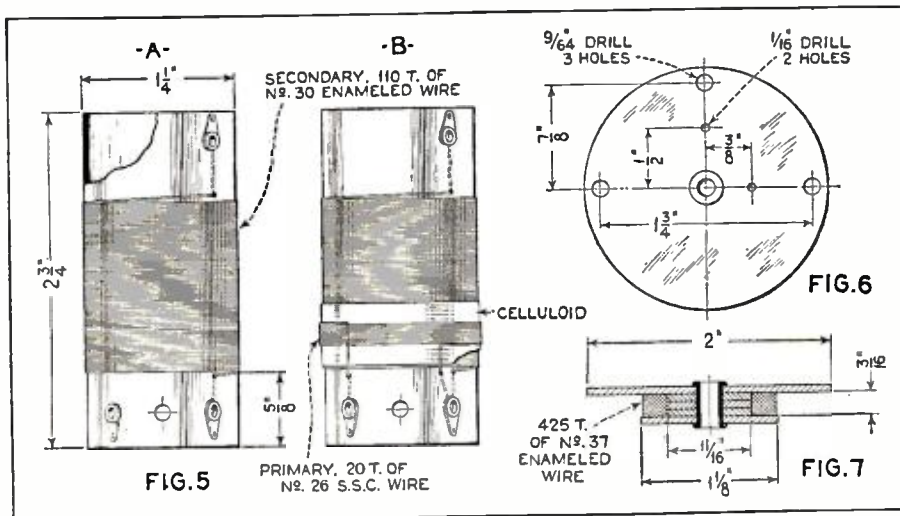

COIL AND CHOKE SPECIFICATIONS

Figure 5. (a) The antenna coil form with secondary winding in place. Same specifications apply to r.f. coupling coil secondaries. (b) Shows antenna coil with primary winding placed over one end of secondary. See text for winding details. Figure 6. Drilling arrangement for largest washer shown and, Figure 7, the winding form as built up of washers riveted or bolted together. Appearance of completed r.f. coils was shown in Figure 1 last month

Reducing Noise in Talking Picture Film

One of the earliest and oft-repeated criticisms of the talking motion picture has concerned the extraneous noises heard during what should be "absolute silence" during interludes between conversation taking place in the action. The author describes the latest methods for solving this problem

By Barton Kreuzer*

PART ONE

IN the reproduction of sound from film one of the factors which has caused the greatest loss of "illusion" for the audience has been the accompanying "hiss" and "roar" which have heretofore been regarded as inseparable from such reproduction.

Apparatus has now been developed which will practically eliminate this background noise by a change in the recording procedure. Numerous articles have appeared describing the manner in which sound is recorded on film by means of light valves, vibrators, or glow lamps and reproduced through the use of the conventional light-beam, slit and photoelectric cell. Further detailed discussion of these processes at this point would be superfluous. Suffice it to mention that the two methods generally employed for sound recording are the variable-density and the variable-area methods. In the former system, reproduction is accomplished by the variation in the light transmitted by the film and falling upon the photoelectric cell caused by changes in photographic density. In the latter system this variation is due to the change in the width of the clear portion of the sound-track, which acts as a valve controlling the light passing through the film.

Causes of "Noise"

Since it is the variation of the intensity or modulation of this light beam which causes the audible-frequency recordings to be reproduced, any other modulation of this beam in the audible range will also be reproduced. This undesired modulation or background "noise" is usually due to several factors which are the same for both types of recording, viz., grain clumps in the film emulsion, scratches and dirt. An additional factor is the hiss originating in the photoelectric cell.

This "noise" may be greatly reduced in either type of recording by reducing the light transmitted through the film. For the same percentage of undesired modulation the audio output of noise will now be much less and the photoelectric-cell hiss, which is proportional to the photoelectric-cell current, will be greatly decreased since the photoelectric-cell current is a linear function of the incident illumination.

*Engineering Department, R.C.A. Photophone.

In the variable-density system of recording this result is obtained by increasing the density of the sound track during those portions of the film which are quiet or when the recorded sound is low in volume level. This increase in density naturally decreases the light transmitted through the film. With sounds of greater amplitude the track density is automatically decreased until at full modulation the mean track density is again the same as on standard recording.

With the variable-area type of recording this diminution of light transmission is accomplished in a different way. An enlarged portion of the sound track on this type of print is shown in Figure 1. Normally

this track would be divided into two corresponding parts, one of which would be opaque and the other transparent. Note that in this print a considerable portion of the transparent side of the sound track has been darkened, thus cutting down the amount of light passing through the film and reaching the photoelectric cell.

The Positive Print

In order to have this result on a positive print, the procedure during recording of the negative which is to be used in making prints must be considered. This involves the consideration of a slight amount of recording technique. The transparent portion of a print naturally corresponds to the opaque portion of the negative. This negative has been rendered opaque by exposure to light in recording. In order to obtain a print such as the one shown in Figure 1, with part of the transparent portion of the sound track "blackened," the corresponding part of the negative must be carefully shielded from exposure in recording. This shielding or "masking" is accomplished by an electromagnetic shutter which protrudes into the light-beam and protects a portion of the sound track from exposure. This shutter principle was first proposed and used by H. McDowell, Jr., of RKO-Radio Pictures in September, 1929.

An alternative method was proposed sometime previously by both C. R. Hanna of the Westinghouse Electric and Manufacturing Company and L. T. Robinson of the General Electric Company. They proposed the shifting of the base-line of variable-area recording or the "time axis," as it would be called on an oscillogram, to the edge of the track when no

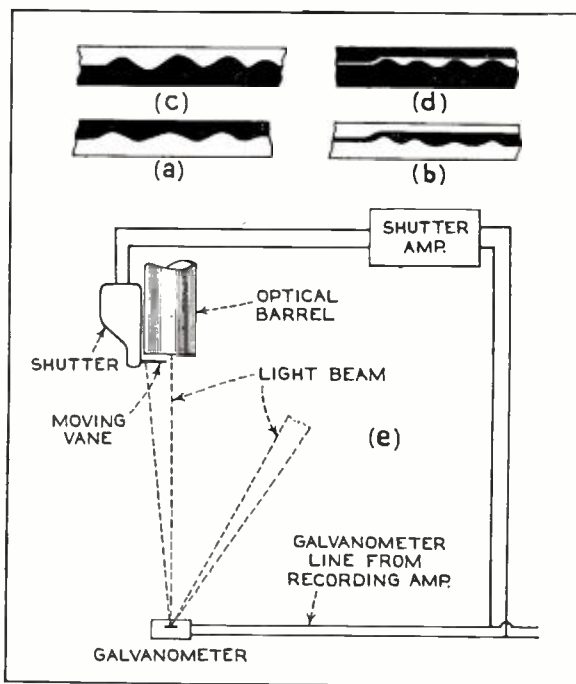

HOW THE NEW SYSTEM OPERATES

Figure 2. The drawing (a) shows a normal sound track negative; (b) shows the new noise reduction sound track negative; (c) shows a positive print obtained from (a); (d) shows a positive print obtained from (b). The diagram of the new recording mechanism is given at (e)

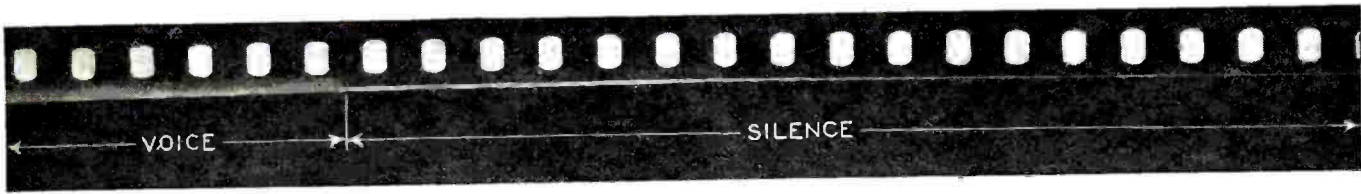

TOO SLOW A RATE OF MASKING

Figure 4. Photograph of a sound track obtained when the masking action at the end of the sound occurs at too slow a rate. This is the case when the shutter does not close fast enough.

sound was recorded, so that almost all of the track would be opaque, and an electrical method for shifting the baseline back towards the central position in proportion to the amplitude of the sound recorded.

This method of recording, while quite ingenious and easily applicable, produces a positive print which, particularly at low modulation values, may be distorted if reproduced in a projector with a bad mechanical "weave" or sidewise swaying of the film. This is because the scanning beam may miss part or all of the modulation on account of the weave.

Although several pictures have been produced by this process, McDowell's system has been further developed by the author and engineers of the RCA-Victor Company.

The rest of this article will be concerned with a description of this latter system in which the electromagnetic shutter previously mentioned is employed to "mask" the film.

Figure 2 (e) shows the schematic arrangement of this system. The galvanometer is driven by the audio signal to be recorded which is supplied by the recording amplifier. The galvanometer mirror moves and the reflected light-beam vibrates, causing the modulation to be recorded on the film. (After the light has passed through the optical barrel that houses the necessary lenses, slit, etc., it registers on the film.) As this light-beam is modulated the shutter must withdraw its vane in order not to interfere with the image to be recorded on the film. It should, however, only withdraw to a degree proportional to the amplitude of the sound which is being recorded. This is accomplished by operating the electromag-

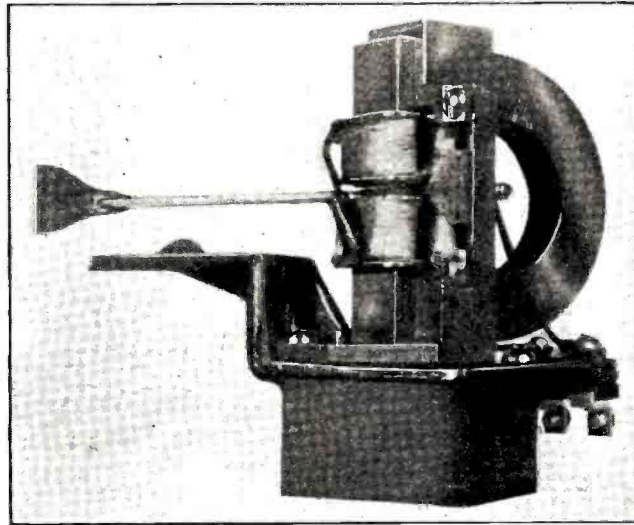

THE MASKING SHUTTER MECHANISM

Figure 5. This is a photograph of the electro-magnetic operating shutter. It consists of a motor with energizing coils connected between the pole pieces of a strong permanent magnet. The armature which carries the low inertia aluminum vane operates back and forth between the pole pieces

netic shutter in a special way.

A tiny portion of the signal voltage, which operates the galvanometer, is diverted, amplified, rectified and used to operate the shutter mechanism. Thus, with a large signal this rectified current is large and the moving vane is drawn further away, allowing the signal to be recorded, while with a small signal it only moves a short way, causing a great deal of the track to be "masked" from the light and thus giving a print with only a small transparent area.

The sound track negative produced in this way appears in Figure 2b, as compared with the normal track shown in Figure 2a. The positive print obtained from Fig. 2b is shown in Figure 2d, and the print obtained from Figure 2a is shown in Figure 2c.

Up to this point only "steady state" conditions have been discussed, i.e., no consideration has been given to the more

complex functions which the system must perform. The shutter must open and close the right amount not only during sounds, but it must close after the sound and yet open in time for the next sound, whether it is a loud noise or the next syllable of a word in conversation. It should be obvious that the shutter cannot open slightly before the signal reaches the galvanometer. At the same time, if the shutter closes at the same rate that it opens it may follow the modulation or "track" with it, unless a delay network is used, which would increase the cost of the system. Such a network can be constructed, however.

If proper care is not exercised in the circuit and equipment design, several types of distortion (Continued on page 521)

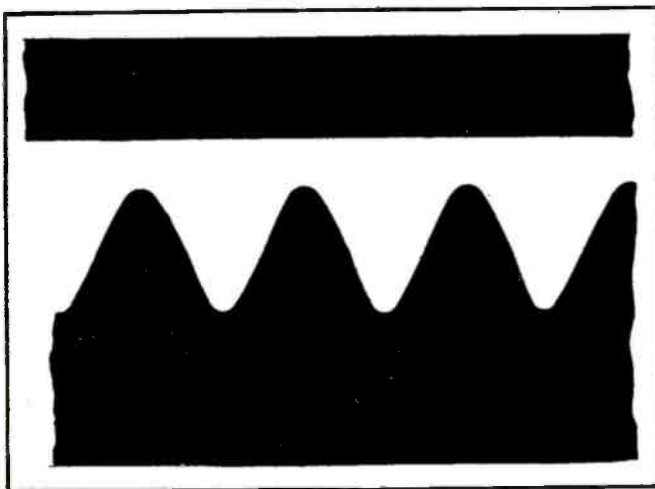

WHAT A "SILENT" FILM LOOKS LIKE

Figure 1. Sound track on a noise reduction positive print. Note the blackened area on the normally clear side

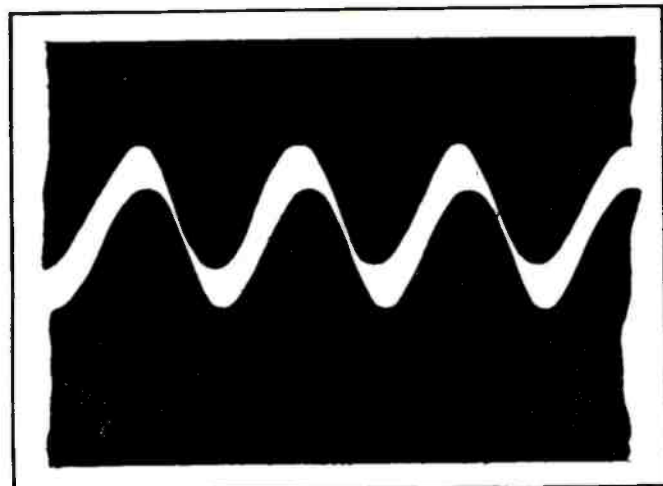

SECONDARY MODULATION

Figure 3. The drawing showing the effect of secondary modulation of the "masking" shutter, greatly exaggerated

Mathematics in Radio

Trigonometry and Its Application in Radio

By J. E. Smith*

Part Twelve

THE fundamentals of trigonometry have been investigated and we have learned the relationships involved in the application of the sine, cosine and tangent functions. Further studies in trigonometry are necessary to show the values of the sum and differences of two angles, to express the functions of an angle in terms of half, double or multiple angles, and a few other relations which we encounter in mathematical analyses of electrical and radio circuits.

Phase Relation

We know that the currents in a radio receiving set are dependent upon the impedances encountered in the various circuits and that they are effected differently by the elements of the circuit, which are usually a combination of resistance, inductance or capacity. The relation of the current and voltage in a system, or of several currents in a circuit, is determined by studying graphically various ways of showing the resultant values.

An alternating electromotive force (e.m.f.) can be represented by the two following methods:

- (1) A graphic representation of the sine wave which is given by the equation $e = E_{max} \sin x$
- (2) A vector diagram, which indicates the magnitude and direction of the voltage.

Consider the circuit of Figure 1, where an e.m.f. of 100 volts maximum alternating current is applied to a resistance of 10 ohms. In showing the graphical representation of this voltage, it is well to tabulate the results as follows:

Let $x = 0$:	then $\sin x = 0$.	;	then $E \sin x = 0$
Let $x = 30^\circ$:	then $\sin x = .5$;	then $E \sin x = 50$
Let $x = 45^\circ$:	then $\sin x = .707$;	then $E \sin x = 70.7$	
Let $x = 60^\circ$:	then $\sin x = .866$;	then $E \sin x = 86.6$	
Let $x = 90^\circ$:	then $\sin x = 1.0$;	then $E \sin x = 100$
	etc.		etc.

The graph of this equation is shown in Figure 2, which has been drawn for values of x from 0 — 360 degrees.

A vector diagram of the instantaneous voltages for the various angular degrees of the function x can be represented as

*President, National Radio Institute.

shown in Figure 3. Let a vector, E_{max} , equal to a hundred volts rotate from a zero position as shown in Figure 3 (f), to a maximum position 90° from this position as shown in Figure 3 (d). Now, in Figure 3 (a), the vector diagram represents the instantaneous e.m.f. (e) when the wave has moved 30° from the zero position. It is noticed that there are two components to the vector E_{max} , a horizontal and a vertical component. The vertical component (e) gives the instantaneous value of the impressed e.m.f. It is interesting to note in Figure 3 (a) the following relation:

$$\sin 30^\circ = \frac{e}{E_{max}} \text{ or } e = E_{max} \sin 30^\circ$$

Thus, if the maximum value of the impressed voltage is known, the instantaneous voltage can be calculated for any angular displacement of the wave. When the vector reaches the 45° position, as shown in Figure 3 (b), the instantaneous value of the e.m.f. has increased, and in a similar manner in c and d it increases respectively until it reaches the 90° position, where it has reached its maximum.

The above diagrams also serve to show the current in the circuit, for whenever there is an alternating e.m.f. in the circuit there is also an alternating current. The representation of the current can therefore also be similar to the above equations and to the above vector diagrams. Thus, the instantaneous current can be represented as follows:

$$i = I_{max} \sin x$$

Let us consider the tube circuit of Figure 4, where an alternating e.m.f., " e_g ," is impressed upon the grid circuit of a vacuum tube and where the plate circuit is closed through a fairly high resistance of about 100,000 ohms.

Now, any voltage which is developed across the plate resistance can be impressed upon the grid circuit of a succeeding amplifier tube, and it is obvious that the maximum possible voltage is desired. We have learned that the circuit of Figure 4 can be replaced by the circuit of Fig. 5, where μe_g represents the voltage e_g multiplied by the voltage amplification factor of the tube " μ ," which may have a value of about 3. The resistance r_p represents the plate resistance of the tube and has a value in some (Continued on page 524)

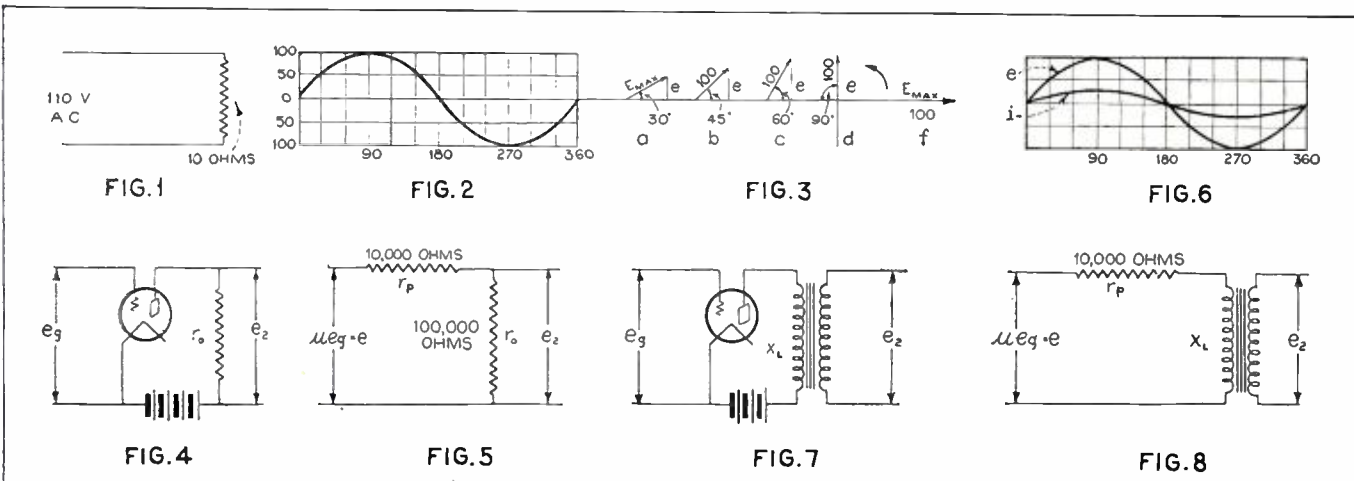

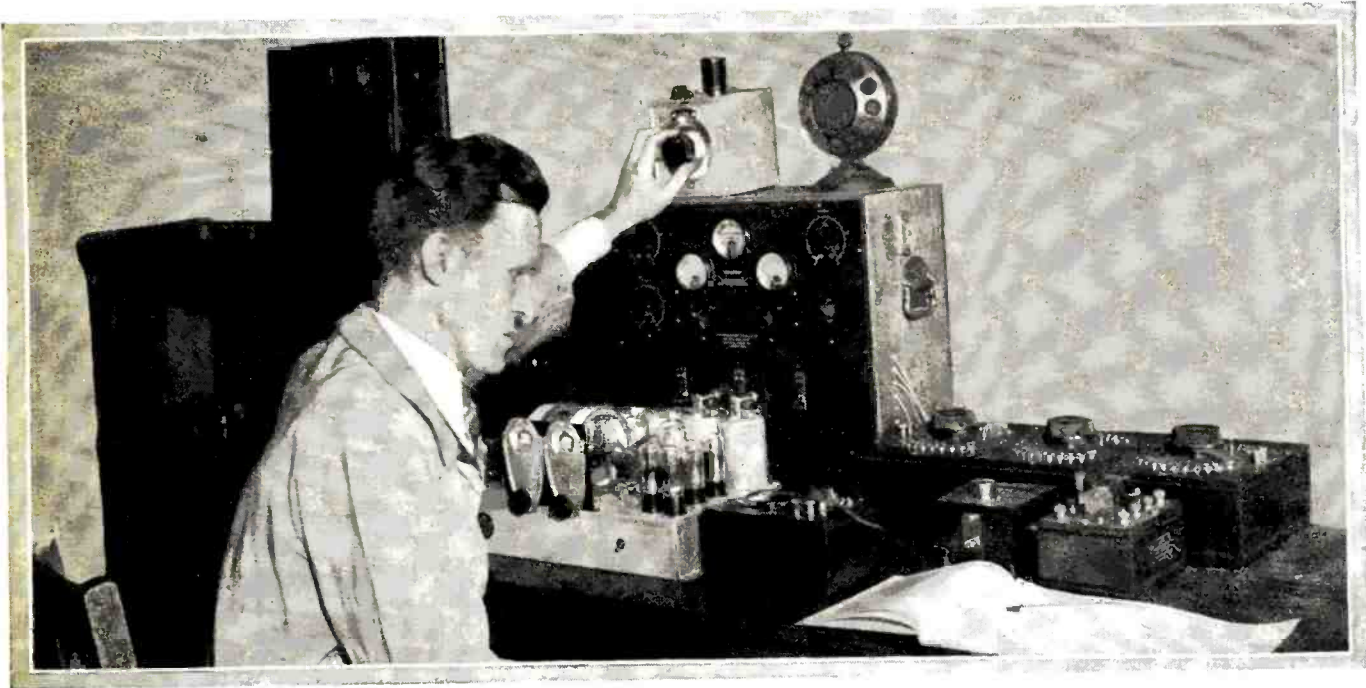

With the Experimenters

Using Headphones with Standard Receivers, without changes in the Receiver; A Simple Radio Time Switch from an Old Alarm Clock; Measuring Small Resistances; Adding a Tube to Short Wave Receivers.

Using Headphones with Standard Receivers

Headphones seem to have become about passé in radio circles during the past few years. Nevertheless, there are times when the use of headphones is highly desirable. For DX reception late at night they always have been, and always will be, decidedly useful, if for no other reason than they keep peace in the family. Even in daylight DX reception, which has become so popular since short-wave transmission developed, much annoyance to other members of the family can be avoided if the DX fan confines himself to headphones.

To those who are hard-of-hearing, radio offers a potential source of vast enjoyment found through no other agency. Here again headphones can be made to play an important part because, as a rule, those who are hard-of-hearing have the same difficulty in listening to loudspeaker reproduction as they have in listening to anything else. Either they only partially hear the programs or else are forced to turn the control up for high volume, which is often a decided inconvenience to others of the family and perhaps even to neighbors.

There are two devices to be described here, which permit the ease of headphones with any type of receiver, and which are easily connected up without change in the wiring of the receiver. The first, shown in Figure 1 and Figure 3a, is all that is necessary to permit DX

Conducted by S. Gordon Taylor

fans to listen in with headphones. This consists of two tube adapters which are slipped under the output tubes of the radio set, assuming it to have a push-pull output stage. With receivers having a single tube in the output, the circuit shown in Figure 3b is used.

Leads from the two adapters connect to

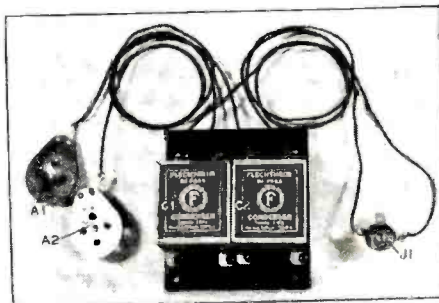

Figure 1

a pair of blocking condensers and the other sides of these condensers connect to a single-circuit jack which may be mounted on the side of the receiver cabinet. To listen in with headphones, all that is necessary is to insert the headphone plug into this jack and operate the set in the normal manner. If this equipment is to be used in DX reception, it will, of course, be desirable to put a

switch in one of the voice-coil leads to the loudspeaker in order that this circuit may be opened. If the headphones are to be used by a person who is hard of hearing, the loudspeaker may, of course, be left in operation for the benefit of other members of the family.

With this first type of equipment, the volume must be controlled by the regular volume control on the receiver itself. In cases where it is desired to operate the loudspeaker and headphones at the same time, this may not prove satisfactory and therefore the unit shown in Figure 2, with the circuit in Figure 4, provides a convenient refinement for the system. This consists of an extension cord, a volume-control box and a pair of light-weight headphones. The extension cord may be of any desired length and thus permit the headphones to be used some distance from the receiver, if desired. The volume-control box regulates the volume of the headphones only and has no noticeable effect on the volume of reproduction from the loudspeaker. Thus a hard-of-hearing individual may sit comfortably in his easy chair with the volume-control box on a table beside him. Other members of the family can listen to the radio as usual but this one individual will be able to regulate the volume at the headphones to suit his individual requirements.

As a matter of convenience, the extension cord is equipped with plugs at each
(Continued on page 533)

A Simple Radio Time Switch

The clock to be described was constructed because a certain member of my family had the bad habit of falling asleep with the radio going at night. As a result, several times I found my batteries prematurely exhausted.

The time clock shown in Figure 5 effectively ended the above evil since it was always set to turn the radio off at some hour after midnight at which time the household would usually be fast asleep.

A dollar alarm clock furnishes the backbone of the mechanism. The clock was mounted in a small wooden box which was constructed to fit. A circular piece was cut from the front of the box to provide a hole through which the face of the clock could protrude.

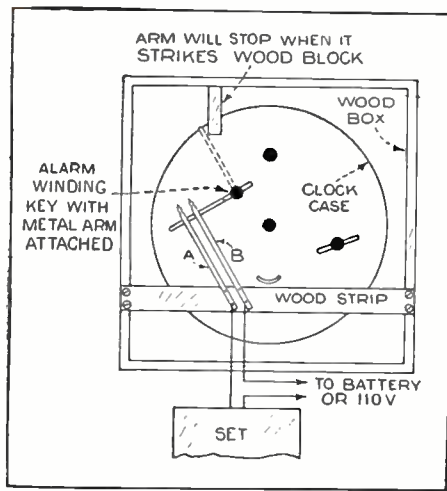

Figure 5

The face of the clock extending through the circular hole of the box helps materially to securely hold it in position. A strip of wood placed across the back of the clock and fastened to the box with screws holds the clock fast. It is convenient to mount the brass contact springs, A and B, on this strip of wood as shown in the drawing. The metal in a single large paper fastener was used for the springs.

To the alarm winding key, a piece of sheet brass (bent "U" shaped to give it rigidity) is either soldered or bolted. A wire is connected to each of the two stationary brass contacts, A and B, and brought out to the radio set to be connected in series with the "A" supply. The brass contacts are adjusted so as to touch the brass arm on the alarm key when the key is rotated so as to wind the clock. The alarm is set in the usual manner and when the alarm sounds, the key rotates the contact arm, breaking the contact with the two stationary brass contacts.

It will be noted that the brass arm on the alarm key will strike the side of the stop after approximately a half revolution and therefore will stop any further unwinding. A half turn of the winding key is all that is necessary to reset the switch since it never completely runs down.

I finished the box in black lacquer and hung it by means of the two screw eyes under the edge of my radio table.

VERNON W. PALEN,
Pennside, Reading, Pa.

Measuring Small Resistances

The experimenter frequently has occasion to use more than one accurately known low resistor when only one resistance box is available. With the device described here it is possible to adjust inexpensive variable resistors to the exact value of a given standard resistor of low ohmage and thus provide standard duplicates.

The circuit is shown in Figure 6; and the 0-1 milliammeter is in series with a 1500 ohm rheostat and a battery. The rheostat is adjusted to full scale deflection of the meter. When the unknown resistance is connected at X the pointer will drop to a lower reading, depending on the value of the unknown resistance.

The scale for low resistances is now well spread out. For example: when the unknown resistor is equal to the meter resistance the pointer will drop to half scale. When the current has first been noted with the standard resistance connected at X, the variable resistance may be substituted and adjusted for the same deflection of the milliammeter. Due to the spreading of the scale this can be done with great accuracy.

When an 0-1 ma. is used, the resistance of the meter is approximately 30 ohms. This means a difference in deflection from zero to half scale for a resistance variation from zero to 30 ohms. Higher up, the scale becomes gradually more crowded, but for resistance below 100 ohms it has sufficient accuracy.

It is possible to spread the scale still more for very low resistors by shunting the meter with a small fixed resistor, as shown at R1 or R2, and again adjusting

the rheostat for full deflection. Thus, in figure 6, with switch S on point 2, the meter is shunted with a 3 ohm resistor. A variation from zero to half scale will now be obtained by variation from zero to approximately 3 ohms of a resistor connected at X. This scheme can be extended further and further if it should

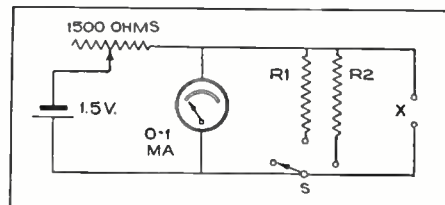

Figure 6. The simple measuring circuit

prove necessary, so that resistances down to .01 ohms can be accurately compared.

The device here described can be calibrated and then it will become an accurate ohmmeter for resistances from 100 ohms down. Theoretically the calibration can be extended down to next to nothing by using smaller and smaller shunts. In practice there are limitations because of a certain amount of resistance in the connections made by the switch, which may be as much as .01 ohm.

In this department next month a method will be described for calibrating the ohmmeter without the need of standard resistances or the necessity of knowing the exact value of the milliammeter resistance.

JOHN M. BORST,
New York City.

Adding a Tube to S. W. Receivers

In your July number (1930) of RADIO NEWS under "On Short Waves" you published a letter from Charles E. Osterhoudt, Maracaibo, Venezuela, and a circuit for including an additional tube of the screen-grid type.

I built the circuit and have since made

audio-amplification, it was thought unnecessary to shield the rest of the tuner. As this showed quite a little improvement, another step seemed advisable, and another box was made, 7 inches high by 11 inches long and 8 inches from panel to back, and a partition put in the center

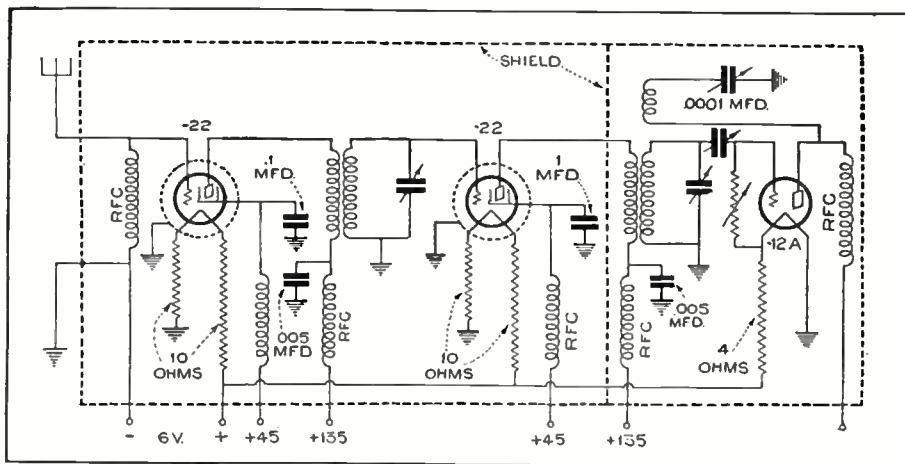

Figure 7

some effective changes. The first was the making of a brass box to totally enclose the detector stage of my s.w. receiver. As it was being plugged into a totally shielded broadcast receiver for the

forming two totally shielded compartments to enclose the entire tuner. The resistor control for regeneration was tried out but was replaced with a small

(Continued on page 534)

The Service Bench

by ZEH BOUCK

Advertising the Serviceman—Short Circuit Testers for Tubes—The Business End of Servicing—Service Displays and Sales—Guarantees and Good Will—Servicing Supers, Philcos, Westinghouse, Graybar and Radiolas

Speed Tests for Tube Shorts

TESTS on tubes suspected of interelement short circuits should not be made on regular test sets, due to the possibility of burning out delicate meter windings. And the usual volt-meter continuity tests are slow, clumsy and often incomplete. The efficient service laboratory will find the time and trouble of constructing one of the following short-circuit testers well justified.

The principle of operation is simple. A tube having a short between two or more elements closes a local circuit, lighting one or more lamps, providing a visual warning of the condition and at the same time designating its location.

Figure 1 shows the most simple arrangement, suggested by the Jewell Electrical Instrument Company. Four six-volt batteries are recommended in series with the same number of six-volt lamps, and connected as indicated to a five-prong and a four-prong socket. (Single number six dry cells can be substituted for the batteries when using 1.5-volt lamps.) Interpretation of the signal is fairly obvious from inspection of the diagram. For instance, a plate-to-grid short will light the right-hand bulb. A plate-to-filament, or heater, cross-over will light all bulbs.

Where portability and independence of

lighting supply is not important, Figure 2, suggested by R. C. A. Radiotron, is almost equally simple. The required parts are:

- 5 miniature porcelain sockets
- 5 6-volt dial illuminating lamps

- 2 5-ampere fuses
- 1 fuse block
- 2 40-ohm resistors
- 1 80-ohm resistor
- 2 Ward Leonard 500-ohm, 500-watt resistors
- 1 400-ohm variable resistor (Electrad)

In some instances shorted tube elements exist only when the tube is lighted—due to expansion with heat. Obviously, for tests discovering these more subtle cross-overs, it is necessary to provide means for lighting the filaments or heaters. Figure 3, also recommended by R.C.A. Radiotron Division, shows an approved diagram. The following parts, additional over Figure 2, are required:

- 1 filament transformer, 1.5, 2, 3.3, 5 and 7.5 volts
- 1 Yaxley seven-contact switch.
- 1 Yaxley double-pole, double-throw panel-mounting jack switch

The possible short indicated by the circuits of Figures 2 and 3 may be tabulated conveniently as follows:

Lamps Lighted	Type of Short
A	Control grid-cathode
B	Control grid or screen-cathode
C	Plate-cathode

WHILE a good, conscientious service job is perhaps the serviceman's best advertisement, a clever line or two in the local paper, a well-composed circular or handbill, may get you the opportunity to do that job. Advertising pays, and the Service Bench will gladly pay its readers for sample advertisements that have brought them in business.

The Service Editor.

- 2 sockets—UX and UY
- 1 snap switch
- 1 push-button
- 1 small battery clip

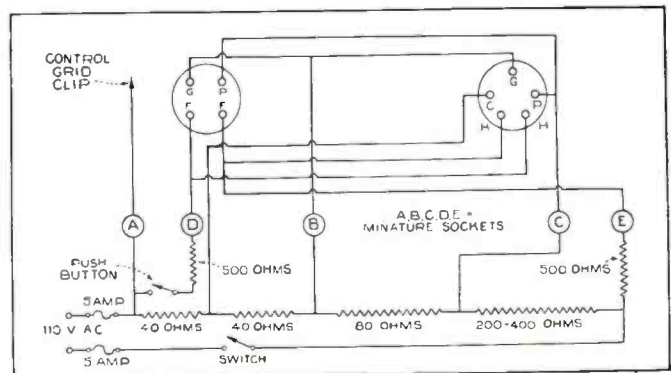
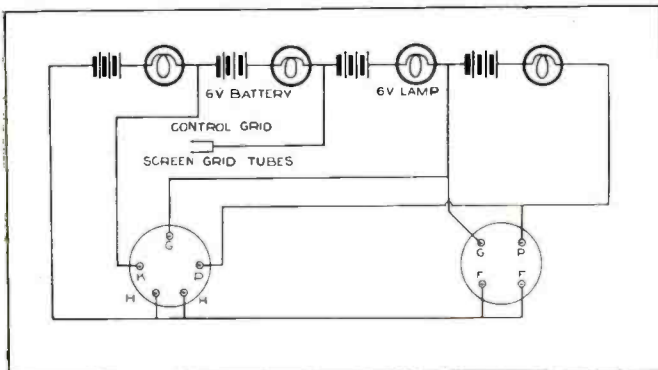

CIRCUITS OF SIMPLE TUBE SHORT-CIRCUIT TESTERS

Figure 1 (left) shows a tester designed to operate from batteries, with four flashlight bulbs to not only indicate any existing short-circuit within the tube, but also to show which of the elements are shorted. Figure 2 shows a somewhat similar test circuit, but utilizing the 110-volt line as the power source

- E Heater-cathode
- A and B Screen-control grid
- A and C Control-grid-plate
- A and E Heater or filament-control grid
- B and C Control grid or screen-plate

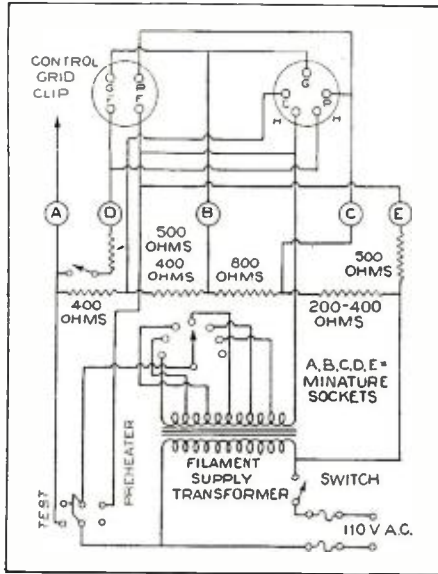

A MORE ADVANCED TESTER

Figure 3. A filament transformer is added here, providing for tests for the type of short-circuits which occur only when the elements are heated

- B and E Heater of filament-control grid or screen
- C and E Heater or filament-plate

All in a Day's Work

The revenue of the serviceman—the amount of money he takes in—depends upon two factors, the amount of work he does and the rate he charges for it. The first factor is largely dependent upon the latter. A fair price for good work generally results in repeats and recommendations. And by a fair price we mean a price that is fair both to the customer and to the serviceman. The laborer is worthy of his hire. Ultimately the economics of

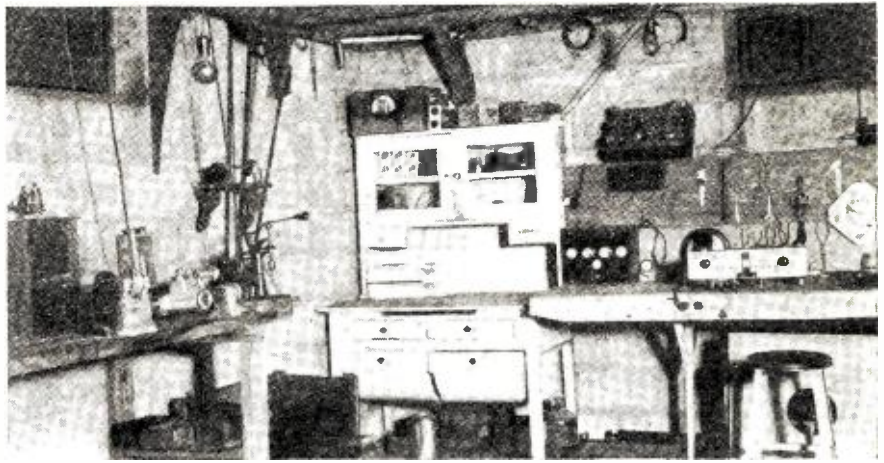

MR. SCHUERMAN'S SHOP

He believes in plenty of room and \$2.00 an hour for service labor

servicing may be dictated by some form of union with a standardization of fees and rates. Service organizations already existing, and now forming, have definite leanings in this direction. In the meantime the general exchange of ideas on the subject continues, in its small way, to sift the various possible systems and rates of charge.

C. M. Hamilton, of Spring Brook, Wis., writes:

"Since reading your article in the July issue, 'How Much Is a Trade-in Worth?' I have been wondering just how much a service job is worth. There seem to be a lot of folks who want to pay by the hour, a system that I consider unsatisfactory to all parties concerned. I charge on a piece-work basis as follows:

Visual inspection	\$0.50
Continuity75
Service call, one mile	1.00
Antenna installation	3.00
Changing resistors75
Changing transformers	3.00
Neutralizing75
Trimming condensers75
Cleaning, polishing, etc.25

"This is the Hamilton method—no free service!"

On the other hand, Mr. Albert J. Herda believes in charging on an hourly basis. Mr. Herda is serviceman for the Herda Electric Company, of Baltimore,

Md., handling Fada, Apex, Brunswick, Stewart-Warner and Atwater Kent. He comments:

"A very large volume of repair business is secured through the help of a salesman, employed by our firm on a commission basis. He makes free tube tests in the homes of our customers. If the receiver requires servicing other than



J. FRANK SCHUERMAN
Serviceman of Decatur, Ill.

tubes, he solicits the work and arranges to transport the set to our shops. We have found it profitable to engage this representative, and as he receives a commission on all articles sold through his efforts, or to his contacts, he makes a good income. The tube test is rendered absolutely free, and is accurate and truthful. My service charges are rated at \$2.50 an hour, with a minimum charge for one hour."

J. Frank Schuerman also charges an hourly fee. He specializes in service on Bremmer-Tully, Crosley, Kolster, Majestic, Airline and Atwater Kent for the radio fans of Decatur, Ill.

"My rates are \$2.00 an hour for actual work, plus \$1.00 additional for each service call up to one-half hour. I have found it a paying plan to leave a number of my business cards with my more enthusiastic clients, for distribution among their friends. I give them a commission on the initial job for each new customer they direct to me.

"The extent of my service work was originally intended merely to offset the cost of my experimentation. However, it has picked up in the last two years to such

Clarion & Silver-Marshall
Sales and Service
TELEPHONE 36-541

193

Service Warranty

Repairs and Replacements made by the undersigned on your _____ Radio, are hereby warranted against defective material and workmanship for a period of ninety days from the above date.

SMITH & WILLSON
"Radio Specialists"
172 FALCONER ST.
JAMESTOWN, N. Y.

Tubes _____
Parts _____
Service _____ Keep This Card By _____

BUILDING A "REP"

A card like this is better than a verbal guarantee. It is a gesture that instills confidence in your work and promotes recommendations



THE VALUE OF DISPLAY

Putting sales appeal into the service laboratory as practiced in Harrisburg, Pa., by the Radio Service Laboratories. An attractive headquarters will sell more than service

an extent that my customers came first and only my spare time could be devoted to other work.

"The latest addition to my equipment consists of an improved set analyzer and tube checker, a signal generator, a new grid dip meter, an output meter and numerous other time savers."

The charges indicated in the above three contributions are, of course, for time only, and in no instance include the cost of new parts.

Superheterodyne Testing

Mr. A. J. Kauder, of Los Angeles, California, sends in the following notes on giving the super the once-over:

"For servicemen with limited equipment, the following tests for superheterodyne receivers will be useful. The super is more complicated than the tuned radio-frequency circuit, and simple voltage tests do not always suffice to locate the trouble.

"The superheterodyne may be considered as consisting of three units, the radio-frequency-preselector stages and first detector (or merely first detector), the oscillator, and the intermediate-frequency amplifier with its second demodulator.

"For the radio-frequency and first detector unit, the simplest test is to break the plate circuit of the first detector and listen with a pair of phones cut in. If this unit is all right, signals should be heard as the dial is turned.

"The oscillator circuit should next be checked by coupling the oscillator coil, by means of a piece of wire, to the antenna post of a standard broadcast receiver of any type. Tune in a station on the broadcast receiver and then turn the dial controlling the oscillator condenser of the super until a squeal is heard. If the super dial is calibrated in kilocycles, a rough check on the alignment can be made by observing the kc. readings of the two dials. There should be a 175 kc. difference between the dials at zero beat.

"Having established the correct functioning of the r.f.-first detector unit and the oscillator, the intermediate-frequency section can now be adjusted, or spotted as the offending unit, by attempting reception on a local station."

Notes on Philcos

Several sources of service notes on Philco receivers, including our familiar contributor, Russell Woolley, of Seattle, Washington, pass on useful information. Writes Mr. Woolley:

"The extreme sensitivity of the modern radio set, especially the superheterodyne, makes it very susceptible to extraneous noises, in particular those occasioned by the transmission of jars and sounds through the chassis to vibratory elements of the receiver—such as tube elements and condenser plates. Some method of absorbing mechanical shock must therefore be utilized. The recent Philco superheterodyne models, for example, are cushioned from the cabinet on rubber spacers. The serviceman may nevertheless encounter conditions where even a floated chassis does not eliminate tube noises. This is often caused by over-tight bolts holding the chassis to the cabinet and compressing the spacers. Loosening these bolts, so that the chassis floats freely, will usually remedy matters.

"Service department managers and independent servicemen who have had little experience with the Philco line will be interested in the warning that the North Coast Electric Company gave its dealers in a letter dated July 10th. This reads in part: 'Operating the Philco Model 70

even momentarily without the speaker plug will immediately ruin the -47 pentode tube. This has the peculiar effect that while it does not burn out the filament, it does destroy the emission 100 per cent.'"

Another condition peculiar to the Philco is commented upon by Morris Landau, of Landau Brothers, Hazleton, Pa.:

"We are experiencing trouble with the new Philco line. These sets stutter and oscillate badly, while a careful check shows the voltages and circuit to be O.K. We finally discovered that the rotor shaft of the tuning condenser is liberally greased at every point of contact with the springs and end plates—for apparently no good reason at all. When the grease is wiped off, and the rotors replaced, the sets work wonderfully, but the situation at first was embarrassing and still is a nuisance."

Radiola Models 80 and 82

"The following data applies equally well to the Westinghouse WR5, Graybar 700 and the General Electric H-31. These models are the most powerful receivers the writer has operated in his twelve years of radio experience. However, their distance-pulling ability can be increased by removing the copper shield on the first intermediate-frequency transformer. If removing this shield causes severe oscillation, it should be partially replaced, or the volume cut down.

"An additional stage of intermediate-frequency amplification can be incorporated in most of the model 80's, with a corresponding gain in sensitivity. Secure a socket, one type -24 tube and one R.C.A. number 8565 i.f. transformer. Connect the green control grid wire that runs to the cap of the fifth tube (second i.f.) to the control grid of the new -24. Wire the heater prongs to any convenient heater terminal in the set. Connect the screen grid connection of the new tube to the spaghetti-covered wire joining the screen-grid of the first detector, first and second i.f. Connect the cathode of the new socket through a 1000-ohm resistor to ground and by-pass with a .1 mfd. condenser. (Occasionally this extra resistor and condenser will not be needed, the connection being made directly to the cathode on tube number 4, or first i.f.) Connect the plate of the new socket

(Continued on page 543)

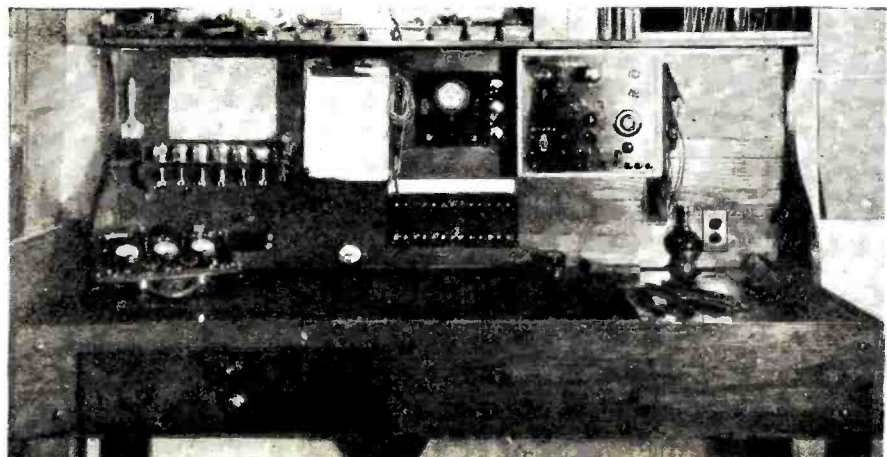

SERVICE IN BALTIMORE

The well laid-out bench of Albert Herda, Baltimore, Md., dealer and service specialist

Service Data for Servicemen

Compiled by
Nat. Feiner*

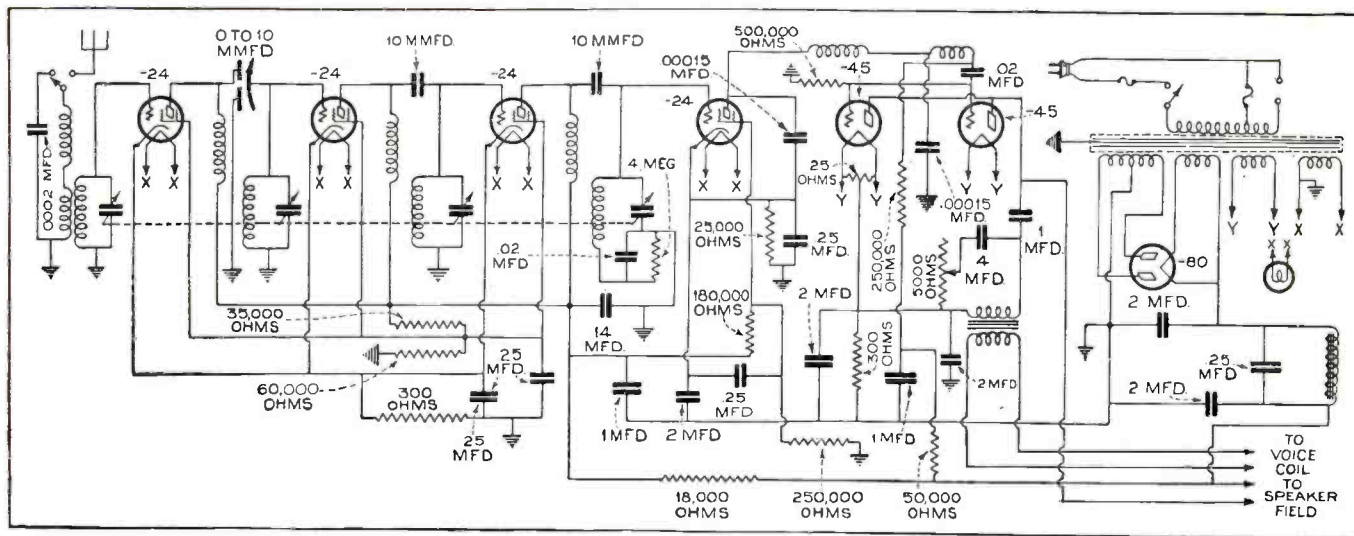

BRUNSWICK, MODEL 15

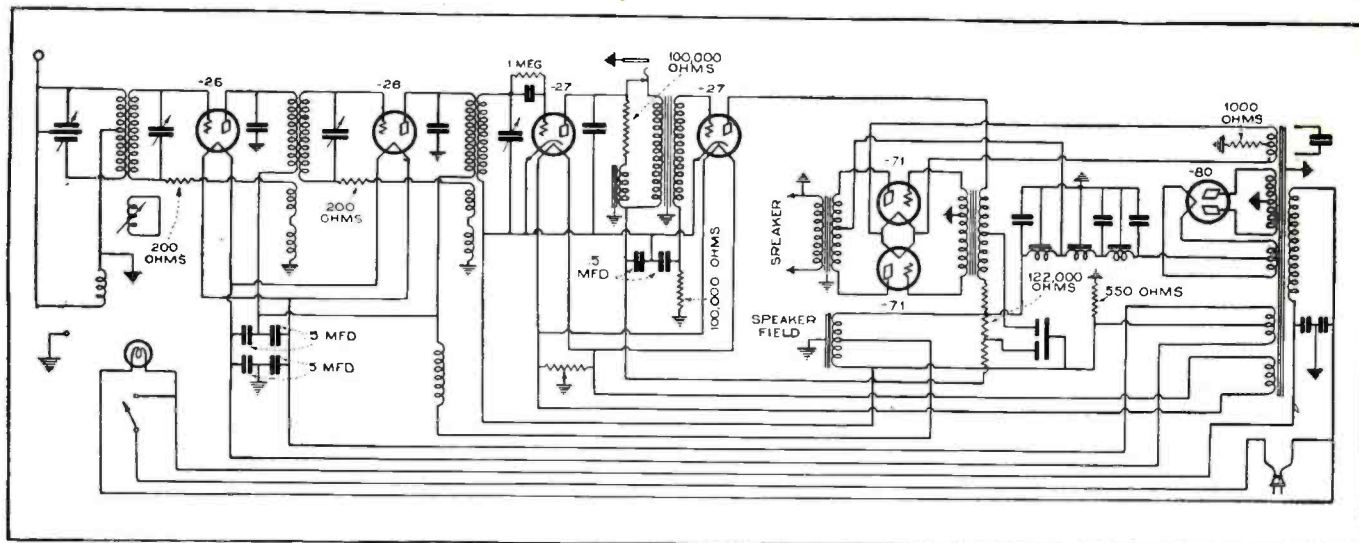

COLONIAL, MODEL 31 A.C.

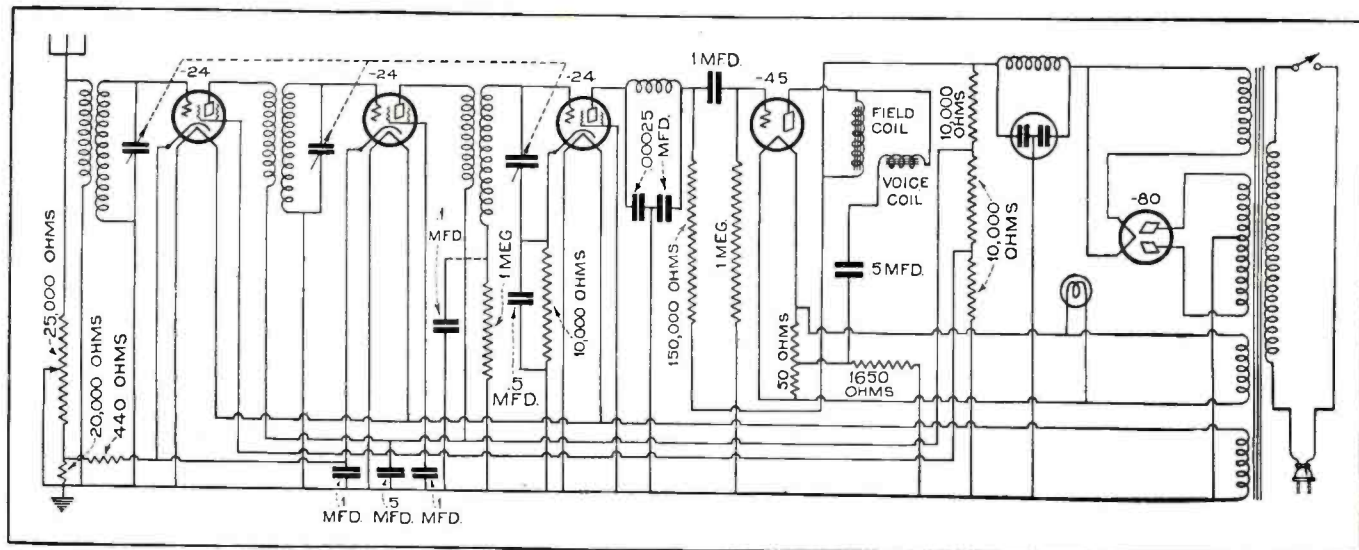

CROSLY, MODEL 54

*Federated Purchaser.

Radio Physics Course

This series deals with the study of the physical aspects of radio phenomena. It contains information of particular value to physics teachers and students in high schools and colleges. The Question Box aids teachers in laying out current class assignments

IN our discussion of the structure of the atom, up to this point we have considered only the condition where the sum total of all the positive charges of the protons in the nucleus is equal to the total negative charge of all the electrons in the atom, and the atom does not exhibit any electrical manifestation outside. A body composed wholly of such atoms is said to be neutral or uncharged. The electrons and protons because of their opposite charges have a great attraction for each other and this normally tends to keep the electrons revolving inside the atom.

Charged Bodies

If by some means, a body is made to have an excess of electrons or protons, its electrical charges are unbalanced (having more positive charges than negative or vice versa) and it exhibits the external effects commonly associated with electrically charged bodies. Whenever a body has an excess of protons (whether the body is of atomic size or as large as the earth), we say it is "positively charged" with electricity; similarly, when it has an excess of negative electrons, it is "negatively charged."

When glass and silk, or cat's fur and sealing wax are rubbed together, the first of each pair loses electrons and thus becomes positively charged, and the second gains these electrons and becomes negatively charged, as shown in Figure 5. The rubbing is simply a means of bringing more points into intimate contact so the exchange of electrons can take place. Since the number of electrons gained by one body is just equal to the number lost by the other body, they became equally and oppositely charged. A charged body may contain millions of normal atoms for every atom that has either an excess or a deficiency of electrons.

If we take two charged bodies, A and B of Figure 6, A being charged positively (deficiency of electrons) and B being charged negatively (excess of electrons), and connect them together by a piece of copper wire, an immediate redistribution of charge will take place. The excess electrons from B will start a flow of electrons through the wire to A. This will continue until A has gained enough and B has lost enough electrons so as to bring them to their normal uncharged condition or to the same electrical potential. Meanwhile, a flow of electrons has taken place through the wire. This is an *electric current*, of exactly the same nature as that furnished by batteries, dynamos, etc. It will produce exactly the same effects as the current found in ordinary power and electric light wires. This experiment can be performed by charging the plates of a 1 or 2 mfd. condenser used in radio receivers, by connecting it across a 110-volt electric light circuit. The condenser is then removed and a short wire is connected across its terminals. A spark will be produced due to the flow of current between the terminals.

Electrons can be made to flow continuously if a proper closed

By Alfred A. Ghirardi*

Lesson Five

(Continued from Lesson Four)

The Electron Theory, Generation of Electric Energy Conductors and Insulators

circuit through some suitable material (particularly metals) is provided as in Figure 7. This is commonly called a flow of electricity, or simply an "electric current." In practice, the circuit is usually arranged in the form of a wire. In order to make the electrons flow in a definite direction, through the wire, an external force must be applied to it. This force is called electron-moving force, or simply *electromotive force*.

The usual abbreviation for this rather long word is *e.m.f.* This will be referred to often in our work.

There can be no definite flow of electrons, or flow of electricity, without the application of electromotive force, just as there can be no flow of water through a pipe unless a pressure is applied to it. As a matter of fact, electromotive force is sometimes called "electrical pressure" since it causes the flow of electrons, but of course it is really not a pressure in the same sense as applied to water.

Sources of e.m.f.

Electromotive force which will force electrons to flow through a suitable conductor (flow of electricity) can be developed or generated in several ways. We have already studied the process of creating an electron flow by friction. This is not used in practice to any extent. Other more practical methods consist of moving an electrical conductor in a magnetic field as in the case of the electric dynamo or generator; by creating chemical changes in suitable substances as in the case of primary batteries and during the discharge of storage batteries; and by heating the junction of two dissimilar metals as in the case of the thermocouple. The common sources of e.m.f. employed in radio receivers are shown in Figure 8.

Flow of electric current by conduction

Let us see just what happens when current flows through a solid conductor. The atoms in solid bodies are more or less restricted in their motion and do not wander around from one part to another as much as do the molecules of gases and liquids. They are constantly in a state of agitation however, depending on the temperature of the body. Through solids, therefore, the conduction of electricity results simply from the motion of electrons

through the body, since they are very small.

The solid substances which conduct electricity best are metals whose atoms will most easily part with an electron. Thus each atom of copper normally has 11 electrons in its outside (fourth) shell. The capacity of this shell is 18 electrons. Therefore it is relatively easy to release at least one electron from each atom and make it move through copper. Copper is therefore said to be a good conductor of electricity, that is, a comparatively small e.m.f. applied to it will cause a large number of electrons (large current) to flow through it. The same is true with the other electrical conductors, such as gold, silver, etc.

When visualizing the flow of electrons through an apparently

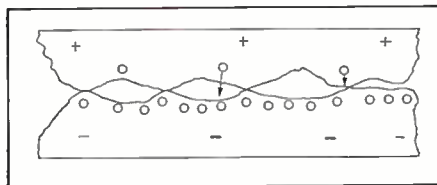

FRICITIONAL ELECTRICITY

Figure 5. Charging Bodies by Rubbing. The upper body is positive because it has lost electrons to the lower body which became negative

*Radio Technical Pub. Co., Publishers, Radio Physics Course.

solid body such as copper it should be remembered that actually the body is very empty; that is, there are comparatively large spaces between the atoms. Thus if a copper penny were enlarged so as to cover the earth's orbit, (to a great copper disc 189,000,000 miles in diameter) the distance between the individual atoms would be about three miles; the cores of the atoms would be about 11 inches in diameter and the electrons would be about 3 inches in diameter! In the whole of a copper cent there are about 700,000,000,000,000,000,000,000,000 electrons. For convenience this can be written 7×10^{23} , which means that 7 is to be multiplied by 10 twenty-three times.

It is evident then, that even in solid objects the tiny electrons have plenty of empty space in which to move around. Imagine the large amount of room a particle about four-thousandths of an inch in diameter would have for movement in a sphere 1 meter (over three feet) in diameter.

When an e.m.f. is applied to a wire as in Figure 7, those electrons which can be taken from their atom families easily are driven from one atom to another through the wire towards the source of the force. This movement of electrons results in a drift of electrons around the complete circuit and is called conduction current or electronic drift. The number of electrons flowing past any point in the circuit depends upon the strength of the applied e.m.f. and the resistance which the conductor offers to the flow of the electrons through it.

If a copper wire is connected to a source of e.m.f., such as the dry cell battery in Figure 7, at the positive terminal of the battery an attraction occurs for those electrons in its immediate vicinity because the chemical action between the materials in the cell has forced many of its electrons out to the negative terminal, leaving the positive terminal with a scarcity of electrons. As copper is a good conductor, that is, electrons can be freed from its atoms by comparatively small electronic forces, some of them will be set free ("free electrons") and will immediately start to rush toward the positive terminal. (According to some investigators a large number of electrons are free in conductors even before any e.m.f. is applied.) As soon as they are set free their atoms have unbalanced positive charges and will tend to attract electrons from the atoms behind them. When these loose electrons they attract some from the atoms behind them, etc. At the same time, since at the negative terminal of the battery there is a surplus of electrons, some electrons in the atoms of the wire in its immediate vicinity are freed from their atoms and repelled forward in a direction through the wire toward the positive terminal of the battery. The chemical changes taking place in the dry cell, tend to maintain the charge at each terminal, that is, maintain the e.m.f. or propelling force in the circuit. There is then a drift or circulation of electrons around through the conductor from the negative to the positive terminal of the source of e.m.f. from positive to negative as shown in Figure 7. This drift of electrons constitutes the flow of electric current by *conduction*.

It is thought that the flow of electrons through the conductor really takes place in several ways. Some of the electrons may flow from one atom to another thus releasing electrons which flow on to the next adjoining atom, etc.; some may flow between the atoms, some may even flow through the relatively large empty spaces in the atoms in the same way as a bullet can be fired through the empty spaces between the planets of our solar system without hitting any of them. The electrons may dash in and out without attaching themselves to the atoms. It must be remembered that while there is a general drift of electrons through the wire, the atoms continue their haphazard vibration in the wire. Whatever the individual electrons may do, an electric current through a conductor consists of a stream of electrons drifting through the wire.

In order to produce a perceptible effect of current flow it is necessary that a large number of electrons

Question Box

PHYSICS and science instructors will find these review questions and the "quiz" questions below useful as reading assignments for their classes. For other readers the questions provide an interesting pastime and permit a check on the reader's grasp of the material presented in the various articles in this issue.

The "Review Questions" cover material in this month's installment of the Radio Physics Course. The "General Quiz" questions are based on other articles in this issue as follows: Radio in the African Jungle, WABC's New "Wireless" Antenna, A 200-2000 Meter Broadcast Receiver Design, Assembling Your Own Home Recorder, Tuned R.F. Design, Telephony on a Light Beam, Optical Train Control, Reducing Noise in Talking Picture Film.

Review Questions

1. *Of what does a current of electricity consist?*
2. *What is the difference between static electricity and a current of electricity? What similar features do they have?*
3. *What is necessary besides a conducting path in order to have a flow of electricity?*
4. *Describe in detail the flow of electricity in a wire connecting two oppositely charged bodies.*
5. *Make a diagram showing the conditions existing in question 4 and show on it the direction of both the electron flow and the current flow.*
6. *Name three sources of electromotive force.*
7. *Why is the direction of electric current flow according to popular usage, just opposite to the actual direction of the electron flow?*
8. *Explain why copper is a good conductor, and Bakelite is a very poor conductor of electricity.*
9. *Why is it that exchanges of electrons can take place between the atoms of a conductor, and electrons can move through the conductor, during the flow of electricity without any change of chemical composition of the material taking place?*
10. *Describe in detail the actions taking place during the flow of current in a complete closed circuit consisting of a dry cell battery with a piece of copper wire connected across its terminals.*
11. *Draw a diagram to illustrate your answer to question 10, and mark on this the positive and negative terminals of the dry cell, and the direction of flow of both the electrons and the current.*

General Quiz on This Issue

1. *Why is a microphone battery not necessary when a microphone is connected in the power detector cathode circuit of a broadcast receiver?*
2. *Why is 175 kc. not suitable as the intermediate frequency in a superheterodyne receiver covering a 200-meter to 2,000-meter range?*
3. *What intermediate frequency is employed in one such receiver? Why?*
4. *Why is the type -35 tube considered a more quiet tube than the type -24?*
5. *What is the common method of inter-tribal communication employed by natives in the African jungle?*
6. *What outstanding advantage is the new "mast" antenna at WABC expected to offer?*
7. *What simple method is employed in one of the newest receiver designs to produce a relatively flat sensitivity curve for the r.f. amplifier?*
8. *How may photoelectric cells be used in controlling and signalling trains?*
9. *How are extraneous noises in talking picture films, due to film grain and photocell variations, being eliminated by the radio engineer?*
10. *Explain how light beams may be modulated with audible signal frequencies to carry speech and music?*

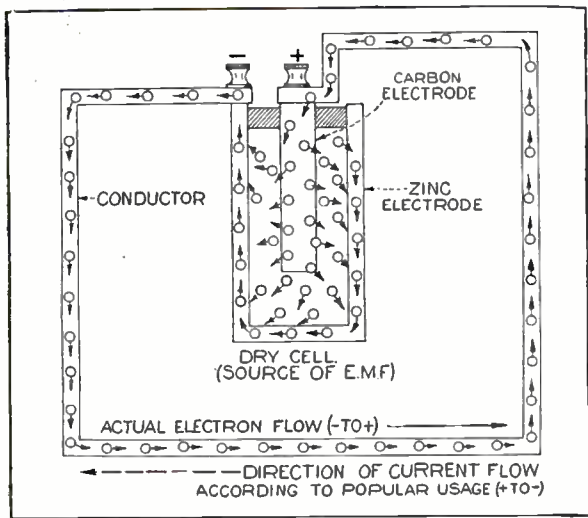

ILLUSTRATING ELECTRON FLOW

Figure 7. Actual Direction of Electron Flow, and the direction of current flow according to popular usage in an electric circuit

be transferred through the wire. Thus when one ampere of current flows through a wire, about 6,280,000,000,000,000,000 electrons are drifting or flowing past any point in the circuit every second. This, however, is only a very small fraction of the total number of electrons contained in the wire. It has been estimated that only one in 5000 electrons resident in a conductor actually is used when current is flowing through the conductor. The others remain in their respective atoms.

Velocity of Propagation

In the usual electric wires the electrons revolve around their protons at very high velocities. However, the free electrons are darting around from atom to atom and they actually move or drift along the wire very slowly, probably only a few inches a minute, but of course they move in enormous numbers. This slow movement of the electrons should not be confused with the speed of electricity or electrical disturbances which is 186,000 miles per second. The latter means that when the electrons at one end of a very long electrical circuit, for instance, are set in motion by the application of an e.m.f. the electrical disturbance of the electrons reach to a point 186,000 miles from this end in one second; so that in one second, electrons in that whole 186,000 miles section of wire would start to move toward the positive terminal (at a comparatively low speed). Any change or variation in the current flow also takes place at this rate.

The effect may be roughly compared to a long column of soldiers standing still. At the instant of the command "forward

march" the front row advances and starts to march, at say two miles per hour. The next row then moves forward, then the next, etc. It may take a fraction of a second before the last row in the column will start to move forward after the first row has started. The steady forward movement of the soldiers is only two miles per hour, whereas the initial wave of disturbance or movement proceeded along the column at a very much faster rate.

Now, if for some reason the first row of soldiers decided to speed up their marching to four miles per hour, this wave of speeding up would proceed back along the line very rapidly (velocity of propagation) so that within a fraction of a second all the soldiers up to the last row would have speeded up. The four miles per hour corresponds to the slow rate of drift of the electrons in a wire, the wave of speeding up or starting up proceeding back along the column corresponds to the rate of propagation of electrical disturbances and electrical waves, 186,000 miles per second.

Direction of Electrons and Current

The atoms cannot drift freely in metals because of their relatively large mass. Consequently the flow of electricity through metals is due solely to the drift movement of the electrons. Obviously the direction of movement of the electrons is continuously from the negative terminal of the source of e.m.f., around through the circuit to the positive terminal of the source of e.m.f., and through the e.m.f. source to the negative terminal as shown in Figure 7. It is unfortunate that in the early experiments with primary batteries

(before the electron theory or the flow of electrons had even been thought of) the electric current was supposed to be a fluid like water and was arbitrarily said to flow from the positive terminal of the battery (point of high pressure or level) to the negative terminal point of low pressure or level. This purely arbitrary terminology has been carried down from that time and is in universal use among electrical workers. Nowadays we know that the electron flow (which is really the current) is actually from the negative terminal around to the positive terminal of the source of e.m.f. This unfortunate apparent discrepancy need not cause any serious difficulty, however, if the student

theory in mind and remember how and why the terminology of current flow now in popular use originated.

It is well known that certain materials like copper, silver, gold, brass, aluminum and other metals and certain solutions will readily permit the passage of electric current through them while other materials, like rubber, bakelite, porcelain, silk, cotton, etc., do not. The former are called *conductors* of electricity. The reason why metals are such good conductors is that their atoms apparently have such weak attraction for electrons that large numbers of them are either in practically a free state throughout the body of the metal, or else are capable of being shifted readily by any outside electric forces. The more easily the electrons can be shifted, in a given material, the better are the current conducting qualities. Good conductors are used extensively in the construction of radio receivers for wires, condenser plates, coil shields, etc.

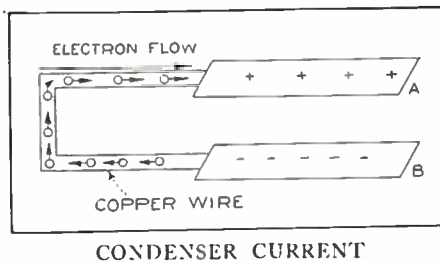
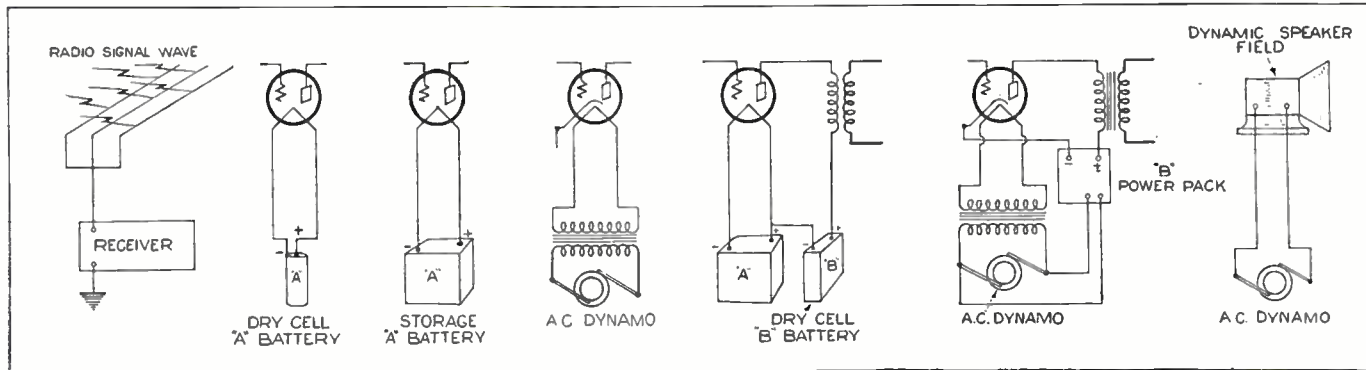
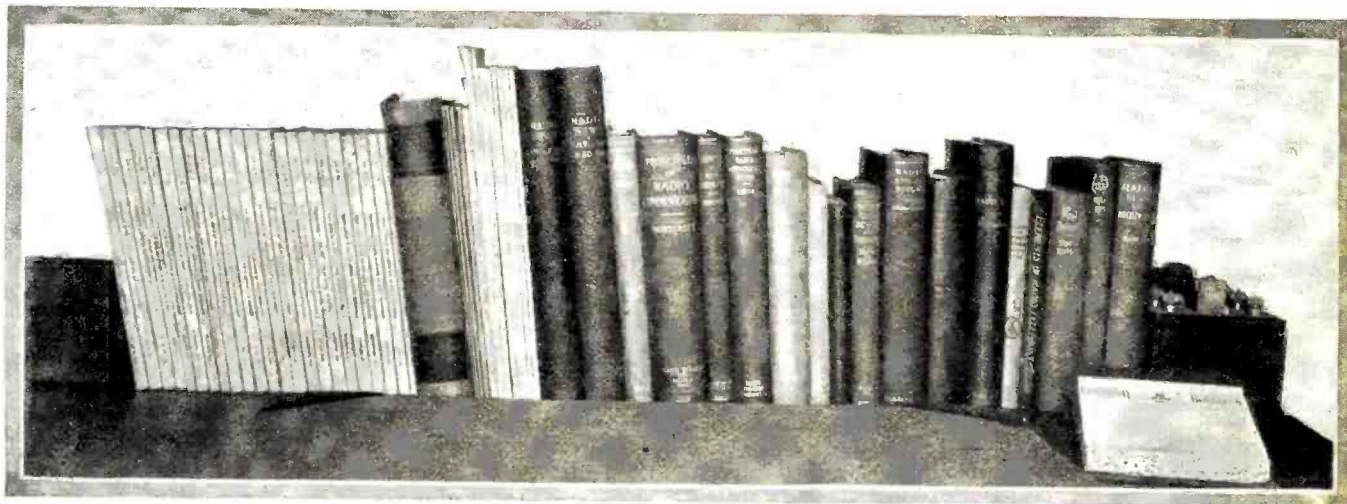

Figure 6. Flow of Electrons (current) through a wire connecting two charged bodies



SOURCES OF VOLTAGE USED IN RADIO

Figure 8. Radio Signal Wave; Dry Cells or Storage "A" battery sends current through filaments of tubes; dry cell "B" batteries or "B" eliminator furnishes E.M.F. for plate circuits; electric light line furnishes E.M.F. for electro-dynamic speaker field



Radio Science Abstracts

Radio engineers, laboratory and research workers will find this department helpful in reviewing important current radio literature, technical books and Institute and Club proceedings

Recording Sound for Motion Pictures. Edited by Lester Cowan for the Academy of Motion-Picture Arts and Sciences. Published by the McGraw-Hill Book Company.

This book is one of the best on sound picture technique that has come to our attention. In scope, it covers quite completely, all phases of sound recording. That it is authoritative there is no doubt, for it represents work of some twenty-five engineers, each a specialist in his own branch of the science; each of the twenty-four chapters that compose the book is written by a different engineer. The result is a sound-picture text complete in coverage and thoroughly to be trusted.

The book is divided into four main sections. The first part deals with sound-recording equipment. Chapters by engineers associated with the various large film companies and with the organizations manufacturing equipment give the reader a complete insight into the essential features of the various systems of recording. The various sound-on-disc and sound-on-film systems are discussed not only from the standpoint of their design and operation but the effect of film exposure, fidelity, dynamic range, noise and other such technical points are illustrated by various curves.

The second part of the book entitled "The Film Record" covers in detail the characteristics of modern film with respect to the recording of sound tracks. The first chapter of this section discusses film speed, latitude, development factors, how they are measured and made use of in practice. Following chapters show the requirements for variable-density recording, the laboratory technique and the editing and assembling of the final prints or positives. All these chapters discuss both the theoretical and practical aspects of the subjects, so one learns not only the theory underlying the various methods but the manner in which the theory has been reduced to practice.

"Studio Acoustics and Technique," the third part of the book, shows how the quality of reproduction depends upon the acoustics of the stage and the theatre. Dr. Vern O. Knudsen, whose excellent work is well known to every student of acoustics, contributes a chapter on the fundamental

Conducted by
Howard Rhodes

acoustic problems that have to be considered in connection with the recording and reproduction of sound. The chapter on sound stages describes how such stages are treated acoustically.

"Problems of Reproduction in the Theatre," are considered in the fourth part of the book. This section describes reproducing systems, and the practice and problems of sound projection.

The above summary of the content of the most excellent book will, we hope, serve to indicate its breadth and completeness. It is a book which no one connected with any branch of the business can afford to be without. In fact the book will prove a useful addition to the library of any radio engineer, for he also is concerned with the production of sound.

Review of Articles Appearing in the October, 1931, issue of the Proceedings of the Institute of Radio Engineers

Communication With Quasi-Optical Waves, by E. Karplus. Proceedings of the Institute of Radio Engineers, October, 1931. This paper deals with electromagnetic waves of from about 0.001 millimeter to 10 meters in wave-length. These waves are called quasi-optical waves because their performance is similar to the performance of visible light.

Due to scattering and absorption in the atmosphere, however, only two relatively small parts of that range can be used for communication, that is, between 5 centimeters and 10 meters and between 0.0008 and 0.002 millimeter.

In the first part of the paper the straight-line propagation characteristics of these high frequencies are discussed. The possibility of concentrating their radiation, and the apparent lack of all disturbances, either atmospheric or man-made, is also emphasized. The

feasibility of modulating very high frequencies, and their advantages and disadvantages in various applications are pointed out. Different ways of producing these high frequencies and of detecting and of measuring them are discussed.

The second part of the paper deals in somewhat greater detail with the design of tube transmitters and receivers in the range of 5 centimeters to 10 meters. In this group of transmitters are tuned-circuit oscillators and electron oscillators of the Barkhausen type. In the group of receivers considered are detector, regenerative, and super-regenerative circuits.

The Conduction of High-Frequency Oscillatory Energy, by H. O. Roosenstein. Proceedings of the Institute of Radio Engineers, October, 1931. This paper deals with the efficiency of wire lines used to carry high-frequency currents. Methods are given for calculating the efficiency and load resistance and for measuring the damping and surge impedance; these measuring methods are applicable up to the highest frequencies, this point having been confirmed by actual test. The paper analyzes the conditions which exist on lines whose feeding or loading showed dissymmetry with respect to ground and the method is given for removing dissymmetry in practical installation.

Radio Writing, by Peter Dixon. Published by the Century Company.

Those who hope some day to be radio writers here have a chance to get the "inside dope" from a man who has been a successful writer—and the author of the "Raising Junior" series—during the past few years. Mr. Dixon doesn't try to teach radio writing in "ten easy lessons" but he does give a clear picture of the problems of writing for the microphone and the preparation of manuscripts for broadcasting.

Mr. Dixon discusses the methods used to train radio writers, the problem of presenting plays only for the ears, how serials are prepared and how radio plays should be sold. He also discusses how lucrative is the profession and the training period through which one must go to earn more than enough

to just pay for bread and butter. We believe Mr. Dixon covers most of the points of essential importance.

At the end of the book are given the scripts of six successful radio plays including "Skyscraper," "Harbor Lights," "Hank Simmons' Showboat," and "Raising Junior."

Review of Contemporary Periodical Literature

Some Electrical Properties of Foreign and Domestic Micas, and the Effect of Elevated Temperatures on Micas, by A. B. Lewis, E. L. Hall and Frank Caldwell. Bureau of Standards Journal of Research, August, 1931. A number of samples of mica, fairly representative of the major sources of the world's supply of mica, have been tested for dielectric constant, power factor, dielectric strength, and ability to withstand elevated temperatures. The results of these tests are as follows:

For clear ruby muscovite, in the frequency range from 100 to 1,000 k.c., a dielectric constant of 7.2 and a power factor of 0.02 per cent may be expected on the average. Individual samples may be expected to vary on the average from these values by 0.03 in dielectric constant and 0.01 per cent in power factor. The presence of stains or inclusions so seriously affects the power factor as to render such stained micas unsuited for radio use. The power factor of phlogopite is found to be too high for radio purposes.

The dielectric strength of mica is found to be relatively unaffected by the presence of air bubbles, and but slightly affected by the presence of moderate amounts of stains in the form of metallic oxides. Curves showing the average dielectric strength of various classes of mica, as a function of the thickness of the specimen, are given.

With but two exceptions all the micas investigated were unaffected by an exposure to a temperature of 600° C. for 30 minutes. Above that temperature the phlogopites withstood heating better than did the muscovites.

In none of these tests was it possible to make any distinction between the various micas based solely on the geographical origin of the samples.

The Apparent Demodulation of a Weak Station by a Stronger One, by F. M. Colebrook. Experimental Wireless and The Wireless Engineer, England, August, 1931. This article by Mr. Colebrook amplifies an article on the same subject written by Mr. S. Butterworth and published in the November, 1929, issue of this magazine. It deals with the fact that when two modulated radio-frequency currents are impressed upon a rectifier system, such as a detector, the percentage of modulation of the weaker signal is apparently decreased with the result that, even though the detector is linear, the ratio of the desired audio-frequency output to the undesired audio-frequency output is much greater than the ratio of the two modulated input voltages to the detector. This effect is explained by realizing that a strong carrier in effect alters the operating point of the detector with the result that the weaker signal causes the detector grid voltage to vary about this new operating point and not about the operating point determined by the d.c. bias voltage. If the rectification characteristic is substantially straight the larger input voltage may cause the detector to be operated on an essentially straight portion of its characteristic so that the weaker modulated signal cannot produce audio-frequency components in the detector output circuit. Obviously this characteristic of a linear detector is quite important in analyzing the selectivity of a radio receiver.

The Variation of the Resistances and Inter-electrode Capacities of Thermionic Valves with Frequency, by L. Hartshorn. Experimental Wireless and The Wireless Engineer, England, August, 1931. This article considers in detail the variation in tube characteristics, with frequency. It considers, in particular, the effect of the various inter-electrode capacities, the input and output conductances and the manner in which they combine to cause the characteristic of a tube to vary with frequency.

Recent Advances in the Production and Measurement of High Vacua, by Saul Dushman. Journal of the Franklin Institute, June, 1931. This article discusses modern methods of producing high vacuum with particular reference to various types of vacuum pumps. The author points out that present practice indicates it may be regarded as axiomatic that a pump must be capable of exhausting to a pressure of less than 10^{-5} mm. of mercury and preferably as low as 10^{-6} mm. which is equivalent to 10^{-3} microns of mercury. It is interesting to note that even with this comparatively high vacuum the number of molecules at zero degree Centigrade is 3.56×10^{10} per cm., which indicates how far removed this condition is from that of a perfect vacuum.

A Method of Determining the Impedance of Hot-Cathode Discharge Tubes, by W. F. Westendorp. The Review of Scientific Instruments, August, 1931. By means of a superposed alternating current, the negative resistance of hot-cathode neon and mercury direct-current arcs was measured and found to follow closely the slope of the static characteristic of the neon arc and to be widely different in the case of the mercury arc. At the same time the reactance, for the ripple current in the arc, was determined. This reactance is explained on the basis of a time-lag in the concentration of metastable atoms; from the phase shift the order of magnitude of the lifetime of the metastable atom is computed and the result is in agreement with calculations made by others.

A New Noise and Vibration Meter, by K. A. Oplinger. The Electric Journal, August, 1931. This meter is a portable instrument which may be used to compare the intensities of various noises, the noise intensities being measured either in terms of dynes-per-sq.-cm.-pressure on the condenser microphone used as a pickup, or if desired, the noise may be measured in decibel terms. The unit has been designed to give uniform response to the important frequencies in the audible range and this characteristic is satisfactory when comparing noises of similar character. Where it is desired to compare noises which differ widely in frequency it is necessary to "weigh" or evaluate the two noises in terms of the response they produce on the ear. This instrument measures total noise and does not analyze the frequency components which go to make up the sound.

The National Physical Laboratory Report for the Year 1929, published in London. This report covers many branches of science not particularly of interest to the radio engineer, but does include a worth-while chapter on radio and sound. The radio material includes measurements on beam-antenna systems and other directional devices, amplifier characteristics, the problems of current measurement at high frequencies and the measurement of resistance and reactance at radio frequencies. There are also reports on the effect of light on dielectrics, the magnetic properties of iron and other materials, standards of resistance, capacity and inductance, radio-frequency bridges, wavemeters, and other radio apparatus. The reports on sound include data on sound transmission, measurement of absorption co-efficients and sound intensity.

The Ultra-Short-Wave Thermionic-Valve Oscillator, by N. A. Petrov. Westnik Elektrotechniki, Leningrad, January, 1931. The author points out that, with an ultra-short-wave oscillator, the maximum frequency obtainable depends largely upon the constants of the oscillator tube. After much theoretical and experimental investigation, formulas have been derived for the design of a valve suited to ultra-short-wave work. Important considerations are: large separation between the plate and grid leads, fairly coarse grid-mesh, large saturation-current and low operating plate-voltage.

Characteristics of Airplane Antennas for Radio Range-Beacon Reception, by H. Diamond and G. L. Davies. Research Paper No. 313 of the Bureau of Standards. This paper gives the results of a series of investigations on the various types of airplane receiving antennas to determine that type having the most desirable electrical characteristics and at the same time free from mechanical difficulties. The symmetrical transverse and symmetrical longitudinal T-type antennas with vertical lead-ins were found to fulfill the desired requirements.

Practical Electron Transmitters and Receivers, by John N. Dyer. Q S T, September, 1931. This article deals in particular with the Barkhausen-Kurz type oscillator and gives considerable data on how it functions; suitable tubes and circuits, methods of measuring the frequency. Data is also included on suitable antennas, modulation and monitoring.

Increasing the Number of Picture Elements in Television, by E. Kinne. Fernsehen, No. 1, Vol. 2. It is suggested that the number of elements in a television transmission might be increased without increasing the side bands, by decreasing the number of pictures per second and projecting the image on a screen having persistence of illumination. It is suggested that the time of persistence may be as much as one-seventh of a second. The author states that using this method it has been proven by experiment that a small number of pictures per second does not produce bad flicker.

New Types of Storage Batteries, translated by John M. Borst from "La Radio-Industrie" (Belgium), July, 1931. *Nickel-Cadmium storage batteries*: The nickel-cadmium storage battery tends to replace the iron-nickel storage battery in all applications where the device is not subjected to frequent charges and discharges. The nickel-cadmium storage battery, it seems, preserves its charge in a remarkable way—much better than the lead cell.

During the charge, the alkali storage batteries react in the following way at the negative plate:

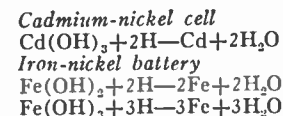

The loss of charge is connected with the oxidation of the iron or cadmium by the water. The iron reacts slightly to the electrolyte in the long run, but the cadmium extremely little; therefore, a charged nickel-cadmium cell can be abandoned for a long time without care, and still retain its charge. This property is obviously very valuable for numerous applications.

The nickel-cadmium cells are less affected by the action of low temperatures; at -15 degrees Centigrade the temporary decrease in capacity does not exceed 25%. The effect of low temperatures on the iron-nickel cell is much more pronounced. The nickel-

(Continued on page 519)

Latest Radio Patents

A description of the outstanding patented inventions on radio, television, acoustics and electronics as they are granted by the United States Patent Office. This information will be found a handy radio reference for inventors, engineers, set designers and production men in establishing the dates of record, as well as describing the important radio inventions

1,816,992. **SOUNDING CONDENSER.** HANS VOGT, Berlin, Germany. Filed Feb. 26, 1929, Serial No. 342,705, and in Germany May 16, 1928. 2 Claims.

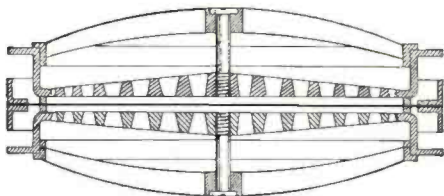

1. A sounding condenser comprising two firmly inter-connected capacity surfaces, a vibratile diaphragm disposed midway between the said two surfaces, and means for causing the said capacity surfaces to bulge in opposed directions with relation to each other so as to form shallow concavities with the diaphragm freely sandwiched there between.

1,817,030. **PIEZO-ELECTRIC FREQUENCY METER.** HEINRICH EBERHARD, Berlin, Germany, assignor to Radio Corporation of America, a Corporation of Delaware. Filed Nov. 2, 1926, Serial No. 145,865, and in Germany Dec. 29, 1925. 7 Claims.

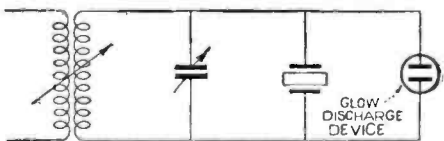

5. In combination, a primary circuit, a secondary circuit, means connected in said secondary circuit to indicate roughly the condition of resonance between said circuits, and means to indicate substantially exactly the condition of resonance between said primary and said secondary circuits.

1,817,177. **SOUND-RECORDING AND SOUND REPRODUCING AND LOCATING APPARATUS.** FRANKLIN M. DOOLITTLE, New Haven, Conn., assignor to Radio Corporation of America, a Corporation of Delaware. Filed June 14, 1921, Serial No. 477,360. 6 Claims.

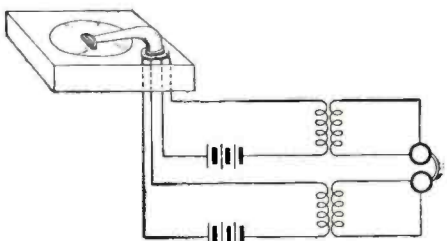

2. The method of sound recording which comprises receiving two time-separated in-

*Patent Attorney, National Press Building, Washington, D. C.

Conducted by
Ben J. Chromy*

dependent trains of like sound energy from the same source, permanently and independently recording each of the two separate sounds, and providing, by the recording, a permanent record in which the time separation of the two records of the same sound is varied in accordance with the arrival of sound from the original sound source with respect to a pair of fixed predetermined points so arranged as to stimulate the binaural effect which would be produced upon the ears of a listener similarly positioned.

1,817,355. **VACUUM TUBE MOUNTING.** HAROLD F. ELLIOTT, Palo Alto, Calif., assignor, by direct and mesne assignments, to Victor Talking Machine Company, Camden, N. J., a Corporation of New Jersey. Filed May 24, 1926. Serial No. 111,296. 5 Claims.

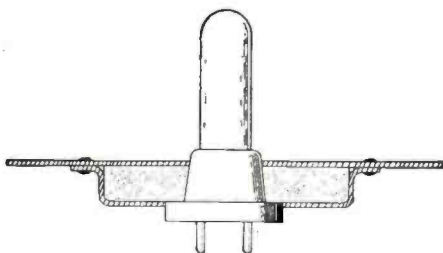

4. In combination, a vacuum tube and socket assembly having an exterior surface concentric with the axis of said assembly, a soft resilient member having a large aperture adapted to engage around said exterior surface and to grip it frictionally, and means for supporting said member.

1,818,760. **PROCESS AND APPARATUS FOR DRAWING ELECTRICAL PICTURES.** PAUL SELENYI, Budapest, Hungary, assignor to Egyesult Izzolampa es Villamossagi Reszventarsasag, Ujpest, Hungary, a Corporation. Filed Jan. 18, 1929. Serial No. 333,462, and in Hungary and Austria Feb. 1, 1928. 10 Claims.

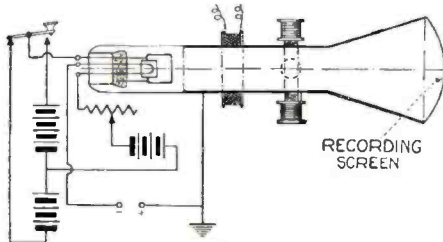

1. A process for registering and permanently recording phenomena transformed into varying electrical forces, by means of cathode rays produced in a cathode ray tube, comprising producing, intensifying and focussing said cathode rays in a vacuum, inter-

cepting said cathode rays by an electrical insulating medium, changing the form and intensity of the cathode rays corresponding to said electrical forces and retaining on said medium the charges imparted to it by said differentiated cathode rays by means of charged particles distributed on said insulating medium.

1,817,612. **SOUND REPRODUCING SYSTEM.** PALMER HUNT CRAIG, Cincinnati, Ohio, assignor to Invex Corporation, a Corporation of New York. Filed July 11, 1928. Serial No. 291,910. 9 Claims.

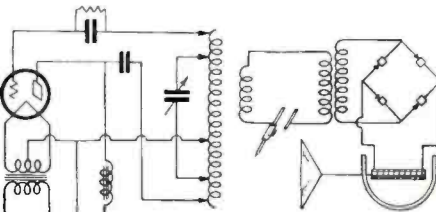

1. A sound reproducing system comprising a source of current constant super-audible frequency and of sufficient energy to operate a loud-speaker, a sound record, means for modulating said current in accordance with the record, and means for rectifying said modulated current and operating said loud-speaker solely by the energy of said modulated current.

1,818,157. **RADIO RECEIVING CIRCUITS.** MAURICE M. PHILLIPS, Pittsburgh, Pa. Filed Apr. 17, 1929. Serial No. 355,949. 4 Claims.

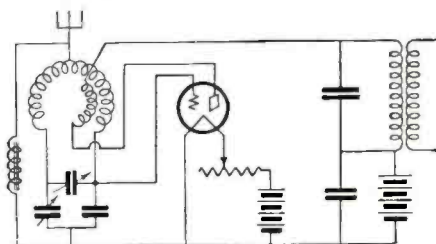

1. In a radio receiving circuit, an oscillator detector tube having a cathode, a grid and a plate, a neutralized inductance in the grid circuit of the tube, an antenna connected to the midpoint of said inductance, and a shunt circuit connecting the midpoint of the inductance and the cathode of the tube and having a radio frequency choke therein.

1,818,363. **INDUCTANCE SYSTEM.** ARTHUR M. TROGNER, East Orange, N. J., assignor to Wired Radio, Inc., New York, N. Y., a Corporation of Delaware. Filed Jan. 25, 1929. Serial No. 335,110. 5 Claims.

1. In an inductance system, a plurality of helical single layer inductor elements, a rotatable frame provided with a plurality of supporting arms, each of said arms carrying one of said inductor elements, inductor connectors attached to each of said inductor

elements at separate points thereof, a plurality of stationary contactors, and supporting rods for carrying said stationary contactors, said stationary contactors being adapted and positioned to engage said inductor connectors as said frame is rotated, whereby the inductance connected between said stationary contactors may be varied.

1,818,854. DIAPHRAGM FOR LOUD SPEAKERS. WILLIAM K. KEARSLEY, Schenectady, N. Y., assignor to General Electric Company, a Corporation of New York. Filed Oct. 1, 1926. Serial No. 138,982. 5 Claims.

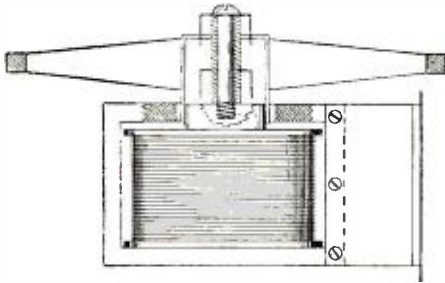

1. A diaphragm comprising a hollow cylindrical member and a series of hollow tubular members radially mounted thereon forming thereby a substantially continuous surface.

1,818,006. METHOD OF MAKING AND PLAYING PHONOGRAPH OR SOUND RECORDS. HEINRICH OHLIGEN, Breslau, Germany. Filed Apr. 2, 1928. Serial No. 266,747, and in Germany Apr. 6, 1927. 2 Claims.

1. A method for eliminating intraneous noises from the reproduction of sounds on talking machines, consisting in the production of the record at a higher tone volume so that the softest piano of the composition rendered is louder than the intraneous noises, and in damping the volume of sound when producing a second record so that the intraneous noises become inaudible.

1,818,585. HIGH SPEED TELEGRAPHY SYSTEM. FRITZ SCHROTER, Berlin, Germany, assignor to Telefunken Gesellschaft Für Drahtlose Telegraphie m. b. H., Berlin, Germany, a Corporation of Germany. Filed June 11, 1929. Serial No. 370,092, and in Germany June 8, 1928. 14 Claims.

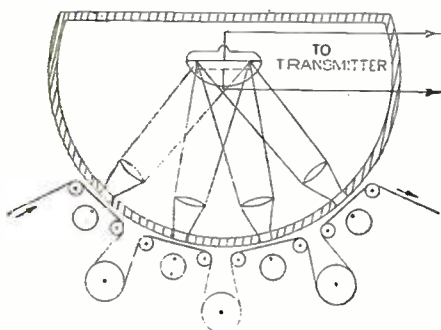

1. In a high speed telegraphy system, the method of transmission which comprises repeatedly transmitting each element of each signal at time-separated intervals, and receiving and independently recording as received each signal to produce the sum total of the separately transmitted impulses for each of the transmitted elements.

1,819,508. COMMUNICATION BY FREQUENCY VARIATION. CLARENCE W. HANSELL, Rocky Point, N. Y., assignor to Radio Corporation of America, a Corporation of Delaware. Filed Aug. 11, 1927. Serial No. 212,192. 26 Claims.

2. The method of transmitting multiple signals by frequency variation which in-

cludes signalling on each of a plurality of different relatively low frequency energies, adding the signal energies, and using the resultant complex wave to frequency modulate transmission energy according to a linear characteristic.

16. A multiple transmission system comprising a single side band transmitter, a source of intermediate frequency for modulating the transmitter carrier energy, a plurality of sources of energy of different relatively low frequencies, means to add the low frequency energies to obtain their resultant, means for frequency modulating the intermediate frequency energy in response to the resultant, and signalling means for separately signalling on each of the low frequency energies.

1,819,299. TUNING SYSTEM. JOHN M. MILLER, Philadelphia, Pa., assignor to Atwater Kent Manufacturing Company, Philadelphia, Pa., a Corporation of Pennsylvania. Filed July 3, 1930. Serial No. 465,603. 20 Claims.

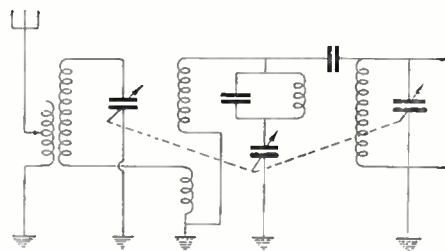

1. A method of tuning to oscillations of various frequencies with additional discrimination against oscillations whose frequencies differ to a substantially fixed extent from said first-named frequencies, which comprises arranging inductive and capacitive reactances effecting a loop tunable to the oscillations of desired frequency, impressing upon a translating device a difference of potential related to the potential difference existing between a terminal of said loop and a point which divides one of said reactances into components one of which is in series with the other of said reactances, and varying only said other of said reactances to tune said loop to desired frequency and to bring into substantial resonance with the undesired frequency said variable reactance and said component of said one of said reactances.

1,819,845. THERMIONIC AMPLIFIER AND OSCILLATION GENERATOR. HENRY JOSEPH ROUND, London, England, assignor to Radio Corporation of America, a Corporation of Delaware. Filed July 19, 1926. Serial No. 123,360, and in Great Britain July 20, 1925. 6 Claims.

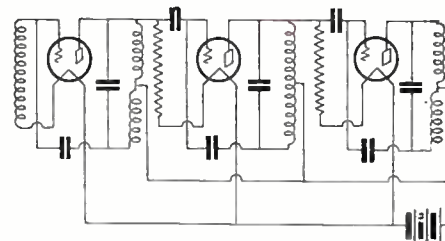

1. In an impedance resistance coupled cascade relay having a vacuum tube in each stage thereof, means for coupling the vacuum tubes of the several stages including an inductance between adjacent stages composed of two portions, one of which is in the output circuit of the preceding tube, alternating ones of said inductances being astatic to prevent electromagnetic coupling between said stages and means in each stage providing a path for neutralizing the inherent feed back between the output and input circuits of each stage.

820,004. AERIAL NAVIGATION SYSTEM AND METHOD. GEOFFREY GOTTLIEB KRUESI, Palo Alto, Calif., assignor to Federal Telegraph Company, San Francisco, Calif., a Corporation of California. Filed June 12, 1928. Serial No. 284,864. 9 Claims.

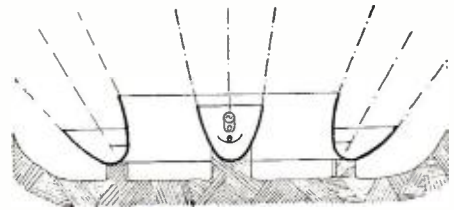

9. In a radio system, a wave reflector formed as a surface of revolution and having a circular focal line, and a circular shaped antenna conductor substantially coincident with said focal line.

1,819,054. CARRIER SIGNALING SYSTEM. HERMAN A. AFFEL, Ridgewood, N. J., assignor to American Telephone and Telegraph Company, a Corporation of New York. Filed May 24, 1927. Serial No. 193,902. 11 Claims.

1. The method of transmission which consists in distorting the signal wave in order to obtain approximately the same level for all frequencies within said wave and introducing a compensating distortion at the receiving end.

1,820,059. RADIO APPARATUS. VINCENT J. FARIAN, Washington, D. C. Filed Feb. 19, 1926. Serial No. 89,471. 6 Claims.

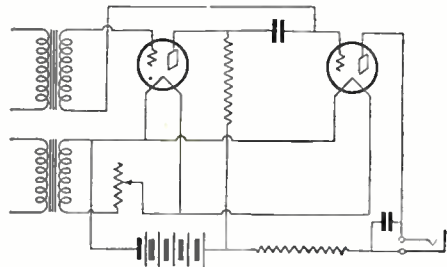

1. The herein-described method of amplifying signal energies introduced into an amplifier including a plurality of audions, which includes the steps of simultaneously impulsing a signal upon the audions, amplifying this signal in one of the audions, then combining the original signal present in the second audion with the amplified signal, amplifying the combined signal, and outputting the resulting signal.

1,820,114. VACUUM TUBE RECTIFIER. KNOX CHARLTON BLACK, Boonton, N. J., assignor, by mesne assignments, to Radio Corporation of America, New York, N. Y., a Corporation of Delaware. Filed Apr. 21, 1930. Serial No. 446,096. 6 Claims.

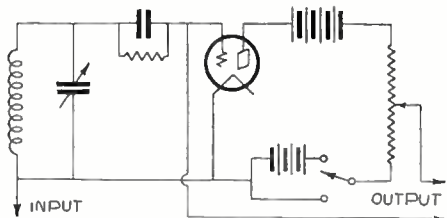

1. In the operation of a vacuum tube rectifier stage having in the input circuit thereof a condenser shunted by a grid leak, the method which comprises combining in the output circuit the rectified potential across said condenser and a rectified voltage developed in the plate-cathode circuit by grid circuit rectification.

(Continued on page 541)

Backstage in Broadcasting

Chatty bits of news on what is happening before the microphone. Personal interviews with broadcast artists and executives. Trends and developments in studio technique

TWO of the most recent network sensations are Russ Columbo and Bing Crosby. Both are baritones and are said to have the sort of microphone personality that swept Rudy Vallee to fame. The NBC got Columbo at about the same time the CBS acquired Crosby. Officials of both chains saw great possibilities for their respective ether charmers and, true to their predictions, Columbo and Crosby soared to stellar positions in no time at all. Both have had previous radio experience—but their present connections are their first opportunities on coast-to-coast networks. The soft quality of Columbo's voice created a following for him in Los Angeles and throughout the Pacific coast. In 1927, while appearing as violinist and vocalist with a small Los



Russ Columbo

the radio qualities of his voice.

The story of Crosby's attachment to Columbia is a bit more dramatic. William S. Paley sailed for Europe to scout for foreign radio talent. The third day out he heard a phonograph in an adjacent stateroom playing "I Surrender, Dear," with Crosby doing the vocal refrain. Paley, according to our CBS informant, immediately surrendered. Like Columbo, Crosby also was in Los Angeles. As soon as Paley returned to New York, he got Crosby on the telephone and the baritone hied Eastward for a lucrative Columbia contract. He started singing professionally while studying at a Seattle college. Since 1926, he has appeared in theatres throughout the United States, Canada and Mexico. He has made numerous recordings, talking shorts and did some West Coast radio work before his big "break" on the CBS—a "break" for CBS as well as himself, as was soon demonstrated.



By
Samuel Kaufman

THE advertising agency's place in broadcasting is an important one today. It is the agency that considers the continuity, the talent, the outlets and the entire program policy of the series of its client. The commercial program—as severely as it may be criticized—is the backbone of all American broadcasting. And the agency's radio department—properly operated—is the structural force behind the commercial program.

Leading agencies have for some time been operating radio departments that vied in personnel and activity with many of our larger broadcasting stations. Large continuity, program and production staffs were modeled after the staffs of stations. Agencies even employ their own talent and announcers for the radio offerings of clients. Now, for what is believed to be the first time, an agency is operating its own radio studio. The advertising agency radio studio is the idea of N. W. Ayer & Son, Inc. The agency's headquarters are in Philadelphia but the entire

radio department is located in the new skyscraper building at 500 Fifth Avenue, New York. It is here that the completely equipped broadcasting studio and control room is located.

The studio, of medium size, is as completely equipped as any network broadcasting studio. It was primarily built for auditions. The presentations may be "piped" into the conference rooms throughout the three floors the agency occupies in the building. The use of the studio in these instances provides for greater privacy than if an outside studio were leased for the purpose. The control room is so equipped that the presentations in the studio can be routed to any broadcasting station or network. Also, provision is made for long-distance auditions by having the studio presentation sent over leased wires to a client in another city for approval.

The control room is completely equipped with Western Electric control and amplifying equipment. Provision is also made for the testing of electrical transcriptions through the amplifying system.

Douglas Coulter is vice-president of the firm, in charge of radio production, while H. L. Hodgson is vice-president in charge of business operations for radio. The interest of the Ayer agency in radio broadcasting dates back to the Eveready Hour of the National Carbon Company which went on the air in 1923 when Station WEAJ, then owned by the American Telephone and Telegraph Company, was the first to open its facilities to commercially-sponsored programs.

The new Ayer offices also include a talking motion-picture projection room.

EVERY now and then some incident occurs which shows the sharpness of the rivalry between the NBC and the CBS. The switching of commercial programs from one chain to the other has become a commonplace and is no longer regarded as a chief source
(Continued on page 523)



Bing Crosby

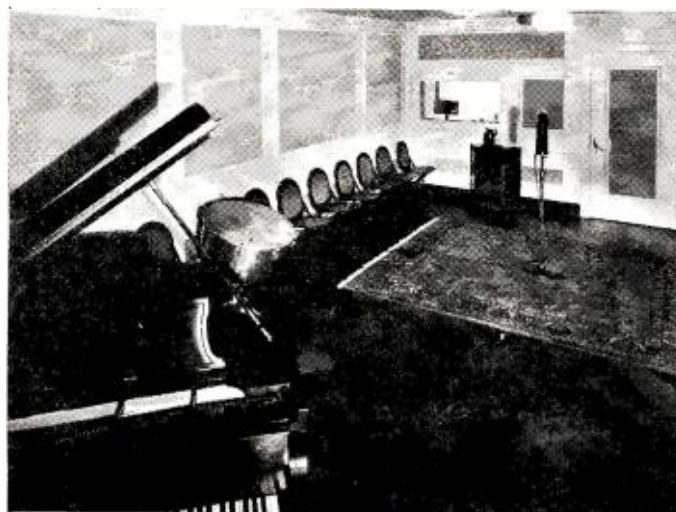

NEW N. W. AYER STUDIO

What's New in Radio

A department devoted to the description of the latest developments in radio equipment. Radio servicemen, experimenters, dealers and set builders will find these items of service in conducting their work

All-Wave Receiver

Description—A combination broadcast and short-wave set mounted on the one chassis. Plug-in coils are eliminated in favor of a switching arrangement by means of which reception on the low wave band of 20 to 200 meters, or the regular broadcast band of 200 to 600 meters, is controlled by a sin-



gle knob mounted on the front panel. The vacuum tubes are as follows: two -35 type, three -24 type, one -27 type, one type -47 Pentode, and one type -80 rectifier tube. The receiver chassis with dynamic speaker is housed in a walnut finished cabinet measuring 16½ inches by 14 inches by 9¾ inches.

Maker—International All-Wave Radio Corp., Ann Arbor, Michigan.

Portable Oscillator

Description—The model 590 oscillator has an intermediate-frequency range of 110 to 200 kilocycles and a range of 550 to 1500 k.c., for the broadcast band. Frequencies between 200 and 500 k.c. and above 1500 k.c. can be obtained by means of harmonics. The grid-dip millimeter mounted on the



panel also serves as a filament and plate voltmeter. Push-button switches are utilized to connect this meter in the latter two circuits. The instrument employs the two type -30 tubes. It is enclosed in a portable carrying case measuring 16¼ inches by 6¾ inches by 5¾ inches and weighs 15 pounds.

Maker—Weston Electrical Inst. Corp., Newark, New Jersey.

Condenser Transmitter

Description—The new type "D" transmitter and amplifier features the development of a new chassis with improved voltage characteristics. The output level of this instrument is approximately minus 30 db. The

Conducted by The Technical Staff

amplifier, which employs a -12A type tube, is easily withdrawn from the instrument case for inspection. A twenty-foot cable connector terminating in a multiple plug and a



brown bakelite flush plate for baseboard or battery box mounting are included with the equipment.

Maker—Jenkins & Adair, Inc., 3333 Belmont Avenue, Chicago, Illinois.

Oscillator

Description—The portable "Acrocycle" oscillator featuring a direct reading scale produces fundamental frequencies from 115 to 280 kilocycles and harmonics from 230 to 1680 kilocycles. The instrument utilizes one



-30 type tube. The leatherette covered wooden carrying case for the instrument measures 12½ inches by 7 inches by 6 inches, provides space for carrying an output meter.

Maker—J.M.P. Mfg. Co., 3418 Fond Du Lac Avenue, Milwaukee, Wis.

Universal Receiver

Description—Here is a midget type five tube receiver with a wavelength range of 200 to 2000 meters. It has three tuned circuits and utilizes a pentode tube. A single switch changes the tuning range of 200 to 550 meters to the higher wavelengths of 500 to 2000 meters. The receiver is available



with or without clock feature for the following lighting supplies: 110 volt, 50-60 cycle a.c., 220 volt a.c. and 110 and 220 volt d.c.

Maker—Automatic Radio Mfg. Co., Inc., 842 Park Square Bldg., Boston, Mass.

Convenient Cable Assembly

Description—The new "Tennacord" is a ten-foot cable containing the antenna, a.c. supply wires and a woven copper shield around the latter to serve as the "ground" conductor. The insulated antenna lead is continued on from the cable for an approximate total length of 25 feet and can be attached along the baseboard, or other convenient place for use as an indoor aerial, or

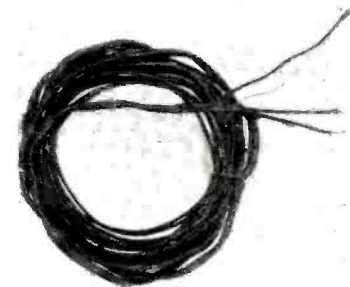

if desired it can be connected to the outside aerial. A lead from the copper shield, which encases the a.c. supply wires, is the ground for the receiver and is connected to the frame or ground terminal of the set, the other end is left free, the "ground" being effected by the high capacity between the shield and the a.c. line. The a.c. wires are connected in the usual way.

Maker—The Holyoke Company, Inc., 621 Broadway, New York City.

Motor Car Generator

Description—The Uppco a.c.-d.c. generator meets a real requirement for the operation of 60 cycle a.c. receivers and sound amplifying systems in automobile radio in-

stallations. It is capable of maintaining 110 volts at variable car speeds. The following models are available in different wattage ratings: model A, 100 watts; model B, 150

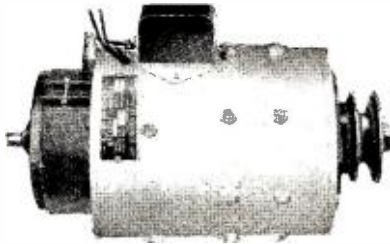

watts; model C, 300 watts. All units supply six volts d.c. for motor car battery charging.

Makers—Upp Electric Company, 303 Westport Avenue, Kansas City, Mo.

Mica Transmitting Condenser Units

Description—These condensers are encased in an isolantite tube, fitted with a cast metal top and bottom, which are the condenser terminals. This type of construction provides maximum insulation between terminals and permits the units to be stacked, thus automatically connecting them in series, for high-voltage condenser requirements encountered in transmitting and carrier current applications. The units are available in a wide



range of capacities and in a.c. voltage ratings up to 50,000 volts.

Maker—Dubilier Condenser Corp., 4377 Bronx Blvd., New York.

Portable Talking Picture Machine

Description—This portable 16 mm. "Talki-ola" machine is designed for use in clubs, schools and wherever talking moving picture equipment is desired. It can play either standard or 16-inch talking picture records. The audio-amplifier employs one screen-grid tube in the first stage and two -45 tubes in the push-pull power output stage. An -80 type tube is used for rectification. Provi-

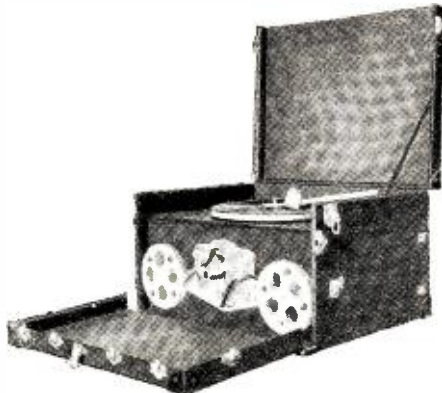

sion is made for the use of a microphone for public address work. The equipment, which includes a transparent screen, is enclosed in a leather finished case measuring 28 inches, by 18 inches by 14 inches. It weighs 80



SOMETHING NEW IN TUNING DIALS

pounds.

Makers—Talki-ola Corporation, 1600 Broadway, New York City.

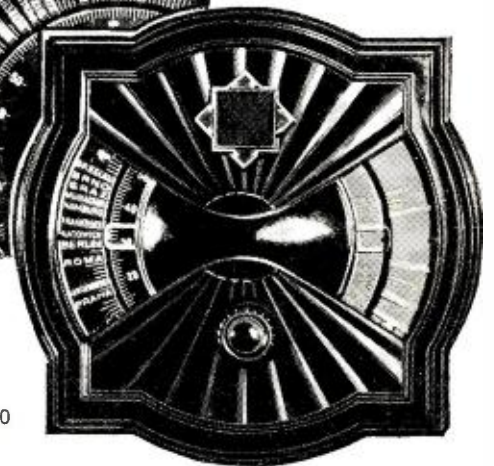

A German inventor developed the tuning dial shown in the illustration. It contains removable station plates easily attached or removed for substitution of wavelength or station name. The dial has two reading windows; at the left is a waveband of 200-600 meters; at the right the higher band of 1000-2000 meters.

Television Kit

Description—Here is a complete outfit for building a television receiver. The "Telescanner" kit shown in one of the accompanying illustrations contains all the necessary parts, which includes a Neon tube and lens, for its construction. The other kit includes the parts for the short-wave televi-



sion receiver. The tubes used in this set are as follows: 4 type -24 tubes, 1 type -27 tube, 1 pentode tube and a type -80 recti-

Maker—Freed Television & Radio Corp., 22 Wilbur Ave., Long Island City, N. Y.

Transmitting Condenser

Description—A low-power transmitting mica condenser of British make, capable of passing five amperes at 15 to 150 meters and rated for 1000 volts d.c. The .002 mfd. condenser shown here is contained in a sturdy bakelite case measuring only 2 3/8 inches in height by 2 1/8 inches in width. This type condenser is available in other values and with different limiting ratings.



Maker—The Telegraph Condenser Co., Ltd., North Acton, London, England.



fier tube. Complete instructions are included in both kits.

Rugged Rectifier Units

Description—A heavy-duty metallic rectifier which employs no moving parts. When used with a suitable step-down power transformer, these rectifiers are capable of providing a constant d.c. output up to 6 amperes or an intermittent amperage of 8 amperes. These currents are obtainable at ratings of either 6 or 7 volts d.c. Other types of rectifiers are available to provide up to 8 amperes at 8, 10 or 12 volts. These units should find numerous application in the field of radio, talking-movie equipment, (Continued on page 535)

News and Comment

A page for the news of the whole radio industry, including important trade developments, new patent situations, comments by leading radio executives, notes, rumors and opinions

New "Arctic" Programs

PITTSBURGH—The Far North broadcasts of Westinghouse Radio Station KDKA at Pittsburgh which have brought thousands of messages of cheer from home to explorers and others in the distant icy wastes have met with such success that the services are being enlarged upon and Westinghouse Stations WBZ, Springfield, and WBZA, Boston, inaugurate a mid-week broadcast.

During the eight years that KDKA has been sending these messages they have brought cheer and comfort to the members of the "Richard E. Byrd Expedition" with base established at Little America, Antarctic, "Dr. Herbert Spencer Dickey and His Orinoco Expedition" during their scientific investigation and discovery of the source of the Orinoco River, and the "Matto Grosso Expedition" in Southwestern Brazil, engaged in the making of sound motion pictures of animals and natives of that section, and to "Captain Bob Bartlett and His Expedition" on the Greenland seas, "The Dr. Sutton Expedition" in the Far North, as well as hosts of others from the outposts of civilization in the Arctic and Antarctic Zones.

Modern Radio Never Obsolete

MARION, IND.—The radio industry has reached a point in its development where the radio fan need have no fear that the radio set purchased today may become obsolete tomorrow due to possible radical changes, it is asserted by J. Clarke Coit, president of the U. S. Radio & Television Corporation, manufacturers of U. S. Apex and Gloritone receivers.

In answer to the question of when the "radio industry is going to settle down like other substantial industries," Mr. Coit stated that no progressive industry ever settles down.

"It is true," he said, "that the radio industry is still suffering from growing pains, for it reached gigantic stature in a comparatively short time. It is estimated that approximately \$3,000,000,000 is invested in radio, and it is attracting more investment capital all the time."

Amperite Head Retires

NEW YORK—Meyer N. Leibowitz, widely known in the radio world as the man who put the word "Amperite" in the radio dictionary, has announced his retirement as president and general manager of the Amperite Corporation.

Radio Equipped Ambulance

WASHINGTON, D. C.—Radio-equipped ambulance, designed to operate with the police station to minimize delay in receiving news of accidents, has been placed in service by Casualty Hospital, here.

Radio Versus Crime

NEW YORK—New York City's Police Department has been authorized to spend \$100,000 with which to equip all squad cars, police launches and the force's two police airplanes with radios. Although it has one long-wave radio station for its harbor police, New York City has never radioized the rest of its force, as have some 50 other American cities.

Reported by

Ray Kelly

New Film Organization

NEW YORK—George Hoppert, formerly advertising manager of the Pacent Electric Company and Pacent Reproducer Corporation, has resigned to assume his new responsibilities as vice-president of International 16mm Pictures, Inc., a newly-formed organization with offices on the tenth floor of the Film Center Building, 630 Ninth Avenue, New York.

International 16mm Pictures, Inc., of which Rudolph Mayer, brother of Louis B. Mayer of M-G-M, is president, was established just recently for the purpose of arranging the release of suitable talking-picture subjects for home, commercial and industrial use. The new company, it is stated, will open approximately 150 exchanges throughout the country, through which will be released, talking and sound films from the libraries of fourteen leading film producers with whom the company is said to have an understanding.

Common Metal Stops "Sputtering"

BOSTON—"Sputtering" is usually associated with a stout old gentleman who has lost his temper to the point where he can say no word, but merely, well "sputter." It may seem a long cry from a sputtering old gentleman to Television but this mechanically calm and young art is addicted to sputtering at times, too.

It is all based on the neon lamps used in reproducing Television pictures. Metals working in gases such as neon, tend to throw off minute particles of themselves which blend with the gases, states Hollis Baird, chief engineer of the Shortwave and Television Corporation. In the Television or neon tube this is the plate. The ultimate result is that the pictures grow dimmer and dimmer since the impedance of the tube goes up as the metal goes off and then the glass darkens as well.

This drawback has seemed to have been pretty well solved by the discovery of metals that had a very small sputtering characteristic such as aluminum, tungsten and tantalum. However, tungsten and tantalum are too expensive for general use and aluminum is too soft.

These metals have practically no sputtering characteristics. Copper, gold, silver, lead, etc., have a sputtering factor of from 75 to 100 times as much as these other metals making their use impossible. Strangely enough, the best solution has been the use of our plain old friend, common iron. Iron has but five times the sputtering characteristic of the good metals compared with the 75 and 100 of the other metals named above.

Discovery of these facts is now permitting the design of lamps for Television which have a long life and which give a steady light during this long period, lamps which need not be too expensive to make. Thus in solving the "sputtering" problem, better pictures are assured.

New Radio Correspondence Course

NEW ROCHELLE, N. Y.—Radio Training Schools, which maintains a resident school in Boston, will shortly offer correspondence courses in various branches of radio. R. L. Duncan, president of Radio Training Schools, is busily engaged in the preparation of the material. His long experience in the radio teaching field, as founder and head of one of the largest such schools in the country until his recent resignation in order to establish an independent school cooperating with, but in no way fettered by, commercial radio concerns, will permit Mr. Duncan to incorporate in his courses various methods and principles whose value he has been able to test through experience but full advantage of which could not be taken until now.

Private Ownership Expands

WASHINGTON, D. C.—Most of the countries of Latin-America and seven countries of Europe are following the American-Canadian plan of licensing private citizens or organizations to operate radio broadcasting stations. Only a handful of countries of the world, however, fail to exact a license fee for the right to own and operate radio sets.

That government operation of the radio is not as widespread as the public has been led to believe is revealed in a new digest of foreign radio broadcasting and receiving requirements just issued by the U. S. Department of Commerce. It was compiled by Lawrence D. Batson of the Electrical Equipment Division as a supplement to his biennial survey of radio markets of the world.

The Batson report reveals that private enterprise conducts broadcasting not only in the United States and Canada, but in Mexico, Cuba, Costa Rica, Honduras, Argentina, British Guiana, Chile, Colombia, Uruguay and Venezuela. Only in the Dominican Republic, Haiti and Peru does the government own and operate the radio. In Brazil a radio club has the concession, while in Bolivia there is a semi-governmental monopoly.

In Europe private enterprise rules in France, Holland, Belgium, Spain, Portugal, Finland and Estonia. Government bureaus operate the systems in Russia, Latvia, Lithuania, Denmark and Danzig. Monopolies and concessions, with the government usually retaining complete or partial control over programs, are the rule in England, Germany, Austria, Czechoslovakia, Greece, Hungary, Italy, Luxemburg, Norway, Poland, Rumania, Sweden, Switzerland, Turkey and Yugoslavia.

In Asia, the governments generally own and operate radio stations, although citizen operation is permitted in China, the Dutch East Indies and the Philippines. In Australia and New Zealand, the high-powered stations are in the hands of a government monopoly and the low-powered stations are operated by citizens. In the countries of Africa that have radio stations, government ownership and monopolies are the general rule, although citizens are licensed in French Morocco, Tunisia and the Canary Islands.

(Continued on page 539)

“For 16 Weeks



I enjoyed every broadcast from

VK3ME

MELBOURNE, AUSTRALIA”

This is not a “freak” record. Hundreds of other Scott All-Wave Receivers—all summer long—have brought their owners loud, clear, perfect music and song from the other side of the world.

EVERY now and then, the story of some phenomenal instance of extremely long distance radio reception breaks into the press. DX fans usually find little interest in such stories because they know the performance which they relate is invariably due to “freak” conditions.

But DX fans KNOW, when my receiver brings in every broadcast from VK3ME for 16 consecutive weeks, that full credit must go to the receiver that did the work. And when they learn that hundreds of other receivers exactly like mine, and located in all parts of the world, are piling up equally sensational records, they are well satisfied that the Scott All-Wave is not only the most powerful, most sensitive receiver possible to obtain, but the one receiver that fulfills their lifelong hopes.

Undeniable Proof

Away last spring I made up my mind to eclipse all standards of radio reception—distance—power—selectivity and tone. I believed the Scott All-Wave would do it, so I set out to make a day-to-day log of VK3ME, Melbourne, 9560 miles away from my receiver. I tuned in every broadcast, on the loud speaker, and to prove to the entire world that I heard every VK3ME program with full volume, and with perfect tone and clarity, I made a disc recording of every broadcast! Half of these records I sent to VK3ME. The others are at my laboratory and will be played for anybody who asks to hear them.

Not a Special Set

The Scott All-Wave Receiver that you may buy, will in no way, differ from the one I used in my 16-week test. It will be identical to the hundreds of other Scott All-Wave Receivers that tune in voice from England, France, Germany, Italy, Japan, Indo-China, and South America every day in the week—summer and win-

E. H. SCOTT RADIO LABORATORIES, Inc. (Formerly Scott Transformer Co.)
4450 Ravenswood Avenue - Dept. N12 - Chicago, Illinois

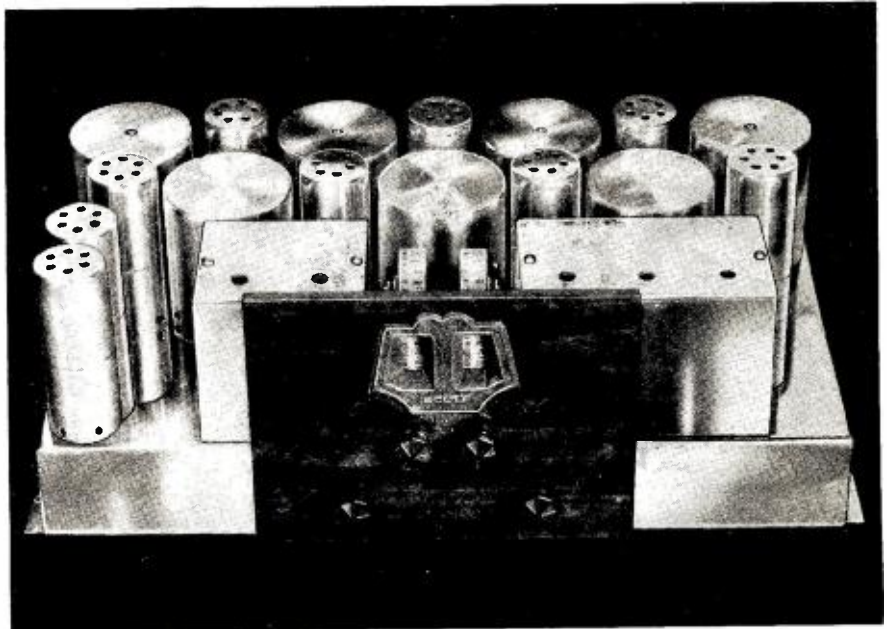

ter. The set that I will send to you will actually be tested on reception from G5SW, Chelmsford, England, or 12RO, Rome, Italy, before shipping!

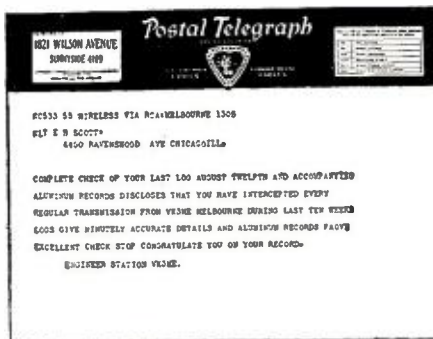

This cablegram verifies the first 10 weeks' reception. To date there has not been time for my log of the last 6 weeks to reach Melbourne.

Another Challenge

Again, I challenge the whole world of radio to any kind of competitive test, between 15 and 550 meters. I guarantee that the Scott All-Wave will bring in the most stations between 15 and 550 meters—that the Scott All-Wave will leave no doubt as to superior tone quality—and that it will give actual 10 kilocycle selectivity over the Broadcast Band.

Clip the coupon—mail it today for full particulars. You'll be amazed when you see how little it costs to own a Scott All-Wave Superheterodyne.

E. H. Scott

CLIP-----

E. H. SCOTT RADIO LABORATORIES, Inc.
(Formerly Scott Transformer Co.)
4450 Ravenswood Ave., Dept. N12, Chicago, Ill.

Send me full particulars of the Scott All-Wave Receiver.

Name.....

Street.....

Town..... State.....

The SCOTT ALL-WAVE

15-550 METER SUPERHETERODYNE

MODERNIZE WITH **AEROVOX** HI-FARAD DRY ELECTROLYTIC CONDENSERS



Every up-to-date radio set, television outfit or any other form of radio apparatus which requires high capacity filter or bypass condensers merits Aerovox Hi-Farad DRY Electrolytic Condensers. They are DRY, compact, light in weight, safe, surge-proof, self-healing, low in cost per microfarad per voltage rating (500 volts peak), low in leakage, provide long life, stable operation and high filtering efficiency.

AN AEROVOX CONDENSER OR RESISTOR FOR EVERY PURPOSE

The Aerovox line includes the most complete variety of fixed condensers and resistors for every radio requirement.

Send for Catalog

Complete specifications of all Aerovox units, including insulation specifications of condensers, current-carrying capacities of resistors, and all physical dimensions, electrical characteristics and list prices of condensers and resistors, are contained in our 40-page catalog which will gladly be sent on request.



The Aerovox Research Worker is a free monthly publication issued to keep radio engineers, experimenters and servicemen abreast of the latest developments in receiver and power supply design, and especially with the proper use of condensers and resistors. A request on the coupon below will place your name on the mailing list.

AEROVOX WIRELESS CORP.

78 Washington St., Brooklyn, N. Y.

Check and Mail This Coupon

AEROVOX WIRELESS CORP. Radio News
78 Washington Street Dec., 1931
Brooklyn, N. Y.

Gentlemen:

Please send me without charge or obligation:
() Your 40-page Condenser and Resistor Manual and Catalog.
() The Research Worker.

Name.....

Street.....

City..... State.....

Radio in the African Jungle

(Continued from page 461)

of the antenna I used was about 65 feet long, and the feeders about 38, tuned in series for 20-meter work, and in parallel for 40 meters.

In general, there was little difference in effect, owing to the height of the receiving antenna. Slightly louder signals resulted from raising the antenna, but this also brought an increase in noise. On the whole, an average height of about fifteen and a length of sixty feet was used for reception quite satisfactorily.

Neither the regulation set-up nor the amateur wavelength bands were varied in the trip. The transmitter is a tuned-plate, tuned-grid type and has functioned without a hitch the whole way through. It has stood a tremendous amount of punishment, both as to the rigorous climate of this country and the rough handling it has undergone—and it hasn't missed a shot. Not the least of its trials was trans-shipment over ocean freight lines, during which stormy handling some of the cases were damaged and the contents broken.

My one regret is that there was not time enough for more extensive experimenting in DX. Naturally, we tried hardest to hook up with some of the United States stations, and considering the limited time available had good success. The Nairobi schedule claimed most of the available spare time, but by squeezing in an odd hour here and there some good contacts were managed.

The greatest individual help during the entire trip was furnished me by W1MK, the official station of the Amateur Radio Relay League, in Hartford, Connecticut. They not only kept after me for the long weeks before any contact was made, but also kept other stations throughout the country on the lookout for our signals. Chief Operator Parmenter deserves a medal for his untiring efforts.

I would like to thank the amateurs who were on the lookout for our station call, FK63R.

As mentioned, I was kept from trying stunts because of lack of time. The messages handled on the Nairobi schedule were all of a necessary nature.

One member of our troupe had misplaced his wife, or rather, did not know in what part of the United States to write to her, as she was visiting, but we were able to reach her by radio. Harry Carey received news of the consummation of a big business deal over our radio. There were times when radio facilitated the movement of supplies to us when we were making unexpected moves or unexpected extended stays.

On one occasion it was easier for the director to communicate with his business manager, by way of radio to the United States, cable, and a telegram to a point in the Uganda Protectorate, Africa, than in any other way, though they were separated by less than 75 miles of country.

Wireless on the safari had a great deal to do with the upkeep of the company morale, although there was practically none of the general entertainment angle about it, although I often did, in cooperation with the sound-recording crew, rig

up a loudspeaker through the amplifying devices, and we had programs including football games, the announcement that Aloysius Horn was broadcasting at Palisades Park, New Jersey, and jazz programs which were quite tame compared to the native African dance music going on in our camp.

For a time an advance party of ours was thought lost, as I had not transmitted for ten days, being on forced marches, but I happened to call Nairobi, and this saved them from sending a search party which was still being organized. At another time, Harry Carey was suffering from fever and a complication of digestive troubles, which I described over the radio. Detailed medical instructions were received—and Carey was soon cured!

Duncan Renaldo had two ribs broken by a stroke from an elephant's trunk, when he was hunting, and I sent this news and other such matters of interest out to Nairobi. Also Miss Edwina Booth suffered a sort of sunstroke, and fell from a tree while Harry Carey and Renaldo were under it chasing away a lion with clubs. Her costume, as required by the picture, was indeed scant, and she was overcome by the heat of the scorching sun on her body.

Talks with Byrd

My best and perhaps most curious performance was not official, but grew out of the visit of an American oil operator and the Governor of Uganda to one of our camps. This oil man was the father of one of the men on Commander Byrd's expedition to the South Pole. Through the A. R. R. League, mentioned above, I radioed to the South Pole and asked about the young man's health, and received an answer that he was okay, which we delivered to his grateful father in Africa.

At one time production was held up because the company was looking for a certain poisonous African spider needed in the story. In gossiping with Nairobi I obtained over the air a description of how the spider might be found, and through this message we shortly located one. From this radio hint, we named the tarantula the "African radio bug."

Amusing incidents occurred from time to time. I have had to guard my precious antenna wire from native tribes, especially the Kavirondos, for they wind copper wire around and around their ankles and arms for ornaments, some women wearing ten or twelve pounds of the metal for a lifetime, and the men wear copper ornaments as well.

I have had monkeys, both a wild band and a tame red colubus and a baboon, playing antics on my antennas from time to time.

The natives regarded the humming of my plant as some sort of magic in remote districts, as indeed they considered everything strange about our motion-picture outfit.

I tried repeatedly to explain to some of our native helpers that I was talking to
(Continued on page 512)



The Top of the World is our "Proving Ground"

The arctic is hardly the ideal place to test radio equipment. Severe magnetic disturbances, violent electrical storms and the Aurora Borealis conspire to make radio communication extremely difficult if not actually impossible. Yet, Lincoln engineers used the polar regions as the proving ground for Lincoln equipment.

The schooner "Bowdoin" of the MacMillan Arctic Expedition was Lincoln equipped, and for the first time in the twelve year history of this famous expedition contact with Chicago was maintained *daily!* Not only were daily short-wave messages received clearly and consistently but broadcast programs and contacts with 17 foreign countries were enjoyed! Such remarkable performance won high praise from members of the expedition and set a new record of performance under the most adverse conditions.

As if this were not alone sufficient to firmly establish Lincoln leadership, the exclusive Lindbergh news scoop

again focused national and international attention upon the phenomenal capabilities of Lincoln equipment. When, on August 5, Col. and Mrs. Lindbergh were feared lost in the arctic wilderness, a Chicago operator sitting at his Lincoln receiver caught the anxiously awaited signal from the speeding plane. The message was relayed to the press and within a few hours the story, with a detailed account of the actual interchange of signals, headlined in 965 papers throughout the country.

Nor are such spectacular achievements confined solely to arctic expeditions. Lincoln receivers, in thousands of homes, are consistently outperforming every other known type of equipment. Super-power under perfect control gives the new Lincoln tremendous range, and the specially designed audio system endows Lincoln receivers with a rich, vibrant, life-like tone. A Lincoln Radio is your assurance that you possess the ultimate in design, quality and performance.

The Famous Lincoln Chassis

Both the Lincoln DeLuxe SW-32 and DeLuxe DC-SW-10 are identical in design, both utilizing the high power of ten tubes. The DC-SW-10 has a very low drain and operates on dry "B" batteries and any two (2) volt "A" supply.

Elimination of AC line interference makes the DC-SW-10 desirable in city communities.

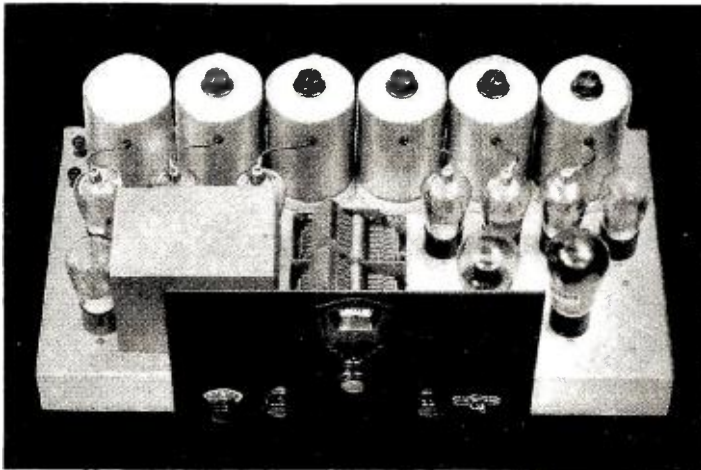

Illustrated, the Lincoln DeLuxe SW-32, an AC model. This same chassis may be had in the DC model, the Lincoln DeLuxe DC-SW-10.



World-Wide Reception without Plug-in Coils!!

Imagine being able to tune in short-wave stations in every corner of the globe with the same ease and certainty of tuning your local broadcast station! Imagine having the entire world of radio at your finger tips—air-mail, amateur phone, short-wave broadcast, police. Trans-Atlantic phone, and all the other fascinating features of the air at your command without having to change a coil or disturb a single connection! Imagine tone of actual life-like fidelity, rich and vibrant with all of the subtle overtones and harmonies preserved intact! It has been the dream of every radio enthusiast, and now such a receiver is here!

The new Lincoln DeLuxe SW-32 embodies all of these features. Broadcast and short-waves are received with equal ease. Plug-in coils have been banished forever—a small no-capacity selector switch on the front panel gives instantaneous access to either broadcast or any of the short-wave bands. A low-high power switch gives added power for the DX fan. The low-power position is sufficient for full loud speaker volume on stations within 500 or 1000 miles, the high-power position for 'round the world reception.

Super-power, developed by Lincoln engineers, gives an entirely new conception of radio performance. A Lincoln owner in Tennessee listens to 92 foreign short-wave stations out of a total of 123 foreign phone stations. From Cushing, Oklahoma, comes the report, "Seven stations

received from Japan one morning, all in the broadcast band." Another Lincoln owner says, "Listening to 2YA Wellington, New Zealand, Ooska, Sendai, and Kumamoto, (750, 770, 790 KC) in Japan, KGMC in Honolulu, 2BL Sydney, Australia, all in the broadcast band."

Such astounding feats are by no means exceptional. Lincoln receivers are built to give outstanding service. Constructed by competent engineers to the highest standards of laboratory precision, each Lincoln receiver is pledged to outperform any other radio equipment known! The tremendous amplification of four stages of tuned I. F. transformation give the Lincoln receiver power and range unheard of before. A specially designed audio system produces tone of amazing quality. From the sweet liquid note of the clarinet to the rich resonant bass viol, every instrument and every voice is brought to your home with all of the timbre and quality of the living artist. Speakers, specially built for the Lincoln receivers insure faithful reproduction of the audio output.

May we not send you an illustrated folder describing each model in detail?

Lincoln Radio Corporation
Dept. N-12, 329 So. Wood St.
Chicago, Illinois.

Will you please send illustrated folder describing the Lincoln DeLuxe "32" models.

Name.....
Street.....
City.....State.....

LINCOLN RADIO CORPORATION

329 S. Wood St.

CHICAGO, ILL.

New "Wire-less" Antenna

(Continued from page 463)

You Need this book

WRITE today for the new Centralab Volume Control Guide. Just the thing for the engineer, experimenter, amateur and serviceman.

Shows how to service all new and most old sets with a tiny stock of Centralab Replacement Volume Controls.

Gives in addition

Control Data on

SOUND EQUIPMENT
MULTIPLE SPEAKER
UNITS

PUBLIC ADDRESS
SYSTEMS

FIXED RESISTORS

etc.

Replete with much new information . . . illustrations, circuit diagrams, etc.

Use the coupon . . . do it at once.

Centralab

MAIL COUPON TODAY

CENTRAL RADIO LAB.
929 Keefe Ave., Milwaukee, Wis.
Here is 25c. Send me new VOLUME CONTROL GUIDE

Address.....

Name.....

City.....State.....
Radio News

requested to be extended to December 15, 1931. The completion of the "booster" station is expected by Columbia engineers to give WABC the widest coverage of any station in the United States. The proposed auxiliary transmitter may use 250 watts on the 860-kilocycle channel experimentally for unlimited time.

William S. Paley, president of the Columbia Broadcasting System, stated that it is planned to synchronize the "booster" station with the new WABC transmitter, seventeen hours each day. If approved by the commission, this will be the first time in American radio history that a network "key" station will be linked on its own wavelength to a "booster" station. The project is said to represent an attempt at conservation of the nation's broadcasting channels.

It was explained that if the Columbia application is granted, Station WMAL, the present CBS outlet in the Capital City, will continue its affiliation with the network for several months after the expiration of its present contract, on November 11, 1931. It was estimated that the construction would require at least ninety days after the Commission's approval is obtained. This would mean that, even if the application was to be immediately approved by the Commis-

sion, the "booster" station could not be on the air before the middle of December, 1931, at the earliest.

Mr. Paley said that WMAL cannot do justice to the broadcasting of local programs as long as it also carries the heavy responsibility of serving the network adequately in Washington. He highly commended WMAL's conscientious service to the Columbia chain in the past. Mr. Paley said that there is a definite and growing need for the CBS to have a full-time, chain-controlled station in Washington.

Technical aspects of the proposed change in Columbia's Washington facilities were explained in detail in the application filed with the commission. For the first time, the application said, an attempt to employ an antenna designed to suppress the high-angle sky wave will be made. The application further stated that in past synchronization attempts, the high-angle sky wave has caused unsatisfactory reception in certain areas.

"Synchronization," the application read, "offers interesting possibilities for conservation and more efficient use of the nation's natural resources represented by the frequencies set aside for broadcasting.

"No synchronization tests are in progress in which the originating station utilizes an antenna designed to suppress the high-angle sky wave. Anticipating the possibilities of rendering more widespread service to a larger audience by making more efficient use of its cleared channel, the applicant has expended more than \$100,000 to develop and erect for WABC a sky-wave antenna.

"Since the sky wave has caused most of the difficulty in synchronization tests, we believe that, with the 665-foot sky-wave-suppressing tower antenna soon to be under operation with 50 kilowatts by WABC, and with which the proposed 250-watt booster in Washington would be synchronized by wire line, we would be able to develop important information on synchronization and to render unusual program service to Washington and vicinity without interfering with the normal, rural service of WABC."

The application emphasized that the experimental project was entirely different from any other synchronization tests approved by the commission, for several reasons. First, because a vertical half-wave antenna, designed to suppress high-angle sky-radiation, will be used for the first time and, second, because the actual method of maintaining synchronization is a radical departure from any other system.

Consideration for the booster station site is being given the National Press Building in Washington. The application, however, stated the location would be in the Washington Building. These plans will be changed if a more favorable site is found. Whether the synchronization plan goes through or not, it will be interesting to follow out the results obtained on high-power transmission from an antenna as radical in construction as this new "wire-less" aerial of WABC's.

African Radio

(Continued from page 510)

people far away, which they seemed to doubt. They have an ancient method of booming enormous wooden drums from village to herald the approach of strangers, and convey information, the drum telegraph, with which I competed on occasion.

There was a great satisfaction in knowing that the expedition was never out of immediate touch with civilization, although many miles into the "blue."

Personally, I have no great amount of advice to offer anyone anticipating a long journey with a radio. There are so many variables to be considered. According to the results expected, the time, the money, and the weight available, different designs might be adopted, and various fancies indulged. Each person would probably prefer to catalogue his own requirements and difficulties, and conquer them accordingly.

However, if experimenting, I should personally strongly recommend getting in touch with Headquarters, ARRL, Hartford. If inquiries of a more commercial angle occur to the enthusiast, I should unhesitatingly refer him to Heintz and Kaufman, San Francisco.

I believe the foregoing covers the salient points of my experience with the M.G.M. "Trader Horn" expedition, on the radio side, and I trust the reader will excuse the rambling form of this discourse. If one or two items have been of any help, even to one or two radio men, I shall have been pleased to have passed on the word.

You Asked Us for this Valuable Book

And NOW It's Ready!

"23 Lessons in Radio" Yours FREE!
With This New Money-Saving Offer
from RADIO NEWS

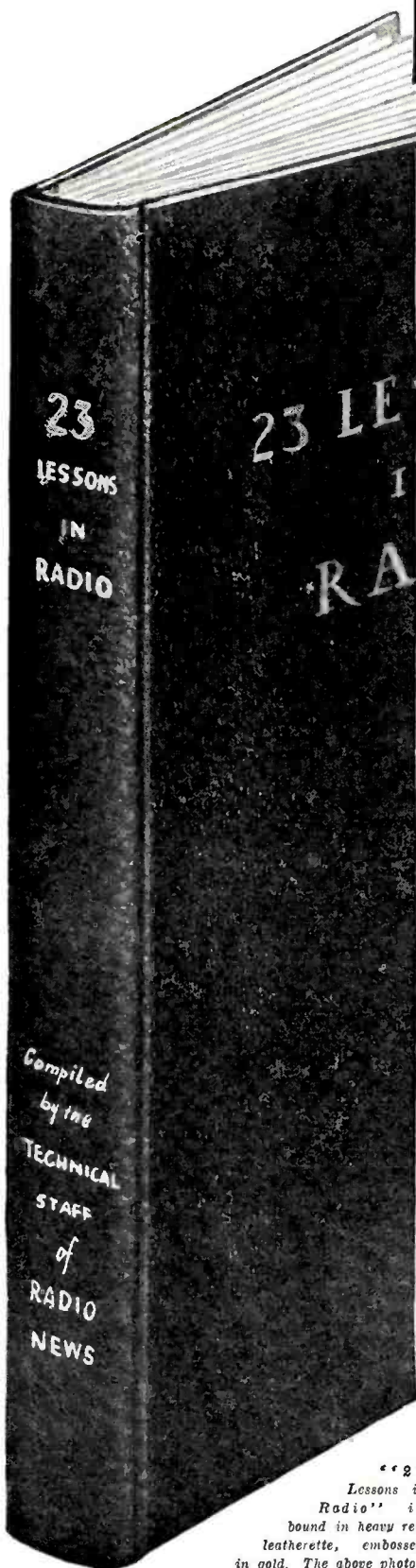

"23 Lessons in Radio" is bound in heavy red leatherette, embossed in gold. The above photograph is actual size.

SO many requests have come into this office asking us for a book covering the Junior Radio Guild lessons, that we have at last, with considerable time and effort, compiled this material (along with some other information) into a great new book!

Boys just beginning radio training—young men needing a reference book which contains the fundamental principles of radio—more experienced men wanting the latest dope on the essentials—all will find "23 LESSONS IN RADIO" the answer!

You—the readers of RADIO NEWS—have asked us for this book, and we are not only glad to be able to present it to you—but we are even more pleased to be able to present it to you FREE!

A Foundation for All Radio Men

All radio men know the tremendous value of a good background in this field. To be well grounded in the first essentials is the kernel which develops success!

"23 LESSONS IN RADIO" furnishes this background. It is not only written to be easily read, but it also contains innumerable illustrations, charts and schematic diagrams. Just for example, the first few lessons are an exposition of radio principles, and they tell how to build, step by step, a complete 5-tube radio receiver. Later lessons include instructions for building a short-wave converter for this same receiver.

There is a chart explaining the standard radio symbols used in sche-

matic diagrams—a chart of the International Morse code—and a thousand other things which make this book a thoroughly comprehensive training for the radio set builder, the experimenter, the service salesman, and the dealer.

And Now You May Have This Book FREE—Just Sign the Coupon TODAY!

"23 LESSONS IN RADIO" is not for sale anywhere! But by subscribing through this special offer, you receive not only this great book FREE, but you also receive two whole years of RADIO NEWS for only \$4, a saving of \$2 over the single copy price. Besides, you do not need to pay the entire amount now! Simply fill out the coupon below and

send it to us with \$1! We will immediately mail your "23 LESSONS IN RADIO" and your first issue of RADIO NEWS. Then you may pay the balance later as we bill you, in easy installments of \$1 a month for 3 months. Renewal or extension of current subscriptions accepted on this offer, but payment must be made now, as specified above, not when subscription expires.

A Few of the
Subjects Covered
in
"23 LESSONS IN
RADIO"

- Elementary Radio Theory
- How the Detector Tube Works
- Construction of a two-stage audio-frequency amplifier
- How the Radio-Frequency Amplifier Works
- How To Build a "Converter" which changes your 5-tube broadcast receiver into a Short-Wave receiver
- Principles of transmitting and receiving
- Complete Chart of Standard Radio Symbols
- How To Build R F Tuner
- How To Build a 3-stage resistance-coupled audio-frequency amplifier
- The How and Why of B-Power Units
- Breaking into the Amateur Game
- How to build a code test outfit
- Circuit, constructional and operating details of a Low-Power Transmitter
- How the Vacuum Tube Works
- Battery construction and how they work
- How to Analyze Receiver Circuits

RADIO NEWS, Dept. 2412
350 Hudson Street, New York, N. Y.

Enter my subscription for two years of RADIO NEWS, and send me the book "23 LESSONS IN RADIO"—all for only \$4.00. I am enclosing \$1.00 herewith, and will pay the balance, \$1.00 a month, for the next three months. (One extra issue—25 months in all—if you send the full amount with your order.) Canada & Foreign \$6.00.

Name

Address

City State

If renewal check here

Are you a Serviceman Engineer Dealer

Experimenter Radio Technician ?

THERE'S ROMANCE IN RADIO!



Look! Short Wave Operation
Between Ground and Airplane!

PREPARE now for these adventurous, exciting branches . . . aircraft radio . . . broadcast station or studio . . . talking pictures . . . direction finder and radio compass . . . disc and film recording . . . servicing home entertainment equipment . . . television.

RADIO offers 7 interesting branches for you to choose from, each filled with possibilities for adventure, advancement, excitement!

Learn these thrilling branches of radio. Study is made simple at the RCA Institutes, through advanced methods, and association with the largest, most complete research laboratory in the radio industry. No rubber stamp courses at RCA Institutes—the man who already has a radio background can enter a course fitted to his particular needs. The four resident schools—at New York, Philadelphia, Boston and Chicago—offer elementary and advanced courses in practical radio. Courses based on 22 years' experience, constantly revised, to include latest developments.

Win Radio Scholarship

If you cannot attend the resident schools, RCA Institutes Extension Courses enable you to study at home. Special laboratory equipment furnished. Outstanding graduates of extension courses become eligible for free scholarship at nearest resident school. All tuition costs moderate. So write today for catalog, full details. The coupon makes it easy.

RCA INSTITUTES, Inc.

RCA Institutes, Inc., Dept. E512, 75 Varick Street, N. Y.
Gentlemen: Please send me your General Catalog. I am checking below the phase of radio in which I am particularly interested.

<input type="checkbox"/> Aircraft Radio	<input type="checkbox"/> Disc and Film Recording
<input type="checkbox"/> Broadcast Station or Studio	<input type="checkbox"/> Servicing, Home Entertainment Equipment
<input type="checkbox"/> Talking Pictures	<input type="checkbox"/> Direction Finder and Radio Compass
<input type="checkbox"/> Direction Finder and Radio Compass	<input type="checkbox"/> Television

Name _____
Address _____
Occupation _____ Age _____

200-2000 Meter Receiver Design

(Continued from page 470)

or honeycomb form. In practice they have proven adequate to prevent any low-wave signals getting through when the set is operated on the long-wave band, and more than adequate for pure image-frequency selectivity.

The change made when the tuning range control knob on the front panel of the set is switched is to select one of the two separate sets of pre-selector and oscillator coils and to connect them into the circuit, the gang tuning condenser remaining unchanged (its dial is calibrated from 0 to 100, because of the dual range, rather than directly in kilocycles).

Examining the circuit diagram and Figure 2, the low-wave pre-selector is seen at L1 (in Figure 2, in the long, square aluminum shield) and consists of an antenna primary coupled to one selector coil, which is in turn coupled to the second selector coil just below critical coupling, or just below where the combined resonance curve of both coils would become "double-humped." The long-wave pre-selector is just to the left of the dial in Figure 2 and appears as L3 in Figure 3. In Figure 2 only the micarta terminal strip of the coil assembly is visible, the coils below it being held on an impregnated wooden dowel, but not being visible in the reduced photograph. The low-wave oscillator coil system is above the chassis, its individual aluminum shield just being visible in front of the oscillator tube seen in the slot in the oscillator and gang condenser shield of Figure 1. The long-wave oscillator coil is at the right of the dial in Figure 2, visible only as a micarta terminal panel. The short and long-wave oscillator coil systems are designated respectively as L2 and L4 in Figure 3. The long-wave coils are effectively shielded by being placed beneath the formed steel chassis upon which the receiver is assembled, there being little advantage in further individually shielding these coils due to the relatively small pick-up effects observed in the frequency band at which they operate. This is not the case, however, for the broadcast band coils, and they are individually shielded both to prevent signal pick-up upon them or direct radiation from the oscillator coil itself.

The switching arrangement allowing selection of either short or long-wave coils is rather interesting and, in effect, consists of a six-pole, double-throw switch which is divided into two sub-assemblies for circuit isolation of three poles, two throws each. In Figure 2 these switches can be seen, one in the upper right-hand corner of the chassis and one just to the right of the dial and above the shielded short-wave selector assembly. The two switches are actuated by a horizontal movement of the small knob directly under the main drum dial tuning knob which is connected to the two switch movements by means of a steel strip sliding in guides. Electrically these switches are seen as the six separate single-pole, double-throw switches at the left of Figure 3. One section of the switch selects between the primaries of the short and long-wave selector coils, while two other sections of

the same assembly select between the two groups of selector coils themselves. The remaining three switches select between the oscillator tank circuit and the oscillator grid and plate coils.

In looking at the diagram and the assembly of the receiver, this switch arrangement appears almost ridiculously simple, but its development was only accomplished with much trouble, for due to the capacities involved in the switching circuit, it was extremely difficult to work out a combination of coils which would permit of permanent and accurate alignment of the gang condenser and oscillator tank circuits for all frequencies in both bands to be covered. As a matter of fact, the oscillator padding circuits will be seen to be substantially duplicated for both short and long-wave bands. Condenser C3 is the oscillator section of the gang condenser, while the small trimmer shunting it is the low-wave trimmer which

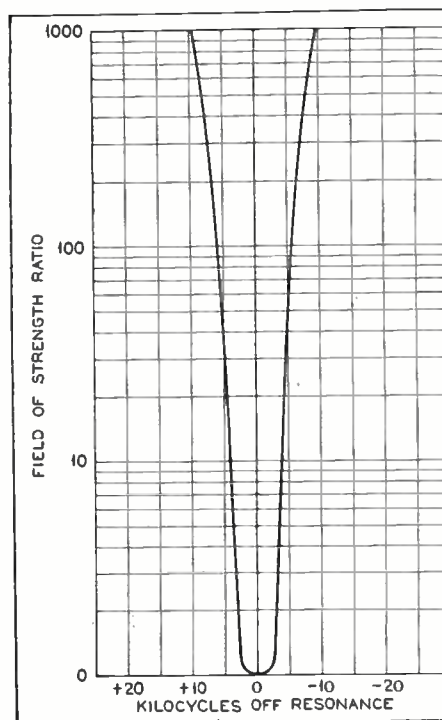

MEASURED SELECTIVITY

Figure 5. A receiver which shows 10-kilocycle separation at a field strength ratio of 40 to 1, as shown in this curve, will provide adequate selectivity under almost any conditions

is aligned at 1400 kc. C4 consists of one fixed and one variable compression type mica condenser and is the broadcast band low frequency, or 600 kc., trimmer. The single trimmer condenser C6 is the long-wave, high-frequency, or 400 kc., trimmer which is required over and above the high-frequency trimmer shunting the tuning condenser C3 to take care of the variations in circuit and switch capacities previously mentioned. The combination C5 of a fixed and variable trimmer condenser is the long-wave, low-frequency, or 175 kc., trimmer.

As the circuit is finally worked out, the

trimming is relatively simple for both bands, it being necessary, however, to align the broadcast band before the long-wave band is aligned, because of the broadcast band high-frequency trimmer shunting C3, effecting the setting of the long-wave trimmers.

The alignment of the finished receiver is easily accomplished by means of the three trimmers for selector and oscillator, upon the gang condenser itself and accessible through apertures in the gang condenser shield housing, and the three trimmers on the right end of the chassis in Figure 2, the top one being C4, the middle one C6 and the lower one C5.

The pick-up coils for the oscillator, connected in the cathode return of the type -24 first detector, are connected in series and no provision is made for switching between them individually, as their reaction upon each other is negligible in practice. A portion of the first detector grid bias is bled through the oscillator grid bias resistor.

The i.f. amplifier employs a total of three tuned transformers, the first being a dual tuned or Siamese unit providing an extra order of selectivity and the two following transformers having tuned secondaries. These i.f. transformers are shown as T1, T2 and T3 in Figure 3 and are seen with their trimmer condensers in the partition assembly at the rear of the chassis in Figure 1 with two type -51 i.f. amplifier tubes and the type -27 second detector tube in individual sections of the partition just behind them. The i.f.

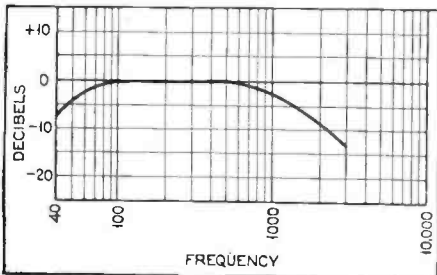

FIDELITY CURVE

Figure 6. The cutting side-bands due to the high degree of selectivity is evident in the slope at the high-frequency end of this curve. Compensation is provided in the loudspeaker to make the overall antenna-to-car fidelity curve relatively flat up to 4000 cycles

trimmers are visible above the three transformers themselves, which are housed in individual aluminum cans. To the right of this partition assembly is the first detector and to its left at the rear are the two -45 power tubes and just in front of them the rectifier.

All filaments and heaters, with the exception of the rectifier, are fed from a single power transformer secondary, the bias resistor R10 for the push-pull -45 tubes being connected between ground and center tap of this winding and shunted by condenser C10, which serves as an r.f. by-pass. No audio by-pass is normally required across the grid bias resistor of a push-pull audio stage.

The filter system of the receiver involves three 4 mfd. semi-self-healing dry electrolytic condensers, a single filter choke and the field of the electrodynamic speaker. In addition, for safety, a bucking coil is used in the speaker circuit, ef-



"I SERVICE HUNDREDS OF SETS EASILY WITH THIS RESISTOR GUIDE"

"I would not give up your Resistor Guide for ten times the price I paid for it. It is my constant companion and saves me many hours of guess work. I service hundreds of sets easily by using the Guide, with greater income as a result of it."
(Name on request)



MF 4 1/2

THIS statement from a Serviceman's letter, one of hundreds mailed to us, goes to the root of the resistor problem in repair work.

The I.R.C. Guide is a remarkable *time saver*. It is a short cut to trouble finding. You are through with one set and on to the next in one-tenth the time it would otherwise take.

The reason? This book gives the value and code of each resistor (and its position in the circuit) of nearly *every popular make* of radio receiver. More than 200 circuits are listed.

The busiest season of the whole year in radio is here. Be ready to get and handle your share of the business. Over 8000 servicemen use the I.R.C. Guide daily. *Write for your copy.*

INTERNATIONAL RESISTANCE COMPANY
Philadelphia - - - - Toronto

FREE with Metallized Resistors

With the purchase of 10 I.R.C. Metallized Resistors, from any wholesaler, you will receive the I.R.C. Guide free—or it may be bought for \$1. Loose-leaf sheets, mailed periodically without charge, keep it constantly up to date. Mail the coupon today.

Ask your wholesaler for

I R C

Metallized

RESISTORS

INTERNATIONAL RESISTANCE CO., N-12
2006 Chestnut St., Philadelphia

Gentlemen: (Check offer you are interested in)

I enclose \$1.00 for Replacement Guide.

Send prices, Metallized Resistors. I wish to buy assortment of 10, entitling me to Resistor Guide Free.

NAME.....

ADDRESS.....

CITY.....STATE.....

WORKS ON ANY RADIO!

NATIONAL NC-5 CONVERTER

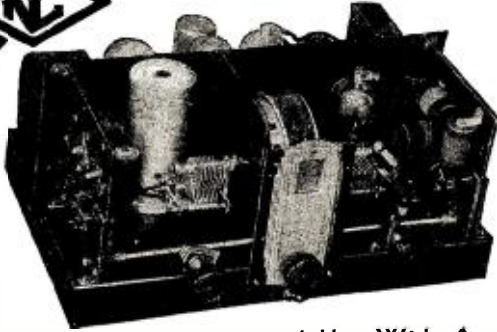

Extends the range of your own radio to bring in short-wave broadcasts and code from anywhere in the world. Contains exclusive features and additional equipment not found elsewhere, giving it a real punch and wallop that sets a new standard in converter performance.

Easy to Connect and Use With Any Radio

Connect antenna to converter and converter to antenna post of radio. Need not be disconnected when receiving ordinary broadcasts. Has own built-in power supply. R. C. A. License.

Extra Amplification Stages

The NC-5 Converter has exclusive HARMONIC TUNED INPUT CIRCUIT, automatically resonating a stage of high-frequency amplification, plus an additional stage of high gain amplification, which also serves as a low impedance coupling with the set.

Single Control Tuning

Specially designed to make circuits "track" each other accurately. No interlocking or "dead spots." Operation is stable over the range.

No Plug-In Coils

The NC-5 Converter has a new coil-switching system with practically perfect

results for converter use, but without the inconvenience of plug-in coils. The new design helps, but R-39, the remarkable low-loss dielectric, really makes it possible. No ordinary insulating material works as well. There is no intercoupling between coils.

A Change in Color of Dial-Light Indicates Which Coils Are in Circuit

Attractive—Compact

Size, 8" x 17½" x 12". Standard Model
In beautifully finished metal cabinet.

De Luxe Model

In hand-rubbed solid mahogany case with genuine inlay in front panel. Harmonizes with the most beautiful radio sets.

and— NATIONAL SW-5 THRILL-BOX

"What a kick this set has! Foreign stations so loud that you can hear the announcements three rooms away." "I guarantee Rome, Italy on the loud speaker and the SW-5 has never failed me yet." . . . "Neatness, precision, good results." . . . "5 continents and 23 countries received." . . . "Truly a masterpiece in the SW field." (Names on request.) So write a few admirers of the SW-5 THRILL-BOX, the outstanding short-wave receiver for serious every-day short-wave phone or broadcast reception, for code or experimental use. If you have a regular radio and want to hear short-waves occasionally, the NATIONAL NC-5 Converter has just been announced (see above) but for every-day short-wave performance the THRILL-BOX is the receiver of them all.

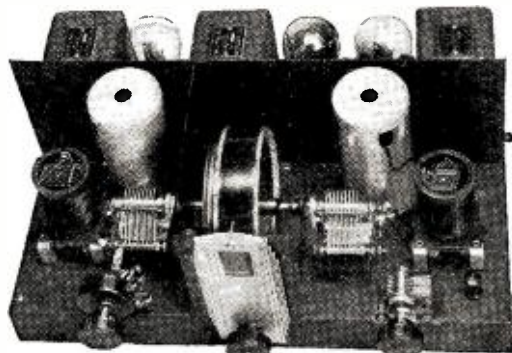

High-Lights on the SW-5

Range 9-2000 meters. Extremely high signal to noise ratio. True single-knob tuning. Set and forget the antenna trimmer. Easy to log with NATIONAL projector Dial, type H, no parallax. Special 270° Type S. E. Tuning Condenser with insulated main-bearing and Constant-impedance pigtail makes gang-tuning possible on the short waves. Equipped with standard set of 4 pairs of R. F. Transformers covering range of 15 to 115 meters wound on forms of genuine NATIONAL R-39. Uses the new UX-235 Variable-Mu tubes, giving improved sensitivity and less critical operation. Humless A.C. Power Supply with special filter section. R. F. Filter on Rectifier Tube, and Electrostatic shield. R.C.A. Licensed.

Send in this
COUPON
for full information
and prices

NATIONAL COMPANY, INC.
61 Sherman Street, Malden, Mass.
Gentlemen:

- (Check which)
- Please send me complete information and prices on your new NATIONAL NC-5 Converter.
 - Please send catalog sheets on the improved SW-5 THRILL-BOX.
 - I enclose 50c (stamps or coin) for your 64-page Handbook of Short-Wave Radio, describing in full the latest and best short-wave receiving circuits, adapters, converters, meters, etc.

Name
Address RN-12

NATIONAL SW-5 THRILL-BOX



fectively balancing out any induction between the field and the voice coil itself. In Figure 2, at the upper left corner of the chassis, a diagram print is seen between the power transformer lugs, illustrating specifically for the user the changes in connection involved when it is desired to shift from low-voltage to high-voltage power lines. The entire receiver is 16½ inches long, 10½ inches deep and 9 inches high. It can be housed in any standard console or other type of cabinet.

Figures 4, 5 and 6 show sensitivity, selectivity and fidelity curves for the receiver. Figure 4, the broadcast band sensitivity is seen to range between 25 and 35 microvolts absolute with a negative slope which is intentional since the best broadcast programs are found on the higher wavelengths and in any case, less sensitivity can usually be used on the lower wavelengths or higher frequencies because of a higher noise level.

Sensitivity

The sensitivity on the long-wave band ranges from 22½ to 35 microvolts between 150 and 450 kc. and here the sensitivity is far higher than that found in a number of examples of the European receiver designs today available upon the market. In direct comparative tests between receivers representative of the latest European production, the actual air performance of the 773 was superior in the matter of reception of distant stations—superior to a point where it would bring in many stations at good volume which could not be heard at all upon the European receivers in either the short or long-wave bands. The selectivity is far superior to that of anything found in Europe and is comparable with that of the best American superheterodynes, as can be seen from examination of Figure 5. It is adequate to insure absolute 10 kc. selectivity in either band in any location in which the receiver would ordinarily be used—even very close to very powerful broadcasting stations.

The fidelity curve of Figure 6 indicates appreciable high note attenuation resulting from side-band cutting in the i.f. amplifier necessary to obtain the desired degree of selectivity. Figure 6, however, does not show the high-frequency compensation incorporated in the speaker, and in consequence is not a true picture for antenna-to-ear fidelity, the antenna-to-ear curve being substantially flat from 60 to 4000 cycles.

European Reception

While no European long-wave stations have as yet been received in America upon this receiver, it having only been developed during the very late spring and early summer months when weather conditions are not particularly favorable, its performance in Europe, showing an ability to bring in at almost any point any of the longer wave stations operating in the British Isles or Europe, would indicate that in the more favorable locations in the United States it should be quite possible during the winter months to bring in one or more of the long-wave European stations—a real thrill, indeed, for the American broadcast listener.

Transformer Design

(Continued from page 481)

we will, for convenience sake, convert this value to turns per volt, or 5.2. Now the turns in each individual winding will be the voltage across that winding times this value, 5.2 [Formula (6)]. Following this out, we get:

Primary, 110 volts \times 5.2 = 572 turns
 Secondary, 400 volts \times 5.2 = 2080 turns (each side)

Secondary, 2.5 volts \times 5.2 = 13 turns
 Secondary, 2.5 volts \times 5.2 = 13 turns
 Secondary, 5 volts \times 5.2 = 26 turns

We notice that secondaries 3 and 4 have the same number of turns, which is correct, since the voltage across them is the same. However, the same size of wire is not to be used, since the current (amperage) is not the same. This brings us to the question of wire sizes. All we have to do in this case, since we have decided to use 1000 cir. mils per ampere, is to multiply the current by 1000 and look up in the appended wire table the proper size of wire to use. First we must determine the amperage of the primary. If watts is volts times amperes, then amperes is watts divided by volts.

$$\text{Amperes} = \frac{92}{110} = .836 \text{ amperes}$$

Turning to the wire table, we get:

Primary .836 ampere \times 1000 = 836 cir. mils or No. 21 wire (nearest size)
 Secondary .1 ampere \times 1000 = 100 cir. mils or No. 29 wire
 Secondary 10.5 amperes \times 1000 = 10,500 cir. mils or No. 10 wire
 Secondary 3 amperes \times 1000 = 3000 cir. mils or No. 15 wire
 Secondary 2 amperes \times 1000 = 2000 cir. mils or No. 17 wire

Now we are ready to determine the size of core necessary for our transformer. Since we are using a "core" type core, our laminations will look like Figure 1. The frequency for which we desire to use our transformer is 60 cycles, so the simplified form of formula (7), or formula (8a), applies. Substituting known values, we get:

$$A = .192 \times 7.50 = 1.44 \text{ sq. in.}$$

If the dimension A in Figure 1 is 1 inch, we will have to use a stack of laminations 1.44 inches high to obtain the necessary cross section. (In stacking laminations, they should be inserted into the windings from opposite ends in groups of not over 3 or 4 laminations, and the additional end pieces put in place as they are stacked.)

We have all the data necessary to the design of our transformer, so the next step is actually to construct it. A form should be made of heavy paper or fiber, with the center opening a little larger than necessary to actually permit insertion of the laminations, and the wire wound in smooth layers, allowing about 1/2 inch at each end of the winding. Layers should be insulated from one another by paper. Glassine paper is most often used in commercial transformers, although a good grade of linen paper may be substituted. Different windings should be insulated from each other by at least two thicknesses of heavy paper.

(Continued on page 518)

NEW, AND STILL BETTER! NATIONAL MB-32 TUNER

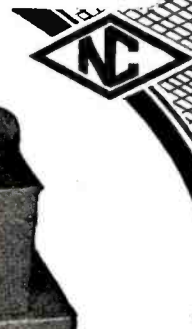
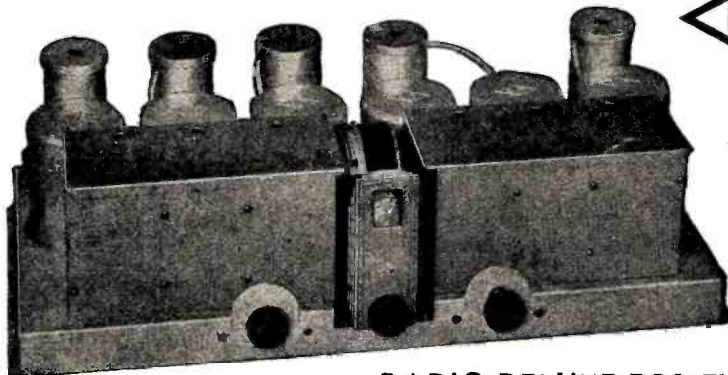

RADIO DELUXE FOR THOSE WHO WANT "THE BEST" IN RADIO, REGARDLESS OF PRICE

The best radio developments of 1931 have been incorporated in the new NATIONAL MB-32 Tuner, making it a finer and still better tuner.

Uses the new 235 Variable-Mu Tubes Retaining All of MB-31 Outstanding Features

The new 235 Variable-Mu tubes are employed to their fullest advantage, giving extreme sensitivity without critical operation, and increasing selectivity at the same time. Sensitivity better than one microvolt per meter, over entire broadcast band . . . designed for use with NATIONAL VSA VELVETONE AMPLIFIER-SPEAKER . . . Licensed under the Vreeland Band-Pass and other patents and applications as developed by Dr. F. K. Vreeland at Stevens Institute of Technology.

No cross-talk. Absolute freedom from oscillation. Elimination of tube-hiss and other background noises. Thorough shielding. Rugged oversize construction. No compromise whatsoever with quality.

and!

NATIONAL VSA VELVETONE AMPLIFIER-SPEAKER

Licensed under R.C.A. Patents

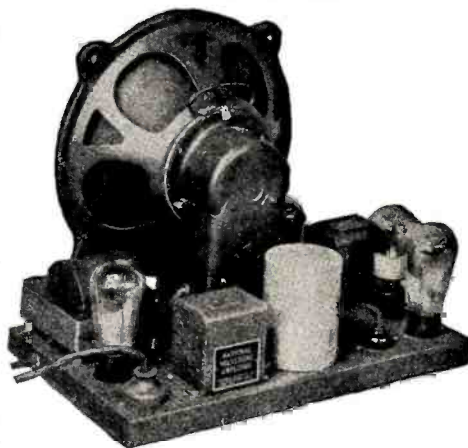

Silent Hum-Free Operation

Modulation, hum and line noises have been completely eliminated by special R.F. Filter. 24 mfd. of Filter Condenser assures additional silence. . . . Send for more complete information on the MB-32 Tuner and VSA Amplifier-Speaker, using coupon below.

While the MB-32 Tuner will operate with any first-class power amplifier, the NATIONAL VSA unit has been designed especially for the best results. Mechanical design permits simple mounting in cabinet, behind speaker opening. Covers entire musical scale. The VSA Amplifier-Speaker utilizes in full the fine quality of the MB-32 Tuner, being practically flat from 50 to 5,000 cycles, the limit broadcasted by any transmitting station at present.

COUPON

NATIONAL CO., INC.
 61 Sherman St., Malden, Mass.

Gentlemen:

(Check which)

Please send me catalog sheet and full information on the new NATIONAL MB-32 TUNER and the NATIONAL VSA VELVETONE AMPLIFIER-SPEAKER.

Name

Address

RN-12

NATIONAL MB-32 TUNER



AERO WORLD-WIDE
 Only \$6.45
 Short Wave Receiver
 Span the World with this Set!



A new radio thrill for you! Listen in DIRECT to London, Paris, Berlin, Buenos Aires and other broadcasting stations throughout the world via short waves. Enjoy unique foreign programs from strange lands. Your ordinary receiver cannot tune in these low wave stations. WORLD-WIDE RECEIVER gets 14 to 550 meter stations with surprising clarity.

AERO SHORT WAVE
 Super-Heterodyne Converter
 Converts Your AC or DC Radio Set
 Into a Short Wave Super-Heterodyne
 15 to 200 METERS

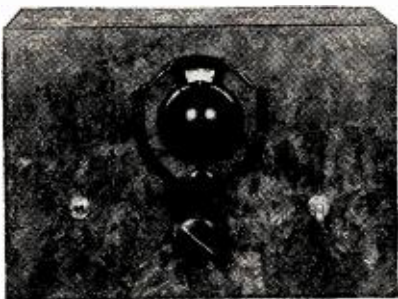

Now in addition to your regular receiver you can have a Short Wave Super-Heterodyne set that will enable you to tune in short wave stations from many different parts of the world. All you have to do is to connect the Aero Converter to your own set and you are then ready to span the world. The Aero Converter is adaptable for AC or DC radio sets. Contains its own filament supply. B voltage can easily be obtained from your regular radio set, or you may use a single 45 voltage B battery. No plug-in coils. Single tuning dial. Very easy to tune. No whistle or squeals. Uses two UX227 tubes, one as oscillator and one as mixer.

Price List

AC Model, less tubes, ready for operation.....	\$12.50
DC Model for battery-operated sets.....	11.50
2 Matched UX227 tubes at 75c each.....	1.50
1 45 Volt B Battery.....	1.45

New Aero Midget \$16.50



Using the latest type Pentode and Multi-Mu Tubes. This Midget performs on distance and has tone qualities like a large expensive set. Wonderful selectivity. Full dynamic speaker, full vision dial, beautiful walnut finish cabinet. A 5-tube set. Price for set of 5 tubes, \$4.50. Available in 25 cycle \$2.50 extra.

Aero Pentode Auto Radio

Amazing Low Price! Quality Performance



We guarantee this is the latest model 6 tube Aero Pentode Auto Radio. Due to the use of the latest Pentode Tubes this set is equal in performance to any 8-tube receiving set. The circuit used is one which will be embodied in most of the expensive 1932

model auto radios. The complete set can be clamped on the steering post of your car or can be operated by remote control from the dashboard.

This set will pull in stations within a radius of 1,000 miles and will deliver the volume and tone qualities of an electric set.

Price of Set only \$20.00

Price complete, including tubes, batteries, dynamic speaker and suppressors, all ready to install and use, \$9.50.

TERMS: Should you order C. O. D. a deposit of \$1.00 is required on Short Wave Receiver or Short Wave Converter. A deposit of \$5.00 is required on the Aero Midget or Auto Radio. 3% discount allowed if remittance is sent in full.

Write for Bargain Catalog
CHARLES HOODWIN COMPANY

4240 Lincoln Ave., Dept. M-30, Chicago, Illinois

Marine Radio Telephony

(Continued from page 475)

wanted to talk with her newly married daughter, Millicent, and, learning about the sea phone, called her up.

"I want to talk to Mrs. Millicent Powers on the *Belgenland*, which is somewhere on the Pacific," she told her local operator.

"Thank you. We will give you 'Ship's Service,'" was the reply.

In a few minutes Ship's Service called: "Here is the *Belgenland*, madam. Your party is on the line."

Then mother and daughter talked over land lines and through the air.

From the Yellow Sea, the Gulf of Siam, Straits of Sunda, Indian Ocean, Gulf of Arabia, Atlantic, Pacific, Mediterranean or Adriatic passengers talk across oceans and continents with friends.

Although the *Belgenland* was the only world cruiser equipped with the radio-telephone at that time, other large ships engaged on long voyages have followed suit—or are planning to do so.

The radiotelephone is a fixture on the larger Atlantic liners and equipment of smaller ships now is in progress. The time is not far distant when conversation between ships at sea will be nearly as common as talks over wire lines ashore. The present long-range sea phone communication is carried on principally between shore stations and ships, in both directions, the shore stations being equipped with special apparatus for sending and receiving. From any point in the world the *Belgenland* can work either Deal Beach, near New York, or Rugby, England. American and Canadian messages are routed through Deal Beach and European messages through Rugby.

Equipment on the *Belgenland* is the

most powerful installed on shipboard, costing approximately \$50,000. Four operators, an engineer and a business manager serve as the ship's special telephone staff. The radiotelephone booth is situated on the principal passenger deck and calls are made through an ordinary telephone set. Dr. Albert Einstein, when speaking from the ship to the American radio public, spoke into a microphone placed on the table of his private sitting room and communicated with a large number of people.

Service has been worked out on the timetable principle, certain hours each day being allotted to the American and certain others to English receiving stations. Operators aboard ship and at the receiving stations converse freely with each other on technical matters.

Equipment on the *Belgenland* consists of a short-wave transmitter rated at 12 kw., a short-wave radio receiver and special telephone transmitting gear and antenna systems suitable for working on the various wavelengths required.

The transmitter, with its associated power plant, is housed on the forward part of the upper deck, and the receiver and transmitting gear are placed further aft on the same deck. The transmitting antennae are rigged between the forward funnel and the foremast, and the receiving antenna between the after funnel and the mainmast.

Separation of the shore radio transmitter and receiver by as great a distance as is practicable facilitates service. In the United Kingdom, for example, the transmitting stations at Rugby are about 45 miles distant from the receivers at Baldock. In the United States, the sending station at Netcong, in the middle of New Jersey, and the receiving station, at Deal Beach, are 62 miles apart.

On the *Belgenland*, where the transmitter and receiver are separated by at most 100 yards, other means involving very special equipment of an intricate nature were adopted, and the equipment was arranged so that advantage might be taken of the extended cruise to carry out transmitting and receiving investigations and tests.

When a connection is set up and a person on board talks to a subscriber on shore, the sounds of the passenger's voice modulate the carrier wave generated by the radio transmitter and radiated by the ship's transmitting antenna. This modulated wave is picked up by the receiving antenna at the land station and converted into speech current, which traverses the land line to the technical operator's position, and is then directed to the circuit of the shore subscriber.

Speech from the shore to the ship is carried similarly over a land network, but at the technical operator's position it takes a different route. From this point it travels over the trunk line leading to the radio transmitter at the land station, whence it is radiated as a modulated carrier wave from the transmitting antenna and picked up by the receiver on board.

Thus there are two completely separate
 (Continued on page 519)

Transformer Design

(Continued from page 517)

Care should be exercised in the winding to prevent "shorted" turns, as almost invariably one shorted turn is sufficient to render the entire transformer useless. If when completed the transformer shows signs of abnormal heating, it will have to be unwound until the shorted turn is located and cleared.

It makes no difference what order of winding is used, but generally the winding that has to dissipate the most heat (watts) is placed on the outside so that it may be better ventilated.

One other caution: look out that your winding is not so large that the "window" of the lamination will fail to hold it. Usually the window is sufficiently large, but if there is the slightest doubt, you had better figure it out. In the wire table the number of turns per inch is given, so you can readily compute the number of layers of wire there will be for each winding, and the diameter of the wire is given. Add in the thickness of the necessary papers for insulation, and add another 15%. This will give close to the thickness of the winding, so that you may ascertain if they exceed the window width.

Radio Science Abstracts

(Continued from page 502)

cadmium batteries still have another advantage that they may be charged with a weak current. One can use them as a "floating" battery, which means changing them continuously with a weak current while the battery occasionally gives a strong current.

The cadmium-nickel battery is used on a large scale for the illumination of trains. It is also used as a substitute for the iron-nickel battery in telegraphy, telephony, the control of signals at a distance.

Boro-zincate of Potassium Cells: In this type of storage battery, still in the experimental stage, the electrolyte is a neutral solution of boro-zincate of potassium of a density of 1.50. The anode consists of small perforated tubes containing an easily reducible metallic peroxide; in practice a mixture of one part lead oxide and two parts nickel oxide is used. This latter mixture is highly conductive. The negative plates are formed on a steel frame, covered with nickel or lead. The positive and negative plates are separated by a slotted sheet of ebonite which maintains their spacing.

During the charge zinc is deposited on the negative plate while at the positive plate peroxide is formed. During the discharge the zinc dissolves and the peroxide is reduced. With nickel-oxide the reactions are as follows:

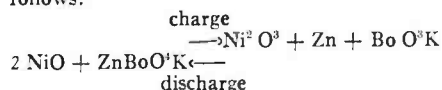

The useful electromotive force is from 1.55 to 1.60 volts, the maximum discharge will be 5 to 8 amperes per kilogram, the energy available will be 54 to 60 ampere-hours per kilogram.

Marine Radio

(Continued from page 518)

radio paths between the technical operator's position ashore and afloat which must be balanced and adjusted by the apparatus at these positions.

Handling of traffic is carried out between technical operators on board and on shore. The ship operator controls the connection in the receiving office. Being notified of calls required by the passengers, he speaks to the shore operator, passing on to him the name and address of the person called.

The shore operator controls the land side of the connection, and, through the medium of the toll board operator, makes connections with the called subscriber. It is then only necessary for him to inform the ship's operator that the land subscriber is on the line, whereupon the calling passenger is called to the telephone and the connection is completed.

Simple though this procedure may seem to the passenger, considerable operational skill and complicated equipment are required, both at the land line telephone terminal and on board ship, to insure that the speech all along the circuit from the subscriber to the passenger is carefully adjusted, and also that all possible extraneous noises are eliminated from the circuit.

With further development of the equipment, conversations between passengers aboard ships widely separated will be possible.

Radio Service Men

Read My Second Big Offer

TO MAKE YOU

MORE MONEY

REMEMBER HOW, in 1928, my special offer on the Knapp "A" Power Kit enabled you to make money you could not otherwise have made? Well, here I am again in 1931—when profit-making troubles you more than ever—with an even finer, faster money-maker for you. Right at this difficult time I have persuaded one of my affiliated industries to make you a proposition on replacement condensers that is a sure winner.

With it you can mystify radio owners with the speed with which played-out condensers can be replaced. And you can mystify yourself with the profit you can make doing it!

No more waiting days and days for new condensers to come from the factory. No more having to put a whole flock of condensers in a set—just because one has gone bad.

Thirty minutes after you diagnose the trouble you have the set back in your customer's home. And your total replacement cost is a single, inexpensive, compact little Elkon condenser on which you can make a long profit both for material and labor.

Instead of replacing an entire condenser box you melt the pitch, remove the

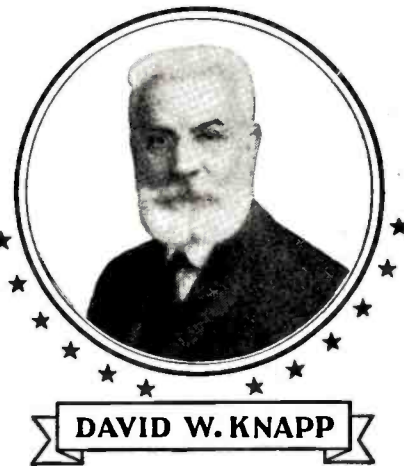

DAVID W. KNAPP

bad condenser, stick in a new Elkon and replace the pitch. Best of all—you always KNOW that the inexpensive little Elkon condenser is a BETTER condenser than the one which you have removed—and you always know that it is a SMALLER condenser too—no trouble fitting it in place!

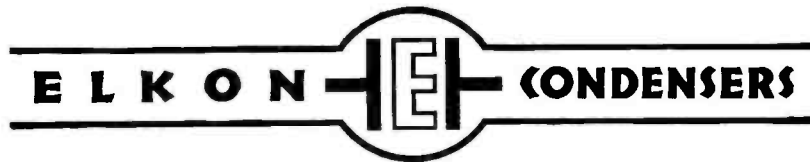

NON-AQUEOUS HIGH VOLTAGE

ACTUAL SIZE

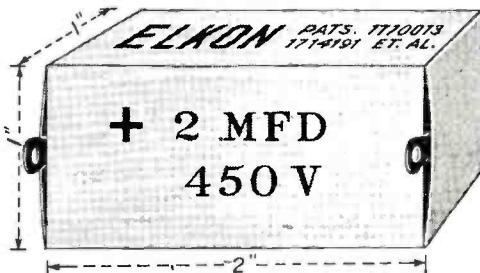

is the condenser all the best-known 1931 radio manufacturers are using. It is the most compact radio condenser ever made. Is noted for its low leakage and its excellent power factor. Its patented NON-AQUEOUS construction prevents it from going bad before installation. So you can afford to order a reasonable stock—especially at the astonishingly low price at which you can buy Elkons.

Just to give you an idea of how COMPACT this condenser is, I'm printing an actual size diagram of the 2MFD-450 Volt type. Notice how small it is. Then take my word as to how LARGE your profit can be if you will mail the money-making coupon.

Don't fail to get the details of this offer. The coupon brings them at no expense to you.

MAIL THIS

Elkon Division
 P. R. MALLORY & CO., Inc.
 1231 Newton St., Indianapolis, Ind.
 Please mail me the details of Mr. Knapp's money-making offer for Radio Service Men.

NAME.....
 ADDRESS.....
 CITY AND STATE.....

Relays



ONLY



put
the

PHOTRONIC CELL to work

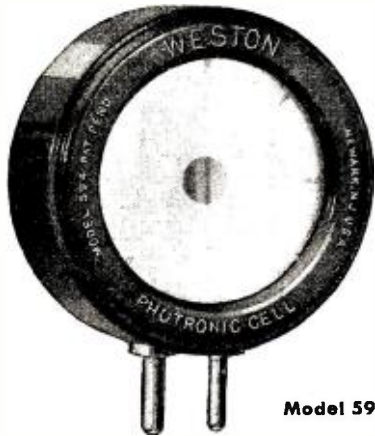

Model 594

In use and construction—the new Weston Photronic Cell is different—utterly simple—low in cost. It cuts first cost and upkeep of light sensitive cell applications.

The Weston Photronic Cell uses no batteries . . . no polarizing or exciting voltages . . . no amplifiers. It operates relays directly. Simple and economical to install and maintain.

Highly sensitive—current output approx. 5 milliamperes in direct sunlight . . . approx. one microampere per foot-candle. No dark current. Response is practically instantaneous.

Unlimited life—as far as known—in use or on shelf. No drifting . . . no readjustments of circuit . . . nothing to replace . . . not easily damaged. Constant characteristics.

Sold independently—or in conjunction with primary and power relays—Model 601 Weston Photronic Relays. Types of relays determined by use.

Amazing in performance, revolutionizing in operation, the new Weston Photronic Relays advance light sensitive cell applications to a new degree of reliability, simplicity and economy.

For further details, CIRCULAR YY on request

WESTON

ELECTRICAL INSTRUMENT CORP.

615 Frelinghuysen Avenue, Newark, N. J.

Assembling a Home Recorder

(Continued from page 472)

can flip the single pole, double-throw switch S2 to the speaker position, and to the recording position when ready to record.

Recording With Radio Sets

In order to record with the amplifier contained in a commercial radio set, we must tackle the problem from a different angle. It is necessary to break in on the input of the audio amplifier in order to use a microphone. This should be done without lowering the efficiency of the set when listening to radio reception.

A convenient way of doing this is shown in Figure 3. By referring to the diagram

voice coil should be opened when recording, in order to remove the reflected load on the output transformer and also to avoid feedback through the loudspeaker when using microphone. When ready to reproduce records, connect the cutter to the input circuit as shown in Figure 2 if using a separate amplifier, or as in Figure 3 if using a radio set.

Whether using a high impedance or low impedance cutter the final results will be the same, providing the correct circuit is used with each. However, one advantage of using the low impedance cutter is that you will be dealing with low a.c. voltages and therefore less chance of getting a shock; although this is not

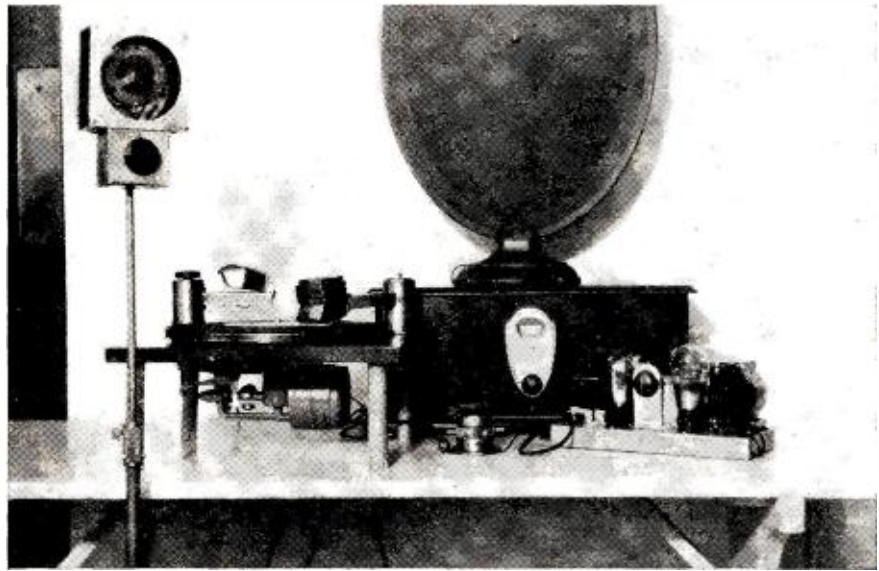

SET-UP FOR RECORDING ON PRE-GROOVED COMPOSITION DISCS

This set-up is similar to the one used in recording on ungrooved aluminum discs except that a weighted Pacent cutter is used, requiring no lead screw inasmuch as the records are pre-grooved

you can see that we can feed into the amplifier from either microphone, pickup, or radio. This is done by splitting the cathode circuit of the detector tube through an adapter and inserting either the pickup or microphone in series with it. When using a single-button microphone in this manner the plate current drawn by the detector tube is also used to energize the microphone. In order to use a double-button microphone in this circuit it is necessary to use a microphone coupling transformer. The secondary of this transformer is connected in series with the cathode while the primary is connected to the microphone with a 4½ volt "C" battery in the center-tap, the same as shown in Figure 2.

Recording With a High Impedance Cutter

Recently a high impedance cutter (4,000 ohms) has been made available on the market. This unit is connected as shown in Figure 4. The condenser C in this diagram is used to block the d.c. from going through the cutter and should be of 1 mfd. capacity or higher. The switch in series with the dynamic speaker

much to worry about in any case.

Life of Records

The number of times that these aluminum records can be played is considerably less than the commercial wax records. Life tests have shown that they can be played about three hundred times before the high frequency modulations are destroyed to a noticeable extent. At this stage the surface scratch becomes objectionable. Music and speech, however, can still be understandable up to about 500 playings.

Home recording today is looked upon by many people as merely a novelty. The same people will probably be surprised to hear that a number of radio set manufacturers will incorporate provisions for recording in their models for this season. Radio enthusiasts who will start on home recording now will be a few steps ahead of the next door neighbor that will buy a new radio-recording combination set.

In conclusion, the writer will be glad to answer technical questions on recording, providing a self-addressed stamped envelope is enclosed.

Reducing Film Noise

(Continued from page 490)

may occur. These may be classified as due to the following causes:

1. Secondary modulation on account of "tracking" of the shutter.
2. Loss of the start of a sound due to shutter or circuit inertia or a combination of both inertias.
3. Extraneous noises due to a too rapid "masking" or "unmasking" of the track.

Secondary modulation caused by the shutter will produce a print such as that shown in Figure 3, in which the defect has been considerably exaggerated.

Since it is the variation in width of the light portion of the track on a positive print which can be said to cause the photoelectric cell response, this record may be analyzed as follows:

W_r = width of clear portion

W_o = width of half track

W_o' = average width of portion darkened for noise reduction (measured from top of track)

W_m = maximum amplitude of sine wave a.c. being recorded

W'_m = Maximum amplitude of sine wave record left by shutter

$$W_r = W_o + W_m \sin \omega t - [W_o' + W'_m \sin (\omega t \pm \theta)] \quad (1)$$

$$W_r = W_o + W_m \sin (\omega t \pm \frac{\theta}{2}) - \frac{0}{2}$$

$$W_o' - W'_m \sin (\omega t \mp \frac{\theta}{2}) \quad (2)$$

To simplify the expression so that a better physical concept may be obtained, assume for the moment that $W_m = W'_m$, and dropping the non-periodic terms:

$$W_r = 2W_m \cos \omega t + \sin \frac{0}{2} \quad (3)$$

Since, for any system, the log "0" is a constant, this will not produce harmonics but will cause amplitude alteration ranging from zero output to double output.

If W_m does not equal W'_m the distortion will be of the type described and will be due to the last term of equation (2) and "0." Its extent will be controlled by the value of " W'_m " and "0."

The occurrence of the second and third types of distortion are the limiting factors determining the speed of the shutter movement.

If the shutter moves too rapidly, thus tracing a steep wave front on the film, extraneous noises such as "clicks" and "plops" may occur at the start and finish of a sound.

On the other hand, if the shutter action is too slow, a portion of the sound may be lost at the start and under extreme conditions the action can be sufficiently slow to make the shutter useless in recording long passages. Figure 4 shows a sound track in which the masking action, after modulation has ceased, was far too slow.

By the proper design of operating circuits and the shutter, all of the difficulties mentioned may be obviated.

The electromagnetic shutter is a low inertia, damped device; *i.e.*, it opens and closes in a very short interval of time and is so constructed that it does not oscillate in opening and closing.

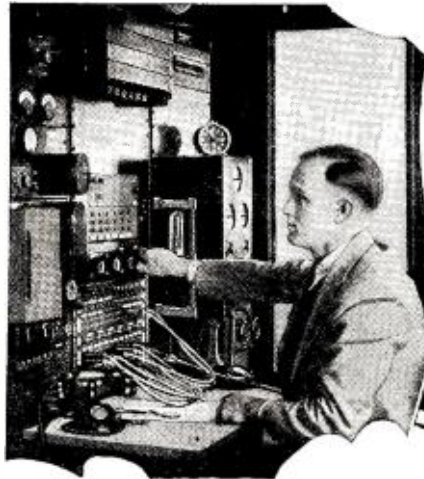

FREE RADIO BOOK~ describes many opportunities to make **BIG MONEY** in *Radio-Talking Movies* (Television also Included)

Here's a famous book that has shown many a man the way to "cash in" on the big-pay opportunities in Radio. I'm not asking \$5 or \$6 for it—it's FREE. If you're earning a penny less than \$50 a week, mail the coupon below and get a copy of this free Radio book. It will be a revelation to you!

Many Make \$50 to \$100 a Week

Radio—the NEW, uncrowded, growing, live-wire profession—needs many *trained men* for its good jobs every year. Television, Talking Movies, Aircraft Radio, Radio Servicing and Merchandising, trans-Atlantic Radio Telephony and many other opportunities are thoroughly covered by N. R. I. training. Each one means more big-money opportunities for a *trained Radio man*. My book gives the facts about these Radio opportunities. And more—it tells how you can get all the training you need, quickly and easily in your spare hours at home, by my new and practical methods. In a short time, through my training, you will be prepared to take advantage of these big-money Radio opportunities. My Free Book will give you all the facts and proof of what I have done for hundreds of other men.

Extra Dollars for You Almost at Once

Think of making \$15, \$20, \$30 extra each week "on the side," without interfering with your regular job! I'll show you how to do that, too, by using spare time that you're wasting now. I'll show you how to turn what I'm teaching you into cash almost at once, when you and I get started together. My Free Book tells you all about it. If you send for the book today, and if you have the average man's ability, it's possible for you to be making extra money in less than thirty days from now. And you can be ready for a good full-time Radio position after eight to twelve months of spare-time training.

I'll Send You This Big NEW 64-Page Book FREE

My book is filled with photos and facts—the pay-raising facts you want to read. If you're interested in Radio, or if you're interested in making more money, you owe it to yourself to read this book. The book absolutely won't cost you a cent, and you place yourself under no obligation by sending for it. No previous Radio experience needed to take advantage of this offer. No special schooling required. Fill in and mail the coupon NOW!

Address **J. E. SMITH, President**
National Radio Institute, Dept. INRA, Washington, D. C.

Hundreds of Men Have Won Success This Way

The National Radio Institute is the pioneer home-study Radio school. It has prepared hundreds of men for the Radio profession—some of them now holding leading positions in this industry. You'll find N. R. I. trained men in practically every Radio organization of any importance throughout the country. The same practical tested training that enabled these men to get ahead is now open to you. And this training has been improved, enlarged greatly to keep up with the constant expansion of Radio opportunities.

Has Made \$10,000 More in Radio

"I can safely say that I have made \$10,000 more in Radio than I would have made if I had continued at the old job. When I enrolled with you I didn't know a volt from an ampere. I advise all ambitious young men to get into Radio. There is no greater opportunity."—Victor L. Osgood, 7101 Bay Parkway, Brooklyn, N. Y.

Over \$400 Monthly

"I had 15 years as traveling salesman and was making good money, but could see the opportunities in Radio. Believe me I have made more money than I ever did before. I have made more than \$400 each month. I can't say too much for your school."—J. G. Dahlstead, Radio Station KYA, San Francisco, Cal.



J. E. Smith

Mail coupon Today!

J. E. SMITH, President,
National Radio Institute,
Dept. INRA Washington, D. C.

Dear Mr. Smith: Kindly send me a free copy of your famous 64-page Radio book, which tells all about the big-pay opportunities in Radio, Talking Movies, Aircraft Radio, Servicing and Merchandising, and those coming in Television, and how you can train me at home to take advantage of them. I understand this places me under no obligation and that no salesman will call.

Name.....

Address.....

Town.....

Hot off the press!

The NEW RADIO and TELEVISION DATA DIGEST and ANALYSIS

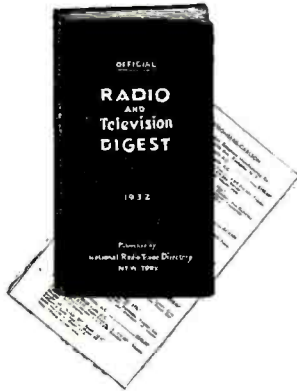

Complete Specifications and Detailed Facts About All the New Lines . . .

This condensed Radio and Television Digest contains all details as to What's New in Radio and Television for the season 1931-1932. Every radio dealer, wholesaler, manufacturer, mechanic, service man and radio fan will want one or more copies.

It contains complete specifications on everything in radio, such as prices, sizes, types (including midget and automobile radios), speakers, tubes, cabinet dimensions and the names and addresses of radio set manufacturers together with their trade-marks. In fact everything that is required to keep abreast of the rapid changes and developments in the industry.

Every Radio Man Needs a Copy

It makes little or no difference which branch of the radio industry you are actively engaged in or whether you are just a radio enthusiast, you will treasure your copy of this valuable book. It may be used as a buying guide or a selling guide,—as a service guide or as a trouble shooting guide. As a matter of fact its uses are so universal that you will wonder how you ever got along without one when you have once put yours to use.

The Only Book of Its Kind

We know of no other source of information that is so concise and valuable to the progressive radio man. It tells at a glance who makes radios with electric clocks,—who makes midget receivers and all there is to know about them,—what receivers are featuring automatic tuning,—what types of tubes the new models are using,—what television sets are on the market. In fact, nothing in radio need go unanswered from the moment you get your copy of this marvelous book.

National Radio Trade Directory, Dept. B

Fourth Ave. and 23rd St., N. Y. City. Here's my two dollars. Reserve a copy of your 1931-1932 Radio and Television Data Digest and Analysis for me and let me have it as soon as possible.

Name

Address

City State.....

Business

Company

Position

Tuned R. F. Design

(Continued from page 477)

Thus, the mathematical equivalent of Figure 2A is Figure 2B. If we let L_1 and L_2 be the inductances of the primary and secondary circuits, τ the coefficient of coupling between these coils, C_2 the capacity of the tuning condenser, R_2 the total resistance of the secondary coil and condenser combined, R_p the plate resistance of the tube, μ the amplification factor, and e_p and e_o the input and output voltages, it may be shown that the voltage amplification when the condenser C_2 is tuned for max. e_o may be expressed by

$$\frac{e_o}{e_p} = \frac{\mu \tau \sqrt{L_1/L_2}}{\tau^2 + \frac{R_p \tau_{12}}{L_1 \omega}} \quad (1)$$

where $\tau_{12} = \frac{R_2}{L_2 \omega}$ and $\omega = 2\pi f$

f being the frequency of the incoming signal.

It may be further shown that there is a certain relation between the coefficient of coupling and the other quantities which will give maximum amplification. However, in the case of utilizing either the screen-grid tube or the variable-mu tube this relationship cannot be utilized in practice because of the high plate resistances of the tubes which would necessitate increasing the inductance of the primary of the r.f. transformer to such a point that the distributed capacity of the winding together with the capacity between plate and screen grid would tune the primary to some frequency in the band being received.

In the case of applying the above equation to the type -35 tube with its variable amplification factor, the quantities must be rearranged so that fairly constant values of mutual conductance and plate resistance are employed. Let

$\frac{L_1 \omega \tau^2}{R_p}$ is very small in comparison to τ_{12} . So, assuming that to be the case

$$\frac{e_o}{e_p} = \frac{\sigma \tau \omega L_1 \sqrt{L_1/L_2}}{\tau_{12}} \quad (3)$$

Now the quantity τ_{12} in a well-designed solenoid secondary coil, even when shielded, is practically constant with frequency over such a wave-band as is employed in broadcasting. Consequently, the amplification of the transformer will be greater the larger σ , τ and $\sigma \tau \omega L_1 \sqrt{L_1/L_2}$. It is also noticed that the amplification will not be constant but will vary with the frequency. This variation from 1500 to 545 kc. would be such that only .364 as much gain would be obtained at 545 kc. as would be expected at 1500 kc. Actually this ratio is not nearly as great as the theory predicts. Figure 3, Curve A, shows the calculated gain of the r.f. transformer, while Curve B shows the measured value. The measured values were obtained by applying a voltage of about .05 volts at the desired frequency, between points 1 and 2 (Figure 2) and measuring the output signal with a vacuum-tube voltmeter. At the high frequencies the two values obtained are considerably different, while at the low frequencies the discrepancy is less marked. This is probably due to the fact that the capacity in the amplifier tube, plus the distributed capacity of the primary, acts as a shunt across the primary winding, by-passing some of the r.f. current. This would also account for the fact that the experimental curve is not a straight line.

This experimental curve shows a ratio of gain of 30 to 71, or .423 to 1. Therefore, if the total gain in a tuner compris-

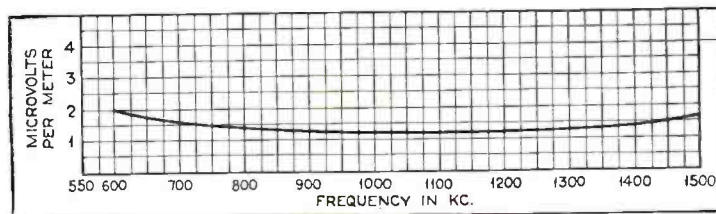

THE OVERALL R.F. AMPLIFICATION

Figure 6. The combination of the characteristics of the tuned stages and the single untuned stage results in a relatively flat curve for the complete tuner and provides maximum amplification through the middle portion of the band

us call the mutual conductance, which is the amplification factor divided by the plate resistance, σ . Then equation 1 becomes:

$$\frac{e_o}{e_p} = \frac{\sigma \tau \omega L_1 \sqrt{L_1/L_2}}{L_1 \omega \tau^2 + \tau_{12} R_p} \quad (2)$$

*See "An Efficient Tuned Radio Frequency Transformer," by F. H. Drake and G. H. Browning, Institute of Radio Engineers, 1925, page 767.

In practically all cases where the -24 or

ing two tuned stages and a band-pass stage of r.f. amplification is to be equalized, some device must be employed that will give a great deal more gain on the low frequencies. Consideration of the problem immediately suggested an untuned stage of amplification as shown in Figure 4, for by choosing various values of inductances and coupling capacities almost any desired curve could be obtained. By utilizing various values which gave the approximate curve desired, and measuring the total amplification of the tuner, the one best equalizing the gain was determined.

Poland Broadcasts

(Continued from page 484)

power amplifiers connected in cascade. The oscillating system is of a new and ingenious design that permits keeping the frequency of the transmitted energy constant within extremely narrow limits but at the same time allowing frequency changes and adjustments of the circuits to be made with ease. The variation in frequency is claimed to be less than one part in a million. The radiation of harmonics from the antenna is prohibited through the use of special harmonic filters of intricate design inserted between the aerial and the transmitter itself. The plate supply to the tubes is accomplished from an alternating current power line using a mercury arc rectifier with a rather standard British filter system.

The new station was built for Polskie Radia, the Polish broadcasting company, by the Marconi Wireless Telegraph Company, Ltd., of England.

It is interesting to note that here is one of the first European stations to be built employing almost exactly the transmission scheme proposed by Lt. Wenstrom in recent issues of RADIO NEWS. It will be remembered that this proposed system called for high power and a wavelength high enough so that an area of many hundreds of miles could be covered by direct transmission without fading.

The new Warsaw station with its remarkable success during only a short period of operation seems to justify many of the claims made for stations of extremely high power and high wavelength. The fact that distance reception can be obtained from such a station with only a simple receiving set is significant during these times when receivers, economical in cost, are being so widely accepted by prospective listeners.

Backstage in Broadcasting

(Continued from page 505)

of bitterness. But much ire is aroused whenever a network star is snatched by the competing chain. In recent months CBS scored two important victories over the NBC by obtaining Kate Smith and the Boswell Sisters. But it did not take the NBC long to retaliate—and strongly at that—by snatching Jesse Crawford, one of the Nation's best-known organists, from the CBS roster, and also by swerving Station WMAQ, the Columbia Chicago outlet, into the NBC family. Crawford recently completed his fifth year with the Paramount Theatre in New York. The strange part about the whole affair is that the Paramount-Publix Corporation owns a large share of the CBS and Crawford's ether offerings are now being aired over the NBC direct from the key theatre of the Paramount chain. Crawford was born in Woodland, California. He started playing the organ in Spokane, Washington, eighteen years ago. After several years of movie theatre work on the West Coast.

**NEW CIRCUIT
GREATER EFFICIENCY
LOWER PRICES**



NEW I. C. A.
Envoy Longfellow

200 to 2000 Meters
A.C. or D.C. Current
This is the all range, world wide reception model of our famous Envoy Receiver. The turn of a knob switches you from intermediate to long wave enabling you to listen in on the world.

I. C. A. constructed throughout, that means superior workmanship, electric and mechanical efficiency and greater selectivity and volume.

NEW **ICA** 1932

ENVOY

200 to 600 Meters—A.C. or D.C. Current
The use of screen grid power detector in connection with a Pentode power output tube, resistance coupled to the detector, gives superlative tone quality and greater power handling capacity for considerably more volume without distortion.
This is only one of the many new features of the new Envoy at new lower prices.

NEW AND IMPROVED

I. C. A. CONQUEROR

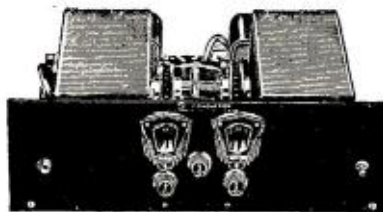

SHORT AND LONG WAVE
RECEIVER AT
REDUCED PRICES

14 to 1,000 Meters
Thoroughly modern throughout employing the new Pentode and Variable-Mu tubes in an entirely new circuit that far surpasses last year's model. Provision is made for ear phone jack and phonograph connection. The circuit comprises one stage of tuned radio frequency, regenerative detector, one stage straight audio amplification and Pentode output.

Models for A.C. or D.C. Current—110-220
Volts and for Battery Operation

We call particular attention to the D.C. Model. No other manufacturer offers a short wave receiver that can be operated from a D.C. line circuit, 110 or 220 volts. All models I. C. A. constructed throughout and guaranteed for workmanship and electrical and mechanical efficiency.

SEND FOR NEW 44-PAGE FREE CATALOG

The new I. C. A. 44-page catalog illustrates, describes and prices the world's most complete line of Radio and Television Sets, Parts and Accessories. Write for your copy today.

INSULINE CORPORATION OF AMERICA
23-25 Park Place Cable Address "INSULATING" New York City, U. S. A.

ALUMINUM BOX SHIELDS

Genuine "ALCOA" stock, sliverly finish, 5x7x3 \$1.50
—Current size \$4.65, 10x12 1/2 size \$2.25, 5x2 1/2
Coil Shield (like picture on the right) \$1.00. Any size
to order.



"BUDDY" Test Prod Always sharp pointed, using photograph needles, 4-ft. wire, spade or phone tips. Colored rings identify each lead. \$1.50 pair.
We can furnish all parts for the Set Tester Dr. Luze described in October Radio News.

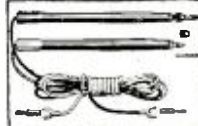

Burgess Vacuum Contacts in Stock.

Yaxley 7-Wire Connector, Male and Female, for 89c

We specialize in parts exclusively. We can furnish everything described in this magazine. Give us a trial. Please include postage.

BLAN, the Radio Man, Inc., 89 Cortlandt St., Box N12, New York City

SOUND SYSTEMS

NEW MODELS **Amplex**

Portable and permanent equipment for the smallest or largest indoor or outdoor installation. AMPLEX matched units assure better results at lower costs than any other known system. And AMPLEX engineering counsel is gratis. Send us your problems. Responsible, experienced men and organizations can build big profitable sound systems business with AMPLEX assistance. Write in detail to our General Manager.

AMPLEX INST. LABS.
132-T West 21st St. New York City

MAKE \$10,000

A year raising rabbits for us. We pay up to \$12.00 each for all you raise. Send 25c for full information and contract, everything explained. Send at once and find out about this big proposition we have to offer you.

THE EASTERN RABBITRY
Route 1, Box 236 New Freedom, Pa.



SAVE SERVICE TIME and MONEY

TRUVOLT RESISTORS. with adjustable clips, mean quicker service and fewer parts to stock. All standard sizes.

Write Dept. RN-12 for Catalog

175 Varick St. New York, N.Y.
ELECTRAD

Mathematics in Radio

(Continued from page 491)

SPEED TELEVISION TUBES

The practical tube for advanced Television reception. The "wall-electrode" construction is an absolutely new departure in Neon tube design. It increases both the picture detail and the efficiency of the tube. Designed for use in modern Television receivers.



\$3.50

AT YOUR DEALERS

Otherwise send purchase price and tube will be sent postpaid.

Manufactured by

CABLE RADIO TUBE CORP.

230-240 N. 9th St., B'klyn, N. Y.

TELEVISION DIVISION

cases of about 10,000 ohms. The resistance r_o has been given a value of 100,000 ohms.

If the current and voltage waves of the circuit of Figure 5 be plotted, they will take the relative shapes of those represented in Figure 6. The current and voltage in this case are said to be "in phase"; that is, they are both zero at the same instant, reach their maximum positions at the same instant, and so throughout the entire cycle have the same phase.

In considering the circuit of Figure 5 a little further, it is seen that the plate current of the tube can be expressed as follows:

$$i = \frac{e}{r_p + r_o}$$

and the voltage drops around the circuit are such that the drop across r_p is ir_p and that across r_o is ir_o . Since r_o is ten times the value of r_p , a considerably greater voltage will be developed across it, and thus an amplified voltage will be available for the grid circuit of another tube. This relation of the output resistance r_o to the tube resistance r_p is an important one and is fundamental in showing the more complicated relation of an impedance in the plate circuit of vacuum tubes.

Let us consider the tube circuit of Figure 7, where an alternating e.m.f., "e_g," is impressed upon the grid circuit of a vacuum tube but where the plate circuit is closed through the primary of a transformer, in this case an audio-frequency transformer. The secondary of the transformer may have a total number of turns 2 to 5 times as great as the primary turns and, therefore, will have 2 to 5 times as much voltage as the primary. This circuit can be replaced by the circuit of Figure 8, and it is the function of the design of X_L to be such that its impedance is very large compared to the plate resistance of the tube r_p .

In considering the primary circuit of Figure 8, it is known that the current lags behind the voltage and the degree with which the current lags the voltage is dependent upon the magnitude of the reactance X_L . It is stated that the current lags behind the voltage by the angle θ , which is determined by the relation—

$$\cos \theta = \frac{r_p}{Z} \text{ or } \tan \theta = \frac{X_L}{r_p} = \frac{2\pi fL}{r_p} = \frac{\omega L}{r_p}$$

Let us study these relations from the standpoint of trigonometry so that they will be more completely understood. Now the current flowing in the primary circuit of Figure 8 is dependent upon the values of e , r_p , X_L and the frequency f . We know that the reactance X_L is expressed as follows:

$$X_L = 2\pi fL = \omega L$$

Suppose that the inductance L of the primary of the transformer has a value of 100 henries, which it may have in a well-designed transformer. The frequencies which are of interest in ordinary radio receiving sets for the audio-frequency range are from 50-5000 cycles, and taking a relatively low frequency of 100 cycles per second, the reactance X_L

is as follows:

$X_L = 2\pi fL = 2 \times 3.1416 \times 100 \times 100$ which gives a value of 62,800 ohms. Thus the reactance of the primary is a little over six times the resistance r_p of the tube.

Let the current i , through the primary

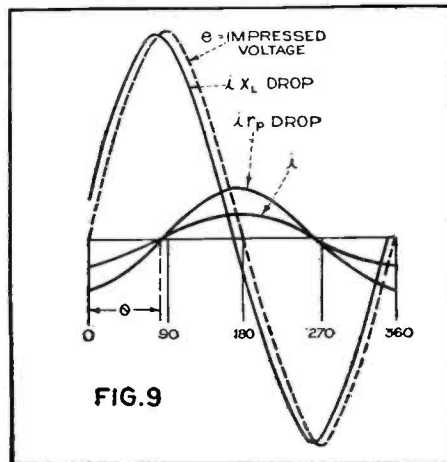

FIG. 9

circuit of Figure 8, be expressed mathematically as follows:

$$i = I_m \sin x$$

This is plotted in Figure 9 and it is noticed that its beginning at zero is approximately at 81° . This can be shown in one way from the formula that the tangent θ is equal to the reactance ωL divided by the resistance r_p . It is remembered that " ω " is equal to $2\pi f$. It has been shown that ωL is equal to 62,800 ohms and r_p is equal to 10,000 ohms, so that—

$$\tan \theta = \frac{62,800}{10,000} = 6.28$$

Referring to an electrical handbook and

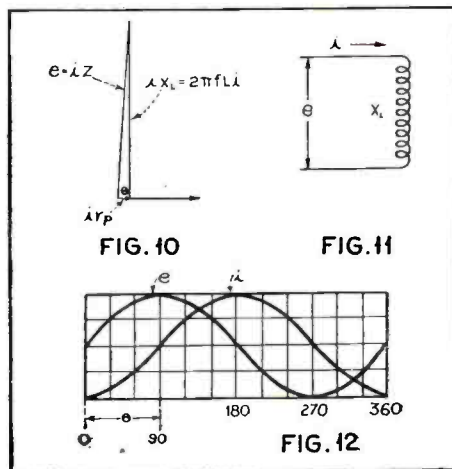

FIG. 10

FIG. 11

FIG. 12

turning to the trigonometric tables, it is seen that when the tangent is equal to 6.28 the value of the angle θ is approximately 81° . Now a sine wave current flowing through the circuit of Figure 8 will produce a sine wave of voltage across the resistance r_p , and the drop across the resistance can be expressed in the trigonometric way as follows:

$$i r_p = I_m r_p \sin x$$

(Continued on page 528)

New **1932**

Acratone

5-tube triple Screen Grid-Pentode
Loftin-White Amplifier—Phonograph Pick-up
jacks—Rola Dynamic—No aerial
or ground necessary—the most
sensational Midget on the Market,
now \$19.85 with Acratone tubes.
Also 6-tube Super at \$23.50 less tubes.

\$16.65

Send for 56-page Tabloid Catalog.

Federated Purchaser

25 Park Place, Dept. A New York, N. Y.

Massachusetts Radio and Telegraph School

18 Boylston Street, Boston

Send for Catalogue

Tel. Hancock 8184 Established 1905

Amateur Transmitter

(Continued from page 483)

such as has been adopted for this transmitter, to the American amateur. Prior to that year, "high c" circuits were being used with much success by our Antipodal brothers. Upon publication of this idea, the writer incorporated it in a new tuned-grid-tuned-plate transmitter, then under construction.

This idea of using as little inductance and as much capacity as possible in a tank circuit did everything Mr. Hull claimed for it. It produced a note and steadiness found only in crystal controlled transmitters and completely eliminated "wobulation" of the transmitted signal. It made a signal which was sharp, clean-cut and stable. In other words, it gave the effect of crystal controlled operation with the added flexibility of being able to change frequency at a moment's notice.

Since then, "high c" tanks have been used at W2WK-W2APD. Sixty-four foreign countries distributed over the six continents of the world have been contacted, four continents on voice. Naval Reserve work was carried on with signal quality that won the praise of Lieut. Reinartz, W1QP, who operates the Master Control Station (NDF) of the Third Naval District. All this above-the-average work was done from a location in the heart of New York City, one which is considered poor for work on the higher frequencies. Never was an input of more than 80 watts used on the 552 tube.

The Frame

In discussing the construction of the frame which is the first step in building the transmitter, care should be taken that all dimensions, as given in Figure 2 and

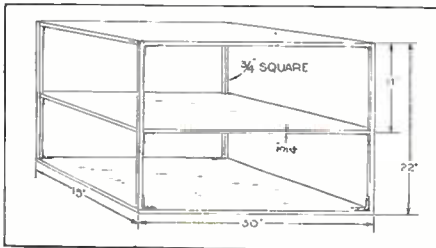

THE WOOD FRAMEWORK

Figure 2. The transmitter described here is confined to the top shelf. The lower shelves will be used for the power supply and later additions to the transmitter

in the text, are strictly adhered to. Although from all outward appearances this large space is not now needed, our finished outfit will utilize every available bit of room.

There will be no panels on the transmitter. It has been found that panels only serve their purpose in providing a convenient mounting place for meters and condensers. Often, such a procedure is more harmful than practical. A panel obstructs a full view of equipment—and sometimes disastrous things happen to equipment when not kept under observation. It is a good transmitter which has its equipment in a position

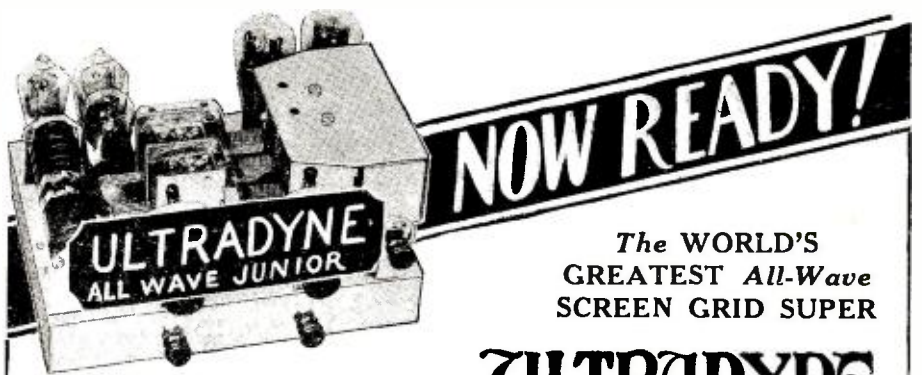

The WORLD'S
GREATEST All-Wave
SCREEN GRID SUPER

ULTRADYNE

The set you have long waited for

The Ultradyne L-33 Junior is now ready, completely wired and assembled at the factory for you. This is the only set of its type that covers the entire wavelength from 15 meters up to 600 meters.

The Ultradyne is a shielded 8-tube chassis and is particularly adapted to the American broadcast, European short wave, police calls, trans-oceanic telephones, ships at sea, aeroplane and airport stations, experimental stations, long-distance reception; in fact, it includes every kind of a need that is possible in the reception of either speech or code signals.

The Ultradyne Junior is not a makeshift chassis nor is it a converter. This is truly a complete long and short-wave set from 15 to 600 meters all made in one chassis.

This circuit uses 8 tubes of the following types: two 235s, three 224s, one 227, one 280, one 247.

Two tuning dials, illuminated escutcheon plates, full range volume control and special switch for short-wave or the regular broadcast band.

This set comes equipped with a dynamic speaker.

List Price, Chassis and Speaker..... \$79.50

List Price, Complete with Tubes..... 94.45

THE ULTRADYNE L-32 SENIOR

We like nothing better than to induce a hard-to-convince buyer. For we know after he has made a real test with this set it will mean more recommended sales for us. If you are hard to convince, all we ask is to send 25c for a booklet which tells you how to construct and operate the Ultradyne Model L-32 Receiver. This booklet also contains life-size picture diagrams and layouts of the entire set; also, life-size wiring diagram of the entire circuit showing every wire location and connection.

The model L-32 Ultradyne, with the Dynatron oscillator, works equally as well on short waves as it does on the broadcast band.

ULTRADYNE KIT The kit contains 3 specially tested and matched Ultraformers with double compensating condensers in aluminum sealed cans, 1 special steel chassis drilled and pierced as per specifications, all ready for mounting, 3 rubber grommets and 4 coil mounting pillars and INSTRUCTION BOOKLET. NOW ONLY

\$32.50

When ordering send 25% with order. Balance C. O. D.

TRAUL RADIO CO., 1074 Atlantic Ave., Brooklyn, N. Y.



WHY SPLIT YOUR ORDERS?

We can supply you with complete standard parts needed for the RADIO NEWS TRANSMITTER down to the copper tubing and wire for the R. F. choke.

Our prices are the lowest anywhere, and we ship same day order is received from the largest radio stock in New York. We do not substitute.

Send for special kit offer on the RADIO NEWS TRANSMITTER as well as lists of our monthly radio bargains.

LEEDS RADIO COMPANY

45-N Vesey Street

New York City

1000 Pages of ACCURATE AND DEPENDABLE RADIO SERVICE DATA

John F. Rider's greatest work... is not to be confused with any other manual... It is a whole radio service library in one loose leaf volume—with FREE Question and Answer service. Rider's PERPETUAL TROUBLE SHOOTER'S MANUAL is acclaimed by the radio manufacturers—it was prepared with the co-operation of the radio receiver manufacturers—it is endorsed by the N. Y. and Philadelphia Radio Service Managers Associations... It is the radio service reference book in the most famous radio schools. Rider's PERPETUAL TROUBLE SHOOTER'S MANUAL is the greatest compilation of radio service material ever offered to the radio industry and we GUARANTEE THAT IT IS UP TO DATE.

We further guarantee that it contains ALL of the information you require to successfully service a radio receiver... We are so certain that you will be satisfied with this magnificent volume, that we sell it with a Money Back Guarantee... If you think that you can do without it, send it back and get your money... No Questions Asked. This guarantee is your protection.

Send for Descriptive Literature

RADIO TREATISE CO., INC.
1440 Broadway, N. Y. C.

Enclosed find \$5.00. Please send, postpaid, Rider's Perpetual Trouble Shooter's Manual. If I am not satisfied with the manual, I have the privilege of returning it within 10 days and getting my money back.

Please send descriptive literature and the FREE Radio Trouble Finding dial.

Name
Address
City State

RADIO TELEVISION

The good jobs in any profession are held by the better-than-average men—the men with technical engineering training.

The leaders in radio today are the men who were STUDYING radio ten years ago. The leaders in Radio and Television tomorrow will be the men who are seriously preparing today.

We offer Advanced Courses in Practical Radio and Television Engineering for the experienced radioman—complete courses in Practical Radio and Television Engineering for the less experienced radioman.

Send in the coupon for complete details TODAY.

Capitol Radio Engineering Institute
Riggs Bank Bldg., 14th and Park Road, N.W.
Washington, D. C.

Please send me without obligation complete details of the following course: (Check course.)

- Advanced course in Practical Radio Engineering.
- Complete course in Practical Radio Engineering.
- Advanced course in Practical Television Engineering.
- Complete course in Practical Television Engineering.

Name.....
Address.....

Dec. RN

where each individual part is easily accessible. This makes for instant repair, if necessary.

Three boards, of a wood which will not warp easily, 30 inches long, 15 inches wide by 3/4 inch thick are needed. Drawing boards, cut down to this size are good as they are so made as to lessen the danger of warping. Where lumber 30 by 15 inches cannot be readily obtained, two pieces 7 1/2 by 30 inches can be placed together and held in place by strips on the undersides. One of these boards which is to be used as the middle shelf should have a square of 3/4 of an inch sawed out at each corner.

Four strips, 3/4 of an inch square and 20 1/2 inches long are needed for the uprights. These should be of a good hardwood, well seasoned, since they are subject to the most strain.

The frame is first nailed together with thin wire nails. Then brass angles are placed on each upright, under the top and middle shelves and on top of the bottom shelf. These brackets should be securely screwed to the uprights and shelves. The resulting frame will be secure and rugged. It may be finished with shellac, insulating varnish, or a vegetable stain. As a final touch, rubber feet may be placed on the four uprights, if desired.

Laying Out the Parts

Too much cannot be said about the placement of parts. They should be placed exactly as shown in the model, where they have been arranged so as to lessen the effects of stray fields and provide the shortest possible leads between the parts.

A standard UX type socket is used for the 552 tube. This effects a saving in the cost of a special socket for this type of tube. The plate lead is brought to a convenient point on the plate condenser, C2, while the grid lead is brought to a binding post as shown on the photographs. In eliminating the regular transmitting socket, our grid and plate leads are materially shortened.

Most of the equipment is mounted on General Radio stand-off insulators. This provides a minimum of loss and keeps the apparatus out in the open. Another feature of using these insulators is that they bring the coils and variable con-

type and will safely stand the voltage encountered here. A .0005 mfd. receiving condenser is used in the grid tank since a transmitting condenser of the double spaced type is not necessary in this circuit. A Cardwell transmitting condenser, type 164-B, with a maximum capacity of .00022 mfd., C4, is used in the antenna feed wire proper.

Both the grid and plate stopping condensers, C5 and C6, are fixed condensers, with a voltage rating of 5000 to provide an ample safety factor. The two filament bypass condensers, C7 and C8, are placed as near to the tube socket as possible. This eliminates a considerable amount of sparking at the key.

The filament transformer, T, is placed on the top shelf to eliminate long filament leads. A variable filament control, having a resistance of from 1/4 to 10 ohms is used (R2) to keep the filament voltage on the tube at approximately 9.5 volts. This can be checked on the O-15 a.c. voltmeter, M3, which is an essential part of the transmitter and assures long life for the tube.

The 10,000 ohm transmitting grid leak, R1, must have a wattage rating of 100 if excessive over-heating is to be avoided. An over-heated grid leak will cause the signals to "creep" and makes for unsteadiness.

The radio-frequency choke coil, RFC, can be constructed by winding 160 turns of 26 gauge d.c.c. wire on a 3/4 inch diameter form. This choke is not very critical at this point. Any commercial r.f. choke designed for use with this tube can be used, if desired.

The Coils

The coils are hand wound, using pieces of iron pipe as the temporary winding forms. Soft drawn copper tubing is used. Care should be taken in winding since copper tubing has a tendency of flattening out if bent sharply. Turns need not be spaced while winding. The edge of a screw driver can later be used to separate them. When the coils are completed the two ends of each coil are flattened and drilled to fit over the screws on the stand-off insulators.

The following table should be followed very closely if the right frequencies are to be covered:

Band		Copper Tubing Outside diam.	Inside Diam. Coil	Number of Turns
3500 k.c.	plate coil L2	3/8 inch	3 1/2 inches	nine
	grid coil L1	1/4 "	2 3/8 "	thirteen
7000 k.c.	plate coil L2	3/8 "	2 3/8 "	five
	grid coil L1	1/4 "	2 3/8 "	five
14000 k.c.	plate coil L2	3/8 "	2 3/8 "	two
	grid coil L1	1/4 "	2 3/8 "	two
28000 k.c.	plate coil L2	3/8 "	2 3/8 "	one
	grid coil L1	1/4 "	2 3/8 "	one

densers up near the leads on the tube and thereby shorten these leads.

Two Cardwell transmitting condensers, type T-199, each having a total capacity of .00033 mfd. are placed in parallel (C2, C3) to provide the high capacity necessary for the "high c" tank circuit. These condensers are the double spaced

The antenna coil, L3, is wound on a bakelite form with a diameter of 2 1/2 inches. The form should be approximately 3 1/2 inches long. 25 turns of No. 14 d.c.c. wire are used, with no spacing between the turns. A hole, large enough to fit over the screw in a stand-off insulator is made in one end of the tubing.



GET THIS
Free new No. 22. Edition of our greatly enlarged **RADIO SERVICE TREATISE**. Every radio man must have it. Contains some 75 new hook-ups, circuit diagrams, over 250 illustrations. **POSITIVELY THE GREATEST BOOK EVER PUT OUT BY ANYONE.** Editorial contents: VACUUM TUBE TREATISE, with many illustrations; Vacuum Tube Average Characteristics Chart; How to Take Care of Your Tubes. How to Connect Photograph Pick-ups; Improving Tone Quality of Old Sets; Connecting Additional Loud Speakers; all fully illustrated with diagrams. Other articles: Modernizing Old Radio Sets; How to Convert Battery to Power Sets; Selection of Tubes; Push-Pull Amplifiers; Replacing Audio Transformer; Phone Attachments; How to Choose Power Transformers; Voltage Dividers; Wattage of Power Transformers; Selecting and Installing Resistor Parts in Radio Sets; Filter Condensers; Repairing Blumhorst, etc.

WRITE TODAY. Enclose 2 cents for postage. Treatise sent by return mail.

RADIO TRADING CO.
27 West Broadway New York City

How to Obtain A Better Looking Nose
Improve Your Personal Appearance



My free book tells you how I guarantee to improve the shape of your nose by remodeling the cartilage and fleshy parts, quickly, safely, and painlessly, or refund your money. The very fine, precise adjustments which only my new patented Model 25 Nose Shaper possesses, make results satisfactory and lasting. Warn night or day. Over 100,000 users. Send for free book to

M. TRILETY, Pioneer Nosesaping Specialist, Dept. 287 Binghamton, N. Y.

MOVIES In Your Home

Our marvelous, practical Movie Machines sell as low as \$5.00 post-paid. Also finest 16 mm. cameras and projectors at factory prices. A complete line of both standard and 16 mm. film available at low prices with exchange service. Write for big, FREE catalogue.

PARAMOUNT MFG. CO. Dept. P-11 Boston, Mass.



With the coil mounted as shown in the photographs, it can be swung from side to side to vary the antenna coupling.

Regarding the antenna coil, it has been found that, by coupling a Hertz or Zepelin antenna directly to the plate coil, approximately the same current is produced in the antenna. This method of antenna coupling does not, however, give as good a tone or as sharp a signal. The 25 turn antenna coil will be found to work best with almost any type of antenna system.

The Wiring Details

In wiring the transmitter, it must be remembered that the tank circuits are subject to a high current load. Poor soldering work or hook-up wire which is not heavy enough will impair the operation of the circuit. A No. 10 wire should be the smallest used, with two of these wires twisted together to be used in connecting the coils to the variable condensers and to their respective circuits. Quarter inch copper tubing is ideal for r.f. connections and was employed in the model shown in the photographs.

Again stressing the need for short leads, one must be cautioned against the use of right-angle leads. It must be remembered that it is better to have a transmitter that works well rather than one that is prettied up with tricky wiring.

The List of Parts

C1 Cardwell type 123-B receiving condenser, max. cap. 500 mmfds.

C2, C3 Cardwell type T-199 transmitting condensers, max. cap. 330 mmfds.

C4 Cardwell type 164-B transmitting condenser, max. cap. 220 mmfds.

C5 Aerovox .00025 mfd. fixed mica transmitting condenser, 5000 volt breakdown.

C6 Aerovox .002 mfd. fixed mica transmitting condenser, 5000-volt breakdown.

C7, C8 Aerovox .002 mfd. mica fixed receiving type condensers.

L1, L2, L3 9 transmitting coils, (see text).

M1 Weston model 301P D.C. plate milliammeter 0-300 mil. range.

M2 Weston model 425 R.F. Thermo-Ammeter, 0-3 amp. range.

M3 Weston model 476 A.C. Filament voltmeter, 0-15 volt range.

R1 Electrad 10,000 ohm center-tapped grid leak, 100 watts rating, mounted.

R2 Clarostat super power filament control.

RFC Radio frequency choke coil (see text).

T1 Thordarson type T-2383 12 volt filament transformer, 175 watts.

- 1 Air-gap UX tube socket.
- 1 DeForest type 552 transmitting tube.
- 14 General Radio stand-off insulators.
- 1 Bakelite knob.
- 3 4" Bakelite dials.
- 1 Binding post strip with 6 Eby posts.
- Assorted hook-up wire or copper tubing, hardware, misc.

THE NEW EMC SIMPLICITY TEST PROBE

PRECISION MADE



As a result of the generous reception given the Simplicity Test Probe in this country and abroad, a startling reduction in price has been made. Increased production and new sales methods have made this possible.

The EMC "Simplicity Test Probe" for Service Men and Dealers fills a long-felt need for a fast and efficient testing device of vest-pocket size. Also, it is the lowest priced testing instrument of real value and quality on the market.

In receiving sets most defects are due to causes of standard nature, which the Simplicity Test Probe locates at a great saving of time and money. Given below are ten of the things it will do without disturbing a single set connection, and which are of great value to you.

1. Locates open or shorted by-pass and filter condensers.
2. Locates burned-out resistors and wiring.
3. Checks presence of filament or heater voltage.
4. Tests continuity of all low resistance windings.
5. Checks correctness of tuning coil polarity.
6. Tests for breaks in tuning-coil windings.
7. Checks shorts in variable tuning condensers.
8. Gives visual resonance indication in aligning condensers.
9. Tests for high voltage and low current with neon tube.
10. Makes a very handy radio or automobile trouble light.

The EMC Simplicity Test Probe is made of a polished red and black dielectric material, neatly engraved in gold, and looks exceptionally attractive and professional. It is a real quality product built for a lifetime of service, and an instrument you cannot afford to be without. The Simplicity Test Probe is guaranteed and comes with standard lamp, eighteen inch cord, test clip, and complete instructions. The size is 7/16" x 7".

\$1.50 NET

Sales at the reduced price of \$1.50 each net are now made direct from the factory. Send your check or money order to us at the address below and get one of the most valuable testing instruments on the market today. The net price outside of the U. S. A. is \$2.00.

ELECTRICAL MANUFACTURING CORPORATION
10 HIGH STREET
BOSTON, MASS.



Transformers for Pentode Circuits

AMERTRAN engineers have designed three output transformers for use with the new 247 Type Pentode power tube. And these pentode transformers, like the 37 various types of AmerTran Audio transformers are constructed to live a longer, more useful life—with perfect fidelity of tone.



For perfect satisfaction—demand AmerTran equipment—it assures you the best—always.

American Transformer Company

Factory and Main Office —
178 EMMET STREET
Newark, N. J.

New York Office
Room 1963
HUDSON TERMINAL
50 Church Street

Write for Bulletin 1000 containing complete information of AmerTran Output Transformers.

Proven Television

NOW

ONLY \$19.75



Price of scanning disc alone \$2.50

SEE-ALL Televisor Kit

No need to wait any longer to enjoy modern television when SEE-ALL offers proven equipment at such low prices.

Less than 20 minutes required to assemble it.

All essential parts and simple instructions to assemble a fool-proof televisor included.

SEE-ALL Short-wave Receiver lists for \$39.50 less tubes.

At your dealers otherwise send purchase price for delivery postpaid.

TELEVISION MFG. COMPANY OF AMERICA, INC.
5 UNION SQUARE NEW YORK CITY

Now Ready! THE BOOK THAT THOUSANDS OF MEN HAVE WAITED FOR

RADIO and ELECTRONIC DICTIONARY

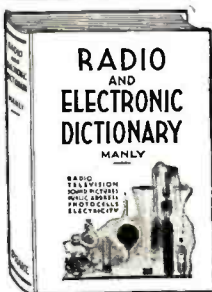

Right up - to - the - minute with definitions of the words and terms used in all branches of radio, including service work, aviation, navigation and industrial control—photo-electricity and photo-cell applications—sound pictures—public address systems—television—telephotography—electricity and magnetism. No longer need ambitious men, who are engaged in any branch of radio service work, be handicapped because they have no means or facilities for keeping up with the new words and terms used in radio and the electronic field. The **RADIO AND ELECTRONIC DICTIONARY**, just published, gives you, at your finger tips, 3800 practical definitions which you must know to insure your success and win promotion to even better jobs in radio. 550 specially made illustrations help to simplify difficult points. Get your copy now—only \$2.50. It's an indispensable handy guide for the beginner and experienced radio man alike. Order it today. Your money back if not pleased.

Size 6 x 9 Inches. 300 pages. 550 illustrations. 3800 definitions. Price Only \$2.50

FREDERICK J. DRAKE & CO.
185 NORTH MICHIGAN AVENUE. CHICAGO
Drake Books are for sale at all Booksellers

R. C. A. No. 103
MAGNETIC SPEAKERS
at \$3.50 ea.
Hundreds of other like values in our new catalog. Write for it.
STUYVESANT ELECTRIC CO.
53 WALKER ST. N. Y. CITY
Phone CAnal 6-1688-1689-1690

Vacuum Tube Aids Hard-of-Hearing

(Continued from page 468)

a single tube and transformer may be anywhere from six to twenty-five times. When a single tube is used with a microphone and earpiece having approximately the same sensitivity as those employed in the "telephone" type of hearing device, it naturally follows that the instrument will be far more helpful, particularly to those who are very hard-of-hearing, than one which cannot provide this high degree of amplification. Even for the moderately hard-of-hearing, the vacuum-tube device has the advantage that its volume

can be regulated to provide just the amount of amplification necessary under any given conditions. There are many deaf persons, for instance, who, with the aid of telephone-type earphone, are enabled to hear ordinary conversation, but where the conversation is very low in volume or the person speaking is some distance away from the listener, there are bound to be numerous occasions when much of the conversation will be missed. With a vacuum-tube hearing aid, it is necessary only to turn up the volume control to make even the lowest-toned conversation clear and understandable.

The Vactophone employs only a single vacuum tube. Experiments conducted, using two such tubes, did not prove particularly satisfactory, because the amplification obtained in this manner was so great that complications arose, particularly in the matter of a high noise-level. If a less-sensitive microphone were used, two vacuum tubes could be used to advantage, but the equipment is both more compact and lighter in weight where a single tube and a sensitive microphone are combined.

As will be seen from Figure 1, the Vactophone consists of a microphone, M, which feeds into the grid of a vacuum tube through a coupling transformer, T. The output of the vacuum tube is connected to an earpiece, E, or headphone.

Mathematics in Radio

(Continued from page 524)

This is plotted in Figure 9.

Now the current flowing through the circuit will produce a voltage across the reactance X_L , and this drop can be expressed trigonometrically as follows:

$$i X_L = I_m X_L \cos x$$

This is plotted in Figure 9 and it is noticed that when the current i is zero or minimum, the iX_L wave is maximum, and also that when the iX_L wave is zero, the current i is maximum. It will be recalled that when two waves were plotted showing the relation of $\sin x$ and $\cos x$ that this same condition existed. The reason for this in the circuit of Figure 8 is quite readily shown by the use of calculus, but can also be understood from the following consideration. Take the circuit of Figure 11, where the current is flowing through a pure reactance X_L . The current in such a circuit will lag the voltage by 90° , and this is represented graphically in Figure 12. The current curve i is expressed by $I_m \sin x$ and the voltage "e," which also represents the voltage drop across the reactance, is expressed by $I_m X_L \cos x$. Thus, the same condition is indicated in the graphs of Figure 9.

In studying further the graphs of Figure 9 it is seen that in order to represent the impressed voltage e it is only necessary to add the two graphs of the iX_L drop and the $i r_p$ drop. We know that this is true, since from Kirchoff's Laws the sum of the voltage drops around a circuit is equal to the impressed voltage. The impressed voltage e then can be expressed mathematically as follows:

$$e = I_m r_p \sin x + I_m X_L \cos x$$

This is shown by the dotted line of Figure 9 and it is noticed in the final analyses that the current i lags the voltage e by the angle θ .

This relation is still more clearly seen from the vector diagram of Figure 10. Let the current be represented by the horizontal line i , of Figure 10, and then the $i r_p$ drop can be represented as shown in phase with the current. The reactance drop iX_L is shown by the vertical vector, 90° ahead of the current, and it has a magnitude of approximately 6 times the $i r_p$ drop. The vector iZ represents the resultant of the two vectors $i r_p$ and iX_L . The amount by which the current lags the voltage is indicated by the angle θ .

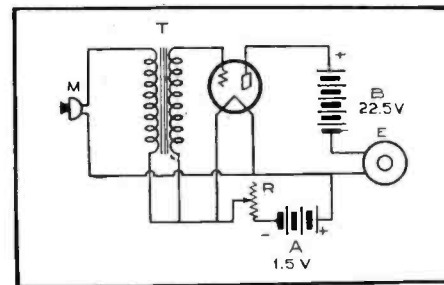

THE CIRCUIT DIAGRAM

Figure 1. The circuit employed shows a typical one stage microphone amplifier

A single battery, A, provides the filament current for the vacuum tube as well as the microphone current. A second battery, B, provides the plate voltage for the vacuum tube. Volume is controlled by means of the rheostat, R, which varies both the filament current and the microphone current, thus providing dual control.

The circuit represents a standard single-stage, vacuum-tube amplifier. Its main difference from the amplifier circuits used in radio sets is the low plate voltage, which in this case is limited to a single $22\frac{1}{2}$ -volt B battery.

The microphone operates on $1\frac{1}{2}$ volts and draws a current of between 10 and 20 milliamperes. The A battery consists of ordinary flashlight batteries, four of which are connected in parallel. The plate battery is a standard small-size B battery, such as is commonly used in portable radio sets. The fact that both A and B batteries are of standard size and make is an important feature to users

of the instrument, because it means that replacement batteries may be readily obtained in any locality, in radio stores, hardware stores, drug stores and even in the "five and ten."

The tube employed in this equipment is the so-called "peanut" tube, more properly known as the Western Electric type "N" tube. This tube is not generally available except from the manufacturers of the Vactuphone direct. This is not a serious drawback, however, as in the majority of cases it probably will not be necessary to replace the tube more than, perhaps, once a year.

The front view of the device conveys a good idea of its size. Referring to Figure 2, the microphone is at the right, behind the recessed wire screen, and to its left is the knob, also recessed, by means of which volume is regulated. The headphone, with headband attached, is seen at the right.

Figure 3 is an inside view of the Vactuphone. The microphone is in the lower right-hand corner and directly behind it are the four flashlight cells which provide the microphone and filament currents. The upper contacts, by means of which the four cells are connected in parallel, will be seen on the under-side of the wood cover. These take the form of a four-point, phosphor-bronze spring, which, when the cover is placed in position, presses down on the center terminals of the batteries and also on the coil-spring, which is seen between the batteries.

In the center compartment will be seen the rheostat at the bottom of the case. Above it is the peanut tube and above that is the microphone transformer. Just to the right of the tube is the terminal block to which the headphone and microphone connections are made. The B battery is seen at the extreme left of the case. Above it, on the cover, will be seen another phosphor-bronze spring, the purpose of which is to hold the B battery snugly in place.

Figure 4 shows the unit "open" but with the sub-cover in place. This sub-cover is the one which carries the spring contact described above. There is a space between the sub-cover and the outside cover, provided as a carrying place for the headphone and headband when the outfit is not in use. This is an attractive feature, because it makes the instrument entirely self-contained.

From the illustrations it will be seen that this hearing aid is extremely compact, considering the service it renders. As a matter of fact, it is only slightly larger than some of the telephone type hearing devices now on the market. It measures 7½ inches in length by 4¾ inches in height by 4 inches deep and weighs 4½ pounds, including the headphone. It cannot be exactly termed an inconspicuous instrument, but neither can any of the electrical hearing aids, with the exception of the pocket type. On the other hand, it certainly presents a vastly improved appearance over the old ear-trumpet on which deaf persons had to depend not so many years ago. At the same time it provides immeasurably increased satisfaction to anyone afflicted with deafness.

That this latter statement is no idle

(Continued on page 530)

You Need Long Quality for Short Waves



Hammarlund Wide-Spaced Short-Wave Condenser. In three desirable capacities: 150, 125 and 100 mmf.



Hammarlund Shielded Polarized Choke. High inductance, low distributed capacity.



Hammarlund Vibration-proof Midget Condenser. 20 to 325 mmf. Many new features.

TICKLISH business—this short-wave tinkering!

Every detail must be so much more carefully worked out than ordinarily, if *real* results are obtained.

That's why seasoned experimenters rely more and more on Hammarlund parts. Hammarlund's more-than-thirty-years' experience in precision engineering stands out conspicuously in every Hammarlund Product.

Play safe—build *your* short-wave receiver with Hammarlund Condensers, Coils and Chokes. Write Dept. RN-12 for circular, showing sizes and values.

HAMMARLUND MANUFACTURING CO.
424-438 W. 33rd Street, New York

For Better Radio
Hammarlund
PRECISION
PRODUCTS

ATTENTION: Radio Servicemen !
Take Pride in Your Work
USE ONLY THE FINEST CONDENSERS

FLECHTHEIM
SUPERIOR CONDENSERS

SAVE

MONEY
WORRY
REPUTATION

THE CHOICE OF
2 of every 3
BROADCASTING STATIONS
in the U. S. A.

Fixed Condensers in all standard capacities in 200, 400, 600, 1000 volt ratings—
TRANSMITTING UNITS in 1000, 1500, 2000, 3000, 5000 and 7000—V. D. C.
SOLD BY RELIABLE JOBBERS and MAIL ORDER HOUSES EVERYWHERE

Write for interesting catalogs No. 23 and No. 24

A. M. FLECHTHEIM & CO., Inc. 138 Liberty Street NEW YORK, N. Y.

\$16⁶⁵ **COMPLETE** **NOTHING ELSE TO BUY**

REALIZING the acme of perfection in midget receiver design. A full size 5 tube Multi-Mu, Pentode all electric A. C. receiver. Incorporates a full size Roia Pentode Dynamic Speaker and Full Vision tuning dial definitely marking it a 1932 Radio. Distortion free reproduction with a new sense of beauty in tonal values. Housed in a cabinet of selected fine woods of a distinctive conservative finish harmonizing with the most fastidious surroundings. An improved circuit giving Power, Quality, Selectivity and Sensitivity heretofore never realized. Limited quantity on hand; 20% cash with order required. Complete with tubes. **\$16.65**

Over 2000 more values equally as great, listed in our new 64 page catalog. Your copy is ready now. A postcard brings it.

RADIO SURPLUS CORP.
NO. 56 VESEY STREET NEW YORK

FULLY GUARANTEED

No P.A. system
is "up to snuff"
without FOX



With a Fox Ram's Horn
and Fox Dynamic Units
you can hold the
crowd.

Fox equipment is
guaranteed to improve
any indoor or outdoor
system in both volume
and tone quality.

Write for prices and specifications



FOX

Engineering Co.
388-392 Dorr St.,
Toledo, Ohio,
U. S. A.

Write for your copy of our latest
Wholesale Radio Bargain Bulletin

HERE ARE JUST A FEW VALUES:

STROMBERG-CARLSON 500 Watt Power Transformer, gives
1200 volts c.t., 7.5 for 2-281'a, 7.5 for 2-250'a, 150 volts c.t. and
4 volts. Cat. No. 1011, \$4.75

THORDARSON new T-3202B 250 Watt Power Transformer, gives
1300 volts c.t., 7.5 volts in two c.t. windings, 2.5 volts at 14 amp.
Cat. No. 1001, \$5.75

Same transformer as above but delivering 200 mls. in secondary
Type T-385-T. Cat. No. 1000, \$6.95

THORDARSON Double Filter Chokes, two windings each 18
henrys, 250 mls. Cat. No. 1751, \$14.75

THORDARSON Double Filter Chokes, two windings, each 30
henrys, 125 mls. Cat. No. 1703, \$1.75

KOLSTER R-5 Dynamic Speaker with 210 power ampli-
fier and "B" supply unit, in console walnut cabinet; uses
2-281'a, 1-1010. Delivers 500 volts, full wave pure D. C. for
210 transmitter. Less tubes. Cat. No. 7525, \$10.95

DUBILIER 11 1/4 mfd. Filter Block, 3 mfd. at 1000, 4 at 500 and
4 1/2 at 160 volts. Cat. No. 2001, \$1.95

WESTINGHOUSE 1 mfd. 2000 volt Filter Condenser (4000 volt
test). Cat. No. 3061, \$2.75

BROWN & CAINE 6 mfd. Filter Condenser Block, volts tapped
at 1, 1.5, 2 and 2 mfd. 1000 volts. Cat. No. 2067, \$1.95

R. C. A. UNIRECTRON Power St., cly and 210 Ampli-
fier. Delivers 400 volts of D. C. filtered current. Ideal for
low power transmitter. If desired, 210 can be used as
modulator. Less tubes. Cat. No. 7242, \$7.50

VICTOR D. C. DYNAMIC SPEAKER CHASSIS for R-32
45, 52, and 75. Cat. No. 2067, \$5.95

AMERICAN SALES CO., R-44 W. 18th St., New York City

TELEVISION Wants Men

Wonderful openings for operators, salesmen, service and repair men
at big pay. More jobs NOW in Television and Aircraft Radio than
there are available trained men. We want ambitious beginners
and will train you to step into a good job quick. No matter what
your past experience, if you are over 18 years old and want to make
\$300 to \$500 a month in this fascinating big pay profession, write
today for full particulars.

"SID" NOEL, PRES.

FIRST NATIONAL TELEVISION, INC.,
1012 Fairfax Airport, Kansas City, Kansas.

Deaf 20 Years



But now I hear and will tell
any deaf person FREE, who writes
me, how I got back my hearing,
and relieved head noises by a sim-
ple, invisible, inexpensive method
which I myself discovered.

Geo. H. Wilson, President
Wilson Ear Drum Company, Inc.
1093 Todd Bldg., Louisville, Ky.

Radio on the DO-X

(Continued from page 479)

distance range of the radiophone is about 200 miles at 900 meters, its regular wave-length.

The long-wave receiver is a 7-tube superheterodyne set, while the short-wave receiver, Figure 3, employs 4 tubes. Although the superheterodyne receiver has a short-wave adapter, the operator usually uses the short-wave receiver. This has one screen-grid r.f. tube and a pentode output tube, the other a.f. tube and the detector are of the three-element type. The radio-compass receiver employs four r.f. stages, detector and three a.f. stages, all resistance coupled.

The man in charge of this equipment is Henry F. Kiel of Hamburg, Germany. He was never aboard a plane until he was assigned to the DO-X, but he has worked similar Debeg equipment on German vessels for the past four years. In discussing the nature of his present duties he said, "The set has to work, and work well, else we don't fly. But it does work well—all of the time. My schedule is 60 minutes an hour, sending or receiving something of importance to the plane. Radio keeps me busy to the exclusion of everything else. However, that is true of every other billet on the DO-X—the captain does not navigate and the navigator does not fly the plane; the pilot flies, but does not navigate, and so it

goes—every man does his one job and mine is radio."

When asked which set he uses most, he replied, "I stick pretty close to marine channels and so I am using the long-wave set most of the time. However, we have done some very nice work with the short-wave set and I like to use it when I can."

"How about the radiophone?" I asked.

"Who can I work?" he wanted to know. "With a little speed I can get all the weather reports I want on regular radio-telegraph schedules, and at a greater distance, which allows us to avoid storms. I find that it pays to stay with the radio-telegraph channel that gives us the desired service. However, the radiophone certainly has its uses. It helped on one occasion when radio-telegraphy failed. When we took off from Casa Verdes for Noronha, our Technical Director Berner was on a Portuguese tugboat in the harbor and wished to communicate with me. I could not work the tug operator in either German or English code. The operator tried to talk to me over the radiophone in Portuguese, but that got us nowhere. All I know of Portuguese is a few cuss words, and we finally got to using these, and it was terrible. Director Berner talks only German, but he finally took over the microphone while the Por-

(Continued on page 531)

Vacuum Tube Aids the Hard-of-Hearing

(Continued from page 529)

boast is clearly demonstrated by tests which have been conducted in and out of the RADIO NEWS Laboratory, both under actual measurement and in use by persons who are hard-of-hearing. Incidentally, the real test of any hearing device is through actual use by the hard-of-hearing. It was found in the tests made in the RADIO NEWS Laboratory that hearing aids which were actually extremely helpful to the deaf seemed entirely unsuitable to persons with normal hearing. A given type of earphone, when listened to by one of normal hearing, may seem to accentuate extraneous noise and oftentimes to present a seemingly poor sound-frequency characteristic. A person who is hard-of-hearing, listening to the same device, may find that it sounds extremely natural and is entirely quiet in operation.

In view of the importance attached to adapting the microphone characteristics to the requirements of each individual case of defective hearing, this article would not be complete without mentioning the provisions made in this instrument for this purpose. The manufacturer has available several different types of microphones, each having different sound-frequency characteristics. From this variety almost any case can be fitted with a reasonably fair degree of exactness. In actual practice it is found that three of these several types of microphones fit practically all types of deafness.

In addition to the individual hearing

aids, such as this one, which employ vacuum tubes, there is available group equipment for use in churches and other gathering places. Such equipment usually consists of a microphone, placed on the pulpit, stage or rostrum; a two-stage audio amplifier and a number of headphones, with jacks or switches located at the seats which are set aside for those who are hard-of-hearing.

For such use the equipment need not be portable and for that reason two or even more tubes may be used, together with their attendant equipment. In fact, more than one tube is made necessary by the fact that relatively insensitive broadcast microphones are normally used in this work. Where a group of persons are listening-in it is considered advisable to amplify all frequencies in approximately the same proportion, using pick-up from a microphone which has a relatively flat frequency characteristic, such as a broadcast microphone.

In one of the later articles of this series this subject of group equipment will be covered in more detail, for the benefit of service and installation men who are looking for additional fields of activity.

The next article in this series on hearing aids will appear next month and will continue the subject of vacuum-tube devices for individual use. It will provide constructional details on a unit which can be made by anyone who is familiar with radio-circuit construction.

Radio on the DO-X

(Continued from page 530)

tuguese operated the set. Then we got along fine. Everyone apologized to everyone else and we completed our communication with Director Berner."

The short-wave set is looked upon as both an emergency means of communication and a long-range set. As most of the operator's time is taken up with the long-wave outfit, the real scope and status of short waves for craft of this kind have not yet been definitely determined. Originally it was thought that this set would

course and as long as the received signals remain at a maximum the radio-compass is acting as an accurate homing device. Usually a course is selected in this manner and then the radio-compass is used only occasionally thereafter to check the "drift" caused by wind.

Most people do not know that reciprocal bearings can be taken between a radio-compass ashore and one at sea, but this is often done. As an example, there are three radio-compass stations in and around

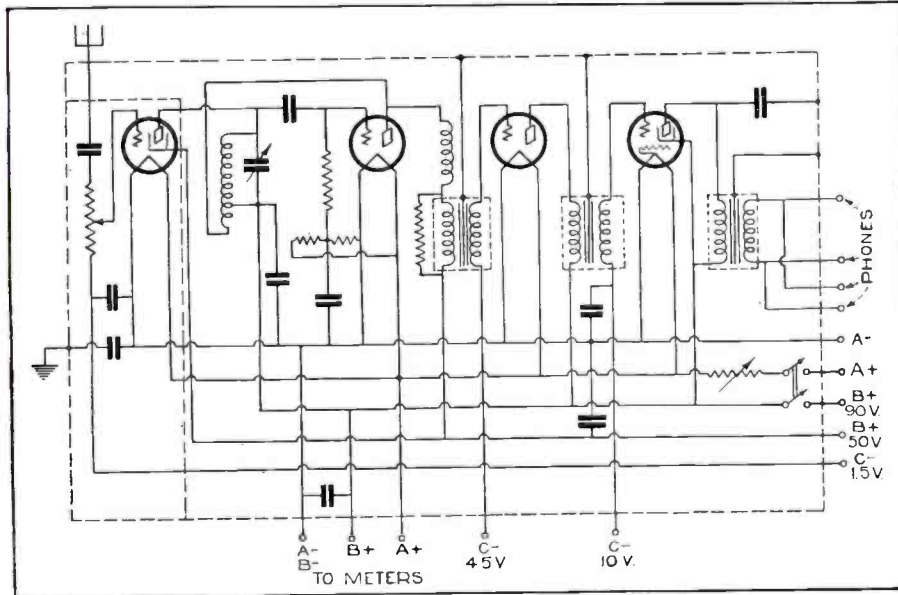

THE CIRCUIT OF THE S. W. RECEIVER

Figure 3. The receiver employs four tubes including a blocking tube, regenerative detector and two audio stages, the last with a pentode tube

be used to work German ports from any part of the Atlantic, but it has not been considered necessary or even desirable to develop this procedure. If DO-X type planes are used to establish a transatlantic air service, a second operator may work a regular short-wave schedule on the crossing. At present the radio-compass is used whenever the operator is free from routine long-wave traffic.

The value of the radio-compass cannot be overestimated. Because of the speed of travel of aircraft and the shifting, high-velocity wind currents, navigation is not easy. The navigator must be taking sights of celestial bodies constantly to make certain that the most direct course is being followed. Many times these sights cannot be taken when desired on account of poor visibility. Bearings are then taken by radio on as many transmitters of known location as possible. Two or more such bearings taken simultaneously allows the navigator to plot a "fix" or known position on his track chart. A series of bearings on a single short transmitter constitutes an accurate "line of bearing" to follow or for guidance. If it is desired to head for a certain port the radio-compass loop is set so as to point directly fore-and-aft and the plane slowly swung right and left until maximum signals register in the radio-compass receiver. Then the plane is steadied on this

New York harbor. All three took bearings of the DO-X at a given instant in a certain latitude and longitude. These, plotted aboard the DO-X, showed it to be bearing southeast from the master station. The bearing taken by the DO-X at the same instant showed the master station was northeast, proving that both bearings were accurate and could be relied upon. This sort of service not only expedites the trip but is invaluable as a safety feature.

Another most important service rendered by the radio is the handling of weather information. It would never do to let the DO-X fly into a storm—it would be bad in the air and worse on the water. A storm can be avoided with little loss of time—with a gain of time if there is a tail wind—providing constant reports are copied. A passage between here and Europe can be kept storm-free by simply copying every weather report broadcast.

It is up to the radio operator, his set and the navigator to make ocean air travel more pleasant than ship travel. The DO-X is a master ship in every sense of the word—a ship that flies straight as the wind but faster—a ship that speaks as she flies. The DO-X represents in the highest sense the wedding of the two greatest developments of the century—radio and aviation.

SUPREME DIAGNOMETER AAA 1



More Service Dollars For every SMART RADIO-MAN

Fewer new radios means more replacement parts—more service calls—more service dollars from old sets in the season of 1931-32. Smart radio-men in every community are leaping into leadership with outstanding service equipment—taking the short cut to economical, superior service for themselves and their clients—with the amazing new instruments—SUPREME DIAGNOMETER AAA 1.

5 Ultra-modern, essential test-instruments in 1, for the price of 1

- Super-DIAGNOMETER plus
- Shielded OSCILLATOR plus
- Advanced TUBE TESTER plus
- OHM-MEGOHMMETER plus
- CAPACITY TESTER

Combined in one smaller, handier case! "THE BIGGEST THING IN RADIO SERVICE PROGRESS SINCE '28!"

The instrument that the radio service world wanted and waited for "SUPREME" to sponsor. Ask your jobber to give you a demonstration of its perfect performance—its well nigh incredible power.

New business insurance that you can't afford not to have in the tough tussle of thrifty '31-'32! Send the coupon for complete details!



Dealers Net Price
f. o. b.
Greenwood, Miss.
\$147.50

SUPREME INSTRUMENTS CORPORATION,
416 Supreme Building,
Greenwood, Mississippi.

Please send me full particulars on SUPREME DIAGNOMETER AAA 1, without obligation.

Name.....

Address.....

City.....State.....

Name of Jobber.....

City.....State.....

Distributors in Principal Cities
Foreign Division 130 West 42nd St., New York City
Cable Address LOPREH.



OFFERS TO SERVICE MEN

Any Type Condenser Block at

\$5.45 Without Coils
(Victor Excepted)

Send us your old block (Prepaid)

and a brand new one will be shipped you.

If you prefer we will repair the defective sections of your old block for

\$3.75 Without Coils
(Victor Excepted)

Victor blocks or blocks with chokes or transformers \$2.75 additional

TOBE DEUTSCHMANN CORPORATION

Service Division
Canton, Mass.

Radio Dealers: Radio Service Men!

NEW LOW PRICES
Guaranteed Replacement Condenser Blocks and Transformers Net

Atwater-Kent 37 Cond. Block with chokes.	\$3.95
Atwater-Kent 37 Power Transformer	2.95
Atwater-Kent 40 Pack Complete	6.50
Zenith ZE9, Stewart-Warner, Mohawk	
Blocks	
Majestic "B" Eliminator Cond. Block	3.45
Electrolytic Condenser, 2 Anode	2.95
Electrolytic Condenser, 3 Anode	2.75

Hard-to-get parts—We have them
Send us your repair work for estimate
Write for our **FREE CATALOGUE**

Grant Radio Laboratories
6523 South Halsted St., Chicago, Ill.

RACON USERS WILL TELL YOU

There is nothing finer than a Racon



RACON HORNS for Schools—Churches—Theatres—Hotels—Amusement Parks—Air-Ports, etc. have proven to be ideal.

RACON NEW HORN No. 2115 (Illustrated). Particularly adapted for small theatres, portable "Talkie" equipment and public-address systems. Bell 18 in. x 24 in. x 23 1/2 in. in depth. Air column 7 1/2 feet. Weighs 23 1/2 pounds, including frame.

RACON HORNS & UNITS ARE COVERED BY U. S. PATENTS NOS. 1,507,711; 1,501,032; 1,577,370; 73,217; 73,218; 1,732,443; 1,711,514; 1,781,489.

Write for Catalog Containing Complete Line
RACON ELECTRIC CO., INC.
18 WASHINGTON PLACE, NEW YORK
England and Canada

GET INTO ELECTRICITY AND THE BIG PAY JOBS

ELECTRICITY, easily learned in 12 weeks, banishes forever the necessity of looking for and taking any old job. Learn Electricity the McSweeney way. No books! No lessons! Not a correspondence course. You learn by DOING; by actual work with real tools on real equipment. Write today for Big Free Book completely describing the 12 weeks course; also Railroad Fare and New Low Tuition Offers.

McSWEENEY ELECTRICAL SCHOOL
E-20-12, Cleveland, Ohio

The International Six

(Continued from page 488)

2 (red). (31) Cathode V2 to C5, terminal 3 (black). (32) Screen V2 to C6, terminal 1 (red). (33) Cathode V3 to C6, terminal 2 (black). (34) Screen V3 to C6, terminal 3 (red). (35) Free terminals of L5, L6, L7 to center of volume control (red).

(36) Twist one end of R11 and R12 together. Solder free end of R12 to output 1, and free end of R11 to L.W. 5. Solder one end of R13 to plate of V4, and other end to twisted leads from R11 and R12. Make sure these connections are rigid, so that no shorts can occur due to any shifting of the resistors after the set is in use.

(37) Transformer terminal 16 along flap past edge of strip to outer lug C15 (black). (38) Bottom of C14 to outer lug C15 (black). (39) Outer lug of C15 to L.W. 5 (black). (40) Field 1 to center C16 (red). (41) Connect R5 from field 1 to screen V3. (42) Condenser C5, terminal 2, to condenser C6, terminals 1 and 3 (red). (43) R4 from screen V3 to lug under nearest mounting bolt. (44) One end R3 to one end of volume control. (45) Other end R3 to center terminal C16 (yellow). (46) Mount one end of R1 on a mounting bolt near the volume control. Connect the other end to the free terminal on the volume control. Cut the wire for this lead one inch longer than necessary. Use flexible wire if available.

(47) Screw together R6 and R7. Mount the free end of R6 on a mounting bolt. Connect R7 to the end of R3 away from the volume control. Make sure no shorts can occur by the resistors shifting position. Do not put tape on the resistors. (48) Run the long red leads from L2, L3, L4 to the joint between R6 and R7. Run the short red leads to C7, C8, C9. Ground the other end of C7, C8, C9 to lugs D, C, B. (49) Shielded wire from L1 to antenna post. Tape where the wire passes through a hole in the sub-panel mounting strip. Be careful that the shielding is not grounded anywhere. (50) Grids of V1, V2, V3, V4 to stators of C1, C2, C3, C4. Splice each lead where it passes over the top of the coil shields, and connect to the black wires coming from L1, L2, L3, L4. Use shielded wire, but be especially careful that the shielding is not grounded accidentally at any point. Tape if necessary to prevent an accidental ground in the future. (51) Transformer terminals 13 and 14 to the dial light. (52) L.W. 1 to lug under nearest mounting bolt.

The usual precautions about making leads direct and keeping high-frequency leads away from all others apply in this set. In addition to this, because of the high voltages encountered in various parts of the circuit special care must be taken to prevent arcing due to the breakdown of the insulation of wires where they pass close to rough metal surfaces. Whenever these leads pass through a hole in the chassis, as in the two large holes under the power transformer, the whole group of wires should be wrapped in tape.

A number of shielded wires are used in

DOES THE WORK OF A HIGH PRICED IRON

Soldering is easy with this handy electric iron.

It plugs in on any current, quickly giving you a red hot point that stays hot! Used by professionals everywhere. Has replaceable forged copper tip; highest grade nickel-chrome heating element; dark mahogany anti-heat handle. Wt. 16 ozs., length 12 1/2 in., 6 ft. flexible cord. A boon to the amateur, for any soldering job! Price complete \$2.75. If your dealer can't supply, send us money order or registered letter. We'll pay parcel post.

Electric Soldering Iron Co., 135 W. 17th St., New York, N. Y.



ESICO "Junior"
REG. U.S. PAT. OFF.

You Can Become a Fast Capable RADIO OPERATOR at HOME

By **CANDLER**

Scientific Method

in less than half time required by any other.

Nothing like it. Amazing results. FREE ADVICE if you're "stuck." Thousands fast Radio operators taught by CANDLER, world's only Code Specialist.

FREE BROCHURE will save you time and money. All questions answered personally. No obligation. If Radio operator, ask about ADVANCED COURSE for SPEED and Copying Behind, and "MILL" Course.

Walter H. Candler,
World's Only Code Specialist

THE CANDLER SYSTEM CO., Dept. N-12
6343 So. Kedzie Ave., Chicago, Ill.

STATEMENT OF THE OWNERSHIP, MANAGEMENT, CIRCULATION, ETC., REQUIRED BY THE ACT OF CONGRESS OF AUGUST 24, 1912.

OF RADIO NEWS, published Monthly at Dunellen, N. J. for October 1st, 1931.

State of New York } ss.
County of New York }

Before me, a Notary Public in and for the State and county aforesaid, personally appeared Lee Ellmaker, who, having been duly sworn according to law, deposes and says that he is the President of the RADIO NEWS and that the following is, to the best of his knowledge and belief, a true statement of the ownership, management (and if a daily paper, the circulation), etc., of the aforesaid publication for the date shown in the above caption, required by the Act of August 24, 1912, embodied in section 411, Postal Laws and Regulations, printed on the reverse of this form, to wit:

1. That the names and addresses of the publisher, editor, managing editor, and business managers are: Publisher, Teck Publishing Corporation, 350 Hudson Street, N. Y. C.; Editor, Laurence M. Cockaday, 350 Hudson Street, N. Y. C.; Managing Editor, None; Business Managers, None.

2. That the owner is: (If owned by a corporation, its name and address must be stated and also immediately thereunder the names and addresses of stockholders owning or holding one per cent or more of total amount of stock. If not owned by a corporation, the names and addresses of the individual owners must be given. If owned by a firm, company, or other unincorporated concern, its name and address, as well as those of each individual member, must be given.) Teck Publishing Corporation, 350 Hudson Street, N. Y. C.; Macfadden Publications, Inc., 1926 Broadway, N. Y. C.; Bernarr Macfadden, 1926 Broadway, N. Y. C.; Orr J. Elder, 1926 Broadway, N. Y. C.

3. That the known bondholders, mortgagees, and other security holders owning or holding 1 per cent or more of total amount of bonds, mortgages, or other securities are: None.

4. That the two paragraphs next above, giving the names of the owners, stockholders, and security holders. If any, contain not only the list of stockholders and security holders as they appear upon the books of the company but also, in cases where the stockholder or security holder appears upon the books of the company as trustee or in any other fiduciary relation, the name of the person or corporation for whom such trustee is acting, is given; also that the said two paragraphs contain statements embracing affiant's full knowledge and belief as to the circumstances and conditions under which stockholders and security holders who do not appear upon the books of the company as trustees, hold stock and securities in a capacity other than that of a bona fide owner; and this affiant has no reason to believe that any other person, association, or corporation has any interest direct or indirect in the said stock, bonds, or other securities than as so stated by him.

LEE ELLMAKER,

President.

Sworn to and subscribed before me this 24th day of September, 1931.

(SEAL)

WESLEY F. PAPE,

Notary Public.

(My commission expires March 30, 1932.)

the circuit. It is very important that the shielding on these wires be not grounded at any point. If accidental grounding does occur, the effect may not be noticeable on local reception, but will cause a lack of pep when fishing for distance.

When the set is first put into operation it will probably be insensitive at all points on the dial. Turn on the volume control full, and tune in a weak station close to 1500 kilocycles. Now set the compensating condensers for maximum volume, beginning with C4 and working back to C1.

The gain control, R1, is next adjusted. This gain control is the 1000-ohm resistor mounted next to the volume control. It may be adjusted by loosening the terminal clamp on one end and sliding it closer to the other terminal. This increases the gain. To adjust this, tune in a station around the middle of the dial and turn on the volume control full. Now rock the tuning condenser back and forth, listening carefully to see if a carrier whistle is present. A weak station is best for this test. If no carrier whistle is heard, turn off the set and advance the gain control. Keep doing this until a carrier whistle is obtained. Then retard the gain control until this whistle just disappears. Now rotate the tuning dial from one end to the other with the vol-

ume control turned on full, listening carefully to see if the set whistles at any point. If it does so, retard the gain control until this whistling stops.

If the volume control works backwards, i.e., volume decreases as the setting is increased, reverse the outer leads.

If a good high-resistance voltmeter is available the operating voltages on all the tubes can be checked up. The radio frequency voltages should all be measured from the cathodes. At any setting of the volume control, the screen voltages should be approximately 90, and the plate voltages approximately 180. The grid bias at full volume should be somewhere between 3 and 10 volts, depending on the setting of the gain control. The grid bias at minimum volume should be at least 50 volts. The overall voltage delivered by the filter as measured from one of the output terminals to the chassis should be about 450 volts. All the above measurements have been made with a 1000-ohms-per-volt voltmeter. If all these voltages are correct, probably none of the apparatus is defective, and any failure in operation is likely due to imperfect wiring.

The writer will be glad to hear from anyone who has built this set and to answer any inquiries.

With the Experimenters

(Continued from page 492)

end and the headphones are equipped with another similar plug. The volume-control box itself includes two jacks into which these plugs are inserted. The box shown in the illustration is considerably larger than necessary, measuring about five inches square by one inch in depth. A much smaller container may be used if desired.

tremely light; the total weight, including the two earpieces, head-band and cord, is only four ounces as compared with over one pound for most other types of headphones. This offers an advantage that will be appreciated by anyone who has tried to sit through an evening with headphones clamped on his ears.

The outstanding feature of the equip-

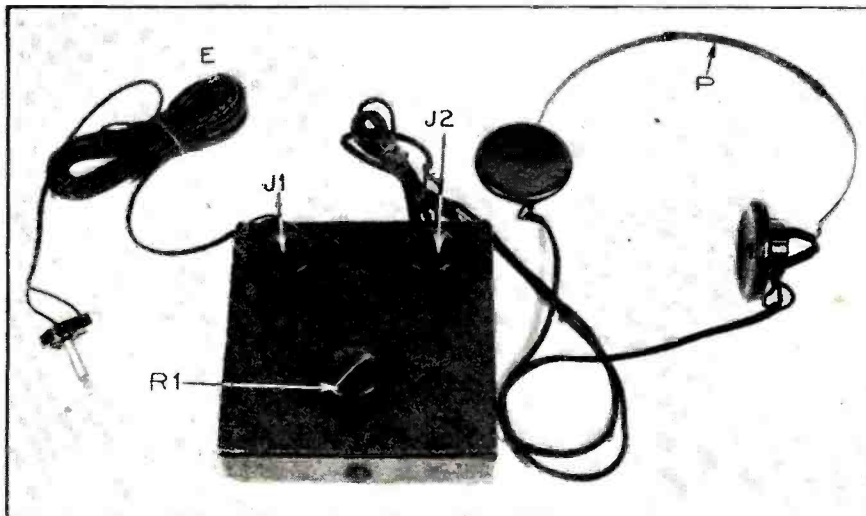

Figure 2

A word about the headphones employed with this unit, as shown in Figure 2, will be in order here. These headphones are a new type, recently introduced; they have the advantage that they can be worn for hours at a time without the fatigue that accompanies the wearing of ordinary headphones. They are ex-

periment described here is its capability of attachment to any type of receiver without any changes in the receiver itself and without requiring access to the receiver wiring. The only connections to the receiver are obtained by means of the adapters which are slipped over the prongs of the output tubes. All of the parts used



Readrite

No. 550

OSCILLATOR

(Licensed by A. T. & T. Co.)

\$18 Net to dealer
\$30 list

\$21 Net to dealer
with output meter

If not at your Jobbers we will ship direct when remittance accompanies order.

A sturdy modulated instrument carefully made. Completely shielded with separate battery compartment. Furnished with 22½-v. and 3-v. batteries. Uses one '30 tube. Covers broadcast band (550-1500 kc.) and intermediate band (120-185 kc.). Other i.f. ranges available through suitable harmonics. Operating instructions attached in case cover with shielded wire leads. Very compact. In leatherette case, 6x11½x5½ in. Weighs but 8 pounds. Built to high standards. Every serviceman should have the No. 550 oscillator to align r.f. gang condensers, locate defective r.f. transformers, adjust i.f. transformers, check oscillator stage and determine sensitivity of a receiver. A necessary instrument. Get yours today. Write for catalog of servicing instruments.

Readrite Meter Works

Established 1904

20 College Ave., Bluffton, Ohio

"CHIRAD"

NATIONAL

Thrill-Box SW-3

3 TUBES

A-C or A-C: D-C or D-C models

"Ham Band short wave Thrill Box with 3 sets band spread coils 20-40-80 meters wired up. List \$55.00.

Net \$31.00

National A.C. Power Pack. List \$34.50.
Net \$19.00

ACSW5 NATIONAL

Short Wave Receiver with tubes and pack. List \$133.00.

Net \$75.00

ACSW45 NATIONAL DELUXE

Outstanding Short Wave Receiver on the market. List \$139.00.

Net \$81.50

REPLACEMENT PARTS

Complete line of Condenser Blocks. Transformers, Volume Controls and Resistors.

SHORT WAVE KITS

sets, transmitter parts, supplies for power packs, high voltage condensers—low prices.

SEND 10 CENTS FOR LATEST CATALOG

CHICAGO RADIO APPARATUS CO.

415 S. Dearborn St., Dept. RN-12, Chicago, Ill

are standard equipment and are readily available.

List of Parts

- A1, A2; Wafer-type tube adapters with plate connections brought out.
- C1, C2; Flechtheim 2-microfarad by-pass condensers, 250-volt rating.

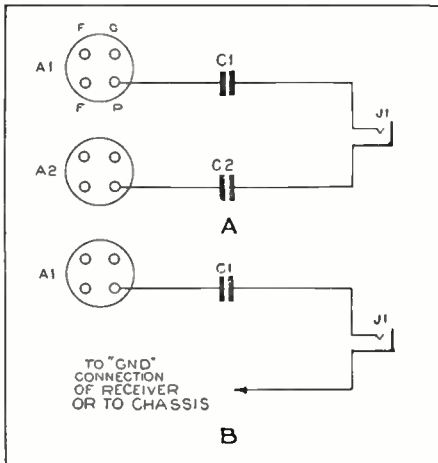

Figure 3

E—Holyoke 20, 30, or 50-foot extension cord.

J1, J2, J3—Carter single-circuit, open, "short" jacks.

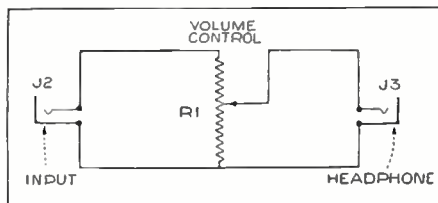

Figure 4

- P—Trimm featherweight headphones.
- R1—Electrad 10,000-ohm potentiometer.
- Bakelite panel for mounting condensers.
- Box for volume control.

S. GORDON TAYLOR.

Adding a Tube

(Continued from page 493)

midget variable condenser and, for the sake of symmetry, a part of the center partition was cut away and an additional small shield added to cover this small condenser and shield it from the screen grid compartment. Fixed resistors for the tubes did away with the necessity for any controls for the filaments, and the panel had only the two main tuning condensers, with the knob for the small midget regeneration control in the lower center.

When the tuner, as shown in Figure 7 was again tried out, it was found that with the regeneration control set to the point of oscillation, as soon as a whistle was heard, a slight movement of one or both main dials to get the dead beat, and then a backing off of the midget regeneration control to the point just below oscillation would bring in the station loud and clear. On July 4th I listened to WGY at 10.30 A. M., Canton (China) time, and while it was impossible to get all of the program, the music and voice were at times very distinct, and under these conditions it may be considered a rather unusual performance.

SHORT WAVE

Reception with Your
BROADCAST RECEIVER

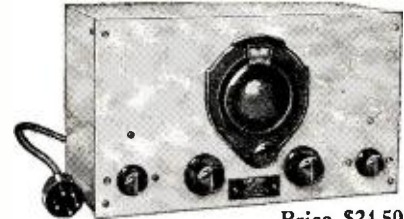

Price \$24.50

THE "EXPLORER"

PLUGLESS POWER CONVERTER

Efficiency—Convenience—Economy

Obtain real short wave reception, efficiently and economically, by using an EXPLORER with your broadcast receiver. Attached to your present receiver, the performance of the EXPLORER equals that of any expensive short wave receiver. Many EXPLORER enthusiasts report consistent reception of stations such as G5SW, England; I2RO, Italy; and VK2ME, Australia, with real loud-speaker volume.

No PLUG-IN COILS. Automatic Band Selector changes wave-length bands in less than a second—the original EXPLORER achievement which many are now trying to imitate.

Power Amplifier in converter gives ample loud-speaker reception of distant stations. Special wide-spread vernier, genuine single dial tuning, and numerous other exclusive features.

Price \$24.50. Each EXPLORER air-tested at factory and ready for use. New 1932 models now ready, designed for every broadcast receiver, including the new Superheterodynes. Order now! Sent C. O. D. on receipt of \$2 or prepaid on receipt of price in full. Foreign price \$25.50, remit in full, shipment prepaid. State make and model number of broadcast receiver.

Send Now for Free Literature

RIM RADIO MFG. CO.

695 Grand St.

Brooklyn, N. Y., U. S. A.

Wireless (Radio)

and Morse telegraphy taught thoroughly. School, oldest and largest; endorsed by Telegraph, Radio, Railway and Government officials. Unusual opportunities. Expenses low—can earn part. Catalog free. **DODGE INSTITUTE, Oak St., Valparaiso, Indiana.**

GET "COAST TO COAST"



Bring in distant stations with Vari-tuner. Doubles volume and selectivity. Easily attached. Write 20th Century Co., 9621 Coke Bldg., Kansas City, Mo., for 15-Day Trial Offer.

ANNOUNCING!

The New RADIO PHYSICS COURSE

by Alfred A. Ghirardi, E.E.

Greatly Enlarged & Revised Second Edition Now Ready

Contains over 950 pages. More than 500 illustrations. A new feature is a complete, simple course in Electricity, written especially for radio students and servicemen.

THE GREATEST RADIO BOOK EVER WRITTEN

Send for free circular



\$3.50

OR USE THIS COUPON

Radio Technical Publishing Co., Dept. G, 22 West 21st Street, New York City. Enclosed please find cash, check or money order for copies of Radio Physics Course at \$3.50 each.

Name..... (Please Print)

Address.....

ACROCYCLE OSCILLATOR

115 to 1680 kc. All frequencies accurately calibrated on dial. A dependable, high-grade instrument. Indispensable for aligning Super-Heterodyne receivers. Self contained, fully shielded. List \$30.00.

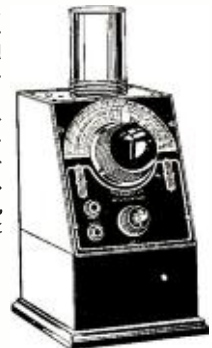

DEALERS' NET PRICE
\$17.50

Handsome leatherette carrying case, net \$2.00.

If your jobber does not carry, order direct from

J-M-P MFG. CO., INC.
3420 Fond du Lac Ave.
Milwaukee, Wisconsin

Made by the manufacturers of the pioneer short wave adapter the SUBMARINER, now \$12.50.

6 FUSES in ONE PLUG

Approved by Underwriters Laboratories

Agents & Distributors Making Big Money

A necessity everywhere. A "turn to the right brings back the light." Safe, economical, dependable, 6-in-1 Fuse Plug. Most useful invention in years. Many of our distributors in exclusive territory making \$500 to \$1000 a month. Easy to demonstrate. Easy to Sell. Profits begin right away. Write at once for proposition. Send 25c for sample and working instructions. 6-in-1 Fuse Co., 801 W. Madison St., Dept. 137, Chicago

It may be thought that an unusual number of chokes and by-pass condensers are used, but they are necessary for maximum results. With the coils made up so far, I have tuned down to about 9½ meters and up to 100 meters, and also covered a good part of the broadcast band.

As none of the commercially made short wave chokes were available, those used were "home-made" and of the polarized type, consisting of 640 turns divided into four sections of 160 turns each with ¼ inch separation between sections, and also wound in such a manner that the terminals come from the inside of the two end sections. This can best be accomplished by winding each section by itself and soldering the ends together, i. e., by joining the outer end of the first section to the outer end of the second and the inner end of the second section to the inner end of the third, and so on. The wire used was No. 32 dsc and the forms were turned up from hardwood and then boiled in paraffin wax until all traces of moisture were removed. These forms were 1½ inches outer diameter, and the recesses were ⅝ inch, while the spool was turned hollow so that with a 6-32 screw and a soldering lug protruding from the side through a hole in the side of the spool, the choke had a terminal at either end and by mounting on the back panel,

served also as a binding post for the battery lead. It was found that these covered the entire range without any "humps" or "hollows" and no holes were found at any frequency from 9.7 meters up to about 100 meters.

List of Parts

- 2 National Velvet Vernier dials.
- 2 DeJur tuning condensers .00015.
- 1 Pilot midjet regeneration control condenser .0001 (Type J-23).
- 2 .1 Mfd. bypass condensers.
- 2 .005 Plate bypass condensers.
- 4 10 ohm resistors.
- 1 4 ohm resistor.
- 1 Pilot Micrograd for grid condenser on detector tube.
- 1 Bretwood variable grid leak.
- 5 Silver-Marshall coil sockets.
- 2 Twin Coupler tube shields.

Spacers, insulating washers, screws and nuts, shield cabinet and Silver-Marshall forms for coils, also the necessary tubing and wire.

The coils were wound with the required number of secondary turns and spacing, and the primaries were of No. 32 dsc wire wound between the secondary turns, and were all of a 1:1 ratio, while the tickler was of No. 28 enameled wire and spaced the width of the wire.

CHAS. M. LARSON,
Canton, China.

What's New in Radio

(Continued from page 507)

alarm systems and many other industrial purposes.

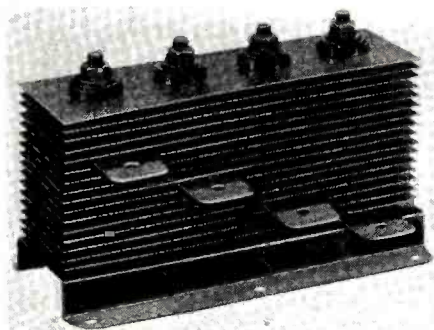

Maker—The B-L Electric Mfg. Co., 19th and Washington Aves., St. Louis, Missouri.

Tube Checker

Description—A self-biasing tube checker that indicates the "end of life," short-circuits, open-circuits and usefulness of all



types of amplifier, power and rectifier tubes, which include the pentode tubes, the two-volt tubes and the six-volt automobile type tubes. The operation of this instrument is simplified by a calibrated chart and the colored push-buttons.

Maker—The Radio Products Company, Dayton, Ohio.

Compact Condensers

Description—A new line of small size, low and high voltage by-pass and filter condensers designed for all types of replacement and construction work. These condensers are available in capacities from .1 to



4. mfd., and in ratings of 200, 400, 600 and 1000 volts d.c. The uncased 1 mfd. filter condenser illustrated here is type NU 100 and measures 2 inches by 1¾ inches by ¾ inches.

Maker—A. M. Flechtheim & Co., Inc., 136 Liberty Street, New York City.

Condensers

Description—A compact high-voltage filter and by-pass condenser, the 2. mfd. unit measuring only 2 inches by 1¾ inches by 1 inch, with a working voltage of 600 volts d.c. and a test voltage of 1500 volts d.c. The condenser is sealed in a metal container with the terminals brought out at the top through an insulating strip. These con-

(Continued on page 536)

SERVICE-MEN RADIO SERVICE-MEN

New Live Items that Sell!

Service men—Save money. Make money! We offer everything for the service men at lowest wholesale prices. New, live items that will make money for you. REPLACEMENT PARTS specialists. Complete stock of parts for all sets. What you need when you need it. Be sure to send for a FREE copy of our new 10th Anniversary 144-page catalog.

BIG New 1932 CATALOG



Special VALUES

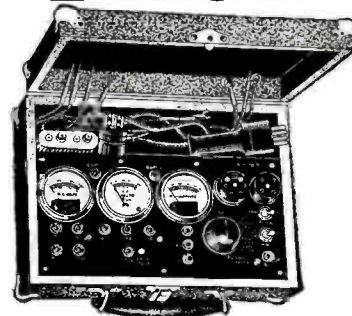

READRITE SET ANALYZER

This is the new Readrite Combination Set Analyzer and Tube Checker Model 730. Every practical test can be made on any type of radio set, new and old. Indispensable for the modern service man. Our special offer includes ABSOLUTELY FREE with every analyzer a high grade pair of radio test leads. **\$14.75 NET**
The special low price is

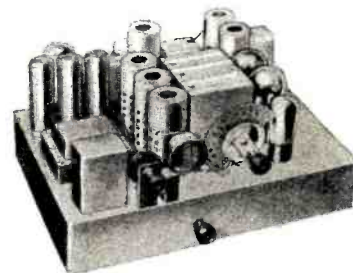

Lafayette 10-Tube Superhet

Most powerful radio receiver ever developed. A 10-tube, completely shielded, super het. Outstanding features are FOUR VARIABLE MU TUBES AND TWO PENTODE TUBES IN PUSH-PULL—VISUAL METER TUNING—AUTOMATIC VOLUME CONTROL—LAFAYETTE PERFECTED TONE CONTROL—LOCAL DISTANCE SWITCH—STADIUM DYNAMIC SPEAKER, etc. Sold on a 30-day free trial offer. Available in large selection of modern cabinets. Wide price range.

WHOLESALE RADIO SERVICE CO. INC.

Dept. M-12
38 VESEY ST. N. Y. C.

LEARN RADIO

this easy, practical way

WRITTEN by two widely known radio engineers, these three books cover every phase of building, repairing and "trouble-shooting" on modern receiving sets. The books include complete instructions for building short-wave and TELEVISION receivers.

Radio Construction Library [1931 Edition]

Including Television Receivers

This practical Library includes: PRACTICAL RADIO—The fundamental principles of radio, presented in an understandable manner. Illustrated with working diagrams. RADIO CONSTRUCTION AND REPAIR—Methods of locating trouble and reception faults and making workmanlike repairs. RADIO RECEIVING TUBES—Principles underlying the operation of all vacuum tubes and their use in reception, remote control and precision measurements. The Library is up-to-the-minute in every respect and is based on the latest 1931 developments in the design and manufacture of equipment.

Three Volumes.
6 x 9—1087 pages,
605 illustrations.

See this Library FREE!

No Money Down

FREE EXAMINATION COUPON

McGraw-Hill Book Company, Inc.
370 Seventh Avenue, New York

Send me the new 1931 RADIO CONSTRUCTION LIBRARY, three volumes, for 10 days' free examination. If satisfactory I will send \$1.50 in ten days, and \$2.00 a month until \$7.50 has been paid. If not wanted I will return the books.

Name

Home Address

City and State

Position

Name of Company RN-12-31

Are you tolerating

RADIO INTERFERENCE?

The first complete treatise on this all-important subject, with many illustrations.

By G. R. WALTERS

Chairman, California Radio Interference Ass'n

Based on six years of exhaustive study and experience by the author.

"RADIO INTERFERENCE, CAUSES, EFFECTS AND CURES FOR 50c.," written so you can understand it.

G. R. Walters,
234 Chamber of Commerce Bldg.,
Los Angeles

Enclosed please find 50c. (cash, check or money order) for one copy RADIO INTERFERENCE, CAUSES, EFFECTS AND CURES.

Name

Address

Baltimore's 1932 Catalog

Just Off the Press

Over 4,000 Radio Items
At Prices That Defy Competition
BALTIMORE RADIO CORP.
725 r Broadway New York, N. Y.
Write and get yours Now!

Eleven-Tube "Superhet"

(Continued from page 486)

hollow-topped one with extremely low "skirting," giving a close approach to the theoretically perfect curve.

Coupling System Prevents Interaction

The system used for coupling the first detector prevents interaction between the tuned circuits that sometimes causes serious misalignment of the variable condensers during tests. The circuit used includes a tertiary winding on the oscillator coil connected between the cathode of the first detector and the ground. This circuit is shown in Figure 4. The voltage induced in this coil is, therefore, placed between the cathode and the ground, and the cathode and the grid, on account of the grid being returned to the ground system. A large amount of energy is therefore induced into the detector circuit from the oscillator tube by this method. In the oscillator coil the windings are all of Litzendraht wire, in order to decrease the resistance of this circuit to the lowest possible value.

Circuits Eliminate "Image" Signals

Three tuned-radio-frequency circuits are used to eliminate "image" signals peculiar to earlier designs. A pre-tuned antenna coil, loosely coupled to the tuned-grid coil of the r.f. amplifier, is employed. It will be noticed that the output circuit of the first tube contains tuned-plate impedance coupling, favoring the lower frequencies. This was used to balance up the effect of the increased sensitivity on the higher frequencies of the following stages.

The various circuits are mounted on a large chassis, fully shielded to retain adequate selectivity, and large enough to permit accurate adjustment and servicing of the parts.

The receiver, during tests in Cincinnati, was capable of tuning out local signals and bringing in distant stations from both coasts, even through the heavy barrage of local stations in that city and from Chicago.

What's New in Radio

(Continued from page 535)

condensers are available in capacities from .1

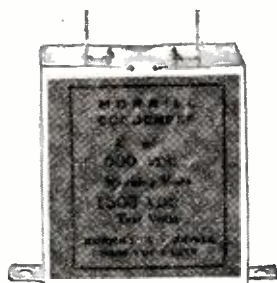

mfd. to 4. mfd.
Maker—Morrill & Morrill, 30 Church Street, New York City.

POMERANZ

Chooses

CARDWELLS

(Why shouldn't he?)

Really, we're not being conceited. When men like Nat Pomeranz specify Cardwells in a transmitter of their own designing, we appreciate the compliment.

Nothing has been spared to make Cardwell Condensers the finest obtainable at any price. Quality has never been compromised.

When a truly better product has been built, it enjoys the favor of those who know. Cardwells are better—that is why we were pleased, but not surprised, to learn they were to be included in this popular transmitter.

Write for literature.

THE ALLEN D. CARDWELL MANUFACTURING CORP.
89 PROSPECT ST., BROOKLYN, N. Y.
"THE STANDARD OF COMPARISON"



"POLICER"

LOW WAVE ADAPTER

80 to 200 METERS

POLICE CALLS
With the Rahm "POLICER"

Over 25 cities now broadcasting daily POLICE CALLS. Most exciting programs "on the air." Help your local police capture criminals.

The Rahm "POLICER" is manufactured in two models, for the 227 detector tube and for the 224, and performs on any t.r.f. receiver. Specify which model when **ONLY** ordering. Fully guaranteed. **\$250** COMPLETE. Dealers get our quantity prices.

RAHM CORP.
1481-A Merchandise Mart, Chicago, Ill.

\$5,000 WILL BE PAID TO ANYONE WHO PROVES THAT THIS

is not the actual photo of myself showing my superb physique and how the Ross System has increased my own height to 6 ft. 3 3/4 inches.

Hundreds of Testimonials.
Clients up to 45 years old gain from 1 to 6 inches in a few weeks!

No Appliances—No Drugs—No Dieting
ROSS SYSTEM NEVER FAILS. For Ten Dollars Complete Convincing Testimony and Particulars 5 cents stamps.
Allow time for return mails across the Atlantic.
G. MALCOLM ROSS, Height Specialist
Scarborough, England. (P. O. Box 18)

FIRST IN 1907 FIRST TO-DAY



GEARS

In stock—immediate delivery
Gears, speed reducers, sprockets, thrust bearings, flexible couplings, pulleys, etc. A complete line is carried in our Chicago stock. Can also quote on special gears of any kind. Send us your blue-prints and inquiries.

Write for Catalog No. 40
CHICAGO GEAR WORKS
769-773 W. Jackson Blvd. Chicago, Ill.

FREE! 32 Page Catalog JUST OFF THE PRESS

NEW LOW PRICES

Complete line of Superheterodyne Receivers, Midsets, Short Wave Adapters, Auto Radio and Electric Clocks. Replacement Condenser Blocks, Power Transformers, Resistors and Test Equipment for the Serviceman. Also Short Wave Supplies for the "HAM." Write NOW to

ROSE-RAD CO.
549 W. Randolph Chicago, Ill., U. S. A.

Telephony on a Light Beam

(Continued from page 467)

needs beyond this is to make use of actual light waves instead of these radio ones that merely are more or less like light.

Light waves, of course, are just the same as radio waves, except that the wavelengths concerned are between one thirty-thousandth of an inch and one seventy-thousandth of an inch, instead of the few inches of the micro-waves or the many feet or meters of ordinary radio waves. Theoretically, also, it is just as possible to modulate a light wave, to detect this modulation and to filter or otherwise refine the waves precisely as these things are done in ordinary radio technique.

One difference exists. No one has learned how to amplify the light waves themselves. Accordingly, in work with modulated light beams detection must come first and amplification later, as though no radio-frequency amplification were possible in ordinary radio receivers but only audio-frequency amplification. Probably this limitation is not permanent. Someone will discover some day, it is permissible to expect, a way to amplify the light waves themselves. For present purposes, however, it makes little difference, since the existing ways of handling, modulating and detecting the signals carried on light beams are ample for the practical needs now foreseen.

The essentials of a light-beam telephone are four: a means of modulating a source of light with the sounds to be carried by the light beam, an optical system adequate to carry the light between this transmitter and the receiver, a detector at the receiving end, competent to pick off the modulation of the light beam precisely as a detector tube takes off the modulation of an ordinary radio wave; finally, an amplifier system to raise the relatively feeble signal thus obtained to an audible level.

The Transmitter

The transmitting end of this outfit is essentially the same as the apparatus now used to make the sound track on talking-motion-picture film. What the sound camera uses for this purpose is a microphone, an amplifier and a recording lamp or light valve, the duty of these latter devices being to modulate a light beam in accordance with the sound energy entering the microphone. The only essential difference between this and the light-beam telephone is that the sound camera equipment uses a light beam which travels only a few millimeters or a few centimeters between the light source and the film. The light beam of a telephone, if it is to be useful at all, must cover many yards or even several miles. Nevertheless, the facts which have been learned in the last few years about the construction and operation of sound-picture equipment will be extremely valuable in developing the light-beam telephone.

The receiving end of the light-beam telephone has its equivalent, also, in the reproducing end of the talking-picture system, the so-called "sound-head" fitted

to the motion-picture machine. The modulated light beam, to which this apparatus responds, is created by the passage of a small pencil of unvarying light through the sound track on the film. Thus the light pencil is varied in intensity by the lines of denser and lighter shadow on the sound track or by the varying width of these transverse to the sound track; the former in the so-called variable-density system, the latter in the variable-area one. In either case the result is nothing but a modulated light beam precisely like that which will reach the receiving end of a light-beam telephone. The difference is the same as before; this modulated light beam is a short one, required merely to cross the sound head from the light source, through the film and into the light-sensitive cell. The beam of a light telephone must be longer.

A Highly Refined Heliograph

There are clear similarities of the light-beam telephone, also, to the old-fashioned heliograph, used for many years for war-time signalling between stations located on neighboring mountain peaks or in other locations where they can see each other. This heliograph employs, in fact, one kind of modulated light beam in which the modulation is all or nothing. The light beam is interrupted at intervals by a shield or mirror which can be worked by the instrument's operator. Thus dot-dash signals can be sent to constitute a code. The light-beam telephone, now proposed, bears the same relation to the heliograph as radio broadcasting of speech or music bears to code radio.

The chief reason why light-beam telephones have not been made cheap and practical long ago and become familiar articles probably is that two of the essential unit devices have been far from perfect. One of these is the source of light to be easily modulated. The other is the light-sensitive cell to do the detecting and to pick the modulation off the light beam at the receiving end. For the first of these it was necessary to perfect something similar to the glow lamps now used in sound-picture recording. For the second, the art has been awaiting the perfection of a fully satisfactory photoelectric cell or similar device.

Both of these are now available. Indeed, several varieties of each are available, so that the amateur contemplating work in this field need fear no dearth of the necessary apparatus. One of the actual lamps used in sound-picture recording may be used, for example, or any type of the still more powerful glow lamps, usually filled with neon, now used in television receivers. Even the small neon lamps, drawing a fraction of a watt, now purchasable at low cost and used as indicator lamps in many kinds of alternating-current machinery, will serve reasonably well as a light source to be modulated. The television lamps and the recording lamps are better but more expensive.

To produce the modulated light beam, one of these lamps is set up, supplied with

F. & H. CAPACITY AERIAL



Price \$1.00 Complete postpaid

Every Instrument Tested on Actual 1127 Mile Reception

A LARGE NUMBER ARE IN USE BY GOVERNMENT, IN NAVY HOSPITAL

The F. & H. Capacity Aerial Eliminator has the capacity of the average 75-foot aerial, 50 feet high. It increases selectivity and full reception on both local and long distance stations is absolutely guaranteed. It eliminates the outdoor aerial along with the unsightly poles, guy wires, mutilation of workwork, lightning hazards, etc. It does not connect to the light socket and requires no current for operation. Installed by anyone in a minute's time and is fully concealed within the set. Enables the radio to be moved into different rooms, or houses, as easily as a piece of furniture.

8,000 dealers handle our line. Dealers! Over 80 leading jobbers carry our line or order sample direct. Write for proposition.

— SEND COUPON, IT PROTECTS YOU —

Name

Address

City State

Send one F. & H. Capacity Aerial with privilege of returning after 3-day trial if not satisfactory, for which enclosed find check M. O. or dollar bill, or send C. O. D. Send Literature, Dealer's proposition.

F. & H. RADIO LABORATORIES
 Fargo, N. Dak. Dept. 19

2 Years RADIO NEWS \$4.00 with
 FREE Copy of "23 Lessons in Radio"
 See Page 513

SERVICE MEN
 Send for this Book
FREE!



YOU NEED IT!
 Everything for your business from the finest mike to the smallest screw is in this book.

GUARANTEED QUALITY GOODS

PRICES LOWEST EVER QUOTED

Fresh new dependable Merchandise at Bargain Prices!

Leading Manufacturers Lines Complete
 Send For Your Copy Now!

SAMPLE BUYS FROM THIS BOOK



Wonderful Quality and Value.
 Walnut Cabinet
 \$14.65 less tubes

4 Tube A.C. Radio, Wonderful Quality and Value.
 Walnut Cabinet
 \$14.65 less tubes

Dry Electrolytic Condenser 500 V. 8 mfd. Guaranteed 69c
 Tube Replacement Transformer Brand New \$1.98

and Three Thousand Other Bargains

HEADQUARTERS
 for SERVICE MEN'S SUPPLIES

RADOLEK CO.

601 W. Randolph St.

CHICAGO

Illinois

Radolek Co.,
 609 West
 Randolph St.
 Chicago, Ill.

Please send me without obligation your Service Man's Supply Book.

Name

Address

City State

A New Circuit

The Engineering Department of the Shallcross Mfg. Company has designed a general purpose

Combination Multi-Range

Voltmeter and Milliammeter, A.C. and D.C.

employing the new Weston A.C. and D.C. Type 301 Universal Meter and

SHALLCROSS Super Akra Ohm



Resistors

The voltage range is from 5 to 1000 volts, 1000 ohms per volt and the current range is from 1 to 500 milliamperes A.C. and D.C.

A complete diagram and full information on the construction of this circuit are contained in our Bulletin 150-D, which also contains very useful information on the application of Akra Ohm Resistors to multi-range voltmeters, ohm meters, etc.

Our new Bulletin 150-D will be sent upon receipt of 4 cents in stamps.



SERVICE MEN!

SAVE MONEY

BUY

Reliable Guaranteed Parts

POWER TRANSFORMERS

FOR ALL SETS

Not Surplus Obsolete Stocks
But New First Quality
Guaranteed Merchandise

Send for Our Special Bulletin Listing
Transformers, Condenser Blocks and Voltage Dividers for All Sets

Get Our Complete Replacement Guide

RADIO ELECTRIC SERVICE COMPANY

N. E. Cor. 7th and Arch Sts.
Philadelphia, Pa.

the proper voltage for its operation and this current supply then connected to the output of an ordinary audio-frequency amplifier which receives, in turn, the output of a microphone, if air-borne sound is to be used, or of a phonograph pick-up if a record is to be played over the light beam.

Practical Circuits

The diagrams and specifications presented with this article show a set of circuits, both for sending and for receiving, which have been tried in our laboratories and found to be successful. Many other circuit arrangements might be used and almost any type of glow lamp, the only requirement for this lamp being that it will fluctuate in brightness in accordance with the variations of voltages which constitute the modulation. Many different types of modulating circuit can be employed, doubtless, as well as any kind of microphone, the circuit constants, the voltage and so on being arranged, in each instance, to suit the particular characteristics of the glow lamp to be used.

To discover exactly what kind of glow lamp, what modulation circuit and what other arrangements are most practical, cheapest, most easily portable and least likely to show difficulties in practical use, is precisely the problem which it is to be hoped the radio amateurs will accept and solve. It may even be possible to use some kind of mechanical light valve, as sometimes is done in making sound motion pictures, instead of a lamp which expresses the modulation by varying in brightness. The problem of modulating extremely intense light beams, like the beam from a million-candle-power searchlight, is still unsolved practically, although many theoretical possibilities exist, including the oscillating or "talking" arc-lamp, examples of which were tried many years ago to announce the trains in Grand Central Station in New York City.

The Optical System

Provided with a modulated light source, either by the lamp and circuit accompanying this article or in any other way, the next step of the maker of a light-beam telephone must be to provide the optical system which will concentrate, into a single beam, as much of this modulated light as possible and which will send that beam off to the receiving station. The simplest system of this sort is a mere condensing lens, like those used in magic lanterns or in motion-picture projectors. A valuable and simple addition is a parabolic mirror placed behind the light source, to catch and send back into the light beam as much as possible of the light which emerges toward the rear.

For ordinary experiments, over distances of a mile or less, nothing more complicated is necessary. An old magic lantern, projector and lens or any similar apparatus will do nicely. Such outfits often can be picked up for a few dollars at stores which handle second-hand motion-picture equipment. The modulated lamp then is placed in the position originally occupied by the arc lamp or incandescent lamp of this apparatus, the lens and mirror are adjusted to produce a

Study RADIO in CANADA



Marshall P. Bellis, service engineer, Sparton Radio of Canada, Limited, completed his radio training in our day classes. Mr. Bellis, who travels from coast to coast says: "Never in the history of radio has the demand for 100% trained men been so universal and Radio College of Canada gives that training so necessary today."

DAY, EVENING AND HOME STUDY CLASSES

on practical radio design and construction, wireless telegraphy, mathematics and drafting. Instruction approved by leading radio manufacturers. Preparation for government examinations. Booklet on request.

RADIO COLLEGE OF CANADA, Limited
310 Yonge St., Toronto

CLAROSTAT

Power Rheostats

for Transmitters, Speed Control, Line Voltage, Plating, etc.



- 2 Sizes—
80 and 250 watts
- 3 Ranges—
1/4 to 10 ohms
25 to 500 ohms
200 to 100,000 ohms

CLAROSTAT MFG. CO. Inc.
285 N. 6th Street, Brooklyn, N. Y.



TRIMM FEATHERWEIGHT HEADSET IN THE ARCTIC WITH MacMILLAN

Chosen for quality and light weight for use in Arctic. Radio Operator Brooks sent this message: "Trimm lightweight fones best I ever had."

Amateur Operator Johnson after using writes: "It is easy to see why Brooks took Trimm Featherweights to Baffin Land. Makes operating 20% easier."

Trimm QUALITY FONES for all purposes. Special attention given "The Hard of Hearing."

Write for Descriptive Literature
TRIMM RADIO MFG. CO., 1528 ARMITAGE AVE., CHICAGO

IN DECEMBER AMAZING STORIES

THE INEVITABLE CONFLICT, by Paul H. Lovering. (A Serial in 2 parts) Part I. Where will these demands for equal rights for women end? Perhaps, after many more wars are fought, women may—with cries for eternal peace—gain the upper hand. What kind of a world would this be, ruled by a Matriarchy? A topsyturvy world? Perhaps. Mr. Lovering gives us his idea.

PIRATES OF SPACE, by B. X. Barry. According to present-day newspaper accounts, pirates seem to have come again into vogue. But the pirates of the future, when interplanetary travel has become an everyday occurrence, and when numerous interplanetary marvels have been disclosed, will undoubtedly work their ends in a very much different manner. Here is an exciting interplanetary novelette.

SKY COPS, by Earl Vincent and Charles Roy Cox. Traffic in the air! That sounds humorous, but for how long? If the automobile roads become very much congested, a great many of us will have to take to the air and perhaps go to other planets. What a job for traffic cops in the air!

THE BLATTIDS, by Morrison Colladay. Scientists of note specifically stated that volcanic activity in a certain part of the country was highly improbable. The natural conclusion, therefore, was that what seemed to be a volcanic eruption, was only a display of the aurora borealis—despite the fact that the aurora borealis was never known to be visible there either. The truth was brought to light and proven by the only two eye-witnesses to a similar display in another region.

On Sale at all Newsstands

light beam as nearly parallel as possible, and the transmitter is ready to work.

The easiest way to see whether the beam is approximately parallel is to hold a sheet of white paper in front of the projector at distances of a few inches and then at a distance of fifty or sixty feet. If the spot of light produced on the paper is of the same size at the two distances, the light beam is approximately parallel. If the sizes are different, the lens and mirror should be moved back or forth until the parallelism is better.

Telescopes for Distance Work

For the optical system at the receiving end the simplest device is an ordinary telescope or one tube of a field glass. This should be mounted on some kind of support which will permit the instrument to be trained in one direction and then clamped there. The ordinary telescope tripod is admirable. The receiving operator then merely looks through the telescope toward the sending station until he sees the small light spot made by the modulated lamp. He then clamps the telescope in that position and the adjustment is complete. If the photoelectric cell or other light-sensitive device then is placed at the eyepiece of the telescope, where the observer's eye was a moment before, the apparatus is ready to work.

For short distances it is not necessary to use a telescope. A common reading glass to focus the received light on the photoelectric cell works admirably. For short distances, like circuit tests in the laboratory, no sending or receiving lenses are needed. The photoelectric cell merely is set up so that it "sees" the modulated lamp. That is enough.

New Optical Developments

When practical outfits come to be developed there will be optical devices, doubtless, to facilitate the focusing of the two stations on each other, such, for example, as special telescopes with the photoelectric cells attached to them so that a switch from visual to photoelectric reception may be made rapidly and accurately; even with half-silvered mirrors or other devices to split the light beam so that the observer may both look at the distant light and hear its message at the same time. These refinements, however, are by no means necessary for the widespread experimentation which seems to be the greatest present need.

For the light-sensitive element which is to serve as the detector of the receiving station and to pick off the light beam the modulation that it carries the experi-

menter has his choice of at least four different devices. One is the ordinary photoelectric cell, having many admirable qualities but yielding such feeble currents as a result of the light variation that high-gain amplifiers are necessary, with corresponding disadvantages in weight, cost and lack of stability. Another possible device is the photo-voltaic cell, containing one type or another of light-sensitive plate submerged in a chemical solution necessary to the cell's operation. The chief disadvantage of these photo-voltaic cells is their proneness to spring leaks and lose the vital solution which they contain.

Standard Equipment Used

Third of the possible light-sensitive devices is the selenium cell, such as the Burgess Radiovisor Bridge type which is used in the circuits presented herewith. These cells do not emit electrons when light enters them, as true photoelectric cells do. Instead, the film of selenium in the cell changes its electrical conductivity, a change which can be picked up and amplified either in the way shown in the circuits or by other methods employing a transformer. Finally, a thoroughly suitable device for the receiving end of these light-beam telephones seems to be the new photronic cell announced at the recent New York City Radio Show by the Weston Electrical Instrument Corporation.

Beyond the light-sensitive detector, the apparatus necessary for the light-beam telephone is fully standard. Some form of amplifier is needed, its gain and characteristics depending upon the type of light-sensitive cell which is used. Listening may be done by headphones or a loudspeaker, as one prefers. Given the lamp that can be modulated and some kind of light-sensitive cell, any competent radio amateur can put the whole apparatus together in a few hours. The only difficulties likely to be encountered are those of stabilization, shielding, proper matching of impedances in different parts of the circuits and others with which every radio experimenter already is familiar.

Experimental Applications

If any amateur who reads this article has two windows between which he wants to communicate without bothering with the telephone, or if he wants to go on a picnic with some other enthusiast and talk between their two automobiles across a mile or so of country, or if he knows a contractor or a tugboat captain who could use such telephones to practical advantage; he could not amuse himself more profitably, it is probable, than by building one.

Some day, if such devices can be made as cheaply and as dependably as seems probable, many other practical utilities will present themselves, probably first in navigation and in warfare. It is not even unthinkable that all of the incandescent lamps of a city could be modulated with sound messages and used to broadcast public announcements or entertainment to which anyone could listen merely by turning a simple light-sensitive device toward the lamp.

News and Comment

(Continued from page 508)

An interesting sidelight in the Batson report is the fact that the United States prohibits broadcasting in Panama, and England permits it at Gibraltar. Radio is also prohibited in Malta, Ethiopia and Egypt, though in Egypt the law is not enforced. The reasons are military.



EVERY RADIO SERVICE MAN should read this book which tells you how to make more money out of radio service. There are secrets which "old timers" have learned through years of experience. You can now have the benefits of these. You don't pay a penny—you don't promise to pay any—for this book will be sent to you without any obligation of any kind with our compliments if you will sign and send in the coupon. It is part of our plan to help independent radio men profit by the experience of others in the industry and make a bigger income.

Brim Full of Facts

This book was written by a man who has probably had more experience than any one else in the industry. It tells you in simple language the principles and practices which made him the outstanding figure in the radio world that he is today. These are a few of the subjects fully covered: Setting the public on radio service—Value of Personality—Newspaper advertising—Business literature—Types of service letters—Electric signs—Making tubes business builders.

This book is for service men only and will be sent FREE and fully postpaid upon receipt of the coupon completely filled in.

RADIO SERVICE MEN'S GUILD
1243 Fullerton Avenue
Chicago, Illinois.

You may send me your book "Making Money Out of Radio Service" absolutely FREE and fully postpaid. (Please answer these simple questions):

What radio training have you had?.....
 No. of years in radio?.....
 Do you give radio all your time?.....
 Have you a store?.....
 Do you work for some one else, if so who?.....
 Name.....
 Address.....
 City.....
 State.....



Books that every radio dealer and serviceman should have.

Chock full of bargains and helpful service data, these books are yours for the asking.

They will save you up to 50% on your replacement parts purchases.

Send for Them Today



25 Park Place, Dept. A. New York City

FILTERMATIC PRODUCTS

Help you to get the **BEST** possible reception from your **RADIO** set.



SUPER-TONE CONTROL

Will make your old Radio (battery or electric) equal in tone to the most modern set. Installed in one minute's time, no tools required. Will tune out much of your noises and so-called static. Will tune your set to suit your ears. Positively cannot harm the finest radio in any way. Price \$2.50 postpaid. Satisfaction guaranteed or money refunded.

SUPER-FILTERMATIC
The Modern Aerial

Thousands of satisfied users, praised by radio experts. Replaces all other aerials, reduces static, and noises. Especially good on distance reception. Helps to separate stations, does not connect in light socket (therefore eliminating hum and line noises). It is very compact, measuring only 1 1/2 inches, is absolutely non-corrosive and non-directional, installed in one minute, no tools needed. Will never wear out. Eliminates trouble and expense of lightning-arrestor.



Price only \$2.00 postpaid. Satisfaction guaranteed or money refunded.



ALL PROGRAMS
Are Good with a **FILTERMATIC**. For all radios only \$1.00 postpaid.

Entirely automatic—no bothersome tuning. Improves tone, reduces static, brings in distance, increases volume, separates stations. Installed in one minute, no tools required, in series with your aerial or across your aerial and ground. Satisfaction guaranteed or money refunded.

Send check or money order. C. O. D. 50% with order. (No foreign C. O. D.) Money back guaranteed after 5-day trial. Service Men and Dealers Write for Particulars
FILTERMATIC MFG. CO.
(Dept. B-10) 4458 Frankford Ave., Philadelphia, Pa.

Servicemen

Morrill Super Condensers
Morrill Quality
Insure You Real

CUSTOMER SATISFACTION

Features: Unexcelled performance. Conservative Voltage Rating. Accurate Capacity Rating. Extremely Compact. Convenient to Stack.

Write for Bulletin X-1

MORRILL & MORRILL
30 Church Street
New York, N. Y.

Sole U. S. A. Distributors for
Siemens & Halske

Condensers, Microphones, Resistors, Interference Eliminators, Interference Locators.



MILLION PARTS

All Replacement parts for FRESHMAN Equi-phase, Model Q and N (Polydyne) sets.
Federal Ortho-sonic Power supply \$6.50
Inductor Dynamic Speaker Chassis 4.50
1 inch Screen-grid coils with shields, ea.49
1 1/4 inch Peerless Screen-grid coils, ea.29
1 1/4 inch Coils, secondary for .00035, no primary, ea. .10

Ask for FREE Price List

Experimenter Radio Shop

129 West St. Dept. RN New York City

LEARN BY LISTENING
Telegraphy
Morse or Continental

Step into this interesting—un-crowded—HIGHLY PAID Profession. Become a trained operator in Morse or Radio

Code, easily, quickly, at home, with **TELEPLEX**, the Master Teacher. Used by the U. S. Government and leading schools. Entirely new code course in 12 rolls of tape. During last ten years **TELEPLEX** has trained more operators than all other methods combined.

Write for Folder E-12

TELEPLEX CO.

76 Cortlandt St., New York, N. Y.

Learn AT HOME With



Antenna Problem

(Continued from page 474)

may be connected to one antenna. Each down-lead should be protected with a lightning arrester and terminate in a resistor. The two branches should have approximately an equal number of multicouplers. The maximum difference allowed is four.

Where there are not more than 6 multicouplers in one down-lead, three risers may be connected in parallel. These three down-leads may all be connected to the same end of the antenna or one may be connected to the other end. The multicouplers do not have to be equally spaced, but there must be an equal number in each down-lead. Different combinations of series and parallel circuits may also be used.

The lead-in from the multicoupler to the receiver should be a thoroughly insulated and moisture-proofed wire running through a hole in the window sill and terminating in a radio wall outlet or other convenient form of connection. This wire should be as short as possible; in no case longer than 75 feet. The terminal outlet should be connected also to a good ground in the apartment, preferably to the cold-water pipe. With this arrangement the tenant need only plug the antenna and ground leads from his receiver into the radio outlet to establish connections.

The terminal resistance indicated in Figure 2 is a weatherproof, non-inductive resistance of approximately 100 ohms and rated at 30 watts. As shown in the drawing, this terminal resistance is mounted outside the building at the bottom of the riser and supported by the down-lead itself. The other end of the resistor should be connected to the cold-water pipe in the basement.

The multicoupler unit, shown in Figure 1, is enclosed in a metal cylinder which is treated with a weatherproof paint. It is a little less than four inches long and has a diameter of one and five-sixteenths of an inch. Even when this down-lead is run on the outside of the building the installation is not conspicuous and certainly an improvement on the loose-hanging wires of the present time.

In the case of a new building the entire system is usually installed in rigid conduit. In every room where a receiver is to be installed the multicoupler is put inside an outlet box in the wall. The aerial and ground are then connected to the outlet plate placed over this box. The a.c. line is brought into the same box so that all connections for the radio are provided by the one outlet. The plug for the aerial and ground connections is different from the power plug, in order to prevent it from being inserted in the power socket by mistake. Further, the box is divided into two compartments separating the power wiring from the antenna-ground wiring as is required in many cities.

There are three types of these outlets available. One model is a two-gang plate with box and cover. The plate has an outlet for antenna and ground and also a

(Continued on page 542)

Read Classified Advertising—It Pays

Advertisements in this section twenty-six cents a word for each insertion. Name and address must be included at the above rate. Cash should accompany all classified advertisements unless placed by an accredited advertising agency. No advertisements for less than 10 words accepted. Objectionable or misleading advertisements not accepted. Advertisements for these columns should reach us not later than 1st of 2nd month preceding issue.
TECK PUBLISHING CORP.
350 Hudson St. New York, N. Y.

Agents Wanted

Guaranteed Genuine Gold Leaf Letters anyone can put on store windows. Large profits, enormous demand. Free samples. Metallic Letter Co., 422 N. Clark, Chicago.

Correspondence Courses

Used correspondence school courses sold on repurchase basis. Also rented and exchanged. Money-back guarantee. Catalog free. (Courses bought.) Lee Mountain, Pisgah, Alabama.

CORRESPONDENCE COURSES—Sold, Bought, Exchanged, Rented, Bargain Catalogue Free. Handling, C-799 Broadway, New York.

Detectives

DETECTIVES. Work home or travel. Experience unnecessary. Particulars free. Write George Wagoner, 2190-A Broadway, N. Y.

For Inventors

INVENTIONS COMMERCIALIZED. Patented or unpatented. Write Adam Fisher Mfg. Co., 273 Enright, St. Louis, Mo.

I CAN FIND a buyer for your Inventions, Patents, Kinks, Wrinkles, etc. Write: D. W. Ross, Railway Exchange Bldg., Portland, Ore.

Outboard Motors and Boats

OUTBOARD MOTORS. Bicycles, Motorcycles, Electric Light and Water Pumping Plants, Gas Engines. Terms, Catalog free. Clymer Motors, D29, Denver, Colorado.

Patent Attorneys

PATENTS—Write for Free Information. HOW TO OBTAIN A PATENT and RECORD OF INVENTION—or send Drawing or Model for Examination. Miller & Miller, Patent Attorneys (former Patent Office Examiners), 1006-D Woolworth Building, New York; 675 Earle Building, Washington, D. C.

PATENTS, TRADE MARKS—All cases submitted given personal attention by a member of the firm. Information and booklet free. Lancaster, Allwine & Rommel, 269 Ouray Building, Washington, D. C.

Inventors—Should write for our Guide Book, "How to Obtain a Patent," and Record of Invention Blank, sent Free. Send model or sketch of inventions for our inspection and instructions free. Radio, Electrical, Chemical, Mechanical and Trademark Experts. Terms Reasonable. Victor J. Evans & Co., 922 Ninth, Washington, D. C.

PATENTS—Advice and booklet free. Highest references. Best results. Promptness assured. Watson E. Coleman, Patent Lawyer, 724 9th Street, Washington, D. C.

PATENTS. Time counts in applying for patents. Send sketch or model for instructions or write for free book, "How to Obtain a Patent," and "Record of Invention" form. No charge for information on how to proceed. Clarence A. O'Brien, Registered Patent Attorney, 3091 Security Savings & Commercial Bank Building (directly opposite U. S. Patent Office), Washington, D. C.

Radio

Transformers and chokes designed, built, or rewound to meet your requirements. Quotations on request. Boston Transformer Co., 886 Main Street, Cambridge, Mass.

RADIO TUBES. Speakers, Pickups, Motors, Switches, Resistances, Condensers, Transformers, Dial Cable, etc. Write for Catalog and exceptionally low wholesale prices. Surplus Sales Company, 1944 Boston Road, New York.

Songwriters

COMPOSERS—VERSE OR MUSIC. Brilliant opportunity. Write at once. Van Buren, 2546 McClurg Bldg., Chicago.

Salesmen Wanted

SCREW-HOLDING Screw drivers! Not magnetic. Remove, hold, insert screws inaccessible places! Factories, garages, electricians, carpenters, mechanics, radio owners buy on sight! Free Trial! Millen, 5020 Winthrop Bldg., Boston.

Telegraphy

LEARN Wireless (Radio) and Morse telegraphy. School, oldest, largest; endorsed by telegraph, radio and government officials. Expenses low—can earn part. Catalog free. Dodge's Institute, Cour Street, Valparaiso, Ind.

Controlling Trains With Light Rays

(Continued from page 465)

principally of a glass plate which is electrolytically coated with a platinum layer deposited upon a thin silver covering. The platinum is divided into two separate sides by a fine crack. This crack is filled with selenium, an element of the same chemical group as sulphur and tellurium. In its crystalline form it has the property of changing its electric resistance considerably under the influence of light, being almost an insulator in the dark and of considerable conductivity if irradiated. One of the pictures shows eight selenium cells arranged on the receiver near the projector opening. These openings are covered with small lenses in order to protect the devices inside and concentrate the beam

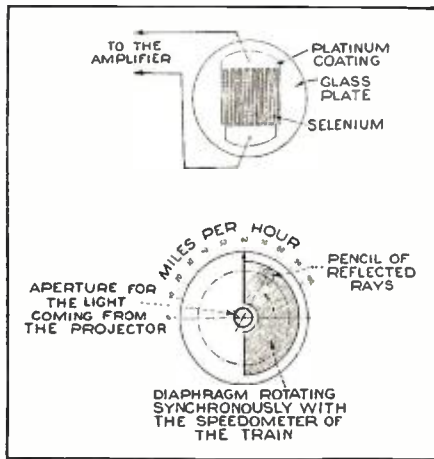

Figure 8 (top). Sketch of the selenium cell. Figure 7. Diagram of the speed control shutter

of light. The cells can be used individually and in different combinations, thus making it possible to transmit not only the stop-and-go signals but for such purposes as the automatic movement of points, indications of level crossings, and

Latest Radio Patents

(Continued from page 504)

1,811,051. ELECTRON DISCHARGE TUBE. GILLES HOLST, Eindhoven, Netherlands, assignor to N. V. Philips' Gloeilampenfabrieken, Eindhoven. Filed Oct. 28, 1924, Serial No. 746,396, and in Germany, Nov. 27, 1923. 1 Claim.

A discharge tube comprising a glass envelope, a base to which the envelope is sealed, a press supported by said base, a straight filamentary cathode perpendicular to the direction of the press, a cylindrical control grid mounted about the filament as axis, a cylindrical plate concentric with the control grid, an auxiliary cylindrical grid between the filament and the control grid, a second auxiliary cylindrical grid mounted between the control grid and the anode, prongs projecting downwardly from said base, an additional terminal on the base, a lead from one of the electrodes to said terminal, and leads from the remaining electrodes to the prongs.

orders can be given for movements within the station and for other purposes.

The projector, although attached to the front of the engine so as to get the signals as soon as possible, is free from snow and ice even when the entire engine is covered with it. This is due to the fact that the transmitter is heated by steam or by electricity.

There is one more attachment connected with the optical train control which makes these instruments an important asset for modern railway engineering. This is the automatic speed control. This control makes it possible to bring the signal post nearer to the danger point than was possible heretofore, as a certain distance had to be allowed to make up for the vigilance of the engineer. Moreover, the speed limit arrangement makes it possible to control the speed on the track, independent of the vigilance of the engineer. This equipment does not operate if the engineer works according to his signals and general instructions. But in case he overlooks a signal or does not respond to it properly, the safety mechanism of the train control is automatically put into action.

The construction of this speed controlling device is simple, as indicated by the accompanying sketch.

A diaphragm is brought before the light which comes back from the three-dimensional mirror and strikes the selenium cell. This diaphragm is connected with the speedometer. It consists, principally, of a plate which is connected with the speedometer. The light is allowed to pass only if the diaphragm is not in the way. In the drawing, for instance, the diaphragm covers a range of over 60 miles per hour. Light being reflected from the three-dimensional mirror, therefore, would only be allowed to strike on the part not covered with the diaphragm. If, however, the train should make, say, 80 miles per hour, the screen would open the way to the light-sensitive cell, under 80, which, in turn, would operate the electric and air relays so as to reduce the speed of the train to the desired limit. As each speed corresponds to a definite angle of the mirror on the signal post, simple means is given by this method to prearrange the speed limit for each point of the road, by making small changes in the arrangement of the reflector.

Optical train control has added an important factor to safe and efficient train control. Independent of bad weather, the vigilance of the engineer and the human factor, orders are transmitted to the train at full speed, which, if no specific action is taken, automatically turn on the necessary safety devices. In addition to this, the development of the optical train control makes it possible to report to the engineer whether the approaching gates are closed or not, or the failure of equipment at level crossings, approaching terminals and curves and grades. The tiny changes in electric currents from light-sensitive cells, together with audio amplification similar to that used in radio are therefore increasing the safety, speed and efficiency of railroad transportation.



"There!... that's more like it!"

Yes... you really can hear the difference after your radio connections have been soldered with Kester. Because Kester Radio Solder has a plastic rosin flux. The flux is non-corrosive and a non-conductor. Dust and moisture will not collect on connections that have been soldered with Kester Radio Solder, and as a result, electrical leakage is prevented—and of course, that aids receptivity.

Kester Radio Solder carries its flux inside itself. You merely apply heat, and the correct amount of flux flows to the job. Even if you've never soldered before, Kester will assure a perfect job.

Try Kester at our expense. Or buy the handy package from your radio store or other dealers. Kester Solder Company, 4201-13 Wrightwood Avenue, Chicago, Illinois. Incorporated 1899.

FREE SAMPLE! Write for it NOW

KESTER

RADIO SOLDER

If It's....

REPLACEMENT PARTS
Federated has it!

A Few Examples:

Filter Condenser Block for Victor R-32, R-35, RE-45, RE-75, Cat. No. 2709 \$1.35
Power Transformer for Victor R-32, Cat. No. 2558 \$2.75

Complete Power Pack replacement for Atwater Kent 40, 42, 44, Cat. No. 2609 \$6.50
Filter Condenser Block for AK37, Cat. No. 5001 \$2.91

Filter Condensers for all Majestic sets (state model) \$2.50
We carry a complete line of genuine Majestic power transformers and chokes at 60 per cent. off list.

Brandes B10, B11 Power Transformer, Cat. No. 5421 \$3.50
Kolster 6H, K5 Power Transformer, Cat. No. 5632 \$7.85
Kolster K24 Power Transformer, Cat. No. 2655 \$5.75
Complete line of genuine Kolster power transformers, audio transformers, chokes, condensers and resistors in stock.

Send for our free 56-page Tubloid Catalog listing over 2000 items.

Federated Purchaser

25 Park Place, Dept. A, New York, N. Y.

LYNCH Resistors

Precision Wire Wound
Metallized
LYNCH
1% Tolerance
Write for details of new RMA Color Code Chart
LYNCH MFG. CO., Inc., Dept. N, 1775 B'way, N. Y.

1/2, 1, 1 1/2, 2 and 3 Watts



**REPLACEMENT
TRANSFORMERS
CONDENSERS
RESISTANCES
AND REPAIR PARTS**
For Dealers and Service Men

Years of thorough study of all makes of receivers enable Wellston Radio Corporation Engineers to produce GOLD-TEST Replacement Parts which are right and allow the greatest margin of safety. Scientifically controlled mass production allows the lowest prices consistent with highest grade material and workmanship. This is the winning combination for Dealers and Service men. The complete line includes Transformers, Condensers, Resistances and miscellaneous parts for every make of receiver. Ask your Jobber for GOLD-TEST Replacement Parts. If he can't supply you, write direct—for our complete catalog.

GOLD-TEST AERIAL
Forget your aerial troubles. Install a GOLD-TEST—the Mighty Midget Marvel of perfect reception. Gets great distance and reduces static and hum. Buy from your dealer. If he can't supply you, write direct.
\$2.50

WELLSTON RADIO CORP.
Dept. 201 St. Louis, Mo.

GET STARTED IN RADIO

Write for free booklet telling about this growing and most promising industry. The radio operator is an officer aboard ship. His work is light, pleasant and interesting. He has many opportunities to travel to all parts of the world.

Announcing a new course in TELEVISION starting immediately. Full information on request.

West Side YMCA Radio Institute
Established 1910
17 West 63rd Street, New York, N. Y.

ROYAL SHORT WAVE RECEIVERS AND TRANSMITTERS

A wonderful new TWO TUBE Short-Wave Receiver with a WORLD-WIDE RANGE! Uses a 232 screen grid and a 233 pentode tube. Amazing volume and extreme sensitivity! Needs only two dry cells and two or three 45 volt "B" Batteries. Tunes 14 to 200 meters. Enjoy direct reception of foreign broadcasting stations, Police transmissions, Amateur stations, etc! Guaranteed to outperform many higher-priced sets. Model RP \$13.95. Also in KIT form for those who prefer to "Roll their own." Complete with all necessary parts, including drilled panel, wire, etc. \$9.95. Set of specially tested tubes—\$2.95.

Two tube Short-Wave Receivers using any battery tubes. Tunes 14-200 meters. World Wide range. Gives better results than any other low priced set. Model RC—\$10.45. Set of two volt tubes—\$1.90.

LOW-POWER TRANSMITTER. Complete with meter and resonance indicator. Just plug in any receiving tube, attach batteries, eliminator, or power supply and start sending! Adaptable for phone. Model TC—\$9.95.

Deposit required. Foreign orders must contain full remittance plus transportation.

High quality parts and scientific design insure maximum results. Many Other Models and Unassembled Kits in

Free Bargain Catalog
HARRISON RADIO CO.
189 Franklin St. Dept. N New York City

Antenna Problem

(Continued from page 540)

double power outlet. Another model has a single-gang plate but a full-size box with a cover to adapt the large box to the one-gang plate. This type has an antenna and ground and one power outlet. Finally, there is a model having only antenna and ground outlets.

The box and cover, of course, must be installed before the walls are plastered. The hole in the cover is large enough to permit the multicoupler to be put in when the wires are pulled. This multicoupler for the conduit type system is a little smaller than that for the outside type.

The same specifications for the aerial as were given above for the outside system apply to the conduit system.

When the length of the conduit between two outlets is more than 50 feet, loading coils are necessary. A loading coil should be installed approximately every 25 feet in series with the down-lead in a standard double outlet box with cover and blank plate. A similar box should be used for the terminal resistance in the basement. One of these is to be connected in each down-lead as in the outside type. Figure 3 shows detail drawings of the outlet box, the loading coil box, the terminal resistance and the lightning arrester as used with the conduit type installation.

In some cases it may be required to install the multicoupler at a distance from the receiver, generally in a closet. The outlet is then covered with a blank plate and the antenna and ground are run through conduit to the receiver location. This branch line should not be more than 20 feet in length.

It is recommended that standard 1/2-inch rigid conduit be used. The wires consist of two single number 18 copper wires with 1/32-inch rubber-insulated and paraffined-braid covering.

The plates and boxes are manufactured by Hart & Hegeman and are distributed by them together with the multicouplers, loading coils and terminal resistors everywhere in the United States except in New York City. The firm of Amy, Aceves & King distribute the complete equipment for installations in New York City and also the equipment for the open system in all territories.

The multicoupler system has been designed so that it passes the broadcast frequencies and it is claimed that most interfering noises do not come through. In practice it has been found that waves down to 100 meters can be received. This makes the system adaptable for television also. For the short-waves it is necessary to connect a 0.0003 mfd. condenser between the down-lead above the multicoupler and the antenna post of the short-wave set. In this case the section of the riser to which the 0.0003 mfd. condenser is connected serves as the short-wave antenna.

The system here described has been installed in many first-class apartment buildings in New York City and elsewhere. In all more than 9000 families are being served by this equipment.

INDEX TO ADVERTISERS

A	
Aerovox Wireless Corp.	510
American Sales Company	530
American Transformer Co.	527
Amperite Corp.	538
Amplex Instrument Laboratories	523
B	
Baltimore Radio Corp.	536
Blan, the Radio Man	523
C	
Cable Radio Tube Corp.	524
Candler System Co., The	532
Capitol Radio Engineering Inst.	526
Cardwell Mfg. Co., Allen D.	536
Central Radio Laboratories	512
Chicago Gear Works	536
Chicago Radio Apparatus Co.	534
Clarostat Mfg. Co., Inc.	538
Classified Advertising	540
Coast to Coast Radio Corp.	543
Coyne Electrical School	453
D	
Deutschman Corp., Tohe	532
Dodges Institute	534
Drake & Co., Frederick J.	528
E	
Eastern Rabbitry	523
Electrad, Inc.	523
Electrical Manufacturing Corp.	527
Electric Soldering Iron Co.	532
Emerson Radio & Phonograph Corp.	3rd Cover
Experimenters Radio Shop	540
F	
F & H Radio Laboratories	537
Federated Purchaser	524, 539, 541
Filtermatic Mfg. Co.	540
First National Television, Inc.	530
Flechthelm & Co., Inc., The	529
Fox Engineering Co.	530
G	
Grant Radio Labs.	532
H	
Hammarlund Mfg. Co.	529
Harrison Radio Co.	542
Hoodwin Co., Chas.	518
I	
Insuline Corp. of America	523
International Correspondence Schools	544
International Resistance Co.	515
J	
J. M. P. Mfg. Co.	534
K	
Kester Solder Co.	541
L	
Leeds Radio Co.	525
Lincoln Radio Corp.	511
Lynch Mfg. Co., Inc.	541
Mc	
McGraw-Hill Book Co., Inc.	536
McSweeney's Electrical School	532
M	
Mallory Co., Inc., P. R.	519
Massachusetts Radio & Telegraph School	524
Midwest Radio Corp.	454, 455
Morrill & Morrill	540
N	
National Co., Inc.	516, 517
National Radio Institute	451, 521
National Radio Trade Directory	522
P	
Paramount Mfg. Co.	526
R	
Racon Electric Co., Inc.	532
Radio College of Canada, Ltd.	538
Radio Electric Service Co.	538
Radio Service Men's Guild	539
Radio Surplus Corp.	529
Radio Technical Publishing Company	534
Radio & Television Institute	456
Radio Trading Co.	526
Radio Training Ass'n of America	449
Radio Treatise Co., Inc.	525
Radolek Co.	537
R.C.A. Institutes, Inc.	514
Readrite Meter Works	533
Rham Corp., The	536
Rim Radio Mfg. Co.	534
Rose-Rad Co.	536
Ross, Malcolm G.	536
S	
Scott Transformer Co.	509
Shallcross Mfg. Co.	538
Silver-Marshall, Inc.	2nd Cover
Six-in-one Fuse Co.	534
Stuyvesant Electric Co.	528
Supreme Instruments Corp.	531
T	
Teleplex Company	540
Television Mfg. Co. of America	528
Traul Radio Co.	525
Trilety, M.	526
Trimm Radio Mfg. Co.	538
Twentieth Century Co.	534
U	
Universal Auto Radio Corp.	543
Universal Microphone Co.	544
V	
Van Nostrand Co., Inc., D.	4th Cover
W	
Walters, G. R.	536
Wellston Radio Corp.	542
West Side Y. M. C. A. Radio Inst.	542
Western Radio Mfg. Co.	543
Weston Electrical Instrument Corp.	520
Wholesale Radio Service Co.	535
Wilson Ear Drum Co.	530

Radiola Models 80 and 82

(Continued from page 496)

to the blue wire on the part No. 8565. Connect the red wire from this part to the connection block holding five red wires and mounted between the i.f. transformers and the volume control. Connect the yellow wire from the new i.f. transformer to the chassis ground. Connect the green wire, through the hole, to the control grid of the original second i.f. tube and line up the new transformer in the usual way.

"When tone control is added to the model 80, old style, be sure to cut loose the 40,000-ohm red and pink resistor located under the terminal board of the pack. It is almost impossible to line up the link circuit of these models without disconnecting the aerial and ground, turning up the volume to full and then adjusting. If an oscillator is used, very

loose coupling should be employed to obviate the possibility of double peaks. If the set seems to have no pep on the local position, test the second resistor (black and white, 500 ohms) under the resistor board and next to the first r.f. plate choke coil.

"These models, when converted to d.c., are among the best direct-current sets on the market. The conversion is readily and economically made, one way or the other, as the different power supply is encountered. In the chassis: Connect all filaments in series, including the dial lamp. Across the dial lamp, connect a 5-watt wire-wound resistor of 1.5 ohms. In the pack: Remove the -80 tube. Connect the -45 filaments in series with a 20-ohm heavy-duty resistor in parallel with the series chassis connection. Nega-



Gets Distance with Marvelous Tone Quality

Universal has revolutionized the reception of automobile radio. Now you can get beautiful tone with ample volume from far as well as nearby stations. Compare these specifications of this Universal Deluxe Model at \$69.50 complete: 6 tubes with Pentode feature; Automatic Volume Control; Super-Dynamic speaker; Remote Control. STANDARD Model same except 5 tubes at \$59.50 complete. Standard installation charge at authorized dealers.

Money-Making Franchise for Dealers and Distributors

Open territory going fast. Write or wire at once for details of profitable franchise backed by strong company with aggressive sales policy. Get in on this LATEST item in radio or accessory fields.

UNIVERSAL AUTO RADIO CORP.

1227 S. Michigan Ave.

Chicago

RADIO NEWS Export Service

AS a service to our readers in locations outside the United States of America, either commercial, professional or private individuals, RADIO NEWS will arrange to provide contact with leading American manufacturers of radio supplies and receiving equipment.

To utilize this service, clip and fill out coupon below and send it attached to your letter on which you list the types of apparatus you are interested in.

Our Export Service Department will refer your inquiries direct to the proper manufacturers, asking them to send you full particulars, catalogues, prices, etc.

ALS eine Dienst für unsere Leser, entweder Kaufleute oder Privatpersonen ausserhalb die Vereinigte Staaten von Amerika, kann RADIO NEWS Kontakt erschaffen mit die wichtigste Amerikanische Fabrikannten von Radio Apparaten.

Für das Gebrauch von dieser Dienst, man schneide die Kupon hierunter aus und sende es mit einen Brief wo man eine Leist von Apparaten der Ihnen interessieren gebe.

Unsere Export Abteilung wird Ihr Schreiben gleich an die richtige Fabrikanten durchsenden und fragen, Ihnen Erkundigung, Katalog, Preis, u.s.w., zu senden.

COMME une service a nos lecteurs demeurant hors des Etats Unis d'Amérique, soit établissements commerciales, soit personnes privés, RADIO NEWS arrangera l'opportunité de procurer le "contact" avec les usines les plus importants des appareils de T.S.F. en l'Amérique.

Pour utiliser cette service, coupez, signez, etc., le coupon sur cette page et l'envoyez attaché à votre lettre en énumérant les types des appareils que vous intéressent.

Notre Département d'Exportation fera suivre vos inquétes aux manufacturiers directement en leur priant de vous envoyer toutes informations, catalogues, prix, etc.

COMO un servicio especial a nuestros lectores que se encuentran fuera de los Estados Unidos de America, ya sean comerciantes, profesionales o personas privadas, RADIO NEWS tendra a bien ponerlas en contacto con los principales centros manufactureros de radio, de aparatos receptores y accesorios.

Para beneficiarse de tal servicio, sirvase recortar el coupón de esta página, enumere los tipos de aparatos que le interesen, y envíenlosla conjuntamente con su carta.

Nuestro Departamento de Exportación se encargará de ponerse en contacto directo con dichos centros, pidiendoles le envíen una información complete. catalogos, precios, etc.

RADIO NEWS Export Service Department

Kindly put me in contact with American firms manufacturing the class of radio apparatus noted on attached sheets.

Name.....

Address.....

Business.....



FREE!

You cannot possibly afford to be without this valuable book. It is not just another CATALOG—it is indeed a VERITABLE ENCYCLOPEDIA of the RADIO INDUSTRY.

WHOLESALE PRICES TO ALL

From a binding post to a Silver-Marshall Super-Heterodyne Receiver—thousands of items are listed and described. Our net prices are so attractive, you will confine all purchases to "Coast-to-Coast." A word to the wise—write for your copy NOW—AT ONCE!

COAST-TO-COAST RADIO CORPORATION

123 N West 17th St., New York N.Y.

new

1932 CATALOG



BIG SAVINGS ON SUPERHETS. MIDGETS AUTO RADIOS

Lowest wholesale prices on the finest and the latest in radio. America's oldest mail-order radio house offers you new Variotone, Pentode Superheterodynes at big savings. Also Midgets, Auto Radios, Short Wave Receivers, Radio Phonograph Combinations, etc. Be sure to send for new 1932 catalog now.

Western Radio Mfg. Co.
128 W. Lake St., Chicago

WESTERN RADIO



**The New Heavy Duty
MODEL "BB"
-The Talk of the
Radio Industry!**

The masterpiece in micro-
Model "BB" phone construction. Hairline
precision. Nearly twice as
LIST PRICE heavy as any other micro-
phone of its size. Extra Heavy
\$25.00 24 kt. pure gold spot centers.
Duralumin diaphragms. Three
degrees of sensitivity. Fully
guaranteed.

Universal Microphone Co., Ltd.
1163 Hyde Park Blvd. Inglewood, Calif., U. S. A.

**There's money for you in
RADIO**

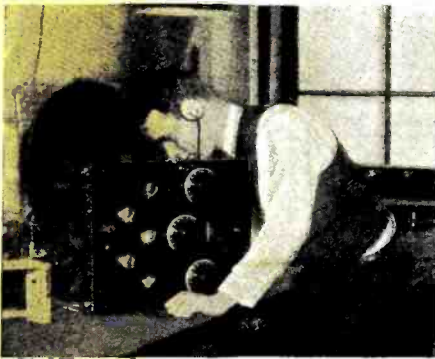

*Wonderful opportunity for ambitious
men to win success in this fast-
growing profession*

THE Radio industry is expanding so rapidly that trained men are at a premium. There is a constant, urgent demand for operators—factory superintendents—engineers—service men—designers—salesmen.

There is no better way for you to succeed in this fascinating business than to study the Radio Course of the International Correspondence Schools. This course is new and complete. It was written by practical authorities in this field. It is endorsed by leading radio experts and radio manufacturers.

Quincy J. Workman, of Scranton, Penna., writes that he has "nearly doubled his salary" since he took up the I. C. S. Radio Course. He is now manager of the Radio Department in a large store.

This same course enabled John M. Paynter, of the U. S. Lighthouse Service, Charleston, S. C., to get a position as Radio Operator and Ship's Electrician. Scores of other men in radio factories, laboratories and stores report similar progress.

You, too, can get in on the ground floor if you act quickly. But don't delay too long. Mark and mail the coupon today and let us tell you all about the I. C. S. Radio Course and what it can do for you.

**Mail the Coupon for Free
Booklet**

International Correspondence Schools
Box 8284-K, Scranton, Penna.

Without cost or obligation, please send me all the facts about the new I. C. S. course in

RADIO

Name.....

Street Address.....

City.....State.....

tive d.c. connects to one end of this resistor—the end connected to the series filaments in the chassis. D.C. positive passes to the filament (through a 60-ohm, 50-watt resistor)—also to the loudspeaker field, to the common terminal of the condenser bank, to the primary of the push-pull input transformer, to the center tap of the push-pull output transformer and to the 40,000-ohm red and pink resistor connected across the power pack terminals 5 and 1 (the latter side of this resistor also connecting to the remaining open side of the push-pull input transformer, primary side). The center tap of the secondary of the push-pull input transformer connects through the regular 60,000-ohm resistor to an external C battery of 16.5 volts, negative terminal. The grids and plates of the -45's are otherwise

undisturbed. The other connection for the field of the dynamic speaker connects directly to the plus terminal of the external C battery. D.C. negative is broken to place the regular filter choke in series with it and ground, a 2 mfd. section of the condenser block preceding the choke, a 3 mfd. section on the end, as the phase buckler in the a.c. set, and another 3 mfd. section from the choke tap to the d.c. plus. This choke tap is grounded to the pack ground or frame. Connections are made as usual between the chassis and the pack. Insert a .1 mfd. condenser in the ground lead and a .0015 mfd. condenser in series with the antenna. Be careful that neither the lead-in nor the ground wire touch the chassis or pack.

"H. F. PITZER,
Baltimore, Md."

Radio News Technical Information Service

The Technical Information Service has been carried on for many years by the technical staff of RADIO NEWS. Its primary purpose is to give helpful information to those readers who run across technical problems in their work or hobby which they are not able to solve without assistance. The service has grown to such large proportions that it is now advisable to outline and regulate activities so that information desired may come to our readers accurately, adequately and promptly.

Long, rambling letters containing requests that are vague or on a subject that is unanswerable take up so large a portion of the staff's working time that legitimate questions may pile up in such quantities as to cause a delay that seriously hinders the promptness of reply. To eliminate this waste of time and the period of waiting, that sometimes occurs to our readers as a consequence, the following list of simple rules *must* be observed in making requests for information. Readers will help themselves by abiding by these rules.

Preparation of Requests

1. Limit each request for information to a single subject.
2. In a request for information, include any data that will aid us in assisting in answering. If the request relates to apparatus described in RADIO NEWS, state the issue, page number, title of article and the name of the device or apparatus.
3. Write only on one side of your paper.
4. Pin the coupon to your request.

The service is directed specifically at the problems of the radio serviceman, engineer, mechanic, experimenter, set builder, student and amateur, but is open to all classes of readers as well.

All questions from subscribers to RADIO NEWS will be answered free of charge, provided they comply with the regulations here set forth. Non-subscribers to RADIO NEWS will be charged a nominal fee of \$1.00 for this service. All ques-

tions will be answered by mail and not through the editorial columns of the magazine, or by telephone. When possible, requests for information will be answered by referring to articles in past issues of the magazine that contain the desired information. For this reason it is advisable to keep RADIO NEWS as a radio reference.

Complete information about sets described in other publications cannot be given, although readers will be referred to other sources of information whenever possible. The staff cannot undertake to design special circuits, receivers, equipment or installations. The staff cannot service receivers or test any radio apparatus. Wiring diagrams of commercial receivers cannot be supplied, but where we have published them in RADIO NEWS, a reference will be given to past issues. Comparisons between various kinds of receivers or manufactured apparatus cannot be made.

Only those requests will be given consideration that are accompanied by the current month's coupon below, accurately filled out.

DECEMBER, 1931

Technical Information Coupon

RADIO NEWS Laboratory
350 Hudson Street
New York, N. Y.

Gentlemen:

Kindly supply me with complete information on the attached question:

I am a regular subscriber to RADIO NEWS and I understand this information will be sent me free of charge.

I am not yet a subscriber to RADIO NEWS

I wish to become a subscriber to RADIO NEWS and enclose \$2.50 to receive the magazine regularly for one year, and to receive this valuable technical information service free of charge.

Name

Address

Listen to Europe

*and the Rest of the World
on the Sensational New
Emerson All-Wave*

SHORT AND LONG WAVE RADIO
with modern Superheterodyne Circuit



The Entire World
Awaited this Great
Achievement



A Famous
Trade Mark
known in mil-
lions of homes.

*The Best REGULAR
Reception*

*The Same SHORT-
WAVE Reception*

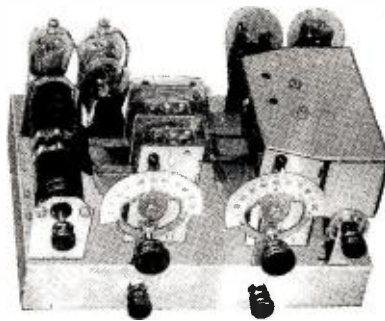

Now . . . at a
Sensational
Low Price . . .
a short and
long wave
Radio on a
single Chassis



Emerson All-Wave
\$69.50
COMPLETE
WITH 8 TUBES

BROADCAST RANGE 15 TO 600 METERS

Merely throw a simple switch to change from long to short-wave reception—NO COILS TO CHANGE.

The Emerson All-Wave fulfills every demand of the most ardent radio fan—good, clear European reception—stations throughout the Americas—amateur broadcasts—police signals—ships at sea—planes in flight, etc.

An efficient 8-tube chassis using 2 No. 235, 3 No. 224, one No. 227, one No. 247, one No. 280. Automatic volume control—tone control—two illuminated full-vision tuning dials—full size dynamic speaker. **Pentode and Vari-Mu Tubes.**

The Emerson is housed in an exquisite walnut finished cabinet of distinctive design.

Emerson Superheterodyne Radios

The last word in radio receivers. Every one appreciates the marvelous tone quality, selectivity and pep of the Superheterodyne circuit—and the Emerson outranks them all.

EMPLOYS THE POWER OF PENTODE AND VARI-MU TUBES

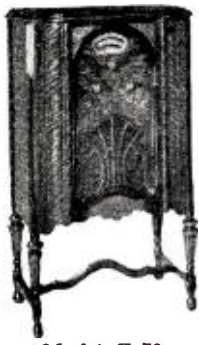

Model E-70

\$69.50
COMPLETE
WITH 8 TUBES

An oversized fully shielded chassis 17" wide. Automatic volume control, tone regulator, full vision dial—uses 8 tubes including powerful Pentode and Vari-Mu.

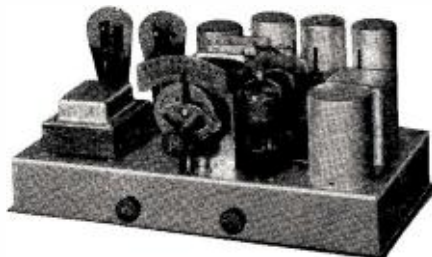

Model E-70
Open face console finished in burl walnut. 10 inch dynamic speaker.

Model E-80
Exquisite Period design finished in burl walnut. French doors. Both consoles have 10 in. full dynamic speaker.

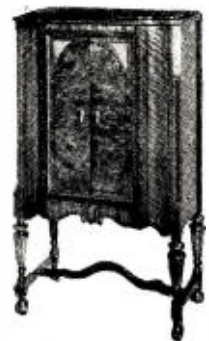

Model E-80

\$79.50
COMPLETE
WITH 8 TUBES

EMERSON RADIO and PHONOGRAPH CORP.

641-649 Sixth Avenue

New York, N. Y.

Ask your dealer to demonstrate the Emerson—otherwise write us direct. Dealers—Here is the double duty set, thousands in your territory have been waiting for. Write for details NOW.

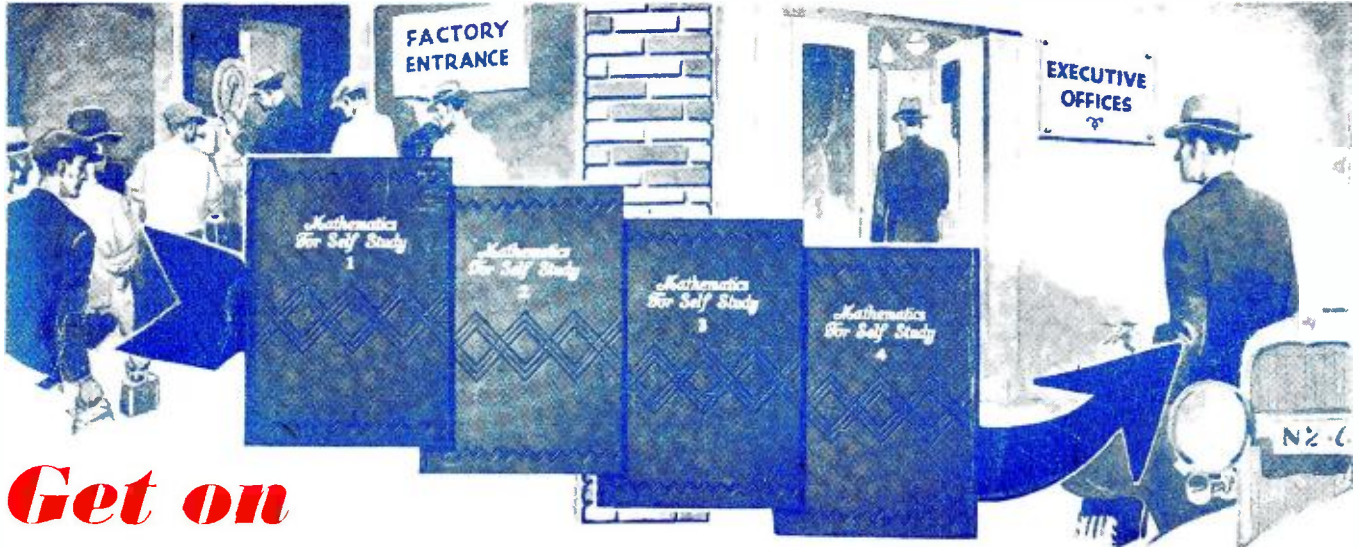

Get on the OTHER Side of the Wall!

MUSCLES Work for Little Pay - TRAINED Men Get the Big Money!

Do you want a better position—with a *man's-size* pay envelope? Do you want an assured future, without lay-offs, without wage cuts? In other words, do you want a "head-man's" job—the kind of job where the firm *needs you* in and out of season? You can lift yourself head and shoulders above the ordinary crowd of workers simply by giving yourself a broader *practical* education—an education in *mathematics*. A knowledge of mathematics is an absolute essential in all technical, scientific and mechanical work requiring skill and precision. Not a day passes in which you do not need mathematics to help you on some job. Just

think what it would mean if you could tackle those problems that puzzle your fellow-workers and solve them quickly and easily with mathematics! That kind of ability quickly attracts attention of the executive office. You know—when you come right down to it, mathematical training means all the difference between an ordinary hired mechanic and a high-salaried engineering executive. So why don't *you* take this one simple step to success? You don't need a lot of time or a lot of money. Here's a new, quick, easy way to learn mathematics!

At Last MATHEMATICS Self-Taught! Easy, Practical, Inexpensive Way!

Now you can take advantage of this easy method which has been worked out by an expert for those who do not wish to give the time and money required by other methods of mathematical study.

A very simple and extremely interesting group of books has been prepared for you by a man who has devoted his life to teaching practical men the fundamentals of this important subject.

MATHEMATICS For Self-Study

by J. E. Thompson, B. S. in E. E., A. M., Dep't of Mathematics, Pratt Institute, Brooklyn

These books start right from the beginning with a review of arithmetic that gives you many short-cuts and "trick" methods of calculation that save countless hours of your time. Then they go right into higher mathematics, and you see how really simple it is when an expert explains it for you. You see at once how you can apply mathematics to your own job—how you can easily solve practical problems that stump everybody else in the shop. In no time at all you will be tackling with confidence the most difficult problems on this subject, and be ready for a more responsible job with your firm. Get these books on approval and see for yourself how much interest and enjoyment you will have while getting this valuable dollars-and-cents training.

A Complete Reference Work on Mathematics in These Four Inexpensive Books

Starting from the first simple principles, these interesting books take you, by easy stages, into detailed applications of higher mathematics. Each step is clearly explained and is followed directly by simple problems and answers. There are, in addition, interesting practice problems with answers.

Arithmetic for the Practical Man
Algebra for the Practical Man
Trigonometry for the Practical Man
Calculus for the Practical Man
4 Volumes—1240 Pages—Illustrated

An Expert Gives You These Simplified Methods

Mr. Thompson, the author of these books, is not an ordinary teacher of mathematics. He has had many years' experience in giving students the kind of mathematical training they need in practical work. He presents each practical method and problem in the clearest and simplest way. He gets right down to the kind of information that you need in your daily work. Look up any mathematical problem that puzzles you in these books and see how quickly you get the solution.

EVERY MINUTE YOU SPEND With These BOOKS Will PAY YOU BIG DIVIDENDS!

"I never could see mathematics until I found these books," says Paul Pelz of N. Y. "I had tried many other books and had given up hope of being able to learn mathematics without attending a school."

J. T. Madden (Dean, School of Commerce, N. Y. U.) says: "The mastery of mathematics will prove of great practical value in this commercial age as a training in accuracy and logical reasoning."

Jerome Alexander says: "... mathematics essential for all business ... in engineering and the sciences. Progress in this field is intimately intertwined with the growth of knowledge in all fields."

Send No Money

EXAMINE THESE BOOKS FOR 10 DAYS FREE

The coupon below brings you the four books for 10 days' free trial. After 10 days return the books to us without obligation, or send us the small down payment of \$1.65—balance in three monthly payments of \$2.00 each (5 per cent. discount for cash).

MAIL THIS COUPON

D. Van Nostrand Co., Inc. (R.N. 12-31)
250 Fourth Ave., New York

Send me MATHEMATICS FOR SELF STUDY in 4 volumes. Within 10 days I will either return the books or send you \$1.65 as first payment and \$2.00 per month for 3 months—total \$7.65. (5 per cent. discount for cash.)

Name.....
Address.....
City and State.....
Business Connection.....
Reference.....