

**ULTRA-SHORT WAVE TESTS**

# **RADIO NEWS**

**November  
25 Cents**

**Tracking Storms  
by Radio**

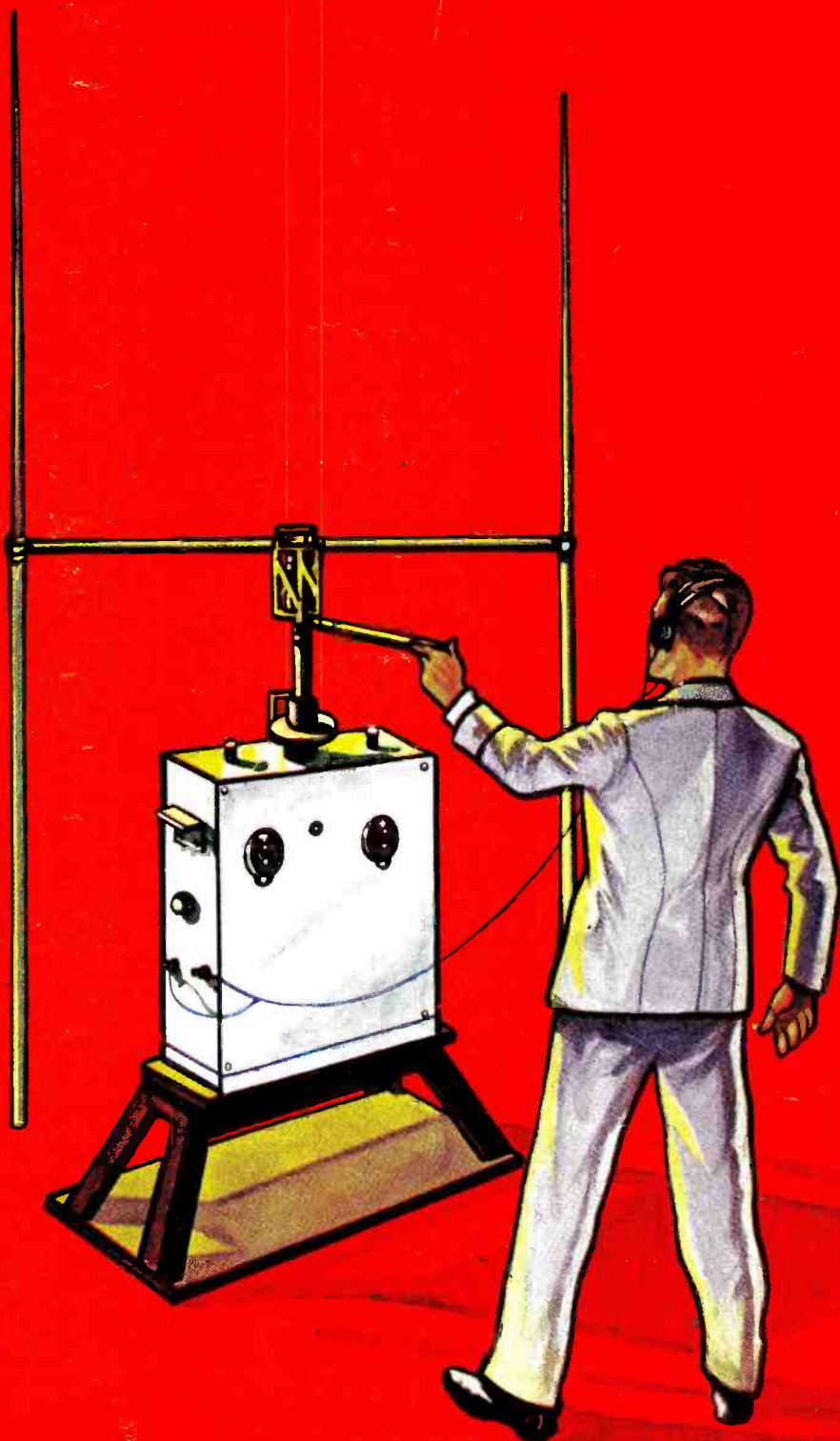

**Photo-cell Relays  
Television Progress  
Defining the Decibel**

*Editor*

# RADIO DEALERS and SERVICE MEN

*Send for our New 1932 Catalog!*

**BUY at WHOLESALE  
and SAVE MONEY!**

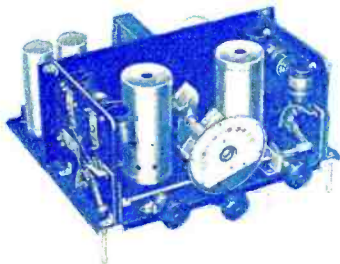

## LAFAYETTE SHORT WAVE CONVERTER

BRAND NEW—the 1932 Lafayette Short Wave Converter. An A.C. self contained unit that converts any standard broadcast receiver into a short wave Superheterodyne. NO PLUG-IN COILS ARE USED IN THIS CONVERTER. Absolute single dial control. The new Lafayette is a highly perfected Short Wave Converter, which will enable you to secure short wave reception from your present radio at an extremely moderate cost. Full details will be found in our new 10th Anniversary Catalog.

## TRU-TEST TUBE MIDGET

This is the radio sensation of the year! The lowest price, fine quality midget set ever developed. 5 TUBES—TWO SCREEN GRID—VARIABLE-MU—PENTODE OUTPUT—GENUINE ROILA DYNAMIC SPEAKER—LOFTIN-WHITE AMPLIFIER—3 GANG CONDENSER—BUILT-IN ANTENNA—RCA LICENSED—LOFTIN-WHITE LICENSED—POWERFUL PERFORMANCE—HANDSOME MANTEL CABINET. And this powerful little beauty sells for only \$16.50 less tubes, complete with speaker and cabinet. Send your order today, together with remittance for \$16.50, or write for 10th Anniversary Catalog.

**16<sup>50</sup>**

LESS TUBES



## LAFAYETTE 10 TUBE SUPERHETERODYNE

The 1932 Lafayette Duo-Symphonic—the most powerful radio receiver ever developed. A 10 tube Superheterodyne. Completely shielded. Outstanding features of this great new receiver are FOUR VARIABLE-MU TUBES AND TWO PENTODE TUBES IN PUSH-PULL—VISUAL METER TUNING—AUTOMATIC VOLUME CONTROL—LAFAYETTE PERFECTED TONE CONTROL—LOCAL DISTANCE SWITCH—STADIUM DYNAMIC SPEAKER—14 MICROVOLTS PER METER SENSITIVITY AND HAZELINE 10 K. C. SELECTIVITY. Available in a wide selection of modern cabinets. All models sold on our 30 day free trial offer, and BONDED by a \$10,000,000.00 BONDING CONCERN. Write for complete information!

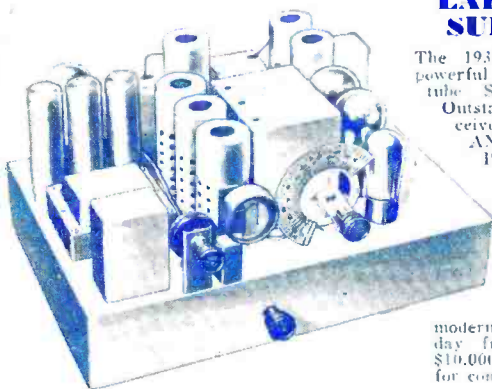

The new 1932 WHOLESALE RADIO 10th Anniversary Catalog is NOW READY! The finest, most complete radio catalog ever published in the United States. EVERYTHING in radio—sets, tubes, speakers, replacement parts, accessories, etc.—at lowest wholesale prices. Brand new, guaranteed merchandise at the lowest prices in our history. Send for this jubilee catalog—it's absolutely free—and see the finest assortment of radio merchandise ever listed.

## REPLACEMENT PARTS HEADQUARTERS

WHOLESALE RADIO is "Replacement Parts" Headquarters. We maintain a huge stock of Replacement Parts for all model sets. Prices are the lowest in the field. All merchandise guaranteed. Prompt, efficient service. You can buy replacement parts with perfect confidence from the largest institution of its kind in the country. Radio Dealers and Service Men will find the Replacement Part Section of our new catalog particularly interesting and helpful.

## MAIL COUPON TODAY!

Write for the Wholesale Jubilee 10th Anniversary Catalog. In it you will find complete descriptions and prices of the items described on this page, together with other typical Wholesale Values. Mail coupon TODAY!

**WHOLESALE RADIO  
SERVICE CO. 38 VESEY ST.  
NEW YORK**

MAIL TODAY **WHOLESALE RADIO SERVICE CO., Inc.**  
38 VESEY ST. DEPT. L-12 NEW YORK, N. Y.

Rush copy of your new 1932 Jubilee Tenth Anniversary Catalog, absolutely free.

Name .....

Address .....

Town .....

State .....

## SPECIAL EXPORT DEPARTMENT

Foreign Radio Dealers, Distributors and Service Men are invited to communicate with our Export Department. We do a huge business all over the world, and are equipped to give service and cooperation far above the average. It will pay you to do business with WHOLESALE. Address all inquiries to Export Department, Wholesale Radio Service Co., 38 Vesey Street, New York, U. S. A. Cable Address "Serve."

# Train *with* R.T.A. *for* Radio Service Work

Important and far-reaching developments in Radio create sudden demand for specially equipped and specially trained Radio Service Men.



*This excellent  
set analyzer  
and trouble  
shooter included  
with our course  
of training*

**M**ANY skilled Radio Service Men are needed now to service all-electric sets. By becoming a certified R. T. A. Service Man, you can make big money, full time or spare time, and fit yourself for the big-pay opportunities that Radio offers.

We will quickly give you the training you need to qualify as a Radio service man . . . certify you . . . furnish you with a marvelous Radio Set Analyzer. This wonder instrument, together with our training, will enable you to compete successfully with experts who have been in the radio business for years. With its help you can quickly diagnose any ailing Radio set. The training we give you will enable you to make necessary analysis and repairs.

Serving as a "radio doctor" with this Radio Set Analyzer is but one of the many easy ways by which we help you make money out of Radio. Wiring rooms for Radio, installing and servicing sets for dealers, building and installing automobile Radio sets, constructing and installing short wave receivers . . . those are a few of the other ways in which our members are cashing in on Radio.

As a member of the Radio Training Association, you receive personal instruction from skilled Radio Engineers. Upon completion of the training, they will advise you personally on any problems which arise in your work. The Association will help you make money in your spare time, increase your pay, or start you in business. The easiest, quickest, best-paying way for you to get into Radio is by joining the Radio Training Association.

This amazing Radio Set Analyzer plus the instructions given you by the Association will transform you into an expert quickly. With it, you can locate troubles in all types of sets, test circuits, measure resistance and condenser capacities, detect defective tubes. Knowing how to make repairs is easy; knowing what the trouble is requires expert knowledge and a Radio Set Analyzer. With this Radio Set Analyzer, you will be able to give expert service and make big money. Possessing this set analyzer and knowing how to use it will be but one of the benefits that will be yours as a member of the R. T. A.

## Write for No-Cost Membership Plan

We have worked out a plan whereby a membership enrollment need not cost you a cent. Our thorough training and the valuable Radio set analyzer can be yours. Write at once and find out how easily both of these can be earned.

Now is the time to prepare to be a Radio Service Man. Greater opportunities are opening up right along. For the sake of extra money in your spare time, bigger pay, a business of your own, a position with a future, get in touch with the Radio Training Association of America now.

Send for this No-Cost Membership Plan and Free Radio Handbook that will open your eyes as to what Radio has in store for the ambitious man. Don't wait. Do it now.

**RADIO TRAINING ASSOCIATION OF AMERICA**  
Dept. RNA-11 4513 Ravenswood Ave. Chicago, Ill.

Fill Out and Mail Today!

RADIO TRAINING ASSOCIATION OF AMERICA  
Dept. RNA-11 4513 Ravenswood Ave., Chicago, Ill.  
Gentlemen: Send me details of your No-Cost Membership Enrollment Plan and information on how to learn to make real money in radio quick.

Name.....

Address.....

City..... State.....

S. GORDON TAYLOR  
Technical Editor  
WILLIAM C. DORF  
Associate Editor



RAYMOND J. KELLY  
Associate Editor  
JOS. F. ODENBACH  
Art Editor

Edited by LAURENCE M. COCKADAY

VOLUME XIII

November, 1931

NUMBER 5

## CONTENTS

(Cover Design by Morcy)

Experimental Reception in the Clouds By S. Gordon Taylor.....	PAGE 363	Aid for the Hard-of-Hearing By Irving J. Saxl.....	PAGE 379
Tracking Storms by Radio By William C. Dorf.....	PAGE 365	A 24-Pound Laboratory By Harry Georges.....	PAGE 382
Fractional Wave Tests By Everett M. Walker.....	PAGE 367	The Decibel By John M. Borst.....	PAGE 384
What Goes On in Your Vacuum Tubes By Emil Reisman.....	PAGE 369	Television Goes to Sea By Violet Hodgson.....	PAGE 386
The International Six By Allan C. Bernstein.....	PAGE 370	Using the Selenium Bridge By Laurence M. Cockaday.....	PAGE 388
Discrepancies in Electrical Units By Thomas Elway.....	PAGE 372	A Universal Receiver By H. G. Cisin.....	PAGE 390
Television Progress By Samuel Kaufman.....	PAGE 375	Mathematics in Radio By J. E. Smith.....	PAGE 392
The Army's New Portable Radio By Carter W. Clarke.....	PAGE 377	A New Pentode Amplifier By McMurdo Silver.....	PAGE 394
Talking Movies for Schools By C. A. Johnson and C. C. Clark....	PAGE 378	Completing the Army Radio Net By Richard L. West.....	PAGE 396

## DEPARTMENTS

With the Experimenters.....	PAGE 398
Backstage in Broadcasting.....	PAGE 401
The Service Bench.....	PAGE 402
Radio Science Abstracts.....	PAGE 405
Radio Physics Course.....	PAGE 407
What's New In Radio.....	PAGE 410
News and Comment.....	PAGE 412
Latest Radio Patents.....	PAGE 413

Published Monthly by Teck Publishing Corporation, Washington and South Avenues, Dunellen, N. J.

### OFFICERS

Lee Ellmaker, *President*  
Warren P. Jeffery } *Vice Presidents*  
Huston D. Crippen }  
William Thompson, *Treasurer*  
Wesley F. Pape, *Secretary*

### EDITORIAL AND EXECUTIVE OFFICES

350 HUDSON STREET, NEW YORK CITY, N. Y.

Entered as second class matter at the Post Office at Dunellen, N. J., under the act of March 3, 1879. Copyright, 1931, by Teck Publishing Corporation. All rights reserved. Title Registered at the U. S. Patent Office. Printed in the United States of America. The contents of this magazine must not be reproduced without permission. We cannot be responsible for lost manuscripts, although every care is taken for their safety.

25c a Copy, \$2.50 a year,  
\$3.00 in Canada, \$3.50 in  
Foreign Countries. Sub-  
scribers are notified that  
change of address must reach  
us five weeks in advance of  
the next day of issue.



# WIN FAME and FORTUNE in RADIO!

Scores of jobs are open to the Trained Man—jobs as Designer, Inspector and Tester—as Radio Salesman and in Service and Installation work—as Operator, Mechanic or Manager of a Broadcasting station—as Wireless Operator on a Ship or Airplane—jobs with Talking Picture Theatres and Manufacturers of Sound Equipment—with Television Laboratories and Studios—fascinating jobs, offering unlimited opportunities to the Trained Man.

## Ten Weeks of Shop Training

Come to Coyne in Chicago and prepare for these jobs the QUICK and PRACTICAL way—BY ACTUAL SHOP WORK ON ACTUAL RADIO EQUIPMENT. Some students finish the entire course in 8 weeks. The average time is only 10 weeks. But you can stay as long as you please, at no extra cost to you. No previous experience necessary.

### TELEVISION and Talking Pictures

In addition to the most modern Radio equipment, we have installed in our shops a complete model Broadcasting Station, with sound-proof

Studio and modern Transmitter with 1,000 watt tubes—the Jenkins Television Transmitter with dozens of home-type Television receiving sets—and a complete Talking Picture installation for both “sound on film” and “sound on disk.” We have spared no expense in our effort to make your training as COMPLETE and PRACTICAL as possible.

### Free Employment Service to Students

After you have finished the course, we will do all we can to help you find the job you want. We employ three men on a full time basis whose sole job is to help our students in finding positions. And should you be a little short of funds, we'll gladly help you in finding part-time work

while at school. Some of our students pay a large part of their living expenses in this way.

### Coyne Is 32 Years Old

Coyne has been located right here in Chicago since 1899. Coyne Training is tested—proven by hundreds of successful graduates. You can get all the facts—FREE. JUST MAIL THE COUPON FOR A FREE COPY OF OUR BIG RADIO AND TELEVISION BOOK, telling all about jobs . . . salaries . . . opportunities. This does not obligate you. Just mail the coupon.

H. C. Lewis, Pres. **Radio Division** Founded 1899  
**Coyne Electrical School**  
 500 S. Paulina Street Dept. 81-8C, Chicago, Illinois

H. C. LEWIS, President  
 Radio Division, Coyne Electrical School  
 500 S. Paulina St., Dept. 81-8C, Chicago, Ill.  
 Send me your Big Free Radio, Television and Talking Picture Book. This does not obligate me in any way.

Name.....  
 Address.....  
 City..... State.....

# You're Wanted

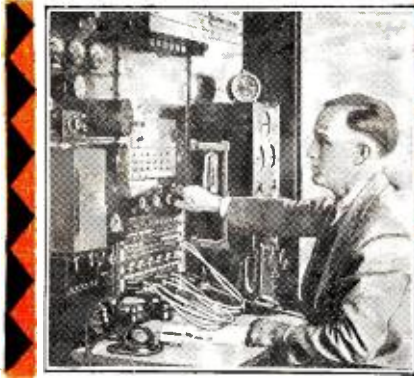

Broadcasting Stations offer fascinating jobs paying from \$1,200 to \$5,000 a year.

## Take your pick of these fine **Big Pay** Radio Jobs

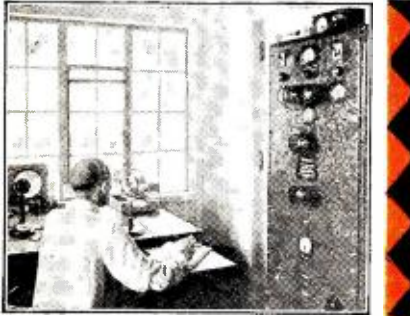

Police Departments are finding Radio a great aid in their work. Many good jobs have been made in this new field.

**Y**OU have seen how the men and young men who got into the automobile, motion picture and other industries when they were started had the first chance at the key jobs—are now the \$5,000, \$10,000 and \$15,000 a year men. Radio offers you the same chance that made men rich in those businesses. Its growth has already made men independent and will make many more wealthy in the future. Its amazing growth can put you ahead, too. Don't pass up this opportunity for a good job and future financial independence.

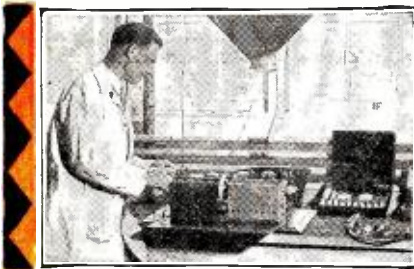

Spare time set servicing is paying N. R. I. men \$200 to \$1,000 a year. Full time men are making as much as \$65, \$75, \$100 a week.

**Many Good, \$50 to \$100 a Week Jobs Opening Every Year**

**Many Make \$10 to \$25 a Week Extra Almost at Once**

Radio needs more trained men badly. Why slave your life away for \$25 to \$40 a week in a no-future job when you can get ready in a short time for Radio where the good jobs pay \$50, \$60, \$75 and \$100 a week? And many of these jobs can quickly lead to \$150 to \$200 a week. Many fine jobs are opening every year for men with the right training—the kind of training I'll give you.

The day you start I'll show you how to do twenty-eight jobs common in most every neighborhood that you can do in your spare time. I'll show you how to repair and service all makes of sets and do many other jobs all through my course. I'll give you the plans and ideas that are making \$200 to \$1,000 for my students while they are taking my course. G. W. Page, 133 Pine Street, McKenzie, Tenn., writes: "I made \$935 in my spare time while taking your course."

### I am Doubling and Tripling Salaries

### You Have Many Jobs to Choose From

Where you find big growth you always find many big opportunities. I am doubling and tripling the salaries of many men every year. After training with me only a short time they are able to make \$1,000 to \$3,000 a year more than they were getting before. Figure out for yourself what an increase like this would mean to you—the many things that mean so much in happiness and comfort that you could buy with an additional \$1,000 to \$3,000 a year.

Broadcasting stations use engineer operators, station managers. Radio manufacturers continually need testers, inspectors, foremen, engineers, service men, buyers and managers. Shipping companies, Police departments, commercial land stations, aircraft companies, offer good operators jobs from time to time. There are hundreds of opportunities for you to have a spare time or full time Radio business of your own. I'll show you how to start one with practically no capital. My book tells you of other opportunities. Be sure to get it at once.



Talking Movies—an invention made possible only by radio—offers many fine jobs to trained radio men, paying \$75 to \$200 a week.



\$400 a Month

"I spent fifteen years as traveling salesman and was making good money but could see the opportunities in Radio. Believe me I am not sorry for I have made more money than ever before. I have made more than \$400 each month and it really was your course that brought me to this. I can't say too much for your school." **J. G. Dahlstead, Radio Station KYA, San Francisco, Cal.**



\$800 in Spare Time

"Money could not pay for what I got out of your course. I did not know a single thing about Radio before I enrolled but I have made \$800 in my spare time although my work keeps me away from home from 6:00 A.M. to 7:00 P.M. Every word I ever read about your course I have found true." **Milton I. Leiby, Jr., Topton, Pennsylvania.**



Seldom Under \$100 a Week

"My earnings in Radio are many times greater than I ever expected them to be. In November I made \$577, December \$645, January \$464. My earnings seldom fall under \$100 a week. I'll say the N. R. I. course is thorough and complete. You give a man more for his money than anybody else." **E. W. Winborne, 1267 W. 48th St., Norfolk, Va.**

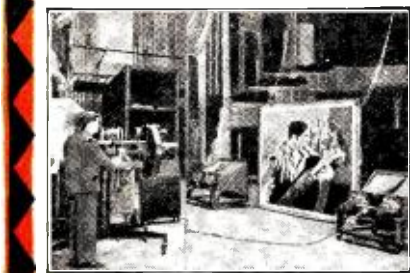

Television—the coming field of many great opportunities—is covered by my course

# for a **Big Pay** Radio Job



## I will train you **AT HOME** free book gives facts and proof

### I Will Train You at Home In Your Spare Time

Hold your job. There is no need for you to leave home. I will train you quickly and inexpensively during your spare time. You don't have to be a high school graduate. My course is written in a clear, interesting style that most anyone can grasp. I'll give you practical experience under my 50-50 method of training — one-half from lesson books and one-half from practical experiments. When you graduate you won't have to take any kind of a job to get experience—you will be trained and experienced ready to take a responsible job in the radio field of your choice.

### Television and Talking Pictures Included

My course not only gives you a thorough training in Radio—but also you need to know to get and hold a good job—but also your choice, without extra charge, of any one of my special advanced courses: (1) Television. (2) Aircraft Radio, (3) Broadcasting, Commercial and Ship Radio Stations, (4) Sound Pictures and Public Address Systems, (5) Advanced Radio Servicing and Merchandising. You won't be a "one job" man when you finish my course. You'll know how to handle a job in any one of Radio's 20 different branches of opportunity.

J. E. SMITH, President

## NATIONAL RADIO INSTITUTE

Dept. 1 M R

WASHINGTON, D. C.

### Lifetime Employment Service to All Graduates

When you finish my course you won't be turned loose to shift for yourself. Then is when I will step in to help you find a job through my Employment Department. This Employment Service is free of extra charge both to you and the employer.

### Your Money Back If Not Satisfied

You do not risk a penny when you enroll with me. I will give you an agreement in writing, legal and binding upon the institute, to refund every penny of your money if, upon completing my course you are not satisfied with my Lessons and Instruction Service. The resources of the N. R. I., Pioneer and Largest Home-Study Radio training organization, stands back of this agreement.

### Find Out What Radio Offers You—Get My Book at Once

One copy of my valuable book, "Rich Rewards in Radio," is free to anyone interested in making more money. It tells you where the good jobs are, what they pay, how you can quickly and easily fit yourself to get one. The coupon below will bring you a copy. Send it at once. Your request does not obligate you in any way. Act NOW.

# I

give You **8 Big Outfits**  
of Radio parts for  
*Extensive Practical Experiments*

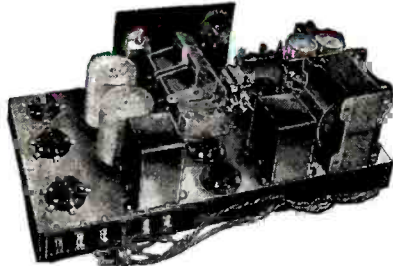

Seven tube screen grid tuned radio frequency receiver.

You can build over 100 circuits with the outfits I give you. You learn from actual experience about A. C., Screen Grid Circuits, push-pull amplification and the other features in modern sets. Shown here are two of the outfits you build. You work out with your hands the principles, diagrams and circuits you learn from my lesson books. You get as much practical experience under this unequaled method of home training, in a few months, as the average fellow gets in two to four years in the field.

Public Address Audio System

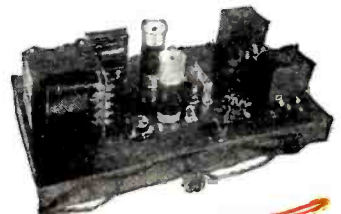

### Salary Three Times Larger

"Before I completed your course I went to work for a Radio dealer. Now I am Assistant Service Manager of the Sparks-Withington Company. My salary is three times what it was before taking your course. I could not have obtained this position without it. I owe my success to N. R. I. training." H. A. Wilmoth, Sparks-Withington Company.

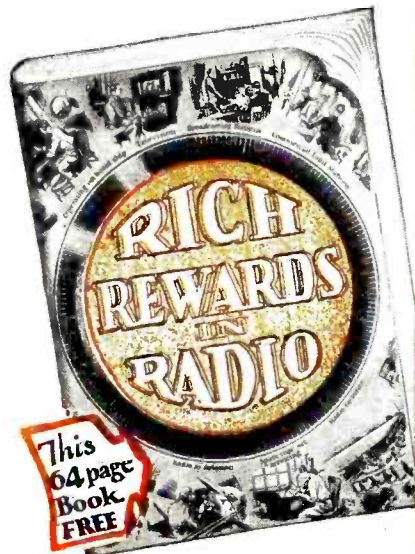

## Clip and mail NOW for FREE INFORMATION

J. E. Smith, President,  
National Radio Institute, Dept. 1 MR  
16th and U Sts., N. W., Washington, D. C.

Dear Mr. Smith: Send me "Rich Rewards in Radio." Tell me more about Radio's opportunities for good jobs and quick promotion; also about your practical method of Home Training. I understand this request does not obligate me and that no agent will call on me.

Name .....  
Address .....  
City ..... State .....

# The Editor—to You

THE scientists promised us, about a year ago, greatly improved radio receiving conditions for this year, and here we are in the midst of the best receiving season we have had for a long time. The prediction, therefore, comes true. This forecast was based upon the eleven-year sun-spot cycle which has just ended and which promises better radio for years to come.

THE year 1931, it seems, is a banner year in the communications industry. Not only is it the twelfth anniversary of our own magazine, but it marks the one-hundredth anniversary of the most fruitful period in the life of the world's greatest electrical experimenter—Michael Faraday. Both in Europe and in America, Faraday's genius is being celebrated for the long series of electrical studies underlying the electrical phenomena which is the basis of our present-day electrical progress.

At the same time we are celebrating, in the United States, the seventieth anniversary of the trans-continental telegraph service, which sounded the death knell of the pony express and was the direct forerunner of radio in the field of communication.

THERE appeared in our September issue an article on the proposed experiments of the Wilkins submarine polar expedition in which was pointed out by Frederick Siemens the pioneer scientific nature of this expedition. The author, however, also called attention to some of the problems and hazards that might be expected. He stated, "No one can deny the venturesome voyage of the new *Nautilus* involves terrific dangers that few stay-at-home individuals would be prepared to face. Possibly some day some amateur at his key and headphones will catch a feeble, interrupted message . . . tragedy. . . . Everyone will hope this may be avoided by the skill and careful planning of Sir Hubert and his crew."

DURING the last few months hard luck and trouble galore seem to have followed Sir Hubert across the Atlantic, first as both engines broke down and second as part of the superstructure was washed away in stormy weather. Engines went out of commission again on the way to Bergen and after leaving Tromsø. By working with almost superhuman energy, repairs were made and the expedition was at last ready in August and the *Nautilus* then set out for Spitzbergen. After leaving there, in meeting the ice pack around 80° north, the machinery still continued to give trouble. While heading through broken ice for a chance to get under the ice pack edge, it was discovered that both diving rudders had been lost.

To go on in the face of all this took plenty of nerve on the part of the commander and crew. However, in spite

of all, Sir Hubert actually did dive his craft underneath the Arctic ice pack and both he and the crew got out alive, although depending upon a recalcitrant power plant and worn accessories which had repeatedly failed.

SIR HUBERT has done something which no man has ever done before. He has saved a forlorn expedition from complete failure and has actually slid the vessel along the bottom of the ice floes and re-emerged again to safety. And he has again proved the worth of short-wave radio for any kind of exploration work. The radio apparatus seemed to be one of the few scientific devices on the expedition that worked consistently and well. It kept him in communication with his bases during the whole trip, except for a three-day period—probably while the daring explorers were underneath the pack.

ANNOUNCEMENT of the postponement of the tenth annual Chicago Radio Electrical Show, scheduled for this month, was made today by Clayton Irwin, Jr., General Manager. The show is to be held some time after the middle of January, 1932. The announcement states the change was made at the request of leaders in the industry. Today everyone is placing his pennies where they will do the most good and maybe, reading between the lines, these leaders did not feel it advisable to support two radio shows coming so close together. Maybe that is also the reason why our business office reports that the copy of RADIO NEWS you are now holding in your hands contains an advance in advertising lineage of more than 50 per cent. over previous issues! RADIO NEWS is read by all radio men.

WILL we have music via the telephone?

THIS is at least a possibility in the New York metropolitan area if "Wired Music," a corporation formed to merchandise the transmission of musical programs to hotels, restaurants and businesses, keeps going ahead with the project. The plan came to light recently when Wired Music complained to the Public Service Commission that the Telephone Company had declined to supply telephone lines for this service. The Commission, it is reported, decided that the Telephone Company must lease its wires for transmission of entertainment programs. But whether subscribers will be willing to listen to music from the telephone—rather than a modern radio receiving apparatus—is still another question.

IN this issue of RADIO NEWS, S. Gordon Taylor tells of some mighty interesting experiments on long and short-wave reception the RADIO NEWS technicians have been making from the towering height of the Empire State Building in New York. He tells of re-

sults obtained and problems encountered.

ENGLISHMEN get more electricity for their money, Germans get the least! Read what Thomas Elway has to say about the many and various kinds of arbitrary watts, ohms and volts still existing in the world today in spite of scientific progress, and how the scientists are working to prepare an accurate single standard for engineers the world over.

CAN the engineer "cure" deafness?

READ what Dr. Saxl suggests for helping persons afflicted with deafness and how, by the aid of electro-acoustical devices, many thousands of people are hearing normally again. If you have friends who are so afflicted, let them read the article. Servicemen, here is another chance for you to step in and show your worth. You can help others and at the same time increase your business.

WHAT is a decibel?

SOUNDS almost as silly as the time-worn query—Why is a cow? But it's serious! Read John Borst's definition, derivation and application of this new unit of measurement. It is the first complete treatise on the subject the Editor has run across.

SERVICEMEN, engineers and experimenters will find a full quota of their own particular and favorite variety of information in the regular departmental articles. *Don't miss the departments!*

THIS month we announce, as promised, a new department NEWS AND COMMENTS OF THE RADIO INDUSTRY. This is a column devoted to important events, patent situations, trade happenings, personal notes, changes in organization, etc., that should be welcomed heartily by our readers and friends in the trade. It is conducted under the able direction of Ray Kelly; he of the seven-league ears and the mile-a-minute typewriter.

Now is the time for all lovers of radio to get their receiving apparatus in A-1 condition to enjoy the wonderful programs promised for the 1931-1932 season. Have a reliable local serviceman check all your tubes, your antenna installation and go over your receiver. If it is an old one, you may ask his advice as to a new set or a new loudspeaker that will immeasurably increase the grade of service you are now getting from your old one. Fine radio receivers, tubes and loudspeakers were never offered at such low prices as obtainable today.

*Samuel H. Lockaday*



# Why be satisfied with less than 'Round the World Reception?

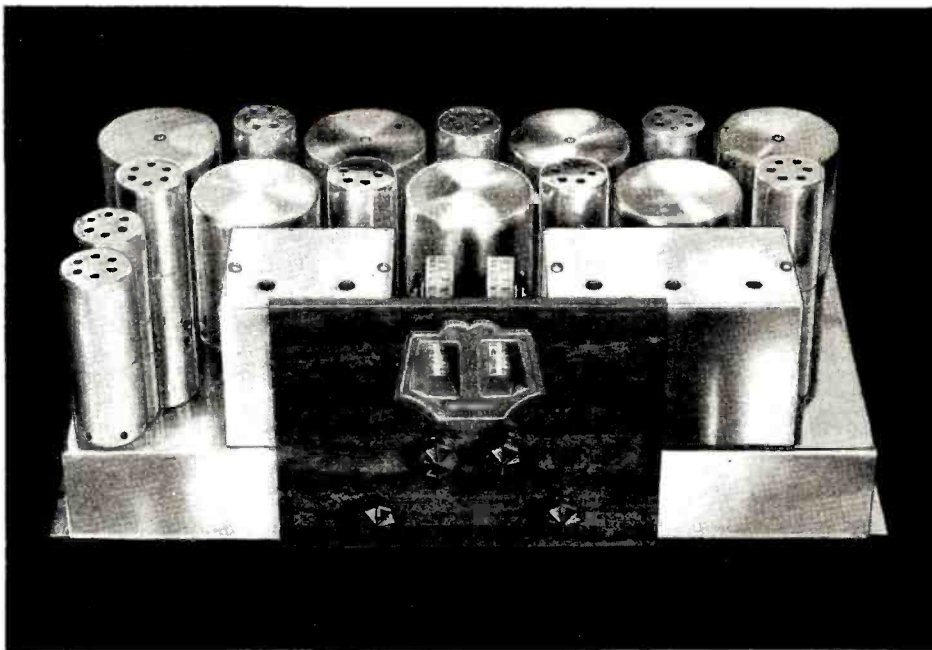

There is a new thrill in Radio—the thrill of actually tuning in the other side of the world—Japan, Indo-China, France, England, Australia, Germany and South America. Not code, but voice, music and song, loud and clear—often so perfect that its quality matches the finest nearby domestic stations. Such is the daily service being given by Scott All-Wave Receivers located in all parts of the country and operating under all sorts of conditions. And the tone of the Scott All-Wave is *naturalness* itself. Think of it! England and Japan, thousands of miles away from each other, yet only a quarter inch apart on the dial of the Scott All-Wave. A fractional turn of the tuning control and either is yours to listen to with an abundance of loud speaker volume. Unbelievable? Read the letters reproduced below. They are but a few of the hundreds received!

## Read What Scott All-Wave Owners Say About This Great Receiver

*England on an indoor aerial...*  
"London, England, comes in with great volume on an indoor aerial, which I have to use on account of static. Can get all the volume I want with the volume control turned up most of the time only one-quarter."  
—W. J. McD., Intervale, N. H.

*'Round the world...*  
"Have heard 'Big Ben' strike midnight in London; Grand Opera from Rome; the 'Marseillaise' played in France and at 8:30 a. m. have heard the laughing Jack-ass from VK2ME at Sydney, Australia."  
—C. L. B., Chicago, Illinois

*China, too...*  
"Static conditions have been extremely bad this Summer.

However, we have been getting regular reception on G5SW at Chelmsford, England, 12RO at Rome, Italy, F3ICD, Indo-China, and VK3ME at Melbourne, Australia."  
—S. F. S., Lock, Utah.

*Paris for 3 hours...*  
"Yesterday I tuned in station FYA at Paris and received them for three hours with considerably more volume than Rome; El Prado, Ecuador, comes in very clear and loud every Thursday evening."  
—S. O. K., Tuskegee, Alabama

*Records Australia...*  
"Last Saturday night I received VK2ME, Sydney, Australia, loud enough to make a recording on my home recorder. It certainly gave me a great thrill to hear the announcer say, 'The time is now

20 minutes to 4, Sunday afternoon' when it was 20 minutes to 12 Saturday night here."  
—J. R. C., Highland, Mass.

*Germany to Australia...*  
"I hear England, France, Italy, daily while Ecuador, Colombia, Honduras and Germany and Manila come in quite often. VK2ME at Sydney, Australia, comes in very well."  
—J. M. B., Wierton, West Virginia

*Austria...*  
"I have tuned in VK3ME at Melbourne with enough volume to be heard across the street. I listened last evening to France, Italy, Austria, as well as G5SW in England and several other European stations. The SCOTT is all you claim and then some."  
—R. N. B., Fullerton, Penna.

The truly amazing performance of which the Scott All-Wave is capable is the natural result of combining advanced design and precision engineering. The system of amplification employed in this receiver is far in advance of any other—and the Scott All-Wave is built in the laboratory, by laboratory experts to laboratory standards so that its advanced design is taken fullest advantage of. Each receiver is tested, before shipment, on reception from either 12RO, Rome, 5SGW, Chelmsford, England, or VK3ME, Melbourne, Australia.

Why be satisfied with less than a Scott All-Wave can give you? The price of this receiver is remarkably low. Mail the coupon for full particulars.

E. H. SCOTT RADIO LABORATORIES, INC., 4450 Ravenswood Ave., Dept. N-11, Chicago (Formerly Scott Transformer Co.)

# The SCOTT ALL-WAVE

15 • 550 METER SUPERHETERODYNE

## Clip

E. H. SCOTT RADIO LABORATORIES, INC.  
(Formerly Scott Transformer Co.)  
4450 Ravenswood Ave., Dept. N-11, Chicago, Ill.

Send me full particulars of the Scott All-Wave.

Name.....

Street.....

Town..... State.....

# NEW Powerful 11-Tube Super Heterodyne

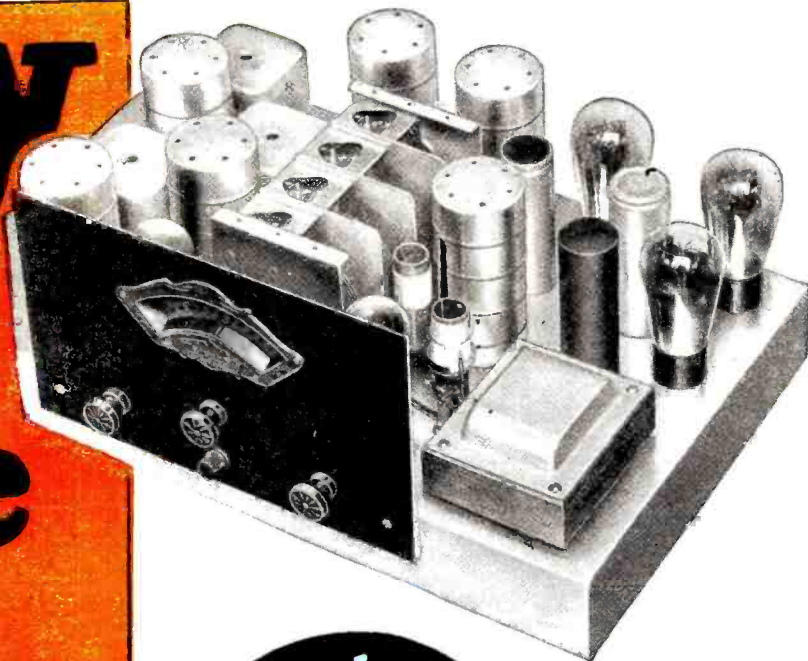

**Push-Pull Pentode Power Output Tubes  
—Multi-Mu Screen-Grid Tubes—Real  
Automatic Volume Control—All the Lat-  
est Improvements That Give Amazing New  
Clarity, Perfect Tone, Split-Hair Selectivity and  
Sensitivity Never Before Heard Of!**

RADIO FANS! Just what you've been looking for! A powerful new 11-tube radio at an unbelievably low price. And what a radio! *Two Push-pull pentode* power output tubes with twice the power and four times the sensitivity of ordinary 45's—and Multi-Mu tubes, together with a -24 first detector, gives you **SIX SCREEN GRIDS**. These six screen grids, together with the -27 oscillator, second detector first A.F., and automatic volume control—the -80 tubes—gives a total of **ELEVEN TUBES**, with reception equal to fifteen ordinary tubes—in a perfectly balanced, non-oscillating, non-radiating, super-heterodyne **TEN-TUNED** circuit with *real Automatic Volume Control* that holds those powerful locals down to the same volume as the distant stations and counteracts that annoying fading on weak stations.

The use of a band-pass or pre-selector stage, together with Multi-Mu full range tubes, makes this radio actually surpass 10 K.C. selectivity. Absolutely eliminates those noisy singing "birdies" and annoying cross talks. You'll be positively amazed and delighted when you see this sensational new set, hear the beautiful mellow, cathedral tone—know what it means to have that pin-dot selectivity and unequalled sensitivity.

Be convinced—**TRY IT 30 DAYS BEFORE YOU BUY**. Don't send a penny. Mail coupon right now for amazing **FREE** trial offer and complete details. You'll be surprised.

**TERMS  
AS LOW AS  
\$5.00  
DOWN**

only  
**\$37.50**  
**COMPLETELY  
ASSEMBLED**  
With Specially  
Matched Large  
**DYNAMIC SPEAKER**

**30  
DAYS  
FREE  
TRIAL**

Deal Direct with  
Factory—Save 50%

Never before in the history of radio has such a powerful set been offered at MID-WEST'S amazingly low price. Deal direct with the big MID-WEST factory. Save the jobber's profit. Your outfit will reach you splendidly packed, rapidly tested with everything in place ready to plug in. No assembling! Entertain yourself for 30 days absolutely **FREE**—then decide. You are not obligated to buy. Save up to 50 per cent in buying direct from factory—insure satisfaction—deal direct with the world's veteran radio builders—MID-WEST. And don't forget—every MID-WEST outfit is backed by an absolute guarantee of satisfaction. You take no risk.

*Hundreds of  
Delighted Users!*

Radio fans from all parts of the country have purchased Mid-west super-heterodynes and many have sent in enthusiastic letters of praise. Here are just a few:

**"DELIGHTED"**

To say that I am delighted is putting it mildly. The sensitivity and selectivity of the new Mid-west set leaves little to be desired. Your advertising has not exaggerated one word as to the merits of the set.  
Cordially yours,  
(Rev.) Wells H. Fitch, Riverhead, L. I., N.Y.

**New Zealand User Hears New York  
and Other Stations Eight Thousand  
Miles Distant!**

I would stack my Mid-west up against any other make of set on the market. I have a log of 141 stations. "Mid-west gets 'em all over the world." 36 stations in New Zealand, 34 Australian, 10 in Japan, 1 in China, 2 in India, 1 in Czechoslovakia and Bratislava, 2 in Honolulu, and a total of 56 stations in the U. S. A. including New York, Cincinnati and Los Angeles.

I have received WTIC on two different frequencies, Siam "Radio Bangkok."  
This is a log which would be hard to eclipse by any other set of any power.  
Yours very sincerely,  
Fred. W. Morley, Hawke's Bay, New Zealand



**Complete Line of  
Consoles**

Rush the coupon for big, beautiful catalog that illustrates the complete line of MID-WEST console cabinets. All new, all different, all priced to save you 30% to 50%. You'll gasp with admiration when you see the vast selection of beauty, style and grace that is crafted into every MID-WEST Console. The catalog is **FREE**—it doesn't cost you a penny! Rush the coupon—**NOW!**

**RUSH THIS COUPON FOR  
AMAZING FREE TRIAL OFFER  
AND BIG BEAUTIFUL CATALOG**

Mid-West Radio Corp.  
Dept. 15  
Cincinnati, Ohio

**USER AGENTS**  
We pay you **BIG MONEY** just for showing your radio to friends and neighbors. Easy **EXTRA MONEY!** Check coupon for details.

Without obligation on my part send me your new 1932 catalog, and complete details of your liberal 30-day free trial offer. This is **NOT** an order.

Name.....  
Address.....  
Town.....State.....R. R. No.....  
 Send me **SPECIAL USER AGENTS PROPOSITION.**

**MID-WEST RADIO CORP.**  
EST. 1919  
Dept. 15 CINCINNATI OHIO



### Keeping Abreast with Radio

*The popular conception of technical opportunities in the broadcasting field is that broadcast activities involve knowledge of how and why a transmitter functions. That was relatively true in radio's pioneer days when an engineer was a Jack-of-all-trades. It then did involve all radio knowledge, but now it is a specialized field. The best licensed man today might be a lot worse in studio activities than a non-licensed man who understands that phase of work. Technical men are now divided into specialized groups. Transmitter engineers must have knowledge of theory and operation of broadcast and high-frequency transmitters and must be licensed. Master control engineers need no license but they must have thorough knowledge of undistorted amplification and long-line telephone practice. Studio engineers must have knowledge of undistorted amplification, acoustics, music appreciation and showmanship. Field engineers require knowledge of all types of audio amplifiers, telephone transmission practices, code, musical appreciation and showmanship and they must be able to size up emergency situations quickly. Television engineers must have knowledge of undistorted amplification over wide frequency ranges, photo-electric cells, motors, optics and showmanship.*

*Constant readers of RADIO NEWS keep themselves accurately abreast of all activities in this broadly specialized field.*

Technical Director,  
Columbia Broadcasting System

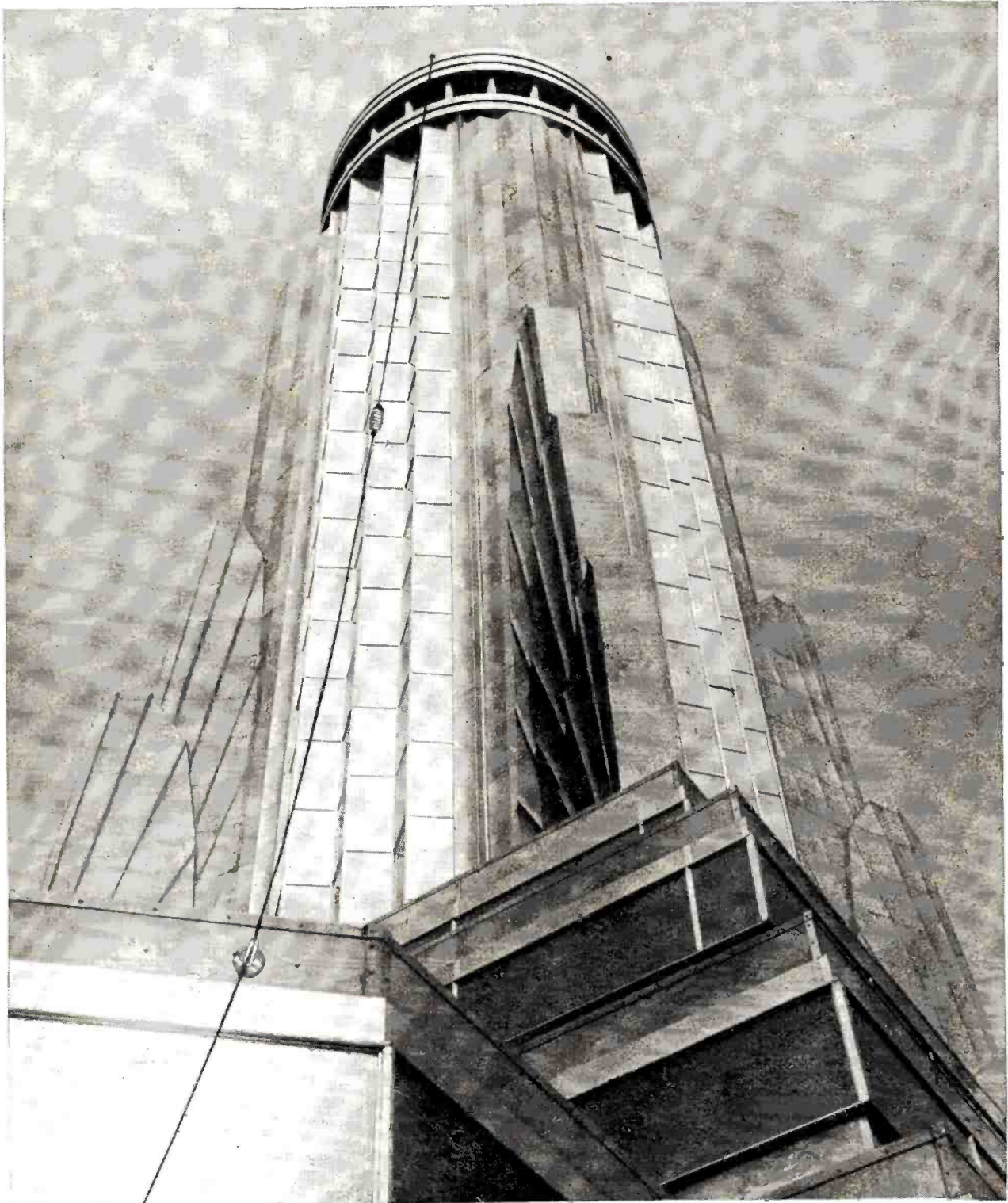

### Radio's Lofty Aspirations

***I**F the Eiffel Tower were moved bodily and placed beside the Empire State Building in New York City, this is the view that would be obtained by a person looking upward from its tip. Actually, the photograph was taken looking up from the 86th floor of the Empire State Building and showing the famous mooring mast which extends up two hundred and fifty feet, making a total elevation of one thousand, two hundred and fifty feet above the street. It was here that RADIO NEWS erected the antenna shown, to determine its effectiveness in long-distance receiving*

# Experimental Reception On The World's TALLEST STRUCTURE

*In a series of reception tests carried on in and around New York City, an antenna was erected twelve hundred feet above the street level, with results as described in this article*

By S. Gordon Taylor

**T**HERE are probably many radio enthusiasts who, seeing the stately Empire State Tower rearing its tremendous shaft skyward, have wondered what sort of reception results could be obtained from an aerial erected at its tip.

Out in the suburbs—and in the city, too—many have erected antenna masts, some of them quite intricate, in order to gain a few extra feet of altitude for their “sky wires.” If this was worth while, what could be expected from a made-to-order mast reaching up 1250 feet above the street level?

It was to determine the answer to this question that RADIO NEWS arranged, through the kind cooperation of ex-Governor Smith, now president and executive head of the Empire State Company, to conduct a series of reception tests in the tower.

Before going into a description of the tests and the results obtained, a description of the building itself might be in order, to give readers a better idea of the conditions under which the tests took place.

The building proper is a massive structure covering an entire block-front on Fifth Avenue. It extends eighty-six stories skyward in a series of set-backs, or steps, which brings the elevation to 1000 feet at the 86th floor. This floor constitutes the main observatory where souvenir, luncheon and lounge rooms are provided for sightseers. Two of these rooms are glass-enclosed, on three sides, to permit an unobstructed view of the magnificent panorama during cold or inclement weather. They also open out onto tiled outdoor terraces for the use of visitors during fair weather conditions.

Arising from the center of this floor is the famous tower. This is really a gigantic all-metal cylinder, as shown on the opposite page, which extends up 250 feet further “into the blue,” bringing its top to an elevation of 1250 feet above street level. The topmost floor in this tower is the 103rd, and it was this floor that was assigned for the RADIO NEWS tests. The floor below serves as an auxiliary observatory and is connected with the eighty-sixth floor by an elevator.

The 103rd floor consists of a fair-sized room completely encircled by an outdoor gallery. It is to this gallery that the aerial gangplanks will be run if the tower is ever used as an

anchorage for dirigible air liners. Strange as it may seem, the “roof” of this monstrous building is a tiny area only about four feet in diameter. This is really the flattened top of the dome, which serves as the ceiling of the room in which the tests were made, and is the very tip of the tower, unless one counts the fifteen-foot steel-pipe mast mounted on this roof to support the weather vane and wind gauge. Incidentally, these instruments register on dials at various locations in the building. One pair may be seen in the wall just over the radio set in one of the photos accompanying this article.

The first consideration in preparing for the tests concerned the location for the antenna. The steel-pipe mast was highly inaccessible and for that reason was discarded as a possible anchorage. A few feet more or less becomes unimportant at an altitude of 1250 feet, so it was decided to use the balustrade on the gallery just outside the test room as a support for the upper end of the wire, and the roof of the 86th floor observatory as the bottom anchorage. This provided a span of wire close to 250 feet in length. It was broken by an insulator to provide two separate antennas, one terminating at the 103rd floor test room and the other at the 86th floor, thus permitting tests to be made in either location.

The receiver selected for the tests was a stock model of the Scott All-Wave Superheterodyne, which was described in the June and July issues. This receiver had the advantage that tests on both broad-

cast and short waves could be made without duplication of equipment. Furthermore, this receiver had been used in a number of other reception tests during previous months and its performance was therefore a known factor.

In addition to this receiver, an adapter box was made up to permit headphones to be used when for any reason it was undesirable to use the loudspeaker. This adapter consisted of a simple circuit arrangement, as shown in the diagram in the present article. Two wafer-type tube adapters were slipped under the output tubes, and leads from the plate terminals of these were carried to the input of the headphone box. Inside the box, these terminals were connected across a 25,000-ohm



THE “LISTENING POST”  
IN THE EMPIRE STATE TOWER

*Most of the tests were carried on in this room on the 103rd floor. It was here that European stations were brought in at loudspeaker volume on a nine-foot antenna—and this tiny antenna was partially shielded within the all-metal tower!*



"RADIO HATH CHARMS"

*The early tests were carried on in the public observatory on the 86th floor, but "local interference," in the form of questions from the three thousand sightseers who visit the tower daily, made it necessary to shift the scene of operations to a private room. This photo was taken at an early-morning hour when the tide of visitors was at low ebb*

potentiometer, through blocking condensers. A group of six jacks were then connected in series—parallel between one end of the potentiometer and the sliding arm so that headphone volume could be varied by adjusting the potentiometer. The jacks used were of the double-circuit type with 2000-ohm resistors connected in such a manner that when headphones were withdrawn the resistors would automatically be cut in, thus maintaining constant volume in the other headphones. Also, due to the high impedance of the potentiometer, which is in parallel with the loudspeaker transformer input, the overall impedance of the headphone-adaptor unit did not affect the total load-impedance enough to cause noticeable change in the loudspeaker volume or quality when both loudspeaker and headphones were used at the same time, as when using the loudspeaker at a remote location, for instance. A switch connected in one of the voice-coil leads of the loudspeaker permitted this unit to be cut in or out when desired.

The headphone adapter is described in detail here for the benefit of many fans who like to fish for DX, and perhaps let their friends do so, after the family has retired for the night. Provision can, of course, be made for more or fewer headphones if desired.

### The Reception Tests

The tests were started with the receiver set up on the 86th floor. The wisdom of providing for headphone operation became immediately apparent because, with the loudspeaker in operation, the test set-up became the center of attraction for crowds (about 3000 persons visit the observatory daily) wanting to know what station they were hearing, how did we know the Italian program was from Rome, and so on. The only way we could keep the crowd from "snowing us under" was by using headphones. Even then the fact that we were conducting tests of transatlantic reception drew the crowd like flies to sugar. Perhaps the rabid radio enthusiasm of old is a thing of the past, but there was no evidence of its passing during these tests.

The first daylight reception was on the broadcast wavelengths, when all the local stations and a number within a 250-mile

radius were tuned in. For the most part these were relatively free from background noise, the exceptions being out-of-town stations which required a highly sensitive adjustment of the receiver. But this freedom from "man-made" static seemed to be about the only advantage offered by the great elevation of the antenna. Evidently the vertical isolation from other buildings, with their numerous sources of electrical noise, was effective in largely eliminating the high local noise-levels encountered in most down-town New York locations.

Broadcast reception at night showed substantially the same results but with increased distance range which allowed fair reception up to a thousand miles.

As far as greater pick-up was concerned, the location had little to offer—somewhat of a surprise! Results obtained with the same receiver in other down-town locations and using antennas of moderate height appeared to be just as good as those obtained

on the Empire State, except for the lower noise-level which made the out-of-town programs more understandable.

The quality of reception was such that several of the executives of the building, on hearing the set in operation, stated their intention of arranging for a permanent installation, employing a duplicate of our equipment, but with several additional loudspeakers to distribute programs to all parts of the observatory.

Reception on the short waves, particularly from European stations, was a distinct disappointment and showed no advantages whatsoever over reception in other locations in the city. True, the local noise-level, for a given volume control setting, was somewhat lower than at some other down-town locations, but actually stronger reception had been obtained in other locations using an antenna erected only a few feet off the roofs of much lower buildings. The ratio of (Continued on page 416)



GIVING NEW YORK THE ONCE-OVER

*This view of New York offers a good idea of the tremendous height at which the antenna was erected—and this was taken from the lower end of the 250-foot span of wire*

# Tracking Storms *by* Radio

*New British technique in making meteorological surveys of the path of thunderstorms is considered important to the future of aviation*

By William C. Dorf

*"The winds may come and the winds may go,  
But where they go to I don't know"*

THE truth of the statement in this time-worn couplet might have been apparent, until recently, but radio engineers in two new research stations, one in England and another in Scotland, contest it now, and rightly so. For with a special form of short-wave apparatus they now are able to "follow" a storm along its path and predict, quite accurately, where it will hit—and when! They are also able to measure and predict its intensity long before its arrival. They know where the winds come from and where they are going.

The two storm-locating stations are situated one at Slough, in England, and the other at Leuchars, in Scotland. The method evolved is bound to be important as an aid to meteorologists and invaluable in speedily mapping storm areas for aviation services.

At each of the stations there is set up an installation comprising a special short-wave directional receiver which may be operated in the field, as well as a complicated recording device that makes a record of the intensity of the storm on moving-picture film.

### *Electric Disturbances Give Direction Clue*

Static, that erstwhile enemy to radio reception the world over, is the unwitting stool-pigeon of the radio engineers who are conducting these important experiments. For static is the tell-tale that enables the operators to locate and keep a continuous check on the storms pass-

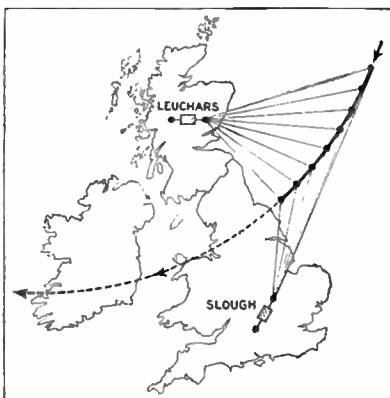

**MAPPING A STORM-PATH**  
*This diagram shows how the individual "directions" from the two stations are plotted on a map at definite time intervals. A line drawn through the plotted points shows the storm's path*

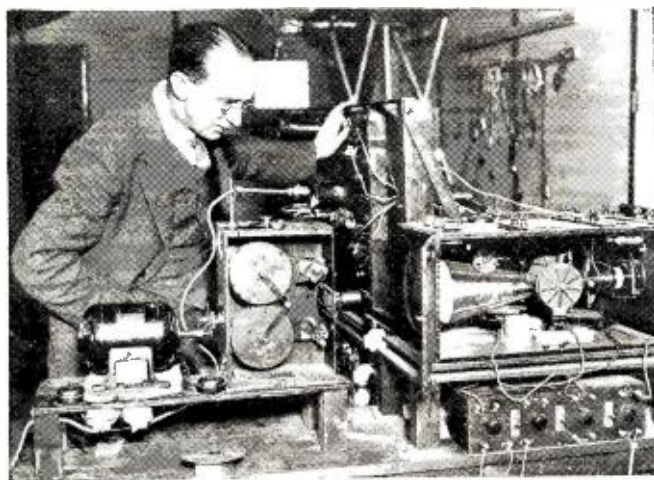

**TAKING STATIC'S PHOTOGRAPH**  
*Scene inside the station where the engineer surveys the recording apparatus. At right is the cathode-ray tube which traces the static disturbances on a screen. At left is the film recorder that takes a continuous picture of the screen carrying the static "image"*

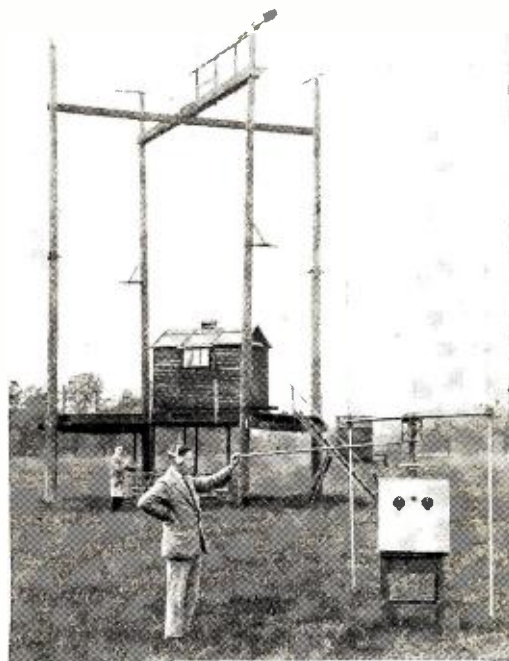

**GETTING A LINE ON STATIC**  
*Here is the equipment set up out-of-doors as the operator adjusts the revolving antenna to the proper direction. The station is seen in the background*

ing by. The radio direction finders at these stations are tuned in by the operators to the static disturbances which accompany the storms that may be headed toward the area. An accurate bearing of the line of direction is thus taken. The two "directions" of the static centers of the storm area are then plotted on a large map of the area. By triangulation, the exact location of the storm center is recorded. The exact time of each reading is also noted. By taking bearings at 10-minute intervals or longer, a succession of storm location "dots" may thus be plotted on the map. A line connected through these dots gives the direction in which the storm is traveling. By a study of the map and the time each record point is made, the operators quickly can gauge the speed of the storm and thus obtain accurate data for predicting the arrival of the storm at any point along its path.

### *How the Determination Is Made*

The map, in Figure 1, indicates the method used in plotting the course of the disturbance. One of the photographic illustrations shows an operator in the field, adjusting the short-wave receiving antenna to determine the direction from which the static is emanating, having previously tuned in the static signals on the two dials on the face of the cabinet. The second illustration shows the apparatus, in the station, for recording the intensity of the static signals. At the right is a cathode-ray oscillograph with its associated apparatus, including the deflection coils which are connected to a second short-wave receiver which picks up the static signals. A tiny pencil of light traces, on the end of the cathode-ray tube, the shape and intensity of the electrical impulses transmitted by the static. At the left is a motor-driven motion-picture-film apparatus, trained, through a lens system, on the static image pictured by the cathode-ray tube. This apparatus, which is timed synchronously with the direction-finding apparatus, gives a written picture of the storm's intensity and denotes whether it is increasing or decreasing in its fury.

Although this is probably the (Continued on page 427)

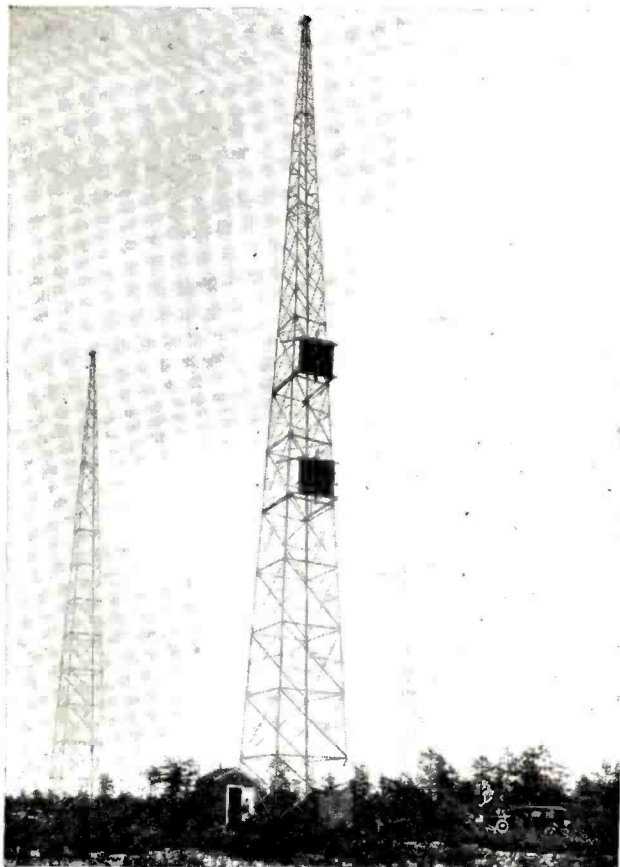

RIVERHEAD, L. I.

The antennas at the Riverhead end of the experimental system are duplicates of those at Rocky Point, shown on the opposite page

**S**EVEN years ago the value of short-wave channels for international communication was first discovered. Today engineers in laboratories are seeking even higher frequencies, and have succeeded in transmitting speech and music on waves so short that they appear to have the same characteristics as light.

Signals transmitted on these new ultra-high frequencies which have been styled "quasi-optical" waves, because of their similarity to light beams, may be focused between two points when both are above the horizon, but apparently do not extend beyond the range of vision, although under rare circumstances they have been known to bend around the curvature of the earth for several miles.

The scene of the most recent American experiments with ultra-high frequencies is the short-wave laboratories of the R. C. A. Communications, Inc., at both Rocky Point and Riverhead, L. I.

Under the direction of Dr. N. E. Lindblad, a former associate of Dr. E. F. W. Alexanderson, apparatus for the transmission of signals on waves of sixty-eight centimeters has been experimented with. So short are these waves that the antenna used to radiate them is small enough to be put in a box less than a foot square. No inductances and capacitors, such as usually go with the short-wave transmitter and receiver, are to be found, but rather connections between the various component parts are made by what appears to be a direct short-circuit between the parts.

Work on the transmission of these high frequencies is said to have been in progress for more than two years, and engineers are beginning just now to solve the many problems involved. Standard apparatus, such as is used in the usual short-wave transmitter and receiver, has been found to be inadequate for use on such high frequencies. Accordingly, entirely new principles

# Fractional

## RIVERHEAD

*This article reveals what one American ment of the quasi-optical wave as a means ether. Articles on foreign developments*

**By Everett**

have been evolved and applied and new apparatus has been developed.

Work on the development of these ultra-high frequencies is a logical transition of short-wave progress. When engineers first discovered the possibilities of short waves for international channels their experiments led to the findings that certain frequencies were more reliable than others. Some channels could be used for transatlantic communication in the daytime with reasonably small amounts of power, while others were more desirable for night-time communication to all parts of the world.

Experiments followed, one after the other, until transmissions were effected on waves as short as ten meters. It was at this point in the development that phenomenal effects began to hamper transmissions. Engineers found their standard apparatus was not adaptable.

### *Hertz—First S.W. Experimenter*

Their development carried them further. They knew that Professor Hertz, long before the invention of radio, had generated waves which now are known to science as "Hertzian waves," and that many of the principles evolved by the famous scientist applied to short-wave transmission. Accordingly they set out on a new field of research. Entirely new conditions presented themselves and they had to start practically from scratch.

Through Professor Hertz's experiments it was established that radio and light waves travel at approximately the same speed; that is, 186,284 miles per second. The relation between radio waves and light waves is shown on the electromagnetic wavelength scale. In this spectrum radio waves are found at the high end. At the top of this group are the long-wave commercial telegraph transmitters, below which are marine telegraph frequencies, then broadcasting and short waves. Below

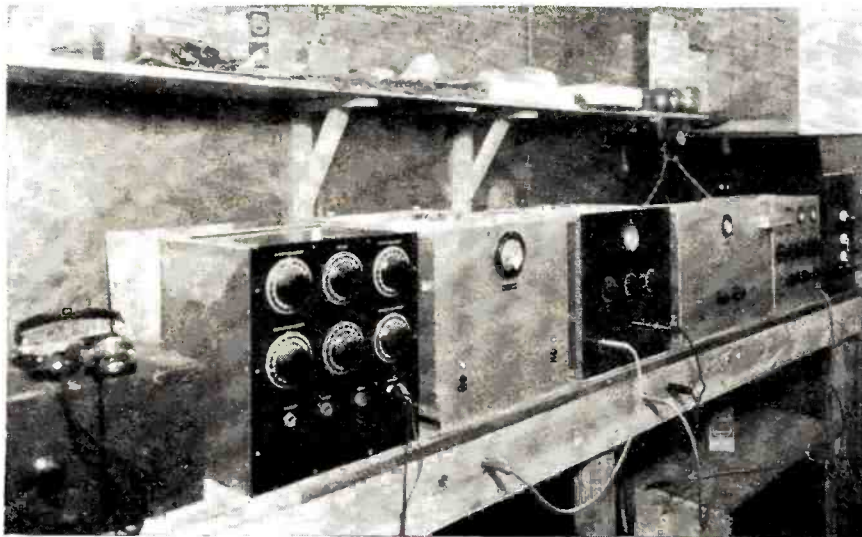

A SIXTY-EIGHT CENTIMETER SUPERHETERODYNE

The tuning unit is at the right. Adjustments are made by turning the cranks. The adjacent panel contains the voltage controls, and in tuning it is necessary to readjust the voltage values. The next panel is the intermediate amplifier. The other cabinets contain audio amplifiers



# Wave Tests

## ROCKY POINT

*laboratory is experiencing in the development of opening additional channel space in the appeared in the August and October issues*

**M. Walker**

the short waves in the spectrum are a small group of waves designated as Hertzian waves. It is within this latter group that Dr. Lindenblad and his assistants are conducting their experiments.

We may establish the relationship of these waves to light waves by further analyzing the scale. Immediately below the Hertzian waves are the infra-red rays which are not visible but are immediately adjacent to visible light waves. The light wave group includes colors we are able to see with the human eye. Below the small visual group are ultra-violet rays, then X and gamma rays, and finally the much discussed cosmic radiations which Dr. R. A. Millikan, the physicist, investigated several years ago.

Feasible application for the radio waves which may be measured with a yard stick has not yet been found, although it is possible that an entirely new communication system may ultimately result.

### *Barkhausen Effect Employed*

It is possible that they might hold some application for broadcasting. In Berlin, Germany, and Paris, France, much interest has been shown in the application of these ultra-short waves. German engineers recently conducted a series of experiments in broadcasting programs on five and six meters, which is considerably higher than the sixty-eight centimeter waves used in the Rocky Point-Riverhead tests. The recent transmissions from Dover to Calais were on a shorter wave of 18 centimeters.

The German tests revealed that the signals traveled about forty kilometers from the broadcasting station. German authorities came to the conclusion that ultra-short-wave broadcasting is possible and that it possesses many advantages over long-wave broadcasting. Before long an ultra-short-wave broadcasting service may be opened there. The test trans-

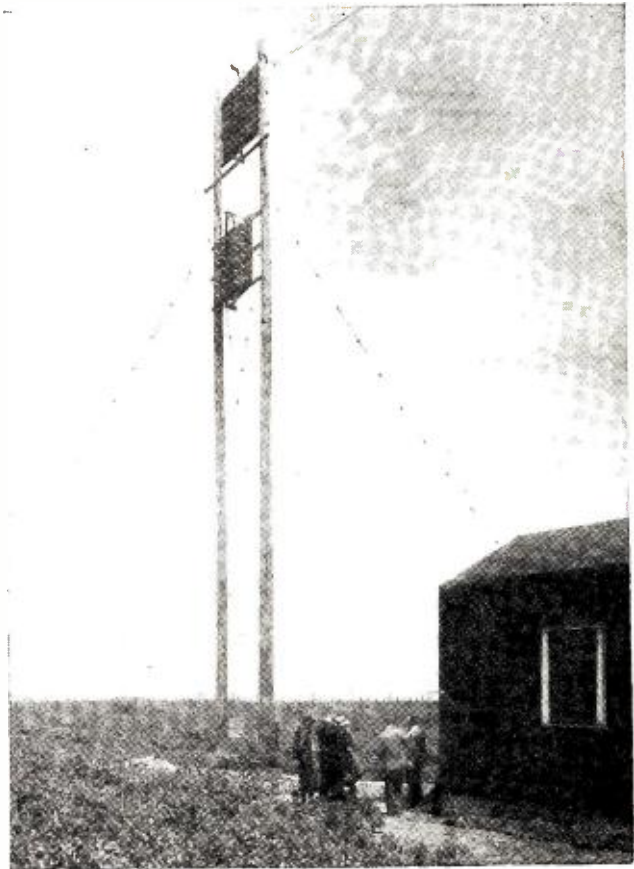

ROCKY POINT, L. I.

*The actual antennas for transmitting (below) and receiving (above) are each thirty-four centimeters long and are surrounded by doublet reflectors, and backed by a copper plate*

missions were intended chiefly to obtain an exact survey of field distribution in Berlin and the strength of signals to be expected, and especially to obtain information on the absorption caused by metal structures such as buildings and bridges.

The chief difficulty of the work of the R. C. A. laboratory was experienced in the vacuum tubes used. Under ordinary conditions it was found impractical to operate standard tubes on wavelengths below 2.1 meters. The normal electron flow in the standard vacuum tube is entirely too slow to obtain efficient oscillations. Something had to be done to speed up this operation, and accordingly new principles were evolved.

Also, it was found that standard vacuum tubes which would ordinarily function well as oscillators on wavelengths as low as five or six meters were impractical for sixty-eight centimeter operation because of the high inter-electrode capacity.

Dr. Lindenblad consequently sought new principles in the design of apparatus for generating these high frequencies, with the result that the system devised by Dr. Heinrich Barkhausen, Professor of Electrical Engineering at Dresden Technical School (Germany) has been used in the experimental apparatus at Rocky Point and Riverhead. This is the same principle used in the Calais transmissions.

In the Barkhausen oscillator the plate, or anode, of the tube is at negative potential and the grid at positive potential. This arrangement gives higher speed to the electron flow in the tube.

### *New System Predicted*

While the Barkhausen oscillators have been used up to the present time, further experiments with different types of apparatus are contemplated. It is expected that eventually a crystal controlled oscillator will be used, and by means of a system of frequency doublers, the wavelength



CLOSE-UP VIEW OF THE ROCKY POINT TRANSMITTER

*The panel in the immediate foreground contains the modulating equipment. The transmitting panel is in the center, and the power supply panel is at the left. The cranks protruding from the oscillator panel control transmitter tuning. Other knobs adjust the tube voltages*



**MEASURING THE SIXTY-EIGHT CENTIMETER WAVE**  
*Dr. Lindenblad measuring the sixty-eight centimeter wave with a small wavemeter. The length of the wire is equal to one-half of the wavelength*

brought down to 2.1 meters. From this point, it is necessary to employ the Barkhausen principle in order to operate the apparatus on the frequencies as low as 450,000,000 cycles.

Duplicate transmitting and receiving apparatus has been installed at Riverhead and Rocky Point, and it is reported that engineers have been flashing the light-like beam signals back and forth for two years. The antennas have to be located at a reasonably good height in order to clear the surrounding objects. Engineers have found that while the waves appear to follow the curvature of the earth to some extent, the radiation is materially affected by opaque objects such as trees and buildings.

The antenna systems at both the Long Island stations are mounted about thirty feet above the ground, and are designed to have marked directional characteristics. Directional reflector systems, not unlike those employed for transoceanic communications, are used.

Antennas atop the masts are connected with the Barkhausen oscillators by means of feeder wires. The radiating portion of the antenna is mounted on a board six feet square and backed with a copper plate. The antenna itself is surrounded by reflector doublets which concentrate the beam signals between the two stations.

While no special effort has been made to sharply focus the beam signals on the receiving antenna, the field of reflection is now well confined within a scope of about thirty degrees. If parabolic reflectors were utilized the signals could be focused within a narrow beam much like the ray of a searchlight, as in the Calais tests.

#### *Elaborate Equipment Employed*

The main equipment, with which most of the development work is done, is located at Rocky Point. More elaborate apparatus is used at this station than at Riverhead for this reason. Both transmitting and receiving sets are contained in a metal shielded room, the transmitting apparatus being situated on one side and the receiving set on the other side. Despite the fact that both stations are operated on the same frequency (450,000,000 cycles), there is no interference experienced.

Transmitting apparatus consists of the oscillator and power supply, and modulating equipment for the transmission of voice. Outside the metal room is an experimental frequency

doubler which is used to amplify the third harmonic of the oscillator. Standard tubes of the 852 type are used for this purpose.

Tuning circuits in the transmitter consist of copper tubing which may be increased in length by sliding one tube within the other much in the same manner as the pitch of a trombone is varied by sliding. It is curious to note that by touching any of the wires in the radio frequency portion of this circuit, while the wires are at room temperature, a sensation of heat is felt. The harder the wires are gripped, the greater the apparent heat. This phenomena is the same as that obtained with apparatus used to give diathermia treatments which are now being employed in some hospitals to induce artificial fever in the human system.

Receivers used for the reception of the signals employ the superheterodyne principle, but instead of the usual oscillator, special Barkhausen tubes are used in this portion of the circuit.

#### *Cranks Control Tuning*

Tuning is accomplished by means of small cranks which slide small contacts along parallel wires, thereby short-circuiting a portion of the wires. The tube also is movable by means of one of these cranks. Adjustments have to be made in all portions of this circuit every time the slightest change is made in the transmitting apparatus. Voltages have to be accurately adjusted. It is necessary to compensate voltages every time a change is made in tuning, and of course, vice versa.

While most of the experiments are conducted at Rocky Point and Riverhead, portable apparatus has been installed in a motor car, and engineers have made field-strength measurements on the reception of signals from both transmitters. For the mobile apparatus, a much smaller receiving set and antenna system is employed. At the time the writer visited the scene of the experiments this mobile equipment was used temporarily at the Riverhead station. The antenna for portable use is thirty-four centimeters long, and is arranged in the form of a 90-degree "V" with the center connected to the receiver. Each leg of the antenna is one-quarter of a wave in length.

These tests revealed the close relationship between the sixty-eight centimeter waves and (*Continued on page 420*)



#### **COPPER PLATE AS AN "INSULATOR"**

*Pointing to the unique all-metal "insulator" which isolates the antenna feeder-wire current from the ground, although one end of this plate is connected to the earth*

# What Goes On In YOUR VACUUM TUBES

*In the September and October issues the author described the working of the more simple types of vacuum tubes, starting with the two-element tube and continuing with three-element tubes used as amplifiers and oscillators.*

*Now he discusses the more complex special-purpose tubes*

**T**HE amplifying properties of the vacuum tube have long been used to extend the sensitivity and application of electrical measuring instruments. A specially designed tube, recently developed, can measure a current of a magnitude so infinitesimal that it is beyond the human mind to conceive. This particular wonder-worker measures currents as small as a hundredth of a millionth of a billionth of an ampere! Expressed in figures, this would be 0.000,000,000.-000,000.01 ampere. With all the inhabitants of the earth, counting day and night, at the highest possible speed, it has been estimated that it would take two years for them to count the number of electrons which pass through an ordinary electric light bulb in one second. The supersensitive vacuum tube described above measures the flow of as little as sixty-three electrons per second!

A vacuum tube in which a beam of electrons draws pictures on a screen is another practical device used in many laboratories. With this tube, periodic alternations of voltage or current are made visible on a fluorescent screen which forms one end of the bulb. In the Braun, or cathode-ray tube, a stream of high-velocity electrons in the form of a beam is directed toward a viewing screen at the other end of the tube. This viewing screen, which is part of the glass of the tube, is coated with a material which emits a tiny scintillation of light wherever an electron strikes it. A beam of electrons focused on this screen will produce a steady spot of light at the point where the electron stream strikes the screen.

As we remember, electrons are easily influenced by electrical charges, so an element somewhat similar in purpose to the grid of a vacuum tube is placed near the path of the

By Emil Reisman  
Part Three

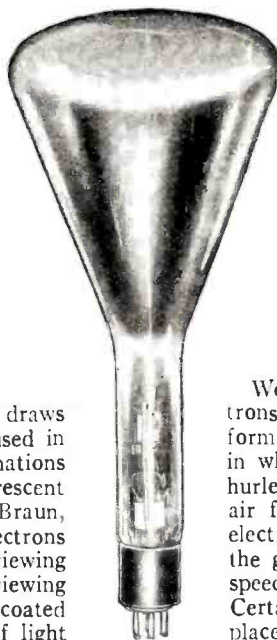

CATHODE-RAY TUBE

*The elements are mounted in the narrow stem, while the large end provides the fluorescent plate or screen on which the moving beam of electrons is played*

electron beam in order to deflect it. Several of these deflecting elements are used so that the electron beam can be deflected in any direction, depending on the relative electrical charges applied. When the voltage on the deflecting elements is periodically altered, as when an alternating voltage is impressed, the beam of electrons is deflected according to the variations in the voltage. The spot of light on the screen, therefore, traces a pattern corresponding to the form of the electrical wave on the deflecting elements. As the electron beam has no appreciable inertia, the oscillograph can show the form of electrical waves alternating millions of times per second. By means of this instrument the electrical oscillations which produce radio waves can actually be traced. Perhaps the future of television lies in a tube of this type.

We have just read of a vacuum tube in which electrons are hurled against a glass screen to picture the form of electric waves. Now we have a vacuum tube in which the electrons are so speeded up that they are hurled clear through the glass of the tube and into the air for a distance of about one inch! The stream of electrons, in order to have sufficient energy to penetrate the glass wall of the tube and enter the atmosphere, is speeded up to as much as 125,000 miles per second. Certain minerals, such as the diamond, fluoresce when placed in the path of this electron bombardment. Salt turns yellow. Milk and butter become rancid. Living cells, bacteria, and small insects are quickly destroyed by the terrific bombardment by electrons.

In this article we have seen how the vacuum tube, the modern version of Aladdin's lamp, has proven of value in practically every field of (Continued on page 447)

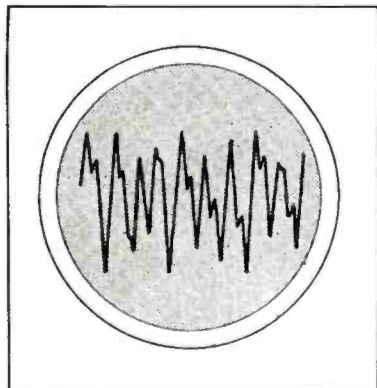

WAVE-FORM ON CATHODE-RAY TUBE

*The engineer can analyze the wave-form of any electric current applied to the tube. In a more complicated cathode-ray device television images may be viewed*

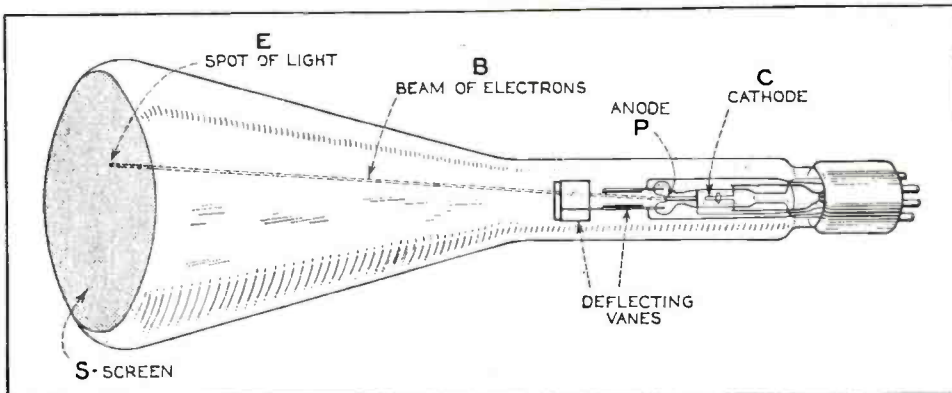

HOW THE CATHODE-RAY TUBE WORKS

*Electrons given off by the cathode, C, shoot through a small aperture, P, which directs them towards the screen, S, in the form of a constant beam, B, terminating in a spot of light, E. This beam, passing between the vanes is deflected by a variation in the voltages applied to these vanes, with the result that the beam visibly traces on the screen, S, the electrical wave-form of the impressed voltage*

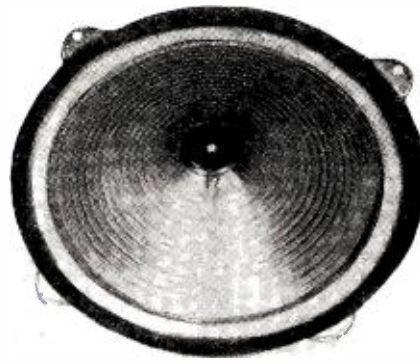
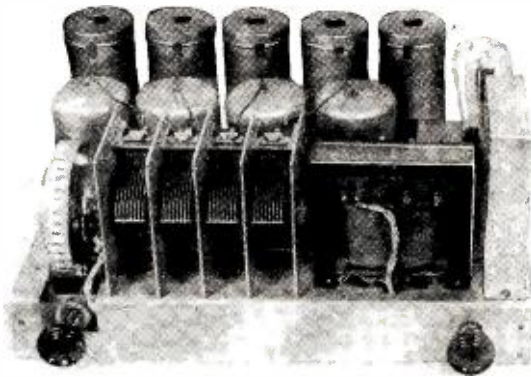

#### THE INTERNATIONAL SIX COMPLETE

*The chassis measures 15 inches by 10 $\frac{1}{8}$  inches by 7 $\frac{1}{8}$  inches and includes three stages of tuned r.f., a power detector, a direct-coupled power stage, and the complete power supply which makes use of a mercury vapor rectifier and a unique voltage-divider arrangement*

# The International Six

## *An Unusual Receiver for Home Construction*

*A receiver which is inexpensive to build, although it probably includes the most advanced features of any design offered to home constructors. Among these are a direct-coupled amplifier, advanced variable- $\mu$  r.f. design and perfect voltage regulation*

**F**OR over a year the direct-coupled audio amplifier has fired the imagination of all radio enthusiasts who have experimented with it. The unusual purity of tone, the ease with which large volume can be handled with perfect quality, the high efficiency of the circuit, all combine to produce a quality amplifier.

The only drawback has been the difficulty of combining the system with radio-frequency amplification. But in the International Six receiver, described here, this drawback has been completely overcome. Three very high gain radio-frequency stages using the new variable- $\mu$  tubes feed into a power detector, which is direct coupled to a type -45 output tube. The gain is so great that the receiver easily reaches the static limit at all points on the dial. Four tuned circuits permit a high degree of selectivity without sideband cutting, yet retain that ease of tuning so often lost in a multi-stage receiver. A special voltage divider prevents the occurrence of any distortion in the radio frequency stages, while the mercury-vapor rectifier tube employed provides the 450 volts required for the direct-coupled audio channel. More of this later, but now for the good news. A complete kit of parts for this receiver, exclusive of speaker and tubes, can be purchased from one of the large mail order houses for thirty-five dollars. This is the lowest price at

By Allan C. Bernstein

### Part One

which parts for a complete receiver of this calibre have ever been available to set builders. Understand, the International Six performs better in many respects than commercial sets selling above the hundred dollar mark, and can more than hold its own with the best of commercial receivers as far as tonal quality is concerned.

The receiver is a real "wow" for distance getting. A gain control, located under the chassis, may be adjusted so that the receiver will just whistle when the volume control is fully advanced, allowing very weak stations to be tuned in by their carrier waves, at the same time utilizing the maximum possible gain. With a good aerial and ground, the only limitation seems to be the amount of static tolerable. Pacific coast reception has been obtained numerous times on the laboratory model.

The selectivity, while not permitting perfect reception 10 kilocycles from nearby high power stations, does permit interference-free results 20 or 30 kilocycles away from the most powerful locals. This is the greatest selectivity consistent with the high degree of quality we have striven so hard to attain.

Now let us analyze the fine points of this receiver one by one. The direct-coupled audio amplifier needs no introduction to the experimenter and radio fan, for its advantages are well known. Its only fault is the high voltage required. At

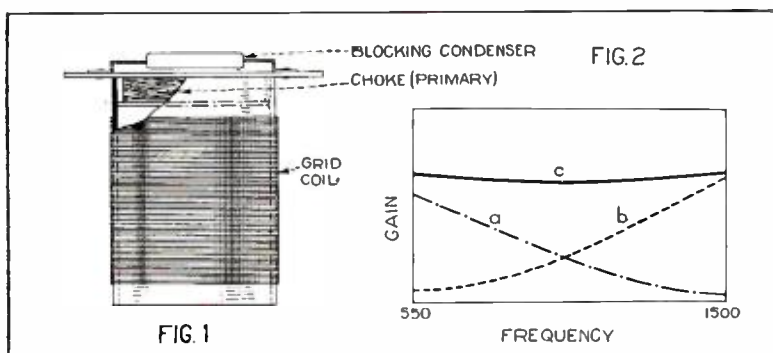

#### R.F. COUPLING COIL DESIGN

*Figure 1. A combination of impedance and inductive coupling is used, for the purpose of obtaining uniform amplification throughout the broadcast band*

*In Figure 2, (a) represents inductive coupling effect; (b) the impedance coupling effect. The combined effect is a relatively flat overall gain, as represented by (c)*

least 400 volts are necessary, any skimping resulting in inferior quality and lower output volume. Any increase naturally improves results. By supplying 450 volts to the system we can secure even greater output and better quality than a standard direct coupled amplifier, if that is possible.

**Special R. F. Design**

Now for the heart of the set, the radio-frequency coils. They consist of a choke placed inside a secondary coil, and a small blocking condenser, as shown in Figure 1. These interstage couplers combine transformer and impedance coupling. Consider the choke and r.f. coil as the primary and secondary of a transformer. The natural period of the choke, tuned by its distributed capacity, is just below the broadcast band in frequency. The gain, if there were no impedance action, would be something as shown in Figure 2a, the highest gain occurring at low frequency because the primary is tuned. Now let us forget the mutual inductance between primary and secondary and consider only the impedance coupling action through the small condenser. The gain would then be more nearly as shown in Figure 2b, being greatest in the high frequency end.

Since both actions occur simultaneously the overall gain will be that due to a combination of both, roughly as shown in Figure 2c.

Next let us examine the voltage divider. With the new variable- $\mu$  tubes the gain of each stage may be controlled by varying the control grid bias. Since the grid is at ground or zero potential, the cathode voltage is varied by the potentiometer R2 (see Figure 4). The plate and screen voltages should be held constant with respect to the cathode, not with respect to ground.

Effective voltages in heater type tubes are measured from the cathode. Thus, when the cathode voltage is 3 the applied plate voltage should be 183 with respect to ground, and when the cathode is 50 the plate should be 230 with respect to ground. A careful study of Figure 3 will show how these voltages are distributed so as to maintain a constant plate voltage with maximum and minimum settings of the volume control, R2. The same reasoning applies to the screen voltages, as shown.

The actual mathematical derivation for a voltage divider which will maintain constant, effective plate and screen grid

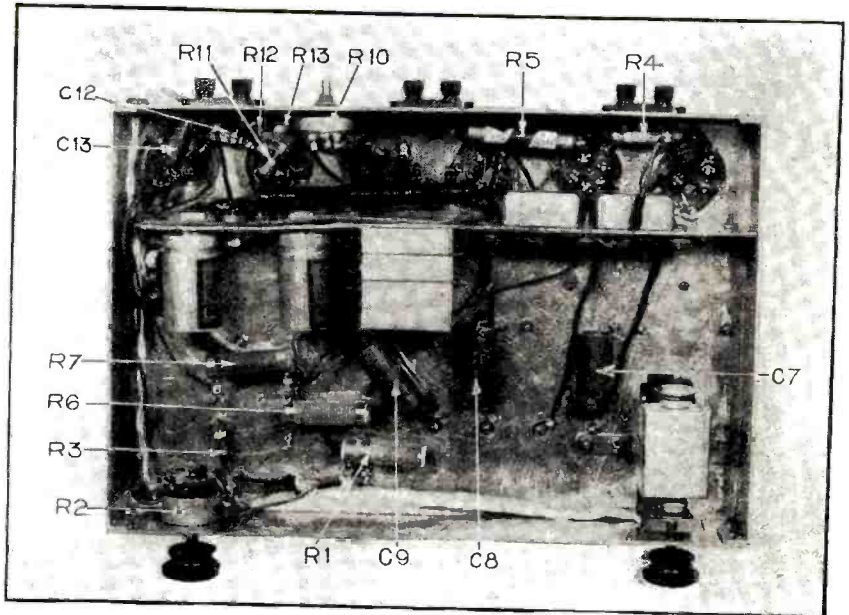

THE UNDER SIDE OF THE CHASSIS

When completely assembled and wired, the chassis looks like this. Next month other views of the partially assembled and wired chassis will be shown in connection with an article describing the construction of the set

voltages, requires the solution of twelve simultaneous equations with twelve unknowns. Without attempting to show the solution, the final values arrived at are shown in Figure 4. The voltage distribution for the cases of minimum grid bias of 3 volts and for maximum bias of 50 volts are shown. In the former case the plates and screens of the 3 variable- $\mu$  tubes are drawing their maximum current; in the latter case they are drawing no current at all. The changing voltage drop in the various resistors, due to the change in current through them, is just enough to keep all voltages at the desired level, as shown.

It being desirable to use resistors of the nearest standard size to the actual calculated values, the exact voltages wanted are not obtained, but the variation is less than five per cent. since in commercial practice neither tubes nor resistors are manufactured as accurately as this, the slight deviation is harmless. In this voltage divider we have developed something not yet, to our knowledge, (Continued on page 422)

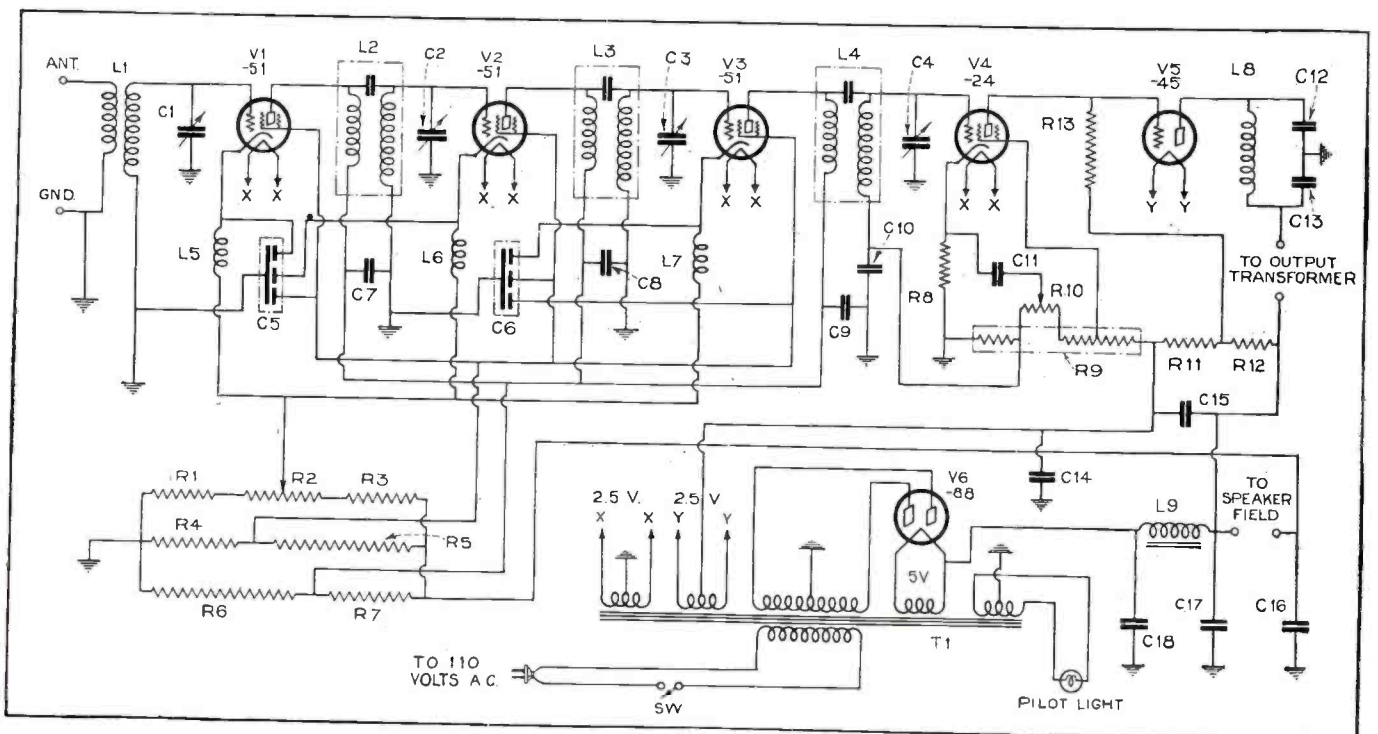

THE CIRCUIT DIAGRAM OF THE RECEIVER

A number of novel design features are shown here, as described in detail in this article

# CLEARING UP

## in Electrical

*Watts, ohms, volts and amperes are just like feet or yards. Small discrepancies present international standards. This are using*

By Thomas

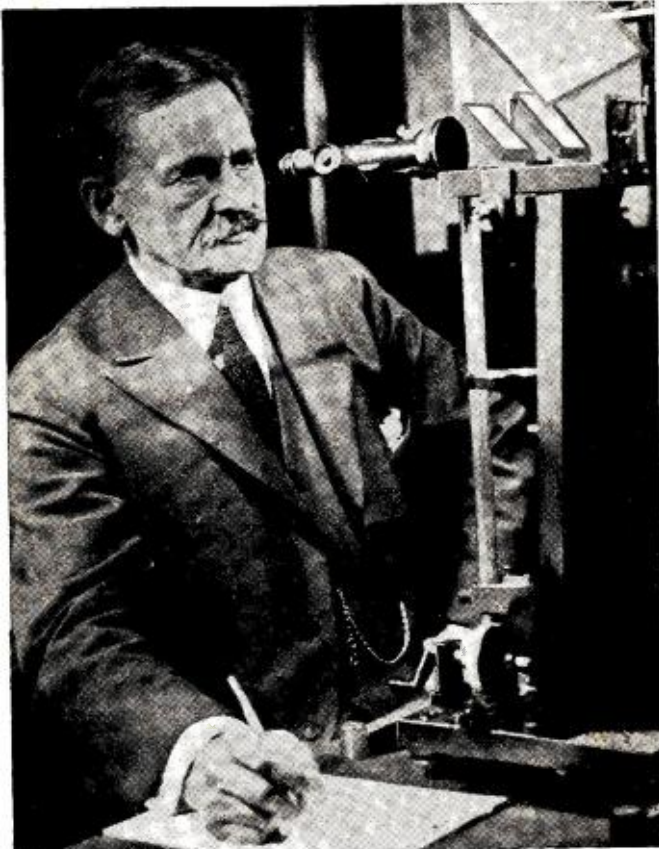

Underwood and Underwood

### AMONG WORLD'S GREATEST STANDARDIZERS

*The late Professor Albert A. Michelson, of the University of Chicago, devoted his lifetime to the accurate determination of the speed of light, a value which scientists consider the most fundamental constant of the universe and which promises to be the basis of all future units, including electric ones*

**E**NGLISHMEN get the most electricity per watt, the Germans the least. The American product is between these two. This is not because supplies or prices vary, it is because watts vary. Three different kinds of watts are in use in the three countries and to make things still more complicated the scientists add three or four more varieties, to say nothing of an assortment of different volts, amperes, ohms, electrostatic units, electromagnetic units and others.

Fortunately, most of the differences between these varying sets of electrical units are too small to be important in practical electrical engineering. Yet the discrepancies are not negligible, especially since the development of the enormous electric magnifications now made possible by radio technique. Knowledge that the British, German and American watts all are different is one result, in fact, of steps taken recently to end these uncertainties and variations in the fundamental units of electricity and to get down, in accurate science as in approximate electrical engineering, to one standard volt, one standard ampere, one standard ohm and one standard watt for the whole world.

A year or two ago the experts of the United States Bureau of Standards perfected new types of standard resistance units measured in ohms. These new devices were better than the old ones chiefly because they could travel. It was possible, if great care were

taken, to move them from Washington to Berlin or London and back again. Meanwhile their electrical resistance did not change, as that of the older standards did.

Immediately, the authorities on weights and measures in the three countries began exchanging these standard ohms. At the same time, scientists took delicate electrolytic cells serving as standards of electromotive force and literally carried these by hand between the same three laboratories. The result is the first direct, precise comparison of the volts, ohms, amperes and watts standard in the three countries, a comparison announced recently in this country by the Bureau of Standards.

### How the Present Standards Vary

The British standard ohm, used for calibrating electric meters throughout England and the British dominions, turns out, the Bureau reports, to be 2 parts in 100,000 larger than the American standard ohm. The German standard ohm is about midway between the other two. The British standard volt also is 2 parts in 100,000 larger than the standard American one, while the German standard volt turns out to be 6 parts in 100,000 less than the American value. In measurements of wattage these discrepancies increase because of the multiplication required by the nature of the unit. The German standard watt is found to be 13 parts in 100,000 smaller than the American unit and 15 parts in 100,000 below the British standard.

These comparisons and discrepancies apply to what are called the "international" watt, volt, ohm and ampere, adopted in October, 1908, by the International Conference on Electrical Units and Standards held that month in London. It is these international units that commonly are used in practical work although scientists sometimes set greater store by the so-called "absolute" units, of which more presently.



New York Electrical Society

### WILL THIS BE THE FUTURE STANDARD?

*This instrument, the Geiger Counter, counts atoms that enter the instrument's electrical chamber from the bit of radioactive metal held by the operator. If enough were known about atoms, electrons and instruments to count and measure them, it might be possible to construct systems of weights, measures and electrical units which would depend on these fundamental natural values, instead of being arbitrary and variable*

# DISCREPANCIES

## Measuring Units

*as arbitrary as other units of measure, have been found, furthermore, in the article tells you just which units you and why*

Elway

Of all possible electrical units, only two are really fundamental and need independent definition. These are the ampere and the ohm. The London conference defined the international ampere as the unvarying electrical current which, passed through a solution of nitrate of silver in water in accordance with certain definite instructions, deposits metallic silver at a definite rate, equalling .00111800 gram per second. The international ohm was defined at the same time as the resistance offered to an unvarying electric current by a thin cylinder of mercury, like a liquid wire, weighing 14.4521 grams and with a length of 106.300 centimeters, at a temperature of zero degrees centigrade. The international volt and international watt then were defined, by Ohm's law and the usual power relationship, in terms of this definite ampere and ohm.

Neither the international ampere or the international ohm has back of it anything more fundamental than these purely arbitrary definitions in terms of mercury and silver. There have been minor errors also. It now turns out, in setting up and testing these ohms and amperes. That is the reason for the three-country differences which the recent comparisons by the Bureau of Standards experts have disclosed.

### *Chemical and Temperature Differences*

Such practical difficulties were inherent in the definitions. Very slight differences of temperature, for example, affect both of the units. Very slight, unnoticed chemical differences in the silver solution may alter the measurement of the international ampere. It is extremely difficult to make a cylinder of mercury of exactly uniform cross section in order to reproduce the international ohm. For practical purposes, therefore, it has become customary to depend, not on the ohm and ampere as thus defined, but on other standards of the international ohm and the international volt.

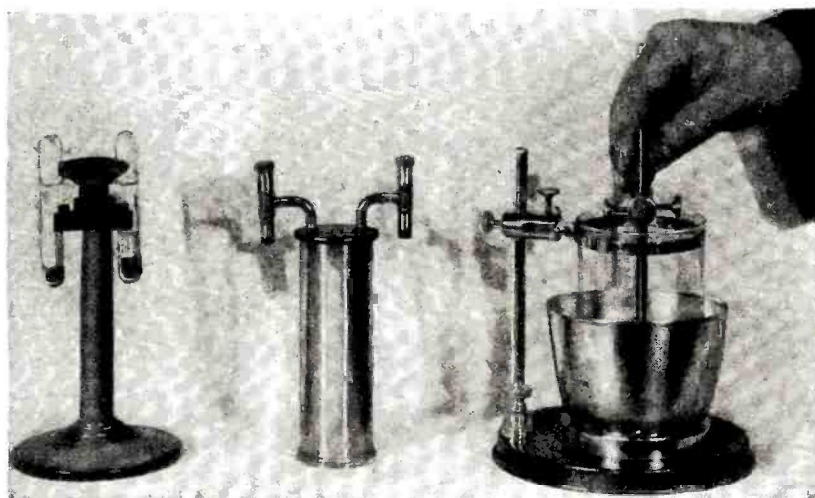

Brown Brothers

### COUNTRY'S PRESENT ELECTRICAL STANDARDS

*At the left is a standard cell, as used by the Bureau of Standards to determine electromotive force and the value of the volt. Center—A standard resistance, containing a coil as nearly inalterable as possible, the resistance of which is determined in terms of the international ohm. Right—A silver voltameter, to determine the weight of silver deposited by a given quantity of current, to fix the standard ampere*



Bureau of Standards

### ALL AMERICAN MEASURES ARE BASED ON THESE

*In the vaults of the Bureau of Standards in Washington are kept the fundamental American standards of weight and measure. On the bottom shelf is the standard meter bar. The middle shelf holds the standard metal weights for the kilogram and the pound. On the top shelf is the standard for units of volume, like the liter and the gallon*

For the ohm standards definite lengths of metallic wire of reasonably definite character, like wires of the alloy called manganin, are used. For the international volt it is customary to use some kind of constant-voltage electrochemical battery, such as the familiar Weston "standard cell" one terminal of which is mercury while the other terminal is an amalgam of mercury and metallic cadmium. The manganin resistance standards are measured individually in terms of the defined mercury ohm or of some other standard. According to the best existing measurements the Weston standard cell, very carefully made and used in accordance with a detailed set of specifications, produce an electromotive force of 1.0183 international volts.

The ordinary electric units thus are disclosed as utterly arbitrary. Were all of the existing resistances and standard cells destroyed by some catastrophe, as the standards of the British pound and yard once were ruined by fire in the Houses of Parliament, it would be difficult, if not impossible, to reconstruct them. Thus modern electricity encounters the ancient problem of how mankind best may establish fundamental units of measurement; a problem which has been bothering scientific men ever since the days of the priest-scientists of Babylonia and Egypt.

Essentially, scientists alternate between two ideas; the idea of arbitrary standards set up

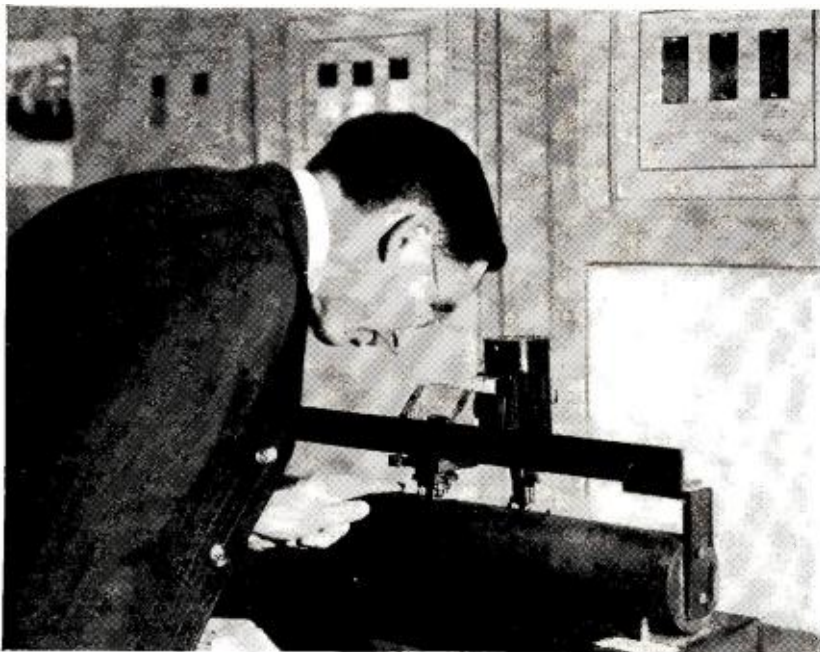

Brown Brothers

**LIGHT WAVES MAKE THE MOST DELICATE MEASURING RODS**

*The weight of a finger bends the stiff steel bar a trifle, too little to be measured in any ordinary way. Yet the apparatus above the bar measures this tiny bending in terms of the wavelength of light, using the interference of one wave with another. Light rays now are proposed as the ultimate standard of length, to replace the arbitrary meter*

by man himself and the idea of units which depend on constants of nature. In the light of the Egyptian and Babylonian beginnings, the two ideas might be called the idea of the King's Forearm and that of the Earth's Waistline.

The earliest unit of length concerning which information has been recovered from Egyptian and Babylonian records is the cubit, probably originally intended as the length of the human forearm from the elbow to the fingertips. Once this may have been the king's forearm; becoming a purely arbitrary standard made suitable only by virtue of general acceptance. That seems to have been man's first idea of how to start a set of weights and measures, although there has come down to us from the dim beginnings of science at least one suggestion that the alternative idea of units based on constants of Nature originated almost as soon. It exists in the length of the cubit used to build the Great Pyramid of Egypt.

By correlation of many Greek and Egyptian records plus study of surviving gauges used in ancient Egypt to measure the height of the Nile and of the dimensions of buildings like the Great Pyramid, modern experts on mensuration have recovered the lengths of two Egyptian cubits, apparently in use for centuries side by side as we today use alternative length units like the meter and the yard. One of these cubits equalled approximately 20.62 modern inches. The other apparently was shorter, equalling 18.24 inches. It is interesting incidentally, as has been pointed out by Colonel N. T. Belaiew of London, that these two cubits seem to be related mathematically. A square formed by the small cubit has an area almost exactly equal to that of a circle with the large cubit for its diameter. A still more interesting relationship appears when the large cubit, which was the one used in constructing the Great Pyramid, is compared with the circumference of the earth.

**Was the Pyramid a Standard?**

Each side of the Great Pyramid seems to have been designed to measure a definite number of cubits. All four sides of the pyramid added together equal, it recently has been pointed out by Sir Richard Glazebrook, distinguished British expert on mensuration, almost exactly one one-hundred-and-twentieth part of the length of a degree on a meridian around the earth. Either this is a most remarkable coincidence or else the scien-

tists and engineers who constructed the Great Pyramid and who fixed the 20.62-inch cubit used at the time knew that the earth was a round ball approximately 8000 modern miles in diameter and designed both the Pyramid and the cubit to represent even fractions of this circumference.

This, if true, is the first indication in human history of an effort to fix standards of measurement with relation to fundamental natural constants. Two similar efforts have been recorded since; one by the founders of the metric system, the other one beginning at the present time.

**A Metric Standard Error**

The story of the metric system is familiar. When the scientists of Paris were commissioned, after the French Revolution, to devise a whole new system of weights and measures their fundamental unit of length, the meter, was designed on what may have been the basis, millennia before, of the Egyptian cubit. It was planned as a definite part, one ten-millionth, of the quarter of the earth's meridian passing through Paris between the Equator and the North Pole. Unfortunately, a slight mistake was made in calculating the length of this quadrant. It now is known, also, that the relative positions of the North Pole and the equator vary slightly from time to time and that the circumference of the earth also is slightly variable.

By these discoveries the metric system has been divorced from its intended dependence on a constant of nature and now rests, like the others, upon a purely arbitrary basis. The present international meter is defined only as the distance between two tiny scratches made on a bar of platinum-iridium alloy preserved in the International Bureau of Weights and Measures, near Paris.

The gram and kilogram, mass units of the metric system, are similarly arbitrary, since another mistake was made in deriving the original kilogram from the original meter plus the density of water. (Continued on page 434)

VALUES OF THE INTERNATIONAL BRITISH AND GERMAN UNITS IN TERMS OF THE INTERNATIONAL AMERICAN ONES.		
	BRITISH	GERMAN
AMPERE	1.00000	.99993
OHM	1.00002	1.00001
VOLT	1.00002	.99994
WATT	1.00002	.99987

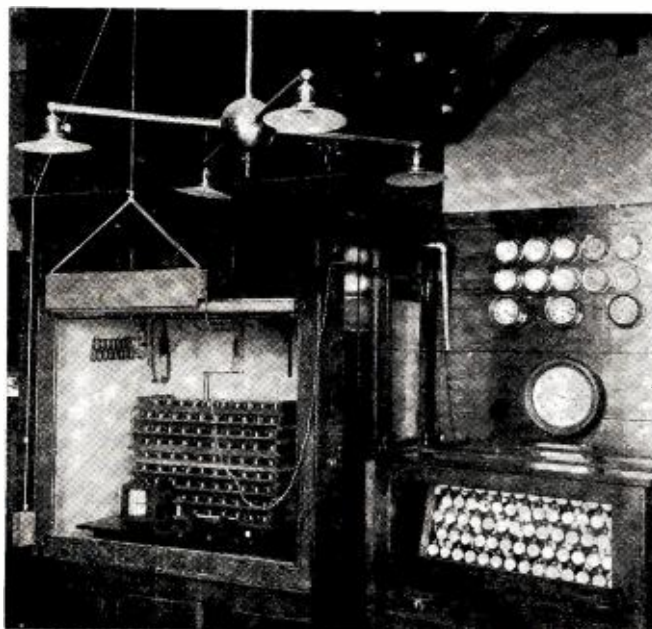

Bureau of Standards

**SCIENCE NEEDS A STANDARD SECOND ALSO**

*In this room at the Bureau of Standards clocks and watches are "rated"; that is, compared with standard timepieces which have been found to keep perfect time or to gain or lose in regular ways. Ultimately, the standard of time is determined by astronomers from the rotation of the earth.*



# Television Progress

## *New York Forges Ahead*

*Television enthusiasts in and around New York City are especially favored in the number of television and combination sight and sound programs regularly available to them. The author tells here what the New York stations are doing in this field—particularly the National and Columbia chains*

By Samuel Kaufman

**N**EW YORKERS are looking-in as well as listening-in. The key city of broadcasting is rapidly becoming the key city of television. Five transmitters are already in operation on regular program schedules and present indications are that more will follow as soon as the Federal Radio Commission approves new applications.

The newest transmitter in New York is W2XAB, the first television project of the Columbia Broadcasting System. The National Broadcasting Company maintains W2XBS. Two transmitters, W2XCR and W2XCD, are operated by the Jenkins Television Corporation. Radio Pictures, Inc., controls the fifth metropolitan television station, W2XR.

Elaborate ceremonies marked the inauguration recently of the Columbia Broadcasting System television station atop the chain's headquarters at Madison Avenue and Fifty-second Street. Before a distinguished assemblage of invited guests, Mayor James J. Walker pulled aside a curtain covering the photo-electric cells and the network's pioneer vision transmitter was officially on the air for the first time.

Unusual public interest was attached to the event because it marked the first occasion of an American network to inaugurate a regular schedule of combination sound and sight programs.

The sound portion of the inaugural program was presented over WABC and the entire Columbia chain on account of the



INAUGURATING THE C. B. S. TELEVISION STATION  
Mayor Walker put the station "on the air" with the able assistance of Helen Gilligan, Broadway star and radio luminary

unusual array of talent. Subsequent programs were presented over W2XE, the chain's New York short-wave station. The large interest in the combination sound-and-sight programs shown by listeners not equipped with short-wave receivers later caused the CBS to alternate between WABC and W2XE as the conveyor of the audible portions of the programs.

Guests at the inaugural broadcast were seated in a studio on the twenty-first floor of the Columbia building. Two flights above, the first program was going on the air. Here, before the photo-electric cells and a microphone, Mayor James J. Walker launched the initial television transmitter of the network. Edwin K. Cohan, technical director of the chain, who supervised the erection of the station, appeared and spoke of the possibilities of television. Dr. Walter Schaffer, chief engineer of the Reichs Rundfunk Gesellschaft, German broadcasting monopoly, also was seen and heard on the first program. Prominent entertainers appearing on the inaugural period included Natalie Towers, Kate Smith, Henry Burbig, Helen Nugent, the Boswell Sisters and others. Edward B. (Ted) Husing, announcer, acted as master-of-ceremonies.

While the program was being presented on the twenty-third floor, the guests below filed past five receivers and viewed the performers. The sound portions of the presentations were audible over loudspeakers and the effect was similar to talking movies. Standard Jenkins and Shortwave & Television receivers were utilized for the reception. The persons performing before the photo-electric cells were easily recognized at the lenses of the television receivers, but at times the images were a bit distorted. At moments, a fairly good image would suddenly spread like melted tallow and resemble the grotesque images usually attached to trick mirrors at amusement parks. Black hollows would appear instead of eyes and some clean-shaven persons would suddenly grow mustaches and whiskers. But these distortions were quickly eliminated by men at the control knobs.

### *The Studio Equipment*

As soon as the program ended, the visitors were escorted to the television studios and transmitting equipment above. Here we found four rooms devoted to television. The transmitter, of American manufacture, utilizes, like all the other New York sight transmitters, sixty-line scanning at twenty frames per second. A miniature piano is used for CBS programs. It is

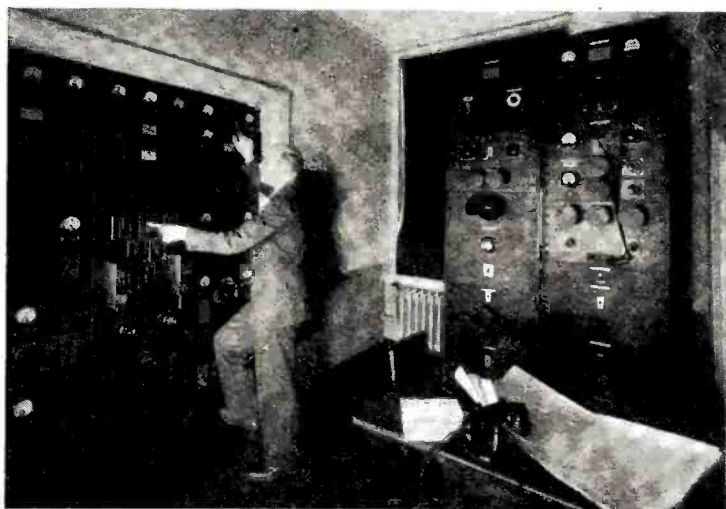

THE CONTROL ROOM OF W2XAB  
E. K. Cohan, Technical Director of the Columbia Broadcasting System, at the transmitter controls

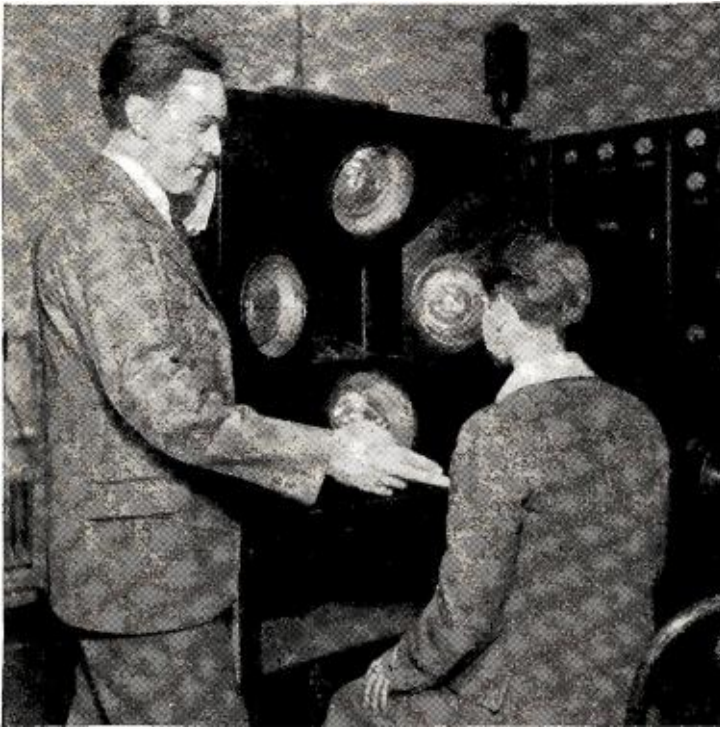

**WATCHING FOR THE BIRDIE**

Harold E. Kennedy, manager of the television equipment at the N. B. C.'s Times Square studio, shown (left) instructing Laddie Seaman, boy actor, how to sit before the television eye

mounted on a movable platform so that it can be moved in and out of the picture at will. A bank of eight photo-electric cells and a microphone are the only technical instruments visible in the studio. Adjoining the studio is the scanning room, and beyond this are the control and transmitter rooms. The transmitter utilizes 500 watts of power.

**Still an Experiment**

Since its inception W2XAB has been on the air seven hours each day. The regular schedule for sound-and-sight programs is 2 to 6 p.m. and 8 to 11 p.m.

William A. Schudt, Jr., formerly a member of the Columbia publicity staff, was named Acting Television Director. He supervised the production of original television programs and, together with Mr. Cohan, earned much praise for the manner in which the limited methods of present television equipment were applied in the production of the Columbia programs.

Mr. Cohan, on the opening night of the television station, emphasized that the CBS television venture was purely experimental. He compared television of today with the phonograph of 1910 and the moving picture of 1905, and added that "upon this pioneering must rest the solid foundation of future progress." He explained that his words were not intended to sound a note of pessimism but rather of conservatism.

"Television," he said, "will advance from now on just as surely as sound broadcasting has, and I believe at no slower a pace. It will progressively bring to you the individual and small groups, the larger groups and complete symphonic and stage presentations, the outdoor sporting events, the spot news events. It will eventually bring these things to you in natural color.

In the future there will be television networks similar to our sound networks of today and functioning much in the same manner. To accomplish this, considerable progress will have to be made, particularly with regard to the width of the transmission band. In addition, pick-up flexibility and future program de-

mands call for a suitable method of scanning whose illumination limitations are no greater than those of the present moving-picture camera.

"We have but one purpose in opening Television Station W2XAB; our interest being solely that of a progressive broadcasting organization intent upon carrying on television experiments of its own to determine the scope and limitations of this new art and to build a well co-ordinated and efficient organization in advance of the day when television no longer remains the crude marvel that it now is."

Several weeks after the Columbia vision transmitter was launched we again inspected the equipment and interviewed Mr. Cohan. He said that results were better than anticipated, that despite the location of the transmitter in the midst of steel-skeletoned buildings, the signals were being well received at a number of test receiving points in the New York area. Fan mail, he said, was comparatively smaller than that of the early days of broadcasting, but the enthusiasm of the audience's responses and the long distances from which reports were sent proved the fruitfulness of the tests.

**Ultimate Television Waveband Unknown**

"Short waves," he told the writer, "are not necessarily the best waves for television. However, they are the only waves available for the purpose and it is up to engineers to obtain the best possible results in image transmission through them. Perhaps the best television frequencies are already used for other purposes. The ultra-short waves are the only ones now available and it is possible that, through experimentation, they will prove very efficient.

"At some future date it is possible that television signals will be transmitted on the broadcast band together with synchronized sound. The vision and sound signals might be scrambled in the transmitter and be broadcast on a single channel. Receivers, in that case, will be equipped with an unscrambling device and the image and synchronized sound will then be efficiently seen and heard."

Pending further data on the New York television project, the CBS plans extending its television activities to other parts of the country.

Although in the experimental television field earlier than Columbia, the National Broadcasting Company has maintained a discreet silence on the subject. In the Summer of 1930 the NBC inaugurated Station W2XBS from a site in the Times Square network studios atop the New Amsterdam Theatre. This transmitter was formerly operated by the Radio Corporation of America from another site. There was no ballyhoo or ceremony attached to the first NBC television transmission. It was a purely experimental affair (Continued on page 436)

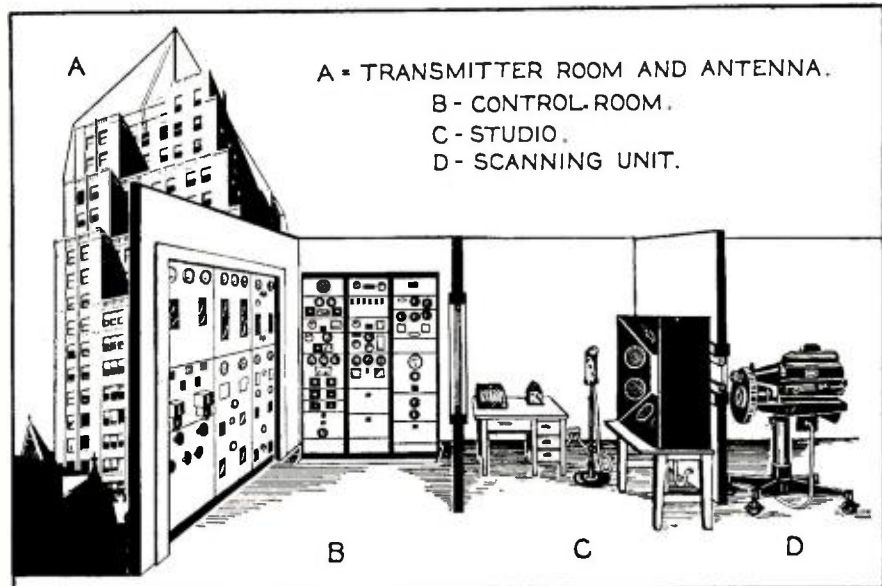

- A - TRANSMITTER ROOM AND ANTENNA.
- B - CONTROL ROOM.
- C - STUDIO.
- D - SCANNING UNIT.

**PICTORIAL LAYOUT OF STATION W2XAB**

From studio to antenna the television station resembles a regular broadcasting station, except for the addition of the scanning equipment

# The Army's New Portable Radio Combination

*A short-wave transmitter and receiver, both operating with a loop, combined in one set, which, with generator and other equipment, weighs only 65 pounds*

By Carter W. Clarke\*

**S**IGNAL CORPS engineers, working in the Signal Corps Laboratories at Fort Monmouth, N. J., have finally solved one of the most difficult combat communication problems that has confronted the Signal Corps since the World War. This problem was the design and construction of a light-weight portable radio set which will insure uninterrupted radio communication between front line battalions and their regimental headquarters.

This new radio set, which is known to Signal Corps officers as the SCR-131, is a continuous wave loop telegraph receiving and transmitting set having a frequency band of 3960 to 4360 kilocycles. This set will furnish reliable communication over a

\*1st Lieutenant, Signal Corps, U. S. Army.



TRANSMITTING AND RECEIVING  
*Close-up of the set, showing key and tuning controls*

distance of about five miles. Since there are forty-five ground radio sets operating in the area of a single infantry division, it is obvious that any overlapping of waves or the use of more than the minimum power will result in considerable interference and confusion.

The SCR-131 weighs only about sixty-five pounds completely equipped and is designed so as to be readily carried by two soldiers. It can be quickly and easily set up for operation and its small size permits of ready concealment from the enemy. This last feature is a vital consideration in the design of radio equipment which will be used by front-line troops.

The radio receiver and transmitter with associated equipment are mounted in two wooden boxes which are permanently hinged together and held closed for transportation by two hooks on either side. The apparatus box is swung back on the hinge so as to rest on the projecting portion of the lower box. A metal panel is mounted on a hinge in the front of the apparatus box, and upon this panel is mounted the receiving equipment and the loop tuning condenser used for both receiver and transmitter.

The loop antenna consists of four lengths of square brass tubing, two pairs being permanently hinged together. Each half of the loop then plugs into sockets on the back of the set box and the two halves snap together in a knife switch contact at the top of the loop. The loop area is square with one corner pointing upward. The top of the loop stands  $57\frac{3}{4}$  inches above the ground.

All transmitting equipment is mounted inside the apparatus box, and spring contacts between the panel and box complete the circuit when the panel is closed. Both the transmitter and receiver tubes are supported on flexible mountings so as to prevent damage and reduce microphonic noise. When the front panel is closed the receiver is completely surrounded by metal walls with all edges in contact. This provides the necessary shielding for the receiver.

*(Continued on page 418)*

## CIRCUITS EMPLOYED IN THE "PORTABLE"

The circuit diagram of the combination receiver and transmitter. For simplicity the second audio stage has been omitted here. Apparatus Legend: A—ammeter; C1 fixed condenser, 300 mmf.; C2 bridge condenser, 50 mmf.; C3 variable condenser, air, 85 mmf. max.; C4 fixed condenser, 1,000 mmf.; C5 variable condenser, air, 150 mmf. max.; C6 compensating condenser, 20-35 mmf.; C7 fixed condenser, 2,500 mmf.; C8 fixed condenser, 10,000 mmf.; C9 fixed condenser, 25 mmf.; J jack type JK-3; L1 grid inductance; L2 plate inductance; L3 transmitting reactor; R1 filament rheostat; R2 resistance, 6,400 ohms; R3 resistance, type RS-3, 2 megohms; RL break-in relay; S 3 pt. socket; T transformer type C-65; U lamp, type LM-4

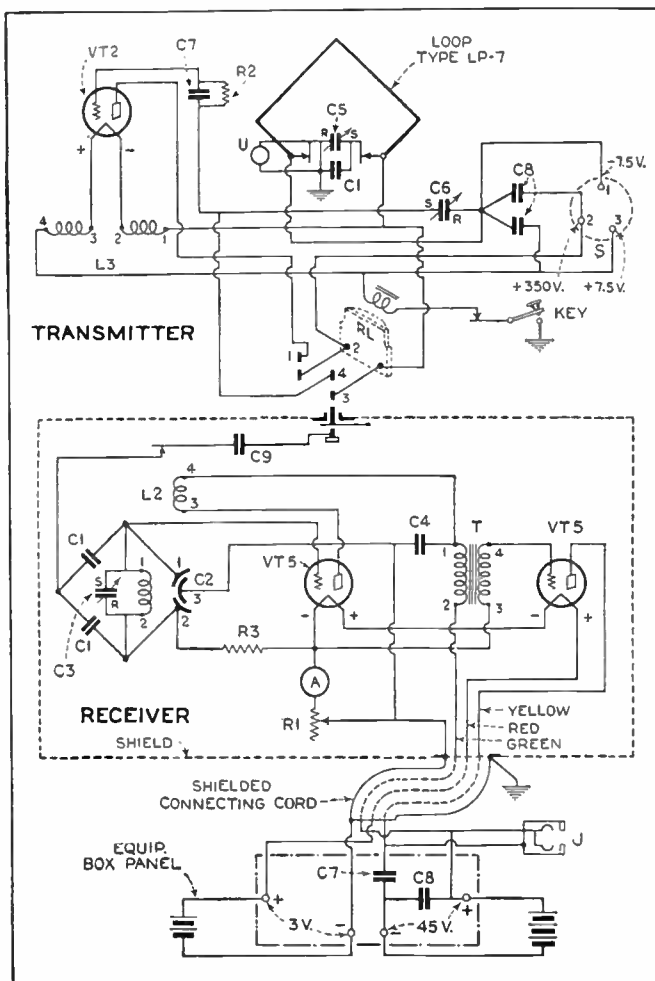

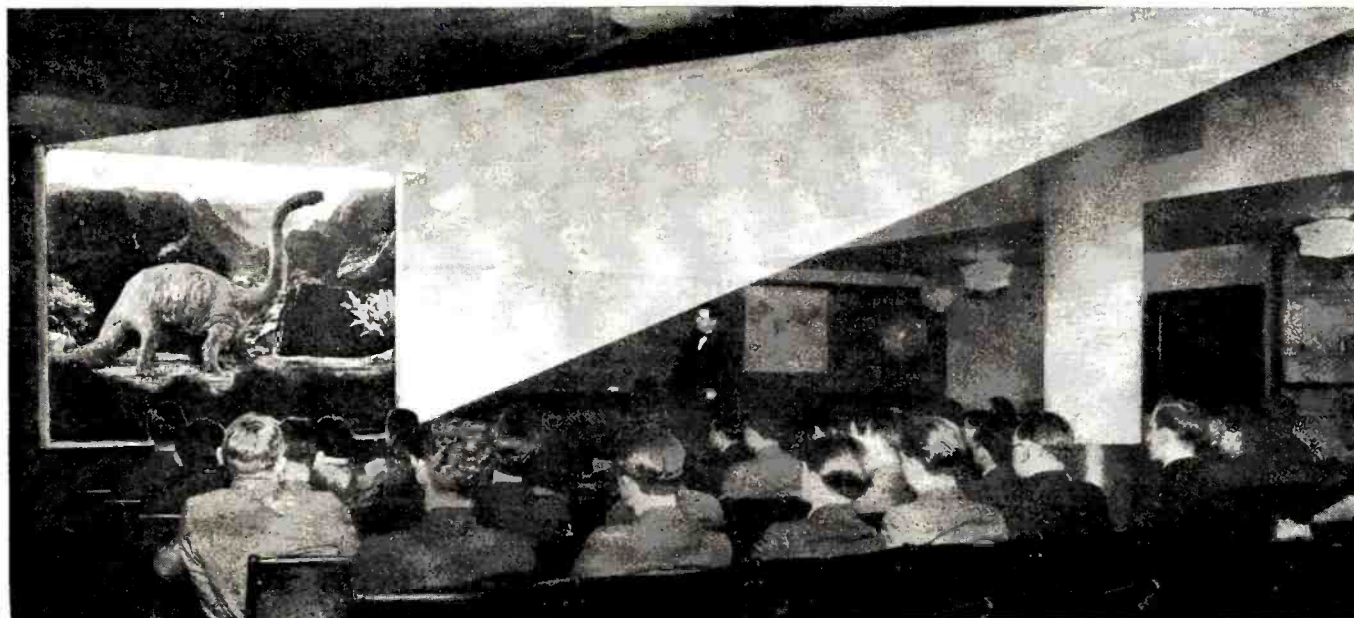

# Talking Movies *for* Schools

*The use of sound films in educational work involves certain problems, principally psychological, not encountered in films of the entertainment type. These problems are discussed here, as are also the sources of educational sound films*

**A**NOTHER important consideration in connection with the educational use of sound motion pictures has to do with the films available which are suitable for that purpose. The final determination as to the extent and effectiveness of this product of radio engineering principles as a means of education in the schools will be based upon the showing as it emanates from the loudspeaker and the screen. The picture is the thing. With the installation and operation of the sound projection equipment the circle is only half complete. It must necessarily follow that effective sound films are available. A sort of vicious circle has existed in the past relating to the use of sound pictures in educational institutions. Producers of sound pictures received the answer "No" from the schoolmaster, he adding that there is no suitable school equipment for sound picture projection. Likewise, the salesmen of the sound projection equipment companies were turned away without a sale by school committees with the statement that educational sound films were not available. The one is dependent upon the other.

## *Reading, 'Riting, 'Rithmetic—and Radio*

The extent of the influence of these modern radio engineering devices on the educational thinking and philosophy of our times is reflected in the changed conception of some early and deeply established educational maxims. To the three R's has been added a fourth, so that now we have Reading, 'Riting, 'Rithmetic and Radio. A prominent educator a few years ago said that for the three R's there have now been substituted in school practice three M's, *i.e.*, Muscles, Minds and Morals. To these must likewise be added a fourth, Movies. However, this is incomplete until movies become movie-tones. The extent to which movie-tones become an integral part of classroom teaching procedure will depend in a large measure on the production of sound films directly and vitally applicable to education.

The analysis of the values to be derived from motion pictures shows the inherent superiority of the sound over the silent film. Every motion picture consists of two kinds of content—

By C. A. Johnson\*  
and C. C. Clark\*

### *Part Three*

concrete and abstract. Freeman and Wood, in an extensive investigation of the value of silent motion pictures in school work, concluded that the purpose of such pictures was to supply a portion of the concrete experience which lies at the basis of abstract thinking. They say: "The immediate function of the silent film is to present clear-cut, concrete notions of the physical aspect of the world, but pictures cannot supplant language as an instrument of abstract thought." So, by adding language in the presentation of concrete ideas the talking picture becomes at once vastly superior to silent films.

The silent film attempts to supplement the photographic representation of the concrete by adding captions or subtitles to organize these concrete impressions into some sort of unified meaning or concept. The incongruity of having the picture life interrupted with a printed subtitle and then the action resumed as though there had been no break was noted generally when motion pictures first appeared. However, until the advent of the talking pictures, people had become so accustomed to this as to be unconscious of this artificiality. The sound picture has eliminated this, and at the same time provided the possibility of educational films not only furnishing concrete illustrative material but also serving as an instrument in developing abstract thinking.

### *Educational Advantages of Sound Movies*

Sound motion pictures can bring to the classroom faithful representation of objects which are too large, too expensive, too rare, too dangerous or otherwise inconvenient. They provide an effective method of portraying vividly and accurately the personalities of the modern leaders in thought and action. By seeing and hearing George Bernard Shaw, for example, in the lifelike talking picture, one is brought into intimate touch with the man and his personality, and thus has a keener insight into his amiable character than by knowing him only through his plays and books. The sound picture lecture, "Cosmic Rays," by R. A. Millikan, gives the student an insight into this scientific phenomenon which he could get only with great difficulty from the printed page, and at the same time a personal contact with the force and (Continued on page 427)

\*School of Commerce, New York University.

# *Electro-Acoustic Studies* Offer Aid for the HARD-of-HEARING



## MEASURING AND DIAGNOSING DEAFNESS

*The audiometer provides a means for accurately measuring the degree of hearing loss at different sound frequencies, thus permitting deaf persons to select hearing devices which best meet their individual needs*

*This article probably constitutes the most comprehensive study of the electric hearing aid field ever published. It discusses practical requirements and design considerations and points out profit-making possibilities for radio dealers and servicemen*

**C**AREFUL estimates obtained from authoritative sources indicate that about 20 million people in the United States have hearing which is impaired to some extent. Of this number, approximately 3,000,000 are school children. Perhaps 25% of the total are afflicted with nervous defects which in most cases cannot be materially helped by hearing devices. Somewhere between 25% and 50% of the total represent minor impairment which does not require the use of hearing aids. The balance represents several millions of people in the United States who really need hearing aids. All told only about half a million hearing devices have been sold thus far, and it is therefore evident that a tremendous market exists for individual hearing aids and likewise for group equipment in churches, theatres, halls, schools, etc. In addition, devices which can be plugged into the average radio set or electric phonograph reproducer add a further field for the expansion of the electro-acoustic industries.

What do we have to consider in helping the hard of hearing? First of all, distinction should be made between those who are totally deaf and those who are partially deaf. For the totally deaf there is usually no help that can be offered, although experiments with bone conduction have indicated that through the use of powerful amplifiers some of these cases can be materially aided. In such cases, a headphone or similar unit is placed against the bony structure of the head rather

By Irving J. Saxl

than the ear and the sound vibrations are carried through the bone to the inner ear, making the sounds audible if this portion of the ear is still in proper working condition. It frequently happens that the physical defect which causes deafness does not involve the inner ear.

For those whose hearing is not completely gone, the hearing devices now on the market offer a tremendous opportunity. There are numerous cases where this does not hold true, of course, but the great majority of persons thus afflicted can be materially aided by present-day devices and many of them can, through this means, attain substantially normal hearing. But how is this amplification of sound to be obtained and what laws do we have to respect to bring again to the deafened person the beauty of a bird song, the laughter of a child, the voice of his beloved or of his teacher?

There are two types of practical hearing aids. One of them is the well-known "trumpet." This is a small horn which collects sound and concentrates it at the ear. In general, this type is helpful when used close to the source of sound but has the disadvantage of clumsiness and generally requires the use of one hand to hold it in position. Roughly, we can consider that sound diminishes with the square of the distance and therefore, at more than a few feet, the trumpet picks up such a small amount of sound energy that it has little value.

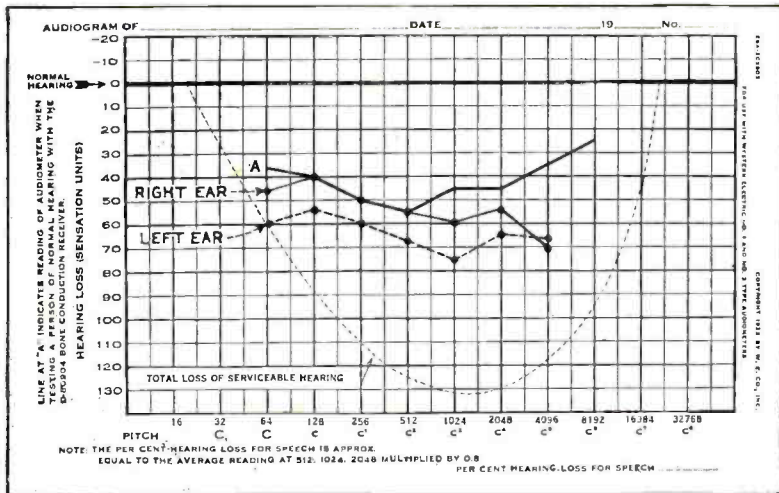

AN ACTUAL AUDIOGRAM

Figure 1. A chart like this, based on audiometer measurements of one case of impaired hearing, shows an average hearing loss of approximately 50 per cent, and indicates that a suitable hearing device must provide a high degree of amplification, particularly at frequencies below 200 and above 2000 cycles per second

The development of the electro-acoustic science has given to the partly deafened persons a number of electrical hearing aids that are compact, not too conspicuous and can be attached to the person of the user, thus leaving his hands free. At least this is true so far as cases of moderate hearing impairment are concerned. For those whose hearing is greatly impaired more powerful electrical devices, some of them making use of vacuum tubes, like those employed in radio sets, are required. Naturally, equipment of this type is not as compact as the more simple electrical devices but nevertheless it provides the means for bringing severely impaired hearing back to an approach to normal.

For the maximum correction of hearing impairment, we have to know exactly where the deficiency lies. For testing this, the Bell Telephone Laboratories have developed devices, among which is the audiometer, with which individual deafness can be measured, not only to determine the overall degree of impairment but also the impairment at different frequencies. Measurement at different frequencies is essential, because almost always impairment is greater at certain frequencies than at others. As a matter of actual fact, many subjects who have been tested show practically normal hearing at certain sound frequencies with decided deficiencies at others.

**The Audiometer Diagnosis**

The audiometer consists of a sound generator capable of producing several different frequencies, usually 64, 128, 256 and so on up to 4096 cycles per second. A calibrated volume control or attenuator is also included to vary the intensity of the sound by definite degrees. The output of this device is fed into a headphone which is placed at the ear of the subject under test as shown in an accompanying illustration. The audiometer is set to produce each of the different frequencies, one after the other, and at each frequency the vol-

**New Field for Radio Profits**

RADIO servicemen, custom set-builders and public address system specialists might consider the potential market for amplifier equipment for use by the hard-of-hearing; not only the easily portable, individual equipment, but the more elaborate equipment for home or office, employing built-in microphones, vacuum-tube amplifiers and wiring systems enabling the user to plug-in at a number of conveniently located outlets. Then, too, group equipment for churches, theatres and other assembly places offer possibilities for good profits.

To aid its readers in developing these almost virgin fields, RADIO NEWS will present constructional and other data from time to time. Just now, for instance, the laboratory is finishing the development work on a compact portable unit which constitutes a powerful hearing aid, which can be stepped up from a whisper to a point which will correct the hearing loss of even advanced cases of deafness and enable persons so afflicted to take part once more in conversation, business conferences and find new enjoyment in the theatre or church. Effort is being made to publish this in the form of a constructional article in the December issue.

—The Editors.

ume control is varied until the sound is just barely audible to the subject. The position of the volume control on its calibrated scale is then read, directly giving the degree of sensitivity for each individual frequency. These readings are noted on charts provided for this purpose. The result is a so-called "audiogram" giving a complete picture of the subject's hearing as shown in Figure 1. Both ears of the subject are, of course, tested in this manner because cases are rare indeed where both ears of a deafened person respond alike.

The normal human ear is much more sensitive to certain sound frequencies than to others and therefore even a small impairment at certain frequencies may represent almost total deafness for these particular frequencies. This is indicated in Figure 1 by the dotted line, which indicates total loss of serviceable hearing. It will be noted here that a loss of 10 sensation units at 24 cycles per second represents a total loss, whereas at 1024 cycles a loss of 10 units would be slight.

From the audiometer measurements we learn one important thing. Straight-line amplification in hearing aids will not give the desired results. If the hearing device is equally sensitive for all frequencies, those at which the subject's hearing approaches normal will be amplified to the same extent as frequencies where he requires greater amplification. The result will be a sense of loudness which constitutes a decided strain not only on the defective organ but on the brain and nerves as well.

**The Ideal Aid**

For bringing a person whose hearing is defective only in the lowest notes and in the highest ones back to nearly normal hearing sensitivity, we should use a hearing

aid which increases the lower and higher notes more than the medium ones to which the patient is sensitive. In the use of hearing devices there are several ways of attaining the desired effect. The simplest one is to place the sound receiver (the microphone or transmitter) in a resonating container—for instance, a wooden box—the natural frequency of which is within the range of the low frequencies the patient is lacking. In addition to this, directly over the transmitter

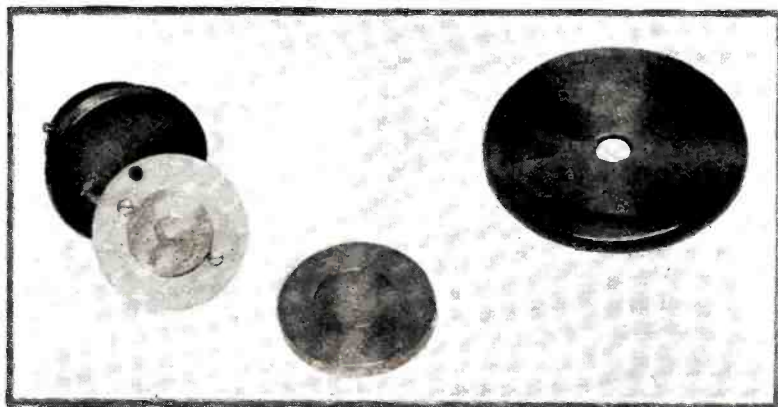
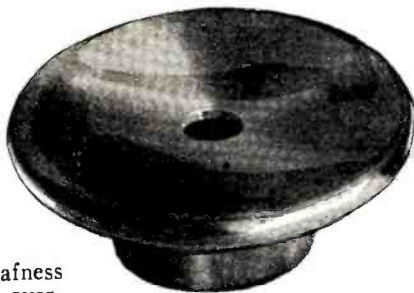

THE HEADPHONE OF ONE HEARING DEVICE

Figure 4. Above is shown the headphone used in one electric hearing aid. Below is a disassembled view which gives some idea of the careful design and workmanship going into these units

diaphragm can be provided a smaller air space which resonates at a higher frequency, thus giving extra amplification of the highest and lowest notes.

An even better way is to employ proper electrical filter arrangements. Having an audiogram, it is possible to design electric filters which will cause the hearing device to exactly supply the deficiencies in any individual's hearing. Equipment of this nature is rather bulky and expensive and, so far as is known, has not as yet been placed on the market. In addition to the filter system, it usually requires the use of one or more vacuum tubes, with their attendant equipment, in order to provide the desired degree of amplification.

The deafened person, naturally enough, wishes to have a small instrument that he can conveniently carry around and use unobtrusively. Although, as far as the appearance is concerned, the American public is learning more and more that earphones for the deaf are nothing to be ashamed of, that defective hearing is much more common than is usually known and that from the increasing numbers coming into use, year after year, it may be predicted with certainty that the hearing device is going to become more common as time goes on.

On the other hand, a unit is desired which will make the hearing as nearly normal as possible. This means that a relatively high degree of amplification is required in order to make weak sounds clearly audible. Obviously, where the hearing is decidedly impaired, it is unreasonable to expect tremendous amplification and at the same time keep the instrument down to pocket size. The size and convenience of the device must therefore vary with the degree of hearing impairment. In the majority of cases the pocket-type earphone, with the high degree of development that has been attained in its design, will serve adequately. In cases where the hearing loss is in the neighborhood of 50% or more, this type of device will not be satisfactory. A



**A MODERN HEARING AID**

*Electric hearing aids are lending new interest in life to the hard-of-hearing who now find themselves able to take the places in business and social life which, without these modern devices, would be denied them*

number of manufacturers have, therefore, produced models in which they include two or three microphones, thus providing added sensitivity. Another method, for which manufacturers have not as yet gone as extensively, is the use of a single microphone feeding into a one or two-stage vacuum-tube amplifier. This latter represents probably the highest type of hearing device that can be made. It has the drawback that, in size, it approximates an ordinary box camera, and the weight is considerably increased by the necessity for plate and filament batteries. In spite of these drawbacks, it is easily portable and is just as easy to use as the smaller types.

*(This is the type of device now being developed in the RADIO NEWS Laboratory, to be described in the next issue or the one following, for the benefit of those who may desire to construct their own.—THE EDITORS.)*



**Electrical Hearing Aid Design**

Portable hearing devices, both those employing vacuum tubes and those of the pocket type that consist only of a microphone, headphone and battery (as shown in Figure 2), require extremely careful design of both microphone and headphone. Vast strides in this direction have been made by engineers during the past few years. The modern microphones consist usually of a carbon membrane or diaphragm under which carbon particles are placed in a carbon block. All of these carbon parts are highly compressed and polished so as to reduce friction to a minimum. These, of course, function on the principle of the ordinary carbon microphone in which the electrical resistance varies with variations of the pressure resulting from the action of sound waves on the diaphragm. This variation in resistance varies the battery current and thus results in the reproduction of sounds in the headphone. Practically all of the factors in both microphone and headphone affect the frequency characteristics of the combination and in no case is a straight-line characteristic obtained nor would such a characteristic be desirable, for reasons already mentioned. The size and shape of the carbon particles, the resonating air spaces within the microphone, the thickness and tension of the diaphragm and the size and shape of the enclosure within which the microphone is placed, all have their effect on the characteristics of reproduction.

In some of the microphones employed in hearing devices other features are incorporated. There is one type, for instance, in which the electrical current passes from one of the terminals, through the carbon balls to the diaphragm, through a portion of the diaphragm and back through another group of carbon balls into another cup which forms the other terminal of the microphone. But in general, the design of sensitive microphones follows that (Continued on page 437)

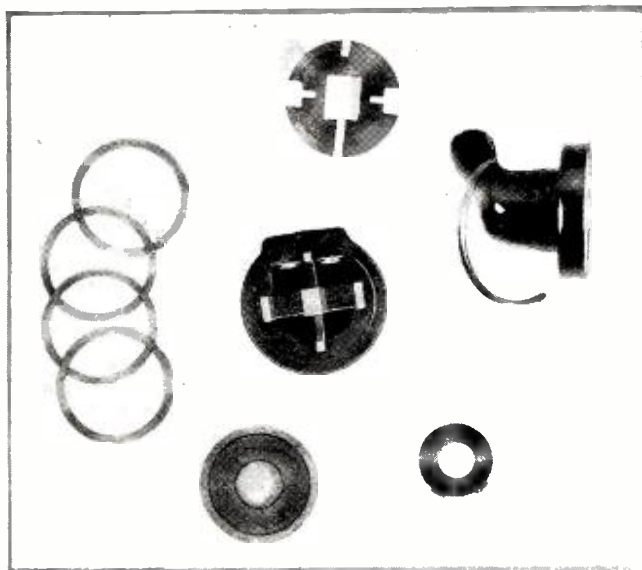

**A MIDGET TYPE HEADPHONE**

Figure 5. The unit shown above measures less than an inch in diameter and is inserted in the ear, carrying the sound directly to the ear canal. To make it highly efficient, in spite of its small size, offered great complications. Lower photo shows parts before assembly. In the center is the shell with its unique arrangement of four U-shaped magnets. At the lower right is the coil winding which slips over the central legs of the magnets. In the center, above, is a plate which concentrates the magnetic flux. At the left are the spacing rings and, below, the diaphragm, which is further illustrated in Figure 3

# A 24 Pound Laboratory

*As radio progresses the diagnosis of trouble in receivers becomes more and more complicated. The portable set analyzer has therefore become indispensable to the service man. The author gives some idea of the amazing variety of tests possible with a modern analyzer*

By Harry Georges

**T**HE serviceman who attempts to remedy faults in a radio receiver by haphazard methods immediately places himself in a disadvantageous position. Set owners have been educated to expect the radio trouble shooter to follow a systematic, definite procedure. They look with suspicion on the serviceman who answers a trouble call without adequate testing equipment. Moreover, they are correct in questioning the competence of the man who, in all cases, insists that the set must be taken back to the shop in order to locate and remedy trouble.

It is obvious that the radio serviceman should provide himself with complete portable testing equipment. This means a comprehensive set analyzer, capable of performing every required test and of locating troubles without removing the radio set from the home of the owner. A miscellaneous assortment of meters and leads does not constitute suitable test equipment.

Without question, an all-around analyzer enables the serviceman to perform more work and to complete each job more satisfactorily than would be possible in any other way. Using a set analyzer of correct design, he can deliver worthwhile results rapidly, instead of having to offer flimsy alibis and excuses.

## Using a Set Analyzer

The carefully designed, up-to-the-minute radio set analyzer is a marvel of human ingenuity, comparable in its precision to the finest watch. The analogy between the analyzer and the watch can be carried still further. Although the "works" of the watch are quite intricate, the user tells the time at a glance, without a thought of the operating mechanism. Beneath the panel of the analyzer there is a complicated system of switches and wiring connections, but here also the user does not have to worry about how the device functions. He merely follows a few simple directions, obtained with the analyzer, and he is then able to locate troubles and to make all sorts of radio tests almost as readily as he tells the time with his watch.

As an illustration of the importance of radio set analyzers, the manager of a large radio service organization recently made the statement that the comparatively inexperienced serviceman equipped with a modern analyzer was able to do better work than the technically trained man without such an instrument. While it is true that no mere instrument can ever take the place of a technical training, it is equally true that for radio trouble finding no amount of training can take the place of an up-to-date set analyzer.

Using a set analyzer, the location of trouble in a defective receiver is systematized and reduced to a simple routine. A compact instruction pamphlet tells exactly how each test is made and test data on all important radio receivers is available.

After using an analyzer once or twice, the routine is readily memorized and thereafter it is no longer necessary to depend on the instruction booklet for reference purposes.

The new Supreme AAA1 Diagnometer is a splendid example of a testing instrument of practically universal application. Although the Diagnometer is only 6 $\frac{3}{8}$  by 11 $\frac{1}{4}$  by 18 $\frac{3}{8}$  inches and weighs less than twenty-four pounds, it is an amazingly complete portable laboratory, capable of testing the newest as well as the oldest types of radio receivers. In fact, it is designed to meet radio service requirements on all radio sets, whether operated from direct current, alternating current, socket power devices or batteries. Careful design, following upon extensive research, has made it possible to incorporate

within a single analyzer all the essentials of set and tube testing which hitherto required a multiplicity of servicing instruments.

This test device combines the functions of five distinct service instruments, namely: analyzer, tube tester, shielded oscillator, ohmmeter-megohmmeter, and capacity tester. Just how is it possible for a single portable unit to accomplish so many different tests? A description of the apparatus incorporated within the Diagnometer will serve to explain this. Since meters constitute the "heart" of an analyzer, this equipment will be described first.

## The Meters

Two panel type meters are used—one a universal a.c.-d.c. meter of the precision copper-oxide rectifier type with a tandem scale selector switch. The other meter is a d.c. milliammeter, which is always connected in the plate circuit. This latter arrangement provides plate current readings of circuits and tubes under analysis, without the manipulation of any current switches while testing the various potentials of other circuits terminating at the tube sockets.

The universal a.c.-d.c. meter, known as a multi-meter, is probably the most unique as well as useful feature of the Diagnometer. It possesses voltage ranges of 2.5, 10, 25, 100, 250 and 1000 volts and is available in all circuits through the analyzer plug. Both a.c. and d.c. voltages are measured at 1000 ohms per volt sensitivity.

Direct-current ranges of 0 to 40 and 0 to 200 volts are available at 2500 ohms per volt. for external use. These are especially desirable in connection with the servicing of automobile and aeroplane radio receivers. An a.c. and d.c. voltage range of 0 to 2500 volts is available externally for servicing public address systems, talking motion picture amplifiers and amateur transmitter installations.

The following a.c. and d.c. milliamperage ranges are available



THE NEW SET ANALYZER

*The hardwood carrying case is provided with a slip-hinge cover and convenient carrying handle. Adequate compartments are provided for accessories and small tools*



for analytical or external use: 0 to 2.5, 0 to 10, 0 to 25, 0 to 100, and 0 to 250 milliamperes. In addition, this universal meter has an external a.c. and d.c. current range of 0 to 2.5 amperes.

All a.c. and d.c. voltage and current ranges of the multi-meter are controlled by a single tandem "scale selector" switch, located near the center of the instrument panel. The two major current and potential measuring ranges of 25 and 100 are decimally associated with the scale selector. With this arrangement, all indications are either directly read or are multiplied or divided by 10, thereby greatly simplifying the practical use of the meter.

The above description of the wide diversity of uses and ranges of the universal multi-meter, while fairly complete, does not give a really adequate conception of the servicing possibilities of this instrument. Even a superficial study of the almost infinite applications of this meter makes it obvious that there is small likelihood of any developments in the radio industry which will ever call for any important change in the Diagonometer.

**Push-Button Safeguards Meter**

The multi-meter is not in any analytical or tube checker circuit until a push-button is pressed for the desired reading. As a result, maximum protection is given to the meter at all times. Actual tests have shown that this instrument will stand a 3000 per cent. overload. All a.c. and d.c. voltage ranges, in addition to being obtainable through the analyzing plug, are also available for external use, through bakelite-protected pin jacks. A special feature of the multi-meter is the fact that the meter glass may be replaced without removing the meter. Incidentally, provision is made for the use of the multi-meter as an output meter, for "synchronizing," "peaking," etc.

The second meter, as mentioned above, is a d.c. milliammeter. This has two ranges for plate current analytical readings and tube testing—0 to 8 ma. and 0 to 80 ma. Dangerous current surges, which often accompany the breaking of high-voltage circuits, are entirely eliminated by keeping the d.c. milliammeter always connected in the plate circuit under analysis.

In the Diagonometer the analyzer circuits are designed to meet all radio service needs on all types of receivers and tubes, including the new power pentode, variable-mu. automobile radio and two-volt tubes. Provisions are also made for adequate tests of the older type battery-operated radio sets and also of power supplies using Raytheon rectifier tubes. This instrument may also be used for analytical a.c. voltage (1000 ohms per volt) test up to 1000 volts on each side of center-tapped plate supply transformers, through the rectifier tube socket. A.C. line voltage may be read through the line supply cable by merely pressing a push-button. External connections are unnecessary for this purpose. All of the circuit analyses of the circuit under test may be made during the actual operation of the radio receiver, using the regular power normally supplied, without disturbing any permanent connection of the set under test.

The analyzer plug is of noteworthy design, being equipped with a special snap-catch arrangement for engaging the adapter. This prevents the adapter from becoming sepa-

rated from the plug when used in tube sockets having tight-fitting contacts. The analyzer plug has a UY base, as the majority of sockets in the new type radio receivers are of the five-prong type. A four-prong adapted is provided for analyses of rectifier and power tube circuits and for sets of the older type having UX sockets. The control grid lug is fastened to the analyzer plug by a flexible lead, which enables the operator to complete the control grid connections of screen-grid tubes, regardless of the type of radio set under test. For the r.f. pentode tubes, a circuit is provided which terminates with the necessary terminal of the analyzer plug, so that this terminal may be connected to a suitable adapter for these tubes.

Among the numerous analytical tests which can be made merely by inserting the analyzer plug in the radio set socket and with the tube in the analyzer load socket are: d.c. or a.c. filament voltage, plate voltage, "C" bias voltage, screen-grid voltage, screen-grid current, cathode voltage, control-grid voltage, plate current and also grid current (other than screen-grid tubes).

Among the numerous analytical tests which can be made merely by inserting the analyzer plug in the radio set socket and with the tube in the analyzer load socket are: d.c. or a.c. filament voltage, plate voltage, "C" bias voltage, screen-grid voltage, screen-grid current, cathode voltage, control-grid voltage, plate current and also grid current (other than screen-grid tubes).

**Tube Test Provisions**

In addition to the sockets provided for analyzing purposes, there are five tube testing sockets, with the necessary switches for connecting the proper potentials to these sockets for tube tests. Alternating current power-supply potentials ranging from 100 to 240 volts may be employed for these tests, a suitable selector switch being included for selecting the power potential. As a result of this convenient arrangement, elaborate tube testing tables are not required. Test readings of the various type of tubes are furnished with the instrument. All potentials employed in the tube tester circuits are also available at external connections for any such tests, as desired. A "filament-heater" selector switch is provided for all tubes having filament ratings of from 1½ to 7½ volts.

The grid potentials of the tube checker circuits are provided by the voltage drop across a biasing (Continued on page 442)

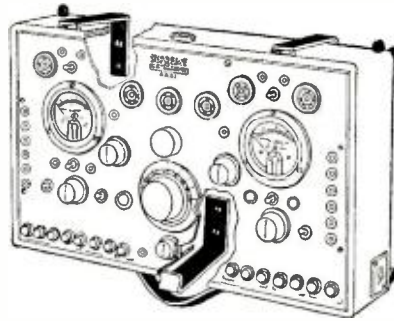

**BRACKETS FOR WALL MOUNTING**

*By means of three iron brackets the instrument can be readily installed as a permanent test panel, either on the wall or on the test bench*

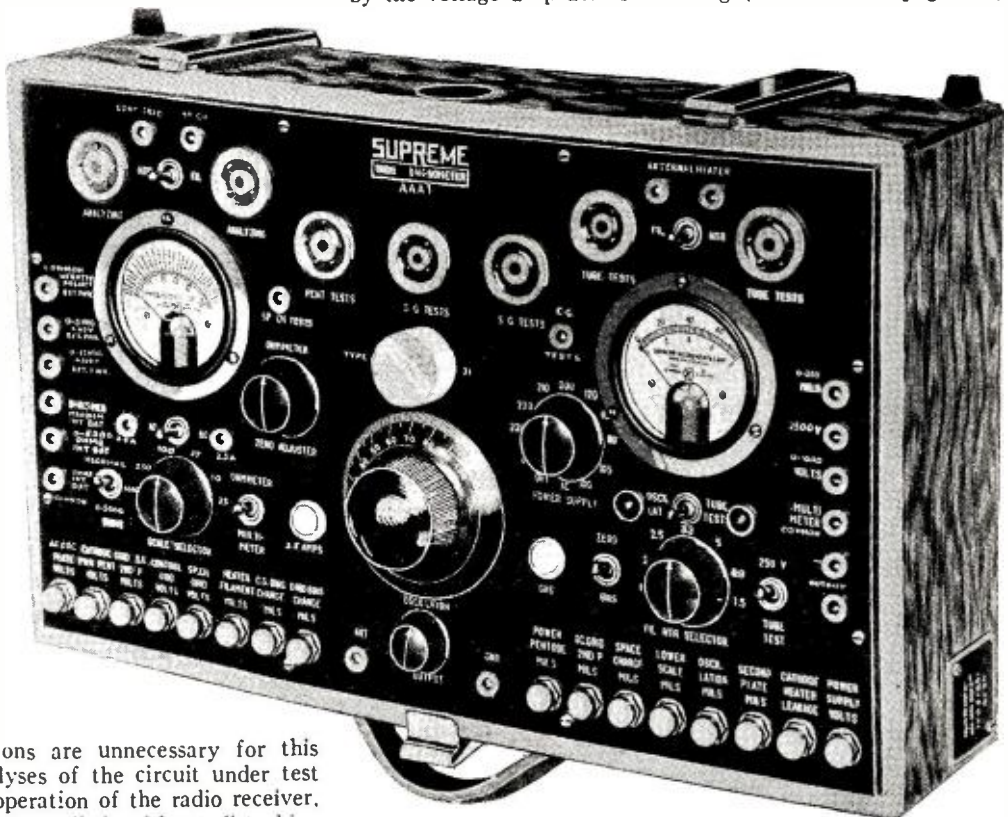

**CLOSE-UPS OF TEST PANEL**

*All controls are clearly marked by permanent engraving on the bakelite panel. The panel measures 17½ inches by 10½ inches*

# The DECIBEL

## *Its Definition, Derivation and Application*

*The decibel is becoming an indispensable unit in the radio field. Yet too few, even among those who use the term, know exactly what it is all about.*

*To these this explanation will be helpful*

By John M. Borst

AS radio progresses, one finds that increasing use is made of the "decibel" in technical literature. An understanding of its meaning and facility in its use are essential to engineers, broadcast station employees, experimenters and servicemen.

There seems to be some difficulty encountered by the average man when studying the subject. Yet it is really simple. The "decibel," which is the same thing as the old "transmission unit," is a unit for measuring the efficiency of telephone or associated electric circuits.

We all know that efficiency is usually measured in percentages. A steam engine with an efficiency of 15% delivers at the crankshaft 15% of the heat energy supplied to it by the fire under the boiler. The ratio of output power to input power is then .15.

Telephone engineers in past decades used as a unit the efficiency of one mile of standard cable with certain standard resistance and capacity assumed. The cable, however, had a different impedance (and therefore a different efficiency) at different frequencies, so that another measurement scale had to be devised, and this was at that time called the "transmission unit." Later, by international agreement, this name was changed to "decibel," meaning one-tenth of a "bel." The "bel" was so called in honor of Alexander Graham Bell, the inventor of the telephone.

Since the definition of the decibel involves some mathematics and logarithms, many readers seem to think that it must necessarily be very unreal and abstract.

The decibel is a natural unit, based approximately on the way our ears react to differences in sound power. When we desire to express the efficiency of a piece of telephone apparatus in per cent. we give the ratio between the output and the input power in watts, ergs or other units. But our ears do not react to sound in the proportion that a wattmeter does; they react to sound proportionally to the logarithm of the power in watts.

The response of our ears is approximately as follows: Let us suppose that a certain amplifier has an output of 1000 milliwatts. Now we insert a network between the output terminals and the loudspeaker and suppose this network has just the right impedance to reduce the volume by so small an amount that the ear can just notice the difference. When we now measure the power at the output terminals of the network it is found to be 794 milliwatts. The efficiency of this network is, then,  $794/1000 = .794$  or 79.4%.

To the ear it is, however, but "one step down," for, as we said, this is the least difference we can notice.

We now insert, between the output of this network and the

loudspeaker, another network of the same impedance. It goes without saying that the power is again going to be reduced, this time to 79.4% of 794 milliwatts, or to  $.794^2$  of the original power. To the ear, however, this is only "two steps down."

We see, then, that every time the power is decreased a certain ratio the sound level, as our ears hear it, is diminished one unit. When we then try to express this by a mathematical equation, the unit is defined by the exponential relation

$$r^n = \frac{P_o}{P_i}$$

where  $r$  = the ratio corresponding to the least difference in volume our ears can detect

$n$  = the number of our new units

$P_o$  = the output power

$P_i$  = the input power

Taking the logarithm of both sides of the equation and solving for  $n$ :

$$n \log r = \log \frac{P_o}{P_i}$$

if we can use a base of logarithms equal to  $r$ , then  $\log r = 1$  and the formula becomes:

$$n = \log_r \frac{P_o}{P_i}$$

the effect of using another base than  $r$  will result in a unit different in size from the minimum difference the ear can detect.

There are two bases for logarithms in common use: The number  $e = 2.71828$ , giving rise to the Napierian (natural logarithms) and the base 10 giving the Briggs (common) logarithms.

When the Napierian logarithms are used we get a unit called the "neper." Using the common logarithms gives  $n$  in "bels" and the decibel (db.) is therefore one-tenth of a bel, so that

$$n = 10 \log_{10} \frac{P_o}{P_i} \text{ decibels}$$

The decibel, it will be seen, corresponds approximately to the least difference the ear can detect. Very often the difference in ratio of output to input is known in terms of a voltage ratio or a current ratio. Since the power is proportional to the square of the current or the voltage—if the impedance remains the same—we have to multiply the logarithm of the voltage or current ratios by twenty instead of by ten, in order to obtain the efficiency in decibels.

DECIBELS	10	20	30	40	50	60	70	80	90	100
POWER RATIO	10	100	10 <sup>3</sup>	10 <sup>4</sup>	10 <sup>5</sup>	10 <sup>6</sup>	10 <sup>7</sup>	10 <sup>8</sup>	10 <sup>9</sup>	10 <sup>10</sup>
CURRENT-VOLTAGE RATIO	5	10	100	1000	10,000	100,000				

A DECIBEL CHART FOR READY REFERENCE

Figure 1. The chart shows relationship between gain in decibels, power ratio and current-voltage ratio. The power-ratio scale may be used both for electrical and sound power. The air-pressure (millibar) ratio may be read on the current-voltage ratio scale

Therefore

$$n = 20 \log_{10} \frac{E_o}{E_i} \text{ decibels}$$

and

$$n = 20 \log_{10} \frac{I_o}{I_i} \text{ decibels}$$

Examples:

1. What is the efficiency, in decibels, of a circuit which gives an output of 398 milliwatts with a 1000-milliwatts input?

Answer: The ratio of output to input power is 398/1000. Taking the logarithm of this ratio, we have  $\log 398/1000 = \log 398 - \log 1000 = 2.5999 - 3 = -0.4001$ . Therefore the efficiency in db. is ten times  $-0.4001$  or  $-4$  db. This is called a 4 db. "loss" or 4 db. "down."

2. An amplifier has a gain of 23 db. If the input is 15 milliwatts, how much is the output?

Answer: The logarithm of the power ratio is 1/10 of 23 or 2.3. Looking in the logarithm table, we find that .3 is the mantissa of the logarithm of 2. The characteristic of the logarithm shows us that the antilogarithm is between 100 and 1000. Therefore the power ratio is 200. Thus the output is found to be  $200 \times 15 = 3000$  milliwatts.

3. In a telephone circuit the power is reduced by 34 db. What is the input if the output is 4 milliwatts?

Answer: The logarithm of the power ratio is 1/10 of  $-34$  or  $-3.4$ . To look this up in the logarithm table we have to make a slight transformation. The mantissa given in the logarithm table is positive; only the characteristics may be negative. Therefore we write  $-3.4 = .6 - 4$  and .6 is the positive mantissa which we may find in the logarithm table. The antilogarithm of .6 is 4. Therefore the power ratio is .0004, according to the rules of logarithm.

There is another way of arriving at the same figure. Let us suppose that it was plus 34 db.; then the log of the power ratio would be 3.4 and the ratio is found to be 2500. Then if we reverse this, we find the ratio corresponding to  $-34$  db. is  $1/2500 = .0004$ . The two methods should not be confused.

4. The voltage gain of an amplifier is 100. What is the gain in db?

Answer: The gain in db. is  $20 \times \log 100 = 20 \times 2 = 40$  db.

Since we have mentioned the existence of another unit, the "neper," the reader may be curious to know just what it is and how many decibels there are in a "neper" and why.

The number of nepers gain or loss equals the natural logarithm of the ratio output-voltage/input-voltage or output-current/input-current. It should be understood that the impedance in the circuits must be the same when making the before-and-after measurements. Then

$$n \text{ (nepers)} = \log_e \frac{E_o}{E_i}$$

or

$$n = \log_e \frac{I_o}{I_i}$$

To find the relation between nepers and decibels we write this same equation in the exponential form:

$$\frac{E_o}{E_i} = e^n$$

which follows from the definition of the logarithm, where n is in nepers.

Also for the same reason

$$\frac{E_o}{E_i} = 10^{\frac{N}{20}}$$

where N is in decibels.

$$\text{Therefore } e^n = 10^{\frac{N}{20}}$$

Taking common logarithms of both sides, we have

$$n \log_{10} e = \frac{N}{20}$$

or  $N = (20 \log_{10} e)n = 20 \times .434n = 8.68n$ . The number of decibels is therefore 8.68 times the number of nepers and one neper equals 8.68 decibels.

The decibel, it should be understood, does not indicate any absolute power-level; it only indicates the ratio between the input and the output. In the case of a volume indicator, as used in broadcast stations, it has become customary to fix a certain reference level and then, if we speak of so many db. above or below this level, the power can be defined in watts. For this reference level is usually chosen the value .006 watt, or 6 milliwatts. There are also other "zero levels" in use, but as a rule we

can assume that the reference level is 6 milliwatts.

In general, in the broadcast field, if an engineer speaks of a generator, like a microphone or a magnetic pick-up, being so many db. down or up, we may assume that the power output of these devices are so many db. below or above 6 milliwatts.

So far we have only spoken of the db. as giving ratios of electrical power, but it applies equally to the power of the sound waves in the air. They may be measured in watts or ergs. Then, if a sound-power level is increased from 10 ergs to 10,000 ergs, the increase is said to be 30 decibels. A decrease to 1 erg corresponds to 10 db. down.

It has been customary, however, to measure sound power in terms of the sound-pressure, in millibars. This is analogous to the voltage in electrical circuits. Consequently, if the ratio between sound powers is expressed in millibars, we must multiply the logarithm by 20 in order to get decibels, just as we did with the current or voltage ratio. This means that an increase of sound pressure of 100 times (Continued on page 443)

N	Log	Log	Antilog
1	0	0	1
2	0.301	0.1	1.26
3	0.477	0.2	1.585
4	0.602 (TWICE Log 2)	0.3	2.0 (NEARLY)
5	0.699 (Log 10 - Log 2)	0.4	2.51
6	0.778 (Log 2 - Log 3)	0.5	3.16
7	0.845	0.6	3.98
8	0.903 (THRICE Log 2)	0.7	5.0 (NEARLY)
9	0.954 (TWICE Log 3)	0.8	6.31
10	1.000	0.9	7.94
		1.0	10.0

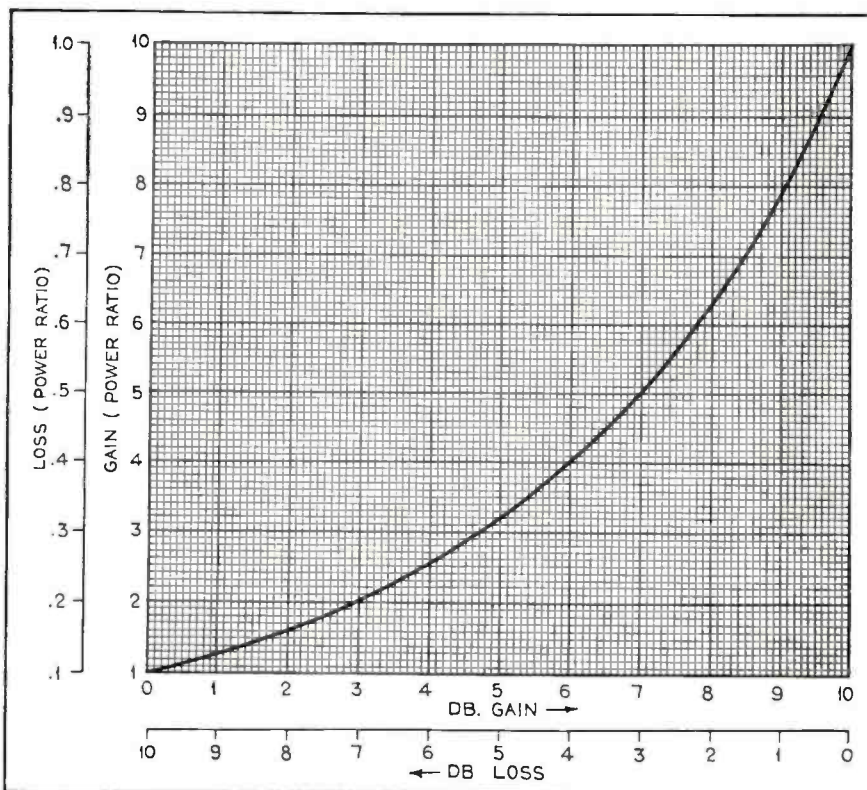

CONVERSION CURVE FOR DB. GAIN OR LOSS

Figure 2. A curve showing db. gain for power-ratios from one to ten and db. loss for power ratios from one to one-tenth. The scales marked "loss" are used together, as are the two scales marked "gain"

# Television Goes to Sea

*Another step was taken in television development when equipment was installed on the S. S. Leviathan to permit pick-up of American television programs at sea. The results of the test are presented here, together with a description of the installation*

**I**T was a real thrill to participate in the first television cruise ever made by a steamship. As a passenger on the *Leviathan*, in the company of 1500 vacationists, I became the first woman—so they tell me—to see a television image at sea during the course of experiments involving the initial shore-to-ship visual broadcasts. Ever since that trip my mind has been figuring the possibilities of television; first, in the reception of scenes on both sides of the Atlantic while a vessel is in mid-ocean; second, in the service that television will render to humanity, in bringing people closer together and hastening the era of real understanding and promoting the cause of education and universal peace in a manner that sociologists and statesmen never dreamed of—and such demonstrations of television's usefulness will come quickly as the art reaches a more practical stage. Judging by what I saw away out on the ocean, television is definitely on its way toward the period when it will be in every-day use.

Special programs had been arranged for reception on the *Leviathan*—the first night by the Columbia Broadcasting System and the second evening through Stations W1XAV and W1XAU in Boston. The former proved to be a mass of black blotches on the screen, because of the terrific electrical disturbances in the atmosphere. Lightning flashes were warnings that weak television signals would be obliterated, and so for several hours engineers just threw up their hands. But when static died down, faces began to appear and the crowd on the *Leviathan* forgot the "talkies" to rush over into the corner of the night club and watch the magic reproductions on the instruments that had been set up by the Shortwave and Television Corporation. All of them knew that static interfered with radio, but probably not one of the throng had ever before perceived what static would do to distort or entirely eliminate vision presentations—and when a singer was shown in clarity there was a hearty burst of applause that must have cheered the spirits of Marshall P. Wilder and J. Everett Nestell, who had labored so industriously in installing the apparatus and testing out all sorts of antennas.

But the real excitement came on the following night—a stirring event, indeed, which will be remembered whenever the story of television development is told by future historians.

Mayor James M. Curley of Boston had returned from Europe on the previous trip of the *Leviathan*. While in Paris he spoke from the Eiffel Tower and was heard in the United States, thanks to short-wave relays. That stunt made him more interested in radio than be-

\*Shortwave and Television Corp.



By Violet Hodgson\*

fore, so when the invitation came for the most prominent rôle in connection with the *Leviathan* television program he accepted with promptness and enthusiasm. It was particularly fitting that Mr. Curley's countenance should be radiated across space, because he has been a well-known figure in American public life for years and many of those on board were friends of long standing—important in that if his image did appear there would be quick recognition.

I vividly recall the excitement about 9:30 o'clock (just 9:00 in Boston, the ship being 350 miles northeast). Mr. Wilder had been making tests in the wireless room, where another short-wave receiver and a television unit had been placed in position. He confessed that static was discouragingly strong—that really the disturbances had surrounded the cheek of Natalie Tower, the CBS television girl, with a most disfiguring array of whiskers—just as static had put a big mustache on Mayor Walker (I know he would have enjoyed seeing himself in the guise of a peanut vendor) on his appearance before the photo-electric cells. It's a habit static has, providing hirsute adornments.

Then Mr. Wilder shouted out that, static or no static, the much-sought-for station had been tuned in. "We've got Boston!" he exclaimed—and sure enough the evidence came out of the loudspeaker. The apparatus in the salon was switched on and everybody fought for a place before the lens. The announcer, a girl, and then—Curley!—all loomed up in rapid succession, the Mayor doing a little dance the like of which only television experimenters know about, then with proper adjustment and a recession of the interference level, in he bobbed again, beaming. "That's Curley," yelled a half dozen voices—and in the background could be heard his distinctive radio voice, brought to the ship via W1XAU, sound auxiliary

of W1XAV. But the atmospheric crashes put an artillery effect on his adjectives, so that only part of his speech could be interpreted on the *Leviathan* loudspeaker system, which finally had to be turned off in favor of two small reproducers when the noise factor became ear-splitting. In the meantime his image was held and a few moments later a rather stern-looking figure took his place—that was George Bancroft, popular movie star of Paramount-Publix Corporation, making a début in radiovision.

But Mr. Bancroft was wiped out hurriedly as the American Telephone and Telegraph circuit on the *Leviathan* was placed into operation, by previous understanding. This was in



THE RADIOVISOR INSTALLATION ON THE LEVIATHAN

The radiovisor was set up in the night club aboard this "floating city." To the right of the radiovisor is Marshall P. Wilder, engineer in charge of the tests. His assistant, J. Everett Nestell, is at the left

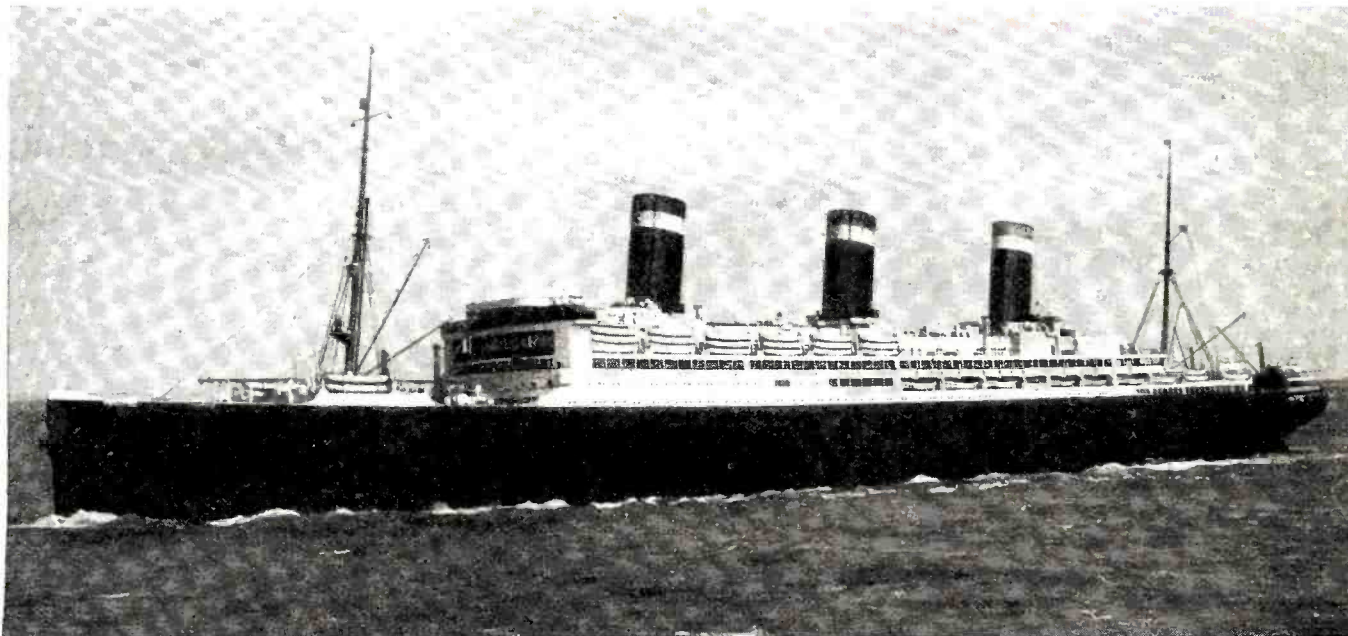

**THE LEVIATHAN TRIES OUT TELEVISION**

*The Leviathan has had a unique history; first under the name "Vaterland," as the flagship of the German merchant marine, then as an American troop transport and later an American liner. The latest page in its history was written when, on a recent trip, it went to sea carrying television equipment, the first ship to be so equipped*

courtesy to Mayor Curley, who naturally was seeking immediate information, via this wonderful medium, as to what happened to physiognomy when hurled through the ether. Commodore Albert Randall had arranged to talk with his friend the Mayor. That would have been his second radio episode of the night, as he had taken part in a program with Robert L. ("Believe It or Not") Ripley sent from the *Leviathan* phone station at 8:00 o'clock. But fog loomed up and the Commodore rushed to the bridge. So Eric Palmer, who had suggested the television test to the United States Lines, sat in the telephone room right next to the television station and spoke with the Mayor. Leaving the booth, Mr. Palmer told the crowd that the Mayor was mighty pleased to have been seen in so amazing a manner and had expressed the hope that folks out at sea were abiding strictly by the Eighteenth Amendment (so solicitous of our welfare!). The phone cost \$7.00 a minute, but the Curley quips as related to the passengers were priceless. It was a jolly ending to a dramatic incident.

**An Experiment**

The passengers had been informed in a speech delivered by Mr. Palmer that they were not to expect entertainment—that it was a scientific test, pure and simple, limited in its chances of success through many obstacles, such as the overcoming of static and the fact that only 1000 watts power was being used by W1XAU, which, like other television stations, does not count on a regular service area of much more than one-tenth the distance that was regarded as a barrier on the experimental program. The whole affair, therefore, was treated in that light—but pictures came in, and that was the main thing. And certainly the pictures a night later were especially fine, so as to mark the true success of the stunt—images being picked up under more normal atmospheric conditions from NBC and Columbia with a most encouraging measure of fidelity.

All those who have been experimenting with television are interested in the technical side of the experiment. That will be conveyed in Mr. Wilder's own words. Let me tell you who Mr. Wilder is—a chap just 25 years of age, filled not only

with knowledge but with genuine fervor for his profession (even to foregoing dinner on the big night). He had spent many previous hours on the *Leviathan* and knew the conditions under which installations had to be made to insure the best results. Mr. Wilder is a personality—as might be expected of the son of the famous humorist, Marshall P. Wilder ("the prince of entertainers and the entertainer of princes"). The late Mr. Wilder, who died 16 years ago, certainly never dreamed that this lad would become a showman of a new era when humorists could be seen and heard by friends miles and miles away from them.

The young engineer is still studying at Massachusetts Institute of Technology. Last year he was abroad, looking into European broadcasting systems; now he is devoting most of his time to the production of television receivers that are so simple the ordinary individual can use them with nearly the same ease as marks the operation of a regular broadcast set for bringing in WJZ, WABC, or KDKA. Herewith Mr. Wilder gives the story of the *Leviathan* test from the experts' viewpoint:

"Arrived in New York Tuesday morning and, with the help of Mr. Godfrey, installed televisor and receiver with necessary rotary transformer in the rheostat room on B deck of the *Leviathan*, lying at her pier.

**The Test Antenna**

"An adequate antenna system was obtained by passing a wire under the carpet of the Night Club entrance salon, through a door entering into a switchboard room, thence via trap door through the motor compartment, and between deck into the radio marine operating room.

"Entire facilities of the *Leviathan's* radio equipment were placed at our disposal through the courtesy of Chief Operator Young. From him we were assigned an antenna strung between two stacks, approximately 150 feet above the water level. We bolted a ground clamp to an 'I' beam below in the rheostat room. Immediately the electrical noises with which we had so much trouble without an antenna disappeared almost entirely. Signals from Columbia, NBC and 3XK of Washington came in with excellent quality. (Continued on page 439)

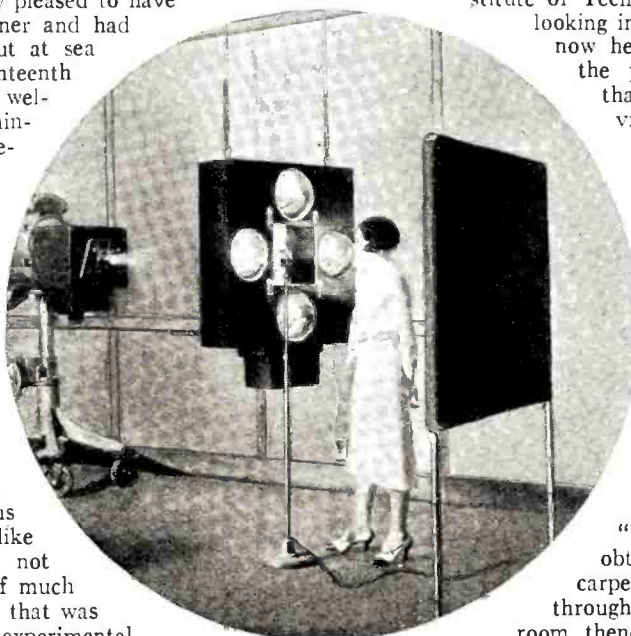

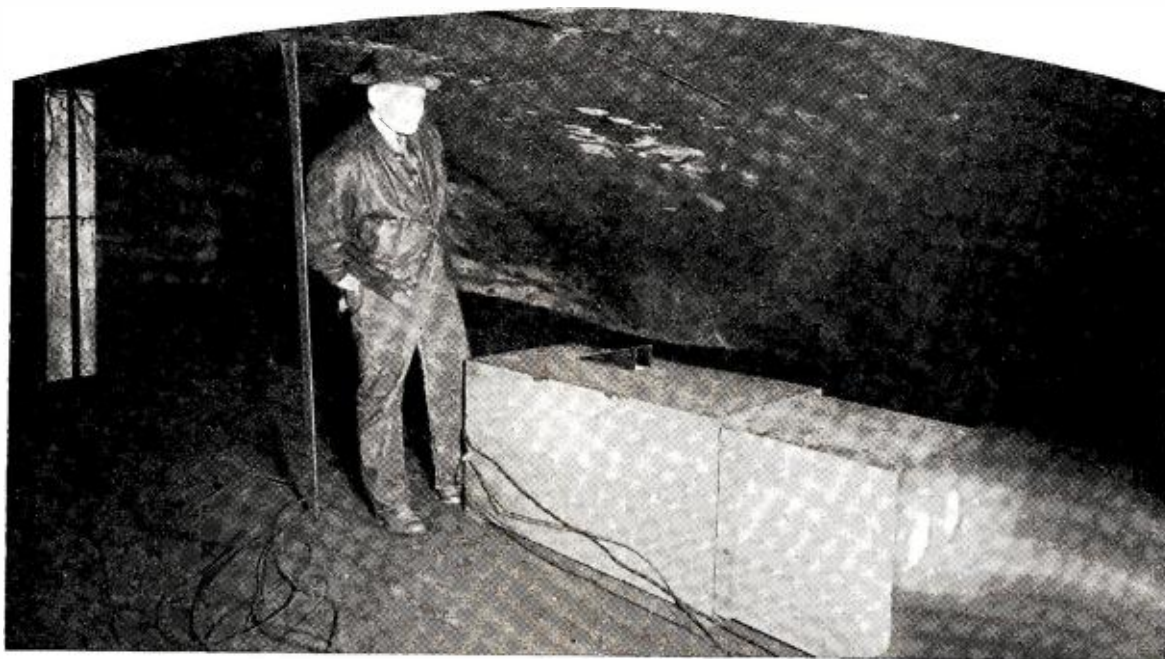

VISIBILITY TEST IN THE HOLLAND TUBE

The light-sensitive measuring equipment used in determining amount of visibility along the upper ventilating compartment of the famous vehicular tunnel incorporated photo-electric tubes and associated devices

# Using the Selenium Bridge

*This is the second article of the series on the new radiovisor bridge, a selenium cell tube of greatly improved qualifications. It includes a discussion of the tube characteristics and hints on circuit operation*

**T**HE development of the selenium bridge, which was the subject of the preceding article in the October issue of

RADIO NEWS, has stimulated a lively interest among American experimenters with light-sensitive devices. Particularly is this true of the new Burgess radiovisor bridge, otherwise known as a selenium-cell tube, as it eliminates a number of the drawbacks formerly associated with photo-conductive cells of the selenium type. It is practically permanent in response, permits minimum leakage and its speed of operation has been increased to frequencies entirely satisfactory for talking-moving-picture work.

## The Cell's Characteristics

This second article will deal with the tube's characteristics and with the associated accessories, relays, etc., that may be used with it in circuit work for employing the bridge as a relay control.

The new cells are available in two types: LB-4, a general-purpose tube for 110 volts d.c., with a resistance of 1-10 megohms. and type LB-5, also a general-purpose tube, for 110 volts a.c., 1-10 megohms. The bridges may be used on any voltage from 10 to 500 where the total power dissipation does not exceed 0.1 watt.

The curve in Figure 1 shows the light and dark currents for the bridge, between the minimum and maximum allowable plate currents, for an illumination approximately 100 foot candle. It should be noticed that the light current remains practically constant above 300 volts.

By Laurence M. Cockaday

## Part Two

The curve in Figure 2 indicates current through the bridge for various illuminations up to 50 foot candles, giving both the rising and falling illumination characteristics. As a comparison between the new bridge and earlier types of selenium cells, in Figure 3, the curve of an ordinary selenium cell is shown against the curve of the radiovisor bridge for an illumination up to 40 foot candles. This illustrates at a glance the improved efficiency of the new tube. Figure 4 shows the effect of illuminating the bridge for a period of one second and then darkening it for a like period. It will be noticed that the cell responds extremely rapidly to changes in light intensity at the upper portions of the curve. This curve is a reproduction of an oscillograph measurement and there is an instantaneous drop of approximately 50% in current from light to darkness.

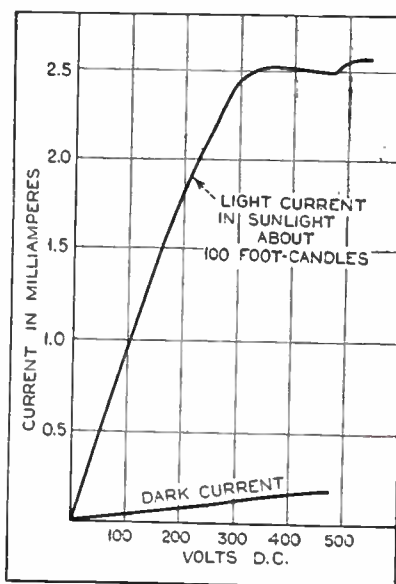

THE TUBE'S RESPONSE

Figure 1. Plotted above are the current curves for the new cell at potentials up to 500 volts

## Suitable Relay Types

When this cell is to be used directly, without amplification, with a sensitive relay, it is imperative that a polarized relay with operating currents of the order of 0.5 milliamperes or less be employed. This relay should make or break its own output on a variation of about 0.03 milliamperes, and the output contacts should be capable of carrying at least 0.2 ampere at 12 volts, for most uses. Adjustments of the field and output contacts should be easily made to allow satisfactory setting of the relay in connection with the bridge, the manufacturers recommend. A suitable moving-coil relay such as those used in electrical

meter movements, provided with contact points, may also be employed.

When the bridge is to be used with an amplifier, as shown in Figure 6, a more powerful relay may be employed in the plate circuit of the amplifier tube. This secondary relay may be of the standard telephone type, similar to the Bell Telephone relay type 221. This relay should be capable of operating on a current flow of 5 milliamperes. The applied voltages may run up to and including 100 volts. Output contacts may be desired. However, when a positive electrical contact is essential in circuits controlling as much as 4 or 5 amperes, up to voltages of 220 volts, a vacuum contact will be found advisable to be used, rather than ordinary contacts in the open air.

**Vacuum Contact Operates Quickly**

The new vacuum contact introduced into the American market by the Burgess Laboratories is an improved device which can be operated by hand, by mechanical means or by an electro-magnetic relay. The device is illustrated in Figure 7. It operates in any position and is unaffected by vibration. The principle of operation is extremely simple.

The new vacuum contact relies for its operation on the elastic property of thin layers of glass to allow movement of mechanical contacts sealed in vacua. As seen in the illustration, the device is mounted in a tubular glass envelope with the two output contacts and connecting leads at one end. The metallic contacts are kept closed by a spring. At the other end of the glass container is a flexible glass bellows attached to a glass operating arm which extends from the end. A slight movement of this stem is communicated to the contact block through the bellows, which causes the contacts to open.

As the electrical contact is made and broken inside the vacuum tube, it is free from arcing or corrosion. It can handle its rated current of six amperes at potentials as high as 220 volts and speed up to 40 interruptions per second. The break is positive and the vac-

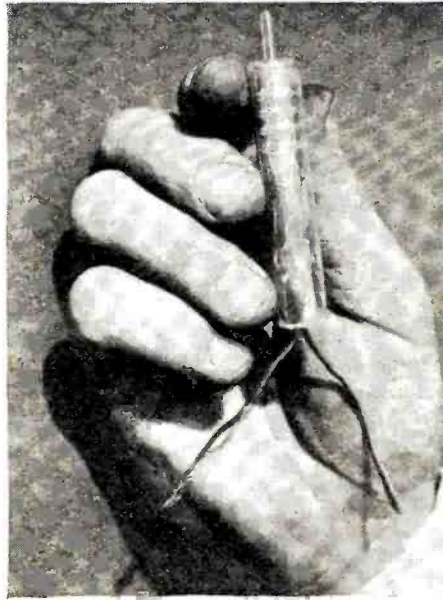

THE VACUUM CONTACT

Figure 7. The unique make-and-break device which will connect and disconnect as much as two horsepower at high speeds without arcing

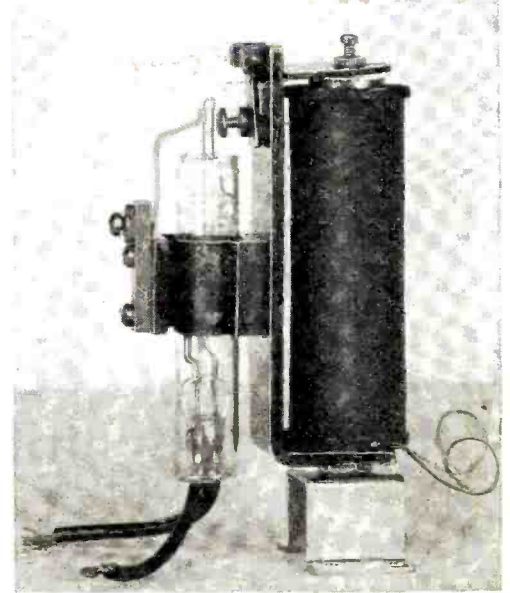

MOUNTED ON THE RELAY

Figure 8. Here is the high-speed vacuum contact attached to a telephone relay which is actuated by a vacuum-tube amplifier working out of the radiovisor bridge

uum eliminates chattering and the hang-overs usually experienced with some other forms of open-air contacts. The new contact requires a movement of only 0.02 inch at the operating stem and this is obtained by an external force of only 6 to 10 ounces. The circuit may be broken without arcing at a separation of 0.001 inch between the internal contact blocks. Under test these contacts have been used as many as 124,000,000 times without interruption or break-down. The device may be mounted as shown in Figure 8, in connection with a telephone relay equipment, with a suitable mechanical link motion installed between the armature and the operating stem of the vacuum contact.

Such a combination of relay and vacuum contact may be placed in circuits for a.c. operation with a vacuum tube amplifier, as shown in the diagram in Figure 5.

The vacuum contact may be used in a number of ways so that it can be opened by the magnetic relay, remaining closed in normal operation, or closed by the magnetic relay, remaining open normally. This effect is shown in the series of illustrations in Figure 9 and the (Continued on page 432)

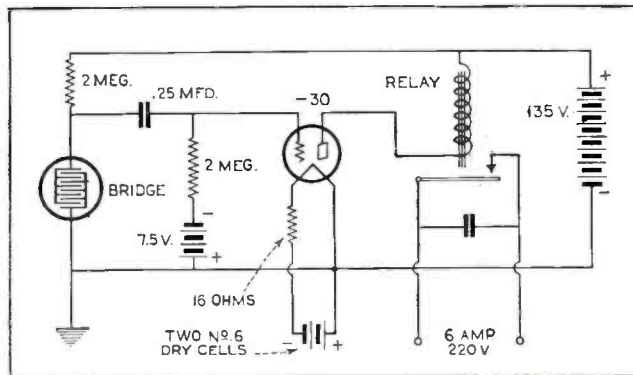

SELENIUM BRIDGE CIRCUIT

Figure 6. Showing the cell operating through an amplifier tube directly into a secondary relay

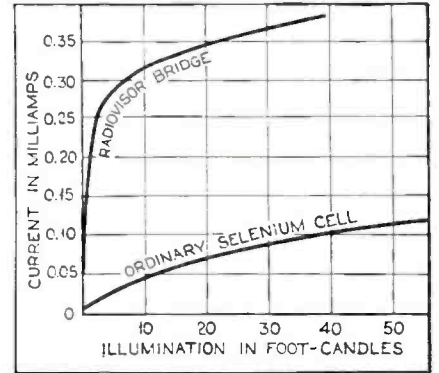
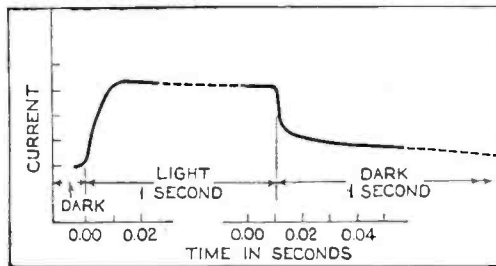
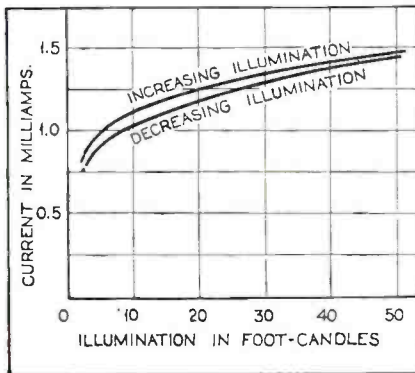

RADIOVISOR BRIDGE CHARACTERISTICS

Figure 2. Here are the current illumination curves for the new cell with both increasing and decreasing illumination. Figure 4, center: Curve showing speed characteristic with light on-and-off in one-second intervals. Figure 3, right: Comparison curves between the bridge and an ordinary selenium cell

# A Universal Receiver

*Which Operates from Either A.C. or D.C. Lines*

*Last month a general description of this new receiver was given, pointing out the unique switching arrangement which permits its use on either a.c. or d.c. line supply. This month complete constructional data are given for the benefit of readers who would like to duplicate this unusual set*

**I**N the article last month we described the circuit of the Ansley a.c.-d.c. receiving set and the features which make it possible to operate this set on either type of electric current. This receiver was designed to meet the needs of residents of those metropolitan districts where both alternating and direct current are supplied in the residential sections. These people have long felt the need for a radio set which would not be useless if they moved to apartments having a different current supply and which would not restrict them in their choice of apartments.

For those who like to build their own sets, a kit of parts is available. Many of the small parts are mounted in assemblies which are partially wired and are tested in the laboratory. This makes the actual wiring and assembling a relatively simple matter for those who can follow a schematic diagram and use a soldering iron.

The base is of heavy steel bent to shape and with all the necessary holes drilled. It is cadmium plated and polished, making an attractive as well as a rugged and substantial chassis. The r.f. coils L1, L2, L3 and L4 are carefully matched in sets and mounted in individual shields which are then mounted on a common base. The carbon resistors, R2, R4, R6, R7, R9, R10, R11, R12, are all mounted on a fibre strip with all connections between them made. The coupling condenser C15 and the .001 condenser C13 are also mounted on this strip. The first step in assembling the set is to mount all the sockets in their proper places, as shown in the photos. Tube shield bases should be installed at the same time for tubes T1, T2, T3 and T4. The bakelite back strip should now be mounted in place with the plug 10 and the speaker socket 6 mounted on it.

## Construction and Wiring Hints

It is advisable to wire up the filament circuit now before other parts are added to make it more difficult. Since the filaments are in series this circuit will be found very simple. Starting from terminal (d) on the plug 10, a wire runs to one filament lug of T1. From the other filament lug of T1 a short wire runs to one filament terminal of T2. The other filament terminal of T2 goes to one on T3, and so on. The polarity of these terminals is immaterial. When T6 is reached it will be noticed that the second terminal is grounded to the chassis as is also one terminal of T7. Grounding lugs may be inserted under the socket mounting screws for this purpose. The wire from the remaining terminal of T7 should be left long enough to reach up to the heavy resistors R17 and R18

By H. G. Cisin

Part Two

which may now be mounted on their brackets on top of the chassis. The long threaded rods pass through the resistors and draw the brackets together against them. The two lugs at each end are

soldered together, connecting the resistors in parallel. The four gang tuning condenser, C1, C2, C3 and C4, with the drum dial in the center, is now mounted at the front of the chassis. It is spaced up from the base by  $\frac{3}{8}$ -inch sleeves and is fastened by  $\frac{1}{8}$ -inch screws which pass through the sleeves and are threaded into the condenser frame. The small resistor R15 is now mounted on the bakelite back strip of the chassis. From the ungrounded filament terminals of T6 and T7 run two pairs of wires, one pair going back to the two ends of R15 and the other pair going out through the base of the dial light. The center tap of R15 is grounded to the chassis.

The long cadmium-plated can, 15, contains all the by-pass condensers. It is mounted across the front of the chassis, using flat head screws, with the open side up next to the base. The leads coming out of this block are marked so that it is an easy matter to connect them to their proper places. The voltage divider, R16, is now mounted on a threaded rod running through the bakelite back strip and the chassis as shown in photograph,

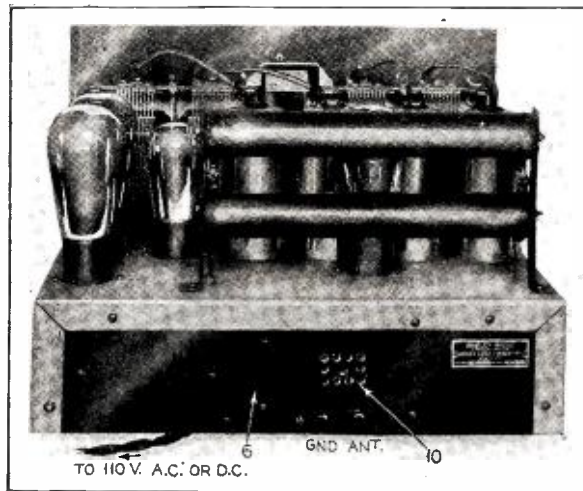

THE REAR CONNECTION PANEL

*In the center is the U. X. socket for loudspeaker connection. At right is the plug, the heart of the scheme which permits set to be used on either a.c. or d.c. supply lines by changing connections*

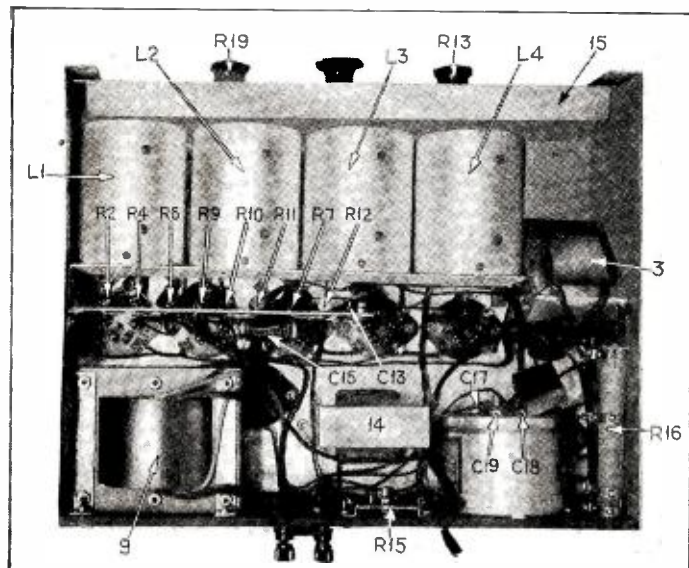

THE RECEIVER FROM BELOW

*The symbols shown here correspond with those in Figure 1 and in the list of parts which appeared in the October issue*



with a mica washer at either end of the resistor. The dry electrolytic filter condenser, C17, C18, C19, is mounted next to R16 on the back. The filter choke, 14, and the "Ant-Gnd" binding post strip are mounted on the base. Four wires, about six inches long, are soldered to the four terminals of the socket T8 and the other ends left open for the time being. The phonograph jack 8 and the power transformer 9 are now mounted on the back strip.

**Wiring the Power Unit**

Before other parts are fastened in place it is advisable to do as much of the wiring as possible. Beginning with the power transformer, 9, the leads from the primary are brought out to terminals (a) and (b) in the plug, 10. The filament and plate wires from the rectifier tube T8 are now connected and the center tap of the high voltage winding brought out to form the negative side of the filter circuit. This is not grounded but is connected to the can of the filter condenser forming one side of C17, C18 and C19, and to the end tap (d) of the voltage divider R16. The center tap of the filament winding forms the positive side of the high voltage circuit and runs to the 4 mfd. condenser C17 and to one side of the choke 14. An additional lead from here connects to terminal (f) on the plug and one from the negative side of the filter to terminal (e). The other side of the choke, 14, is brought out to C18 and to terminal (i) on the plug. Terminal (j) runs to C19 and to the end tap (a) of the voltage divider R16. The tap (c) of R16 is grounded to the chassis. The leads from C21 in the by-pass condenser block are brought out to C18 and C19. The wire from C20 in the block runs to the end (d) of the voltage divider. A lead from terminal (g) on the plug is connected to the F-prong on the speaker socket, 6. Terminal (h) is run to the F+ on the same socket.

The electric cord with the plug on it may now be inserted through the large hole in the back strip and a knot tied on the inside about three inches from the end to prevent it from pulling through. One wire from the cord runs directly to terminal (c) on the plug 10, and an additional wire from this terminal connects to the free side of the resistors R17 and R18. A pair of wires is now run up through the large hole in the front of the chassis on the left hand side. These will later be connected to the switch 13. One of them is spliced to the remaining wire from the electric cord while the other

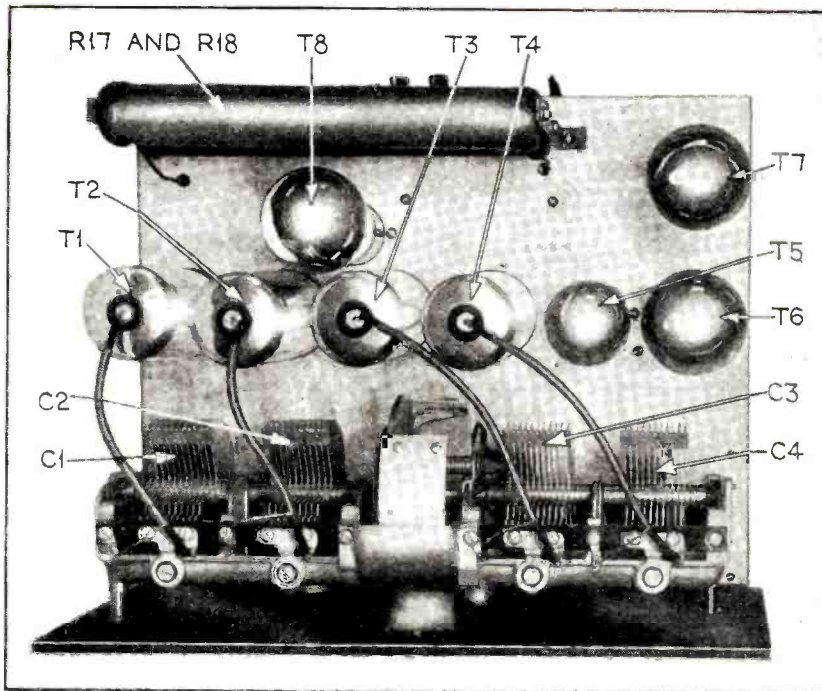

TOP VIEW OF CHASSIS  
The simplicity of the layout above deck is quite striking. Even the coils are mounted underneath, out of sight

runs to terminal (d) on the plug, which already has one end of the filament circuit connected to it. This completes the wiring of the power unit.

**The Receiver Circuits Proper**

The wires from the by-pass condenser block are brought down to their proper places on the sockets. Since one side of each of these is grounded through the common wire from each condenser, it is only necessary to consider one wire from each condenser. The cathode terminals of sockets T1, T2 and T3 are grounded through the flexible resistors R1, R3 and R5, one end of each resistor being connected to the cathode and the other to any convenient screw through the chassis. Be careful to see that the cathode end does not short-circuit on the other tube terminals. The leads from C5, C7 and C9 are also connected to these cathodes. The 1500 ohm resistor R14 is connected to the cathode of T5 in the same way. The leads from C6, C8, C10 and C12 are soldered to the screen-grid terminal clips on T1, T2, T3 and T4 respectively. C11 runs to

the center lug of the phonograph jack 8 and the lug from the outer frame of the jack is grounded through the 1000 ohm flexible resistor R8. The remaining lug on the jack goes directly to the cathode of T4.

Wires from the plate terminals of T6 and T7 are connected to the grid and plate terminals of the speaker socket 6, and a short piece of wire is connected to the grid terminals of T6 and T7. The audio transformer, 3, should now be mounted and these grid wires fastened to the two ends of the secondary winding. The center tap of this winding is connected to end (d) of the voltage divider R16. The plate (Cont'd on page 433)

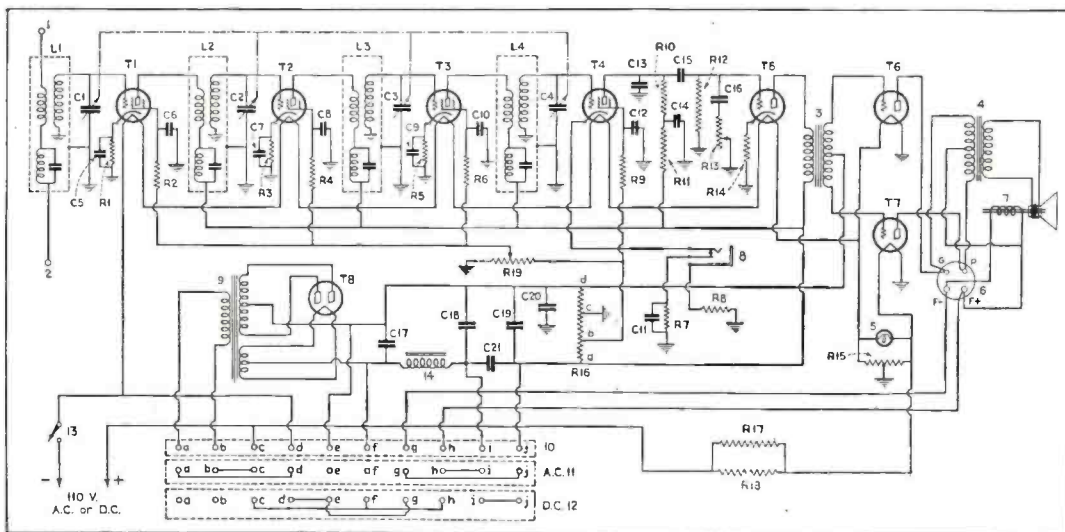

THE CIRCUIT DIAGRAM

Figure 1. Through an oversight the ground connection shown at one end of the volume-control resistor, R10, was omitted in the original circuit in the October issue. The diagram is therefore repeated here with this omission corrected. All of the remaining circuit features remain unchanged, as in the original drawing

# Mathematics in Radio

## Trigonometry and Its Application in Radio

By J. E. Smith\*

### Part Eleven

**W**E are dealing constantly with electric waves in radio circuits, particularly with waves symmetrical in shape, and it is of interest at this time to develop the sine wave. With reference to Figure 8, if the abscissa is represented by the angular degrees from 0 to 360, we are in a position to plot as ordinates the numerical values of the sines of the angles which we already know. Thus, by plotting the sines of the respective angles for 0, 30, 45, 60 and 90 degrees, we have the ordinates for the points lying in the first quadrant of the full circle.

Regarding the points lying in the second quadrant, it is shown in Figure 9 that if the sine of 60° in the first quadrant has a value equal to AB, that there will be some oblique angle, such as shown in Figure 9 (b) that will have a sine of the same value in the second quadrant. Thus, the sine of 120° will have a numerical value equal to the sine of 60°.

Again, referring to Figure 10 (a), we see that the sine of 45° in the first quadrant will have a sine of the same value in the second quadrant. Thus the sine of 135° will have a numerical value equal to the sine of 45°. In a similar manner, we are able to compute the values for the remaining ordinates of the curve, and remembering that the sines of those angles below the reference line are negative, the complete curve of Figure 8 is obtained. By drawing a smooth curve through the points as indicated, we have the *sinusoid* in which the abscissæ represent the angles, and the ordinates represent their sines.

Such a wave as the sine wave is encountered in the various circuits of a radio receiver and it will be appreciated as we progress further that the different trigonometric functions play an important part in the analyses of electric circuits. As in the cases of the other branches of mathematics, we shall find that trigonometry is essential in conclusively proving certain

engineering results in radio technique.

Let us determine the shape of the output wave in the plate circuit of an amplifier (radio or audio amplifier tube) when a sinusoidal wave is impressed upon the input of the tube. Considering the circuit of Figure 11, we know that the action of the vacuum tube is such that for a given plate voltage the plate current will vary as the grid voltage is altered. Thus, as shown in Figure 12, for negative grid volts which are high in value, the d.c. component in the plate circuit will be low, while for smaller values of negative grid volts and for positive grid volts the plate current rapidly increases to the saturation point of the tube. It is obvious that for a certain value of grid volts we shall be operating on the straight portion of the characteristic curve. This is the part of the curve we are interested in at this time.

If a varying grid voltage is applied to the input of the tube, we state that the instantaneous grid potential is equal to the sum of the d.c. grid voltage and the impressed sinusoidal voltage, as indicated in Figure 13. This may not at first be quite clear, but it can be seen from Figure 14 (a) that if two simultaneous waves be added together by adding their instantaneous values, a result will be obtained which can be expressed in one function. In this case the second wave is a straight line, representing the d.c. grid voltage, but we shall have occasion shortly to study the effects of two symmetrical waves, acting in the circuit at the same time.

Continuing the investigation of the circuit of Figure 13, we see that when the instantaneous value of the input wave is zero, the plate current has a value corresponding to its d.c. value, but as the instantaneous value of the input wave changes through its various values, corresponding changes are noted in the plate circuit of the tube. It is noted even in this diagram that the wave is also correspondingly amplified, and we can state that the instantaneous current in the plate circuit is equal to the sum of the d.c. current plus a sinusoidal current, as shown in Figure 13.

**H**EREWITH is presented the eleventh of a series of instruction articles on mathematics, emphasizing especially its application to radio. The articles which have appeared thus far are:

#### WHAT HAS GONE BEFORE

Arithmetic.....	Page	542	Dec., '30
The Slide Rule.....		630	Jan., '31
Algebra in Radio.....		722	Feb., '31
Algebra in Radio.....		826	Mar., '31
Algebra in Radio.....		920	Apr., '31
Algebra in Radio.....		1004	May, '31
Geometry in Radio...		1088	June, '31
Geometry in Radio...		63	July, '31
Geometry in Radio...		230	Sept., '31
Trigonometry in Radio		288	Oct., '31

\*President, National Radio Institute.

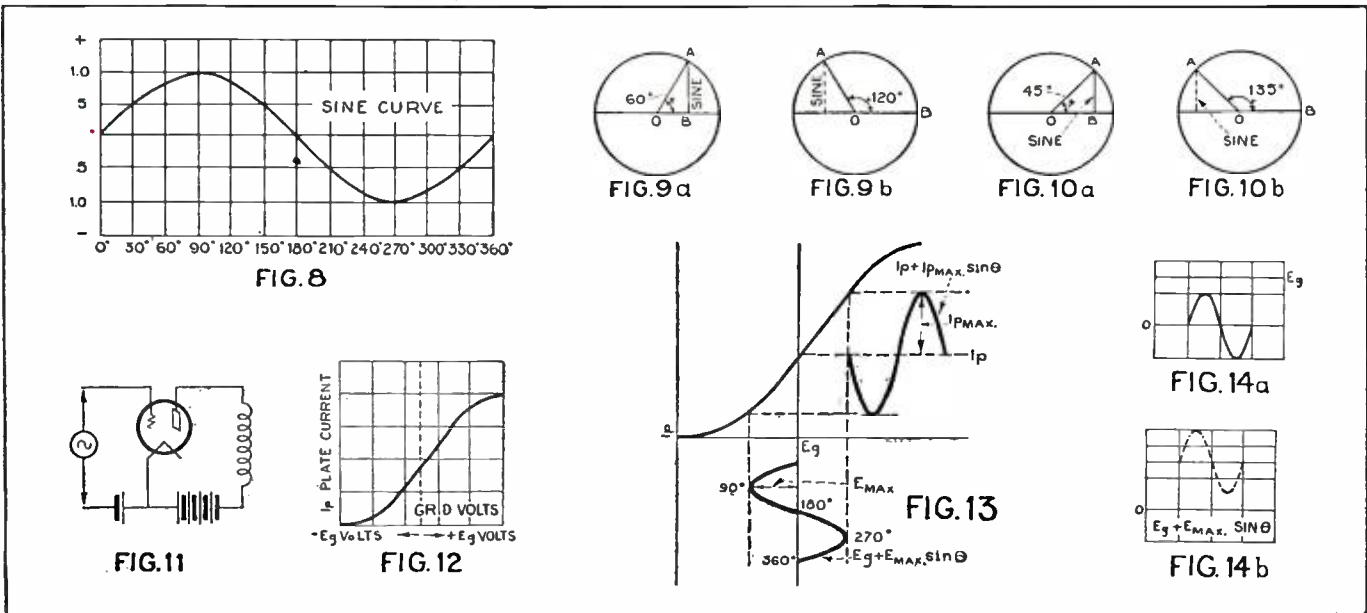

We have seen the shape of a sine wave from 0 to 360 degrees, and it is of interest to study the shape of other waves which might be encountered in radio circuits.

In this discussion we have noted the values of the cosine function for the angular degrees of 0, 45, 60 and 90 degrees and, therefore, are in a position to plot these results on graph paper in order to determine the resulting shape of the wave. With reference to Figure 15, if the abscissa is represented by the angular degrees from 0 to 360, we are in a position to plot as ordinates the numerical values of the cosines of the angles which we already know. Thus, by plotting the cosines of the respective angles for 0, 30, 45, 60 and 90 degrees, we have the ordinates for the points lying in the first quadrant.

Regarding the points lying in the second quadrant, it is shown in Figure 16 that the cosine of 120 degrees has the same value as the cosine of 60 degrees in the first quadrant, but since it is to the left of the reference line, YY, it will be opposite in sign. Thus, the cosine of all values in the second and third quadrants will be negative.

We have learned that the tangent of an angle is the ratio of the side opposite to the side adjacent, or, in other words, is the ratio of the sine to the cosine of the angle. Since we know the values of these two functions, the curve representing the tangent of an angle can be plotted as shown in Figure 17. It is interesting to note that for the tangent of 90 degrees the numerical value of the tangent is an infinite amount, for the tangent of 90 degrees, expressed as the ratio of the sine to the cosine, has the value in the ratio of 1 to 0, which is, of course, infinite.

**Applications of Trigonometry**

We have learned the fundamental relations of the trigonometric functions in considering the sines, cosines, tangents and their cofunctions. A further study of this very interesting subject leads to an expansion of these relations and it is of interest to learn of these new functions by referring to the practical electrical application of these relations.

By the use of trigonometry, we can obtain a better and a clearer idea of the electrical theory involved and the student needs to know and appreciate the various functions in order to follow the standard textbooks outlining such relationships.

An analysis of a few examples of this application to the principle of electric power in a circuit follows:

The power consumed in an electrical circuit is most clearly brought out by the use of trigonometry and calculus, and the latter will be brought out in a later article. We know that in a direct-current circuit the power is the product of the impressed voltage and the current consumed by the resistance. In an alternating-current circuit the power is the product of the impressed voltage and the current, if we consider that the power in this case is the product of the instantaneous voltage and the instantaneous current.

With reference to Figure 18, let us study the relation of the voltage and current through a resistance and the power consumed. Curve (a) represents the instantaneous voltage impressed on the circuit and is drawn for a maximum voltage equal to 20. Curve (b) represents the instantaneous current through the resistance and is drawn for a maximum current equal to 10. Since the power is

the product of these two instantaneous values, we can substitute their respective values in equation (1) of Figure 18 and obtain the expression as indicated in equation (2). Multiplying this, we have that the power is the product of the maximum values of the voltage and current and the square of the sine of the angle, as shown in equation (3).

We have here one case where the trigonometric expression is not in a simple form for a ready solution, and time will be taken now to show how this may be changed. We shall digress from the present problem for a moment and prove a very important trigonometric function. With reference to Figure 19, we can readily see that the sum of the sine of the two angles x and y (BOQ) can be expressed as indicated in equation (1). We have

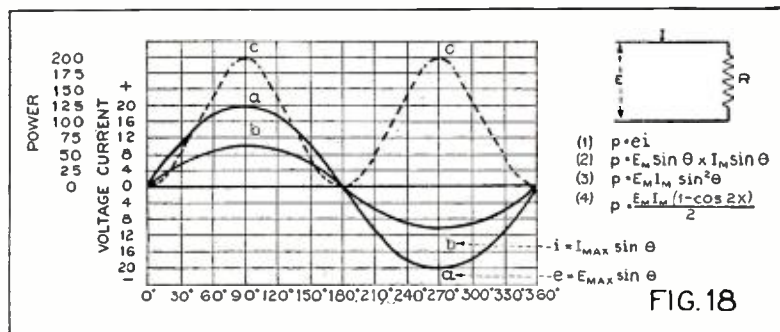

FIG. 18

drawn the figure such that QC is perpendicular to OC and use is now made of a part of geometry which was reviewed in a past article. It will be remembered that when a transversal is cutting two parallel lines, the alternate interior angles are equal. These angles are shown equal which are marked by a double arc, since the transversal OC cuts the two parallel lines ED and BC. It will be seen that when the corresponding right triangles SQC and BOC are considered, the angle EQC must equal the angle x of triangle BOC. Now, considering triangle BOC, we can express the relation as indicated in equation (2) and considering triangle EQC we can express the relation in equation (3). Substituting these relations in equation (1), and remembering that OC is the cosine of the angle y, and CQ the sine of this angle, we obtain the expression as indicated in equation (4). We thus have the expression for the sine of the sum of two angles.

Continuing this analysis a little further, let us assume that the angle y is equal to the angle x. In a similar manner to the above, we can prove that the cosine of the sum of two angles is as indicated in equation (5). Now, if y equals x, the relation of equation (6) is obtained. Substituting for the equivalent value of the square of the cosine of the angle, and transposing, we obtain the expression of equation (7). We thus have an expression for the square of the sine of an angle which can be used in equation (3) of Figure 18, and we can now proceed with the analysis of this circuit. The above expressions are very important in trigonometry and are often encountered in practice, as is evident in the present analysis.

With reference to equation (3), Figure 18, we can substitute the value of the square of the sine of the angle already obtained and the expression of equation (Continued on page 430)

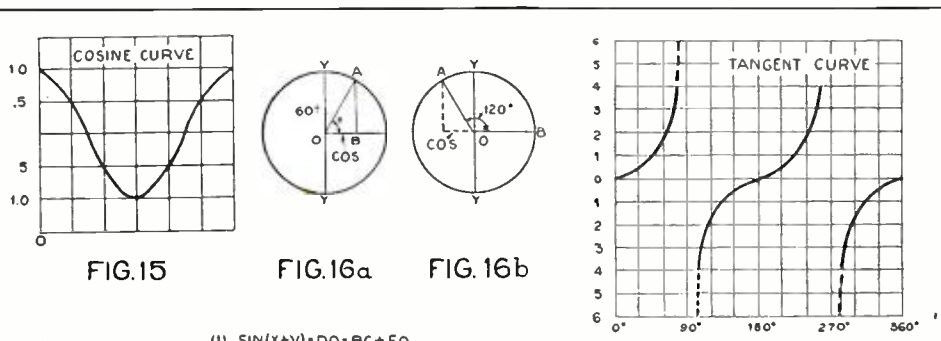

FIG. 17

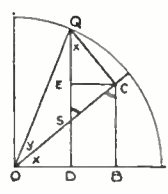
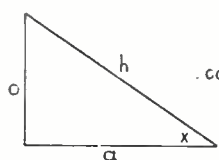

FIG. 19

- (1)  $\sin(x+y) = DQ + BC + EQ$
- (2)  $\sin x = \frac{BC}{OC} \therefore BC = OC \sin x$
- (3)  $\cos x = \frac{CQ}{OC} \therefore CQ = OC \cos x$
- (4)  $\sin(x+y) = \cos y \sin x + \sin y \cos x$
- (5)  $\cos(x+y) = \cos x \cos y - \sin x \sin y$
- FOR  $y = x$
- (6)  $\cos 2x = \cos^2 x - \sin^2 x$   
 $= 1 - \sin^2 x - \sin^2 x$   
 $= 1 - 2 \sin^2 x$
- (7)  $\sin^2 x = \frac{1 - \cos 2x}{2}$



$$h^2 = a^2 + c^2$$

$$1 = \sin^2 x + \cos^2 x$$

$$\therefore \cos^2 x = 1 - \sin^2 x$$

FIG. 20

# A New Pentode Amplifier

## *Adaptable to Portable Public Address Work*

*The amplifier described here offers an unusual combination of high gain, flat response and low price. The 90 db. gain makes it particularly suitable for use with microphone and photo-cell inputs without pre-amplification*

By **McMurdo Silver\***

**F**OR some time past a general need has been felt for a medium-powered but quite high-gain audio amplifier capable of operation not only out of a phonograph pick-up, but capable of giving full output from typical microphone inputs and also able to work directly out of a photo-electric cell without additional amplification.

Typical three-stage, 15-watt power amplifiers have had gains on the order of 50 to 75 db., which is more than adequate for pick-up work, satisfactory with well-placed microphones, but distinctly insufficient for photo-electric cell operation. In addition, the power output of these amplifiers has often far exceeded actual requirements in many cases, yet they had to be used, since no high-gain, low-powered amplifiers have been available, the next step down being to two-stage 4 to 5-watt units showing gains only of approximately 20 to 40 db. A disadvantage of these low-power amplifiers has been that their power output has been so low that, with available speaker units, the coverage provided has been quite limited. In some measure, this disadvantage can be regarded as a thing of the past, since today good, highly efficient electro-dynamic units are available whose electro-acoustic conversion efficiency, in effect, greatly raises the coverage of 5-watt amplifiers.

In this article is described a new amplifier employing a pair of the new type -47 pentode output tubes in push-pull and delivering six to seven watts of undistorted output, combined with an overall gain of 90 db.—sufficient to ordinarily provide full undistorted power output when fed directly by a photo-electric cell with no intermediate amplification.

This amplifier is illustrated in Figure 1, its circuit in Figure 2, and its frequency response in Figure 3. It is unusually compact, and despite its high gain is absolutely stable, and free from hum, though completely a.c. operated. Its frequency response curve, shown in Figure 3, is particularly interesting and will be discussed later.

The amplifier, employing a total of three stages, is seen fully as-

sembled at the right of Figure 1, with a bottom view of the chassis at the left. The schematic circuit diagram showing all connections appears in Figure 2.

The chassis is 12 inches by 9½ inches by 9 inches over power transformer housing. At the left of the chassis is the type -24 first-stage amplifier tube, and to its right, successively, the type -27 second-stage tube, the two type -47 pentodes in the push-pull output stage, and at the extreme right the type -80 rectifier. Two binding posts at the left are for the input, which may be a pick-up, pick-up or microphone transformer, photo-electric cell, or radio set output.

The central pair of posts supply 270 volts d.c., which, through a 250,000-ohm potentiometer, furnishes required power for photo-electric cell operation. The right-hand pair of posts are the output terminals for feeding the 15-ohm voice coil of an electro-dynamic loudspeaker unit, such as the Silver-Marshall 855-B, 862 or 864 units. On the front of the amplifier are, at the left, the gain control, and at the right, the on-off switch, all power being derived from any 105 to 125-volt, 50 to 60-cycle power line.

Examining Figure 2, the circuit diagram, the input is seen to be directly into the grid circuit of the first-stage tube, through only a .25-mfd. blocking condenser and 2-megohm grid leak. If a high-impedance source is used, the input leads must be kept short, and possibly may have to be shielded. If, for instance, a photo-electric cell is fed into the 684 amplifier, the amplifier will have to be mounted as close to the cell as possible, and the high lead well

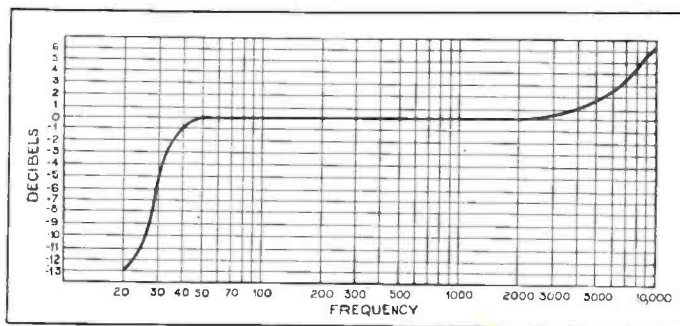

FREQUENCY RESPONSE CHARACTERISTIC

Figure 3. This curve taken working with constant load resistance. Working into a loudspeaker would change the characteristic somewhat but still it would remain unusually good

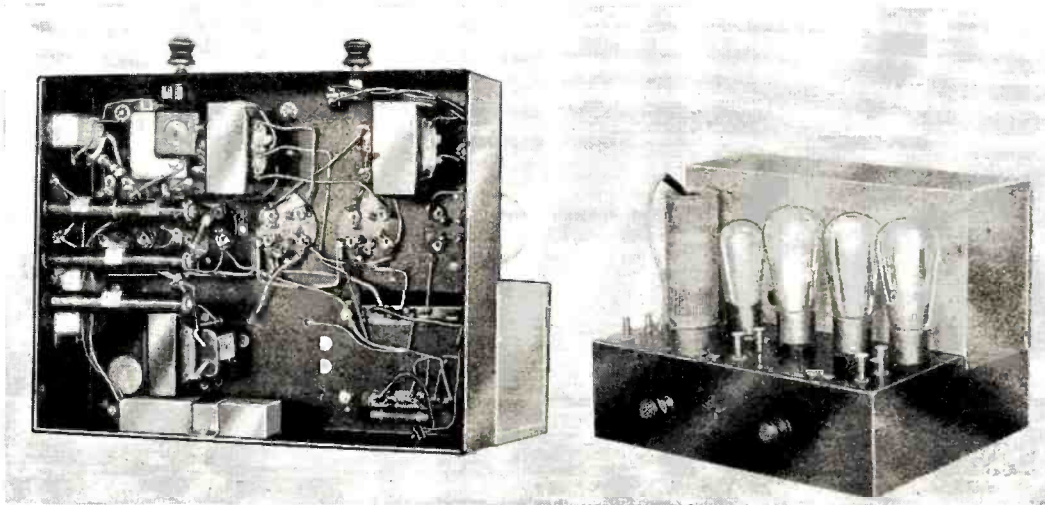

TOP AND BOTTOM VIEWS OF THE NEW AMPLIFIER

Figure 1. Three stages are provided, with the first stage tube and input shielded to prevent instability which might otherwise result because of the unusually high overall gain

\*President, Silver-Marshall, Inc.

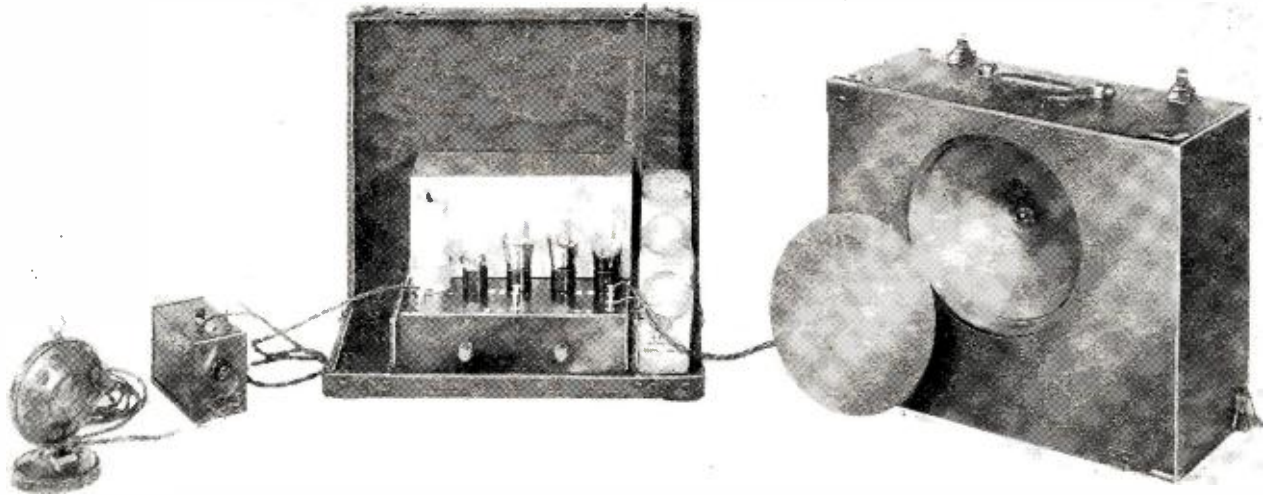

PORTABLE PUBLIC ADDRESS UNIT

Figure 4. The amplifier described here is particularly well adapted for such use because of its compact size and high gain

shielded to avoid noise pick-up, possible input-to-output coupling, with resultant instability or even a.c. hum. If a low-impedance input source is used, such precautions become unnecessary, and it is only needful to keep the input and output leads well apart to prevent singing. The amplifier itself, however, is entirely stable, and singing or oscillation will ordinarily only be caused by input-to-output coupling, either between leads, microphone or pick-up and speaker or other input and output apparatus.

**Adequate Shielding Used**

The type -24 first audio tube is individually shielded, as is its control grid lead. It is coupled to the second-stage tube by a 500,000-ohm plate resistor, .01 mfd. blocking condenser and a 1.0 megohm grid leak, which is arranged as a potentiometer for continuously variable gain control. A 60,000-ohm resistor is included in the screen-grid lead of the type -24 tube, both for isolation and further for adjustment of the screen potential, which is bled from a voltage divider across the

power supply filter output. A second isolating resistor, of 30,000 ohms, is included in the plate feed lead to this tube to further insure stability and to eliminate degenerative effects which are usually noticed in such high-gain amplifiers. Grid bias for the -24 and -27 tubes is not automatic, but is obtained from drops across portions of the voltage divider circuit.

The second-stage tube is coupled to the two pentodes by a tuned Clough system transformer of 1-1 ratio, which ratio allows an excellent bass response characteristic as well as unusually good high-frequency transmission.

The push-pull pentodes feed a self-contained output transformer having a 15-ohm secondary impedance. The secondary may be used to feed the voice coil of one standard dynamic speaker unit, or, if desired, the voice coils of four standard speaker units connected in series parallel. The output transformer is included directly in the 684 amplifier to avoid any loss of high frequencies which would occur due to the capacity of the high-impedance plate leads being brought out, possibly some distance, to an output transformer located at the speaker unit.

The loss of highs, even on a quite long speaker line, is negligible when the voice-coil leads are run between amplifier and speaker, due to the diminished effect of lead capacity on the low-impedance voice coil line. This is really no inconvenience, as practically all standard speakers today have 15-ohm voice coils and may be had without output transformers.

**The Power Supply**

The power supply consists of a large power transformer, a type -80 rectifier tube and a two-section filter. Both sections of the filter are tuned to eliminate the 120-cycle ripple of the rectifier output, and plate voltage for the pentodes is taken off after the first section of the filter. This total voltage of about 290 volts is divided between "B" and "C" for the -47's, resulting in an undistorted power output of about 3 watts or more per tube. A total of 12 mfd. is included in the filter circuit, plus the two .25 mid. condensers tuning the two filter chokes, with additional filtration provided (Continued on page 431)

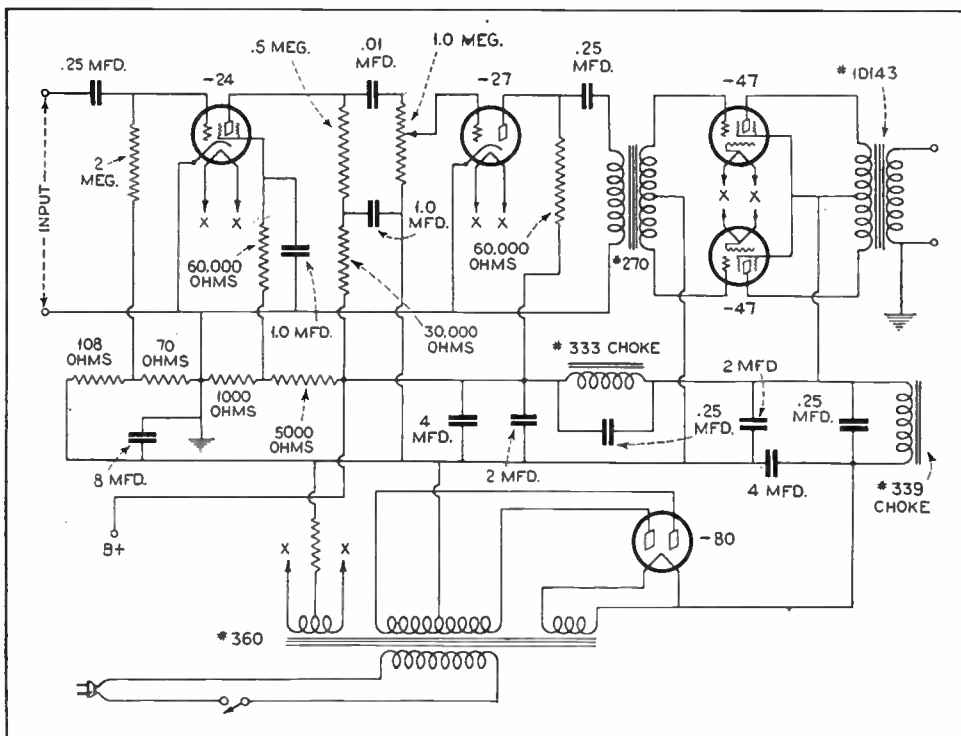

THE CIRCUIT DIAGRAM

Figure 2. The output obtained fills a needed requirement for an amplifier of medium power

# Completing the



## EVERYTHING BUT THE TIMBER

*Four Army men transported all the equipment and supplies over hundreds of miles of dangerous trail by dogsled for this outpost radio station at Point Barrow, Alaska*

WHILE the average American has been peacefully enjoying his radio entertainment, other Americans, quiet hard-bitten soldiers, have been pushing up inside the Arctic Circle, over snow and ice on the trail, with whole radio stations "knocked down" on sledges and in the bottoms of Arctic exploring vessels. Slowly, the Army men, enlisted privates, corporals and sergeants with the authority of Major Generals in their hands, have been weaving around Alaska the Army Radio Net. The same network that serves the United States with its weather and crop reports and guides vessels at sea in the far north.

Working on short waves, this network is said to vie with the Navy's gigantic system, working both short and long waves, around the world. The Army Net, too, extends around the world, thus giving the United States world-radio coverage.

The entire system is rigidly controlled from Station WAR, in the War Department message center, at Washington, D. C. Ten kilowatt power-amplifiers in Washington, Atlanta, San Antonio, Omaha, San Francisco, Seattle, Seward (Alaska), Manila, Honolulu, and Quarry Heights, Panama, with San Francisco the relay point for the Orient and San Antonio the relay point for Panama, extend this mighty system completely around the world.

This system operates continuously and with an error percentage of less than one-tenth of one per cent.

## The Army Gets a Call

Before we tell how this radio net operates radio beams to guide the United States aircraft to any point on American territory, let us look into this Alaska, Point Barrow matter. There's an Army station under a Captain of the Signal Corps, at Seward, far south in Alaska, as a glance at the map will reveal.

Point Barrow, where the weather comes from, needed the station, and called on the Army to find the money and the man to erect it.

The Chief Signal Officer found his man in Private Soldier Richard Heyser, who was assigned to take a short-wave set up to Barrow and establish communications. Heyser would have had a month's land cruise on his hands, and the Signal Corps naturally expected to hear from him in about 54 days. Instead, imagine the agreeable astonishment of the Chief Signal Officer at Washington, when this humble private soldier started sending weather reports through in—not 54 days, but 54 hours and 28 minutes. No, he wasn't a miracle worker. A party from the Fox Film Corporation had chartered a plane to

*With a network of radio stations the tropics and on distant island wave station on an arctic hillside*

By Richard

take them to Barrow for some news-reel pictures. Heyser struck a deal with these gentlemen, and in exchange for continuous radio communication, and free sending of their messages from Barrow, he got transportation in the plane for himself and his short-wave set. This was on June 12th. On June 19th, the Signal Corps was so well satisfied with the service, that it ordered Staff Sergeant Stanley R. Morgan, an old experienced sourdough radioman, to go up to Barrow, take equipment for a fairly large station in the ship he was to travel in, and hand Private Heyser the congratulations of the "old man" in Washington, also take command, firmly establish the Station and stay there until ordered out.

Then there were two men at Barrow. Heyser and Morgan got along well together. They represented the Army at Barrow.

United States farmers have reaped millions of dollars in beneficial weather reports, and so have hundreds of ships in the Pacific seas, from the work of these men. It is an Army classic in any language you care to tell it.

## Making Army Radio Pay Its Way

Before letting Staff Sergeant Morgan tell his own story, it will be the course of wisdom to mention that another of these nonchalant noncommissioned officers who know their Arctics, Corporal Leo W. Bundy, took \$4,500 of War Department money for gum drops and travelling expenses as early as 1926 and went through all the north Alaskan isolated habitations—alone and on the trail with his dogs—to investigate the chances of such a station paying the War Department from the commercial radio service it could handle for traders, shippers and individuals in general. The report he made out finally was an intelligent, professional description. Few West Pointers could equal that report, let alone exceed it, either in diction or reasoning. It was businesslike and to the point,



## CONTROL SERGEANTS AT MASTER SWITCHBOARD

*From this point all the communications to the Army net are routed through America and to the overseas territories*

# Army Radio Net

*in the United States, stations in territories, the far-flung short-in Alaska completes the chain*

**L. West**

and that corporal "recommended" the station. The Army authorized it and the wheels started moving.

After telling of Barrow's physical description, Corporal Bundy said, "The native population is progressive, and standards of living fairly established." He mentioned numerous trading posts, though the population of Barrow, he says is about 200 Eskimoes, 12 whites and 20 half-breeds. He described Wainwright, Kotzebue and other Alaskan settlements, detailing their need for communication with Barrow, and shows reasons why they'll pay for the service at commercial rates. He procured the cooperation of the Chamber of Commerce at Fairbanks, and he interviewed ships' captains by contacting them along the coast in lonely fishing areas and trading points. These captains told him of the perils of the coast, and of their willingness to pay at commercial rates for radio service to and from Barrow, saving them useless cruises sometimes, at others enabling them to secure speedy succor in times of distress.

He mentioned that mail reaches Point Barrow only once during the summer and three times during the winter. He talked to ships' radio operators, found they have peculiar transmission and reception problems due to northern magnetic disturbances. These he carefully studied and mentioned in his report. He suggested certain Signal Corps apparatus which would meet these discrepancies. He gave instructions how to ship separate radio items by rail and boat.

And here's Morgan's verbatim account of the furthest north radio station's birth. "Arriving at Point Barrow on the Northland at about 2 p.m. July 27, I found that Private (First Class) Richard Heyser had superintended the building of the new radio shack, and had it ready for occupancy.

"The equipment was unloaded by 5 p.m. and the Northland then departed. Due to a threatening rain, I decided to move



**ARMY RADIO HEADQUARTERS**

*View of the Radio Section in the message center of the War Department at the Munitions Building in Washington, D. C. The corps of radio operators are seen handling messages at the row of receiver desks*

all the equipment into the station immediately, which job was accomplished by midnight. It may be well to note that all handling and movement of equipment from beach to station was accomplished by native labor, packing by hand. This is a slow and expensive method, but it is the only available means here of moving articles from one place to another in the summer time.

"After his flight up from Fairbanks in June, Private Heyser had installed the transmitter in the hospital as a temporary arrangement. The following day was spent in erecting one of the 30-foot poles in preparation for the installation of this set at the new shack; this pole also served as a "gin" pole in raising the larger masts.

## *A Summer "Freeze-Up"*

"A vertical antenna was erected of the same length as that sent up by plane and the transmitter was then moved to the new location. The first tests, however, showed poor results. due to faulty construction in the transmitter. In order to get his signals through, Private Heyser had been compelled to operate his motor-generator on 32 volts. That method was satisfactory perhaps for the emergency set-up but it was not at all in line with the A-1 installation we had planned for Barrow. So we spent the next few days in rebuilding and testing. Much better results were obtained.

"In the meantime, holes were being dug for the big poles. Due to the bad weather conditions and the frozen ground, this was necessarily slow work, for although we were favored with perpetual daylight the weather was cold enough to freeze up our tackle and to otherwise delay the job and make the work disagreeable. July is the warmest month of the year at Barrow, yet it freezes at some time during the 24 hours on 13 days of this month. The installation was finally completed, however, and we had an antenna of the following dimensions: 4-wire T-type antenna, separation of wires 4 feet, length 80 feet, with a 60-foot vertical 4-wire lead-in, bunched together 10 feet from the house.

"As I had used the lead-in insulators for the short-wave transmitter, I had to improvise insulators for this transmitter. Fortunately, we had two large mixing bowls, and by drilling holes in these and using the ramrod of my rifle to hold them in place, we had a very fair lead-in insulator.

"The BC-86-A transmitter was found to work best, with maximum output, on 300 meters. This is the transmitter of the SCR-109-A set, 300 to 500 meters; one 5-watt, two 50-watt tubes; rated transmission ranges telephone, 20 miles; buzzer-modulated telegraph, 30 miles; (Continued on page 441)

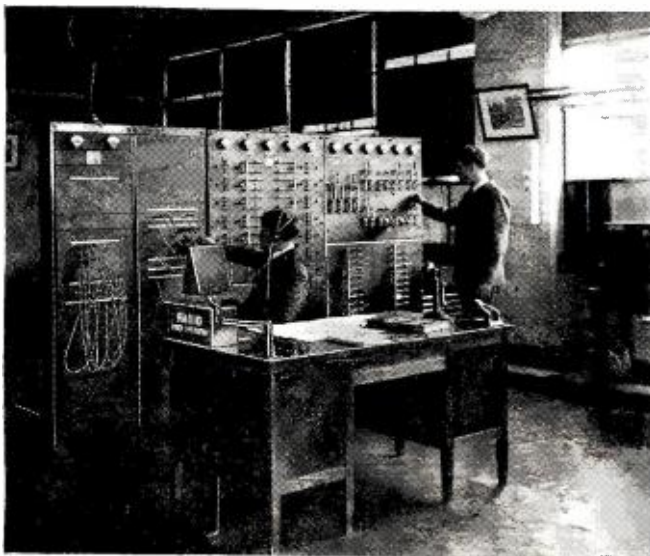

**RECEIVING EQUIPMENT AT STATION WAR**

*Government operators of the Department in Washington handling long-distance communications through the net*



# With the Experimenters

*Eight Meters in One—Variable Ticklers—That Blue Glow in Pentodes—A Novel Antenna Switch—A Tip on Capacity Measurements—Improved Method of Antenna Coupling—Measuring Resistance—Code Practice Set*

## *Eight Meters in One*

Meters are the tools with which the radio serviceman has to work, but such wide ranges of current and voltages are met with in radio practice that a number of expensive meters are required. The idea of using series resistors and resistance shunts to make a single meter serve the purpose of several is, of course, not a new one, but it has been difficult heretofore to construct such auxiliary equipment because of the difficulty in obtaining precision resistors of exactly the right values, particularly for the shunts.

Just recently the International Resistance Company has placed on the market a kit of resistors that fill a long-felt need in this connection. Following their introduction of this kit, a simple unit was built up in the RADIO NEWS Laboratory which will undoubtedly be of considerable interest to readers because it employs only a single 0-1 milliammeter to accurately perform the job of eight different meters and at the same time is inexpensive to construct.

The circuit employed and the idea upon which it is based were suggested by the International Resistance Company. The unit, shown in the accompanying illustrations, employs standard parts which are readily available.

The circuit diagram, Figure 1, shows the complete layout. Figure 2 gives all necessary information for the panel arrangement and the front-view photograph shows a view of an engraved panel. Such a panel is, of course, not essential, but it

Conducted by  
**S. Gordon Taylor**

gives the instrument a professional appearance and the expense involved is therefore justified.



THE COMPLETED MULTIPLIER

As will be seen from Figure 1, the resistances, V1, V2, V3 and V4, constitute the multipliers which adapt the milliammeter for use as a voltmeter, thus providing voltmeter ranges of 0-1, 0-10, 0-100 and 0-500 volts. When the switch S1 is thrown to the 1-volt position, the resistance of V4 is placed in series with the internal resistance of the meter, giving a total resistance of 1000 ohms, which is the series value necessary for full deflection of the meter. When the switch is set in position for the 10-volt range, V3 and V4 are both in series with the internal resistance of the meter, giving a total of 10,000 ohms. For the 100-volt range, V2 is added to the total resistance, and at the 500-volt setting V1 is also added, providing values of 100,000 ohms and 500,000 ohms respectively.

For current measurement, the meter is used without any external resistance when the switch is set for the 1-ma. range. For the 2-ma. range, the resistance V5 is automatically connected in series with the meter and the combined resistance of V5 and the meter is shunted by the resistance V6, of 28 ohms. This results in one-tenth of the current under measurement passing through the meter while the other nine-tenths passes through the shunt, V6. The total current is, therefore, ten times that indicated by the meter. This same arrangement is employed for the other milliamperage ranges except that, for the 50-milliamperage range, V7 is thrown into the circuit as a shunt and for the 100-milliamperage range V8



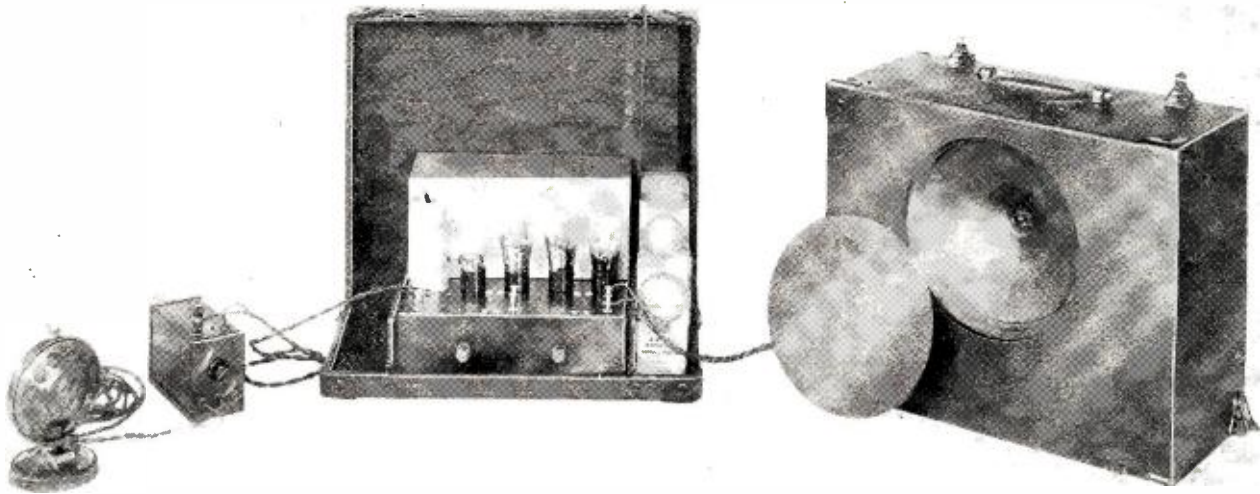

PORTABLE PUBLIC ADDRESS UNIT

Figure 4. The amplifier described here is particularly well adapted for such use because of its compact size and high gain

shielded to avoid noise pick-up, possible input-to-output coupling, with resultant instability or even a.c. hum. If a low-impedance input source is used, such precautions become unnecessary, and it is only needful to keep the input and output leads well apart to prevent singing. The amplifier itself, however, is entirely stable, and singing or oscillation will ordinarily only be caused by input-to-output coupling, either between leads, microphone or pick-up and speaker or other input and output apparatus.

**Adequate Shielding Used**

The type -24 first audio tube is individually shielded, as is its control grid lead. It is coupled to the second-stage tube by a 500,000-ohm plate resistor, .01 mfd. blocking condenser and a 1.0 megohm grid leak, which is arranged as a potentiometer for continuously variable gain control. A 60,000-ohm resistor is included in the screen-grid lead of the type -24 tube, both for isolation and further for adjustment of the screen potential, which is bled from a voltage divider across the

power supply filter output. A second isolating resistor, of 30,000 ohms, is included in the plate feed lead to this tube to further insure stability and to eliminate degenerative effects which are usually noticed in such high-gain amplifiers. Grid bias for the -24 and -27 tubes is not automatic, but is obtained from drops across portions of the voltage divider circuit.

The second-stage tube is coupled to the two pentodes by a tuned Clough system transformer of 1-1 ratio, which ratio allows an excellent bass response characteristic as well as unusually good high-frequency transmission.

The push-pull pentodes feed a self-contained output transformer having a 15-ohm secondary impedance. The secondary may be used to feed the voice coil of one standard speaker unit, or, if desired, the voice coils of four standard speaker units connected in series parallel. The output transformer is included directly in the 634 amplifier to avoid any loss of high frequencies which would occur due to the capacity of the high-impedance plate leads being brought out, possibly some distance, to an output transformer located at the speaker

unit. The loss of highs, even on a quite long speaker line, is negligible when the voice-coil leads are run between amplifier and speaker, due to the diminished effect of lead capacity on the low-impedance voice coil line. This is really no inconvenience, as practically all standard speakers today have 15-ohm voice coils and may be had without output transformers.

**The Power Supply**

The power supply consists of a large power transformer, a type -80 rectifier tube and a two-section filter. Both sections of the filter are tuned to eliminate the 120-cycle ripple of the rectifier output, and plate voltage for the pentodes is taken off after the first section of the filter. This total voltage of about 290 volts is divided between "B" and "C" for the -47's, resulting in an undistorted power output of about 3 watts or more per tube. A total of 12 mfd. is included in the filter circuit, plus the two .25 mfd. condensers tuning the two filter chokes, with additional filtration provided (Continued on page 431)

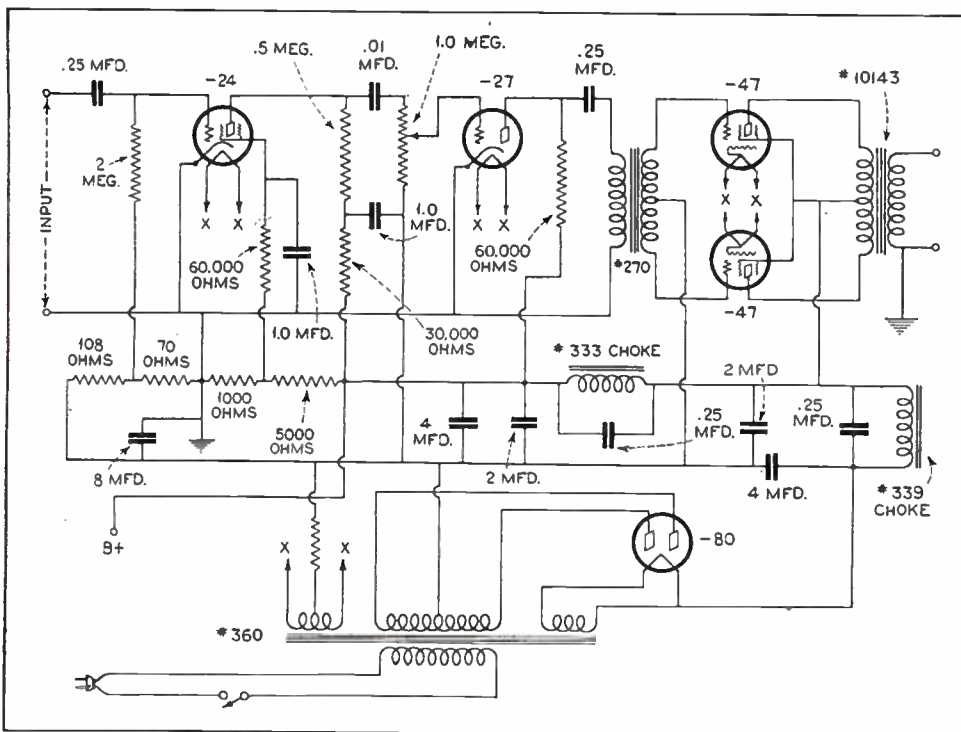

THE CIRCUIT DIAGRAM

Figure 2. The output obtained fills a needed requirement for an amplifier of medium power

# Completing the



## EVERYTHING BUT THE TIMBER

*Four Army men transported all the equipment and supplies over hundreds of miles of dangerous trail by dogsled for this outpost radio station at Point Barrow, Alaska*

WHILE the average American has been peacefully enjoying his radio entertainment, other Americans, quiet hard-bitten soldiers, have been pushing up inside the Arctic Circle, over snow and ice on the trail, with whole radio stations "knocked down" on sleds and in the bottoms of Arctic exploring vessels. Slowly, the Army men, enlisted privates, corporals and sergeants with the authority of Major Generals in their hands, have been weaving around Alaska the Army Radio Net. The same network that serves the United States with its weather and crop reports and guides vessels at sea in the far north.

Working on short waves, this network is said to vie with the Navy's gigantic system, working both short and long waves, around the world. The Army Net, too, extends around the world, thus giving the United States world-radio coverage.

The entire system is rigidly controlled from Station WAR, in the War Department message center, at Washington, D. C. Ten kilowatt power-amplifiers in Washington, Atlanta, San Antonio, Omaha, San Francisco, Seattle, Seward (Alaska), Manila, Honolulu, and Quarry Heights, Panama, with San Francisco the relay point for the Orient and San Antonio the relay point for Panama, extend this mighty system completely around the world.

This system operates continuously and with an error percentage of less than one-tenth of one per cent.

## The Army Gets a Call

Before we tell how this radio net operates radio beams to guide the United States aircraft to any point on American territory, let us look into this Alaska, Point Barrow matter. There's an Army station under a Captain of the Signal Corps, at Seward, far south in Alaska, as a glance at the map will reveal.

Point Barrow, where the weather comes from, needed the station, and called on the Army to find the money and the man to erect it.

The Chief Signal Officer found his man in Private Soldier Richard Heyser, who was assigned to take a short-wave set up to Barrow and establish communications. Heyser would have had a month's land cruise on his hands, and the Signal Corps naturally expected to hear from him in about 54 days. Instead, imagine the agreeable astonishment of the Chief Signal Officer at Washington, when this humble private soldier started sending weather reports through in—not 54 days, but 54 hours and 28 minutes. No, he wasn't a miracle worker. A party from the Fox Film Corporation had chartered a plane to

*With a network of radio stations the tropics and on distant island wave station on an arctic hillside*

By Richard

take them to Barrow for some news-reel pictures. Heyser

struck a deal with these gentlemen, and in exchange for continuous radio communication, and free sending of their messages from Barrow, he got transportation in the plane for himself and his short-wave set. This was on June 12th. On June 19th, the Signal Corps was so well satisfied with the service, that it ordered Staff Sergeant Stanley R. Morgan, an old experienced sourdough radioman, to go up to Barrow, take equipment for a fairly large station in the ship he was to travel in, and hand Private Heyser the congratulations of the "old man" in Washington, also take command, firmly establish the Station and stay there until ordered out.

Then there were two men at Barrow. Heyser and Morgan got along well together. They represented the Army at Barrow.

United States farmers have reaped millions of dollars in beneficial weather reports, and so have hundreds of ships in the Pacific seas, from the work of these men. It is an Army classic in any language you care to tell it.

## Making Army Radio Pay Its Way

Before letting Staff Sergeant Morgan tell his own story, it will be the course of wisdom to mention that another of these nonchalant noncommissioned officers who know their Arctics, Corporal Leo W. Bundy, took \$4,500 of War Department money for gum drops and travelling expenses as early as 1926 and went through all the north Alaskan isolated habitations—alone and on the trail with his dogs—to investigate the chances of such a station paying the War Department from the commercial radio service it could handle for traders, shippers and individuals in general. The report he made out finally was an intelligent, professional description. Few West Pointers could equal that report, let alone exceed it, either in diction or reasoning. It was businesslike and to the point,

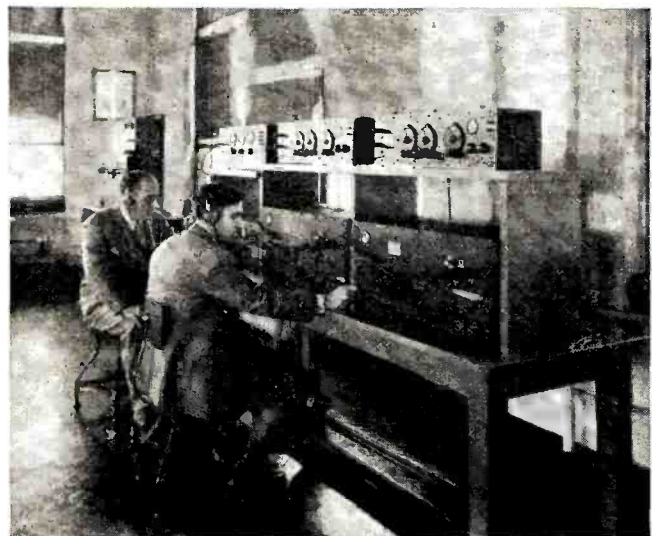

## CONTROL SERGEANTS AT MASTER SWITCHBOARD

*From this point all the communications to the Army net are routed through America and to the overseas territories*

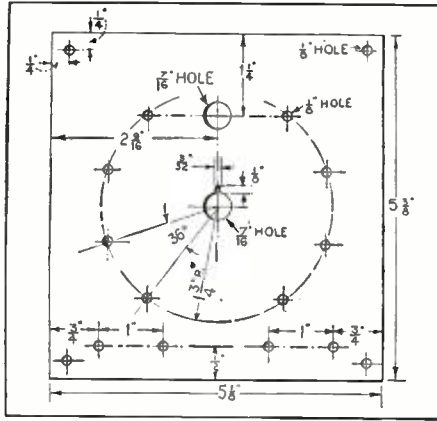

Figure 2

serves this purpose.

If we were to assume 30 ohms as the exact internal resistance of the meter, the calculations would show that the values employed for V6, V7 and V8 are slightly off the calculated values. However, the meter resistance has been found to vary somewhat with different makes of meters and the resistor values employed here actually provide highly accurate results. Employing any of the standard makes of good quality milliammeters, the maximum error should not exceed 2% on the 10-ma. range and 1% for the 50-ma. and 100-ma. ranges, providing, of course, that the meter itself is accurate. In the voltmeter ranges, accuracy of 1% or better is obtained. It is in order to reduce to a minimum the factor of error introduced by meters of different internal resistance that the series resistors are employed in all current measurements above the 1-ma. range.

The switch S2 is used to avoid any possibility of excessive current passing

through the meter while throwing the switch from one current range to another. On the voltmeter side of the switch there is no chance of such trouble occurring but when making current measurement it is advisable to open switch S2 before throwing S1 from one range to another. The reason for this is that if the one contact of the bi-polar switch opens up before the other, the full current under measurement will pass through the resistor, V5, and the meter for an instant, with no shunt resistor in the circuit. If the constructor is of the type who occasionally suffers a lapse of memory, it will be found advisable to substitute a push-

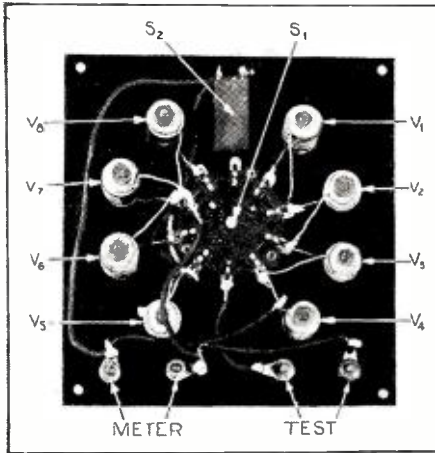

REAR-PANEL VIEW

button for a switch S2 so that this circuit will always be open except while the the push-button is held down.

In using this unit the meter is connected across the right-hand binding posts as shown in the front view of the unit.

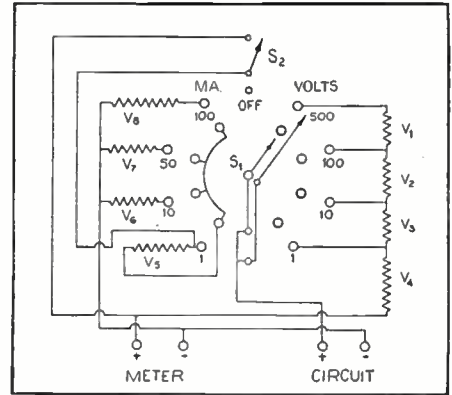

Figure 1

and the circuit to be measured is connected across the "test" binding post.

### The Parts List

- S1—Best 9-throw, bi-polar, non-shorting switch
- S2—Carter toggle switch
- V1 } 400,000 ohms
- V2 } 90,000 ohms
- V3 } I.R.C. volt-ammeter adapter resistance kit. All resistors accurate within 1%
- V4 } 9,000 ohms
- V5 } 970 ohms
- V6 } 230 ohms
- V7 } 28 ohms
- V8 } 5.25 ohms
- } 2.55 ohms

Card index file box, 5 1/8 inches x 5 7/8 inches x 2 3/4 inches, inside dimensions

Eby binding posts

General Fabricating Company's drilled and engraved panel

The accessories shown in the photograph include the following:

Jewell type 88 d.c. milliammeter, 0-1 ma.  
International Air Research Laboratories test prods.

### Variable Ticklers

In making s.w. coils of the cage type there is a great amount of guesswork as to where to put the tickler coils. This may be overcome by winding the tickler coil on a piece of cardboard tubing which will fit snugly inside the secondary coil frame. The tubing and its wires may

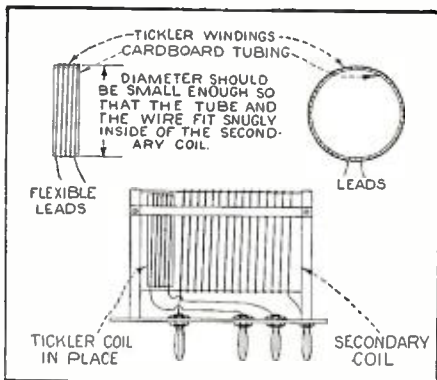

Figure 3

be moved back and forth until the best location is found. The accompanying drawing, Figure 3, may help the constructor.

I have found this idea to be a remedy for a set which failed to go into oscillation because of faulty tickler coils.

FRED F. SHRIER,  
Ansonia, Conn.

### That Blue Glow in Pentodes

There seems to be some considerable misunderstanding in regard to what should be the appearance of the Pentode type of tube. We have had a number of customers write us, stating that the Pentode type has the appearance of having gas, as evidenced by a blue glow, and in consequence there was some doubt as to the quality.

We want to remove any misconception of this gaseous content in the Pentode tube. This phenomenon is not gas but a cathode ray bombardment of the glass, and is proof of high quality.

This condition is caused by the electrons passing through the grid either above or below the plate, receiving an accelerating energy from the plate but not being stopped by it, then striking the glass and causing the getter deposits on the glass to fluoresce with a blue color.

This phenomenon is only present in tubes which are gas-free, as a slight trace of gas disperses the electrons in such a manner that their energy and path is not concentrated enough to produce this effect.

Please bear in mind that the phenomenon caused by the bombardment is proof of a gas-free tube. It appears only on the surface of the glass and not throughout the bulb. The real gas glow is most in evidence immediately surrounding the plate, between the filament and plate, or sometimes filling the whole bulb volume.

Where this phenomenon is not present in the Pentode type, it is an indication of poor quality, not the reverse.

CABLE RADIO TUBE CORPORATION,  
Brooklyn, N. Y.

### A Novel Antenna Switch

I have been using a simple switch arrangement in the input to a radio receiver and I have found it very useful in eliminating local noises and also as a simple means of protection during thunderstorms. The diagram of the arrangement is shown in Figure 4. In the position

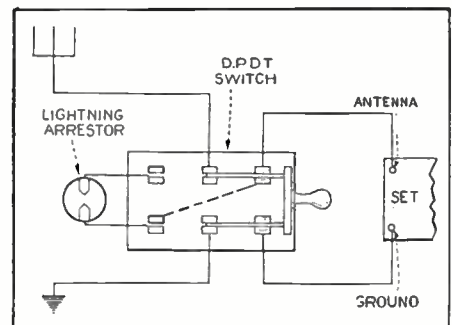

Figure 4

shown, the switch connects the antenna and ground to the radio set in the usual manner. When thrown to the left, the

antenna is connected to ground through the lightning arrester and the ground is connected to the antenna binding post of the receiver, thus employing the double-ground system of reception, the other ground being automatically provided through the power supply lines. This scheme is particularly applicable to receivers which draw their operating power from the electric light lines.

CHAS. MORRIS,  
Baltimore, Md.

**A Tip on Capacity Measurements**

In obtaining approximate capacities of by-pass condensers, using a circuit applying an a.c. voltage to an a.c. meter in series with the condenser, it is essential that the resistance of the meter (or meter and its external resistance) be not too high as compared with the average reactance of the capacities to be measured.

For example (Figure 5), maximum changes in deflection of M for changes in value of C would result if  $R_x + R_m = 0$ ; however, a breakdown, short or too high a capacity in C would damage the meter, so a resistance is needed to limit the current.  $R_x + R_m$  must therefore be just large enough to limit the current to full-scale deflection in case C was

shorted, or  $R_x + R_m$  should equal  $\frac{E}{I}$  where I = full-scale current required by meter. Since E is fixed at 110 volts, our only way to lower  $R_x + R_m$  is to choose a meter requiring a comparatively large current for full scale.

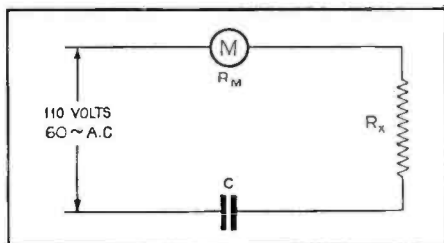

Figure 5

As an example (using approximate values), a Weston No. 476 voltmeter, 0-4-8-150 volts, has a resistance of 10,050 ohms on the 0-150 scale, and using it with no external resistance, a change from 1 to 2 mfd. in C would increase deflection on the 0-150 scale only from 105 to 108, an amount so small as to probably be overlooked entirely.

But suppose we use the 0-8 meter connections with a resistance of 68 ohms (for the meter mentioned), adding 1000 ohms at  $R_x$  to limit our current in case of a short. Now our total resistance is only 1068 ohms, compared with 10,050 in the previous case. (This is because the meter requires 100 ma. for full scale on this tap, where before on the 0-150 tap it only required 15 ma.) Now a change from 1 to 2 mfd. in C produces a change (on 150 scale) of from 56 to 96, sufficient to be easily read.

To calibrate a chart or table, a few known capacities may be checked and meter readings noted, or the readings may be calculated by formulas.

C. C. SCHUDER,  
Pasadena, Calif.

**Improved Method of Antenna Coupling**

One of the difficulties encountered when endeavoring to "gang" the condensers in a tunable radio-frequency amplifier is to so arrange the antenna coupling that the first stage condenser "tracks" with the others throughout the desired range. To compensate for antenna effects on the tuning range of this first condenser, the design of the associated transformer is generally not the same as that of the following transformers and some form of variable connection is

mally used in amplifiers of this type, the presence of L2 and its associated circuit will now have an effect on L1; this effect being to increase the inductance of L1 and change the tuning range of C1 as is shown in Figure 5, curve (B).

Fig. 2 (b) approximates the actual condition of all tunable stages except the first, which must be connected to the antenna and yet have the same tuning range as Figure 2, curve (B), if perfect single-dial control is to be realized.

If an antenna now be connected to this same primary, L2, Figure 3, it will be found that the effect of L2 on L1 becomes much greater since now the inductance and the capacity of the antenna has been introduced in the primary circuit. This effect is shown for short, medium and long antennas in Figure 5, curves (C), (D) and (E).

It is evident that L2 in the first stage cannot be as great as L2 of the following stages, which means that the first transformer requires special treatment in design. Further, only an approximation of the exact tuning range can be made for the first condenser if such transformer differences exist, and this approximation holds for only one antenna condition. By means of taps or auxilliary condensers allowance may be made for antennas of different lengths. Luckily the conditions are not so critical but what approximations may be made with some degree of success.

However, it is possible to eliminate some of the difficulties outlined above by attacking the problem from another angle. Assuming that it would be best, from a design and cost standpoint, to keep the transformers of the first stage the same as the transformers of all the other stages, the primary, secondary and their proximity are then fixed by the result of the general transformer design dealing with selectivity and gain. Going a step further, a variable condenser, C3, Figure

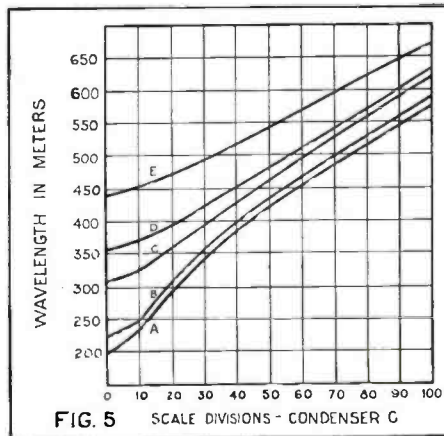
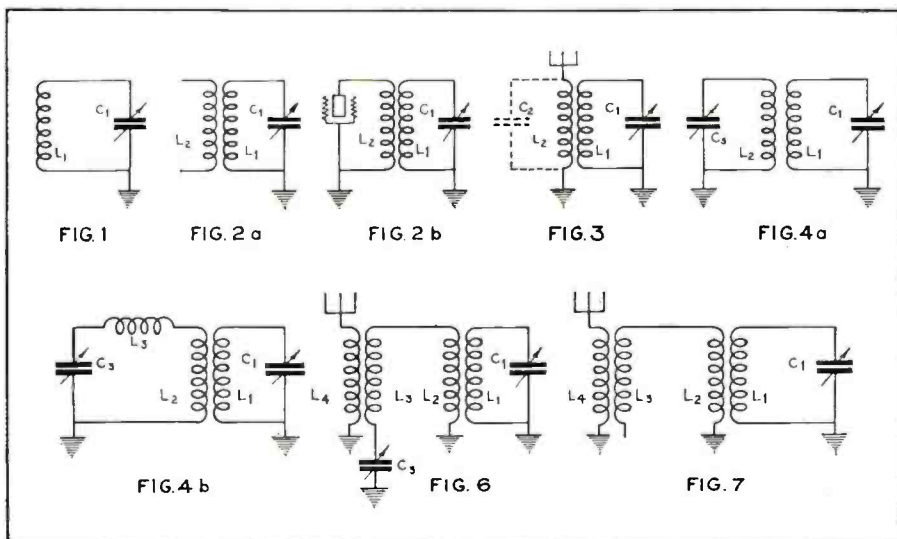

FIG. 5

supplied for antennas of different lengths.

The reason for this change in tuning range is readily found on comparing the characteristics of the primary circuits. Given a simple circuit, as shown in Figure 1 below, a tuning curve can be plotted which depends entirely upon the value of inductance L1, the distributed capacity of the coil, and the maximum and minimum values of condenser C1. Such a curve is shown in Figure 5, curve (A). If a second inductance, L2, Figure 2, representing the usual primary of a radio-frequency transformer, is coupled to L1 and left open-circuited the tuning of curve of C1 will be practically unchanged.



To produce more nearly the actual conditions found in an assembled radio-frequency amplifier the plate and shield grid of a tube may be connected across L2, Figure 2 (b). Assuming a coefficient of coupling between L2 and L1 as nor-

4 (a), may be connected across L2, and if adjusted to the same capacity as that formed by the shield grid and plate within the tube, plus any additional capacity introduced by the connecting leads, the  
(Continued on page 445)

# Backstage in Broadcasting

*Chatty bits of news on what is happening before the microphone. Personal interviews with broadcast artists and executives. Trends and developments in studio technique*

**U**NDER arrangements made by the National Broadcasting Company and Deems Taylor, noted composer, a total of \$10,000 in awards will be made to the five American composers producing the best original orchestral works by Thursday, December 31, 1931. In announcing details of the award. Mr. Taylor asserted that it constitutes, to his mind, "the composer's idea of what a composer award should really be." He explained that anyone who wrote a serious piece of music did so as a luxury. He believes that the large awards offered by the NBC are a material recognition of the merit of musical accomplishment.



Deems Taylor

When Mr. Taylor's plan was accepted by the NBC, he was invited by Merlin H. Aylesworth, president of the chain, to become director of the plan. He accepted and announcement of the proposed awards was made on the air at the close of the Deems Taylor Musical Series.

The completed details of the contest reveal that all compositions must be received by 5 p.m., Eastern Standard Time, December 31, 1931 at the New York headquarters of the NBC. The decisions will be announced on a special program Sunday, February 21, 1932. The compositions will then be played by a symphony orchestra. The composition obtaining the first award of \$5,000 will be played over the combined NBC chains on February 22, 1932—the two-hundredth anniversary of the birth of George Washington. The four remaining awards total \$2,500, \$1,250, \$750 and \$500, respectively.

**D**URING the past two years, Leopold Stokowski, dynamic conductor of the Philadelphia Orchestra — one of the world's greatest symphonic organizations, has been an ardent student of microphone technique for musical broadcasting. With O. B. Hanson, manager of plant operation and engineering, and other National Broadcasting Company executives, Mr. Stokowski made an intensive study of microphone placement and other important technical problems that vitally affect the quality of broadcast presentations. Last season, when the Philadelphia Storage Battery Company, sponsors of the weekly Philco Hours, switched to the Columbia Broadcasting System, it was believed to



By  
**Samuel Kaufman**

be only a matter of time that Mr. Stokowski and the Philadelphia Orchestra would also be heard over that chain. Now, Mr. Stokowski's offerings will be presented over the CBS under the same sponsorship as heretofore. During the 1931-1932 concert season, six full-length programs of the Philadelphia Orchestra under Stokowski's baton will be heard over a 71-station hook-up of the CBS. Officials of the network declare that no symphonic program has been previously broadcast over such an extensive chain. The season's initial presentation has been scheduled for October 12 and the remaining concerts of the series will be heard in November, December, January, March and April. Mr. Stokowski brings to the CBS a splendid musical organization carefully schooled in broadcasting technique. Each of the six programs will last one hour and forty-five minutes. It is likely that a special broadcast during the Christmas season will be presented by the orchestra, thus bringing the series total to seven concerts. Mr. Stokowski again plunged into engineering studies



Leopold Stokowski

during the Summer in an effort to find further improvements for symphonic pick-ups. Mr. Stokowski believes that it is the duty of every symphonic conductor to improve, as far as in his power, the conditions under which his organization broadcasts.

**T**HE Radio Guild offerings of the National Broadcasting Company have, in past seasons, reached unusually high levels for dramatic broadcasts. The presentation of dramatic works before a microphone, without the aid of television's electric eyes, has been very successful despite the seeming handicaps. While original radio scripts are prepared to suit the limited presentation facilities of broadcasting, the production of adapted stage works, through careful handling and direction, have been equally successful over the ether. Under the direction of Vernon Radcliff, the network will present thirty-two plays during the 1931-1932 season. The series will be heard Friday evenings between the period beginning October 9, 1931 and ending April 29, 1932. Five Shakespeare plays will be heard during the season as well as works of Ibsen, Barrie, Shaw, Sheridan, Wilde and others.



V. Radcliff

**S**IXTY-ONE stations of the NBC are conveying the resumed series of Musical Appreciation Hours conducted by Walter Damrosch, music counsel of the network and famous American conductor. This is the largest network yet assigned to the educational series which won considerable attention in scholastic and musical circles the past few years. More than 56,000 instructor manuals were distributed to schools throughout the country to assist teachers in deriving the greatest value out of the broadcasts, which were resumed October 9. Many new features have been included in the manual, including a list of suggestions to teachers regarding classroom reception. These suggestions were prepared by Dr. Will Earhart, director of music in the Pittsburgh public schools, who also serves as chairman of the advisory board for the Damrosch educational series. An orchestral seating plan, a schedule of concert dates, a list of network stations, descriptive notes on all compositions scheduled.

(Continued on page 448)

# The Service Bench

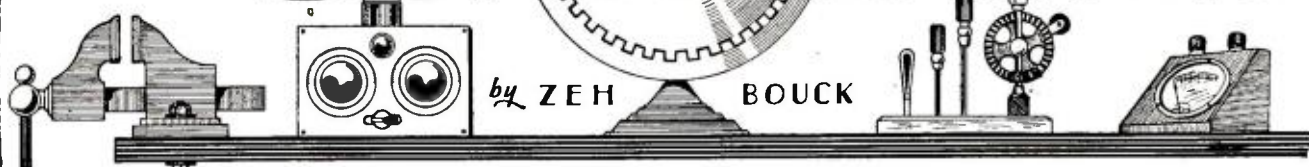

*Money-Making Tips—Direct-Reading Tube-Tester—S-M's—A-K's—Crosley—  
Serviceman Publicity—Extra Loudspeakers—P. A. Correspondence Courses  
—Pointers on Strombergs—Pentode Test Equipment—Service Charge Analysis*

## Tips on the Service Market

**W**ITHOUT the hard work and intelligent effort that spells success in any endeavor, the service business is likely to fall considerably short of even a reasonable success. But there is a comfortable living in it—occasionally leading up the sunny roads to Easy Street—for the radio expert who combines a technical knowledge with an eye for business and the willingness to go after it.

A digest of business stimulating ideas contributed by readers of the Service Bench gives a good idea of what may be done to pep up, not merely the dull season, but to put the cash register bell, for all time, in the category of sustained oscillations.

A semi-rural serviceman points out that in all but the larger cities, the grade and high schools provide a potential market for P. A. systems. The average school auditorium can be handled adequately by a pair of type 50 tubes in push-pull, working into one to three dynamic loudspeakers. In many instances the complete public address systems, offered by several mail-order houses at considerably reduced prices, provide the most simple and profitable method of making the installation. In small towns the firemen's hall is another possibility, and where the Town Board does not care to purchase the equipment outright, the serviceman can invariably rent it for many occasions, from a church picnic to commencement exercises, clearing the cost almost immediately and soon "ringing up the velvet."

In small towns, the active serviceman can generally sell himself to the governing body as official radio and electrical

expert, a proposition that may in time assume the pleasant proportions of a "good thing."

James Knight of Berlin, New York, quit hunting for the end of the rainbow and concentrated on designing a simple form of hotel radio, taking care of from twenty-five to fifty rooms. He sold the idea to the keeper of a suburban hostelry, and then the equipment itself. Transients are attracted to this particular

ting payment, by the installment plan, on the monthly electric light bill. All service calls are turned over to the serviceman, and he receives his pay envelope every month as the accounts are audited. While a certain percentage necessarily goes to the electric light company, the serviceman is definitely insured against bad debts, a depression in itself.

Harry Conrad of Little Falls, New York, has made arrangements with three local building contractors and architects whereby his services are utilized in designing built-in facilities, antenna, ground and loudspeaker outlets and walled-in antennas in new homes. Here are three business letters which, properly addressed by the service shop, are worth a lot more than their weight in postage:

"My dear Mr. ———: Have you had your radio installation checked to see if it conforms with the requirements of the board of fire underwriters and your fire insurance policy? Very few installations pass these requirements and automatically void insurances in the case of fire traceable to the electric wiring. The matter may even be brought up and the insurance contested when the fire is due to causes in no way associated with your radio!

"We should be glad to look over your installation, and, if necessary, make such changes as will safeguard your property and protect your insurance. The cost will be nominal, and it may save you thousands of dollars."

"Yours for safety,  
....."

Taking a tip from the automobile service stations: (Continued on page 425)

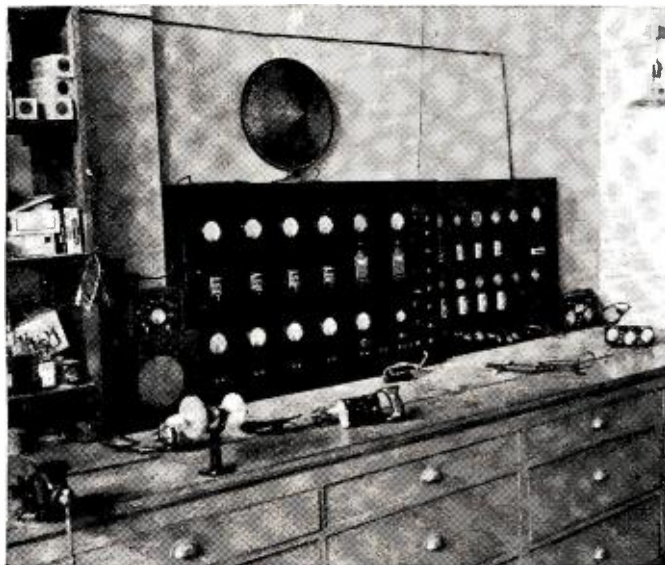

A MODEL SERVICE SHOP

Figure 1. Exemplifying three aids to successful servicing—a clean bench, motor-driven tools and adequate test equipment. The service station of the A. C. Radio Shop, Arkansas City, Kansas

hotel, not so much by the radio-in-every-room idea as by the fact that an establishment that features so modern an idea undoubtedly provides other facilities of comparable convenience.

A serviceman in a small Carolina town has made arrangements with the local lighting company whereby they accept the responsibility for servicing radio receivers operated from their lines, permit-

## All in a Day's Work

### QRN in Silver-Marshalls

From the notebook of James H. Mills, authorized S-M dealer in South Haven, Michigan:

"I have found two causes for noise in the Silver-Marshall 750 and 760 sets. The first was on a 760 chassis and was traced, after an hour of testing, to the filter condenser block mounted below the base of the dial. The ground wire of the condenser block was grounded to the base of the dial. In ninety-nine cases out of a hundred this would have been all right, but this was the hundredth. It is true that the dial was grounded but only through the usual rolling contact to the condenser shaft. This rolling contact was the noise producer. A wire direct to the chassis cured the trouble.

"Here is a fault in a 750 chassis which cannot be found with the best of set testers. By touching the dial or by walking across the floor in front of the set, noise was produced in the speaker which suggested a loose or broken connection. I removed the chassis and could find neither a loose nor broken wire anywhere. The set tester showed everything okay. However, the trouble started again when the chassis was returned to the console. Nothing was found wrong after removing the chassis a second time. Then I kept the set working while placing it back in the console. The noise started just as soon as I put the escutcheon plate in place. The cause of the noise was a short between the volume control and the dial shaft. A new volume control had just been put in. The volume control on these sets is a potentiometer using the center and one outside tap across aerial and ground. The aerial was connected to the center or ground tap and when the escutcheon plate was in place it shorted the antenna to the dial shaft. Reversing the connections on the volume control did the trick.

### Tone Compensation on an A.-K.

On our next jaunt we look over another Atwater Kent, this time serviced by Nelson E. Grubbe, of Eutaw, Alabama—the state that first came into the radio limelight by casting twenty-four votes for Underwood. Mr. Grubbe remarks on the tonal characteristics of the Models 55 and 60.

"The F4 loudspeaker, which is made of metal, gives a better response to the high notes, such as the crackle of static and Schott Effects, or the high-pitched whistle of heterodyne interference, than the type F4C, which uses a wooden baffle. It is possible to compensate the tone selection of the former type by connecting a small fixed condenser across the grid terminals of the tubes in the push-pull audio stage. Try different values of capacity between .0005 and .005 mfd. About .001 is a good average. The higher the value of the condenser, the more the high frequencies will be attenuated, the effect being the emphasis of the bass."

Mr. Grubbe's idea is an old one. It

has been practiced for many years, and many amplifying transformers have integral small capacities connected across the windings. But the scheme works and is quite practical in many instances, and we pass it on for the benefit of those to

## How to Cure Radio Noises

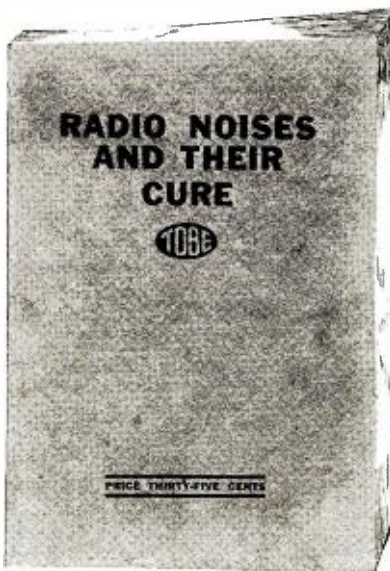

**R**ADIO NEWS takes pleasure in offering, through the courtesy of the Tobe Deutschmann Corporation, and without charge to its bonafide servicemen readers, this 96-page book on Radio Noises and Their Cure. This is undoubtedly the most complete discussion of "man-made static" that has ever been published. It tells how to identify different types of interference by the nature of the sound, how to track it down and how to effect a remedy.

To obtain your copy of this book, simply write a request on your letterhead, or enclose your business card to indicate that you are actively engaged in the design, engineering or servicing of radio equipment. Include 5c in postage to cover the cost of mailing and a copy of the book will be sent to you immediately. Address your request to RADIO NEWS, Department T, 350 Hudson Street, New York City.

whom it may be new.

Our last service call for the day, in the good company of Jack Howard of Lafayette, Mo., is in response to an SOS from the owner of a

### Crosley Showbox

who complains of a bad hum. Mr. Howard, being, as you note, from Missouri, delves into the matter with typical skepticism, and discovers that in turning the set over the hum ceases. He finally determines that the only part of the set that needs to be inverted to eliminate the hum is the Mershon condenser. This is left upside down pending the arrival of a new unit.

### Publicity for the Serviceman

F. J. Harriman, of the Harriman Radio Service, Appleton, Wis., remarks on the excellent results he is securing from publicity, advertising and general circularization. Properly approached, your local editor is glad to give publicity to any home town industry. The way to publicity may be readily paved by favors, occasional advertising, and a news slant on local radio activities.

The local serviceman will find it worthwhile to co-operate with his town newspaper in the installation of equipment for the reception of World Series reports and other sporting events achieving national broadcast. Such equipment need merely be loaned for the occasions.

The following events make good local news copy:

The purchase of a particularly elaborate receiver by a prominent citizen.

Announcement of direct short-wave reception of some international broadcast.

The installation in the fireman's hall, school or church, or merely in front of the radio shop, of loud speaking equipment for the audible broadcast of election returns or other important events.

Brief descriptions, emanating from the local expert, of new radio inventions and developments.

Remember that while it pays to advertise, nothing pays like publicity!

### Building Up Trade With Extra Speakers

George Foley, specializing in Atwater Kent and Silver-Marshall service in Ottawa, Canada, sees remunerative possibilities in merchandising extra loud speakers.

"I have disposed of quite a number of second-hand magnetic speakers (taken as trade-ins) as well as several new ones and a half dozen or so dynamics, by convincing my customers that an extra loud speaker could contribute to their radio pleasure. These have been installed everywhere from a den in the attic or cellar to the maid's room.

"The electrical connections are fairly simple and obvious. Magnetic speakers are generally wired in a simple series arrangement, while the dynamics are connected in parallel, at the voice coils, or some other point where the impedances

(Continued on page 426)

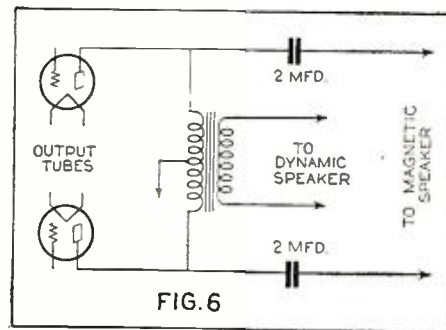

Figure 6. A simple method of connecting a magnetic speaker to a dynamic hook-up. Either speaker may be operated, or both may be used simultaneously.



## Direct Reading Tube Tester

By Carl J. Penther

IT may be said without fear of contradiction that the most important single item in a radio set is the vacuum tube. It is of major importance to the radio dealer and the service-man because a third of the entire radio business in this country is the sale of tubes, and the majority of service calls are likewise for the replacement of defective tubes.

### Importance of Tube Testing

The vacuum tube of today is a standardized product. The type -45 of one manufacturer is designed to have the same characteristics as that of any other reputable manufacturer. This is as it should be, because the nicety with which the modern receiver is built demands that tubes of like characteristics be used for the best results.

The three things of importance to consider when selling tubes are:

1. Sell only the nationally advertised brands.
2. Test them at the time of sale.
3. See that they are operated under the correct conditions.

In selling nationally advertised tubes, you are reasonably certain that the manufacturer is reliable and has sufficient resources to keep his product up to the latest development of the art.

The test of the tubes at the time of sale assures the buyer that he is getting a good tube, and therefore he can expect natural life and normal results.

pect natural life and normal results.

Seeing that tubes are operated under the correct conditions of plate and filament voltages will also insure the user of normal tube life. It is well known that even a slight excess filament voltage shortens the tube life, and a low voltage gives rise to audio distortion and other undesirable reception effects.

The fulfillment of the second condition requires a device whereby the tube may be tested for characteristics which determine its quality. It is the purpose of this article to describe such a device.

While this tester is similar to many of those on the market, it has the unique feature of being direct-reading. That is, the type -71 tube has a definite scale marking, as has the -45 type and all the others.

The scale for the meter used in the set constructed by the author is shown in Figure 2. This illustration is reproduced to give a general idea of the scale, rather than for exact copying. The scale will be determined by the voltages and values of resistors used.

As the mutual conductance is the best criterion for the general condition of a tube, the present tube-tester gives an indication of this value. It will be recalled that the mutual conductance is defined as the increment change in the plate current per increment change in grid voltage, or the slope of the grid-voltage plate-current curve. An indication of this may be best obtained by changing the bias from one definite voltage to another while the plate and filament potentials are held constant. In this tester the tubes are self biased, a part of the biasing resistor being shorted-out for the test.

A single dry-cell and a 2000-ohm variable resistor are placed around the meter in such a manner as to balance out the normal plate-current of the tube. When a tube is placed in a socket, the resistor is adjusted so that the meter reads zero. Upon pressing the test button (shorting part of the bias resistor) the reading is a direct indication of the mutual conductance of the tube. *The meter scale may be calibrated by testing a number of good tubes of each type and taking the average values.*

A device of this kind is particularly useful as counter equipment, for the customer can actually see that the tube he is purchasing gives the proper indication on the tester—showing that it is a good tube. The time required to adjust the needle to the zero reading is negligible.

Another feature of this tester, the circuit of which is shown in Figure 3, is the fact that both plates of the type -80 rectifying tube can be tested without the

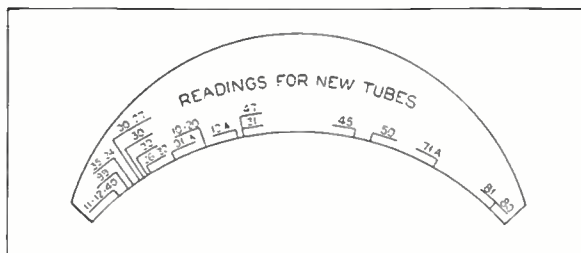

THE DIRECT READING SCALE

Figure 2. This is the scale as calibrated and drawn by the author

use of an adapter. This test is quite useful, as it occasionally happens that one plate will be good and the other poor, resulting in an excessive hum which cannot be eliminated in the usual way. This test is effected by pressing a button which transfers the meter and plate supply from one plate to the other.

A push-button is provided for testing screen-grid tubes and power pentodes (using the regular pentode adapter). This switch connects the screen grid to the plate and transfers the control-grid circuit from the socket to the flexible lead. The switch takes care of both four and five-prong sockets, thus taking care of both d.c. and a.c. screen-grid tubes.

The range of the meter, normally, is one hundred milliamperes, but is reduced to twenty milliamperes by another push-button switch.

The filament transformer was constructed on the core of an old audio-frequency amplifying transformer. The design was quite liberal, ten watts dissipation being the power for which it was designed. However, as it is in use for only short periods of time, it may be made somewhat skimpy in order to save space. If the core has a cross section of between 3/4 and 1 square inch, 10, 9 or even 8 turns of wire per volt will be safe. The primary may be wound with number 30 enameled wire. Number 18 for the secondary is heavy enough for the greatest current to be drawn for short periods.

It will be noted from the illustrations that the unit is quite compact, measuring only 5 1/2 inches by 9 inches by 3 inches, and that the arrangement of the parts is such as to make the operation as simple as possible.

As is usual in an article of this kind, no layout or specifications are given, as the individual builder always has his own  
(Continued on page 430)

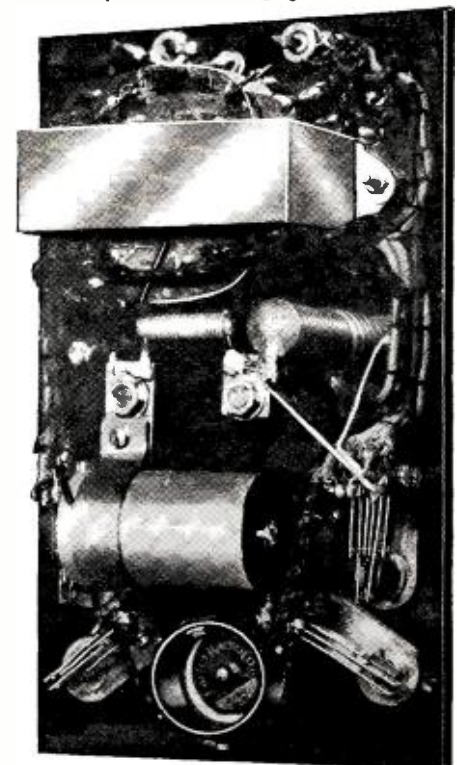

BEHIND THE PANEL

Figure 4. The arrangement of parts in this compact tube tester is clearly shown





# Radio Science Abstracts

*Radio engineers, laboratory and research workers will find this department helpful in reviewing important current radio literature, technical books and Institute and Club proceedings*

*Drake's Radio Cyclopedia*, by Harold P. Manly. Published by Frederick J. Drake and Company. This is the fourth edition of a book which aims to be a practical reference work for the ordinary radio experimenter by presenting useful information on all units and circuits found in radio. It defines the various units, describes their use and construction and tells the manner in which they are ordinarily used in radio receivers. The text is arranged alphabetically to permit ready reference; cross references permit the reader to delve further into any particular subject.

The lengthy treatment which the book gives to practical problems and the somewhat abbreviated manner in which it covers technical information is advisable considering the scope and purpose of the book; it aims more to aid those requiring practical knowledge than those in search of technical information. For this reason we usually find formulas written with words rather than with symbols.

*Drake's Radio Cyclopedia* is a book which should prove useful to the radio experimenter who is interested, not so much in accurate information on how things really work as he is in practical data on the arrangement of various types of receivers; what parts to use for various purposes and where to look for trouble. Past editions of this book have enjoyed a wide sale. There is no reason why this newest edition should not be just as popular.

*The Radio Manual*, by George E. Sterling. Published by D. Van Nostrand Company, Inc. This manual, prepared to serve as a guide and text to those who expect to enter the radio profession, gives essential, technical and practical data on all types of radio equipment. The first part of the book is devoted to elementary electricity and sources of power. Following chapters discuss the theory and application of the vacuum tube and the circuits in which vacuum tubes are employed. Various types of transmitters and modulating systems are described, including those used for aircraft, marine, and broadcasting. Considerable information is also supplied on amateur short-

## Conducted by Howard Rhodes

wave apparatus, and chapters devoted to these subjects include information which, if carefully studied, will enable the student to pass the technical examination required to secure any type of radio-operator's license.

The book, as its name implies, aims not so much to be a textbook as a technically accurate reference work on radio theory and practice.

### *Review of Articles appearing in the September, 1931, issue of the Proceedings of the Institute of Radio Engineers*

*Some Characteristics of Thyratrons*, by J. C. Warner. This article discusses in a general manner the characteristics of thyratrons. The tube contains three elements but differs from an ordinary tube in that the bulb contains a small amount of gas or vapor. The ionization of the vapor at a certain critical voltage (about 15 volts for mercury) neutralizes the space charge and this leads to two important results. First: above the critical ionization voltage the current is limited only by the impedance of the external circuit, provided, of course, that the electron emission is ample. As a result the voltage across the tube is practically constant for any amount of current.

The second effect of space charge neutralization is that it becomes unnecessary to have the cathode open and exposed to the field of the anode, as in a high vacuum tube. This makes it possible to place heat reflecting shields around the cathode and thereby increase the emission efficiency. While an open cathode may be expected to give a useful emission-efficiency of 100 milliamperes per watt, a heat shielded cathode, with internal tungsten heater, will supply current of more than 1 ampere per watt.

The fundamental characteristics of the thyatron may be summarized as follows:

1. As in ordinary tubes the power controlled is much greater than the power expended in the control circuit.
2. The current in the plate circuit may be started by a change in grid voltage but cannot be stopped by a change in grid voltage.
3. With a.c. on the plate the average plate current can be controlled exactly.
4. The voltage drop across the tube is low and essentially constant.
5. The cathode efficiency is very high.
6. The plate current is unidirectional except for small deionization currents.

Thyratrons are at present made for control of average currents ranging from  $\frac{1}{2}$  ampere up to 100 amperes; the instantaneous currents are usually from four to six times the average. The voltage limits range from 1000 to 15,000 volts.

*Twenty-Watt Aircraft Transmitter*, by A. P. Bock. A transmitter for aircraft, employing c.w. signals only, that is unusually effective in performance and economical in operation. By means of a special method of screen-grid modulation phone signaling can be provided for use when phone signaling is most needed—namely, when flying in the vicinity of airports—with almost negligible additions to the c.w. transmitter. When flying on regular courses, c.w. is rapid enough; such signals remain one hundred percent intelligible under conditions which would be near zero-intelligibility for the same power phone signal.

*Some Acoustical Problems of Sound Figure Engineering*, by W. A. MacNair. The purpose of this paper is to point out that many advances in acoustical engineering have been necessary in order to control adequately the condition under which sound pictures are recorded and reproduced. The sudden and successive changes in sound intensity level to be expected in a room during the growth and decay of sound from an intermittent source are pointed out. The paper gives a general reverberation-time formula which must be used when dealing with comparatively "dead" rooms. Until recently the formula used to calculate reverberation time was

$$T = \frac{0.05V}{a} \frac{0.05V}{S \alpha_a}$$

where T is the reverberation time in seconds  
V is the volume of the room in cubic feet.  
a is the number of absorption units in square feet.

S is the surface of the room in square feet.  
 $\alpha_a$  is the average coefficient of absorption of the surface.

Using this formula discrepancies mounting up to fifty percent were found between the calculated and measured reverberation times. The formula was found accurate for "live" rooms, but is not applicable to "dead" rooms. A more general formula, applicable to all types of rooms, has been developed. It is

$$T = \frac{0.05V}{-S \log(1 - \alpha_a)}$$

*The Propagation of Short Radio Waves Over the North Atlantic*, by C. R. Burrows. Many measurements on radio transmission at various high frequencies have indicated that those near 18 mc. are best for daytime transmission. In summer the best frequencies for night transmission are those near 9 mc. In winter an additional frequency near 6 mc. is required during the middle of the night. A frequency (such as 14 mc.) intermediate between the day and night frequency is useful during the transition between total daylight and total darkness over the path. The paper indicates that the effect of solar disturbances on short-wave transmission is to reduce reception on all frequencies although the higher frequencies are sometimes the more adversely affected.

*Use of Automatic Recording Equipment in Radio Transmission Research*, by P. A. de Mars, G. W. Kenrick, and G. W. Pickard. This is an apparatus paper describing equipment recently developed for low frequency (17.8 kc) intermediate frequency (770 kc) and high frequency (7415 kc) field-intensity recording. The circuits employed are presented and discussed with particular reference to expedients for obtaining nearly logarithmic scales (when used with Leeds and Northrup recording potentiometers).

Typical records obtained with the aid of the equipment described are presented and the salient characteristics of the high-frequency records (which show striking evidences of skip distance phenomena) are pointed out.

*A Course Indicator of Pointer Type for the Visual Radio Range Beacon System*, by F. W. Dunmore. A form of tuned-reed, range-beacon course-indicator is described, called a reed converter, in which the course indications are not given by observing the two reed motions as heretofore, but by means of a zero-center, pointer-type indicating instrument. The motion of the two reeds generates small alternating voltages, which when rectified by oxide rectifiers and passed in opposing polarities through a zero-center indicating instrument, serve to give course indications by the deflection of the indicating instrument needle in the direction of deviation of the airplane from the course.

*Radio Tracking of Meteorological Balloons*, by W. K. Blair and H. M. Lewis. There is a need for upper-air meteorological observation at night as well as in the daytime, in cloudy and in foggy weather as well as in clear. This need has given rise to a number of interesting methods for obtaining these data, among them radio tracking of meteorological balloons. A free balloon moves in the air current prevailing at the level it occupies. A small rubber balloon, six inches or less in diameter, when inflated

with hydrogen to a given excess-lift will rise at a given ascensional rate to great heights. Successive determinations of the position of one of these pilot balloons provides ready means for computing the mean direction and speed of the wind in the layer of air through which the balloon has risen during the interval between determinations of position. On clear days these balloons have been followed by visual methods to heights of 20 miles.

This paper deals with a radio method of determining successive balloon positions. A light transmitter, weighing about a pound, is carried up by the balloon at a known ascensional rate. Loop receivers are employed in ranging for this transmitter. The whole project involves the determination of air temperature aloft as well as air movement.

### Review of Contemporary Periodical Literature

*Duplex Phone on 50 Mc.*, by Ross A. Hull. QST, August, 1931. A description of a complete phone transmitter designed to operate on 56 mc. The entire unit is mounted in a small aluminum box. Two type -71-A tubes are used for oscillators and two type -47 pentodes for modulators. The article includes complete constructional data together with notes on the results obtained.

*A Linear Time-Axis for a Cathode-Ray Oscillograph*, by A. L. Samuel. Bell Laboratories Record, August, 1931. The usefulness of the cathode-ray tube is extended if one of the pair of plates is used to supply a linear time-axis so as to make the image indicate, directly, the wave form. In the past various systems have been used to obtain a linear time-action, one of the commonest being a glow tube in conjunction with resistances and condensers, to vary the timing. The objectional features of this

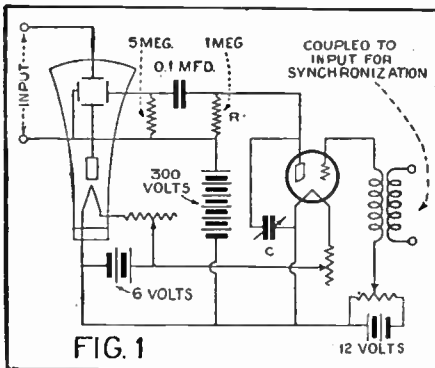

circuit has been the inconveniently high voltages at which such tubes operate and to the fact that the characteristics of the tube could not be accurately controlled. For these reasons a new three-element, hot-cathode type tube has been developed, which makes it possible to control the timing very accurately and to maintain a constant relationship between the timing frequency and the frequency of the phenomena being measured. Figure 1 shows the circuit arrangement used with this new tube. It will be noted that the grid of the tube is coupled to the source being studied, the coupling being sufficient to maintain synchronism between the timing voltage and the voltage being studied.

*Measuring the Frequencies of Radio Signals*, by A. A. Roetken. Bell Laboratories Record, August, 1931. An instrument has been constructed capable of measuring frequencies in the range of 5-million to 30-million cycles with an accuracy of better than three parts in a million. The apparatus is simple to operate and after the

proper controls have been manipulated the desired frequency is displayed as a number in a bank of switchboard lamps. The instrument operates on the fundamental principle of producing gradually lower beat-frequencies until one is obtained which can be measured with high precision by comparison with an electric oscillator.

*What Is This Thing Called Decibel?*, by James L. McLaughlin and James J. Lamb. QST, August, 1931. A good practical yarn on the decibel, where it started, why it's here and what it's used for. Besides explaining the significance of the decibel by means of charts, the article shows how the db can be put to practical use in connection with problems of radio experimenters.

*Single-Tracking the Superheterodyne*, by F. I. Anderson. QST, August, 1931. The author discusses the problem of making the tuning and oscillator condensers of the superheterodyne keep in step. He describes, in some detail, the system which is now to be found in some manufactured receivers utilizing a semi-fixed condenser in series with the oscillator tuning condenser. By adjusting this series condenser to the proper size and by using the proper inductance coil the tuning and oscillator condensers may be made to track quite accurately throughout the entire range.

*An Inexpensive Constant-Temperature Crystal Oven*, by Louis F. Lauman, Jr. QST, August, 1931. For most accurate frequency control, using quartz crystals, it is necessary that the crystals be mounted in a heat-insulated box with its temperature accurately controlled by a thermo-regulator. The author describes how for \$15 one can build a complete insulated box (with thermostat) that will hold the temperature constant within about 0.25 degree centigrade.

*Application of Piezo-electric Crystals to Receivers*, by R. R. Batcher, Electronics, August, 1931. The author here discusses the application of quartz crystals to receiver circuits. The circuit is analyzed in terms of a bridge circuit of which the crystal and its holder form one arm. The analysis is of course particularly applicable to the stonode circuit in which a crystal system is used.

*Solving Network Problems by Graph*, by W. Waterman. Electronics, August, 1931. This article includes a large decibel chart useful in solving transmission problems. The author gives several typical examples of how the chart can be used. The chart and the accompanying description will prove useful to those who make general use of the decibel in connection with measurement work.

*A Rapid-record Oscillograph*, by A. M. Curtis and I. E. Cole. Electronics, August, 1931. A new oscillograph has been developed by the Bell Telephone Laboratories. It is of the "string" type, the galvanometer elements being duralumin wire, 0.008 inch in diameter. They are mounted in a strong magnetic field and when an a.c. current passes through the string it vibrates in accordance with the wave-form of the current. Unlike most ordinary vibration-type oscillographs this new unit can be used on frequencies up to 9000 cycles. It is used in conjunction with an associated amplifier and the amplifier characteristic is such as to compensate partly for the frequency-characteristic of the galvanometer. By this means and by the use of additional equalizing circuits the galvanometer is made uniformly sensitive to a wide range of frequencies.  
(Continued on page 444)

# Radio Physics Course

*This series deals with the study of the physical aspects of radio phenomena. It contains information of particular value to physics teachers and students in high schools and colleges. The Question Box aids teachers in laying out current class assignments*

**A**LL component parts and instruments used in radio have an electric circuit of some conducting material and most of them have either a magnetic circuit in air or some magnetic material, or electro-static circuit in air. Such instruments as loudspeakers, condensers, choke coils, transformers and resistors used in radio receivers, depend on the proper use of electricity for their operation. Radio waves manifest their actions by magnetic and electro-static fields. It is, therefore, desirable that students of radio learn something about the nature of electric current and magnetism, the properties of electric and magnetic material and the laws governing such action, in order that they may understand the design, operation, servicing and use of radio apparatus. In a complete radio system, we are dealing with almost every form of electricity known to science.

Another important consideration which is too often overlooked is the fact that the student who thoroughly understands, and has a good mental picture of the fundamental actions associated with the flow of current and magnetism is excellently prepared to keep abreast of all the new developments which are coming almost daily in the radio art. He finds that the new things are merely new adaptations and arrangements of the fundamental principles he is already familiar with, and he is usually able to quickly understand their operation and apply his fundamental knowledge to practical use.

Since the most recent scientific discoveries and investigations in science indicate strongly that the manifestations of electricity and magnetism are really due to actions of tiny electrical charges called electrons, it is necessary that our study of these two important servants of man be preceded by a study of the behavior of the electron.

### Use of Electron Theory

The flow of electricity through a wire is always a very puzzling thing to the novice, possibly because the action is not directly visible to the naked eye. However, by making use of the information brought to light in recent discoveries, and employing our powers of imagination and visualization, a rather complete picture of what goes on inside the wire can be presented. Many theories have been advanced to explain the reasons for the observed behavior of electric currents. The one most commonly accepted at present, because it explains the observed actions most satisfactorily and completely, is the *electron theory*. The student is reminded here, that the electron theory is simply an explanation of these things which fits and explains most of the observed facts. It has not been definitely proven in its entirety, for then it would have become a *law* of science. It does, however, explain more satisfactorily and more thoroughly than any other theory thus far presented, the observed behavior of the flow of electric

By Alfred A. Ghirardi\*

### Lesson Four

## The Electron Theory, Generation of Electric Energy Conductors and Insulators

current, magnetism and electromagnetic waves and for this reason has been extensively adopted in scientific circles.

### Electrical Charges

The word "electricity" is derived from "electron," the Greek word for amber. The early Greeks discovered that amber, when rubbed, would attract bodies of light weight. As no satisfactory explanation was forthcoming, at that time the action was looked upon as being rather mysterious.

Benjamin Franklin investigated this phenomenon of the electrical action of various substances and combinations of substances when rubbed together. For instance, a piece of glass, when rubbed with a

piece of fur or a cloth became electrified and would attract light objects. (This experiment may easily be repeated by the reader by rubbing an ordinary hard rubber comb, rubber rod, or fountain pen with a piece of silk or flannel cloth. The comb will then attract small pieces of paper, or balls made from the dried pith of the elder bush, as shown in Figure 1.) As a result of his work, Franklin concluded that there are two kinds of electrification, or "electricity," *positive* and *negative*. Bodies that behave like the rubbed glass rod, he said, possessed *positive* electricity, and those behaving like the rubbed rubber rod, possessed *negative* electricity.

After an insulator like hard rubber or glass has been electrified by rubbing, or some other means, the electricity does not move through it as it does in an ordinary conductor like copper, but remains at rest in the form of a stationary (static) charge. The electricity remaining at rest in an insulator is called a *static charge*, *static electricity*, or just an *electrical charge*.

### Laws of Electrical Charges

It has been determined by experiment that a field of force exists around every charged body, and that like charges repel each other, and unlike charges attract each other.

Thus a negative charge attracts a positive charge.

Two negative charges repel each other.

Two positive charges repel each other.

The more highly charged the bodies are, the greater is the force of attraction or repulsion between them. The closer together they are, the greater is the force of attraction or repulsion. The force is directly proportional to the strength of the charges and inversely proportional to the square of the distance between them. Thus tripling the distance between the two charged bodies makes the force of attraction or repulsion

$$\frac{1}{3^2} \text{ or } \frac{1}{9} \text{ as great.}$$

A single body on which there is an equal amount of positive

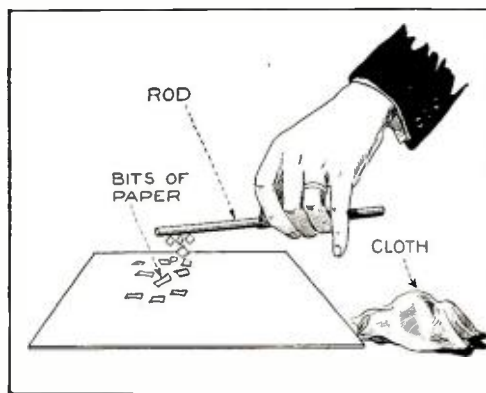

FRICITIONAL ELECTRICITY

Figure 1. A glass or rubber rod, electrified by rubbing, attracts bits of paper and other light objects

\*Radio Technical Pub. Co., Publishers, Radio Physics Course.

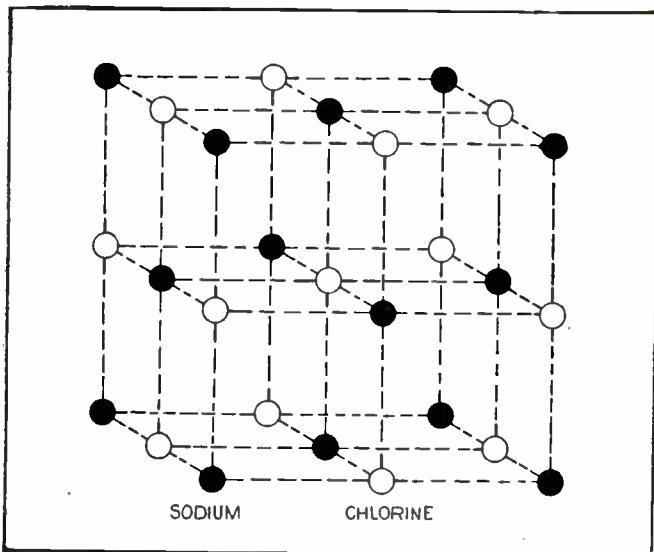

A MODEL MOLECULE

Figure 3. Arrangement of the atoms in sodium chloride. The black spots represent sodium atoms and the white spots chlorine atoms.

and negative charge is said to be neutral, or in equilibrium. If a single body has an excess of either positive or negative electricity it is said to be charged either positively or negatively.

An understanding of the actions between electrical charges is important in radio work, for it has direct application when considering the design of condensers, vacuum tubes, hand capacity effects in tuning, etc.

Charged bodies may be studied by the simple apparatus shown in Figure 2. A small piece of paper or a piece of pith from a dry cornstalk, elder or sunflower stalk is suspended from a stand by a short silk thread. The stand should be well insulated from the table by a sheet of clean glass or other good insulator. Stands for the purpose are made with a glass rod for a shaft.

The forces of attraction or repulsion between charged bodies may be considered to act along imaginary lines called *electrostatic lines of force*. The sum total of the lines of force around a charged body constitutes the *electric field*. Every charged body is surrounded by such a field.

**Matter and Molecules**

The word "electron" is generally familiar and is usually understood to represent a very small particle of matter. Beyond this very elementary conception the average person's ideas on the subject are vague and usually altogether too confused to be useful to him.

Let us consider *matter*. Matter is any substance having weight, volume and other physical characteristics. The water

we drink, the clothes we wear, the earth we live on, the air around us, our bodies, all constitute matter. It has been found that all matter really consists of numerous very tiny particles instead of single large chunks. The smallest possible portion to which a substance (compound) can be divided, and yet retain all its individual characteristics is called a *molecule*. The molecule is too small to be visible even under the most powerful microscopes we have, due to the grossness of our sense of sight. The smallest portion of matter we can see under even the most powerful microscope still contains several hundred molecules.

**Compounds, Elements, Atoms**

Those readers who have already studied physics or chemistry will remember that there are 92 different chemical elements on the earth, from which all matter in this world is made up. Among the more common are oxygen, hydrogen, gold, silver, copper, iron, etc. An *element* contains nothing other than the single material itself. The smallest particle of an element is an *atom*. Single elements such as the above are common in our daily lives, but most of the substances and materials with which we are familiar, consist of a chemical combination of the atoms of two or more elements to form a new substance or *compound* whose physical and chemical properties are entirely different from those of any of the constituent elements. Examples of common compounds are table salt (sodium and chlorine), iron rust (iron and oxygen), water (hydrogen and oxygen), etc. The smallest portion into which a compound can be divided without splitting it up into its element atoms is called a *molecule*. Of course if a substance is a simple single element, then its molecules and its atoms are identical. The term *molecule* is usually associated with compounds, whereas *atom* is associated with the elements.

In general each molecule of a compound is made up of two or more smaller atoms of the simpler elements entering into its composition. The properties of a compound prove to be due to the particular way in which the atoms are architecturally grouped. The strength and elasticity of metals, their power of conducting electricity, heat, etc., can be explained in terms of their structure as it is revealed by the actions of X-rays upon them. Much experimental work on the determination of the arrangements of atoms in substances has been carried on by means of X-rays by Sir William H. Bragg and Prof. W. L. Bragg. It is thought that the atoms arrange themselves in regular geometric forms, which in some substances are extremely complicated. Figure 3 shows the structure or arrangement of the atoms of sodium and chlorine as they are thought to appear in sodium chloride (ordinary table salt).

The innumerable possible combinations of the 92 chemical elements explain why it is possible for us to have so many different kinds of materials in existence today. Thus two atoms of the element hydrogen will combine with one atom of the element oxygen to form each molecule of a new substance, water. The chemist uses a special simplified method for expressing this elementary combination of atoms, thus

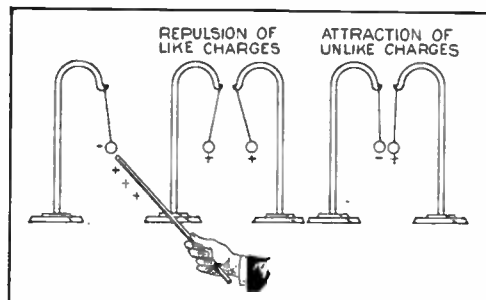

ELECTROSTATIC FORCES  
Figure 2. Demonstrating the attraction and repulsion of charged bodies hung on silken strings for insulators

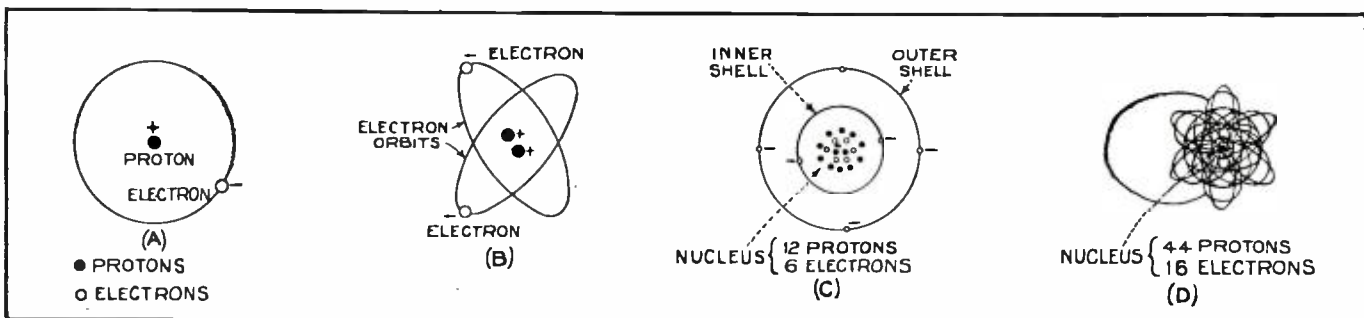

**"BOHR" CHARTS OF REPRESENTATIVE ATOMS**

Figure 4. Structure and electron orbits of atoms of hydrogen, helium, carbon and copper, according to Bohr. The hydrogen atom is the simplest, containing a single proton for the nucleus around which rotates a single electron.

$H^2 + O = H^2O$ . One atom of sodium combines with one atom of chlorine to form each atom of sodium chloride (common table salt); thus  $Na + Cl = NaCl$ . The salt does not look, taste, or act like either of the two constituent elements. It is a new material entirely. Hydrogen and chlorine are both gases under ordinary conditions; salt formed by their chemical combination is a solid. Figure 3 shows the arrangement of the atoms in salt. The black spots represent the atoms of sodium and the white ones represent the atoms of chlorine as they are arranged inside of a crystal of the salt.

### Electronic Structure

Molecules are extremely small, so small that we cannot see them with the lenses of the most powerful microscopes. Lenses are themselves composed of molecules and atoms. To see molecules, the lenses and our eyes themselves would have to become molecular in size. Still, the empty space between the molecules of a substance is thousands of times greater than the space actually occupied by the molecules themselves! A molecule, however, is a relatively huge affair compared to the size of an atom.

Every atom consists of a miniature planetary system with a central nucleus or "sun" around which constantly revolve in regular orbits, one or more tiny particles or planets. This is somewhat like our solar system, of the earth, sun, and moon. The nucleus or core of each atom contains one or more particles called *protons*; each proton having a definite positive electrical charge. The little bodies revolving around the nucleus were called *electrons* by Johnston Stoney in 1891 because of their electrical nature. These electrons are simply infinitesimally tiny *negative* electrical charges. The number of negative electrons revolving around the central core or nucleus of each atom varies in the different chemical elements. Also the number of positive protons in the nucleus is different in each chemical element. In some elements the nucleus consists of both protons (positive charges) and a few electrons (negative charges) with additional electrons revolving in concentric rings around the core, as shown in C of Figure 4. The latter revolving electrons are commonly called *planetary electrons* to distinguish them from the electrons which remain in the core. Under normal conditions each atom is electrically neutral as a whole, that is, the sum total of the negative charges of all its electrons just balances and equals the total positive charge of its protons. Under this condition the body is uncharged electrically, so far as any outside effects are concerned.

It is evident then, that according to the electron theory, the final analysis of all elements and compounds of which all matter is composed, reveals them to be made up of but two things, positive electrical charges known as protons, and negative electrical charges known as electrons. The atom is pictured as a core or nucleus of positive charge (with a few electrons in it, also, in some elements) surrounded by a number of negative electrons rapidly rotating in circular or slightly elliptical orbits which form more or less concentric rings around it. The atoms and the molecules in matter are constantly in motion, carrying within them in their movements, the electrons that constitute them. In the bumping of one atom against another, electrons may be gained, lost, or interchanged.

The simplest of all atoms is that of hydrogen (one of the constituent elements of water). This consists of a nucleus composed of one revolving proton, around which rotates a single planetary electron as shown in A of Figure 4. The circle indicates one of the several orbits the moving planetary electron may take.

The next simplest atom is that of helium (the gas used in lighter-than-air craft), having a rotating nucleus of two positive protons with two electrons revolving about it as shown in B of Figure 4.

In those atoms which contain more than two planetary electrons all those planetary electrons in excess of these first two are arranged in shells external to the one just described. The next (Continued on page 440)

## Question Box

PHYSICS and science instructors will find these review questions and the "quiz" questions below useful as reading assignments for their classes. For other readers the questions provide an interesting pastime and permit a check on the reader's grasp of the material presented in the various articles in this issue.

The "Review Questions" cover material in this month's installment of the Radio Physics Course. The "General Quiz" questions are based on other articles in this issue as follows: What Goes On in Your Vacuum Tubes, Fractional Wave Tests, Experimental Reception on The World's Tallest Structure, Electro-Acoustic Studies Offer Aid for the Hard of Hearing, The Decibel, Clearing up Discrepancies in Electrical Measuring Units, With the Experimenters.

### Review Questions

1. Why is it important for a student of radio to have a good knowledge of the fundamentals of electricity and magnetism?
2. The entire electron theory has never been proven to be correct by actual experiments. Why then, is it accepted as an explanation of the actions existing in all bodies?
3. Why does a body become charged when it is rubbed?
4. Define in accordance with the electron theory, (a) a charged body. (b) a positively charged body. (c) a negatively charged body.
5. Describe a simple way of determining if a body is charged.
6. How would you determine if two charged bodies had like charges or unlike charges? State the rule upon which your method depends.
7. How did the words "electricity," "positive charge," "negative charge," "electron" originate?
8. What factors affect the force of attraction and repulsion between two charged bodies? State the quantitative relations.
9. Name three elements and six compounds. In each case give your reason for classifying the substance as an element or compound.
10. According to the electron theory, what is an atom of any material supposed to consist of? Draw a simple picture to illustrate your answer.
11. Why is it that electrons can flow or drift through iron which is apparently a hard, dense, solid substance?
12. A piece of copper wire contains negative charges (electrons) and positive charges (protons). Why doesn't every piece of copper then exhibit all the external properties or effects of a charged body?
13. A substance contains 20 protons and 4 electrons in the nucleus, with two additional planetary electrons in the first outer shell, eight electrons in the second outer shell, and six electrons in the third outer shell. Draw a picture of the internal arrangement of this atom. Will this substance be chemically active?

### General Quiz on This Issue

1. How are the units of electrical measurement standardized?
2. What ultra-high frequency has been employed in recent American experimental transmission and reception?
3. Does an extremely high antenna necessarily provide greater pick-up than a similar antenna closer to the ground?
4. Is straight line amplification desirable in devices for the hard-of-hearing? Why?
5. What physical standards are necessary to determine the volt? The Ampere? The Ohm?
6. What is the audiometer and what outstanding feature does it offer in analyzing defective hearing?
7. When using a multi-range a.c. voltmeter in capacity measurements is it advisable to use the lower or higher meter ranges? Why?
8. What feature of design is employed by one manufacturer to permit a great reduction in headphone size?
9. What is the decibel and for what purpose is it commonly employed in radio work?
10. What causes the beam of electrons to trace electric wave forms on the screen of a cathode-ray tube?
11. Why, in some meter multiplier arrangements, is the shunt resistor placed across both the meter and a series resistance, instead of across the meter only?

# What's New in Radio

*A department devoted to the description of the latest developments in radio equipment. Radio servicemen, experimenters, dealers and set builders will find these items of service in conducting their work*

## Gang Condensers for Superheterodynes

*Description*—A new type of tracking condensers for single control superheterodyne receivers. One section is a special oscillator while the others are standard tuning sections. Its type of construction and design eliminates external "padding" condensers and reduces the number of adjustments. To utilize this condenser it is necessary that 240

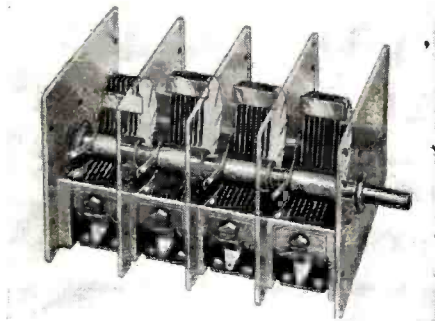

microhenry coils be employed in the pre-selector and first detector stages and a 144 microhenry coil in the oscillator stage. With these values the oscillator circuit tuning will track with the other circuits but maintain a constant frequency difference of 175 k.c. These condensers are available in two, three and four gang units.

*Maker*—DeJur-Amsco Corporation, 95 Morton Street, New York City.

## Battery-Operated Superheterodyne Receiver

*Description*—The Majestic model 121 is a six tube superheterodyne receiver designed for use in homes where electric line supply



is not available. This set operates from the new "Air cell" "A" battery, three heavy duty

## Conducted by The Technical Staff

45 volt "B" batteries and one 22½ volt "C" battery. The vacuum tubes employed are of the two volt types, as follows: four -32 type, one -30 type and one -33 pentode. The walnut console model illustrated here measures 37½ inches high by 24½ inches wide by 16¼ inches deep.

*Maker*—Grigsby-Grunow Company, Chicago, Illinois.

## An Attractive Microphone Stand

*Description*—A new line of microphone stands all of which are finished in an attractive shade of light brown electroplated bronze. Model 882, illustrated here, is a full length stand and is adjustable for various speaker and orchestra requirements. The other models include two desk or table



types and one full length stand to accommodate two microphones.

*Maker*—Samson Electric Company, Canton, Mass.

## Gang Mounting for Metallized Resistors

*Description*—A special cast metal center support is provided as a mounting for each

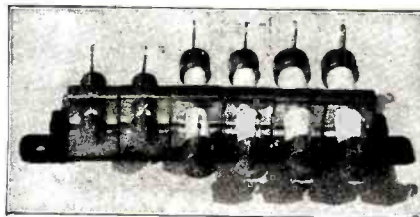

individual metallized resistor. The units are placed side by side and a rod is slipped through the aligned holes of the metal

mountings. End brackets and nuts for fastening the rod complete the assembly. Various combinations of ½ watt, 1 watt or 2 watt resistors of any resistance value may be assembled and ganged to meet different requirements. This type of gang mounting is convenient and reduces the overall assembly cost.

*Maker*—International Resistance Company, 2006 Chestnut St., Philadelphia, Pa.

## High-Voltage Transmitting Condensers

*Description*—The model S-1855 high voltage variable condenser shown in the ac-

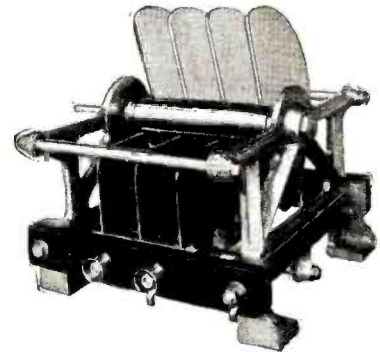

companying illustration is designed for use in transmitter equipment of over 500 watts and is standard for 1 k.w. installations. The maximum capacity is 95 mfd. and the minimum capacity is 45 mfd. The airgap between adjacent rotor and stator plates is 1 inch. Its breakdown voltage is 29,000 volts. The panel space required is 15½ by 15½ inches.

*Maker*—Allen D. Cardwell Mfg. Corp., 81 Prospect St., Brooklyn, New York.

## Baffles for Electro-Dynamic Speakers

*Description*—A one-piece baffle measuring

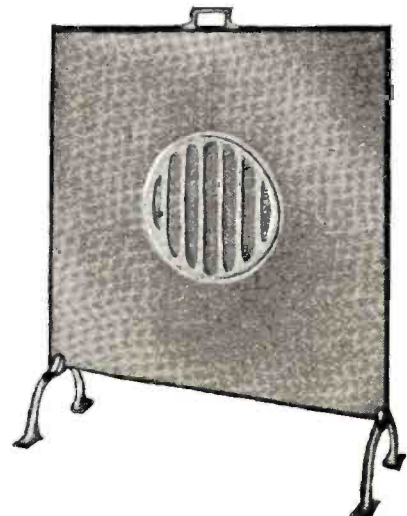

24 inches square by  $\frac{3}{8}$  of an inch thick. This unit is manufactured by a British concern and is available in various finished designs. The model illustrated here is a portable type and is equipped with metal legs and a metal carrying handle thus permitting the reproducer and baffle to be easily moved to other positions in the room. Other models include cabinet types and the plain baffle board with speaker grill for attachment to a speaker cabinet or for letting into the wall.

*Maker*—Charles Borst & Sons, 306 Euston Road, London, England.

### High-Voltage Condensers

*Description*—The new series of oil impregnated and oil filled high-voltage tank constructed condensers are designed especially for laboratories, tube manufacturers, broad-



casting and amateur stations where continuous operating voltages of from 3500 to 15,000 volts are encountered.

*Maker*—Tobe Deutschmann Corp., Canton, Mass.

### Portable Receiver

*Description*—Here is a real compact five tube receiver made for vacation use or for the many occasions when a portable receiver



is desired. The set and speaker are encased in a brown leatherette covered case with a convenient carrying handle. A -45 type tube is used in the power output stage. It is furnished with a tone-control, electro-dynamic speaker and phonograph jacks.

*Maker*—Keller-Fuller Mfg. Co., Ltd., 1573 W. Jefferson Boulevard., Los Angeles, Cal.

### Unique Radio Receiver

*Description*—This model, designated as the Standish receiver, is designed after an early American end-table and it encloses a complete seven tube superheterodyne receiver with a self-contained aerial. The same manufacturer offers two separate lines of receivers, employing three different circuits. Five models are in the standard series and nine are custom-built period furniture models. In addition to the above receivers the Pioneer,

a battery set, is offered for use on farms and other localities where outside current is not available.



*Maker*—General Motors Radio Corp., Dayton, Ohio.

### Audio Oscillator

*Description*—This beat-note or heterodyne oscillator is capable of generating audio frequencies from 40 to 15,000 cycles per second. It employs four tubes all of which are of the 2-volt type. It is especially adapted for providing a source of variable audio frequencies for the testing of loud speakers, amplifiers and other associated apparatus. The instrument is encased in a black crystallized cabinet measuring 10

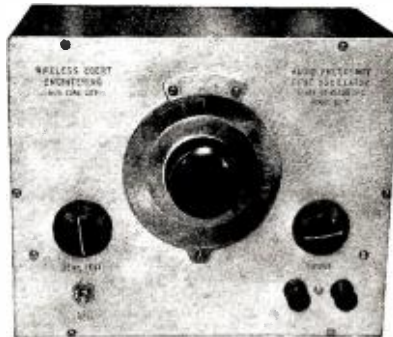

inches by 8 inches by  $7\frac{3}{8}$  inches and each unit is supplied with a calibrated curve.

*Maker*—Wireless Expert Engineering, Inc., 179 Varick St., New York.

### A Compact Receiver

*Description*—A six tube midget receiver, employing four -24 type screen-grid tubes,



one -80 rectifier tube and a power pentode tube. The set is provided with a tone control, an electro-dynamic reproducer and a noise filter. It is available for 110 volt 25 to 40 cycle a.c., 110 volt 50 to 60 cycle a.c.,



### LOOP AND ALL—

*Slung over the shoulder of Mr. Gerhard R. Fisher, Research Engineer of Los Angeles, is a complete direction finder, including receiver and loop. Mr. Fisher's invention may be used as a radio compass by tuning to broadcasting stations in known locations*

and 220 volt 50 to 60 cycle a.c. The dimensions are 20 inches high by 15 inches wide by  $9\frac{3}{8}$  inches deep.

*Maker*—Plaza Music Co., 10 W. 20th St., New York City.

### Binding-Posts

*Description*—A new type of binding post so constructed that one piece of metal forms the wire guide and connection. The center of the metal is drawn to the form of an

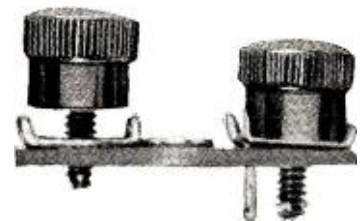

eyelet which is riveted to the bakelite mounting strip and the inside threaded to take the binding post. After the screw, to which the bakelite knob is permanently screwed, is in place the end of the screw is enlarged so that it cannot become unscrewed and lost. This design permits either a large or a small size wire to be easily and quickly connected.

*Maker*—Alden Products Company, Brockton, Mass.

### Short-Wave Converter Without Plug-in Coils

*Description*—A special wave-band shifting mechanism controlled by a knob which is mounted on the front panel, is employed in the new Lafayette short-wave superheterodyne converter, to eliminate the nuisance of  
(Continued on page 447)

# News and Comment

*A page for the news of the whole radio industry, including important trade developments, new patent situations, comments by leading radio executives, notes, rumors and opinions*

## **R. M. A. to Propose Patent Pool**

NEW YORK—In an effort to develop a fair and equitable solution of the important patent problem in the radio industry, the Radio Manufacturers' Association, embracing virtually all prominent manufacturers, has decided to intervene in present negotiations toward establishment of a radio patent pool.

According to announcement today by J. Clarke Coit of Chicago, president of the R.M.A., the Board of Directors meeting at Niagara Falls, Canada, decided formally to take part in negotiations between the U. S. Department of Justice and the R.C.A. regarding the founding of a radio patent pool for the interchange between radio manufacturers of patent privileges.

## **Columbia Increases Business**

NEW YORK—The Columbia Broadcasting System reports an increase of 46% in commercial broadcasting for the first six months of 1931 over the first six months of 1930.

## **WAPI to Be Leased**

BIRMINGHAM, ALA.—The future disposition of station WAPI, located here, was placed in the hands of a special committee when the Executive Committee held a meeting at Montgomery. The station will be leased to a private organization unless funds can be secured for endowing it as now operated. The station is owned jointly by the University of Alabama, Alabama College and Auburn.

## **Randall to Head Tube Works**

BOSTON—Completion of a tube research division for the development of television tubes is announced by the Shortwave and Television Corporation. Tubes acting as light sources are as important to television as tubes in a radio set are to radio. The new tube department contains the latest machinery necessary for the building of tubes and is in charge of Eugene F. Randall.

## **Lowell-Dunmore Patent Sustained**

WASHINGTON, D. C.—The Board of Appeals of the United States Patent Office recently affirmed the decision of the Examiner of Interferences in upholding the Lowell and Dunmore patent on the alternating current operation of radio receiving apparatus.

## **Lowenstein Patent Declared Invalid**

BUFFALO, N. Y.—In an interview with Louis Gerard Pacent, president of the Pacent Reproducer Corporation, he made the following statement regarding the effect of the decision of Judge Galston in the suit brought against Sol Wallerstein, a Buffalo exhibitor, who had installed a Pacent talking picture apparatus, by the American Telephone & Telegraph Company, Western Electric Company, Inc., and Electrical Research Products, Inc.

Mr. Pacent expressed himself as gratified at the decision, inasmuch as the claims of infringement originally involved in the suit

## **Reported by Ray Kelly**

which related to eight patents, the claims on three of the patents had been wholly abandoned by the plaintiffs and the aggregate number of claims had been voluntarily reduced from 54 to 18 of the remaining patents which were litigated, for the most important were the Lowenstein, covering negative grid bias, and the Colpitts, so-called push-pull patent. The first was declared invalid and the latter expires in February next.

The Lowenstein patent, Mr. Pacent said, was heretofore considered basic with relation not only to amplification for sound-picture reproduction, but also for radio receiving set amplifiers, radio broadcasting, and in connection with telephone transmission.

## **Crosley Says, "Plenty of Business for Those Who Work for It"**

CINCINNATI, O.—Powel Crosley, Jr., president of the Crosley Radio Corporation, claims that manufacturers have to get after business—not wait for it to come to them.

"It is normal for people to work for what they get," Mr. Crosley remarked. "Therefore it behooves all of us—those in the radio business in particular—to forget that there was a time when people mobbed radio stores to buy radio apparatus, and, instead, to get out and work for business."

## **Appoint New Sales Head**

LAWRENCE, MASS.—Mr. A. Van Santen, of Amsterdam, Holland, recently in the United States on a visit, has been appointed commercial vice-president in charge of European sales of the Pilot Radio & Tube Corporation, of this city. He will make his headquarters in Amsterdam.

## **RCA Income Higher**

NEW YORK—Total gross income of \$47,973,727 and net income of \$2,638,703 for the Radio Corporation of America and its subsidiaries for the first six months of the year 1931 were announced today by David Sarnoff, president of the corporation. During the same period last year the gross income was \$52,732,079 and the net income \$505,098.

## **Replacement Market Looms Big**

NEWARK, N. J.—Frank Holmstrom, Jr., vice-president in charge of sales of Kolster Radio, Inc., which is backed by Mackay Radio & Telegraph Company, sees the replacement market as a large contributor towards the success of the new season.

"The new sets offered by radio manufacturers this fall will tempt owners of obsolete sets to scrap them and enjoy modern reception. The vast number of new families that will go to housekeeping will include radio in their first year's budget. The thousands upon thousands of newly wired homes will want electrically operated sets. Surprising at it may seem, there are millions of homes that have yet to buy their first set."

## **Grigsby Predicts Greatest Radio Year**

CHICAGO, ILL.—B. J. Grigsby, president of the Grigsby-Grunow Company, says the industry has already sensed the renewed public interest in radio and is now prepared to meet its responsibility.

"After careful consideration of all factors entering into general business and the public attitude on such commodities as radio," said Mr. Grigsby, "it is my sincere and unbiased opinion that the approaching fall season will be one of the greatest that the radio industry has yet seen."

## **Public Interest in Radio Growing**

NEW YORK—R. W. Jackson, vice-president of the Brunswick Radio Corporation, sees public interest in radio increasing from every direction.

"Probably the main contributing element," he said, "is the fact that radio manufacturers are building into radio instruments a degree of musical quality heretofore not attained, and at a retail price that will be highly acceptable to the public."

## **Lynch Stresses 1932 Keynote**

HEMPSTEAD, L. I.—Describing the general trend of radio progress for the 1931-32 season, Arthur H. Lynch, vice-president of the Stenode Corporation of America, believes that a significant aspect will be the reduction of background noise. "Reduction in background noise," said Mr. Lynch, "means genuine reception enjoyment on distant stations as well as locals." Background noise is caused by natural and artificial radio strays—irregular and scratchy signals that find their origin in static and electrical appliances such as electric fans, auto ignition systems, traffic lights, dial telephones, incinerators, elevators, etc.

## **5-Meter Programs**

SCHENECTADY, N. Y.—Believing the ultra short-wave bands of 5 meters and under offer great possibilities in radio, especially in television, Dr. E. F. W. Alexander, radio engineer of the General Electric Company, has arranged for broadcasting one-hour programs twice a week over W2XAW, operating on 5 meters. These programs, the same as broadcast by WGY, will be sent out from 5 to 6 o'clock every Tuesday and Thursday afternoon.

## **Aerovox Awarded Patent on Electrolyte**

BROOKLYN, N. Y.—The Aerovox Wireless Corporation has recently been granted U. S. Patent No. 1,815,768, covering the special electrolyte used in the manufacture of Hi-Farad dry electrolytic condensers.

## **Wireless Specialty Moves to Camden**

CAMDEN, N. J.—The entire facilities formerly maintained by the Wireless Specialty Apparatus Company at Boston, Massachusetts, have been transferred here by the RCA-Victor Company, Inc.

According to Dr. W. R. G. Baker, vice-president in charge of engineering and manu-  
(Continued on page 438)



# Latest Radio Patents

*A description of the outstanding patented inventions on radio, television, acoustics and electronics as they are granted by the United States Patent Office. This information will be found a handy radio reference for inventors, engineers, set designers and production men in establishing the dates of record, as well as describing the important radio inventions*

1,812,879. ACOUSTIC CHAMBER. JAMES C. Karnes, Buffalo, N. Y. Filed Nov. 21, 1929. Serial No. 408,841. 8 Claims. (Cl. 181-30.) (Granted under the act of Mar. 3, 1883, as amended Apr. 30, 1928.)

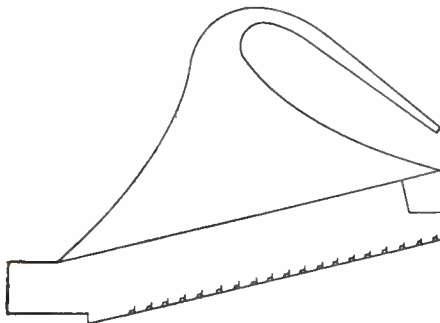

1. In an acoustic chamber, a ceiling formed in the shape of a horn having an exponential variation of cross section with the length and a floor in projection of the mouth of the horn, the axis of the horn being perpendicular to the floor.

1,813,204. RADIO PHOTOGRAPHY TRANSMITTER. VIRGIL ADOLF SCHOENBERG, Niles Center, Chicago, Ill. Filed Aug. 1, 1929. Serial No. 382,750. 6 Claims.

1. In radio photography transmitters, a framework, a film head arranged thereupon and carrying the film mounting, a door for said film head, a photo-electric cell mounted to said door, a potentiometer mounted in said door and in circuit with said photo-electric cell, said electric circuit being made and broken by the closing and opening of said door, and light transmission and focusing means mounted to said framework and associated with said film mounting and cell.

1,813,137. RADIO FREQUENCY COIL. ALFRED E. BAUMANN, Milwaukee, Wis. Filed Nov. 25, 1925. Serial No. 71,379. 5 Claims.

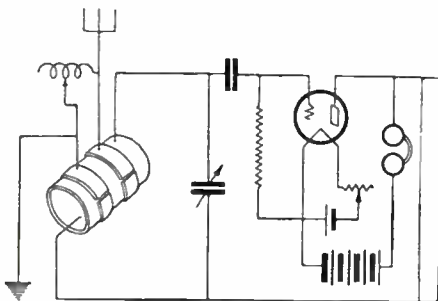

1. The combination with a solenoidal radio-frequency coil and tubular supporting form therefor, of a discontinuous annular metallic shielding band surrounding said coil and having inturned flanges at opposite edges beyond the ends of the coil resting on said tubular supporting form.

\*Patent Attorney, National Press Building, Washington, D. C.

## Conducted by Ben J. Chromy\*

1,813,208. ACOUSTIC DEVICE. EDWIN H. SMYTHE, Evanston, Ill., assignor to Western Electric Company, Incorporated, New York, N. Y., a Corporation of New York. Filed Nov. 26, 1926. Serial No. 150,830. 10 Claims.

1. A sound radiator comprising a continuous exponentially tapered sound passage, said sound radiator being formed by a plurality of telescoping sections and having an annular mouth.

1,813,180. RADIO RECEIVING APPARATUS. PERCIVAL D. LOWELL, Jamaica, N. Y., assignor to A. H. Grebe & Co., Inc., Richmond Hill, N. Y., a Corporation of New York. Filed July 16, 1927. Serial No. 206,168. 6 Claims.

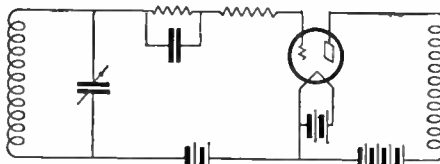

1. In a radio frequency amplifier using a triode vacuum tube, the combination of a tuned input circuit, an inductively reactive plate circuit, two resistances in series between the grid and tuned input circuit, and means for paralleling part of such resistance by a capacity path.

1,813,563. RADIO SIGNALLING. LOUIS COHEN, Washington, D. C. Filed July 18, 1928. Serial No. 293,608. 18 Claims.



(Granted under the act of Mar. 3, 1883, as amended Apr. 30, 1928; 870 O. G. 757.)

1. In a system for the reception of radio signals comprising an antenna, a wave conductor connected in series therewith, the said wave conductor being adjustable to a quarter wave length of the signals to be received, an oscillatory circuit placed in inductive relation to the said wave conductor, and means associated with said oscillatory circuit for detecting and amplifying said radio signals.

1,813,845. APPARATUS FOR THE STUDY OF THE EARTH'S CRUST. OLIVER H. GISH, Somerset, Chevy Chase, Md., assignor to Carnegie Institution of Washington, Washington, D. C., a Corporation. Filed Apr. 19, 1929. Serial No. 356,333. 7 Claims.

1. An apparatus for studying the earth's crust consisting of a source of current, an instrument for measuring the value thereof, a potentiometer, a double rotor commutator,

leads from each rotor of said commutator to the earth, leads from one of said rotors to the current measuring instrument and the source of current, and leads from the other rotor of said commutator to the potentiometer.

1,813,541. CIRCUIT CONTROL SYSTEM FOR RADIO APPARATUS. CHARLES C. LAURITSEN, St. Louis, Mo., assignor, by

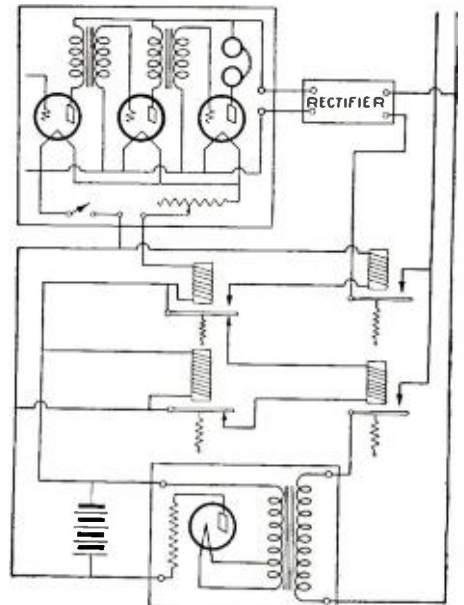

direct and mesne assignments, to Colin B. Kennedy Incorporated, St. Louis, Mo., a Corporation of Missouri. Filed May 7, 1925. Serial No. 28,557. 6 Claims.

6. The combination of a wireless set having vacuum tubes, rectifying apparatus for supplying power to the tubes, and means adapted to automatically control the connection of the rectifying device to a source of alternating current, said means being responsive to the operative condition of the tubes.

1,816,448. COIL CONSTRUCTION. FREDERICK E. TERMAN, Stanford University, Calif. Filed Nov. 12, 1929. Serial No. 406,585. 2 Claims.

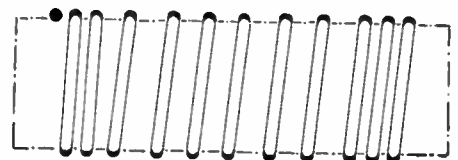

1. An inductance coil comprising a plurality of turns of conductor separated by a dielectric in which the separation between turns is a maximum at the center of each layer of winding and progressively decreases toward the ends thereof, the separation per turn being a maximum in the outer layers of the coil and progressively decreasing toward the axis of the coil.

1,813,775. MEANS FOR PREVENTING RETROACTIVE EFFECTS IN AUDION AMPLIFIER CIRCUITS. GEORGE A. SOMERSALO, New York, N. Y. Filed Jan. 27, 1927. Serial No. 164,009. 8 Claims.

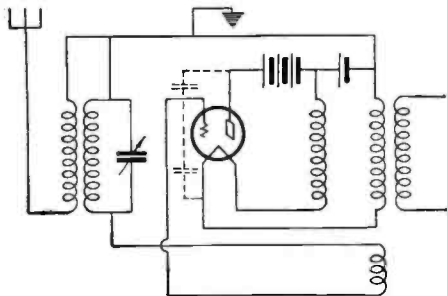

1. The method of controlling or eliminating the effect of a disturbing electro-motive force in the plate filament circuit of a three-element thermionic device upon the input element associated with the grid and plate of said thermionic device, which comprises establishing a point which due to said disturbing electro-motive force assumes the potential of the plate, and impressing the input energy through said input element between said point and the plate.

1,813,855. ELECTROSTATIC VIBRATION STRUCTURE. ERNST KLAR, Berlin, Germany, assignor, by mesne assignments, to United Reproducers Patents Corporation, a Corporation of Nevada. Filed May 21, 1927, Serial No. 193,217, and in Germany May 21, 1926. Renewed Nov. 14, 1930. 10 Claims.

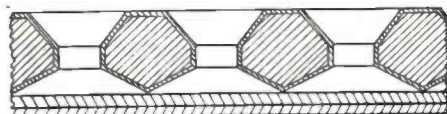

2. An acoustic device comprising a supporting plate having a plurality of concave depressions therein forming cross ribs and terminating into apertures, a dielectric coating on said plate and a conducting membrane disposed on said cross ribs, said concave depressions exposing limited areas of said conducting membrane to permit unrestrained vibrations thereof.

1,813,961. SIGNALING SYSTEM. JOHN C. SCHELLENG, Milburn, N. J., assignor to Western Electric Company, Incorporated, New York, N. Y., a Corporation of New York. Filed Aug. 28, 1925. Serial No. 52,989. 15 Claims.

4. A directive polyphase transmitting antenna system comprising a plurality of multiple-tuned aerials in parallel planes, each of said aerials having a horizontal length substantially greater than the length of the wave to be radiated therefrom.

1,814,137. TELEVISION. JUDAH B. FELSHIN, New York, N. Y., assignor of one-third to Morris Kirschstein and one-third to Louis Oskow, Brooklyn, N. Y. Filed Apr. 8, 1929. Serial No. 353,545. 11 Claims.

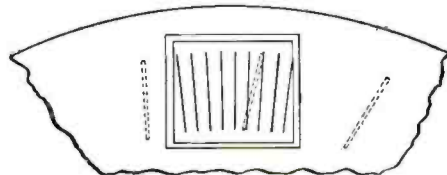

1. In a scanning device, a rotatably mounted member, means for rotating said member, and means associated with said member for scanning a predetermined area a plurality of times during each revolution of said member said last mentioned means comprising a member having a plurality of narrow elongated openings.

1,814,018. MEANS FOR CONTROLLING SENSITIVITY OF VOICE OPERATED DEVICES. SUMNER B. WRIGHT, South Orange, N. J., and DOREN MITCHELL, New York, N. Y., assignors to American Telephone and Telegraph Company, a Corporation of New York. Filed June 6, 1928. Serial No. 283,407. 3 Claims.

1. A transmission line, an echo suppressor device associated therewith, and a device in said line for controlling the operation of said echo suppressor device, said control device comprising a vacuum tube arrangement having the threshold of operation affected solely in proportion to the amount of input current applied thereto in a comparatively steady state.

1,814,554. HORN HAVING RESONATING CHAMBERS AT ANTINODAL POINTS. MILLER REESE HUTCHISON, Llewellyn Park, West Orange, N. J., assignor, by mesne assignments, to Acoustic Products Company, New York, N. Y., a Corporation of Delaware. Filed May 24, 1927. Serial No. 193,814. Renewed Dec. 2, 1930.



1. A sound propagating device comprising a vibrating diaphragm, a tubular member associated therewith and adapted to form an air column resonant to waves of a definite frequency, said column having nodal and antinodal points, and a resonator located at one of said antinodal points tuned to the same frequency as said tubular member.

1,815,931. VACUUM TUBE. SAMUEL RUBEN, New York, N. Y., assignor to Ruben Tube Company, Englewood, N. J., a Corporation of Delaware. Filed Feb. 8, 1930. Serial No. 426,828. 3 Claims.

1. A vacuum tube comprising an envelope containing a cathode, a grid and a plate element, another cathode, grid and plate element, a heater element for indirectly heating said cathodes, said second mentioned grid being directly connected with the first mentioned cathode.

1,816,461. SHORT WAVE RECEPTION. HOLLIS S. BAIRD, Boston, Mass., assignor to Shortwave & Television Corporation, Boston, Mass., a Corporation of Delaware. Filed Apr. 30, 1929. Serial No. 359,268. 5 Claims.

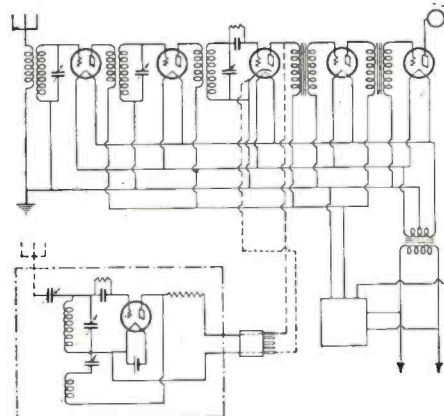

1. The combination of a long wave multi-stage radio receiver having a plurality of tubes and a source of alternating current power for heating the cathodes of said tubes, and a short wave adapter for said long wave receiver having a detector tube, an input circuit tunable to the short waves, an output circuit having a detachable connection with an intermediate stage of said long wave receiver and having a direct current source of power for heating the cathode of said detector tube independently of the source of alternating current power.

1,815,833. SUBDIVIDED SERVICE SYSTEM OF RADIO BROADCAST DISTRIBUTION. EDWARD E. CLEMENT, Washington, D. C., assignor to Edward F. Colladay, Washington, D. C. Filed June 28, 1924. Serial No. 722,993. 9 Claims.

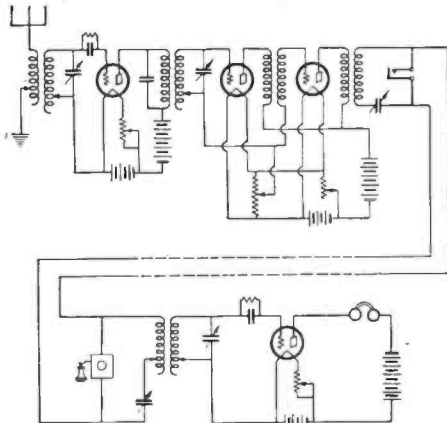

1. In a wired system of radio broadcast distribution, a primary transmitting station, a secondary distributing station, subscribers' stations connected to said secondary station by wire lines, and means whereby modulations imposed on a short carrier wave at the primary station are resolved into modulations on a longer carrier wave at the secondary station, means to distribute said long waves over said wires to the subscribers' stations, and a common receiving means for both the radio and wire transmitted waves at each subscriber's station.

1,814,119. LOUD SPEAKING APPARATUS. CLIFFORD C. BRADBURY, Glencoe, Ill. Filed Sept. 3, 1929. Serial No. 389,903.

9. In a loud speaking apparatus, a magnetic circuit, means for supplying an energizing current therefor, means for eliminating the effect of variations of the energizing current comprising a neutralizing coil, and a generating coil differentially connected thereto, said generating coil being more subject to change of magnetic circuit than the neutralizing coil.

1,815,073. URANIUM PHOTO-ELECTRIC TUBE. HARVEY C. RENTSCHLER, East Orange, and DONALD E. HENRY, Bloomfield, N. J., assignors to Westinghouse Lamp Company, a Corporation of Pennsylvania. Filed June 12, 1929. Serial No. 370,223. 9 Claims.

7. A photo electric tube comprising an envelope transparent to ultra-violet light, an anode and a cathode therein, said cathode consisting of metallic uranium.

1,815,131. MEANS FOR HEATING FILAMENTS. HENRY JOSEPH ROUND, London, England, assignor to Radio Corporation of America, a Corporation of Delaware. Filed Oct. 14, 1921. Serial No. 507,756. 6 Claims.

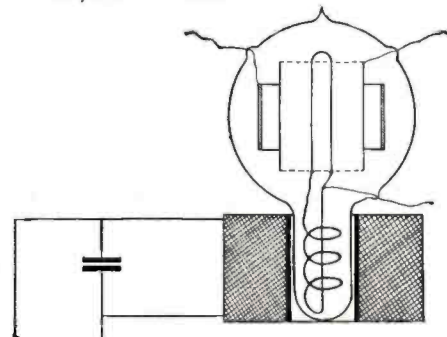

1. The combination of an evacuated container, a filament adapted to be heated located within said container, a coil located within said container and connected to said

(Continued on page 447)



# The Finest Tuner and Amplifier Money Can Buy

The 716 is a six-tube Vario-Mu Superheterodyne tuner that on tests has brought in ninety-seven stations on the ninety-five channels—and brought them in beautifully. It is intended to operate with the S-M 683 Amplifier and the 855B Speaker, altho it will operate satisfactorily with any high quality amplifier and speaker. The 716 is the great-grandson of the famous Sargent-Rayment 710, and was built to be—and is—the finest radio instrument the S-M Laboratories can produce.

Tubes required: 3—'51s, 2—'27s, 1—'24. Size: 16½ x 10½ x 7¾ inches high.

Price of 716 Tuner, wired, less speaker and tubes, \$69.50 LIST

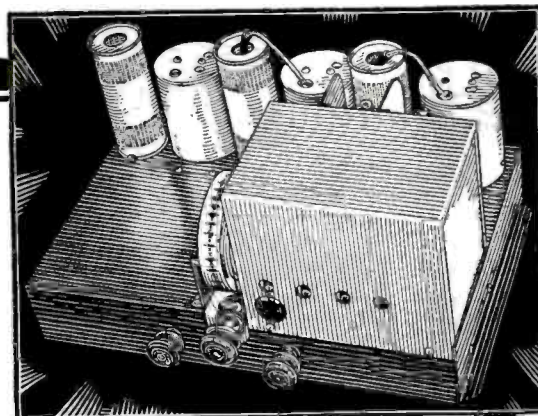

## 683 Pentode Audio Amplifier

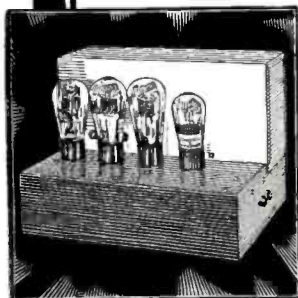

The 683 Compensated Pentode Audio Amplifier is designed expressly for use with the 716 tuner and 855B dynamic speaker and consists of one low-gain '27 stage (used in tone control circuit) and a high-gain '47 pentode push-pull stage. It is provided with a special dual tone control feature which allows both the bass or treble range to be raised, leveled off, or lowered to suit the varying response of the human ear with volume, and to permit of optional adjustment for local noise or installation conditions. This control may be optionally placed in the 683 amplifier or on the 716 tuner chassis, or on a cabinet side or front panel, as desired.

The 683 amplifier supplies all A, B and C power required by the 716 tuner, and is designed to operate on 110-120 volt, 50-60 cycle AC power lines.

Tubes required: 1—'27, 2—'47s, 1—'80. Size: 9½ in. deep, 12 in. wide, 9 in. high.

Price of 683, less tubes, \$69.50 LIST Price of 855B Dynamic Speaker, \$20.00 LIST

## 686 Complete Portable P. A. Unit

The latest addition to the S-M amplifier line is the 686 Portable. It contains a very high gain push-pull Pentode Amplifier similar to the 684 described in the S-M catalog. The 686 is absolutely complete; three-stage push-pull pentode amplifier (with a gain of 90 DB, and an output of 7 to 8 watts), dynamic speaker with baffle, extension speaker cable, control box, microphone, microphone cord. It is all AC, supplying P. E. cell voltage and microphone current. All material fits into one carrying case and weighs less than 75 pounds. A steady, profitable business can be developed in almost any city by renting a 686. Price, absolutely complete, including tubes .....\$199.50 LIST



## Write for *New* General Parts Catalog

**SILVER-MARSHALL, Inc.**

6405 West 65th Street • Chicago, U. S. A.

Canadian Division: SILVER-MARSHALL of CANADA, Ltd.

75 Sherbourne Street, Toronto

Export Office: 41 Water Street

New York City, U. S. A.

SILVER-MARSHALL, Inc.

6405 W. 65th Street, Chicago, U. S. A.

Please send me full details on the S-M 716 and 683 (enclosed you will find 2c).

Please send me FREE your new General Parts Catalog.

Name .....

Address .....

# MODERNIZE WITH AEROVOX HI-FARAD DRY ELECTROLYTIC CONDENSERS



Every up-to-date radio set, television outfit or any other form of radio apparatus which requires high capacity filter or bypass condensers merits Aerovox Hi-Farad DRY Electrolytic Condensers. They are DRY, compact, light in weight, safe, surge-proof, self-healing, low in cost per microfarad per voltage rating (500 volts peak), low in leakage, provide long life, stable operation and high filtering efficiency.

## AN AEROVOX CONDENSER OR RESISTOR FOR EVERY PURPOSE

The Aerovox line includes the most complete variety of fixed condensers and resistors for every radio requirement.

### Send for Catalog

Complete specifications of all Aerovox units, including insulation specifications of condensers, current-carrying capacities of resistors, and all physical dimensions, electrical characteristics and list prices of condensers and resistors, are contained in our 40-page catalog which will gladly be sent on request.



The Aerovox Research Worker is a free monthly publication issued to keep radio engineers, experimenters and servicemen abreast of the latest developments in receiver and power supply design, and especially with the proper use of condensers and resistors. A request on the coupon below will place your name on the mailing list.

### AEROVOX WIRELESS CORP.

78 Washington St., Brooklyn, N. Y.

#### Check and Mail This Coupon

AEROVOX WIRELESS CORP. Radio News  
78 Washington Street Nov., 1931  
Brooklyn, N. Y.

Gentlemen:

Please send me without charge or obligation:  
( ) Your 40-page Condenser and Resistor Manual and Catalog.  
( ) The Research Worker.

Name.....

Street.....

City..... State.....

## 'On the World's Tallest Structure

(Continued from page 364)

signal-to-noise did not seem to be a bit improved by the Empire State location when the volume was turned up to produce normal signals.

A day or two later the receiver was set up in the room assigned at the top of the tower, and connected to the upper portion of the antenna. Here tests were carried on intermittently over a period of two weeks, both day and night. In general the results were much the same as those encountered in the tests made on the 86th floor. The noise interference on the broadcast waves was still further reduced, but on the short waves the noise level remained about the same as in the earlier tests downstairs. All of the usual short-wave European stations were heard but at no time did they come in as well as they are ordinarily received in many other locations in the city where this same receiver had been tried. There was no time, for instance, when the European programs could have been clearly recorded on phonograph records, as they were in the tests described in the July issue. These programs were neither as loud as during the recording described in our July article, nor was the signal-to-noise level as favorable. The best foreign reception obtained in the tower was that from Rome. Chelmsford, (England) ran second, followed by various stations in Honduras, South America, Cuba and Mexico. Rome and Chelmsford were the only two that might be rated good.

There were a number of peculiarities noticed which are worthy of comment here. One afternoon, for instance, Rome was tuned in with somewhat less than the volume to which we had become accustomed during the preceding days. A check-up of the receiver showed it to be performing efficiently in every respect and the antenna appeared to be right also. We would have laid the cause of the reduced volume to a change in atmospheric conditions if it were not for the fact that background noise had dropped off in more or less the same proportion as the signal.

### Lead-in "Shorted"

A further, careful check-up finally disclosed that the lead-in wire, where it entered the room through a steel door frame, had become shorted to the steel and thus grounded about nine feet from the receiver. The steel of the building and a water pipe were bonded together and used as the ground for the receiver, so in effect the ground and antenna leads constituted a sort of single-turn, grounded loop having nine feet as its greatest dimension. It was on this loop that signals were being picked up, although this was entirely inclosed within the steel shell of the tower and would have been completely shielded if it were not for the glazed windows and open door. Insulating the antenna lead at the point where the short had occurred brought reception up to the level of the preceding day. This reception, on such a tiny antenna, certainly proved the extreme sensitivity of the receiver, but it also gave further evidence of the comparative ineffectiveness of the large outdoor antenna.

One of the greatest difficulties encountered in the short wave reception was in the radio interference from two nearby television transmitters. One experimental station was just a few blocks away. Not only could this one be heard over a wide frequency band at its proper wavelength, but also at innumerable points all the way down the line to the neighborhood of fifteen meters. In order to make sure that these repeat-points were not due to some sort of harmonic-heterodyne action in the receiver a wavetrap was connected in the antenna circuit and adjusted to the fundamental of the television station. This successfully eliminated the television signal on its normal frequency but it could still be heard at numerous points on the lower wavelengths, indicating that hybrid signals were actually being picked

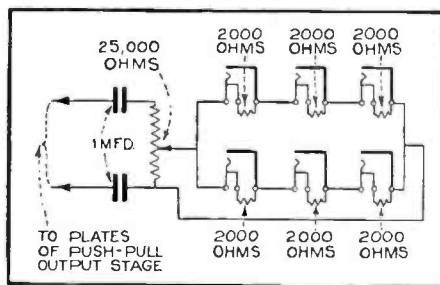

### HEADPHONE ADAPTER

This is the circuit employed to permit a group of headphones to be connected into the receiver output at times when the use of the loudspeaker was undesirable or when the loudspeaker was to be placed in a remote location. Its design is described in the text.

up on these frequency settings and were not being developed in the receiver equipment. Another television station a few blocks up Fifth Avenue caused similar trouble but somewhat less pronounced.

Another peculiarity was found. At certain times a television signal, with a superimposed voice-signal from some broadcast station could be heard at every few degrees on the dials, (apparently whenever the carrier wave of any other station was present) when tuning in the short-wave bands. When this occurred there was nothing to do but give up short-wave reception because this superimposed modulation completely garbled all signals. Evidently this trouble occurred only when a certain broadcast station was on the air, or a certain television transmitter. But the voices were so garbled that it was impossible to catch the station announcements and as a result it was impossible to determine the exact source and explanation of this difficulty. It was suggested that the trouble might have been caused by the natural frequency of the building coinciding with that of one of these transmitters, but no tests were made to check this theory.

When the antenna system was first installed on the tower it was on the west side which meant that if the tower were casting a "radio shadow" the shadow would fall on the antenna when trying for European reception, but not when re-

# The Big, Smashing Thrill of MODERN RADIO

## "Programs from All the World"



# PILOT "ALL-WAVE" Super-Heterodyne

### 11 TUBES!

Pilot's new ALL-WAVE is two sets in one! A standard 7-tube superheterodyne chassis in combination with a 4-tube converter. Pulls in everything from 11 to 550 meters. No coils to plug in. Nothing to change. Just a flick of a switch to turn from long-wave to short-wave. As simple to operate as an ordinary receiver. Converter has own power pack and rectifier tube, and more signal strength than ever before possible. Six wave-length tuning stages. No regenerative distortion. Now you can hear England, Holland, Rome, Australia, Honduras and other short wave stations as well as local stations with good broadcast quality and volume. Your dealer will be glad to demonstrate the new Pilot 11-tube superheterodyne ALL-WAVE for you.

#### Table Model

**\$99.50**

#### Complete with tubes

Pilot Radio & Tube Corp.  
Lawrence, Mass.

Send me complete information about the new 11-tube superheterodyne ALL-WAVE.

Name.....

Address.....

10 TUBE  
SUPER-HET.  
\$129 COMPLETE



CONSOLE  
7 TUBE SUPER  
\$89.50 COMPLETE



MODERNISTIC  
7 TUBE SUPER  
\$79.50 COMPLETE



5 TUBE  
T. R. F. MIDGET  
\$42.50 COMPLETE



PILOT VALUE IS MORE



THAN PRICE DEEP

# WHICH BRANCHES OF RADIO DO YOU PREFER?

Aircraft Radio... Broadcast Station or Studio... Direction Finder and Radio Compass... Talking Pictures... Film and Disc Recording... Servicing Home Entertainment Equipment... Television



## Learn Them at RCA INSTITUTES, Inc.

New developments... new inventions... new problems come almost every day in the radio industry. Yet only the well-trained man can hope to win. Prepare yourself!

For no other purpose than to train and equip men of unusual promise... RCA Institutes, Inc. maintains four complete resident schools in New York, Philadelphia, Boston and Chicago. They are the only schools associated with the largest, most complete research laboratory in the radio industry.

These schools offer elementary and advanced courses, based on 22 years experience, in practical radio. See list in coupon below. New courses added, old ones constantly revised as new developments are perfected.

### Win Radio Scholarship from RCA Institute

If you cannot attend the resident schools, RCA Institutes Extension Courses enable you to study at home. Special laboratory equipment furnished. Outstanding graduates of home courses become eligible for one term free scholarship at nearest resident school. Cost of either extension or resident study moderate. Will you become a vital part of a great and thrilling industry? Write for details. The coupon makes it easy.

### RCA INSTITUTES, Inc.

RCA Institutes, Inc., Dept. 23-1175 Varick Street, N. Y. Gentlemen: Please send me your General Catalog. I am checking below the phase of radio in which I am particularly interested.

- Aircraft Radio
- Broadcast Station or Studio
- Talking Pictures
- Direction Finder and Radio Compass
- Disc and Film Recording
- Servicing Home Entertainment Equipment
- Television

Name \_\_\_\_\_  
Address \_\_\_\_\_  
Occupation \_\_\_\_\_ Age \_\_\_\_\_

ceiving from American stations to the west. After several days of testing it was believed that the relatively poor reception from Europe might be traced to this condition, so the antenna was swung around to the east side of the tower.

But this change brought no improvement, or if there was any difference it was not noticeable. Theoretically the new position of the antenna would expose it directly to signals from the east, but would shield it from western signals.

### Not Shadow Effect

This experiment led definitely to the conclusion that it was not the shadow effect of the tower that was causing the lack of unusual reception but rather the relatively high capacity between the antenna and the tower. This is another way of saying that the effective height of the antenna was its distance from the massive metal bulk of the tower rather than its height above the ground. The average spacing of the wire from the tower was approximately fifteen feet and the antenna probably had about the same ef-

fectiveness as one of equal length strung between two poles fifteen feet above ground.

But even this does not explain why results were not better, because an antenna not much more than fifteen feet above ground and approximately sixty feet in length used with the same receiver, at the author's summer residence in Connecticut, brought the European stations in, regularly throughout the summer, with far greater volume than anything attained in the Empire State Tower. There it was possible to tune in Italian, French and English stations on any afternoon with volume that at times would make the programs audible several hundred feet from the house. This was particularly true in the case of the French station which operates on almost exactly the same wavelength as G5SW, Chelmsford, and of the English 'phone station which transmits the short-wave programs that are rebroadcast by WABC and the Columbia chain, and which come in about eight degrees, down the dial, from Rome.

## The Army's New Portable Radio

(Continued from page 377)

The receiver battery compartment, which supports the apparatus box, rests upon the ground. In this compartment are carried the dry cell receiver filament batteries and the receiver plate batteries. The headsets used with this set are also carried in this box when the set is closed for transportation. A double telephone jack to receive the headset plugs is mounted in this box, and a short three-conductor cord with copper braid shield connects the batteries and telephone jack to the upper apparatus box.

marked "Receiver" on the panel, is set at the frequency at which it is desired to operate the set. With another man turning the hand generator, the operator then presses the sending key. The pointer of the loop tuning condenser marked "Transmitter" on the panel, is turned clockwise until the beat note heard passes through zero beat and gives a beat note of about 1000 cycles.

The transmitter will then be operating on a frequency of about one kilocycle higher than the receiver. All stations in

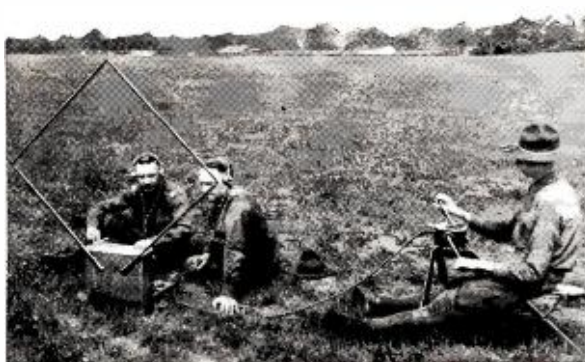

OUT ON THE FIELD

Signal Corps operators using portable transmitter-receiver with hand generator

A metal cover provides access to the interior of the receiver battery compartment, and on this is mounted the telegraph key. Alongside of the telegraph key is mounted a piece of white celluloid upon which the operator may write call letters, short messages, etc., with a lead pencil. When so desired these markings can be erased by rubbing with a damp cloth.

The general operation of the receiver and transmitter is comparatively simple. With the key up, the loop is connected to the receiver through the contacts of a relay. The heterodyne tuning condenser,

a net are adjusted so that all the transmitters operate on approximately the same frequency. This condition is secured by stations adjusting for operation with the net control station. Any two net stations working together will then hear a satisfactory pitch beat note, with little or no further adjustment. As the sets are connected for receiving each time the key comes up, the receiving operator can "break" the sending operator at will.

The design of the receiver circuits of this set presented several very peculiar problems. Due to the rigid weight re-

(Continued on page 420)

**EXCLUSIVE NEWS FROM**  
**LINDBERGH PLANE**  
**FLYING OVER ARCTIC WILDERNESS, RECEIVED ON A**  
**LINCOLN RADIO**

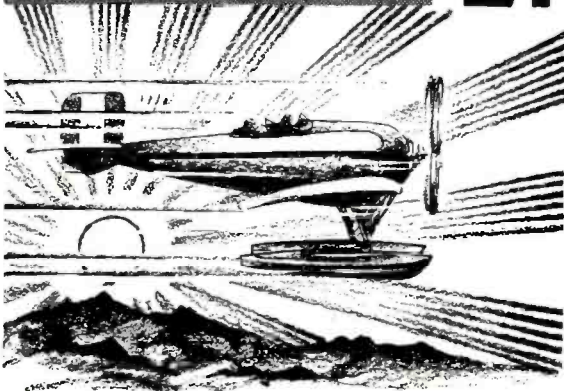

On the eve of August 5th, Roscoe H. Johnson, operator and owner of a powerful short-wave station, using a LINCOLN RECEIVER, had just finished his daily schedule of messages with the Bowdoin ship of the MacMillan expedition, now located off the shores of Baffin Land; turning his dials to the frequency of the Lindbergh transmitter, strong and clear came in the signals from the Lindbergh plane, flying over the Arctic circle.

Realizing that this was the first message received for some time from the famous aviator and that the public were much concerned as to the safety of the plane, Mr. Johnson immediately phoned the United Press and in a flash it was headlined in newspapers throughout the world.

When the operator, in Chicago, turned his dials to the 20 meter band, the sharp clear note of the Lindbergh transmitter brought its message through the violent storms and electrical disturbances of the Arctic. Hundreds of amateur and commercial stations in all parts of the world were vainly combing the air for some news of the flying colonel and his wife. It remained for a LINCOLN receiver to catch the anxiously-awaited signal from the far north reassuring the world that all was well.

Such spectacular performance is an impressive tribute to the excellence of Lincoln equipment, and proves, in a conclusive manner, the outstanding superiority of Lincoln receivers.

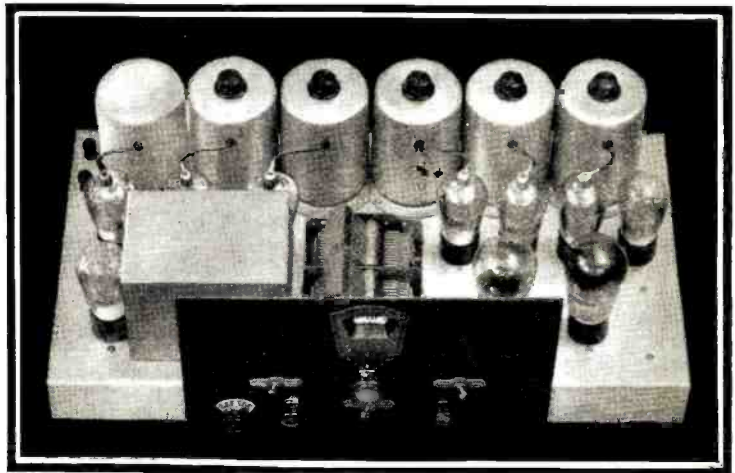

**SUPER-POWERED, WORLD-WIDE RECEPTION**  
**15 to 550 METERS- NO PLUG-IN COILS-WITH THE**  
**LINCOLN DE LUXE SW 32 and DE LUXE D.C. SW 10**

Now, you can sit comfortably in your easy chair and switch instantly from your local station to London, Paris, Rome, Nauen, Morocco, Saigon, Wellington—over 100 phone stations throughout the world.

No plug-in coils, six screen-grid tubes in the highest amplifying system known WITH PERFECT 10 KC REJECTIVITY famous in Lincoln equipment for the last four years.

Turn the indicator to the desired band of frequencies and apply the full tremendous power of the DeLuxe to Short-Wave or Broadcast signals. Utilizing the tremendous amplification and rejectivity of the famous Lincoln tuned intermediate transformers, originated four years ago and perfected to a high degree, the DeLuxe brings in distant signals with tremendous volume with perfect rejectivity. A Lincoln owner in Tennessee listens to NINETY-TWO FOREIGN SHORT WAVE STATIONS out of a total of 128 foreign phone stations. Old time "Hams" and radio fans marvel at the tremendous volume available on signals thousands of miles away. Even in the Broadcast band, owners of Lincoln equipment located in the Central West are actually listening to stations 7,000 miles away with loudspeaker volume. A report from Cushing, Oklahoma, states: "Seven stations received from Japan in one morning, all in the broadcast band." While another report reads: "Listening to 2YA Wellington, New Zealand, Osaka, Sendai, and Kumamoto, (750, 770 and 790 KC) in Japan, KGMC Honolulu, 2BL Sydney, Australia, all in the Broadcast Band." Do you wonder that Lincoln receivers are classed as the most powerful equipment in the world?

Do you wonder why Lincoln equipment out-performs any known receiver and is chosen by the Polar Expedition, Broadcasting Station, and individuals who want the best?

Months of intensive laboratory study has been put into these two new receivers. Capitalizing on years of advanced engineering developments, Lincoln engineers have worked out every detail of performance—Selectivity—Sensitivity—Fidelity and Stability, to work perfectly from frequencies of 15 to 550 meters. The tremendous amplification of the new models now applied to short-wave, as well as broadcast stations, gives a new conception of what is possible in radio.

MARVELOUS TONE QUALITY for which Lincoln equipment has so long been noted, is maintained. The heavy volume of the organ or orchestra can be brought into the home with realistic reproduction or tuned down to a whisper without destroying the quality and without a sign of AC hum.

**EVERY RECEIVER IS LABORATORY BUILT, CONSTRUCTED BY COMPETENT ENGINEERS AND THOROUGHLY TESTED ON THE AIR BEFORE SHIPMENT.**

**THE LINCOLN DELUXE DC-SW-10**

This receiver is designed for use with new low drain series 2-volt tubes, employing three '30 type, five '32 type and two '31 type in push-pull output. Will operate on any two volt "A" supply and dry "B" batteries. For quietness of operation due to elimination of AC line interference, the new DC DeLuxe gives perfect reproduction on extreme distance.

The Lincoln DeLuxe DC-SW-10 is without question the highest designed and most powerful battery receiver ever offered to the public.

**LINCOLN RADIO CORPORATION**

Dept. N-11 329 SO. WOOD ST.  
 CHICAGO, ILLINOIS

Write today for Arctic Expedition Bulletins and illustrated descriptive literature with attractive distributors' discount.

NAME \_\_\_\_\_  
 ADDRESS \_\_\_\_\_

# NEW



## PENTODE TRANSFORMERS

Three AmerTran Output Transformers for use with the new 247-type pentode power tube have won the enthusiastic approval of set builders. These pentode transformers are designed and built with the same skill and fine quality materials and workmanship that has made AmerTran Products the Standard of Excellence since 1922.

Type 6150—Output from two type 247 pentode tubes to 500 ohms (center tapped primary)

Type 6152—Output from two type 247 pentode tubes to 4000 ohms (center tapped primary)

Type 6200—Output from two type 247 pentode tubes to 15 ohms (center tapped primary)

## DO YOU KNOW

that your set can provide perfect reproduction of music if AmerTran audio Transformers are installed?

that radio results are improved if burnt-out transformers are replaced by AmerTran in your commercial set?

that an AmerTran audio transformer is available to satisfy every amplifier need?

### American Transformer Company

Factory and  
Main Office—  
178 Emmet St.  
Newark, N. J.



New York Office  
Room 1963  
Hudson Terminal  
50 Church Street

R. N. 11-31

American Transformer Company  
178 Emmet Street, Newark, N. J.

Gentlemen: Send me bulletin with complete information of Amertran Output Transformers.

Name.....

Street.....

City and State.....

## Fractional Wave Tests

(Continued from page 368)

and light radiation. It was found that signals could be received with good strength as long as the transmitting antenna and the portable receiver were not below the curvature of the earth, *i. e.*, providing visibility permitted, were within visual distance.

Further, however, it was found that under certain conditions, the signals traveled beyond the horizon for a short distance, usually with a definite maximum of five miles below the horizon point. This condition was not regularly detected, and led Dr. Lindenblad to evolve a theory that an effect something like that caused by the Heaviside layer was occurring, although apparently these ultra-high frequency signals are not affected by this phenomena.

The belief was set forth that the earth's atmosphere which at all times contains a considerable amount of moisture, was giving the same effect as the Heaviside layer, and causing the signals to bend beyond the horizon point.

Early in the course of the experiments it was found that the usual means of insulating an antenna and feeder wires with porcelain and glass was not satisfactory.

Accordingly, a rather ingenious support was designed which actually is not an insulator, but is a metallic ground at an anti-node point. This "feeder" consists of two wires, arranged in parallel and each equal to one-quarter wavelength (seventeen centimeters) and grounded at the end opposite to where they attach to the antenna feeder wires. Were these two wires to be arranged in any other position except parallel, they would radiate signal energy, which is exactly what is not desired. However, arranged in parallel the radiating fields of each of the wires is within the area between the two, and therefore the fields cancel out.

### Ground Absorption

During the course of the experiments it has been found that the ground absorption at such high frequencies is far less per unit of wavelength than it is for longer waves. However, because the length of the wave is so short the ground component of the sixty-eight centimeter wave is absorbed entirely within several feet from the apparatus.

The engineers are still carrying on their research with the hope of opening an entirely new field of communication. Their chief concern has not been with the view of revolutionizing communication or finding a practical application for the system, but to develop apparatus which may be made to operate efficiently on these frequencies.

In the course of their present experiments they are radiating about fifteen watts of power from each of the two transmitters and are conducting tests between the two points. For the most part voices and music are transmitted over the circuit. Telephonic communication between the two stations is extremely reliable. Music and voice transmissions are extremely clear.

Possibilities for communication systems and broadcasting on frequencies of this high order are enormous. The number of channels available for transmission in the vicinity of centimeters could accommodate all of the radio stations at present in the world, and still there would be a number of channels available for other purposes.

Just what will be the ultimate outcome of these experiments is not known yet. In addition to holding some possibilities for local broadcasting, they might be used as a series of repeater stations for transcontinental communication. Inasmuch as the beams may be focused with the accuracy of a ray of light, but are not materially affected by fog and other barriers to light, they might be used for this purpose.

Furthermore, waves of this order have a potential military value which could be developed with the proper research. Because of the fact that they might be focused they could be used as a means of inter-trench communication for military maneuvers. Only further development will determine their ultimate value.

## The Army Portable

(Continued from page 418)

quirements laid down for the set complete, it was necessary to eliminate every possible ounce. It was decided, therefore, to use peanut tubes in the receiving circuit. The first tube is used for autodyne reception, while two other tubes used are audio amplifiers. (In the circuit diagram of the receiver only one audio stage is shown for the sake of simplicity.)

The transmitter oscillating circuit consists of the loop and the fixed and variable air condenser connected in parallel. This is the same tuned circuit as is used for receiving. When the sending key is closed, with the hand generator in operation, the tuned circuit is disconnected from the receiver and connected to the transmitter. A signal corps vacuum tube, type VT-2, or the UX-210 tube is used with the transmitter.

A hand generator supplies the plate and filament current for the transmitting tube only. The low voltage side of this generator develops 8.4 volts at the brushes with 7.5 volts at the tube terminals in the apparatus box. A voltage regulator is adjusted to maintain this voltage for all crank speeds above five revolutions a minute. The vibrator, when attracted by the electromagnet, inserts a 20-ohm resistor between the field and the plus armature terminal and at the same time short circuits the field winding by means of an additional contact.

The generator has three removable legs, one of which carries a seat for the man turning the generator. There are provided two carrying bags, one for the loop, generator legs, cranks and cord, the other for spare batteries, spare tubes and message books.



# WANTED

**\$20 to \$35 a week men who want to earn \$50 to \$75 a week and more**

**T**ODAY—more than any time before in the history of the great Radio Industry—Manufacturers, Broadcasting Stations, Sound Picture and Television concerns, and others—are on the lookout for men capable of being promoted to their more responsible jobs.

They can get all the men they want for their ordinary work—jobs that pay \$20 to \$35 a week or less. Which, of course, is one reason why these jobs don't pay better wages—almost any man can do the work.

But for their better-paying jobs—those jobs that pay \$50 to \$75 a week and up—well, it's different. Here brains, not muscle, are required. Here knowledge, not guess work, is necessary. Here men capable of some day being promoted to still better-paying jobs are needed.

This big demand for men of this type has been brought about by the amazingly rapid expansion of the Radio field. Because of dozens and dozens of new, and almost revolutionary, developments, hundreds and hundreds of big-pay jobs have been created almost over-night.

Radio work is no longer limited to the building and servicing of Radio sets.

It now includes such other things as Sound Pictures, Public Address Systems, Radio in Industry, Radio in Aviation, Radio aboard ship (for operating mechanisms of different kinds, and even for running the ship itself), telephotography, Television, etc.—everything, in fact, that makes use of the vacuum tube or photo-electric cell.

Radio devices, today, are operating great machines formerly operated by man—are grading by color or size such manufactured articles as cigars, paper, silks, etc.—are counting people or automobiles as they go by any given point—are turning on and off lights in our big factories or on our city streets—are operating airplanes in the air—directing ships at sea from stations on land—creating music more perfect than played by our best masters—and doing a thousand other things not dreamed of a few years ago.

To know Radio is to know the principles of all of these things.

And to such men the great Radio Industry offers many wonderful opportunities—steady work at good pay, NOW—and an early advancement to still better-paying jobs, as a future.

But no ordinary knowledge of Radio will do. To qualify for these better-paying jobs—men

must know the theory and practical application of all Radio devices—old and new, and they should be able to teach other men some of the things they know.

That means they must be "trained".

As few men can afford to get this training at some College or University, the Radio and Television Institute, of Chicago, was organized to train men at home—no matter where they live—in their spare time—easily and quickly—and at a cost of only a few cents a day.

The Radio and Television Institute is the ONLY Institution of its kind whose Course of home-training is actually supervised by an Advisory Board of outside business men,—all highly paid engineers and executives,—each actively connected with some large Radio concern. It is, too, the ONLY Radio School to be endorsed by some fifteen of our largest and most progressive manufacturers of Radio and Television equipment. These public endorsements were given to guide ambitious men who seek a future in Radio. These manufacturers want all such men to know that the Radio and Television Institute has their unqualified approval, and their hearty support, in its work of training men, through spare-time home-study, for the many better-paying jobs that exist today in Radio . . . Sound Pictures . . . and Television work.

Radio and Television Institute home-training prepares men, easily and quickly, for these better-paying jobs. It is the ONE recognized connecting link between ambitious men and a splendid future in Radio.

To the man, then, who is earning \$20 to \$35 a week NOW—and who would like to earn \$50 to \$75 a week or more—regardless of whether or not he is doing Radio work today—we say in all honesty—"we think we can help you." Just mail the coupon below for full particulars of our plan and a free copy of the new Opportunity Book.



Radio—first an experiment—then a plaything—now a giant industry—the fastest growing industry the world has ever known—offering thousands of wonderful opportunities to ambitious men.

✧ **RADIO AND TELEVISION INSTITUTE** ✧  
DEPT. 848 2130 LAWRENCE AVENUE, CHICAGO

Please send me a copy of your Opportunity Book and full particulars of your plan for helping men into good pay positions in the Radio field.

Name.....

Address.....

City..... State.....

# Announcing THE NEW WESTON PHOTRONIC CELL

(Photo-electric)

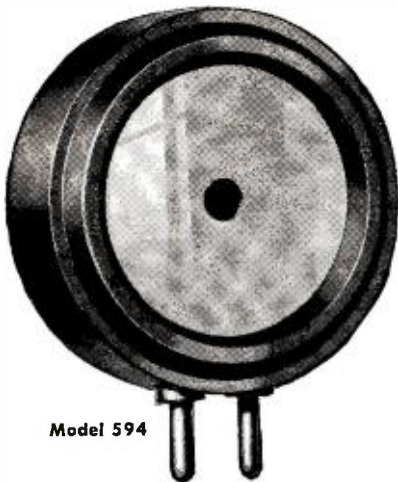

Model 594

Dry type—amazing in performance—utterly simple in design—the new Weston Photronic Cell is radically different—a marked advance in light sensitive calls.

It is revolutionizing in its operation. It establishes a new standard of performance. Almost limitless application. And its cost is low.

## OUTSTANDING FEATURES

- Highly Sensitive
- High current output (approx. 5 milliamperes in direct sunlight)
- No drifting
- No chemical change
- No physical change
- Unlimited life—so far as known
- No deterioration on shelf

- No dark current
- No batteries
- No polarizing voltage
- No exciting voltage
- No readjustments of the circuit
- Non-microphonic
- Withstands direct sunlight

- No liquid
- No glass bulb
- No gas
- No vacuum
- Not easily damaged
- Nothing to replace

Low cost

Write  
for  
Circular  
YY

**WESTON ELECTRICAL  
INSTRUMENT CORPORATION**  
615 Frelinghuysen Avenue, Newark, N. J.

# The International Six

(Continued from page 371)

embodied in any other receiver using the new variable-mu tubes!

Last, but far from least, we come to the new mercury-vapor rectifier. Years ago, the railway engineers tried all types of rectifiers, mechanical, chemical, and thermionic, and eventually standardized on the mercury-vapor rectifier. Today radio engineers are running the same gamut. They have tried mechanical rectifiers, argon rectifiers, electrolytic rectifiers, helium rectifiers, and thermionic rectifiers. Now they, too, are learning their lesson, and turning to the mercury-vapor tube, because of the many advantages it has to offer over the standard type -80, which it replaces.

In the first place, the rating is much higher,—300 ma. at 500 volts as compared with 110 ma. at 400 volts from the type -80 tube. This allows the power supply to be designed for higher voltages and bigger loads.

ference between good and poor design. Those items which have already been covered will, of course, be dwelt on but briefly.

The power transformer was designed for operation on a 115-volt line but will not overload the tubes on 120 volts. For higher line voltages it is necessary to place a line voltage regulator of some sort in series with the primary. As voltages above 120 are seldom encountered, a regulator was not included in the power supply design.

The high-voltage secondary supplies about 900 volts, center-tapped, to the plates of the type 583 full-wave rectifier. Another secondary supplies 5 volts for the rectifier filament. There are also three 2½-volt secondaries. A high-amperage one is used to light all the heater tubes, while a low-amperage winding is used for the type -45 tube filament. The third 2½-volt winding is used exclusively

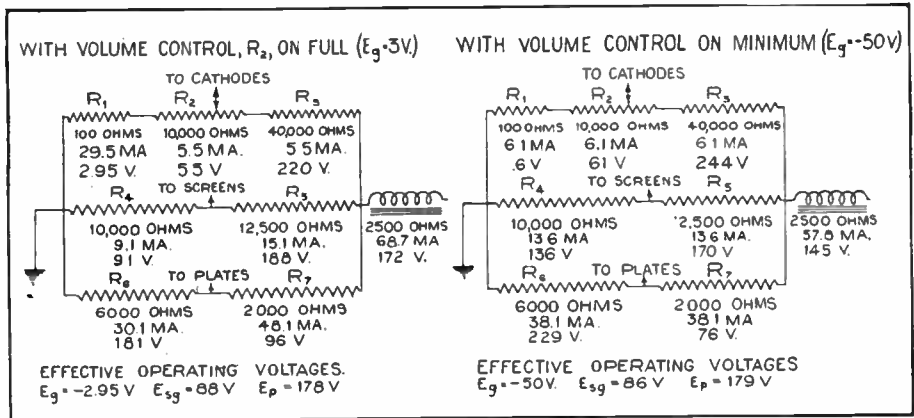

### UNIQUE VOLTAGE DIVIDER DESIGN

Figure 4. (A) shows the effective plate and screen-grid voltages (measured from cathodes) with volume control, R<sub>2</sub>, in control-grid circuits set for maximum volume. (B) shows these voltages to be almost identical when volume control is set for minimum volume. Thus, in spite of large variation in tube current drain, voltage regulation is well-nigh perfect

Secondly, the voltage drop in the tube is much lower, which greatly improves the regulation of the power unit. The current can change by fifteen milliamperes without altering the voltage output appreciably. Such regulation would be impossible with the type -80 rectifier, even using choke input. Then, too, for the same transformer secondary voltage, the tube will deliver a much higher d.c. voltage to the filter. At the current drain of the International Six, this gain is approximately 30 volts.

Third, the heat developed in the tube is quite low, due again to the low voltage drop. At 460 volts and 100 mls, which is the rectifier output, the tube runs so cool you can place your hand on it without discomfort. This is important in a compact receiver, where all excess heat lowers the voltage rating of the electrolytic condensers. All in all, this tube, pioneered by the Perryman people, has been a large contributing factor to the success of the International Six receiver.

Having analyzed the special features of the receiver, we can now make a study of the schematic diagram, noting the many fine points that make all the dif-

ferences between good and poor design. Those items which have already been covered will, of course, be dwelt on but briefly.

The filter circuit is generously oversized. As a brute-force filter it would be ample, but a hum balancer supplies additional filtering to the audio end. The hum is so far below the audibility level it can only be detected by feeling the diaphragm of the dynamic speaker. No hum can be heard, even with earphones. The first filter condenser (C18) is a 2-microfarad, 600-volt job. Following this is a 30-henry choke of only 300 ohms direct-current resistance (L9) and a 4-microfarad electrolytic condenser (C17). The radio-frequency voltage supply passes from here through the 2500-ohm speaker field, followed by another 4-microfarad electrolytic condenser (C16) and then through a resistance-capacity filter network to the various tubes. The audio supply is drawn directly from the first filter choke. The usual direct-coupled circuit hum balancer is used with a variable hum-bucker adjustment, located on the rear of the chassis (R10). In addition to this, a 4-micro-

farad electrolytic condenser (C15) is used between the high-voltage lead and the mid-tap of the -45 tube filament supply, in place of the 1-microfarad condenser used here in the conventional amplifier. No wonder there is no audible hum present in the output.

The direct-coupled audio amplifier is of standard design, except for the addition of the electrolytic condenser referred to above, and the radio-frequency filter in the plate circuit of the output tube. This consists of a 16-millihenry choke (L8) and two .00025 condensers (C12, C13) and is necessary to keep all stray radio-frequency currents out of the speaker leads. These stray currents exist in the

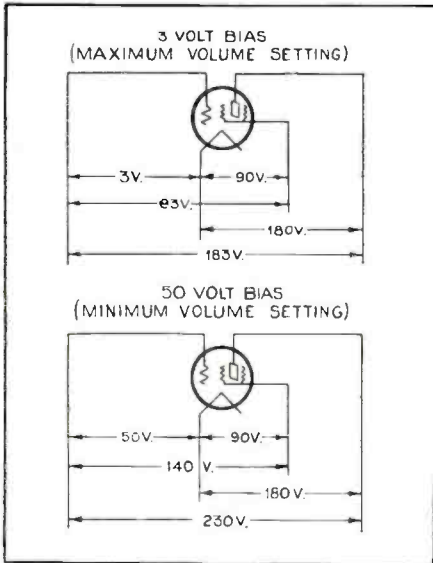

**MULTI-MU TUBES PRESENT A PROBLEM**

Figure 3. Varying the volume control from zero to maximum results in an increase of over 15 ma. in current drain, and of close to 50 volts change in overall voltage to ground, as shown here. Figure 4 shows method of solving this problem in the voltage divider of the International Six receiver

type -45 tube, and the small coupling between its plate and the aerial lead was sufficient to cause regeneration in an experimental model. Shielding the power tube completely eliminated this difficulty.

The radio-frequency amplifier has been covered before. There is no band-pass filter or local-distance switch in the antenna circuit because such things are unnecessary in a multi-stage amplifier using variable-mu tubes, and would only cut down the gain and complicate the design of the circuit.

The filtering of each stage is rather complete. By-pass condensers are connected to the cathode and screen terminals of each tube socket by very short, direct leads. The B+ leads of each coil are individually by-passed. Each cathode lead also has a radio-frequency choke in it.

The volume control and switch are in one unit for convenience. This volume control is part of the voltage-divider network and controls the cathode voltage, or grid bias, on the variable-mu tubes. The gain control (R1), located beside the volume control, varies the minimum grid bias, i.e., the grid bias which will be ob-

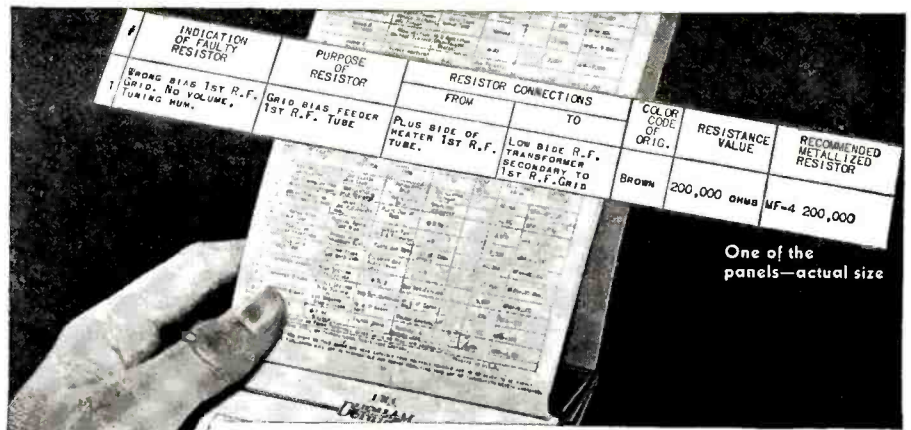

One of the panels—actual size

# In 1/2 minute! you know what RESISTOR you need

WOULDN'T you like to have the resistor question answered, *instantly*, no matter what set you're servicing? The I.R.C. Resistor Guide will do just that for you.

Once you know it is resistor trouble, this remarkable book will give the value and code, and position in the circuit of each defective unit. It lists all popular makes of receivers (over 200 circuits)—with the types to use in each.

No need to guess or worry over the proper units. The I.R.C. Guide will be right there in your pocket ready to do its stuff—a short cut to trouble finding. Leading servicemen the country over use it daily.

With the purchase of 10 Resistors, you receive our complete, authoritative Guide *free*—or it may be bought for \$1.00.

Loose-leaf sheets, made up by our engineers, are mailed periodically, without charge, to every Guide owner—keep it constantly up to date. Thousands of sets this fall will need servicing. Be ready to get your share of the business.

With the Guide, we will send our new I.R.C. Color Code Chart, quickly telling range and type of any resistor.

Published by

**INTERNATIONAL RESISTANCE CO.**

Philadelphia

Toronto

Ask Your Jobber for

# Metallized

Also Precision Wire Wound

# RESISTORS



FREE With  
10 Metallized  
Resistors



INTERNATIONAL RESISTANCE CO., N-10  
2006 Chestnut St., Philadelphia

Gentlemen: (Check offer you are interested in)

I enclose \$1.00 for Replacement Guide.

Send prices. Metallized Resistors. I wish to buy assortment of 10, entitling me to Resistor Guide Free.

NAME.....

ADDRESS.....

CITY.....STATE.....

# WHAT A WALLOP!

## NATIONAL NC-5 CONVERTER

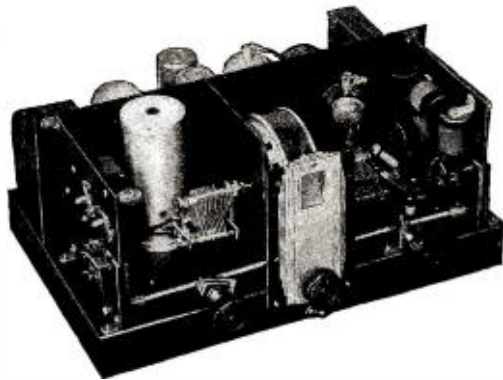

### For Adapting Your Regular Radio Set to Receive Short-Waves Too! Range 15—185 Meters

A brand new kind of converter, that works on *any* broadcast receiver, bringing in short-wave broadcasts and code from anywhere. Contains exclusive HARMONIC TUNED INPUT CIRCUIT which automatically resonates a stage of high-frequency amplification, *plus* an additional stage of high gain amplification, which also serves as a low impedance coupling with the radio set. Performance is a revelation. The NC-5 has a real punch and is a fitting companion in fineness and quality to the well known NATIONAL SW-5 THRILL BOX. (See description on opposite page.)

#### NO PLUG-IN COILS

The NATIONAL NC-5 Converter is equipped with a new coil-switching system giving practically perfect results for converter use, comparable in every way to plug-in coils, but without their inconveniences. This is because of new design but would be out of the question without the remarkable low-loss dielectric R-39, which is used in the coil-forms and panels and was developed for NATIONAL CO. use by the Radio Frequency Laboratories. With ordinary insulating materials, such performance would be impossible. Coils are mounted so there is *no inter-coupling*, and are cut in or out by the turn of a front panel knob. . . . As wave-changing knob turns, the color of the dial-light changes, showing red for red coils, green for green coils, etc., and indicating which coils are in circuit.

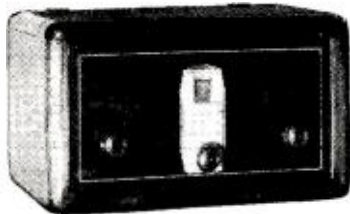

Send in coupon for full information and prices.

#### SINGLE CONTROL TUNING

The tuning-system is true-single control and is especially designed to make circuits "track" each other accurately.

#### NO INTERLOCKING OR "DEAD-SPOTS"

Operation is stable over the whole range.

#### EASY TO CONNECT AND USE

Need not be disconnected when receiving ordinary broadcasts. Has own built-in power supply. RCA License.

#### ATTRACTIVE—COMPACT

Size, 8" x 17½" x 12".

#### STANDARD MODEL

In beautifully finished metal cabinet.

#### DE LUXE MODEL

In hand-rubbed solid mahogany case with genuine inlay in front panel. Harmonizes with the most beautiful radio sets. Write us today for particulars and prices using coupon at left.

## NATIONAL NC-5 Short-Wave Converter

NATIONAL COMPANY, INC.  
61 Sherman Street, Malden, Mass.

Gentlemen: Please send me full information about your new NC-5 Short-Wave Converter.

Name.....

Address.....

RN-11

tained when the volume control is turned on full. Reducing the gain control has exactly the same electrical effect as reducing the setting of the volume control. When the grid bias is reduced below a certain value, the set oscillates. The gain control can be adjusted so that this just occurs at the maximum setting of the volume control, or it may be adjusted so that no oscillation will occur at all. The former adjustment is of course better for distance reception, while the latter adjustment simplifies tuning somewhat for the non-technical members of the family.

Next month complete constructional details will be given, as well as operating notes.

#### List of Parts

- L1, L2, L3, L4—International Six coil units.
- L5, L6, L7, L8—General Manufacturing Co. 16-millihenry chokes.
- L9—Kenyon 30-henry choke.
- T1—Jefferson International Six power transformer.
- C1, C2, C3, C4—DeJur .00035 type A, counter-clockwise 4-gang r.f. condenser.
- C5, C6—Aerovox type 260 condenser blocks, 0-1-1-1.
- C7, C8, C9—Aerovox type 480 condensers, .1 mfd.
- C10, C11—Aerovox type 200s condensers, 1 mfd.
- C12, C13—Aerovox type 1462 condensers, .00025 mfd.
- C14—Aerovox type 330s condenser, 1 mfd.
- C15—Aerovox type I5-4 electrolytic condenser, 4 mfd.
- C16, C17—Aerovox G5-4 electrolytic condensers, 4 mfd.
- C18—Aerovox type 602 condenser, 2 mfd.
- R1—Electrad type B10 1000-ohm resistor.
- R2—Electrad 10,000-ohm potentiometer with switch, type Ri210P.
- R3—Lynch type LR-4, 40,000-ohm, 1½-watt resistor.
- R4—Lynch type LR-4, 10,000-ohm, 2-watt resistor.
- R5—Lynch type LM-3, 12,500-ohm, 3 watt resistor.
- R6—Electrad type B60, 6000-ohm, 10-watt resistor.
- R7—Electrad type B20, 2000-ohm, 5-watt resistor.
- R8—Lynch type LF-4½, 50,000-ohm, ½-watt resistor.
- R9—Electrad type V586D10, Loftin-White resistor.
- R10—Electrad 200-ohm hum-bucking potentiometer.
- R11—Lynch type LF-4½, 25,000-ohm, ½-watt resistor.
- R12—Lynch type LF-4½, 100,000-ohm, ½-watt resistor.
- R13—Lynch type LF-4½, 500,000-ohm, ½-watt resistor.
- V1, V2, V3—Eby type 551 wafer sockets, 1 27/32 mounting holes.
- V4—Eby type -24 wafer socket, 1 27/32 mounting holes.
- V5—Eby type -45 wafer socket, 1 27/32 mounting holes.
- V6—Eby type UX (no label) wafer socket, 1 27/32 mounting holes.
- 1 Eby binding post strip, marked "Ant.-Gd."
- 1 Eby binding post strip, marked "Field."

(Continued on page 425)

## Service Tips

(Continued from page 402)

"My dear Mr. . . . : With the feature programs of the winter season just in the offing, we are making a special radio-service proposition to our old customers—a general check-over that may save you considerable money and which should insure uninterrupted enjoyment of your radio for many months. Our special fall check-over includes the following work:

- "Replace rectifying tube.
  - "Test all tubes.
  - "Inspect and repair antenna.
  - "Clean and tighten ground connection.
  - "Inspect and tighten all receiver and chassis connections.
  - "Clean volume control and tighten arm.
  - "Adjust speaker clearance.
- "Our group price for this special check-over is only \$5.00. A 'phone call—or merely drop the enclosed card in the mail box (it requires no stamp)—and an efficient, courteous serviceman will call at your convenience. Our work is guaranteed—as usual!"

"Yours for service,  
"....."

### Antenna and Noise Service Letter

And cashing in on the final rumble of summer static, you might try the following:

"My dear Mr. . . . : Has your radio been noisy of late? The greater part of radio noise, which so seriously interferes with the full enjoyment of a radio program, is often caused by faulty or aging antenna and ground installations. Let us install a new, noise-proof antenna for you. Aside from the permanently noiseless quality of this antenna, it will be engineered particularly for your receiver—strung in the direction best suited to the reception of the stations you want and of the correct length to give you maximum signal strength without interference from undesired stations."

"Yours for improved reception,  
"....."

## International Six

(Continued from page 424)

- 1 Eby binding post strip, marked "Output."
- 4 National coil shields.
- 5 National tube shields.
- 1 Cortland Panel Engraving Co. International Six chassis, drilled.
- 1 Eddy drum dial.
- Miscellaneous hardware, red, yellow and black wire, etc.

### Accessories

- 3 type -51 tubes.
- 1 type-24 tube.
- 1 type -45 tube.
- 1 Perryman type 588 tube (mercury vapor rectifier).
- 1 Jensen type D15 dynamic speaker, for single -45 output.

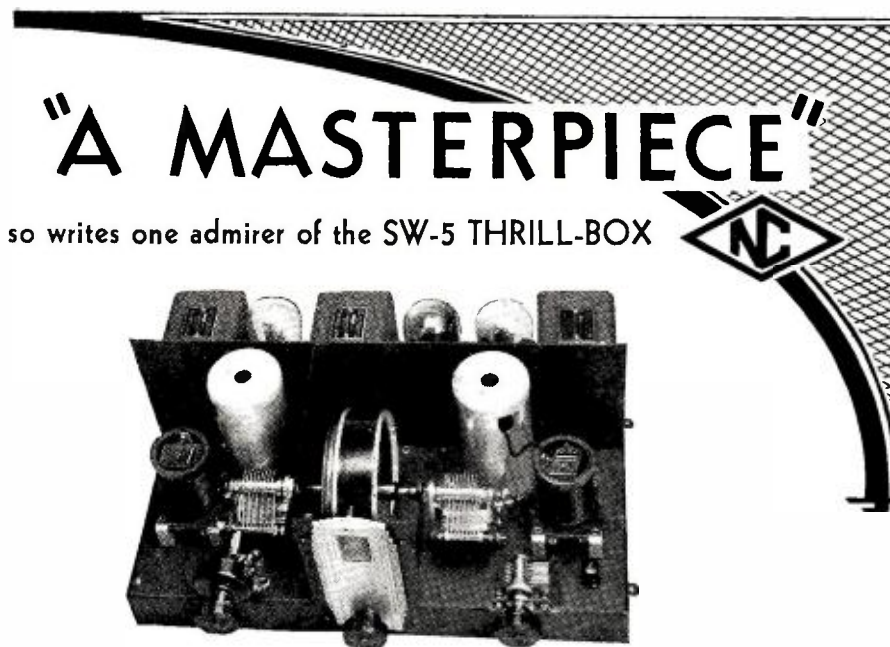

so writes one admirer of the SW-5 THRILL-BOX

Others say: "No comparison possible with other receivers!" . . . . "Works perfectly and surely brings in the DX." . . . . "Have had years of S.W. experience and I have never seen a receiver that nearly approaches the NATIONAL SW-5 THRILL-BOX in performance." . . . . "5 continents and 23 countries received." . . . . "They don't make SW Receivers better than the NATIONAL SW-5." (Names on request.)

## OUTSTANDING SHORT-WAVE RECEIVER

The SW-5 THRILL-BOX is the outstanding receiver for short-wave communications, for serious every-day short-wave phone or broadcast reception,—for code or experimental use. It is standard equipment on leading air-lines, on ships and boats, on exploring expeditions to every corner of the world. Hundreds of enthusiastic short-wave broadcast listeners cheer for it, as the quotations above indicate . . . . For those who have a regular broadcast Radio-Set, and who may wish to broaden their pleasure and entertainment by listening also to short-wave broadcasts (or code) from time to time, we have announced the new NATIONAL NC-5 Converter. (See opposite page for details.) But for the every-day user of short waves, the SW-5 THRILL-BOX is THE short-wave receiver of them all.

### HIGH-LIGHTS on the SW-5.

- Range 9-850 meters.
- True single-knob tuning. Set and forget the antenna trimmer.
- Easy to log with NATIONAL projector Dial, type II, no parallax.
- Special 270° Type S. E. Tuning Condenser with insulated main-bearing and Constant-impedance pig-tail makes gang-tuning possible on the short waves.
- Equipped with standard set of 4 pairs of R.F. Transformers wound on forms of genuine NATIONAL R-39. On a set of this type, plug-in coils are essential for maximum results in receiving weak code, etc.
- Uses the new UX-235 Variable-Mu Tubes, giving improved sensitivity (see below).
- Humless A.C. Power Supply with special filter section.
- R.F. Filter on Rectifier Tube, and Electrostatic Shield. RCA Licensed.

### Why R-39 Makes Better Coil-Forms

Ground mica, not wood filler, is used in making R-39, and a minimum of pure uncolored Bakelite. This makes the material practically moisture-free and dielectric losses are extremely low. Coil-forms and panels of the NATIONAL NC-5 Short-Wave Converter are also made of this wonderful material.

### Why the 235 Variable-Mu Tubes Improve the SW-5.

Employing a hitherto unknown and unused principle of the 235 tubes in the THRILL-BOX, the point of greatest sensitivity is approached on an inverse exponential curve. Thus the operator can always secure stable operation at a much higher level of sensitivity without critical handling of controls.

### Battery Model

Made also in Low-Drain Battery Model using new air-cell battery and 2-volt tubes.

### Special Broadcast Model

Model now available using 245's in Push-Pull for Audio output, for greater volume.



Send in Coupon for Full Information and Prices

## NATIONAL SW-5 THRILL-BOX

NATIONAL CO., INC.  
61 Sherman St., Malden, Mass.

Gentlemen:

(Check which)

( ) Please send me complete information and prices on your new Improved SW-5 THRILL-BOX.

( ) I enclose 50c (stamps or coin) for your 64-page Handbook of Short-Wave Radio, describing in full the latest and best short-wave receiving circuits, adapters, meters, etc.

Name.....

Address.....

RN-11



# SEND for this book NOW!

WE would like to send the third edition of the **CENTRALAB** Volume Control Guide to you. Contains much *new* information, including volume control circuits and data for Sound Equipment, Multiple Speaker Installations, Public Address Systems, Phonograph Pick-ups, Fixed Resistors, etc. Best of all, it shows how to service all new and most old sets with a mere handful of Centralab Replacement Volume Controls.

It's a mighty necessary part of every serviceman's kit. Use the coupon below at once.

## Centralab VOLUME CONTROLS



### MAIL COUPON TODAY

**CENTRAL RADIO LAB.**  
929 Keefe Ave., Milwaukee, Wis.  
Here is 25c. Send me new **VOLUME CONTROL GUIDE**

Address.....

Name.....

City.....State.....

Radio News

## The Service Bench

(Continued from page 403)

are fairly well balanced. A magnetic speaker may be operated in conjunction with a dynamic in accordance with the diagram of Figure 6. The series arrangements are turned off by means of short circuiting switch and the parallel connected speakers by opening the circuit."

### P. A. Courses in Correspondence Schools

In recognition of the growing utility of the radio serviceman in the installation and maintenance of public address systems, the Service Bench has made a general inquiry as to the training facilities along this line offered by the prominent radio schools. In almost every instance, special courses dealing with related subjects either have been or are being prepared.

A. G. Mohaupt, President of the Radio Training Association of America, writes that their new course on public address systems will include "a very thorough treatment on the subject of audio amplifying systems as used for these purposes, various types of coupling transformers employed, line impedance calculations, sound reproducing systems, etc."

The fall courses of the National Radio Institute will similarly include intensive training in "public address and sound pictures, covering every phase of reproduction, transmission and projection."

Instructors in the Loomis Radio College have had special training with the Western Electric Company on this by-product of radio, and the Radio College of Canada announces that their staff of instructors is revising and elaborating the portion of their course dealing with sound reproduction.

Other schools offering such courses include the Coyne Electrical School, R.C.A. Institute and the West Side Y.M.C.A. Radio Institute.

Radio servicemen contemplating going in for a course in general radio work would do well to investigate the extent to which their intended school specializes in this highly important phase of service and radio engineering.

### A Few Pointers on Strombergs

Don Blair, Stromberg-Carlson expert of Franklin, Pa., passes along a bit of inside dope:

"Stromberg-Carlson models 635 gave us considerable volume-control trouble until we hit upon the idea of using a rocking-disc type of contact instead of the roller. As a matter of fact, one manufacturer now makes a replacement unit especially for this model that seems to be a lasting answer to our prayers. However, we found that it was impossible to balance the set properly if the new control was mounted directly in front of the set, as was apparently the intention of the manufacturer. We solved the problem by saving the old control, which is in two parts with a steel connection shaft between them—one part being the antenna potentiometer and mounted near the rear of the chassis, and the other a rheostat shunting the third r.f. primary. We

mount the new dual unit in place of the old antenna potentiometer at the rear, and use the shell of the rheostat and the shaft to connect to the volume-control knob, the same as was originally done. The antenna control is now in the same position as formerly, and the shunt rheostat is wired to the primary of the first r.f. transformer instead of the third. The set can now be balanced easily, and the volume-control unit will have a much longer life than the original roller type.

"This same idea can also be applied to later models, such as the 652, where we substitute a new 10,000-ohm antenna potentiometer by cutting off the old shaft and soldering a thin brass collar to couple it to the new control. The wire-wound 'C'-bias control on this model seems to be satisfactory, but should be dismantled and cleaned when the set is in the shop.

"It is a good plan to wipe clean the spring-clip contacts to the condenser rotor-shaft, on all Strombergs, at every opportunity. Some persistent cases of oscillation have been cured by substituting pigtailed for these same spring clips."

### New Test Equipment for Pentodes

Many radio men who have investments in radio testing equipment are interested in the adaptability of this equipment for the new test requirements imposed by the new power pentode tubes. The new variable-mu tubes will not apparently introduce any problems by way of design limitations in present testing devices.

In general appearance, the new power pentode tube is similar to the type -45, there being no top or side terminals. The base prongs or terminals correspond to the terminal arrangement of the type -27, except that the "space charge grid" of the new tube utilizes the terminal which corresponds to the cathode prong of the type -27. The space charge or pentode potential may be ascertained with present analyzers or testers in the manner prescribed for measuring cathode potentials, provided the meter range connected to the cathode switch contacts is adequate for accommodating the higher space charge potentials. These potentials will probably be about 250 volts.

The Supreme Instruments Corporation has announced to the service trade that the Supreme Set Analyzer is adaptable without modification for measurements of all potentials involved in the new power pentode tubes. This adaptability is automatically provided by the switching arrangement which permits the optional connection of any range of the meter across any tube circuit, so that cathode or power pentode potentials may be read on meter ranges of 3, 9, 30, 300 and 900 volts. The power pentode tests will be best accommodated on the 300 range.

### Analysis of Service Charges

The generous response to our service editorial on "The Business End of Servicing," has established the following interesting facts concerning the economics of servicing:

The average serviceman charges \$1.50

per service call at the home of the client, and \$1.00 for the general inspection of a receiver brought to his shop.

A service call at the home includes check of the antenna, ground and power connections, and any minor tightening of connections.

The average serviceman will make only minor repairs at the home of his clients, and repair work is charged for at \$1.50 an hour at either the home or radio shop.

Many servicemen have fixed charges for certain classes of work, such as lining up and adjusting a t.r.f. receiver, \$3.00, a neutrodyne \$4.00, and a superheterodyne \$7.50.

While the majority of servicemen are not dealers themselves, they are under contract with local dealers for service work.

### Tracking Storms by Radio

*(Continued from page 365)*

latest developments for tracking storms by radio, there have been many earlier attempts to do this in various manners. One of the first actual experiments was that of Lieutenant E. H. Kincaid, who, as early as 1927, evolved the theory that the strength of static is proportional to the rate of change of atmospheric pressure. It was already known that static emanating from an intense storm area is greatest at or near its center. Lieutenant Kincaid made many experiments, by means of an inductive loop direction-finder, on the U. S. S. *Kittery*, a small naval auxiliary plying between the West Indies and Hampton Roads. This ship, under his system, was able to dodge cyclones and hurricanes that destroyed many other vessels not so equipped.

The U. S. Weather Bureau has also done excellent work in locating storms and in predicting their path by radio observations as well as by the strictly meteorological methods. The U. S. Navy Department has from time to time made use of static bearings through radio-compass stations along the southeast and the Gulf coasts of the United States, with promising results.

In the opinion of the few experts who have had an opportunity to witness the new English short-wave method in operation, it is believed to be the leading solution of the problem of getting adequate storm-warning advice for modern aerial navigation upon the short notice required.

### Talking Movies for Schools and Colleges

*(Continued from page 378)*

personality of this noted scientist. Such, of course, would be impossible with a silent film.

It is safe to say that half the value of educational pictures lies in the explanations accompanying them. In the silent films this must be provided by the use of subtitles, while in the sound pictures a second sense is used in securing these values. Psychologists claim that of the concrete experiences necessary for one to have in order to do abstract thinking, from 50 per cent. to 75 per cent. are gained through the visual and about 25 per cent. are gained through the auditory senses. The sound picture has thus a

# Another Big MONEY-MAKING OFFER for RADIO SERVICE MEN

by David W. Knapp

**I** PRIDE MYSELF on my ability to find ways for the SERVICE MAN to make money—because he is the man on whom the Radio Industry depends to keep the customer satisfied.

So—repeating my sensational success of 1928 in giving you the Knapp "A" Power Kit, I have persuaded one of my affiliated industries to make you another amazing money-making offer!

You know how hard it has been to keep customers from kicking when a condenser went bad—the days of waiting for a new condenser assembly. This offer does away with all of that.

Thirty minutes after you diagnose the trouble, you have the set back in your customer's home. And your total replacement cost is a single, inexpensive, compact little Elkon condenser on which you can make a long profit both for material and labor.

Instead of replacing an entire condenser box, you melt the pitch, re-



move the bad condenser, stick in a new Elkon, and replace the pitch. Best of all—you always KNOW that the inexpensive little Elkon condenser is a BETTER condenser than the one which you have removed—and you always know that it is a SMALLER condenser, too—no trouble fitting it in place!

## You Can Now Make Big Money Replacing Radio Condensers

—and at the same time have better pleased customers. Because the set will operate better than ever. No need to tell you about the qualities of the Elkon Non-Aqueous High Voltage Condenser.

You know that it is the condenser used by practically all the manufacturers this year. You know that it is the most COMPACT radio condenser ever made—noted for its low leakage and its excellent power factor. No deterioration. You can afford to order a reasonable stock—especially at the astonishingly low price at which you can buy Elkons.

Just to give you an idea of how COMPACT this condenser is, I'm printing an actual size diagram of the 2MFD-450 Volt type. Notice how small it is. Then take my word as to how LARGE your profit can be if you will mail the money-making coupon. It costs you nothing to find out!

### MAIL THIS TODAY!

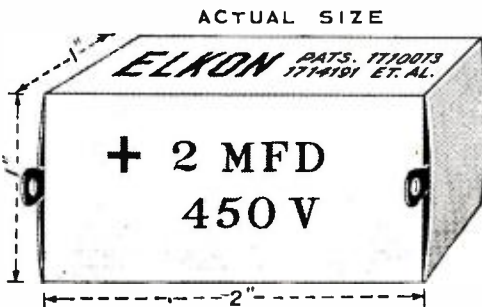

Elkon Division  
P. R. Mallory Co., Inc.  
1131 Newton Street  
Indianapolis, Ind.  
*Please mail me the details of Mr. Knapp's money-making offer for Radio Service Men.*

NAME . . . . .  
ADDRESS . . . . .  
CITY & STATE . . . . .



## 974 Pages of Accurate Radio Service Data

John F. Rider's greatest work—a whole radio service library in one loose leaf volume, with **FREE** Question and Answer service. Your work is the sale of time and knowledge. With this book you will save time and gain more knowledge—render better service—more rapid service—because all of the information you require will be at your finger tips.

MORE PROFITS.

Thousands have acclaimed this book because it contains—974 pages of accurate, authentic radio service data—1,800 diagrams—large and easy to read—not only schematics, but chassis wiring as well—layouts—electrical values—color coding—voltage data—socket layouts—special information—set analyzer diagrams—and explanations—broadcast receivers—short wave receivers—kit receivers—power amplifiers—eliminators—midjet sets—practical trouble shooting methods as recommended by manufacturers—those hard-to-get and nowhere-else-available diagrams—a quick and simple index—in fact, the **GREATEST** compilation of radio service data.

The 1931 Trouble Shooter's Manual is approved by the radio manufacturers—is endorsed by the New York and Philadelphia Radio Service Managers' Associations.

**PAY AS YOU EARN.** Remember that one successful job will pay the total cost of the book.

The 1931 Trouble Shooter's Manual is **GUARANTEED.** If you think that it is not as represented—that you can do your work without the information in the book—send back and get your money. **NO QUESTIONS ASKED.**

EASY  
PAYMENT  
PLAN

\$2.98  
DOWN

Enclosed find \$2.98. Ship postal charges collect 1931 Trouble Shooter's Manual. I will pay the balance of \$2.00 during the next two months at the rate of \$1.00 per month. Check here for detailed circular.

Name.....

Address.....

City.....

State.....

Radio Treatise Co., Inc.  
1440 Broadway,  
New York City.

greater potential value as a means of education.

In setting up standards for production, selection and evaluation of sound pictures a large number of factors must receive consideration. The fact that sound motion pictures, particularly educational sound pictures, are of such recent development makes the establishment of such standards more speculative than scientific. Fortunately, however, considerable scientific study has been done on this for silent and sound pictures. Some of these criteria must necessarily be the same for silent and sound pictures.

First of all, the picture must appeal to socially approved native interests. This involves motion and action, struggle and success, human beings and animals. In appealing to these interests the film must not only present what is good and true, but also what is pleasing and artistic. In this manner the material is presented in such ways as to touch the feelings as well as intellectual interests.

### Should Offer Problem

In the second place, the film should create some problem for the observer. This problem may be answered or partly so in the picture. Here is a scientific principle to be explained and illustrated, a vocational occupation to be explored, a period in history to be relived and understood. A kaleidoscopic grouping of scenes could scarcely be considered an educational film even though possibly having some little educational merit.

The film should have unity and homogeneity. It must show the important thing as outstanding and the remaining things so related and correlated as to give one or several complete concepts to the student. The significant facts of the film should be developed rather than obscured by the details. The "flash back" may be effectively used in jogging the memory of the observer of the essential theme of the picture.

The sound accompaniment to the picture should be such as to synchronize harmoniously and effectively with the movement on the screen. This would include the natural sounds of machines, animals or talking of foreign peoples. One essential is that only lecturers and scholars be chosen for educational talking pictures who are pleasing and effective speakers. It is necessary to have rhetorical clearness and charm. Many present silent films of educational worth have been damaged by substituting for the subtitles a lecture accompaniment which is difficult of understanding and devoid of effectiveness and rhetorical charm.

Lastly, the mechanics of the picture should be good. This means good photography, good recording of the sound effects. The arrangement of the continuity should be such as to produce the best emphasis, with the elimination of irrelevant material. The duration of the scenes should be sufficient for comprehension. This will mean not such rapid action as is characteristic of the theatrical picture, since in the educational picture often new concepts and experiences are being presented to the observer which must be comprehended by him. In the theatrical picture the action is based upon known elements, while in the educational

### Radio Dealers: Radio Service Men!

NEW LOW PRICES  
Guaranteed Replacement Condenser Blocks and Transformers Net

Atwater-Kent 37 Cond. Block with chokes.....	\$2.75
Atwater-Kent 37 Power Transformer.....	2.10
Atwater-Kent 40 Pack Complete.....	7.50
Zenith ZE9. Stewart-Warner, Mohawk Blocks.....	3.15
Majestic "B" Eliminator Cond. Block.....	2.10
Crosley Electrolytic Condenser, 2 Anode.....	2.10
Crosley Electrolytic Condenser, 3 Anode.....	2.75

Hard-to-get parts—We have them  
Send us your repair work for estimate  
Write for our **FREE CATALOGUE**

Grant Radio Laboratories  
6523 South Halsted St., Chicago, Ill.

## FREE!

### SHORT-WAVE TIME TABLE

The important short-wave program stations of the world are listed in our table "N" in chronological order. Call, location, frequency and wavelength given. Ask for Table "N". No charge.

SUPERTONE PRODUCTS Corp.  
27 to 35 Hooper St.  
Brooklyn, N. Y.



## Adjustable Sliding Clips

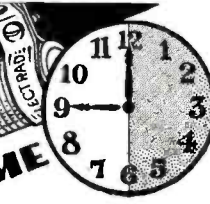

# LESS STOCK TO CARRY—SAVES TIME

TRUVOLT RESISTORS lead in service work because they save time, expense, labor and they cost less.

The exclusive Truvolt Sliding Adjustable Clips enable you quickly to obtain the exact voltages required, and the unique open-air winding insures superior cooling and more stable performance.

Use TRUVOLT Adjustables and you need fewer resistor sizes, less investment in stock on the shelves—fewer parts in the service kit and you give prompter service to your customers.

Mail Coupon for Truvolt Catalog

175 Varick St., New York, N.Y.

## ELECTRAD INC.

ELECTRAD, INC., New York  
175 Varick St.,  
Please send me complete 36-page catalog and special replacement volume control guide.

Name.....

Address.....

Dept. RN-11



film it is often based upon unknown elements.

*Films Now in Use*

A number of educational institutions are already using sound motion pictures somewhat as a means of instruction. Sound pictures have been used with portable equipment in the public schools of Newark, N. J., New York City, Detroit, Cleveland, and at the University of Southern California, as well as in certain departments of Columbia, Yale and Harvard. The medical schools of Johns Hopkins, University of Pennsylvania, University of Michigan, Ohio State and Columbia have developed a series of sound pictures including such subjects as delivery, treatment of nervous diseases, and instructions to nurses. Dr. Truesdale's sound picture, "Hernia of the Diaphragm," is well known. At the annual meeting of the Clinical Congress of the American College of Surgeons last year six talking films were shown, including one on the technique of cancer operation, which are being used in the education of medical students. It is quite likely that the use of sound pictures will begin largely in the colleges and universities and later be extended to the secondary schools.

*Sound Pictures at N. Y. U.*

The writers for the past school year have been extensively engaged in using sound pictures in their classes at New York University under the direction of Dr. E. E. Free, head of the Department of Science in the School of Commerce. An attempt is being made to bring together a collection of sound films suitable to the course, and at the same time to make a scientific evaluation of the use of such films for educational purposes.

The producers and distributors of educational sound pictures at present are few in number. Pathé's Educational and Historical Series include a number of sound films. U. F. A., Inc., has adapted sound to a number of their films. The University Film Foundation of Harvard University is producing and collecting a series of films adapted especially to educational work. The American Telephone and Telegraph Company and General Electric Company have a number of sound pictures explaining some of the scientific applications of these industries. Talking Pictures Epic, Inc., have a number of educational films available. Visu-graphic Pictures, also Metropolitan Sound Studio, Hollywood, have a number of sound films suitable for school use. Warner Brothers have a large collection of musical films featuring many opera stars, as well as ensembles and instrumental selections. The Electrical Research Products, Inc., have probably been the most active up to the present in producing sound pictures from a purely educational viewpoint. Their productions include medical films teaching technique, a science series, and industrial films.

*200 Films Available*

Altogether, a recent compilation of sound films suitable for educational purposes shows about two hundred such films now available from which the educator may make his selection.



200 to 600 Meters—A.C. or D.C. Current  
AND THE

**I. C. A. ENVOY LONGFELLOW**

200 to 2000 Meters—A.C. or D.C. Current  
AT NEW LOWER PRICES

An entirely new circuit employing the new Pentode and Variable-Mu Screen Grid Tubes, insuring better tone, sharper tuning and elimination of cross station interference. I. C. A. super construction throughout, with I. C. A. Tone Control. Phonograph switch and jack for any phonograph pick up and new full volume Dynamic Speaker; all encased in a beautiful American walnut cabinet, 18" high by 15" by 9". Truly the aristocrat of radio receivers and without an equal at I. C. A.'s new low prices. Compact and portable weighing only 28 pounds. With the Longfellow just the turn of a knob switches you from intermediate to long wave.

NEW AND IMPROVED

**I. C. A. CONQUEROR**

SHORT AND LONG WAVE  
RECEIVER AT  
REDUCED PRICES

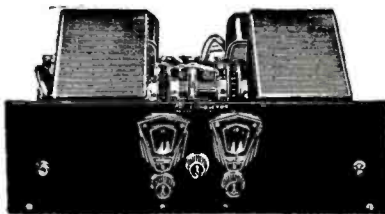

Pentode and Variable-Mu Tubes—Ear Phone Jack—Phonograph Connection —14 to 1,000 Meters—Models for A.C. and D.C. Currents and Batteries

The new 1932 I. C. A. Conqueror employs an entirely new circuit; 100% more efficient than last year's model. Far surpasses any other

receiver on the market in workmanship, electrical and mechanical efficiency, selectivity and volume.

Models Available for A.C. or D.C. Current, 110-220 Volts, and for Battery Operation

We call particular attention to the D.C. Model. No other manufacturer has yet offered a short wave receiver that can be operated from a D. C. line circuit 110 or 220 volts.

Prices have been reduced to meet present conditions.

**SEND FOR NEW 44-PAGE FREE CATALOG**

The new I. C. A. 44-page catalog illustrates, describes and prices the world's most complete line of Radio and Television Sets, Parts and Accessories. Write for your copy today.

**INSULINE CORPORATION OF AMERICA**

23-25 Park Place Cable Address "INSULATING" New York City, U. S. A.

*Write for Free Booklet*

**"OPPORTUNITIES IN RADIO"**

Radio operators are officers aboard ships. Well paid, pleasant work, travel. You can qualify in a short time in our well-equipped school under expert instructors.

**Announcing a new course in TELEVISION starting immediately. Full information on request.**

**West Side YMCA Radio Institute**

113 West 64th St., New York, N. Y.



**GET THIS**

Free new No 23, Edition of our greatly enlarged **RADIO SERVICE TREATISE**. Every radio man must have it. Contains some 75 new hook-ups, circuit diagrams, over 250 illustrations. **POSITIVELY THE GREATEST BOOK EVER PUT OUT BY ANYONE**

Editorial contents: VACUUM TUBE TREATISE with many illustrations; Vacuum Tube Average Characteristics Chart; How to Take Care of Your Tubes. How to Connect Phonograph Pick-ups. Improving Tone Quality of Old Sets; Connecting Additional Loud Speakers; all fully illustrated with diagrams. Other sections: Modernizing Old Radio Sets; How to Convert Battery to Power Sets; Selection of Tubes; Push-Pull Amplifiers; Replacing Audio Transformers; Phone Attachments; How to Choose Power Transformers; Voltage Dividers; Wattage of Power Transformers; Selecting and Installing Replacement Parts in Radio Sets; Filter Condensers; Repairing Eliminators, etc.

**WRITE TODAY. Enclose 2 cents for postage. Treatise sent by return mail.**

**RADIO TRADING CO.**

27 West Broadway New York City

# "Super Ball" Antenna

**More Volume—Less Static  
Greater Distance—Sharper  
Tuning**

**Over 1,000,000 In Use**

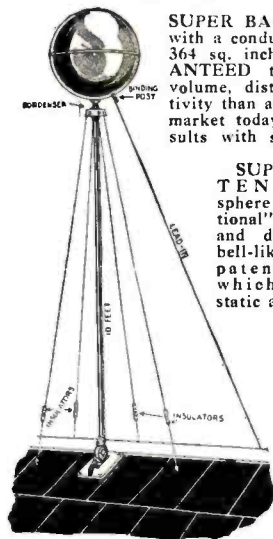

**SUPER BALL ANTENNA** with a conductive surface of 364 sq. inches. Is **GUARANTEED** to give greater volume, distance and selectivity than any aerial on the market today. Excellent results with short wave.

**SUPER BALL ANTENNA** Being a sphere is "all directional" in reception and delivers a clear bell-like tone due to a patented condenser which "filters out" static and interference.

**THE SUPER BALL ANTENNA** is sold with the **GUARANTEE** that if you are not entirely satisfied with the results your money will be re-

funded **PLUS** the shipping charges both ways. **ORDER ONE NOW!**

**Super Ball Antenna \$8.25**

with Condenser and Complete Kit for Installation  
Dealers: Get our proposition

**YAHRLANGE, INC.**  
143 N. Water St. Milwaukee, Wisc., U.S.A.

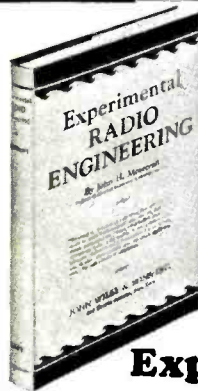

**Good News**  
for the  
**Radio Profession**

A New  
**MORECROFT**  
Book

## Experimental Radio Engineering

By **John H. Morecroft**  
Professor of Electrical Engineering,  
Columbia University

51 valuable and carefully selected experiments serve to present and explain, by means of laboratory work, the principles involved in the performance of radio apparatus. This book is of the usual unexcelled Morecroft calibre and will be indispensable to every engineer or radio man who wishes to master the relationships of the multitudinous factors which affect the successful operation of radio apparatus.

**Price, \$3.50**

On Approval Coupon

John Wiley and Sons, Inc.,  
440 Fourth Ave., New York

Gentlemen: Kindly send me Morecroft's "Experimental Radio Engineering." I agree to remit the price (\$3.50) within ten days after its receipt or return the book postpaid.

Name.....  
Address.....  
Reference.....RN-11-31

# Mathematics in Radio

(Continued from page 393)

(4) is as indicated. This can readily be operated upon, and values can be obtained which will produce the curve (c). The area beneath the power curve (c) represents the energy or power consumed in the circuit and it will be shown by calculus that in a resistance circuit the average power is equal to the product of the effective values of the voltage and the current.

dreds of formulas and it is only necessary to appreciate that these relations exist and that a fundamental knowledge of the subject has been obtained.

### Recalls Old Formula

A simple relation exists from the fundamentals of geometry which occurs very often in the solution of electrical problems. It will be recalled from the study of geometry that it was shown that the square of the hypotenuse of a right angle triangle was equal to the sum of the squares of the other two sides. Since, in trigonometry, the hypotenuse can be taken as equal to unity, we can show that the relation of Figure 20 is valid.

### Trigonometric Relations

There are numerous relations of the functions of an angle which are important and it is obvious that all of them cannot be given in the present text. But most engineers are equipped with electrical handbooks for a ready reference to hun-

# Direct Reading Tube Tester

(Continued from page 404)

ideas regarding the construction, in many instances dictated by the parts he has on hand. The photos, however, show the general layout and construction of this particular model.

suitable deflections, but a slight increase or decrease in these values will not make an objectionable change. Other essential values are given on the wiring diagram.

It is believed that a tester such as this

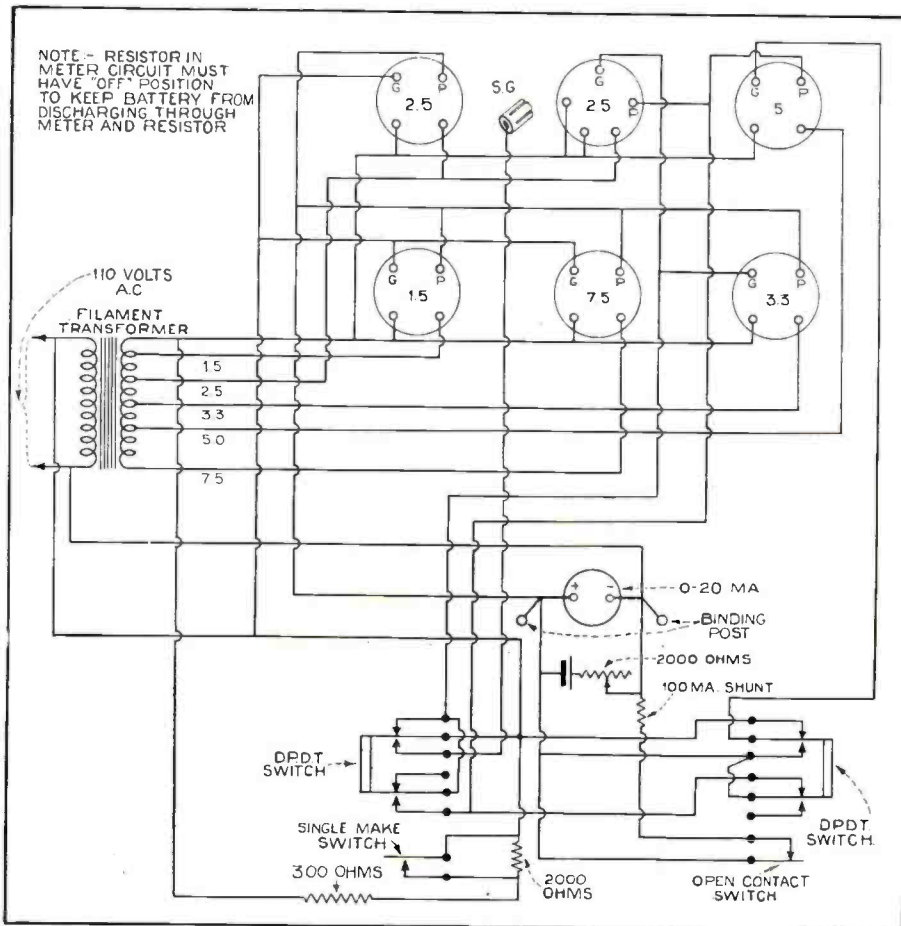

**TUBE TESTER WIRING DIAGRAM**

Figure 3. The circuit and principal constants of the direct-reading tube tester

The meter is brought out to binding-posts, as a combined 20 and 100-milliamper-range meter has many uses.

As can be seen in the reproduction of the scale, the biasing resistors used give

will well repay the dealer or serviceman for his efforts in constructing it. It is a compact unit, and indicates instantly just how close the tube comes to being one of average good characteristics.

## Pentode Amplifier

(Continued from page 395)

by the isolation resistors and by-pass condensers of the amplifier circuit proper.

The placement of parts has been very carefully worked out to eliminate any tendency toward instability or a.c. hum, and is clearly shown in the bottom view of the chassis, Figure 1. At the upper right is the output transformer, to its left the interstage push-pull transformer. At the lower right are seen the power transformer lugs, and at the left, the second filter choke, first filter choke, power transformer and filter condensers are located above the chassis, beneath the large housing. At the lower left is seen the 8-mfd. dry electrolytic by-pass condenser for the -24 and -27 bias resistors. At the left center are the vitreous-enamel voltage-divider resistors.

### Frequency Response Curve

The frequency response curve of Figure 3 was taken with the amplifier working into a constant resistance load, a condition not equalled when it works into a speaker unit. However, the speaker will show an impedance rising with frequency, which will cause a gradual rise in the higher portion of the curve. This is desirable for extreme clarity of speech and music, and to compensate for the drooping high-frequency characteristic of the input apparatus with which the amplifier may be associated, and which will serve to neutralize the rise in the amplifier's high-frequency response. The curve of Figure 3 is seen to be flat to 2 db. from 40 to 3000 cycles, and to gradually rise to 6 db. up at 10,000 cycles.

Used with one good dynamic unit, it will give coverage of a 500 to 1000-seat hall, while with an S-M 866 air-column horn and high-efficiency unit it will cover a 1000 to 2000-seat hall.

The 684 amplifier described here is available completely housed in an easily portable carrying case, complete with speaker unit, microphone, input control panel and tubes, for public address purposes. So assembled, it is known as the 686 portable P.A. amplifier. The 684 amplifier used in this outfit differs from the standard 684 amplifier in that it provides microphone and speaker field current, and consequently is known as the 684B.

The unit is illustrated in Figure 4, opened up ready for use. The case is in two parts, the base and back containing the amplifier and control panel, with packing space for microphone, lead wires, spare tubes or other accessories or tools. The cover of the case, which is removable, contains the speaker unit and can be placed any reasonable distance from the amplifier. With the microphone provided voice announcements from the outfit will cover a 500 to 1000-seat hall nicely. Additional speakers can be added, of course, to increase coverage. The whole outfit, when not in use, closes up into an easily transported case, 18 inches by 18 inches by 13 inches self-contained with a cover over the speaker opening. It may be used anywhere where 105 to 125-volt, 50 to 60-cycle a.c. power is available.

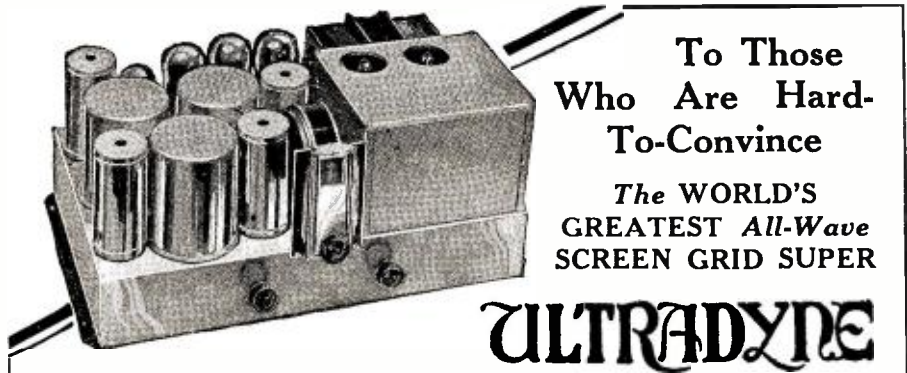

To Those  
Who Are Hard-  
To-Convince

The WORLD'S  
GREATEST All-Wave  
SCREEN GRID SUPER

# ULTRADYNE

## LOGGED 74 STATIONS IN ONE NIGHT

We like nothing better than to induce a hard-to-convince buyer. For we know after he has made a real test with this set it will mean more recommended sales for us. If you are hard to convince, all we ask is to send 25c for a booklet which tells you how to construct and operate the Ultradyne Model L-32 Receiver. This booklet also contains life-size picture diagrams and layouts of the entire set; also, life-size wiring diagram of the entire circuit showing every wire location and connection. Then try to be without owning one.

The model L-32 Ultradyne, with the Dynatron oscillator, works equally as well on short waves as it does on the broadcast band.

### ULTRADYNE KIT

The kit contains 3 specially tested and matched Ultra-formers with double compensating condensers in aluminum sealed cans, 1 special steel chassis drilled and pierced as per specifications, all ready for mounting, 3 rubber grommets and 4 coil mounting pillars and INSTRUCTION BOOKLET. **\$32.50 NOW ONLY** .....

**NEW LOWER  
DISCOUNTS  
NEW LOWER  
LIST PRICE**

Operates entirely from A.C. Line  
Completely Shielded Throughout  
Covers All Wavelengths from 15  
to 600 Meters  
Tunes as easily and smoothly on  
the short wave as it does on the  
broadcast band  
10 K.C. Selectivity Over Entire  
Band  
Selectivity and Sensitivity so great,  
distance range is unlimited  
Power Detection  
Push Pull Amplification  
Full Natural Tone  
Not a Trace of Hum or Distortion  
Steel Chassis  
Simplified Construction

**TRAUL RADIO CO., 1074 Atlantic Ave., Brooklyn, N. Y.**

*This is the set that was described in the April Issue of Radio News, Page 937*

# RACON

## SOUND PRODUCTS OF PROVEN SUPERIORITY



PORTABLE  
HORN

Again the Pioneer manufacturers of acoustic sound reproducers prove Leadership. The immediate success of our 9-unit trumpet and portable, knockdown air column attest to Racons superiority. Weather proof, sturdy in construction, designed for tremendous volume and perfect, natural sound reproduction, nothing is finer than Racon!

Whether or not you are satisfied with your present sound, there is room for improvement. Let us solve your problem! **RACON HORNS & UNITS ARE COVERED BY U. S. PATENTS NOS. 1,507,711; 1,501,032; 1,577,270; 73,217; 73,218; 1,722,448; 1,711,514; 1,781,489.**

Write for Catalog Containing Complete Line  
**RACON ELECTRIC CO., INC.**  
18 WASHINGTON PLACE, NEW YORK  
England and Canada



9-UNIT  
AEROPLANE HORN

### Serviceman's Oscillator



A modern oscillator for all model sets. Covers broadcast and intermediate frequency bands. Completely shielded. Used to align R.F. and I.F. stages. Very compact. Complete with tubes, batteries and duo range output **\$20.60** meter. Special at

Send for Free Wholesale Catalog  
**RADIO SURPLUS CORP.**  
56 N. Vesey Street, New York City

### "CHI-RAD"

#### NEW NATIONAL AG-SW-3

3 TUBE THRILL BOX  
for amateur short-wave and all other reception.  
Tuner only ..... **\$30.50 Net**  
National A.C. Power Pack ..... **\$18.95 Net**

#### REPLACEMENT PARTS

Complete line of Condenser Blocks, Transformers, Volume Controls and Rheostats.

#### SHORT WAVE KITS

sets, transmitter parts, supplies for power packs, high voltage condensers—low prices.

**SEND 10 CENTS FOR  
LATEST CATALOG**

**CHICAGO RADIO APPARATUS CO.**

415 S. Dearborn St., Dept. RN-11 Chicago, Ill.

# SHORT WAVE

Reception with Your  
**BROADCAST RECEIVER**

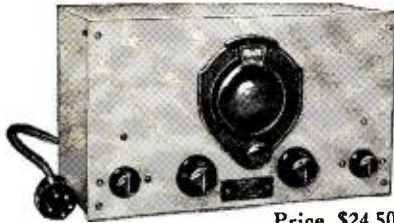

Price \$24.50

## THE "EXPLORER"

**PLUGLESS POWER CONVERTER**

Efficiency—Convenience—Economy

Obtain real short wave reception, efficiently and economically, by using an EXPLORER with your broadcast receiver. Attached to your receiver, the performance of the EXPLORER equals that of any expensive short wave receiver. Many EXPLORER enthusiasts report consistent reception of stations such as G6SW, England; I2RO, Italy; FYA, France; and VK2ME, Australia, with excellent loud-speaker volume.

**NO PLUG-IN COILS.** Wave-length range 15 to 160 meters; Automatic Band Selector changes wave-length bands in less than a second—an original EXPLORER achievement.

Power Amplifier in converter gives real loud-speaker reception of distant stations. Special wide-spread vernier, real single dial tuning, non-roaring oscillation control, numerous other exclusive features.

Price \$24.50. Each EXPLORER air-tested at factory and ready for use. New 1932 models now ready, designed for every broadcast receiver, including the latest super-heterodynes. Order now! Sent C. O. D. on receipt of \$2 or prepaid on receipt of price in full. Foreign price \$25.50, remit in full, shipment prepaid. State make and model of broadcast receiver.

Send Now for Free Literature

### RIM RADIO MFG. CO.

695 Grand St. Brooklyn, N. Y., U. S. A.

## SERVICE MEN!

SAVE MONEY

BUY

Reliable Guaranteed Parts

### POWER TRANSFORMERS

FOR ALL SETS

Not Surplus Obsolete Stocks  
But New First Quality  
Guaranteed Merchandise

Send for Our Special Bulletin Listing  
Transformers, Condenser Blocks and Volt-  
age Dividers for All Sets

Get Our Complete Replacement Guide

## RADIO ELECTRIC SERVICE COMPANY

N. E. Cor. 7th and Arch Sts.  
Philadelphia, Pa.

## MOVIES In Your Home

Our marvelous, practical  
Movie Machines sell as low as \$5.00 post-  
paid. Also finest 16 mm. cameras and  
projectors at factory prices. A complete line  
of both standard and 18 mm. film avail-  
able at low prices with exchange service.  
Write for big, FREE catalogue.  
**PARAMOUNT MFG. CO.** Dept. R-10  
Boston, Mass.

**\$5,000 WILL BE PAID TO ANYONE WHO PROVES THAT THIS**  
is not the actual photo of myself showing  
my superb physique and how the Ross  
System has increased my own height  
to 5 ft. 3 3/4 inches.

Hundreds of Testimonials.  
Clients up to 45 years old gain from  
1 to 6 inches in a few weeks!

No Appliances—No Drugs—No Dieting  
**ROSS SYSTEM NEVER FAILS.** For Ten Dollars Complete  
Convincing Testimony and Particulars 5 cents stamps.  
Allow time for return mails across the Atlantic.  
**G. MALCOLM ROSS, Height Specialist**  
Scarborough, England, (P. O. Box 15)

# Using the Selenium Bridge

(Continued from page 389)

reverse operation may be obtained by reversing the action of the relay.

In utilizing the radiovisor bridge circuits on either 110 or 220 volts a.c., suitable power transformers are, of course, required to take care of the filament and

The foregoing information regarding the new cell and associated apparatus should enable the experimenter to design light-sensitive equipment for a large number of uses. Among these are: counting devices, timing devices, musical

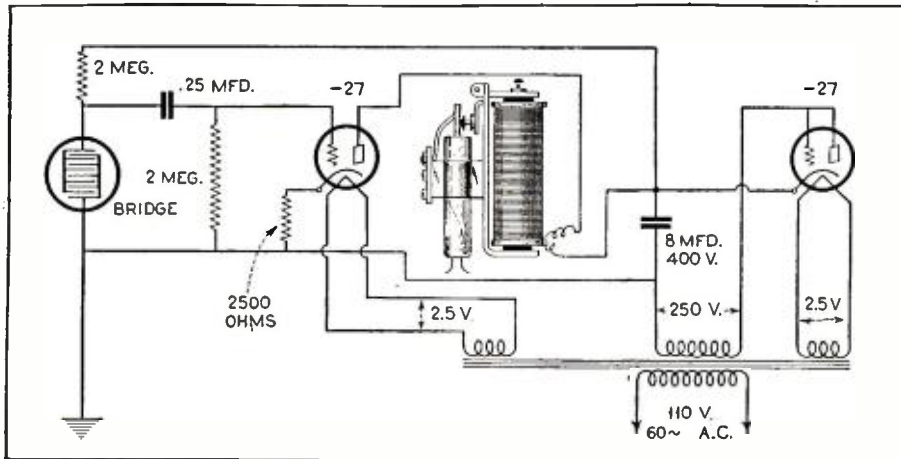

CIRCUIT FOR VACUUM CONTACT

Figure 5. This diagram shows the connections for using the contact with a standard telephone relay on alternating current

plate requirements of the tubes. Such transformers should be of 5 to 8-watts rating and should supply secondary voltage of 2.5 volts for the filaments of the type -27 tubes and 250 volts for the plates of the tubes. If the transformer is to be used out of doors or in locations exposed to moist atmosphere, the transformer should be fully enclosed. Where the transformer is to be constantly operated, its design should be for continuous operation at the rated wattage.

### Condensers Recommended

The condensers recommended for use with the bridge should be of mica-dielectric for the 0.25 mfd. size, and of high-grade paper dielectric for 8 mfd. size used as a filter.

Condensers recommended for full load conditions across the vacuum contact are as follows: For non-inductive loads the condensers should be of 0.0025 mfd. capacity and for inductive loads 0.005 mfd., although under certain operating conditions, capacities as high as 0.01 have been found advisable.

### Counting Devices

If the light-sensitive circuit is to be employed in connection with a counting device, the mechanical relay counter should have the following general specifications: a speed up to 100 per minute, 6 volts, 0.2 ampere, reading up to 99,999 and should be capable of easy resetting.

The resistors used with this cell are of 2—megohms resistance and are preferably of the metallized-resistor type. They should be permanently wired in circuits or fitted in spring clips making good contact.

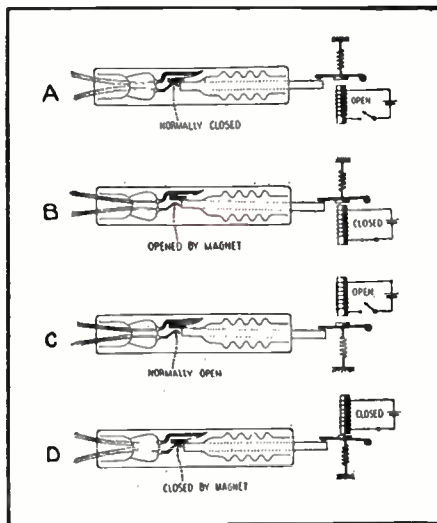

HOW CONTACT OPERATES

Figure 9. A shows contact closed, to be opened by relay. B shows contact opened by relay. C shows contact open, to be closed by relay. D shows contact closed by relay

reproducers, daylight-operated light switches, street lighting controls, safety devices, fire-detecting apparatus, train-stopping devices, color analyzers and matching units, automatic sorting units, light-measuring instruments, burglar-alarm systems, relay systems, and many hundreds of other control applications.

### Write to Author

The author will be interested in hearing from our readers regarding new applications which they develop or in aiding them in the solution of their light-sensitive problems employing this apparatus.

## Universal Receiver

(Continued from page 391)

lead of the transformer. 3, runs to the plate of T5 and the B+ lead to the terminal (a) of R16.

We are now ready for the resistor strip to be mounted in place and connected up. R2, R4 and R6 are connected together at one end. A lead from here runs out through the base to the center (moving arm) of the volume control R19. One end of R19 is grounded to the chassis and the other runs to tap (b) of the voltage divider R16. Through an oversight this ground connection was not shown in the circuit diagram last month but is shown correctly in Figure 1 this month. The other ends of R2, R4 and R6 run to the screen grid terminals of T1, T2, and T3 respectively. The upper end of R9 goes to the screen grid of T4 and the lower end to terminal (b) on R16. The lower ends of R10 and R11 are connected together and joined to the wire from C14 in the by-pass condenser block. The free end of R10 connects to the plate of T4 and the free end of R11 to terminal (d) in R16. The lower ends of R7 and R12 are connected together and grounded through the mounting bracket. The upper end of R7 goes to the center lug of jack, 8, and that of R12 to the grid of T5. Condensers C13 and C15 are already connected in place. Condenser C16 is connected to the grid of T5 and the other end brought out through the chassis to the tone control R13. The other end of R13 is grounded to the chassis.

Turn the chassis right side up and solder wires about six inches long to the lower stator terminals of C1, C2, C3 and C4, running them down through the base. The chassis is turned over again and the coil assembly mounted in place. The wires from the tuning condensers are fastened to the grid terminals of their respective coils. The plate of T1 runs to the plate terminal of L2, the plate of T2 to L3 and the plate of T3 to L4. The B+ terminals of L2, L3 and L4 are connected together and brought out to end (a) of R16. The aerial and ground leads from L1 are connected to the binding posts 1 and 2.

We are now through with the wiring on the bottom side of the chassis and it may be turned right side up again. The shielded leads with a screen grid clip on each are soldered to the upper stator terminals of C1, C2, C3 and C4, with the shield grounded to the condenser frame, and the set is ready to try.

The tubes are inserted, the speaker plugged in the back and the proper terminal plug cap slipped on to the plug 10. If the set is used on d.c., the plug on the electric cord must be inserted in the wall socket with the proper polarity, as in any d.c. set. If no sound is heard when the tubes have had 30 seconds or so to heat up, the plug should be reversed. If the set is likely to be tampered with, it is a good idea to fasten the plug cap 11 or 12 in place with a metal strap screwed to the back strip. This will make it more difficult for an unauthorized person to slip on the wrong cap.

Best results will be secured from this  
(Continued on page 434)

## You Need Long Quality for Short Waves

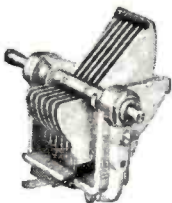

Hammarlund Wide-Spaced Short-Wave Condenser, in three desirable capacities 150, 125 and 100 mmf.



Hammarlund Shielded Polarized Choke. High inductance, low distributed capacity.

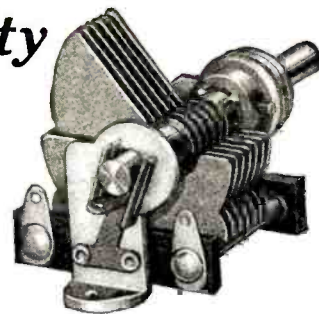

Hammarlund Vibration-proof Midget Condenser. 20 to 325 mmf. Many new features.

TICKLISH business—this short-wave tinkering!

Every detail must be so much more carefully worked out than ordinarily, if real results are obtained.

That's why seasoned experimenters rely more and more on Hammarlund parts. Hammarlund's more-than-thirty-years' experience in precision engineering stands out conspicuously in every Hammarlund Product.

Play safe—build your short-wave receiver with Hammarlund Condensers, Coils and Chokes. Write Dept. RN-11 for circular, showing sizes and values.

HAMMARLUND MANUFACTURING CO.  
424-438 W. 33rd Street, New York

For Better Radio  
**Hammarlund**  
PRECISION PRODUCTS

## SHALLCROSS

Wire Wound

### Resistors

.0025 to 10,000,000 ohms

are recommended and extensively used for television radio production, and service test equipment. The accuracy and dependability of the testers described on page 1085 June and page 118 July RADIO NEWS depend upon SHALLCROSS RESISTORS.

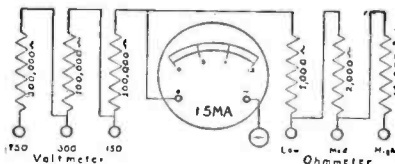

Send 4 cents in stamps for Bulletin 100-D and other literature describing the multi-range meter circuit, similar to the diagram above.

**Shallcross Mfg. Company**  
ELECTRICAL SPECIALTIES  
700 PARKER AVENUE  
Collingdale, Pa.

## LYNCH Resistors



Precision Wire Wound  
1% Tolerance

Using New "K" Filament  
1/2, 1, 1 1/2, 2, and 3 Watts  
Write for NEW illustrated catalog  
LYNCH MFG. CO., Inc., Dept. N. 1775 B'way, N. Y.

## LEARN RADIO

this easy, practical way

WRITTEN by two widely known radio engineers, these three books cover every phase of building, repairing and "trouble-shooting" on modern receiving sets. The books include short-wave receivers and television.

### Radio Construction Library [1931 Edition]

This practical Library includes: PRACTICAL RADIO—The fundamental principles of radio, presented in an understandable manner. Illustrated with working diagrams. PRACTICAL RADIO CONSTRUCTION AND REPAIR—Methods of locating trouble and reception faults and making workmanlike repairs. RADIO RECEIVING TUBES—Principles underlying the operation of all vacuum tubes and their use in reception, remote control and precision measurements. The Library is up-to-the-minute in every respect and is based on the latest 1931 developments in the design and manufacture of equipment.

Three Volumes,  
6 x 9—993 pages,  
561 illustrations.

See this Library FREE!

No Money Down

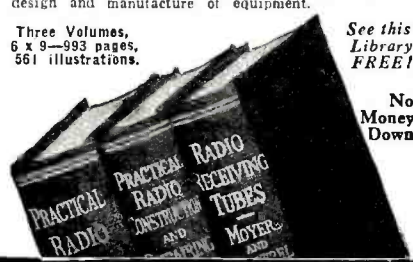

## FREE EXAMINATION COUPON

McGraw-Hill Book Company, Inc.  
370 Seventh Avenue, New York

Send me the new 1931 RADIO CONSTRUCTION LIBRARY, three volumes, for 10 days' free examination. If satisfactory I will send \$1.50 in ten days, and \$2.00 a month until \$7.50 has been paid. If not wanted I will return the books.

Name .....

Home Address .....

City and State .....

Position .....

Name of Company..... RN-11-31

## SEND FOR FREE RADIO CATALOG



123-N West 17th St., New York

"Buy Now, with Confidence,  
and Save Money"

# FLECHTHEIM

## SUPERIOR CONDENSERS

In Use by Over 50% of the  
Broadcasting Stations

ARE SOLD BY RELIABLE  
JOBBER EVERYWHERE

## SERVICE MEN

Get our new 1932 catalog No. 24. New complete line of condensers for all kinds of repair and construction at remarkably low prices.

NOTE: Clip this "ad" to a sheet of paper on which you have written your name and complete address, and send it to us. We'll do the rest.



Type HSM-1000V  
cased—for all types  
of power packs, etc.

A. M. FLECHTHEIM & CO., Inc.  
136 Liberty St., New York City



Model "B B"  
List Price  
**\$25.00**

Microphone Only

UNIVERSAL MICROPHONE CO., Ltd.  
1163 Hyde Park Boulevard  
Inglewood Calif., U. S. A.

### The Superlative Broadcast Microphone Extra Heavy Type— Two Button

Outstanding beauty of workmanship and finish. True, Natural Tone. Tremendous Volume. Scientifically Damped.  
Extra Heavy 24-Karat Pure Gold Spot Centers, Duralumin diaphragms. Accurately Machined. Carefully Adjusted. Fully Guaranteed. Three Degrees of Sensitivity.  
Other Models from \$5.00 up.

**SOLDER LIKE A PROFESSIONAL**  
with the **ESICO Junior**  
Reg. U. S. Pat. Off.  
**MAKES SOLDERING EASY!**  
Anyone handy with tools can do a good job in jig time with this "little wizard" of soldering irons. Thousands in use by professional mechanics. Plugs in on any current; heats quickly and stays hot! Highest grade nickel-chrome heating element; dark mahogany anti-heat handle; replaceable forged copper tip. Wt. 16 ozs., length 12 3/4 in., 6 ft. flexible cord.

Send us direct if your dealer can't supply you  
Electric Soldering Iron Co., 135 W. 17th St., New York, N. Y.

**Short Wave Is Here**  
New Adapter Fits Any AC Radio  
New WORKRITE Model brings Police, Foreign, Airplane, Amateur and leading U. S. Short Wave Stations, on any AC Radio. All wave lengths. Easily attached. Big demand. We guarantee it. Special proposition to live dealers and agents. Write today to 20th Century Co., 1287 Coke Bldg., Kansas City, Mo.

## Clearing Up Discrepancies

(Continued from page 374)

The international kilogram, too, is now defined merely as the mass of a certain lump of metal also preserved in the Bureau near Paris.

The second of time, third of the fundamental units of the scientists' boasted "C. G. S." or centimeter-gram-second system of units, is the only one that remains related to the earth, being defined as 1/86,164.09 part of the average time

earth's rotation varies slightly from century to century, even from year to year. Astronomers now have clocks which measure time more accurately, or at least more uniformly, than does the earth. A new re-definition of the second is likely soon to be demanded, therefore, to join the arbitrary re-definitions of the meter and the kilogram.

The C. G. S. system is responsible, too,



Science Museum, London

### HOW ANCIENT EGYPTIAN PRIESTS STRUGGLED WITH MEASUREMENTS

To determine time from the stars as well as to measure angles and distances on the ground, Egyptian priest-scientists used this instrument, called the Merkhet. Sights at stars or other objects were taken through the notched stick and past the string, held up as a plumb bob

of the earth's daily rotation as measured from the stars. Even this unit, however, has suffered the fatality which seems to pursue all efforts to derive the units of measurement from natural constants. It is now known that the speed of the

## Universal Receiver

(Continued from page 433)

receiver with an outside aerial 75 to 150 feet long, though an inside aerial often gives good results. In steel buildings where motor noises are very troublesome an aerial should be erected on the roof, as high and clear as possible, even if it is necessary to use a long lead-in to reach the set. If tuning is too broad a fixed condenser of .00025 or .0001 capacity may be used in series with the aerial. It will be found that much quieter reception is secured in this way since the ratio of signal to noise will be higher. If it is necessary to use the set without an aerial, the antenna binding post may be connected to a water pipe ground, and the ground post to the chassis through a .001 condenser. This uses the electric line as an aerial and sometimes works very satisfactorily. Be careful not to touch the ground wire to the chassis, as a short circuit might result.

for another chapter of confusion in the electrical units. The same London conference of 1908 which accepted arbitrary definitions of the international ohm of mercury and the international ampere of silver did not quite have the courage of its convictions. While accepting these purely arbitrary units, the conference decided that volts, amperes, ohms and watts also ought to be defined in some more fundamental way. Thus the so-called "absolute" units; ohm, ampere and the others, based on C. G. S. units and slightly different from all three of the international sets of units, the British, the American and the German.

Mathematical scientists, seeking to make the C. G. S. system all-inclusive, already had constructed two sets of electric units unrelated to the ohm and ampere system and also responsible for much confusion. One of these sets, based on electrostatic actions, includes the so-called C. G. S. Electrostatic Units or ESU. The others are the C. G. S. Electromagnetic Units or EMU. Both begin with the C. G. S. unit of force, the dyne, defined as the force which will move a mass of one gram with an acceleration of one centimeter per second per second.

The C. G. S. electrostatic unit of charge, for example, is the quantity of electricity which will repel a like quantity at a distance of one centimeter with a force of one dyne. Similarly, the "unit magnetic pole" of the C. G. S. electromagnetic system is one which repels with a force of one dyne a like pole one centimeter away. The C. G. S. electromagnetic unit of current is one which will produce this unit magnetic pole at the center of a circle 4π centimeters in

### Commission Changes

WASHINGTON, D. C.—One important post on the Federal Radio Commission staff was vacated and another filled by promotion recently by the resignation of Paul D. P. Spearman as assistant general counsel and the elevation of Lieut. E. K. Jett to assistant chief engineer.

diameter around which the current is flowing. The C. G. S. electromagnetic units are much used in scientific calculations because of the ease of conversion to or from the units of energy, work or other quantities in the C. G. S. system. The C. G. S. electrostatic units are seldom used even in scientific work.

Any unit of the C. G. S. electromagnetic system may be converted into the corresponding unit of the C. G. S. electrostatic system by multiplying by 29,979,000,000. The absolute ohm, not quite the same, it will be remembered, as any of the conventional international ohms, equals 1,000,000,000 C. G. S. electromagnetic units of resistance. The absolute ampere equals 0.1 C. G. S. electromagnetic unit of current. The absolute volt equals 100,000,000 C. G. S. electromagnetic units of electromotive force. The absolute watt equals 10,000,000 C. G. S. electromagnetic units of power.

**Six Separate Standards**

Electrical science is confused, therefore, by no less than six separate sets of units of current, resistance, electromotive force and the rest: the extremely theoretical electrostatic set; the somewhat more useful electromagnetic set; the so-called "absolute" set of volt, ohm, ampere and watt based on the electromagnetic ones; and three different sets of "international" volts, ohms, amperes and



Westinghouse

**MAGNETIC UNITS NEEDED TOO**  
Magnetic properties of materials usually are determined electrically, as in this apparatus. Magnetic units usually depend on electrical ones and share the uncertainties of these

watts, intended to be alike but actually different, the Bureau of Standards has discovered, in Great Britain, Germany and the United States. Doubtless there are still different values for the international volt, ohm, ampere and watt in France, Japan and other countries but the inter-comparisons of standards necessary to determine this have not yet been made.

**Mechanical Units**

Confusions about watts are still greater, for here enter still another set of power units, the horse-power, the foot-pound, the "mechanical watt" and so on, related to the electrical units by the mechanical equivalent and electrical equivalent of heat. Again according to the

United States Bureau of Standards one American international electric watt equals 1.00034 mechanical watts, the latter based upon the accepted unit of heat or mechanical work, the international joule.

**Human Inaccuracy**

The chief reason for all this confusion is human inaccuracy. The international units in all countries should be the same. These, furthermore, should be exactly the same as the so-called absolute units, leaving the engineering world with but two important sets of electrical measures, the ordinary ohm-ampere set and the scientific C. G. S. electromagnetic set. Presently, one may hope, this will come about through the present inter-comparisons initiated by the United States Bureau of Standards and through better and better determination of the two fundamental units, the ohm and the ampere, in terms of the centimeter, the gram and the second.

**No Absolute Values**

Again the so-called "absolute" values of the ohm and ampere are not absolute at all but still depend, just as do the international units, upon purely arbitrary values for the centimeter, the gram and the second. This arbitrary character could be removed, easily enough, if modern science could succeed in the ancient quest of the pyramid builders and the founders of the metric system for constants of the earth or of Nature from which units for length, mass and time might be derived. The most promising of these efforts today is that of re-defining the length units of meter and centimeter in terms of the wavelength of light.

**Light Wavelength Clue**

When atoms of the chemical element cadmium are heated in a flame they give off red light which is definitely of one wavelength. Nearly forty years ago the famous American physicist, the late Professor A. A. Michelson, attempted to find the exact number of wavelengths of this red cadmium light which would equal the international standard meter. That would amount to defining all lengths in terms of the light's wavelength. More recent measurements of the same kind have been made by Benoit, Fabry and Perot in France; by Watambe and Timaszumi in Japan and only this year by Dr. A. E. H. Tutton in England. Dr. Tutton finds that 1,420,210.3 wavelengths of the red cadmium light equal the standard meter. The value accepted by Professor Raymond T. Birge for the American Physical Society differs only by five points in the eighth significant figure.

**Speed of Light**

When this figure can be established accurately enough to be accepted by everyone the long quest for fundamental, non-arbitrary standards will be over and volts, amperes, ohms and watts can join with other physical units in being all alike everywhere and all dependent on what scientific men now consider to be the one most fundamental and unvarying constant in the universe, the speed of light.



**DON'T RUN AWAY**

from an Opportunity to attend professional school in

**RADIO AVIATION TELEVISION**

Your success depends on whether you accept money-making opportunities or "run away" from them because of no ambition, negligence or unnecessary thoughts of fear in getting started.

At the Dutton Radio Institute you'll find highly recognized instructors ready to personally assist you in your studies and hundreds of students you'll enjoy knowing.

**Prepare Yourself Now!**

Unemployment conditions and depressions do not disturb the positions held by men who are professionally trained in Radio and Aviation. The man untrained today cannot find work while thousands of positions are open to the "trained man."

If you want training ability equal to leading colleges, write today for catalog giving full information about various courses.

**DUTTON RADIO INSTITUTE**

Dept. 25 DePaul University Bldg., Chicago, Ill.



Combination or separate courses in Radio and Aviation.

Dutton Radio Institute:  
Please mail me your new FREE catalog on Radio and Aviation.

Name.....

Address.....

Phone.....

# SERVICEMEN

## SPECIAL OFFER

To introduce this up-to-date

### MULTICOUPLER ANTENNA SYSTEM

to the thousands of servicemen who have not yet had an opportunity to try out its many advantages, we will ship, parcel post prepaid, two outside Multicouplers type PL-2724 and one special terminal resistance, complete with installation instructions, for \$5.00 C.O.D.

If after trying out these units they do not prove satisfactory, they may be returned and the \$5.00 will be refunded.

Do not pass up this opportunity to make this test.

### I AERIAL FOR PLURALITY OF RADIO SETS

Easily installed in apartments, hotels, etc. No tubes, no counterpoises, television pickup also possible.

Write us on your letterhead for detailed information, prices and discounts.

**Amy, Aceves & King, Inc.**  
Consulting Engineers  
55 West 42nd Street  
New York, N. Y.

### ALUMINUM BOX SHIELDS

Genwin "ALCOA" stock, aluminum finish. 6x8x5 \$1.60  
—Dormer size \$4.65. 10x12x7 Monitor size \$3.25. 6x6x5  
Coil Shield (like picture on the right) \$1.00. Any size to order.



**"BUDDY" Test Prod** Always sharp pointed, using phonograph needles, 4-ft. wires, spades or phone tips. Colored nipples identify each lead, \$1.60 pair.  
Flexible Shield, Jewell O-1 M. Ammeter \$5.50; spool type plus 4 or 5. 20c; S. P. D. T. Toggle Switch, 25c; Push Button, 25c; 9 point by-pole switch; 9 point inductance switch; portable one for test kit or set, \$3.50.  
**Yanley 7-Wire Connector, Male and Female, for \$9c**

We specialize in parts exclusively. We can furnish everything described in this magazine. Give us a trial. Please include postage.

**BLAN, the Radio Man, Inc.,** 89 Cortlandt St., Box 111, New York City

## G. E. Phonograph Motor

Synchronous 110 Volt, 60 Cycle, 80 R.P.M. Motor

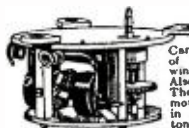

Can be installed in place of old fashioned hand winding spring motors. Also many other uses. These G.E. Electric motors are all brand new in original factory cartons. Fully guaranteed. \$12.00 value only \$3.95.

\$12.00 value only \$3.95

Shipped Prepaid. Manufacturer and dealer write for Special Quantity prices.  
**NATIONAL JOBBING & EXPORT CO.**  
Dept. A-1 192 N. Clark St. Chicago

## TELEVISION Wants Men

Wonderful openings for operators, salesmen, service and repair men at big pay. More jobs NOW in Television and Aerial Radio than there are available trained men. We want ambitious beginners and will train you to step into a good job quick. No matter what your past experience, if you are over 18 years old and want to make \$100 to \$200 a month in this fascinating big pay profession, write today for full particulars.

SUPD. NOEL PRES.  
FIRST NATIONAL TELEVISION, INC.,  
1011 Fairfax Airport, Kansas City, Kansas.

## Fascinating-Profitable LEARN TELEGRAPHY This Easy Way —



Thomas A. Edison—Andrew Carnegie—most of the presidents of railroads and other world leaders got their start as telegraphers.  
Today—on land—on the air, men who know the code are commanding big money—in the world's most fascinating profession.  
Learn At Home—with TELEPLEX—The Master Teacher.  
Write for Folder B-11.

CARNEGIE—world-famous ex-telegrapher  
Teleplex Co. & Corporation  
St. New York



**Teleplex**

# Television Progress in New York

(Continued from page 376)

and, although the station operated on regular schedule, it was not synchronized with any broadcast sound station and the programs consisted chiefly of dolls and figures placed on a phonograph turntable before the photo-electric cells. Occasionally, the engineers and visitors would take places at the "electric eyes," but no special continuities were provided.

The television station was housed in space formerly used as dressing rooms for the stage performers of the old Frolic Theatre. The day the writer inspected the plant it was observed that the images, received over a direct wire connection, were unusually clear. Our escort, an NBC executive, sat before the photo-electric cells and lit a cigarette. Glancing in the lens of the receiving unit, we observed his facial details, the lit cigarette and the rising rings of smoke.

### The Flying Spot

Glancing at the subject seated before the photo-electric cells, we noticed that the streaks of light sweeping across his face were difficult to observe for an extended length of time. However, when we, ourselves, were invited to sit before the "electric eyes," the carbon arc light was not at all difficult to face. R.C.A. and General Electric equipment is utilized by W2XBS.

Early this year the NBC conducted television wave tests from the tower of the new R.C.A. Building at Lexington Avenue and Fifty-first Street. Reception points were established in and around the city to measure the signal strength. It was believed that on account of the unusual height of the antenna, better signal strength would result. The desire for a high point for television transmission was consummated last July when former Governor Alfred E. Smith, president of Empire State, Inc., and Merlin H. Aylesworth, president of the network, jointly announced that television studios and laboratories would be established on the eighty-fifth floor of the Empire State Building—the tallest structure in the world.

It is believed that when the Empire State television studios are completed, the network will scrap the transmitter atop the New Amsterdam Theatre Building.

### Highest "Sight" Studio

The new NBC television studios and laboratories will occupy the east half of the eighty-fifth floor of the Empire State Building, which is about 1,000 feet above the intersection of Fifth Avenue and Thirty-fourth Street. The chain's engineers claim that this height above the city will be helpful in surmounting the difficulties which have beset television transmission in the past. The station's antenna will be placed at the top of the building's dirigible mooring mast, which is 1,250 feet above street level.

According to Charles W. Horn, NBC general engineer, the opening of the Empire State television laboratory is a logical step to be taken at this time to meet the necessity for means of testing tele-

vision transmission under actual operating conditions rather than in the laboratory.

### New Laboratory

"A great deal of development and research work has already been accomplished by the RCA-Victor Company and the National Broadcasting Company," he said. "The new laboratory will give an opportunity to apply the results of this search practically."

### Two Jenkins Stations

The Jenkins Television Corporation is operating two television stations in the metropolitan area. Station W2XCR is atop an office building at Fifth Avenue and Fifty-second Street—just one block from the Columbia transmitter, W2XAB. This station was launched in the spring of this year. Synchronized sound is broadcast by Station WGBS. Invited guests, witnessing the inaugural program on a receiver a few blocks distant, were particularly impressed with the images received, inasmuch as they were obtained over a "home" rather than a "laboratory" receiver. This writer noticed that even two heads were reproduced with exceptional clarity.

The second Jenkins station, which preceded the New York transmitter, is W2XCD, Passaic, New Jersey, a suburb of New York.

### Radio Movies

One of the oldest television transmitters in New York is W2XR, operated by Radio Pictures, Inc., in Long Island City. This firm is headed by John V. L. Hogan, prominent consulting engineer, who is actively engaged in directing the station's operations. The Radio Pictures Station was originally located at 41 Park Row, New York, in 1927. It was moved to Long Island City in 1930. Programs have consisted chiefly of silhouette and moving picture films with synchronized music on W2XAR, another short-wave station.

Engineers of all the New York television stations realize that everything accomplished to date is experimental and they all look forward to the day when the Federal Radio Commission will delete the numerals from their respective call letters, thus establishing them as full-fledged broadcasters.

But, meanwhile, New York is looking in. It is following television from the inside. Whether the visual branch of radio may go, New Yorkers will continue to follow it.

### Philco Sales Mount

PHILADELPHIA.—Shipments of Philco radios during the months of June and July were nearly three hundred per cent. greater than shipments made during the same period in 1930, it was announced today by officials of Philco, who are observing this week the twenty-fifth anniversary of the company's founding. Shipments during the spring also were reported to be 250 per cent. greater than in the spring of 1930, which was Philco's banner year in point of sales.



# Aids for Hard-of-Hearing

(Continued from page 381)

described in the paragraph above.

To make the microphone as free as possible from inertia, the diaphragm is made as thin as possible in order to keep its natural frequency somewhere in the neighborhood of 6000 cycles or higher. Otherwise the diaphragm might likely cause an exaggerated peak somewhere within the normal range of voice frequencies. The carbon particles are often in the shape of perfectly round balls, absolutely smooth, and in some cases they are highly polished. In some designs the balls are of absolutely uniform size, while in others balls of several different sizes are employed. Exactness in the microphone is so important that carefully designed units call for the precise number of carbon balls to be used in each cup, otherwise uniform action cannot be expected.

The larger the active surface of the microphone, the more current can be controlled. We therefore find, in devices designed for severe cases of deafness, that

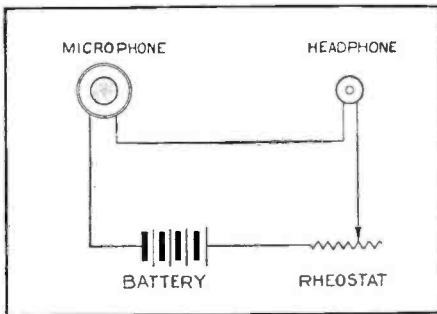

SIMPLE CIRCUIT

Figure 2. The more common types of hearing aids consist simply of a sensitive microphone and headphone, a small battery and a rheostat to regulate sensitivity. The headphone and microphone are, of course, especially designed for this use

several microphones are wired in parallel. This increases the current drain on the battery and necessitates larger cells, but even with these larger cells the life is rather short and this constitutes one of the inconveniences of these multiple-microphone devices.

It is usual to include some sort of a cover over the diaphragm. Sometimes this takes the shape of a disc, surrounded by holes, through which the sound is impinged on the diaphragm. In other cases the disc is perforated to allow the sound to reach the diaphragm. This cover results in air space resonant to the higher frequencies. In addition, the microphone assembly is sometimes mounted in such a way that the carrying case acts as a resonating box for the lower frequencies. These are the common methods employed to provide increased amplification at the lower and higher frequencies where defective hearing is usually most pronounced.

The shape, size and form of hearing devices vary considerably with different manufacturers. Probably the most common type is the one in which the microphone slips directly over the terminals of

a special battery. This is the pocket type, which is the most convenient of all, although, of course, not as effective as the larger types which are mounted in carrying cases.

## Standard Batteries Best

Most manufacturers of portable hearing devices sell special batteries with both battery and hearing devices so designed that only they can be used together. This constitutes a decided drawback from the standpoint of the user, because the batteries can be purchased only from the manufacturer or his agent. A standardization of batteries and connections would be highly advantageous to users of hearing devices and an even greater advantage would be the design of equipment to use ordinary flashlight batteries, such as are readily available in all localities. There are two or three manufacturers who already have adopted this latter idea and naturally enough they are finding it a strong selling point.

The design of the headphone is, of course, just as important as the design of the microphone. The headphone is exposed to view and may be worn for hours at a time. It is therefore essential that it be pleasing in appearance and light in weight. Yet nothing must be sacrificed so far as efficiency is concerned. There are two general types of headphones used with hearing aids. Examples of these are shown in Figures 4 and 5, products of Teutonophone, Inc., makers of a hearing aid of the same name. The type shown in Figure 4 rests against the ear in the same manner as a telephone receiver or radio headphone and is held in position by a light headband. It has the advantage that it weighs only a few ounces. The midget type shown in Figure 5 is placed in the ear instead of on the outside. The small tube projects directly into the channel of the outer ear, but in order to take the weight off this sensitive area, a supporting clip is provided which fits into the convolutions of the outer ear. Because of its extremely small size, this type of headphone is not as sensitive as the type shown in Figure 4, even though it concentrates the sound directly into the ear without the losses that are bound to occur in any device which is placed on the outside of the ear.

## Diaphragm Designs

The massive magnets commonly employed in telephone receivers naturally cannot be employed in these light-weight headphones. It is therefore necessary to make up in other features of design what is lost through the inability to use large magnets. Much attention is therefore devoted to the diaphragm when designing these units. The diaphragm must be as free from inertia as possible, but, on the other hand, it must be able to carry a reasonable amount of magnetic flux. These two conditions conflict, because the light diaphragm is unable to carry sufficient magnetic flux, but a heavy diaphragm is high in inertia. The manufacturer of the "Teutonophone" has over-

**AERO WORLD-WIDE**

Only \$6.45  
**Short Wave Receiver**

Span the World with this Set!



A new radio thrill for you! Listen in DIRECT to London, Paris, Berlin, Buenos Aires and other broadcasting stations throughout the world via short waves. Enjoy unique foreign programs from strange lands. Your ordinary receiver cannot tune in these low wave stations. **WORLD-WIDE RECEIVER** gets 14 to 550 meter stations with surprising clarity.

## AERO SHORT WAVE Super-Heterodyne Converter Converts Your AC or DC Radio Set Into a Short Wave Super-Heterodyne 15 to 200 METERS

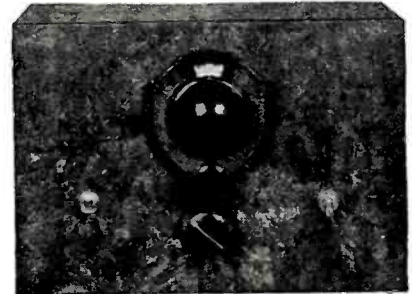

Now in addition to your regular receiver you can have a Short Wave Super-Heterodyne set that will enable you to tune in short wave stations from many different parts of the world. All you have to do is to connect the Aero Converter to your own set and you are then ready to span the world. The Aero Converter is adaptable for AC or DC radio sets. Contains its own filament supply. B voltage can easily be obtained from your regular radio set, or you may use a single 45 voltage B battery. No plug-in coils. Single tuning dial. Very easy to tune. No whistle or squeals. Uses two UX227 tubes, one as oscillator and one as mixer.

### Price List

- AC Model, less tubes, ready for operation.....\$12.50
- DC Model for battery-operated sets..... 11.50
- 2 Matched UX227 tubes at 75c each..... 1.50
- 1 45 Volt B Battery..... 1.45

## New Aero Midget \$16.50



Using the latest type Pentode and Multi-Mu Tubes. This Midget performs on distance and has tone qualities like a large expensive set. Wonderful selectivity. Full dynamic speaker, full vision dial, beautiful walnut finish cabinet. A 5-tube set. Price for set of 5 tubes, \$6.00. Available in 25 cycle \$2.50 extra.

## Aero Pentode Auto Radio

Amazing Low Price! Quality Performance



We guarantee this is the latest model 6 tube Aero Pentode Auto Radio. Due to the use of the latest Pentode Tubes this set is equal in performance to any 8-tube receiving set. The circuit used is one which will be embodied in most of the expensive 1932

model auto radios. The complete set can be clamped on the steering post of your car or can be operated by remote control from the dashboard. This set will pull in stations within a radius of 1,000 miles and will deliver the volume and tone qualities of an electric set.

### Price of Set only \$20.00

Price complete, including tubes, batteries, dynamic speaker and suppressors, all ready to install and use. \$39.50.

TERMS: Should you order C. O. D. a deposit of \$1.00 is required on Short Wave Receiver or Short Wave Converter. A deposit of \$5.00 is required on the Aero Midget or Auto Radio. 3% discount allowed if remittance is sent in full.

Write for Bargain Catalog  
**CHARLES HOODWIN COMPANY**  
4240 Lincoln Ave., Dept. L-30 Chicago, Illinois

**F. & H. CAPACITY AERIAL**



Price \$1.00 Complete

Every Instrument Tested on Actual 1000 Mile Reception

The F. & H. Capacity Aerial Eliminator has the capacity of the average 75 foot aerial, 50 feet high. It increases selectivity, and full reception on both local and long distance stations is absolutely guaranteed. It eliminates unsightly poles, guy wires, mutilation of woodwork, lightning hazards, etc. It does not connect to the light socket and requires no current for operation. Installed by anyone in a minute's time and is fully concealed within the set. Enables the radio to be moved into different rooms or houses, as easily as a piece of furniture.

**WE PREDICT THIS TYPE OF AERIAL WILL BE USED PRACTICALLY ENTIRELY IN THE FUTURE.** 8,000 dealers handle our line. Dealers! Over 80 leading jobbers carry our line, or order sample direct; write for proposition.

Send coupon today, it protects you

Name.....

Address.....

City.....State.....

Send one F. & H. Capacity Aerial with privilege of returning after 3-day trial if not satisfactory, for which enclosed find ( ) check ( ) M.O. or dollar bill, or send ( ) C.O.D. ( ) Send Literature. ( ) Dealer's Proposition.

**F. & H. RADIO LABORATORIES**  
FARGO, N. DAK., DEPT. 14

**NOW OFF PRESS**

**Radio Set ANALYZERS**  
and  
**How To Use Them**

THE only book of its kind in print. If you are a radio Service Man or if you intend becoming one, this book is ABSOLUTELY INVALUABLE to you. It goes into every phase of testing, and gives you the very information you have been looking for. It contains also complete description and hookups of every important analyzer on the market. Fully illustrated with diagrams, hookups and other important illustrations.

Send for your copy today  
PRICE PREPAID 50c  
GERNSBACK PUBLICATIONS, INC.  
94-F Park Place, New York City

**BECOME A RADIO OPERATOR QUICKLY AT HOME BY CANDLER SCIENTIFIC SOUND METHOD**

We teach you CODE in less than half the usual time. We've taught thousands in past 20 years, including former champion McElroy, whose speed was 56 1/2 wpm. Our methods originated by world's foremost CODE SPECIALIST, who instructs you personally. Endorsed by officials and 45000 Morse and Radio operators. We help you set your "tickets" quickly and inexpensively. Make a start TO-DAY! Send for FREE Brochure.

**THE CANDLER SYSTEM CO., Dept. N-11**  
6343 So. Kedzie Ave., Chicago, Ill.

**SOUND SYSTEMS**  
By **Amplex**

**NEW MODELS**

Portable and permanent equipment for the smallest or largest indoor or outdoor installation. AMPLEX matched units assure better results at lower costs than any other known system. And AMPLEX engineering counsel is gratis. Send us your problems. Responsible, experienced men and organizations can build big profitable sound systems business with AMPLEX assistance. Write in detail to our General Manager.

**AMPLEX INST. LABS.**  
133-R West 21st St. New York City

**MILLION PARTS**

Farrand type inductor dynamic speaker, 9 inch, push-pull or straight for 171 or 245.....\$4.50  
Farrand type inductor dynamic unit.....1.59  
Inductor dynamic speaker solenoid......25  
Paper for inductor dynamic speaker......20  
Speaker cards, double or triple......20  
Midget sets complete with tubes, any current...27.50

Price List Free  
**EXPERIMENTERS RADIO SHOP**  
129 West St., Dept. RN, New York City

come this apparently impassable obstacle by making a very thin elastic diaphragm of a special alloy which is stretched over a ring. In the center of this diaphragm a button of high magnetic permeability is mounted and the entire headphone is designed to concentrate the major part of the magnetic flux on this button. A cross section of this special diaphragm is shown in Figure 3 and photographs in Figures 4 and 5.

**Using Amplifiers**

It is obvious that component parts of high sensitivity are essentially in electrical hearing aids which do not resort to the use of vacuum-tube amplifiers. Even where a vacuum tube is employed, this sensitivity in the microphone and headphone can be used to advantage, because then only a single stage of amplification is usually necessary and this can easily be incorporated in a portable device. For equipment that is not portable, as in the group systems employed in churches and theatres, size is no longer a factor. Therefore any lack of sensitivity in the microphone and headphone can be made up for by additional stages of amplification. For this latter type of installation, therefore, ordinary microphones, similar to those used in broadcast studios, are employed, being placed in the pulpit or on the stage, as the case may be. The output of these microphones is then fed into an amplifier which provides the required degree of step-up. In the output of the amplifier a group of headphones is connected, each one having its individual volume control so that users may adjust the volume to their individual requirements.

Electrical hearing aids have always been inordinately costly, and this is undoubtedly one of the reasons why they have not enjoyed more common use. Even the small pocket type devices, such as that shown in the circuit in Figure 2, costs anywhere from \$35.00 to \$60.00. This seems astonishing when one remembers that there are a number of complete radio sets on the market selling in this price range. There is the consideration, of course, that the keen competition in the hearing device field results in high advertising and merchandising costs and also in high production costs, resulting from limited production. Prices have gradually been coming down within the past few years, and there is no question that they will continue to drop until they finally reach a more appropriate level.

**Servicemen's Opportunity**

In the meantime, the dealers' profit is high and there is an excellent opportunity here for radio servicemen and dealers to carry these devices, along with their radio stocks.

Experience shows that hard-of-hearing persons are constantly approaching radio dealers and servicemen for information and advice concerning hearing aids. Also those engaged in the radio field have a much better knowledge of the principles involved in these devices than do the agents and dealers who ordinarily constitute the market outlet.

Under these circumstances, it would seem worth while for the hearing device manufacturers and the radio retail outlets

to get together for their mutual benefit. The author has been informed by the editors of RADIO NEWS that this publication will be glad to lend its co-operation in this direction in the hope that through the development of additional outlets, sales and production may be increased with a corresponding drop in retail price and therefore a more general adoption of hearing aids by those whose hearing is impaired.

In closing, the author would like to bring to the attention of those so afflicted the helpful work that is being carried on by the New York League for the Hard-of-Hearing at 480 Lexington Avenue, New York City, New York. This is a non-profit-making organization, whose sole purpose is to bring to the public the understanding that defective hearing does

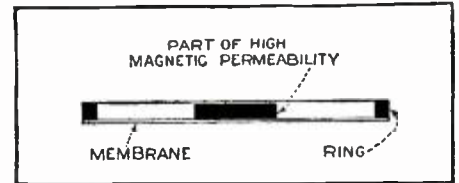

**OBTAINING SENSITIVITY**

Figure 3. In one device, described in this article, the diaphragm in the headphone is as shown in this cross-section. Instead of a relatively heavy iron diaphragm a light membrane of low inertia is used, limiting the iron to a small button and ring, as shown

not necessarily decrease one's possibilities in life and economic usefulness. Thanks are due and hereby given to the League for some of the statistical data and part of the illustrative material used in this article.

**News and Comment**

(Continued from page 412)

facturing, the transfer of these facilities was made to complete the centralization of all the manufacturing, research and engineering resources of the RCA-Victor Company in this city.

Some of the more important products available for sale to radio manufacturers and others by this section are as follows: Loudspeakers, transformers, magnetic pick-ups, electric phonograph assemblies and parts, laboratory and test instruments, commercial receivers, "Faradon" capacitors, geophysical apparatus, rectox units, paper capacitors.

**Returns to New York**

LAWRENCE, MASS.—Robert Hertzberg, for two and a half years sales promotion manager and more recently advertising manager of the Pilot Radio & Tube Corporation, of Lawrence, Mass., announces his resignation. He will return to New York, where he was formerly active in radio publishing circles.

**Protests Radio Tariffs**

NEW YORK—Assistance of the State Department at Washington has been accorded to Radio Manufacturers' Association in opposing drastic increases ordered recently by Latin-American countries in their tariff rates on radio apparatus. Four countries—Argentina, Uruguay, Costa Rica and Mexico—decreed higher customs rates on radio sets, tubes, phonographs and phonograph records. (Continued on page 439)

## Television Goes to Sea

(Continued from page 387)

The sixty-tooth wheel with double magnet mounting assembly held framing as long as we wished.

"We immediately took advantage of the opportunity to demonstrate the instruments. Fully 300 visitors and passengers viewed Columbia and NBC. All remarks were favorable—and the only unusual remarks seemed to be due to the lack of sound accompaniment. We were

Light. The pictures from NBC and 2XR came in with remarkable clearness.

"At the close of dinner J. E. Nestell and myself returned to the apparatus to find an entirely different situation. Not only could we not receive any pictures from W2XAB, Columbia, but those obtainable from NBC were poor. We made practically no demonstration at this time. We were about fifty miles from New

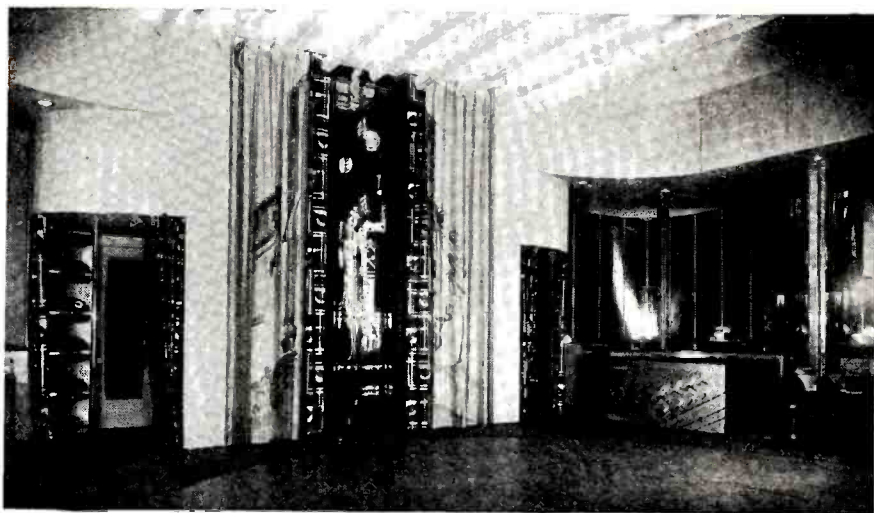

A "TELEVISION" NIGHT ON THE OCEAN WAVE

*Strange things happen in night clubs, but this is probably the first one offering its guests vision to penetrate 350 miles of darkness to witness the actions of persons on shore. This shows a corner of "Club Leviathan" in which the television demonstrations were held*

unable, lying at the pier, to tune in 2XE.

"Many people remarked that it hardly seemed possible that the pictures they were seeing were those of living people, feeling that somehow the image reproduced was being transmitted from a source in which the object was produced also by some mechanical means. I mention this criticism because I consider it unique and the product of a much greater ignorance on the part of the public with regard to television than I thought existed. And I suggest that any further demonstration of television be interspersed or started by a short lecture on the subject by the operator in charge.

"I remained at the instrument as the boat left the dock as far as Ambrose

York, the conditions under which we were working were very poor. W8NB, the telephone station on board, reported the noise level was 5DB plus, a most unusual circumstance according to the operator. Under normal conditions the signal is usually 20 db above the noise level.

"At approximately 10:20 our home station came in with remarkable clearness. Columbia was entirely in the background. 3XE in Washington gave us a fair picture. We decided to close down our demonstration for the evening as static was still at a high level.

"A few remarks as to location of receiving apparatus may aid in any further experiments. We placed our televisior on a stand built by the ship's carpenter and the receiver below on a shelf in the same stand. The instruments were placed in one of the vestibules of the night club.

"On Friday I spent the afternoon experimenting with a better location of the receiver. Conditions electrically had not improved very much. About five o'clock we were able to pick up a signal from the National Broadcasting Company.

"I experimented by placing a receiver in the radio room and a receiver in the vestibule of the night club. I wished to ascertain whether or not capacity to ground of the antenna in running through the ship was causing me very much loss and also to know the amount of noise we were picking up from the elevator and ventilator motors. This necessitated mov-

## An Electrical Hair Trigger

The lightest touch . . . imperceptible motion . . . the most delicate controlling force—and the powerful current is set to work. No arcing. No corrosion. No exposed spark. No hangers. No chattering. Only clean makes and breaks, even at high speed.

Such is the character and purpose of an entirely new conception of electrical contact now introduced as the



### BURGESS VACUUM CONTACT

Manually, mechanically, thermally or electromagnetically operated, this contact device has no end of applications. Particularly applicable to usual telephone type relay when power relay is desired. Converts ordinary telegraph key into flameproof power key. Essential in light control circuits, particularly in combination with Burgess Radiovisor Bridge, for simplified operation.

**WRITE** for descriptive literature. Also watch the columns of this and other practical journals for applications.

### BURGESS BATTERY COMPANY

Radiovisor Division

202 E. 44th St., New York City  
111 W. Monroe St., Chicago, Ill.

## News and Comment

(Continued from page 438)

A vigorous protest against the new Latin-American radio tariffs was made to the State Department by Bond Geddes, executive vice-president of the R.M.A.

In response to the R.M.A. protest, the State Department last week cabled appropriate instructions to the American Ambassador at Buenos Aires and the American Minister at Montevideo.

### Combines Business and Pleasure

NEW YORK—Ralph DeJur, of the DeJur-Amsco Corporation, sailed recently on the *Majestic* for a combined business and pleasure trip to Europe.



## If something snaps...

Like a projectile from a great gun—thundering down the track. Mile after mile—hour after hour. What if a vital part should fail? These cars have to be **BUILT**.

Human life itself sometimes depends upon the performance of a radio condenser.

CARDWELL condensers are built with the same exacting precision as that which goes into the engine of a fine machine.

Tie up to CARDWELLS and be **SURE**.

Transmitting condensers for high, medium and low power. A wide range of types and capacities in receiving condensers.

Send for literature.

THE ALLEN D. CARDWELL MFG. CORP.  
89 PROSPECT STREET. BROOKLYN, N. Y.

"THE STANDARD OF COMPARISON"

### ANNOUNCING!

The New  
**RADIO PHYSICS COURSE**  
by Alfred A. Ghirardi, E.E.

Greatly Enlarged  
Second Edition  
Now Ready

Contains over 850 pages.  
More than 500 illustrations.  
A new feature is a complete,  
simple course in Electricity,  
written especially for radio  
students and servicemen.

**THE GREATEST RADIO  
BOOK EVER WRITTEN**

Send for free circular

**\$3.50**  
Postpaid

OR USE THIS COUPON

Radio Technical Publishing Co.  
Dept. F, 22 West 21st Street, New York City  
Enclosed please find cash, check or money order for  
..... copies of Radio Physics Course at \$3.50 each.

Name.....  
(Please Print)

Address.....

### Lowest Prices!

on  
thousands  
of  
**NATIONALLY  
ADVERTISED  
RADIO ITEMS**

**American  
SALES COMPANY**  
WHOLESALE RADIO DISTRIBUTORS  
N. 44 W. 18th Street  
New York, N. Y., U. S. A.

**FREE WHOLESALE  
RADIO CATALOG**

## The Universal Receiver

which operates on  
**Either A.C. or D.C.**

Complete with Tubes and Speaker \$89.50  
Constructional Blueprints \$1.00

ANSLEY RADIO LABORATORY  
147 West 23rd Street New York City

ing our rotary transformer in the rheostat room on B deck to the radio room.

"The output of the receiver in the ship's radio room was much to be preferred. We then placed a two-wire lead from this receiver to the television in the night club vestibule operating the latter with a.c. from the second motor generator. The situation was very difficult because it was so inflexible. We obtained excellent telephone communication through the ship-to-shore telephone booth. This considerably aided tuning. We found the signals from NBC very unsatisfactory in quality, although greater in strength than those from WIXAV.

### Mayor Curley "Seen"

"In spite of the static and fading, we were able to receive quite a clear image of Mayor Curley, an image so fine that several of the passengers who knew him by sight exclaimed, 'That's Mayor Curley.' Conditions at this moment seemed by far the best of the whole evening. They were so good that the televisior held this image over three minutes in spite of the static. The Mayor's voice, received with excellent quality, was put on the ship's public address system, but this was a total failure because the roar of the static drowned out the voice.

"Attempts were made Saturday night in the radio room to receive signals from American stations, but no television was heard. The noise level was excellent—by far the best of the trip. We were lying outside Halifax Harbor in a heavy fog.

"Sunday night we once more set our apparatus in operation with the television receiver placed more advantageously with regard to handling a larger crowd of people. The ship's position at 9. P. M. was 103 miles east of Ambrose and 110 miles south of Boston. At this time we received from Columbia both in the radio room and on the public demonstrator.

By 10 P. M. Columbia had faded very badly and Boston once more came to view. We found that the quality of the



### VIEWED AT SEA

Mayor Curley of Boston and George Bancroft, popular movie star, appeared in person at the television studio in Boston and through the media of television and broadcast transmitters projected themselves to the Leviathan, 350 miles at sea, where their images were readily recognized by the passengers "looking-in"

Columbia transmitter this evening superior to that of Boston. Two evenings before, the reverse had been true."

## Radio Physics Course

(Continued from page 409)

outer shell is supposed to be twice as far from the nucleus, and to have four times its imaginary area. In it a maximum of 8 electrons may be revolving. If the total number of electrons in the atom is greater than 10, an additional outer shell is required; for electrons greater than 18, a fourth shell is required, etc. More complicated atoms then have electrons revolving in additional shells. Two elements may have the exact same number and arrangement of planetary electrons in the outer shells but differ simply because the proton and electron arrangement at the nucleus is different.

### Atom Structure

In C of Figure 4, the internal structure of an atom of carbon is shown. This consists of 12 protons and 6 electrons in the nucleus. Around this are two planetary electrons in the first outer imaginary shell, and four electrons in the second outer shell.

The internal arrangement of each atom in a piece of copper wire is shown at D. Here the central nucleus contains 15 electrons and 44 protons. Flying about in planetary orbits outside of this are the other 29 electrons; distributed in four concentric spheres or shells (a total of 44 electrons).

### Complicated Uranium Has 92 Electrons

The atoms of all the chemical elements are formed by various combinations of protons and electrons. The most complicated of all the 92 different atoms or chemical elements known at the present time is that of uranium (one of the radioactive substances). This has a nucleus into which are tightly packed 238 protons and 146 electrons, around which revolve 92 planetary electrons distributed systematically in seven concentric shells or spheres.

# Completing the Army Radio Net

(Continued from page 397)

undamped-wave telegraphy, 60 miles; but many times the 60-mile range is procurable in Alaska.

"After a few nights' testing, we made contact with Wiseman, he reporting our signal R5 to R7. This was encouraging, and although their signals were faint we were sure of one or two contacts a day. This was a great relief, as it gave us an outlet for our weather reports, and we had been especially enjoined to get them through.

"During the first few weeks, reception was poor, due, no doubt, to the fact that it was daylight all the time. As darkness gradually approached, however, long-wave reception picked up, and schedules with Wiseman were now assured at any time of the day. It was thought at first that Kotzebue would be the logical relay for this station, as there is nothing but flat country and water between the two places, but, through a series of tests it was found impracticable to work any reliable schedule with him. His signal strength was never over R2 (very faint—unreadable), and he reported our signals of about the same strength.

## Hourly Tests Made

"Now that the long-wave was well established, more attention could be given to the short. A listening-in test was conducted every hour, covering the entire range between 18 and 80 meters. I decided that the 35-meter band was as satisfactory as any, although it has two remarkable peculiarities. Between 8 and 9 p.m. this band is 50 per cent better than at any other time in the day; but at any time signals of R8 strength (strong) may fade out completely, stay out as long as two hours and then come in again with the old R8 strength. I frankly admit that I do not know what causes this. My theory is that it is due to the rapidly changing weather. Sometimes the wind will change from north to south in a few minutes. This causes the sky to cloud up or to clear in about the same length of time, and I believe this causes the fading. This effect is not so noticeable, however, on the longer waves, though faint signals from extremely distant stations do fade out at times.

"It was found that short-wave station signals arriving from over the Pole, including most of the European countries, were much louder and were subject to less fading than stations south from here. By listening-in at the right time of day, one continent after another came in regularly each day the test was conducted. This was an interesting thing to note. Tests were now conducted using different types of antenna, different circuits, and, in fact, everything that seemed likely to improve things. At last, a tuned-plate, tuned-grid transmitter, using two 50-watt tubes, was found to give the best results when using a semi-vertical Hertz antenna, working on fundamental.

"I now received orders to go down to 25 meters. Using the coils sent up with the original transmitter and with condensers of wrong capacity; it was a hard

thing to do. However, luck was with me. I found some old copper pipe, made up a set of coils and using some old receiving condensers, constructed a transmitter to work on the band from 21 to 25 meters. Tests with Seward, however, did not give the desired results, and here again a peculiar phenomenon was observed. Seward reported my signal R7 one hour and with not the slightest change in weather or in equipment here, he, during the next hour, would be unable to even hear me.

"Shortly after these tests, the 35-meter band became less satisfactory, and it was necessary to go up to 43 meters, which band gave better results. I believe this condition was due to the approaching winter and that with the return of daylight again in the spring, we will probably have to drop back to 35 meters. I recommended that the station be authorized the three wave bands—21, 35 and 43 meters."

That report of Morgan's was the classic of Arctic radio reportorial effort. It detailed the effort of getting established, but it told nothing of the routine up there in the dark.

The traffic handled on the complete Army Net consists of the Post Office, Department of Agriculture, Civil Service Commission, Department of Labor, War Department and other department radiograms. These make a volume of from 1,000 to 1,500 messages daily. Messages containing 200 to 300 words are ordinary everyday affairs. Those of 500 to 600 words are not extraordinary and many that run into thousands of words are handled.

## Network Business

The War Department Net, in fact, handles everything except Navy Department communications and some other odds and ends. The Navy Department stations around the world, while more numerous so far as high powered stations are concerned, have so much purely military traffic, due to Fleet movements, and administration of Island Governments, as well as service to ships of the merchant service, that they cannot care for interior traffic. They are not supposed to work in the interior of the United States. That is the Army's territory.

But, like the Navy Department, the War Department can talk to Honolulu direct, with its own stations operating.

Just across the Potomac from Washington, on the rim of the Fort Meyer Military Reservation, is a radio station little known to the public. In this ancient red-brick structure, are located the transmitters of WAR, the net control, operated by remote control from the Munitions Building in Washington.

With the completion of the new short-wave system at Fort Meyer, the Signal Corps introduces the beam transmission system for the 55 government bureaus now using the station. Directional short waves will be employed for all govern-

(Continued on page 442)



With a Fox Ram's Horn and Fox Dynamic Units you can hold the crowd.

Fox equipment is guaranteed to improve any indoor or outdoor system in both volume and tone quality.

Write for prices and specifications



**FOX**

Engineering Co.  
388-392 Dorr St.,  
Toledo, Ohio,  
U. S. A.

**6 FUSES in ONE PLUG**

**Agents & Distributors Making Big Money**

A necessity everywhere. A turn to the right brings back the light. Safe, economical, dependable. **6-in-1 Fuse Plug**. Most useful invention in years. Many of our distributors in exclusive territory making \$500 to \$1000 a month. Easy to demonstrate. Easy to sell. Profits begin right away. Write at once for proposition. Send 25c for sample and working instructions. **6-in-1 Fuse Co., 801 W. Madison St., Dept. 108, Chicago**

**ROYAL** SHORT WAVE RECEIVERS AND TRANSMITTERS

Complete **TWO TUBE** short wave receiver with a **WORLD-WIDE** range! Enjoy direct reception of foreign broadcasting stations! Tunes 11 to 200 Meters. Uses any tubes and batteries. Guaranteed to give better results than any other low-priced set. **Model RC—\$10.45. LOW-POWER TRANSMITTER**. Complete with meter and resonance indicator. Just plug in any receiving tube and start sending! Adaptable for phone. **Model TC—\$9.95.** High quality parts and scientific design insure maximum results. **Many Other Models and Unassembled Kits in**

**Free Bargain Catalog**  
**HARRISON RADIO CO.**  
189 Franklin St. Dept. N New York City

## Servicemen, Dealers, Jobbers

We specialize exclusively in the repair of speakers and phonograph pickups. Price list on request.

**MULTIPLEX RADIO SERVICE, INC.**  
1177 Broadway, Brooklyn, N. Y.



# Readrite

No. 550

## OSCILLATOR

(Licensed by A. T. & T. Co.)

**\$18** Net to dealer  
\$30 list

**\$21** Net to dealer  
with output meter

*If not at your Jobbers we will ship direct when remittance accompanies order.*

A sturdy modulated instrument carefully made. Completely shielded with separate battery compartment. Furnished with 22½-v. and 3-v. batteries. Uses one '30 tube. Covers broadcast band (550-1500 kc.) and intermediate band (120-185 kc.). Operating instructions attached in case cover with shielded wire leads. Very compact. In leatherette case, 6x11½x5½ in. Weighs but 8 pounds. Built to high standards.

Every serviceman should have the No. 550 oscillator to align r.f. gang condensers, locate defective r.f. transformers, adjust i.f. transformers, check oscillator stage and determine sensitivity of a receiver. A necessary instrument. Get yours today. Write for catalog of servicing instruments.

**Readrite Meter Works**

Established 1904

20 College Ave., Bluffton, Ohio

## A 24-Pound Laboratory

(Continued from page 383)

resistor. This arrangement requires the "grid test" or mutual conductance index method of tube testing. An oscillation test is also included for matching tubes for the r.f. stages. An innovation in tube testing is the incorporation of a gas test, used for all amplifier type tubes, which indicates the gas content of the tubes under test. Another ingenious arrangement is included for indicating the cathode-heater leakages of cathode type tubes. In addition to showing whether or not the cathode is shorted to the heater of the independent cathode type of tube, this arrangement furnishes an indication of leakages which would not be perceived through the use of an ordinary "short" tested.

With the ever-growing popularity of the superheterodyne, the oscillator becomes a more and more important feature of the serviceman's essential equipment. This analyzer is equipped with a completely shielded and attenuated oscillator, designed for tuning over a range of approximately 90 kc. to 1500 kc. This

wide band of frequencies is covered through the use of the harmonic tuning principle. By means of a very clever circuit arrangement, both the intermediate and the broadcast bands are covered with a single set of inductance coils and tuning condenser. A type -31 tube is used as the oscillator tube. For output measurements the multi-meter, connected in series with the self-contained condenser, is used. This provides a very wide range for output measurements.

This oscillator covers a band of fundamental frequencies between 90 and 250 kilocycles. For all higher frequency bands the multiples or harmonics of the fundamental frequencies are utilized. Hence frequencies up to 1500 kc. are generated in the single tuning circuit without the necessity of employing complicated switching circuits. Complete calibration charts permit one to determine the frequency with an accuracy within one-half of one per cent.

The output of the oscillator can be controlled from its maximum to an absolute minimum. The oscillator is modulated at the frequency of the power supply system. A vernier tuning dial permits of very fine adjustment, as required in many types of servicing.

Having discussed the analyzer, the tube tester and the oscillator, there still remains the utilization of the Diagonometer for measuring resistances and capacities. The resistance measuring ranges are indicated on the top scale of the multi-meter. External connections are provided for two ranges indicated as "low" and "high." The low range covers 0 to 5000 ohms, while the high range covers 0 to 500,000 ohms (approximately). A self-contained three-cell flashlight battery is utilized with these two ranges and a zero corrector is incorporated for maximum accuracy. A 45-volt dry battery may also be employed with the ohmmeter circuit, so as to have an indicating range from zero to approximately 5 megohms. Provision is also made for obtaining a d.c. potential of 250 volts, which is employed for continuity testing up to 25 megohms.

In accordance with the recommendations of the R.M.A. standardization committees, the analyzer has provision for applying 250 volts d.c. to paper condensers under test. Leakage up to about 4 megohms is indicated satisfactorily by this test. In addition to the leakage test of condensers, capacities may be measured from approximately .002 mfd. up to 10 mfd. Charts are supplied for accurately determining the capacity of various sizes of condensers.

Mechanically, as well as electrically, the Diagonometer is made for accurate work. Every effort has been made to make this instrument as fool-proof and safe as possible. The power-supply circuits are provided with fuses, and fuses are used in the milliammeter circuits to minimize possible damage to the milliammeter. Special precautions have been taken to prevent damage to any part by the inadvertent insertion of tubes with shorted elements.

## Army Radio Net

(Continued from page 441)

ment traffic. The new installation is comprised of three groups of transmitting sets—one 10,000 watt, two 1,000 watt, and three 500-watt high frequency transmitters. Their frequency range is extensive—from 4,000 to 18,000 kilocycles—and the six sending sets have been so installed as to afford maximum flexibility in the selection of any one or group of frequencies. Beam transmission, the first attempt to handle traffic out of Washington by directional waves, will be effected on the 16,000 and 12,000 kilocycle bands. The signals on both beams have a spread of approximately 60 degrees, this insuring coverage of the entire United States from north to south.

Five hundred officers and men of the Signal Corps operate this vast Army Net, most of them operators. Eighty Army posts and stations are served by them, in addition to what has been said of service in the foregoing. Also, all recruiting stations of both Army and Navy are communicated with over this Net. It saves the Government in actual cash \$300,000 a year, after paying its own expenses. Most of the remote outlying stations show good profits from commercial traffic unable to secure regular civilian service. The War Department never competes with civil commercial stations.

In some 6,000,000 words of traffic handled it has made less than one-tenth of one percent errors. The director of the Budget has described the War Department Radio Net, which is operated by enlisted Army-trained radio men, as "an efficient and model organization of the Federal Establishment which is saving the taxpayers dollars and thoroughly expresses the administration's economy platform."

# Defining the Decibel

(Continued from page 385)

corresponds to 40 decibels, of 1000 times to 60 decibels, a reduction of .01 corresponds to 40 db. down, etc.

In the measurement of sound it is desirable also to have a reference level and it was the original idea to use, as zero level, such a volume as would be just audible to a person's ear.

People differ, however, in ear sensitivity to sound; also, the sensitivity is not the same for different frequencies. For some time a zero level of .46 millibars was used by engineers. Recently a new "threshold" of one millibar has been agreed upon, and it is expected that this will soon be internationally accepted. The use of fractions is then avoided.

In order to be able rapidly to convert gain or reduction to db. and vice versa, we are printing a chart in Figure 1. This chart, prepared by Dr. E. E. Free, gives db. gain for different power ratios and current or voltage ratios.

### Chart for "Gain" or "Loss"

Although this chart only indicates db. gain, it can also be used for loss by inverting the power ratio and placing a minus sign before the amount of db. so obtained.

Example: Suppose in a circuit there is a ratio of output-to-input power of .002. The inverse of this ratio is 500. On the chart we find that this corresponds to a gain of 27 decibels. Therefore when the ratio is 1/500 or .002 there is a loss of 27 decibels or 27 db. "down."

In order that the reader may be able to read these ratios with a little more accuracy, the curve in Figure 2 shows db. against power ratios between -10 db. and +10 db. For higher ratios it is only necessary to add 10 to the number of decibels as many times as the power ratio has been multiplied by ten, and to subtract ten from the number of decibels as many times as the power ratio has been reduced ten times.

Suppose the power ratio has increased 1260 times. Then looking on the chart of Figure 2 we see that 1.26 corresponds to 1 db. But the power ratio is 1000 times 1.26. Therefore the gain is  $30 + 1 = 31$  db.

When the power has been reduced to .03 of its former value, we see in Figure 2 that a reduction of .3 corresponds to 5.23 db. down. The reduction of .03 then corresponds to  $10 + 5.23 = 15.23$  db. down.

### Obtaining Logarithms

Mental calculations can be rather easily made if we remember that all logarithms of numbers can be obtained by adding the logarithms of its factors. If then we remember all the logarithms of the prime numbers we can have all logarithms at our finger tips. For the logarithms below 10 only three have to be remembered: the logarithm of 2, or 3 and of 7. All the others are then easily found.

As we remember from our algebra lessons, a logarithm is made up of a mantissa and a characteristic. The mantissa

is the decimal fraction and this is the same for the same significant figure regardless of where the decimal point stands or how many zeros are behind it. The characteristic varies with the decimal point. For instance, the logarithms of the numbers 2, 20, 200, 2000 and 20,000 all have the same mantissa, .301, but the characteristic is 0, 1, 2, 3, and 4, respectively, so that their logarithms are: 0.301, 1.301, 2.301, 3.301 and 4.301. It becomes a little harder when the number is less than one, and the logarithm is negative. If we wish to stick to the rule that the mantissa of a significant figure shall always be the same, then we must write the negative logarithm so that the mantissa is positive and only the characteristic is negative. Therefore, the log of .2 is .301-1, the log of .02 is .301-2 and so on. The following notation is used for this purpose (in the United States only): Log 0.2 is 1.301, the log of 0.02 is 2.301. The minus sign above the characteristic means that only the latter is negative but the mantissa is positive.

### Negative Mantissa

Therefore, if, after a calculation, a mantissa might come out negative, it should be converted into a positive mantissa by adding 1 to the mantissa and subtracting 1 from the characteristic.

The final rule for the location of the decimal point is as follows: With a positive characteristic, there are as many digits to the left of the decimal point as the characteristic indicates, plus one. When the characteristic is negative it is one greater than the number of ciphers immediately following the decimal point.

After all these mathematical explanations, we can give some examples of how to work the tables.

### Examples

Suppose we must find the power ratio expressed by a gain of 17 decibels. Dividing by ten, we find the logarithm of the power ratio is 1.7. Looking in the table, we find the antilog of .7 is 5. Therefore the power ratio is 50 for the characteristic 1 indicates that the antilog consists of two figures.

But if there was a loss of 16 decibels? Again dividing by ten, we find for the log of the power ratio -1.6. To make the mantissa positive we have to change it to 2.4.

In the table on page 385 we find the antilog of .4 is 2.51 and since the characteristic is -2 we must divide this figure by 100, so the power ratio corresponding to -16 db. is .0251.

### Making Tables Useful

The reader with some ingenuity will find that he can extend the use of these small tables by adding some of the logarithms and getting the logarithm of their product. In this way sufficient data will be present to always estimate the db. for power ratio and vice versa.

## RADIO TELEVISION

The good jobs in any profession are held by the better-than-average men—the men with technical engineering training.

The leaders in radio today are the men who were STUDYING radio ten years ago. The leaders in Radio and Television tomorrow will be the men who are seriously preparing today.

We offer Advanced Courses in Practical Radio and Television Engineering for the experienced radioman—complete courses in Practical Radio and Television Engineering for the less experienced radioman.

Send in the coupon for complete details TODAY.

Nov. RN  
Capitol Radio Engineering Institute  
Riggs Bank Bldg., 14th and Park Road, N.W.  
Washington, D. C.

Please send me without obligation complete details of the following course: (Check course.)

- Advanced course in Practical Radio Engineering.
- Complete course in Practical Radio Engineering.
- Advanced course in Practical Television Engineering.
- Complete course in Practical Television Engineering.

Name.....

Address.....

## Baird SHORTWAVE or TELEVISION KITS

No. 25 Shortwave Kit, formerly \$95.10. Wavelength range 15 to 520 meters. Easy to assemble, easy tuning. Complete with 15 Octocolls, blueprints and construction manual (less tubes and cabinet). May be purchased in 3 units at \$13.95 each.  
No. 26 Television Kit, formerly \$88.99; complete with lens, lamp, synchronizing amplifier, synchronizing motor, cabinet and wiring diagrams. Works in conjunction with Baird Shortwave Set. May be purchased in separate units: Unit X, \$13.50; Unit Y, \$15.50; Unit Z, \$13.50.

Now only  
**\$39.50**

Write for complete descriptive folder  
TELEVISION SALES CO., Dept. RN-3  
Lansdowne St. and Brookline Ave.  
Boston, Mass.

### MAKE \$10,000

A year raising rabbits for us. We pay up to \$12.00 each for all you raise. Send 25c for full information and contract, everything explained. Send at once and find out about this big proposition we have to offer you.

THE EASTERN RABBITRY  
Route 1, Box 236 New Freedom, Pa.

### Power Amplifiers

Complete systems, parts, speakers, trumpets, microphone stands

Send us your specifications for our quotations

Products of Merit

MOE MFG. CO.

Melrose, Mass.

### Servicemen and Dealers! OUR PRICES ARE THE LOWEST

We carry a complete line of Standard Radio Replacement Units. We stock no JUNK or JOB-LOTS. All units are BRAND NEW and GUARANTEED by STANDARD RELIABLE MANUFACTURERS. Satisfaction guaranteed or money refunded. WRITE FOR OUR LATEST BARGAIN BULLETIN ON RADIOS, TUBES and REPLACEMENT UNITS. We ship everywhere. "Pioneers in Radio"

MAURICE SCHWARTZ & SON  
710-712 Broadway Schenectady, New York

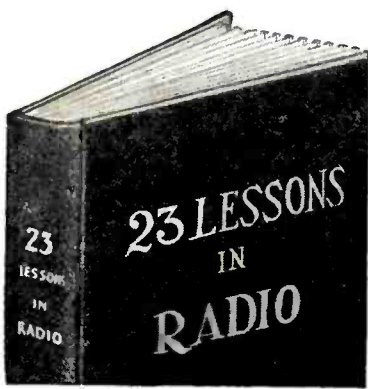

# FREE

## With this New Money-Saving Offer From RADIO NEWS

SO many requests have come into this office asking us for a book covering the Junior Radio Guild lessons, that we have at last, with considerable time and effort, compiled this material (along with some other information) into a great new book!

"23 LESSONS IN RADIO" is not for sale anywhere! But by subscribing through this special offer, you receive not only this great book FREE, but you also receive two whole years of RADIO NEWS for only \$4, a saving of \$2, over the single copy price. Besides, you do not need to pay the entire amount now! Simply fill out the coupon below and send it to us with \$1! We will immediately mail your "23 LESSONS IN RADIO" and your first issue of RADIO NEWS. Then you may pay the balance later as we bill you, in easy installments of \$1 a month for 3 months. Renewal or extension of current subscriptions accepted on this offer, but payment must be made now, as specified above, not when subscription expires.

### A Few of the Subjects Covered:

- Elementary Radio Theory
- How the Detector Tube Works
- Construction of a two-stage audio-frequency amplifier
- How the Radio-Frequency Amplifier Works
- How To Build a "Converter" which changes your 5-tube broadcast receiver into a Short-Wave receiver
- Principles of transmitting and receiving
- Complete Chart of Standard Radio Symbols
- How To Build R F Tuner
- How To Build a 3-stage resistance coupled audio-frequency amplifier
- The How and Why of B-Power Units
- Breaking into the Amateur Game
- How to build a radio test outfit
- Circuit, constructional and operating details of a Low-Power Transmitter
- How the Vacuum Tube Works
- Battery construction details
- How to Analyze Receiver Circuits

RADIO NEWS, Dept. 2411  
350 Hudson Street, New York, N. Y.

Enter my subscription for two years of RADIO NEWS, and send me the book "23 LESSONS IN RADIO"—all for only \$4.00. I am enclosing \$1.00 herewith, and will pay the balance, \$1.00 a month, for the next three months. (One extra issue—25 months in all—if you send the full amount with your order.)

Name .....

Address .....

City ..... State .....

Are you a Serviceman  Engineer  Dealer   
 Experimenter  Radio Technician

Canadian and Foreign Price, \$6.00

## Radio Science Abstracts

(Continued from page 406)

quency. The oscillograph produces photographic records on a paper 35 mm. wide. The light-sensitive paper is contained in a roll which is mounted like an ordinary motion-picture reel. It passes down before a slit, where it is exposed; then the film is automatically passed through a developing solution so that a photographic record, of the current being studied, is obtained only a few minutes after the test is made.

*Dynamic Loudspeaker Design*, by J. E. Goeth. Electronics, August, 1931. A design article useful to those concerned with the manufacture of electro-dynamic loudspeakers. The author discusses correct dimensioning of the magnetic system and the conductor length and current required to produce a desired field. He also discusses the design of the moving coil, the number of turns, its diameter, and the proper ratio of transformation for the output transformer. He points out that the number of turns on the moving coil is unimportant *per se*. The number of turns is only important insofar as it affects the mass and the freedom with which the unit can move in the air gap.

*Noise Generation Within Radio Receivers*, by Rinaldo de Cola. Radio Engineering, August, 1931. This article discusses the causes of noise in a receiver; the discussion is limited to noises inherent in the receiver design and does not consider noises produced from outside sources. The major

(Continued on page 445)

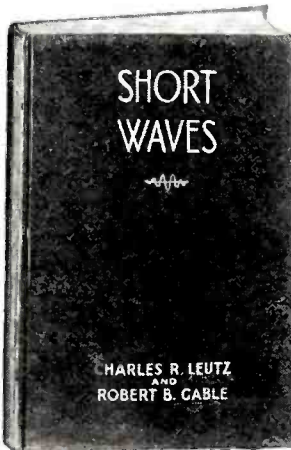

384 Pages (6 1/2 x 9 1/4)

This is the most complete book on short waves yet issued, published by Charles R. Leutz and Robert B. Gable. Price of book \$3.00.

The chapters on the propagation of short waves and directional antennas with their applications to the transatlantic radio links are the most complete of any yet available in book form. Skip distance, useful range and how they are affected by day, night or season, are exhaustively treated. Amateur and broadcast equipment, airplane radio, television and medical applications are among the other subjects covered. All the latest systems for the guiding of airplanes in fog, American and European television systems, the bloodless electric knife and many other late developments have here been brought together for the first time in a single volume.

Through a special arrangement with the publishers, we are able to offer you this book in combination with an 18 months' subscription to Radio News for \$5.00—a saving of \$1.75. Send coupon below.

TECK PUBLISHING CORPORATION  
350 Hudson Street, New York, N. Y.

Enclosed is \$5.00. Send me "Short Waves" and enter my subscription for Radio News for 18 months.

Name .....

Address .....

City .....

State .....

## INDEX TO ADVERTISERS

<b>A</b>	Aerovox Wireless Corp.	416
	American Sales Company	440
	American Transformer Co.	420
	Aniperite Corp.	447
	Amplex Instrument Laboratories	438
	Amy. Aeeves & King	436
	Ansley Radio Laboratory	440
<b>B</b>	Baltimore Radio Corp.	445
	Blan the Radio Man	436
	Burgess Battery Company	439
<b>C</b>	Candler System Co., The	438
	Capitol Radio Engineering Inst.	443
	Cardwell Mfg. Co., Allen D.	440
	Central Radio Laboratories	426
	Chicago Radio Apparatus Co.	431
	Clarostat Mfg. Co., Inc.	448
	Classified Advertising	446
	Coast to Coast Radio Corp.	433
	Coyne Electrical School	355
<b>D</b>	Dutton Radio Institute	435
<b>E</b>	Eastern Rabbity	443
	Electrad, Inc.	428
	Electric Soldering Iron Co.	434
	Experimenters' Radio Shop	438
<b>F</b>	F & H Radio Laboratories	438
	Federated Purchaser	447
	Filtermatic Mfg. Co.	447
	First National Television, Inc.	436
	Flechtheim & Co., Inc., The	434
	Fox Engineering Co.	441
<b>G</b>	Gernsback Publishing Co.	438
	Grant Radio Labs.	428
<b>H</b>	Hanmarlund Mfg. Co.	433
	Harrison Radio Co.	441
	Hoodwin Co., Chas.	437
<b>I</b>	Insuline Corp. of America	429
	International Correspondence Schools	448
	International Resistance Co.	423
<b>L</b>	Lincoln Radio Corp.	419
	Lynch Mfg. Co., Inc.	433
<b>M</b>	Mallory Co., Inc., P. R.	427
	Massachusetts Radio Telegraph School	447
	McGraw-Hill Book Co., Inc.	433
	Midwest Radio Corp.	360
	Miles Reproducer Co.	446
	Moe Mfg. Co.	443
	Multiplex Radio Service, Inc.	441
<b>N</b>	National Co., Inc.	424-425
	National Jobbing & Export Co.	436
	National Radio Institute	356-357
<b>P</b>	Paramount Mfg. Co.	432
	Pilot Radio & Tube Corp.	417
	Pioneer Radio Laboratories	446
<b>R</b>	R.C.A. Institutes, Inc.	418
	Racon Electric Co., Inc.	431
	Radio & Television Inst.	421
	Racon Electric Service Co.	432
	Radio Surplus Corp.	431
	Radio Technical Publishing Company	440
	Radio Trading Co.	429
	Radio Training Ass'n of America	353
	Radio Treatise Co., Inc.	428
	Radolek Co.	446
	Readrite Meter Works	442
	Rim Radio Mfg. Co.	432
	Ross, Malcolm G.	432
<b>S</b>	Schwartz & Son, Maurice	443
	Scott Transformer Co.	359
	Shallcross Mfg. Co.	433
	Silver-Marshall, Inc.	415
	Six-In-One Fuse Co.	441
	Supertone Products Corp.	428
	Supreme Instruments Corp.	Third Cover
<b>T</b>	Teleplex Company	436
	Television Sales Co.	443
	Traul Radio Co.	431
	Triley, M.	447
	Twentieth Century Co.	434
<b>U</b>	Universal Microphone Co.	434
<b>V</b>	Van Nostrand Co., Inc., D.	Fourth Cover
<b>W</b>	Wellston Radio Corp.	445
	Western Radio Mfg. Co.	446
	Weston Electrical Instrument Corp.	422
	West Side Y. M. C. A. Radio Inst.	429
	Wholesale Radio Service Co.	Second Cover
	Wiley & Sons, Inc., John	430
<b>Y</b>	Yahr-Lange, Inc.	430



## With the Experimenters

(Continued from page 400)

identical curve (B) of Figure 5 will again be obtained.

In order to secure a means of coupling the antenna to the primary circuit an additional inductance L3 can now be inserted in series, Figure 4 (b). L3 is completely shielded from L2 and L1 and the characteristics of the primary can be adjusted to their former values by reducing the capacity of C3. If now the antenna be coupled to L3 by an inductance L4, Figure 6, it is evident that large changes may be made in the circuit of L4 with but negligible changes in L1, since the inductance changes produced by one circuit upon the other become progressively smaller. This is readily checked experimentally by obtaining the tuning range curves for short, medium and long antennas. It will be found that they all coincide with curve (B). A further check consists in varying the coupling between L3 and L4. It will be found that the effect on the value of C1 for a given fre-

quency is substantially negligible.

The value of L3 depends to some extent on the characteristic of the transformer L2-L1 and the desired operation of the amplifier as a whole, but is not at all critical. If it is of the order of L1, C3 will be reduced to such a small value that it can be eliminated entirely, the capacity of the winding L3 to ground being sufficient. The final arrangement then takes the form of Figure 7.

The advantages of the above system of antenna coupling are: (1) it allows perfect "tracking" of the first-stage condenser with the other condensers; (2) all the radio-frequency transformers can be identical in construction; (3) it opens possibilities of volume control by variation in antenna coupling.

W. E. SPICER, JR.

Radio and Acoustical Eng., Burgess  
Battery Co., Madison, Wisconsin.

### Measuring Resistance with the Set Tester Described Last Month

In the constructional article on "The Set Tester DeLuxe" in the October issue, directions were given for using the outfit to measure resistances over a fairly large range. Those who constructed this tester but wish to expand the ohmmeter range will find the following of interest:

In order to accurately measure resistances of less than 100 ohms, the 4.5-volt battery in the continuity circuit of the tester should be replaced with a 1.5-volt flashlight battery, a 400-ohm resistance should be connected in series with it and the switch on the tester set for the lowest meter scale. It will then be found that if the test prods are touched together, full-scale deflection of the meter will result. When the test prods are touched to the terminals of a resistor under test, a smaller deflection will be obtained, the difference between this and full-scale deflection indicating the value of the resistance.

A calibration scale may be made up in accordance with the formula given in the constructional article in the October issue or, better still, on page 1010 of the May issue, will be found a printed scale which will give a complete calibration for resistance measurements up to 50,000 ohms. The use of the arrangement suggested here will provide greater accuracy on all resistance measurements up to 2000 ohms than was provided for in the resistance charts published in the set tester article in the October issue.

To extend the ohmmeter range above the 60,000 ohms shown in the October chart, it is necessary to use a 45-volt battery. A calibration curve can then be plotted by calculating a sufficient number of values—not forgetting to subtract the 1000 ohms in the voltmeter multiplier resistor incorporated in the set tester.

Actually it is not necessary to substitute the 45-volt battery for the 4.5-volt battery that was originally specified in the set tester. Instead, the 45-volt battery may be connected externally across the two binding posts provided for the external voltage measurements. The main

## Radio Science Abstracts

(Continued from page 444)

sources of noise within a receiver are thermal-agitation, the shot-effect, and secondary-emission and ionization. Curves are given showing how the noise varies with frequency and with voltages on the tube.

**Measuring the Power Factor of Electrolytic Condensers.** Radio Engineering, August, 1931. This article, prepared by the Engineering Department of the Aerovox Wireless Corporation, discusses methods of measuring the power factor and capacity. The article includes typical bridge circuits indicating how the usual Wheatstone bridge must be altered to permit the application of polarizing voltages to the electrolytic condenser. The article brings out the importance of using a comparatively pure a.c. input to the bridge, since the power factor measurements are usually made at frequencies around 120 cycles, where harmonics may make it especially difficult to secure accurate balances. In the event that the source of a.c. contains harmonics it is suggested that a low-pass filter be connected between the bridge and the source of a.c.

**The High Vacuum Tube Comes Before the Supreme Court,** by William R. Ballard, Bell Laboratories Record, July, 1931. This is one of the most interesting articles we have read on the litigation concerning the high vacuum tube and the Langmuir patent, a controversy in which the Telephone Company has been continuously involved since 1915. It tells briefly the history of the vacuum tube from 1912, when Dr. Lee DeForest came East with his tube to sell the Telephone Company rights, under his audion patents, to use the tube for telephone repeaters. It tells how Dr. H. D. Arnold, Director of Research of Bell Telephone Laboratories, first became connected with the company, and how he worked to make the DeForest tube applicable to telephone repeaters. This article by Mr. Ballard will prove interesting reading to those who have followed the long court fights around the Langmuir patent, a patent which the United States Supreme Court held on May 25, 1931, to be invalid.

Do away with messy, unsightly inside and outside aerials by installing the NEW IMPROVED WELLSTON GOLD TEST AERIAL. Small enough to fit the palm of your hand, it's the mighty midget that brings in far-away stations with crystal-clear tone quality. Better than the original WELLSTON GOLD TEST giving thorough satisfaction to thousands of users all over the world. Reduces static and hum—gives selectivity without distortion—helps eliminate overlapping of stations, noises and electrical interference. Does not connect with light socket and therefore cuts out AC aerial hum and line noises. Absolutely non-directional, non-corrosive and guaranteed never to wear out. Anybody can install it in a few minutes. No tools needed. Size 2½ by 5 inches.

If Your Dealer Can't Supply, Order Direct

Price \$2.50

GOLD TEST  
Replacement Parts

Send for new and enlarged Catalog No. 16 listing GOLD TEST REPLACEMENT CONDENSERS, TRANSFORMERS AND RESISTANCES. All units designed with large margin of safety and individually tested at factory.

DEALERS: Stock WELLSTON GOLD TEST IMPROVED AERIAL AND REPLACEMENT PARTS. Cash in on BIG DEMAND. Write for information and discounts.

WELLSTON RADIO CORP.

Dept. 200

St. Louis, Mo.

**Baltimore's New Catalog**  
Just Off the Press  
Over 3,000 Radio Items  
At Prices That Defy Competition  
**BALTIMORE RADIO CORP.**  
725 r Broadway New York, N. Y.  
Write and get yours Now!

## In November "Amazing Stories"

**THE ANTARCTIC TRANSFORMATION.** by I. R. Nathanson. There is more to this business of North and South Pole expeditions than merely determining the ability of man to reach these extremes of the globe. When these regions become more accessible, natural resources of vast proportions may be discovered, which might, with the aid of man, assume great importance. It is of such a possibility in the Antarctic regions that our well-known author writes. This is an impressive story and quite plausible.

**AUTOMATON.** by Ahner J. Gelula. Most of us ask ourselves every once in a while, "What will all this machine age bring us to eventually?" It is not an illogical question. Mechanical science has made such marvellous strides in the past thirty years that its possibilities seem unlimited. One trend, the tendency to replace human labor with the machine, is treated in an absorbing manner by our new author in this unusual tale.

**THE RAT RACKET.** by David H. Keller. M.D. The racket business has reached dangerous dimensions. This distinctively Keller story about a new kind of persecution and robbery seems very opportune and we know you will enjoy it.

**LI'VIN'.** by A. R. McKenzie. Here is an ingenious phantasy of a subterranean race, living beneath the sands of the Sahara. It is an excellent example of good scientific fiction.

**THE STONE FROM THE GREEN STAR.** by Jack Williamson. (A serial in two parts) Part II. After a series of dangers, unique in the history of science fiction, the blind scientist and his co-workers reach their goal and get their prize, but at what a cost! Only Jack Williamson could have written such a story!

On Sale At All Newsstands

**SERVICE MEN**  
Send for this Book  
**FREE!**

**YOU NEED IT!**  
Everything for your business from the finest mike to the smallest screw is in this book.

**GUARANTEED QUALITY GOODS**  
**PRICES LOWEST EVER QUOTED**  
Fresh new dependable Merchandise at Bargain Prices!  
Leading Manufacturers Lines Complete  
Send For Your Copy Now!

**HEADQUARTERS**  
for **SERVICE MEN'S SUPPLIES**

**RADOLEK CO.**  
601 W. Randolph St.  
**CHICAGO**  
Illinois

USE THIS CONVENIENT COUPON

Radolek Co.,  
603 West  
Randolph St.  
Chicago, Ill.

Please send me without obligation your Service Man's Supply Book.

Name \_\_\_\_\_  
Address \_\_\_\_\_  
City \_\_\_\_\_ State \_\_\_\_\_

**new 1932 CATALOG**

**BIG SAVINGS ON SUPERHETS. MIDGETS AUTO RADIOS**

Lowest wholesale prices on the finest and the latest in radio. America's oldest mail-order radio house offers you new Variotone, Pentode Superheterodynes at big savings. Also Midgets, Auto Radios, Short Wave Receivers, Radio Phonographs, Combinations, etc. Be sure to send for new 1932 catalog now.

**Western Radio Mfg. Co.**  
128 W. Lake St., Chicago

**WESTERN RADIO**

**Super-Heterodyne**

6-Tube Midget at Amazing Low Price! The best toned small receiver on the market. Uses 1-235, 1-224, 2-227, 1-247 and 1-250. Full range dynamic speaker. A radio with great Pentode power. The latest product of our laboratory. Fully guaranteed. Special Dealers Price **\$25.75** Made to sell for \$49.50 complete. Dealers net price only \$25.75 complete with quality tubes. Send 25% with order. Balance C.O.D. A great value—ORDER TODAY!

**PIONEER RADIO LABORATORIES**  
859 W. Harrison St. Cable "RADCOM" Chicago, Ill.

**A Wonderful Microphone**

Type No. 300—Special Alloy Diaphragm  
Single button. Carbon type. Superb performance from 50 to 3500 cycles. Resistance 100 ohms.

List Price—\$15  
Also mfrs. of complete sound equipment. Send for free catalog H.

**MILES Reproducer Co.**  
26 East 22nd St. N. Y.

switch of the tester is then set on the "Ext. Volts" position and the range switch on the 1-volt scale.

With the arrangement suggested here resistance values from 10 to 2000 ohms and 50,000 to 500,000 ohms can be measured with a reasonable degree of accuracy. Still higher resistances may be measured by using higher voltages.

JOHN M. BORST,  
New York City.

**Simple Code Practice Set**

Those interested in learning the code can easily construct a practice set which employs a single type -99 tube, a 4.5-volt battery, an old audio transformer and a rheostat, connected as shown in the dia-

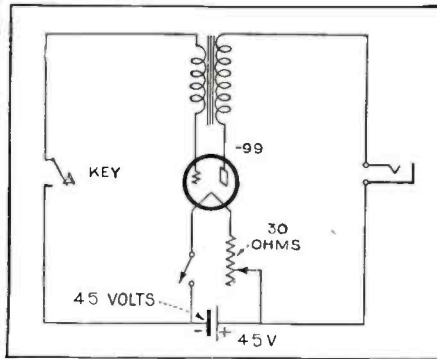

**CODE PRACTICE SET**

Figure 1. Hook-up for practice oscillator using key, tube, rheostat, audio transformer, jack and 4 1/2-volt battery

gram (Figure 1.) In this circuit the filament battery serves also for the plate supply and for this reason the rheostat must be connected in the positive side of the filament so as to raise the plate potential slightly above that of the filament. Ordinary headphones are plugged into the jack and the practice key is connected as shown. A pleasing and rather high-pitched note will be heard in the telephone when the key is pressed.

J. E. KITCHIN,  
Alert Bay, B. C., Canada.

**Protecting Storage Battery Terminals**

Corrosion of storage battery terminals can be prevented and they can be kept free of the white paste that usually accumulates on them by putting oiled felt washers around the bottom of each terminal post. The washers should be of fairly thick felt about an inch and a half in diameter. Holes just large enough to fit the battery posts snugly must be made in the felt washers. The battery terminals will have to be removed, so that the washers can be put over the posts. Before placing them over the battery terminals, the washers should be soaked in oil, either automobile oil or ordinary 3-in-1 lubricating oil. The washer keeps the battery terminal covered with a thin film of oil, which prevents the formation of the troublesome corrosion. The washers should be remoistened with oil occasionally. Felt cut from an old hat will be thick enough.

CHARLES FELSTEAD,  
Los Angeles, California.

**Read Classified Advertising—It Pays**

Advertisements in this section twenty-six cents a word for each insertion. Name and address must be included at the above rate. Cash should accompany all classified advertisements unless placed by an accredited advertising agency. No advertisements for less than 10 words accepted. Objectionable or misleading advertisements not accepted. Advertisements for these columns should reach us not later than 1st of 2nd month preceding issue.

**Agents Wanted**

**CASH IN YOUR POCKET** every day. Every man needs Pants, Breeches, Coveralls, Shopcoats. Longwear's Work Clothes sell on sight. Belt FREE with every order for 3. No investment. Complete sales outfit FREE. Write TODAY, Dept. R-11, Longwear, 489 Broome St., New York.

Guaranteed Genuine Gold Leaf Letters anyone can put on store windows. Large profits, enormous demand. Free samples. Metallic Letter Co., 422 N. Clark, Chicago.

**Correspondence Courses**

Used correspondence school courses sold on repurchase basis. Also rented and exchanged. Money-back guarantee. Catalog free. (Courses bought.) Lee Mountain, Pisgah, Alabama.

**CORRESPONDENCE COURSES**—Sold, Bought, Exchanged, Rented. Bargain Catalogue Free. Hanfling, C-789 Broadway, New York.

**Detectives**

**DETECTIVES.** Work home or travel. Experience unnecessary. Particulars free. Write George Wagoner, 2190-A Broadway, N. Y.

**For Inventors**

**INVENTIONS COMMERCIALIZED.** Patented or unpatented. Write Adam Fisher Mfg. Co., 278 Enright, St. Louis, Mo.

**Help Wanted**

**WANTED**—Names of men desiring steady outdoor Gov't Jobs; \$1,700-\$2,400 a year; vacation. Patrol Parks; protect game. Write immediately. Delmar Institutes, A-54, Denver, Colo.

**Patent Attorneys**

**PATENTS**—Write for Free Information, HOW TO OBTAIN A PATENT and RECORD OF INVENTION—or send Drawing or Model for Examination. Miller & Miller, Patent Attorneys (former Patent Office Examiners), 1006-D Woolworth Building, New York; 262 McGill Building, Washington, D. C.

**PATENTS, TRADE MARKS**—All cases submitted given personal attention by a member of the firm. Information and booklet free. Lancaster, Alwine & Rommel, 269 Ouray Building, Washington, D. C.

**Inventors**—Should write for our Guide Book, "How to Obtain a Patent," and Record of Invention Blank, sent Free. Send models or sketch of inventions for our inspection and instructions free. Radio, Electrical, Chemical, Mechanical and Trademark Experts. Terms Reasonable. Victor J. Evans & Co., 922 Ninth, Washington, D. C.

**PATENTS**—Advice and booklet free. Highest references. Best results. Promptness assured. Watson E. Coleman, Patent Lawyer, 724 9th Street, Washington, D. C.

**Radio**

**SHORT WAVE** receiver, \$5.00. Complete transmitter, \$15.00. Free List. Radio Exchange, Richland Springs, Texas.

**RADIO APPARATUS BUILT** to specifications. Workmanship guaranteed. John Barta, 221 Clay Street, Middleboro, Mass.

**Songwriters**

**COMPOSERS—VERSE OR MUSIC.** Brilliant opportunity. Write at once. Van Buren, 2523 McClurg Bldg., Chicago.

**Telegraphy**

**LEARN** Wireless (Radio) and Morse telegraphy. School, oldest, largest; endorsed by telegraph, radio and government officials. Expenses low—can earn part. Catalog free. Dodge's Institute, Cour Street, Valparaiso, Ind.

# Latest Radio Patents

(Continued from page 414)

filament, a winding external to said container and arranged in inductive relation with said coil through the material of said container and means for controlling the potential of said filament including a single conductor passed through said envelope and connected to said filament.

1,814,063. CURRENT RECTIFIER. STEGMUND STRAUSS, Vienna, Austria. Filed June 26, 1929, Serial No. 373,877, and in Austria May 19, 1927. 3 Claims.

1. A current rectifier adapted to be connected with measuring apparatus for high resistances and ionic currents in which a condenser is employed repeatedly charged up to

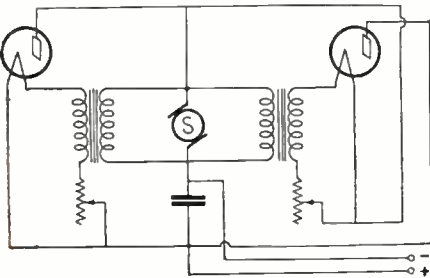

a constant voltage, said rectifier comprising a condenser charged by way of a rectifying valve from a supply of current, another thermionic valve connected as a discharge path, by which part of the condenser charge is carried away in dependence of the actual voltage value of the supply, this dependence resulting from heating the filament of the thermionic valve from the supply.

1,815,987. CONICAL DIAPHRAGM FOR LOUD SPEAKERS. CHARLES W. PETERSON, Cincinnati, Ohio. Filed Feb. 13, 1929. Serial No. 339,557. 2 Claims.

1. A diaphragm made up of a central rigid zone, a larger rigid zone and connection between the zones made of less rigid material than that of the zones.

1,816,690. GASEOUS CONDUCTION LAMP. DANIEL MCFARLAN MOORE, East Orange, N. J., assignor to General Electric Company, a Corporation of New York. Filed Nov. 7, 1924. Serial No. 748,346. 7 Claims.

## Your Vacuum Tubes

(Continued from page 369)

human endeavor. The art of vacuum tube engineering is yet young, and thousands of new and important applications for tubes will be developed. In many ways it is already taking an important place in our everyday lives. In industry, communication, entertainment, research, and in numerous other fields the use of vacuum tubes is well recognized.

Science has explored the regions of space through great telescopes. Barriers to the exploration of the earth have been overcome by means of the airplane. Supersensitive vacuum tubes and other electronic devices open to man a field of exploration into a new world—the infinitesimal world of atoms and electrons. This is the dawn of the age of electrons, and one can do little more than speculate on what new advances this age will bring.

1. A gaseous conduction lamp comprising a sealed vessel containing an atmosphere of good conductivity and a pair of parallel electrodes therein, one having in the end a hole deeper than its diameter, the pressure of said atmosphere being so chosen that at the operating potential substantially all the glow discharge appears in said hole.

1,812,449. SYNCHRONIZED SOUND AND PHOTOGRAPHY. HARRISON W. ROGERS, New York, N. Y. Filed Oct. 31, 1928. Serial No. 316,197. 3 Claims.

1. In an apparatus of the character described, the combinations of two motor driven motion picture projectors, a sound reproducing machine having a driving motor, said latter machine being interposed between the two motion picture projectors, a synchronizing device, a common shaft drive from one side thereof, two one way clutches one to each projector connecting the projectors to said shaft, said clutches being of the type that when one is being driven by the projector the other clutch is free or in reverse, and means connecting the motor of the sound reproducing machine to the other side of the synchronizing device.

## What's New in Radio

(Continued from page 411)

plug-in coils. The converter is single dial control and a switching arrangement permits the use of either the converter or the broadcast receiver without changing any connections. Variable tuning condensers of 270 degree straight-frequency-line design are

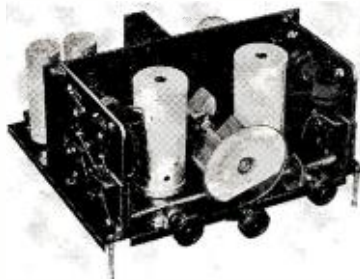

utilized to provide a smooth tuning control for the entire wave-length range from 15 to 180 meters. This adapter is available for the following a.c. lighting supplies: 110 volts, 50-60 cycles; 220-230 volts, 50-60 cycles; and 110 volts, 25-40 cycles.

Maker—Wholesale Radio Service Co., 38 Vesey Street, New York City.

### Lightning Arrester

Description—The mounting case of the visible "Vulcan" lightning arrester is made of crystal-clear glass, making the entire assembly visible at all times. An engineering feature of this arrester is the special element mounted between the two springs. This is designed to provide a positive resistance of about 600,000 ohms for low or normal operating voltages. At higher voltages this special element becomes a positive conductor, allowing the electric charge to pass to ground and not to the radio set. This arrester is sturdily constructed to withstand severe weather conditions.

Maker—Cornish Wire Company, Inc., 30 Church St., New York City.

## FILTERMATIC PRODUCTS

Help you to get the BEST possible reception from your RADIO set.



### SUPER-TONE CONTROL

Will make your old Radio (battery or electric) equal in tone to the best modern set.

Installed in one minute's time, no tools required.

Will tune out much of your noise and so-called static.

Will tune your set to suit your ears.

Positively cannot harm the finest radio in any way.

Price \$2.50 postpaid. Satisfaction guaranteed or money refunded.

### SUPER-FILTERMATIC The Modern Aerial

Thousands of satisfied users, praised by radio experts. Replaces all other aerials, reduces static, and noise. Especially good on distance reception. Helps to separate stations, does not connect in light sockets (therefore eliminating both and line noises). It is very compact, measuring only 1 1/2 x 2 inches, is absolutely non-corrosive and non-directional. Installed in one minute, no tools needed. Will never wear out. Eliminates trouble and expense of lightning-arrester.

Price only \$2.00 postpaid.

Satisfaction guaranteed or money refunded.



### ALL PROGRAMS

Are Good with a FILTERMATIC. For all radios only \$1.00 postpaid.

Entirely automatic—no bothersome tuning. Improves tone, reduces static, brings in distance, increases volume, separates stations. Installed in one minute, no tools required, in series with your aerial or across your aerial and ground. Satisfaction guaranteed or money refunded. Send check or money order. U. S. D. 25% with order.

(No foreign C. O. D.) Money back guaranteed after 5 day trial. Service Men and Dealers Write for Particulars. FILTERMATIC MFG. CO. (Dept. B-10) 4458 Frankford Ave., Philadelphia, Pa.

**DEALERS and SERVICEMEN**

*Write Now!*

FREE

See Dealer Just Out

Over 3000 BARGAIN VALUES IN 800 MONTHLY

8 Pages OF VALUABLE SERVICE DATA

Federated Purchaser

Federated Purchaser

25 PARK PL., DEPT. A

NEW YORK, N.Y.

### How to Obtain A Better Looking Nose

Improve Your Personal Appearance



My free book tells you how I guarantee to improve the shape of your nose by remodeling the cartilage and fleshy parts, quickly, safely, and painlessly, or refund your money. The very fine, precise adjustments which only my new patented Model 25 Nose Shaper possesses, make results satisfactory and lasting. Worn night or day. Over 100,000 users. Send for free book to

M. TRILETY, Pioneer Noseshaping Specialist, Dept. 287 Binghamton, N. Y.

### Massachusetts Radio and Telegraph School

18 Boylston Street, Boston

Send for Catalogue

Tel. Hancock 8184 Established 1905

*Make a*

**PROFIT**

On Every Service Call

Easily installed in 5 minutes. Write Dept. RN-11 for money-making proposition.

**AMPERITE Corporation**  
361 BROADWAY, NEW YORK

**AMPERITE**  
Self-Adjusting  
LINE VOLTAGE CONTROL

**Protect the Midget Set!**  
 Midgets are designed to operate on 110 volt lines and will not stand up on higher voltages.  
 Save the set—save your reputation!  
 Install a 50-watt  
**CLAROSTAT AUTOMATIC LINE VOLTAGE REGULATOR.**  
 Retail Price..... \$1.75  
 Other Sizes for Other Receivers  
 Clarostat Mfg. Co. Inc.  
 285 N. 6th St. Brooklyn New York



# RADIO IS BROADCASTING FOR TRAINED MEN



MANY successes have been made in radio. Still more successes will be made in the future! But the industry is already closed to all except *trained men*. A man must possess the latest scientific knowledge before he can enter or succeed in radio.

Radio is changing constantly. In the 11 years it has been a reality to the general public, many revolutionary things have happened—tomorrow will bring new revelations! A man must keep constantly alert in this profession to make sure that he does not fall behind.

The International Correspondence Schools, through courses prepared by leading radio authorities, have proved they can give men the necessary training to succeed in radio. Many men in the industry today are studying I. C. S. Radio Courses to keep abreast of the times. They recommend these courses to other men anxious to become associated with the radio industry. **Complete Radio Course—Radio Servicing Course—Radio Operating Course**—in which are you interested? Mark and mail the coupon! Without obligation, it will bring you the important information. Act today!

INTERNATIONAL CORRESPONDENCE SCHOOLS  
 Box 8283-K, Scranton, Pa.  
 Without cost or obligation, please tell me all about the  
**NEW RADIO COURSE**  
 Name \_\_\_\_\_ Age \_\_\_\_\_  
 Street Address \_\_\_\_\_  
 City \_\_\_\_\_ State \_\_\_\_\_  
 If you reside in Canada, send this coupon to the  
 International Correspondence Schools Canadian, Ltd.,  
 Montreal, Canada

## Backstage in Broadcasting

(Continued from page 401)

uled, and an extensive bibliography are included in the manual. Student notebooks for the course were also made available. They were prepared by Dr. Charles H. Fransworth, professor emeritus of musical education, Columbia University, and by Ernest La Prade, assistant to Damrosch.

ON the desk of every executive of the Columbia Broadcasting System in the network's New York headquarters, there is an odd rectangular object bearing a telephone dial that serves a unique purpose. This instrument, conceived by the CBS engineering staff, is utilized to automatically convey a desired radio pro-

gram of either the CBS or a contemporary broadcaster to the persons within the room. By spinning the dial to a special numeral, the program is immediately heard through loudspeakers in the room. Special numbers are provided to pick-up non-broadcast auditions within the building. At this writing, only ten pick-ups can be made for each dial inasmuch as single numerals are used. E. K. Cohan, technical director of the chain, in explaining the device to the writer, asserted that through the use of combination numerals, at a later date, an unlimited amount of program fare can be automatically heard within the office of every chain executive. A special knob on the device controls volume.

## Radio News Technical Information Service

The Technical Information Service has been carried on for many years by the technical staff of RADIO NEWS. Its primary purpose is to give helpful information to those readers who run across technical problems in their work or hobby which they are not able to solve without assistance. The service has grown to such large proportions that it is now advisable to outline and regulate activities so that information desired may come to our readers accurately, adequately and promptly.

Long, rambling letters containing requests that are vague or on a subject that is unanswerable take up so large a portion of the staff's working time that legitimate questions may pile up in such quantities as to cause a delay that seriously hinders the promptness of reply. To eliminate this waste of time and the period of waiting, that sometimes occurs to our readers as a consequence, the following list of simple rules *must* be observed in making requests for information. Readers will help themselves by abiding by these rules.

### Preparation of Requests

1. Limit each request for information to a single subject.
2. In a request for information, include any data that will aid us in assisting in answering. If the request relates to apparatus described in RADIO NEWS, state the issue, page number, title of article and the name of the device or apparatus.
3. Write only on one side of your paper.
4. Pin the coupon to your request.

The service is directed specifically at the problems of the radio serviceman, engineer, mechanic, experimenter, set builder, student and amateur, but is open to all classes of readers as well.

All questions from subscribers to RADIO NEWS will be answered free of charge, provided they comply with the regulations here set forth. Non-subscribers to RADIO NEWS will be charged a nominal fee of \$1.00 for this service. All ques-

tions will be answered by mail and not through the editorial columns of the magazine, or by telephone. When possible, requests for information will be answered by referring to articles in past issues of the magazine that contain the desired information. For this reason it is advisable to keep RADIO NEWS as a radio reference.

Complete information about sets described in other publications cannot be given, although readers will be referred to other sources of information whenever possible. The staff cannot undertake to design special circuits, receivers, equipment or installations. The staff cannot service receivers or test any radio apparatus. Wiring diagrams of commercial receivers cannot be supplied, but where we have published them in RADIO NEWS, a reference will be given to past issues. Comparisons between various kinds of receivers or manufactured apparatus cannot be made.

Only those requests will be given consideration that are accompanied by the current month's coupon below, accurately filled out.

NOVEMBER, 1931  
 Technical Information Coupon  
 RADIO NEWS Laboratory  
 350 Hudson Street  
 New York, N. Y.  
 Gentlemen:  
 Kindly supply me with complete information on the attached question:  
 I am a regular subscriber to RADIO NEWS and I understand this information will be sent me free of charge.  
 I am not yet a subscriber to RADIO NEWS and enclose \$1.00 to cover costs of the service.  
 I wish to become a subscriber to RADIO NEWS and enclose \$2.50 to receive the magazine regularly for one year, and to receive this valuable technical information service free of charge.  
 Name .....  
 Address .....

# The Biggest Thing In

## Radio Service Since '28



- ← Super DIAGNOMETER
- ← plus
- ← Shielded OSCILLATOR
- ← plus
- ← Advanced TUBE TESTER
- ← plus
- ← OHM-MEGOHMMETER
- ← plus
- ← CAPACITOR TESTER

### SUPREME DIAGNOMETER AAAI

Dealers' Net Price  
F.O.B. Greenwood, Miss.

**\$147.50**

**5** Ultra-modern, essential, **1**  
testing instruments in  
1, for the price of

*A combined test panel and portable laboratory—mounts on the wall as easily as removing the lid.*

#### QUICK FACTS

1. Analytical A. C. and D. C. voltage ranges of 0.2, 5, 10, 25, 100, 250, 1000 volts. 1000 ohms per volt sensitivity.
2. External D. C. voltage ranges of 0.40 and 0.200 volts at 2500 ohms per volt for automotive and aeroplane installations.
3. External A. C. and D. C. voltage range of 0.2500 volts.
4. Resistance ranges 0.5000 - 500,000 ohms. continuity ranges 0.5/25 megohms with zero corrector.
5. Capacity measurements .002 to 10 mfd. Condenser tests at 250 volts D. C.
6. A. C. power transformer with primary selector for line voltages between 100 to 240 volts.
7. Tests ALL tubes. Oscillation test, gas test, cathode-heater leakage of 100,000 ohms. and short test.
8. Completely shielded modulated and attenuated Oscillator individually calibrated 90 to 1500 kilocycles. Equipped with vernier tuning dial.

THAT'S what leading service-men, technicians and dealers are saying of the new SUPREME DIAGNOMETER AAAI—"the Biggest Thing in Radio Service Since '28." Not since that season, which introduced the first DIAGNOMETER, has the service world welcomed such a revolutionary and versatile testing instrument. The BIG 5 of service—SUPER-DIAGNOMETER, OSCILLATOR, TUBE TESTER, OHM-MEGOHMMETER, CAPACITOR TESTER,—combined and condensed into one smaller, handier case!

No matter how much you have heard of the wonders of this "Supreme" product, you will be amazed at an actual demonstration. The instrument that the radio world wanted and waited for SUPREME to sponsor. You must see it—compare it.

#### Ask Your Jobber to Demonstrate

Jobbers everywhere are prepared to demonstrate. Send the accompanying coupon for complete details and name of nearest jobber. Not because it offers you 5 vital instruments in 1, at the economical price of 1, but because your own standards of modern service demand it, do you need this, the greatest testing instrument in history. Soon pays for itself in savings of time and labor and increased profits. An investment for profits and prestige!

#### SUPREME INSTRUMENTS CORP.

416 Supreme Bldg., Greenwood, Miss.

*Distributors in all Principal Cities  
Foreign Division: 131 West 42nd St., New York City  
Cable Address: LOPREH, New York*

SUPREME INSTRUMENTS CORPORATION  
416 Supreme Building  
Greenwood, Miss.

Please send me full particulars on SUPREME DIAGNOMETER AAAI, without obligation.

Name.....

Address.....

City..... State.....

Name of Jobber.....

City..... State.....

## Follow the Direct Road to Success

Do you want a better position and a larger pay envelope? There is just one way to win success—be head and shoulders above your fellows by gaining a broader basic education. Mathematics is the basis of all education. Not a day passes in which you do not have to use mathematics in your work. Do you make your own calculations, or are you handicapped by your inability to do this work yourself? Here is the whole secret of success. This is why mathematics is taught in every school and college. A thorough knowledge of it makes clear so many things which are puzzling you today.



Do not let another day pass without doing something to improve your knowledge of mathematics. But how can you obtain this knowledge? By going back to school or college, or taking an expensive correspondence course? You need do neither!

## At Last! Mathematics Self-Taught This Simple, Easy Way!

Now you can take advantage of this easy method which has been worked out by an expert for those who do not wish to give the time and money required by other methods of mathematical study. A very simple and extremely interesting group of books has been prepared for you by a man who has devoted his life to teaching practical men the fundamentals of this important subject.

# MATHEMATICS FOR SELF STUDY

By J. E. Thompson, B.S. in E.E., A.M.  
Dept. of Mathematics, Pratt Institute, Brooklyn

These books start right from the beginning with a review of arithmetic that gives you all special short-cuts and trick problems that save countless hours of your time and make you more valuable to yourself and your job. Then they go right into higher mathematics and show you how simple it is when an expert explains it for you. Don't let appearances fool you, mathematics is easy. You can get these books on approval and see for yourself how much enjoyment you can have while getting this valuable training and solving interesting practical problems that puzzle your friends and fellow-workers. In no time at all you will be tackling with ease the most difficult question on this subject.

### A Complete Reference Work on Mathematics in These Four Inexpensive Books

Starting from the first simple principles, these interesting books take you, by easy stages, into the detailed applications of higher mathematics. Each step is clearly explained and is followed directly by sample problems. **Arithmetic for the Practical Man**  
**Algebra for the Practical Man**  
**Trigonometry for the Practical Man**  
**Calculus for the Practical Man**  
4 Volumes—1240 Pages—Illustrated

### An Expert Gives You These Simplified Methods

Mr. Thompson, the author of these books, is not an ordinary teacher of mathematics. He has had many years' experience in giving students the kind of mathematical training they need in practical work. He presents each practical method and problem in the clearest and simplest way. He gets right down to the kind of information that you need in your daily work. Look up any mathematical problem that puzzles you in these books and see how quickly you get the solution.

## Send No Money

### Examine These Books for 10 Days FREE!

The coupon below brings you the four books for 10 days' free trial. After 10 days, return the books to us without obligation or send us the small down payment of \$1.65—balance in three monthly payments of \$2.00 each (5% discount for cash).

### MAIL THIS COUPON

D. Van Nostrand Co., Inc.  
250 Fourth Ave., New York

Send me MATHEMATICS FOR SELF STUDY in 4 volumes. Within 10 days I will either return the books or send you \$1.65 as first payment and \$2.00 per month for 3 months—total \$7.65. (5% discount for cash.) (R. N. 1-311)

Name .....  
Address .....  
City and State.....  
Business Connection .....  
Reference .....

## The Latest Data!

Complete and up-to-date information covering the entire field of radio—all arranged for ready reference in this one big guide book.

**BYRD'S Antarctic Radio Equipment**—Receivers, transmitters, and latest navigation aids used on this epochal flight fully described.

**TELEVISION**—Mr. C. F. Jenkins, father of television and radio movies, gives you in his own words complete directions for building practical television equipment.

**INTERFERENCE ELIMINATION**—New methods systematically outlined by W. F. Fleming, radio engineer.

**RADIO AUTO ALARM**—Description of new device for ships which keeps the SOS watch while operator is off duty.

**SHORT WAVE APPARATUS**—Commercial and amateur, described and illustrated.

**NEW BROADCASTING EQUIPMENT**—Temperature-controlled Piezo crystal oscillator; 100% modulation panel and other new apparatus. —and these are only a few of the new subjects added to the most complete radio handbook ever published.

## THE RADIO MANUAL

A Handbook for Students, Amateurs, Operators, and Inspectors



Here's the answer to every question about the principles, operation, and maintenance of apparatus for radio transmitting and receiving. Important new chapters have been added to bring it right up to the minute. Many new photographs and diagrams have been included. It is now more than ever the one complete handbook covering the entire radio field.

A Complete Course in Radio Operation in ONE VOLUME

### Prepares for Government License

20 big chapters cover: Elementary Electricity and Magnetism; Motors and Generators; Storage Batteries and Charging Circuits; The Vacuum Tube; Circuits Employed in Vacuum Tube Transmitters; Modulating Systems and 100% Modulation; Wave meters; Piezo-Electric Oscillators; Wave Trap; Marine Vacuum Tube Transmitters; Radio Broadcasting Equipment; Arc Transmitters; Spark Transmitters; Commercial Radio Receivers; Marconi Auto-Alarm; Radio Beacons and Direction Finders; Aircraft Radio Equipment; Practical Television and Radio Movies; Eliminating Radio Interference; Radio Laws and Regulations; Handling and Abstracting Traffic.

### Prepared by Official Examining Officer

The author, G. E. Sterling, is Radio Inspector and Examining Officer, Radio Division, U. S. Dept. of Commerce. The book has been edited in detail by Robert S. Ivins, for five years Technical Editor of QST, the Magazine of the American Radio Relay League, and Radio Consultant. Many other experts assisted them.

### Examine It FREE!

The revised edition of "The Radio Manual" is now ready. Nearly 800 pages; 300 Illustrations. Bound in flexible bookboard. The coupon brings the volume for free examination. Within 10 days you may return the volume or send the price of \$6.00.

### MAIL THIS COUPON

D. Van Nostrand Co., Inc.  
250 Fourth Ave., New York

Send me the Revised Edition of THE RADIO MANUAL for examination. Within ten days after receipt I will either return the volume or send you \$6.00, the price in full. (R. N. 1-311)

Name .....  
St. and No. ....  
City and State.....  
Business Connection .....  
Reference .....