

**SPECIAL TUBE DATA ISSUE**

**SEPTEMBER  
25 CENTS**

# **RADIO NEWS**

**An Untuned R. F.  
Coupler for Screen-  
Grid Tubes**

**The 1930 Ama-  
teur Regulations**

**How to Judge  
Tubes**

**Complete Tabulation of  
Tube Characteristics**

**DAVID  
HUME**



# Hold Everything, service-men, 'til you can see and check this Revolutionary Set Analyzer

**A ONE METER** instrument more complete and with greater range and elasticity than any other set tester or analyzer, regardless of the number of meters employed.

## 25 TESTING INSTRUMENTS IN 1

**B**E sure to have your jobber show you this new wonder-instrument. Its marvelous range and elasticity, its multiplicity of tests and functions will prove astounding. To those accustomed to other set testers and analyzers it will prove a revelation in completeness, thoroughness, simplicity and beauty.

And still it is available at the cost of ordinary Set Testers—Priced only \$78.50 Net to Dealer. Note just a few of its features:

- 79 Distinct readings and ranges available—as compared with a maximum of 20 in nearest approaching competitive instruments.
- 22 Distinct ranges for external use—against a maximum of 13 in other instruments—and obtained with only 3 connections, compared with 7 to 16 connections required in other set analyzers.
- All Pentode, screen grid and overhead heater type analyses and tests made **WITHOUT ADAPTERS OR EXTRA LEADS.**
- Measures screen grid current and Pentode current.
- Tests helium non-filament rectifier tubes.
- Measures resistances and capacities.
- Measures reactance of choke coils from 2 to 100 henrys.
- May be used as output meter on any type of radio, meter adaptable for output impedances ranging from 1000 to 35,000 ohms.
- Provides high and low resistance continuity tests.
- READS GRID TO PLATE VOLTAGES.**
- Meter measures alternating voltages at 1000 ohms per volt.
- ONLY SET TESTER OR ANALYZER PROVIDING READINGS OF ALTERNATING CURRENT IN MILLIAMPERES.**
- Supreme analyzer plug eliminates the need for extra leads and adapters.
- Battery for continuity testing enclosed and protected, preventing accidental shorts and loose connections. Ordinary flashlight cells, readily obtainable everywhere, employed.
- PARTICULARLY ADAPTED FOR TESTING AUTO RECEIVERS**

### METER RANGES

- A.C. Voltage 0/3—0/9—0/30—0/90—0/300—0/900
- D.C. Voltage 0/3—0/9—0/30—0/90—0/300—0/900
- A.C. Milliamperes 0/3—0/9—0/30—0/90—0/300
- D.C. Milliamperes 0/3—0/9—0/30—0/90—0/300
- All scales read with utmost ease—no complication—no guess-work.
- Twice the efficiency of any other set analyzer with greater speed and simplicity.

### “Only one Meter to Read”

Most good distributors carry the complete line of Supreme Instruments in stock. If yours cannot supply you, use inquiry coupon to right, being sure to specify which “Supreme” instrument you are interested in.

## SUPREME Set Analyzer MODEL 90



Size 4¼x9¼x11¼. Weight 6 lbs. Dealers Net Price, **\$78.50**  
F.O.B. Greenwood, Miss.....

### “SUPREME BY COMPARISON”

Simplify your choice of testing instruments—assure “Supreme” results—standardize on “Supreme” Instruments.

Supreme Diagonometer Model 400-B.....	<b>\$13950</b>
Supreme Set Analyzer Model 90.....	<b>7850</b>
Supreme Tube Tester Model 50.....	<b>9850</b>
Supreme Tube Checker Model 17.....	<b>2175</b>
Supreme Tube Checker Model 19. Counter type..	<b>2695</b>
Portable type.....	<b>2995</b>
Supreme Ohmmeter.....	<b>1850</b>

## Supreme Instruments Corp.

Greenwood, Miss.

Distributors in all principal cities

Service Depots in New York, Philadelphia, Pittsburgh, Chicago, Kansas City, Seattle, Toronto, San Francisco

**SUPREME**  
Testing Instruments

“SUPREME BY COMPARISON”

SUPREME INSTRUMENTS CORP.  
374 Supreme Bldg.  
Greenwood, Miss.

Please give full particulars on

.....  
.....  
Name .....

Firm Name .....

Street Address .....

City ..... State .....

# 5,000



## Radio Service Men Needed Now!

The replacing of the old battery operated receivers with all-electric Radios has created a tremendous country-wide demand for expert Radio Service Men. Thousands of trained men are needed quick!

### 30 Days of R.T.A. Home Training

*... enables you to cash in on this latest opportunity in Radio*

**\$40 to \$100**  
a week  
Full Time  
**\$3.00** an hour  
Spare Time

Ever on the alert for new ways of helping our members make more money out of Radio, the Radio Training Association of America now offers ambitious men an intensified training course in Radio Service Work. By taking this training you can qualify for Radio Service Work in 30 days, earn \$3.00 an hour and up, spare time; prepare yourself for full-time work paying \$40 to \$100 a week.

hour spare time or \$40 to \$100 a week full time, this R. T. A. training offers you the opportunity of a lifetime.

**More Positions Open Than There Are Trained Men to Fill Them**

If you were qualified for Radio Service Work today, we could place you. We can't begin to fill the requests that pour in from great Radio organizations and dealers. Members wanting full-time positions are being placed as soon as they qualify. 5,000 more men are needed **quick!** If you want to get into Radio, earn \$3.00 an

**We furnish you with all the equipment you need to become a Radio Service Man!**

**Radio Service Work a Quick Route to the Big-Pay Radio Positions**

Radio Service Work gives you the basic experience you need to qualify for the big \$8,000, \$10,000 to \$25,000 a year Radio positions. Once you get this experience, the whole range of rich opportunities in Radio lies open before you. Training in the Association, starting as a Radio Service Man, is one of the quickest, most profitable ways of qualifying for rapid advancement.

If you want to get out of small-pay, monotonous work and cash in on Radio quick, investigate this R. T. A. training and the rich money-making opportunities it opens up. No special education or electrical experience necessary. The will to succeed is all you need.

## Mail Coupon for No-Cost Training Offer

Cash in on Radio's latest opportunity! Enroll in the Association. For a limited time we will give to the ambitious man a No-Cost Membership which need not . . . should not . . . cost you a cent. But you must act quickly. Filling out coupon can enable you to cash in on Radio within 30 days, lift you out of the small-pay, no-opportunity rut, into a field where phenomenal earnings await the ambitious. You owe it to yourself to investigate. Fill out coupon NOW for details of No-Cost Membership.

**The Radio Training Association of America**  
4513 Ravenswood Ave. Dept. RNA-9, Chicago, Ill.

THE RADIO TRAINING ASSOCIATION OF AMERICA  
4513 Ravenswood Ave., Dept RNA-9, Chicago, Ill.

Gentlemen: Please send me details of your No-Cost training offer by which I can qualify for Radio Service Work within 30 days. This does not obligate me in any way.

Name .....

Address .....

City ..... State .....

# Radio News

Vol. XII

CONTENTS FOR SEPTEMBER, 1930

No. 3

ALBERT PFALTZ  
Associate Editor

ARTHUR H. LYNCH, Editorial Director  
JOHN B. BRENNAN, JR.  
Managing Editor

GEORGE E. FLEMING  
Technical Editor

## And Now—

### A Special Tube Number

FOLLOWING the rather general policy inaugurated with the June, 1930, issue of RADIO NEWS this issue dwells in the main on one outstanding subject—tubes. In this issue we present information on the three new two-volt tubes which have been announced only recently by leading tube manufacturers. Then, there's the article by James Martin on "How To Judge Tubes," a compilation of tube information extremely valuable to servicemen. A tabulation of tube characteristics and tube checkers together with the regular RADIO NEWS Information Sheets and Junior Radio Guild devoted especially to tube subjects complete the tube line-up.

\* \* \*  
Fred Schnell writes; in his second article on the RADIO NEWS Short-Wave Superheterodyne, about the construction of the intermediate frequency amplifier.

\* \* \*  
There are three articles on sound amplifiers for "talkies", two articles on auto-radio receivers and three articles especially intended for the short-wave fan. Of the latter, one deals with the all-important subject of the new 1930 Government regulations governing "ham" transmitter operation.

Dr. DeForest, who has publicly denounced the practice of radio broadcast advertisers to oversell their products through too long dissertation or advertising blurbs, has finally solved the problem by devising the Anti-Ad.

### Next Month—

A broadcast receiver using the new two-volt tubes.

All about batteries, what they are composed of, how they work and how to use them—another enlightening article by James Martin.

And other articles from leading radio authorities.

	PAGE
Cover—From a Painting by David Hymes	
Frontispiece: Radio Pilots the Southern Cross to America.....	196
Editorial .....	198
The Master Who Talks with the Winds.....	200
<small>A part played by Clyde DeVinna and his short-wave radio during the filming of the M-G-M picture "Trader Horn" in British East Africa, by L. ELDEN SMITH</small>	
The New 1930 Ham Regulations.....	203
<small>A reprint and analysis of the QST amateur regulations, by K. B. WARNER</small>	
Three New Tubes for Battery Operation.....	205
<small>Dry-cell tubes with long life and economical operation</small>	
Marshall S-W Push-Pull Receiver.....	206
<small>A description of the Marshall Seven which has been chosen by the U. S. Navy for its 5 and 10 meter and ultra-high frequency reception, by THOMAS A. MARSHALL</small>	
The Telephone Goes to Sea.....	210
<small>The part played by radio in the ship-to-shore communication systems, by EVERETT M. WALKER</small>	
I. F. Amplifier for the RADIO NEWS S-W Superheterodyne.....	213
<small>Its importance in the operation of a "super," by FRED H. SCHNELL</small>	
Dr. DeForest Designs the Anti-Ad.....	215
<small>An interesting device for deleting advertising blurbs via radio, by DR. LEE DEFOREST</small>	
Radio Principles Govern the Technique of Sound Recording.....	216
<small>Analysis of some of the problems which face the sound engineer in talking pictures, by CARL DREHER</small>	
Practical Problems in Auto-Radio Systems.....	219
<small>A consideration of special instructional pictures in design and installation of auto-radio receivers, by CHAS. R. WEXLER</small>	
How to Judge Tubes.....	220
<small>An analysis of the tube operating characteristics, by JAMES E. MARTIN</small>	
Tabulation of Tube Testers and Tube Characteristics.....	222
A New Deal for the Untuned R. F. Amplifier.....	224
<small>By AUSTIN C. LESCARBOURA</small>	
A Broadcast Superheterodyne Using a Loftin-White Audio Channel.....	226
<small>A description of the constructional details by G. E. FLEMING</small>	
Television Advances from Peephole to Screen.....	228
<small>Recent developments have shifted the scene from the laboratory to the theatre, by EDGAR H. FELIX</small>	
Laboratory Tests Insure Satisfactory Tuner Operation.....	231
<small>Curves, graphs and tabulation are now the indices of receiver's performance, by GLENN H. BROWNING and JAMES MILLEN</small>	
The Hopkins Band Rejector System.....	234
<small>How it used to improve super performance, by E. K. ONNER</small>	
The Versatile Vacuum Tube.....	236
<small>Its countless uses in industry described by FRED E. KAUER</small>	
Some Methods and Problems of Sound Recording.....	238
<small>Part Two, by C. F. GOUDY and W. P. POWERS</small>	
Sound Amplifiers, Theatres and Their Acoustics.....	240
<small>The acoustical properties often "make" or "break" suitable reproduction, by FRED E. JEWELL</small>	
Junior Radio Guild.....	242
RADIO NEWS Manufactured Receiver Circuits.....	244
News from Manufacturers.....	246
RADIO NEWS Information Sheets.....	248
Radio Forum.....	250
RADIO NEWS Home Laboratory Experiments.....	253

Published Monthly by the Experimenter Publications, Inc., at 184-10 Jamaica Ave., Jamaica, N. Y.

Member: Audit Bureau of Circulations

B. A. MACKINNON, President

H. K. ELY, Vice-President and Treasurer

Entered as Second-Class Matter at Jamaica, N. Y., under Act of March 3, 1879.

Executive and Editorial Offices, 381 Fourth Ave., New York, N. Y.

RADIO NEWS is published monthly, on the tenth day of each month preceding that of date. Entered as second-class matter at the postoffice, Jamaica, N. Y., under the act of March 3, 1879. Copyrighted 1930 by Experimenter Publications, Inc.; title

registered U. S. Patent Office. Subscription price \$3.00 a year; \$3.50 in Canada and \$4.00 in foreign countries. Single copies, 25 cents each. The contents of RADIO NEWS are indexed in the Industrial Arts Index.

# will train you at home

to fill a

# BIG PAY

# Radio Job!



**Here's Proof**



**\$100 a week**

"My earnings in Radio are many times greater than I ever expected they would be when I enrolled. They seldom fall under \$100 a week. If your course cost four or five times more I would still consider it a good investment."

**E. E. WINBORNE**  
1414 W. 48th St.,  
Norfolk, Va.



**Jumped from \$35 to \$100 a week**

"Before I entered Radio I was making \$35 a week. Last week I earned \$110 servicing and selling Radios. I owe my success to N. R. I. You started me off on the right foot."

**J. A. VAUGHN**  
3715 S. Kingshighway,  
St. Louis, Mo.



**\$500 extra in 6 months**

"In looking over my records I find I made \$500 from January to May in my spare time. My best week brought me \$107. I have only one regret regarding your course—I should have taken it long ago."

**HOYT MOORE**  
R. R. 3, Box 919,  
Indianapolis, Ind.,

If you are earning a penny less than \$50 a week, send for my book of information on the opportunities in Radio. It is free. Clip the coupon NOW. Why be satisfied with \$25, \$30 or \$40 a week for longer than the short time it takes to get ready for Radio.

**Radio's growth opening hundreds of \$50, \$75, \$100 a week jobs every year**

In about ten years Radio has grown from a \$2,000,000 to a \$1,000,000,000 industry. Over 300,000 jobs have been created. Hundreds more are being opened every year by its continued growth. Men and young men with the right training—the kind of training I give you—are needed continually.

**You have many jobs to choose from**

Broadcasting stations use engineers, operators, station managers and pay \$1,800 to \$5,000 a year. Manufacturers continually need testers, inspectors, foremen, engineers, service men, buyers, for jobs paying up to \$15,000 a year. Shipping companies use hundreds of Radio operators, give them world wide travel at practically no expense and a salary of \$85 to \$200 a month. Dealers and jobbers employ service men, salesmen, buyers, managers, and pay \$30 to \$100 a week. There are many other opportunities too. My book tells you about them.

**So many opportunities many N. R. I. men make \$5 to \$25 a week while learning**

The day you enroll with me I'll show you how to do 10 jobs, common in most every neighborhood, for spare time money. Throughout your course I send you information on servicing popular makes of sets; I give you the plans and ideas that are making \$200 to \$1,000 for hundreds of N. R. I. students in their spare time while studying.

**Talking Movies, Television, Wired Radio included**

Radio principles as used in Talking Movies, Television and home Television experiments. Wired Radio, Radio's use in Aviation, are all given. I am so sure that I can train you satisfactorily that I will agree in writing to refund every penny of your tuition if you are not satisfied with my Lessons and Instruction Service upon completing.

**64-page book of information FREE**

Get your copy today. It tells you where Radio's good jobs are, what they pay, tells you about my course, what others who have taken it are doing and making. Find out what Radio offers you, without the slightest obligation. ACT NOW.

**J. E. SMITH, President**  
**National Radio Institute Dept. OKS**  
**Washington, D. C.**



**Our Own Home**  
Pioneer and World's Largest Home-Study Radio training organization devoted entirely to training men and young men for good jobs in the Radio industry. Our growth has paralleled Radio's growth. We occupy three hundred times as much floor space now as we did when organized in 1914.

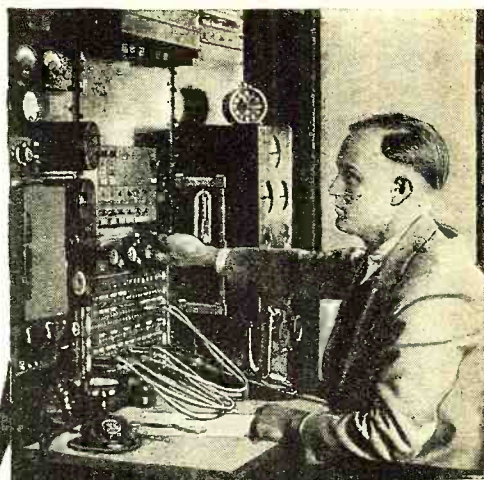

**I will give you my new 8 OUTFITS of RADIO PARTS for a home Experimental Laboratory**

You can build over 100 circuits with these outfits. You build and experiment with the circuits used in Crosley, Atwater - Kent, Eveready, Majestic, Zenith, and other popular sets. You learn how these sets work, why they work, how to make them work. This makes learning at home easy, fascinating, practical.

Back view of 5 tube Screen Grid A. C. tuned Radio frequency set—only one of many circuits you can build with my outfits.

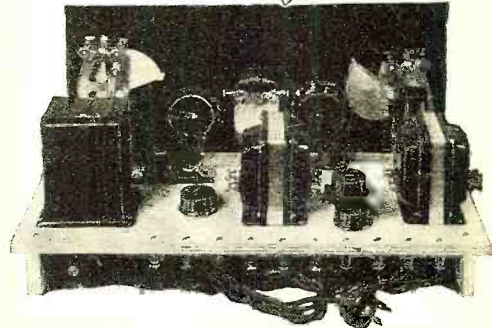

**I am doubling and tripling the salaries of many in one year and less Find out about this quick way to**

**BIGGER PAY**



**FILL OUT AND MAIL THIS COUPON TODAY**

**J. E. SMITH, President,**  
National Radio Institute, Dept. OKS  
Washington, D. C.

Dear Mr. Smith: Send me your book. This request does not obligate me.

Name .....

Address .....

City ..... State .....

**Lifetime Employment Service to all Graduates**

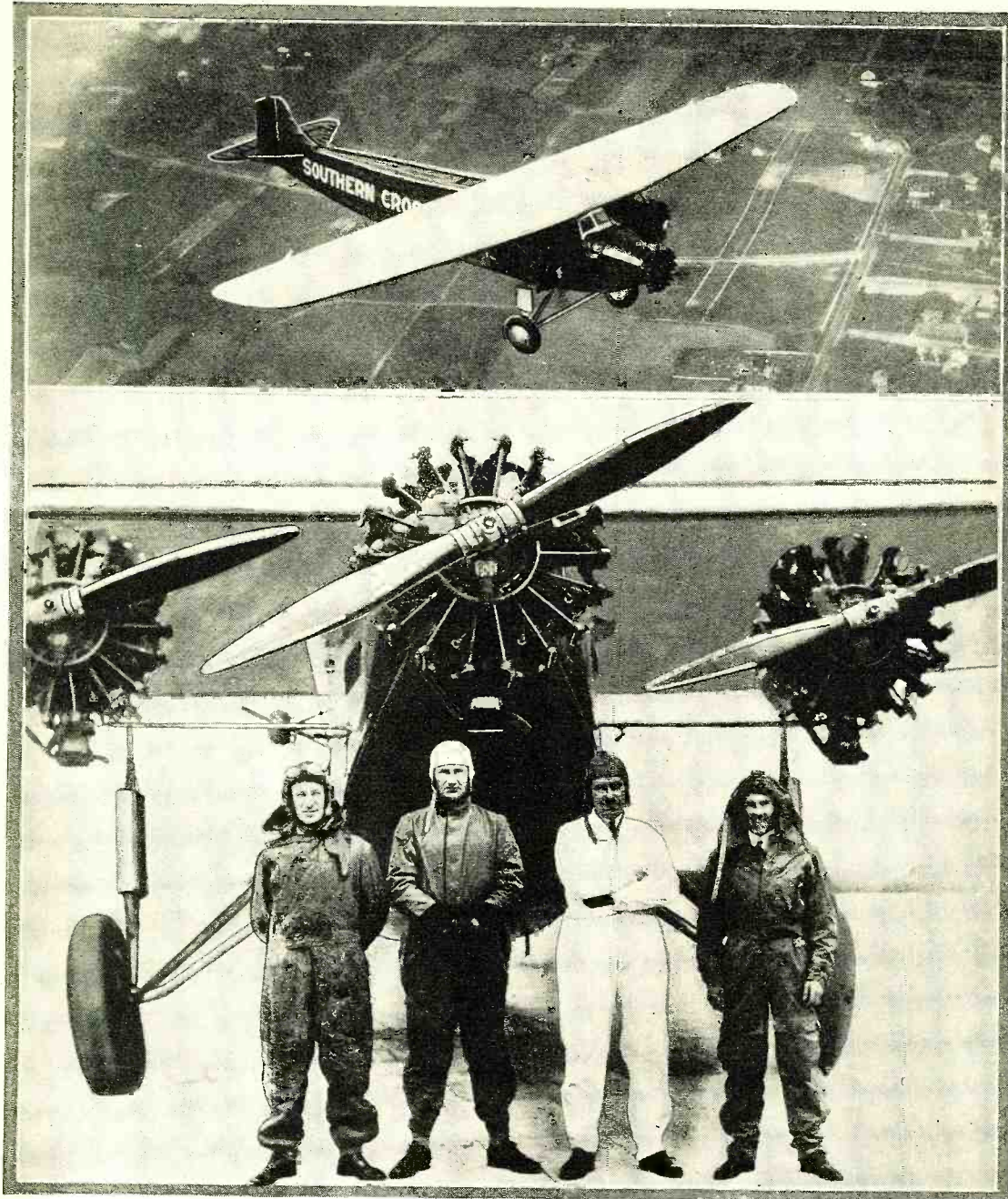

Top—The "Southern Cross." Left to right, Major Charles Kingsford-Smith, Evert Van Dyk, Captain J. P. Saul and John Stannage

## Radio Pilots the Southern Cross to America

**I**N a signed article to the *New York Times*, Friday, June 27th, Major Kingsford-Smith, Commander and Chief Pilot of the "Southern Cross," said, referring to the part radio played in his successful east-to-west crossing of the Atlantic, "I have referred before to Stannage (the radio operator of the 'Southern Cross') and I expect to refer to him many times again before this story is told. His steady radio bearings were all that kept us on our course. The clouds thickened up mile after mile, climbing in high mountains ahead of us, blotting out the sea and sky. There was no chance to really correct our drift, and it was the radio bearings and the calculation of Captain Saul (the navigator of the flight) alone which kept us on our course."

# for . . . Dependability

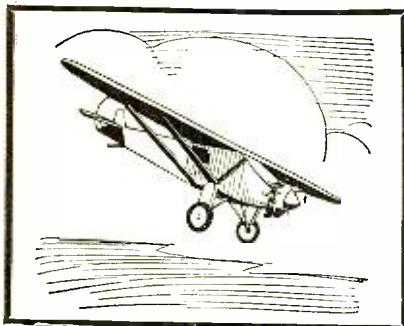

Up in the air—flying across great open stretches of sea to the little Isle of Bermuda, making a world record and keeping in touch with the world every minute of the day and night with a Pilot Super-Wasp Set, relying all the time on the Dependability of Pilotron Radio Tubes.

« « «

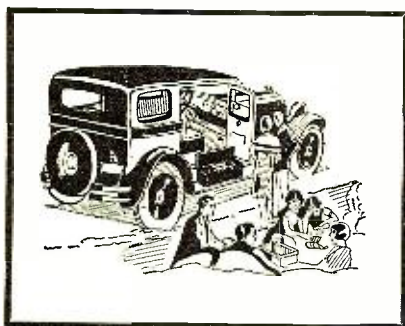

Camping miles from anywhere—enjoying some favorite program with your Auto-Pilot Screen Grid receiver and knowing that you can depend on your Pilotron Radio Tubes under all conditions.

« « «

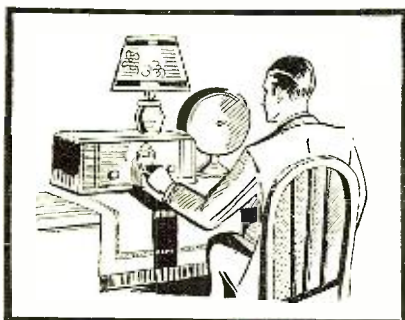

The Professional operating on world wide reception—keen and alert, must avoid confusing tube noises—crackles and distortion—and with dependable Pilotron Radio Tubes in every socket he enjoys the thrill of “pulling in” messages from far away.

« « «

You too—under all conditions—on any set will appreciate the difference that dependable Pilotron Radio “long life” Tubes give to the reception of radio broadcast programs.

# PILOTRON

## RADIO TUBES

### ENDORSED BY PROFESSIONALS

LICENSED BY R C A

PILOT RADIO & TUBE CORP.

LAWRENCE, MASSACHUSETTS

Chicago Office: 234 South Wells St.

San Francisco Office: 1278 Mission St.

## The Modern Aladdin's Lamp

**T**HE vacuum tube, audion, or, as our English friends have it, valve, is coming to play a more and more important part in our daily lives than could have been dreamed a few years ago. The first application of the vacuum tube was limited to the detector circuit, in an extremely simple type of radio receiver. Later, by the application of the third element or grid, it was possible to use the vacuum tube in amplifying circuits as well as for the production of oscillatory currents which made tube transmission possible.

But the use of the vacuum tube has not by any means been confined to radio receiving circuits. Recent developments in transmitters have indicated that comparatively low power can now be counted upon to do consistently with vacuum tubes what could be done only under the most favorable conditions with hundreds of horsepower a few years ago. As a typical example, radio telegraphic communication with France during the war was maintained rather irregularly with the 300-kilowatt United States naval station at Lafayette, France. Telegraphic communication over distances of this order ordinarily requires about one-tenth of the power necessary for telephone communication. But a short time ago, by the application of vacuum tubes in European transmitters, folks all over the United States were able to hear the voices of European diplomats carried to this country over the International telephone, and the power used was approximately one-fifteenth the power used at the Lafayette transmitter.

The application of vacuum tube transmitters and receivers of extremely compact design has demonstrated that it is no longer necessary for Polar or Antarctic expeditions to be out of touch with civilization for more than a portion of a second. Within the past few months we have witnessed the application of similar equipment to aircraft. The wise pilot starting on a long overseas journey today is able to call for immediate assistance if it becomes necessary. At the same time, he is able to communicate a running story of his flight to the newspapers, and it frequently happens that before his actual landing is made his well wishers in various parts of the world are notified by radio that he has arrived over the field of his destination.

Nor shall we fail to recognize the marvelous strides that have been made by radio engineers in the marine field. It is at present possible for us to pick up the telephone in our stateroom, on several of the more important trans-Atlantic liners, and converse with our friends at home or with our business associates as simply and as well as it would be possible for us to talk by telephone to the lady next door!

We feel very confident that within a reasonably short time a very large percentage of the autos used for pleasure will be radio equipped. It rarely takes more than one ride in a car, in which the ignition system has been properly shielded and in which a good automobile radio receiver has been installed, to convince even the most skeptical that a great deal of pleasure can be had from receivers of this character.

Most of us must remember that it is little more than a year ago the important newspapers in the country carried front-page stories dealing with the statements of motion picture magnates that their organizations would or would not contemplate the production of talking movies. There are approximately 21,000 theatres in the country today. Nearly 70% of them have been equipped for sound reproduction. And the talking movies would be an utter impossibility without the vacuum tube. As a matter of fact, a great portion of the electrical technique required for the talking movies, and undoubtedly one of the greatest reasons for its rapid scientific and practical development, has resulted from the drafting of engineers and engineering technique from the radio broadcasting field. And all this in about a year.

Then, too, there is the field of broadcasting itself, which has come to be such an important part of our daily lives. In fact, so casually do we take it that it has almost slipped by unnoticed. We have here perhaps the greatest single application of the vacuum tube because it is the vacuum tube which makes broadcast transmission and reception the highly satisfactory service it is today.

But we find the vacuum tube doing many other things entirely outside the field of telegraphic and telephonic communication. We find a simple application of the photo-electric cell used in combination with vacuum tube amplifiers controlling to a nicety the starting and stopping of elevators in some of our office buildings and hotels. We find similar devices used for the counting of vehicles passing over bridges and through tunnels and we find similar devices protecting, by invisible rays, safe deposit vaults, etc.

Other and more recent developments in the vacuum tube field have made it possible for us to witness, by means of television, events taking place a great distance away. Our own belief is that it will not be long before practical television will have entered the homes of many throughout the country and that we will find a complete revolution in radio broadcasting similar in some measure to the revolution which has taken place in the motion picture and entertainment field.

The new vacuum tubes, about to be introduced, which may be operated from dry batteries, will carry the effects of broadcasting still further in that they will allow the farmer and others who are not supplied with electric power to keep themselves as well supplied with information and entertainment as their city neighbors.

Speed of transportation and communication, to a large extent, indicates progress. The vacuum tube, within the past twenty years, has been responsible for beating down more barriers than any other communication agency has done since the world began. It is gratifying to us to recall that each step in this interesting application of this Aladdin's Lamp to the fields of aviation, exploration, broadcasting, television, telephotography, marine beacons, short-wave communication, etc., has been very completely chronicled in RADIO NEWS.

*Arthur H. Szyck*



**R. T. I.** R. T. I. QUALIFIES YOU TO MAKE MONEY AND ITS SERVICE KEEPS YOU UP-TO-THE-MINUTE **R. T. I.**  
ON THE NEWEST DEVELOPMENTS IN RADIO, TELEVISION, AND TALKING PICTURES

**RADIO TELEVISION-TALKING PICTURES**

**TUNE IN ON R.T.I.**

**BIG MONEY NOW!**

*More to Come*

**Radio now offers ambitious men the greatest Money-Making Opportunity the world has ever seen!** Hundreds of trained service

men are needed by radio dealers, jobbers, and manufacturers! A "trained" Radio "Service and Repair" man can easily make \$40 to \$50 a week, and it's very common for a "trained" man with experience to make \$75 a week, and up.

**BIG MONEY** for Spare-Time Radio Work is easily made in every city and village. You can now qualify for this Big-Money work quickly through R. T. I. Get the Big Money Now and go up and up in this Big Pay field. The Radio industry calls for More Men, and R. T. I. supplies what the industry wants you to know.

**Supervised by Radio Leaders**

R. T. I. training is prepared and supervised by prominent men in radio, television and talking picture engineering; distributing; sales; manufacturing; broadcasting, etc. These men know what you must know to make money in Radio. You learn easily in spare time at home with the R. T. I. wonderful combination of Testing Outfits, Parts, Work Sheets, Job Tickets,

It is easy, quick and practical, covers everything in Radio

—includes Talking Pictures and the latest in Television. Get started in Big Money Radio work now.



**\$60-\$70-\$80-PER WEEK AND UP.** That's what R. T. I. training leads to. Send for the R. T. I. Book and see for yourself.



**THE R. T. I. ADVISORY BOARD.** These men are executives with important concerns in the radio industry—manufacturing, sales, service, broadcasting, engineering, etc., etc. They supervise R. T. I. Work Sheets, Job Tickets, and other training methods.

**R. T. I.** R. T. I. TRAINS YOU AT HOME FOR A GOOD JOB OR A PROFITABLE PART TIME OR FULL TIME BUSINESS OF YOUR OWN

**No Experience Needed**

**ALL YOU NEED** is ambition and the ability to read and write. The Radio industry needs practical trained men. Remember, R. T. I. makes it easy to earn spare time money while you learn at home.

**More to come**

**THE MEN** who get into this Big-Money field now will have an unlimited future. Why? Because this billion dollar Radio industry is only a few years old and is growing by leaps and bounds. Get in and grow with it. \$10 to \$25 per week and more is easily made in spare hours while you are preparing for Big Money. Television, too, will soon be on the market, so the leaders say. Be ready for this amazing new money-making field. Remember, R. T. I. "3 in 1" home-training gives you all the developments in Television and Talking Picture Equipment, together with the complete Radio Training.

**Warning**

Do not start R. T. I. training if you are going to be satisfied to make \$15 or \$20 per week more than you are now. Most R. T. I. men will make that much increase after a few weeks. There is no reason to stop short of the Big Money Jobs or the Big Profits in a spare time or full time business of your own. No capital needed. Get started with R. T. I. now. Make money while you learn at home.

**R. T. I. Book Now FREE**

The thrilling story of Radio, Television and Talking Pictures is told with hundreds of pictures and facts — its hundreds of big money jobs and spare time money-making opportunities everywhere.

Send for your copy now. **USE THE COUPON.**



**LET F. H. SCHNELL AND R. T. I. ADVISORY BOARD HELP YOU**

Mr. Schnell, Chief of the R. T. I. Staff, is one of the ablest and best known radio men in America. He has twenty years of Radio experience. First to establish two-way amateur communication with Europe.

Former traffic manager of American Radio Relay League, Lieutenant Commander of the U. S. N. R. Inventor and designer of Radio apparatus. Consultant Engineer to large Radio manufacturers.

Assisting him is the R. T. I. Advisory Board composed of men prominent in the Radio industry.

**RADIO & TELEVISION INSTITUTE**  
Dept. 846, 4806 St. Anthony Ct., Chicago

**RADIO & TELEVISION INSTITUTE**  
Dept. 846, 4806 St. Anthony Court, Chicago

Send me Free and prepaid your **BIG BOOK** "Tune In On Big Pay" and full details of your three-in-one Home Training (without obligating me in any way).

Name.....  
Address.....  
City..... State.....



# The Master who TALKS



Two "stills" from the M-G-M picture "Trader Horn," filmed in the heart of Africa. The short-wave radio tie-up between the group on location and the film-developing base headquarters contributed greatly to the dispatch with which the picture was taken, with a resulting decrease in the daily expense of the expedition

**C**LYDE DEVINNA, who is known in the ham world as W6OJ of Hollywood when he is not off shooting scenery in one corner of the world or another, first used short-wave radio as an aid in motion picture work by taking a small ham set to Tahiti during the filming of "White Shadows in the South Seas." On this occasion regular nightly communication was maintained between the location in the South Seas and the main studios in Hollywood. This work was carried on so regularly and effectively that one of the head executives of the company became concerned over the well-being of Mr. DeVinna, fearing that his radio activities were interfering with his duties as chief cinematographer of the picture, possibly affecting the quality of his work. This is interesting in view of the fact that Mr. DeVinna recently received the 1929 gold medal award in cinematography of the Academy of Motion Picture Arts and Sciences "for his distinctive achievements in photographing the unique motion picture, 'White Shadows in the South Seas.'"

Needless to say, short-wave radio apparatus went as standard equipment on the recent expedition into Central Africa to make a film version of that popular book, "Trader Horn." Mr. DeVinna was again chief in charge of both radio and photography. The troupe, including some thirty people, went by steamer to Mombasa in British East Africa and thence inland by rail to Nairobi, where the base of operations was established. Offices were opened at Nairobi as well as the all-important photographic laboratory for processing of the film as "shot" and sent in by the group on location.

One of those very important details of the modern short-wave station, particularly one contemplating semi-commercial work—the license—offered some trouble for a time, but an arrangement was made whereby the British authorities at VPQ would receive valuable practical data on the use of short waves throughout that territory and the call FK6CR was allotted to DeVinna's station. As a matter of fact, the outstanding reliability and performance of the short-wave circuit under all kinds of conditions, offered some interesting comparisons to the work of the local 400-meter commercial circuit. The traffic at the base station in Nairobi was handled by Sydney Pegrume, operating a special station—FK5CR, now VQ4CRE.

Once the base was established in Nairobi, scouting trips were

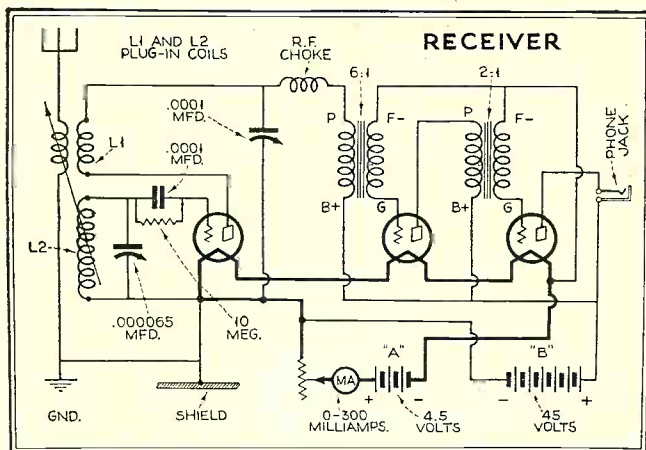

Plug-in coils used in the circuit shown above give the simple three-tube short-wave receiver a frequency range of from 3,000 to 25,000 kilocycles (12 to 100 meters). The filaments are operated from dry cells

In the circuit of the transmitter, shown to the right, the Heintz modification of the well-known TPTG system, employing a single 50-watt tube, is used. Plug-in coils provide a range of from 4,000 to 30,000 kilocycles (10 to 75 meters)

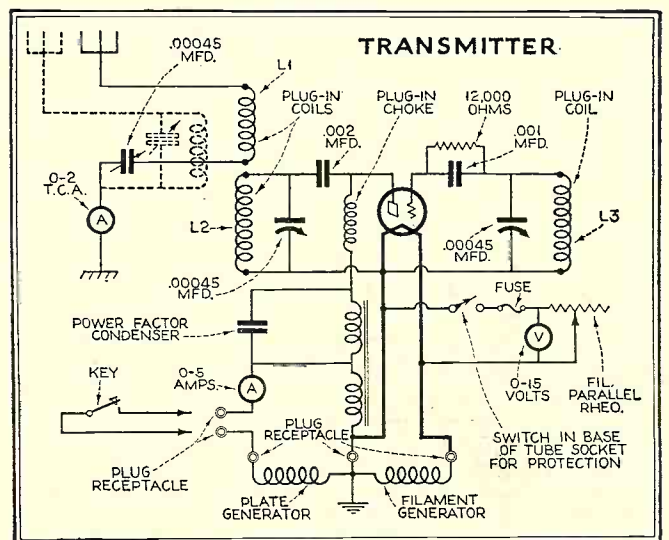

# with the WINDS

*Such was the title that the African natives gave Clyde DeVinna, brass pounder and Chief Cinematographer on the recent Metro-Goldwyn-Mayer "Trader Horn" expedition into British East Africa, in which short-wave radio played an important rôle*

By L. Elden Smith W6BUR

made for testing the various forms of equipment, including radio, and within six weeks actual work was under way. Travel was by automobile wherever possible, by boat and in some cases by foot, the equipment being packed by native porters. Working locations were established at various spots throughout the territory, in some instances as far as 1,500 miles from the base. You will notice on the map that this territory is all within a few miles of the Equator. The average elevation of the country is about 4,000 feet and locations were usually surrounded by mountains, some as high as 14,000 feet. Most of the country is wooded, eliminating the problem of masts but naturally complicating short-wave conditions. As would be expected, thunderstorms were daily affairs and Old Man Static was never absent. With tropical static, lightning, rain, and often dozens of hyenas creating quantities of local QRM a few feet from the tents, operating conditions could not be said to have been ideal. Such circumstances certainly call for the very best in equipment.

The layout used consists of a simple three-tube short-wave receiver, a fifty-watt transmitter, a gasoline-driven power supply, and a suitable antennæ system, with all accessories. For portability, the equipment when knocked down is contained in seven units—three canvas-covered plywood cases, three canvas bags, and one aluminum case containing the gas engine. This outfit was originally designed for the use of the United States Marine Corps. It weighs a little under two hundred pounds and can be transported by three men and set up and operated by one.

The power supply utilizes a single-cylinder, three-port, two-cycle, water-

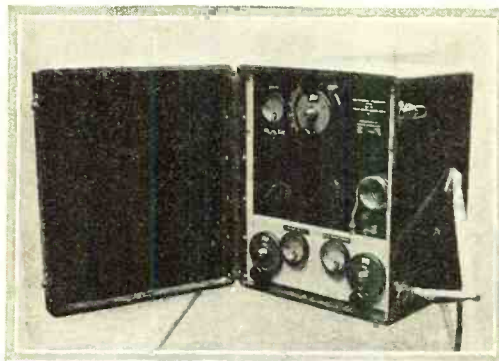
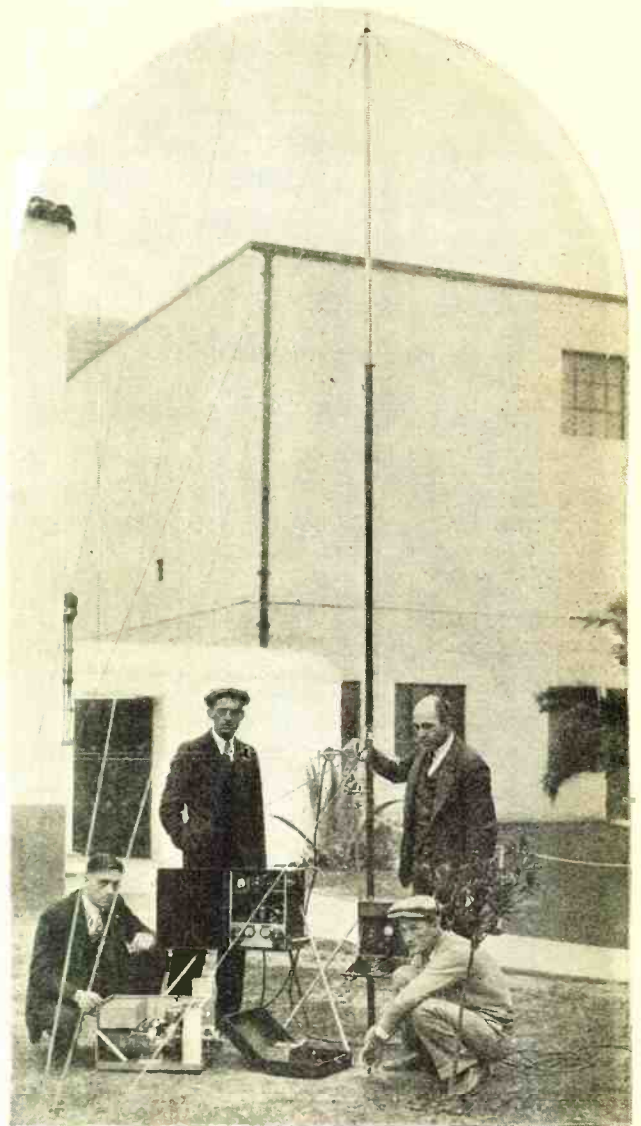

*Upper Right*

The entire outfit set up for operation on the studio lot in Hollywood. Mr. DeVinna is kneeling in front of the receiver. Ralph Heintz, designer and constructor of the equipment, is directly behind him, and Mr. Van Dyke, director of "White Shadows" and "Trader Horn," is directly behind the transmitter

*Center*

The transmitter with canvas case removed and set up for operation

*Left*

The receiver set up for operation, showing operating desk, key and the drawer for tubes, wavemeter and coils

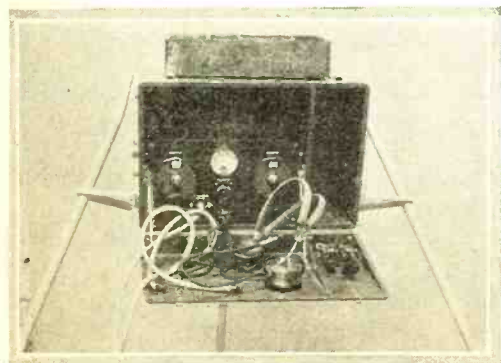

cooled gasoline engine, with a two-inch bore and one and one-half-inch stroke. To aid portability, the radiator, water pump, gas tank and starter are removable. The generator is of the duplex type with two laminated rotors driven by a common gear. It has two identical fixed windings with permanent field magnets and no rotating windings, slip rings, commutators or brushes. It is connected to the engine through a suitable clutch and delivers plate and filament power at approximately 240 cycles. The plate side of the machine delivers 120 watts power at 65 volts, which is fed into the auto-transformer in the transmitter, providing high voltage for the tube. The filament side gives 3.25 amperes at ten volts and is consequently fed directly to the filament of the tube. As the power output of this type of machine depends on the resistance or impedance of the external circuit a parallel filament rheostat is used.

The transmitter uses the Heintz modification of the conventional TPTG circuit, with a single fifty-watt tube. Plate, grid and antennæ coils are all of the plug-in variety, as is the plate radio-frequency choke.

An adequate supply of plug-in coils gives the set a frequency range of 4,000 to 30,000 kc. The antenna variable condenser may be used in series or parallel with the antenna coil, a feature which adds to the flexibility of adaptation to various antenna systems and conditions. The antenna ammeter has a double reading feature for the same reason. A plug receptacle on the transmitter provides the keying connection in the primary of the auto-transformer. By locating the transmitter at some distance from the receiver, audible interference from the gas engine is eliminated and break-in work is facilitated. A covered cable is provided to connect the key, which is mounted on the receiver operating desk, with the transmitter. The transmitter is housed in a canvas-covered plywood case 12 inches by 14 inches by 16 inches, weighing 34 pounds and provided with detachable steel legs.

The receiver has a similar case, 16 inches by 9 inches by 11 inches, weighing 32 pounds, complete with tubes, batteries, phones and spares. It uses a simple three-tube circuit with Western Electric tubes and has a particularly unique portable design. Plug-in coils give it a tuning range of 3,000 to 25,000 kc. The tube filaments are operated in series from three No. 6 dry cells, carried in the rear of the case. A milliammeter indicates proper filament temperature. Plate voltage is obtained from two 22½-volt "B" blocks and the "C" voltage is automatically provided by the drop across the series filaments. A slide tray in the bottom of the receiver cabinet holds the receiver and wavemeter coils, headphones and wavemeter. A second tray holds the transmitting and receiving tubes, both those for regular use and spares. The receiver cabinet has a drop front which forms an operating desk when down. The transmitting key is mounted on this. Something of the detail of this construction may be seen in the pictures.

The wavemeter is particularly interesting, being the most portable of its tribe. It uses one of the smaller midget condensers, which together with a small neon indicating lamp, is mounted in a compact bakelite case. Jacks for the plug-in coils, of tube-base size, appear on the top of the case. The coils are provided with a separate winding for the indicator. The neon lamp appears through a hole in the case and an engraved scale makes possible calibration. Here we have a surprisingly accurate wavemeter with a good band coverage that can be held in the palm of the hand.

The equipment includes a complete antenna system. The antenna mast, made of brass tubing, is of the telescoping type, being six feet high when collapsed and 35 feet when extended. As most of the expedition's work was done in wooded country, the pole was not used. A portable one-half-wave voltage-fed zepplin 65½ feet long with a 38-foot feeder was found most satisfactory. A simple plug and jack system between the antenna and feeder wires added to the simplicity of handling. This antenna was used with series condenser tuning on 7 mc. and with parallel tuning on 14 mc. A separate counterpoise was used for 3,500 kc. work, but most of the schedules were carried on the 7 mc. band.

The equipment worked admirably well, standing the rough handling, thunderstorms and all the hazards of travel without difficulty. Approximately 700 messages were handled between the portable and base stations at distances varying from 40 to 1,500 miles. For several days the set was operated as a ship station aboard the *S.S. Luggard* on Lake Albert and the Lower

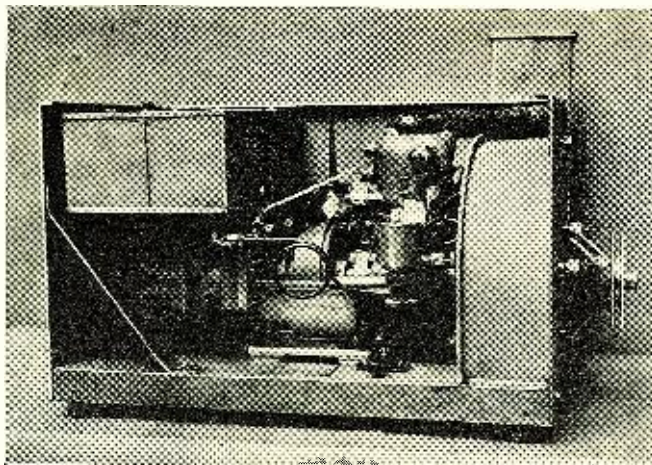

The portable gasoline engine 240-cycle power supply with cover removed. The wheel on the end of the case is for starting

and the 240-cycle note seemed to be preferable.

While working in Uganda, the camp was visited by the Governor of the province and a party of English guests. The radio facilities naturally attracted attention and it developed that one of the guests, a prominent Englishman, had a son with Commander Byrd at Little America. As a result, a message was sent the son via W1MK and an answer received in due time. Actual communication with his son near the South Pole, while he himself was on a hunting trip in Central Africa, afforded the father no small surprise and pleasure. It appears that these "uncivilized" spots are doing quite well these days.

The economic value of radio communication to such an expedition is almost limitless. The cost of keeping the troupe was approximately \$5,000 per day. At this rate, but a few hours would have to be saved to warrant the money and time invested in radio. The handling of film reports constituted one of the most valuable features of the service. As each day's scenes were shot, the film was immediately sent in to the base laboratory, where it was developed and given a test run. If all was satisfactory, the company was ordered to proceed to the next work at hand, perhaps at a location many miles away. But if there were defects in the film and "retakes" to be made, the company remained on the location and continued work until satisfactory film was obtained. The natives, comprehending telegraph but doubting the phenomenon of radio, volunteered to assist in digging up the "buried wires" when the first few camps were broken.

The facility with which radio handled these communications between the laboratory and location was of great value. And, of course, there were the numerous business details to be handled, orders for food, equipment, emergency supplies, news, and a thousand and one other things that arose on the moment. In one instance, one of the troupe was so worried over the condition of relatives ill at Nairobi that he decided to return there. This would have involved a trip of more than a week and meant absolute cessation of activities—an expensive matter. A detailed radio report on the

condition of the sick relieved the worries and work continued as usual. There are few investments that pay such dividends as this.

Mr. DeVinna is a great lover of animals and it is rare that he returns from any extended trip without some new pet. The "Trader Horn" trip proved no exception. In fact, it resulted in a new and unique acquisition in the form of two red-headed monkeys—Dot and Dash. These animals frequent the African plateaus through which the expedition passed and were daily visitors at the camps. A number of the more friendly monks became rather domesticated in time and two of these, dubbed Dot and Dash, were taken under the wing of the radio department. They successfully negotiated the long voyage home and now inhabit a portion of the DeVinna back yard.

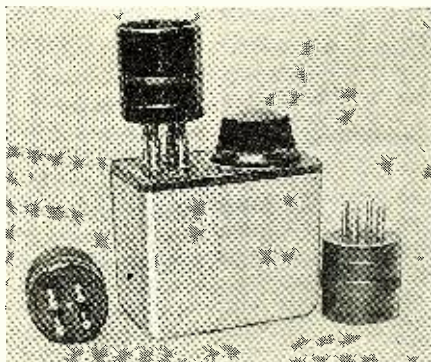

The midget wavemeter and its three coils. Some idea of its size may be gained from the fact that the coils are wound on tube bases



# The New 1930 Ham Regulations

*Some of the new requirements governing amateur radio station operation are: logs are compulsory; silent periods more clearly defined; spark and i.c.w. transmitters are definitely banned; no mobile stations at present*

By K. B. Warner\*

**T**HE United States amateur regulations have been revised by the Federal Radio Commission, effective April 5th. For the first time we have a complete set of regulations which proceed in orderly and logical fashion under the 1927 law. We have now, we believe, a better and more understandable set of regulations than exists for any other class of stations in this country. In the revision, much has been done to clarify language and to make more exact specifications. There are also now introduced into the regulations many minor specifications which previously had been covered by special instructions of some sort but never codified and included in the actual "regs" themselves.

There are a few changes of importance. The most important one is the requirement that all amateur stations use adequately filtered d.c. supply or arrangements such that inferior supplies will not produce "wobulation." We shall discuss this in detail later. The 28 to 30-mc. and the 56 to 60-mc. bands are made exclusive amateur assignments in this country, which is a big gain. Station logs are made compulsory. Quiet hours are better defined. In fact, it may be said that the big merit of the new regulations is the definiteness with which they outline the whole field of amateur radio in this country. The older regulations contained many phrases which were subject to varying interpretation and which in fact were variously interpreted in many quarters. Much of the regulation of amateur radio was simply "agreed practice," never formally reduced to writing, and there has been considerable lack of uniformity in enforcement in the different districts. The new text, it may be hoped, will go far in overcoming these faults.

The authorities at Washington have felt for some time the necessity for overhauling our regulations, but pressure of duties has delayed the job until recently. On March 21st the Commission held an informal conference on the subject at Washington, primarily between its legal and engineering divisions, the Radio Division of the Department of Commerce, and the American Radio Relay League, but also attended by many others. Mr. W. D. Terrell, chief of the Radio Division, presided at the request of the Commission, and the A. R. R. L. was represented by Mr. Charles H. Stewart, its vice-president, Mr. Paul M. Segal, its general counsel, and the writer, its secretary. After a full day of discussion the major features were agreed upon, and the following week a drafting committee, on which we were also represented, undertook to reduce the agreements to formal writing. The finished document is largely the work of

Mr. Arthur W. Scharfeld of the legal division of the Commission.

The conference's work was then reported to the Commission by Mr. Terrell, and the Commission by a general order set aside its previous amateur orders and substituted the new regulations. And there we are.

We now present the complete text of the new regulations, which are now in effect, and follow it with a discussion of the intention and effect of the various provisions.

Under the provisions of Section 4 of the Radio Act of 1927, as amended, the Federal Radio Commission establishes the following regulations for amateur radio stations:

Section 1. Definitions: As used in the regulations—

(a) An amateur is a person interested in radio technique solely with a personal aim and without pecuniary interest;

(b) An amateur operator is a person holding a valid license from the Secretary of Commerce as a radio operator who is authorized under the regulations of the Secretary of Commerce to operate amateur radio stations;

(c) An amateur station is all the apparatus controlled from one location used for amateur radio communication;

(d) Amateur radio communication is radio communication between amateur radio stations by telegraph, telephone, facsimile, or television solely with a personal aim and without pecuniary interest;

(e) A fixed station is a station permanently located;

(f) A portable station is a station so constructed that it may conveniently be moved about from place to place for communication and is in fact so moved about from time to time, but not ordinarily used while in motion.

(g) A mobile station is a station permanently located upon a mobile unit and ordinarily used while in motion.

Section II. Classification of Amateur Stations:

The public interest, convenience and necessity will be served by the operation of amateur stations. Save as restricted by and subject to the provisions of treaty, law or regulations of the Commission and with the exception of individual cases where the public interest, convenience or necessity requires otherwise, all applications from amateurs for amateur station licenses will be granted.

Section III. Prescription

**T**HIS article by Mr. Warner appeared in the May, 1930, issue of *QST*, the official organ of the American Radio Relay League, and is reprinted here with their permission. Mr. Warner has explained herein concisely and completely the meaning of the new regulations, which are now in effect, and we are pleased to be able to reprint this article so that readers of *RADIO NEWS* will be informed at first hand by one who knows what it's all about. Our thanks to Mr. Warner and *QST*.—THE EDITORS.



No "ham" mobile stations

\*A. R. R. L. Secretary—Editor *QST*.



Alien stations prohibited

communicate with mobile craft and expeditions which do not have general public service licenses and which may have difficulty in establishing communication with commercial or government stations.

(c) Amateur stations shall not broadcast news, music, lectures, sermons, or any form of entertainment to the general public.

(d) Amateur stations shall not transmit or receive messages for hire nor engage in any communication for material compensation, direct or indirect, paid or promised.

(e) Except as otherwise herein provided, amateur radio stations shall be used only for amateur radio communication, as defined in Section I, paragraph (d) above.

#### Section IV. Assignment of Bands of Frequencies:

(a) The following bands of frequencies are assigned exclusively to amateur stations:

1,715 to 2,000	kilocycles
3,500 to 4,000	"
7,000 to 7,300	"
14,000 to 14,400	"
28,000 to 30,000	"
56,000 to 60,000	"
400,000 to 401,000	"

(b) All bands of frequencies so assigned may be used for continuous wave telegraphy.

(c) The following bands of frequencies may also be used for radio telephony:

1,715 to 2,000	kilocycles
3,500 to 3,550	"
56,000 to 60,000	"

(d) Upon application, amateurs who hold operators' licenses from the Secretary of Commerce of the Extra First Class Amateur grade, or higher, or who show special technical qualifications, satisfactory to the licensing authority, will also be licensed for radio telephony in the band of frequencies:

14,100 to 14,300 kilocycles

(e) The following bands of frequencies may also be used for television, facsimile and picture transmission:

1,715 to 2,000	kilocycles
56,000 to 60,000	"

(f) Licenses to individual amateur stations shall permit the use of all frequencies within the service bands above assigned which the licensee may be entitled to use and shall not specify individual frequencies.

Section V. Location: An amateur radio station shall not be located upon premises controlled by an alien.

Section VI. Regulations Concerning the Kind of Apparatus to be used with Reference to its External Effects:

(a) Amateur stations shall not use apparatus, transmitting damped waves.

(b) The frequency of the waves emitted by amateur stations must be as constant and as free from harmonics as the state of the art permits. For this purpose they must use circuits loosely coupled to the radiating system or devices that will produce equivalent effects to minimize keying impacts and harmonics. Conductive coupling to the radiating antenna, even though loose, is not permitted, but this restriction does not apply against the employment of transmission-line feeder systems to Hertzian antennas.

(c) Amateur stations must use adequately filtered direct current power supply or arrangements that produce equivalent effects to minimize frequency modulation and prevent the emission of broad signals.

(d) Amateur stations are authorized to use a maximum power input into the last stage of a transmitter of one kilowatt.

Section VII. Regulations Deemed Necessary to Prevent Interference:

of Nature of Service to be Rendered:

(a) For the present, amateur mobile stations will not be licensed.

(b) Amateur stations are to communicate only with similar stations. In emergencies or for testing purposes they may communicate with commercial or government stations. They may also

(a) In the event that the operation of an amateur station causes general interference with broadcast reception on receiving apparatus of modern design, that amateur station shall not operate during the hours from eight o'clock p.m. to ten-thirty p.m., and on Sundays from ten-thirty a.m. to one p.m., local time, upon such frequency or frequencies as cause such interference.

(b) An amateur station shall transmit its assigned call at the end of each transmission but in any event at least once during each fifteen minutes of operation.

#### Section VIII. Other Regulations:

(a) Amateur station licenses shall be issued only to persons who are amateurs, as defined in Section I, paragraph (a) above.

(b) Amateur station licenses shall be issued only to persons who are amateur operators, as defined in Section I, paragraph (b) above, provided, however, that if an applicant is not such an operator, an amateur station license shall be issued him upon the presentation of affirmative evidence that the station, when licensed, will be operated by an amateur operator.

(c) Amateur station licenses shall not be issued to corporations or associations, provided, however, that in the case of a bona fide amateur radio society, a license may be issued to an authorized official of such society as trustee therefor.

(d) The licensee of a portable station shall give advance notice to the Supervisor of Radio in the district where application was made for said portable station license, of all locations at which the station will be operated.

(e) The licensee of an amateur station shall keep an accurate log of station operation, in which shall be recorded the time of each transmission, the station called, the input power to the last stage of the transmitter, and the frequency band used.

Section IX. Administration: For the purpose of administering these regulations and under the findings of public interest, convenience and necessity herein made, all ministerial and routine duties in connection with the licensing of amateur radio stations will be performed by the Radio Division of the Department of Commerce. That Division will issue, on behalf of and in the name of the Commission, all licenses, the applications for which disclose no question involving discretion and which require no determination of controverted questions of fact. All applications tendering such questions shall be referred by the Radio Division to the Commission.

Let us now examine our new regulations and see what their effect is.

Section I starts off with definitions. Important as this is in any set of regulations, in ours the definitions are particularly important because of the protection they give us. They establish our status definitely. An amateur is this particular kind of a person, and his communication is of the type defined. Other people who have not this interest may not obtain the right to our privileges. We are definitely protected against invasion by commercials who might seek amateur licenses, for they have not "a personal aim" and, on the other hand, are not "without pecuniary interest."

A distinction is made between an amateur and an amateur operator to fit in with the licensing regulations in Section VIII.

There is much confusion in other branches of radio as to what constitutes a "station." In the commercial world each transmitter is frequently considered a separate station and given a call of its own. It became questionable whether amateurs had the right to build separate transmitters for different bands. Paragraph (c) disposes of this and makes one station out of all the apparatus controlled by one amateur—in 999 out of a thousand cases. An amateur station must be identifiable, in case of interference—its call must indicate its location. If one transmitter of a multiple-transmitter amateur station were too far away it might create entirely different interference conditions not identified with the remainder of the apparatus. If a single transmitter is controlled from a distance of over five miles, the location of the station

(Continued on page 264)



Keep an accurate log



Observe the "silent periods"

# Announcing Three New Tubes for Battery Operation

*Working from dry cells and boasting of economical drain on the B batteries these new tubes will find an immediate use in receivers designed especially for farm use, for automobiles, motor-boats, airplanes, in short-wave work or portable use*

By the Laboratory Staff

**I**N response to insistent demands for dry-cell tubes that would give long life, economical operation, and results approximating those to be obtained from their larger brothers, three leading manufacturers have announced three tubes to meet this demand. These manufacturers are Radio Corporation of America, De Forest, and Raytheon. Doubtless other manufacturers will release similar tubes as soon their experimental work is completed.

It is an open secret that the -99 and -20 type tubes were never as satisfactory as they might have been, principally due to the delicate construction of the elements, as well as having a filament that was rapidly exhausted. The new tubes are of very rugged construction, and the filaments are oxide coated, thus ensuring normal life. They are also non-microphonic.

The three new tubes are the 230, which is a general purpose tube, the 231, a power output tube, and the 232, a screen-grid amplifier tube. All three have two-volt filaments, the 230 and 232 each drawing 60 milliamperes filament current, while the 231 draws 135 milliamperes. The filament voltage may be supplied from dry cells, or from a single storage cell. A filament voltmeter should be a permanent part of the installation, for if the voltage rating is exceeded the life of the tubes will be shortened materially.

The heavy-duty type of "B" batteries should be used to supply plate voltage to the new tubes, and the grid potential may be furnished by the usual type of "C" battery. The "C" bias may also be supplied by resistors between the filament and "B" negative in a manner similar to the method used in a.c. receivers, and this system has the advantage of keeping the bias proportional to the plate voltage when the plate voltage has dropped, due to aging of the batteries. This has the drawback, however, of requiring separate "A" batteries for each of the tubes that require a different bias.

### The 230 Tube

#### Service

The 230 is a general-purpose tube suitable for use as detector, intermediate audio-frequency amplifier or radio-frequency amplifier. It is recommended particularly for the first two classes of service.

#### Rating

##### Electrical characteristics:

Filament voltage	2.0 volts
Filament current	0.06 ampere
Plate voltage—nominal and recommended	90 volts (max. 150 volts)



The three new 2-volt tubes are shown here

Grid voltage—nominal	4.5 volts
Plate current	2.0 milliamperes
Plate resistance	12,500 ohms
Amplification factor	8.8
Mutual conductance	700 micromhos
Approximate direct inter-electrode capacitances:	
Grid-to-plate	6 mmfd.
Grid-to-filament	3.5 mmfd.
Plate-to-filament	2 mmfd.
Dimensions:	
Maximum overall length	4 1/4"
Maximum diameter	1 3/16"
Base	Small UX

#### Operation

##### Audio Amplifier (Transformer Coupling)

The 230 may be operated either with fixed bias voltage as supplied by a "C" battery or with a self-bias arrangement with transformer coupling. With fixed bias and an initial plate voltage of 90 volts a 4.5-volt "C" battery will give best overall results. It is necessary to use a transformer having a high primary impedance to obtain good quality over the useful life of the "B" battery.

##### Audio Amplifier (Resistance Coupling)

The "B" voltage should be 135 volts for resistance coupling. A fixed bias of 4.5 volts will give satisfactory operating conditions.

##### Detector

When the 230 is used as a grid circuit detector the values of grid condenser and grid-leak resistor are not critical. Values of .00025 microfarads for the condenser and 2 to 5 megohms for the resistor are suitable. The grid return should be connected to the positive end of the filament.

The 230 may be used as a grid bias or anode detector with either transformer or resistance-coupled output. With transformer coupling it will give sufficient output to work directly into a single 231 output tube. A high-impedance transformer is required for good quality. With resistance coupling an intermediate audio stage is required to (Continued on page 279)

Practical Design  
and Constructional  
Data on the

# Marshall S-W

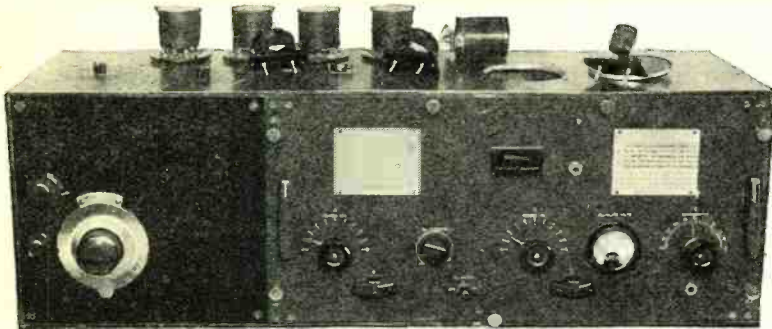

Fig. 5. Here's the Marshall push-pull receiver with the added stage of radio-frequency amplification at the extreme left

For its 5 and 10 meter and ultra-high frequency reception the United States Navy has officially chosen the Marshall push-pull short-wave receiver which in its modernized form is described here for the first time. While particularly adapted to 5 and 10 meter reception this receiver may also be built for use in the regular amateur band

**R**OUNDING out three years of experimental work on circuits for reception of high frequencies and ultra-high frequencies, the writer has developed a new circuit which is particularly suitable and adaptable for reception of frequencies up to 75,000 kilocycles (4.5 meters). The complete circuit is now employed in the U. S. Naval service and is described in the article to follow.

Photographically the arrangement of the complete receiver may be seen in Fig. 1, A, B and C, where a back view is shown, while the schematic diagram of the circuit may be traced from the drawing in Fig. 2. For the benefit of those interested in the factors which determine the choice of circuits developed, a full description and theory are given in order that any one may build the receiver and obtain most pleasing results in the ultra-high frequency bands. Although at the present time these bands

are practically unexplored, yet they yield unusual results in reception of harmonics from distant stations. An example of this condition may be given by recalling reception of KKP (Khuka, Hawaii) on 27,410 kilocycles (10.9 meters) while at Port of Spain, Island of Trinidad. The great circle distance is about 5,700 miles. This station could not be heard on its fundamental frequency, but yet it yielded a perfect signal on the second harmonic value, which shows that unusual results may be easily accomplished with the proper type of circuit.

As disclosed in the schematic diagram, Fig. 2, the circuit has two stages of tuned radio-frequency amplification, a tuned detector circuit, and two stages of audio-frequency amplification. The antenna coupling is made variable in order to permit reduction of the noise level, to increase selectivity and to permit

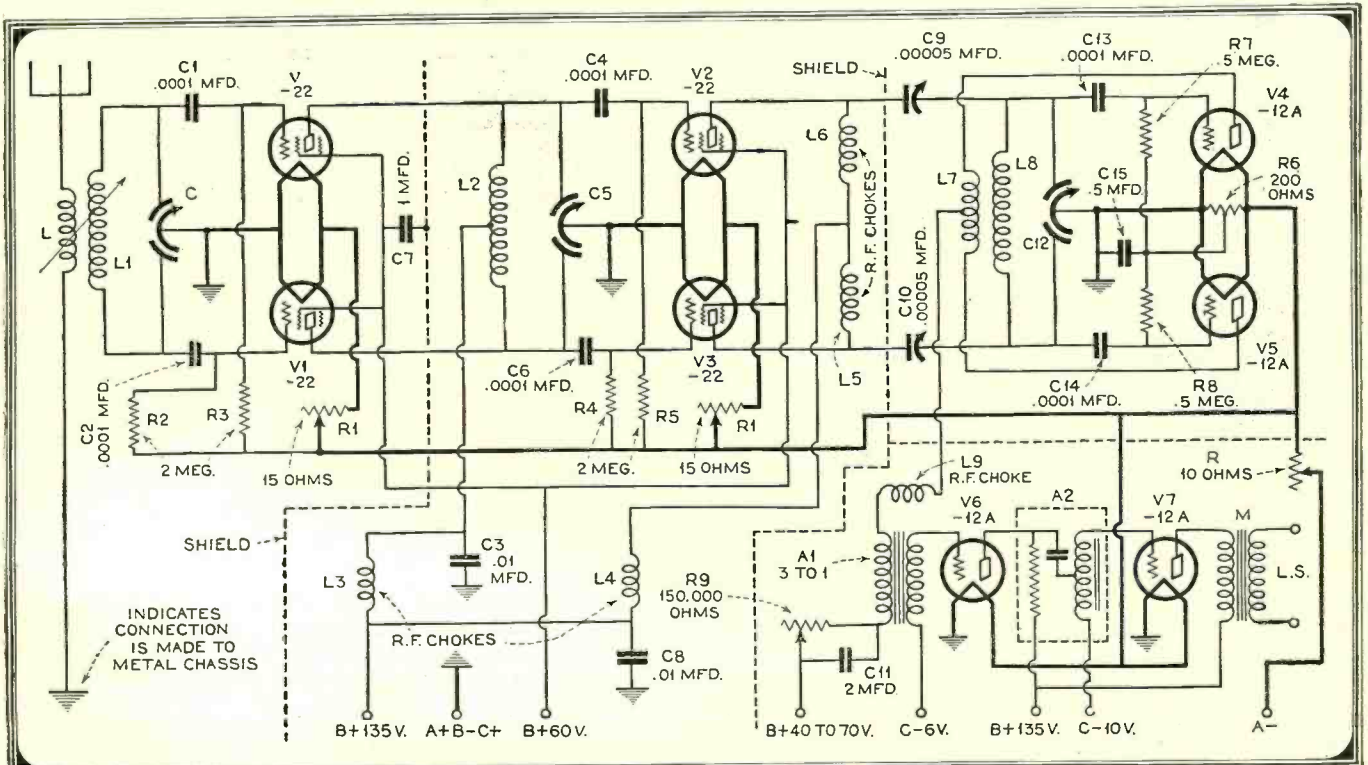
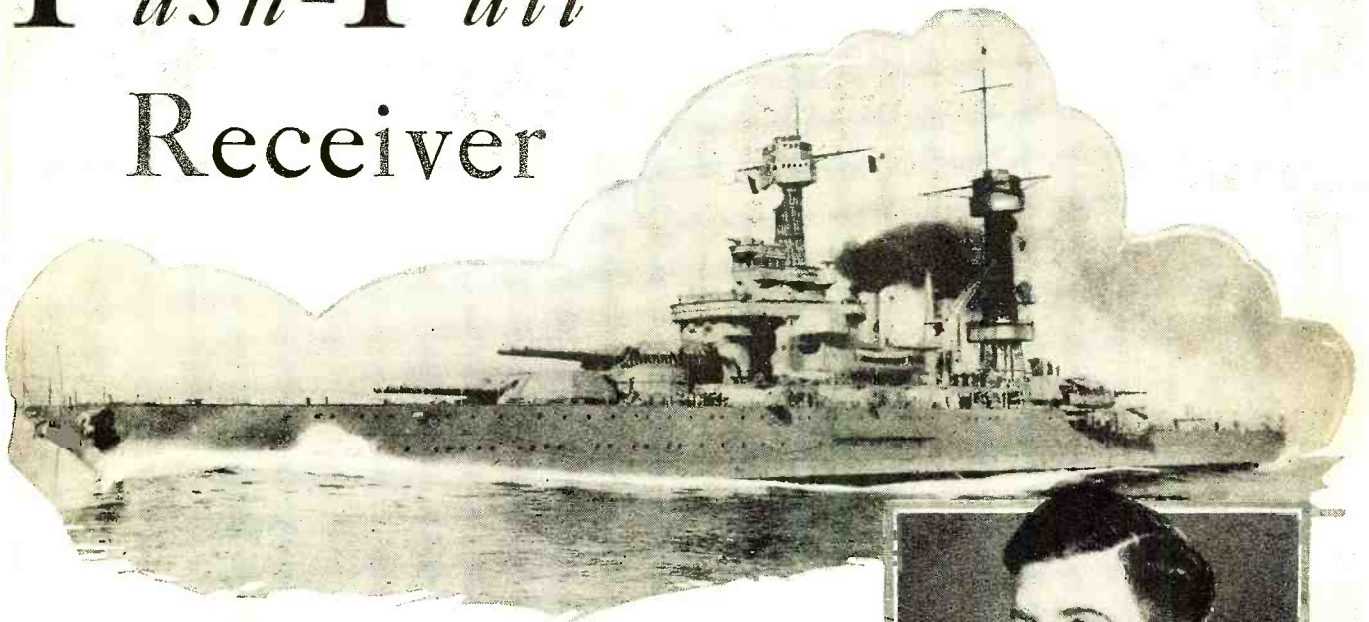

Fig. 2. The complete circuit of the Marshall push-pull short-wave receiver for ultra-high frequency reception. Both of the r.f. stages and the detector employ push-pull circuits. The audio channel consists of two stages of transformer-coupled audio



# Push-Pull Receiver

By Thomas A.  
Marshall



The U. S. S. *California*, flagship of the Battle Fleet and scene of Mr. Marshall's experiments in the ultra-short-wave field



**THOMAS A. MARSHALL**, Radio Officer, attached to the Admiral's Staff has been a frequent contributor to **RADIO NEWS**. Next month he continues the constructional description of his push-pull receiver

better tuning when "hunting" for a given station. This is brought about by setting the antenna coil at maximum coupling position, which has the effect of broadening the first radio-frequency amplifier stage. Stations may, therefore, be heard when within five or ten degrees on either side of the point of resonance. After a given station has been tuned to resonance on the detector and on the second amplifier stage, the antenna coupling is reduced and the first amplifier stage retuned. This procedure is followed until the noise level is reduced to zero. It will be found that for best results the coupling should be increased to about three inches from the grid coil. Under this condition, signals are received with a minimum of interference. The first radio-frequency amplifier stage has a tuned grid circuit and a 1-1 ratio tuned plate circuit. This combination makes it possible to get a much larger proportion of the voltage generated. In viewing the circuit, it is easily seen that the output of a transformer employed with shield-grid tubes must be tuned. The plate-to-filament resistance is exceedingly high; therefore, its effect upon the tuned output in producing an equivalent series resistance is quite negligible. Hence, no loss in selectivity but a marked gain in voltage amplification.

The second radio-frequency amplifier stage has a tuned grid circuit and an untuned plate circuit. The latter is termed "parallel plate feed" system, and is capacitatively fed to the detector circuit through the two small variable condensers C9 and C10. These condensers are 70 micromicrofarads each, and require approximately 50 mmfds. to feed the detector circuit. The correct value of capacity should be kept relatively small in order to prevent interaction of the second radio-frequency amplifier stage on the detector circuit. The value of capacity selected must be determined by trial, and not changed after the receiver has been tested and calibrated.

The detector is of the regenerative type. The tickler inductance, L7, is tapped in the center and two coil ends are connected to the plates of the detector tubes. The plate voltage is fed through a radio-frequency choke, L9, and through the primary of the first audio transformer, A1. The detector tubes operate from a plate voltage of about 60 volts, which is made continuously variable by means of the universal range clarostat, R9, which is by-passed by a 2 mfd. condenser, C11. The condenser is required in order to eliminate noise in adjusting the detector for maximum regeneration.

The conventional type of radio circuit employed for short-wave reception has a low input impedance due to the relatively high grid-to-filament capacity of the three-element tube. The L/C ratio is also low, making it incapable of giving amplification in high or ultra-high frequency bands. In the four-

electrode shield-grid tube, the presence of a shield between the grid and the plate reduces the capacity between the grid and the plate. The shield does not materially change the input capacity, which is the grid-to-filament capacity, but the plate-to-filament capacity is considerably increased. By using the shield-grid tube, the input capacity, C, equals CG—F plus CG—plate screen, thus giving a relatively lower tube capacity which increases the tuned input circuit constants without plate circuit reaction of phase relationship.

The equivalent of internal tube capacities for the circuit shown in Fig. 2 may be thoroughly understood by referring to

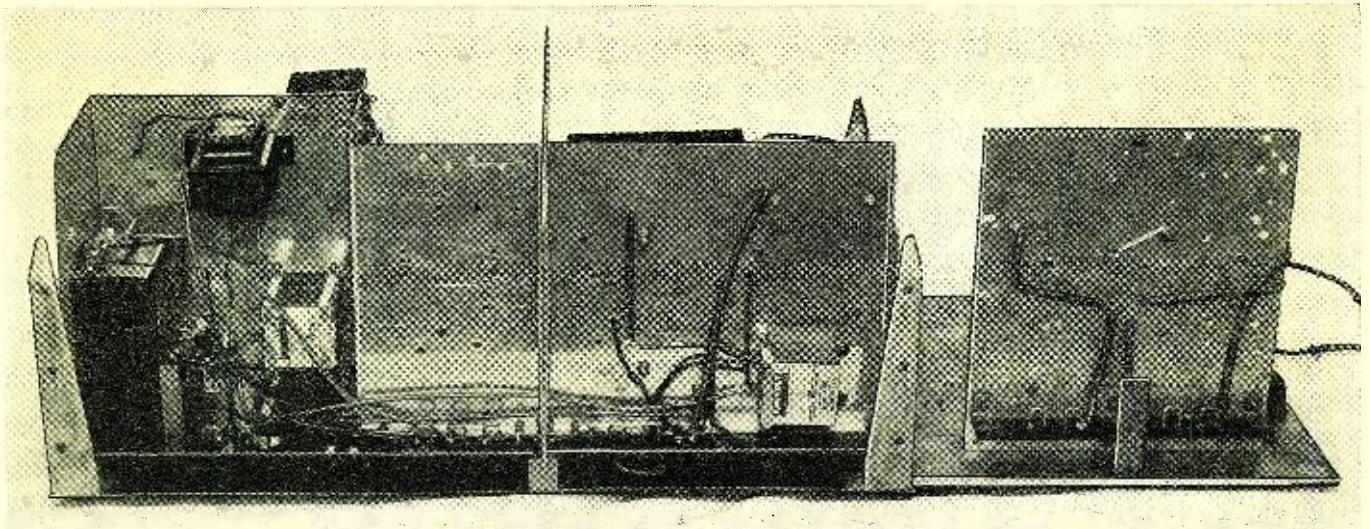

Fig. 6. Some idea of the care in shielding exercised in the construction of this push-pull receiver can be gotten from the above photograph

Fig. 3. C and C1 represent the grid-to-filament capacity of the vacuum tubes. These capacities are in series, resulting in reducing the input capacity to one-half value, which permits a greater number of turns to be used in the grid coil for a given wavelength. C3 and C4 are in series, thus permitting a greater number of turns to be used in the plate circuit. Due to the circuit permitting a greater number of turns to be employed in the grid and plate circuits, regenerative properties are increased manifold, resulting in ease of oscillations within the detector circuit and a gain in signal strength due to increased regeneration. The new circuit employs a symmetrical push-pull type of circuit for the two radio-frequency stages and for the detector circuit. The tuned input circuits are permitted to find their own electrical center, which may be different from the apparent center due to electrical irregularities in the tubes and in the wiring. This method helps to preserve a symmetry which is essential to efficient and stable operation, particularly at the higher and ultra-high frequencies.

It is to be noted that the tube grid-to-filament circuits are across half of the tuned circuit input voltage. Thus, the grid-to-filament conductance is decreased to half value for each tube. Since the two reactances are in series, the total conductance across the tuned input circuit is one-quarter the value as found in a single-tube circuit. In view of these features, it is apparent that the symmetrical push-pull circuit will increase the tube impedance manifold. This improved condition makes it possible to maintain a much higher potential across the two input grids.

**Description**

The high-inductance, low-capacity chokes, L5 and L6, 250 millihenries each, are employed which perform satisfactorily throughout the range of the receiver. A third choke, L4, is connected to the junction of the two plate chokes and in series with the plate voltage supply. This choke isolates the junction of the two plate chokes, thus permitting the output circuit to find its own electrical center. Similar chokes are employed in other parts of the circuit as follows: L3 and L9. The three chokes, L4, L5 and L6, are mounted near the tubes V2 and V3 and permit a certain amount of feed-back to take place within the circuit. The amount of feed-back is not sufficiently great to cause interaction to take place between the second amplifier stage and the detector circuit. It is particularly advantageous to permit a certain amount of feed-back to take place in order

to gain in amplification and to increase the selectivity. In addition, the receiver requires less number of coils to cover all the required frequencies. Fig. 4 shows arrangements of the output circuit. By carefully observing the arrangements of these chokes as shown in Fig. 1, it will be possible to mount them exactly as illustrated. Note that the height of L5 and L6 corresponds to about the same as the caps on V2 and V3.

Regeneration or oscillation control is accomplished by varying the plate voltage on the plates of the two detector tubes by means of R9, which is a 150,000-ohm resistor. This method of regeneration control does not change the calibration of the receiver or change the settings for a given station. The detector tubes, V4 and V5, are of 112A type, which are quieter in performance than the 201A type. The first audio stage is a 3-1 ratio type. V6 is a 201A tube. A2 is a S.-M. 256 audio transformer, and V7 is a 112A tube. M is a 1-1 ratio output transformer of any well-known design. C3 may be any value from 1/10 to 1/2 microfarad. R6 is a 200-ohm potentiometer and is used to obtain the correct bias for the detector tubes. The bias is regulated so as to cause the detector circuit to go in and out of oscillation without hangover effect. Thus it is possible to receive weak signals at the point of maximum regeneration, while ACW may be received near the point of oscillations. The condensers, C1, C2, C4, C6, C13 and C14 are Sangamo .0001 mfd. type. Grid leaks, R2, R3, R4 and R5 are 2 megohms each. Grid leaks R7 and R8 are 1/2 megohm each. C15 is a 1/2 mfd. condenser. The grids of the tubes in the first and second radio-frequency stages receive a negative bias by utilizing the drop in the filament voltages through the rheostat R1, which is a 15-ohm type. R is a heavy-duty 10-ohm type. C7 is a 1-mfd. type of condenser. C8 is a .01-mfd. type. C11 is a 2-mfd. type of by-pass condenser.

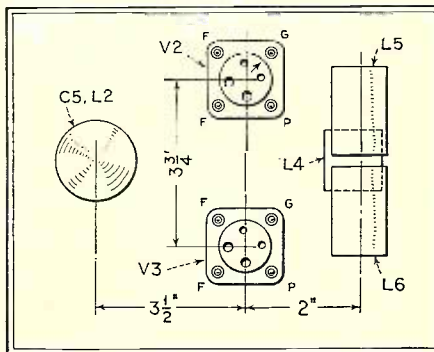

Fig. 4. It is important, if best results are to be obtained, that the two chokes, L5 and L6, bear the relation to each other and to its adjacent parts as indicated in the sketch above

1/2 mfd. condenser. The grids of the tubes in the first and second radio-frequency stages receive a negative bias by utilizing the drop in the filament voltages through the rheostat R1, which is a 15-ohm type. R is a heavy-duty 10-ohm type. C7 is a 1-mfd. type of condenser. C8 is a .01-mfd. type. C11 is a 2-mfd. type of by-pass condenser.

**Mechanical Details**

The mechanical layout of the parts in the final push-pull receiver is the result of many trials with different experimental models. For this reason it will be inadvisable for the constructor to vary to any extent from the design recommended. The shields are of heavy aluminum 3/16 inch in thickness. Dimensions of the complete receiver are as follows:

- Front panel—33 x 10 1/2.
- Top and bottom panels—33 3/8 x 9 1/2.
- Ends and partitions—10 1/2 x 9 5/16.

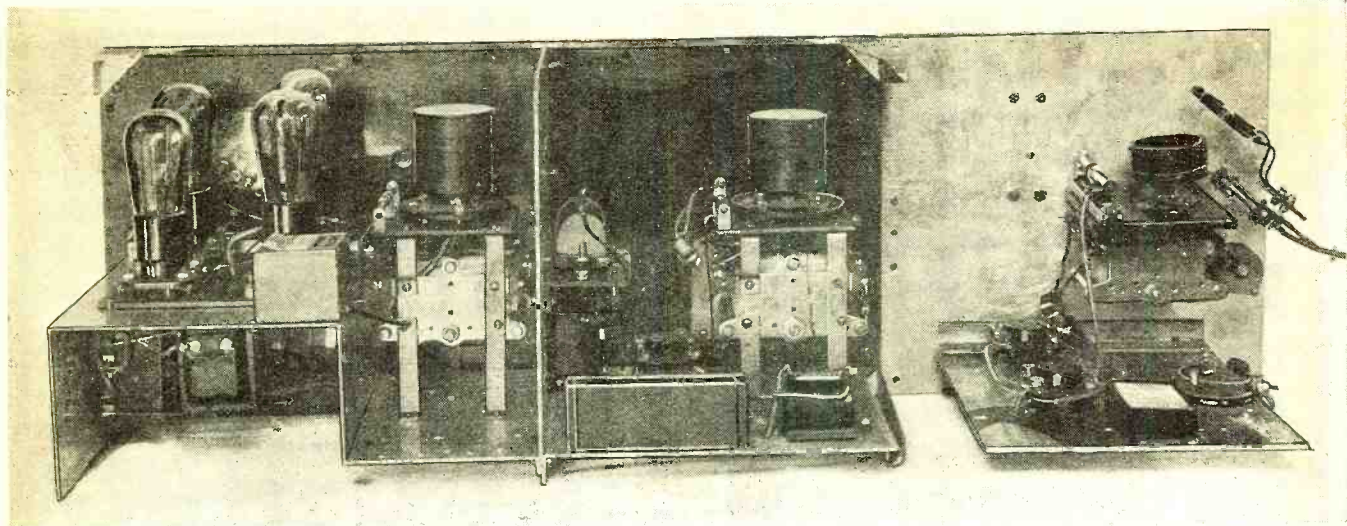

Fig. 1. Looking at the rear of the receiver. The added r.f. stage is shown at the extreme right, while the location of the audio channel below the shielding may be noted at the extreme left

Back—10½ x 33⅞.

Approximate length of each compartment:

First stage—11".

Second stage—9½".

Detector and audio—12½".

The components of the first radio-frequency amplifier stage, L, L1, C, C1, C2, R2, R3, C7, V and V1, may be mounted in the first compartment as shown. As shown in the photograph, Fig. 1, the antenna coil is arranged so as to be variable in coupling to L1. The coupling is controlled by a knob mounted on front of the receiver. The condensers, C, C5 and C12, are of Cardwell 169E type, having heavy rotor plates. This type of variable condenser permits the builder to saw out a section of the side brackets without impairing the rigidity of the plates. Each condenser is split. The rotor is grounded and tunes both halves of the circuit simultaneously.

The component parts of the second radio-frequency amplifier stage should be mounted as shown in Fig. 1. The exact dimensions for this stage are shown in Fig. 4. It is essential that this circuit be built to specifications as given. Mounting parts for the detector and audio circuits are not critical. However, all leads should be made as short as possible.

The range in miles of the receiver is unlimited; the operator merely has to shift coils and tune in stations from all parts of the globe. Not only is the receiver unlimited in distance, but will also receive signals up to 40,000 kcs. by utilizing harmonics of distant stations. On the west coast, Panama, South America and Cuba, WIK could be heard with good signal strength on 27,860 kilocycles. NAA could be heard on 32,120 kilocycles. Daily observations have been made on the following stations scattered throughout the world:

CPC, 23,800 kcs.; NAA, 24,090 kcs.; WAR, 24,150 kcs.; LSD, 25,540 kcs.; WNU, 25,940 kcs.; WEX, 26,900 kcs.; HJO, 27,160 kcs.; KKZ, 27,380 kcs.; KKP, 27,410 kcs.; WGT, 27,560 kcs.; WQU, 27,710 kcs.; WIY, 27,740 kcs.; WQP, 27,800 kcs.; WQS, 27,830 kcs.; WKU, 29,660 kcs.; WML, 29,480 kcs.; WQL, 29,630 kcs.; TIR, 29,660 kcs.; WAZ, 29,840 kcs.; YVF, 32,040 kcs.; NAA, 32,120 kcs.; WKW, 3,060 kcs.; CMA1, 34,560 kcs.; XDA, 36,120 kcs.; KQJ, 36,040 kcs.; WNDP, 36,680 kcs.; PPZ, 37,100 kcs.; NKF, 20,000 to 40,000 kcs.

Frequencies given above are for the second harmonic values except for NKF. The receiver will give the best of results from short-wave broadcast stations WGY, KDKA, KGO, WENR, WABC, and G5SW. In direct comparison with short-wave receivers of standard make, the receiver as shown in Fig. 1 was found to be superior in sensitivity and selectivity. In fact, these features were so pronounced that tests were of unusual interest to observers. During tests with Bellevue, NKF, signals have been received on frequencies up to 38,000 kcs. with enough volume to block the detector circuit.

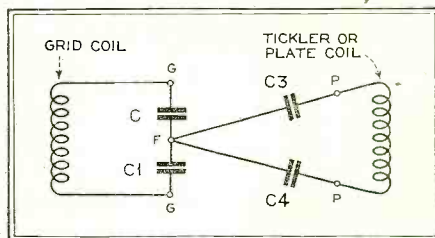

Fig. 3. The circuit representing the equivalent of internal tube capacities. C and C1 represent the grid-to-filament capacities. C3 and C4, the tuning capacities, are in series, thus permitting a greater number of coil turns

Coil Data

Band in Meters	Coil No.	L	L1	L2	L8	L7	Diameter
80	1	6	22	21	21	6	2
40	2	6	14	14	13	6	2
30	3	6	8	8	7¾	4	2
20	4	5	6	6	5	4	2
15	5	5	3¾	3¾	3	3¾	2
11	6	4	4	4	4	4	1
9	7	4	3	3	3	4	1
7	8	4	2½	2½	2	4	¾
5	9	4	2	2	2	4	¾

For coils numbers 8 and 9 space tickler coil until the desired frequency is obtained. L, L1, L2 and L8 for coils numbers 1 to 5 inclusive are wound 18 turns to the inch with No. 22 enamel-covered wire. Tickler and grid coils 1 to 5 are spaced one-half inch. Tickler

coils 1 to 5 inclusive are wound 30 turns to the inch with No. 28 enamel-covered wire. Coils 6 to 9 are wound with No. 22 d.s.c. wire without spacing of turns.

From results obtained, it appears that the band of frequencies ranging from 20,000 to 40,000 kilocycles should be considered available for immediate use. The receiver as described in this article had brought to light the use of these frequencies.

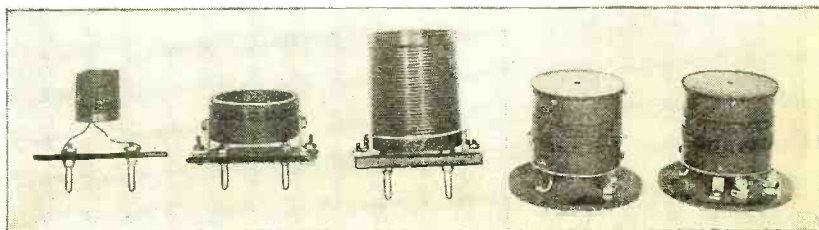
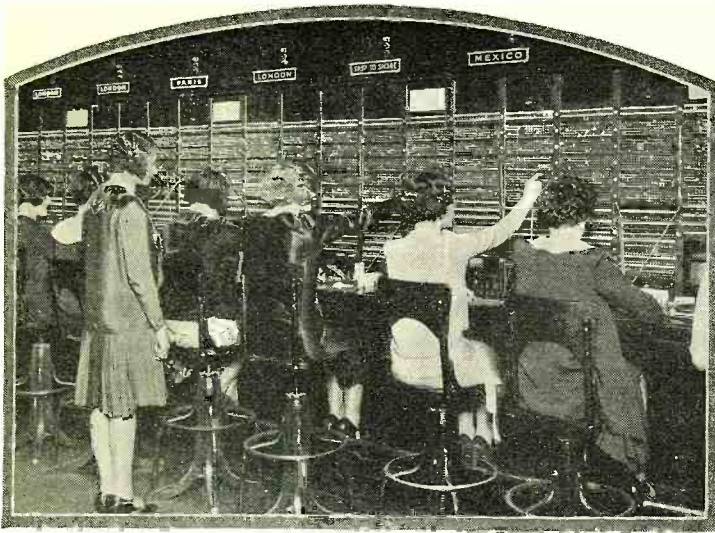

Fig. 7. A few of the coils for the various tuned circuits of the receiver. Complete winding and coil constructional details will be contained in the October RADIO NEWS

# The Telephone

By Everett



The scene above shows part of the room at 24 Walker Street, New York City, where transatlantic, ship-to-shore, and other distant point telephone communications are handled

At the right is a sketch showing the method of handling ship-to-shore telephone service. The operators below are shown at their control stations during the inauguration of the ship-to-shore telephone service connecting the S. S. *Leviathan* with the telephones of the Bell systems

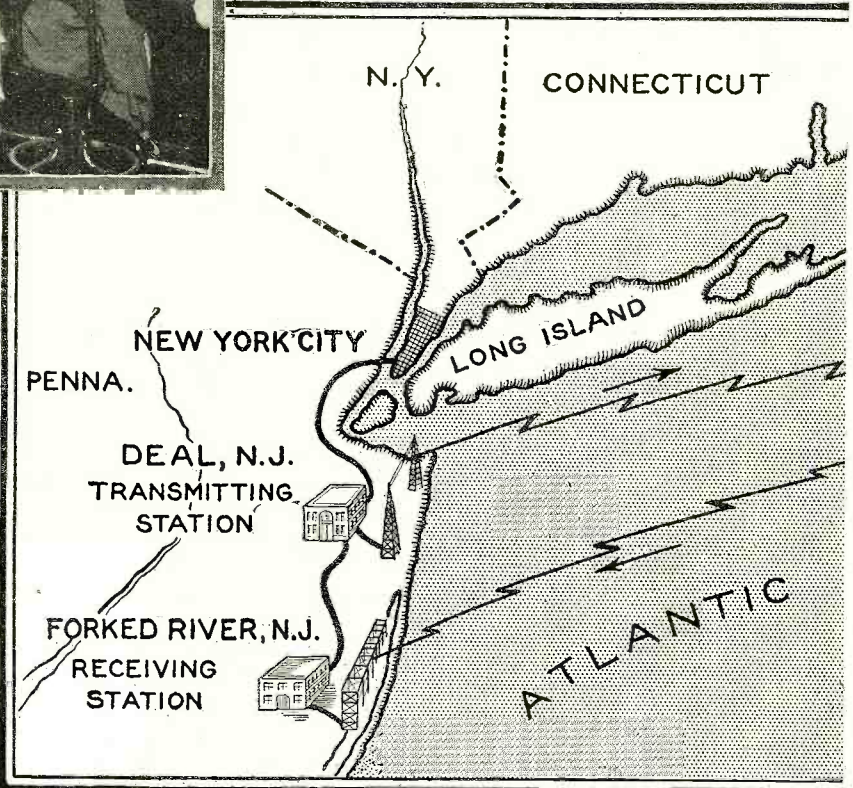
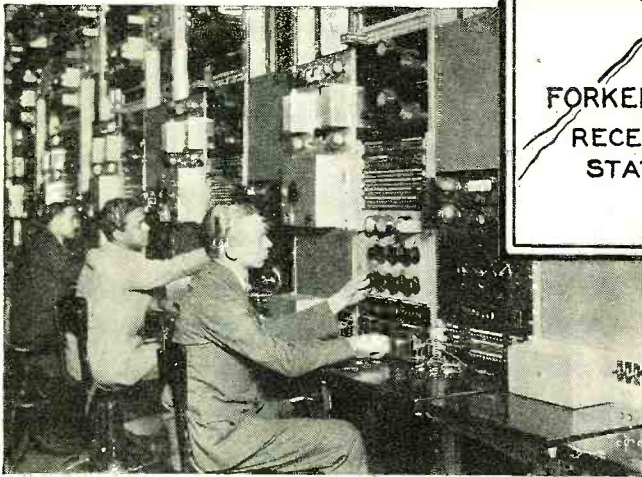

the Bell Laboratories and the Navy Department. When President Wilson sailed abroad on the *U.S.S. George Washington*, a radio telephone installation was erected on the ship in order to permit the President to maintain personal contact with Washington while en route. The radio telephone functioned until the vessel was about 2,100 miles off the coast of the United States. Although transmission and reception were fairly successful up to that point, thereafter it was necessary to resort to radio telegraph.

Following the war American engineers resumed experimentation on the idea of adapting the radio telephone for conversing with ships at sea through the ordinary subscriber's house installation. During 1922 the steamship *America* was equipped with radio telephone transmitting apparatus by the Radio Corporation of America. On one voyage of the ship during this year, experiments were carried on over a distance of 1,200 miles. Transmission from land was accomplished through a broadcasting and experimental station at Roselle Park, N. J. (WDY). Experiments were carried on for a period of several months, and on several occasions officials of the Radio Corporation talked from their homes to operators aboard the *America*.

On December 8, 1929, after a culmination of all these advanced experiments drawn out over this period of years, direct telephone service to ships at sea and available to the 20,000,000 subscribers in the country was opened. It is possible for every owner of a telephone in the United States to pick up the telephone receiver in his home, ask the operator for the S.S. *Leviathan* and talk with an acquaintance aboard the liner at the rate of \$7 a minute.

This service itself did not originate overnight, but rather is the result of an extensive series of experiments which had been in progress for six months. Careful forethought was given by the Bell laboratories engineers, and apparatus was designed,

**F**OR more than fourteen years radio experts and engineers have visioned the successful solution of the problem of overcoming the isolation of ocean travel by providing continuous personal contact with shore through the extension of telephone service to ships at sea.

Experiments with the first ship-to-shore radio telephone date back to 1916, when William Wilbur, a Bell System engineer, obtained permission to install a land telephone station somewhere in New Jersey and apparatus aboard several trans-Atlantic liners. Tests were made in co-operation with the United States Navy Department. First official record of a land-to-sea telephone conversation is that made by the Secretary of the Navy in that year, with the captain of the *U.S.S. New Hampshire*. The Secretary of the Navy spoke from his office in Washington, his conversation being transmitted by land wire to the New Jersey transmitter and flashed by radio to the battleship. While transmission and reception were subject to considerable interference, they were effected when the ship was several hundred miles at sea and pronounced successful by engineers conducting the tests.

This experiment was virtually the forerunner of the present ship-to-shore telephone, although during the intervening time much experimental and developmental work has been in progress. During the war a number of experiments were made by

# Goes to Sea

M. Walker



In order to telephone from the *Leviathan* to any point ashore, it is only necessary to pick up the receiver of a telephone aboard the ship, as shown here

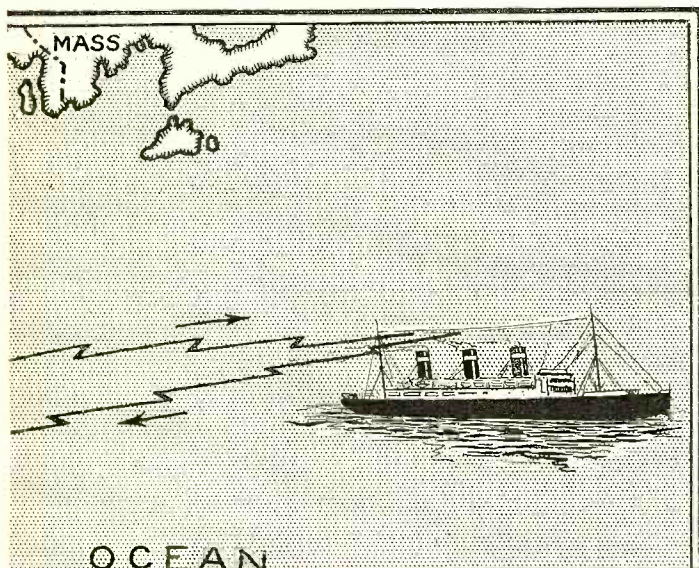

*We are apt to think too often that radio is purely a means for providing entertainment—in the form of broadcasting. Here we see how radio has been a means to an end, linking the shore with ships that ply the sea. Now, by means of an elaborate radio link, you can pick up your telephone and hold two-way converse with passengers at sea*

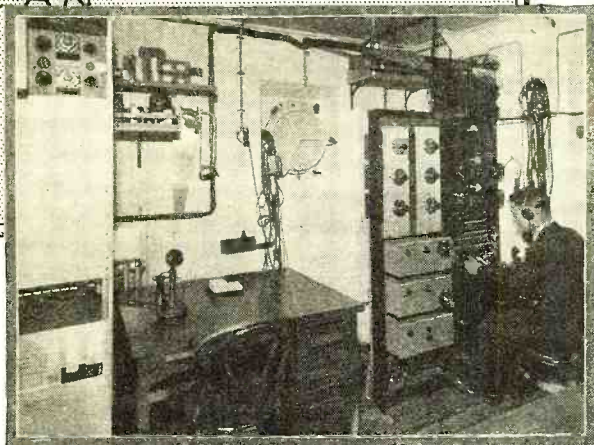

Interior of the deck house on the *Leviathan* which houses the short-wave radio telephone equipment. To the right is the receiving set where voices from shore telephones are received

constructed and tested in the laboratories before the actual experiments were tried.

In June of last year, permission was granted by the Federal Radio Commission to install the experimental apparatus aboard the steamship *Leviathan* and to make use of the Deal Beach (N. J.) radio station of the laboratories. Up to the time of the beginning of the tests the Deal Beach station was the American short-wave link for the trans-Atlantic radio telephone, and, of course, offered an ideal transmitting plant for the ship-to-shore wireless.

Four frequencies were assigned the Deal Beach station for the experiments. The bands were 3124, 4116, 6515 and 6630. Three other bands were assigned for use aboard the *Leviathan*, which were 3248, 5618 and 8450. During the tests which followed, the chief problem was to determine the most desirable wave-length or frequency which would permit reliable communication at least during the major portion of the trans-Atlantic crossing.

The problem which baffled the engineers most was that of maintaining reliable day and night communication with the liner while it changed its position on its voyage across the

ocean. The so-called skip-distance phenomena, which causes short-wave signals emanating from a fixed antenna to glance off at an obtuse angle, strike a layer of ionized atmosphere, commonly referred to as the Heaviside layer, and reflect back again, made the problem of selecting the most desirable wavelength difficult. It was found that while one channel would insure reliable communication when the vessel was in one location, as it progressed, the distance became greater and the signal began to weaken. It was then necessary to choose another wavelength in order to maintain a reliable signal standard.

This problem was overcome through the selection of four frequencies for the land station and three for the *Leviathan*. Frequency-controlling units were designed which could be switched into service by either the operator on the liner or at the land station. By merely throwing a switch, when it was noticed that the signals began to weaken, another channel could be chosen and the voice signals maintained at a constant level.

Another development brought out in the perfection of the land-to-sea radiophone is the use of an automatic volume control on the short-wave receivers used for reception of the voice. Through the use of this device it is possible to maintain a constant level on signals.

Following these six months of experimentation the land-to-sea telephone was perfected to the extent that it was thought to be satisfactory by the engineers and placed into actual operation on December 8, 1929. Although the Deal Beach transmitter was replaced by new apparatus for the opening of the new service, it virtually remained the same as the original experimental station.

A special short-wave receiving station was erected at

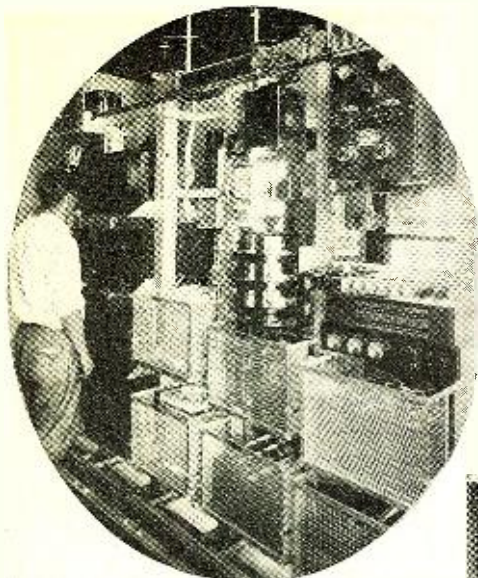

Shown above is the battery-operated equipment which provides power for the receiving set. An automatic device controls the voltage within a small fraction of a volt of that required for satisfactory operation

At the right is a special type receiving set designed to operate over a varied range of wavelengths. It is provided with switching devices to permit connection to any one of several antennæ

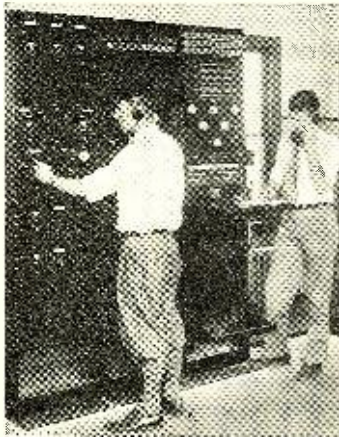

Forked River, N. J., not far from Atlantic City, where short-wave sets maintained a constant watch for the *Leviathan's* radio signals.

Transmission from Deal Beach is effected through a beam-type antenna which casts a directional signal in the general path of the *Leviathan*. This antenna consists of an interconnection of wires in the form of a coarse-meshed screen or curtain, the dimensions of which bear a direct relation to the wavelength or impulses sent out, the signals being strongest in a direction at right angles to the plane of the curtain. This type of antenna permits the reflection of the signals oceanward and gives practically no radiation in the opposite direction.

One of the major problems encountered by the engineers during the experimental work in the development of the ship-to-shore radio-telephone was the necessity of closely locating the transmitter and receiving apparatus aboard the *Leviathan*. The problem was to permit simultaneous transmission and reception without interference. This was accomplished only after considerable research. It was found necessary to ground every stay wire aboard the ship to the hull in order to prevent re-radiation. This problem was eliminated on land by choosing the separate locations for the transmitting and receiving stations, which are nearly forty miles apart.

The *Leviathan* has completed less than a half-dozen round trips with the radio-telephone. However, during the first voyage westward twenty-nine calls from shore were made. On the first eastward run this number was far exceeded with a total of 130 calls. The record distance for a call during this run was made when the vessel was 2,400 miles east of New York City.

### Method of Handling Calls

Calls for the ship-to-shore telephone are handled exactly like those for the trans-Atlantic service. A special switchboard for handling all these messages has been installed at 24 Walker Street (New York City), where all calls for the ship at sea and foreign countries are distributed. All calls for the liners are routed through this board, where they are connected directly with the liner. Wires from this central are permanently connected with the transmitting station at Deal Beach and the receiving station at Forked River.

Rates for the ship-to-shore service are based on \$7 a minute, with a three-

minute minimum from New York. When the steamer is beyond certain limits at sea additional charge is made through a zoning system. Calls made from the interior of the country are charged at the ship-to-shore rate, plus the normal toll. Calls from some of the larger cities are given a special rate.

While the first ship-to-shore telephone to the *Leviathan* has been completed in co-operation with the United States Lines, Inc., it is expected that the service will be greatly expanded in the near future. The telephone company has already applied to the Federal Radio Commission for additional short-wave channels for expansion of the service.

### Great Future Is Indicated

An official of the telephone company recently told the writer that the service will be installed on any vessel desiring it. In the not far distant future, it is safe to predict, it will be possible to lift the hook on any one of the 20,000,000 telephones in the United States and register a call to a passenger on any one of the major trans-Atlantic liners. Several foreign steamship companies have already installed apparatus for maintaining service to England and Germany.

It is possible that before the end of the year, through the mutual agreement between these companies, it will be possible to converse with both American and foreign ships from either side of the Atlantic.

Further developments of ship-to-shore radio-telephone were revealed last March, when the White Star steamship *Majestic*, through the special efforts of its radio engineers, maintained contact with England during the entire westward voyage, and up until the vessel had passed Ellis Island.

The *Majestic* was the first of several British liners to be equipped. The record thus established is said to even surpass the results obtained with the equipment installed aboard the *Leviathan*. Communication was established with the short-wave transmitting station operated by the British Post Office at Rugby. Signals from

the liner were picked up by a receiving station at Baldock, Hertfordshire, about forty miles from London. From this point, conversations are sent by wire to the postoffice exchange in London, where connection is made with any telephone in Britain.



At the left are the monitoring panels on the speech input equipment

Below is shown a test board at which lines to the various overseas radio telephone stations are connected. At this board tests are conducted to insure satisfactory operation

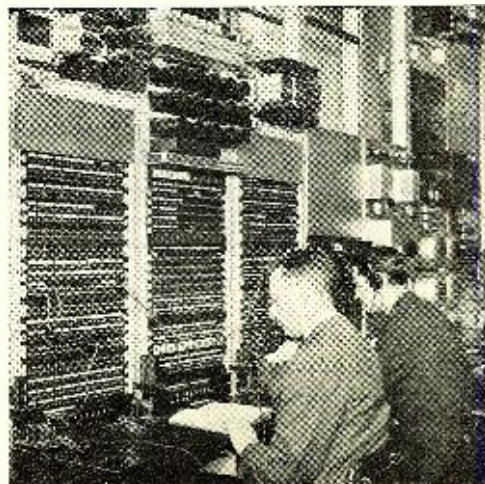

# How to Build the I. F. Amplifier for the RADIO NEWS *S-W Superheterodyne*

*Success or failure in the operation of a "super" usually depends on the care exercised in the planning and design of the intermediate-frequency amplifier. But once you have a good r.f. amplifier you can be sure of dependable, accurate results*

By Fred H. Schnell\* W9UZ

**I**N days gone by, the mere mention of a short-wave superheterodyne receiver was a general signal of alarm for everybody to throw up their hands in some degree of horror. Such a state of affairs had been brought about by the misconception of information that was sincere in all probability, yet which was incomplete. The general impression gained was that a short-wave superheterodyne receiver was a most terrible thing to make and even more difficult to operate. Even if such a receiver showed good results, using the three-element tubes, it always left the thought that it couldn't be duplicated and that something tricky was used to make it work. The sum total result has been that nobody (assuming he was in his right mind) would care to bother with such a receiver for fear that it wouldn't work after it was finished.

Let those thoughts vanish into the past. A short-wave superheterodyne receiver is more complicated than a three or four-tube receiver only by virtue of the additional parts used—nothing more. Once this thought is absorbed, there will be more short-wave superheterodyne receivers constructed and operated by those who want the desirable things they cannot get in a simple regenerative receiver. Even the novice short-wave broadcast listener might just as well get started now if he has any intentions of making this type of receiver. If he waits until the receiver is "perfected 100%"—he may wait a long, long time. No receiver is entirely that, nor is any automobile, for that matter. Just get the idea that the thing is practicable and satisfactory and enjoy it now.

The thought must be kept in mind that this particular receiver is not the last word in short-wave receivers—no receiver can ever be the last word for any length of time. It most

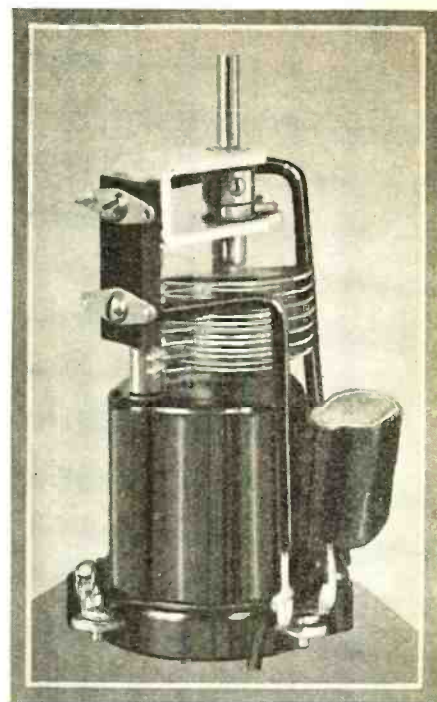

This illustration shows the assembly details of one of the r.f. amplifier coupler units, with shield can removed

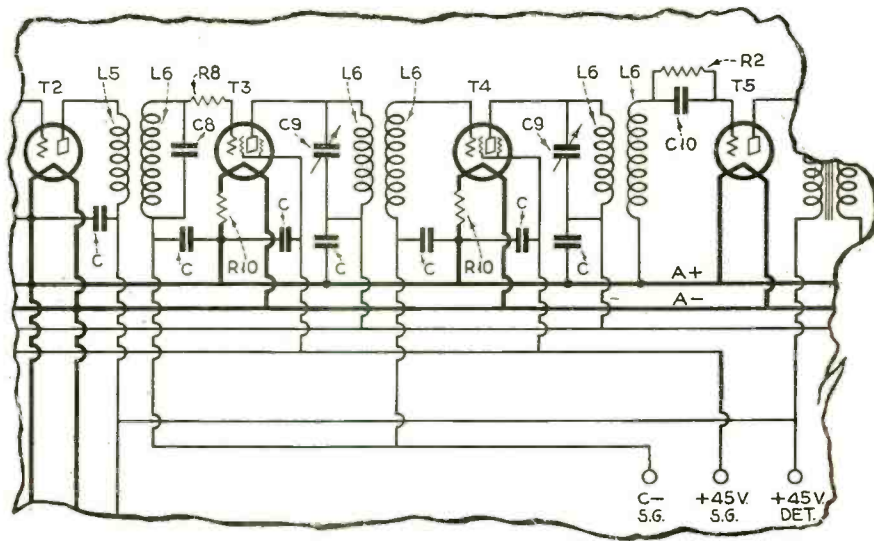

This part of the complete circuit (published last month) comprises the intermediate frequency amplifier, using two screen-grid tubes

probably should be considered as a step in the right direction. Very shortly there will be short-wave superheterodyne receivers using three or four intermediate radio-frequency stages, all operating on a.c. The signals will be far greater than this receiver can produce. Banish that attitude of fear, or whatever it is, and take the initiative toward improving any receiver you make. Six years ago it was said by some that it was impossible to make a single-control broadcast receiver that would sell—manufacturers have been making them and selling them for three years and they are many times superior in every respect. No receiver of six years ago can compare in any way with the average broadcast receiver of today, and there will be the same improvement or more in the next three years. So it is high time that something was done about this business of short-wave superheterodyne receivers, and more particularly since we have short-wave broadcasting practically every day from the different countries of the world.

After all is said about the difficulties of making a short-wave superheterodyne receiver, the whole thing centers around the

\*Chief of Staff, Radio & Television Institute, Chicago, Ill.

intermediate-frequency transformers. To list the many different ones which were tried out and measured would take a lot of unnecessary space. Finally, after getting on the right track, it was but a matter of picking one, which was only one of any number of good ones, and then using it in the receiver.

It wouldn't be fair to omit the name of Mr. E. T. Thineman, engineer in charge of the coil-winding department of Real Equity Company, 1331 North Wells Street, Chicago. Mr. Thineman and his assistant, whom I know as Margaret, were extremely patient and ever willing to wind coils and transformers until I thought they would run out of wire. A few turns more, a few turns less, a larger core, a greater diameter, a greater thickness, a different size wire—just a few of the things I asked. Yet, never a refusal. On the contrary, always a genuine spirit of co-operation and willingness, and if this be called advertising, let me say that without this assistance, RADIO NEWS wouldn't be getting this first chance at a receiver that otherwise wouldn't have been made. Mr. Thineman wound the coils which are used in this receiver and to him due credit. Coil details will follow.

After the coils were wound, dozens and dozens of them, they had to be measured. For this measurement work, I had to go to my close friend, good old reliable "Hoff," as we know him. "Hoff" is Mr. W. H. Hoffman, of the Burgess Battery Company, Madison, Wisconsin. Mr. Hoffman, of course, is in the radio laboratory (W9EK-W9XH), and only because he would do laboratory work in preference to anything else did he spend hours and hours late at night making

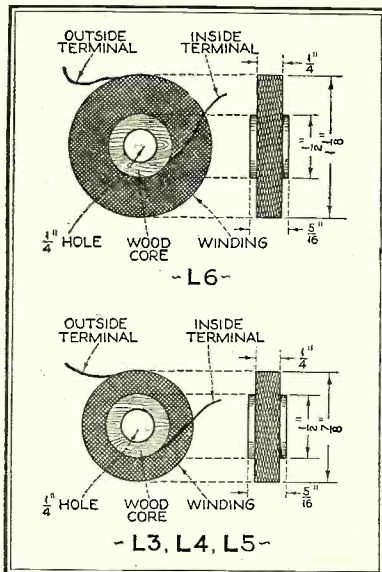

Coil winding details for the home-made coupling units of L3, L4, L5, L6. The table below gives further data on these coils

TABLE ONE			
Primary Coil	Secondary Coil	Voltage Amplification	Wavelength in Meters
1140 turns	1140 turns	73 per stage	1,970
900 "	1140 "	64 " "	1,725
*900 "	" "	70 " "	1,655
900 "	1260 "	61 " "	1,945
†900 "	900 "	69 " "	1,485
1260 "	900 "	64 " "	2,138
1260 "	400 "	19 " "	2,060
1140 "	800 "	64 " "	1,810
400 "	285 "	27 " "	533
400 "	400 "	47 " "	575
‡1140 "	1140 "	64 " "	1,728
§550 "	550 "	58 " "	1,175

a series of measurements, when he could have been operating his amateur station, W9WF. These measurements on voltage amplification, therefore, can be relied upon to be accurate within the smallest percentage of error, which in no case is greater than one per cent. or the possible error in splitting a degree on a Rawson multimeter. To Hoff—due credit and again the assistance which makes this article possible.

In Table One are the figures on the final family of coils used in the intermediate transformers, from which the coils were selected. The coil \*900 was impedance coupled, no secondary being used. The coils †900, using 900 turns in the primary winding and 900 turns in the secondary winding, are the ones used in this receiver. The voltage gain is 69 per stage. The ‡1140 coils were spaced 1/2 inch. loose coupling. The §550 coils consisted of two each in the primary and two each in the secondary, staggered for tight coupling. Other than these mentioned, the last two sets, the primary and secondary windings are tightly coupled; that is, the primary winding is separated from the

secondary winding by a very thin sheet of paper. The primary coils, in each case, were tuned with a 50-mmfd. condenser set at 1/2 maximum capacity. All measurements were made at 20 millivolts input, using the 222 screen-grid tube. One thing not shown in the above measurements is a second peak of resonance, which seems to be the wavelength of the coil itself, less the tuning capacity. It is of no consequence in the receiver because the resonant peak is much above the second peak. For example, in the 900-

(Continued on page 256)

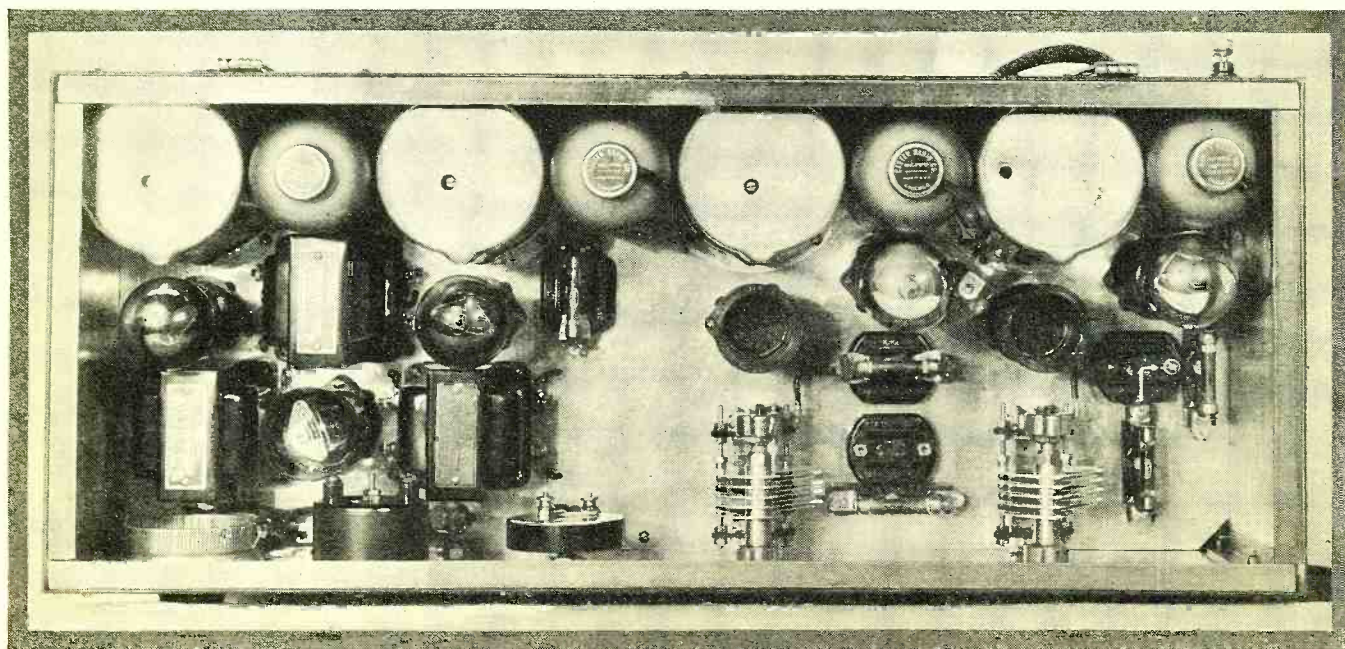

Looking down on the top of the Radio News Short-Wave Superheterodyne. The placement of the parts is clearly indicated



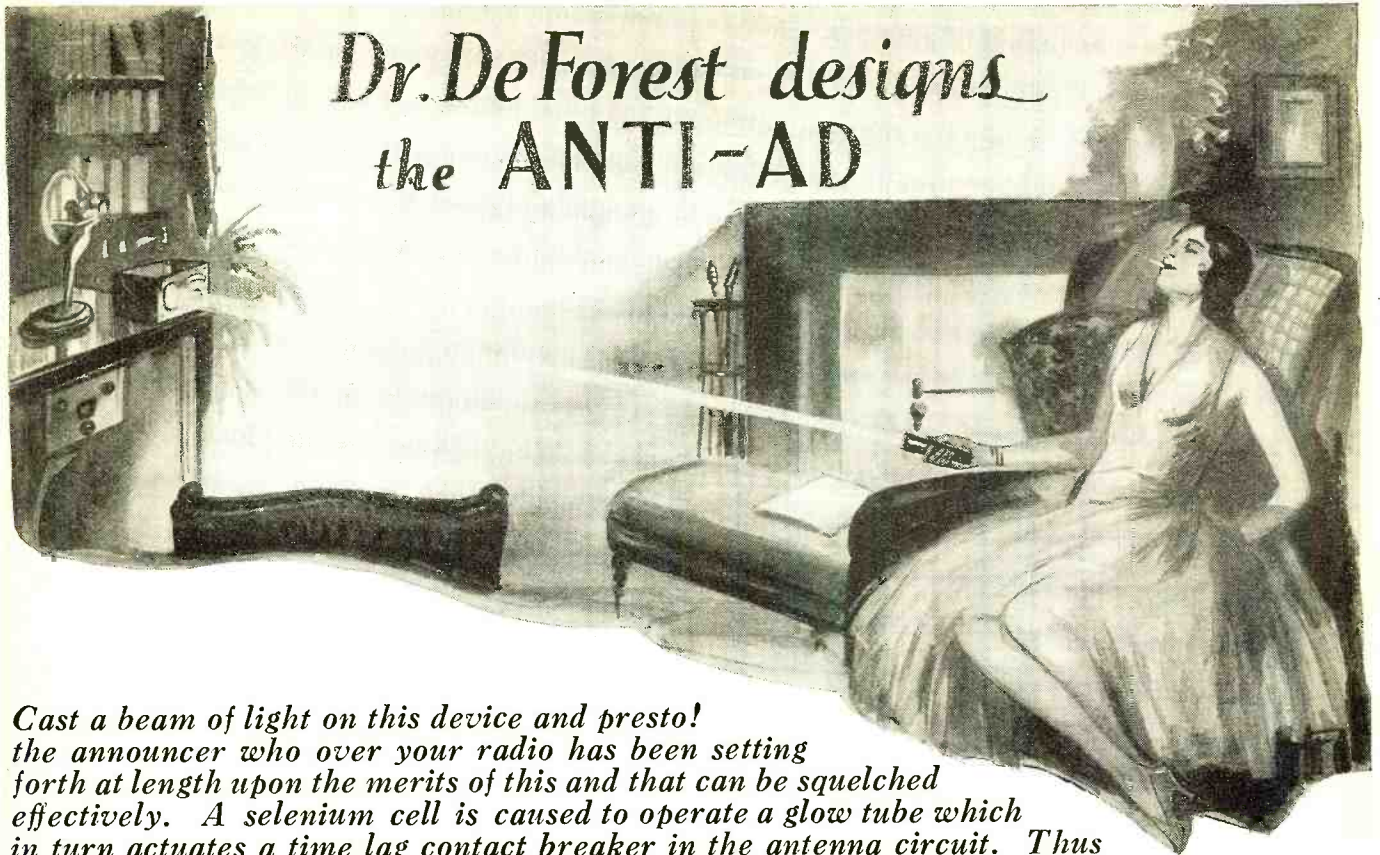

# Dr. De Forest designs the ANTI-AD

*Cast a beam of light on this device and presto! the announcer who over your radio has been setting forth at length upon the merits of this and that can be squelched effectively. A selenium cell is caused to operate a glow tube which in turn actuates a time lag contact breaker in the antenna circuit. Thus nauseating advertising blurbs are painlessly deleted from your enjoyment of otherwise fine programs*

By Dr. Lee DeForest

THE tendency of the present radio broadcast programs to degenerate more and more into crass commercialism and to devote a steadily increasing proportion of the time to exploiting the merits of every conceivable commodity from tooth-paste and cigarettes to household furniture and diamond rings is steadily diminishing the number of radio users or the hours for which the radio sets are turned on. One tires of continually getting up from his easy-chair every little while and going over to the dial, shutting off the set, or tuning it to another station as soon as the music of a program ceases and the blatant advertiser begins to announce his wares. So many of the best musical programs are nowadays more and more interrupted by these utterly uninteresting selling blurbs that although the radio listener realizes that in a few minutes, if he can endure the nuisance, the enjoyable part of the program will be resumed, he tires of continually running from his seat across the room to the radio set, and finally in disgust turns off the set altogether.

The remote control sets which are now coming into the market are enjoying ever increasing popularity, for which the advertising nuisance is largely responsible, offer one solution to the difficulty. But the nuisance of having a cable stretched across the room from the set to the easy-chair and the reading lamp, over which the missus and the children invariably trip, is a distinct disadvantage.

What the long-suffering radio user needs is a simple wireless device whereby he can instantly assassinate the advertising announcer and

allow the set to resume its musical outpourings when the story of the tooth-paste or furniture salesman is terminated.

The "Anti-Ad" device perfectly solves this problem. It consists of a small metal box approximately 6" square and 4" high which can be placed on top of the radio receiver or anywhere near it and is connected to the latter by a short flexible conductor cable. The "Anti-Ad" contains a selenium cell and a "grid glow" relay tube and simple relay. The selenium cell is set in the small end of a funnel-shaped shadow box so that it is not affected by daylight or the ordinary diffused lamp-light in a room. The current for energizing the selenium cell, the "grid-glow" tube and the relay is all supplied from the radio set through the two-conductor cord which is connected to a two-contact disc which is fitted over the plugs of the detector tube, and the tube is then plugged back into its socket. The antenna is taken direct to a binding-post on the back of the Anti-Ad and a lead from the second binding post on the same leads to the antenna binding post on the radio set. The relay acts to break the contact in the aerial, thus cutting off all incoming energy from the radio set.

All that the discriminating and ad-exhausted radio listener needs to have at hand in order to operate the Anti-Ad is a small flashlight, which can be had in very ornamental form, located within easy reach on the table or chair where he or she is seated. When the musical program ends and the advertising agony begins, she merely picks up this flashlight, presses the button, aims this (Continued on page 285)

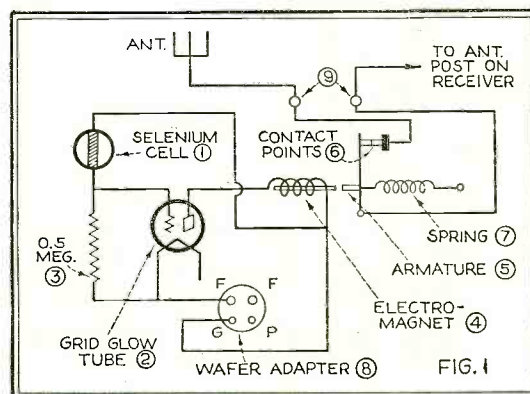

This is the circuit of Dr. DeForest's Anti-Ad. When the beam of light strikes the selenium cell (1); its resistance is lowered causing a voltage drop across the grid leak (3); and current to flow across the grid glow tube (2); operating the magnet (4); and breaking the antenna contacts (6).

# Radio Principles Govern the Technique of

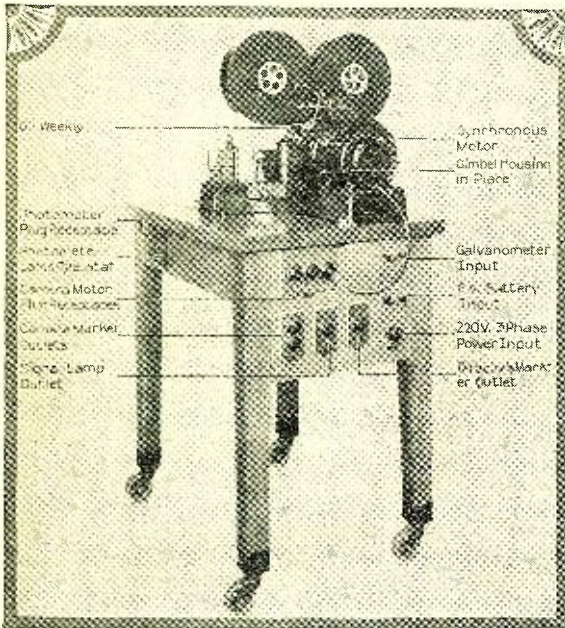

A recorder for taking both picture and sound, mounted on a specially constructed mobile table. The various parts of the recorder and the controls assembled in the table construction are labeled, above

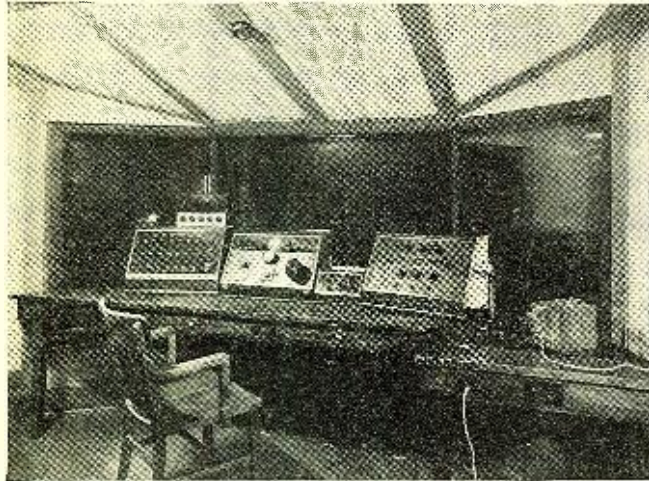

To the left, a photograph illustrating the monitor's mixing facilities at the Fox Studios

Below

A simplified schematic diagram of the optical portion of a variable area photographic recorder

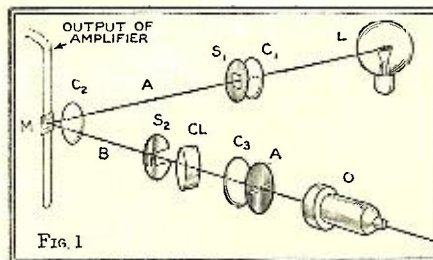

FIG. 1

*But—It Doesn't Necessarily Follow That the Merely Step Out of the Broadcast Studio Onto to Do Sound Movie Work. He Has Much to Clearly Outlined Here. Microphone Placement Properties of Stage Sets and Photo - Cell Problems Which the Sound*

score to a silent picture. The pick-up problems there are very similar to those encountered in broadcasting. The rest requires considerable education, often painful to all concerned.

Motion-picture stages are usually 60 to 80 feet wide, from 80 to over 300 feet long, and 25 to 50 feet high. In the larger dimensions such rooms, untreated, run to reverberation times of the order of 10 seconds and higher. Acoustic lining with such materials as felt, celotex, curtain material, wool packing of various kinds, or quilt, will reduce this figure, but in the case of a very large studio the period, particularly at low frequencies, cannot be brought down to a usable value for speech. (A higher reverberation period is in general permissible for music than for speech.) The remedy which has been adopted generally is to make the set itself of absorbing material, at least in part, and to box it in with absorbents as far as possible—sometimes quite completely. In this way it is possible to get down to a reverberation period of under one second within a medium size set, even at low frequencies. It may be asked whether there is any object, when the set itself is treated, in also lining the complete stage. The answer is in the affirmative, on the ground that some sound is likely to escape from the set, and then to get back into it after reflection from the walls. Wall and ceiling absorbents will reduce this disturbance to a point where it can be tolerated. In practice it is usually impossible to isolate a set acoustically with anything approaching perfection, because of the lighting requirements, ventilation, etc.

As a very rough approximation, useful only in preliminary surveys when some executive is waiting for a snap decision, one may assume that with the best sort of acoustic treatment the period of a room can be brought down to 1.0 second at 100 cycles for every 100,000 cubic feet of volume, and about 0.5 second per 100,000 cubic feet at 1,000 and 5,000 cycles. On this basis, asked to estimate on a stage 100 by 70 by 30 feet, one could safely figure that with its cubic content of slightly over 200,000 cubic feet it could be brought down to a reverberation period of 2.0 seconds at 100 cycles, and 1.0 second at the higher frequencies (1,000-5,000 cycles). A 50 by 50 set, well enclosed with absorbents, could be brought down below one second and would yield satisfactory results on speech, and a moderate reaction of sound escaping and coming back from the walls of

the stage could be tolerated.

Once the problem of reverberation has been satisfactorily solved, the technique of microphone placing consists in getting microphones as close to the actors as possible, and, in general, in the direction in which they talk. It is well known that high frequencies issue, both from a loud speaker and the human mouth, in a beam, much like the rays of a searchlight. As soon as the microphones are no longer in the beam, the

**S**OUND recording in a motion-picture studio presents a number of complications not encountered in broadcast pick-up, although the fundamental problems are the same. One difficulty is that picture studios are in general much larger than broadcasting rooms, with a consequently higher reverberation period. Then, in a broadcast studio, the arrangements, considered visually, are nobody's business as long as the resulting sound is satisfactory, whereas in the movies both sound and picture requirements must be met, with the performers, furthermore, moving about the stage instead of standing paralyzed before the microphone. What with all this, the broadcaster who thinks he can step out of a radio station into a picture studio and run the place is due for a rude awakening. All he can step into is an orchestration job; that is, adding a synchronized

\*Chief Sound Engineer, RKO Studios.

# Sound Recording

*Broadcast Receiver Engineer Need the Sound Stage and Feel Qualified Learn in the New Technique, as Is and Concealment, the Acoustical Adjustment Are Only a Few of the Engineer Must Solve*

By Carl Dreher\*

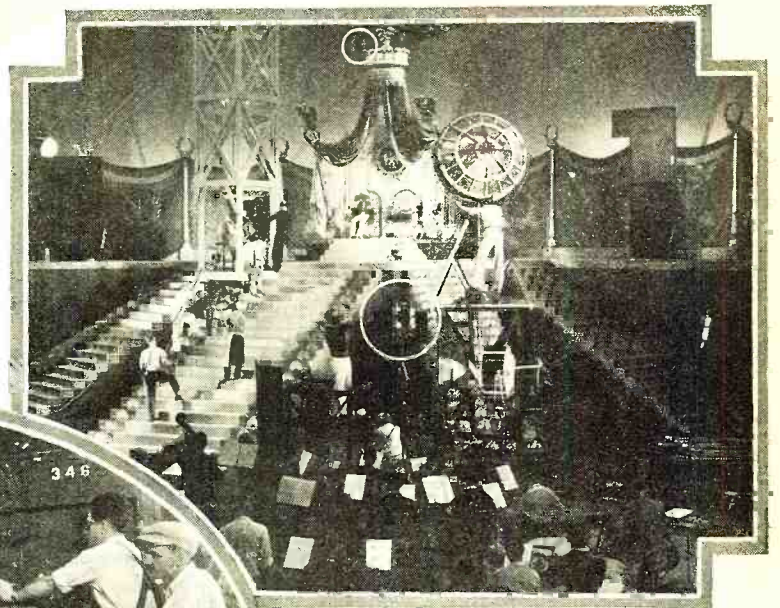

Courtesy RKO

Above, a shot from "Dixiana," an RKO picture showing an orchestra in the foreground, with the microphones for orchestration and speech indicated in the white circles

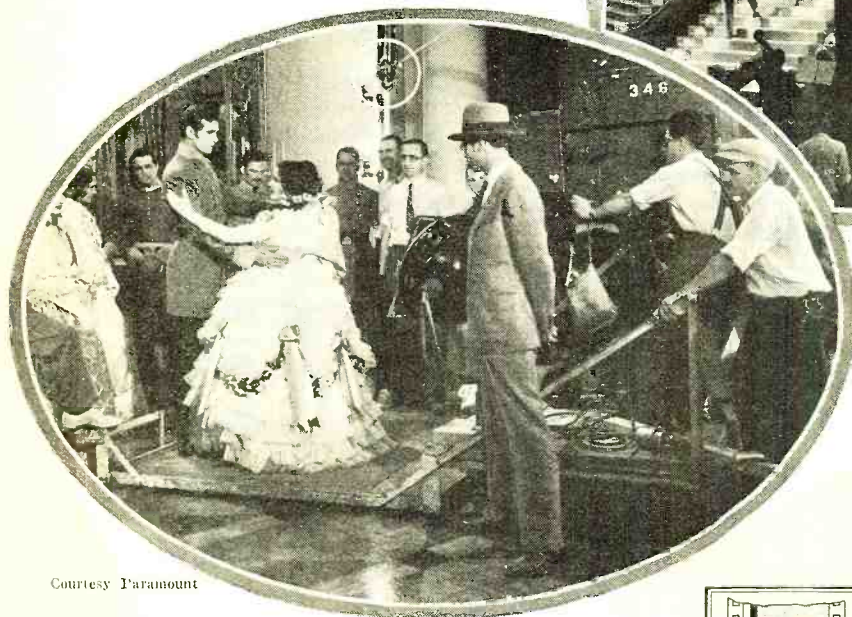

Courtesy Paramount

This mobile sound truck and platform permits the cameraman to follow the motion in the execution of the Virginia Reel in a ball-room scene from "Only the Brave," a Paramount picture. Note the location of the "mike"

intelligibility drops off. Thus, a microphone to one side of a speaker, or behind him, is unlikely to afford good speech pick-up. The question of distance is equally important. With the microphone close to the performer, the sound picked up directly predominates, while farther away as much sound may reach the microphone in the shape of reflection from the walls as directly. Thus, on a set with lively characteristics it is important to get the microphone close to the speakers for high-quality pick-up; as the absorption is increased, the permissible distance of pick-up becomes somewhat higher.

Various ingenious devices are utilized by the sound-movie technicians to get the microphones into the right positions in the set, without photographing them. Sometimes, when the camera is panned, *i.e.*, moved during the taking of the picture for the purpose of getting the desired photographic effect, the microphone is similarly swung, being kept just out of range of the camera during the process. Objects may be placed in the set for the purpose of hiding a microphone. Ornamental lamps, branches of trees, statues, and similar objects, are used for this purpose. The main trouble with many of these devices is reflection from the object itself interfering with the pick-up. Probably the most widely used pick-up position for speech, and the most useful, is with the transmitters hanging in front of the actors and above their heads, just out of the camera field. Another common position is off to one side.

In the construction of anti-reverberant sets, absorbing materials like celotex, which resemble wood but offer higher absorption, are widely utilized. In room scenes the same furnishings

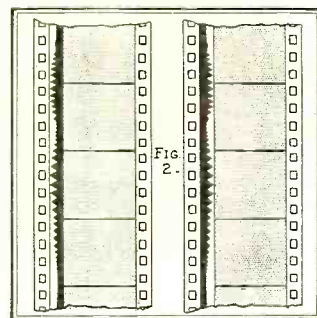

To the left, two strips of sound track film before and after developing, showing the position of the track to the inside of the film before developing and to the outside after printing

that deaden a room acoustically under actual living conditions are available for motion-picture purposes. These include over-stuffed furniture, drapes, hangings, heavy carpets, etc. The reverberation problem is least formidable in outdoor work, naturally, but the problem of shutting out foreign sounds takes its place. The only way of solving this, in general, is through good judgment in choice of locations. The machinery of picture making itself is a possible source of noise disturbance, and must be treated accordingly. Frequently a gasoline-motor-driven direct-current generator goes along as a source of current for lights. This may also drive a motor generator supplying alternating current for picture-sound synchronization. Such machines must be placed at a sufficient distance from the set to prevent interference. As for accidental disturbances like low-flying airplanes, which are a prolific source of distress to the Hollywood sound-recording experts, usually luck and retakes are relied upon to combat these, although some producers make a practice of sending up captive balloons to keep the aerial intruders at a distance.

The technique of operating the sound recorders themselves

Below, the housing and adjustment details for the "string," the galvanometer movement which records the light variations on the sound track of the film

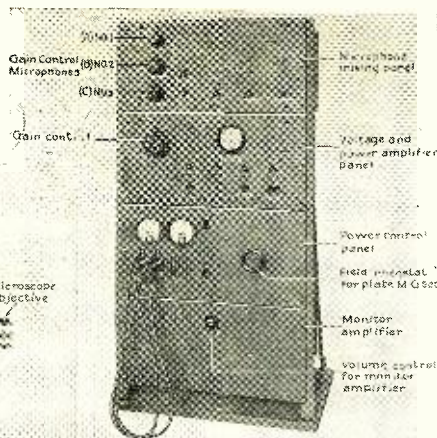
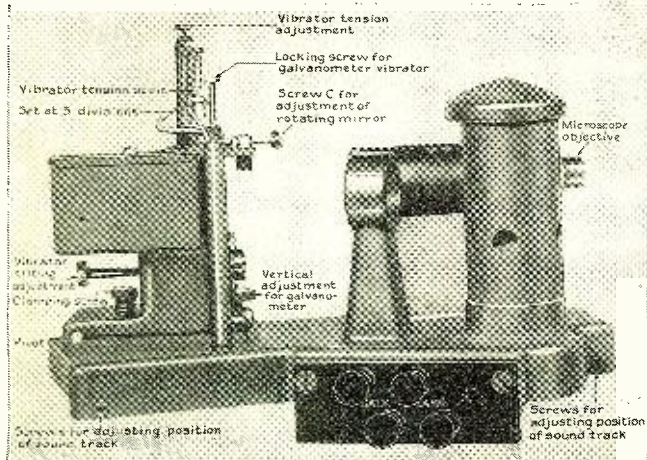

Above, a power and control panel with microphone mixer and voltage and power amplifier racks, used to convert the sound picked up by the microphone into electrical impulses

essentially it consists, in the bifilar string type used in sound work, of a wire loop stretched taut in a constant magnetic field, the two sides of the loop being close to each other, so that a small mirror may be bridged across them. The current to be recorded flows down one side of the loop and up the other, in directions at right angles to the permanent magnetic field of the instrument. As in other electrodynamic instruments, the constant magnetic field and the varying one interact to produce motion, which, in this case, takes the form of rotation of the loop with its mirror about a vertical axis. The wire is stretched, for sound recording purposes, to a suitable tension, so that it resonates at 4,000-7,000 cycles. As in broad-

cast monitoring practice, the oscillograph is tuned to a frequency above the usual working band of audio frequencies, for the same reason that a microphone diaphragm, for example, is adjusted by stretching it to a natural frequency above the cut-off point in the transmission system.

requires some treatment at this point. Since the functioning of the associated apparatus, such as microphones and amplifiers, is familiar to the readers of this department, only special aspects of its use will be touched on. One such point is the almost universal use of condenser transmitters in place of carbon microphones. One reason for this lies in the relatively low ground noise of the condenser transmitter. Since sound motion-picture pick-up in general involves greater distances from the transmitters than broadcasting, this is a more serious factor in the picture field. Another advantage of the condenser transmitter is that it may be tilted at any angle, whereas standard high-quality carbon microphones operate normally only in the vertical position.

Coming to the recorder proper, Fig. 1 shows a simplified schematic diagram of the optical portion of a variable-area photographic recorder. Such an instrument is described by H. B. Marvin in "A System of Motion Pictures with Sound," in the invaluable *Transactions of the Society of Motion Picture Engineers*, Vol. XII, No. 33, April, 1928, while some of the photometric aspects are discussed in the same journal by Arthur C. Hardy in "The Rendering of Tone Values in the Photographic Recording of Sound," Vol. XI, No. 31, September, 1927; "Optics of Sound Recording Systems," Vol. XII, No. 35, September, 1928; and in "The Optical System of the Oscillograph and Similar Recording Instruments," *Journal of the Optical Society of America*, Vol. 14, June, 1927, p. 505. Professor Hardy's two S. M. P. E. papers, cited above, also analyze variable-density recording.

In Fig. 1 the light source is an incandescent lamp, L, which is operated at high brilliancy from a 6- to 8-volt storage battery. The current supply for this lamp must necessarily be very constant. A spherical lens, C1, in conjunction with another lens, C2, focuses the light from L on the oscillograph mirror, M, through a light stop, S1, which acts as a framing device. The mirror, M, is attached to the vibrating element of the oscillograph which receives the audio output of the recording amplifier. The oscillograph is familiar to radio and electrical technicians and will not be described in detail here. Es-

The light passes through the lens C2 twice, once on its way to the mirror and again after reflection. Continuing to trace the path of the light in Fig. 1, we note, in order, a scale S2, on which, by utilization of the unused half of the beam, the amplitude of recording may be measured, a cylindrical lens CL, a spherical lens C3, and a horizontal slit A. These two lenses serve to focus the light on the slit and through this aperture on to the objective O. The whole system is lined up so that one edge of the light stop, S1, when there is no input to the microphones and the oscillograph mirror is in the neutral position, is imaged in the middle of the sound track on the film. The film is moved past this rectangle of light, which is 1.0 or 0.5 mil high in the direction of travel, with perfectly constant velocity (90 feet per minute). As long as no sound impinges on the microphone the resulting record (after development) appears as a dark band on the sound negative, covering half the width of the track on the inside. When sound is recorded, the oscillation of the mirror deflects the beam rapidly to one side and the other, producing a record like that in the upper half of the section of film shown in Fig. 2. Printing reverses the dark and light portions, so that the sound positive, corresponding to the sound negative, has the dark band during the absence of modulation on the outside of the track, close to the sprocket holes.

The objective O generally has a reduction ratio of 4 to 1, so that the aperture A may be 0.320 inch by 0.004 inch, say, to produce an image on the film 0.080 (Continued on page 262)

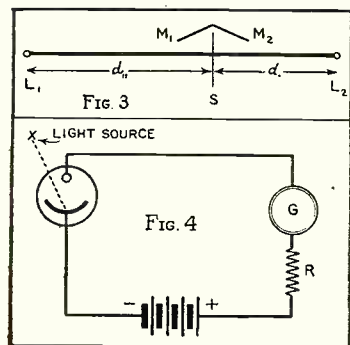
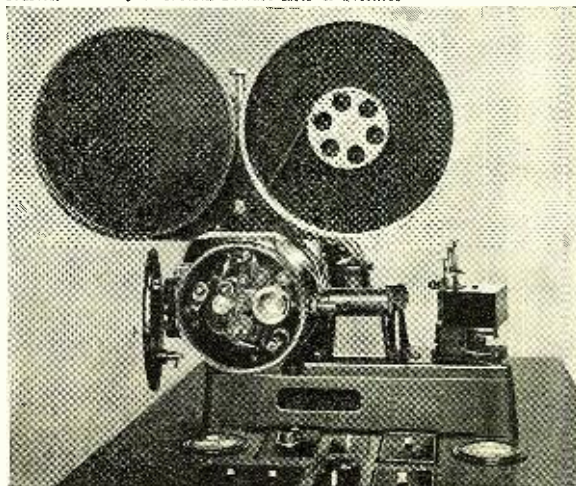

Fig. 3. Above, to the left a system employed to gauge the brightness of light from the exposure lamp. Fig. 4, below, a photo-cell arrangement employed as a substitute for the system shown in Fig. 3 for ascertaining exposure lamp brilliancy

This photograph illustrates the position of the galvanometer movement and its associated apparatus in the completely assembled recorder

Courtesy Academy of Motion Picture Arts & Sciences



# Practical Problems Encountered in the Design of Auto-Radio Systems

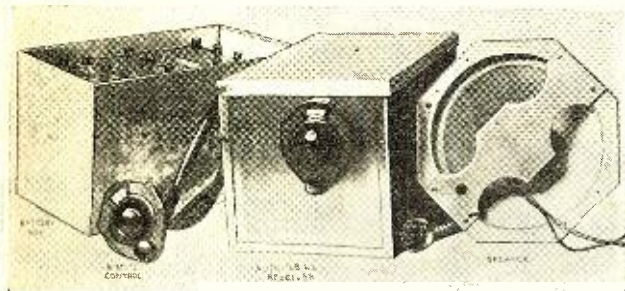

*Radio receivers satisfactory for use in automobiles are not merely compressed or revamped home broadcast receivers. Because of the special consideration which must be given to size, placement, manual control and the signal pick-up qualities of such a receiver a different method of attack is necessary*

By Charles R. Wexler\*

THERE is no question that automobile radio has "arrived." This has been no sudden outbreak, but rather a gradual development of several years. Two years ago we made our first receiver for automobile use, and look back at the earlier models with some degree of tolerance, in view of the rapid strides made in receiver design in the past two years. Then, as now, the following characteristics were considered—probably in order of their importance: (1) sensitivity, (2) selectivity, (3) quality, (4) size, (5) economy, (6) ruggedness. Although all of these characteristics are hardly independent, let us discuss each of these in detail.

The problem of sensitivity becomes more involved and more complicated the more we delve into it. Let us investigate certain phases. The advanced reader is familiar with the I. R. E. convention giving an antenna of .0002 mmfd. capacity, 20 microhenries inductance and 25-ohm resistance an effective height of four meters. This was intended to approximate an "average" antenna system. However, for automobile use, we are limited because of space to either a capacity type (wire or plate) antenna or a loop (coil) type antenna. The latter is objectionable because of the large size loop required for good pick-up and also because it is directional, necessitating constant turning while the car is in motion. Thus we must resort to the capacity antenna, and in view of the fact that we must confine ourselves to the physical limitations of

the automobile it is seen that the effective height is correspondingly low. Bearing in mind then that the average house antenna has an effective height of four meters, we can readily believe that the effective height of the automobile antenna is approximately one meter. Translating this into single terms, this means that if we connect a receiver to the four-meter effective height antenna and receive a station with a certain volume, to receive this station with the same volume on a one-meter effective height antenna in the same location the receiver would have to be four times as sensitive. Therefore we conclude from this that either we must be content with one-fourth the performance of an ordinary receiver, or we must design a receiver having four times the sensitivity of an ordinary receiver. To secure this great sensitivity, use has been made of the screen-grid tube. This tube in itself does not give greater gain if used in circuits which have been used in the past as those circuits were developed for use with particular tubes. To realize the tremendous amplification possibilities of the screen-grid tube it has been necessary to design radio-frequency transformers to make it possible. Much work has been done by various organizations and laboratories along (Continued on page 270)

\*Chief Engineer, Automatic Radio Mfg. Co.

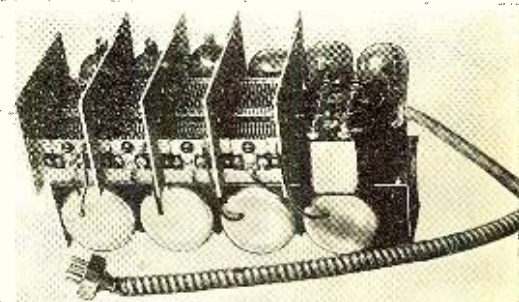
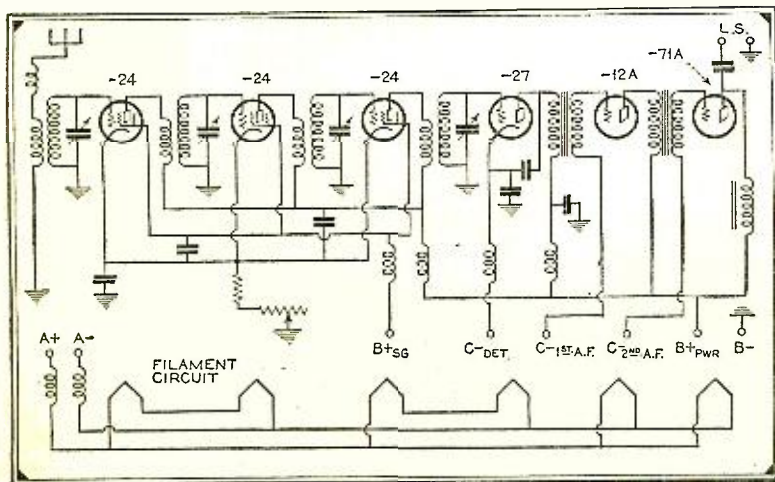

An illustration of the auto-radio chassis, showing the disposition of the tuner section, tubes and audio channel. The photograph at the top of the page illustrates the complete installation

This is the circuit employed in the Automatic Radio Manufacturing Company's six-tube auto receiver. Note the arrangement of the complete filament circuit

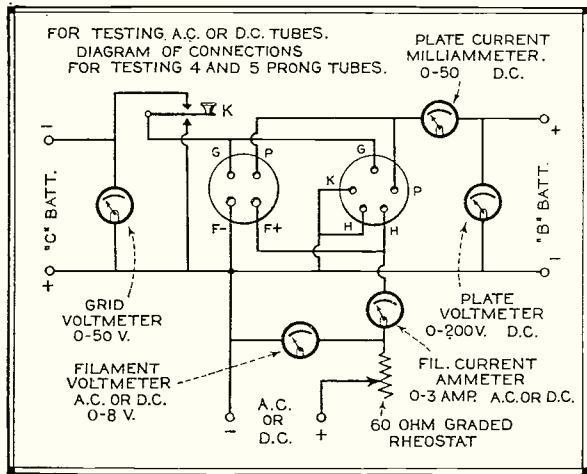

Fig. 1. The circuit for a tube tester recommended by Weston. The key "K" is used to alter the bias on the tube so as to obtain an idea of the tube's mutual conductance

A tabulation of plate currents for various types of tubes to be tested in the circuit shown in Fig. 2

TUBE	AVERAGE PLATE CURRENT K <sub>1</sub> OPEN	VALUES FOR TUBES K <sub>1</sub> CLOSED
-11	1-1.5	2-2.5
-12	1-1.5	2-2.5
-26	1.5	4
-45	3	11
-24	1	2.6
-27	1.5-2	3-5.5
-99	1.5	3
-20	2.5-3	5.5-6
-22	2	4-6
-12	2	6.5-7
-01A	1.7	4.5-5
-40	.7	1.7
-71	3.5-4	12-13
-71A	3.5-4	12-13
-00A	1.5	3.5
-10	2	6
-50	3	10.5
-12A	2	6.5-7

Of all the instruments that go to make up a modern radio receiver there are none which approach the tube in importance. Upon its operation depend all the qualities of which the owner of the receiver brags. The sensitivity of the receiver, the quality and volume of the reproduction, its economy of operation, all depend upon the tube. The receiver is a dead thing until the tubes are placed in the sockets and the power turned on. But from the time this final act is completed the receiver becomes, not a mere assembly of parts, but a stage upon which many interesting things can happen.

Most experimenters, servicemen and dealers, but probably few of the public, realize that the tube is the only part of a modern receiver over which they have any control. The modern receiver arrives completely assembled in a cabinet with the loud speaker, sometimes already supplied with a set of tubes. But when these tubes must be replaced, the owner is free to pick any make he prefers. He may have his own ideas regarding the companies who make good tubes, or he may rely entirely on the recommendation of a dealer or serviceman. But in any event, the replacement tubes *must* be chosen with care.

All the responsibility for satisfactory tube performance does not rest upon the manufacturer. The serviceman or the dealer who recommends or sells the tube must share this responsibility. The serviceman's responsibility is particularly great, for it is he who knows whether the tubes in the set are being operated under the proper voltage conditions as recommended by the tube manufacturer. It is the serviceman who must properly adjust the taps on the transformer to give the correct voltages on the tubes, and who must warn the user not to change the adjustment. A tube manufacturer is more familiar with his product than anyone else possibly can be, and when he sets the voltage limits for the proper operation of his tubes the user has no right to assume new ratings and then to expect a manufacturer to replace tubes that fail prematurely. Long healthy tube life can only be obtained by using them under proper conditions.

How can a user tell a good tube from a bad one? It is certainly true that one can't tell much about a tube by looking at it. When purchasing tubes the buyer must first of all choose a tube whose name is known to him. It is usually true that a purchaser of tubes gets exactly what he pays for, and if he wants freedom from replacement worries, he should purchase a tube whose name he knows, one that is nationally advertised and sold and backed by a manufacturer who has a reputation

# How to JUDGE TUBES

for making good products out of glass, metal and electrons. From the user's standpoint there are four rules to follow: 1, buy a well-known tube; 2, buy it from a responsible dealer; 3, have the tube tested at the time of purchase; 4, be sure to operate the tube under proper conditions.

And from the standpoint of the dealer who sells the tube, the rules to create satisfied customers are: 1, sell only well-known tubes; 2, test each tube before it is sold; 3, when possible have the serviceman make certain that the tubes are being operated under proper conditions.

Vacuum tubes in the early days were not what they are today. Anyone who remembers the old inefficient tungsten filaments knows that. Tubes weren't pumped as hard—they were gassy. No two tubes were alike. A number of "gyp" manufacturers, attracted by a rapidly growing market, began to make tubes—tubes that were not uniform, that were gassy and short-lived.

Today the picture is different. There are now perhaps a dozen reputable manufacturers of tubes for receivers and power apparatus—and yet the market has increased to a degree never dreamed of by the forefathers of radio. The tubes made by these manufacturers are uniform. They have longer life. The tube business is "shaking down"; it is becoming more a matter of engineering and less cut-and-try. The names of companies we hear of today, or see on tube cartons, are the names of organizations that have learned by experience how to make a good tube.

But just what is a "good tube"?

The discussion in the following text is an attempt to answer that question. It is presented especially for servicemen and dealers—whose responsibility to the public is great. These men are in close contact with the public and must daily answer the question, "What tube do you recommend?" The more the serviceman and dealer knows about tubes the better he can satisfy the user who wants a good product more than he wants a cheap price. Gone forever are the days of the salesman who was prone to say, "The less I know about a product the better I can sell it."

The standard types of tubes in use today have very nearly the same constants, no matter what company makes them. A type 201A tube, for example, has an amplification constant of eight, no matter who makes it. This is as it should be. It is only when the tubes of different manufacturers are uniform in their electrical characteristics that it becomes possible safely to replace any particular make of tube with the product of some other manufacturer. The uniformity in the characteristics of tubes can be appreciated by referring to the tube booklets issued by the various tube manufacturers. Every responsible tube manufacturer who is interested in his future is doing his best to build good tubes, tubes whose characteristics are good when the user buys them, and good for a long time afterward.

Differences among the products of tube manufacturers are

*Good tubes mean satisfied set-users and acceptable receiver performance. Servicemen and also experimenters are frequently given the job of "finding out what's wrong with this receiver." Simple tests of determining whether a tube lights or not, or whether it is microphonic, are not enough. Do the job right by acquainting yourself with tube operating characteristics and conditions of health*

**By James Martin**

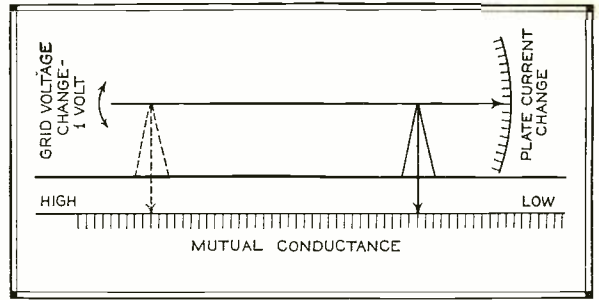

This diagram serves to illustrate the meaning of "mutual conductance." With the fulcrum at the solid-lined tripod at the right even a considerable grid swing will result only in a small plate current change, while for a high mutual conductance (dotted line tripod) a small grid swing will produce a large plate current change

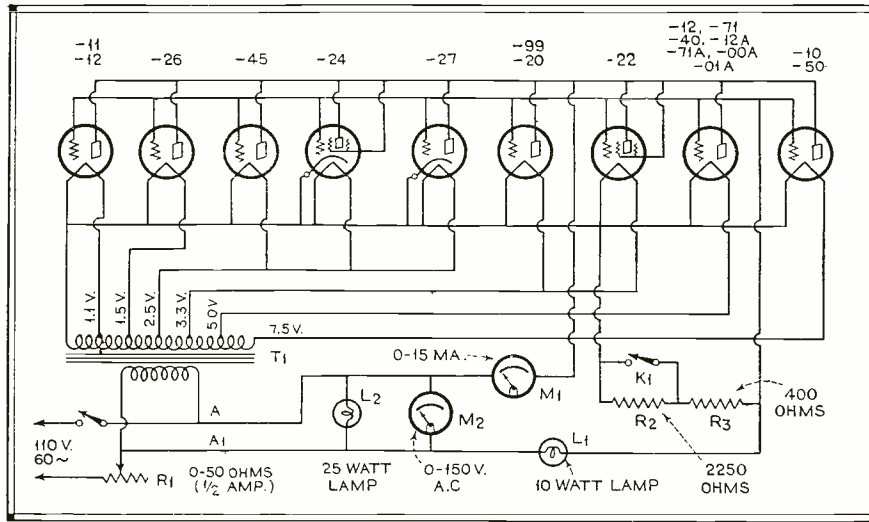

Fig. 2. A tube tester circuit recommended by Cunningham for determining the mutual conductance of a.c. or d.c. tubes

differences in mechanical construction, in pumping, in the choice of materials for the elements, in the methods of coating filament wire, in the methods of testing, and all these factors have a bearing on the life of the tube—one of the most important criterions on which to judge whether a particular tube deserves the appellation, "This is a good tube."

The fundamental characteristics of a tube involves the manufacturer alone, but the life of a tube involves both the manufacturer and the user. The best of tubes will blow up if certain wires in a receiver are crossed. The best of tubes will have a short life if its filament or plate are overloaded with voltage. The electrons which make the radio wheels go round are tireless workers, but their supply is limited. The best tube will give poor performance if it is forced to work under conditions for which it was not designed.

Tubes cannot be bought on faith alone. Faith in a particular make of tube must be built on a superstructure of knowledge of a responsible manufacturer in back of the product and upon always having tubes carefully tested at the time they are purchased. If these two points are considered, the average user will have done all he can to insure him his money's worth.

In the testing of tubes care must be taken to choose tests that will actually give some indication of tube performance. We must be sure not to go to the trouble of making some tests which must finally be discarded as useless. I remember reading a sportsman's recipe for cooking porcupines which included long stewings and changes of water. The recipe concluded with the advice to throw it all away without serving. We must be sure that in deciding what tests should be made that we don't

get in the same sort of jam—we don't want to go to a great deal of trouble to test tubes in a particular way, only to conclude that the tests we are making are not actually indicative of tube performance. Simple tests for plate current are especially apt to be misleading. A particular type of tube giving normal plate current at normal voltages might or might not be of the correct characteristics—some test besides a simple plate current reading is essential.

Some idea of the importance attached to the testing of tubes at the time they are sold is indicated by the fact that many tube manufacturers recommend such tests and also by the fact that many manufacturers of electrical instruments have designed special instruments for the testing of tubes. In the following paragraphs some data is given on the subject of tube testing and tube testing instruments which we hope may be of help to readers when they are called upon to check tubes.

The basis for any tests on tubes is a chart of standard tube characteristics such as that accompanying this article. These charts will be supplied gratis to anyone who writes to a tube manufacturer and requests the information. The data given in these charts, together with the other tube data which usually accompanies them, is invaluable, and we cannot recommend too strongly that readers write to the various prominent tube manufacturers for this information. It should be carefully filed so that it will always be available for future reference.

The tube characteristic which forms the basis for the operation of most tube tests is the "mutual conductance." This characteristic cannot be used to compare *different* type tubes, but it does serve as a good indicator of the worth of a *particular* type of tube. But before we can work out a simple method of testing mutual conductance we must know exactly what this expression means.

We all know that the tube operates on the fundamental idea that a change in grid voltage produces a change in plate current. Some types of tubes produce but a slight change in plate current for a given change in grid voltage, while other types of tubes produce a much larger change in plate current for the same grid voltage change. Now the extent of the change in plate current produced by a given change in grid voltage is known as the mutual conductance. That is,

$$\text{Mutual conductance} = \frac{\text{Change in plate current}}{\text{Change in grid voltage}}$$

The unit of mutual conductance is the "mho." But one mho is quite a large unit and so to get a working figure the mutual conductance is expressed in micromhos, one million micromhos being equal to one mho. That is, if the mutual conductance was found to be 0.0009 mhos, then we would multiply it by one million, which gives us 900 micromhos. If we will refer to Table 1 we will find that the (Continued on page 276)

# Tabulation of Tube Testers



Van Horne Tube Co.  
Model D

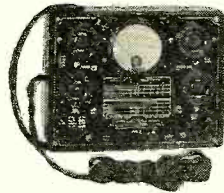

Radio Products Co.  
Model C



Burton Rogers  
Model F

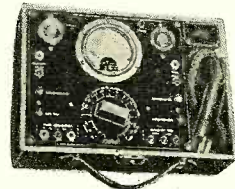

Radio Products Co.  
Set Analyzer

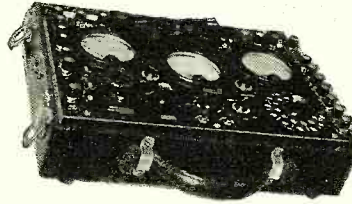

Weston Elec. Inst. Corp.  
Model 565

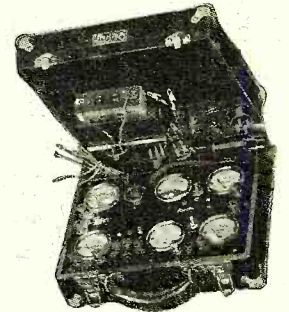

Sterling Mfg. Co.  
Model R-522

Manufacturer	Device	Price	Meter Ranges		Description
			Voltmeter	Milliammeter	
Burton Rogers Boston, Mass.	Tube Checker "C"	\$22.80	0-20-400 V.	0-20 Ma.	Universal tube checker works on 110 volts. Supplied with exploring tips and clips.
	Set Analyzer	58.50	0-4-8-160-800 A.C. 0-20-100-200-600 D.C.	0-20-100 Ma.	A portable unit with adapter plug for testing tubes in radio receiver.
Hickok Elec. Inst. Co. Cleveland, Ohio	Tube Tester "A.C.-47"	125.00	—	0-25	A tube tester, providing a direct reading of mutual conductance from a meter graduated in micromhos.
Jewell Elec. Inst. Co. Chicago, Ill.	Set Analyzer "199"	97.50	0-7.5-75-300-600 D.C. 0-4-8-16-160 A.C.	0-15-150 Ma.	A complete set tester and tube analyzer.
	"210"	48.75	A.C. Voltmeter 1.1 to 7.5 V.	0-100 Ma.	A portable tube tester having two meters, one of which reads arbitrarily the tube's amplification.
Radio Products Co. Dayton, Ohio	Auto-Radio Set Analyzer	66.00	0-1-5-10-100-200 V.	0-400 Mma. 0-5-10 Ma.	Portable unit with adapter especially intended for testing auto-radio receivers.
	Tube Checker "F"	38.75	0-30-300-600 V.	—	A tube tester for all types of tubes, including rectifiers.
Readrite Meter Works Bluffton, Ohio	Tube Tester "400"	20.00	—	0-30 Ma.	An a.c.-operated device for testing all types of tubes, including rectifiers, screen-grids and pentodes.
	Tube Tester "245"	20.00	0-10-140 V. 0-60-300 V. A.C. and D.C.	0-20-100 Ma.	A portable unit complete with test leads and clips. For all tubes.
Sterling Mfg. Co. Cleveland, Ohio	Portable Tube Tester R-522	67.50	0-150 V. A.C. 0-3-15 V. A.C. 0-10-125-500	0-10-100 Ma.	For all types of tubes. In a carrying case, complete with battery and test leads.
	R-511	—	0-3 V. 0-15 V. A.C.	0-15 Ma. 0-100 Ma.	Portable tube tester and re-activator.
Supreme Inst. Corp. Greenwood, Miss.	Tube Checker "17"	21.75	—	Double Scale	A portable single meter tube checker for all types of tubes.
	Radio Diagonometer "400-B"	139.50	4-scale Voltmeter D.C. 4-scale Voltmeter A.C.	3-scale Milli-ammeter 0-25-125 Ma.	A complete radio test outfit with r.f. oscillator and standard for capacity and resistance measurements.
Van Horne Tube Co. Franklin, Ohio	Tube Checker "D"	22.50	—	0-20 Ma.	Tests all tubes. A line-operated device.
	Tube Checker "555"	50.63	Variable Range 0-7.5 Volts	0-20 Ma.	A "counter" style tube checker for all tubes.
Weston Elec. Inst. Corp. Newark, N. J.	Set Analyzer "565"	140.63	8-range Voltmeter 13-range Volt-ohmmeter	Double-range D.C. Milli-ammeter 0-20-100 Ma. with Shunts	A tube checker and set tester equipped with oscillator and ohmmeter.



# and Tube Characteristics



Burton Rogers Model C



Supreme Inst. Corp. Tube Checker 17



Hickok Elec. Inst. Co. Model A.C. 47



Readrite Meter Works Model 245



Weston Elec. Inst. Corp. Model 555



Jewell Elec. Inst. Co. Model 210

The tube characteristics listed below hold true generally for all makes of tubes. However, if you are building a receiver to a mathematically prepared design, it is well to obtain the characteristic chart from the manufacturer whose tubes you use

GENERAL		DETECTION				AMPLIFICATION																
TYPE	USE	CIRCUIT REQUIRED	FIL. VOLTS	FIL. AMPS.	DET. GRID RETURN	GRID LEAK MEG.	DET. 'B' VOLTS	PLATE CURRENT M.A.	AMP. 'B' VOLTS	AMP. 'C' VOLTS	PLATE CURRENT M.A.	A.C. PLATE RESIS. IN OHMS	MUTUAL COND. M.MHOS	VOLTAGE AMP. FACTOR	MAX. UND. OUTPUT M.WATTS							
DETECTORS AND AMPLIFIERS	-11	DET. OR AMP.	TRANS. COUP.	1.1	.25	F +	3 TO 5	22.5-45	1.5	90	- 4.5	2.5	15,000	425	6.6	7						
	-12	DET. OR AMP.	TRANS. COUP.	5.0	.25	F +	3 TO 5	45	1.5	90	- 4.5	3.5	15,000	450	6.6	35						
	-99	DET. OR AMP.	TRANS. COUP.	3.0	.06	F +	2 TO 9	45	1.0	90	- 4.5	7.0	5,000	1500	8.0	30						
	-00A	DETECTOR	TRANS. OR RESIS. COUP.	5.0	.25	F -	2 TO 3	45	1.5	90	- 4.5	2.5	15,000	425	6.6	7						
	-01A	DET. OR AMP.	TRANS. COUP.	5.0	.25	F +	2 TO 9	45	1.5	90	- 4.5	3.0	11,000	725	8.0	15						
	-22	R.F. AMP. A.F. AMP.	SPECIAL SPECIAL	3.3	.132	----	----	----	----	135	- 1.5	1.5	850,000	350	300.0	----						
	-24	R.F. AMP.	SPECIAL	2.5	1.75	----	----	----	----	180	- 1.5	0.3	150,000	400	60.0	----						
	-26	AMPLIFIER A-C FIL. TYPE	TRANS. COUP.	1.5	1.05	----	----	----	----	180	- 1.5	4.0	400,000	1050	420.0	----						
	-27	DET. OR AMP. A-C HEATER TYPE	TRANS. COUP.	2.5	1.75	CATHODE	2 TO 9	45	2.0	90	- 6	3.0	10,000	900	9.0	30						
	-40	DET. OR AMP.	RESIS. COUP.	5.0	.25	F +	2 TO 5	135	0.3	135	- 1.5	0.2	150,000	200	30.0	----						
POWER AMPLIFIERS	-12A	POW. AMP.	NO L.S.C. REQ'D.	5.0	.25	----	----	----	135	- 9	7.0	5,000	1600	8.0	120							
	-20	POW. AMP.	NO L.S.C. REQ'D.	3.0	.125	----	----	----	180	- 10.5	9.5	4,700	1,700	8.0	185							
	-71A	POW. AMP.	L.S.C. REQ'D. EXCEPT AT 90 VOLTS	5.0	.25	----	----	----	180	- 13.5	6.5	4,700	1,700	8.0	275							
	-10	POW. AMP.	L.S.C.	7.5	1.25	----	----	----	250	- 18	10.0	6,000	1,330	8.0	340							
	-45	POW. AMP.	L.S.C.	2.5	1.50	----	----	----	300	- 22.5	13.0	5,600	1,450	8.0	600							
	-50	POW. AMP.	L.S.C.	7.5	1.25	----	----	----	400	- 22.5	18.0	5,000	1,600	8.0	1,000							
RECTIFIERS	-66	MERCURY VAPOR RECT.	HALF OR FULL-WAVE CIRCUIT	2.5	5.0	MAX. PEAK INVERSE VOLTAGE = 7500 V.				MAX. PEAK PLATE CURRENT = 0.6 AMPS.												
	-72	MERCURY VAPOR RECT.	HALF OR FULL-WAVE CIRCUIT	5.0	10.0	MAX. PEAK INVERSE VOLTAGE = 7500 V.				MAX. PEAK PLATE CURRENT = 2.5 AMPS.												
	-80	FULL-WAVE RECTIFIER	FULL-WAVE CIRCUIT	5.0	2.0	A-C PLATE VOLTAGE = 350 V. (R.M.S.) @				MAX. D.C. OUTPUT CURRENT (BOTH PLATES).....125 M.A.												
	-81	HALF-WAVE RECTIFIER	HALF OR FULL-WAVE CIRCUIT	7.5	1.25	A-C PLATE VOLTAGE = 700 V. (R.M.S.) (MAXIMUM)				A.C. PLATE VOLTAGE.....RECOMMENDED 650 D.C. OUTPUT CURRENT.....65 D.C. OUTPUT VOLT. APPLIED TO FILTER.....620												
GENERAL		OSC. OR R.F. POWER AMPLIFIER						A.F. POWER AMPLIFIER OR MODULATOR														
THREE ELECTRODE TYPE	USE	RATING WATTS	FIL. VOLTS	FIL. AMPS.	VOLT. AMP. FAC.	MAX. PLATE AMPS.	MAX. D-C OPER. VOLT. MODULAT'D	MAX. D-C OPER. VOLT. NON-MOD.	MAX. PLATE DISSIPATION WATTS	MAX. R.F. GRID AMPS.	MAX. PLATE VOLT.	MAX. PLATE WATTS	NORM. PLATE VOLT.	BIAS VOLT.	PLATE M.A.	NORM. OUT. WATTS	PLATE RESIS. OHMS	MUTUAL COND. M.MHOS	TYPE FIL.			
-10	OSC. AMP.	15	7.5	1.25	8	.06	425	500	15	5	----	----	----	----	----	----	5450	1550	OXIDE COATED			
-03A	OSCILLATOR	50	10	3.25	25	.175	1000	1250	100	7.5	----	----	----	----	----	----	5000	5000	OXIDE COATED			
-11	MODULATOR, AMP. OSC.	50	10	3.25	12	.175	1000	1250	100	7.5	1250	75	1000	-55	72	10	10	3400	3530	SPECIAL THORiated TUBES		
-45	MOD. AMP.	50	10	3.25	5	----	1000	1250	----	----	1250	75	1000	-150	75	20	2100	2380	SPECIAL THORiated TUBES			
-52	OSCILLATOR	75	10	3.25	12	.100	2000	3000	100	10	----	----	----	----	----	----	6000	2000	SPECIAL THORiated TUBES			
-04A	R.F. AMP. OSC.	250	11	3.85	25	.200	2000	2500	250	10	----	----	----	----	----	----	5000	5000	SPECIAL THORiated TUBES			
-00	OSCILLATOR	5000	15	8.5	15	.350	2000	3000	300	15	----	----	----	----	----	----	3800	3950	TUNG.			
-20B	R.F. AMP. OSC.	5000	22	30	----	.800	10,000	10,000	5000	20	NOTE: THIS TUBE WATER COOLED									----	----	TUNG.
FOUR ELECTRODE TYPE	USE	RATING WATTS	FIL. VOLTS	FIL. AMPS.	VOLT. AMP. FAC.	MAX. D-C OPER. VOLT. MODULAT'D	MAX. D-C OPER. VOLT. NON-MOD.	MAX. A.C. VOLTS R.M.S.	NORM. S.G. DISSIPAT'N IN WATTS	MAX. S.G. DISSIPAT'N IN WATTS	MAX. R.F. GRID AMPS.	AVERAGE PLATE RESIS.	MUTUAL COND. M.MHOS	DIRECT INTERNAL CAP. PLATE TO CONTR'L GRID	TYPE FIL.							
-60	R.F. AMP. OSC.	7.5	10	3.25	200	2000	3000	3000	500	100	10	10	150,000	1350	.05 M.MFD.	SPEC. THORiated TUNG.						
-65	R.F. AMP. OSC.	7.5	7.5	2.0	150	500	500	500	125	15	3	5	200,000	750	.05 M.MFD.	SPEC. THORiated TUNG.						
-61	R.F. AMP. OSC.	750	11	10	300	3000	4000	4000	750	400	35	10	133,000	2250	10 M.MFD.	SPEC. THORiated TUNG.						

# A New Deal for the Untuned R. F. Amplifier

*For a Time Untuned Radio-Frequency Coupling Units Were Extensively Used, But with the Increase in the Number of Broadcasting Stations and the Poor Frequency-Response Characteristic of These Transformers They Were Soon Relegated to the Junk Box. The Coming of Screen-Grid Tubes and Perfection in the Design of Untuned Transformers Having Satisfactory Performance Curves Have Done Much to Hasten Their Return to Active Service*

By Austin C. Lescarbours

**H**ISTORY seems to be repeating itself in the matter of radio-frequency amplification, or that boosting process in radio reception which precedes, rather than follows, the usual detector. When radio-frequency or r.f. amplification first made its appearance, it was in the form of fixed transformers not very unlike the usual audio amplifying equipment. However, the transformers were made up with relatively little iron, with far more delicate windings, and called for critical handling due to the idiosyncrasies of r.f. energy. Also, the fixed transformers, while called "untuned," actually did do some tuning, although over a considerable range. The early transformers were efficient only over a very narrow part of the broadcast wavelength band, which made the efficiency of the untuned r.f. amplifier a matter of much discussion.

Late in 1923 the successful untuned r.f. amplifier made its bow in the forms of home-made amplifiers making use of suitable r.f. transformers and complete, manufactured amplifiers. So much stress had been laid on the difficulties of taming the r.f. signal energy that the radio-minded public could hardly believe the news. Yet soon the regenerative detector had to make way for the untuned r.f. amplifier, introducing a marked simplicity in set operation if not some improvement in general efficiency. Shortly after, the tuned r.f. amplifier made its commercial appearance for broadcast reception purposes, and it was in 1924 that the stabilized and simplified tuned r.f. circuit, in the form of the famous neutrodyne, made its bid for public approval. Because of the possibility of charting or logging the various dials of the tuned r.f. amplifier to given readings, together with the higher amplification per stage for the tuned r.f. amplifier over the untuned type, this form soon gained preference over both regenerative detector circuit and untuned r.f. amplifier.

Early in the development of the untuned r.f. amplifier, Harry W. Houck, whose name has long been associated with important receiver developments such as

the superheterodyne, quite as well as with condensers, and his associates took a prominent part in this work. In 1923 the Dubilier duratran or untuned r.f. transformer was introduced, in the form of a compact bakelite case with four binding posts. This device, due to its high efficiency over the broad-

cast band, became quite popular and has continued so even in the face of important tuned r.f. amplifier developments. In more recent years, however, it has been employed mainly in portable sets, where compactness and light weight are prime requisites.

With the introduction of the screen-grid or four-element tube, presenting a new standard of high amplification constant, the engineering staff of the Dubilier organization undertook the design of a new duratran for use with the new tube. After many designs, experiments and tests, a screen-grid duratran has been evolved which provides remarkably high amplification per stage over the entire broadcast band, while retaining the greater

stability, all-round efficiency, marked simplicity and decreased cost of the untuned r.f. amplifier as contrasted with the tuned variety. The dimensions of the untuned r.f. amplifier, utilizing the screen-grid duratran are but a fraction of those of a corresponding tuned r.f. amplifier with variable condensers and inductance coils, and likewise with the weight and cost.

## Screen-Grid Duratran

The screen-grid duratran itself is of more than ordinary interest. It is a miniature transformer, utilizing a closed core made of special iron laminations .002 inch thick, L-shaped. There are two small air gaps in the closed core, accurately maintained by means of fibre spacing members. Opposite legs of the closed core carry the primary and secondary windings of exceedingly fine enameled wire. The r.f. energy of the signal is electro-magnetically transferred from one winding to the other. The assembly is placed in a metal can provided with the

---

**H**ARRY W. HOUCK, the designer of the untuned transformers employed in the circuit described here, will be remembered as one of the real oldtimers in radio. It was he who, with Major Edwin Armstrong, developed the superheterodyne receiver. As long as we can remember Harry Houck has been delving into the problems and possibilities associated with untuned r.f. transformers. As a matter of fact, our first job in radio was under the able direction of Mr. Houck, and, believe it or not, we were working on untuned r.f. transformers.

THE EDITOR.

---

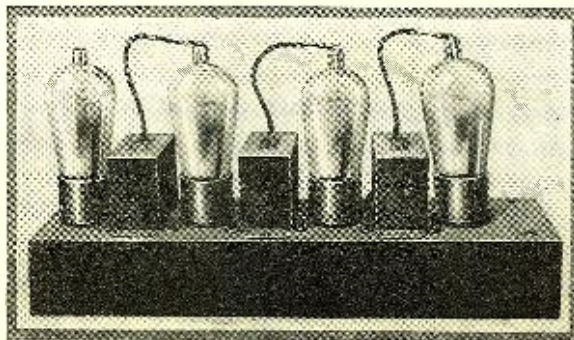

A three-stage screen-grid radio-frequency amplifier employing untuned coupling units interstage

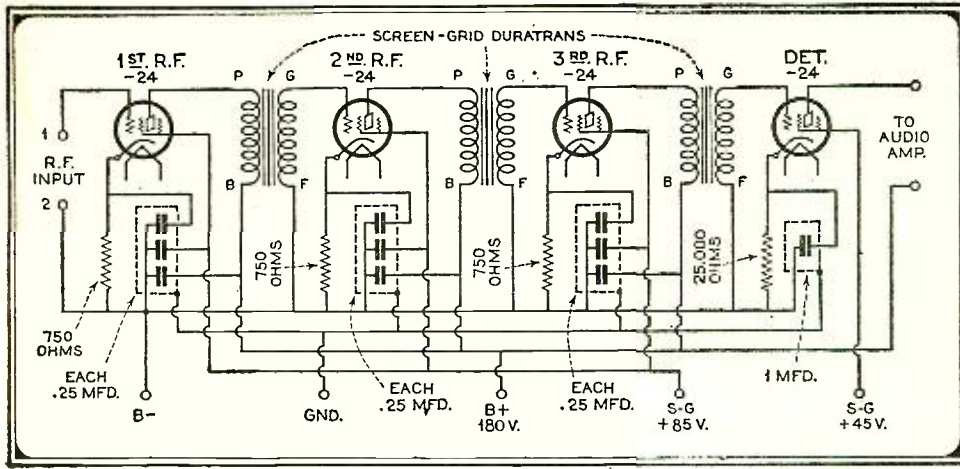

The fundamental circuit for the three-stage untuned r.f. screen-grid amplifier. A regular tuned input and audio amplifier complete the set-up

Below, the untuned r.f. transformer unit, showing its connecting leads, in particular that which connects to the screen-grid cap of the tube. Note the dimension of the unit

necessary pigtail leads, including the shielded control grid lead. The metal case is grounded. It is mounted upright, between tube sockets, in the usual assembly, keeping the wiring as short as possible.

With the screen-grid duratran, each stage represents approximately half the gain of the best tuned r.f. stage. However, a number of factors serve to reduce the theoretically greater gain of tune r.f. amplification. Firstly, more stages of screen-grid duratran amplification may be employed, because of the simplicity, compactness and low cost of this arrangement. Secondly, because of the accurate balance required for its several components, the commercial tuned r.f. stage is seldom operating at its full capabilities, at least throughout the broadcast range. The various stages are usually out of step at many points throughout the tuning range, even though they may be matched at the low, medium and high points. With the duratran stage, on the other hand, it is possible to obtain an amplification factor in excess of 10, while the amplification curve is practically flat from 550 to 1,500 kilocycles, or the full broadcast band, as contrasted with the uneven curve of the usual tuned r.f. amplifier. There is nothing to get out of step.

The circuit employing the screen-grid duratran is relatively simple, as shown in the accompanying diagram. The antenna tuning circuit and audio amplifier are not given, since these features are standard and require no reiteration in this brief statement.

It may be well, however, to analyze briefly the various types of antenna tuning circuits that may be employed for best results under different circumstances. In the portable receiver and the automobile receiver, the antenna circuit may consist of a loop for the wave interceptor, together with a single variable condenser shunted across the terminals. Such a circuit is connected with the input of the compact duratran amplifier. For ordinary purposes where extreme selectivity is not essential, the familiar primary and secondary antenna coil with variable condenser will serve as the input circuit. In congested localities requiring extreme selectivity, the best results are obtained by adding a band-pass filter in the primary circuit, increasing selectivity without adding to the tuning controls.

For best results, the constants given in the diagram should be strictly adhered to. The screen-grid duratran is

thoroughly shielded, being placed in a metal container with the control grid lead shielded and grounded thereto. The untuned r.f. amplifier may be mounted on a small panel or inverted metal case, with the necessary resistors and condensers below or concealed for utmost simplicity and compactness. The tube sockets and tubes may be placed between the duratrans, on top of panel or metal case.

All in all, history is about to repeat itself in the r.f. amplifier art. With the introduction of the screen-grid tube, together with the duratran designed to take advantage of the high-amplification constant of this tube, the untuned r.f. amplifier is certain to gain in popularity, particularly in portable, automobile, and the extremely compact and inexpensive receivers for use in the home.

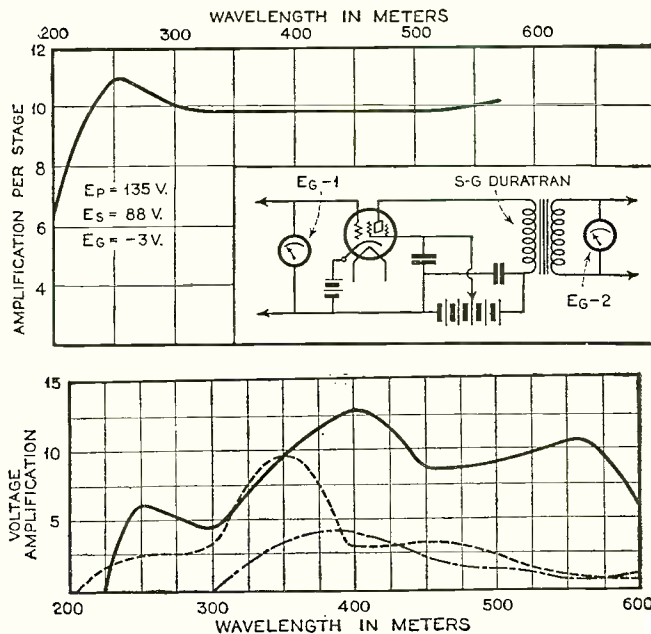
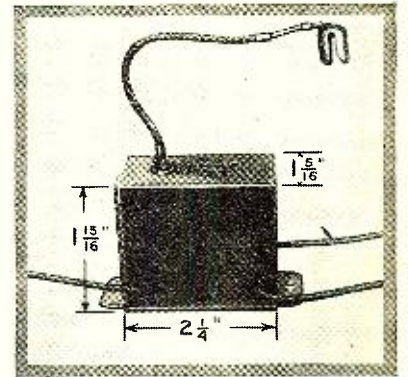

The circuit and curve above illustrate the practically flat frequency response obtained by the untuned r.f. transformer over a wave band ranging from 200 to 550 meters. The circuit shows the conditions obtaining at the time the transformer's characteristics were measured. Below, for comparison, some curves of typical untuned r.f. transformer of six or seven years ago. Note the uneven response obtained over the broadcast band

### New Receiver to Be Described

IN this article, which is the first of a group of two on untuned r.f. amplifiers, the general historical background has been presented together with some information on the circuit in which the newly designed untuned r.f. coupling units may be employed and used to advantage.

Mr. Houck has designed a simple receiver employing a radio-frequency amplifier consisting of a number of untuned screen-grid stages. The tuning end of this receiver consists of a standard, readily obtainable band-pass tuner unit employing three tuned circuits. In a forthcoming issue of RADIO NEWS this receiver's construction will be fully described.

# A Broadcast Using a Loftin-

By George E. Fleming

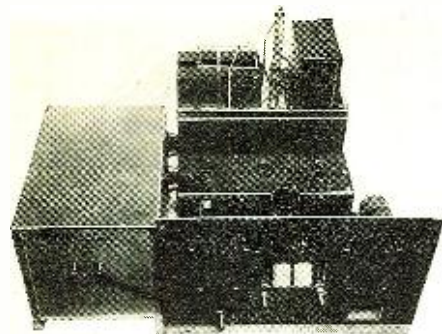

Assembly view of the three units. It will not be necessary to follow this layout exactly, if cabinet space requires another

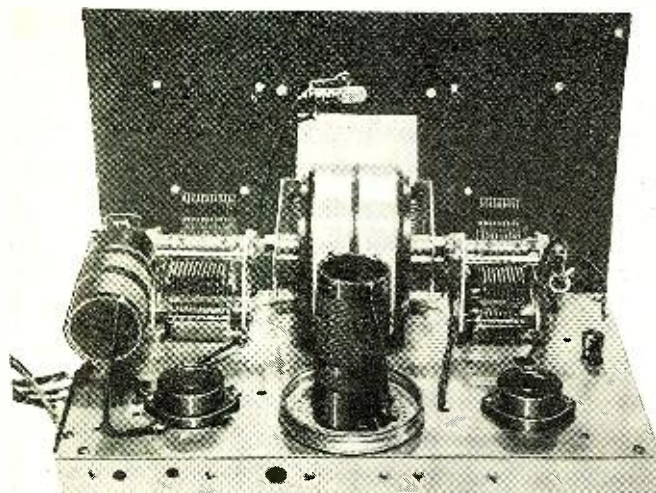

Back view of the detector oscillator unit. The relative position of the two coils is important to prevent stray coupling

FOR some months experiments have been conducted with the end in view of designing a receiver that would be on a par with the exceptional results that may be obtained from the Loftin-White system of audio amplification. The use of a superheterodyne immediately suggested itself, so this type was adopted. Various models were constructed, six in all, and the good points of each were noted. This, the seventh model, embodies all of the advantages of its predecessors, but with most of their kinks ironed out.

The modern broadcast receiver must have three attributes: sensitivity, selectivity, and excellent tone quality. The use of a superheterodyne assured the two first requirements, and the use of the Loftin-White audio assured the latter. Further, an effort has been made to make the entire assembly as flexible as possible. To this end, three units comprise the assembly, the first detector, or modulator tube, with the oscillator, comprise the first unit, while the second unit is made up of the two intermediate radio-frequency stages, and the second detector. The third unit is the power output stage, along with the power supply of the entire receiver. The physical relation of these units may vary greatly as long as the high potential leads connecting them are reasonably short. The layout as shown in the photograph is suggested, different conditions may also be met.

The idea of flexibility has been carried into the various units also. In cities like New York or Chicago, extreme selectivity is desirable. In other localities less selectivity will be desirable, as the receiver will be considerably easier to tune in if

it is not too selective, and the tone quality will be improved. In testing, another thing was noted; that was, if the tuning was sharpened to too great a degree in the first detector-oscillator stage, the condenser plates of the oscillator circuit were responsible for a very undesirable type of microphonics, due to their tendency to vibrate at their natural period. This alternately tuned and detuned the oscillator stage at this frequency, and if the tuning was too sharp, the tremendous attenuation of the signal when the tuning was slightly off the peak gave rise to the microphonic condition. This was readily overcome by so adjusting the tuning in this stage so that its resonance curve was not quite so sharp.

It will be noted that the oscillator is coupled to the first detector through a condenser and a high resistance. In order that this shall be the only source of coupling, the two coils should be placed at right angles, and the wiring of the two stages so run that there is little or no coupling between one wire and another. If this is done, the degree of coupling may be varied at will by varying the value of the resistance. This should be a resistance of the non-inductive type and so held in grid leak clips that its capacity to ground is negligible. Its value may be anywhere from 10,000 ohms to 100,000 ohms, depending on the degree of coupling necessary in any given case, and the value to use is best determined by experiment.

In purchasing condensers for tuning these two stages, care should be exercised to see that the plates are heavy enough to prevent

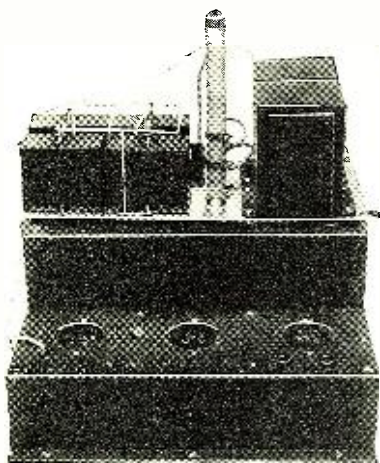

The audio unit. The power supply on its false deck is shown on the back deck of a commercial Loftin-White amplifier. The socket at the left is not used

This view of the intermediate amplifier clearly shows the type of construction used in the shield can, as well as the relative layout of parts. The .0001 variable condensers used to tune the intermediate are seen in the last two cans

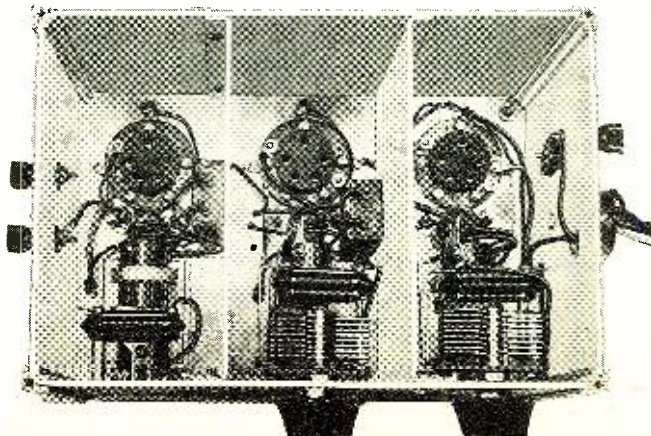

# SUPERHETERODYNE

## White Audio Channel

*In the "super," whose general design is described here, the Loftin-White audio amplifier has been employed to obtain well-nigh perfect audio reproduction. A following article will describe the actual constructional details*

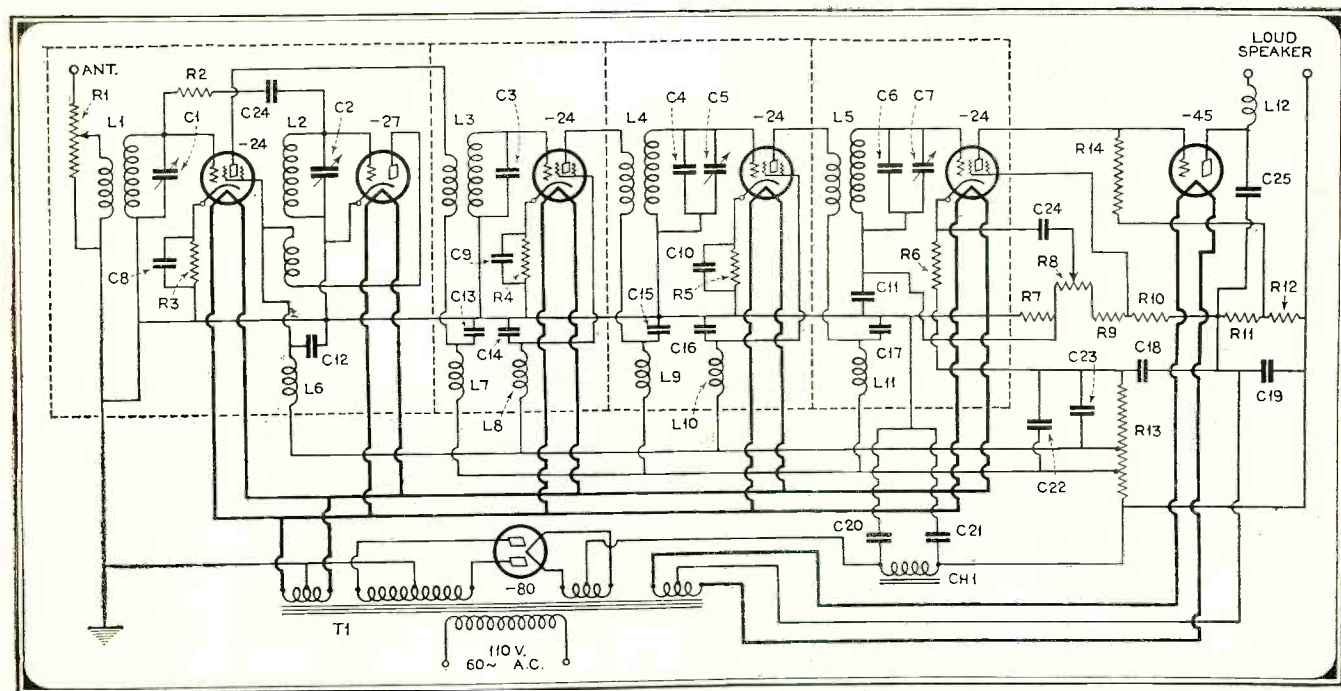

Schematic diagram of the superheterodyne. The components in the large dotted square are on the first detector oscillator unit, while those in the three dotted rectangles are in the intermediate amplifier shield can. All parts shown outside of the dotted lines are on the audio-power supply unit

vibration. Either the ones specified should be used or this precaution heeded.

The coils used in this section are not obtainable commercially in kit form, but must be constructed at home. The forms used are 1½-inch bakelite tubing wound No. 28 double silk-covered wire. Full instructions will be given later for the winding of these coils.

Now let us take up the intermediate amplifier. The "can" for this is made up of one unit subdivided into three sections to make individual stage shields. The entire unit is 1/16 aluminum, and is 7 inches high by 7 inches wide by 9 inches long. The length is divided into three sections approximately three inches wide. The first two of these stages are for the two radio-frequency stages, and the remaining one for the second detector. This can is commercially available or may be home constructed. All the joints of the can should be close fitting, and the entire assembly mounted on aluminum channel 1 inch high to permit wiring underneath.

The coils for the intermediate amplifier are not hard to construct, but as they are special they must be made by the builder. The mountings are made of 3-inch lengths of 1-inch bakelite tubing, with the coils slipped on. Full directions will be given

in the next issue for the construction of these coils.

The audio amplifier and power supply is probably the most difficult unit of the three to build. In the photographs a commercial amplifier is shown, with the additional parts necessary for the power supply added to the top deck. The constructor, however, may follow his fancy in the type of construction, for if reasonable care is exercised, any form may be used. Several of these units have been built on wooden bases, breadboard style, and have been perfectly satisfactory. If a commercial amplifier is used, the socket at the extreme left is not used, as the second detector is in the intermediate can. This manner of assembly requires the audio amplifier to be close to the intermediate amplifier, but in case one desires to place the audio unit at some distance from the intermediate unit, an alternate method of coupling will be described later.

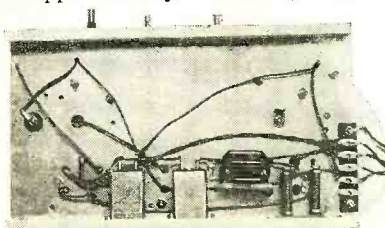

The method used in wiring is the point-to-point method. This reduces stray coupling to a minimum. The bottom of the first unit is indicative of this type of wiring

So that it may be possible for the constructor to obtain all necessary parts and thus be in a position to go right ahead with the assembly next month, we list here the parts actually used. If the constructor so desires, he may substitute other parts of like electrical characteristics and quality and still accomplish approximately the same results.

(Continued on page 281)

To the right, R. D. Kell, one of the assistants of Dr. E. F. W. Alexanderson, of the General Electric Company, operating the television theatre projector, showing how the picture is projected from backstage. Below, Matilda B. Russ, soprano, before the television camera and "mike" in the G. E. laboratory

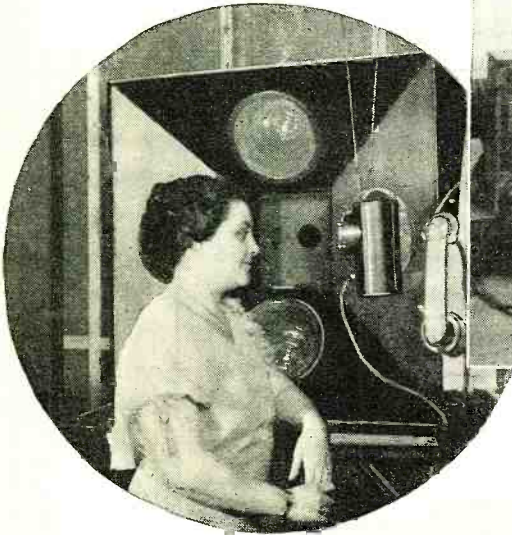
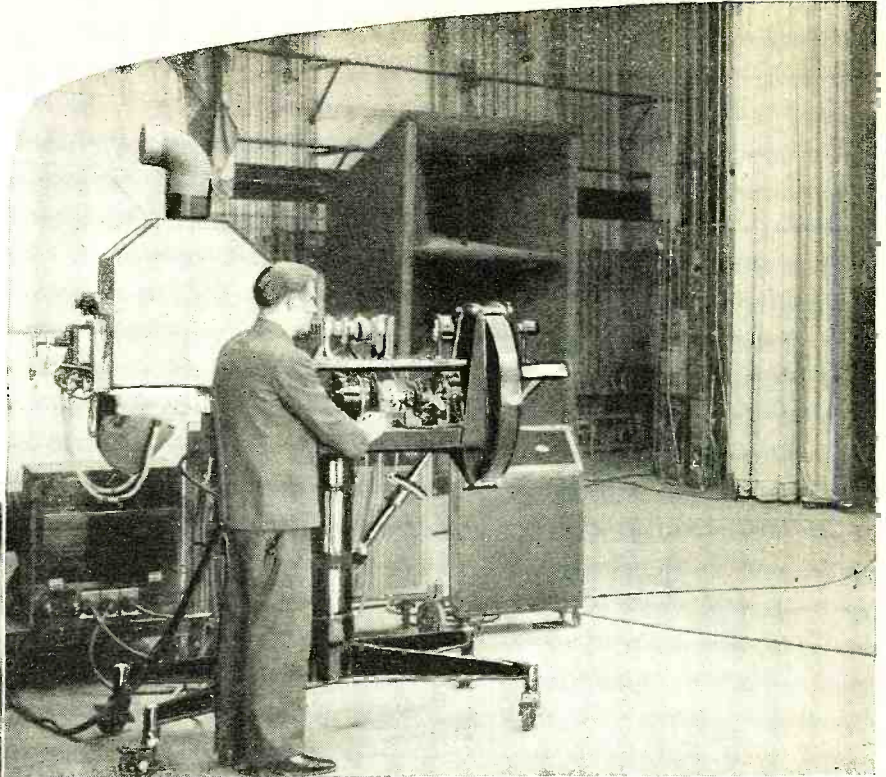

# TELEVISION

## from Peephole

*Most people are accustomed to think of along one of these days, but at present streaked picture which is viewed through ments have shifted the scene from*

By Edgar

**T**HE spectacular character of the recent television demonstration at the RKO theatre in Schenectady tended to overshadow the real significance of the event. A human face projected on a screen six feet square proved so startling a contrast to the best one-foot image heretofore seen at laboratory demonstrations and radio shows that its size was naturally emphasized in the newspaper accounts rather than the fundamental technical improvement disclosed.

After the audience of the first television performance in a regular theatre had been seated, the curtain rose, exposing a screen six feet square, approximately one-fourth the area of the standard motion picture screen. To one side of the screen was a pedestal with a telephone, where the host announcer stood awaiting a connection with the television studio in Dr. Alex-

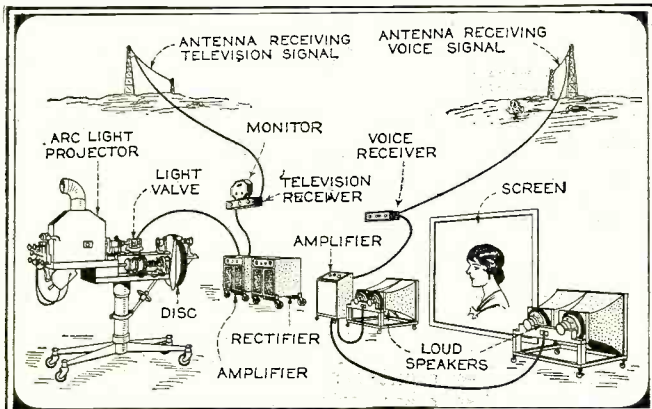

This pictorial drawing shows the apparatus which is employed at the receiving end of the radio-television set-up. Two receivers, one for radio voice reception and one for the television signals, are used

anderson's laboratory in the General Electric buildings nearly a mile away. The smiling face of Merrill Trainer, one of Dr. Alexanderson's laboratory assistants, soon appeared on the screen, much larger than life, answering the telephone at the other end, while his voice echoed realistically from the loud speakers back of the screen. Then a series of vaudeville actors took Trainer's place. Each did his act with his partner at the other end of the telephone line, the audience seeing and hearing one actor in person and the other through television projector and loud speaker. The finale of the program was an orchestra number with the conductor directing from the television studio a mile away.

### Quality of Reproduction Attained

The range of brilliancy of illumination seemed to be about half that to which we are accustomed from motion pictures. Good reproduction of the entire range of shading between the limits of illumination was retained. The artists were placed close enough to the television pick-up to avoid scanning more than a half bust view, which includes the head and neck, not

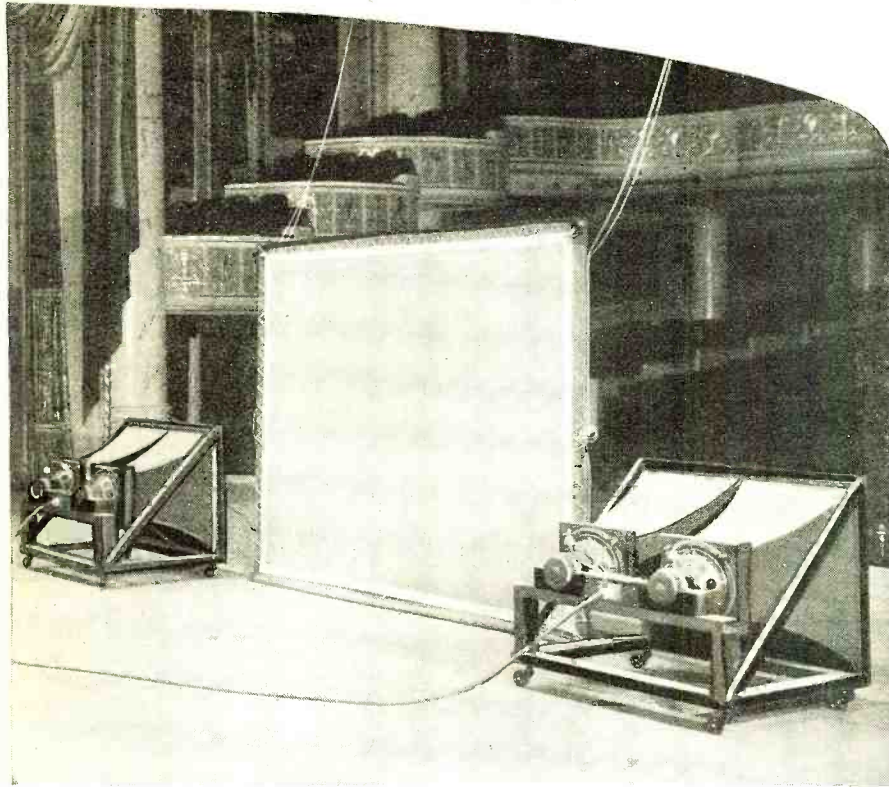

To the left, the battery of dynamic loud speakers is shown placed alongside the television screen. These speakers reproduce the radio voice which accompanies the picture. Below, a view of the incandescent lamp, which shines on the face of the person televised, in its housing

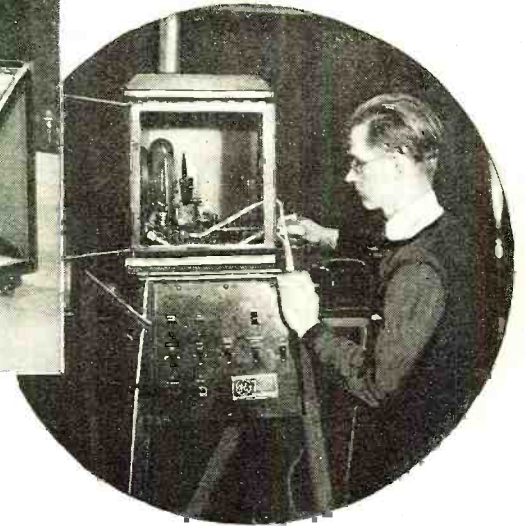

# ADVANCES to Screen

*television as something that is coming provides only a quite indistinct, wobbly, a peephole. However, recent developments have brought the laboratory to the theatre*

H. Felix

quite the entire width of the shoulders and down to about the position of the middle button of a man's coat.

Because of the large size to which the image was projected, it was easy to analyze the defects due to insufficient detail attributable to course scanning. Apparently, judging from the results of 48-line television suitably projected, 100-line television would give clear enough reproduction of simple subjects, such as close-ups of one or two individuals, to offer permanent and pleasing entertainment of a commercial character, provided, of course, that the use of television reproduction is justified by an element of real news value.

### The Scanning Process

The television system used at Schenectady involved conventional equipment up to the point of projection. The subjects stand before a spot of light projected through a 48-hole scanning disc which explores the field of reproduction about sixteen times a second. The light from the subject is reflected to a bank of photoelectric cells. Since the total reflection is largely influenced by the reflection of the exploring beam and that, in

turn, depends upon the shading of the spot being illuminated at each instant, the photoelectric cell amplifier output is proportionate to the shading of the area being scanned. The picture signal, after requisite amplification, was transmitted by wire line to South Schenectady and there projected by a 140-meter short-wave transmitter to the receiving antenna atop the theatre in the heart of Schenectady, a mile away. The radio receiver had a special audio system capable of amplifying the frequencies as high as 20,000 cycles, the maximum picture signal frequency. A small monitoring reproducer of the disc type as well as the new projector were supplied with the television signal picked up by the radio receiver.

### The Significance of the Light Valve

The importance of a projector having a high-frequency light shutter controlling a local light source is difficult to appreciate

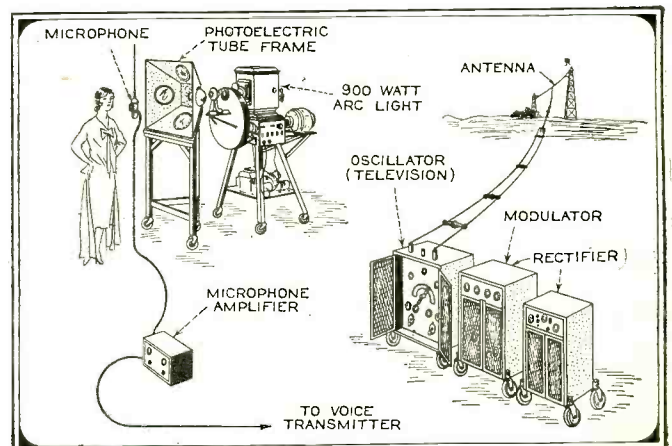

Here is shown the arrangement of the apparatus employed at the transmitting end of the circuit. Two transmitters, one for voice and one for television, are used

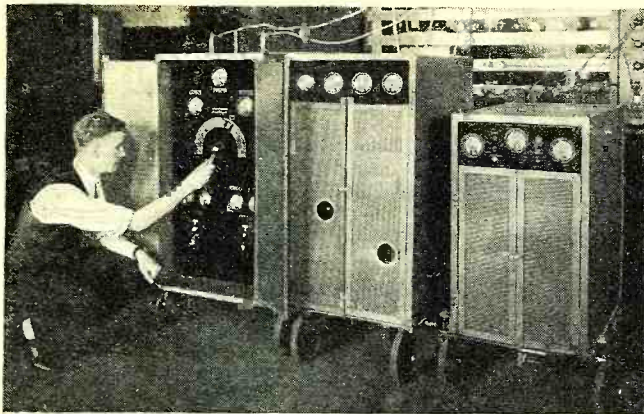

The transmitter of station W2XCW, operating on 139.5 meters for sending out the television signals from the General Electric Company's laboratory, is shown here. The units, from left to right, are: power amplifier, modulator and rectifier

This drawing serves to illustrate the rather complicated optical system employed in the scanning section of the televisior

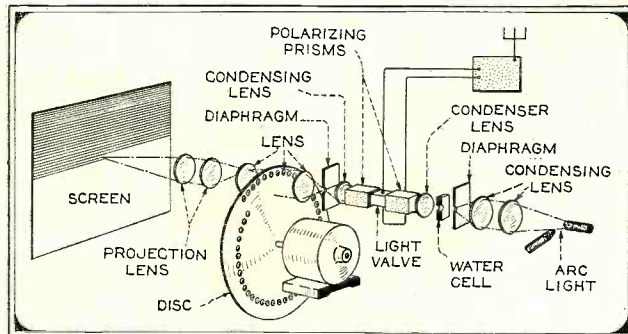

at this stage of development of television. The invention of the grid by De Forest was also but little appreciated at the time of its discovery. Yet that invention relieved radio communication of dependence upon the energy from a distant transmitter to determine the volume of signal reproduction. By means of vacuum tube amplifiers, any signal can be used to control any amount of local energy required by the reproducing system, the limit of amplification being only the parasitic noise introduced through the ether as interference and atmospheric disturbance and that set up within the receiver itself. The important feature of the vacuum tube amplifier is the fact that a large amount of local energy is controlled by a small amount of applied energy.

The invention first practically demonstrated at Schenectady is both analogous to and quite as significant to the development of television as the invention of the grid to electronic amplification. The projector accomplished for the first time high-frequency control of a local light source by a non-mechanical means. The light projected on the television screen originated from a commercial motion picture arc.

*Limitations of the Neon Tube*

Heretofore the only practical method of converting television signals to light depended upon bringing a rarified atmosphere of neon gas to luminosity by means of the two-element neon tube, the invention of Dr. D. McFarland Moore. The neon tube is amazingly rapid in its action and fully capable of handling picture signals representative of much greater detail than has so far been attained by any television system. At the two-way wire television demonstration conducted by the Bell System in New York recently, using 72-line scanning (double the number of picture elements of 48-line scanning), the reproduction was an optically enlarged view of a reproduction about two inches square. To produce this image, a somewhat larger neon tube than has been used heretofore was developed, capable of handling 200 milliamperes. It was necessary to employ water cooling, so large is the energy dissipated in heat.

Yet this was still "peep hole" television, limited to a single observer. Hence, when we consider the requirements of projection on the screen with the neon tube, it rises to the impractical proportions of a power device.

If a neon tube could be made to produce a maximum light as intense as the arc, it would be a simple matter to project its ray upon a screen through a scanning disc by merely reversing the scanning process at the transmitter. But such a powerful neon tube does not appear to be an early prospect.

The salient and outstanding feature of the General Electric development is a light valve controlling a powerful illumination source from a radio signal. Projection is accomplished by passing an intensely powerful beam of a standard 175-ampere motion picture arc through a high-frequency light valve through a scanning disc to a translucent screen to the eyes of the observers. The operation of the light valve is analogous to that of the grid of the vacuum tube by means of which a

small incoming impulse controls a relatively large space current obtained from a local plate battery. The light valve, like the grid, has no apparent inertia and can handle picture signals of any conceivable frequency.

The apparatus, which was built under the direction of Dr. E. F. W. Alexanderson, is expected to be as effective in handling television signals having frequencies up to a million cycles as it proved to be with light changes with a maximum rate of change of a twenty thousandth of a second, in-

involved in 48-line television.

*The Kerr Effect*

A principle long known to science is applied in this light valve. It is the discovery of a Scotchman, John Kerr, whose interest in physics was developed as a student and protégé of William Thomson, the great English physicist. Kerr observed that the direction of polarization of a beam of polarized light can be altered by passing it through an electrostatic field. Faraday had previously observed a similar phenomenon in connection with intense magnetic fields and the pioneer, Nipkow, who evolved the working fundamentals still used in present-day television systems, suggested the use of that phenomenon for projecting television. Kerr's electrostatic bending of polarized light was embodied in a practical light control device by Dr. August Karolus of Leipsig, Germany. The General Electric Company has obtained American rights to Dr. Karolus' inventions, which Dr. Alexanderson has built into a practical television projector.

*The Nature of Polarized Light*

It is difficult for the layman to understand the difference between a beam of polarized light and an ordinary ray. It is indeed a subtle distinction but worth understanding because polarized light exhibits properties of great prospective importance in television. A beam of polarized light can be deflected by magnetic and electrostatic fields in the same way that a stream of electrons in a vacuum can be controlled. Small changes in the direction of the beam of polarized light projected through certain crystals produces great changes in their intensity. The angle of maximum projection is determined by the structure of the crystal. By rotating the crystal about the angle of maximum light (Continued on page 268)

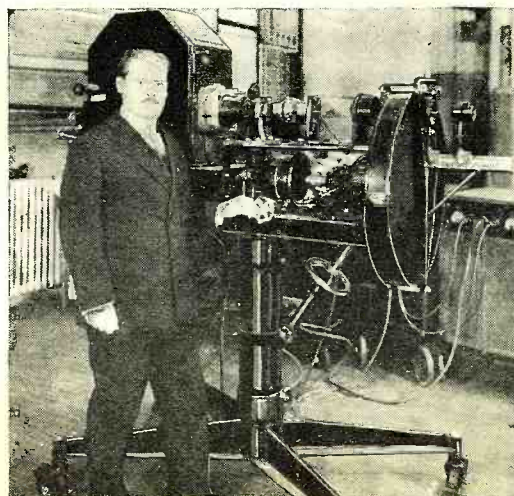

Dr. E. F. W. Alexanderson, engineer in charge of the radio consulting department of the General Electric Company, with his television receiver which projects the picture on the theatre screen



# Exacting Laboratory TESTS INSURE

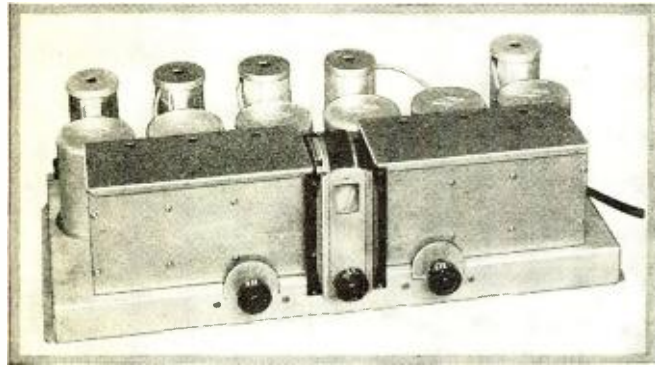

## Satisfactory Tuner OPERATION

By Glenn H. Browning and James Millen

*In former years a set builder was content to know that the receiver he contemplated building would cut through the "locals" and tune in that distant station XYZ with loud-speaker volume. Now he demands curves, graphs and tabulations indicating the order of the receiver's sensitivity, selectivity and tone quality. How well the laboratories are supplying this data is indicated in this article*

A PREVIOUS article in RADIO NEWS has already acquainted the reader with many of the engineering considerations connected with the design of the MB-30 so that it remains to take up the performance curves and give a few constructional details.

Those who have read the previous article will recall that the MB-30 is an extremely sensitive and selective kit radio-frequency tuner and detector, designed primarily to be used with a power amplifier such as the Velvetone. The fundamental idea behind the design of the tuner was to make available a very sensitive and selective de luxe receiver which will at the same time be absolutely stable (no tendency to oscillate, even with the volume control fully advanced), for those whose conditions demanded such a set. The tuner is also ideally suited for use with public address systems in hotels, theatres and halls where the high-grade radio "pick-up" is desired.

The MB-30 consists essentially of an antenna tuning system (Fig. 1) composed of two coupled tuned circuits so designed as to give a slight band-pass or John Stone "Stone tuner" effect. Besides the advantage of the band-admittance arrangement, the two tuned circuits eliminate entirely "cross talk" or "cross modulation" due to the receiver being located near a powerful broadcasting station. Following the first screen-grid amplifier tube is another band-pass circuit which adds selectivity to the system. The second screen-grid amplifier tube works into an untuned coupling stage whose primary function, besides amplification of signals, is to level out the radio-frequency gain over the broadcast spectrum. This untuned stage is followed by two stages of tuned radio-frequency amplification, culminating in a -27 power detector. Each of the separate units has been so designed that almost even sensitivity and selectivity have been achieved, for the band-pass circuits are sufficiently sharp on the high frequencies to make up for the broadness in the

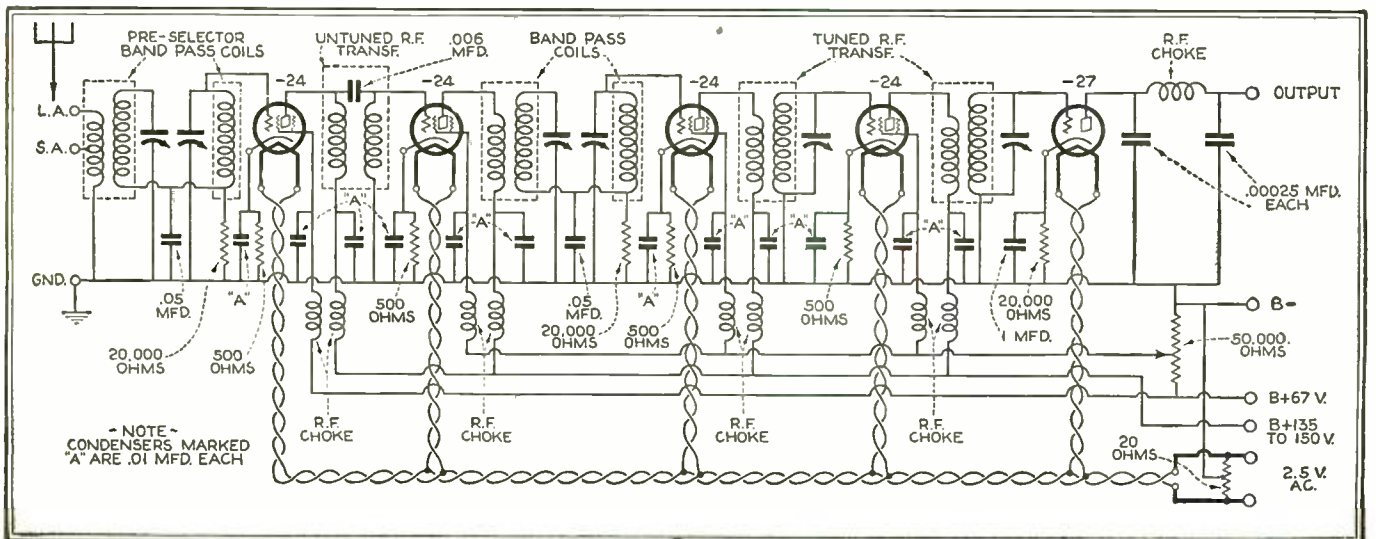
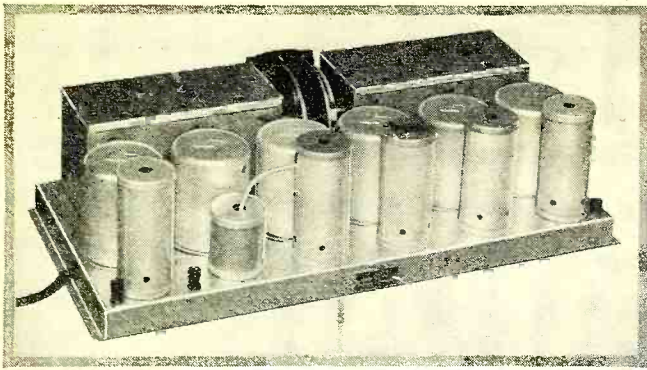

Fig. 1. The complete circuit of the five-tube tuner. Note the band pass or "Stone Tuner" circuit as used in the antenna tuning system. Note also that the second s.g. tube works into an untuned coupling stage for leveling out the overall r.f. gain of the tuner



A rear view of the tuner chassis, showing how even the tubes are enclosed in shield cans to prevent intercoupling effects from producing an unstable operating condition

Fig. 3 shows the selectivity curves of the tuner at 1,400, 1,000 and 600 kilocycles, indicating that from 30 microvolts down the three curves are practically superimposed one on the other

ordinary tuned r.f. stages, and the untuned stage gives more gain on the low frequencies to balance up for the loss in gain at those frequencies in the rest of the circuit. To obtain this result, four screen-grid radio-frequency amplifier tubes have been employed, and six tuned circuits.

The results of tests on the tuner, used in conjunction with a Velvetone audio amplifier and power supply, are shown in Figs. 2 and 3. These curves were taken with the new General Radio signal generator. Fig. 1 shows the sensitivity of the tuner over the broadcast band in microvolts per meter. These measurements were made employing a standard dummy antenna whose capacity was 200 micromicrofarads, resistance 25 ohms, and inductance 20 microhenries. Most readers are probably familiar with this method of measurement. It consists essentially of introducing into the receiver through a dummy antenna a modulated radio-frequency signal, such as is transmitted by a broadcasting station. This is generated by an extremely well shielded oscillator, whose output is known and variable. The output of the generator is read in microvolts. The signal put into the set by the generator is varied until an audio output of 50 milliwatts is obtained in the loud speaker. This output will give about the required volume in a medium sized room, provided the loud speaker is of average sensitivity. Signals from broadcasting stations are rated in microvolts per meter. That is, a vertical wire a meter long erected in a field strength of 2 microvolts per meter would pick up a signal of 2 microvolts. Ordinarily the antennae used with radio sets have an effective height of about four meters, so that if such an antenna were located in a field whose strength was 2 microvolts per meter the total signal put into the receiver would be 8 microvolts. Therefore, in measurements on radio sets it is common practice to determine the input to the dummy antenna in microvolts, which is necessary to produce the standard output of 50 milliwatts and divide by four to obtain the sensitivity in microvolts per meter.

Now let us examine the sensitivity curve of the tuner. At 1,400 kilocycles a field strength of .6 microvolt per meter will give a standard signal, while at 1,000 kc., the most sensitive point, only .45 of a microvolt per meter is necessary. At 600 kc. the sensitivity is less, as a field strength of 1.25 microvolts per meter is necessary for the same output. Thus the ratio in sensitivity throughout the broadcast band is less than three

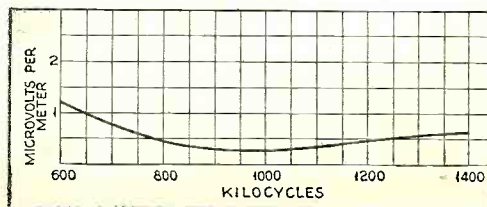
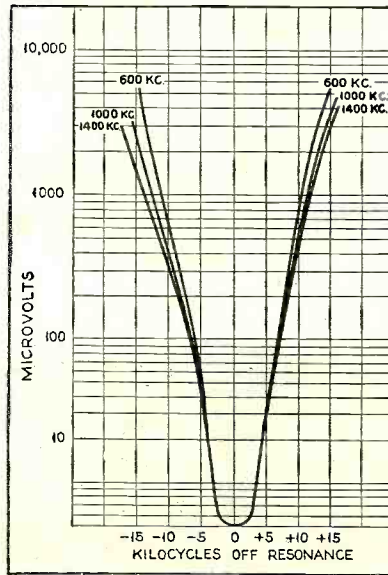

Fig. 2. The sensitivity of the tuner as represented by a curve charted in microvolts per meter. It will be seen that the ratio of sensitivity throughout the broadcast band is less than three to one, a most satisfactory condition

to one, which is most satisfactory, especially as the sensitivity throughout the band is always less than 1.5 microvolts per meter. In fact, sensitivities of around 3 microvolts per meter are sufficient for most practical purposes.

Fig. 3 shows the selectivity curves at 1,400, 1,000 and 600 kilocycles. In order that these curves might be readily compared, the volume control was adjusted so that a signal of 5 microvolts in the standard antenna, with the receiver tuned to resonance with the signal, gave the standard output of 50 milliwatts.

The curves are obtained by then leaving the receiver tuned to the signal generator and changing the signal frequency throughout the desired range, then determining the input signal at the various frequencies off resonance necessary to give 50 milliwatts output. The General Radio signal generator is particularly adapted to obtaining points on the curve near the resonant frequency, for an adjustment is provided for changing this frequency up to 1.5% of the resonant frequency. When, however, it is necessary to make measurements at frequencies further removed from the resonant frequency, the main oscillator dial must be changed.

The results of a series of such measurements on the MB-30 show the selectivity over the broadcast range to be very satisfactory. The three resonance curves taken at 1,400, 1,000 and 600 kc. practically fall on top of each other from 30 microvolts down. As will be noted, numerous points were taken close to the resonant frequency to determine how much band-pass effect was being obtained. If these resonance curves were too sharply peaked at the bottom, the quality of the receiver signals would be somewhat impaired for the high audio frequencies, which are the outer side bands of the carrier, would not be amplified as much as the lower ones. Thus these curves show that the audio frequencies 5,000 cycles either side of the carrier are amplified about 1/6th the amount of a 100-cycle note. However, that ratio is much better than usually obtained in a receiver of equal selectivity without band-pass tuning.

The curves show that if the receiver was tuned to a station which set up an input signal of 5 microvolts, that a station on an adjacent channel—i.e., 10 kilocycles either side of the station tuned to—would have to have a signal strength of approximately 60 to 90 times the signal strength to interfere seriously. It is convenient many times to rate the selectivity of a receiver by saying that the resonance curve is so many kilocycles wide at a hundred times the signal strength and so many kilocycles wide at say 10 times the signal strength. The ideal resonance curve would be one that was about 10 to 15 kc. wide at 10 times signal strength and approximately the same width at 100 times the signal input. That is, the resonance curve would be flat at the bottom with practically straight sides. However, that ideal is only one to be striven for—it is never obtained. As will be noted, the MB-30 is about 10 kc. wide at 10 times the input signal and 20 to 25 kc. wide at 100 times. That is, the curve doubles its width in going from 10 to 100 times.

The resonance or selectivity curves at the three frequencies are nearly the same, though there is a tendency for the receiver to be slightly broader at 1,400 kc. than at 600 kc. However, the usual tendency in tuned radio-frequency receivers—that of being much broader at 1,400 than at 600 kc.—has been largely overcome by the proper matching of the coupled circuits with the straight tuned radio-frequency stages. The two sides of the curves are not identical, in part due to the fact that perfect alignment of the tuning condensers is extremely difficult.

The MB-30 is put out as a kit set, but the construction is not at all difficult. The coils are all accurately matched and mounted in their shields, together with the proper by-pass condensers and radio-frequency chokes,

being much broader at 1,400 than at 600 kc.—has been largely overcome by the proper matching of the coupled circuits with the straight tuned radio-frequency stages. The two sides of the curves are not identical, in part due to the fact that perfect alignment of the tuning condensers is extremely difficult.

The MB-30 is put out as a kit set, but the construction is not at all difficult. The coils are all accurately matched and mounted in their shields, together with the proper by-pass condensers and radio-frequency chokes,

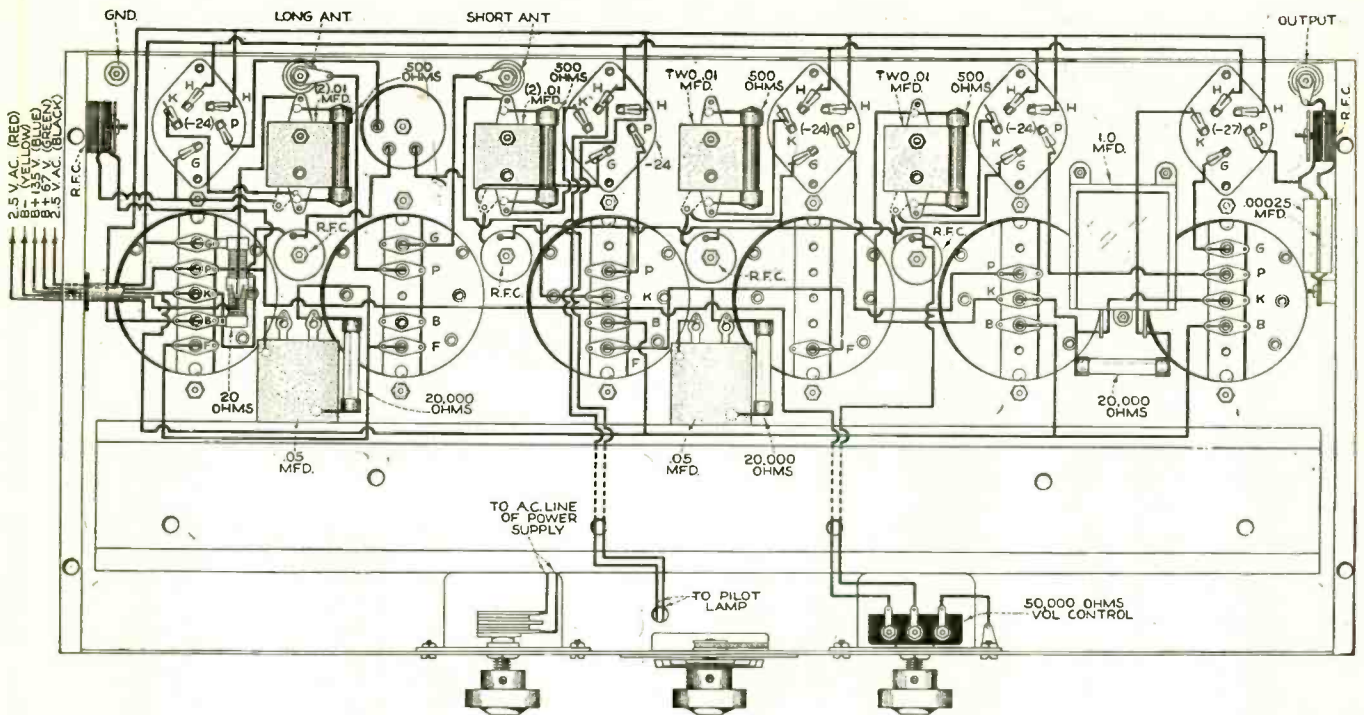

An underside pictorial wiring diagram of the tuner which shows how all of the parts are situated and wired into the complete circuit

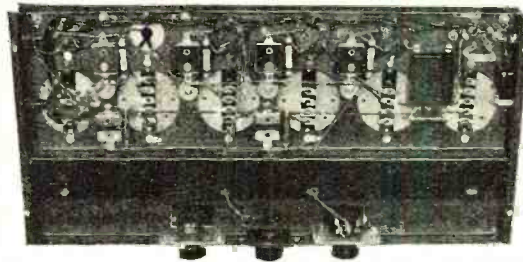

To more clearly understand the drawing shown above, it should be compared with the photographic view of the under-side of the tuner chassis

so that radio-frequency current will not be present to any extent in any of the leads. Three tuning condensers are mounted either side of the drum dial and are so located with respect to the coils that the high-frequency leads running to the stator plates are extremely short. Each section of the tuning condensers is shielded so that there will be practically no feed-back between adjacent stator plates. This latter point was found to be quite essential. The ground lead on the last two tuned circuits which connect the lower end of the coil with the rotor plate of the condenser is brought out the same opening in the coil shield as the wire to the stator plates. This tends to keep down circulating currents in the metal base which may be very troublesome and at times cause oscillation. At the same time, it does away with the loop effect which causes feedback. In the case of the coupled circuit or band-pass stages, this is not feasible, and as the gain between the two is not so great—there being only one screen-grid amplifier tube separating the four tuning condensers—it was found to be non-essential.

Separate resistors are used to obtain the proper bias on the screen-grid r.f. tubes. These should be mounted as shown in the photograph. The leads to all by-pass condensers must be short. The by-pass condensers have been carefully located with this in mind. The screen-grid tubes themselves are entirely shielded. This is particularly essential in the case of the first tube, for any signal impressed directly on its grid would not have to pass through the first tuned circuit and consequently the band-pass effect of the first two circuits would be lost.

A radio-frequency filter is placed in the output lead so that no radio-frequency current will be present. Thus it is possible to have the audio amplifier and "B" supply some distance away

from the tuner, where such an arrangement is desirable. In fact, if the transformer used to light the filaments of the a.c. tubes is somewhere near the tuner, the "B" supply and audio amplifier may be placed in the

cellar or other distant location.

Power detection employing a -27 tube has been chosen as preferable to use with this tuner, because in this case the detector is not so apt to overload on strong signals. A 1-mfd. condenser by-passes the 20,000-ohm detector bias resistor, and this is quite essential, for otherwise the bass notes are reduced in amplitude to a considerable extent. Other systems of detection may, of course, be employed should the constructor desire. In fact, the kit set is extremely flexible for those who desire to experiment.

The volume control is a 10,000-ohm potentiometer shunted across the minus "B" and plus "B" 67 volts, with the movable point connected to the screen-grids of the r.f. tubes, so that any voltage within that range may be impressed upon them. This control is very effective and not too critical.

After the tuner has been constructed and a careful check made upon the wiring, the variable condensers must be carefully lined up. To do this, it is best to tune in a weak, high-frequency (low wavelength) station—one around 1,400 kc. is about right—then adjust the trimmer condensers on the variable air condensers for maximum signal. It will be found that some circuits will be sharper than others. These are usually the band-pass circuits and input circuit to the detector.

It is necessary to carefully align each and every tuning circuit, for although the coils and condensers are carefully matched, the wiring and tubes place different fixed capacities across the tuned circuits which must be compensated for. If the tuned circuits are not in alignment, the tuning will be broader than it should and the sensitivity considerably reduced. If some type of signal generator is available, together with an output meter, it will be found that better alignment may be obtained than by relying on the ear for maximum signal. If alignment is made on a broadcast signal, choose one which may be just heard with the volume control well advanced. Sometimes because of the sensitivity of the set it is hard to locate a weakly received station, but by reducing the antenna the desired result may be obtained.

It is not necessary to say anything (Continued on page 275)

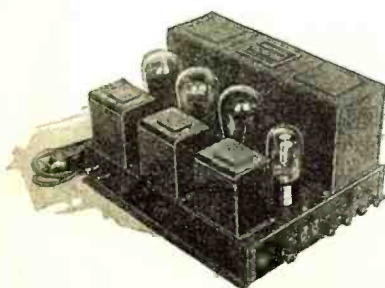

This is the type of power supply-power amplifier which is suitable for use with the tuner described

# Improving "Super" Performance with the Hopkins

*This second article describing the Hopkins Band Rejector System and its application outlines the advantages which may be obtained in superheterodyne performance when the Band Rejector principle is incorporated in the design and construction of intermediate frequency amplifiers. Future articles will describe further uses*

MUCH has been said and written of the excellence of the superheterodyne as a broadcast receiver. These receivers have, for the past few years, and in particular those of the "custom-built" variety, been characterized by the unusual degree of selectivity which they afforded as compared to the usual t.r.f. receivers. Large numbers of supers have been sold which embodied moderately low-frequency amplifiers, in which excellence of i.f. amplifier design, accompanied by some considerable assistance from preceding "broadcast frequency" circuits, contributed to the desired end. In the average "custom-built" super, the overall reactivity to undesired frequencies has been accomplished by means of a rather long succession of tuned circuits in the i.f. amplifier.

It will be readily seen that, aside from such assistance as is afforded by preceding broadcast-frequency circuits, the burden falls completely upon the i.f. amplifier, and that, generally, the overall performance of the complete super is a counterpart of that of its i.f. amplifier. For this reason, and because of the public acceptance of the super as an excellent receiver, continual investigation takes place into ways and means for the improvement of the characteristics of the i.f. amplifier.

The advent of the "double-tuned" or "band-pass" circuits, and their general use in t.r.f. receivers, immediately suggests, and naturally so, their incorporation into the i.f. amplifier. Such amplifiers have seen widespread use, although it would appear that they were generally of the "insufficiently coupled" type, producing only to a limited degree the benefits expected from a true band-pass amplifier. Their use merely increased the total number of tuned circuits in the entire receiver, producing selectivity of a rather high degree, if selectivity be defined only as station separating ability, without regard for the tendency to greatly attenuate the high-frequency sidebands. Equally good reactivity is secured by the use of an equal number of cascaded circuits, each containing an amplifier tube, and the latter naturally supplies considerably greater amplification. The degree of damage to the fidelity characteristic, with either method, is greatly a matter of excellence of the individual circuit design and great difficulty is experienced in attempts to avoid such damaging attenuation.

All study of amplifier design would appear to be directed toward the possibility of maintaining sufficiently high reactivity to insure reception of programs on channels only 10 kilocycles removed from the most powerful local transmitters, and at the same time, without radically impairing the fidelity with respect to the higher audio fre-

quencies, at least those below 5000 cycles. To do this, whether at broadcast frequencies, or in the intermediate amplifier, involves an overall resonance characteristic having almost vertical slope, with as close to a flat top as the designer can produce. This has been referred to facetiously as a "chimney" type of characteristic, and quite probably is as yet unknown to the industry, except with a width so great as to make it useless for the requirement as stated above. There has been offered for investigation recently a new circuit combination for securing a close approach to this much wanted characteristic in r.f. amplifiers. This new arrangement is known as the "Hopkins Band Rejector System." The fundamental elements of such a system, together with some simple curves showing its possibilities, were outlined in RADIO NEWS for August. Its value as an intermediate amplifier will be immediately recognized upon further study. It would appear that the voltage amplification per stage should closely approximate that realized with the simplest type of tuned plate impedance, which in itself would be entirely lacking in the required selectivity; its reactivity should be that of the ideally coupled "double-tuner," which, however, when so coupled, seriously reduces the effective energy transfer from tube to tube. Further, the band width may be fixed, by design, at a value which will allow the desired station separation, and at extremely high ratios of field strength, with respect to normal.

After lengthy laboratory study of the effects of the numerous design factors involved, the Hopkins system has been chosen for use in the i.f. amplifier of a super, as pictured in these columns. In combination with properly chosen units the system results in such admirable overall performance that some of the design factors entering into the complete receiver are presented, in order to more clearly portray its possibilities.

It is well known to the readers of RADIO NEWS that the

An idea of the sensitivity of the receiver for distance reception over local reception may be obtained from the two sensitivity curves shown above

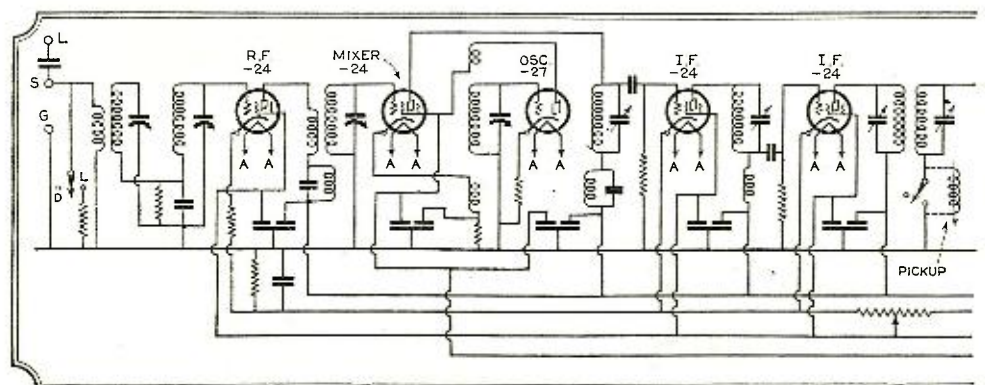
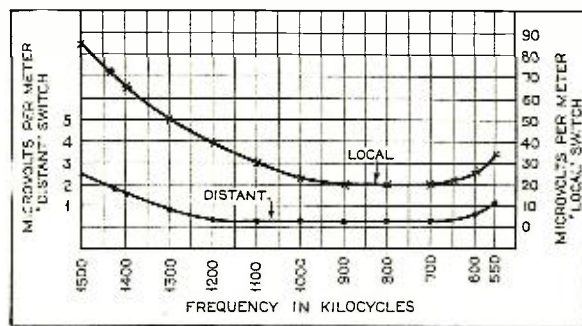

\*High Frequency Laboratories.

# Band Rejector System

By E. K. Oxner\*

second oscillator beat tuning position found in early supers cannot now be tolerated, and that it has been in the past removed by means of sufficient r.f. tuning preceding the mixer tube. No great selectivity demand was placed on such circuits, as they had only to suppress energy at a frequency removed from the desired channel by twice the intermediate frequency. Another means was used, namely the tuning of the i.f. amplifier to a frequency approximating 475 k.c., which, with a broadcast spectrum 950 k.c. in total width, successfully prevented the second tuning position, by removing it from the range of the tuning circuits of the receiver. With the r.f. circuits preceding the mixer, a choice of i.f. frequencies is offered the designer, and if the use of such r.f. be justified for other reasons as well, greater latitude is permitted in selecting an i.f. frequency at which the maximum benefits are realized.

With the increase in the number of high-power broadcasters, and some of the transmitters located quite near to heavily populated residential sections, carrier modulation or "cross-talk" has become serious. Such interference is being combated in t.r.f. sets by the general adoption of pre-selectors, in most cases coupled below the critical coupling value. At the same time, the spectrum around 475 k.c. is becoming more fully occupied with commercial services, and the power outputs of such transmitters are such as to seriously affect the simple single-circuit input tuning systems generally used with supers of the high intermediate-frequency type, even though such circuits be of the best design. From this, it would appear that the use of broadcast-frequency circuits, preferably with a pre-selector, with or without r.f. amplifiers, is by all means justified.

In the choice of the proper intermediate frequency, many factors are involved. It is well known that the maximum voltage amplification of the -24 type of tube may be more nearly approached at the lower radio frequencies, especially when freedom from the requirement of tuning over a considerable frequency band permits wide latitude in the l.c. ratio of the

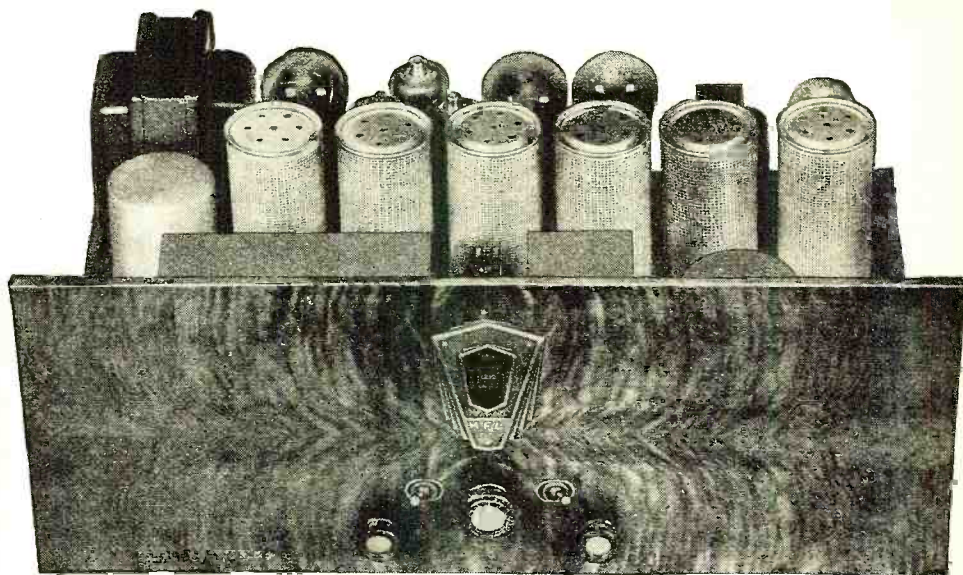

This HFL superheterodyne has been designed incorporating the features of band rejection in its intermediate amplifier, as described in the text

tuned circuits. For more detailed study of the other factors, the interested reader is referred to I. R. E. Proceedings for March, 1929. The Hopkins amplifiers described herein are tuned to operate at a frequency of 182.5 k.c. At this frequency, with extremely low circuit losses secured by Litzendraht coils of proper form, and with selection of series-resonant choke coils of proper values of effective capacity and low resistance, the amplification per stage is such that but a single "pair" of Hopkins stages is necessary. Examination of the curves in the August issue will disclose the necessity of using the system in properly "paired" stages. In the amplifier described, the Hopkins system is followed by a conventional tuned plate-tuned grid stage, so designed as to completely eliminate the portions of the curve which tend to return above the baseline at some distance from the channel center, yet wide enough in band width as to not affect

(Continued on page 277)

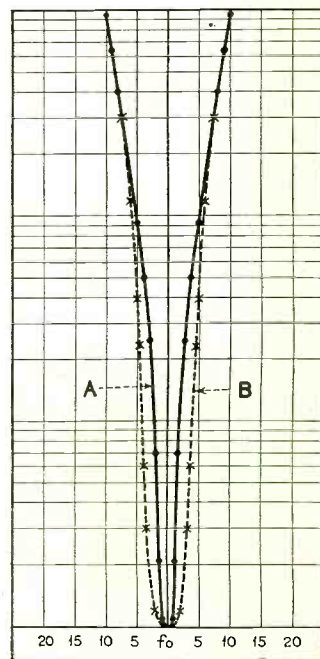

Above, A shows the curve obtained when receiver is adjusted for maximum gain (sensitivity = 1 mv abs. @ 1000 kc.). B shows the curve for best fidelity (by ear) (sensitivity = 3.6 mv abs. @ 1000 kc.). To the left is shown the circuit diagram of the HFL "super"

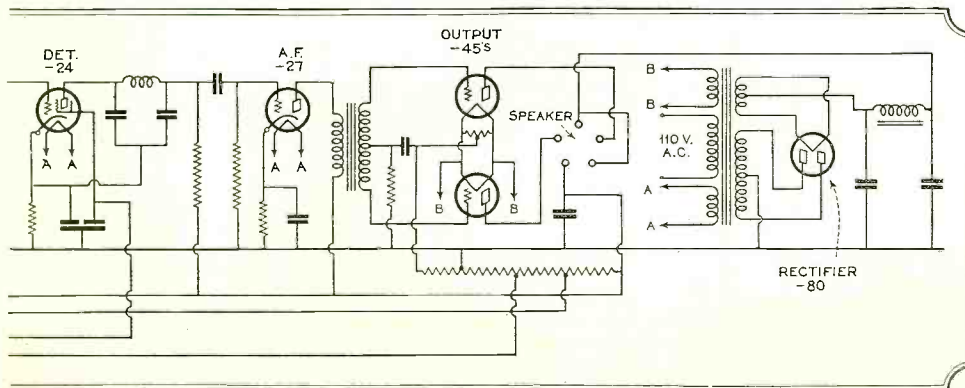

# The Versatile Vacuum Tube

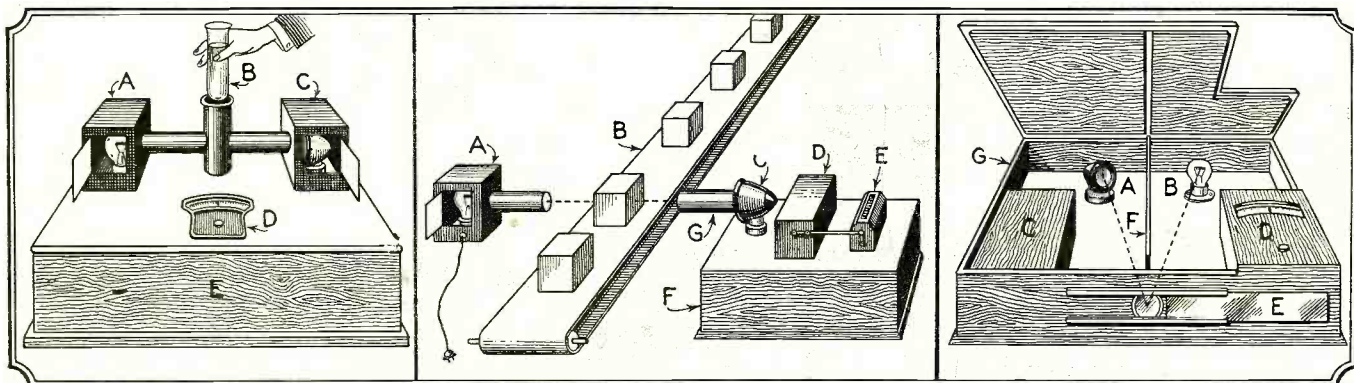

Three uses of the photo-lytic cell. (Left) Testing color density of a liquid by use of the photo-lytic cell. The source of light "A" is so placed that a beam is directed on the cell "C." The liquid "B," in a test tube, is placed in the beam so that the light passes through it. A meter "D" measures current. (Center) Counting articles on a moving belt. The light "A" is interrupted by the body "B." The cell "C" operates a sensitive relay "D," which in turn operates a counter "E." (Right) Testing color density by reflection. The light from "B" is reflected from the specimen "E"

FOR the last five years the world has been watching the romantic progress of the radio industry, but there has developed within radio an entirely new science founded on the radio tube. And, already, the radio tube with its offspring, the photo cell or "electric eye," has brought about revolutionary changes in trade and commerce. Starting with radio, it has swiftly found additional application in sound pictures and television. It is now being used to guide ships, trains and airplanes. In industry, it is used to grade and measure products. In agriculture, to detect pests. In geophysics, to discover oil and precious metal deposits.

When we stop to consider just what these new uses of the vacuum tube mean, it staggers the imagination.

Recently a prominent national figure talked to a gathering in another city from the easy chair of his Florida home—the audience saw his every gesture as well as heard every word he spoke—because of the electronic tube.

An airplane pilot can now fly blind—take off, fly, and then land within ten feet of his take-off—relying entirely on the radio tube for his guidance.

Physicians can hear the vital organs of the body operating—heart-beats and murmurs can be amplified to steam-engine proportions, and so a whole new

science of heart therapy has been developed through the use of the electronic tube.

And in many other ways is the radio tube, with its minute mechanism, becoming a powerful lever by which sounds, inaudible to the human sense, can be detected or heard by the more sensitive "ear" of the electronic tube, then transferred and amplified into sound impulses which are audible to the human ear.

Before entering into greater detail on some interesting light-sensitive devices and their applications, I want to indicate some of the simple fundamentals of science which are the basis of radio.

Radio has to do with sound waves. Sound is caused by vibrations in the air. A comparatively slow vibration gives a low note. As the vibrations per second increase, the notes get higher and higher—you get up to the top note of the piano, for

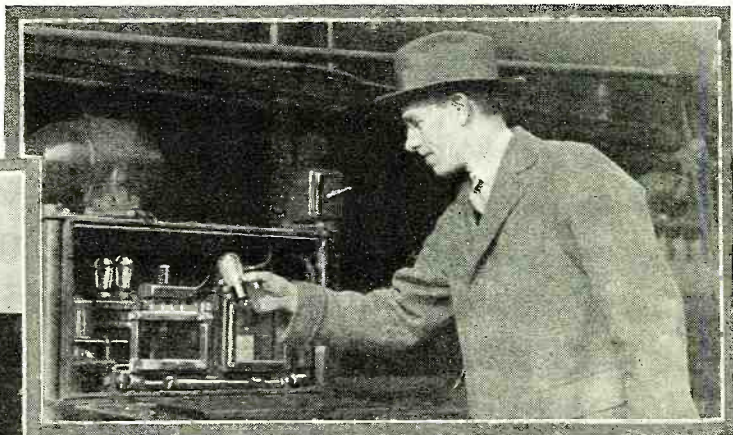
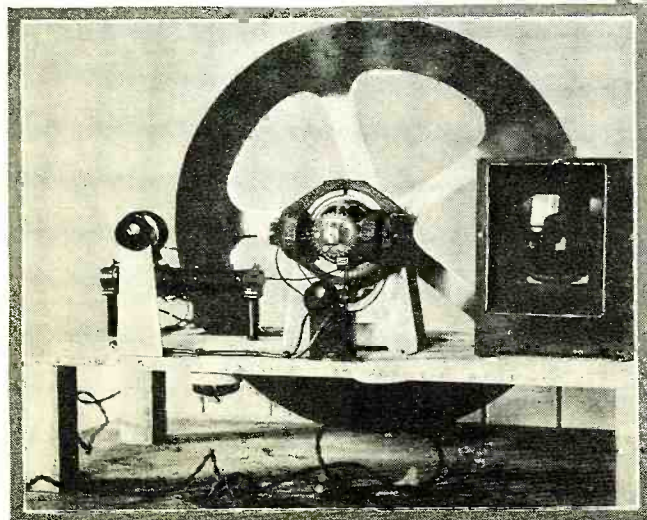

Shown above is an all-electric device for halting trains automatically, which was recently demonstrated by the Reading Railroad, N. J. P. S. Lewis, superintendent of the railroad, is pointing to the control box on the side of the locomotive containing the electrically controlled safety device and activating vacuum tubes. When the locomotive reaches the danger zone the brakes are automatically set. At the left is a "tone wheel" which interrupts a light a given number of times a second. If the number of interruptions falls between 50 and 10,000 times a second, a musical note is produced

*Ordinarily we assume that vacuum tubes are used in radio only. The truth of the matter is that vacuum tubes are now being used in many industries for manifold purposes; to count objects, determine thickness of paper and cloth, automatically control elevators, to set off burglar alarms, detect color differences and for countless other workaday jobs*

**By Fred E. Kauer**



One of the multi-tube tests now assigned to the photo-electric cell is indicated above and the apparatus which records daylight. The giant photo-electric cell appears above the recorder

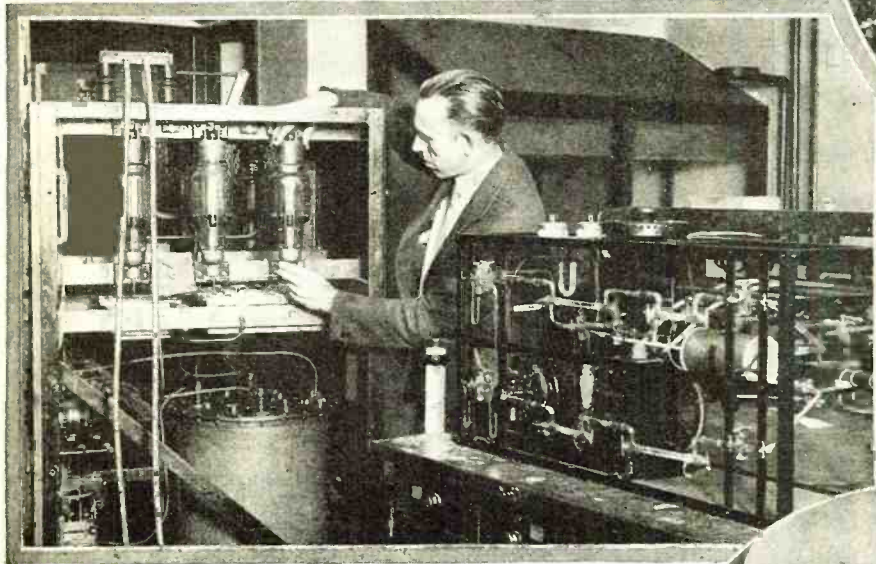

Lewis Jordan, scientist of the Bureau of Standards, is shown examining a high-frequency indicator furnace operated by means of radio vacuum tubes used in the metallurgical laboratories for melting metal and extracting gas from metals

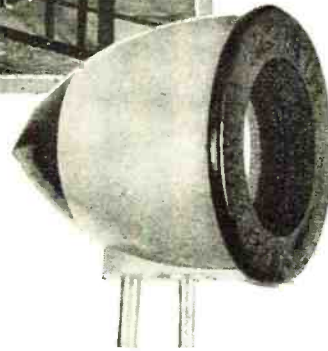

At the left is a new type of photo-electric cell recently brought out by the Arcturus Radio Company

instance. Then you go higher still and get a very rapid vibration or "frequency" that is emitted when you sound the letter "s"—and finally the frequency gets so high that you cannot hear it at all.

The frequencies that you can hear are called "audio frequencies." But while they are in the air, between broadcasting station and your receiving set, they are not audio frequencies—the rate of vibration has been increased from say 1,000 cycles or vibrations per second—my speaking voice—to perhaps 300,000 cycles. This change was made through the vacuum tubes and other equipment in the broadcasting station, which multiplied low frequencies into high ones. In fact, the very nature of the impulses themselves has been changed.

Now an interesting thing to remember is that when this "stepping up" of my voice is going out on the air, say from WABC, its frequency is 400,000 vibrations each second, while from another station it is only 275,000 cycles.

But why do different stations multiply my voice to different frequencies when it is broadcast? Well, it is this way. If you and I were singing, both in the same pitch, people would have a hard time telling one voice from the other. But if we sang, say three notes apart, people could hear the two voices distinctly, and, with only moderately sensitive apparatus, could listen to one of us without listening to the other. Radio stations, too, must keep their frequencies a certain distance apart so our receivers can separate one station from another. When these radio impulses come into your radio set their speed is divided in the same proportion and in much the same way it was multiplied in the microphones, transformers and sending equipment—in other words, they are changed back to sound impulses of audio frequencies. You can hear them again.

It will be interesting, I think, to describe some of the many

practical applications of the principle of the radio tube.

Many of you, I am sure, have been in one of the newer types of elevators.

Upon entering one of these you call out your floor. The operator presses a button.

Then you are carried aloft and when the car is opposite your floor the door opens automatically and you note that the elevator car floor is perfectly level with the building floor.

Now how does that happen?

Let me give you an example with which you are familiar—your own radio set.

In order to hear a broadcast say from station WABC here in New York you turn the dial on your radio set to 348.6 meters wavelength. This movement of the dial corresponds to a similar movement of the rotary plates of a variable condenser which is inside your set. It adjusts the circuit of your receiver so that the latter will respond to the particular energy and you are "tuned in" to this station and hear the wave sent out from the station. In other words, you tune your receiver to the transmitter.

Now then, something happens in the elevator. On the side of the car there has been placed a control box which contains condenser plates similar to those in your radio set. Also, there are other plates inside the elevator shaft, one at each floor level, in such positions that the plate on the car moves directly past them.

As the car goes up or down, the operator presses a button corresponding to the floor at which a stop is to be made, thereby energizing the floor circuit. When the condenser plate on the car reaches the correct one in the shaft the capacity between the two plates is just right (Continued on page 265)

# Some Methods and Problems

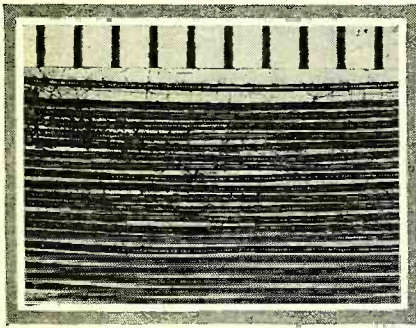

Fig. 14. Low-frequency recording

WHEN analyzing a disc recording by inspection, we must keep in mind the fact that the actual generated voltage wave is not as a rule similar to the recording. As stated, the generated voltage at any instant is determined by the rate of radial motion of the needle. In other words, we obtain the slope of the recording curve

(strictly  $\frac{dy}{d\theta}$ ) at the instant in question

in order to determine the magnitude of the corresponding voltage ordinate. For sine waves, this derivative curve will, of course, have the same shape as the recording curve, being a cosine curve. For other wave forms, however, we must not expect any great degree of similarity. (See Fig. 9.) The derivative curve is, as a rule, a much more rugged curve.

Fourier's theorem states that any periodic function may be considered as composed of a constant, a fundamental, and a series of harmonics. We therefore think of our complex wave forms as being the result of several simultaneous waves. We may, in fact, consider each component wave as existing separately. Circuits can as a matter of fact be arranged to favor certain terms in this series. A complex voltage wave is composed, therefore, of several voltage waves of different frequencies. An ordinate of

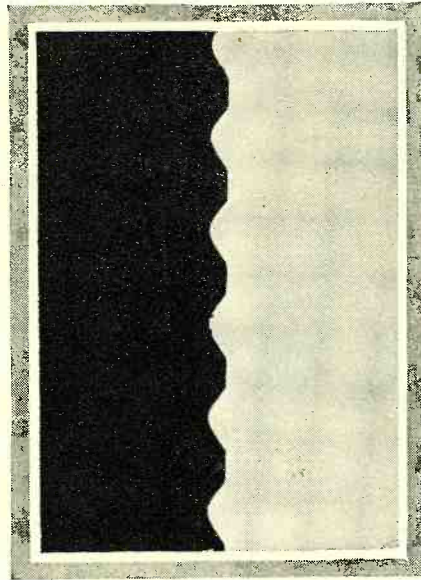

Fig. 15. Section 16-inch record

the resulting curve is found by adding the instantaneous ordinates of the components at the particular point in question. The slope of the resulting curve is merely the sum of the slopes of the component curves at the point in question. Hence, in the case of disc recording, the voltage generated at any instant is equal to the sum of the instantaneous voltages of the components of the recording for the instant under consideration.

*Being a detailed account of the various in the recording of sound. Both sound-on-disc complete fashion. To servicemen who would tered in this field of work this*

PART

By C. F. Goudy

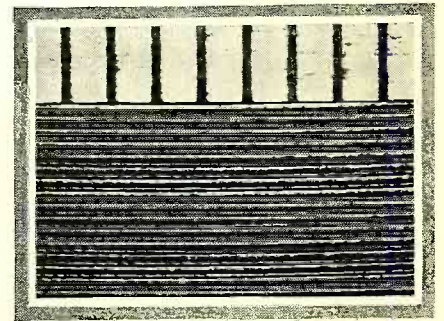

Fig. 17. Two-thousand cycles per second

It is not the purpose of this paper to treat the subject mathematically, but we should not overlook the great possibilities of mathematical analysis. Reproducing arrangements are indeed analyzers of the highest order. It seems hardly possible that in the contour of the resulting recording we have the possibility of reproducing every component in its original form.

In order to reduce groove wear to a minimum it is imperative that the pick-up unit be located properly with respect to the record. (See Fig. 10.) The pick-up arm is shown coinciding with a line drawn tangent to the groove of average radius. Mounted in this position, the pick-up imposes the least wear on the sides of the grooves.

## Slit Width vs. Frequency

Slit width and needle diameter are analogous in so far as they both impose frequency response limitations in the respective reproducing systems of which they are an integral part.

Perfect scanning of the sound track is obtained only by an ideal slit, that is, a slit having zero width. Such a slit is purely theoretical, we must be content with an approximation to the ideal slit, or one having finite width.

The upper limit of frequency response decreases as the slit width increases. If the slit width is equal in length to one

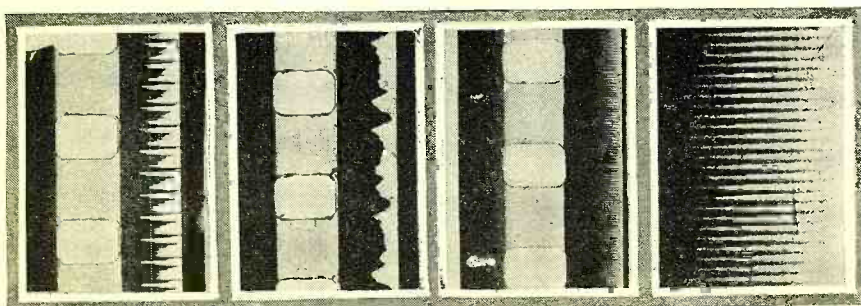

Fig. 19. Voice and piano fundamental approximately 450 cycles per second.  
Fig. 20. Repeating waveform fundamental approximately 115 cycles per second.  
Fig. 21. Five thousand per second. Fig. 22. Five thousand per second. Magnified 30 diameters to show grain



# of Sound Recording

systems which are now universally employed and sound-on-film are dealt with in a most know more of the practical problems encountered article is particularly recommended

## TWO

and W. P. Powers



Fig. 16. 10-inch record showing needle

cycle there will be no modulation of light and no response for the particular frequency.

Since the upper frequency limit decreases with slit width increase, it is obvious that the fidelity of reproduction also decreases accordingly.

Fig. 11 shows a table of frequencies and their corresponding wavelengths as found in sound recording on film.

### Comparison of Disc and Film Recordings

Fig. 12 illustrates the contour of the resultant wave formed by the combination of a fundamental and its eighth harmonic. In recording, nearly all wave forms are complex, *i.e.*, they are composed of several sinusoidal waves. By a close inspection of a wave, it is generally possible to determine the pronounced frequencies that are present.

Figs. 12A and 12B are examples of sound-on-film recording in which we have a clearly defined fundamental and a superimposed harmonic.

The fundamental frequency and pronounced harmonic which constitute the wave shown in Fig. 12A are (if accu-

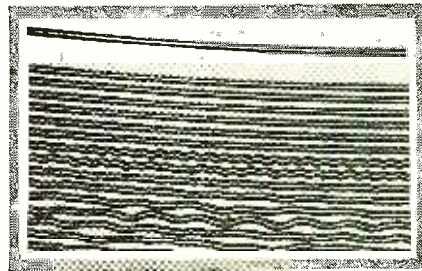

Fig. 18. Steam whistle approximately 1,000 cycles per second

rately scaled) 154 and 770 cycles per second respectively.

Fig. 12B shows a fundamental of approximately 330 cycles, with the corresponding eighth harmonic. (Note the peculiar contour due possibly to the presence of an even harmonic.) This is a piano recording, and it is interesting to note that in general the shape of piano recording is not so complex as voice recording.

Fig. 13 is a view (magnification 12½ diameters) of a 16-inch record showing difficult recording. The weakened condition of the groove wall at the points of high lateral cuts is plainly visible. Great care is necessary when these records are reproduced to prevent the formation of a cross-over.

The exceedingly high amplitude cuts employed in recording low frequencies are



Fig. 23. Complex recording

shown in Fig. 14. Here the recorded frequency (inside groove) is approximately 50 cycles. The wavelength at this frequency is readily appreciated when comparison is made with the millimeter scale along the top of the picture. Ten diameters is the magnification at which this picture was taken.

A cross-section view (magnification 57 diameters) of record grooves is shown in Fig. 15. This view accurately shows the dimensional relations between the groove width, the groove depth, and the wall thickness. It might be well at this time to refer to Fig. 5, which shows all the above dimensions.

Fig. 16 shows a needle tracing a groove. From this figure we obtain some idea of the relative dimensions in the vicinity of the needle tip.

A constant frequency recording at 2,000 cycles is shown in Fig. 17. A millimeter scale is included for purposes of comparison. The photomicrograph was taken at a radius of approximately 6.5 inches and a magnification of 10 diameters. It can be seen that at this radius there are approximately four wavelengths per millimeter, which corresponds to the designated frequency marked on the record.

A pronounced 1,000 cycle note corresponding to a steam whistle as recorded on the trailer of "The Toilers" appears in grooves eight and nine of Fig. 18.

(Continued on page 267)

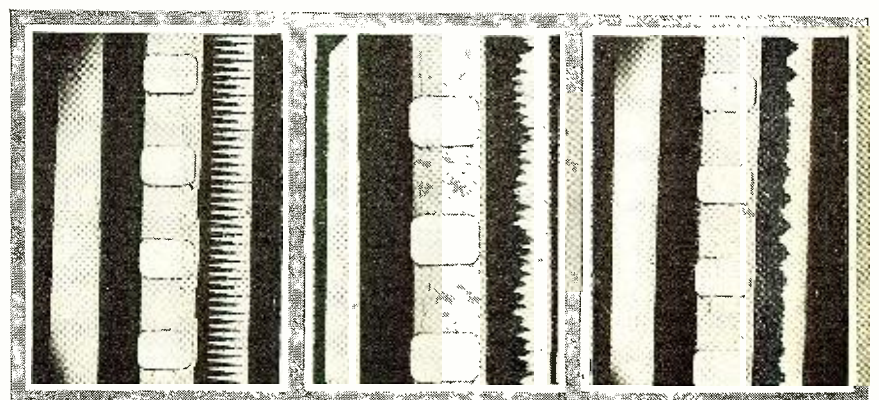
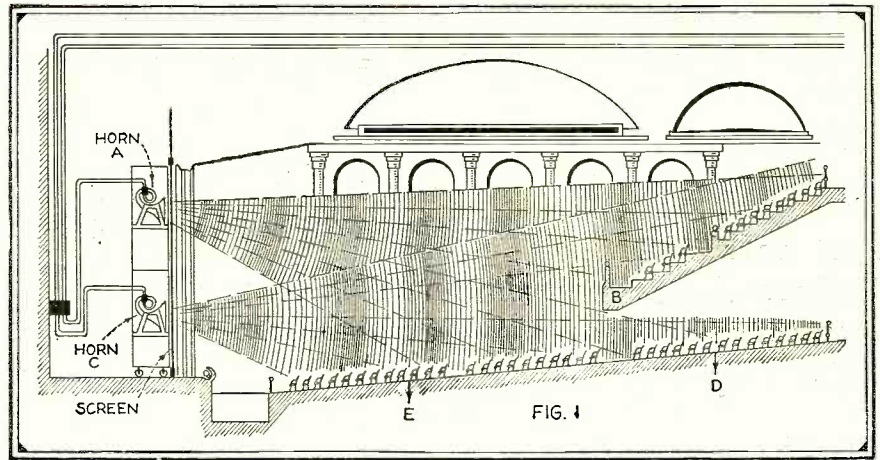

Fig. 24. Whistle approximately 1,000 cycles per second. Fig. 25. Whistle frequency with other frequencies. Fig. 26. Periodic low-frequency groups

If only loud speaker "A" were used in the theatre, which is sketched to the right, the portion of seats under the balcony would not be "covered" with sound. However, as will be seen, horn "C" takes care of this situation



# Sound

# Amplifiers, Theatres

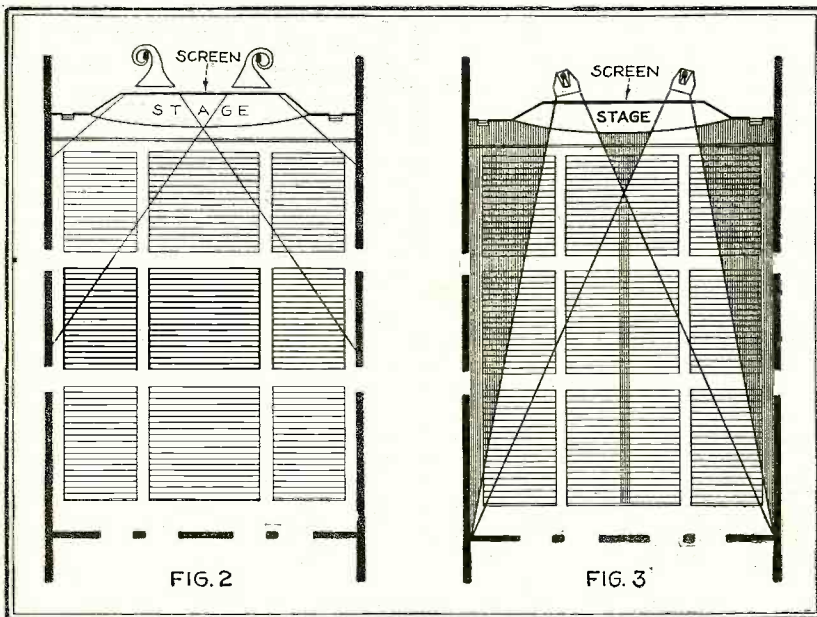

Above, two sound patterns which show how the placement and location of the loud speaker horns have a direct bearing on how well the sound is carried to the entire audience

IN many cases after the installation men have packed up their tools and said good-bye to the manager of a theatre, he heaves a sigh of relief and thinks, "Well, now I've got my sound apparatus installed and all I have to do is count the extra money that will come in because of the added attraction." In some cases he is correct, but in a great many he is woefully wrong, because the installation engineers sometimes do not do as good a job as they might.

It is a relatively simple matter to install sound equipment, but the greatest installation problem of all is to make the equipment reproduce faithfully. There are, roughly, two-thirds of the theatres in the United States equipped for sound at the present time and it is the writer's belief that in nearly every house so equipped different acoustical conditions were encountered. This matter of the theatre's acoustical properties is the big item in installation and too much consideration cannot be given to it.

You have doubtless read how carefully broadcasting studios

*Out of about 21,000 theatres and States about 14,000 are equipped for talkie reproduction. In the demand for talkies the theatre thought to the acoustical or "break" suitable*

**By Fred A.**

are treated acoustically so that the speech or music that is put out over the air will be as natural as possible. This is comparatively a simple matter, for even the largest studio cannot approach in size the dimensions of the average theatre. Then, too, in a studio just one point must be considered, the microphone, while in a theatre hundreds of ears are listening to the loud speakers' reproduction.

Now what are some of these problems that the acoustical engineer is up against? In the first place we have the reflection of the sound waves from the walls, ceiling, floors, doors, empty seats, etc., to the audience's ears. It is needless to mention that sound acts much in the same way as does a beam of light in that it can be reflected from one surface to another and that sound travels through air at an approximate speed of 1,100 feet per second.

Various materials used in theatre construction have the ability to reflect more sound than others. For example, cement, marble, linoleum, plaster, glass, steel walls and ceilings, wooden floors and similar materials reflect between 94 and 99% of the sound energy that strikes them. Softer materials—those having a porous structure—reflect very little sound energy and it is the judicious use of these that the acoustical engineer has to consider, for if a sound wave be reflected from a hard, smooth surface to the audience's ears, they will hear a distorted noise instead of the sound as recorded on the disc or film. In other words, the beginning and ending of a sound wave must not overlap.

Consider for a moment that a character on the screen speaks the word "Philadelphia." This is, of course, a long word and it takes an appreciable time for the actor to say it. The first syllable, "Phil," comes from the loud speakers a fraction of a second before the final "a"; in fact, it takes almost an entire second to pronounce the word clearly. Now if the first syllable

\*General Manager, Projectionist Sound Institute.

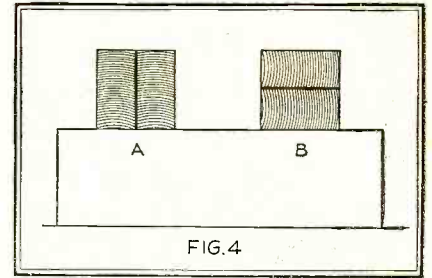
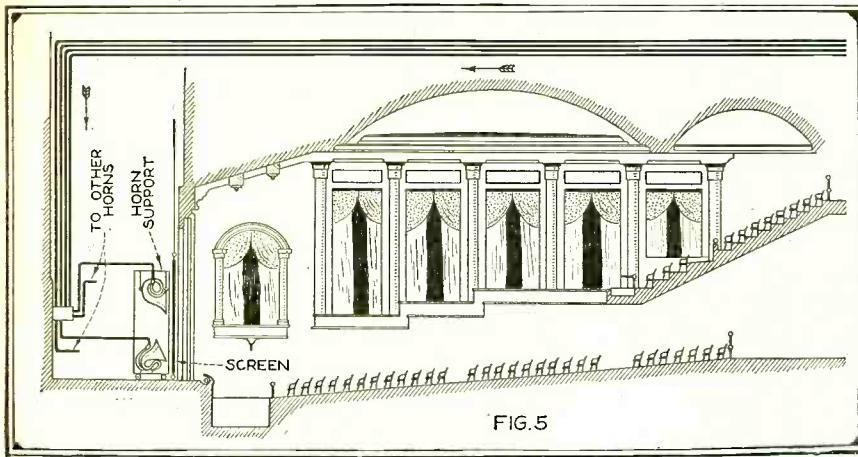

Above at A the flare of the horn is vertical, while at B it is horizontal

To the left, the side view of the interior of a theatre, showing the placement of draperies along the side walls so as to absorb sound and prevent a disagreeable reflection of sound

# and Their Acoustics

movie palaces in the United with speech amplifier equipment mad rush to cater to public manager has given little or no properties which often "make" reproduction

## Jewell\*

is heard by the audience and then the last one, everything is satisfactory, but if after the last one has registered on the ears of the audience and then the first one comes along with it, it being reflected from a wall, for instance, then the word cannot be understood. It really amounts to an overlapping of the sound waves.

Another problem which the engineer has to face is that of reverberation. When sound is reflected from one surface to another and then back again, the effect is said to be reverberatory. This effect produces an overlapping of successive syllables and musical sounds with an attendant loss of intelligibility. The time of reverberation depends on the sound absorbent qualities of the interior surfaces of the theatre and it is influenced by carpets, upholstered seats, draperies, etc. These materials all increase the rate at which the sound decays and consequently help to reduce the length of time during which reverberation lasts.

As stated previously, certain hard-surfaced materials will reflect between 94 and 99% of the sound energy impinged upon them. This means that between 1 and 6% of the sound has been absorbed. It is clear that if the reflecting surfaces would reflect 100% of the sound energy, the sound would go on indefinitely and would build up in amplitude as additional sound energy was added to it; but as surfaces absorb a portion of the energy each time that it is reflected, the sound diminishes in intensity proportionately to the amount of energy that has been absorbed.

It is comparatively a simple matter to determine if a theatre needs acoustical treatment. For example, if someone will stand on a stage with his back to the auditorium and read a passage from a newspaper and if a second person can distinguish every word that is read in any part of the house, then the acoustical



While the illustration above does not depict the interior of a theatre, it does illustrate how one of the larger of the NBC studios has been treated with sound-absorbing curtains, drapes, etc., so as to make for better quality of transmission without reverberation or reflection of sounds within the studio

properties of that theatre are said to be entirely satisfactory. However, if the reading be of sufficient clarity in some parts of the theatre and not in others, then the house needs acoustical treatment.

Another simple test is to have someone stand on the stage and clap his hands together about every five seconds and then listen for an echo. If the echo from the noise of the hand-clapping be distinguished as a pulsating wave gradually dying out, this can be set down as both echo and reverberation, but if the sound wave dies gradually and steadily, it is simply reverberation. Another indication of poor acoustics is when the quality of reproduction improves as the theatre fills up with patrons. The reason for this being that the average person will absorb as much sound energy as 10 square feet of drapery or 14 empty upholstered chairs. Therefore, the larger the audience the quicker will be the period of the decay of the sound energy.

It was previously mentioned that different building materials had different absorption qualities. This is easily demonstrated. You have heard the expression, "He is (Continued on page 271)"



# The Junior RADIO Guild



## LESSON NUMBER TWELVE

### How the Vacuum Tube Works

**I**N the late 1880's Thomas Edison was experimenting with his electric light when he noticed an effect that has had a very great bearing on the developments of numerous sciences. In some of his model lamps there was a metal plate sealed in the bulb, but not connected to any of the other elements. In his experimenting, he noted that if he connected this plate to the positive side of the filament; with a current-indicating meter in the circuit, there was a current flow. If the plate was connected to the negative side of the filament, no current would flow. This became known as the "Edison effect," and although the effect was not fully understood, it was familiar to all electrical experimenters of the day. This phenomenon, now fully understood and applied, makes possible radio as we know it today.

Without going into atomic theory, let us ascertain what an electron is. An electron is a minute particle of negative electricity. Although infinitesimally small, it may be considered to have mass. It is the smallest known division of matter. Now let us see just why we are interested in electrons.

When any mass capable of electrical conductivity is heated above its normal temperature, these little electrons separate themselves from the rest of the mass and come to the surface. Some even leave the surface and go on a little distance into space. Unless some attraction is offered to them, they float in the space very close to the mass, and when the mass cools they return to the surface. The mass referred to is, in the case of a vacuum tube, the filament which we see lighted in the center of the tube. There is no other reason for the light except as a by-product of the necessary heat, and if it were mechanically practical, this heat might come from any other source, such as a gas flame, etc.

Now let us return to the Edison effect. Suppose we place a metal plate in close proximity to the lighted filament, as shown in Fig. 1. The filament will continue to "evaporate" or give off electrons, but unless the plate is connected there will be no attraction for the electrons. However, if we supply the plate with a positive potential from a battery, as shown in Fig. 2, and use a meter to indicate current flow, we will find that we have established an electrical circuit and that current is flowing between the filament and the plate. In other words, when a positive potential is applied to the plate, the electrons, which are negative particles of electricity, are attracted to the plate, and the space between the filament and the plate is rendered conductive. If the battery is reversed so that the plate has a negative charge, no current will flow. Thus we have unilateral conductivity, or conductivity in one direction only.

All this, while very fundamental, fully explains one of the most important uses of the vacuum tube, that is, rectification. Replacing the battery with a generator of alternating current, as shown in Fig. 3, will demonstrate. Alternating current, of course, changes its direction of flow periodically. At one instant one pole will be positive and the other negative. The next instant will find the condition reversed and the pole that was positive will now be negative, and the pole that was negative will now

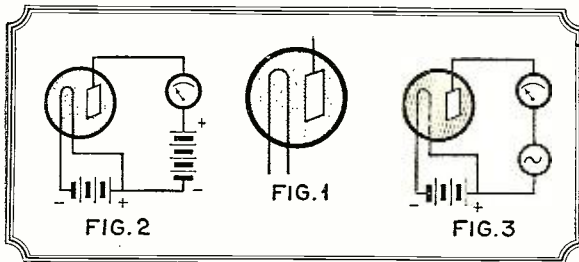

Fig. 1. Two-element tube, or "Fleming valve." Fig. 2. Showing how current flows, or "The Edison effect." Fig. 3. Unilateral conductivity, or the rectifying action of the tube

be positive. When hooked up as shown, when the pole that is connected to the plate of the tube is positive, current will flow. When the reverse condition prevails, no current will flow. We have thus changed alternating current to direct current. This principle is used in every alternating-current receiver to supply voltage to the plates of the other tubes in the receiver. Of course "filtering" of this rectified current is necessary before it can be used, but that is outside the scope of this article. The same principle was

used for some years for detection, which is nothing more nor less than rectification, and when so used the tube was known as the "Fleming Valve," named after the inventor.

Some one has described a vacuum tube as "Something with nothing in it, out of which you get a lot of things that you don't expect." This is not quite true, but unless the various functions are understood the statement will certainly appear beyond contradiction. Take, for instance, the ability of a tube to amplify.

We have until the present time considered the action of a tube with only a filament and a plate, or, as it is commonly called, "a two-element tube." Now let us consider the action of the "Grid," or the third element in a three-element tube. The grid usually takes the form of a coil of wire placed between the filament and the plate, and takes its name from the fact that it closely resembles a gridiron. In practice it is considerably closer to the filament than it is to the plate. We are indebted to Dr. Lee De Forest for this invention, without which the vacuum tube would be incapable of amplifying.

Refer to Fig. 4A. Here we see the grid in its position within the tube. The symbol of a generator is the same as shown in Fig. 3 except in this instance it is connected in the grid circuit. For clarity we may assume it to be the secondary of an audio-frequency transformer, or the secondary of a radio-frequency coil, as the amplifying action of the tube is the same regardless of frequency.

We said above that unlike charges attract. It is equally true that like charges repel. As the path of the current inside of the tube is from filament to plate, and as the grid is in this path, we see that as the grid is alternately made positive and negative, it will alternately attract and repel the electrons from the filament. As the grid is made of fine wires, very few of the electrons are actually stopped by the grid, but pass on through the open spaces between the wires until they reach the plate. So we see that the grid has perfect control over the number of electrons that flow between filament and plate. We

can consider a tube as being a variable resistance, as shown in Fig. 4B, with the grid as the sliding tap that controls the internal resistance of the tube. When the grid is negative, the resistance is high; when the grid is positive, the resistance is low. The fixed resistance R connected in series with the plate is called the plate "Load," and due to its series connection, the total current flows through it. As the current in the circuit varies, a voltage is developed across this resistance that is available for further amplification, or to operate our phones or loud speaker.

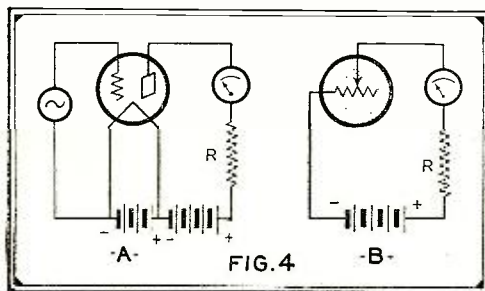

Fig. 4. A vacuum tube hooked up as an amplifier, and the equivalent electrical circuit

(See previous articles for a study of Ohm's law.)

Since the grid only controls the number of electrons that flow between the filament and plate, and as it is placed closer to the filament, it should be easy to see in what manner the tube amplifies. Let us take an analogy. One man can only do so much work. Let us assume that the voltage (signal) on the grid is the working ability of one man. Now we will further assume that the stream of electrons is a group of men. Now if the one man totally directs the actions of the entire group of men, we see that his exertions are "amplified" by the number of men in the group. The analogy holds good, for all the work that the grid does is to "tell" the electrons what they shall do. A little study of the "characteristic curve" will make this even clearer. We see that even a small potential on the grid will affect the plate current considerably, and as the plate current flows through the load resistance in series with it that the voltage across the plate load will be much greater than the voltage applied to the grid.

In the above discussion, for the sake of clarity, we have not mentioned grid bias. In actual practice a tube is biased negatively to limit the plate current to a safe value, as well as to determine the point on its characteristic curve at which the tube works. A tube should be so biased that it works about the center of its curve.

In the study of detection we will take the grid bias detector first, as it is the most easily understood. This type of detection is sometimes called "plate detection" or "power detection."

Again studying the curve in Fig. 5, we see that if we continue increasing the negative bias enough, we reach a point where the plate current does not decrease in proportion to the bias; in other words, we reach the "knee of the curve." Now let us assume that the "generator" in Fig. 4 is the secondary of a radio-frequency transformer. In this case, radio frequency modulated with the desired signal will be applied to the grid. (See Lessons 1, 2 and 3 for data on radio frequency and modulation.) As the radio-frequency wave is made up of cycles first positive and negative, we see that the voltage applied to the grid will be first positive and negative. As we are working the tube at a point where the negative loop of the cycle will cause little change in plate current, and the positive loop will cause a much larger change, we accomplish rectification, or detection. As the radio-frequency signal is above audibility, the changes in the plate current will conform to the modulation, although there will be some residual radio frequency present.

An older and now practically obsolete type of detection was the leak and condenser type. See Fig. 6. In this case no grid bias was used, and the tube was operated at a low plate potential. In this case the negative loops caused a greater change in plate current than the positive loops. Again study the curve to make this clear. The condenser served to increase the sensitivity, charging on one half of the cycle and discharging on the other half. The leak served to permit any accumulation of negative charge to leak off of the grid.

It would be impossible to cover all of the various uses of the vacuum tube, but practically all of its various applications depend upon one of the functions we have outlined.

All modern radio transmission depends upon the ability of the vacuum tube to "oscillate." All tuned circuits are made up of inductance and capacity in some form, the most used form being a coil of wire with a condenser in series with it. Now, theoretically, if a current is set up in such a circuit it will continue to flow forever, if we neglect the resistance of the circuit. However, we cannot neglect the resistance, which in practice may run into a good many ohms. Even though we do set up a current in the circuit, it will be immediately damped by this resistance, so that unless we continue to feed the circuit from an outside source of potential, the current stops flowing.

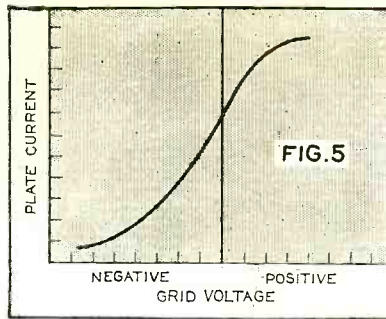

Fig. 5. Graph illustrating the effect on the plate current of a vacuum tube by changing the grid voltage. A "characteristic curve"

But let us suppose that this circuit is connected to the input of a tube. We have seen that a tube amplifies the potential applied to the grid, so that the plate current swing is an enlargement of the grid potential. So it naturally follows that we can "feed back" some of the energy from the plate circuit to the grid circuit, and by carefully adjusting the feed-back, the damping effect of the resistance can be neutralized. With this adjustment, the circuit has in effect no resistance, and becomes very highly efficient. The circuit is then said to be "regenerative."

But suppose we go just a little farther, and feed back more energy than is necessary to cancel the resistance. In this case we reach a point of "negative resistance," and we have in actuality a generator of

alternating current, the frequency of which will be determined by the tuning effect of the inductance and the capacity in the circuit, and if of the proper frequency, a radio-frequency wave is generated.

In commercial practice, tubes take many forms. While we started out to discuss vacuum tubes, gas-filled and other special-purpose tubes naturally come more or less under the same classification. Let us hastily review some of the tubes in daily use.

The sensitivity of selenium to light has long been known, and experiments along this line have led to the development of the photo-electric cell. Selenium is a non-metallic substance resembling lead, that will vary its electrical resistance directly proportional to the amount of light that falls on its surface. Potassium, as well as several other elements and gases have the same properties. A cell of this type is utilized in talking movie work, color analysis, counting, television, and numerous arts that depend upon light interruption.

Just the opposite is the neon lamp. The neon lamp is a tube with two elements or plates inclosed in a glass bulb from which the air has been exhausted and neon gas introduced. If a potential is applied to the elements, the plate that is negative will glow, provided the potential is above the "striking voltage." If alternating current is applied to the cell, the same phenomena will take place, except that first one plate will glow, and then the other, following the cycle. The amount of light for a given time will be determined directly by the instantaneous voltage across the cell. These properties are utilized in the reception of television signals, etc. Experiments have been made to photograph this light source, properly modulated, on film, so that recording of sound may be accomplished without any moving parts, such as a galvanometer, in the system. We also have the

neon advertising signs that are very attractive, due to the unusual red glow. The light given off from a neon cell also has the ability to penetrate fog to an extent, and they have been so used for airport illumination.

Among other interesting applications of vacuum tubes, we find them used in the Holland Tunnel between New York and New Jersey to count the number of automobiles passing through the tunnel. This is an application of the principle mentioned above, where a beam of light is interrupted by the cars passing between the source of light and a photo-electric cell. Other tubes are used to amplify the electrical impulse thus created to sufficient

level to operate a relay and counter. A similar application is frequently used by progressive firms to count the people passing a given location when the location is under consideration as a place of business. Numerous musical devices rely upon the vacuum tube as a source of audible tone, notable among them being the "Therimin." In this case the tubes are used as oscillators, the frequency or pitch being varied by the capacity of the operator's body. Doctors, too, have utilized amplifiers to amplify the heart beats of a patient in cardiac diagnosis. By so doing, several doctors may listen to the heart beats simultaneously, and agree upon their diagnosis.

Certainly the vacuum tube deserves to be called the most versatile of all devices.

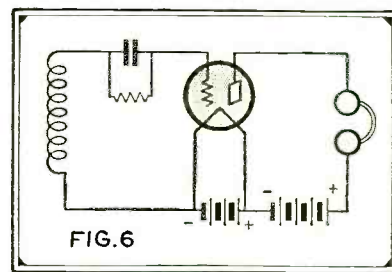

Fig. 6. Hook-up of a vacuum tube as a leak-condenser detector. This method is practically obsolete

# Radio News Manufactured Receiver Circuits

## Edison—Models R1, R2, C2

THE Edison Models R1, R2 and C2 utilize 4 '26 tubes, 1 '27 tube and one '50 tube in a circuit that consists of three stages of tuned radio frequency, detector, and two stages of audio frequency amplification. The power output stage is one '50 type tube. (In the wiring diagram a '26 tube is specified in this position by error. Ed.)

Among the features of these receivers are: adaptation to any length antenna by appropriate series condensers, a phonograph switch and a regeneration switch. By throwing this switch to the proper position a little regeneration may be introduced, which of course materially increases the sensitivity and selectivity. At no time can the regeneration become sufficient to cause annoying squeals. A rotary switch adapts the power supply to any line voltage from 95 to 118.

Oscillation is controlled in the radio frequency amplifier by use of the grid suppressor method, and the power pack

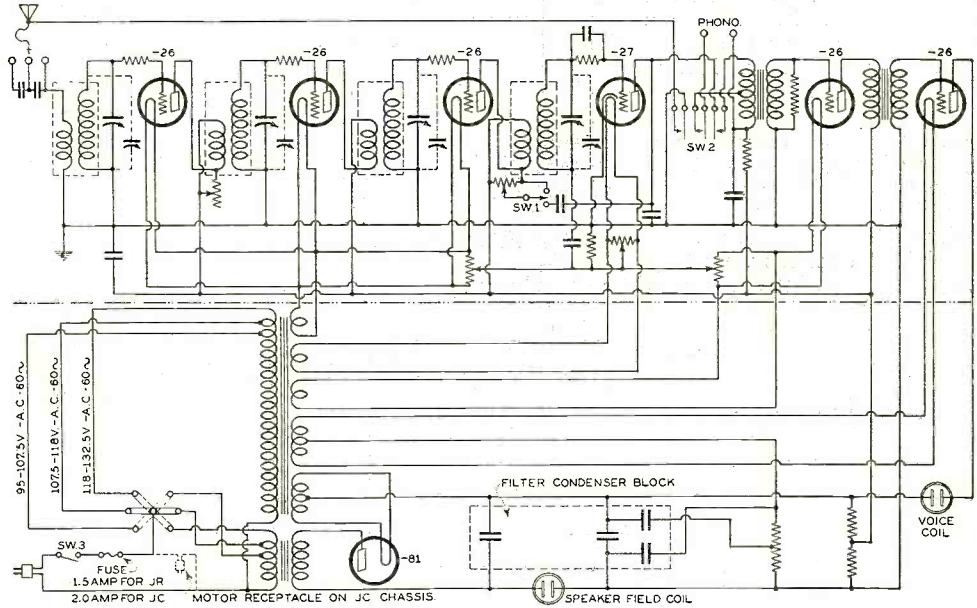

furnishes the necessary voltage to properly excite the speaker field. A line voltage switch is also included.

# Radio News Manufactured Receiver Circuits

## Sparton AC-89

THE Sparton A.C. 89 is a distinct departure from the usual in receiver design. In this receiver, all of the tuning is accomplished before the signal reaches the first radio frequency stage. This band pass circuit consists of two stages, with both primaries and secondaries tuned, making four tuned circuits. A series condenser, also variable, tunes the antenna circuit.

Eight tubes in all are used, 6 '27's, 1 '50 and 1 '80. Five of the '27's are in the radio frequency stages, the sixth being a power detector. The output tube is a '50 type, and power is supplied from an '80 tube. Provision has been made for use on any line voltage from 100 to 130 volts.

A phonograph jack is placed in the circuit ahead of the detector tube, and when used the detector becomes an amplifier.

A line voltage switch adapts the receiver for use on any line voltage between 100 and 130 volts, by appropriate taps on the transformer primary.

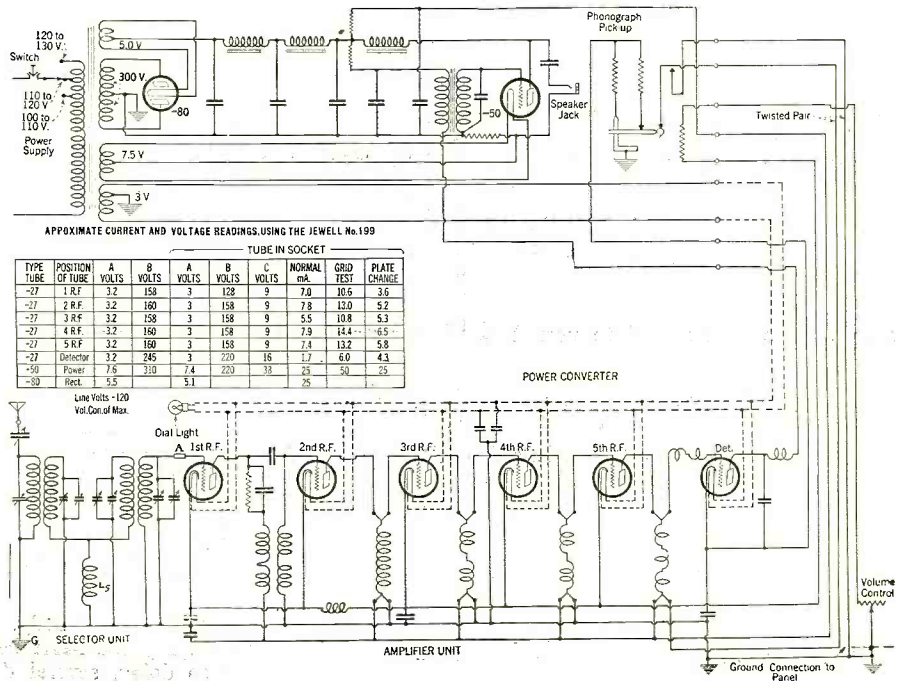

# Radio News Manufactured Receiver Circuits

## APEX No. 47

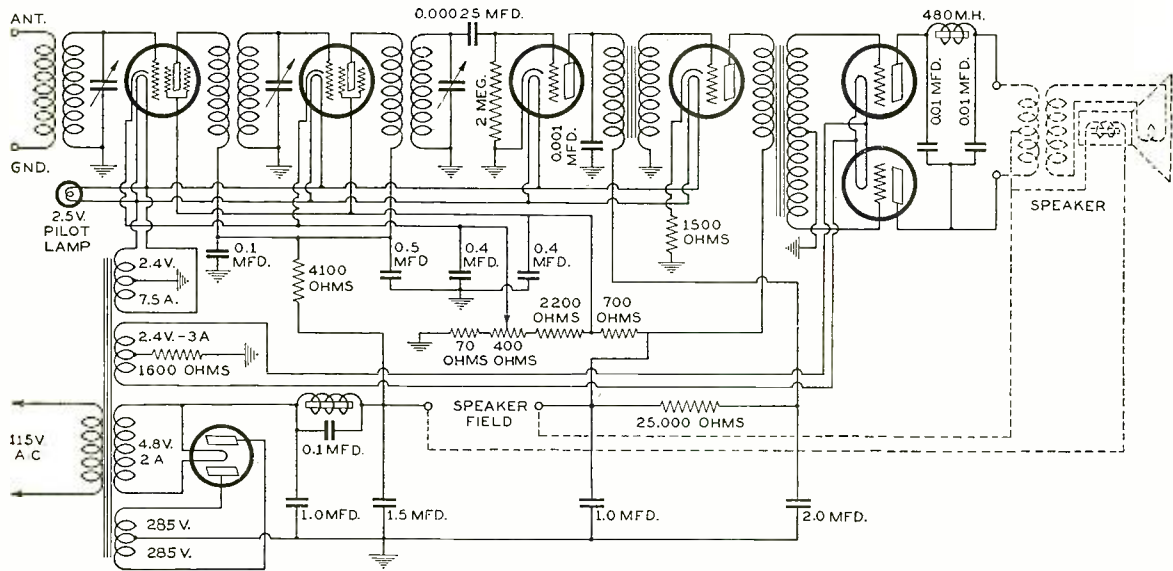

The Apex No. 47 receiver utilizes two -24 tubes, two -27 tubes and two -45 tubes. The -24's are in the radio frequency stages, the -27's are in the detector and first audio stage, and the -45's are in the push-pull power output stage. The radio frequency amplifier is of three tuned stages, and a grid-leak condenser detector follows. The audio amplifier is transformer coupled and consists of two stages. In the output stage a tuned circuit is used that markedly improves the tone quality.

In the power supply the first choke is tuned to assist in hum elimination, while the speaker field is used as the second choke. Volume control is effected in this receiver by varying the grid bias on the radio frequency tubes. A 400 ohm potentiometer, so connected that it is a part of the voltage divider circuit, gives positive control, inasmuch as the bias is not determined by the plate current of the radio frequency tubes, but rather by the current flowing in the voltage divider circuit.

# Radio News Manufactured Receiver Circuits

## SILVER No. 30-B

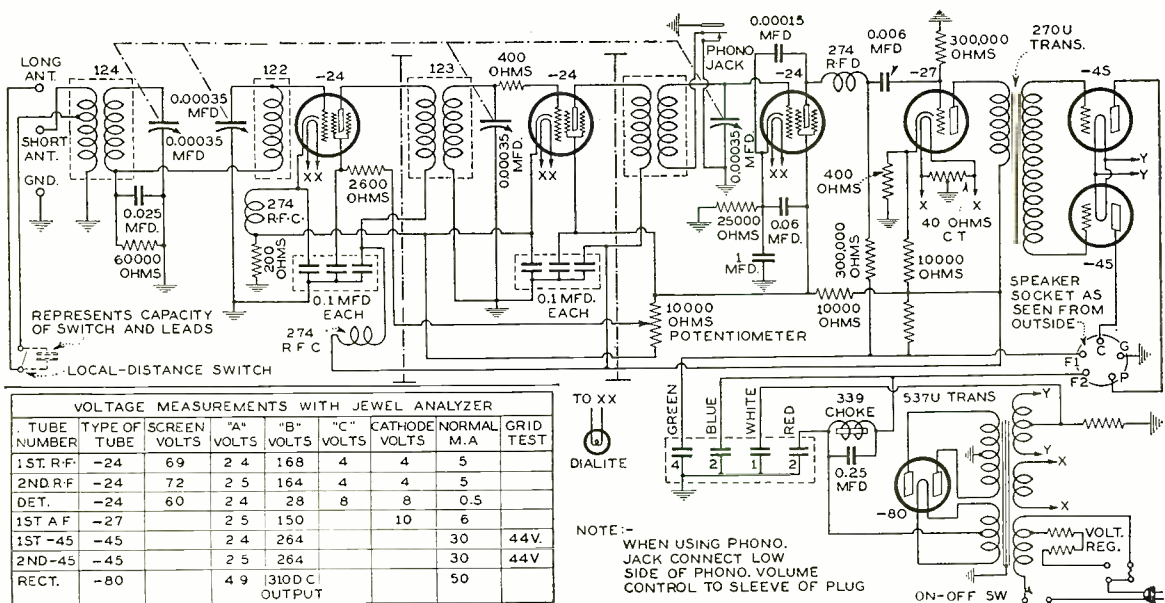

VOLTAGE MEASUREMENTS WITH JEWEL ANALYZER							
TUBE NUMBER	TYPE OF TUBE	SCREEN VOLTS	"A" VOLTS	"B" VOLTS	"C" VOLTS	CATHODE VOLTS	NORMAL M.A
1ST R.F.	-24	69	2.4	168	4	4	5
2ND R.F.	-24	72	2.5	164	4	4	5
DET.	-24	60	2.4	28	8	8	0.5
1ST A.F.	-27		2.5	150		10	6
1ST -45	-45		2.4	264			30
2ND -45	-45		2.5	264			30
RECT.	-80		4.9	1310 C			50

The Silver Model 30 is a six-tube receiver embodying some of the latest design trends. The tubes used are three -24's, one -27 and two -45's, and one -80 in the power supply. Bandpass tuning ahead of the first radio frequency

stage, tuning between the stages and screen grid detector. The first audio stage is resistance coupled to the detector, and the power output is push-pull. Provision is made to plug in a phonograph pick-up ahead of the detector.

# NEWS from the MANUFACTURERS

## Automobile Chassis Speaker

A loud speaker, developed especially for use with automobile radio sets, has just been placed on the market by the Amplion Corporation of America. It is known as the Amplion Model GW Auto-

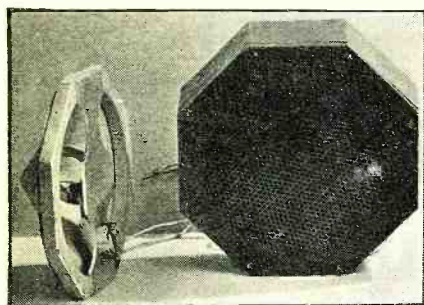

mobile Chassis Speaker. The entire chassis with the unit weighs only 15 ounces. The speaker utilizes a small but high-powered magnetic unit of the balanced armature type. The cone is approximately 7 inches in diameter and the depth of the chassis is  $3\frac{1}{4}$  inches. While the speaker may be mounted in any desired position, it is generally placed behind the automobile instrument board so that the latter acts as a baffle.

## Rubber Insulated Lead-In Strip

Mueller Electric Company, 1583 E. 31st Street, Cleveland, Ohio, is marketing a rubber insulated lead-in strip known as Dry Ribbon. The copper ribbon conductor is entirely insulated by tough rubber. A rubber cap covers the outdoor connection with the aerial wire eliminating dirt and oxidation around the contact.

## Multi-Stage Transmitter Kit

The Radio Engineering Laboratories, Inc., 100 Wilbur Avenue, Long Island City, is manufacturing a multi-stage trans-

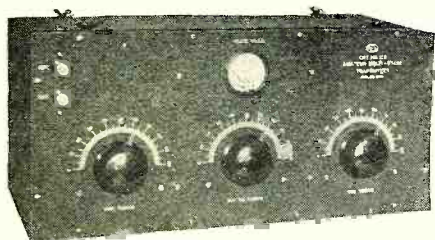

mitter kit which may be used as a straight C-W telegraph transmitter or combined with separate modulator unit for telephone uses. It can also be used in conjunction with additional higher power linear amplifiers.

## Home Radiovision Folder

For those interested in reception of radiovision pictures and radio talkies now being transmitted by various television stations throughout the country, the Jenkins Television Corporation, 370 Clermont Avenue, Jersey City, N. J., has issued a large folder entitled "How to Build Home Radiovision Equipment." This piece of literature explains the technique of radiovision reception and what is required and then goes on to describe the construction of a practical radiovisor made from a kit of parts now on the market. This folder is available on request to Jenkins Television Corporation.

## A New Sensitive Relay

The G-M Laboratories, Inc., Grace and Ravenswood Avenue, Chicago, Ill., has brought out a new sensitive relay for use in conjunction with the photoelectric cell.

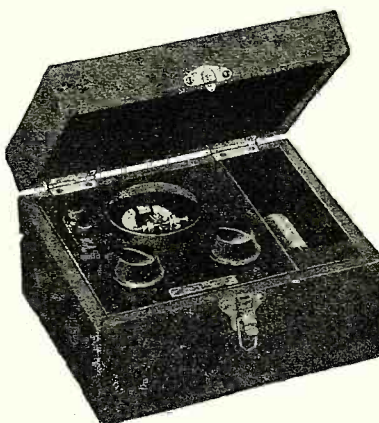

It is complete in itself, as it embodies a one-stage amplifier, using standard -99 tube, which makes possible sensitivity to as minute a change in light intensity as .005 of a lumen.

## Antenna Substitute

The Insuline Corporation of America, 78 Cortlandt Street, New York City, has brought out an antenna substitute known as the "Insultenna." This is not a light socket antenna and the device dispenses with lightning arresters, insulators, lead-in wire, etc. The Insultenna is constructed in a metal case with polished bakelite panel. It is  $4\frac{1}{2}$  inches long,  $2\frac{1}{2}$  inches wide and 1 inch thick. To install the Insultenna, the ground binding post is connected to any convenient water pipe or similar ground. The other two posts are connected to the set aerial post and the set ground post respectively.

## Station Selector

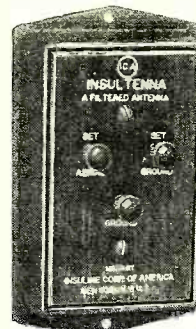

Insuline Corporation of America, 78 Cortlandt Street, New York City, announces a new form of station selector based on the band-pass principle. This device is known as the "Accuratuner." In this type of band pass the characteristic curve, in addition to the flat top, has very steep sides.

Hence the selectivity is obtained without the cutting of "side-bands" and, as a result, tone quality is unimpaired. The "Accuratuner" is connected between the aerial lead-in and the aerial binding post of the receiver.

## Corwico Super Braidite

The Cornish Wire Company, 30 Church Street, New York City, announces a new hook-up wire known as "Corwico Super Braidite." This wire has an average voltage breakdown of 1340 volts. It can be readily stripped back with any automatic stripper and is made with a solid or stranded core in 15 different color combinations.

## Cordless Soldering Iron

The Electric Soldering Iron Co., Inc., 135 West 17th Street, New York, is manufacturing a cordless soldering iron and stand as illustrated.



This tool is claimed to be particularly suitable for electrical soldering, or any soldering where there is a rest period between the actual soldering operations. The iron pulls directly out of the stand and, due to the angle, there is a gradual curve straight to the work.

The especially desirable feature about this tool is the fact that there is no cord to get in the way of the work and the elimination of service work on cords. It is therefore very desirable for radio laboratories and repair shops where the soldering operations are not uniform.

The iron can be inserted into the socket stand in any manner whatever, due to the simple construction of the terminal.



**Audio Amplifiers**

Thomas Engineering & Manufacturing Company, St. Charles, Ill., announces its entrance into the audio amplifier field with a complete line of two and three-stage amplifiers.

The Thomas amplifiers are particularly suited for installations that require dis-

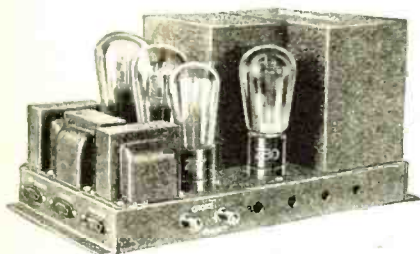

ortionless reproduction with large volume, such as theatres, dance halls, clubs, parties, schools, parks, dining-rooms, music studios and large homes. Additional speakers or a microphone may be attached as desired for making announcements.

**New Shielded Condenser**

The DeJur-Amsco Corp., Fairbanks Building, New York City, is now marketing a new variable condenser which is

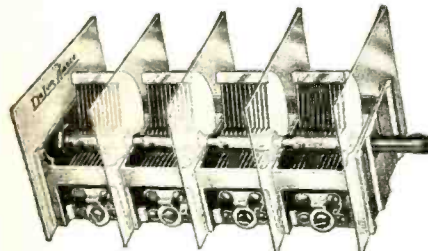

completely shielded and developed especially for use in screen-grid receivers. This condenser has an aluminum cast frame and aluminum cast shield plates. It is available in two, three and four-gang units.

**Electrolytic Condensers**

Polymet Manufacturing Corporation, 829 E. 134th Street, New York City, has developed a line of electrolytic condensers. The condenser, known as Polymet "E" condenser, is available in capacities up to 72 mfd. Single units are supplied with either standard top terminals or for "upside down" mounting with bottom connections. Thorough tests indicate continuous reliability with voltages not exceeding 400 volts and also show that this particular form of construction results in lower current leakage than experienced with previous types.

**Vitreous Enameled Wire-Wound Resistors**

The Electro-Motive Engineering Corporation, 127 W. 17th Street, New York City, is manufacturing a line of vitreous enameled wire-wound resistors which comprise vitreous enameled types, bakelite enameled types, special heat resistance covering type and the lacquer type. These resistors are rated at 7.2 watts per square inch outside surface. They can be supplied tapped to specifications with either soldering tabs or flexible wire leads. Every resistor is individually tested and guaranteed to be within 10 per cent. of its rated resistance.

**Constant Impedance and Line-Matching Volume Controls**

Electrad, Inc., 175 Varick Street, New York City, announces a new type of constant impedance and line matching volume control suitable for talking pictures and public address systems where a number of speakers are supplied from the same amplifier.

The resistance element is especially developed and is permanently fused to the surface of a vitreous enameled steel plate. A new type pure silver floating brush, riding directly on the surface of the resistance element, insures positive contact and stepless variation. Constant impedance units can be made to specifications with all usual resistance values, curves and wattage ratings.

screen-grid tubes enclosed in aluminum housing. The speaker, of the electromagnetic type, has been especially designed for auto service.

**Tube Checker**

Jewell Electrical Instrument Company, 1650 Walnut Street, Chicago, Ill., is manufacturing a new tube checker operating on a 50-60 cycle 110-120 volt alternating current. No batteries are needed.

The Jewell Pattern 209 tube checker, as it is called, consists of a direct current meter with six tube sockets in a case of molded bakelite. The sockets provide filament voltages of 1.5, 2.5, 3.3, 5 and 7.5 to four-prong sockets, and 2.5 to a five-prong socket. The two terminals giv-



ing 3 volts are provided for tubes that have heater elements on top. A jack and suitable lead are provided for a grid control connection.

The actual grid test is accomplished by shifting the grid from one position in the network to another, thereby giving a definite change in plate current corresponding to the difference between the two polarities. Expected values of the first plate current reading are given in an engraved chart on the face of the tube checker, together with the expected increase in plate current when the button is pressed. The base plate carries detailed instructions.

**Molded Bakelite Condensers**



The Electro-Motive Engineering Corporation, 127 W. 17th Street, New York City, announces a line of molded bakelite condensers which includes various types meeting the demands of different specifications of practically all set manufacturers. These condensers are furnished in capacities from .000025 mfd. to .02 mfd., with either single-hole mount, double-hole mount or without any mounting holes, as desired. The dielectric is of the finest grade India ruby mica. Plates are tin foil and the element is thoroughly impregnated. A canvas bakelite mica condenser is also manufactured by this company.

United States Radio & Television Corporation, 3301 S. Adams Street, Marion, Ind., announces a five-tube screen-grid automobile receiver. The chassis of this set is fully shielded and the set has three tuned stages, two stages of audio, and five tubes including two

**Automobile Receiver**

United States Radio & Television Corporation, 3301 S. Adams Street, Marion, Ind., announces a five-tube screen-grid automobile receiver. The chassis of this set is fully shielded and the set has three tuned stages, two stages of audio, and five tubes including two

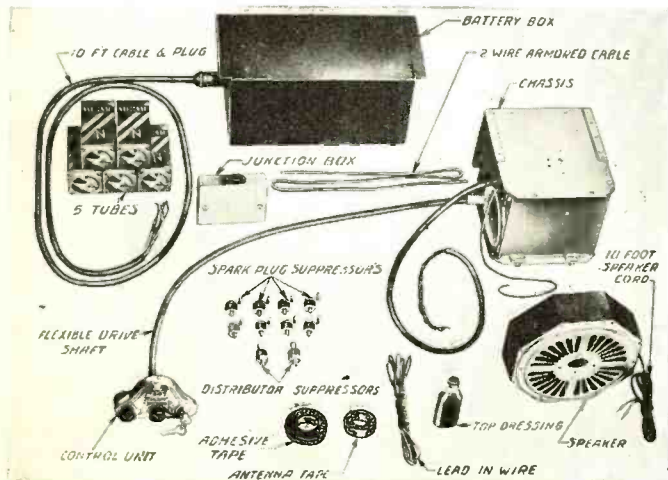

# RADIO NEWS INFORMATION SHEETS

## Mixing Circuits in Superheterodynes

**W**HEN a musician strikes two notes simultaneously, a listener not only hears the two notes as played, but he also hears a third tone, or beat note that is the difference between the two original notes. If the third tone is pleasing, it is harmony; if displeasing, a discord. In either case the third tone is heard.

In superheterodynes we make use of the same phenomena, except that we use electrical vibrations instead of musical ones.

The wave train as picked up from a broadcast transmitter is made up of vibrations somewhere in the spectrum between 1500 kc. and 500 kc. Thus we have available one of the two vibrations. The oscillator in the receiver is the source of the second vibration. A typical oscillator is shown in the cut.

Suppose we mingle these two waves, or vibrations. In that case a third wave train results that is the difference between the two originals. This is called the "beat frequency." To make this clear, suppose we pick up a broadcast station wave of 1500 kc., and adjust our local oscillator to 1470 kc. In this case we have a beat frequency of 30 kc. (We might also have adjusted the oscillator to 1530 kc. In either case, the difference is still 30 kc.) There are several satisfactory methods of mixing the two

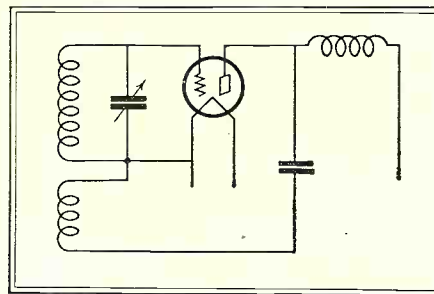

frequencies. One of the most popular methods is to wind a small pick-up coil on the oscillator coil form, and connect the pick-up coil in series with the grid return of the detector coil. Another method that can be used satisfactorily when a screen-grid first detector is used is to connect the screen grid to the plate of the oscillator and adjust the common voltage to the correct value for the screen grid.

If the intermediate amplifier in the receiver is adjusted to 30 kc. the signal will be amplified through it. Any two frequencies may be chosen as long as their difference is 30 kc.

The advantages of such a system are many. To begin with, it is comparatively easy to design a very high gain amplifier to work at these low frequencies. Not only will such an amplifier be inherently stable, but it may have many tuned circuits working at peak efficiency, as when they are once adjusted they remain so, and do not have to be constantly varied as do the tuned circuits in any other type of receiver. This of course reflects itself in extreme selectivity and sensitivity.

Not only do these advantages accrue, but the oscillator will naturally be a very sharp circuit, due to the fact that it will have no resistance. In actual practice it is sometimes necessary to deliberately broaden the tuning.

# RADIO NEWS INFORMATION SHEETS

## The Static Characteristics of Vacuum Tubes

**W**E frequently hear the words "static" and "dynamic," but to many their meaning when applied to tubes is not quite clear. They simply mean the characteristics of the tube when not actually working in a circuit, or the static characteristics. Opposed to this, the dynamic characteristics are the characteristics when actually working in a circuit, or when circuit conditions are simulated.

Of course, what we are ultimately interested in are the dynamic characteristics, but if upon test we find that the static characteristics are normal, we can be fairly sure that the tube will operate properly.

The cut shows a hook-up that will give the static characteristics at a glance. The meters shown are voltmeters and ammeters, designated by V and A respectively. Every manufacturer rates his tubes on the box according to grid voltage, filament voltage, filament amperage, plate voltage, and plate amperage. A grid current meter is also included in the hook-up, although the use of the same is not strictly in accord with finding the static characteristics. Suppose we take a typical manufacturer's rated tube:

-45—Filament volts, 2.5; filament amperes, 1.5.

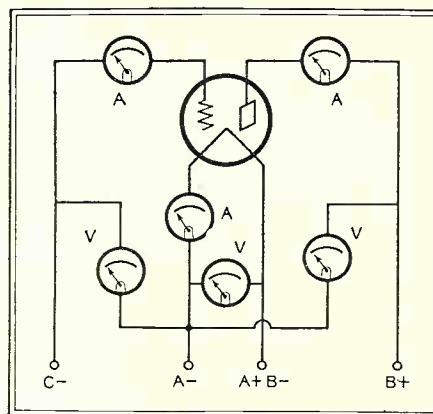

Plate volts	Grid bias volts	Plate milliamperes
150	-27	24
200	-38	28
250	-50	32

In this case we would set the voltages at normal for the particular tube under test, and observe the meters. If all of them agree with the rating given that particular tube, then the tube is good. The fact that grid current is not mentioned simply means that the tube should not draw any grid current. If, however, the tube should happen to be gassy, grid current will flow, indicating the fact that gas is present in the tube.

Anyone that has had experience in trying to design a receiver with the proper resistances, etc., will appreciate the importance of using tubes with standard characteristics. Also, until one becomes accustomed to handling tubes, they will be surprised at how much they do vary in practice, even when marketed by some of the largest firms. This is no reflection on the manufacturing methods employed, however, for uniform tubes can be made. Certain tolerances must be allowed to prevent having such a large number of rejects that the cost of the perfect tubes would be prohibitive.

# RADIO NEWS INFORMATION SHEETS

## Action of Screen Grid in Four-Element Tubes

**T**HE -24 tube, with which we are all familiar, is a very interesting tube from a number of standpoints. To begin with, it permits amplification per stage that was unheard of a year or so ago. Also a perfectly stable amplifier may be built around this type of tube with no means of neutralization, such as the Hazeltine or Rice system as used with three-element tubes.

The very high  $\mu$  of this tube arises from two functions of the screen grid. First let us consider its accelerating action.

In the cut the physical relationship of the various elements within the tube is shown. The position of the filament, or cathode, the grid, and the plate is the same as in the more familiar three-element tubes. The screen grid, or fourth element, is made in two parts, connected together, and completely surrounds the plate.

When electrons are evaporated from the filament they do not all leave the filament with the same velocity. Some of them lack sufficient "push" to accomplish their tremendous journey to the plate. When this occurs, they simply group themselves in space, and remain there. To

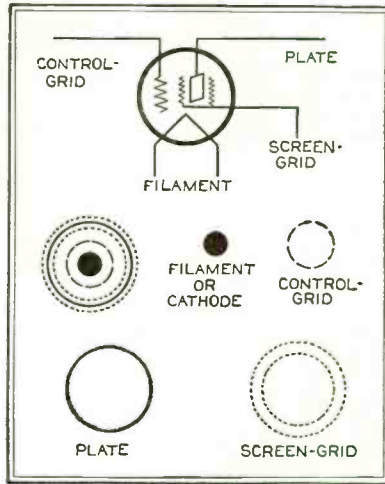

this electron cloud will be added more electrons from still another source. Occasionally an electron is traveling at sufficient velocity to knock several more electrons from the surface of the plate. By this time we have accumulated quite a crowd of these orphans, and they actually begin to impede the progress of the electrons that would ordinarily have reached the plate.

Now let us place an openwork grid in the space where these electrons gather in greatest number. Connected to a source of high potential, higher than the cathode, but lower than the plate, this fourth element will serve to attract this cloud and clear up the atmosphere, so that the other electrons are not impeded. Not only is this accomplished,

but since the screen grid is positive it serves to attract electrons emitted by the cathode and give them very high impetus. By the time they reach the openwork of the screen grid they come under the influence of the plate, which is at even higher positive potential, so they pass on through the openings in the screen grid and reach the plate. At least the vast majority do. (Further discussion on this subject will appear next month.)

# RADIO NEWS INFORMATION SHEETS

## Alternating Current "Resistance"

**W**E are all familiar with the fact that when current flows through a wire or other conducting medium it meets a certain opposition to its flow. This is called "resistance." Some mediums have more resistance than others, so we have a unit by which we designate the opposition offered by any given medium, the ohm. If the opposition is little, the resistance is few ohms; if high, the resistance is many ohms.

When we speak of "resistance," we usually think of it in direct current circuits, and figure it accordingly. In alternating current circuits, however, we run into resistance in other forms. A coil of wire, for instance, will offer two distinctly different oppositions to direct current and to alternating current. If carrying direct current, the resistance will be simply the resistance of so much wire, but if carrying alternating current, the resistance will be much higher. A coil of wire will have "inductance" and this inductance will have to be reckoned with in figuring the "reactance" of the coil. Reactance is the same thing as resistance, except in an alternating current sense. The reason the reactance is greater than the resistance in a coil

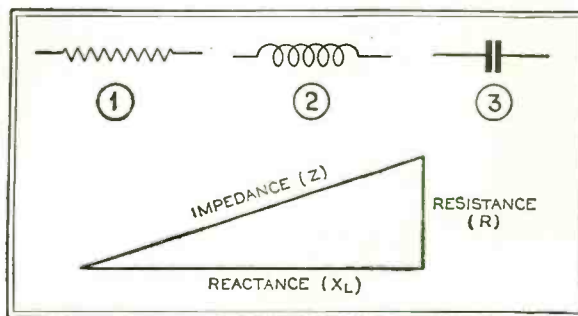

of wire is that current flowing in the turns induces a counter current in the other turns, thus setting up a counter electromotive force that opposes the direction of the original flow.

To figure the reactance of a coil, the following formula applies:

$$2\pi F L$$

$\pi$  is equal to 3.14

F the frequency of the alternating current

L the inductance (in hen-

ries) of the coil.

For very close figuring we must also take into consideration the pure resistance of the wire in the coil. The diagram shows a vector relationship between the reactance and the resistance. Solving the triangle will give the actual opposition when all things are taken into consideration, and this actual opposition is called "impedance." The following formula solves the triangle:

$$ZL \text{ equals } \sqrt{R^2 \text{ plus } XL^2}$$

(Part two of this series will appear next month with discussion of capacitive reactance and combinations of capacity and inductive reactance.)

# The Radio Forum

*A Meeting-Place for Experimenter, Serviceman  
and Short-Wave Enthusiast*

## The Experimenter

### Measuring Vacuum Tube Constants

THE art of vacuum tube design and manufacture has progressed so rapidly during the past two years that the problem of tube characteristics confronts no one but the most inquisitive of radio experimenters. Whereas, in past months one paid a special premium for five or six matched tubes, today one may purchase five or six tubes of different makes, but of the same type, and will find their characteristics much in concordance with each other.

There are still many instances where the experimenter could, writes Mr. Carl W. Evans, of San Antonio, Texas, profit by knowing the constants of the tubes he is using in a particular circuit and under the conditions of that circuit. Such knowledge would vastly simplify the work of applying the same circuit to tubes of a different type, or to other tubes of the same type when the circuit involved is critical to such constants.

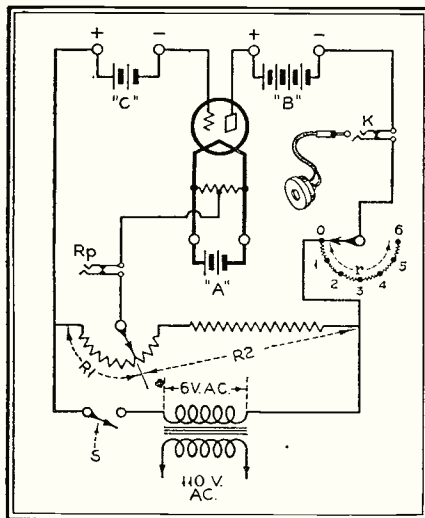

Fig. 1

In general, the constants in which the experimenter will be interested will be the amplification factor  $K$ , the internal plate resistance  $R_p$ , the mutual conductance  $G_m$ , and the internal plate impedance  $Z_p$ . Of these constants the only tubes need to be measured  $K$  and  $R_p$ , for  $G_m$  equals  $K/30 R_p$ , and  $R_p$  equals  $Z_p$  for all cases except where very high frequencies are involved, in which case the impedance will be modified by having the effect of a small capacity shunted across the internal plate resistance. For determining the bulk constants, Mr. Evans has

constructed a device which has proved most satisfactory, yet inexpensive.

In Fig. XX is given a wiring diagram of the device. In this figure it will be observed that two jacks are provided for the telephone circuit. These jacks are of such type that they close the circuit when the phone plug is removed. Two jacks are utilized in order that the device may be quickly converted from an instrument measuring amplification factor to one determining internal plate resistance. The only other change required for the conversion is in the variable step resistor  $R$ . This resistance is entirely cut out of the circuit while the device is used for measuring amplification factor.

The operation of the set, when measuring amplification factors, is as follows:

Insert the tube to be tested and adjust the "A," "B" and "C" voltages to the value at which the tube is to be operated, close the switch  $S$ . The telephone plug should be inserted in jack  $K$ , and the resistance  $R$  should be set at zero. The main variable resistor is then rotated back and forth until a point is reached at which no hum is heard in the telephone receiver. As will be seen in the diagram, Fig. 1, this point divides the resistance into two sections. The ratio of the plate section to the grid section is the tube amplification factor, i.e.,  $R_2/R_1$  equals  $K$ .

If the instrument is to be operated as a measurer of plate resistance the operation is practically the same, except that the telephone receivers are plugged in jack  $R_p$  and the resistor  $R$  is utilized. In this instance the dial  $R$  is turned to the point 1 and the main dial is rotated until a point is found where no hum in the receiver is indicated. If this point is not clearly found, the dial  $R$  is turned to other points and the process continued until a definite point is found where no hum is heard in the receiver. The setting of  $R$  and the ratio of  $R_1/R_2$  should be noted, and if the setting of  $R$  is converted to its resistance the internal plate resistance will be  $R_p$  equals  $R_1/R_2$  times  $R$  ohms. If the tube is to be used at moderate frequency only,  $R_p$  will also be equal to  $Z_p$ , the internal plate impedance. With the constants  $K$  and  $R_p$  determined, the calculations of the mutual conductance  $G_m$  is quite simple, since it is determined as  $K/R$ .

The theory underlying the operation of the device is not difficult to understand. In the latter case it is quite evident that the device is simply a Wheatstone bridge,  $R_1/R_2$  being the ratio arms,  $R$  the standard resistance and  $R_p$  the unknown.

When operating as a measure of amplification factors, the operation is upon an

entirely different basis. It will be observed that the alternating components of the voltages between the grid to filament and plate to filament are in opposition of 180 degrees out of phase. When a point is located on the main resistance dial at which no hum in the receiver is heard, it is an indication that no a.c. component is flowing from the filament to the plate, i.e.,

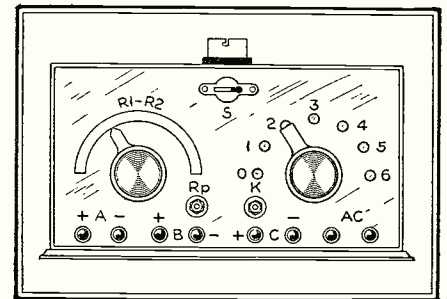

Fig. 2

the instantaneous potentials of the grid is just sufficient to counteract the effect of the instantaneous potentials of the plate. If no current (the a.c. component in this case) is flowing, then  $E_p + KE_g = 0$ . This relation may be obtained from the formula  $I_p = A(E_p + KE_g) B$  in which  $I_p =$  plate current,  $E_p =$  plate potential,  $E_g =$  grid potential,  $K =$  amplification factor,  $A$  and  $B =$  constants of the tube and operating conditions. From the first relation given above it is seen that  $K = E_p/E_g$  in which the negative sign indicates that the two potentials are in opposition. Referring to the diagram, it will be observed that  $K = R_2/R_1 = E_p/E_g$ .

To those experimenters who attempt the construction of this device the panel layout shown in Fig. 2 should prove useful. The material required is evident from the diagram. The magnitude of the resistances depend, to some extent, upon the type of tubes to be tested, but for general use the units of the dial  $R$  should be about 20,000 ohms each. The accuracy of their calibration depending upon the accuracy desired by the tester. For ordinary purposes this need not be closer than 97 to 103 per cent. of rated value. The variable and fixed resistance of the main dial should each be about 20,000 ohms. The readings and calculations required in using the instruments for both purposes will be greatly simplified if the dial of the main resistance has two scales, one calibrated for  $R_1/R_2$  and the other for  $R_2/R_1$ . It is needless to say that many improvements and modifications may be made upon the basic instrument

(Continued on page 282)

# The Serviceman

## A Really Practical Oscillator for Servicemen

Mr. Fredrick J. Kahn describes this month an oscillator that should be a welcome addition to the testing equipment of any serviceman.

**N**O doubt everyone has had the disconcerting experience of having spent considerable time in making repairs and adjustments to a set, and when you were ready to make the final adjustments, found to your discomfort that, tune as you may, no broadcast signals were heard. You then proceeded to test all the circuits again, checked the tubes and nearly broke your neck going over the antenna system, only to later find out that an SOS had caused all broadcasting to be shut down! If by chance you had a good oscillator with you, just think of how much time and patience would have been saved and how much better you would have impressed your customer.

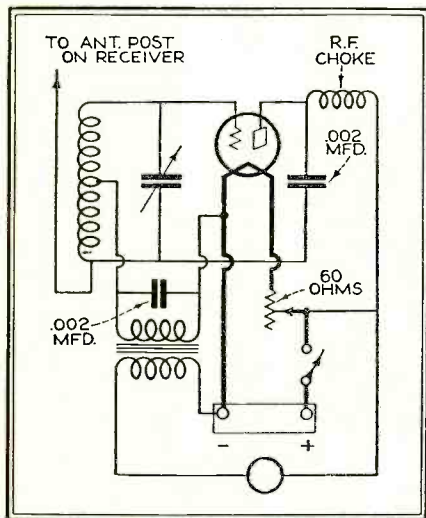

Fig. 1. Schematic wiring

We all know it is a very easy matter to sit back and recommend that all servicemen carry oscillators with them, along with the rest of their equipment, but who is going to carry around with him the necessary power supply units to operate the oscillator with? Some people recommend using the a.c. line as a supply. This is all right, but what will be done if the service call is in a d.c. district or if no power lines are available? The best all-around equipment to use is batteries, thereby making the outfit really universal, and therefore the following described device is recommended because it delivers a signal of sufficient intensity to balance neutrodyne sets with and test the overall operation of any type of radio receiving set. At the same time it is small and compact enough so that it can be carried from job to job without any difficulty, and also the battery requirements consist of one 4 1/2-volt "C" battery, and in addition

## 25 Cents A Question

Bear in mind, fellows, that, even though an actual question and answer department doesn't appear in the pages of RADIO NEWS, we have at your service a Technical Information Service.

All technical inquiries should be addressed to this department, accompanied with our regular fee of 25 cents per question and return postage.

Remember, if you want a reply to your inquiries make sure that this condition is observed.

tion it can be made up out of odds and ends found in the average radio shop. What could be simpler?

## Material Required

The material required, as listed below, can be changed somewhat to make use of the most available material:

- 1 .0005 mfd. variable condenser
- 1 1 1/2" tube with 100 turns No. 30 d.s.c., centre tapped.
- 1 UX199 tube.
- 1 UX199 socket.
- 1 modulation transformer (Acme), unmounted.
- 1 Century or General Radio buzzer.
- 2 .002 mfd. fixed condensers.
- 1 4 1/2-volt "C" battery.
- 1 small snap switch.
- 1 suitable case.
- 1 60-ohm rheostat.

The serviceman making this oscillator can use his own ideas as to the size and layout of the various parts, but it is recommended that the unit be as compact as possible. In this model the "C" battery is enclosed in the case.

Fig. 1 gives the schematic wiring and you will note how the primary of the modulation transformer is wired in series with the buzzer and also that the snap switch is wired in the common positive side of the battery, so that the tube and buzzer are both turned off when the use of the unit is not needed.

The buzzer should be mounted on the top of the case because it requires adjusting occasionally in order to keep the pitch of the signal at a rather high frequency.

The actual size of the carrying case is not given, as everyone has their own ideas, and this also allows the builder to use such parts as are most available.

After constructing the oscillator it is oftentimes desirable to plot a frequency curve, so that the condenser can be set at a given point on the dial to produce a signal at a desired frequency. The signal output is governed by the amount of coupling between the oscillator coil and the set under test. Actual use will determine this factor for you. No signal will be made unless the buzzer is working, so be sure that is properly adjusted.

## A Simple Line Booster

Mr. T. Anderson of Philadelphia, Pa., contributes a simple booster circuit for use in a.c. districts where the line voltage falls below that required for efficient operation of "electric" receivers, and for the reduction of this voltage where it is dangerously excessive. The diagram of Mr. Anderson's arrangement is self-explanatory. The extra apparatus consists of a bell-ringing or other type of step-

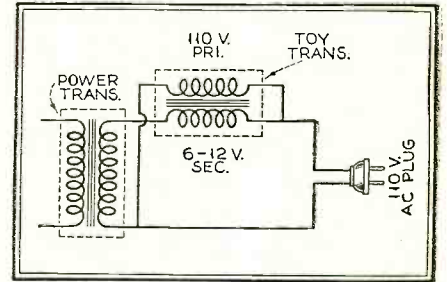

A simple line-booster circuit

down transformer, connected as shown. Either the primary or the secondary connections should be reversed to reverse the effect. When connected in one direction, the voltage to the power supply apparatus will be increased by the secondary voltage of the step-down transformer, and when reversed, the voltage will be dropped by the same amount.

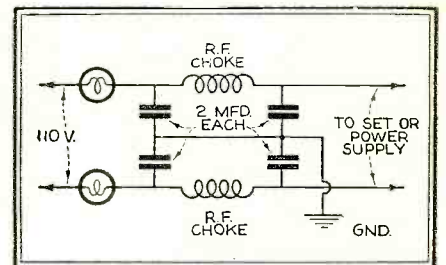

Fig. 2

## Eliminating Line Noises in Battery Substitutes

Mr. R. William Tanner of Springfield, Ohio, has run into a trouble common to batteryless receivers, that of line noises, and has solved the difficulty by means of a simple filter arrangement which, by the way, is recommended by several manufacturers of "electric" sets.

In certain locations, especially close to the business or commercial centers, line noises quite frequently make radio reception very unpleasant when employing "A" and "B" eliminators.

Where the antenna is not picking up the noises directly, a filter may be employed in the 110-volt supply line to the transformers. The connections are shown in Fig. 2. Four 2 mfd. condensers and two radio-frequency chokes are necessary.

(Continued on page 281)

# With the Short-Wave Fans

## An Audio Oscillator Code Practice Set

WITH the increasing popularity of short-wave receivers and converters, in response to more extensive short-wave broadcasting and television experiments, it is natural that an interest in code reception should be stimulated in the heretofore strictly broadcast enthusiast. The possibilities of code reception are genuinely intriguing to the serious experimenter, and have been suggested, from time to time, by R. S. Kruse in his short-wave department.

Several readers have suggested inexpensive code practice equipment utilizing a simple vacuum tube audio oscillator arrangement to supply a high-pitched note similar to that characteristic of reception from a good c.w. transmitter.

### Practice Set

Lawrence W. Robbins goes into some detail in the description of the practice set he has photographed and sketched.

"The diagram of the oscillator is shown in Fig. 1, while the drawings of Fig. 2 and the photograph, Fig. 3, are fairly self-explanatory of the constructional details.

### Construction

"The cabinet was built of thin box-wood and later stained to suit. The base was first cut out 5½ in. square. Upon this was mounted a UX tube socket, audio transformer, and a spring clip by which a "C" battery of 4½ volts was clipped to the base alongside the transformer. Then a 6-ohm rheostat was attached to the back of the panel and the pair of phone tip-jacks inserted below it. The "C" battery furnishes both filament and plate power to a 199 tube.

"One point must be especially noted. The tube will not oscillate when the plate of the tube is hooked to the plate post of the transformer. It must be wired to the "B" plus post.

"When all the parts were assembled and wired as compactly as possible at the left of the base, the partition was inserted vertically in two slots cut down inside the front and back.

This held the battery against the transformer and made a separate compartment at the right for the key when the key table was folded up. The key leads should be flexible and pass through the partition to transformer P and phone jack. Other leads may also be flexible from the rheostat and phone jacks so the sides can be un-

screwed from the base and lifted away from it if it is ever necessary to get at the works.

### Code

"The key table has two strips of cardboard glued to its surface upon which the code is printed. Underneath is also a common chair leg tip of rubber upon which the table rests when it is let down. This keeps it level.

### Transformer

"Any ordinary ratio transformer can be used, but a 3 to 1 seems to give the best note. Turn the rheostat on until the tube just lights, place the phones over the ears and press the key. The note will be a high-pitched whistle, clean and sweet and unwavering. It is exactly the note one would be liable to listen to from any well-constructed and expertly operated transmitting station. By varying the rheostat the pitch can be changed to suit, but, of course, a low setting will be easiest on the tube and battery. An ordinary "C" battery should give at least 75 hours of service with a 199 tube, plenty of time in which to learn the code quite thoroughly.

### Low Cost

"The total cost of such a set, if all parts have to be purchased, need not be over \$4.50 because everything can be of the cheapest make such as can be found in the chain stores. If most of the material is cast-off stuff that will be found on any amateur constructor's bench the cost will never be noticed."

Frank Fearman suggests a similar oscillator, but employs a 201A tube in series with a 25-watt lamp operated from the 110-volt lighting current, eliminating all batteries. The circuit suggested by Mr. Fearman is shown in Fig. 4. When the house current is a.c. the note will be modulated by the supply current. However, it will not be at all bad—and, as a matter of fact, identical with the note radiated by the majority of amateur transmitting stations.

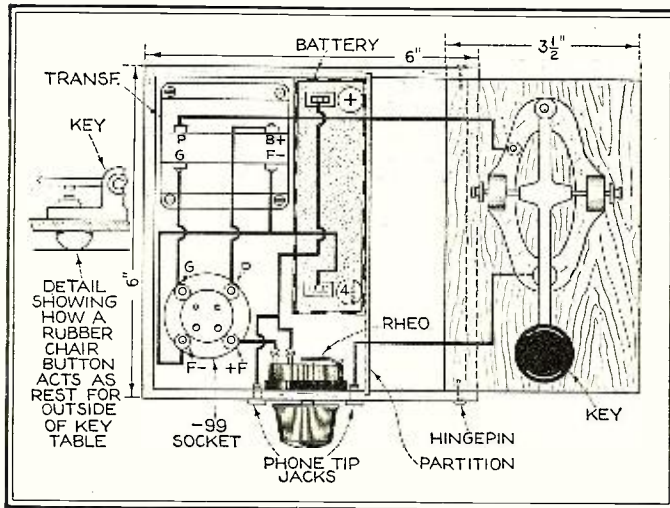

Fig. 2. Picture-wiring diagram of code test-set

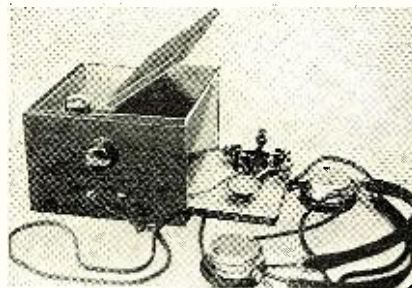

Fig. 3. Illustrating the complete outfit

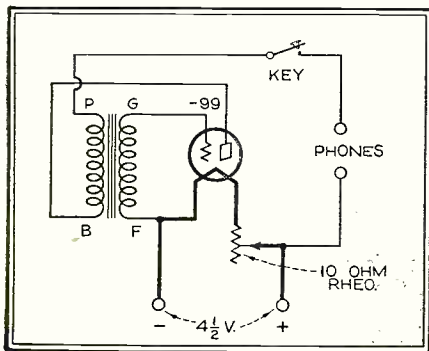

Fig. 1. The circuit of the oscillator

RADIO NEWS will be glad to receive communications from short-wave fans detailing their experiences or discussing matters of technical interest. Such items accepted for publication in RADIO NEWS will be paid for at a fixed space rate.

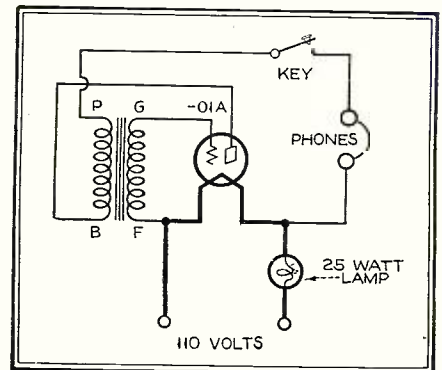

Fig. 4. Using 110-volt supply

# ~RADIO NEWS HOME LABORATORY EXPERIMENTS~

## Experiments with Audio Amplifiers

**M**OST common sources of audio-frequency currents, such as microphones, phonograph pick-ups, detectors, etc., cannot supply sufficient power directly for the operation of a loud speaker. It is for this reason that audio amplifiers must be used to amplify the audio output of these devices to the point where sufficient voltage is available to drive power tubes, which in turn must be capable of supplying sufficient power output to satisfactorily operate the loud speaker. This Home Experiment Sheet discusses the characteristics of audio amplifiers. In this connection we are considering an audio amplifier to consist of all the apparatus located between the source of audio-frequency voltage and the grid of the power tubes. The characteristics of power tubes will be the subject of the sheet to be published next month.

The two characteristics of major importance in the design of audio amplifiers are (1) the frequency response characteristic and (2) the load characteristic.

The frequency characteristic indicates how uniformly the device amplifies the audio frequencies. Laboratory measurements of the frequency response of an amplifier are made by impressing small audio-frequency voltages on the input of the amplifier and measuring the voltage at the output of the amplifier. These measurements are made with a constant input voltage, at different frequencies throughout the band of audio frequencies. If the amplifier has a perfectly uniform (flat) characteristic, then the output voltage will be the same at all frequencies, since the input voltage is held constant. If, however, the amplifier does not respond uniformly to different frequencies the output voltage will not be the same at all frequencies and the extent of the output voltage variations will tell us how good is the amplifier. Some amplifiers, for example, give very good response to low frequencies, say 60 cycles, while others give very little response at this frequency. The response of a resistance-coupled amplifier to 60 cycles depends largely on the size of the coupling condensers. By means of a simple series of experiments described below we are going to compare the response of different amplifiers at 60 cycles and also determine how the coupling resistance in a resistance-coupled amplifier effects the response at 60 cycles.

The load characteristic is used to indicate what are the largest a.c. voltages the amplifier can handle without overloading. In the case of all the ordinary types of amplifiers the maximum voltage output is determined by the types of tubes employed and the voltages at which they are operated. Up to the point where an amplifier begins to overload the output voltage is directly proportional to the input voltage; that is, if we double the input voltage we get twice as much output, five times the input gives five times the output, and so forth. But when the amplifier is overloaded this relationship is no longer true and four times the input might, for example, give only twice as much output. Overloading can be readily illustrated by means of a simple experiment.

To perform the following experiments the apparatus listed below is required:

- 1 25-ma. milliammeter; 1 400-ohm potentiometer, with dial; audio transformers, resistances and condensers for constructing a resistance-coupled amplifier; batteries and tubes.

Construct a two-stage transformer-coupled amplifier as per the circuit given in Fig. 1. All data, including types of tubes and battery voltages, are given in the figure. Note that the primary of the first audio transformer T1 is fed through a 30,000-ohm resistance, which represents the plate resistance of the detector tube. Input voltage is obtained from the filament power transformer. The 400-ohm potentiometer is connected directly across the 5-volt winding of this transformer, with the movable arm of the potentiometer connected to one side of the 30,000-ohm resistor. The potentiometer must be equipped with a dial. We used a Yaxley potentiometer with a dial reading from 0 to 180. The potentiometer should be so wired into the circuit that when the dial reads zero the movable arm is connected to that side of the potentiometer which is attached to the "B" plus terminal of the first audio transformer T1. Therefore when the potentiometer dial reads zero no voltage will be impressed across the primary of T1 but as the dial is turned towards the 180 mark more and more voltage from the filament transformer is impressed across the first audio transformer primary, until when the dial reads 180 all the voltage from the filament transformer winding is impressed across the amplifier.

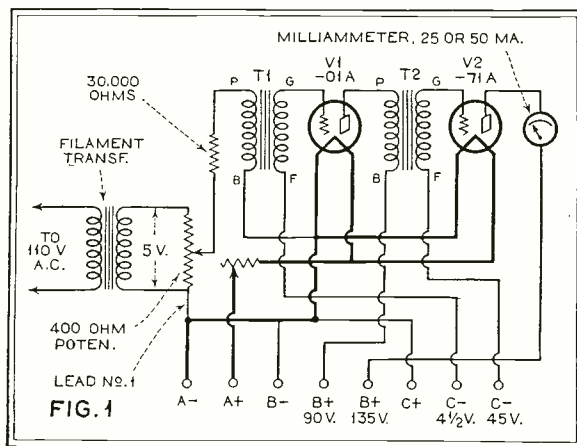

FIG. 1

The voltage across the secondary of the second audio transformer T2 will be measured by the last tube V2, the voltages on this tube being such that it operates as a vacuum tube voltmeter. As the input to the amplifier is increased the reading of the plate milliammeter will rapidly increase up to the point where the amplifier begins to overload, after which increasing the input will produce but a very small change in the reading of the milliammeter.

Having set up the amplifier as indicated in the circuit of Fig. 1, proceed as follows: Adjust the potentiometer dial to read 10 and then note the reading of the milliammeter. Then set the dial at 20 and again note the meter reading. Continue this procedure until the dial reads 100. Put all the data down in table form as shown in Table 1. Now change the bias of the first tube from  $-4\frac{1}{2}$  volts to zero. Proceed as before, setting the potentiometer at 10, then 20 and so on, each time reading the deflection of the milliammeter. These two tests will indicate the effect of operating a tube with and without bias.

Now connect lead No. 1 to the "B" plus 90-volt tap on the "B" battery instead of to "A—" as indicated in the diagram.

This will cause a current to flow through the primary of T1. We have all heard that current through the primary of a transformer effects its characteristic. By this test we can determine if it is actually so. The procedure is the same as before. Vary the dial setting and note down the meter readings as in Table 1, column 3.

Now let us make a test on a resistance-coupled circuit. The a.c. voltage available across the plate resistor of a resistance-coupled circuit depends upon the ratio of the load resistance to the plate resistance of the tube. If the load resistance is high compared to the resistance of the tube, then most of the voltage developed in the tube will be available across the load resistor where it can be used. If, on the other hand, the plate resistor has a low value compared to the tube resistance, then very

**TABLE 1**  
- TESTS ON TRANSFORMER-  
COUPLED AMPLIFIER -

DIAL READING	METER READINGS WITH		
	NORMAL CIRCUIT	NO BIAS ON FIRST TUBE	LEAD NO. 1 ON 90 VOLTS
10	0.5	—	—
20	2.0	1.5	1.0
30	5.0	3.5	2.0
40	8.0	6.0	3.0
50	12	8.5	4.5
60	15	11	7.0
70	17	13	10
80	18	14	13.5
90	19	16	16
110	20	19	19
150	23	21	21
180	24	23	22

little voltage will appear across the load. Let us prove this by an experiment.

The circuit is given in Fig. 2. It is the same as Fig. 1 except that the first transformer T1 has been replaced by a resistance-coupled circuit.

Place a resistor with a value of 1 megohm for R1. Adjust the potentiometer dial so that the meter reads about 10 milliamperes. During the remainder of this experiment do not again adjust the dial. Remove the 1-megohm resistor and replace with 0.5 megohm, then 0.1 megohm, then 50,000 ohms, and so on down to about 10,000 ohms. Each time note down the resistance and the current obtained, as in Table 2.

Now we are ready to plot some curves. To plot curves from the data given in Table 1 (those who actually perform these experiments will of course plot their own data) it is best to use "log-log" paper such as we used to plot the curves of Fig. 3 in this sheet. Space is not available to describe exactly why this type of cross-section paper should be used, save to state that by the use of such paper the range over which the amplifier can be used will be indicated by a straight line. A future Home Experiment Sheet is to be devoted entirely to this subject of plotting curves, and the value of various types of curve paper. Readers will find it possible to buy "log-log" paper at most any store selling drawing instruments and artists' supplies. It costs a few cents per sheet.

The curves to be plotted from Table 1 will show the relation between the dial setting and the meter reading. Therefore the dial setting should be indicated along the lower edge and along the vertical left-hand edge the meter reading should be shown. See Fig. 3. The dial readings can start at 10 and the meter readings at 1 ma., since it will not be found possible to obtain accurate readings below these values. The curves are plotted by making small dots on the curve sheet at various points corresponding to the readings given in Table 1. As an example one such point is indicated at A on curve 1. This point corresponds to a dial reading of 30 and the corresponding current of 5 milliamperes found in column 2 of Table 1. Other points should be found in a similar fashion and a smooth curve then drawn through all the points. First plot the curve for the dial reading and the currents shown in column 2, then for the dial reading and the currents in column 3, and so forth. When finished you should have a group of curves somewhat similar to those of Fig. 3.

Now plot a curve from the data in Table 2. This curve will show the relation between meter reading and the value of the plate resistor. The curve obtained from our data is given in Fig. 4.

First let us examine carefully the group of curves given in Fig. 3 showing the results of our tests on the transformer-coupled amplifier. As we stated previously, the useful part of the amplifier's characteristic is over the straight portion of the curve. When the curve begins to bend over and flatten out, the amplifier is overloaded. The curve for the "normal circuit" is straight up to a dial reading corresponding to about 36, the exact point at which it begins to curve being clearly indicated by the dotted line which shows the path the curve would have followed had it continued straight. Beyond the point corresponding to a dial reading of 36 the overloading effect rapidly became worse. The practical result of such overloading is to produce serious distortion in the amplifier.

The curve for "no C bias" begins to depart from the straight line at just about the same point as the previous curve, but we should note also that the "no C bias" curve falls below the curve corre-

**TABLE 2**  
- TEST ON RESISTANCE-COUPLED AMPLIFIER -  
DIAL SETTING HELD CONSTANT AT 60

VALUE OF PLATE RESISTOR R1	METER READING
1 MEG.	10
0.1 "	7.0
25,000 OHMS	3.0
10,000 "	1.0

sponding to the normal circuit. The fact that the curve is below indicates that the gain or amplification of the circuit has been decreased. For example, an input voltage corresponding to a dial reading of 30 produced 5 ma. in the meter circuit with the normal circuit, but when the "C" bias was removed the same input voltage produced only 3.5 ma.

With lead No. 1 connected to 90 volts we obtain a curve that falls below both the other curves and a dial reading of 30 gives only 2 ma. Quite evidently the ability of the transformer to satisfactorily amplify 60 cycles has been considerably reduced by the

flow of current through the primary. It is for this reason that it is always wise to work transformers with the smallest possible current through the primary. Most transformer manufacturers state the maximum current which their transformer will satisfactorily carry. This maximum current is not determined by the current-carrying capacity of the wire in the transformer, but is determined by the effect of this current on the transformer's characteristic. The poorer response obtained from a transformer carrying excessive plate current is due to the fact that this current lowers the inductances of the windings—the effect is very much the same as though some of the iron were to be removed from the transformer.

The fact both the "no C bias" curve and the "current through the primary" curve fall below the normal characteristic would seem to indicate that both have somewhat the same effect on the transformer. Such is actually the case. When a tube is operated without "C" bias current will flow in the grid circuit whenever a signal is impressed on the circuit. This grid current must of course flow through the secondary of the transformer. This small current flowing through the thousands of turns of wind on the secondary has just the same effect as a much larger plate current flowing through the fewer turns on the primary. It is probably possible to find some value of current through the primary which would have exactly the same effect on the transformer as operating it into a tube that has no bias on the grid.

The curve of Fig. 4 brings out one of the most important

points in the design of a resistance-coupled amplifier. In a resistance-coupled amplifier the current from the "B" battery or power unit must flow through the plate resistor. This produces a loss in voltage, equal to the current times the resistance in ohms, so the voltage at the plate of the tube may be much less than the voltage at the battery. It is desirable therefore to use the lowest value of plate resistance that will produce satisfactory amplification. You will recall that in our test on resistance-coupled circuit we keep the input voltage constant. Therefore the reading of the milliammeter can be taken as a direct indication of the amplification obtained with different values of plate resistance (R1 in the circuit of Fig. 2). With very large values of resistance the amplification will approach a maximum and as the resistance is reduced the amplification will decrease. In our test a very large value of plate resistance (1 megohm) gave a current of 10 milliamperes. If the curve of Fig. 4 is examined, however, it will be noted that as the plate resistance is lowered the current drops very slowly at first and then very rapidly. For example, cutting the plate resistance to one-tenth its value (from 1,000,000 ohms to 100,000 ohms) only reduced the current by 3 milliamperes—from 10 to 7. But if we again cut the resistance to one-tenth (100,000 to 10,000 ohms) we reduce the current by 6 milliamperes—from 7 to 1.

(Continued on page 269)

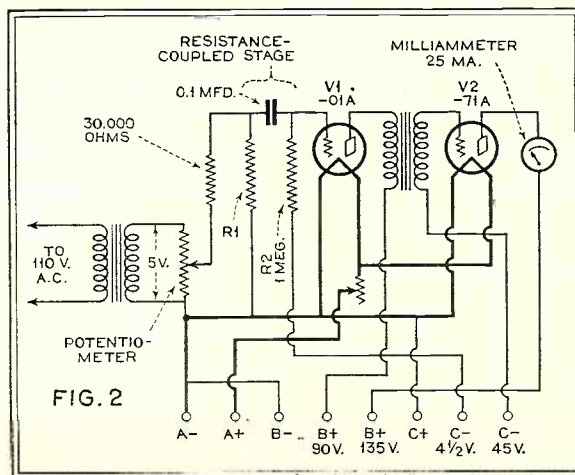
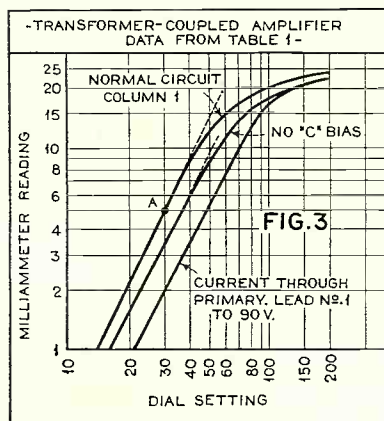



# FREE

*you can make real money*

# in RADIO

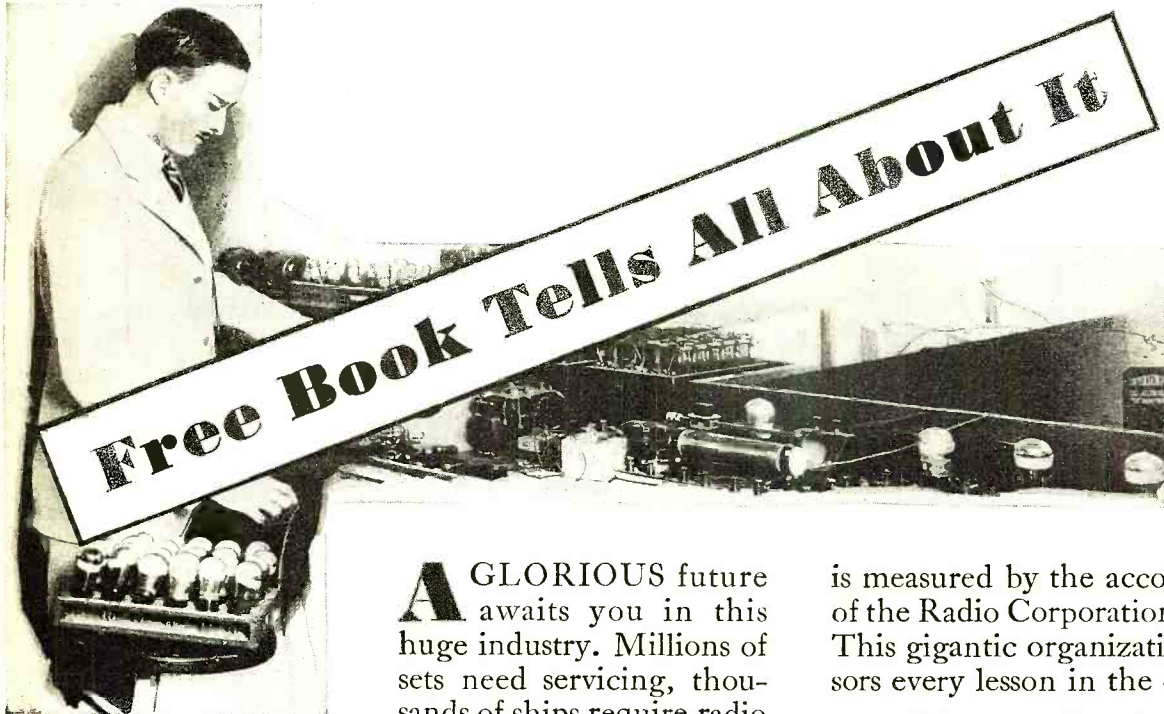

**Free Book Tells All About It**

**A** GLORIOUS future awaits you in this huge industry. Millions of sets need servicing, thousands of ships require radio operators... manufacturers and broadcasting stations throughout the land are eagerly seeking trained men... and now, nation-wide radio telegraph service, telephony, sound motion pictures, open up thousands of new and amazing opportunities.

is measured by the accomplishments of the Radio Corporation of America. This gigantic organization... sponsors every lesson in the course.

**Money Back if not Satisfied**

As a student you will receive an agreement signed by the president of this school assuring you of complete satisfaction upon completion of your training—or your money instantly refunded.

**Free!**

This fascinating book on Radio's glorious opportunities... written by one of America's well-known radio experts.

**RCA INSTITUTES, INC.**

A Division of

**Radio Corporation of America**

RCA INSTITUTES, Inc.  
Dept. Exp. 9, 75 Varick Street, New York

Gentlemen: Please send me your FREE 40-page book which illustrates the opportunities in Radio and describes your home laboratory method of instruction.

Name .....

Address .....

Occupation .....



Radio Operator \$90—\$200 per month with all expenses paid.



Broadcast Operator \$1,800—\$4,800 a year.



Radio Repair Mechanic \$1,800—\$4,000 a year.



Radio Inspector \$2,000—\$4,500 a year.

**Learn at Home**

By means of this marvelous, simplified home-training course, sponsored by the Radio Corporation of America, you can now prepare for success in every phase of Radio. The remarkable outlay of apparatus given to you with this course enables you to learn by actual practice how to solve every problem in radio work. That's why you, too, upon graduation can have the confidence and ability to command good money.

**Backed by RCA**

Graduates of this school are always posted in newest developments in Radio. That's why they are always in big demand. The progress of Radio

# Radio News Short-Wave Superheterodyne

(Continued from page 214)

turn coils, the peak used is at 1,485 meters (about 200 kilocycles) and the second peak appears at 972 meters.

These measurements were made with the 222 tube. The De Forest 422 tube shows somewhat higher gain per stage and signal increase is noticeable when the two different makes of tubes are interchanged. The plate impedance of the De Forest tube is lower than the RCA or Cunningham, hence higher gains are possible.

The physical dimensions of the primary and secondary coils of the radio-frequency transformers are identical. The wire used is No. 36 B. & S., silk enamel. The winding is much the same as the "honeycomb" style. The wood core is  $\frac{1}{2}$ " outside diameter, through which is drilled a hole  $\frac{1}{4}$ " in diameter, for mounting. The wood core is  $\frac{5}{16}$ " in thickness. The winding is  $\frac{1}{4}$ " in thickness and  $1\frac{1}{8}$ " outside diameter. These are the D coils shown as L6 in the diagram. L3, the grid coil of the long-wave oscillator, L4, the plate coil of the long-wave oscillator and L5, the plate or filter coil of the first detector, are identical. Each of these coils, L3, L4 and L5, consists of 450 turns of the same size wire, otherwise the same except for outside diameter, which is  $\frac{7}{8}$ ". Coils dimensions are shown in Fig. 1.

In assembling the intermediate transformers it is important that the two coils be tightly coupled, both windings in the same direction. The inside terminal of the primary goes to B+, the outside winding of the primary to the plate. The inside terminal of the secondary goes to C- of the screen grid of T3 and T4 and to B- of T5. The outside terminal of the secondary of L6 goes to one terminal of the grid suppressor of T3. The other terminal of the grid suppressor, R8, connects to the grid of T3. The outside terminal of the secondary of the first radio-frequency transformer goes to the grid of T4 and the outside terminal of the secondary of the second radio-frequency

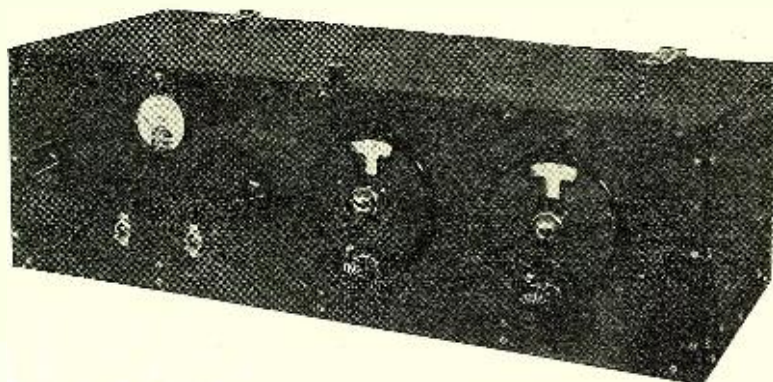

The front view of the S-W super, a ship-shape job

transformer goes to the grid condenser and leak of the second detector—all shown in Fig. 2, the complete wiring diagram of the receiver.

For the wiring and assembly of the receiver the following parts were used:

R—Lynch 20,000-ohm resistor, grid leak type.  
 R1—Lynch 2-megohm grid leak.  
 R2—Lynch 8-megohm grid leak.  
 R3—Lynch 100,000-ohm resistor, grid leak type.

R4—Lynch 0.5-megohm grid leak.  
 R5—Lynch 0.03-megohm grid leak.  
 R6—Carter 10-ohm heavy duty rheostat.  
 R7—Centralab 500,000-ohm potentiometer.  
 R8—Lynch grid leak type resistor (varies from 20,000 to 100,000 ohms, depending upon the tubes).  
 R9—Carter 13-ohm resistor, tapped at 10 ohms.  
 R10—Carter 13-ohm resistor.  
 C—Sprague 0.25-mfd. midget condensers (11 required).  
 C1—Sangamo 0.01-mfd.  
 C2—National Equicycle type EC 50, 50 mmfd. with type B dials (2 required).  
 C3—Sangamo 0.00015 mfd.  
 C4, C5, C10—Sangamo 0.00025 mfd.  
 C6—Hammarlund 100-mmfd. midget type, variable condenser.  
 C7—Sangamo 0.002 mfd.  
 C8—Sangamo 0.000050 mfd.  
 C9—Hammarlund 65 mmfd. midget type, variable condenser.  
 AT1, AT2—Thordarson R-300 audio transformers.  
 OT—Thordarson R-76 output transformer.  
 V—Jewell, pattern No. 135, 0-8 d.c. voltmeter.  
 T1, T3, T4—De Forest 422 screen-grid tubes.  
 T2, T5, T8, T9—Type -01A tubes.  
 T6—Type -12A tube.  
 T7—Type -71A or De Forest 471B. (Continued on page 283)

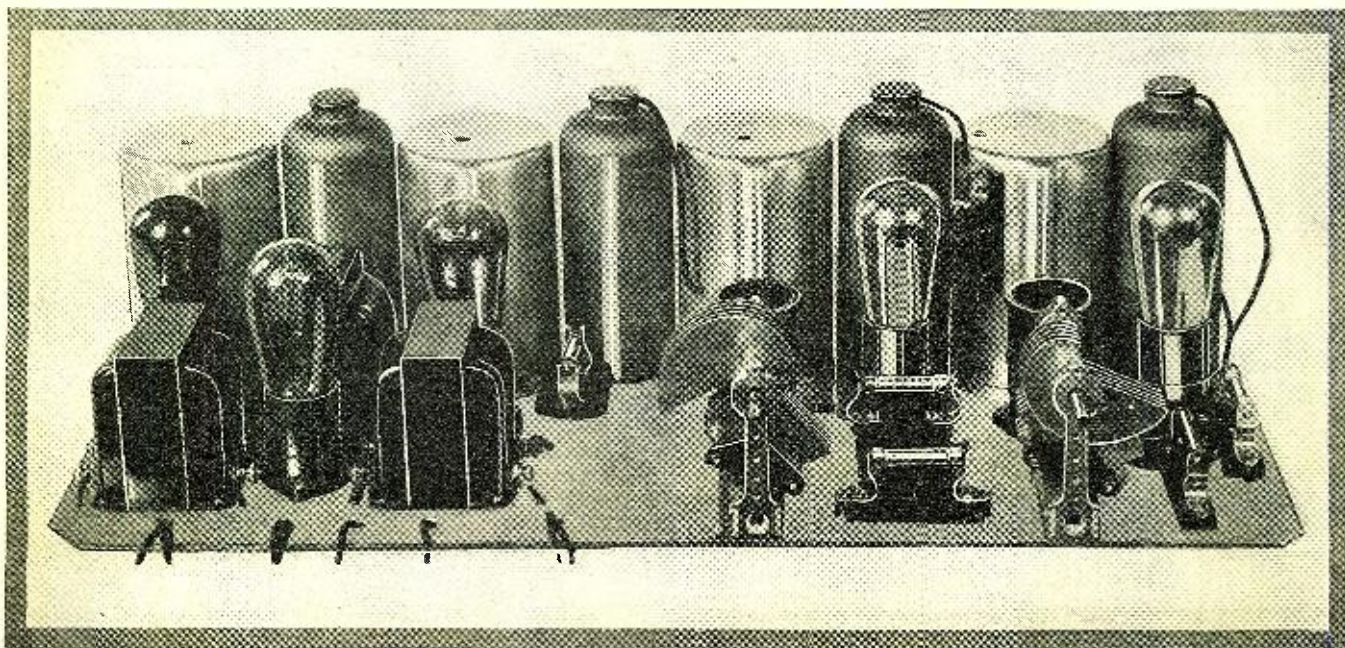

This illustration shows plainly the location of all of the major parts on the sub-panel. Actual assembly details will be described in a forthcoming issue of RADIO NEWS

# HAVE YOU LISTENED TO THE DIFFERENCE WITH EVEREADY ★ RAYTHEON TUBES? ★

Nearly every service-man, dealer, and radio-set owner, who has directly compared Eveready Raytheon reception-quality with that of ordinary tubes, has been amazed at the startling difference. If you have not yet heard Eveready Raytheons in your favorite set, try them now, by all means. There is no other way you can fully appreciate the tremendous improvement that lies in the patented Eveready Raytheon 4-pillar construction.

After you're sold yourself, it's as plain as day that your customers will be convinced by the same method . . . by demonstrations in *their* radio-sets, in their own homes! When you can offer customers anything as fine as Eveready Raytheons, you know you've got something to sell.

So whenever you make a service-call, take along a set of Eveready Raytheons—for the odds are ten to one the trouble you've been called to repair is due to weak or worn-out tubes. When customers hear the difference with Eveready Raytheons, you've sold a set of tubes.

Information and sales-helps, designed for your use, will gladly be sent to you free. Among them is a blueprint, giving engineering data on Eveready Raytheon 4-Pillar Tubes. Thousands of service-men are using this material to advantage. Write our nearest branch.

\* \* \*

*The Eveready Hour, radio's oldest commercial feature, is broadcast every Tuesday evening at nine (Eastern Daylight Saving Time) from WEAJ over a nation-wide N. B. C. network of 31 stations.*



Trade-marks

NATIONAL CARBON COMPANY, Inc.

General Offices: New York, N. Y.

Branches: Chicago Kansas City New York San Francisco

Unit of Union Carbide  and Carbon Corporation

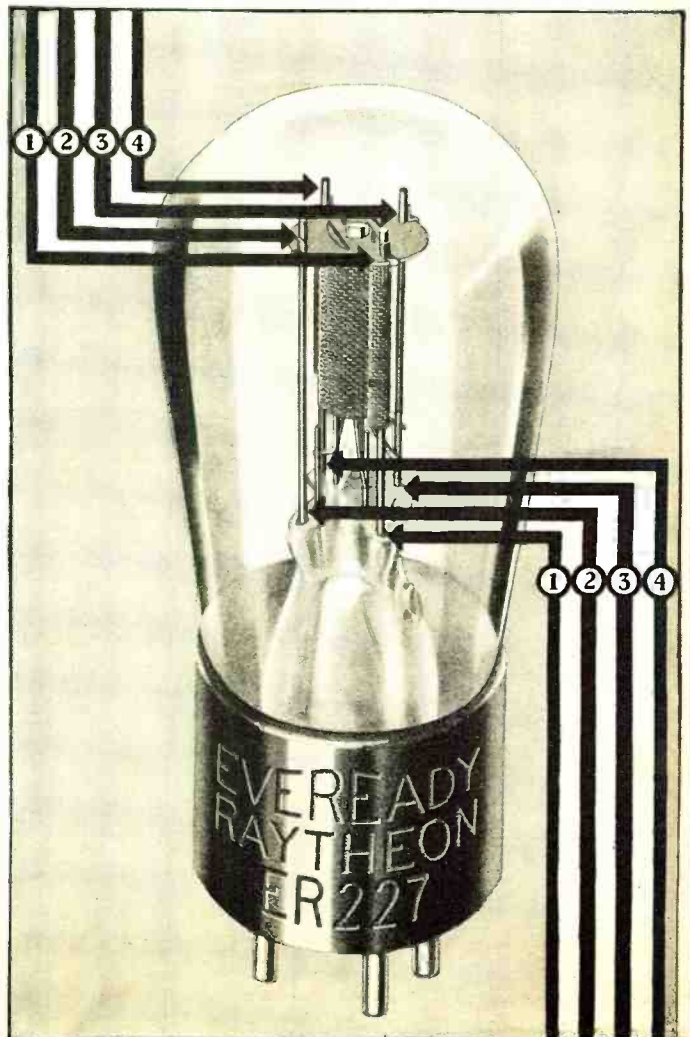

# Build a Two-Way Phone Receiver

*By using a double-detector system the short-wave enthusiast can listen to both ends of a two-way radio-phone conversation. For the short-wave amateur this system permits him to facilitate contacting another amateur who at the time may be busy with another amateur station*

By Nat Pomeranz

**T**HE latest thing at amateur radio stations is the double detector receiver whose varied uses are so beneficial as to make the idea necessary at all well-operated and efficient stations.

Its benefits are such as to permit the operator to receive two stations on different frequencies at the same time, provide an accurate check on his own transmitter wavelength and permit him to listen to his own outgoing signals in his own receiver without making any changes by throwing switches or changing coils in the tuning circuit.

For the short-wave listener, the idea has practical possibilities. One can tune one detector to one side of a short-wave conversation and the other to the other side and listen in on a full-fledged two-way communication.

The germ of the idea was planted when we needed a bi-detector arrangement at W2WK-W2APD. At the time, this station acted as the alternate master control station of the United States Naval Reserve, Third District. John L. Reinartz, operating the master control station, NDF, at South Manchester, Conn., and W2WK-W2APD at Brooklyn, N. Y., had to

control the thirty odd reserve stations on schedule and found it hard to tune for any of these stations without losing contact with each other. The double detector came into existence. At W2WK-W2APD one detector was locked to NDF's frequency, 4,045 kc., and the other was used to tune for scheduled stations. In this way NDF was able to be heard calling W2WK-W2APD even though other stations were being contacted.

The idea is a simple one. A separate antenna system, a detector tube, a set of coils, grid leak and condensers do the trick. Both detectors are hooked into the plate circuit of the first audio primary winding on the transformer.

At W2WK-W2APD the regular detector circuit consists of a stage of tuned radio frequency added to a Grebe CR18 Special receiver. The second detector tube is hooked into the plate terminal of the first audio-frequency transformer.

The use of the bi-detector circuit can readily be shown by the stunt done during Marconi's 4,400-mile two-way phone conversations with Schenectady. The screened-grid tuning circuit was set to Marconi's 750-watt transmitter aboard his yacht *Electra* at Rome, Italy, and the second (Continued on page 273)

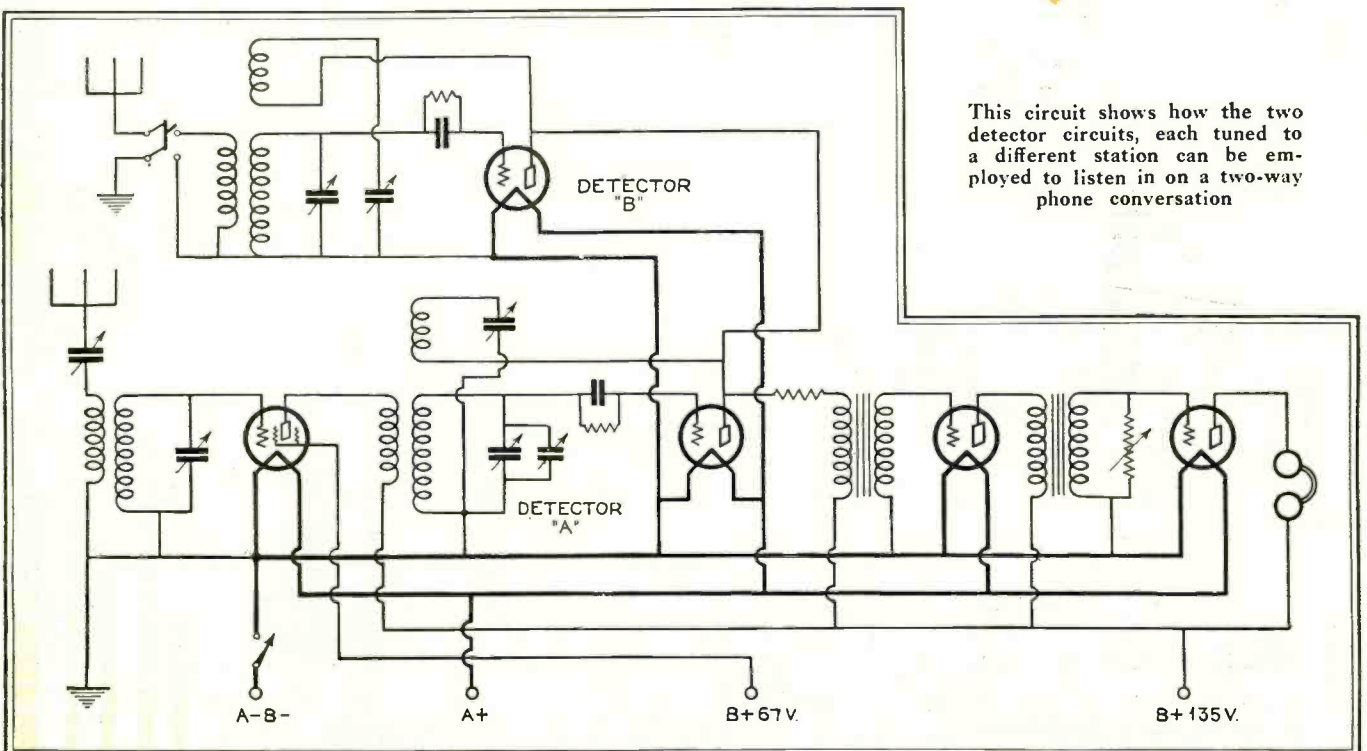

This circuit shows how the two detector circuits, each tuned to a different station can be employed to listen in on a two-way phone conversation

FACTORY TO YOU—SAVE to 50%—COMPARE WITH COSTLIEST OUTFITS BEFORE YOU BUY

# Enjoy a powerful new Miraco 30 DAYS FREE

Latest 1931 SUPER Screen Grid Outfit (No obligation to buy)



### NEWEST IN RADIO! TOP OPERATION

in this 1931 Miraco "Easy-Chair" model with magazine racks, each end. Place it anywhere in any room. Easily moved about. Small door in top conceals dial and controls when not in use. 26 in. high, 15 in. wide—yet it contains a complete full-size radio and Super-Dynamic speaker! No outside aerial or ground required. Many other new, clever models, obtainable nowhere else, shown in free literature.

Get Our "SEND NO MONEY" 11th Anniversary Offer!

Latest 1931

## Super Screen Grid FULL YEAR'S GUAR.

lighted dial steel chassis Vari-Tone and Automatic Sensitivity Control

Also latest PUSH-PULL Amplification

Built like—looks like—performs like newest radios in many outfits much more costly. Latest, finest, heavy duty construction. Skillfully engineered to super-utilize a battery of "224" SCREEN GRID tubes—in addition to "245" PUSH-PULL POWER, "224" HUM-FREE long-lived POWER DETECTOR and AMPLIFIER and "280" A-C TUBES. Vari-tone feature gives any tone-pitch your ears prefer. Automatic Sensitivity Control reduces "fading," protects tubes. Phonograph pick-up connection. Built-in house wiring aerial and ground. Built-in plug for electric clock, lighter, lamp, etc. Super-sturdy power section. Razor-edge selectivity; Super-Dynamic Cathedral tone quality; marvelous distance-getter. Solid one-year guarantee if you buy! Wide choice of cabinets.

Easy Chair Model

(as illustrated less tubes)

Only \$49<sup>88</sup> COMPLETELY ASSEMBLED

Values possible because you deal direct with big factory

# MIRACO

TRADE MARK REGISTERED

CATHEDRAL TONED, SUPER SELECTIVE, POWERFUL DISTANCE GETTERS

You need not send us a cent! For its 11th successful year, America's big, old, reliable Radio Factory again sets the pace in high-grade, latest guaranteed radios *direct to you*. And

### Don't Confuse with Cheap Radios

With Miraco's rich, clear Cathedral Tone, quiet operation, razor-sharp separation of nearby stations, tremendous "kick" on distant stations, Vari-Tone and automatic sensitivity control, and other latest features—be the envy of many who pay 2 or 3 times as much!

EASY TERMS to reliable persons only

### USER-AGENTS WANTED

Exclusive Territory—Try it at Our Risk!

Spare or full time. No contract, no experience required. Big money! Send coupon now!

Send for proof that delighted thousands of Miraco users cut through locals, get coast to coast, with tone and power of costly sets.



Miraco's are built of finest parts—approved by Radio's highest authorities. Our 11th successful year!

### Deal Direct with Big Factory

Miraco outfits arrive splendidly packed, rigidly tested, to plug in like a lamp and enjoy at once. No experience needed. Entertain yourself 30 days—then decide. Liberal year's guarantee if you buy. Play safe, save lots of money, insure satisfaction—deal direct with Radio's big, reliable, pioneer builders of fine sets—successful since 1920. SEND POSTAL OR COUPON NOW for Amazing Offer!

At history's greatest savings. With this newest perfected SUPER SCREEN GRID, push-pull, super-powered and humless electric AC set in clever, beautiful new Miraco-Mastercrest consoles obtainable nowhere else—you are guaranteed satisfaction, values and savings unsurpassed. *Get Amazing Special Offer!*

At our risk, compare a Miraco outfit with highest priced radios 30 days and nights. Surprise, entertain your friends—get their opinions. Unless 100% delighted, *don't buy!* Your decision is final—no argument!

Only marvelously fine radios, of latest perfected type, at rock-bottom prices, can back up such a guarantee. Send postal or coupon for *Amazing Special Factory Offer!*

MIDWEST RADIO CORP., 804-AS Miraco Dept., Cincinnati, Ohio

BEAUTIFULLY ILLUSTRATED LITERATURE, TESTIMONY OF NEARBY USERS, PROOF OF OUR RELIABILITY—

All the proof you want—of our honesty, fairness, size, financial integrity, radio experience and the performance of our sets—including Amazing Factory Offer—sent without obligation!



MIDWEST RADIO CORPORATION  
Pioneer Builders of Sets—11th Successful Year  
804-AS Miraco Dept., Cincinnati, Ohio

THIS COUPON IS NOT AN ORDER

WITHOUT OBLIGATION, send latest literature, Amazing Special Free Trial Send-No-Money Offer, testimony of nearby users and all Proof.  User.  Agent.  Dealer  
 Check here if interested in an EXCLUSIVE TERRITORY PROPOSITION  
NAME..... ADDRESS.....



Free!

**NEW LOW FACTORY PRICES**

**SAVE to 50%**

**Similar Low Prices on Beautiful Variety of Latest Fine Consoles. Send Coupon!**

**30 DAYS FREE TRIAL**

Electric Clock Model Medium-size "Hi-Boy." Built-in clock over dial. Latest drop-panel front. Rich design, fine woods, fine finish. Astonishingly low factory to you price.





Stylish small console with convenient magazine racks, each end. Another exclusive Miraco-Mastercrest 1931 design. Bargain factory to you price!



Full-size wall console with latest 1931 features. Beautiful design and woods. Priced very low, factory to you.

These Consoles are Equipped with **SUPER DYNAMIC CATHEDRAL TONE REPRODUCERS**

**Also: built-in aerial and ground—and built-in extra light socket!**

Magnificent new 1931 Miraco-Mastercrest creation. Send coupon for complete showing including Radio-Phonographs. Low factory-to-you prices.



# Some New Slants on Motor Car Radio

*In the design of a radio receiver for automobile use the consideration of space limitation comes first . . . then existing circuit designs are revamped to meet the new arrangement. Here's how two engineers tackled the job from the outside and worked in*

By

Walter H. Goldstein  
and Jerry Margolish\*

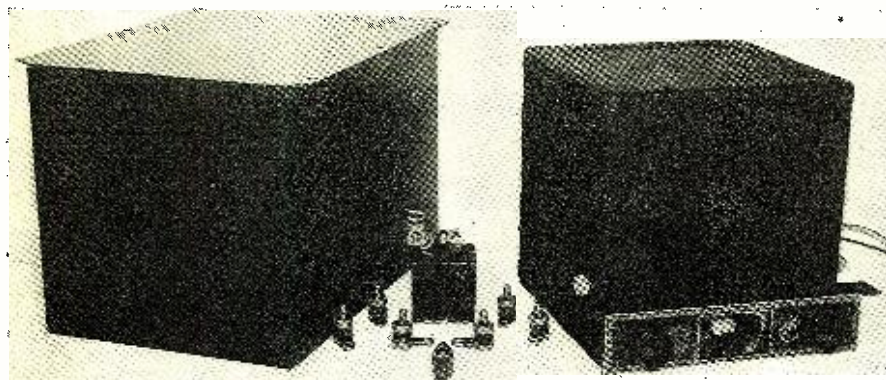
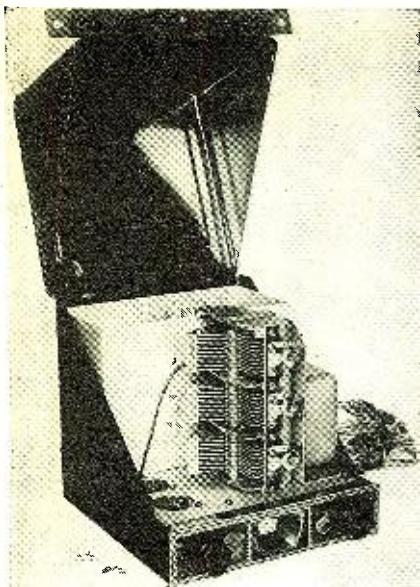

At the top: a view of one type of auto-radio receiver with diagonally hinged case so as to allow access to the receiver's "innards." Above, the battery box, ignition interference eliminator kit and the receiver are illustrated

THE considerations which obtain, during the design of any piece of radio apparatus are very complex. Usually the apparatus is laid out, built and refinements made in make-up and operation before any great consideration is given to the physical space limitations under which the device is to operate. The device is then usually revamped into the smaller space required and such problems as then arise are solved as they present themselves.

We are now going to tell you how an engineering group set about designing a motor car radio in reverse order; that is, the container was first built with all the desirable features and to the extreme physical limitations of the average space available in the greatest majority of cars. It was also built having in mind the convictions of the designers as to what features it should and should not have.

And so they set out with three major premises. First, the receiver must be made up electrically of five tubes, as follows: two stages of screen-grid tuned r.f., tuned detector and two audio-frequency stages. This arrangement, it was determined, everything considered, was required to get the requisite sensitivity and volume to make such a device acceptable. Second, it must be direct driven; that is, the tuning control must work directly, not through flexible shafts, cables, belts, pulleys, universals

or gears. Every one of the above-mentioned methods introduce more or less backlash or play between the control knob and the tuning element it is driving, resulting in poor and particularly uncertain allocation of the stations on the tuning dial. Thirdly, a survey of most of the cars on the market showed that the only logical place for such equipment was on the dashboard to the extreme right and the average space available was approximately 8 inches wide, 8 inches deep and 6½ inches high. Allowing for some extension below the edge of the dash for the controls, we have a space 8 by 8 by 8 inches for our receiver.

A welded steel case of that approximate size was made which closed diagonally across, allowing every part to be accessible and still be able to utilize every bit of available space. When we grouped the necessary parts into the car our spirits fell. But we persevered. By careful design and by mounting the three-gang special compact condenser upright we were able to build the set properly and efficiently.

The proper shielding requirements are met by a three-compartment aluminum box mounted on a steel chassis. No dependence for support or mounting is (Continued on page 287)

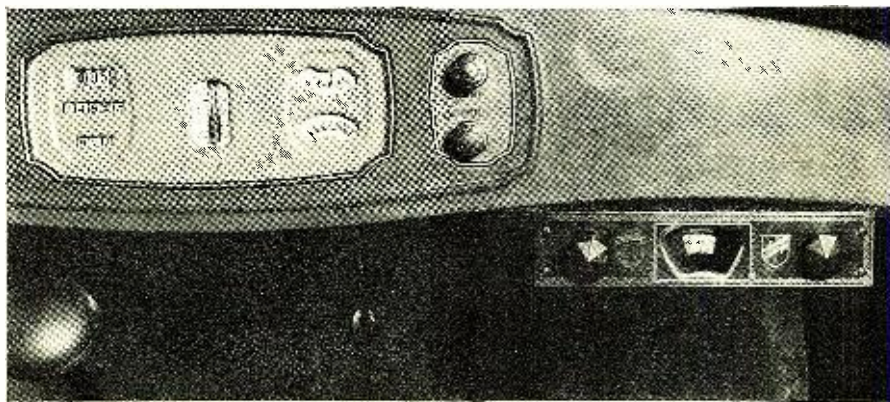

As can be seen, only the front porch of the receiver is exposed, the rest of the case being hidden underneath the dash

\*Carteret Radio Laboratories, Inc.

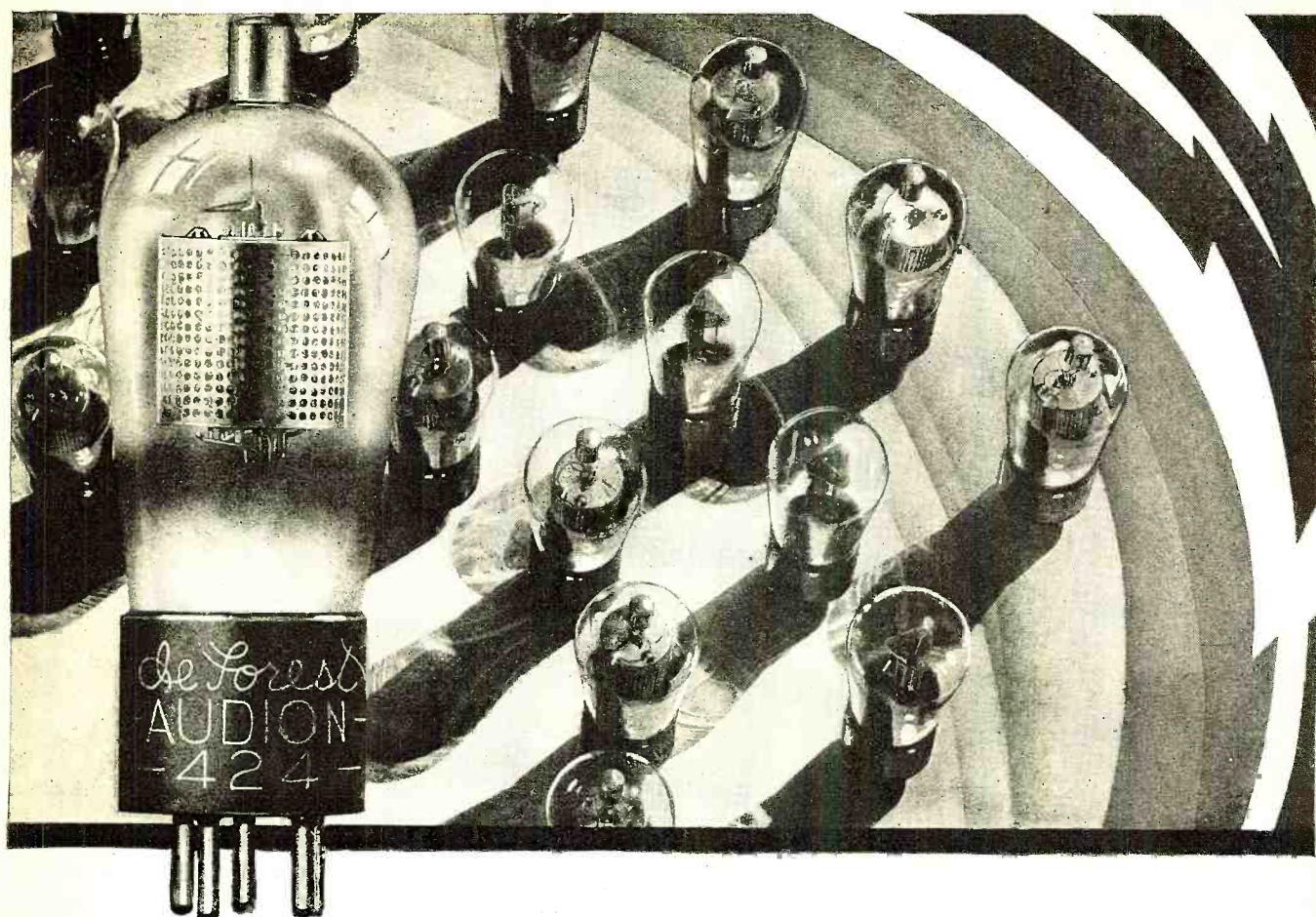

# Watch your service calls drop when you push de Forest Tubes

**I**T pays you to handle de Forest Radio Tubes because they stand up longer under constant use—your profits are not erased by an excess of service calls.

You can get behind de Forest Tubes with full enthusiasm, knowing that they will give the listener the satisfaction he should get out of his set.

Rigid mechanical construction, the sturdiness of the element assembly, the husky, non-fragile oxide-coated filament, the improved insulation of the cathode heater and the higher vacuum of these precision-built tubes are some of the features which contribute to their long life.

Once again: Don't overlook the lowered prices on de Forest Tubes. The recent reduction of 20% to 25% gives you one more powerful selling weapon to help you expand your business on radio sets, as well as on tubes.

DE FOREST RADIO COMPANY, Passaic, New Jersey

BOSTON · NEW YORK · PHILADELPHIA · ATLANTA · PITTSBURGH · CHICAGO  
ST. LOUIS · KANSAS CITY · DENVER · LOS ANGELES · SEATTLE · DETROIT  
MINNEAPOLIS · DALLAS · CLEVELAND

Export Department: 304 E. 45th Street, New York City, N.Y., U. S. A.

*de Forest*  
(AUDIONS)  
**RADIO TUBES**



# Technique of Sound Recording

(Continued from page 218)

inch by 0.001 inch, which will produce a sound track 80 mils wide. This is close to the standard width of sound track found in practice.

The combination of the cylindrical lens CL and the spherical lens C3, it should be further explained, concentrates the light on the slit in the vertical plane, but in the horizontal plane permits it freedom of motion to produce the variable width record on the film.

The mirror M may be of the order of one-twentieth of an inch on a side. It

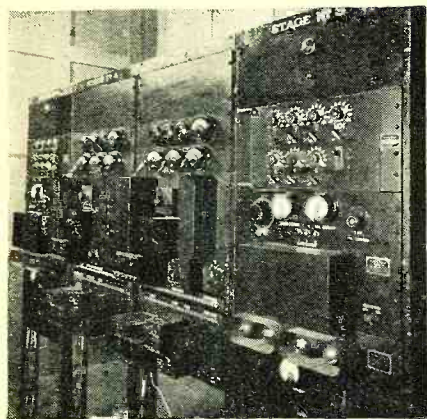

W. E. amplifier equipment

must be accurately plane and flawless. The whole vibrator system is mounted in a case containing a damping fluid which is changed every few months, so that it is always transparent to light in the thin layer interposed between the lens C2 and the mirror. It is usually a mixture of castor oil and turpentine. The lens C2 forms the window of the fluid-filled cell in which the oscillograph mirror is mounted. It is slightly tilted, in practice, so that light reflected from its surface does not continue along the axis B leading from the mirror to the film.

The adjustment of a variable area recorder of the type described is a fairly intricate process, requiring some skill in optical technique and mechanics. The whole system must be lined up and focused accurately along the axes A and B marked in Fig. 1. This is accomplished by means of a multiplicity of adjustment screws. The bifilar loop is rotated, through one of these adjustments, so that the light covers half the sound track. The edge of the light then coincides with the inside vertical line on the scale S2. The amplifier gain must be set so that in oscillating the spot of light does not extend beyond the outer line on this scale, during the loudest portion of the recording. If this is neglected the result is an "over-shot" record, which sounds as bad in reproduction as transmitter over-modulation in radio telephony. It should be noted that optical over-shooting may take place without any indication in the monitoring loud speaker across the output of the recording amplifier. Quality in the latter may be excellent, but if the amplitude of recording is not kept within the limits where cutting of the peaks begins the record will be

distorted. Hence both aural and visual checks must be utilized.

An important element in photographic recording is the relation between the exposure of the film and the final record secured after developing. It is necessary that the film should be correctly exposed and developed, if loss of quality is to be avoided. The requirements are more critical in the variable density method than in the variable area type, because of the fine gradations inherent in variable density recording. However, in both cases quality depends on the photographic elements, introduction of false harmonics and loss of high frequencies being the most common faults.

The exposure of the film depends on the time and the intensity of the light. Since the film moves at a fixed speed the time element is invariable. The intensity of the light, in the variable area method which is at present under discussion, must be sufficient to produce a solid black record against a clear background without forcing of the developing process. A gray, foggy record produces higher noise background, etc.

However, it is not desirable to work with too intense an exposure lamp, first because of frequent burn-outs, some of which may occur during important "takes" (the exposure lamps, in normal operation, are usually run at a brightness of 1,200 candlepower per square centimeter, which is near the limit of reasonable life expectation) and also because of photographic difficulties linked with over-exposure. Hence it is necessary to gauge the brightness of the light source with some degree of accuracy. For this purpose an instrument called a *photometer*, shown schematically in Fig. 3, is used.

This form of the instrument employs the principle that a grease spot on a piece of white paper, or a similar surface, appears darker than the surrounding area when viewed by reflected light, and brighter when observed by transmitted light. Given two sources of light, L1 and L2, the screen S is moved to such a position between them that the two images of S in the mirrors M1 and M2 look alike when compared by the eye, which is placed directly in front of S. Provided there is no considerable difference in the color the two lights, a fairly accurate comparison may be made. If one of the lights is a standard source of known intensity, the intensity of the other may be calculated from the equation

$$\frac{I_1}{I_2} = \frac{d^2}{d^2}$$

which is the inverse square law. In another form of photometer the shadows cast by the two sources of light on either side of a rod in front of a screen are equalized by adjustment of the distance of the two sources, the relative intensities being calculated on the same basis as above. The type of photometer generally used with a variable area recorder operates with two diffusing screens viewed through a single eye-piece. The

light which falls on one of the screens comes from a standard lamp supplied with a definite current, which is checked with an ammeter. The intensity of the recording lamp is then adjusted to such a value that there is no difference in the brightness of the two screens. Another type of photometer which might be used with a recorder employs a photo-electric cell and a galvanometer or microammeter in the anode circuit, as in Fig. 4. As the intensity of the light is increased, the distance between the source of light and

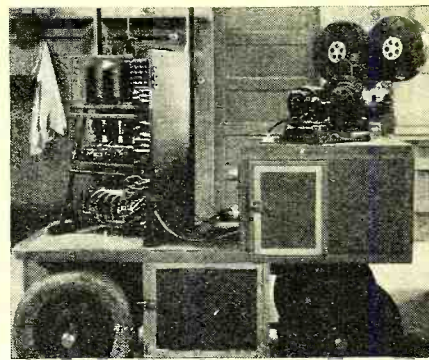

An R.C.A. recording amplifier and recorder (partly disassembled) mounted on a "dolly" for mobile recording

the cell remaining constant, the space current of the cell will increase. The cell may be calibrated, so that the proper intensity for the recording lamp, reached by adjustment of the filament current will be indicated by a certain value of photo-cell current. This method, however, relies on the internal constancy of the photo-cell, which must retain its characteristics over a reasonable period.

Systematic methods of working are quite as important in sound recording as in broadcast operation. Just as in a broadcasting station standard tones are transmitted over wire lines, through amplifiers, etc., to uncover any abnormality in the equipment, an oscillator should be provided in a sound motion picture studio and used for the same purpose. Microphones require frequent checking in the same way. Tools and meters should be generously provided; a little money spent in this way usually saves many expensive retakes. As in broadcast practice, a log is kept in which the details of the day's work are entered. These include the particular recording equipment used, meter readings, such as the recorder lamp amperage, filament and plate voltages, tube plate currents, etc. The magazines are loaded with film in a dark room with the usual photographic precautions, and a footage counter, which is a part of the recorder mechanism, indicates the number of feet used in a given take and the number still remaining in the magazine. The footage at the beginning and end of each take, and the action during this interval, are entered in the log. With this there is an entry indicating whether the take is to be printed or not, and, if the

(Continued on page 265)



# NOW READY

## Get Your Copy of RADIO BROADCAST'S DATA SHEETS— SERIES TWO

*A Convenient, Accurate and Useful Book  
of Technical Radio Information*

**S**ERIES TWO of Radio Broadcast's Data Sheets can now be obtained at all newsstands where radio magazines are sold. Series Two contains one hundred and fifty-two Radio Broadcast Laboratory Information Sheets, compiled by the Technical Staff of Radio Broadcast's Laboratory.

These Data Sheets cover a wide range of radio information of value to the technical radio man. The book also contains the circuit diagrams of twenty-five or more receivers made by the country's leading set manufacturers, including:

Majestic	Sonora	Kennedy
Crosley	Steinite	Grebe
Sparton	Edison	Colonial
Fada	Freed Eiseman	
Balkeit	Amrad, etc., etc.	

Go to your newsdealer now and ask him for a copy of Radio Broadcast's Data Sheets, Series Two. The price is only fifty cents. If he cannot sell you a copy, you may order direct, using the coupon below for your convenience.

**DOUBLEDAY, DORAN & COMPANY, Inc., GARDEN CITY, N. Y.**

Doubleday, Doran & Co., Inc., RN-9, Garden City, N. Y.

Gentlemen: Enclosed please find fifty cents for one copy of Series Two of Radio Broadcast's Data Sheets.

Name .....

Address .....

## The New 1930 Ham Regulations

(Continued from page 204)



# YOUR SERVICE STAYS SOLD

## When You Install Majestic Radio Tubes

**H**ERE at last are tubes that stay sold. Majestic Radio Tubes stop those re-service calls that cut profit and lose customers. When you recommend and install Majestic tubes, you're sure of results, sure of satisfaction and performance.

Sure that power and tone will be 100% for months to come. Sure that tube noises are gone for good. Sure that your customers will praise your service to others—that you will get more business, more profit, built on the good-will and recommendations of every family you serve.

More than a million homes are using Majestic Radio Tubes in Majestic Radios. A million more Majestics are still waiting for these better tubes. Majestic advertising is telling these owners of the increased power and truer Colorful Tone made possible by these finer tubes. Your selling is made easy. Your market is enormous—and ready-made.

Get complete information now on these more profitable tubes. Find out how exclusive materials, methods and design make them stronger, longer-lasting, more powerful. Write or phone your Majestic distributor today for complete information.

GRIGSBY-GRUNOW COMPANY  
CHICAGO, U. S. A.

World's Largest Manufacturers of Complete Radio Receivers

# Majestic

## RADIO TUBES

Unconditionally Guaranteed Against  
Manufacturing Defects

is specified as that of the radiator; otherwise it is specified as that of the control point. If a station has one or more transmitters close by and one controlled over a distance of five miles or more, the ones close by constitute one station, with one call, with its location that of the control point, while the distant transmitter becomes known as another station and must be the subject of a separate license, with another call to identify it and distinguish it (because of its separation) from the other transmitters.

Section II. The Commission is forbidden by law to issue any license not found to be in the public interest, convenience or necessity. To avoid holding a special hearing on every amateur application, the Commission here reaffirms its present policy of declaring that the granting of licenses to bona fide amateurs is in the public interest, convenience or necessity, and that in the absence of exceptional circumstances the license will be issued.

Section III. The first paragraph of this section, denying licenses to amateur mobile stations, is nothing new; they

VIII (d), but they may not obtain a license to operate while in motion because there are no amateur mobile stations.

Paragraph (b) is a rewording of a similar old paragraph, with clarification of the language. Paragraph (c) is an old friend. Paragraphs (d) and (e) define the kind of communications that may be handled and, while giving further protection against commercial enterprises masquerading as amateurs, put in much plainer language the accepted prohibition of compensation by amateurs and eliminate the misunderstandings which always surrounded the old language.

In Section IV there is nothing new except the important fact that the bands 28,000 to 30,000 kc. and 56,000 to 60,000 kc. (our 10-meter and 5-meter bands) are now assigned exclusively to amateur stations instead of jointly to amateur and experimental stations. There is plenty of space in this part of the spectrum. There are only a couple of non-amateur licenses in existence for these bands, and they are temporary. The telephony assignments have been repeated without change.

Section V is a new regulation. Aliens are denied station licenses, and it is plainly the intent of the basic law to prevent their control of a station. The law has been circumvented in the past, occasionally, by organizing a club and having the club station located in the home of its alien organizer who, as an operator, then enjoyed all the privileges of a citizen. The new regulation must be regarded as in accord with the Radio Act.

In Section VI, paragraph (a) prohibits the use not only of spark but of all other forms of Class B waves "consisting of successive trains in which the amplitude of the oscillations, after having reached a maximum, decreases gradually." (I. R. C., 1927.) Although the use of "continuous waves modulated at audible frequency" (Type A2) is not barred by this paragraph, it does definitely prohibit interrupted c.w. ("I. C. W.") as obtained by chopper or buzzer or any other mechanical method of interrupting a radio-frequency circuit.

Paragraphs (b) and (d) represent no change from existing practice. Paragraph (c), however, is a departure and an important one. Their intent, in general, is to do away with a.c. signals and substitute d.c. signals for them. In the case of self-excited transmitters it will take a d.c. power supply to do this, in almost every case. Ingenuity must not be stifled, however, and if an amateur can show, for example, that he has a newfangled tank-circuit arrangement of his own which, although supplied with a.c., is free of "wobulation" and produces a d.c. signal modulated at the supply frequency instead of producing the usual infamous "spray" of frequencies, he will be permitted to use it. This is admittedly an extreme case. In general, it is only oscillator-amplifier transmitters (crystal-controlled or self-excited oscillators) that can hope to get under the wire and be permitted to use a.c. plate supply, and even they only under the provisions (1) that they have a buffer stage

(Continued on page 274)

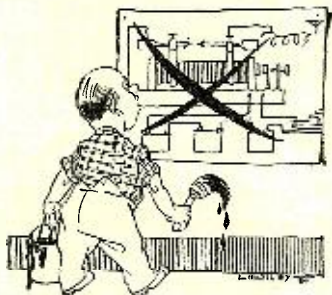

Good-Bye to Sparks

have never been licensed. A few amateurs owning yachts have sought such a license but always, so far as we know, for more or less utilitarian communication and hardly because of interest in radio technique. If the bars were ever let down we would be invaded by hordes of non-amateur boat owners who would represent themselves as amateurs in order to obtain utilitarian private communication for themselves. It would swamp us. For instance, in the port of New York alone there are small power-driven pleasure craft registered to the number of 32,000! This would not be a bona fide amateur use, and the present regulation protects us. Where a small private craft has need for radio, it may hope to obtain a marine license to use the H. F. marine channels; the Secretary of Commerce has discretion to permit the operation of such apparatus under an amateur operator's license; and Section III (b) would permit such craft to communicate with amateurs.

Amateurs should draw a careful distinction between mobile and portable stations. See paragraphs (e), (f) and (g) of Section I. Portables are still to be licensed, but may not be used while in motion. If amateurs rigged a station on an automobile, they may obtain a license for it as a portable station, to operate while not in motion and at fixed locations previously reported as required in Section

## Technique of Sound Recording

(Continued from page 262)

decision is negative, the reason. This may be poor sound pick-up, unsatisfactory action as determined by the director, or some other defect. A copy of the log is sent to the cutting room with the exposed film and this determines what sections are to be printed after the sound negative is developed. Synchronism marks are added by means of an auxiliary device which, on the throwing of a switch, exposes the edge of the film in both camera and sound recorder to a light, fogging a few inches so that the sound and picture negatives may be matched for the printing of a combined negative later. The recording operators, as a part of the operating routine, should listen to the "rushes," which are prints made at the laboratory as soon as possible after studio work is completed, as a check on the results. If anything has gone wrong the scenes may be done over while the cast and set are still available. By being present when the rushes are shown the recording technicians are in a position to analyze their work and to improve its quality. It goes without saying that a typical and carefully maintained projection outfit is as much a necessity in a sound motion picture studio as the recording equipment itself, since serious distortion in the studio reproducing equipment may hide defects in quality which will become evident later in theatre showings. Any peculiar frequency characteristics in the studio, theatre or viewing room will have a like effect—for example, if the equipment at this point has "tinny" characteristics, it will tend to compensate for a loss of high frequencies in recording, and when the product gets out into the theatres the speech may be unintelligible. Attention to such details, careful measurements and an attitude of constant vigilance on the part of the technicians are all essential to consistent success in this field.

## The Versatile Vacuum Tube

(Continued from page 237)

to make the vacuum tubes in the circuit operative. Their action is to release the mechanism for stopping and leveling the car and for opening the doors.

About six weeks ago there was demonstrated another use of electronics. This took place in Boston, before a group of engineers. Here is what happened:

A model of a prisoner crept stealthily up the side of a model prison wall. As it reached the top it came within the range of vision of a photo-electric cell or "electric eye." As this happened, a revolver trained on the dummy prisoner was discharged and a bell on the prison wall set into furious clangor.

Remarkable as this may sound, the mechanism involved is relatively simple.

(Continued on page 266)



# CARTERET MOTORADIO

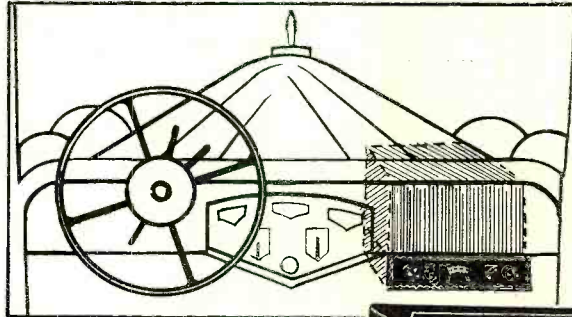

The Most Practical of All Auto Radios

### Because It's COMPACT

Entire set is only approximately 3" cube and fits snugly behind the dashboard. No separate tuner or flexible shafts. Direct tuning control.

### Easy to Install

No cutting or marring of dashboard. Anyone can install. Suspended by springs. Shockproof. Battery box and speaker can be placed in any convenient place.

### EFFICIENT

Two 224 screen grid and two power tubes give clear rich tone and plenty of volume. Needs only small aerial. Direct tuning control with clear vision illuminated dial.

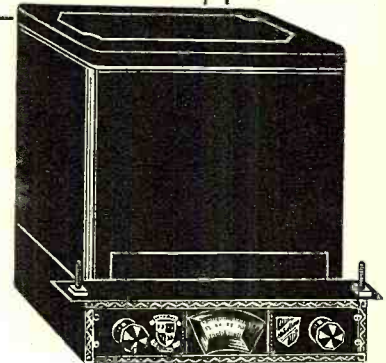

This five-tube Carteret Motoradio uses two screen-grid tubes UV224, detector tube UV227, amplifying tube UX112A, power tube UX171A, and operates power speaker. List price, less accessories and installation **\$67.50**

Descriptive Folder mailed on request

Dealers and Service men: Write for wholesale trade discount

**SERVICE MEN**  
now is the time to  
**BUY PARTS**

**Radio Bargain News**  
*Federated Purchaser*  
16-22 HUDSON STREET, NEW YORK, N.Y.  
PHONE BR 6-1171

**Dealers and Service Men**  
**\$100,000**  
**WORTH OF RADIO**

**MERCHANDISE SUCH AS REPLACEMENT  
CONDENSER BLOCKS, TRANSFORMERS  
SETS, SPEAKERS, AND TUBES SOLD  
AT 75% OFF THE LIST PRICE.**

**SEND FOR FREE COPY OF THIS  
BIG CATALOG JUST ISSUED**

A NATIONAL ORGANIZATION SERVING OVER 20,000 RETAIL MERCHANTS

Here Are a Few Typical Values

- RCA No. 8335 Power Transformer for No. 17, 18, 33 and 51 sets \$3.25
- RCA No. 8333 Filter Condenser Blocks for same sets..... 1.50
- RCA No. 8336 Double Filter Chokes for same sets..... 1.70
- RCA No. 8289 Filter Condenser Block for Radiola 17..... 5.95
- RCA No. 8346 Filter Condenser Block for Radiolas 60-62.... 4.95

- RCA No. 8472 Power Transformer for Radiola 44-46..... 4.95
- RCA No. 5666 Audio Transformer for Radiolas 17-18..... .65

We are Headquarters for RCA, Zenith, Edison, Victor, Philco and Kolster Replacement Parts

**Federated Purchaser**

20 HUDSON STREET,  
NEW YORK CITY

## The Versatile Vacuum Tube

(Continued from page 265)



**The  
ACME  
of  
smooth performance**

Catapulted silently into the air, the glider taking advantage of every tiny air current, soars noiselessly and gracefully up and down the air valleys at the touch of the control stick. It's the acme of smooth performance.

The modern radio receiver, if it is **CENTRALAB** equipped, figuratively speaking, rides the ether waves smoothly and noiselessly. For real adventure in radio reception insist on **CENTRALAB** volume control equipment.



Write Dept. 225-G for Free Booklet, "Volume Control, Voltage Control and Their Uses."

**Centralab**

CENTRAL RADIO LABORATORIES  
Dept. 225-G 22 Keefe Ave. Milwaukee, Wis.

It operates like this. Parallel to the wall and near its top, a ray of light, practically invisible to the less sensitive human eye, is made to shine steadily into a photoelectric cell which is mounted at one end-of the wall. A photo-electric cell or "electric eye" has the appearance of a radio tube. The inner surface of its glass envelope is coated with a silvery deposit with the exception of a small, clear "window" for the admission of light rays. In the center of the bulb a small metal electrode is placed. When light enters the window it causes a current of electricity to flow between the silvery coating of the bulb and the central electrode. But the moment anything interrupts the light ray the flow of current through the photo-electric cell ceases. Thus, when the dummy prisoner interrupted the light to the electric eye there was a cessation of current in the cell. The impulse, begun this way, was amplified by means of other vacuum tubes and then used to set off the mechanism which fires the revolver and rings the bell.

Only a few weeks ago the world witnessed another demonstration of the marvelous possibilities of radio. Sitting in the cabin of his yacht near Genoa, Italy, Senator Marconi pressed a button causing radio impulses to leave the aerial on the yacht, span eleven thousand miles of land and sea, actuate a receiving set in Sydney, Australia, and thereby turn on thousands of electric lights in that city.

This seemingly miraculous feat was made possible through the help of the vacuum tubes, which converted the pressure of Marconi's finger into electric impulses, amplified them and sent them into space. Tubes detected these impulses after a journey across two oceans and a continent. Tubes amplified these impulses for a second time so that they were strong enough to cause a switch to close and light the lamps. At every place in the entire set-up tubes supplied the connecting links that made it possible.

To understand just how this feat was accomplished is not difficult. Put your fingers on the cone of your loud speaker. As voice impulses come to you, via your receiving set, you can feel a distinct motion of the cone. If the person at the transmitting end were to shout very loudly, the cone would move much more vigorously, or if another amplifier were connected between your set and the speaker, the impulses could be made very strong. Suppose the button of a light switch were pressed against the cone. If the cone jumped hard enough, the switch which it was connected would be lighted. This would be a very crude set-up, but it would serve to show the principle of Marconi's experiment.

Many chemical analyses, basic processes in every industry, depend upon the detection of color changes, the more elementary among which are the shade variations of "indicators" used to show whether a solution is alkaline or acid or when these two chemical conditions neutralize each other. As we all know, the

sensitivity of the human eye to color changes varies with the individual. Some of us are color blind. Such persons are unable to discriminate among delicate color changes. To a mild case of color blindness, pink and yellow appear the same color, and so do blue and green. A bad case of color blindness sees "photographically"—that is, everything appears like a photograph, in varying shades of black and white. Many people are color blind without knowing it, and often hold down positions where a certain degree of color discrimination is desirable or even necessary.

An artificial eye, however, employing the photo-electric cell, can be designed that is sensitive to color changes which even the normal eye cannot detect. The possibilities of such a device in colorimetric chemical analysis are considerable, and will contribute an added degree of accuracy to this already accurate science. Automatic mixing machinery can be designed for industrial chemical plants, in which the flow of different chemicals will be automatically stopped when an acid or alkaline neutralization is achieved, the neutral point being instantly noted by the photo-electric cell, and the associated apparatus made to control or stop the addition of the neutralizing agent.

In the final analysis, this may mean anything from a cheaper toothpaste to a better soap!

The latest development of the photo-electric cell, the electric eye of modern science, contributes to the safety of blind flying by reducing the hazard of making a landing through a ground fog.

The combination of radio and marked beacons has contributed much to the safety of blind flying, in leading the pilot directly to his terminal field. And the use of a sensitive barometric altimeter as recently demonstrated by Jimmie Doolittle at Mitchel Field, brings the safe blind landing into the realm of possibility. It remains, however, to mark accurately the boundary of the field for the pilot concentrating upon his instruments, as he must do when flying blind. The pilot cannot look over the side of his plane—a useless waste of time, anyway, for, in a heavy ground fog, there is nothing for him to see. Science, however, has provided a third and highly sensitive eye in the photo-electric cell, which with associated apparatus can be depended upon to inform the flier that he has crossed the border of the field, and may flatten out for the landing.

A series of photo-electric cells are placed along the field boundary and the plane is equipped with a special neon light projector, throwing a wide beam downward. From an altitude of fifty feet, this light will penetrate a thick fog, and cast a line of light upon the ground at right angles to the plane and sufficiently long to actuate at least one cell. The flash of light actuates a radio transmitter that sends an unmistakable signal, received on the standard airplane beacon receiver, and the pilot knows that a safe, smooth runway is beneath him.

**NOW!**

# RACON'S

**Newest Development**  
**The ALL WEATHER PROOF**  
**HORN**

for Public Address and all Outdoor use. This horn has been perfected after years of exhaustive research in Racon Laboratories. Will withstand all weather conditions. No time limit to guarantee. Made to last forever. Requires no replacements or servicing after heavy rainstorms. . . . Prices slightly higher than regular horns.



AEROPLANE HORN

(ILLUSTRATED)  
**RACON**

Products Famed Throughout the World  
for Most Natural Sound

PUBLIC ADDRESS—THEATRE—RADIO—AEROPLANE REPRODUCTION

**The New Unit**



This revolutionary change in the type speaker for radio use is but slightly higher priced than the ordinary speaker, but marvelously better. Tests prove it. Write for descriptive catalog.

Baby Electro-Dynamic Type Horn Unit  
List Price, \$35.00

The largest horn speaker manufacturers in the world

**RACON ELECTRIC CO., INC.**

FACTORIES:  
18 WASHINGTON PLACE, NEW YORK.  
Slough, Bucks, England, and 3 Mutual Street  
Toronto, Canada

## Methods and Problems of Sound Recording

(Continued from page 239)

Fig. 19 is a typical example of the resulting waveform obtained by the simultaneous recording of voice and piano. Here the wave form repeats approximately 4.6 times in every 3/16 inch, indicating that the fundamental frequency is roughly 450 cycles.

Another interesting uniformly repeating wave is shown in Fig. 20. The fundamental frequency here is approximately 115 cycles.

A very good example of high-frequency recording (5,000 cycles) is shown in Fig. 21. The wavelength corresponding to this frequency is .0036 inches.

Fig. 22 shows the same 5,000 cycle recording but at a much higher magnification (30 diameters). This view clearly brings out the relative size of the emulsion grain. It is apparent that the granular structure of the emulsion is one of the serious limiting factors in high-frequency recording.

Fig. 23 shows a variety of wave shapes. Attention is called to the recording on the seventh groove, where a series of wave groups is found. The frequency can be scaled as 333 cycles per second (one-third of the whistle frequency shown in groove nine) and checks closely with the corresponding portion of film recording shown in Fig. 26 (3.4 wavelengths per sprocket hole).

Referring again to Fig. 23, grooves nine and ten show a 1,000-cycle frequency recording previously referred to and shown in Fig. 18. This whistle frequency checks closely with the corresponding film impression shown in Fig. 24. (10.5 wavelengths per sprocket hole—1,008 cycles per second.)

It is interesting to note that this whistle frequency occurs again on the twenty-ninth groove and is easily identified by inspection. The thirty-fourth groove shows this whistle frequency superimposed on a lower frequency. The corresponding film recording is shown in Fig. 25.

### Experimental Work

Intensive experimental work on pickups is being conducted by the Pacent Electric Company at the present time. Highly interesting facts have been revealed as a result of this research, but unfortunately they were not available in time to include them in this paper.

In closing, we wish to acknowledge the cooperation of the following:

Max C. Batsel, chief engineer RCA Photophone, Inc., who furnished film and disc records for a study.

Dr. Percy Hodge, professor of physics, Stevens Institute of Technology, who took many photographs and conducted the study microscopically.

P. H. Evans, chief engineer, The Vitaphone Corp., and J. G. Aceves of Amy, Aceves & King, for many valuable suggestions.

Adney Wyeth, educational director, Pacent Reproducer Corp., for valuable assistance in preparing the paper.

# SPRAGUE

Here you  
**SEE**  
why it's  
**Years Ahead!**

**JUST** glance at the diagram here, and you'll see Sprague superiority at a glance. Notice the exclusive, one-piece, round-edge anode—no soldered or welded joints either above or below the solution.

See the breather vent sealed by a soft rubber nipple, inseparably vulcanized to a hard rubber top—an absolutely leak-proof one-piece construction. Don't miss the screw threaded, individual mounting—adapting the Sprague condenser to all types of sets.

And then bear in mind that its 8 MFD capacity is concentrated within a space of 1 3/8" diameter x 5" overall. Giant capacity in midget size.

SPRAGUE SPECIALTIES COMPANY  
QUINCY (Boston) MASS.  
Manufacturers also of the well-known  
SPRAGUE PAPER CONDENSERS

## Electrolytic

# CONDENSER

## ✓ FREE BOOKS of BUSINESS HELPS

We publish over 200 Home Study Books, each a complete treatise of its subject. We have one or more for you. Books on

- |   |  |
|---|--|
| <ul style="list-style-type: none"> <li><input type="checkbox"/> Commercial Art</li> <li><input type="checkbox"/> Lettering</li> <li><input type="checkbox"/> Advertising</li> <li><input type="checkbox"/> Sign Making</li> <li><input type="checkbox"/> Radio</li> <li><input type="checkbox"/> Aviation</li> <li><input type="checkbox"/> Painting</li> <li><input type="checkbox"/> Silk Screen Process</li> </ul> | <ul style="list-style-type: none"> <li><input type="checkbox"/> Decoration</li> <li><input type="checkbox"/> Automobiles</li> <li><input type="checkbox"/> Battery Work</li> <li><input type="checkbox"/> Electricity</li> <li><input type="checkbox"/> Carpentry</li> <li><input type="checkbox"/> Building</li> <li><input type="checkbox"/> Contracting</li> <li><input type="checkbox"/> Sheet Metal Work</li> </ul> |
|---|--|

and many other subjects. All fully described in our FREE CATALOG. Check the subjects in which you are interested and write today.  
**FREDERICK J. DRAKE & CO., Publishers**  
Room 510—179 No. Michigan Blvd., Chicago  
Drake books are for sale in all book stores

# WESTON

Model 564

## VOLT-OHMETER

for checking

VOLTAGE,  
RESISTANCE

and  
CONTINUITY  
of CIRCUITS

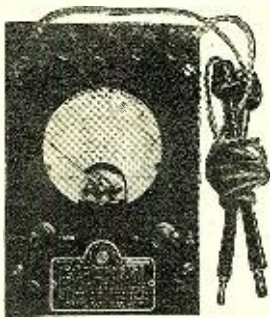

**T**HIS instrument is ideally suited to the needs of radio service men. Besides it is very useful for general purposes in radio laboratories.

Model 564 is compact, completely self-contained. It is typically Weston in design and manufacture. Even though moderately priced, it gives that same dependable service for which all Weston instruments are famous.

It consists of a Model 301,  $3\frac{1}{4}$ " diameter meter with ranges of 3, 30, 300 and 600 volts and two resistance ranges, 0-10,000 and 0-100,000 ohms. Two toggle switches serve to connect the meter in circuit. All voltage ranges have a resistance of 1,000 ohms per volt. A pair of 30" cables with long test prods is provided with each instrument.

Change from voltage to resistance measurements and different ranges can easily be effected by connecting test leads to correct binding posts as indicated on the meter and by use of the two toggle switches.

Testing continuity of high and low resistance circuits is simplified by means of a toggle switch which easily changes the sensitivity of the meter to either 1 or 10 milliamperes. Accuracy 2%. Size  $5\frac{1}{2}$ " x  $3\frac{3}{8}$ " x  $2\frac{3}{8}$ " deep (excluding binding posts). Weight 2.3 lbs. (including self-contained "C" battery).

Weston Electrical Instrument Corporation  
615 Frelinghuysen Avenue Newark, N. J.



## Television Advances

(Continued from page 230)

projection, that is, the axis of the crystal, or by varying the direction of the beam itself in relation to that angle, the intensity of the resulting light projected beyond the crystal is readily controlled.

If we project a powerful light beam through a shutter with only a pinhole aperture, a tiny spot of light can be projected to a screen. The spot, however, is not perfect. There is always slight diffusion. The cut-off from black to white is not as sharp as might be expected. Apparently, in the motion of an ordinary beam of light, there is not only motion in the direction of projection, but a component of transverse motion. Passing light through a crystal of proper construction, it is possible to divert the transverse component in a ray separate from that moving forward as a plane. A Nicol prism is a crystal device of special construction which completely isolates the component of transverse motion from that of forward motion, producing a beam of polarized light.

Crystal structure comprises a rigid arrangement of electrons. Their orbits of motion are restricted to very definitely limited directions. The atoms of crystals are arranged in perfectly orderly array so that the entire crystal structure has the characteristics of a single crystal atom. When a source of energy, such as a light beam, is projected through a crystal, only that component of energy coinciding with the crystal structure is successfully projected through it. The sun, rising upon a city of tall buildings, projects light through it only in the proportion that the light energy coincides with the direction of the streets. Obviously slight alterations in the direction of a ray of light projected through a street will make significant differences in the amount of light reaching to the other end.

### Application of the Kerr Effect

The light of the arc passed through the Karolus projector is first formed into parallel rays by means of a lens system. It then passes through a Nicol prism, which disposes of all of the transverse energy in the light ray, leaving only a plane polarized ray to be projected through the light valve. The polarized ray then passes through a transparent nitrobenzol solution which forms the dielectric of a condenser. The television signal is impressed on the plates of the condenser, bending the polarized ray according to the intensity of the television signal which, in turn, corresponds to the light value being scanned at each instant. This bending is only a minute angle, but is sufficient to produce a substantial effect upon the total light passing beyond a second Nicol prism, to which it is then directed. Thus we obtain a powerful ray of light varying in proportion to the television signal.

The rest of the projection process is easy to visualize. The intensely powerful ray is projected to the screen through a scanning disc revolving in synchrony with the transmitting disc. It covers the entire surface of the screen with sufficient

rapidity so that the eye, through its property of persistence of vision, collates the separate impressions into a single picture. A new revised scene is flashed on the screen in so short an interval that motion is blended smoothly, without the jumpy action of the early moving picture films.

### Distortion in 48-Line Television

Certain distorting effects were observed by the more critical and experienced technicians, but these defects did not detract from the glory of the achievement. They were due entirely to the fact that 48-line scanning does not resolve the subject into sufficient detail. The scanning spot of light covers the subject in horizontal sweeps. When important elements of the scene presented a small angle to the direction of scanning, distortion was observed. This type of distortion is present in any 48-line system, but has never been so emphatically brought forward because of the relatively small projection heretofore used. When the mouth is in its normal position, for example, coinciding with the direction of the scanning line, the lower lip, the white space indicating the position of the teeth and the upper line may be represented by three parallel lines, black, white and black respectively. If the actor slowly tilts his head, so that the mouth deviates from the horizontal position, these three parallel lines tend to become jagged, making them appear like a step of a stair. With a somewhat narrower scanning path, like that of a 100-line scanning system, the minimum angle that a straight line presents to the scanning path to be reproduced as a straight line is considerably reduced.

Another interesting point developed by the demonstration was the insufficiency of 60-cycle synchronization for holding the reproduced image in frame. The scene swung before the eye like a pendulum of slow period, a defect hardly noticed in such an amazing demonstration but one which would arouse criticism if not disposed of before television reaches the commercial stage.

The press reports frequently mentioned the perfect synchronism of speech with motion. This constituted a considerable problem with talking pictures, where synchrony is maintained between a film and a phonographic disc. But with microphone and photocell pick-up, no recording of any kind is involved, both processes having the instantaneous and uniform character of electrical transmission through identical channels. More remarkable than maintaining synchrony would be the phenomenon of appreciable lack of synchrony.

### When Is Television Coming?

One of the questions most frequently asked at the demonstration was, how difficult would it be to control sufficient light to project the image to full motion picture screen size? Dr. Alexanderson stated that only a more powerful arc is required as a light source. While this would accomplish full screen illumination, it must

(Continued on page 269)

## Television Advances

(Continued from page 268)

be borne in mind that the information conveyed to the eye is dependent upon the number of picture elements. Projection merely changes the distance that the reproduction may be conveniently viewed. A 48-line image, viewed ten inches from the eye, reproduced as a one-inch square, is as clear as a six-foot image of the same television signal viewed fifty feet from the eye. In both cases, 2,304 picture elements ( $48 \times 48$ ) contribute to each reproduction and convey the same information to the eye. If the audience remains at a fixed distance from the screen and projection is increased to full motion picture screen size, the image becomes more blurred and diffused, just as the appearance of a half-tone is impaired by looking at it through a powerful reading glass. The Karolus cell is adapted to full screen projection, but to retain only the present standard of quality requires increasing the scanning to 200 lines. That means 40,000 picture elements per image instead of 2,304, and, with twenty images per second, a communication channel of 400,000 cycles instead of 23,000 for faithful reproduction of the signal. The improvement of television therefore resolves itself into a communication problem. Considering the time it has taken to develop faithful reproduction of 10,000-cycle channels involved in broadcast music, a great deal of work is yet to be done before we can handle a signal band of 40,000 cycles faithfully. But the terminal apparatus, from photocell to projector, is available. We await only amplifiers and communication channels for good quality theatre projection of commercial character.

## Home Laboratory

(Continued from page 254)

The experiments which have been described in this sheet have only scratched the surface. An almost unlimited number of experiments can be made with the aid of some simple set-up of apparatus as we have described. Old and new transformers

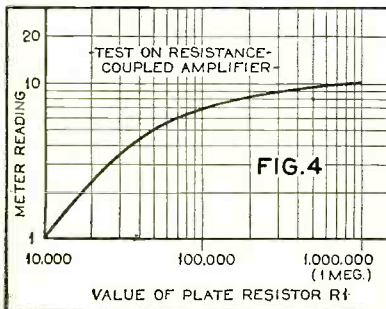

can be checked for their response at 60 cycles, the effect of using high- $\mu$  tubes in a transformer-coupled amplifier can be determined, experiments on the effect of changing the capacity of the coupling condenser in a resistance-coupled amplifier can be made, the effect of changing the value of the grid resistor can be noted, etc.

# Actual Verified Performance

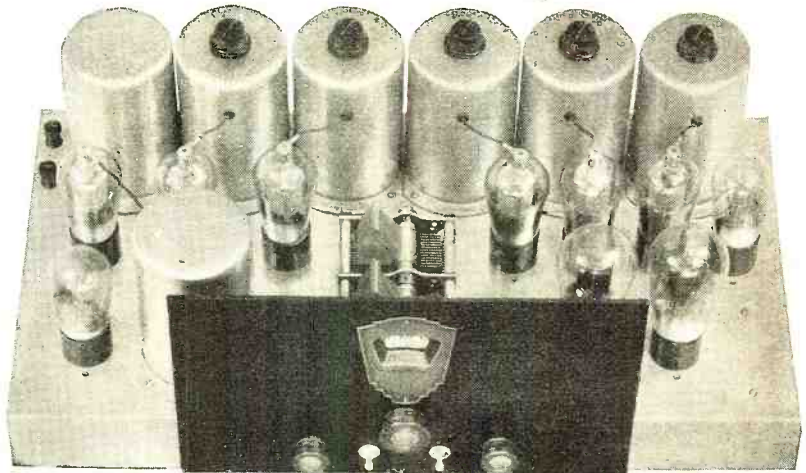

## New Standards Again Set by the Lincoln De Luxe 31

SELECTED by men of international fame who want the best.

APPROVED by prominent Engineering Colleges.

VERIFIED by unbiased published laboratory reports.

Lincoln Engineering has never produced any sensational discoveries, but has conservatively offered to the discriminating buyer radio performance which has been made possible by years of research work.

AND NOW comes the new De Luxe "31" with all of the proved superior qualities of the De Luxe "10" with added features: High grade cadmium plated steel chassis; Six screen grid tubes with high gain perfectly controlled; Completely shielded antenna and oscillator coils; Phonograph attachment utilizing the finest audio system known; Local and long distance switch; Absolutely no A.C. hum. Price: Chassis and power unit (no tubes) \$190.00. Think of 312 verified stations logged on the De Luxe in Brooklyn, N. Y. This exceptional performance has been published repeatedly in New York papers by enthusiastic owner.

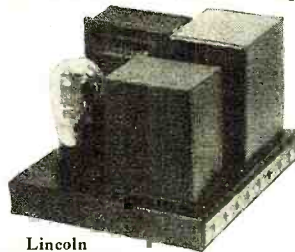

Lincoln De Luxe B-31

DISTRIBUTION: Made only thru qualified distributors. Many of our distributors are making from \$200.00 to \$400.00 a week. When you sell the De Luxe "31" you not only are selling verified performance, but you are getting the co-operation of everyone in our nine-year-old Corporation, who, together with hundreds of our good friends and authorized distributors, have put Lincoln equipment into many of America's most prominent and wealthy homes. If you are qualified to handle and service this equipment, write for full information and special demonstrator discounts.

**LINCOLN RADIO CORPORATION**

Dept. N

329 S. Wood Street

Chicago

## CARDWELL'S BANNER PERFORMANCE

The Star Spangled record of Cardwell Condensers stands on a high peak. With Byrd over both poles—with Dyott in Brazil—the choice of Army and Navy experts! They have always been specified when performance was the prime factor. There's a Cardwell for every tube and purpose. Order direct if your dealer does not stock. Write for literature.

THE ALLEN D. CARDWELL MFG. CORPORATION  
81 Prospect Street :: Brooklyn, New York

**WE SPECIALIZE IN REPLACEMENT PARTS**

**BAL-RAD**  
**REPLACEMENT BLOCK**  
 For Atwater Kent No. 37  
 This unit contains the proper chokes and high voltage condensers. All flexible wire colored leads identical to the original. Fully guaranteed. **\$4.95 ea**

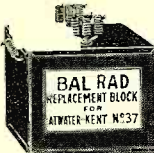

**BAL-RAD**  
**Replacement Block for Majestic "B" Eliminator**  
 The condensers in this block are composed of high voltage condensers. Guaranteed for 1 year. **\$2.95 ea**



**RCA CHOKE COILS**  
**15 Henries**  
 Impregnated in Rosin. Ideal choke for use in "B" Elim. and A. C. Sets. D. C. Resistance 500 ohms. **35c ea**



**POLYMET**  
 Hi-Volt 1 mfd. Filter Condenser. 300 Volts D. C. **35c ea.**

**POLYMET**  
 By-Pass Tubular Condenser 1 mfd., 200 volts  
 Can be used across Choke Terminals in Victor Sets to reduce hum. **\$1.00 per doz.**



**RCA BY-PASS CONDENSER**  
 Part No. 5996  
 Comprising one 1/2 and three .1 mfd. condensers. **35c ea**  
 List \$3.00



**YAXLEY 2,000-OHM VOLUME CONTROL**  
 For Radiola 17, 18, 32, 42, 44, and practically all sets. Insulating strip (easily removed) for metal panels. List Price \$1.95. **45c ea**



**RCA POWER TRANSFORMER**  
 For Radiolas 17-18-32-51  
 This shielded Power Transformer can be used to convert your Battery set to an A. C. Set. Will supply all filament and plate voltages up to 7 tubes. Part No. 8335 **Special \$2.95 ea**



**BAL-RAD HY VOLTAGE**  
**Surge-proof Condensers**  
 For General Repair and Power-Pack Work  
 We guarantee these condensers for 100 per cent. free replacement. Repairmen should carry a few dozen in stock.

	MFD.	Working Volts	Each
One	600	"	30c
Two	600	"	40c
Four	600	"	60c
One-half	300	"	25c



**RCA REPLACEMENT 600V CONDENSER BLOCK**  
 For Radiolas 18-33-51  
 Part No. 8333 **Special \$1.50 ea**

**Victor 30-Henry Choke**  
 Will Pass 125 Mils.  
 For replacement in Victor, Edison and Radiola sets. **50c ea**

**RCA Double-Filter Chokes**  
 R. C. A. Replacement Part No. 8336. Contains two 30 Henry 80 Mill Chokes. Each choke insulated for 1000 volts. Part No. 8336 **\$1.70 ea**



**VICTOR PUSH-PULL TRANSFORMER—Input and Output**  
 Can be used with 171A—245 or 250 type tubes. Output matches moving coil on all dynamic speakers.  
 With Metal Jacket **\$2.50** Without Metal Jacket **\$1.75**



**TERMS** 20% with order, balance C. O. D. 2% discount allowed for full remittance with order only.

No Orders Accepted for Less Than \$2.50

**BALTIMORE RADIO CO.**  
 47 N. MURRAY ST., N. Y. C.  
 Send for Our Latest Bargain Bulletin

**Practical Problems of Auto-Radio**

(Continued from page 219)

the lines of "high-gain" and "equal gain" radio amplification and this work is reflected in present-day receivers.

Let us consider another problem in sensitivity. It has been found that the interference of "static" caused by the ignition and electrical system of an automobile increases with frequency. Stating this another way—if we had a receiver which was equally sensitive at high and low frequencies, the interference caused by the automobile would be worse at high frequencies than at low frequencies. This assures a receiver of equal sensitivity at high and low frequencies, but when we consider that the majority of receivers today are much more sensitive at high frequencies than at low frequencies, the interference at high frequencies might be unbearable although inaudible at low frequencies. We conclude then that the proper design is a receiver having characteristics directly opposite to conventional receivers, namely, having greater amplification at low frequencies than at high frequencies. This, of course, allows the receiver to be worked right down to "noise level" throughout the entire broadcast band.

The question of selectivity raises several interesting points. For example, two similar receivers of equal selectivity and equal sensitivity will perform similarly regarding selectivity. However, considering two similar receivers of equal selectivity but unequal sensitivity, the more sensitive receiver will appear to be less selective because the incoming signal is amplified more and has a greater dial spread. Therefore we must differentiate between apparent and inherent selectivity and design the receiver to be selective even within range of powerful locals.

Taking up the question of quality or fidelity, we are confronted with the task of maintaining the high standard of reproduction obtained in the a.c. home receiver operating on unlimited power supply from the light socket. As the power supply in an automobile must be local and necessarily limited, it is very important to go to extremes in obtaining good reproduction. Due to the fact that the upholstered interior of the car serves to seriously deaden or attenuate high frequencies, the radio-frequency amplifier must not be so sharp as to cut side-bands and the audio amplifier must reproduce faithfully over the entire audio channel.

We must provide for good quality at all volume levels, from a whisper to a roar. It has been noticed that several receivers reproduce with good quality at loud volume, but the quality simply goes to pieces when it is attempted to reduce the volume. The reason for this effect is due to the fact that in reducing the volume the characteristic of the radio-frequency amplifier tubes has been changed so seriously that they no longer amplify faithfully but act as "peak-voltmeters." Needless to state that an audio-frequency amplifier, fed by a high-gain radio-frequency tuner, must be properly "C" biased so that the grid swing on strong signals will not exceed the "C" bias volt-

age and cause the tubes to draw grid current.

There is no question that a receiver for automobile use must necessarily be small and compact. The problem of attempting to include a four-gang shielded condenser, four shielded radio-frequency coils, two shielded audio transformers, six tubes, numerous by-pass condensers, and chokes, etc., in a small space was upon first consideration declared impossible. However, the final solution of this mechanical problem as shown in the photographs not only offers a compact mechanical layout, but is ideal from an electrical standpoint, as the critical parts are spaced and shielded favorably and the high-tension leads are short and shielded by the chassis.

Not only is it necessary that the receiver be small and compact, but the overall dimensions must be such that the receiver may be installed behind the instrument board, on the dashboard, under the hood, or other positions, such as under the floor boards.

In view of the fact that the receiver is to be operated from a supply of "B" batteries, and since these batteries must be mounted out of the way in a convenient place, it is important that the drain on the "B" supply allow the use of the smaller type of "B" battery, if desired, with fairly long life. There is no question heavy duty "B" batteries give much longer life if they can be utilized. However, the available space in an automobile is rather limited, and the use of the larger size "B" battery may be prohibitive. The receiver obtains the filament supply from the automobile storage battery, therefore it is important that the filament circuit be designed for drain on the battery, comparable to the drain caused by the automobile itself, such as headlights, etc., allowing the receiver to be operated for hours without running down the battery.

Let us now discuss the receiver from an electrical standpoint. Referring to the schematic diagram, it is seen that there are four tuned circuits—i.e., three tuned radio-frequency stages and a tuned detector stage. The gain per stage of the radio-frequency stage is very high, being limited only by the overall and interstage coupling. The gain characteristic is fairly flat over the entire broadcast band, although slightly greater at long waves. It is noticed that the antenna stage is tuned and that the primary of the antenna stage is resonated outside the long-wave limit of the broadcast band. As mentioned before, all this serves to obtain the sensitivity characteristic desired, namely, greater amplification at long waves than at short waves. Interstage coupling through common battery connections has been reduced to a minimum due to the use of chokes and condensers in the critical leads. The "C" bias type of volume control was found to be the most desirable after experimenting with other controls.

Preference was given to the use of a -27 tube as a power detector. A stage of audio frequency is interposed between the detector and the power output tubes, as a

(Continued on page 271)



## Practical Problems of Auto-Radio

(Continued from page 270)

power detector feeding into the power output tube was found to overload quite readily. Two stages of transformer-coupled audio frequency are utilized to provide plenty of volume as it was found that the use of the low- $\mu$  tubes and transformer coupling, with the attendant high "C" bias, was preferable to high- $\mu$  tubes and resistance coupling and low "C" bias, since in the latter case the grid swing was limited to the rather small "C" bias voltage. To prevent the speaker from being injured by the plate current of the output tube, and also to guard against danger of high voltages at the speaker terminals, it was found that a choke-condenser combination gave the most satisfactory results.

Referring to the filament circuit diagram, it is seen that the heater type tubes are connected in series parallel to reduce the drain, and then in parallel with the d.c. type tubes. The use of chokes in the filament leads serves to reduce the voltage to the correct value and also to prevent any interference from this source.

## Sound Amplifiers, Theatres and Their Acoustics

(Continued from page 241)

a fine bathroom singer," haven't you? Try it yourself. If your bathroom is one that is walled with tiles or plastered, your voice will be large and full when you sing. Then to get the opposite, go into the rug or carpet department of a store and hear how voices sound there. An enormous difference will be noticed, due to the amount of sound energy that the rugs absorb, whereas in a bathroom the walls reflect nearly all the sound waves that strike against them.

Certain materials are known to absorb certain amounts of sound energy and it might be of interest to the reader to know what some of these are. In Table I will be found a list of building materials and the percentage of the sound energy they absorb.

Now in addition to those materials of Table I there must be taken into consideration the seats, carpets, hangings, etc., that are in every theatre. Also it must be remembered that when a theatre is filled to different capacities, the absorbent properties are different. In order to get the exact amount of sound energy absorbed by one person many tests were performed and the final figure was found to be 4.3 units. In Table II you will find the amount of sound which is absorbed by some of the common items used in the interior of theatres reduced to the sound absorbed by one person.

It should be noted that the amount of sound energy that any material absorbs varies with the pitch of the sound. The standard pitch used in the correction of  
(Continued on page 272)

# Remarkable FREE OFFER

With the purchase of 10 Durham Metallized Resistors (until October 15th, 1930) you receive our complete Resistor Replacement Guide free; or you may buy it for 50c.

This remarkable booklet shows service men clearly and concisely:

- (1) How to locate cause of trouble in radio sets.
- (2) Proper types and values of resistors to use in all popular types of radio receivers.

Every day service men are finding this guide a most valuable aid in speeding up their work—you'll be able to do more repair jobs per day—easier too!

Send your order for 10 resistors—or 50c—today and get this valuable Resistor Replacement Guide.



**DURHAM**  
*Metallized*  
**RESISTORS**

Buy Durham Precision Wire Wound Resistors for your voltage multipliers—non-inductive and accurate to 1% guaranteed.

**INTERNATIONAL RESISTANCE COMPANY**  
2006 Chestnut Street Philadelphia, Pa.  
"No other Resistor has all of Metallized's Advantages."

## AUTOMatic MOTOR CAR RADIO

(Junior Model) features

- THREE TUNED CIRCUITS
- 2 SCREEN GRID POWER DETECTOR
- THREE AUDIO SIX TUBES

List price **\$49.50**

less accessories

## This is the Set That's Going to Get the Motor Radio Business

There's no question now about motor radio coming. The question is what set to sell. Here's the cheapest and the best little performer now made. Get the dope on it today and you'll get the jump on competition.

**SENIOR MODEL**

complete with all necessary equipment—Speaker—Battery Box—Spark Plug and Distributor Suppressors—Antenna—Remote control for operation from instrument panel.

**\$95**

less tubes and batteries

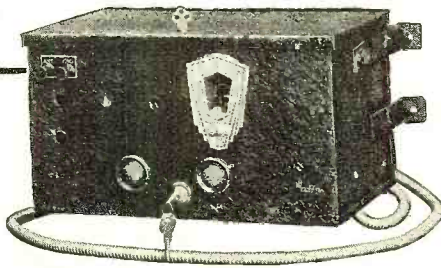

Amazingly clear reception under extreme conditions.

WRITE OR WIRE FOR COMPLETE DETAILS

**AUTOMATIC RADIO MANUFACTURING COMPANY**  
112-118 Canal Street, Department R, Boston, Mass.

# SERVICE MEN!

SELL THIS

*Automatic* Line Voltage Regulator  
**CLAROSTAT**



Regulates the line voltage on all makes of electric sets insuring an even steady flow of current. Reduces Noises—A Real Saver of tubes from excessive voltages. A Big Market awaits you. Carry a supply in your Kit Bag and sell them to your service patrons. List Price .....

**\$1.75**

Send for circular on discounts

CLAROSTAT MANUFACTURING CO.  
281 North Sixth St. Brooklyn, N. Y.

# Sound Amplifiers, Theatres and Acoustics

(Continued from page 271)

acoustical properties of theatres is 512 vibrations per second. This frequency corresponds to the seventh note above middle C on the piano, which has a frequency of 256 vibrations per second. In order to find if there be a need for treating a theatre for sound absorption, the following rule can be easily applied and will furnish data that is sufficiently accurate for most cases:

- (1) Measure the number of cubic feet in the auditorium.
- (2) Find the average number of people in the audience.
- (3) Add to (2) the equivalent in people of all sound absorbent items in the space to be treated. Call this the total average audience.
- (4) Divide (1) by (3).

The result obtained in (4) should be under 150. If this figure is exceeded it is an indication that the theatre needs acoustical treatment. This figure has been checked a number of times under different conditions and has been found to be a safe one on which to base calculations.

from the loud speakers can be heard. It must be remembered that sound can be directed from loud speakers in about the same manner as a light beam can be projected from a searchlight; this is especially true if exponential horns are used.

Table II

Each of the following equals 4.3 sound-absorbing units: 10 sq. ft. of velour, velvet or tapestry; 17 sq. ft. of lined carpet; 14 empty upholstered chairs; 3 empty upholstered chairs; 22 sq. ft. sound-absorbing material, 1/4 in.; 12 sq. ft. sound-absorbing material, 1/2 in.

Note—4.3 sound-absorbing units is the equivalent of the sound energy absorbed by one person.

In Fig. 1 will be seen two horns located at points A and C. It will be noticed that the area under the balcony is in a sound shadow if only the speaker A is used, while the sound from the speaker C covers all this area back from the point D. Also the people in seats in front of point E will not be served properly from the horn A.

The matter of placing the flares of the horns properly also has an effect on the way the sound is distributed over the house. Consider the plan views of a theatre shown in Figs. 2 and 3. In the former sketch the two exponential horns located behind the screen have their flares in a vertical position, as indicated at A in Fig. 4. This type of installation throws the sound out to the sides of the auditorium and away from the ceiling. In Fig. 3 the flares of the horns are horizontal, as in Fig. 4B, the sound waves being directed up to the ceiling and down to the floor.

The method of Fig. 2 is satisfactory to use when the ceiling is of such a material that would reflect a large amount of the sound back down to the audience and so cause annoying echoes and if the side walls are so treated that any sound waves that strike them will be broken up and no troublesome effects are set up. Draperies can be hung along walls to do this, generally at a smaller cost than if the ceiling were acoustically treated, as in Fig. 5.

On the other hand, it might be imperative to keep the sound waves away from the walls of the auditorium, in which case the method of installation of Fig. 3 could be used to advantage. If the ceiling were one which did not reflect the waves back down at the audience and if it were necessary to keep the sound energy away from the walls, this method could be satisfactorily employed.

The subject of the placing of loud speakers and attendant problems of acoustics will be covered in following articles in this series. It is difficult to describe even roughly all the problems that an acoustical engineer encounters, but these few brief outlines will give you a rough idea of the manifold problems that must be considered if the sound reproduction is to be anything like the original.

Table I

	Per Cent.
Cement .....	1.5
Steel Walls and Ceilings...	1.5
Marble .....	1
Linoleum .....	3
Rubber Tile.....	3
Plaster .....	2 to 3
Glass .....	2.75
Wood Trim.....	3
Wood Floor.....	3 to 6
Sheet Metal.....	1.5

Let us take a practical example of such a theatre. Let us assume that the dimensions of the auditorium are 80 feet wide, 25 feet high and 110 feet long. Multiplying these three dimensions gives us 220,000 cubic feet. The average audience for use in (2) is found by taking the daily attendance for 30 days at different seasons of the year and getting the approximate daily attendance per year. This we will assume to be 600. We will say that the theatre has 2,000 upholstered seats and that there is approximately 510 square feet of carpet in the auditorium. By consulting the accompanying table it is found that 17 square feet of carpet and also that three upholstered chairs are equal to one person.

Therefore, we divide 510 by 17 and get 30 people and 1,400 empty seats (2,000 — 600 = 1,400) by 3 equals 466 people. So the average audience is equal to 30 people + 466 people + 600 people = 1,096, the total average audience. Now apply (4), which means dividing 220,000 by 1,096, we get approximately 200. Now as this figure is in excess of 150, it is evident that the theatre requires acoustical treatment.

This is one of the most important factors that has to be considered by the installation engineers. If the theatre under treatment has a balcony, then it is likely that a dead spot will be under this projection in which practically no sound

## PHOTOELECTRIC CELLS

By DR. NORMAN R. CAMPBELL and DOROTHY RITCHIE, Research Staff, General Electric Co., Wembley, England. Illustrated, \$4.50.

The first thorough presentation of practical application of photoelectric cells in television, sound projection, etc. Also discusses theory and uses. "Particularly timely... well worth its addition to one's library."—*Electronics*. Send for Technical Book List.

## ELEVISION

By SYDNEY A. MOSELEY and H. J. BARTON CHAMPLE. Illus., \$2.50

Foreword by John L. Baird

The development of television, early experiments and its present and probable commercial use, is told as a fascinating story of scientific triumph. Well illustrated, it shows a number of hitherto unpublished photographs and diagrams.

Write for Technical Book List

ISAAC PITMAN & SONS, 2 W. 45th St., N. Y.

## ELECTRAD PERFECTED

Loftin-White

TUNER-AMPLIFIER KITS

Designed and manufactured by Electrad—pioneers in the introduction of a perfected Loftin-White Amplifier Kit. Licensed under Loftin-White and R. C. A. Patents. Tuner Kit \$40.00, Amplifier Kit, \$35.00 (Less Tubes).

Interesting, instructive literature on request to Dept. RN-9.

175 Varick St., New York, N.Y.

**ELECTRAD** INC.

\$375

## RCASPEAKER CHASSIS

A wonderful value. Used in Models 100A and 100B Radiola Speakers which sold as high as \$30.00. Made by General Electric Co. Limited quantity. Order by check, money order or stamps. Send for

FREE RADIO CATALOG  
RADIO SURPLUS CORP.  
56 N. Vesey St., New York



## Two-Way Phone Receiver

(Continued from page 258)

detector was tuned to the General Electric short-wave station at Schenectady, N. Y. In this way, both sides of the conversation were received through one pair of phones at the same time without any additional tuning. Both detectors were left just below the points of oscillation on the frequencies of both short-wave transmitters.

For the amateur, the bi-detector circuit has all of the advantages of a good monitor as well as a good reproduction of his own signals on top of those being received. Break-in communication is ideal under these operating conditions.

For this sort of work the antenna is removed from the second detector and the proper tuning coil inserted to receive the transmitter harmonics on twice or four times the wave of the transmitter. The harmonic is tuned in and then the transmitter shut down. By listening on the first detector one can pick up the harmonic of the second detector in the desired band of frequencies and the wave of the harmonic will represent the true wave of the transmitter.

To clarify: let us say that transmitter at W2WK-W2APD is to be set to a frequency of 4,000 kcs. With the wavemeter, the operator adjusts the transmitter's wave as near that frequency as he can judge. He then listens for a harmonic of his transmitter around 2,000 kcs. He tunes it in and shuts the transmitter power off. He then listens for the 4,000 kc. harmonic from the second detector whose wave is tuned to twice that of the transmitter. By locating the 4,000-kc. harmonic of the second detector on the first detector tuned to that band of frequencies, he is able to compare the result with the frequency markers to be found near that band. By further adjustments of the transmitter, 4,000 kc. can be reached.

The bi-detector idea comes in handy when an amateur operator desires to speak to another amateur operator who is speaking to a third station. An example of this came when the operator at W2WK-W2APD had an urgent message for W2PF, who was working W2SC, Governor's Island, N. Y., on schedule. The wave of the transmitter was slowly manoeuvred so that the harmonic of the second detector tuned to twice the transmitter's wave fell exactly on that of W2SC. This was done while W2SC was copying W2PF to eliminate interference. It was a simple thing to call W2PF just as soon as W2SC sent his 73 GB (best regards, good-bye) and "raise" him. The bi-detector idea saved a lot of time in the delivery of the important message.

And then, by tuning to twice the wave of the transmitter on the second detector, the operator can get a true reproduction of his own signals through the same phones as he copies those of the stations he is "working." This is urgent where straight, clean-cut sending is desirable.

Another example of the work possible with this arrangement can be seen in the work done on the 14,000-kc. band. A key was inserted in the plate circuit of the second detector and it was tuned to a

(Continued on page 276)

# The New NATIONAL A. C. THRILL-BOX

New Product of NATIONAL Company, designed in collaboration with Robert S. Kruse. Brings foreign S. W. Broadcast Reception within the reach of all. Easily assembled by anyone, with genuine NATIONAL Radio Products.



New type SE-100 S. W. Condensers. Insulated bearings, constant impedance pigtail, straight frequency line plates.



The coil-forms used in the new THRILL-BOX are made of R-39, the low-loss coil-form material recently developed by Radio-Frequency Laboratories.

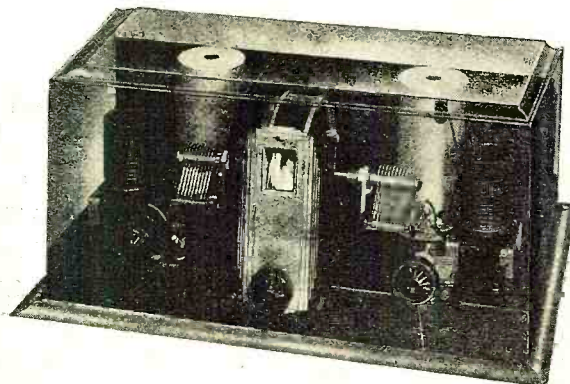

**FULL A.C. OPERATION**, but no A.C. hum, even on phones. **DOUBLE SCREEN-GRID.** Push-Pull Audio loud speaker reception of S. W. Broadcasts all over the world. Single Dial Operation. Accurate logging. Easily adjusted for wide spread of Amateur Bands. Special Construction eliminates "clicking" on higher frequencies.

**ALSO AVAILABLE IN BATTERY MODELS** for use with new UX 230, 231 and 232 Tubes. Send Today for full information. **USE COUPON.**

### COUPON

NATIONAL COMPANY, INC., Sherman, Abbot and Jackson Sts., Malden, Mass.

Gentlemen: Please send me complete information on the NEW National S. W. 5 THRILL-BOX. ( ) A.C. ( ) Battery Operated.

I am interested in S. W. Apparatus for Experimental and amateur use (check here) ( )

Name ..... Address .....

## NEW NATIONAL SHORT-WAVE AC & DC RECEIVER

In Kit Form or Completely Constructed.

## AUTO-RADIO

Kits and Sets and Accessories.

## TELEVISION

Kits and Supplies.

### 1930 CATALOG FREE

Set Builders! Write for your copy. Complete line of short-wave supplies, standard parts and accessories.

CHICAGO RADIO APPARATUS CO.  
415 S. Dearborn St., Dept. RN, Chicago, Ill.

## HOTEL WASHINGTON

PENNA. AVE. 15th &  
F STREETS N. W.

WASHINGTON, D. C.

400 ROOMS — 400 BATHS

Opposite the United States Treasury and the new \$17,000,000.00 Department of Commerce Building

*Easy of access yet located  
at the very center of  
life in the Capital City  
Rates no higher than any other  
first class hotel*

BOOKLET SENT UPON REQUEST  
S. E. BONNEVILLE, Managing Director

# SMOOTHES OUT RADIO VOLTAGE "BUMPS" Automatically!

The new AMPERITE for electric radio automatically prevents fluctuating line voltage which interferes with radio reception. Delivers to your radio, exactly the voltage required for efficient operation. Greatly improves tone and sensitivity. Saves tubes. Insist on AMPERITE in the electric radio you buy or build.

Install AMPERITE in the radio you now have.

Write Dept. RN-9, giving name and model number of your set.



## EXPLORE THE SHORT WAVES

WITH THE  
**EXPLORER PLUGLESS  
CONVERTER**

**\$14.50**

NO PLUG-IN COILS! Wave length range 15 to 200 meters; CHANGES WAVE LENGTH BANDS BY THE TURN OF A KNOB. The EXPLORER enables you to explore the wonders of modern short wave reception with your broadcast receiver. Stations all over the world are at your disposal on the short waves.

The EXPLORER is a 1930 model, efficient and scientifically improved converter. Beautiful appearance; Illuminated vernier dial; shielded; tube inserts inside of cabinet; and absence of plug-in coils make it the most convenient of all converters.

Best performance at the lowest price. GUARANTEED. Sold Direct From Factory. Order now! A. C. or D. C. model only \$14.50. Sent postpaid upon receipt of price or C. O. D. plus postage upon receipt of 3 C. State whether A. C. or D. C. model is desired. SEND FOR FREE LITERATURE.

**RIM RADIO MFG. CO.**  
695 Grand Street Brooklyn, N. Y.

## Newest THING IN RADIO

# Vari-Tone

MAKES A 1931 MODEL OF YOUR PRESENT RADIO

**\$2.95**

Gives you **TONE CONTROL!**  
Connects in One Minute to any Electric or Battery Radio

**TRY IT A WEEK At Our Risk!**  
Makes your set sound like a latest 1931 "tone control" model. **SATISFACTION or money back!** Vary tone and pitch to suit yourself. No need to buy a new \$200 radio. Send \$2.95 or order C. O. D. Free literature. Radio agents wanted.

**VARI-TONE LAB. Dept. 101**  
P. O. Box 700, Cincinnati, O.

## A L U M I N U M

BOXES FOR SHIELDING—Genuine "ALCOA" stock, Dip finish, 5x9x6 \$1.85—9x14x7 \$4.65.

COIL SHIELDS, COIL HOLE COVERS, PANELS—Merchom Cond. Cans, 59c. Pilot and Octo-Coils and forms. Magnet wire, Celluloid sheets, Acetone, Microphone transformers, etc. 48-hole scanning disk, \$6.95. Telephone coils and neon tubes, \$5.95. Sprague .25 Cond., 59c. Carter Tube Shields, Dubilier Distortors, Hammarlund Parts. Pilot lamp bracket and bulls eye, 25c. 4 in. Bakelite Dials, 25c. Telegraph Keys, U. S. Navy surplus, 75c. Murdock Phones, 3000 ohms, \$2.25. Insulating washers, doz., 10c. 3-Plate Midget Cond., 55c. Xaxley Tin Jacks, 12 pair. Test Prods for service men, 45c. 65c, \$1.00. Please include postage.

**BLAN, the Radio Man, Inc.**  
89N Cortlandt Street New York City

# The New 1930 Ham Regulations

(Continued from page 264)

so that the changing plate voltage on the amplifier has no opportunity to get back into the oscillator and affect its frequency and (2) that the oscillator and buffer stage are, of course, fed with d.c. Putting all of this into ham language, modulated signals are still permitted but "wobblated" signals are now prohibited, and the transmitter which uses other than d.c. supply must be built like a good phone set.

It is high time that we had such a regulation. Every other country which licenses amateurs has long had such a requirement, but we in North America have merrily continued with the selfish signals that eat out great chunks of the band. And we the most numerous, the most congested! There has been much amateur agitation the last two years to oblige the selfish signal to take a course of treatment and transform itself into what was first known as a "1929 signal." When spark finally went, years too late, there were still a few disappointed lads, and we suppose there will be a few who will object to making the effort to better their plate supplies. It must be done, though, for our own good—that is the overwhelming majority sentiment of the League.

Barring the use of a.c. on the amplifier stages of oscillator-amplifier transmitters, or similar arrangements, every power supply must now have a filter, even the motor-generator supply, although of course it won't take a large filter for that. The chap with a rectifier but no filter must add the filter. The owner of a self-excited transmitter using "raw a.c., self-rectifying" is under the obligation of installing both a rectifier and a filter or of making some other provision for d.c. The owners of "full-wave back-to-back self-rectifying" a.c. transmitters would probably be best advised to provide a d.c. supply and convert the oscillator to push-pull at radio frequency, a rather simple constructional job—unless they can demonstrate to the Supervisor that they have one of those possible but extremely rare jobs where "wobblation" is practically absent. The owners of "1929 type" transmitters with d.c. supplies have nothing to worry about.

Section VII contains a much more definite statement of the silent-period regulation than we have had in the past, although making no change from the accepted interpretation of it. It remains impossible, of course, to state minutely in regulations just when quiet hours must be observed. The terms "general interference" and "modern design" express the desired thought, but, unfortunately, are still subject to human interpretation. It should be noted that when a Supervisor of Radio informs an amateur that he should observe quiet hours it is not because the Department of Commerce has authority to fix the hours of operation (for it has not), but because this paragraph (a) is a Commission regulation which becomes operative if and when general interference ensues. The Supervisor informs the amateur of the fact; the pro-

vision then applies. If the amateur and the Supervisor disagree on the facts, only a Commission hearing can properly decide the case. Fortunately this is an academic issue nowadays.

One big improvement in this regulation is the definite specification of the Sunday morning silent period (when one must be observed) as from 10:30 a.m. until 1 p.m. The old regulation said "Sundays during local church services." In some cities, what with early masses and afternoon services, church services are in progress all day long. Obviously the regulation cannot refer to local broadcasting. Its intent is to give special protection to religious broadcasts for people who desire to worship thereby instead of attending church in person, and the present wording extends such protection during the hours that persons normally assemble for worship. The evening silent period applies on Sunday, too, of course, for stations which have the quiet-hours obligation. It should be noted that if one frequency band causes local interference but another does not, the station remains free to operate on the bands that do not cause interference, or even on the other end of the same band if interference is thereby avoided.

Paragraph (b), about signing, is a logical provision. All stations are under the obligation of indicating their identity frequently.

In Section VIII the first two paragraphs are further protection to us that the right to the amateur bands shall be extended only to amateurs and used only for amateur purposes. Paragraph (b) solves a troublesome problem in a satisfactory way which is self-explanatory. In pursuance of this same thought of protection it has been necessary, in (c), to provide that club licenses must also be issued to individuals as trustees for the club. Club licenses in the past have all too frequently been blinds for persons who were not entitled, as individuals, to station licenses. A bona fide amateur club owning an amateur station will have no difficulty in securing a license, but some official must be delegated to assume full responsibility under the law for the station's operation. Examples: W1MK, F. E. Handy, Communications Manager, trustee for American Radio Relay League, Brainard Field, Hartford, Conn.; W9ABCD, John K. Smith, President, trustee for Sunflower Radio Club, 98 S. Main St., Sumwarin, Kansas. Listings in the call book will thus properly show that the station is the station of a society and not individually owned.

Paragraph (d) has the effect of wiping out the old Department of Commerce regulations establishing two kinds of portable stations and provides that every portable station must confine its operation to points for which an itinerary has been filed in advance with the home Supervisor. The Government, of course, has every right to know the location and identity of every transmitting station.

Partly in this vein and partly because every station ought to do it anyhow, (Continued on page 275)

**E**njoy **SHORT WAVE** reception on your radio.



**“THE SUBMARINER”**

Short wave reception from all parts of the world is now possible with the SUBMARINER.

No need to buy a special short wave receiver when the SUBMARINER will bring in reception at a fraction of the cost.

Plugs in on your present broadcast receiver. Versatile tuning device with a ratio of 64 to 1 makes tuning exceptionally easy, thus enabling you to pick up stations otherwise impossible to get. The SUBMARINER made since 1929 is completely shielded—a quality product throughout.

Prices: Regular model AC or DC, fixed wave band 19-50 meters, \$17.50. Interchangeable coil, 13-145 meters \$22.50. The “J” feature, an exclusive “Submariner” achievement, gives five times the volume of any other adapter. AC or DC, prices as follows: Fixed wave band, 19-50 meters, \$22.50. Interchangeable coil, 13-145 meters, \$27.50. In ordering give model of set and numbers on tubes in it. Five-prong tube for AC receivers recommended for short waves, \$2.50.

Will be sent prepaid on receipt of price, or C.O.D. if \$1.00 accompanies order. Foreign orders, add 60c postage, no C.O.D.

**J-M-P MANUFACTURING CO., INC.**  
3416 Fond du Lac Ave. Milwaukee, Wis., U.S.A.

**LEARN BY LISTENING**

**Telegraphy**  
*Morse or Continental*

Step into this interesting—uncrowded—HIGHLY PAID profession. Become a trained operator in Morse or Radio Code, easily, quickly, at home, with TELEPLEX, the Master Teacher. Used by the U. S. Government and leading schools.

Write for Folder E-9

**TELEPLEX CO.**  
76 Cortlandt St., New York, N. Y.

Learn at HOME  
With



**Teleplex**

SEND NOW FOR OUR LATEST

**RADIO BARGAIN BULLETIN No. 31**

CHOCK FULL OF REAL LIVE BUYS AT REMARKABLY BIG SAVINGS TO YOU

**AMERICAN SALES CO.**  
19-21 Warren St., New York, N. Y.

**RADIO BARGAINS**

Short Wave Sets, one tube complete with 5 coils, 14 to 550 meters ..... \$ 6.45

Low Power Transmitter adaptable for phone or code. With plug-in coils ..... 14.75

Auto Radio—Uses 3—334 and 3—227 tubes, single dial, tremendous volume. Compact. Fits any car 20.00

B Eliminator. Bone Dry with 280 tube, 180 volts, will operate up to ten tube set, fully guaranteed. 6.75

AC—A B C power packs ..... 8.75

Power and Filament Transformers for 226, 227 and 171 tubes, with double choke ..... 4.00

Tubes: UX type, 30-day replacement guarantee. No. 210, \$2.25; No. 250, \$2.35; No. 281, \$1.85; No. 245, \$1.25; No. 224, \$1.25; No. 227, 75c; No. 226, 65c; No. 171, 75c.

CHAS. HOOBWIN CO. 4240 Lincoln Ave. Dept. J-3, Chicago

**RADIO TUBES**  
*All of the Standard Makes*

CUNNINGHAM—ARCTURUS—RADIO-TRON—EVEREADY—RAYTHEON

Write for Special Prices

**NELSON ELECTRIC COMPANY**  
WHOLESALE RADIO APPARATUS  
508 South Dearborn Street, Chicago, Illinois  
Wholesale Radio Catalog Sent Free Upon Request

## 1930 Ham Regulations

(Continued from page 274)

paragraph (e) makes compulsory the keeping of a simple station log. The Radio Act requires that the records of a station must be made available to the radio authorities upon demand. The log, then, becomes available to the Supervisor in investigating interference cases, etc., and will assist in showing what frequencies and what powers interfere, what do not, and so on. Note that the input power (to the last stage of the transmitter) must be specified for every transmission. This is a compromise provision. Some of the Government people believed that amateurs should keep an accurate description of their station on file, reporting every change; some even believed that a new application should be filed for every important change. We felt that the amateur station should be judged only by its external effects. Power changes were what the authorities most wanted to have on record. It was finally solved by the requirement that the amateur note his plate watts input (to the last stage) on his log at every transmission.

Section IX is a simple authorization of the Department of Commerce to carry on the routine licensing of amateur stations. The Department of Commerce would have no authority over stations without this declaration. The Commission is not permitted to delegate any of its discretionary functions, however, and the legal situation is necessarily such that all special cases must come to the Commission itself and be handled in all due formality as provided in the Radio Act.

These new regulations are now in effect. The Radio Division is already at work making the license changes dictated by the changes in text. So far as the regulations require change from the present practice in the individual amateur's station, they apply at once and each of us should proceed to make the necessary changes. Although no one will insist or admit that they are perfect, they are a big improvement over the old text, they better fortify the amateur position, and by and large they are the most liberal and the most sensible amateur regulations anywhere in the world today.

## Laboratory Tests

(Continued from page 233)

concerning the kit set's performance for the curves speak for themselves. However, the daylight reception is quite unusual. In a fairly good location near Boston 29 stations were picked up in a few minutes one afternoon. In the evening, stations may be heard without interference from each other at almost every division on the dial, provided atmospheric conditions are such that not too much static is picked up when the volume control is advanced.

A conventional type a.c. switch is mounted on the chassis—symmetrically to the volume control—so that it may be used, if desired, for controlling the line voltage not only to the tuner unit but to the power amplifier unit as well.

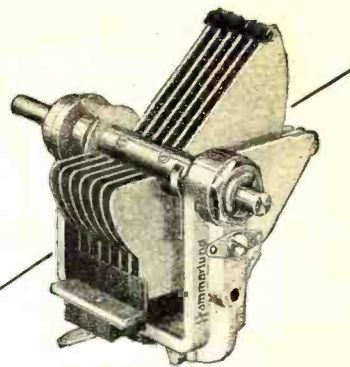

## A New and Better Condenser For SHORT-WAVE Work

Heavy, widely-spaced plates for strength. Less chance for accumulation of dust affecting capacity changes in close tuning.

“Parmica” insulation, the remarkable new material which so closely matches the ideal dielectric efficiency of dry air. Current loss greatly reduced; sensitivity and selectivity improved.

Double cone, smooth-operating bearings—easily adjusted for wear, non-corrosive brass plates, with tie-bars. Strong aluminum alloy frame.

A real short-wave condenser in the three most desirable sizes: .00025, .00014 and .0001 mfd.

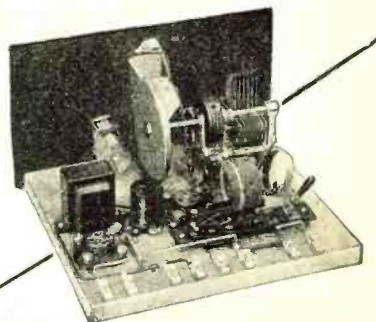

## Here's Fun for the SHORT-WAVE Fan

A remarkably efficient two-tube distance getter, with regenerative detector and one audio-stage. Designed for use with the new 230-type, 2-volt battery tubes. Easily constructed from the Hammarlund kit, containing all parts, as illustrated.

It includes the famous Hammarlund Drum Dial, the new Hammarlund wide-spaced short-wave “Midline” condenser and the improved Hammarlund space-wound plug-in coils. Extra coils are available covering wave bands from 10 to 225 meters.

Makes a wonderful tuning unit for the short-wave experimenter.

Write Dept. RN9 for Details of Hammarlund Short-Wave Equipment.

**HAMMARLUND MFG. CO.**

424-438 W. 33rd Street New York

For Better Radio  
**Hammarlund**  
PRECISION PRODUCTS

# Every Radio Man Needs These Books

## Now Sold at Magazine Prices or FREE with RADIO NEWS



### NEW SHORT WAVE MANUAL

Experience the thrills of the Short Waves—of hearing Europe, Africa or Australia direct as clearly as native stations. This big book, replete with illustrations and How-to-Build diagrams and plans, crowded with 28 chapters by Lieut. Wenstrom, Marshall, Spangenberg and other foremost S-W authorities, represents the last word in authentic S-W data. The most complete up-to-the-minute short wave manual ever published. Brings you more information than books selling at ten times its price. Shipped, prepaid, to your home **50c** for only .....

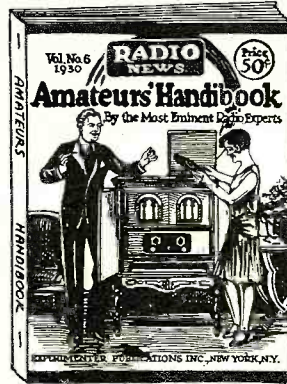

### RADIO AMATEURS' HANDBOOK

Sometimes called the Radio Amateurs' Bible. 30 profusely illustrated chapters bring you 10 How-to-Build articles, with complete instructions and diagrams; new radio wrinkles, DX hints, data on the new tubes, answers to AC problems, and helpful, money-saving ideas for the radio service man. 96 illustrated pages. Large 9 by 12-inch size. Beautiful colored cover. **50c** Shipped, prepaid, to your home for only



### NEW RADIO TROUBLE FINDER & SERVICE MANUAL

Ever have your radio reception fail or become distorted just when a big program was on and you wanted to hear every delicate inflection of tone distinctly? That's when this big, new book is worth its weight in gold. In simple words and easy to understand charts and pictures, it shows you how to find and correct any radio trouble quickly. Just the book you need for improving the reception of your set, or for starting a profitable repair business of your own. Shipped, prepaid, to your home **50c** for only ....

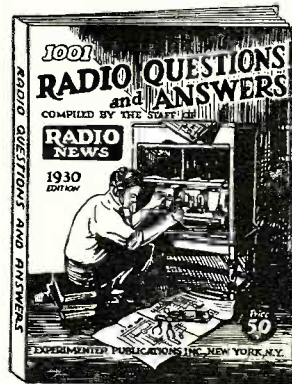

### 1001 RADIO QUESTIONS and ANSWERS

If you own a radio, you need this book. Everything you want to know about radio is in it, from "How to Kill Outside Radio Noises," to a clear description of the newest tubes and how to use them. If you have a question on radio, here is your answer and a thousand more. 96 illustrated pages. Large 9 by 12-inch size. Beautiful colored cover. Shipped, prepaid to your home for only **50c**.....

### Two-Way Phone Receiver

(Continued from page 273)

wave in the 14,000-kc. band with the antenna connected to that circuit. By using the second detector as a transmitter and the first detector as a receiver, W9BBA at Chicago, Ill., was "worked" on the first attempt. It is a well-known fact that very little power is needed to transmit signals on the 20-meter band. In this case, the power on the 201A in the second detector circuit was sufficient to contact W9BBA. W8GZ-W8ZG contacted with New Zealand and Australia using only 45 volts on the plate of a 199 type tube as a transmitter. His receiver had more power than that. A bi-detector receiver can easily be used as a transmitter-receiver for portable work.

But the greatest advantage of the idea lies in the ability to tune in on both sides of a short-wave phone broadcast. It provides something new for our short-wave experimenters to work with.

Who knows but that the necessity of a second detector at W2WK-W2APD may go far toward a radical change of short-wave receiver design of the future.

### How to Judge Tubes

(Continued from page 221)

mutual conductance of all the tubes is given in micromhos.

Now so far as tube testing is concerned we do not need to accurately measure the mutual conductance—all we need is some method of determining whether a particular tube has a normal value of mutual conductance. The formula for mutual conductance given above suggests a method of doing this. Evidently we would get an idea of the mutual conductance if we were to change the grid voltage a certain amount and note the change in plate current. Actually this is the basis of operation of many tube testers on the market.

The Jewell radio set analyzers, for example, have a "grid test button" which serves to change the bias on the tube under test. Then by noting the meter readings one is able to determine from the chart supplied with the instrument whether the tube is good or bad. The Jewell pattern No. 210 tube tester has a similar device.

In Fig. 1 is the circuit of a simple tester recommended by Weston. In this circuit the key K is used to change the bias on the tube. Then the key is up (normal position) the voltage of the "C" battery is impressed on the grid and a certain current is read on the plate milliammeter. When the key is pressed the grid is connected directly to the filament and the plate current is increased. By noting the difference between the plate current with the key up and the plate current with the key down the worth of the tube can be determined.

The E. T. Cunningham Company suggests the use of the circuit of Fig. 2 for (Continued on page 277)

Clip and Mail TODAY!

EXPERIMENTER PUBLICATIONS, INC., Dept. 2409, 381 Fourth Ave., New York, N. Y.

Gentlemen: Please ship me postpaid the Radio Books I have checked below. Remittance is enclosed.

- New Short Wave Manual
- Amateurs' Handbook
- New Radio Trouble Finder
- 1001 Questions & Answers & Service Manual

Name .....

Address .....

City and State.....

## FREE!

You may have any one of the above Radio Books ENTIRELY FREE with RADIO NEWS at a reduced price. To accept this offer check square below.

Ship me ENTIRELY FREE the Radio Book I have checked above and enter my subscription for the next eleven big issues of RADIO NEWS at the special price of only \$2, which I enclose. (Regular newsstand price of Radio News \$2.75.)

## How to Judge Tubes

(Continued from page 276)

testing of tubes. Here we have a completely a.c.-operated tube tester. Nine sockets are provided for the various types of tubes, filament voltage being obtained from a small filament transformer. Grid bias is obtained from the two resistors R2 and R3 connected in one side of the circuit. The grid bias is changed by pressing the key K which shorts out the resistance R2. In operation of this tube tester the following procedure should be used. The tube to be tested is placed in the proper socket and resistance R1 is adjusted if necessary to give the proper voltage across the primary of the transformer. The plate current is then noted before and after pressing the key K. For Cunningham tubes the following plate currents are obtained with the key open and with the key closed.

It should be realized that these readings depend entirely upon the characteristics of the apparatus used in the tester. Different transformers, different values of resistors, etc., will affect the meter readings. In the same tester constructed to obtain the data given directly above, the following apparatus was used:

- T1—Special filament transformer, 20 watts capacity and having 7.5-volt secondary with taps at 1.1, 1.5, 2.5, 3.3 and 5.0 volts. Primary wound for 100 volts, 60 cycles, and secondary delivering above voltages at rated primary voltage. (Amertran.)
- R1—50-ohm variable resistor, 500 ma. capacity. General Radio 50-ohm rheostat, type 214.
- L2—25-watt 110-volt lamp.
- L1—10-watt 110-volt lamp.
- M2—Weston 476 0-150 scale a.c. volt-meter.
- M1—Weston model 301 milliammeter (d.c.), 0-15 ma.
- 6 Remler CX type sockets.
- 3 Remler five-prong base tube sockets.
- K1—S.P.S.T switch or key (push-button will do), single pole single throw.
- R2—Electrad type B 2250-ohm resistance.
- R3—Electrad type B 400-ohm resistance.
- 2 clips for connection to control grid of screen-grid tubes.
- K2—General Electric single-pole tumbler switch; catalogue 269943.

This method of testing mutual conductance is therefore one of the best criteria of tube performance. At the same time it is also important that the plate current be approximately correct. As we stated previously, the tube with the highest plate current is not always the best tube, but nevertheless it is usually inadvisable to use tubes whose plate current is considerably lower or higher than normal. For example, a 201A tube with 90 volts on the plate and a  $-4\frac{1}{2}$  volt bias on the grid draws a plate current of 2.5 mils on the average, but another tube might draw 2.0 mils or 3.0 mils and be a perfectly good tube, *provided* the mutual conductance tests were also satisfactory. In other words, these two tests, mutual conductance and actual plate current, are complementary. Neither of them alone is a definite indicator of the tube's value, but both of them together give an excellent check on a tube.

It would be possible to supplement these tests by putting measurements for emission, power output, gas, filament current, filament voltage, etc. Some organizations may prefer to make these additional tests, but our purpose in this article has been simply to indicate a method of testing sufficiently effective and simple so that the average dealer or serviceman could perform it without difficulty or loss of time.

Since the mutual conductance and plate current readings obtained on a tube tester depend largely upon the design of the tester, it is not possible to give definite figures for good and bad tubes. The best procedure is to test a number of new tubes and determine how much they vary and then use these figures as a basis for future tests on tubes.

Although, as the preceding data indicate, it is possible to construct tube testers, most servicemen and dealers will probably find it advisable to purchase one of the many excellent tube testers that are available. In Table 2 we have therefore compiled data on practically all of the commercial tube testers made by the leading companies. All of these instruments are supplied with complete instructions and charts so that the testing of tubes can be quickly and accurately accomplished. The important point is to make use of a tube tester, whether constructed of parts or purchased complete, and not to take the chance of selling tubes without testing them: No matter how well a tube is made, there is always the chance that it has been damaged in shipment and a good tube checker will indicate if this has happened. The dealer or serviceman who wants to stay in business cannot afford to take the chance of selling a defective tube.

It is also certain that the dealer must not trick the buyer into purchasing tubes that are "just as good" on the supposition that it pays better. A dealer or serviceman who has a monopoly on tube sales in his community might sell the tubes that cost the least and have the shortest life, but he would have no assurance that someone else might not soon furnish his customers with better tubes.

## Band Rejector System

(Continued from page 235)

the transmission band desired of the Hopkins stages.

The overall characteristics of such an amplifier are such that when accurately tuned to 182.5 k.c., with normal field strength of less than ten microvolts, no transmission of energy is possible at frequencies 5 k.c. above or below the resonant frequency with field strengths up to two hundred times normal. With careful adjustment, such rejectivity may be secured without too serious impair-

(Continued on page 279)

# A Valuable GUIDE



for  
**Servicemen  
and  
Dealers**

**I**n this day, with power-converters being universally used, it is vitally important that men in the radio business know how they are made—how they can be improved—how they can be repaired. Not the least important part of a power-converter or power-pack is the filter condenser, and the New Mershon booklet on Filter Condensers is the most complete, helpful booklet on this phase of radio ever written.

In successive chapters this booklet deals with the various condenser problems and their solutions. Voltage surge effects, condenser life limits, moisture, safety-valve action, cost and size, are all carefully and completely analyzed so that the average man can easily understand which filter condensers are the best to use and why.

The booklet is replete with diagrams and photographs illustrating all the important points. It also contains a complete description of the Mershon Puncture-Proof Filter Condenser and shows why it ranks first in this all-important field of radio equipment.

Although the regular price of the booklet is 10 cents, we offer it FREE to RADIO NEWS readers. Send for your copy today.

USE THE COUPON  
BELOW AND GET THE

# NEW MERSHON BOOKLET

The Amrad Corporation,  
295 College Ave.,  
Medford Hillside, Mass.

Gentlemen:

Please send me a copy of your new booklet, entitled "Puncture Proof Filter Condensers," regularly priced at 10 cents a copy, but FREE to me.

Name .....

Address .....

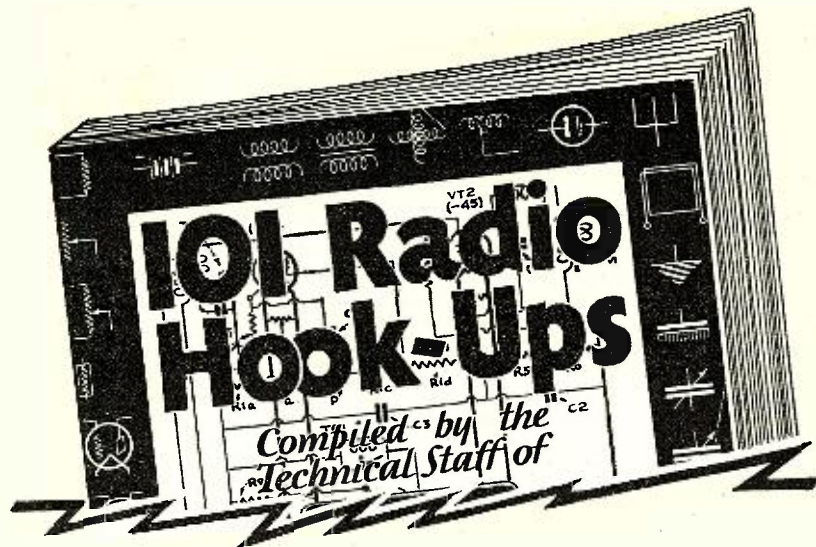

# FREE This Big New Radio Book with 6 Months of RADIO NEWS *only*

*Special Summer Offer Good for One Month Only!*

**H**ERE'S a big brand new book that every radio fan, set owner, set builder, service man and experimenter has been eagerly looking for! In it we present a cross-section of the latest progress made in every phase of radio reception, to serve both as an ideal source of reference and as a stimulant for even greater achievement.

As the book's title indicates, it contains complete schematic diagrams and thorough descriptions of Short-Wave Transmitters and Receivers, all the most popular types of Manufacturers' and Home-Built Receivers, Serviceman's Test Apparatus and a Group of the New Loftin-White Direct-Coupled Amplifiers. Below are a few of the more than 101 sets included in this invaluable book, which will be shipped to you **ENTIRELY FREE!**

Radiola No. 33  
HFL Mastertone  
Colonial Model SG32  
The Stromberg-Carlson Screen-Grid Receiver  
Zenith 34P and 342P.  
Hammarlund Roberts HiQ 30  
Grebe D.C. No. SK-4  
Atwater Kent No. 35  
Silver Marshall Automobile-Radio Receiver  
Lincoln 8-80 Superheterodyne 10-Tube  
Silver Marshall Auditorium Power Amplifier  
National Screen-Grid Short-Wave  
4 Loftin-White Direct-Coupled Amplifying Systems  
Cornet Short-Wave Receiver

A Short-Wave Adapter for Use on an A.C.-Operated Receiver  
Bosch No. 48  
Fada No. 35B  
Freshman Q15  
Jackson NJ-30  
Pilot A.C. Short-Wave Super-Wasp  
Kolster K-21  
Majestic No. 180  
Stewart-Warner Series 950  
Victor Radio Models R32 and RE45.  
Test Panel for Radio Serviceman or Radio Laboratory  
Tube Tester Eliminating Need of Batteries  
An Audio-Frequency Oscillator  
A High-Power Crystal-Control Short-Wave Transmitter

Other diagrams and descriptions cover complete receivers or units thereof used in virtually every field of radio activity.

**Other Radio Book Bargains on Page 276**

## The New Loftin-White System

No single radio development in recent years has received the attention now being given the Loftin-White System. It has provided us with a new, cheaper and better method of reproduction and one which, from the standpoint of true radio and mechanical engineering, offers some really astounding possibilities. Their ingenious system has been incorporated with remarkable results in many of the circuits contained in this publication. As RADIO NEWS has the exclusive right to the publication of articles by Messrs. Loftin and White, this information is not obtainable from any other source.

## Get Your FREE Copy NOW!

As you can readily see from the copy you are now reading, RADIO NEWS is deservedly the outstanding leader of all radio magazines. Of course, you want it every month. Here's your opportunity to get 6 big issues (\$1.50 single copy value) for only \$1.00—and to have this big new manual, "101 Radio Hook-Ups," shipped to your home, postpaid, entirely free. You save 50 cents on RADIO NEWS and get the book **WITHOUT COST!** Risk nothing—

### -----Mail Coupon TODAY!-----

RADIO NEWS, Dept. 2409,  
381 Fourth Avenue, New York, N. Y.

Gentlemen: Send me, **ENTIRELY FREE**, postpaid, the new completely revised 1930 edition of your book "101 RADIO HOOK-UPS" and enter my subscription for the next Six Big Issues of RADIO NEWS at only \$1, which I enclose (regular price \$1.50). I understand you will cheerfully refund my \$1 and I may keep the "101 RADIO HOOK-UPS" if I am not perfectly satisfied after reading the first issue.

Name .....

Address .....

City and State .....

Are you a Service man ? Engineer ? Dealer ? Experimenter ?  
Present subscriptions will be extended from expiration.



# Hopkins Band Rejector System

(Continued from page 277)

ments of the higher modulation frequencies up to 4000 cycles. By means of the adjusting condenser which is a part of each stage, the amplifier may be readily adjusted, by ear, to produce an extremely narrow band with sidebands badly attenuated, merely by turning the adjusting condenser until the signal disappears, and then turning back until the very edge of the cutoff is reached. This must of course be done in both stages of any "pair" as will be seen from the curves previously published. Similarly, the stages may be tuned to such points on the gradual slopes of their respective characteristics as may be required, with the result that the band width becomes greater, and with but very little increase in the angle of the slope on the cutoff side. This is clearly shown in the overall curves taken on a typical receiver; the narrow band results from tuning the stages solely for maximum output; the proper band for best attainable fidelity was, in this case, secured by ear, while tuned to a broadcast program, merely by rotating the adjusting condensers slowly until the usual high note background became evident. At this point, the outer curve was secured.

The r.f. amplifier tube used in the receiver, when used with the proper output coupling provides the necessary enhancement of transmission of the lower broadcast frequencies, which would be attenuated seriously by the use, alone, of the type of pre-selector chosen for reduction of "cross-talk." It further provides r.f. amplification of average value, sufficient to permit the operation of the mixer tube at a relatively high control grid bias, which is desirable for best operation.

The proper choice of operating constants in the second detector stage, using a -24 tube, together with an audio system with a most pronounced rising characteristic above 2500 cycles, further equalizes the tendency toward attenuation of the higher sideband frequencies, so that the receiver, when used with the average dynamic speaker, does not have the effect of extremely high bass note reproduction usually anticipated in receivers of extreme selectivity.

The overall sensitivity curves shown were taken on a typical model of the receiver described, after the set had been subjected to the regular test line-up and adjustment. The antenna used was standard RMA 4-meter substitute. It will be seen that the average sensitivity is ample for the reception of distant stations, when accompanied by the extreme degree of selectivity offered. The curve of lower sensitivity indicated the results to be expected with the Local-Distance switch on the "Local" side. A resistance between antenna and ground is inserted by such switch and is readily accessible, so that the ratio of sensitivities may, if desirable, be altered by the set owner.

The complete receiver with self-contained power plant measures 20 inches by 12 inches in area. Due to this compactness, straight-line-frequency condensers of

the necessary maximum capacity are not feasible, although their use would appear to permit of easy alignment of circuits for approximate one dial operation. This receiver employs a mechanical trimmer device which serves to tune the entire r.f. amplifier exactly to resonance. Due to this feature the input of the pre-selector was necessarily made of a type resulting in extremely minute mistuning effects due to antenna loading.

The rectifier supply includes an electrolytic filter consisting of three 9 m.f. units of the "Electrofarad" type together with heavy current choke and dynamic speaker field (2250 ohms plus or minus 10%) resulting in an extremely low hum level, usually termed "humless."

Provision is made whereby the "phonoradio" switch inserts the pick-up (of ordinary high impedance type) directly into the -24 detector's input circuit for "phono" operation. Biasing arrangements are such that correct amplifier relations are maintained while playing records.

## Three New Tubes

(Continued from page 205)

provide sufficient voltage to operate a 231 output tube.

### The ER-231 Tube

#### Service

The 231 is an output tube designed for use as a last stage audio amplifier in primary battery-operated receivers. The power output is as high as possible, consistent with low filament and plate current consumption.

#### Rating

Electrical characteristics: Filament voltage, 2.0 volts; filament current 0.13 ampere; plate voltage—nominal and recommended, 135 volts (max. 150 volts); grid voltage—nominal, -22.5 volts; plate current, 8.0 milliamperes; plate resistance, 4,000 ohms; amplification factor, 3.5; mutual conductance, 875 micromhos; undistorted power output, 170 milliwatts. Approximate direct inter-electrode capacitances: Grid-to-plate, 6 mmfd.; grid-to-filament, 3.5 mmfds.; plate-to-filament, 2 mmfds. Dimensions: Maximum overall length, 4 1/4"; maximum diameter, 1 3/16". Base, small UX.

### The ER-232 Tube

#### Service

The 232 is a screen-grid tube suitable for use as a radio-frequency amplifier, detector, or intermediate audio-frequency amplifier. It is recommended particularly for use as a radio-frequency amplifier.

#### Rating

Electrical characteristics: Filament voltage, 2.0 volts; filament current, 0.06 ampere; plate voltage—nominal and recom-

(Continued on page 280)

# CHOOSE YOUR OWN PLACE IN RADIO

## Through This Training



Radio is on the verge of a further big expansion. Moreover, wide acceptance of the A.C. screen grid tube with its complexity of circuits demands more highly trained men for manufacture and service. Now is the most opportune time to enter this magic new field of work.

## Widely Approved Method

The industry no longer wants just "tinkerers" but demands trained, skilled men. For example, the Wisconsin Radio Trades Association compels every service man to pass a severe examination and become registered. School of Engineering graduates are prepared for acceptance and registered by this association.



R. C. A. Photophone, Inc., have employed fourteen S. of E. graduates in important positions on their talking pictures. S. of E. graduates welcomed everywhere by leading companies.

## A Great School

Founded in 1903 by Oscar Werwath, internationally known electrical engineer. Over 26,000 successful graduates all over the world. Big unique laboratories afford thorough, practical training. Recognized faculty of specialists. Widely indorsed by radio and electrical industry.



## EARN WHILE YOU LEARN

Co-operative part-time work plan. Earnest students of high character assisted to earn part of their expenses. Student Loan Foundation for those who need it. Moderate tuition fee. Broadcasting Stations WISN and W9SO, athletics, orchestra, fraternities, delightful environment.

## APTITUDE TEST

### Given Free

Coupon brings Special Aptitude Test designed to help you find your rightful place in this wonder world of endeavor. Also full details of intensive unique training of 3 months, 6 months or 1 year—depending on place to which you aspire. A few Free Scholarships awarded to men of outstanding merit. Enter the contest now!



## SCHOOL OF ENGINEERING OF MILWAUKEE

Dept. E.R.G. 930 MILWAUKEE, WISCONSIN

School of Engineering of Milwaukee, Dept. E.R.G. 9-30 Milwaukee, Wisconsin

Without obligation, send me, free, Aptitude Test for Commercial Radio Engineering. I am interested in:

- 3 Months' Junior Radio Technician Course
- 6 Months' Radio Technician Course
- 1 Year Commercial Radio Engineering Course

I am a graduate of  Grammar School  High School  College.

Name ..... Age .....

Address .....

City ..... State .....

I am interested in  Elec. Refrig.  Coml. Elec. Engr.  Elec. Engr., B.S. Degree.

## Build Your Own Multi-Range Volt-ammeter

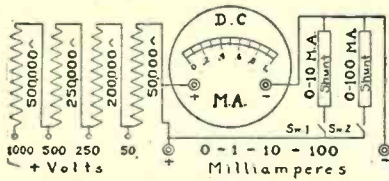

The Super Akra-Ohm wire-wound Resistors and Shunts afford an inexpensive way to build an accurate Multi-range Volt-ammeter as shown in the above diagram.

We manufacture wire-wound resistors of any value from 0.01 ohms to 10 meg-ohms. They are carefully designed to insure an accuracy of 1 per cent and a constant permanency of calibration. Their use is highly recommended for Laboratory Standards, High Voltage Regulators, Telephone Equipment, and Television Amplifiers, Grid and Plate Resistors, etc.



Prices range from \$1.25 for 100 ohms to \$4.00 for 500,000 ohms

**SHUNTS** for increasing the range of milliammeters, \$3.00 each.

Send us your dealer's or jobber's name and we will send you Bulletin 100-D, containing the original voltage multiplier chart for the use of Super Akra-Ohm Resistors for constructing Multi-Range Volt-meters.

**Shallcross Mfg. Company**  
ELECTRICAL SPECIALTIES  
700 PARKER AVENUE  
Collingdale, Pa.

## Laboratory Instruments

of All Sorts Built to Order

Write us your specifications and we will forward your estimate immediately.

**WIRELESS EGERT ENGINEERING**  
179 Greenwich Street New York City

**LOFTIN-WHITE**  
Licensed **SOUND** systems by

# Amplex

Offer An Interesting and Profitable proposition for responsible, experienced Installation Engineers, Custom Builders, Service Men, Dealers, Contractors. AMPLEX will help you sell and install super-AMPLEX L-W sound systems for parks, airports, schools, hotels, theatres, etc. . . . You can bid lower, make more sales and profits, and get better results than with any other known system. Protected territories. Write in detail to our General Manager.

**AMPLEX INST. LABS.**  
132-F West 21 St. New York City

**STUYVESANT ELECTRIC CO.**  
53 Walker St. New York

Write for  
**FREE CATALOGUE**  
ON LATEST RADIO BUYS

## Three New Tubes

(Continued from page 279)

mended, 135 volts (max. 150 volts); control grid voltage—nominal, —3.0 volts; plate current, 1.5 milliamperes; screen-grid current, not over 1/3 of plate current; plate resistance, 800,000 ohms; amplification factor, 440; mutual conductance, 550 micromhos; effective grid-plate capacitance, 0.02 mmfd. max. Dimensions: Maximum overall length, 5 1/4"; maximum diameter, 1 3/16"; control grid cap diameter, 0.346"-0.369". Base, large UX.

### Operation

#### Radio-Frequency Amplifier

The 232 may be operated either with fixed "C" battery or with a self-bias arrangement. The control grid bias with 135 volts on the plate should be 3 volts in either case.

The 232 is a high-impedance tube and requires a high external impedance. Somewhat higher amplification may be obtained with impedance coupling than with transformer coupling. Transformer coupling, however, results in simpler circuits than impedance coupling and by careful design sufficient amplification may be obtained using transformer coupling.

Careful shielding between the input and output is necessary if high stable amplification is to be obtained. The tube parameters are such that the theoretical limit of stable amplification is considerably higher than that of the 222 type of tube.

#### Audio-Frequency Amplifier

The 232 as an audio-frequency amplifier will require either resistance or impedance coupling. The internal impedance is too high to obtain good quality with transformer coupling. The coupling resistance should not be over 250,000 ohms because of quality considerations, although the amplification will increase as the coupling resistors are increased.

#### Detector

The 232 may be used as a resistance or impedance-coupled detector and will be somewhat more sensitive than the 231. It is recommended that a 100,000-ohm resistor be used in series with the screen grid and a coupling resistor of approximately 150,000 to 200,000 ohms in the plate circuit. The voltages and values of resistances used are such that they are not critical and would give good results over the useful life of the battery. Higher sensitivity could be obtained but at the expense of making the circuit elements and voltages more critical.

The utility of these new tubes will be readily appreciated when one considers that there are practically 16,000 homes in the United States that are unwired for alternating current, as well as the growing popularity of portable receivers, a popularity that is bound to increase now that tubes are available that will ensure satisfactory operation. They are particularly useful in automobile receivers where ruggedness is essential.

At this writing (July) these tubes are not available to the general public, but probably by the time this magazine reaches the reader sufficient quantities will have been distributed for receiver construction.

## RADIO'S GREATEST VALUE

NEW 1930 MODEL  
NATIONALLY KNOWN  
SCREEN GRID



Dynamic Walnut Console A C Electric Radio

\$39.50 Net

Complete with eight R C A licensed tubes. R C A Licensed A C Tubes at the lowest price ever offered—ALL REDUCED TO ONE PRICE!



UX226  
UY227  
UY224

35¢ EACH

UX245  
UX280  
UX171A

Isn't This What You've Been Wanting?



HEAVY DUTY MODEL  
**MAXIM**  
FILTERED  
LINE NOISE ELIMINATOR

\$2.65 EA. List \$7.50

Write for Our 1930 Bargain Catalog  
**DIXON RADIO & ELECTRIC CORP.**  
135-137 Bleecker St., N. Y. C., New York

## Home-Study Business Training

Your opportunity will never be bigger than your preparation. Prepare now and reap the rewards of early success. Free 64-Page Books Tell How. Write NOW for book you want, or mail coupon with your name, present position and address in margin today.

- |  |  |
|--|--|
| <input type="checkbox"/> Higher Accountancy        | <input type="checkbox"/> Business Corres.      |
| <input type="checkbox"/> Mod. Salesmanship         | <input type="checkbox"/> Credit and Collection |
| <input type="checkbox"/> Traffic Management        | <input type="checkbox"/> Correspondence        |
| <input type="checkbox"/> Rail. Station Mgm't       | <input type="checkbox"/> Modern Foremanship    |
| <input type="checkbox"/> Law: Degree of LL.B.      | <input type="checkbox"/> Personnel Mgm't       |
| <input type="checkbox"/> Commercial Law            | <input type="checkbox"/> Expert Bookkeeping    |
| <input type="checkbox"/> Industrial Mgm't          | <input type="checkbox"/> C. P. A. Coaching     |
| <input type="checkbox"/> Banking and Finance       | <input type="checkbox"/> Business English      |
| <input type="checkbox"/> Telegraphy                | <input type="checkbox"/> Commercial Spanish    |
| <input type="checkbox"/> Business Mgm't            | <input type="checkbox"/> Effective Speaking    |
| <input type="checkbox"/> Railway Accounting        | <input type="checkbox"/> Stenotypy—Stenog'y    |
| <input type="checkbox"/> Paper Salesman's Training |  |

LaSalle Extension University, Dept 994-R, Chicago.

## See the Craters in the MOON!

Astronomical and Terrestrial  
**TELESCOPE**  
Magnifies 30 Times

Own a genuine Astronomer's Telescope. See thousands of miles away. Make Sun, Moon Planets. Stars your next door neighbors. Craters, Sun Spots, Eclipses, Comets enlarged 30 times. Strange thrills!

Price Only \$3.95

Hours of fun looking at scenery, games, bathing beauties. Great for trips and voyages. Made like telescopes used in observatories. Gerding wrote, "Moon seemed 10 yards away."

See Landscapes, Games, Ocean Scenes, Enlarged 30 Times!

Diameter 2 inches. Special friction adjustment for focusing. Adjustable bracket and clamp can be fastened to chair, fence, branch, etc. Finest materials. Will last a lifetime.

**Five Days' Free Trial**  
Rush only \$1.00 now. Pay balance (\$2.95 plus postage), when postman delivers. Keep 5 days. If not delighted, return telescope and money will be refunded.

**EARN \$10 A DAY**  
Charge 25c to look at the moon

**ROLL-O SPECIALTY CO.**  
Dept. K-335  
220 E. 3rd St., Cincinnati, O.

## ACME WIRE PRODUCTS

Parvolt Filter and By-Pass Condensers, Magnet Wire-All Insulations, Varnished Insulations, Coils.

**THE ACME WIRE CO.**  
NEW HAVEN, CONN.

## New Discovery

STATIONS all over the earth now come in loud and clear. Regular broadcast band. Super-powered HFL Mastertone with new rectifying amplifier gets them. Patented system amazes experts. FREE booklet explains all. Send for it NOW! High Frequency Laboratories 3000 N. Clearmont Av., Dept. C, Chicago, U.S.A.



# NEW YORK'S NEW HOTEL LINCOLN



Where modern scientific planning and management make possible rates surprisingly moderate. 1400 Rooms, each with bath and shower.

\$3-5 For One \$4-7 For Two

Telephone Lackawanna 1400

Eighth Ave., 44th, 45th Sts. Times Square · NEW YORK

**FREE! RADIO BARGAIN CATALOG**

**ALSO FREE RADIO GIFT**

Send now for this new free radio catalog which saves you many dollars on radio outfits, kits, parts, tubes and accessories! Also **TIME CONVERSION CHART FREE**. Tells you instantly what time it is in any part of the world! Given free if your request for catalog reaches us this month.



200 Jackson St., Chicago, Ill.

Genuine **PILOT** Products

## REAL MEN WANTED



Two distinct lines in one. For either salesmen or those mechanically inclined.

**\$50.00 value for \$6.00** with profits accordingly large

We can provide you with unlimited quantities of all leading makes of electric vacuum cleaners at sensationally low prices, each guaranteed perfect in action and appearance. Such extreme value and profit offers any man of average intelligence a splendid income even for spare time.

### Free Vac Course

To our associates we give in bound book form, free expert advice and seldom disclosed instructions in building and servicing all vacs. Through this free training you may readily develop a permanent, well-paying business all your own. From our immense resources we supply all needs. At trifling cost and no risk you can prosper with us, the originators. Oldest and largest in the line. Literature tells all.

**URON ASSOCIATED INDUSTRIES** Cleveland, Ohio  
1311 Engineers Bldg.

Write for booklet

*"Opportunities in Radio"*

**West Side Y.M.C.A. Radio Institute**

113 West 64th Street, New York City

## The CROSLBY ROAMING

**AUTOMOBILE RADIO RECEIVING SET**

## The Serviceman

(Continued from page 251)

While only two condensers will suffice in some cases, it is usually more satisfactory to use four, two in series across the line at each end of the chokes with their mid-points grounded.

The r.f. chokes will have to be wound to carry the total current drawn by the eliminators without causing too great a voltage drop in the supply line. This means that a comparatively large size wire will have to be used and that the chokes must be designed to have the greatest possible inductance for the amount of wire employed.

A total of 150 turns of number 16 single cotton-covered wire wound in three banks on a 3-inch-diameter cardboard or bakelite form 4 inches long will be needed for each choke. The resistance of these coils is not high enough to lower the line voltage to any great extent.

### Cutting Machine Screws

Having had occasion to use machine screws of lengths other than standard, or to cut down conveniently available sizes, I always ran into trouble starting the nuts over the burred edges until I hit upon the idea of putting the nut on before cutting to size. When the nut is removed it automatically cuts away the burr.

ARTHUR MELONIE,  
Buffalo, N. Y.

### Inexpensive Tube Protection

As long as there are battery sets (and they will be plentiful for years to come) tubes will be jeopardized by shorting over from the high-voltage supply. This possibility can be definitely eliminated by connecting a small flashlight bulb in the negative "B" battery lead. These bulbs are inexpensive and are easier to obtain than fuses.

ANTHONY DUKES,  
Camden, N. J.

## Broadcast Super-heterodyne

(Continued from page 227)

- C1—Mignon .00035 straight line frequency variable condenser.
- C2—Mignon .0005 straight line frequency variable condenser.
- C3—Sangamo .0004 mica condenser.
- C4—Sangamo .00035 mica condenser.
- C5—Hammarlund .0001 midget condenser.
- C6—Sangamo .00035 mica condenser.
- C7—Hammarlund .0001 midget condenser.
- C8-9-10-11-12-13-14-15-16-17—1 mfd. Flechtheim non-inductive condensers.
- C18-19—1 mfd. Flechtheim condensers, type HV.\*
- C20-21-22-23—4 mfd. Flechtheim condensers, type HV.\*
- C24—1 mfd. Flechtheim condenser, type HV.\*
- C25—Sangamo .0005 mica condenser.

(Continued on page 282)



## This NEW Attractive Antenna Brings Results

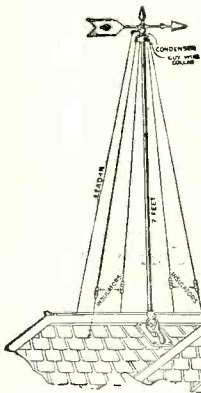

The RED ARROW ANTENNA is both ornate and effective. It easily brings in distant stations with amazing clearness due to the patented condenser which acts as a neutralizer for the entire system.

The revolving RED ARROW is also a handsome weather-vane.

'RED' ARROW WITH CONDENSER **\$3.25**

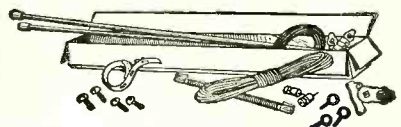

COMPLETE KIT FOR INSTALLATION **\$3.50**

Get your RED ARROW ANTENNA today from your radio dealer. Write direct for further detailed description to

**YAHR-LANGE**  
INCORPORATED

205 E. Water Street Milwaukee, Wis.

**SM**

Nothing New in Radio

this year for the ? Custom-Builder

## Oh Man!— Just Wait

till you see what Silver-Marshall drops "out of a clear sky"—in the October Radio News!

**YAXLEY**



**Push Button Switches**

In a wide range of multi-spring combinations. Yaxley construction throughout. Now, in the following numbers:

- No. 2001—Make Contact .....\$1.00
- No. 2002—Break Contact ..... 1.00
- No. 2003—Single Pole, Double Throw..... 1.15
- No. 2004—Two Make Contacts ..... 1.30
- No. 2005—Two Break Contacts ..... 1.30
- No. 2006—Double Pole, Double Throw..... 1.60

**YAXLEY MFG. CO.**

Dept. N 1528 W. Adams St. Chicago

# A Complete New \$200 Detective Novel

In Magazine  
Form—Only

## 25c

**D**O you know that you can buy a New Complete Detective novel at your local newsdealer at a price that is only one-eighth the cost of the same novel when put out in bookbinding? Well, you can!

Every month your newsdealer has a brand new Complete Detective Novel waiting for you—a rip-snortin' thriller, tense with mystery, crowded with exciting, puzzling action. Just the kind of crime mystery that will bring you keen, intriguing, mind-exercising recreation—just the kind thousands of people gladly buy at \$2.00 per in bookstores! And it will cost you—not \$2.00—but only 25c. For example, the September COM-

"I threatened to shoot, but she only laughed and laughed." Illustration from "THE JEKYLL-HYDE MURDER CASE" in the September COMPLETE DETECTIVE NOVEL.



COMPLETE DETECTIVE NOVEL, now on sale, contains

### "THE JEKYLL-HYDE MURDER CASE"

by that internationally famous master of crime literature, Madelon St. Denis.

In this story the great girl sleuth, Tam O'Shanter, faces the most baffling case of her career when she attempts to solve the murder of the beautiful Leslie Carew, social leader and drug addict.

Seven astounding clues to the murderer lie near the denuded body. The evidence points to seven possible suspects. Yet only a genius could have discovered the true murderer. Can you? Try it in this new great Tam O'Shanter mystery.

COMPLETE DETECTIVE NOVEL MAGAZINE is such a bargain at 25c that newsstands quickly sell out. BUY YOUR COPY TODAY!

"Calhoun dead! Murdered—almost under her very eyes! Who? How? Why this second murder?" Read the September COMPLETE DETECTIVE NOVEL.

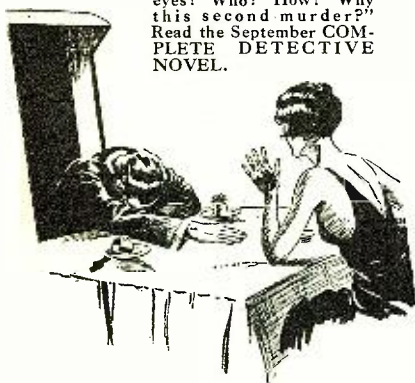

COMPLETE  
**DETECTIVE  
NOVEL**  
MAGAZINE

**NOW on Sale -:- Buy It TODAY!**

## Broadcast Super

(Continued from page 281)

- L1-2—Special coils wound on 1½-inch bakelite forms.
- L3-4-5—Special coils wound and slipped on 1-inch bakelite forms.
- L6-7-8-9-10-11-12—Silver-Marshall long-wave radio-frequency chokes.
- R1—3,000-ohm Electrad potentiometer.
- R2—25,000-ohm Electrad grid leak.
- R3-4-5—Electrad grid bias resistors, 500 ohms.
- R6—Electrad 100,000-ohm grid leak.\*
- R7-9-10—Special Loftin-White 45 arm. Electrad.\*
- R8—200-ohm potentiometer, Electrad.\*
- R11—25,000-ohm Electrad grid leak.\*
- R12—100,000-ohm Electrad grid leak.\*
- R13—20,000-ohm 50-watt Electrad resistor, Truvolt type. Two sliding taps.
- T1—Power transformer, Todd.\*
- Ch1—Amertran 854 choke.
- 5 1" angles, brass, for mounting coils.
- 1 double drum dial, Pilot.
- Electrad grid leak mounts for R2, R6, R11, R12.

Hardware, screws, etc.

Aluminum and channel material, etc.

½ pound No. 28 double silk-covered wire.

Parts marked \* not used if commercial amplifier is used.

Next month the reader will be given full instructions for winding the coils, manner of assembly and wiring the receiver, as well as full data on its operation.

The transformer for use in the power supply-amplifier unit may be of any make that conforms to the following specifications:

- Primary—110 volts.
- Secondary—900 volts, centre tapped, 75 milliamperes.
- Secondary—2.5 volts, 12 amperes.
- Secondary—2.5 volts, 3 amperes.
- Secondary—5 volts, 3 amperes.

## The Experimenter

(Continued from page 250)

described. For example, several sockets may be parallel in order that various types of tubes may be tested, or connections may be added to make it possible to test screen-grid tubes.

### PARTS LIST

- C1, C7—Variable condensers, .000125 mfd.
- C2, C3, C4, C5—Fixed condensers, .5 mfd.
- C6—Fixed condenser, .00025 mfd.
- D8—Fixed condenser, .006 mfd.
- L1—Special resistor, National.
- L2, L3—Short-wave coils, plug-in type, National.
- L4—Choke coil, National No. 90.
- R1, R2—Amperite 622.
- R2—Replaced with tapped resistor.
- R3—Amperite 01A.
- R4—Grid leak, 6 to 10 megohms.
- R5—Variable resistor, 10,000 ohms.
- V1, V2—Type -22 tubes.
- V3—Type -12A tube.
- SW—Single-circuit battery switch.

# Radio News S-W Superheterodyne

(Continued from page 256)

Carter tube shields are used on T1, T3, T4 and T9.

The filters, L5 and L6, and the two intermediate transformers, L6-L6 and L6-L6, as well as the long-wave oscillator coils, L3 and L4, are shielded in Mershon condenser cans.

The base mounting is a piece of aluminum 9" x 22" x 1/8" thick. Eby tube sockets are used throughout, eleven of them being required, nine for the tubes and two for coil bases for L, in one socket and L1 and L2 in the other. L, L1 and L2 are wound on Silver-Marshall type 130-P coil forms, L1 and L2 being wound on the same form. L is the first detector tuning inductance. L1 is the short-wave oscillator secondary tuning inductance and L2 is the tickler inductance.

Particular attention is directed to the method of coupling the short-wave oscillator to the first detector. This does away with an inductance and possibly two, yet the amount of energy from the oscillator to the first detector can be increased or decreased at will simply by changing the value of the resistor coupling, R3. By decreasing the resistance the coupling is increased, and by increasing the resistance the coupling is decreased. It is not at all critical within wide limits. One very desirable feature about this method of coupling is that there is no tendency for the oscillator to "drag" the detector tuning all over the dial or vice versa. On weak signals (which I have yet to find) the coupling resistor may be increased to about 500,000 ohms, but such a condition is something yet to be tried on this receiver. No signal heard has been sufficiently weak to permit the use of full volume on a speaker without causing a

rift in the affairs of domestic relations.

The case is made of 1/16" thick aluminum, black sheridize finish. Instead of using a regular phone plug jack, two Yaxley phone tip connectors are used in the output to the speaker.

The first screen-grid tube, acting as the untuned stage, is more to sharpen up the detector tuning, yet there is an appreciable gain in signal strength with this tube in the circuit. A choke, Aero type C-60, may be used in place of the grid leak resistor, R.

## Resistance-Coupled Amplifier Units

Stevens Manufacturing Corporation, Newark, N. J., has developed a new line of resistance-coupled amplifiers which are now available in several types, ranging from a simple 3-tube chassis with single

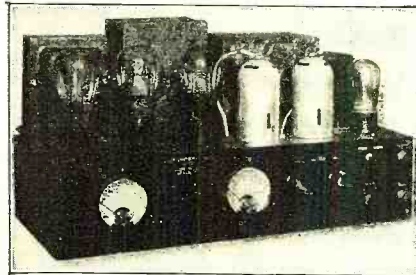

-45 type power tube in elaborate units with two -45 type power tubes in push-pull, preceded by two screen-grid tubes and a single three-element tube, including meters and controls if desired.

Ten Dollars for a "Lab" Photograph!

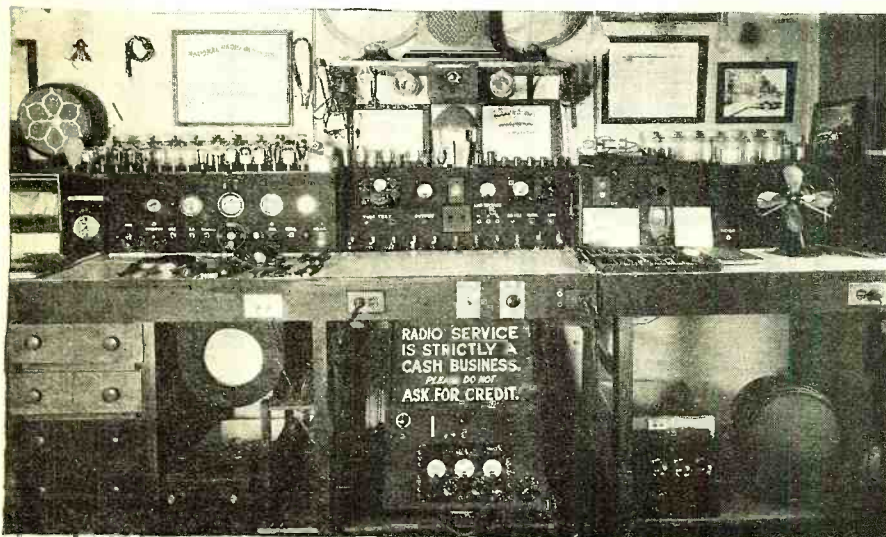

The photograph above, which was submitted by the Radio Service Company, Cleveland, Tennessee, shows a neat, orderly and complete test bench for servicing radio receivers. A photograph of the company's service car appears in the upper right-hand corner. RADIO NEWS will pay \$10 for similar photographs accepted for publication which are submitted by bona fide service men

## EXCELLO Radio Consoles



Model R171

An example of the superlative art of Excello Radio both in appearance and performance.

This genuine screen grid radio with dynamic speaker and phonograph combination perfectly meets the highest standards of program recreation.

Excello Radio Means Excellent Reproduction.

Write for free illustrated catalog of complete line—Excello Radio, Radio-Phonograph Combinations and Radio Consoles.

EXCELLO PRODUCTS CORPORATION  
4832 West 16th St., Cicero, Illinois

## WORLD-WIDE SHORT WAVE RECEIVE

ONLY \$6.45

Span the World with this Set!

A new radio thrill for you! Listen in DIRECT to London, Paris, Berlin, Buenos Aires and other broadcasting stations throughout the world via short waves. Enjoy unique foreign programs from strange lands. Your ordinary receiver cannot tune in these low wave stations. WORLD-WIDE RECEIVER gets 14 to 550 meter stations with surprising clarity. SEND NO MONEY! Just write your name and address on a postcard and ask us to send you this wonderful guaranteed short wave set. Pay postman \$6.45 plus a small delivery charge. Write today!

CHAS. HOODWIN CO.  
4240 Lincoln Ave., Dept. J-30, CHICAGO

## "Dependable 'B' Battery Power"

For long and short wave receivers. Prices reasonable. Also "B" batteries operating from 32 to 110 volt D. C. farm lighting systems.

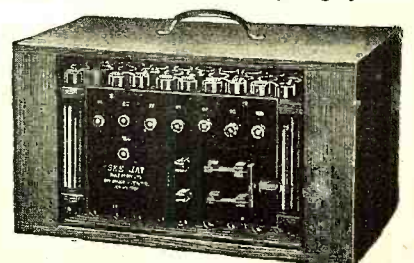

Write for our free interesting booklet. See Jay Battery Co., 911 Brook Ave., N. Y. C.

## Read Classified Advertising—It Pays!!!

Advertisements in this section twenty-six cents a word for each insertion. Name and address must be included at the above rate. Cash should accompany all classified advertisements unless placed by an accredited advertising agency. No advertisements for less than 10 words accepted. Objectionable or misleading advertisements not accepted. Advertisements for these columns should reach us not later than 1st of 2nd month preceding issue.

### Agents Wanted

Guaranteed Genuine Gold Leaf Letters anyone can put on store windows. Large profits, enormous demand. Free samples. Metallic Letter Co., 422 N. Clark, Chicago.

### Business Opportunities

**A SPLENDID SIDE LINE**—We sell pass books, check covers, coin bags, etc., mainly to banks. They are centrally located and do business quickly. Little time is lost. Our samples are light, compact, easily carried. Sales run into money, items repeat well, commission is liberal, and all of advertising novelties for merchants. Our quality is good, the variety extensive, the styles interesting. Line is big enough to devote your whole time if you wish. We are manufacturers, own our buildings, been in business sixteen years, ship to every State. Eighteen thousand banks have bought from us. You could work wherever you happen to be. Correspondence invited. Continental Bank-Supply Co., Mexico, Mo.

**AMAZING New Invention!** Screw-Holding Screw Drivers! Remove, insert screws inaccessible places! Factories, garages, electricians, auto, radio owners buy on sight! Exclusive territory. Free trial! Tooleo, 1645 Water St., Boston.

**Amateur Cartoonists:** Sell your cartoons, new plan. Smith's Service, EX1194, Venetia, Wash.

### Code

**RADIO and TELEGRAPHY** at home with Automatic Omnigraph. Has helped thousands. On land, sea and air. Teaches you easily and quickly. \$17-\$25. Catalog: The Omnigraph Mfg. Co., 810 E. 39th St., N-6, Brooklyn, N. Y.

### Correspondence Courses

Used correspondence school courses sold on repurchase basis. Also rented and exchanged. Money-back guarantee. Catalog free. (Courses bought.) Lee Mountain, Pisgah, Alabama.

**CORRESPONDENCE COURSES**—Sold, Bought, Exchanged, Rented, Bargain Catalogue Free. Handing, C-799 Broadway, New York.

### Help Wanted—Male—Instruction

**Detectives—Earn Big Money.** Experience unnecessary. Write. American Detective System, 2190K Broadway, N. Y.

## IN AMAZING STORIES for September

**"The Troglodytes,"** by Fred M. Barclay. Just now the daily papers are making much of the Carlsbad Cave, which has recently been discovered. Already the explorers have penetrated within 600 feet below the surface. Marvelous discoveries have been made. But the exploration continues. Who can tell what wonders greater depths might reveal. In "The Troglodytes" our new author goes deeper than the explorers and pictures in an absorbing manner many untold possibilities.

**"Free Energy,"** by Harl Vincent. Power is generated now by rotating armatures of dynamos in an electric field. But earth is rotating like a gigantic armature. Electricity is everywhere in the air. Why could we not capture some of this power which circulates so freely all about us and put it to use for our own purposes? Mr. Vincent gives us some very ingenious new ideas in good scientific fiction form.

**"The Translation of John Forsythe,"** by Edmund W. Putnam. When you stop to think of it, is there any really good reason why we should assume that we are the only living beings—that there is nothing beyond our vision? We can't find any. Our new author, having thought about the subject, has woven a fascinating short story around this idea.

**"The Passing Star,"** by Isaac R. Nathanson. Once more this author comes forward with a short story of undisputed excellence in the field of scientific fiction. What does happen to shooting stars, etc.?

**"Skylark Three"** (A Serial in three parts). Part II, by Edward Elmer Smith, Ph.D. After the Skylark is successfully launched in intergalactic space, adventures aplenty hold sway. We strongly advise a deep breath before beginning this instalment.

**"The Inferiority Complex,"** by Miles J. Breuer, M.D. Crowded out of July issue.

## EX-STAT Ignition Filter Systems

For Auto Radio. Easy to install on any car—permits use of car battery for radio. Standard kits for 4 (\$7.00 list), 6 (\$8.50 list), 8 (\$12.00 list) cylinder motors, containing spark plug suppressors, ignition filter and 2 filter condensers. Approved by laboratories of Radio News and leading radio manufacturers. Write Dept. RN-9 for free circular.

TILTON MANUFACTURING CO.  
15 East 26th St. New York, N. Y.

### Inventions

**INVENTIONS WANTED**—Patented, Unpatented. If you have an idea for sale write, Hartley, Box 928, Bangor, Maine.

### Male Help Wanted

**GET outdoor government jobs;** \$135-\$200 month; vacation. Patrol forests and parks; protect game. Details free. Write, DELMAR INSTITUTE, B. 31, Denver, Colo.

### Miscellaneous

**Let's Swap!** What's a got? What d'ye want? Dime Trial, Swap Bulletin, Detroit.

### Patent Attorneys

**PATENTS**—Write for Free Instructions. Send Drawing or Model for Examination. Miller & Miller, Registered Patent Attorneys (former Patent Office Examiners), 262 McGill Building, Washington, D. C.

**Inventors**—Should write for our Guide Book, "How to Obtain a Patent" and Record of Invention Blank, sent free. Send model or sketch of inventions for our inspection and instructions free. Radio, Electrical, Chemical, Mechanical and Trademark Experts. Terms Reasonable. Victor J. Evans & Co., 922 Ninth, Washington, D. C.

**Patents**—Advice and booklet free. Highest references. Best results. Promptness assured. Watson E. Coleman, Patent Lawyer, 724 9th Street, Washington, D. C.

### Radio

**Wanted**—Men to work with National Radio Service organization. No selling scheme. Radio Doctors, Inc., Dept. N, Essex St., Salem, Mass.

### Salesmen

**SELL PRINTING**—Make good money. Koehler Printing Co., 9032 Windom, St. Louis, Mo.

### Songwriters

**COMPOSERS—VERSE OR MUSIC.** Brilliant opportunity. Write at once. Van Buren, 2111 McClurg Bldg., Chicago.

### Telegraphy

**Learn Morse and wireless telegraphy.** Big salaries. Tremendous demand. Expenses low, can earn part. Catalog free. Dodge's Institute, Cour Street, Valparaiso, Indiana.

## A GENUINE 240 POWER MICROSCOPE!

Sent for Only \$100 DOWN

An educational and entertaining instrument that enables all to see and know life invisible to the naked eye. Thrills and fun galore! See tiny bugs grow to proportions of great elephants. See plant and mineral life reveal amazing wonders in form and color. Made just like microscopes used by physicians, scientists, etc. Now only \$3.98. Could easily sell for \$10 and \$20 more. Adjustable lens of 240 power! Send only \$1.00. Pay balance (\$2.98 plus tax) when postman delivers. If not satisfied return within 5 days and your money will be promptly refunded.

### Ideal for Students!

A wonderful help in studying science, botany, etc. Never before has such a wonderful instrument been offered at the amazing low price of \$3.98.

**DEALERS AND TEACHERS FOR WIFE PROPOSITION!**

**R. B. SPECIALTY COMPANY**  
Dept. K-340, 220 E. 3rd St., Cincinnati, O.

## QUIT TOBACCO

Don't try to banish unaided the hold tobacco has upon you. Thousands of inveterate tobacco users have, with the aid of the Keeley Treatment, found it easy to quit.

**KEELEY TREATMENT FOR TOBACCO HABIT** Quickly banishes craving for tobacco. Successful for over 50 years. Write today for FREE BOOK and particulars of our MONEY-BACK GUARANTEE.

**THE KEELEY INSTITUTE, Dept. L-607, Dwight, Ill.**  
Home of the famous Keeley Treatment for Liquor and Drugs. Booklet Sent on Request. Correspondence Strictly Confidential.

## U. S. NAVY SURPLUS

General Electric 24/750-volt 150-watt Dynamotors	..... \$27.50
General Electric 24/1500-volt 350-watt Dynamotors	..... 37.50
500-watt 500-cycle generators with exciters	..... 7.50
Westinghouse 6-15 V 500-watt	..... 15.00
Westinghouse 27.5/350-volt 80 mills	..... 12.50
Twins for double voltage or current	..... 20.00

Shafts for external drive \$3.00 additional.

**HENRY KIENZLE, 501 E. 84th Street, N. Y.**  
Pioneer Distributor of Government Surplus  
Complete list on request

## MASON, FENWICK & LAWRENCE PATENT LAWYERS

600 F St., N. W., Washington, D. C.

*Estb. over sixty years. Send sketches.*  
Electrical, Aeronautical and Chemical Inventions carefully handled. Practice before the U. S. Courts and the Patent Office. Prompt and careful service. Write us. Protect your inventions.

**TRADE MARKS REGISTERED**

## A Communication from Scotland

Short-Wave Editor, RADIO NEWS, Sir:

At the invitation of Mr. H. Drewett, Haverhill, Mass., I write you a few lines. Perhaps you are aware that I have been in communication with Mr. Drewett for some time. We were drawn together by the common bond of short-waveitis, which I am afraid is a disease now incurable. Mr. Drewett's splendid achievements in picking up G5SW short-wave station has drawn my admiration, owing to the unflinching regularity with which he has tuned this station in.

I have also had constant reception from short-wave stations in United States, Mexico and South America, as well as Australia, Java, Africa and the Byrd Expedition at the Antarctic, the S.S. *City of New York*.

The receiver I used at my point is a simple one of the plug-in adapter type, two tubes, simple regenerator with one tube acting as a reactor or signal booster, not an r.f., as commonly known. It can be joined to the audio-frequency side of my broadcast set by an adapter which plugs into the detector socket by removing the detector and plugging in a three-pin adapter to pick off the filament and plate circuits. The reactor tube is supplied with plate potential through a short-wave radio-frequency choke. The tubes used are of the British Cossor make, two-volt, 1/10 ampere, with 120 volts on the plate of the reactor and 80 volts on the detector. The American station W2XAD at 19.56 meters is by far the Saturn from U. S. A. and I can say without exaggeration that I have been able to follow every word spoken by him up to 150 feet distant from the loud speaker.

What I look upon as the best reception I obtained was the broadcast of the landing of the *Graf Zeppelin* at Los Angeles on her world tour from W2XAD at Schenectady. Next in order of merit comes W2XAL of Cincinnati, who came across the Atlantic on 49.5 meters with the welcome to Mr. Ramsay MacDonald in New York. Every word of the reception reached here splendidly.

Wishing you and the many short-wave American enthusiasts the best of luck, I am

C. J. McLOUGHLIN,  
Brechin, Airgers,  
Scotland.

## D.C. Receiver

Dealers and consumers living in sections where the electrical supply is direct current will be glad to know that a special all-electric radio for operation on direct current is now available from Pierce-Airo, Inc., 117 Fourth Ave., New York. These sets have specially designed selected control tuning, double push-pull amplification, triple screen-grid tubes, humless filter circuit, novel non-glare metal drum dial, completely shielded r.f. assembly, special bridge circuit compensated antenna, automatic phonograph attachment.

# RADIO NEWS Radio Association

## A Shortwave Club Open to All

**B**ELIEVING as we do that much is yet to be done in the matter of educating experimenters and those who would know more about the intricacies of shortwave transmission and reception, RADIO NEWS magazine has formed a club, the Radio News Radio Association, so that by actual experience more fellows may become initiated into this amazingly interesting work.

At present our plans include the erection of a transmitter, so that those who become members may have the activities of the club sessions brought to them via short waves.

The organization of the Club is being completed rapidly and if you are interested write to: Secretary, Radio News Radio Association, 381 4th Avenue, New York City.

## Dr. De Forest Designs the Anti-Ad

(Continued from page 215)

spot at the shadow-box on the Anti-Ad and presto! the relay operates. the antenna is cut off and our friend Mr. Radio Advertiser is talking into empty space, as he should be.

It is not necessary to hold the spotlight focused on the selenium cell throughout the desired period of interruption of radio set because attached to the relay is a time lag device which permits the relay to return to contact only after a definite period of delay. The duration of this period of delay is adjustable by means of the knob and dial on top of the Anti-Ad which is calibrated in seconds. Thus, for example, if the radio listener knows that the "Third Strike Cigarette" announcer invariably talks for 20 or 30 or 45 seconds before permitting his excellent orchestra to resume their work, she can at the opening of the "Third Strike" program set the dial to say 40 seconds. Then when the announcer begins to tell the health benefits of his cigarette she gives one quick flash of her spotlight onto the Anti-Ad and can resume her reading in peace of mind, knowing that at the end of the 40 seconds the relay device will be released and the program will go on. It is possible that she may miss a few bars of the selection or possibly, if the advertiser is unusually windy, she may catch a few final words of his speech, but the peace of mind of

the radio listener will be immeasurably conserved.

In using the Anti-Ad one experiences a new joy not unlike that which one would experience in shooting a noisy tom-cat on the top of a back fence on a moonlight night and thus terminating the awful cat-erwaul. It is infinitely more satisfactory to recline in your easy-chair and kill the announcer with the simple flash of light than it is to get up, walk across the room and throw the radio switch.

The Anti-Ad adds to real radio enjoyment and greatly extends the number of hours throughout the month when the radio set is in operation. It should therefore be received with open arms by the entire radio industry.

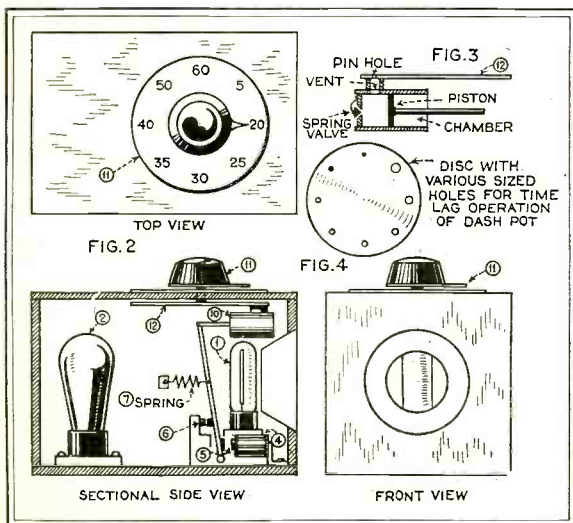
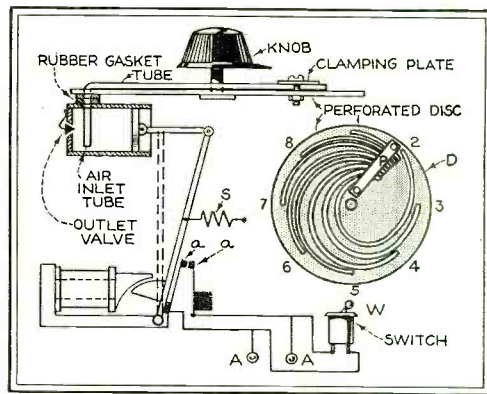

To the left are given the details for constructing the De Forest Anti-Ad, a device for automatically disconnecting the antenna for a prearranged time interval. Above is shown an alternative method of obtaining the time lag operation by means of various length pieces of tubing

## SENSATIONAL NEW AERIAL Assures Improved Radio Reception!



Patents Pending  
The World's Smallest Aerial  
**NON-DIRECTIONAL—NON-CORROSIVE**  
It Will Never Wear Out

In less than a year this amazing new invention—the WELLSTON GOLD TEST AERIAL—has conclusively demonstrated, in the homes of thousands of radio owners throughout the country, that it IMPROVES radio reception and eliminates not only all cumbersome present type aerials, but also many of the annoying noises so common in the average radio set.

**EASY TO INSTALL**  
It is a simple matter to install the Wellston Gold Test Aerial—even a child can do it in less than a minute's time. No extra tools are needed. Place it anywhere. Once installed no further attention is required. It is fully efficient at all times.

**A FILTERED TYPE AERIAL**  
The Wellston Gold Test Aerial is a filtered type aerial. It has a capacity equivalent to 54 feet of aerial wire, 50 feet high in free air. This small, compact aerial—it measures but 2½ by 5 inches in size—contains gold plated wire. It is non-directional, non-corrosive and will never have to be replaced. The Wellston Gold Test Aerial does away with all lightning hazards and because it does not connect into a light socket all AC hum and line noise are eliminated. Not fully efficient on battery sets.

For Sale by All Leading Radio Dealers Everywhere

**Price \$2.50**

Avoid Imitations and Substitutes

**WELLSTON RADIO CORP.**

Dept. O. T.

St. Louis, Mo.

## The Radio Construction Library

[Latest Data on Radio Receivers for the Dealer, Serviceman and Amateur]

WRITTEN by two widely known radio engineers, these three books cover every phase of building, repairing and "trouble-shooting" on modern receiving sets. This practical Library includes: **PRACTICAL RADIO**—The fundamental principles of radio, presented in an understandable manner. Illustrated with working diagrams. **PRACTICAL RADIO CONSTRUCTION AND REPAIR**—Methods of locating trouble and reception faults, and making workmanlike repairs. Discusses modern Short Wave Receivers fully. **RADIO RECEIVING TUBES**—Principles underlying the operation of all vacuum tubes and their use in reception, amplification, remote control and precision measurements.

Three Volumes, 6 x 9—993 pages, 561 illustrations.

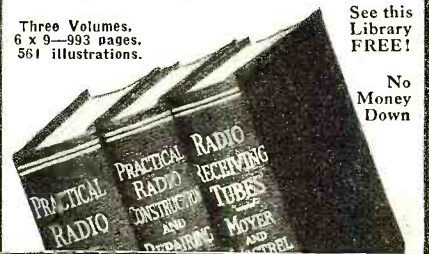

See this Library FREE!

No Money Down

**McGraw-Hill**  
**FREE EXAMINATION COUPON**

McGraw-Hill Book Company, Inc.  
370 Seventh Avenue, New York

Send me the new RADIO CONSTRUCTION LIBRARY, three volumes, for 10 days' free examination. If satisfactory I will send \$1.50 in ten days, and \$2.00 a month until \$7.50 has been paid. If not wanted I will return the books postpaid.

Name .....  
Home Address .....  
City and State .....  
Position .....  
Name of Company..... R. N. 9-30



As perfect as science can make it »»»» »»»» this new and improved

# TRIAD T-224 TUBE



Long hours of constant research, combined with the finest engineering skill obtainable, have brought to this improved TRIAD T-224 tube a far more rigid construction which practically eliminates micro-

phonics and burn-outs. A new and startlingly realistic tonal quality is the result — super-clear and undistorted. Make your own test of this remarkable new tube—in your own set—you'll appreciate its better performance *instantly!*

TRIADS are now manufactured under R. C. A., G. E. and Westinghouse patents. TRIAD MFG. CO., Inc. Pawtucket, R. I.

# TRIAD RADIO TUBES

## INDEX TO ADVERTISERS

<b>A</b>	
Acme Wire Co. ....	280
Allied Radio Corp. ....	288
American Sales Co. ....	275
Amperite Corp. ....	274
Amplex Instrument Laboratories	280
Anrad Corp. ....	277
Automatic Radio Mfg. Co. ....	271
<b>B</b>	
Baltimore Radio Co. ....	270
Blanch the Radio Man	274
<b>C</b>	
Cardwell Mfg. Corp., The Allen D. ....	269
Central Radio Laboratories	266
Champion Radio Works. .... Inside Back Cover	
Chicago Radio Apparatus Co. ....	273
Clarostat Mfg. Co. ....	272
Classified Advertising	284
Conn., Ltd., C. G. ....	267
Cornish Wire	287
Coyne Electrical School	Back Cover
Crosley Radio Corp. ....	281
<b>D</b>	
DeForest Radio Co. ....	261
Dixon Radio and Electric Corp. ....	280
Doubleday, Doran & Co. ....	263
Drake, Frederick J., & Co. ....	267
Drake Hotel, The	286
<b>E</b>	
Electrad, Inc. ....	272
Excello Products Corp. ....	283
<b>F</b>	
Federated Purchaser	265
Flechtheim & Co., Inc. ....	287
<b>G</b>	
Grigsby-Grunow	264
<b>H</b>	
Hammarlund Mfg. Co. ....	275
High Frequency Labs. ....	280
Hoodwin Co., Chas. ....	275-283
<b>I</b>	
International Resistance Co. ....	271
<b>J</b>	
J. M. P. Mfg. Co., Inc. ....	275
<b>K</b>	
Keeley Institute	284
Kienzle, Henry	284
<b>L</b>	
LaSalle Extension University	280
Lincoln Hotel	281
Lincoln Radio Corp. ....	269
<b>M</b>	
McGraw-Hill Book Co., Inc. ....	285
Majestic Radio Tubes	264
Mason, Fenwick & Lawrence	284
Metal Cast Products	286
Midwest Radio Corp. ....	259
<b>N</b>	
National Carbon Co., Inc. ....	257
National Co., Inc. ....	273
National Radio Institute	195
Nelson Electric Co. ....	275
<b>P</b>	
Pilot Radio & Tube Corp. ....	197
Pitman, Isaac, & Sons	272
<b>R</b>	
R. B. Specialty Co. ....	284
R. C. A. Institutes, Inc. ....	255
Racon Electric Co. ....	266
Radio Surplus Corp. ....	272
Radio & Television Institute	199
Radio Training Association of America	193
Rim Radio Mfg. Co. ....	274
Roll-O Specialty Company	280
<b>S</b>	
School of Engineering	279
See Jay Battery Co. ....	283
Shallercross Mfg. Co. ....	280
Silver Marshall, Inc. ....	281
Sprague Specialties Co. ....	267
Stuyvesant Electric Co. ....	280
Supreme Instrument Corp. .... Inside Front Cover	
<b>T</b>	
Teleplex Co. ....	275
Tilton Mfg. Co. ....	284
Triad Mfg. Co., Inc. ....	286
20th Century Mail Order Corp. ....	281
<b>U</b>	
Uron Associated Industries	281
<b>V</b>	
Vari-Tone Lab. ....	274
<b>W</b>	
Washington Hotel	273
Wellston Radio Corp. ....	285
Weston Electrical Instrument Corp. ....	268
West Sides Y. M. C. A. Radio Inst. ....	281
Wireless Egert Engineering	280
<b>Y</b>	
Yahr-Lange, Inc. ....	281
Yaxley Mfg. Co. ....	281

The Crossroads of a Nation  
 THE DRAKE is admittedly one of the great hotels of the world... the stopping place of seasoned travelers. Rooms are spacious and smartly elegant continental in atmosphere. Available, also is an experienced Travel Bureau to relieve you of every travel detail. Rates begin at \$5 per day. Permanent Suites at Special Discounts.

# THE DRAKE HOTEL, CHICAGO

Under Blackstone Management

"AN ADDRESS OF DISTINCTION"

### WANTED—MEN

To Manufacture METAL TOYS AND NOVELTIES

Big demand for 5 and 10c store Novelties, Ashtrays, Toy Soldiers, Animals, Auto Radiator Ornaments, etc. We co-operate in selling goods you make; also buy these from you. Small investment needed to start and we help you build up. We furnish COMPLETE OUT-FITS and start you in well paying business. Absolutely NO EXPERIENCE and no special place needed. A chance of a lifetime for man with small capital. Write AT ONCE if you mean strictly business and want to handle wholesale orders now being placed.

METAL CAST PRODUCTS COMPANY  
 Dept. 12, 1696 Boston Rd. New York City

## In SCIENCE AND INVENTION for September

*Uncle Sam's Mechanical Live Stock*—G. H. Daey tells how cows talk and pigs preach at government fair exhibits.

*Shears of Flame*—Forming presses and other heavy machines are cut automatically from heavy sheet metal by the oxy-acetylene torch process.

*How to Match the Hull, Motor and Propeller of Your Outboard*—The second article in our outboard operation series, by J. Phillips Dykes, Secretary and Rear-Commodore, American Outboard Association.

*What's New in Radio, and A Short-Wave Set* that anyone can build, for the radio fans.

*How to Build a SCOUT Secondary Glider*—The third article in Lieutenant H. A. Reynolds' and Herr Martin H. Schempp's construction series.

*Several How-to-Make-Its, Including: A Rock Garden, A Telephone Table, A Wrought and Hammered Lamp, Decorative Rustic Woodwork, A Magazine Rack, A Smoking Stand and An End Table in the Mode Moderne.*



# Motor Car Radio

(Continued from page 260)

panel. Heavy spot-light might be some what out of line as well under strain. This is caused by the construction. The lower portion of extended out about one inch, a small "front porch" upon which and controls are mounted. This extension is formed of extra heavy steel and has extension wings which fasten the chassis to the under bend of the dash with two bolts. These mounting holes and bolts, being on the under lap of the dash, do not show if perchance the set is removed to another car, and thus the question of impairing the resale value of the car is solved. The rear portion of the set case is supported by a spring especially designed to take the major road shocks and to support the weight of the case and set when extended to twice its normal length.

## Electrical Circuit

We next turned our attention to the electrical circuit improvements and more efficient by-passing. In this regard we arranged for the "B" battery load to be

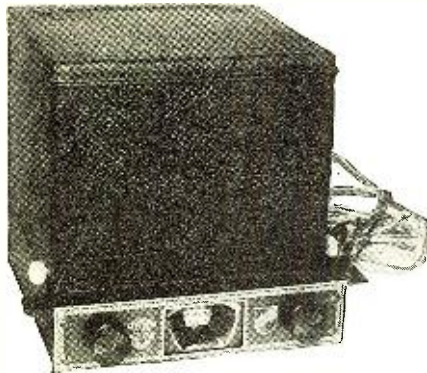

A compact, easily accessible auto-radio receiver

applied to the whole system, the various voltages required being obtained by resistance "drops" within the receiver. This, of course, has the advantage that, barring chemical breakdown, the "B" supply will go down uniformly and it will never be necessary to replace one block of "B" before the others or to discard some of the "B" blocks while still usable because of the others, or one section is lower than an allowable minimum. The total "B" drain is held down to approximately 17½ mils. The resulting "B" battery life is longer than that usually experienced on the modern battery-operated receiver. We used the heater or a.c. type tubes for the r.f. and detector because of their superior characteristics as well as their sturdy mechanical construction. We used two -24 screen-grid and one -27 with their heater filaments in series. When the car is at rest each filament is receiving a slight undervoltage and when

the generator in the car is charging, the voltage per tube is raised only a small fraction of a volt. This lower filament voltage has been compensated for in the rest of the electrical values and the time lag prevents voltage changes from effecting operation noticeably. The audio system is composed of one -12A and one -71A, transformer coupled, with their filaments in parallel with the other series of three. Thus the total drain on the car's storage battery is 2¼ amperes, which, by comparison, is less than that drawn by one 21 c.p. headlight.

## Care of Cable

In addition to the shielding precautions taken within the receiver proper, the cable to the batteries has been strip-wound with metal to armor it against mechanical abrasion. A heavily paraf-

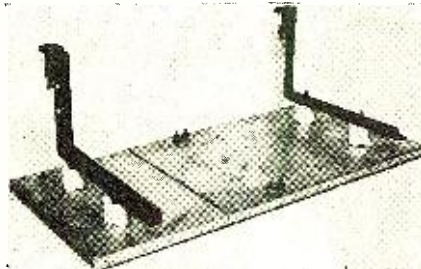

Although it doesn't look like it, this metal plate is the antenna for the auto-radio receiver. It is supported by brackets which mount underneath one of the running boards of the car

ined undersleeve prevents shorts due to the action of water or acid. Between the paraffined under-braid and the metal armor there is laid a stranded bare wire in order to effectively short-circuit each turn so that no r.f. potential difference will be set up due to the coiled conductor and no noise will result from the cable rubbing on the chassis of the car.

## Receivers Now Available

Radio in the motor car has graduated from the makeshift stage and suitable receivers that are designed for that exacting use are now available.

We did not set out to create a new device, but to adapt the well-known radio receiver to a new use. What we succeeded in doing in the last analysis is not only to make radio available for motor-car use, but to evolve a new type of set construction to fit the needs and space limitations of motor-car radio.

## Booklet on Microphones

The Universal Microphone Co., Ltd., 1163 Hyde Park Boulevard, Inglewood, California, has published a booklet on both the care and use of microphones. Mr. E. E. Griffin, chief engineer of the Universal Microphone Company, is the author of this pamphlet.

Carrying the Unqualified Endorsement of Leading Engineers

FLECHTHEIM SUPERIOR CONDENSERS ARE

"SMALLER and BETTER than ever"



Types HV and HS are unexcelled for use in Low Powered Aircraft Radio, Short Wave Receivers and Transmitters.



FLECHTHEIM has always stood for the Highest Quality in paper dielectric condensers. And as leaders in the field have continually established a precedent.

The word "BIGGER" is an antiquated and out-of-date expression when it comes to measuring up condensers, for our new types HV and HS have astounded the entire Radio field by their REMARKABLE and OUTSTANDING characteristics, among which are their SMALL SIZE and HIGH OPERATING VOLTAGE.

Flechtheim superior transmitting condensers are in use by over 50% of the broadcast stations in the U. S. A.

Catalog No. 22 Now Available

A. M. FLECHTHEIM & CO., INC., 138 Liberty St. New York City, N. Y.

**CORWICO VULCAN LIGHTNING ARRESTER**

Also Ejects Static Charges Improving Reception

The Corwico Vulcan Lightning Arrester is manufactured in accordance with a new engineering principle that protects your radio against damage from lightning and also dissipates accumulated static charges. Buy today for lightning protection and better reception.

At Your Dealer's or Direct Upon Receipt of Price.

**CORNISH WIRE**  
24 Church St. New York

MAKERS OF CORWICO BRAIDITE

# A REVELATION *in* RADIO VARIETY

**FREE**  
**68**  
**PAGE BOOK**

*Get This Catalog*

*All the Latest*  
**RADIO ATTRACTIONS**

A wonder Book of remarkable money-saving bargains—168 pages and over 500 illustrations—all your radio needs priced so low it will startle you.

The latest radio devices—the last minute improvements in sets, accessories, parts and kits.

**New 1931 Screen Grid, Tone Control  
A. C. Humless All-Electric Sets**

remote control, public address, phono-combinations, all dynamic speaker equipped. Beautiful Consoles. Bed-rock prices and unusual values on all sets, parts and appliances.

You must have this catalog—whether owner or dealer—to tune in on the newest and greatest values in radio merchandising—made possible by the tremendous buying power of this great corporation. The catalog of catalogs. Brimful of bargain information. Money-saving values on every page. Send for it TODAY. It's FREE.

*The House of  
Outstanding Values*



Sets, Parts,  
Kits and  
Everything  
in Radio

**ALLIED RADIO CORPORATION**

**711 W. Lake Street Dept. B Chicago**

Resources  
Over  
Three  
Million



# Don't Argue!

**A**RGUMENTS get you nothing but trouble and headaches. Remember, "the customer is always right" . . . that is, up to a certain point. Ribbon Labels for Dating establish what that point is . . . definitely . . . equitably . . . satisfactorily. They are furnished with every Champion Tube. Simply fill in date of sale. The customer is protected to the full extent of the guarantee. The dealer is protected against unfair claims for adjustment. No more arguments! No more trouble! No more headaches! And everybody's happy!"

# Champion

**RADIO TUBES**

CHAMPION RADIO WORKS, INC., DANVERS, MASS.

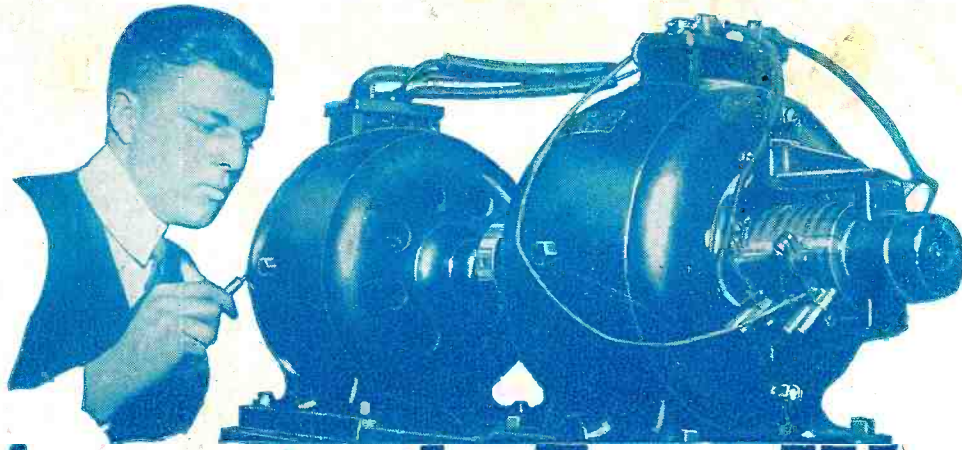

# Amazingly Easy Way to get into **ELECTRICITY**

Don't spend your life waiting for \$5 raises in a dull, hopeless job. Now . . . and forever . . . say good-bye to 25 and 35 dollars a week. Let me show you how to qualify for jobs leading to salaries of \$50, \$60 and up, a week, in Electricity —NOT by correspondence, but by an amazing way to teach, **RIGHT HERE IN THE GREAT COYNE SHOPS.** You become a practical expert in 90 days! Getting into Electricity is far easier than you imagine!

## Learn Without Lessons in **90 DAYS** By Actual Work—in the Great Shops of Coyne

Lack of experience—age, or advanced education bars no one. I don't care if you don't know an armature from an air brake—I don't expect you to! I don't care if you're 16 years old or 48—it makes no difference! Don't let lack of money stop you. Most of the men at Coyne have no more money than you have.

### Railroad Fare Allowed

I will allow your railroad fare to Chicago, and if you should need part-time work I'll assist you to it. Then, in 12 brief weeks, in the great roaring shops of Coyne, I train you as you never dreamed you could be trained on a gigantic outlay of electrical apparatus . . . costing hundreds of thousands of dollars . . . real dynamos, engines, power plants, autos, switchboards, transmitting stations . . . everything from doorbells to farm power and lighting . . . full-sized . . . in full operation every day!

### No Books—No Printed Lessons

No books, no baffling charts . . . all real actual work . . . right here in the great Coyne school . . . building



### Prepare for Jobs Like These

Here are a few of hundreds of positions open to Coyne-trained men. Our free employment bureau gives you lifetime employment service.  
 Armature Expert, to \$100 a Wk.  
 Substation Operator \$50 a Week and up  
 Auto Electrician \$110 a Week  
 Inventor . . . . . Unlimited  
 Maintenance Engineer up to \$150 a Week  
 Service Station Owner up to \$200 a Week  
 Radio Expert up to \$100 a Week

real batteries . . . winding real armatures, operating real motors, dynamos and generators, wiring houses, etc., etc. That's a glimpse of how we make you a master practical electrician in 90 days, teaching you far more than the average ordinary electrician ever knows and fitting you to step into jobs leading to big pay immediately after graduation. Here, in this world-famous *Parent school*—and nowhere else in the world—can you get this training!

### Jobs—Pay—Future

Don't worry about a job, Coyne training settles the job question for life. Demand for Coyne men often exceeds the supply. Our

employment bureau gives you a lifetime service. Two weeks after graduation, Clyde F. Hart got a position as electrician for the Great Western Railroad at over \$100 a week. That's not unusual. We can point to Coyne men making up to \$600 a month. \$60 a week is only the beginning of your opportunity. You can go into radio, battery, or automotive electrical business for yourself and make up to \$15,000 a year.

### GET THE FACTS

Coyne is your one great chance to get into electricity. Every obstacle is removed. This school is 30 years old—Coyne training is tested—proven beyond all doubt—endorsed by many large electrical concerns. You can find out everything absolutely free. Simply mail the coupon and let me send you the big, free Coyne book of 150 photographs . . . facts . . . jobs . . . salaries . . . opportunities. Tells you how many earn expenses while training and how we assist our graduates in the field. This does not obligate you. So act at once. Just mail coupon.



### Get This FREE Book

Mr. H. C. LEWIS, President  
**COYNE ELECTRICAL SCHOOL, Dept. 60-27**  
 500 S. Paulina St., Chicago, Ill.

Dear Mr. Lewis:  
 Without obligation send me your big free catalog and all details of Railroad Fare to Chicago, Free Employment Service, Radio, Aviation Electricity, and Automotive Courses, and how I can "earn while learning."

Name . . . . .  
 Address . . . . .  
 City . . . . . State . . . . .



### Now in Our New Home

This is our new, fire-proof, modern home wherein is installed thousands of dollars' worth of the newest and most modern Electrical Equipment of all kinds. Every comfort and convenience has been arranged to make you happy and contented during your training.

**COYNE ELECTRICAL SCHOOL**  
 H. C. LEWIS, Pres. **Established 1899**  
 500 S. Paulina Street • Dept. 60-27 • Chicago, Illinois