

RADIO'S GREATEST MAGAZINE

RADIO NEWS

JUNE
25 Cents

Over 200
Illustrations



BROADCAST STATIONS
WRNY W2XAL

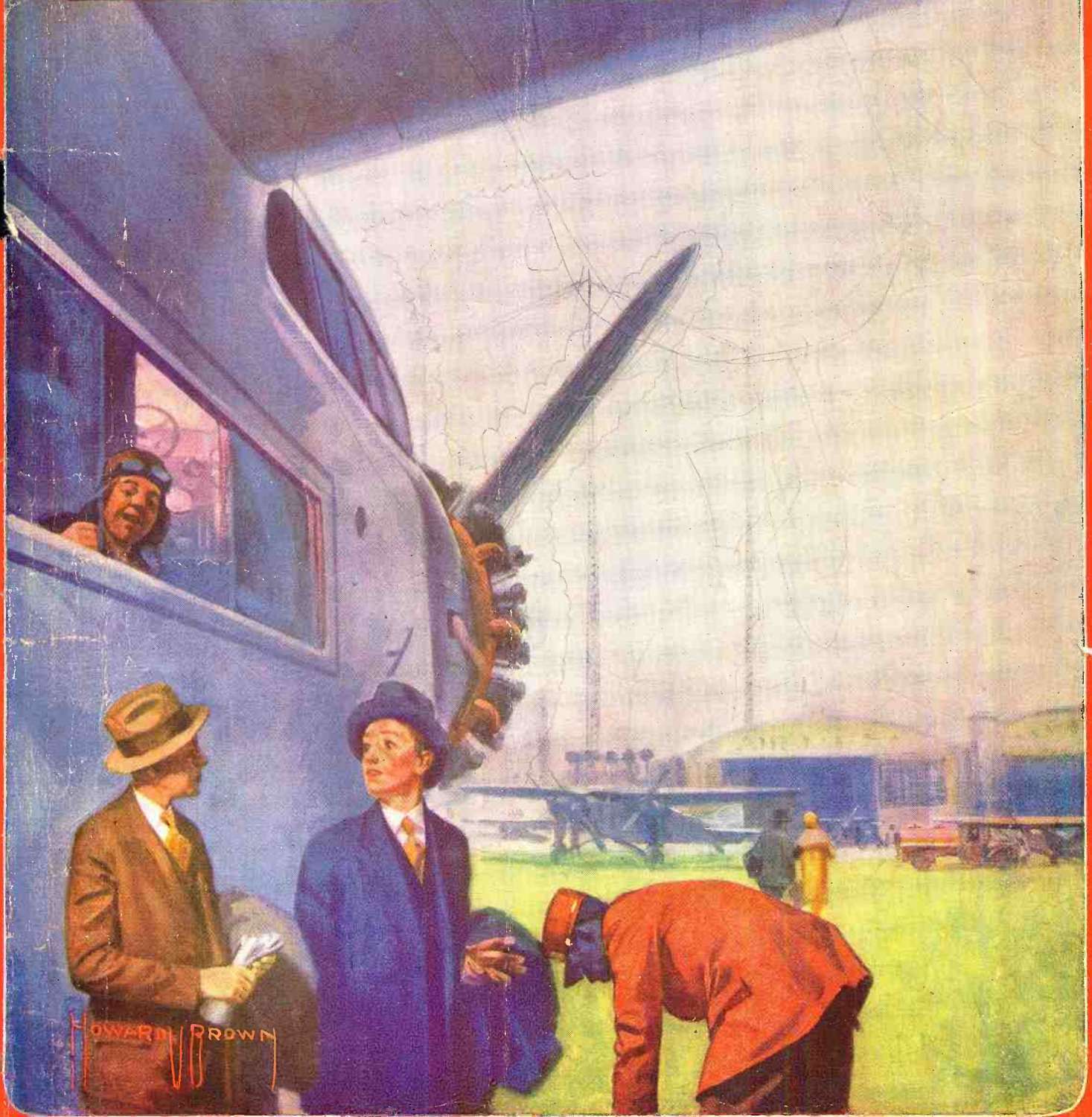

On Time Through the Fog

EXPERIMENTAL PUBLISHING COMPANY 230 FIFTH AVENUE, NEW YORK

www.americanradiohistory.com

TELEVISION

RADIOVISION



Patents Applied for

Model 400A

What the SUPREME Diagnometer Will Do

In addition to providing plate voltage readings, grid bias readings, filament voltage readings, and plate current readings, the Supreme Diagnometer 400A provides oscillation tests of tubes—the best known method of showing normal, subnormal and abnormal tubes. Gives direct full output readings of filament rectifiers. Tests screen grid tubes. Makes continuity tests without use of external batteries. Contains modulated radiator which takes place of broadcast stations for testing, and also furnishes signal for neutralizing and oscillator for synchronizing condensers, giving meter dip and speaker click at resonance. Has heavy duty rejuvenator. Bridges open stages of audio, alters outputs, tests fixed condensers, contains stages of audio, fixed capacities, 500,000-ohm variable resistance and 30-ohm rheostat. All meters and apparatus available for external use.

Absolute Accuracy Assured

Three Weston Meters and Supreme engineering, combined with the finest of materials and workmanship, insure absolute accuracy. A Voltmeter of three scales, 0-10-100-600, 1,000 ohms per volt; a Milliammeter of 125 mills and 2½ amps; and an A.C. Voltmeter, three large scales of 0-3-15-150, are built into the Supreme test panel and are housed in Bakelite cases.

All instruments are manufactured for 110 volts and 50-60 cycles. Instruments of other frequencies can be furnished special at slight increase in price.

Be Sure
to Visit Our
Exhibit
R. M. A.
Show
Chicago
June 3rd to 7th
inclusive

It has Revolutionized Radio Service

This complete, portable radio laboratory is the sensation of the radio industry

AMERICA'S foremost authorities have proclaimed the SUPREME DIAGNOMETER to be the greatest contribution to radio service since the inception of radio. The day of hit-and-miss service methods supplemented by a few service meter readings has passed. Set owners are demanding scientific, accurate, meter readings has passed. Set owners are demanding scientific, accurate, service and the SUPREME DIAGNOMETER offers the only practical, convenient, proved means of giving such service.

Do not confuse the SUPREME DIAGNOMETER with set testers. The Supreme is a complete portable radio laboratory that not only will provide plate voltage, grid bias, plate current, and filament voltage readings (which is the limit of the most elaborate set testers), but offers all the elasticity and range of the most expensive stationary laboratory equipment.

It is impossible to describe here all the functions of the Supreme, for its possibilities and flexibility are almost limitless. Practical tests have proved that one man with a Supreme can do the work of three with old-fashioned methods, and attain an accuracy otherwise impossible. Supreme League members everywhere report big increases in earnings.

Yet the Supreme is simple to understand and operate. Its brass-bound carrying case measures only 18x10½x7 inches, and complete with the Diagnometer weighs only 25 lbs. The case contains ample and easily accessible compartments for carrying all necessary adapters and tools. A cushioned tube shelf that affords absolute protection for extra tubes is included. The instrument can be removed from carrying case for shop use.

Look for the Sign of Efficient Radio Service



Radio Owners: Look for this emblem in your radio shop or on the button worn or card carried by your service man. It is your guarantee of dependable service.

Prices and Terms

SUPREME DIAGNOMETERS may be chased either for cash or on the time-payment plan. Under our deferred payment plan, 400A can be purchased for \$38.50 cash trade acceptances (installment notes) of each, due monthly. Cash price, \$124.65. All net F.O.B. Greenwood. No dealers' discount.

Send No Money

Thousands of owners attest to the superiority of the SUPREME. Prove its value to you using it six days in actual service work, let you be the sole judge. Sign and fill in six-day trial request and mail today.

Date.....

Supreme Instruments Corp.
327 Supreme Building,
Greenwood, Mississippi.

Please ship me one Model 400A SUPREME DIAGNOMETER.

Upon delivery of the instrument, I will deposit with the express agent either the cash price of \$124.65, or \$38.50 cash and 10 trade acceptances (installment notes) for \$10.00 each, due monthly, at my option, subject to the following conditions:

It is agreed that the deposit made with the express agent shall be retained by him for 8 x days. If, within that time, after testing the instrument, I am not entirely satisfied, I have the privilege of returning the instrument to the express agent in good condition, with the seal unbroken (see note below) and adapters and parts intact. Upon such return, and upon the prepayment of return express charges, the deposit I have made with the express agent will be promptly returned to me.

Signed

Firm Name

Address

City..... State.....

Please send three or more trade references including at least one bank, with this coupon

NOTE: The seal on the panel of the instrument covers the master screw in the assembly. It is never necessary to disturb this, and does not in any way prevent or restrict use of the instrument. Factory guarantee ceases with disturbance of seal.

SUPREME

Radio Diagnometer

Makes every ^{conceivable} test on any Radio Set-

5 Easy Ways to Make \$3.00 an hour in Your Spare Time in RADIO

Each of these plans, developed by the Radio Association of America, is a big money-maker. Set owners everywhere want to get rid of static, to have their sets operate from the electric light socket, the tone improved, and the volume increased, and transformed into single-dial controls. Phonograph owners want their machines electrified and radiofied. If you learn to render these services, you can easily make \$3.00 an hour for your spare time, to say nothing of the money you can make installing, servicing, repairing, building radio sets, and selling supplies.

Over \$600,000,000 is being spent yearly for sets, supplies, service. You can get your share of this business and, at the same time, fit yourself for the big-pay opportunities in Radio by joining the Association.

Join the Radio Training Association of America

A membership in the Association offers you the easiest way into Radio. It will enable you to earn \$3.00 an hour upwards in your spare time—train you to install, repair and build all kinds of sets—start you in business without capital or finance an invention—train you for the \$3,000 to \$10,000 big-pay radio positions—help secure a better position at bigger pay for you.

A membership need not cost you a cent! The Association will give you a comprehensive, practical, and theoretical training and the benefit of its Employment Service. You earn while you learn. Our cooperative plan will make it possible for you to establish a radio store. You have the privilege of buying radio supplies at wholesale from the very first.

Earned \$500.00 Spare Time
Frank J. Deutsch, Penn.: "I have made over \$500 out of Radio in my spare time."

Radio Engineer in One Year
Claude De Grave, Canada: "I knew nothing about Radio when I joined a year ago. I am now a member of a very exclusive organization of Radio Engineers, and my income is 225% greater than it was."

Doubles Income in 6 Months
W. E. Thon, Chicago: "Six months after I enrolled I secured the managership of large Radio Store and doubled my income."

ACT NOW — If You Wish the No-Cost Membership Plan

To a limited number of ambitious men, we will give Special Memberships that may not—need not—cost you a cent. To secure one, write today. We will send you details and also our Radio Handbook filled with dollars-and-cents radio ideas. It will open your eyes to the money-making possibilities of Radio.

Radio Training Association of America
4513 Ravenswood Ave., Dept. RN-6, Chicago, Ill.

Radio Training Association of America
Dept. RN-6, 4513 Ravenswood Ave., Chicago, Ill.

Gentlemen: Please send me by return mail full details of your Special Membership Plan, and also copy of your Radio Handbook,

Name.....

Address.....

City..... State.....



Volume X

June, 1929

No. 12

ARTHUR H. LYNCH, Editorial Director

C. P. MASON, Associate Editor

JOHN B. BRENNAN, JR., Technical Editor

C. WALTER PALMER, Direction Information Service

Contents of this Issue

Editorial—"Opportunity" By Arthur H. Lynch	1062	Ten Instructions for the "DX" Fan	1101
Making the Air Safe for Traffic By Zeh Bouck	1065	How to Build the New A.C. Screen-Grid "Everyman" Tuner By Zeh Bouck	1102
What Flying Has to Offer Trained Radio Experts By E. R. Haas	1069	"DX" and the "Band-Isolator" Receiver By S. Gordon Taylor	1105
"Up and Going" By W. B. Courtney	1070	Need of High Standards in Frequency-Maintenance By Robert H. Marriott	1108
"New Wings for Young Americans" By E. W. Sawyer	1073	The "Super-Wasp" By Robert Hertzberg	1109
Automatic Radio Transmitter Designed for Emergency Use By C. P. Mason	1075	Radio Regulations Drafted for Air Service	1112
Making Room at the Top in Radio By A. Henry	1076	Radio Wrinkles	1113
What's New in Radio	1079	Principles of Transformer Design By R. D. Ross	1114
The Radio Beginner—"The Beginner's Three" By C. Walter Palmer	1084	The Service Man	1118
Making the New Short-Waver "Perk" By H. M. Bayer	1088	Large Television Images Broadcast by R.C.A.	1121
The "RE 29" Receiver By R. E. Lacault	1090	List of Broadcast Station Calls	1122
Designing a Tuned-Radio-Frequency Transformer for the A.C. Screen-Grid Tube By Glenn H. Browning	1093	On the Short Waves	1124
The "Explorer Eight" By John B. Brennan, Jr.	1095	A Few Letters from the Editor's Mail Bag	1126
The "Velvetone" 245 Push-Pull Amplifier By James Millen	1099	I Want to Know By C. W. Palmer	1127
		Index of Advertisers	1148

IN FORTHCOMING ISSUES

The July number of RADIO NEWS marks the tenth anniversary of its publication. It will contain for our readers many general and constructional articles in addition to those already announced by us, or commenced as series in this issue. We shall continue our vigorous new policy of adding stories of aviation interest to the strictly radio matter, while publishing more of the latter than before in this magazine.

Among the new subjects to be dealt with in July and the following issues will be:

AVIATION RADIO IN AMERICA AND ABROAD: profusely-illustrated articles showing the latest receiving and transmitting equipment in use by the air services here and in Europe. A great deal of ingenuity has been shown in the latest products of engineers who are working along these lines.

A SHORT-WAVE PRIZE-WINNING RECEIVER, by E. T. Somerset. This apparatus utilizes screen-grid amplification in a new and ingenious way, facilitating the operation of the receiver on very low waves.

MODERN MANUFACTURE OF RADIO TUBES, by C. W. Palmer. Remarkably ingenious methods for mass production of these necessary devices have brought them down to very low prices; so that the number of tubes in the average American receiver astonishes the world.

A SET AND TUBE TESTER FOR A LEAN PURSE, by M. K. Barber. The writer, in two senses a "service man," has devised a very ingenious and inexpensive layout within the reach of any experimenter.

A HOME-MADE DYNAMIC SPEAKER, by Ralph E. Dunbar and M. C. Parks. The complete constructional data of such a reproducer will be given in this article, and answer the requests of hundreds of readers who have been anxious for the necessary information.

"HOW MANY TURNS ON THE COIL?" by C. P. Mason. A discussion, in simplified form, of the rules for calculation of simple inductance coils (for radio-frequency transformers) with rules and tables which will be worth preserving.

In addition to these, we will present following continuations of series started in this issue:

"The Radio Altimeter," by Zeh Bouck; a second biographical article on "Making Room at the Top in Radio," by A. Henry; "A Simple Power Amplifier" for the "Beginner's Three" and like sets, by C. W. Palmer; and other illustrated articles showing the construction of the "RE 29" by R. E. Lacault, the "Band-Isolator" receiver by S. Gordon Taylor, the new A.C. Screen-Grid tuner by Glenn H. Browning, and a Booster Unit for DX work with other refinements on the "Explorer Eight," by John B. Brennan, Jr.

Other articles by recognized authorities in every branch of aviation and radio work are now the subject of editorial negotiation, and will appear in July and the next few issues of the new RADIO NEWS.

RADIO NEWS is published monthly, on the tenth day of each month preceding that of date. Entered as second-class matter, July 12, 1924, at the postoffice, New York, N. Y., under the act of March 3, 1879. Additional entry at Duellen, N. J., and San Francisco, Calif. Copyright 1929 by Experimenter Publications, Inc.; title registered U. S. Patent Office. Subscription price \$2.50 a year, \$3.00 in Canada and foreign countries. Single copies, 25 cents each. The contents of

RADIO NEWS are indexed in the Industrial Arts Index. Communications and manuscripts should be addressed to the Editor, Radio News, 381 Fourth Ave., New York, N. Y.; subscriptions and orders for magazines and other publications to the Circulation Department, Experimenter Publications, 381 Fourth Ave., New York, N. Y.

Published by **Experimenter Publications, Inc.**

B. A. MACKINNON, President

H. K. FLY, Vice President and Treasurer

Member: Audit Bureau of Circulations

Radio Magazine Publishers Association

Advertising Representatives: RHODES & LEISENRING

New York Offices: 624 Graybar Building

Chicago Offices: 307 North Michigan Ave.

Editorial and General Offices

381 Fourth Avenue, New York City

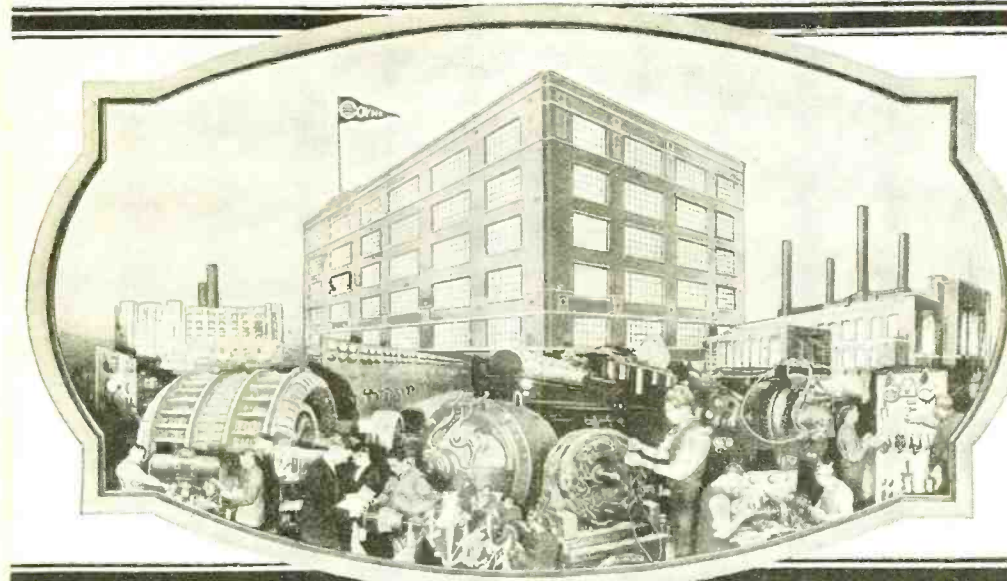

"I Will Help You to Succeed Quickly in a Big Paying Job"

I will Train You by Actual Work in 90 Days

You can have unlimited rewards and Big Pay possibilities—carrying salaries ranging from \$60 a week and up! Right now big electrical jobs are going begging, Coyne Electrical Experts with 12 weeks' training are in demand—and the need for new fellows like you grows every day.



Get Into ELECTRICITY

Where Experts Make \$60 to \$200 a Week



The whole world is open to the trained electrician. Get away from the humdrum existence in a small, dull, hopeless job, where you spend your life waiting for \$5.00 raises. Get out of the rut. Electricity opens the way for you. Learn to be an electrician (not by correspondence but on actual electrical machinery) and go anywhere you wish. You will find positions open to you in any city at salaries of \$50.00 and \$60.00 and up in electrical factories, power plants, street railway companies, railroads, contractors, etc.

Don't Be Held Down

Can you wonder why thousands of Coyne Graduates are grateful to me? Look at Clyde P. Hart who got a position paying over \$100 per week. Clarence Ackland, a farmer boy draws \$60 a week right back in his own small village. I can point out thousands of others. There is always a demand for trained men—to rapid promotion and big pay.

You Learn-By-Doing Not Books At Coyne, Electricity will fascinate you. You work on real plant sized machinery—not dummies or toys. But on the same kind of machinery you will work on when you graduate and take a job in the electrical field.



YOU CAN MAKE GOOD, TOO

Never mind—don't hesitate because you lack experience—or advanced education. They bar no one at Coyne. Coyne accepts you because you want big pay. Coyne trains you to get it quick. Coyne fits you for big jobs after graduation and helps you for life at your work in the field.

Earn While You Learn

If you should need part time work, I'll assist you in getting it. Then, in 12 brief weeks in the great roaring shops of Coyne, I'll train you as you never dreamed you could be trained.

My Latest Methods Will Fascinate You

I don't make you a mere "paper" electrician. I train you by practice on our mammoth outlay of actual equipment. I train you in housewiring by having you do it exactly as it is done outside—not just by reading about it. The same applies to armature winding, power plant operating, motor installations, automotive work and hundreds of electrical jobs. That's why we can train you to become an ELECTRICAL EXPERT.

FREE Employment Service

MAIL COUPON AT RIGHT — QUICK

That brings you my big book free and complete information. It costs me \$1.00—it costs you nothing. Learn why Coyne training is endorsed by so many large electrical concerns—what its reputation of 30 years' standing means to the electrical field, and best of all, why the word Coyne opens the door quick to real jobs that lead to salaries of \$60 to \$200 a week for its graduates. It's all told in MY FREE BOOK of "Big Pay Facts." Mail coupon today. This does not obligate you—so do it right now! *Not a Correspondence School.*

COYNE Electrical School
H. C. Lewis, Pres., Est. 1899
500 S. Paulina St., Dept. A9-27 Chicago

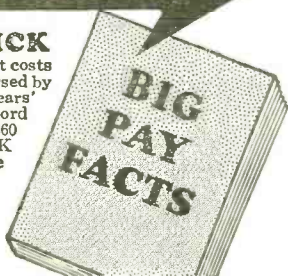

Send for FREE Book

H. C. LEWIS, President
COYNE ELECTRICAL SCHOOL, Dept. A9-27
500 S. Paulina St., Chicago, Ill.

Dear Mr. Lewis: Without obligation send me your big free catalog and all details of Free Employment Service, Radio and Automotive Courses that are included and how many "earn while learning." I understand I will not be bothered by any salesman.

Name
Address
City State

Please say you saw it in RADIO NEWS

AN OPEN LETTER

To Our Readers:

Radio News, as well as **Science and Invention**, **Amazing Stories**, **Amazing Stories Quarterly**, **Your Body Quarterly** and the **Radio Listeners' Guide and Call Book Quarterly** have changed hands. All of these magazines are now owned by a new corporation, headed by the undersigned.

It is the policy of the new organization to improve materially all of these periodicals, and a very definite indication of what may be expected in forthcoming issues may be had from a perusal of the issue in your hands. In this number, you will find sixteen pages more text than were used in our May number. You will find articles on radio subjects by recognized authorities. You will find articles on radio as it applies to the very important development which is coming in the aeronautical field during this year, as well as articles of very great interest on purely aviation lines.

You will find that the editorial policy has been completely changed; and, from the present magazine, you will see that it is our purpose in the future to be of just as much assistance as possible in the development of any sound idea which will benefit the radio business. We believe that, when we describe a particularly good receiver, we should also supply our readers with the information concerning where the parts may be procured and who makes them. We do not believe it is desirable to withhold this information until our readers write us for blueprints, and for this reason all of the technical information from now on is to be contained in the articles themselves. We do not contemplate staying in the blueprint business.

We believe that every reader and every advertiser in **Radio News** and all the other magazines published by this Company is keenly interested in our activities, and it is our purpose to keep all of you advised concerning what we are doing. You will find this issue of the magazine free from any "house copy" for subsidiary companies owned by the publishers, and in direct competition with other manufacturers and other advertisers. You will also find that a great many of the most reputable advertisers in the business are so well satisfied with the changes in policy in these magazines that contracts are being signed up by many of them covering not only **Radio News**, but the entire group of **Radio News**, **Science and Invention** and **Amazing Stories**.

With each succeeding month, we hope to make our magazines better. We shall welcome any co-operation from our readers in the form of comment or criticism.

Cordially yours,



Publisher.

SM

Sweetest of Loud Speakers—It's a Real S-M!

ONLY two months old is the S-M dynamic speaker; yet already it has taken its proud place among S-M audio products—the acknowledged aristocrats of tone quality. . . “Sweetness” is taking on a new meaning for owners of S-M speakers. All the mellow flow of the “lows,” as well as the brilliancy of the “highs,” come out smoothly on an S-M dynamic—with a surprising absence of all rumbles, roars and rattles. . . As always, there are underlying engineering reasons. Sound design in the speaker head is coordinated with similar mathematical correctness in the built-in S-M 229 output transformer, which has various taps to insure proper impedance matching for 171A, 210, 245, or 250 type tubes, singly or in push-pull. . . The 110-volt d.c. type (851), at \$29.10 net, is ideal where the field winding is to be connected as a choke in a power circuit. . . The a.c. type (850), at \$35.10 net, operates on 50 to 60 cycles, 105 to 120 volts. Thorough rectification of field current, with a 280 tube and a 2-mfd. filter condenser, reduces hum to the point of defying detection. . . Either type fits an 8½” baffle hole. . . Try an 850 or an 851 unit in the next set you build—and the S-M speaker will become your speaker!

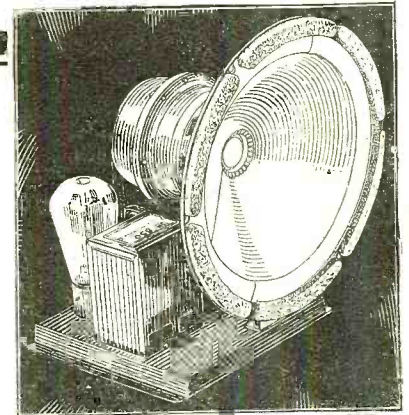

S-M 850 Dynamic Speaker
105-120 volts, 50-60 cycles.

720AC Screen-Grid Six (All-Electric)

The 720AC is giving to experimenters everywhere a preview of radio as it will be in 1930—combining the sensation of the 1928 season—all-a.c. operation—with the sensation of 1929—screen-grid r.f. amplification—and with them the entirely new 1930 features of a screen-grid tube almost 100% better than the d.c. operated '22, and a moderate-voltage output tube (the '45) nearly as powerful as the high-voltage '50. And, with these, the S-M precision engineering which has brought in broadcasting from across the Pacific with six tubes—and even with four.

S-M tone quality is the accepted criterion of the audio transformer industry. All these things in the 720AC (licensed under patents of RCA and associated companies), at only \$70.20 net for the set completely wired in the 700 two-tone shielding cabinet, less tubes and power units. Component parts total \$47.07 net; cabinet \$5.55 net additional. S-M 669 power unit, furnishing all A, B, and C power required, wired complete \$34.50 net. S-M 720 receivers can be changed over at slight cost to the 720 AC circuit; full directions in Data Sheet No. 10.

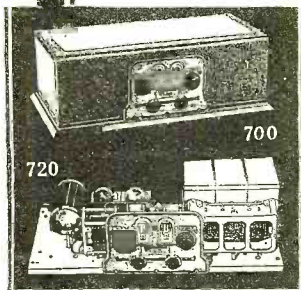

“Round-the-World Four” (Short-Wave Sets)

Bigger and bigger grow the thrills that are coming in on the short-waves—biggest of all when received clearly on an S-M Round-the-World Four. One screen-grid r.f. tube is used, with regenerative (non-radiating) detector and two S-M Clough-system audio stages. Wired complete in the aluminum cabinet shown, (Type 730) with coils giving 17 to 200 meter range, \$42.90 net—or as a two-tube adapter (Type 731) for use with any broadcast receiver, \$30.00 net. Component parts also available, at \$31.71 net for the 4 tube set, or \$22.86 net for the 2 tube adapter.

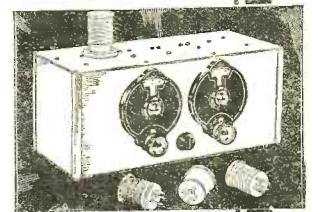

New 810 Drum Dial

As beautiful an illuminated dial as you will find anywhere, in the highest-priced receivers. Smooth—absolutely quiet—rigid and accurate—a full ¼” for each of the 100 dial divisions—and only 1½” thick over all—truly a dial to delight the heart of the set-builder with modern ideas. Obtainable for condensers to right or to left of dial; 810R or 810L, price \$2.25 net.

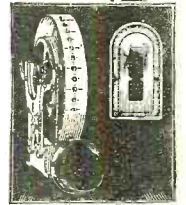

Are you getting the Radiobuilder, a monthly publication telling the very latest developments of the S-M laboratories? No. 11 (Mar. 1929) gave the first details of the new 720AC All Electric Screen Grid Six, and the 669 Power Unit for the new a.c. screen grid and 245 tubes, with complete circuits. Send the coupon for free sample copy, or to enter your subscription if you want it regularly.

If you build professionally, but do not have as yet the S-M Authorized Service Station appointment, ask about it.

SILVER-MARSHALL, Inc.
6405 West 65th St., Chicago, U. S. A.

- Silver-Marshall, Inc.
6405 W. 65th St., Chicago, U. S. A.
- ... Please send me, free, the 1929 Summer S-M Catalog; also sample copy of The Radiobuilder.
- For enclosed..... in stamps, send me the following:
- 50c Next 12 issues of The Radiobuilder
 - \$1.00 Next 25 issues of The Radiobuilder
 - S-M DATA SHEETS as follows, a 12c each:
 - No. 1. 670B, 670ABC Reservoir Power Units
 - No. 2. 685 Public Address Unitpac
 - No. 3. 730, 731, 732 “Round-the-World” Short Wave Sets
 - No. 4. 223, 225, 226, 256, 251 Audio Transformers
 - No. 5. 720 Screen Grid Six Receiver
 - No. 6. 740 “Coast-to-Coast” screen Grid Four
 - No. 7. 675ABC High-Voltage Power Supply and 676 Dynamic Speaker Amplifier
 - No. 8. Sargent-Rayment Seven
 - No. 9. 678PD Phonograph Amplifier
 - No. 10. 720AC All-Electric Screen-Grid Six.
 - No. 12. 669 Power Unit (for 720AC)

Name.....
Address.....

Please say you saw it in RADIO NEWS

Radio News

Vol. 10

JUNE, 1929

No. 12

Opportunity

Is Knocking At the Door of the Student—as well as Those of Big Business
and the Man in the Street—Let's Be Prepared for a Welcome!

THE scientific magazines owned by the Experimenter Publishing Company will, from now on, carry on an aggressive campaign for the development of radio and other scientific protective devices for air navigation. Our first consideration, very naturally, has to do with various radio developments; because that is the particular field in which most of our activities have been centered. Within a short time, we hope to be able to present to our readers some practical, as well as historical articles concerning this development, prepared for us by leaders in the field.

Today is the day of pioneering in work of this kind, and at present it is one from which an immediate profit may not be derived. There will come a day, however, and that day is very rapidly approaching, when the aircraft radio business will be one of the most important parts of the radio business itself.

We know of one company which specializes in the design of radio aircraft receivers used for picking up the various beacon signals provided by the Department of Commerce and which, a short time ago, was notified by one of the air transportation companies that it required a single receiver for these purposes. At that time, the transport company indicated that it was very unlikely that additional receivers would be required for some little time. A telegram, however, was received by the radio company a few days later inquiring as to how soon twenty-five additional receivers could be supplied.

Up to a very short time ago, the air transport operators were almost completely disorganized insofar as radio is concerned; and many of them, if they thought of radio at all, considered it from a purely selfish viewpoint. Since that time, these transport operators have managed to get together and have formed themselves into a single governing body which has presented a very comprehensive plan to the Federal Radio Commission for the operation of suitable ground transmitting stations for use in connection with air carriers in flight and for point-to-point communication between airports. Establishment of this radio network will, to a very large extent, reduce some of the most important hazards facing the development of commercial aviation.

SYSTEMATIC ORGANIZATION

In passing, it is extremely interesting to note that the gentlemen engaged in considering this radio network include some of the most important leaders in the field of aeronautics in this country. Among them are Mr. Luther K. Wells, Secretary of the Aeronautical Chamber of Commerce, and representatives of the Boeing Air Transport Co., National Air Transport Company, Northwest Airways, Inc., Pan-American Airways, Inc., Transcontinental Air Transport, Inc., Universal Aviation Corp. and Western Air Express. Mr. L. D. Seymour was elected Chairman of the committee, and a technical sub-committee comprising Herbert Hoover, Jr., of the Western Air Express, Thorp Hiscock, Paul Goldborough, H. C. Lenteritz and E. W. Proctor was formed to work out further details concerning the manner in which this combination system might function. H. J. Walls of the Department of Commerce was invited to act in an ex-officio capacity with this technical sub-committee.

There is no doubt, whatever, that this committee has a huge job on its hands. There are, at present, very few waves available for air transport work and what few high-frequency channels are now available for any radio development are being contested by almost every type of commercial enterprise. People in the oil fields want them; the existing telegraph companies are casting an anxious eye on short waves; the rubber interests; groups of bankers,

brokers, and various enterprises having offices in points distant from each other are making every effort to secure a right to communicate by radio on short waves.

Waves have been set aside, however, for beacon transmission, a work which will be carried on by the Department of Commerce; as well as for the transmission of weather reports and other information having to do with increasing the safety of air travel. Inter-communicating services, in order to be satisfactory, must be extremely well organized, and it is the building of this service that the committee has in hand.

HERE AND ABROAD

Coming to us, from what we consider a highly reliable source, is the information that, while in this country every effort is being made to have our communicating systems, used in connection with air travel, of the very latest type, a great deal of work is being done in Europe in a very satisfactory manner with equipment which we would consider to be more or less obsolete. For instance, the use of the direction finder, the beacon and similar instruments, although found valuable, does not prevail to anything like the same extent as that of transmitters and receivers, which allow direct communication from the plane to the air-field.

Every effort is made abroad to design radio equipment with a view to making it most efficient for the particular service in which it is to be used. As a rule, radio equipment for airplane use in this country has been more or less an offshoot of the equipment designed for use in some other field. Receivers covering a limited-frequency band have, however, been developed by at least one company here, and it is very likely that others will follow along this line very shortly.

The introduction of the screen-grid tube will allow receivers to be made very much lighter than heretofore, and at the same time provide very much more sensitivity. Possible developments of this kind in connection with transmitters are undoubtedly in the offing.

In connection with this development work, it is interesting to know that the Guggenheim Fund, the General Electric Company, Radio Corp. of America, Radio Aircraft Corp., Ford Motor Company, Pilot Electric Mfg. Co., and the air transport operators themselves, are spending huge sums.

Details of just what is going on in this field will be published in future issues of *RADIO NEWS*. With a fertile field like this in which to work there is, without question, an opportunity for every man interested either in radio itself or directly in aviation. An increasing number of radio engineers, mechanics, riggers, designers, manufacturers, etc., is required immediately.

The successful pilot of tomorrow must not only be familiar with the controls on his machine, but must also be thoroughly familiar with all of the radio and scientific instruments designed for the protection of life in the air. In order to lead in this most interesting of commercial fields it is necessary that the leaders know what they are about, and now is the time to begin learning about it, if you wish to lead.

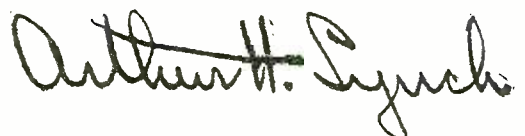

EDITORIAL DIRECTOR.

Quick SUCCESS in RADIO

**Satisfaction Guaranteed
or Money Refunded**

At last! A guaranteed method of radio training... sponsored by RCA... based on the research and discoveries made in the great RCA laboratories... a method that insures quick success in all branches of radio; manufacturing, servicing, selling, ship-and-shore broadcasting, television, photoradiograms! Radio needs you... big pay... amazing opportunities... thrilling work... adventure galore. Prepare at home through this marvelous new laboratory method! Act now... mail the coupon below for thrilling free book about this guaranteed short-cut to success in America's fastest growing profession! Radio Institute of America, Dept. Ex-6, 326 Broadway, New York, N.Y.

**Pick the job you
want and fill it
in 9 months**

SPONSORED BY



**RADIO INSTITUTE
OF AMERICA**



FREE!

This valuable book on Radio's great opportunities... written by one of America's well-known authorities.

RADIO INSTITUTE OF AMERICA
Dept. Ex-6
326 Broadway, New York, N. Y.

Gentlemen: Please send me your big FREE 50-page book which describes the brilliant opportunities in Radio and your laboratory-method of guaranteed instructions at home.

Name.....
Address.....



Please say you saw it in RADIO NEWS

GO UP!

Young Man, and Grow Up with Aviation



HORACE GREELEY said: "Go West, young man, and grow up with the country."

Were he alive today to witness the boundless promise that beckons from the air, he would say: "Go Up! young man, and grow up with Aviation."

For a new and wonderful world dimension has opened to the dauntless gaze of this fortunate generation. Wilbur and Orville Wright proved human flight possible; Lindbergh proved it probable, and thousands of men today are proving it dependable and inevitable.

Every day brings us additional evidence of miraculous progress in Aviation. Thousands of aircraft fly thousands of miles, to and from a thousand airports daily bearing their cargo of men, mail and merchandise. But—for months a shortage of aircraft has been shown in the demand that beats against the factory doors, and a more serious danger looms on the horizon.

Whence will come the men to design, to manufacture, and to control this flood of flying craft? The young men of the country must face this duty, assume this responsibility and accept this privilege.

Just as radio engineering owes so much to the thousands of enthusiastic young amateurs who gave their time and money to research and experiment, so the future of Aviation will belong to the young men of today who possess vision, courage and determination. For such as these *Aero Mechanics* has been created, and while, of course, no single volume can cover the vast field of theoretical and applied aeronautics, I have endeavored to trace therein the art of flying from its beginning and tell in simple words and pictures the easy elementary laws that govern this revolutionary art.

Without this knowledge no man can pass the portals of flying except as an observer. With this knowledge any man can step forward with assurance and certainty and take his place, any place in the world of Aviation—

Young Man! Go Up!—

Augustus Post

*20 Years Secretary Aero Club of America;
Author of many books and articles on flying
as well as one of Aviation's best books,*

AERO MECHANICS

(Now on Sale at Most Newsstands)

Making The Air Safe for Traffic

The Lighthouse of the Air—the Radio Beacon

By Zeh Bouck

WE took off from the flying field along the Venetian Causeway, Miami, Florida, at exactly eight o'clock in the morning of March 4, 1929—a delightful day made more so by a healthy tail wind, hit the coast immediately, and began checking off the seaside resorts with pleasant and frequency regularity. Pahn Beach, Daytona, Ormond and St. Augustine we passed, heading inland for Jacksonville, and covering the three hundred and forty miles in two hours and forty minutes.

From Jacksonville we took off again into the same perfect Florida blue, and the tail wind whisked us merrily and promptly on our way at about two miles a minute. We cut over to the coast again and, about three-quarters of an hour later, picked up Savannah to our left—and to the right, close to the horizon along the shore, a soft, beautiful streak of white down, the most feared of all flying portents! Louis Meier, my pilot, saw it the same time I did.

"Fog," he said, simply.

"Not so hot," I replied. "Let's cut into the right and see if we can pick up the railroad."

As we passed over Beaufort, the clouds

began to thicken below us—blowing in from the west.

"That's not so hot either," commented Meier, as we strained our eyes for a glimpse

THE writer of this thrilling yarn of present-day aviation adventure—and prediction for the future—is well known to most readers of radio literature. He is now no less at home in the air than in the laboratory; and is well fitted, as both radio authority and aviation enthusiast, to tell the story of the mutual aid that radio and flying are giving to each other's development. This is the first of the articles Mr. Bouck has in preparation for RADIO NEWS readers, who will, we are sure, find them a treat.—EDITOR.

of a railroad three thousand feet below. "I'm goin' to haul tail outa this, and how!"

INTO THE FOG

He cut the gun and we nosed down into an opening in the mess of fleecy white—

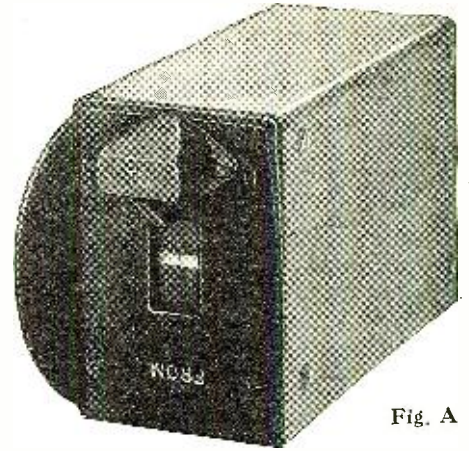

Fig. A

The magic box which is the pilot's third eye—it sees through fog!

from the bright world of sunshine and cotton mountains, blue sky and only the shadow of the plane on the clouds surrounded by a circular rainbow—from this empyrean Parnassus to a grey, cold dripping world below, sodden forests of pine trees rooted in swamps and oppressed by a heavy grey sky a hundred feet or so overhead.

We had located a single-track railroad and, from its general direction, figured it was the line on the map running some sixty miles to Charleston in the northeast. As we fell through the hole in the clouds, the visibility was fairly good and the ceiling some five hundred feet. But the weather rapidly thickened, and five minutes later we were skimming along sideways over the railroad, heading slightly into a fifty-mile gale, at no time more than fifty feet above ground. And when I say gale, I mean a gale! A gale that tossed the hedgehopping plane through a never-ending series of sickening bumps and gyrations that took all the aileron the skilful pilot could give her. It was left wing down and the control wheel jammed to the right, and then the right wing down and the controls jammed to the left, a split second of hesitation, then a momentary recovery—all the time skimming sidewise like a flying crab a hundred miles per hour just over the telegraph poles along the track. Meier had throttled the plane to cut the speed and give us a chance to swerve in case something unexpected loomed up ahead of us. Farm houses and lumber camps sped by us in a dizzy panorama, sometimes half-hidden in a wisp of fog. Once a gang of negro track hands gazed up at us with looks of mingled terror and amazement. We must have presented something in the way of a thrilling spectacle—a whining roar mingled with the gale, suddenly dominating the wind, a roaring spectre out of the mist living for one careening, hurtling second, then lost again in the muffling and enveloping fog. Yes—it must have been thrilling from the ground and—well—let us say, somewhat stimulating from above.

We whistled to assure ourselves that we were superbly indifferent to it all and, at the same time, made a resolution that if we ever got on ground again, and lived through it, we would never leave it in anything more spectacular than an elevator!

GROPING THROUGH

"Where in hell are we?" yelled Meier.

"O. K., watch for a river on your right."

"Nice things, these planes! How much farther?"

"Fifteen miles—only fifteen!"

"Gimme the map."

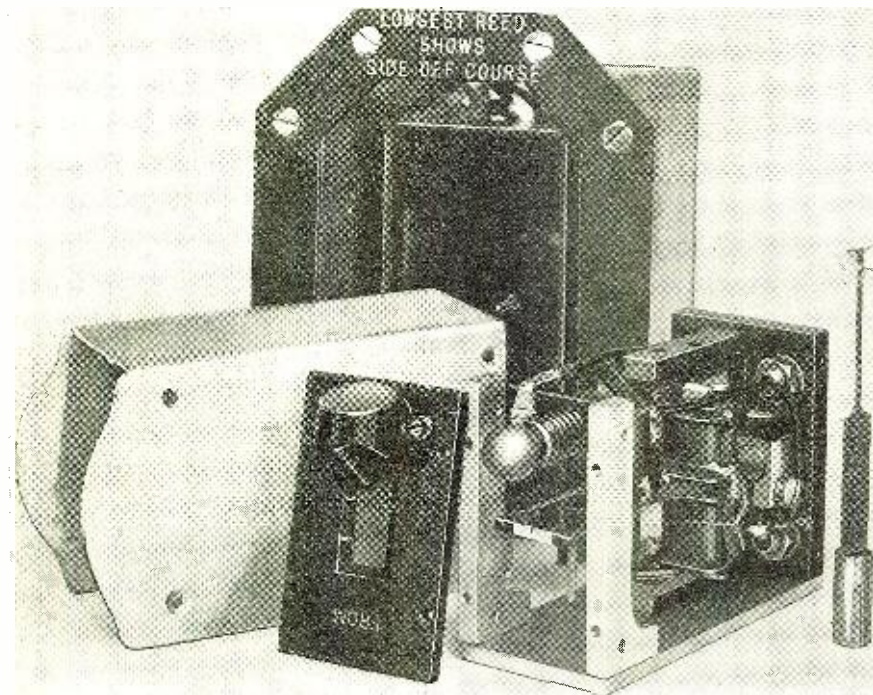

Fig. C

The "works" of the radio-beacon indicator pictured above. The magnets which drive the vibrating reeds may be seen at the right. The apparatus, though delicate, is essentially simple in its nature.

Meier grabbed the map to check me up—the plane nosed down.

"Watch it, Louis!"—quick, like the crack of a whip.

He dropped the map, pulled the wheel back and we zoomed over a pine forest. There were fields here and there—one or two of them—in which he might have put the plane down. But, after all, there was little sense in a forced landing—outside of the fact that nothing in the world would have felt quite so good as a bit of earth underneath our wheels. If our motor cut, we could turn into the wind and in that gale put the plane down gently into anything from a swamp to tree tops with good chances of escaping obituary comment. Our only real danger was the possibility of the fog closing in on us—and I thought of Merrill, Augie Houck, Jap Pierson, the *Yankee Doodle*, all tragic legends of the fog, and of such things as Pullmans and parlor cars and my own safe LaSalle.

Fog dead ahead—clean to the ground. That queer sinking feeling within—old newspaper clipping . . . "plane tore a path for five hundred feet through the trees. . . ."

A quick bank to the left, over a corn patch . . . clothes on a line . . . clear ahead but no ceiling . . . and back again over the railroad.

"Atta boy, Louie!" . . . and a bit more damn-fool whistling.

"What's that, Charleston?"

"Who knows—let's look."

And look we did—for twenty minutes, dodging chimneys, housetops, docks and boats in the bay—before we identified the place and located the naval air station.

* * * *

The above story is a true story. Today it represents a tale not unusual in the history of flying. Tomorrow, fortunately, it will be nothing more than history. Such flying is dangerous—very dangerous; and the majority of our major aerial disasters

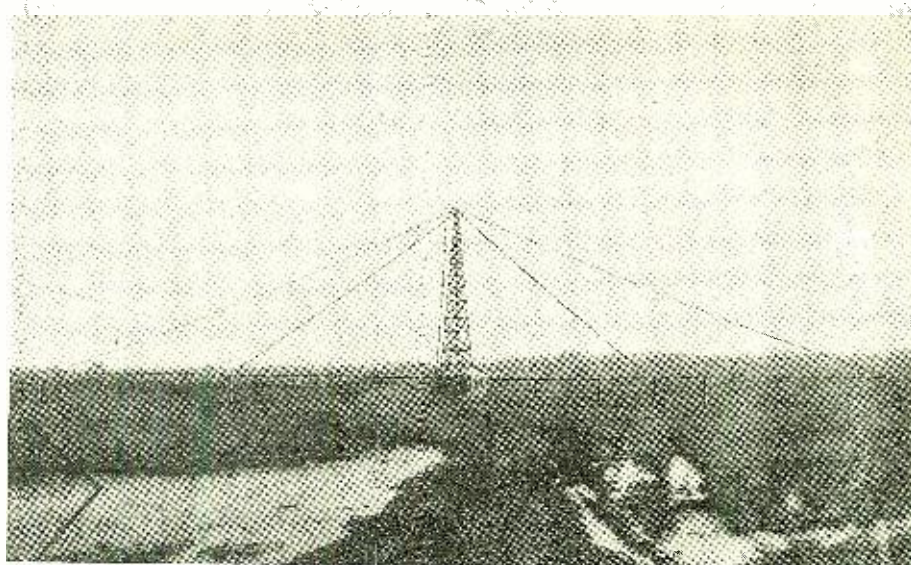

The tower and antenna loops of the beacon at the College Park field. By means of the goniometer shown opposite in Fig. C, it is possible to turn the fields of the antennas and change the course.

can be traced to the hazards of blind flying.

The development of the radio beacon practically eliminates the necessity for dangerous flying. The radio beacon is an automatic navigator that brings the pilot directly to his destination even with the ground hidden from him by fog and clouds.

Navigation has always had a fascination for me—the fascination of the mysterious. Looking over the side of an ocean liner, glancing at the fog swimming briskly along with us, I have been positively awed by the thought that here we were with "water, water everywhere" and speeding to our port with almost the inevitability of a solar eclipse.

Aerial navigation, as far as general cross-country flying is concerned, is more obvious and less scientific than finding one's way at sea. But eliminate the constant checking of

one's course by landmarks—let your pilot fly in fog or above a low ceiling—and the difficulties that make ocean travel interesting are multiplied manifold.

As a matter of fact, piloting a plane across country, even with good visibility, is a tiresome undertaking, requiring constant vigilance of the man at the controls. Winds move much more rapidly than sluggish ocean currents, and the plane travels so fast that it requires small errors in compass or judgment to throw the flier off his course.

HOW THE PILOT FLIES

The pilot, today, flies by map. His course is generally laid out for him by government survey—or he lays it out himself, on a conventional map, plots his course in degrees, and flies by compass accordingly. At its best, this is a rather inaccurate way of traveling. It is difficult to compensate the compass for all directions; and the amount of compensation varies in a manner that can be approximated only by guess, as the plane turns from one direction to another. Also, the wind must be taken into consideration, as it is only on those very rare occasions when one has either a direct tail or a head wind that the pilot can fly exactly in accord with the course laid out on the map. Almost invariably, he must compensate wind drift. The plane rarely flies in the direction in which it is headed.

If the destination of the plane is to the north, and a west wind is blowing, the nose of the plane will be turned to somewhere in the northeast. The plane actually flies along (partly) sideways, as a bull pup runs and a crab crawls. When we were caught beneath the low ceiling en route to Charleston, we followed the railroad for many miles; though a line drawn through the nose and tail of the plane would have made an angle of some thirty degrees with the railroad.

It is tiresome rather than difficult to compensate wind drift. The pilot notes the direction of the wind, and heads at what he thinks to be the right angle into it. After he has traveled for five minutes or so, he checks his position on the map, noting whether he is on his course or off it. If he is to the leeward he turns more into the wind; if to the windward, he turns toward



The "flying laboratory" visits Washington. Left to right, F. W. Dunmore and Harry Diamond of the Bureau of Standards, Pilot Louis Meier, Mr. Bouck, and A. K. Hinman, also of the Bureau. The Bureau men are holding parts of the beacon apparatus which they have designed for airplane use.

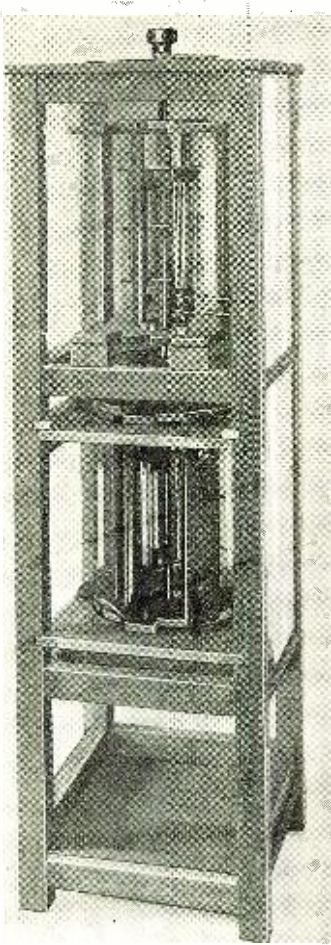

Fig. C

The "goniometer" which produces an effect like turning the antennas of the beacon station.

his compass course. It takes him only a short time to gauge the correct degree of eccentricity. He notes the compass reading and maintains this until the wind shifts, either in direction or velocity, when he must readjust himself to the new condition.

On long flights, he may resort to a drift indicator, which is merely a more mechanical means of determining how much he should nose into the wind. It consists, principally, of an angle-measuring device, mounted alongside of the plane, and so arranged that it may be sighted against any fairly stationary object below (we say "fairly stationary" because sometimes a cloud or a white cap on the water is the object sighted) and so adjusted that this object moves along the sight. The angle between the sight and the direction in which the plane is pointed is a clear indication of the drift caused by the wind, and the pilot compensates accordingly.

With low-hanging clouds, he will invariably fly beneath them for safety. If he flies above the clouds he is without a reliable check on wind drift, and he dares not come down through them in case of a forced landing, for fear of mountains or even housetops of "ceiling" height. In fog he is completely lost.

THE NEW GUIDE

These dreaded uncertainties of flying will be definitely eliminated when the radio beacon developed by the Bureau of Standards comes into general use. It will guide the pilot directly to his landing field, without recourse to his map, in fog, cloudy or fair weather.

The beacon indicator (Fig. A) in its perfected form is nothing more than an instrument, a little larger than a pack of cigarettes, that plugs into a mounting in the instrument board in front of the pilot. Behind the glass face are two little squares of white that, when the plane is following its course, vibrate up and down, tracing two vertical lines of equal length; just as a line is traced by a glowing cigarette moved swiftly. If the plane moves off its course to the left, the left line becomes longer—the reverse holding true for a right-hand deviation. The reed indicator holds the true course, regardless of wind drift or magnetic deviation, whether the pilot is within sight of ground or at a safe altitude above the clouds; and, when the plane is directly over the transmitting aerials, both reeds stop moving. If the transmitter is located at the flying field, the plane will be led to within one hundred feet of a safe landing.

It was the pleasure of the Pilot Electric Manufacturing Company to send their "flying laboratory," in charge of the writer, to Washington to test this radio beacon in cooperation with the Bureau of Standards. The work on the development of the directive transmitter has been under the direction of Drs. Dellinger and Pratt. Receiver design has occupied the attention of Harry Diamond; while the visual recorder, the vibrating reed, is principally the work of F. W. Dunmore—all engineers and physicists with the Bureau of Standards.

The entire radio installation, including receiver, indicator, batteries and antenna, weighs only about twenty-five pounds—a good example in portability.

THE BEACON ITSELF

The radio-beacon equipment divides itself logically into three divisions, the transmitter, the receiver and the visual indicator. However, to grasp the idea of the way it operates, it is necessary to consider briefly the system as a whole.

The theoretical aspects of the radio beacon are not difficult to understand. The

transmitter is so designed that it transmits two audible frequencies on the same wavelength; the frequencies employed at present are 85 and 65 cycles. The radiating system comprises, essentially, two loops mounted at right angles to each other, or approximately so. It is characteristic of a loop radiating system that the loudest signal, at any given distance from the loop, will be received in the plane of the loop. In other words, for the best results the loop should be pointing at the receiver, just as, when receiving, the loop should be pointed at the transmitter. The curve of constant field strength about the loop is like a figure 8. If two loops are mounted on a common vertical axis, at right angles to each other, we shall have two figure 8s shown in Fig. 1. One loop transmits the 65-cycle and the other loop the 85-cycle wave; the two frequencies will be received most emphatically in areas where the two 8s overlap, the shaded portions indicating the zones of equal signal strength on the "course." In other words, a plane flying in this darkened area would receive equally strong 65- or 85-cycle impulses. Such a plane is suggested by the point P. A plane at P' will receive more 85-cycle than 65-cycle signals; while the plane at P'' will receive more at 65 cycles than at 85 cycles.

The reeds in the indicator are carefully tuned to these two frequencies (one reed to 65 cycles and the other to 85 cycles) and so connected in the receiving circuit that they will respond to the incoming signals. If the 65-cycle signal is stronger than the 85-cycle signal, as at P'', the 65-cycle reed will vibrate more than the 85-cycle reed, tracing the longer line, and vice versa.

It is obvious, that by revolving the transmitting loops, the radio beacon can be set for any desired course, just as, by revolving a receiving loop, it is possible to receive signals better from different directions.

THE APPARATUS

The transmitter consists of an oscillator and two power amplifiers, each amplifier working into its own antenna system. By

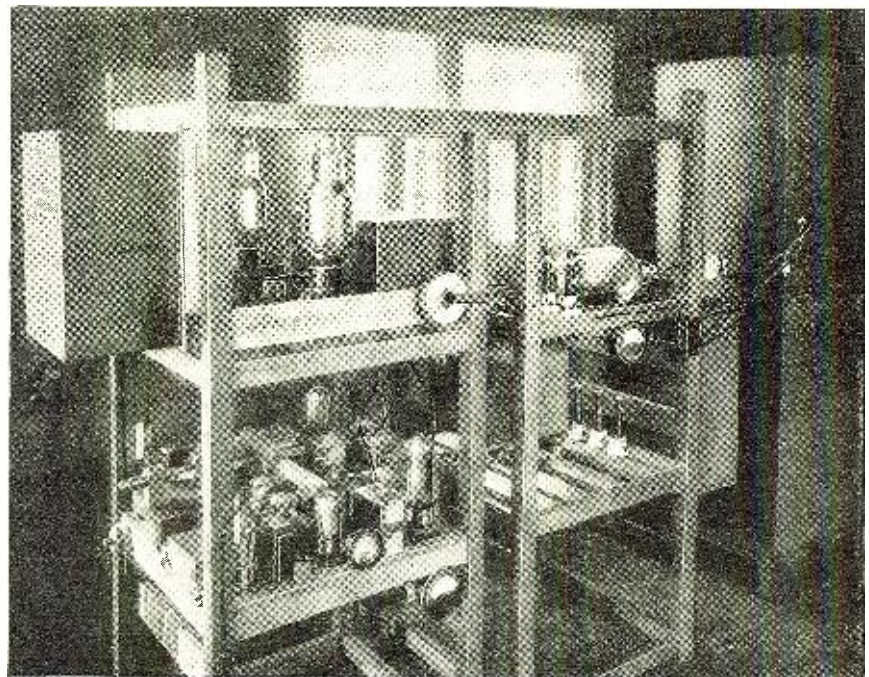

The transmitting apparatus shown above is that used for experimental development work at the Bureau of Standards during the researches which have brought the radio beacon to practicality.

employing one oscillator, both waves are maintained constantly at the same wavelength or radio-frequency (290 kilocycles—1034 meters). One of the power amplifiers is modulated by the 65-cycle current and the other by the 85-cycle current, in much the same manner that the carrier of a broadcasting station is modulated by the voice. The power amplifiers are coupled to the antennas by means of a goniometer, an instrument not dissimilar to the familiar variometer. The goniometer makes it possible to rotate the fields without actually moving the antennas, which are permanently erected as in the installation at College Park illustrated. The goniometer sets up "phantom loops" that turn as the goniometer is turned.

The receiver is of the standard aircraft type developed by the Bureau of Standards, operating on the airplane channels between 285 and 350 kilocycles. It is of single-control design, with a trimming condenser to compensate antenna variations. A simple movement of the control handle tunes the receiver to any desired frequency within the aircraft band. While manual volume control was used in the tests made by the writer, future receivers will incorporate an automatic volume control, relieving the pilot of all concern and responsibility in this direction.

The receiver can be used for telephonic reception, as well as beacon indication, by plugging in headphones in place of the reed indicator. A short twenty-foot trailing-wire antenna, or a ten-foot vertical-rod antenna is used with the receiver-beacon combination. A short and comparatively straight antenna should be employed to eliminate directional effects at the receiving end. With the antenna system described, it is possible to locate the transmitter within one hundred feet, from an altitude of one thousand feet. As an antenna of this description is not responsive to a horizontal field, and as no vertical field exists directly over the transmitting aerials, no signal is picked up and consequently both reeds stop vibrating at this point.

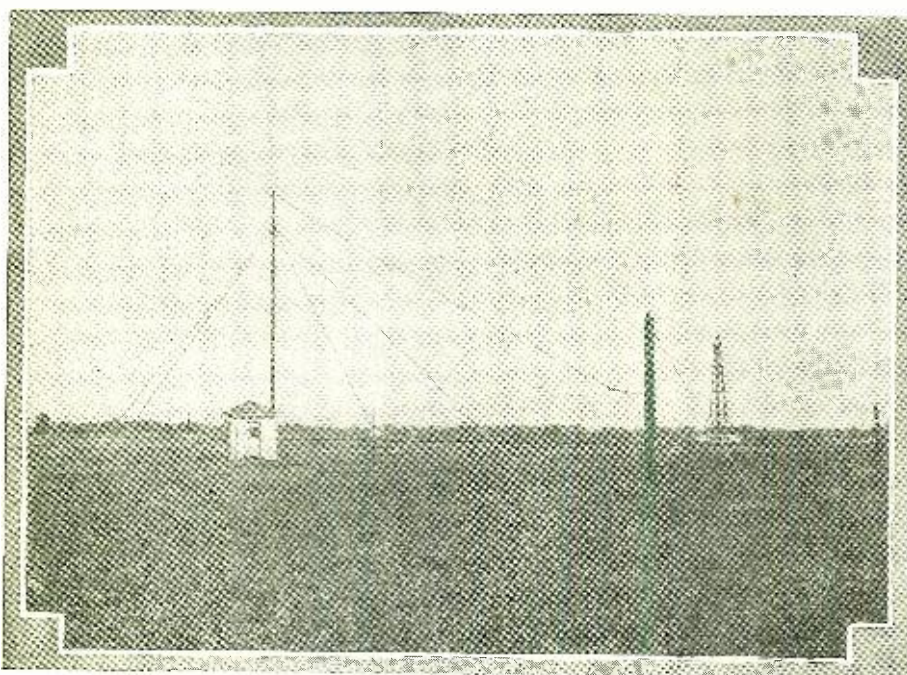

The first commercial radio beacon in the United States, that of the Ford Motor Company, is located at its large flying field in Dearborn, Michigan, just outside Detroit, and is illustrated above. The transmitter is in the small white house. In the background is the mooring mast for dirigibles.

THE FIRST RADIO MESSAGE FROM AN AIRPLANE IN FLIGHT
 Another chapter in aerial achievement is recorded in the sending
 of this wireless message from an aeroplane. *in flight*

J. A. D. McCurdy

The short dispatch reproduced in facsimile above marks the first successful team-work of radio and aviation. It was written at Sheepshead Bay, New York, on August 21, 1910, by F. D. Caruthers; sent by J. A. D. McCurdy from a Curtiss biplane at 10,000 feet elevation and received by H. M. Horton at a ground station, on August 27, after several unsuccessful endeavors.

EFFECTIVE OPERATION

The indicator consists of two short reeds, tuned exactly to the correct frequencies, and mounted in a suitable electro-magnetic actuating arrangement (See Fig. C). The reeds are so perfectly tuned to their respective frequencies, that a variation of plus or minus a twentieth of a cycle per second is sufficient to affect operation. They furnish a beautiful example of mechanical resonance.

During the tests in which the writer participated, it was impossible to pick up either frequency on the phones, because of the spark interference from the motor. However, the reeds gave no trouble in discriminating between engine noise and their own particular frequencies. The reeds are therefore unaffected by static or any other form of interference that does not exactly duplicate the frequencies to which they are tuned.

This apparatus was installed in less than a half hour, using the trailing-wire antenna with which the flying laboratory is equipped. Mr. Meier, our pilot, required less than a minute's instruction on the technique of beacon flying. The goniometer was set for Baltimore, and we took off. Two minutes later we passed directly over the beacon transmitter, and in fifteen minutes we were

over the city of Baltimore. We turned around, and with a bit of a head wind, passed again over the beacon and flying field twenty-five minutes later—all without a single reference to compass or maps!

The radio beacon indicates a deviation of two degrees off course. At a distance of sixty miles this amounts to a maximum of one mile on either side of the direct course. At a distance of two hundred miles from the beacon—about the practical limit when using present-day equipment—the indicator will show a drift of about three and a half miles. By noting the relative amplitudes of the two reeds, it is possible to ascertain, approximately, how much the plane is off the course.

It is planned to equip radio-directive courses with "marker" beacons—low-powered transmitters along the route having a maximum range of about two miles. Transmitting their own particular frequency, they will actuate a third reed, for a minute or so, with a zero point directly over the marker, showing the pilot his exact position along the course, and the speed at which he is traveling.

* * * *

We commenced this article with a true story of flying today. Let us end it with a little imaginary tale of an immediate tomorrow.

A plane leaves the New York Municipal airport with passengers for Washington. The three motors of the giant transport roar into a crescendo of power. The plane moves along the runway, the tail lifts. The giant metallic condor gathers speed, the pilot eases up on the wheel, and the plane takes off into a low-hanging sky that we now describe as poor flying weather. The passengers ease themselves into their seats, adjusting their parachutes to a comfortable position. (They are wearing chutes for the same reason that the Leviathan today carries life preservers.)

The pilot glances before him at his tiny beacon, notes that both reeds are of equal length. He throttles the motor to cruising speed, and glances, without a pucker of the brow, at the clouds thickening before him. The gray sky is gloomy, and he pulls back on the wheel, ever so slightly. The slope of a climb needle swings up, and the altimeter slowly rises until its reading shows an altitude of three thousand feet. The sun is shining brightly on the plane, as the clouds close in below.

The beacon shows the pilot that he is slightly to the left of his course. He touches the rudder, ever so deftly, gives the ship a little aileron. Fifteen minutes later, he

(Continued on page 1138)

What Flying Has to Offer for Trained Radio Experts



And How the Ambitious Radio Enthusiast May Break Into the Big Game of Aviation Radio



By E. R. Haas*

WITHIN two years, the demand for radio experts to install, operate, and maintain airplane radio equipment will cause the same shortage of radio personnel that is now threatening as the result of talking-movie developments. Within two years, airplanes carrying fifty passengers and ten tons of express and mail will be competing with the railroads for long-haul traffic. These great air liners will be more dependent upon radio communication than the railroads are upon the line telegraph.

The planes will be guided along the airways by radio. This method of communication will serve to dispatch the planes, and advise the pilot of weather conditions. Again, radio signals will advise the filling stations of the approach of the plane, so that gas can be taken on board without landing.

During the last summer, the Army, Navy and Commerce Departments inaugurated a very comprehensive weather reporting service operating by radio between airports. I had planned on several consecutive days to fly down to Washington from New York City. Each morning, at nine o'clock, I phoned Mitchel Field to ask for the weather report from Washington. Each morning they said, "The weather is bad along the Aberdeen Proving Grounds, with a low ceiling at Washington; but the fog is expected to clear by afternoon."

*Vice-President, National Radio Institute.

Radio Technician F. E. Gray working at the receiving set of a mail plane. The cable which runs forward from the receiver is the tuning control, operated by the pilot from his cockpit. The pole running up above Mr. Gray's head is the vertical aerial of the receiver. With an antenna of this type, the reception is not affected by any change in the direction of the plane's flight.

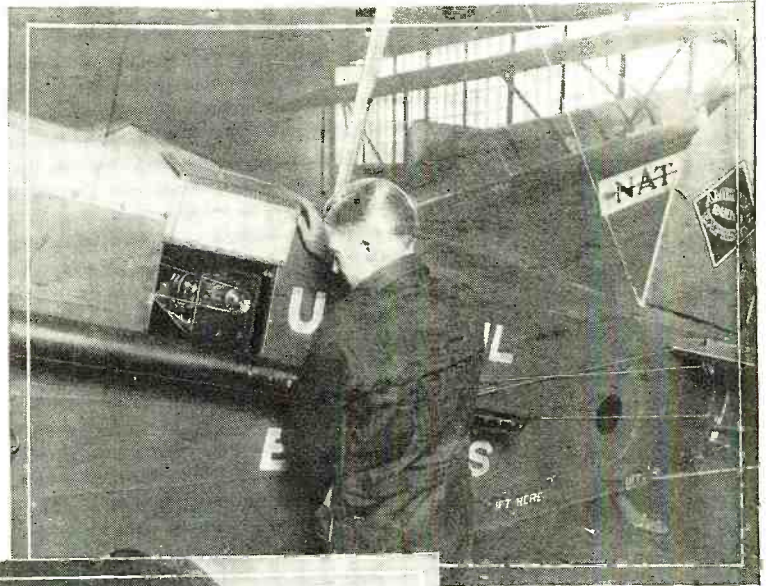

Photos from National Air Transport Co.

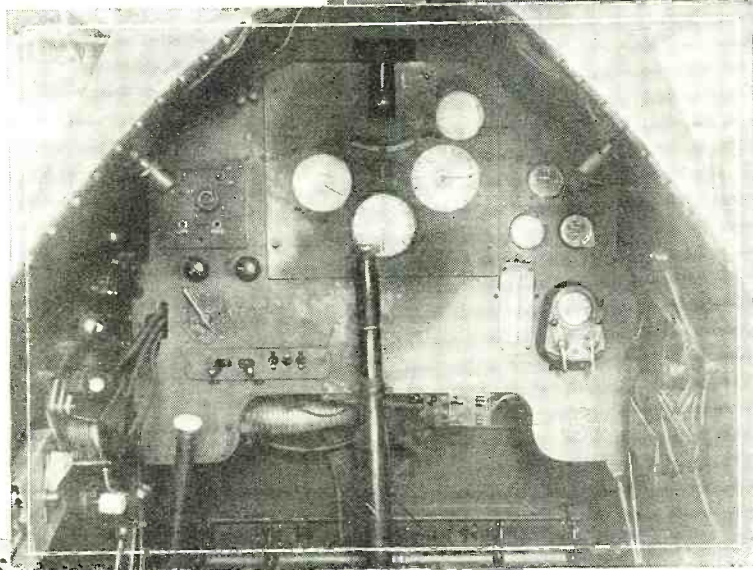

Above, the cockpit in an N. A. T. radio-equipped mail and express plane. The tuning-control handle is at the pilot's left hand. The switchboard at the left of the meters has the phone jacks. At the left, the radio control room at the Cleveland airport. Weather reports are sent out by teletype and radio. At the switchboard, a technician is working on the remote control of the directional transmitter.

But the subsequent reports during the morning were unfavorable, although the weather was clear enough in New York. It was not until the fourth day that we could get away. Suppose our plane, had been a great air liner, operating on timetable schedule. These planes will have to fly as regularly as the trains run; and they will, radio will make it possible for them to do so.

RADIO ROUTINE ON A PLANE

Each plane will carry a radio operator. Travelling from New York to Chicago, for example, the operator will have a transmitting and receiving set, and a radio course-plotter.

At regular intervals, he will report the weather conditions to the ground stations along the route. This information will be passed on to planes passing subsequently. In turn, he will receive weather information on conditions ahead.

As the ship approaches refueling stations, he will notify the ground, and a plane will take the air at once, loaded with gasoline for transfer in mid-air. This use of radio alone will do much to increase safety, as it will reduce the number of landings; for taking off and landing are the most hazardous parts of air travel.

(Continued on page 1146)

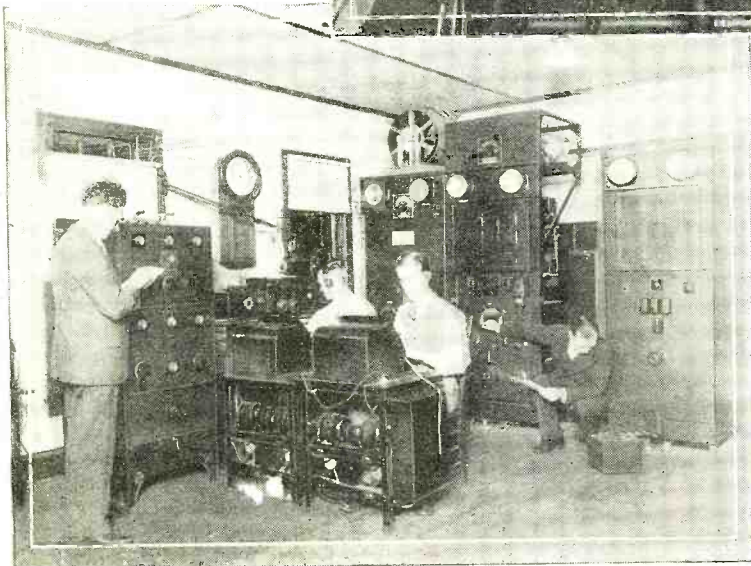

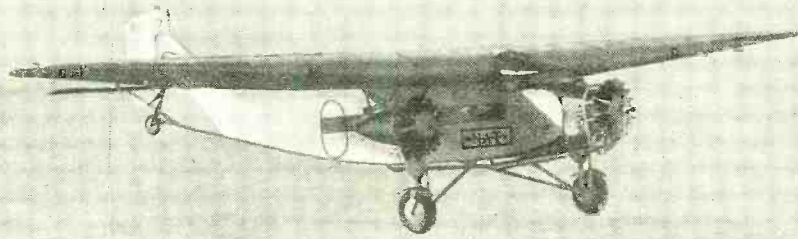

Up and Going

By W. B. Courtney

Flagship of the fleet of 1,275 h.p. planes which will carry mail in their wings and twelve passengers in their cabins, New York to Chicago in eight hours.

© National Air Transport, Inc.

The airplane has come into your front yard. By the middle of this summer anyone in this country will be able to go by air wherever he wants to go. Here are the facts about costs, comforts and schedules that mean a telescoping of distances in all directions



A glimpse into one of the giant four-motored planes which will link Kansas City and the Eastern seaboard. The accommodations for thirty-two sit-up passengers can be changed into sixteen berths.

© Robertson Aircraft Corp.-Universal Air Lines System

ONE day last summer a lard salesman in Albany, N. Y., was notified by his firm that the market price had just slumped half a cent a pound. And the salesman for a competing firm, unaware of this sudden price decline, had started for Boston on an express train half an hour before, to see the territory's most important customer.

The first salesman knew that if he could reach the customer ahead of his rival he could land a big order. Therefore, he requested permission from his firm to hire a plane at the local airport. The firm refused and ordered him to telephone; but the salesman feared that, in the circumstances, the customer might consider a phone call too "smart-alecky." Face to face, he decided—or no order.

On his own responsibility the salesman hired a plane, flew to Boston, and sold five carloads of lard to the customer. The latter, pleased, sent him to another wholesaler to whom he sold two carloads. On the homeward trip the pilot asked permission to stop at Springfield, Mass.—he wanted to have a look at a new flying field there. This brought another customer into the salesman's mind; he dropped in, sold three carloads—and *was back in Albany before his rival on the train*

had reached Boston.

AMERICA'S BID FOR AIR SUPREMACY

All very well, you say, but what of it?—you don't dispute the superiority in swiftness of the airplane over every other form of modern carrier. But you can't hire a plane every time you want to go some place in a hurry. So what's the point? Simply this:

Next summer it won't be necessary to charter special planes. Regular air passenger service will be a commonplace in everyday American life. You will be able to travel by air to all principal cities and population centers of the country; and be set down within easy surface-transit reach of most of the communities which do not happen to be on the schedules.

The astonishing truth is that the United States is blazing into the skies with established and projected passenger services that in a single uprush will give it world supremacy. "Astonishing"—because it will be a shock to most of us to discover that, while our heads have been tilted to record flights by glamorous Americans, other and quieter

men have been engraving a new map at lesser altitudes. This new map will fetch San Francisco closer to New York than Hartford was to Boston in the Thirteen Colonies; Salt Lake closer to the Atlantic seaboard now than Washington's Mount Vernon was then; Montreal as close to Times Square as Harlem was to Stuyvesant's Bowery. Kansas City will be a hop from Chicago, Dallas a skip, San Diego a jump.

Three transcontinental lines will form the backbone of the nation-wide passenger service:

1. National Air Transport—Boeing Air Transport: An all-air route following the present air railway, and approximating its time of thirty hours. The NAT will shuttle between New York and Chicago, using twelve-passenger 1,275-horsepower tri-motored Ford planes. BAT will fly the

Western division, using its own twelve-passenger tri-motored ships.

2. Western Air Express—Robertson-Universal Air Lines System: An all-air route, offering, however, many opportunities for train connections, chiefly at Cleveland and Columbus, Ohio. WAE, using twelve-passenger Fokker tri-motors, will have its eastern terminal at Kansas City; Robertson-Universal will go to Columbus at first, and presently direct to New York via Indianapolis, Pittsburgh and Philadelphia. It will use twelve-passenger Fokkers on the Columbus division; thirty-two passenger quadruple-motored Fokkers, with sleeping accommodations for sixteen, on the New York line.

3. Transcontinental Air Transport: an air-rail route, using Pennsylvania Railroad between New York, Philadelphia, Washington and Columbus, where transfer is effected to or from twelve-passenger Ford tri-motors. The Columbus field will adjoin the railroad tracks. Between Columbus and Waynoka, Okla., flying; between Waynoka and Clovis, N. M., Santa Fe Railroad; between Clovis and San Francisco or Los Angeles, flying. Time, forty-eight hours. Later air divisions will be longer, decreasing time.

Spun from these core routes to the four corners of the country will be a web of lines operated by twenty-five passenger transportation companies, providing scheduled stops in more than 110 cities, flying a total daily mileage of nearly 40,000. These are the official figures of the American Air Transport Association. Hundreds of local carriers, a nation-wide chain of air-taxies flown by Curtiss, and sundry auxiliary projects will provide lightning-fast connections to the through routes and swell the daily averages by thousands of miles.

THE DOWNWARD TREND OF FARES

But is the American public air-minded enough at present to support this elaborate air-passenger service—to justify the vast investment in manufacture and organization, the millions of dollars being laid out for equipment?

"I believe it is," said William P. MacCracken, the brilliant young Assistant Secretary of Commerce for Aeronautics, when I discussed the matter with him in Washington recently, "and I'm sure it is quite obvious to everyone interested in civil aviation that the growth of passenger traffic over our airways will be limited only by two things; first, the safety of the services operated; second, the speed with which fares are reduced."

I asked the Operations Chief of one of the big Mid-West carriers to summarize the fare situation. He said:

"Tri-motored ships cost up to \$85,000. That price includes motors which cost from \$6,000 to \$8,000 apiece. You can't count on a useful life of more than three or four years for these outfits; improvement in speed and design is too rapid—even if depreciation isn't.

"We've been charging twelve to fifteen cents a mile for what passenger carrying we've been doing with 100-mile-an-hour ships. Our new tri-motors will cost about \$125 an hour to run—that includes all overhead. But they'll do a minimum of 125 miles an hour. At that speed, with any kind of traffic, we'll make a nice profit at ten cents a mile. As we get faster ships, faster schedules, we'll charge you much less than that. And just wait until some of the big boys get into direct competition this summer—mark my words, fares will be falling faster than a punctured parachute.

"The railroad fare from coast to coast, figuring meals and extra fares and the like, comes close to \$200. If a drawing-room is engaged it is more than \$350. The all-air fare will be around \$300, with free meals aboard ship. In Europe subsidy has helped cut air fares below first-class train fares in

in Walla Walla it is front-page stuff—in Walla Walla, or perhaps as far as Boise or Seattle. Before it crosses the Rockies it is back in the help wanted pages. And it never crosses the Mississippi. Familiarity, I reckon. Automobiles kill more than 30,000 a year in this country; but the best that licensed pilots and planes could do in the first six months of last year was six.

"The papers haven't helped people to realize the difference between unlicensed and licensed flying. They lump all fatal wash-outs—and that's about as fair as scaring a family man out of his auto-tour vacation because some racing driver got killed doing two-ten an hour, or because some movie-stunt guy broke his neck driving down Pike's Peak in reverse. Lufthansa's records show that an air traveler's chances of reaching his destination safely are 99.9997 per cent. The Imperial Airways haven't killed a pas-

senger since 1924—or in close to 20,000,000 miles of flying. Here in this country Western Air Express, for instance, has flown more than 2,000,000 miles without a serious accident. In fact we could overwhelm the public with statistics proving the safety of licensed American air travel, but what's the use? Statistics have precious little influence over prejudice and fear. People want some tangible representation of safety before they'll take planes as a matter of course. And I think they've got it—in the radio.

WE have spent much time of late in making an investigation of aviation activities in this country; as well as of the direct relationship between radio and safety of life in the air.

We have found this subject so completely covered in the accompanying article (which appeared on March 23, 1929, in *COLLIER'S The National Weekly*, from the pen of one of its editors) that we requested permission to bring it to the attention of our readers. The permission has been given, and we are pleased to present Mr. Courtney's article, which we consider to be one of the most comprehensive appearing on this subject up to this time.

Arthur H. Lynch

EDITORIAL DIRECTOR.

some instances, notably on the international lines—Paris to Vienna and Berlin to Vienna. That won't happen here this year—or next. But if Americans take to air travel with the same gusto and on the same scale they have taken to other progress—the radio, for instance—why—" He shrugged dreamily.

AN UNFAIR SHARE OF THE NEWS

However, there's something more important than cost—safety. On this single factor, more than on all others combined, rests the decision whether air travel will soon become a national habit. I mentioned this to the chief. He crossed his fingers before saying:

"I'm asking Allah for six months free from bad crashes. Then I believe we'll have people on the way to becoming as plane-minded as they are now train-minded and ship-minded. When the Vestris survivors got back to port most of them shipped at once on other boats—some on the sister ship of the Vestris. These people would shudder and tell you how terrible it must be to fall through a mile of air. But I don't see that it is any more terrible than to fall through a mile of water—that's what you do when a ship sinks under you. And in the air there aren't any sharks to nibble at you.

"One thing all flying men are bitter about is the inclination of newspapers to sensationalize aviation accidents. If a mail pilot, caught in a blizzard, cracks up in Walla Walla it is front-page stuff in New York. If a motorist gets himself and his wife and their seven children scrambled under a train

SCIENCE MAKES THE AIRWAYS SAFE

Quite apart from the public's faith in it, radio is destined to bear a tremendous part in passenger aviation. Secretary MacCracken told me:

"Radio will have three mighty important functions. First, as a reliable automatic guide—radio directional beacon, you know. This will make up for the shortcomings of the magnetic compass. Second, for the dissemination of safety information. Weather reports and changes will be transmitted to pilots aloft; while pilots who might be forced down can send their location and summon help. Third, handling messages of convenience both for pilots and passengers. Pilots can report their express and mail cargoes so that ground arrangements can be made in advance. Passengers can talk to their offices and homes."

The Department of Commerce, in conjunction with a committee representing the aeronautical industry, is engaged with the Federal Radio Commission in drawing up a standard system of nation-wide radio stations. These will be for the use of all air lines. To prevent chaos, frequencies will be allotted to certain regions rather than to individual carriers. Low-powered transmitters will be employed, closely spaced. Meanwhile, however, the big passenger operators, getting ready for spring, have been devising and organizing their own systems, pending a federal standard. They have been experimenting with two-way radio telephony, with various directional finders and the like.

Paul Henderson, vice president and general manager of TAT, told me of the exhaustive researches and experiments his company had carried on to find a foolproof radio system—and the result. Elaborate in conception and organization, it is remarkably simple in application.

TAT will designate one town on each of its flying divisions as a clearing house for weather reports and operations orders. An expert meteorologist and observer will be stationed here at the elbow of the division superintendent. This weather chief will have three things to guide him: the regular Department of Agriculture Weather Bureau daily chart, weather reports from bureaus in every state, and special reports from observers at railroad stations for hundreds of miles in all directions from the chief's post.

These railroad station observers will be the regular station agents of the various railroads—an arrangement made possible by TAT'S close financial and operating affiliations with railroads. They will be specially trained by the TAT, and each will be supplied with meteorological instruments costing about \$1,000. However, the functions of these agents will be purely negative; they will make reports, on prearranged forms, only when they discern unfavorable tendencies or conditions. The taking of observations will employ one hour of each agent's time each day.

CURIOSITY WILL PLAY ITS PART

From these channels, the division superintendent, through his weather chief, will thus have at every instant an accurate knowledge of weather conditions at any and every field.

The plane carries twelve passengers, two pilots and 1,000 lbs. of cargo 120 miles an hour.

© Western Air Express, Inc.

The \$100,000 international air-rail terminal at Miami has customs, immigration and public health offices, restaurants, observatory deck and other facilities.

© Pan-American Airways, Inc.

Since most air accidents to licensed planes in the past have been due to pilots' mistakes in judgment, this system is significant because it lifts from the pilots for the first time all responsibility for decisions. They simply do as they are told by the division superintendent, who is in constant radio telephone or telegraph touch with every ship aloft.

A pilot might say into his transmitter: "There's a fog bank ahead; what shall I do?"

And the superintendent might reply: "Go through. It only extends three miles across your route. The next field is open."

Or a pilot, feeling chipper, might report: "Weather sure looks sweet ahead, boss, not a cloud"—and be told peremptorily: "Turn back and land at Field F to await further instructions. There's a twister coming up from Oklahoma and headed directly across your route near Field G."

Colonel Henderson is typical of aviation leaders—fired with the great things at hand, yet eminently cautious. He took care to emphasize that while this system was the best TAT had found up to this stage no

man could say, what with the swift progress in radio discoveries and technique, that April's method would not be obsolete by August.

The important thing from your point of view and mine is that passenger safety is the paramount concern of the air carriers. There is nothing of the old-time railroad pirates—who could say, "The public be damned"—about men like Henderson, Hanshue, Boeing, W. R. Ireland, Frank Robertson and the others who are organizing passenger aviation in this country.

Now you are reasonably convinced, we'll assume, that licensed air travel is safe and that the cost is moderate enough, figured in hours and distance and social and business values. So you grow curious as to just what you will find regular air travel like. What will be the sensations of flying in those huge tri-motored liners of the skyways?—will you be comfortable?—ill?—on time wherever you're going? Curiosity, as much as any other consideration, will probably impel you to take your first air trip.

It is a day in early summer, let's say, and you've just got a telegram summoning

you, as soon as possible, to a city 500 miles away on urgent business. Having reached the momentous decision to go by air, as a novice you glance into the sky with some misgiving. Nary a cloud. No excuse. So you sigh a little, grin a little, and wonder about reservations.

A MODEL TERMINAL

You can phone the carrier's town office, or the airport; or, if it is handier, you can book passage at any railroad station. Before the middle of summer practically every railroad in the country will have wedded its service and some of its money to air carriers. For example, in the Winsted, Conn., railroad station you will be able to buy through tickets, rail and air, to Merida, Yucatan, on the Pan-American lines.

Presently a luxurious bus picks you up
(Continued on page 1130)





By E. W. Sawyer

THE recent developments in the field of motorless flight have been little short of amazing. Hundreds of individuals and flying clubs all over the country are now actively participating in this thrilling and invigorating sport.

As already well known to most readers, the motored plane resulted from early experiments with gliders; but it has remained for present-day aviation enthusiasts and sportsmen to take up and popularize *gliding* and *soaring*. Motorless flight is well on the way toward becoming a national sport, and the air-minded public is becoming aware

of its tremendous significance in the history of aviation in the United States.

There are sound and fundamental reasons for gliding and soaring activities. First of all, the glider is a relatively cheap and practically safe vehicle for introducing the

novice to the air. Moreover, the glider-trained pilot has a great advantage. From the very first, he maintains his lateral balance in flight by "feel" alone; in other words, motorless flight develops in the student pilot that "sixth sense" of equilibrium.

At the right, we have a "secondary" or "circling" ship; below, a "soarer" of the Darmstadt type, the finest of motorless planes, taking the air.

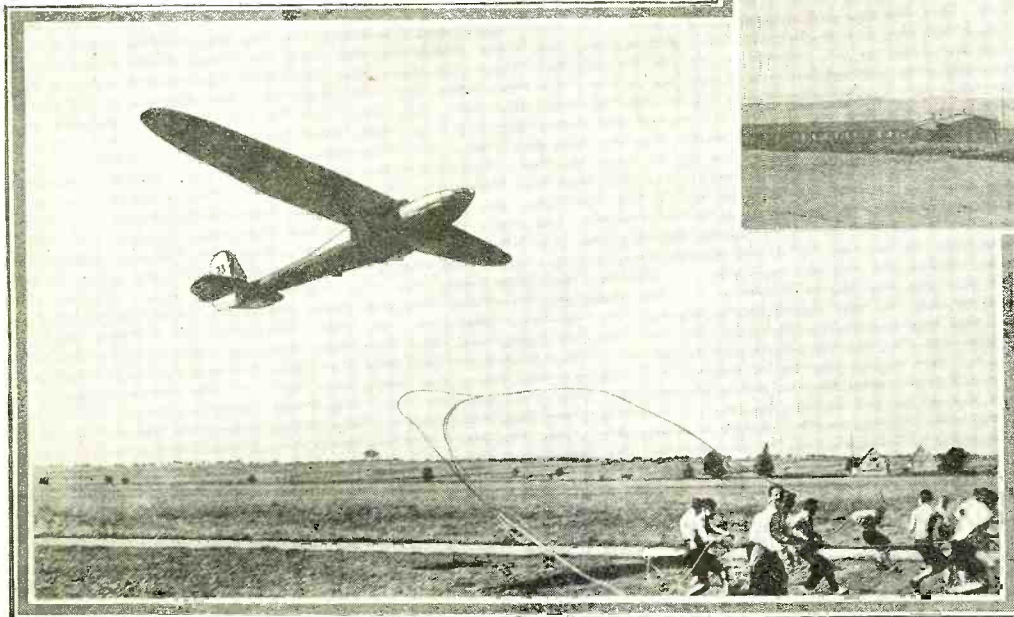
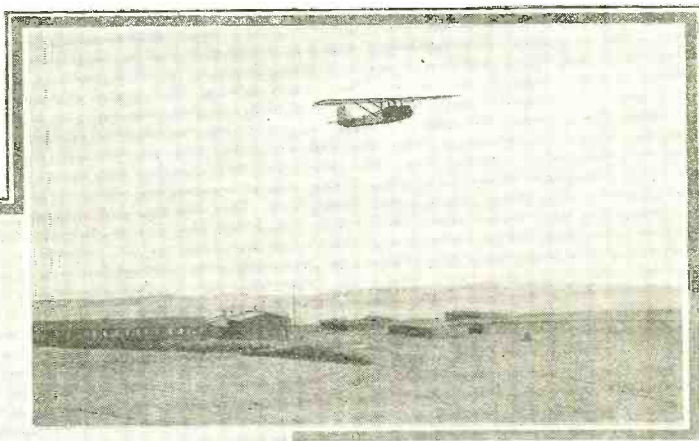

The author of this article, who is associated with the Detroit Gliders Sales Co., is an enthusiast of the sport as well as interested in a business way. His explanation will intrigue all not yet familiar with the subject.

The heading illustration, furnished like the others by the courtesy of the National Gliders Association, represents Miss Amelia Earhart ("Lady Lindy") about to take off in a "primary" or training glider. A new thrill for a transatlantic flier!

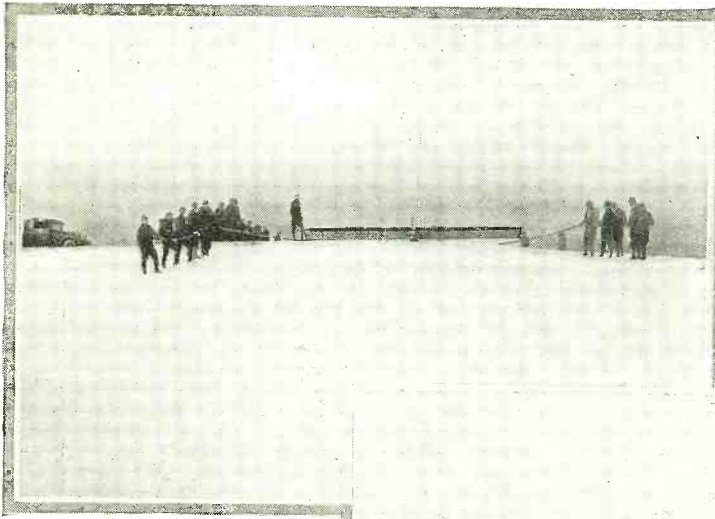

The several steps in the taking-off of a "schooling," or "primary training" glider are shown in the three pictures here. In the first the rubber "shock-cord" has been fastened in its center to the glider, and five of the "ground crew" have taken hold on each side, awaiting the word.

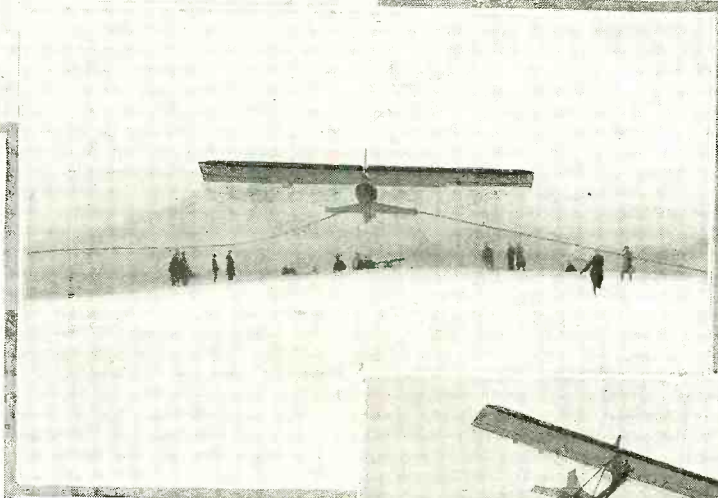

In the center we have the glider lifted into the air by the pull of the runners, the "shock-cord" slackening as the glider gains speed. In the final view the glider is free, with its tail rope in the air and the shock-cord falling to earth. The pilot is now "on his own."



HOW IT IS DONE

The average landing speed of a training type glider is about twelve miles per hour, and the static gliding angle is in the neighborhood of one to ten. The take-off is accomplished by the catapult method. The "ship" is launched into the air by means of a piece of rubber "shock-cord" about 40 yards in length. The cord is attached to the ship at its centre, which is looped and slips into a hook placed for that purpose at the nose of the glider. The two free ends are extended out in front of the ship; so that they make an angle of about 30 degrees, bisected by the proposed line of flight. The ship is held stationary by a short piece of ordinary rope, fastened on the tail and held by one or two men.

At the command "Walk!" the members of the ground crew pulling the two free ends of the shock cord, walk forward stretching the cord. At the word "Run!", they do so. The pilot then cries "Let Go!" The little ship gathers immediate momentum and soars up into the air. The accompanying series of take-off pictures will serve to make clearer just how this is done.

The slow flying speed of the training glider, combined with its low sinking rate, gives the novice a chance to take a "shot" at flying "with one foot on the ground." In an ordinary wind he will have decent controllability with a ground speed of only ten or twelve miles per hour.

ACQUIRING THE FLYING SENSE

The pilot of the training or schooling glider sits well forward of the wing, and hence cannot use that as a line of reference in checking his lateral balance; he has none, except the horizon and his sense of "feel." To get all the way down the hill with his ship, he must develop a sense of balance; and the remarkable part of it all is that, after scraping the ship's wings on the turf a time or two, the student begins to do tolerably well. He learns to make slow turns and, above all, he learns to land his ship.

Every landing with a glider or soaring plane is a "dead-stick" landing. One can't "give her the gun" and come back and try

again. If the student notices too late that he is settling down on rough ground, he has to make the best of it. The slow landing speed of the ship saves him any serious damage to his ship; and he learns soon to "set it down anywhere."

TYPES OF SHIPS

In general, there are three classes of gliders and soaring planes: (1) the primary training, or schooling glider; (2) the secondary, or circling ship, and (3) the soaring plane of the Darmstadt type.

The primary training or schooling ship, properly designed and constructed, is sturdily built to withstand the shocks and strains incidental to its use as a training unit. Several firms are manufacturing ships of this kind to sell at around four hundred dollars. This type of glider has a low aspect ratio (about 1:6 or 1:7) and is built with high controllability and stability factors.

The secondary ship is of much the same dimensions as the primary training craft, but has an enclosed fuselage, greatly cutting down the wind resistance and improving its aerodynamic characteristics.

The Darmstadt type of soaring plane represents the acme in motorless design. With

a wing span of some 60 feet, and an aspect ratio of 1:20, is combined a fully streamlined fuselage. It is in this latter type of ship that the astounding records for flight endurance have been made in Europe and last summer at Cape Cod. All types of gliders and soarers are equipped with standard aircraft controls; *i.e.*, stick and rudder bar units.

ASSOCIATION ACTIVITIES

Early in 1928 there was formed at Detroit the Evans Glider Clubs of America. Its founder was Edward S. Evans, a Detroit capitalist, widely known for his various aviation interests. The Evans Glider Clubs have since come to be known as the National Glider Association, and now is the official parent organization of gliding and soaring in the United States.

Under authority from the National Aeronautical Association it issues "B" and "C" class glider-pilot's licenses. The "A" class soaring license is issued directly by the N. A. A., upon the pilot's completion of final soaring tests and producing his "B" and "C" class gliding licenses as evidence of sufficient training. With Edward S. Evans as the present president, and an auspicious group of directors serving as advisors, the National Gliding Association seems eminently capable of handling the motorless field.

Among the pioneers in collegiate interest in gliding is the Aero Society of the University of Michigan. The student group there have already purchased one training glider and have constructed several others. They are, at the present time, engaged in a flight training schedule for members of the society.

Typical among the other glider clubs that are being formed is the San Francisco Glider Club. This group has built its own equipment and done a great deal of successful flying; and the word has been carried by the Associated Press all over the nation. This type of introductory work is (Continued on page 1146)

Automatic Radio Transmitter Designed For Emergency Use

By C. P. Mason

INGENUITY, as well as skillful workmanship, is shown in a new device which has been recently produced by a leading French manufacturer, and is capable of sending messages of a limited nature from the radio transmitter of a ship or of an airplane, without any knowledge of the code by the person operating it. It is not, of course, intended to make an operator's

(Continued on page 1145)

An automatic transmitter of distress signals, etc., designed for airplane use. The slides are set to send the plane's position. (Courtesy Société Française Radio-Electrique.)

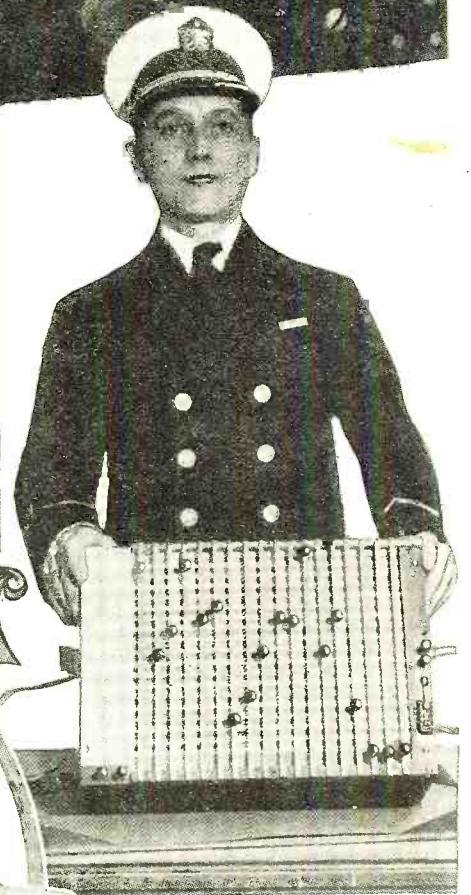
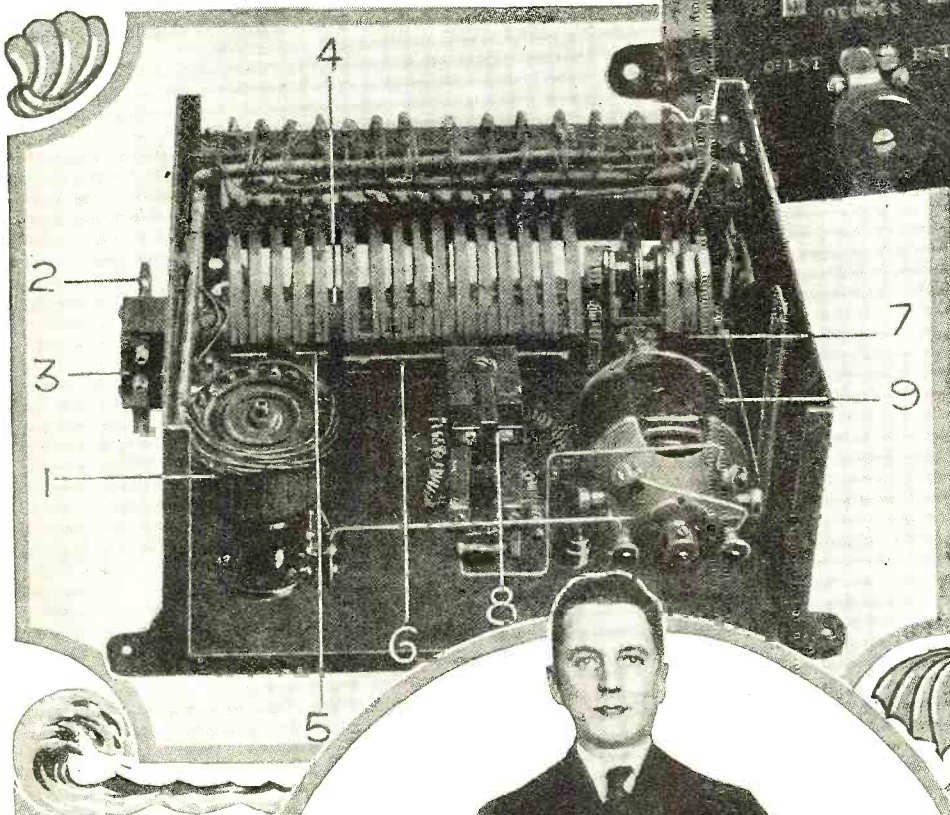
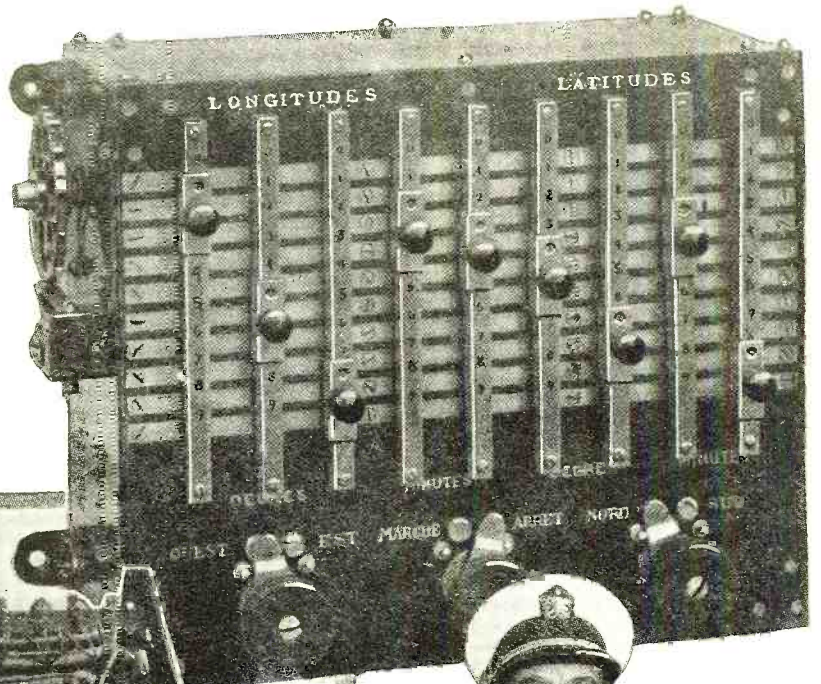

Above, interior view of the automatic transmitter, showing the working parts. The 19-contact distributor (1) is revolved by the motor 9. The "SOS" signal disc, which may be replaced by others cut with conventional signals, is at 2; its auxiliary keying device is 3; the contact-drum at 4 makes connection with the ring 5 (shown at B2 in the diagram, Fig. 1) which carries the points of the compass in code. The ring B1, adjusted by the slides to give positions, is at 6; and 7 is the ring into which the call letters are cut. The relay 8 operates the regular radio transmitter to send out these signals.

Above and at the left, Lieut. Pedro C. Andres of the Cuban navy is shown with his automatic transmitter, which he exhibited and demonstrated at the U. S. Navy Department in Washington. The model shown here, for ship use, weighs fifteen pounds; it includes several additional slides.

© International Newsreel Photo.

Making Room at the Top in Radio

Which Begins a Series of Brief Biographies of Figures in Radio Industry Who Did Not Wait For Opportunity to Knock at the Door

By A. Henry

HAVE you ever sat in one of the skyscraping stadiums which now dot the land and watched a famous football team in action—and then, later in the game, had an opportunity to stand close by the side-lines and see that team rush past you, literally shaking the ground as it bucked the line of its adversaries with speed “faster than the eye can follow?” That is, perhaps, a feeble suggestion of the impression one gets from meeting the newest and youngest among those radio manufacturers who hold the coveted “RCA license.” He is one of the most remarkable figures in an industry distinguished for the number of young men who have attained high places.

Yet, lest the impression be conveyed that McMurdo Silver is a superman sent to earth with some peculiar sort of silver spoon in his mouth which causes difficulties to vanish before his inspired onslaught, it had best be explained that such by no means appears to be the case. Those familiar with Silver's short but adventurous business life know that, if he is a whole football team in himself, his life has been no continual succession of marches down the field to repeated touch-downs. On the contrary, there have been times when the ball was in the enemy's hands, with the line gritting its teeth to withstand the opponents' determined rushes. But, after all, the important thing about a football game is the final score. And there is no better way of stating his score than to say that in 1924 Silver went into the radio parts business with a determination to attain leadership in that business within five years; and that the thing was done in four years instead of five—for 1928 saw Silver-Marshall at the top of the heap!

And—if further evidence is needed—1929 finds this same 26-year old executive the recipient of a manufacturer's license from the Radio Corporation of America, General Electric Company, Westinghouse Electric & Manufacturing Company, and American

Telephone & Telegraph Company, to manufacture radio receivers under the famous “pooled patents” which opened the door to large-scale radio production in the market of the middle twenties. When it is remembered that these licenses have consistently been issued only to large and long-established radio manufacturing corporations—and that a minimum payment of \$100,000 per year is required of each licensee as compensation for the use of these combined patents of the largest electrical research laboratories in America—it becomes clear that those in the high councils of electrical big business are much of the deliberate opinion that McMurdo Silver is a “good bet.”

And the story of this man who is still a mere boy, is doubly interesting; for it can easily be the story of any “amateur” young man of today, if only he is willing to follow in Silver's footsteps, and work and study to fit himself—not to seize, but to do as Silver did—to make, his own opportunities.

McMurdo Silver was born on the 15th of March, 1903, in Geneva, New York—almost a St. Patrick's baby. His father was professor of ancient history at Hobart College. Both of his parents were of American stock for several centuries back, with Scotch, English and French blood behind their American ancestry. The boy's early youth was uneventful except, as this narrative may fall in the class of “success stories,” it must be stated that young Silver did not run true to “success” form. He was not a leader among the boys of the town, he did not play the most devilish of practical jokes, and he was not at the head of his class—actually, he was far from the top, most of the time. Nor was he a book-worm—in fact, up to the age of nine, nothing unusual seems to have been apparent in the boy except a rather noticeable seriousness.

AS THE TWIG IS BENT

At the age of nine, “wireless” came into Silver's life. How it came, and how he assimilated it, forms an amusing anecdote. Some older members of his family, seeking to instill educational thoughts in the child's mind, one day read to him two accounts from a monthly magazine. One was of “wireless,” which had come into the lime-

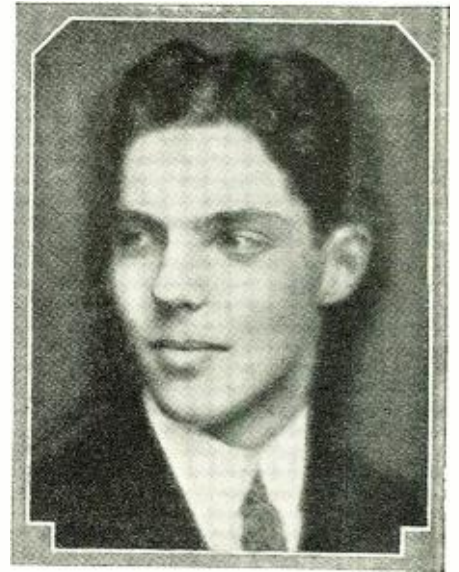

McMURDO SILVER

light of public attention through the sinking of the *Republic* and, just then, of the *Titanic*. At the same time an account was also read of the Mexican Rurales, a troop of mounted police recruited from criminals by the simple and masterly expedient of catching one, putting a rope around his neck, placing him upon a horse all ready to be gently stroked with a whip, and asking the individual so situated if he wished to become a Rurale, or if he preferred to dismount from his steed posthaste and remain in the unenviable position of hanging by his neck to an obliging tree limb, separated from it by several feet of rope, and from the ground by several feet more. The answer, unless choked off by the culprit's emotion, or the executioner's desire for the unusual negative reply by way of a bit of extra excitement, was invariably “yes.”

Strange as it may seem, these two bits of instruction stuck firmly in the young man's mind. The next day the cook, called to the back yard of the family residence by unearthly yells, beheld a strange sight. Sitting astride a saw-horse was a young Mexican boy hurriedly conscripted for the part of the convict. His hands were tightly tied, and a very heavy rope, almost thicker than his pudgy arms, connected his unwilling neck with the limb of a small tree directly above him. He was calling loudly upon all the saints known to him in a somewhat unintelligible imitation of Spanish. Next to him stood one of the “Silver Gang,” asking loudly and repeatedly whether he “joined or died.” The executioner, in anticipation of the reply, held the nozzle of a length of garden hose in his hand. Some distance away, in a confiscated wash-boiler, stood the instigator of this new game, holding the other end of the hose in one hand, while in the other was another piece of hose which reached back to the gibbet and terminated in the grimy grip of the assistant executioner. As the victim's pleas were uttered, the executioner shouted them into one hose, through which they were presumably transmitted to the ship at sea, represented by the wash-boiler. From there, through the other hose, the verdict was shouted in a high falsetto to the assistant executioner, who in turn put the all-important question to the prisoner.

In this way wisdom was assimilated by



A young constructor, a few years back, busy with a set which its contemporaries can readily date. He has since grown up with the industry—in fact, from a business standpoint, much faster.

the analytical mind of McMurdo; communication with ships could only be through rubber hose, since one couldn't shout several thousand miles. And to use "wireless telegraphy" one had to have a reason; which was opportunely provided by the recalcitrant son of a Mexican villager, who might even yet be reclaimed to the cause of the law by strong-rope methods and the marvels of radio.

THE TREE'S INCLINED

Having had the error of his ways physically impressed on him in no uncertain manner, the inquiring streak of Silver's mind came to the surface. He set out to find out about "wireless," and the reason for his chastisement. This he did for several years with no overpowering success. To earn money to buy the parts with which to experiment, he obtained a job that every older boy in town had had before him, and given up after a few days—or few weeks—for the job required a degree of regularity abhorrent to a small boy's soul. It was the newspaper route in the village. Every day, including Sunday, the boy had to get the New York City papers from the noon train, make up his route, and deliver papers from one end of town to the other, rain or shine. Fortunately, Silver's school hours permitted this and somehow he held the job not for a month, but for years. And so the paper route that had once been a source of emergency revenue to small boys of the town, ceased to be a source of annoyance to the methodical villagers who wanted their papers promptly on the dot, and seldom had got them. But let us not give young Silver credit for too much perseverance. Two factors held him on the job, rain or shine, winter or summer. The first was a parent anxious for his daily paper to arrive promptly and regularly, and the second was a similar determination on the part of the no-longer harassed proprietor of the route, which manifested itself in a much more substantial manner than parental orders.

All the money gained does not seem to have given him a "wireless" that was ever the talk of the town, but the foundation was being laid; he was reading and studying "wireless" to a point where his school studies suffered badly. Early in 1916 Professor Silver died, and the young man moved to New York City with his mother. By this time he had managed to squeeze out of grammar school, from which he never did graduate, and into high school; and for three successive years he was the discouragement of his instructors, all of whom finally gave him up as hopeless, and firmly threw him out of school.

So on a memorable Armistice Day of November 11, 1918, while Wall Street was covered from top and bottom with paper and ticker tape, and the world was terribly jubilant at the prospect of peace after the long repression of the war years, young Silver started to work in earnest to help support his family. And had Professor Silver been alive, it is doubtful if he would have been greatly grieved at the failure of his son to acquire an academic education; for the liberal-minded father had always felt from his years of experience that for a young man so uninterested in a college training as not to desire it, or to be unable, through lack of interest, to assimilate it, its loss was no real loss.

But this time the secret of Silver's success could be seen, but by most parents it

would not have been recognized. He was a failure at school; yet at the age of thirteen, in 1916, he had written, and had succeeded in having published in a sporting magazine of the day, an article of several thousand words on a subject in which he was deeply interested—early American firearms. This was during wartime, and as "wireless" had been prohibited to amateurs, Silver had thrown his whole interest into studying his other hobby, antique guns. His interest was so great, and he had spent his waking hours in such deep study and determined efforts to satisfy his curiosity at public libraries, museums, and in gun stores, that he possessed at the age of thirteen a more complete knowledge of early American arms than many a veteran collector or dealer. And this knowledge had enabled him to earn many hundreds of dollars in the years of 1916, 1917 and 1918 in buying, selling and trading old arms; for in this field his commercial talent first showed itself.

Interested as he was in firearms, he could not enlist, for he was but fifteen years old when the war ended. The ban was lifted from radio shortly after Armistice Day, and Silver began to experiment again, with the new vacuum tubes that had been developed during the war. Not content to work as a Wall Street messenger during the day and play with wireless at night as most boys would have been, he added the commercial element of building, buying and selling the crude "wireless" parts and sets of the day in addition to his trading in old arms. Silver was ambitious, and spent in study his every waking hour outside of a job that he seldom left before seven or eight o'clock in the evening.

WORKING INTO RADIO

The story is told that he gave himself five years to become a partner in the old, established brokerage house for which he worked and, upon finding himself advanced

only to the position of quotation-board boy after a year and a half, forsook Wall Street. At this point his life work was determined upon. Up to then "wireless" and antique arms had had his almost equal interest. The offer of a position as laboratory assistant in the tube laboratories of the Westinghouse Lamp Company at Bloomfield, New Jersey, decided his fate and radio definitely claimed him early in 1920. The work of developing the tubes that preceded the present Radiotrons so intrigued Silver that he decided to become an engineer—this lad who had failed at every scholastic study. How did the boy who had been disappointed because he could not rise to the top over night in Wall Street go about it?

His interest aroused, he set to work, blindly at first, then pointedly. First he asked—"Why can't I have an engineer's job now?" And when laughed at he persisted until he found out concretely just what he would have to do to become an engineer. Having then little money for education, he decided to take night courses in engineering at Cooper Union. But he was unable to pass the entrance examinations; for his only education was what he had absorbed from his parents and dug out of his hobbies for himself. Unable to take up an engineering course at once, he set out to lay the groundwork that would enable him to enter Cooper Union later. Starting in another night school to prepare, he soon passed his examinations at the head of one class, second in another. Such was the strength of his interest when once aroused. In the meantime, having learned all he could at the Westinghouse Laboratories without knowledge of his own, he went to work for a radio and electrical jobber in New York to broaden his experience. Not greatly interested in his work, he made no startling success, though promoted twice in eighteen months, once to head of his department, the second time to a higher department.



A modest start for a manufacturing industry: the second floor of a garage in a Chicago suburb was the first home of "S-M." (Turn the page.)

The spring of 1922 saw the radio broadcasting boom well under way, and the formation of the Griffin Radio Service—to become in a few months the Haynes-Griffin Radio Service, well known to all old-timers—and when the new store was opened Silver was on hand as first employe. The summer of 1922 brought the partnership of A. J. Haynes and John Griffin as the Haynes-Griffin Radio Service, and in the fall came the Haynes D.X. Tuner, one of the first kit-sets ever developed, and the work of A. J. Haynes.

Superheterodynes were almost unknown to the average listener of that day, but Silver's mind, always ranging ahead, realized the possibility of the superheterodyne circuit for broadcast reception. He "sold" both Haynes and Griffin of the idea; the result, in 1923, was the Haynes Superheterodyne, practically every experimental model of which was built and most of the actual testing work done by Silver. After this, he spent a month at Plattsburg training camp, "resting." Intensely interested in his job, Silver worked day and night. But he did not work blindly. He absorbed ideas like a sponge, always prying into things, asking "why?" And as soon as he was told, experimenting to see if he had assimilated the idea well enough so he could do the thing himself—always, always trying until he could. He soaked up merchandising, advertising, selling and engineering ideas with equal rapidity as a result of his intense interest and curiosity, and continuously stirred these ideas about in his mind until he produced a newer one from them.

GOING WEST

During this period a number of influential New York business men, caught by the radio craze and sensing Silver's ability, offered to finance him in a business venture of his own, but he would not leave Haynes-Griffin to start out on someone else's capital. In 1926 the unexpected death of a step-grandfather (Frederic Courtland Penfield, ambassador to Austria from the United States, just before the war years) and an equally unexpected bequest, gave Silver his chance. Sensing Chicago as the coming radio center of the country, Silver said goodbye to Haynes and Griffin, went to Chicago, and organized, with his distant cousin, John R. Marshall, the firm of Silver-Marshall, Inc. Silver gave the new firm five years to become a leader in the radio parts business—we shall see if his determination was to be as ill-fated as the earlier one, to jump from messenger boy to partner in the brokerage house in five years.

Silver and Marshall laid their plans well. In those chaotic days they realized that, if they were going to manufacture parts and kits, they must have a retail store to service them and help users, and they would also have to act as jobbers. So they opened a store on Wabash Avenue in Chicago and took the second story of the garage pictured.

spring of 1925 saw Marshall retiring from an active interest in the young concern and Silver carrying on alone. As the manufacturing business developed, the need for a wholesale business diminished, and it was abandoned. Soon it was possible to abandon the retail store also, and 1927 saw these two stepping-stones cast away, and Silver's whole attention devoted to manufacturing. The unexpected business slump of the fall and winter of 1926 hit Silver-Marshall hard, as it did other manufacturers. But the young concern pulled through a period of acute financial stringency, and by the fall of 1927 was well out of the woods, and with a not-to-be-forgotten lesson behind it.

In just four years after the opening of the S-M store, Silver had achieved the goal

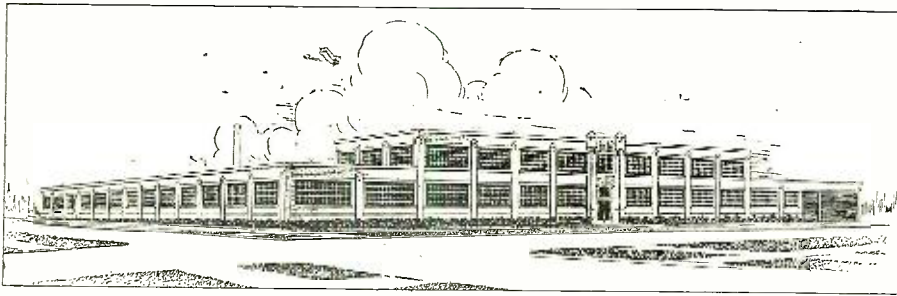

Five years later: the most modern factory architecture characterizes the extensive plant which Silver-Marshall will occupy in their fifth year.

he had given himself five years to attain—Silver-Marshall had become one of the largest manufacturers of radio kits and parts distributed through jobbers and dealers in America. In 1928 the firm's position was further strengthened, and leadership in the parts business was lifted well beyond the reach of competition—in a market in which the gross sales had fallen almost forty per cent. a year for every year that Silver had been in it for himself. And—his goal attained . . . a new one which had always been in his mind's eye was quickly set.

Such is the story of a young man who has not ridden to success overnight on a wave of gambler's luck, but who has worked very step of his way upward in a business that has decreased greatly each year. Had the radio parts business increased each year, it would be difficult to estimate Silver's position today, but no favorable boom of general business in his line ever gave him a boost.

AS A LEADER

What, then, is the man like who at the age of twenty-six is the youngest executive to have obtained the much-coveted R.C.A. manufacturing license which many an old, established corporation has not been able to secure? Over six feet tall, of lean build, he is a combination of nervous energy at one moment and almost phlegmatic calm at the next. But through all runs the determination that is his secret of success—the will to do what he sets out to do, in one honest way or another. This determination is seldom expressed, but it is evident at every moment in a grimness of purpose that never brooks the excuse, "It can't be done because no one has ever done it before." No man in the S-M organization can ever come, discouraged, to the president, and say, "It can't be done," but Silver will reply, "It can be done—but maybe in another way," and then work to find the way. For a man

of a rather mercurial temperament, given to ups and downs of feeling, this steady, never-yielding determination is one of his most interesting and contradictory characteristics, for this man's mind is never "made up." It is always open to suggestion—his mental attitude is always that of the true student, seeking to learn all he can from other men's thoughts and methods. To him the pride that will not allow a change of mind is unknown; if the humblest of his employes wishes to tell Silver that his decision upon one subject is wrong, he will listen attentively—and change his mind in a flash if the arguments advanced are better than those on which his original decision was based. He is never unwilling to take older counsel, and has steadily added to his organization

older men of far greater experience and wisdom than himself, that he may seek their advice.

But though he seeks advice on all matters, important or unimportant, Silver possesses to a marked degree that first requirement of a great executive—the ability to make an instantaneous decision, later to be revised, maybe, if they prove wrong, but made so quickly

that the wheels of his organization are seldom stopped "waiting for the president to make up his mind." He can make up that mind in a flash, and the accuracy of his instantaneous decisions is a by-word with his associates. Yet there is nothing at all phenomenal in this—it is simply the instantaneous summing up of the facts that have been gleaned and continuously mulled over in a mind which is never still, waking or sleeping. Both conscious and sub-conscious mind are always working at top speed—yet a speed that is possible to any other boy once his interest is really aroused.

AN INTERPRETER OF RADIO

Silver is best known to the public as a writer of technical articles. Editors everywhere, of magazines and newspapers alike, learned that articles sent them by McMurdo Silver and published over his name, were found to be intensely interesting to their readers; and when an editor wakes up to such a realization, it requires no button-holing, or sending of flowers or beverages to induce him to publish the "stuff." One of the things which editors liked most was the completeness of the information which Silver gave in his articles as to how the radio sets he wrote about could actually be built. Little things which most writer passed over as being "clear to anybody without explanation" Silver explained carefully; for he realized that in order to be of greatest value, articles must be such that the reader need not be an expert in order to understand them. True, his articles contained, as a part of the unusually complete information they supplied, a list of parts which would be required to build the radio set described, and in these parts one was sure to find several of the "S-M" make. This was in large measure the kind of "advertising" which caused the Silver-Marshall business to grow by leaps and bounds—and it was published

(Continued on page 1138)

What's New in Radio

A Double-Range Receiver

THERE is a great demand for a receiver which will cover both the regular 200-550-meter broadcast band and the short-wave bands now extensively used for broadcast purposes. Several solutions have been offered to overcome the lack of efficiency and selectivity, on the broadcast band, in sets using the usual low-capacity condensers for tuning; but the method described here is the most logical and economical put forth up to this time. The results are equal to those obtained when separate condensers are employed for the two bands; and much less space and apparatus is required.

The system is shown in the pictures of a new short-wave receiver. The tuning condenser used has two sections; one (the smaller one used for the short waves) is connected permanently in the circuit. An additional set of plates is fastened to the same shaft, but is connected in the circuit only when a small switch on the side of the unit is closed.

In this way, the actual capacity range of the condenser is very wide; on short waves it is small enough to allow easy manipulation of the set while on the broadcast band (thanks to the switch and the additional plates) the capacity is made sufficiently high to assure sharp tuning. This is a wide departure from the ordinary method, but, as may readily be seen, it is both efficient and economical.

The actual design of the set is not unusual and follows the ordinary construction of the short-wave receivers made by the same manufacturer (The National Company of Malden, Mass.). All the apparatus is mounted on a metal chassis, and a metal cabinet is provided with the construction kit. This assembly makes the receiver neat in appearance as well as substantial; while the cabinet serves also as a shield.

Four tubes are employed, one of which is a screen-grid 222-type used as a radio-frequency amplifier and coupling tube. Its input is not tuned, but is coupled to the aerial by a radio-frequency choke. The detector is coupled inductively to the radio-frequency amplifier, and the regeneration in

are fastened to the back of the sub-panel. The batteries are connected through a cable provided for the purpose.

The dial for the tuning condensers is of the vernier type, to facilitate close tuning, and a dial light is mounted at the top. Its appearance is decidedly attractive.

The tuning coils are of the plug-in type, each of the set containing three windings. The primary is larger than usual, because of the use of a screen-grid tube, which requires a higher output impedance. The plate coil or tickler is fixed, since the regeneration is controlled by the variable resistor R3. Two fixed resistors, R1 and R2, reduce the voltage of the "A" battery to the correct values for the tubes. The grid leak R4, which depends in value on the tube employed as the detector, may be 3 megohms, or higher with a 201A. The blocking condenser C6 prevents a short-circuit between "B+ Det." and the filament.

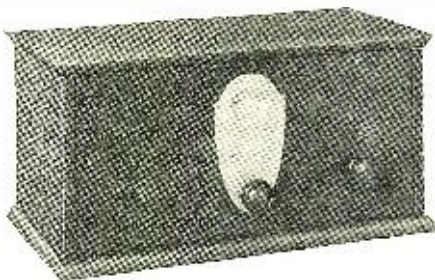

Fig. A

The new National short-wave and broadcast receiver in its attractive metal cabinet, with hammered-silver dial. The volume-control is at the right, and the switch at the left.

this stage is controlled by a variable resistor in series with the "B+" lead to this tube. A radio-frequency choke coil is placed in the circuit, between the detector and the audio-frequency amplifier; it serves the purpose of keeping the residual radio-frequency currents out of the audio amplifier.

The audio-frequency amplifier is the usual transformer-coupled type, the two transformers being enclosed in a single metal case. The front panel holds the dial of the tuning condensers C1 and C2, the oscillation control R3 and the filament switch; the remainder of the apparatus is mounted either on or under the sub-panel. Two by-pass condensers C3 and C4 form a low-impedance path for the radio-frequency currents in the plate and screen-grid circuits of the radio-frequency tube V1. Three binding posts for the aerial and the phones or loud speaker

The complete set assembled is shown in the three photographs, Figs. A, B and C. It is supplied by the manufacturer as a kit; but the assembly is very much simplified by the inclusion of a drilled panel and sub-panel. It will be noticed that the screen-grid tube is not shielded; it has been found that this was not necessary, since this tube is not tuned, but merely coupled aperiodically to the aerial. This radio-frequency tube does, however, give a very definite gain on all wavelengths.

A Positive-Action Drum Dial

A DRUM dial of new design is illustrated in Fig. 1. Back-lash is here prevented by the use of a flexible bronze cable which is carried around a number of pulleys and is fastened to the shaft. The method of assembly also permits the driving rod to be mounted directly below the window of the

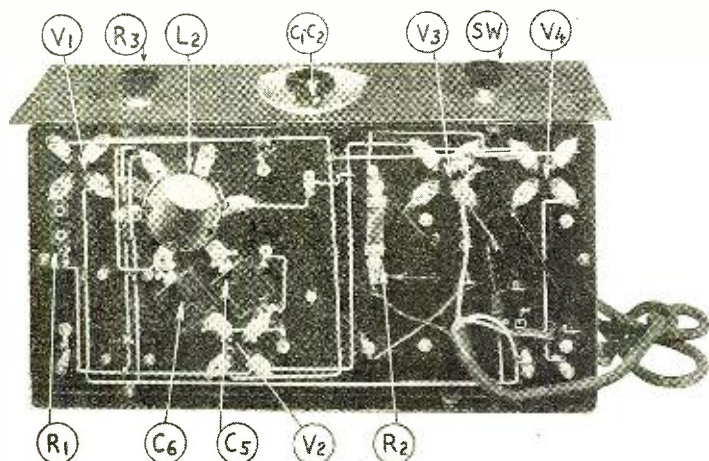

Fig. B

An under view of the receiver; the plug-in coil L2 is inserted through the sub-panel. All the leads, it will be observed, are under the metal chassis, and run to a battery cable. The two transformers are incorporated in one housing, as shown at the right, and the whole is most compact.

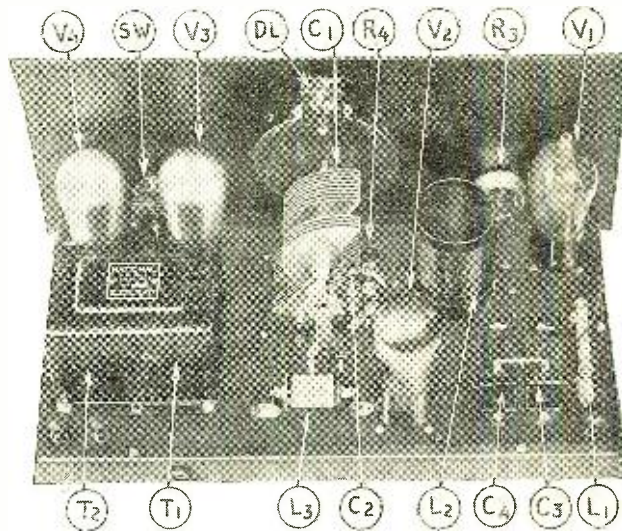

Fig. C

The condenser switch is directly below the grid leak R4.

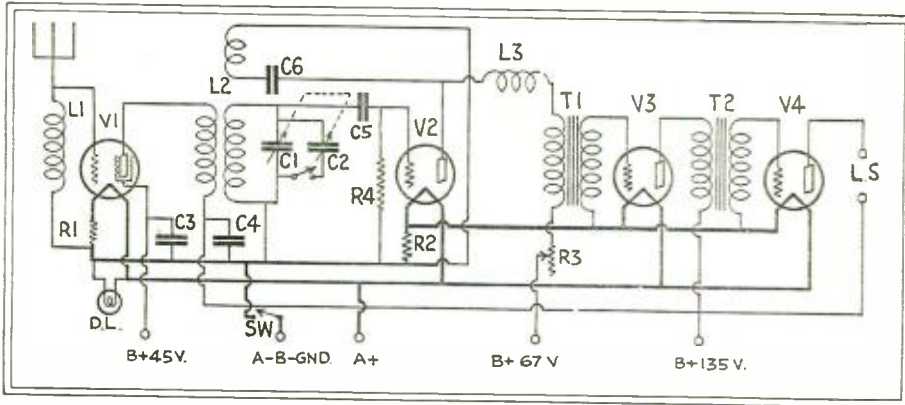

Fig. 1

The schematic circuit of the National combination short-wave and broadcast receiver illustrated and described on the preceding page. The screen-grid stage prevents radiation on any wavelength, while giving needed amplification.

dial, which is an advantage from the standpoint of appearance.

The dial, which is manufactured by Precise Products, Inc., of Rochester, New York, is equipped with a small bulb for illumination purposes; while the calibrated bands which act as the indicating device, are supplied in two types. The first of these is the usual 0-100 graduation, over half the drum circumference, and the second is a scale with the approximate kilocycle readings from 1500 to 550.

A feature of the assembly is the construction of the bracket, which may be used for either sub-base or panel mounting. If the condensers are rigidly fastened to the chassis or baseboard, the dial need not be fastened down, as the knob will prevent it from turning when the panel is in place.

A take-up screw, on the side of the disc, allows the tension on the cable to be adjusted, so that the required degree can be attained. In this way also any slippage which might occur after the dial has been used for some time, can be overcome by turning the tension screw. The use of a bronze cable for the drive overcomes the usual difficulty of breakage or stretching of the cable. The drum is equipped with stops, so that it can be turned but a little more than one-half revolution.

The entire dial and bracket are made of heavy steel, which has been nickel-plated; it measures 5 1/8 inches in diameter.



Fig. H

The new "Radiola 33," a six-tube receiver of metal-console type issued by its makers to meet a popular-price demand. It is shown here in combination with the new "Type 100B" magnetic speaker, brought out also by the R. C. A., and which fits into a special groove on the cabinet.

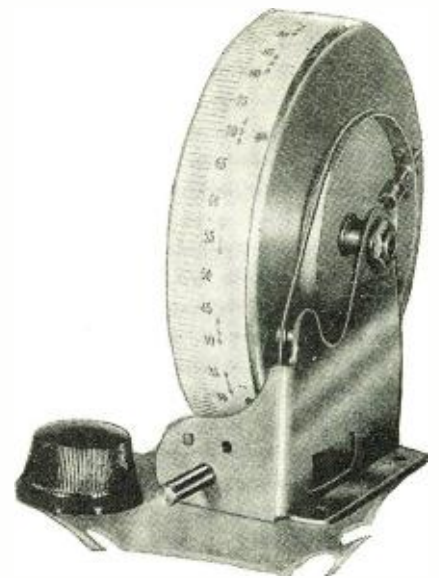

Fig. I

The "Precise" dial described in the first column. It may be obtained with kilocycle readings.

The Season's Receivers

AFTER a winter spent in the design and development of new circuits, and an investigation into the uses of recently developed apparatus, several of the leading manufacturers have announced their latest receiver models.

As was to be expected, these new receivers exemplify such important features, only recently perfected, as the band-pass filter system of tuning, the use of screen-grid tubes in tuned circuits, the adaptation to audio channels and "B" power-supply units of the improved dynamic speaker, and the use of the new intermediate power amplifier tubes (the 245) arranged in push-pull fashion in the power-output stage.

RADIO NEWS is pleased to present herewith a general description of the salient features of these receivers, in so far as this information is available to us.

A group of accompanying illustrations show the new "Eveready" receiver, which is produced in several models, the only difference in the line being the type of cabinet furniture which houses the receiver unit; the "Ware Band-Selector" receiver and the RCA "Model 33."

The "Eveready Model 30" chassis, illustrated in Figs. D, E and F, is a seven-tube, single-dial, antenna-operated, all-electric A.C. set, having three stages of radio-frequency amplification, detector and two audio stages, the last of which consists of two 171A-type tubes in push-pull.

The tuner part of the circuit is one developed by the Radio Frequency Laboratories and, among other things, is different from the accepted run of tuned-radio-frequency circuits in that the antenna-tuning circuit consists of a fixed condenser and variable inductor (variometer), instead of the regular fixed inductance and variable capacity. From the use of a combination of both systems in the tuning unit of the receiver, Eveready engineers claim a more uniform degree of sensitivity throughout the broadcast band of frequencies. Stated in another way this means that (unlike the usual system employed in radio-frequency receivers, where the sensitivity is apt to be greater at the higher frequencies—lower wavelengths—than at the lower frequencies, because of

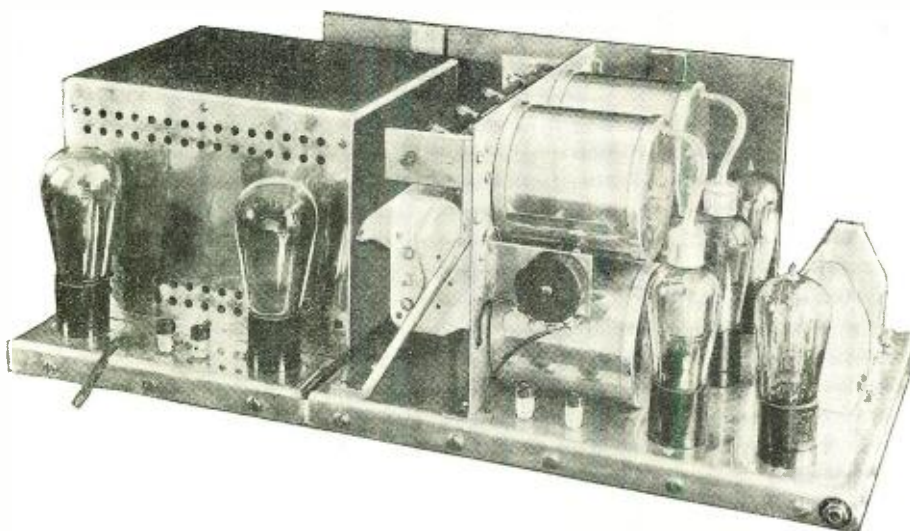

Fig. G

The "Ware Band-Selector" chassis, which incorporates the latest A.C. screen-grid tubes with coupling units of the Vreeland type. The special mounting of the R.F. transformers, shortening their leads to the screen-grid caps, will be noticed. The power plant is at the left, and the gang tuning condenser in the center.

their inherent regenerative tendencies) the Eveready receiver is designed to produce sensitivity which is as pronounced at the lower frequencies as at the higher.

In the audio and power units, which are housed in the same chassis bearing the tuner unit, provision is made for operating a loud speaker of either a magnetic-drive type or the newly developed dynamic type. In the latter case, field excitation is obtained from the power unit.

Through the convenient arrangement of terminals, access to the audio channel is obtained for the operation of an electric pick-up for the reproduction of phonograph records. The unit construction is illustrated clearly below.

THE "BAND-SELECTOR"

The Ware Mfg. Corp offers a receiver employing the band-selector circuit evolved by Dr. F. K. Vreeland, the principle of which has been described in previous issues of RADIO NEWS. Fig. G shows the principal construction features of this receiver, which

utilizes four UX-226 A.C. radio-tubes, one UY-227, and a UX-171A power-amplifier tube; as well as one 280 rectifier supplying plate voltages.

The new loud speaker (Model 100B), which is of the improved magnetic type, matches the receiver in design and fits into a border groove on top of the console.

New Power Tube Available

SEVERAL well-known tube manufacturers have placed on the market the "intermediate" audio power-amplifier tubes of the new 245 type. This tube, which is now available for general use, is not interchangeable with tubes of 112A, 171A, 210 or 250 types; as its filament voltage requirements are of a different order. Essentially, this tube is intended only for use in receivers where A.C. filament current in the order of 2.5 volts is available. It is capable, however, of delivering a power-output equal to that of the 210-type amplifier tube, when operated at little more than half of the latter's plate voltage.

Due to the rigid construction and support of the internal elements of the tube, long life is mechanically assured. Through the use of a heavy, "coated-ribbon" filament a high steady filament emission is maintained.

Because of the high plate current drawn by this tube, it is essential that a coupling unit be employed between it and the loud speaker, for the latter's protection.

This tube may be operated with plate potentials from 180 to 250 volts. The rating and other data concerning this tube, when operated at these voltages, are as follows:

Filament voltage (A.C. or D.C.)	2.5
Filament current, amperes	1.5
Plate voltage	180 250
Grid voltage	-33 -50
Plate current (milliamps)	26 32
Amplification constant	3.5 3.5
Plate resistance (ohms)	1950 1900
Mutual conductance (micromhos)	1800 1850
Undistorted power output (milliwatts)	780 1600

The tube is 5 7/8 inches high by 2 3/16 inches in diameter, and takes a UX type of socket. It is now available in the following makes: R.C.A., Cunningham, CeCo, Raytheon, Arcturus and others.

New Audio-Amplifier Design

A POPULAR-PRICED kit, comprising all components of a combination power supply and audio channel incorporating two stages of transformer-coupled amplification, is the latest offering of Silver-Marshall, Inc.

The combination kit comprises units of the new "Senator" line of apparatus which is being introduced by this company and is especially intended for distribution through a popular chain-store organization which handles radio parts.

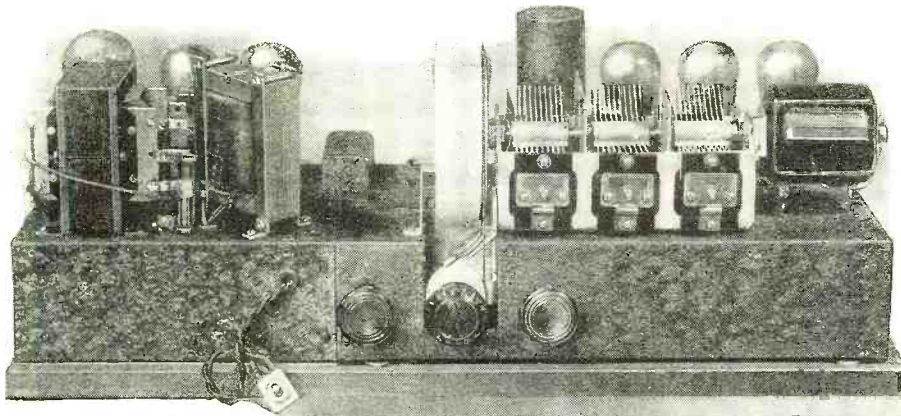

Fig. D

The new "Series 30" Eveready receiver is shown above and at the right in various positions. The bottom illustration (of the front of the assembly) shows only the antenna variometer projecting from the shielding of the R.F. tuning unit; while the single drum dial is inserted into the case. Above, we have the upper housing removed from both the condensers and the audio stages.

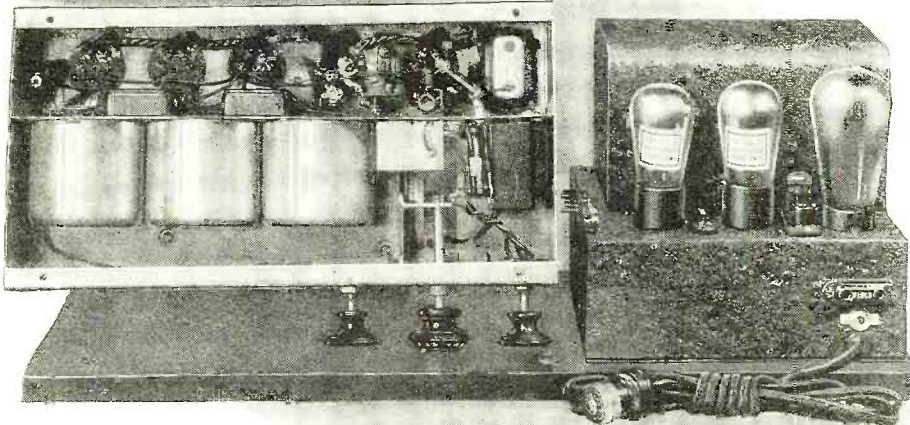

Fig. E (left)

At the left, the rear of the Eveready "Series 30" with the radio-frequency tuning unit up-ended to show the wiring, the interior shielding, and accessibility of parts. The connecting plug of the two units will be observed, and also the pin jacks at the right for dynamic or magnetic speaker connection.

Fig. F (below)

is chassis-constructed. The circuit employs two stages of tuned radio-frequency amplification, each using an A.C. screen-grid tube. The detector is followed by two stages of audio-frequency amplification, the second employing the new 245 (intermediate) power-amplifier tube. A power-supply unit, incorporating a 280-type rectifier tube, is also contained on the chassis.

THE LATEST RADIOLA

A modernistic trend is strikingly indicated in the latest receiver to come from the laboratories of the R.C.A. It is illustrated in Fig. H and is known as the "Model 33."

Three stages of radio-frequency amplification, a detector and two stages of audio-frequency amplification comprise the cir-

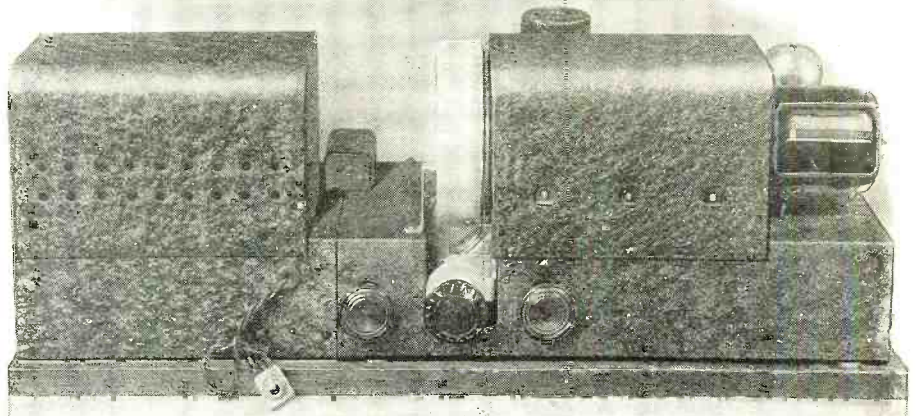

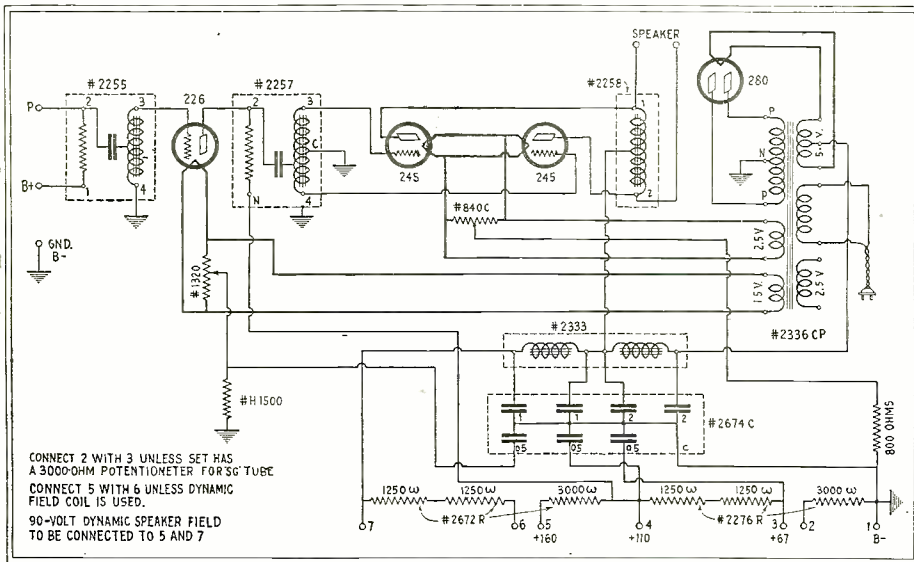

Fig. 2

The schematic diagram of the new 245 push-pull amplifier, using "Scenator" parts, which incorporates a complete "B" power unit. It is adapted for use with a magnetic phonograph pick-up, as well as with a tuner, and will operate several speakers if desired. The simple assembly is shown below.

The audio channel of the combination kit consists of two stages, the first employing an A.C. tube of the 226 type. The second stage is arranged in push-pull and requires two of the new "intermediate" 2½-volt power audio amplifier tubes, the 245s.

The power unit, which is of standard design, employs a 280 tube for a rectifier. In addition to supplying filament and plate current to the tubes in the audio channel, the power supply apparatus provides also such voltages as may be required for the operation of a tuner unit.

Terminals have been conveniently located, so that they make the kit combination suitable for use with either a radio tuner unit or with a magnetic pick-up for the electric reproduction of phonograph records.

The photograph (Fig. J) shows the general layout of the apparatus when assembled on a baseboard. When completed, the unit may be housed either in the same cabinet as the tuner or phonograph or that housing a dynamic loud speaker; or, if the constructor prefers, it may be removed to some out-of-the-way place, such as a closet shelf.

This flexibility of the separate amplifier is bringing it into favor, both for custom set building and for the experimenter.

Fig. J

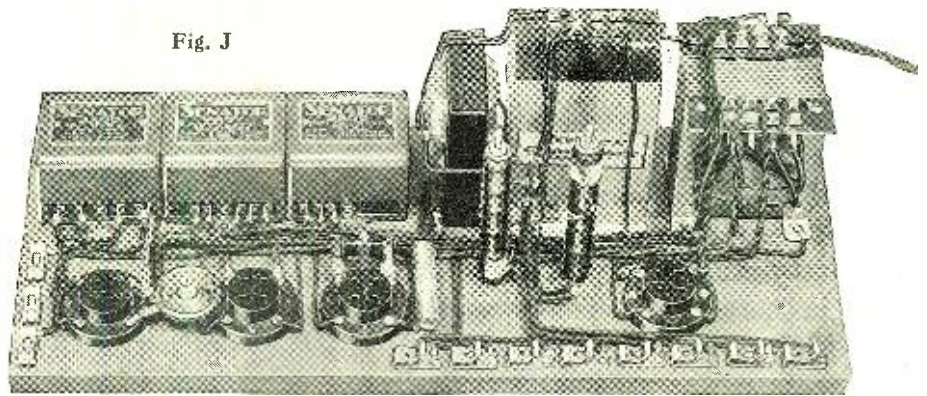

Interference Eliminators

THE illustration (Fig. L) of a group of apparatus in wall boxes includes the late additions to a complete line of "man-made static" eliminators, which have been received at the RADIO NEWS Laboratories. These are intended for use with electric motors of varying size and current characteristics. Connected across the input of these, they filter out the noises which are created at the brush contacts, and which would otherwise disturb radio reception for miles. The importance of preventing such high-frequency

disturbances is increased by the fact that a very large proportion of the receivers in use today are connected to the light lines, which serve admirably as carriers—as "wired wireless" experiments prove.

Filtering action is obtained by the use of chokes and condensers of proper capacity and voltage rating, which by-pass high-frequency components directly back to their source, via ground, while putting little load on the 60-cycle current which is fed to the motor. The Tobe Deutschmann Corporation, of Canton, Mass., who have been condenser specialists for many years, have been actively developing a complete line of such filter devices adapted to the varying needs which are encountered in connection with household and business appliances.

A Service Man's Friend

AN A.C. tube checker giving direct readings, which has been announced by the Jewell Electrical Instrument Company of Chicago, and known as "Pattern 210," is designed to test all tubes, including rectifiers. It operates from the A.C. service lines, a variable high resistor being furnished to compensate for line variations between 100 and 130 volts.

This new tester is furnished in a compact leather case. The panel carries an A.C. voltmeter, a direct-current instrument and a transformer that supplies filament voltages of 1.1, 1.5, 2.5, 3.5, and 7.5, with a selector switch for any of these. Both four- and five-prong (UX and UY) sockets are provided.

The scale of the D.C. instrument is divided into 100 units, and normal values for all standard tubes, in accordance with the scale, are included in the instructions fur-

Fig. L

The "Filterettes," illustrated at the left, are but a few of a large family which has grown markedly in the past year. The fundamental circuit of each appliance is the same, being a low-pass filter which takes radio frequency noises out of a 60-cycle line. The small object at the lower right is the "Junior," a light-socket appliance.

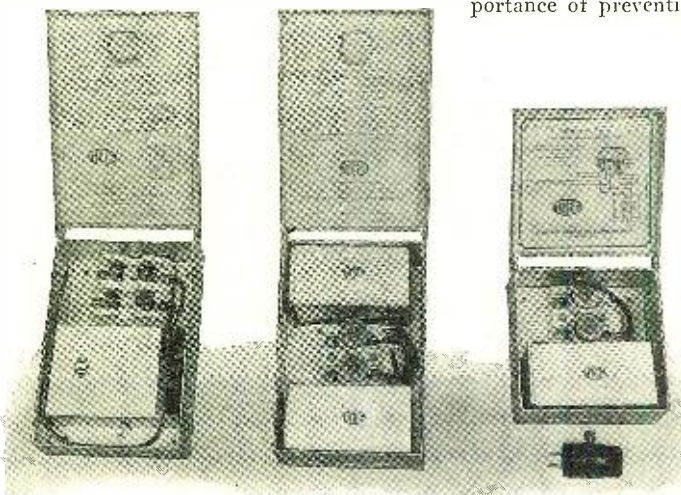



Fig. K

A set and tube tester for all purposes.

nished with the tester. For rectifier tubes, a push-button is pressed and the instrument then indicates the rectified current on a 100-milliamper scale. In previous commercial testers, full-wave tubes such as the 280 could not be tested; in this unit, an additional push-button is provided, so that the rectified current of the second plate is registered on the 100-milliamper scale.

In operation, the correct filament voltage is set on the selector switch, the tube inserted in the socket and the adjusting rheostat turned until the voltmeter registers the normal condition. Then the potentiometer at the lower right corner is adjusted until the D.C. instrument registers zero. By pressing the grid-test button, the net change in plate current is read directly from the instrument; which eliminates the necessity of taking two readings and subtracting one from the other.

Fig. M

The interference filter shown at right is for the purpose of keeping disturbances inside a motor or other electrical appliance, or that of keeping it outside a radio receiver.

A "Line-Noise" Filter

AN interference filter for reducing noises caused by electric apparatus, which may be connected either at the receiver or to the interfering apparatus, has been placed on the market by the Inuline Corp. of America, a well-known New York manufacturer. The filter consists of a number of choke coils, condensers and resistors which are connected as shown in the diagram (Fig. 3).

The filter is recommended for the larger types of apparatus, such as electric refrigerators, electric flashing signs, washing machines, furnace blowers, etc., but will operate with equal success in connection with smaller apparatus as sewing machines, vacuum cleaners, small motors, telephone bells, etc. As explained above, it may be connected in the line between the interfering apparatus and the set, either between the set and the light socket, or between the interfering appliance or apparatus and the power line.

As many readers know, a great deal of trouble with electric receivers, due to the noises which are picked up from the light lines, is encountered in many locations. The use of a filter to stop such interference is essential, in order to obtain satisfactory results; especially where the noise is constant. In many cases, the use of this filter will overcome all difficulties from line interference.

The complete filter is enclosed in a metal

box 6½ inches long, 4 inches wide and 6 inches high. A cord and plug is attached to connect the unit to the line, and the receptacle on the top of the box is used to supply power to the set, or apparatus, from the line through the filter. The binding post mounted on one end of the case should be connected to ground.

Raytheon Expands Line

THE Raytheon Manufacturing Company of Cambridge, Massachusetts, a pioneer in the manufacture of filamentless rectifier tubes for radio use, through the completion of arrangements with the Radio Corporation of America, has obtained a license to augment its present line of tubes with those types now being manufactured only under patents held and processes developed by the R.C.A. and its associates.

Prominent among the products of the Raytheon Manufacturing Company during the past few years have been its "B" and "BIP" filamentless-rectifier tubes for use in "B" power supply units, its complete line of



heater and filament types of A.C. receiving tubes and, more recently, the neon-glow "Kino-Lamp" used in the receiving circuits of television installations.

The new licensing arrangement will make available to the Raytheon Manufacturing Company the very complete line of receiving, transmitting and rectifying tubes now being produced by the R.C.A. and its associated companies.

An All-Around Radio Device

A MOST versatile instrument has come to our laboratory; this piece of equipment, illustrated at the right, and whose circuit is shown in Fig. 4, has been rigidly inspected, and found to possess a markedly high degree of workmanship. In explaining its wide range of usefulness, Mr. Walker, its designer, whose work in the superheterodyne

Fig. N

There is a certain limit to what one tuned circuit and one tube can do; but seemingly the inventor of the device at the right has boosted it a trifle.

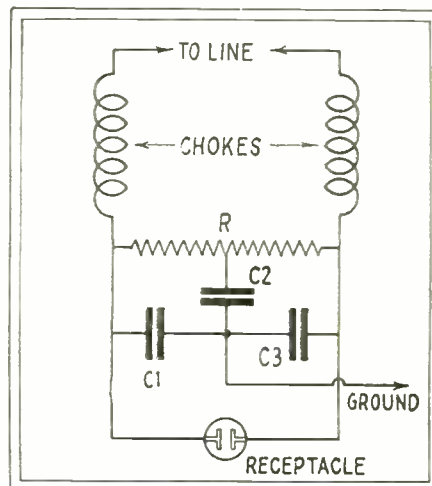
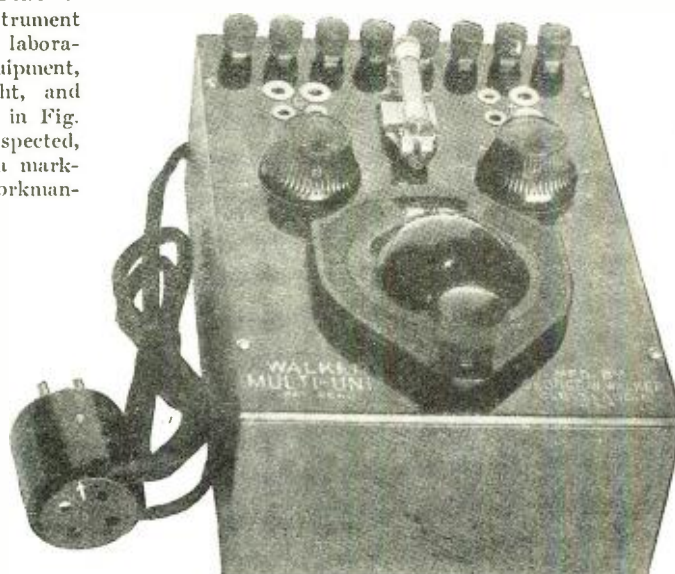

Fig. 3

The schematic circuit of the interference filter shown in the center column. The resistor "damps" the condenser circuits.

field is known to all our readers, pointed out that it is adaptable to more than twenty different uses as a piece of radio apparatus. Some of the more important are listed here: it can be used either as a short-wave receiver, a short-wave adapter, a screen-grid pre-amplifier, a remote-control adapter, an extra stage of radio-frequency amplification or "booster," as a wavetrapp, or as an audio oscillator, etc., etc.

As the circuit diagram (page 1120) and picture show, binding posts are conveniently arranged on the panel: making all or part of the circuit available for any of these various uses. By the use of plug-in coils both the short-wave and broadcast wavelengths can be tuned in. All the parts employed are of quality manufacture and present an appearance of unusual attractiveness in finish. While the unit is furnished with a four-lead adapter plug, regularly, it can be supplied with a five-prong plug for use in the detector socket of an A.C. electric set. A further description of the "Multi-Unit," as it is called, will be given in our next issue.

This apparatus is produced and distributed by a new company, the George W. Walker Mfg. Co., 13301 Durkee Ave., Cleveland, Ohio.

(Continued on page 1120)

The Radio Beginner

"The Beginner's Three"—A Good Little Receiver

By C. Walter Palmer

THE set described here was designed especially for those readers who are as yet not well versed in the art of set construction, who are using either a crystal receiver, a small one- or two-tube set, or no set at all. There are, we know, a great number of crystal and one-tube sets being used at present, despite the reductions in the price of larger apparatus and the great number of inexpensive larger receivers that have been described in radio magazines and newspapers. Many beginners believe that the construction of a larger set would be beyond their scope, but it will be found (by those who try) that the construction of a good, if simple, receiver is quite easy.

This "Beginner's Three" has been designed with several points in view. In the first place, the cost of the parts is an important consideration; for most beginners are rather skeptical about spending very much as they are not sure that the set will work properly. This hesitancy can be overcome by careful choice in the matter of the circuit and the apparatus. It is for this reason that some of the parts used in this receiver are somewhat old in their appearance.

Another question, equally important with

WHILE the sets which appear in this department are not complicated, this is not to say that they are inefficient. This receiver is capable of distance, using the tubes specified here; it will do good work even with general-purpose tubes. For loud-speaker operation, however, except on locals, the addition of another stage of audio is recommended; and this will be described in another article. In the meantime, the builder of this receiver will find that he has invested his money and time well.

the cost, is that of the efficiency of the receiver; and for this reason, in the vital parts of this set, the best available apparatus is used. Such parts as the new-style dials, while they add much to the appearance of the receiver, have very little effect on its actual operation; and those of the older style, which can be obtained quite cheaply from your local dealer, are quite suitable for our purpose. Should the constructor desire to "dress up" the little set

later on, he may readily do so. Many readers who would be interested in building a set of this type, will have some parts already in their "junk-box" and, of course, these will help to keep the cost at a minimum.

SIMPLE AND COMPACT

The "Beginner's Three" contains one stage of radio-frequency amplification, a regenerative detector and one stage of audio-frequency amplification. In locations where one or more broadcast stations are within a few miles, loud-speaker volume can be obtained; although the receiver was not designed with this point primarily in mind. It cannot, of course, be recommended in a congested district with many locals operating at once.

A combination "B" power unit and amplifier will be described in a forthcoming issue, which will supply plate current for all the tubes, as well as increase the volume so that loud-speaker results can be obtained. By designing the receiver in this way, it will be more attractive to constructors, who would not otherwise attempt to build it, until more certain of its possibilities. Also, the sectional construction will be more suitable to the beginner; who will gain experience by building the three-tube set first. After it has been made and is operating properly, the fan will be more confident as well as, perhaps, better prepared financially.

The first thing to do, when building any receiver, is to collect all the necessary parts. The apparatus used in the original set is as follows:

LIST OF PARTS

- One length of Hammarlund two-inch (diameter) inductance strip, $6\frac{1}{4}$ inches (L1, L2);
- Two Hammarlund variable condensers, .0005-mf. with panel shields (C1, C2);
- Three Pilot UX tube sockets, baseboard type;
- One Thordarson audio-frequency transformer, 6:1 ratio (T1);
- One Electrad "Phasatrol" (PH);
- One Cunningham 301A tube (V1);
- One Cunningham 300A tube (V2);
- One Cunningham 112A tube (V3);
- One Electrad "Royalty" variable resistor, 0-500,000-ohm (R3);
- Two Silver-Marshall (old-style) vernier dials (a later model may be used, if the constructor desires to improve the appearance of the set);
- One Aero "Type 60" radio-frequency choke (L3);
- One Lynch "Equalizer" and mounting, "Type 4/3" (R1);
- One Electrad by-pass condenser, 0.5-mf. (C4);

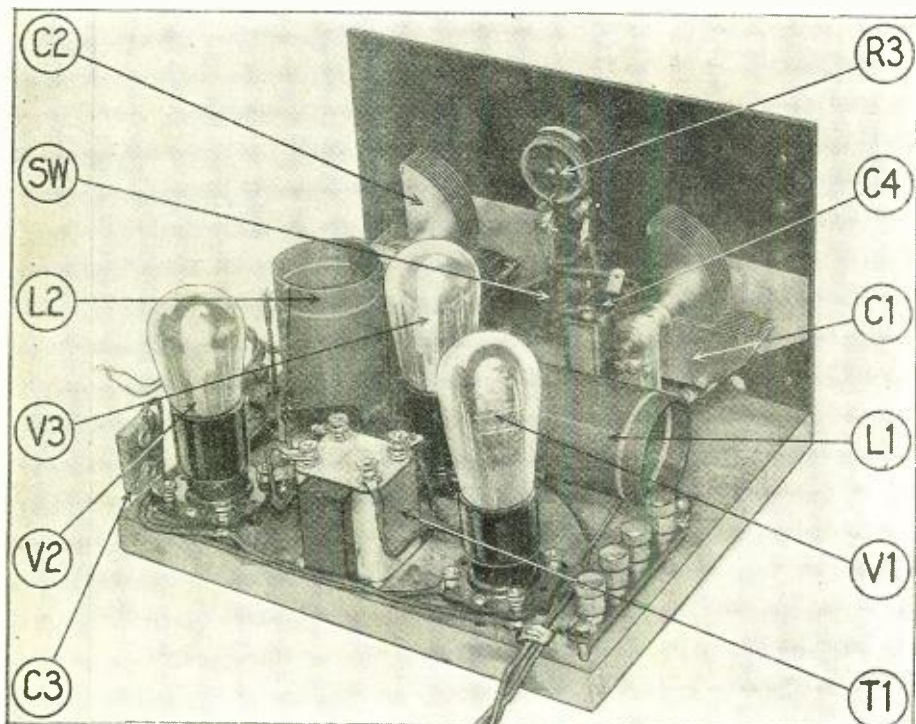

The view of the "Beginner's Three" above shows how snugly it may be put together; a very small cabinet may be improvised. The radio-frequency leads are as short as possible; note the coils are at right angles.

- ✓ One Aerovox .002-mf. fixed condenser (C3);
- ✓ One Electrad filament switch (SW):
- ✓ One Insuline bakelite panel, 7 inches high, 10 inches wide;
- ✓ Four X-1. binding posts;
- ✓ One roll Cornish "Braidite" hook-up wire;
- ✓ One baseboard 10 inches long, 8¾ inches wide and 1 inch thick;
- ✓ Screws, angles, washers and several strips of bakelite for coil mounting and for the binding posts.

inch forms. The secondary of each coupler contains 86 turns of No. 28 S.S.C. wire. The turns should be space-wound, by placing a piece of silk sewing-thread beside the wire. The primary of each coupler contains 15 turns and the tickler (on the detector coupler) 20 turns.

Some fans may have on hand smaller condensers such as .00035-mf. and, in this case, the outlay for the set will be reduced by using them. The same size of Hammarlund coil strip may be used as for the coils described above; but in this case, the secondaries should be arranged so that 115 turns are left for each of these coils. The use of these smaller condensers will make the

MOUNTING THE COILS

After the coils have been arranged, the next point is to mount them. The strips for mounting the coils are cut from bakelite, hard-rubber or fiber panels. They are each 3½ inches long, ½ inch wide and ¼-inch thick. That for the aerial coupler (the one with two coils) has a hole drilled in each end to hold the mounting screws. The other is drilled at one end only. While the strips for the coils are being made, it may be well to make the binding-post strip also. This strip is also cut from ¼-inch panel material, and is 3½ inches long by ½-inch wide; in this, however, six holes are drilled. The two at the ends are for the mounting screws; four others are then evenly spaced over the remaining space, for the aerial, ground and two phone binding posts.

After the strips have been prepared, they should be cemented to the coils. Collodion (or liquid court plaster, as it is sometimes called) is a very convenient material for this purpose. It can be obtained from the corner drug store in a small bottle and should not cost more than 25 cents.

When the cement has dried, the coils are ready for mounting on the baseboard. It may be well to explain how this is done, even though we are not quite ready for assembling all the parts. The antenna coil is secured to the wooden base by two long wood-screws, passed through the holes in the coil mounting strips, and through a suitable washer which raises the coil above the base. The washer may be made from a piece of metal tubing; or any other suitable method which suggests itself to the reader may be used. In the original set, two old binding posts of the metal type used several years ago (those with a screw in the top and a hole in the side for the wire to pass through) were drilled out so that the wood-screw would pass through.

The detector coupling coil (the one with the three windings) is mounted by a small

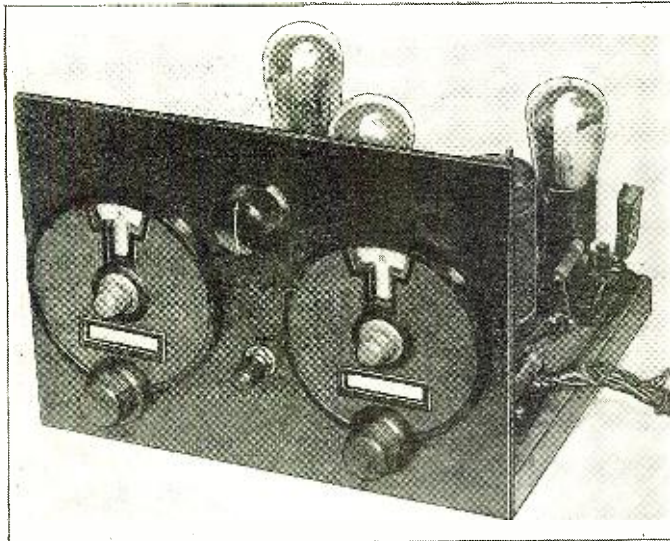

The dials used here are out of fashion, but highly efficient. The builder may use a later model to suit his taste.

The inductance strip mentioned is space-wound on a thin celluloid support and is a very convenient article for the experimenter. This method of construction gives very low self-capacity and dielectric losses; while it is very substantial, as the celluloid holds the wire firmly and is easily attached to a mounting bracket. The two-inch size is now favored over larger tubing formerly used.

The coils are made by taking the strip of inductance winding and measuring 2¾ inches from one end. A sharp knife run through the thin insulating form, will separate the two coils at this point. The wire joining the two coils should then be cut. The next point is to count 17 turns from the end of the 2¾-inch coil, and cut the wire at this point, with a sharp instrument. If a pair of cutting pliers is not available, an old pair of scissors will be satisfactory. The wire is then loosened from the form, a turn and a half on each side. This leaves a space equal to three turns from the two sections of the aerial coupler and supplies two windings, one of 15 turns and the other 86 turns.

The other coil is then prepared in the same way, except that a space of five turns is left between the primary and secondary. This is done by counting 18 turns and removing 2½ turns from each side of the cut. On the farther side of the coil, 86 turns should be counted and at two turns further the wire should be cut. Here also, the wire should be removed from the insulating form; in this case, 11½ turns are loosened on each side, leaving a space of 3 turns between. The end of the coil, which is the tickler, should give 20 turns. If the remainder of coil is longer than the space covered by these turns, the extra wire should be loosened from the insulating film and a sharp knife should be used to trim down the extra insulation.

Those who desire to make their own coils, rather than use the prepared tubing made by the Hammarlund Company, may use 2-

coils longer and a longer piece (7¾ inches) of the coil strip must be obtained.

If difficulty is encountered in purchasing this prepared inductance strip locally, it may be obtained directly from the manufacturer. While the manufacturer does not ordinarily sell this inductance strip directly to set builders, a concession has been made in this case; so that it may be obtained by those who desire to build the receiver, if it is not available from a dealer.

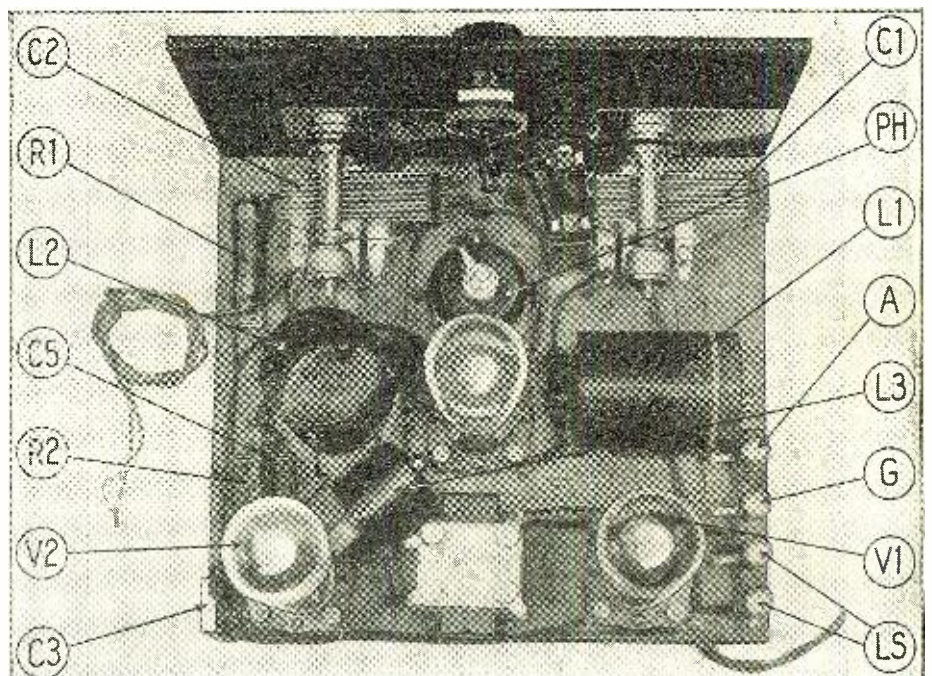

The layout of parts in the "Beginner's Three" is shown so well above that a diagram is hardly needed but the wiring may be traced with the aid of Fig. 2. The leads at the right are for the "B" and "C"; those at the left for the "A." The arrangement is convenient.

angle-piece which is screwed to the coil strip and is secured to the baseboard with a small wood-screw. A 6-32 machine-screw and nut are used to fasten the coil strip to the angle, which is one of the small brass brackets found in the local 5-an-10-cent store.

OTHER ASSEMBLY

After the coils have been prepared, the next point is to drill the panel for the tuning condensers, oscillation-control resistor R3, and the filament switch. The templates supplied with the condensers will provide the most convenient way of laying out the holes for these instruments. The resistor and switch are centered between the two condensers, as shown in the illustrations. If the specified type of condensers is used, the panel shields should be placed between each condenser and the panel; so that the possibility of the set being effected by hand-capacity will be kept at a minimum.

The pictorial layout (Fig. 2) shows the positions of the other parts of the set. The coils are placed at right angles to each other, so that there will be the minimum of interaction between them. They are also so located that the wiring between the grid end of the coil and its condenser and tube-socket terminal is as short as possible. The radio-frequency choke, which is equipped with a machine screw for sub-panel mounting, is fastened to a small brass angle; which is in turn fastened as shown, to the plate (P) terminal of the detector tube socket. This is done for convenience only, as the mounting bracket is not connected in any way to the terminals of the choke.

The "Phasatrol" stabilizes the radio-frequency amplifier, and the resistor R3 is used to control the detector as mentioned before. The latter resistor is shunted by an 0.5-mf. by-pass condenser which serves to carry the audio-frequency currents in the primary circuit of the transformer, so that they will not have to pass through the high resistance. In order to make the set as low in cost as possible, a cable has been improvised from the hook-up wire. This reduces the cost of the cable and still permits the convenience of the cable leads; though a manufactured cable, the cost of which is low, will enhance the convenience of connecting and disconnecting the battery.

The set is wired with the convenient "Braidite" insulated hook-up wire. Point-to-point wiring is used, so that the leads will be as short as possible, and also to keep them from running parallel. The wires

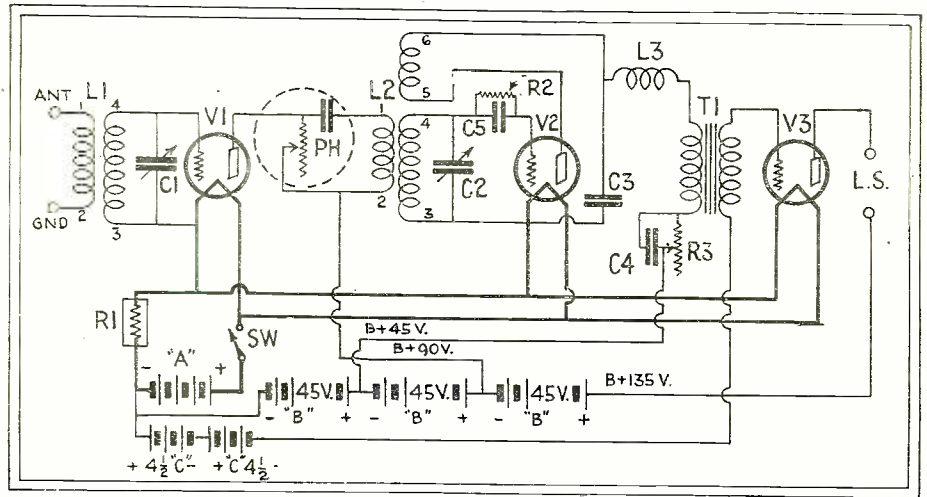

Fig. 1

The "Beginner's Three" is shown here with all the connections to the batteries, for the convenience of the beginner. An experienced friend should check a beginner's work, however.

which connect to the batteries are arranged with an excess length of several feet, and are brought together at the back of the baseboard. These wires are used as a cable, and they may be braided together if desired. A staple, driven into the base, will serve to keep the wires of the cable together.

CHOICE OF TUBES

The tubes used in the set were chosen to give the best and most stable results. The standard 301A-tube is used as the radio-frequency amplifier; this stage serves the triple purpose of increasing the volume, the sensitivity and the selectivity of the receiver, while preventing the oscillation in the detector stage from causing interference in neighboring sets.

The second tube is of the special-detector, high-amplification type; since this tube is far more sensitive than the 301A type, when properly used. It will be noted that the grid return of the detector is connected to the negative side of the filament, contrary to the usual procedure. Since this might cause confusion in the minds of some of our readers, it is well to mention that this is done solely because of the special type of tube used in this socket. If the regular 301A tube is used in this socket, the grid return should be connected to the positive side of the tube filament.

The tube in the audio-frequency stage is a 312A semi-power tube. This was chosen

because of the better quality resulting from its use. This is especially true if a second audio stage is to be employed and, since we are building the set with the thought in mind that a power amplifier and "B" power unit may be built later to give good loud-speaker volume, we have incorporated the 312A in the original set.

TESTING AND OPERATION

After the set has been completed, the next point is to test the wiring to be sure that no mistakes have been made. This is done by connecting a "C" battery and a pair of headphones in series and applying this test unit across the various cable connections in turn. With the tubes out of the sockets, no click should be heard between any of the wires; either in the filament line or the wires to the plate supply. If no clicks are heard, the batteries are connected as shown in the schematic diagram (Fig. 1) and the tubes then inserted in the sockets. The headphones should be connected to the terminals marked "L.S."; and the aerial and ground connected to the other two terminals on the binding-post strip. The set is then ready for operation, and the filament switch may be closed.

It is not important which side of the primary coil is connected to the aerial and which to the ground. In some cases, however, the operation of the receiver may be improved by connecting the "-" (negative) side of the "A" battery to ground. If

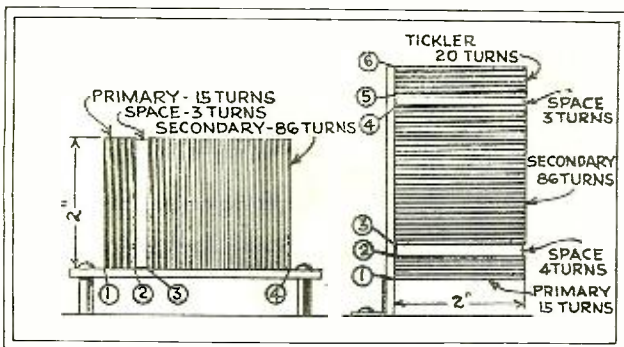
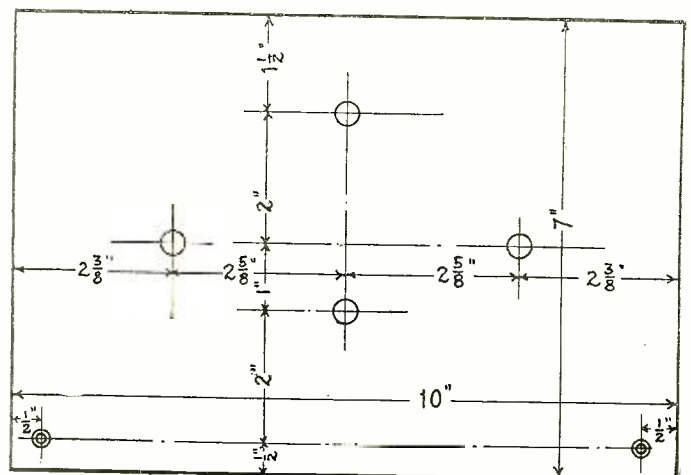
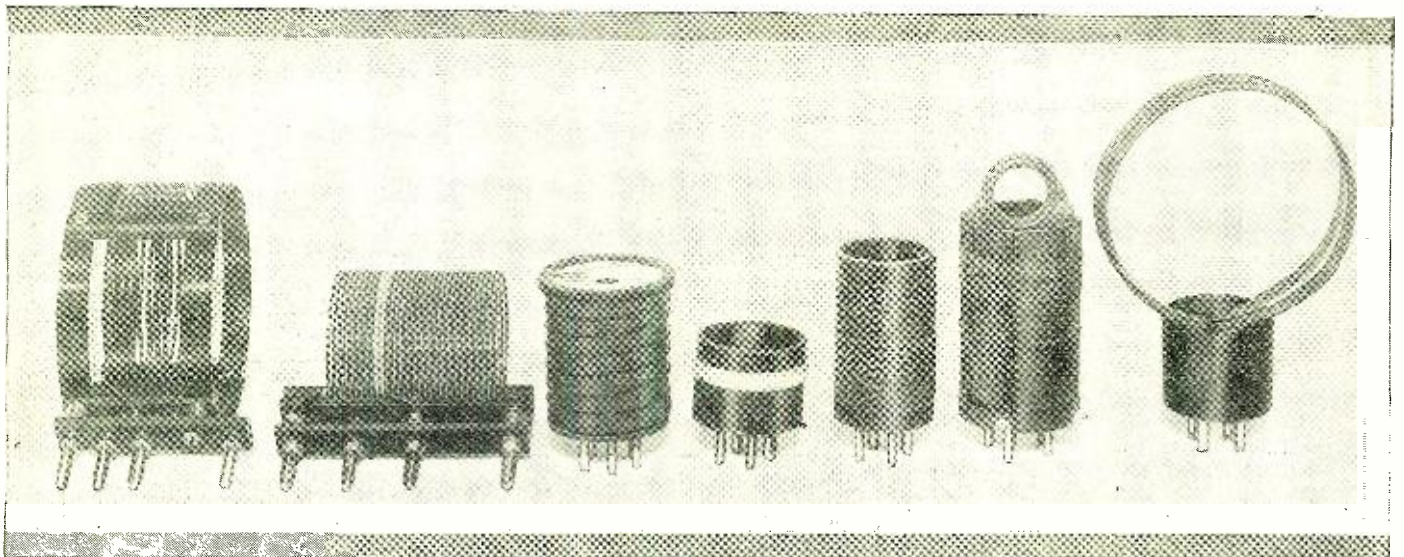

Fig. 3 (above) Fig. 4 (right)

The details of the two coils used are shown above, with the terminals indicated, as in Fig. 1, to avoid error. The loosened wire is suitable for connections. At the right, locations of the six panel holes needed.





Plug-in coils of types made popular by short-wave broadcasting; from the left, Aero, Hammarlund, Silver-Marshall, "junk-box" (home-made on tube-base form), Dresner, Pilot and R. B. Specialty (Hammarlund-type). They are used with low-capacity condensers.

Making The New Short-Waver "Perk"

By H. M. Bayer

MANY an experimenter, after soldering the final wire to his short-wave assembly, finds that he cannot get the proverbial "peep" out of it; it is for his special benefit that this article is written—for the man who places the phones on his ears, turns the filament switch and hears not a click. What is he to do now?

In trouble-shooting a short-wave receiver which refuses to function, the same procedure is followed as with a broadcast receiver; that is, the antenna system (aerial and ground), tubes, batteries, and reproducing device (phones or speaker), should be carefully tested and checked before tackling the receiver itself. Obviously, it is far simpler to start with the accessories and work toward the set.



Fig. A

With telephones and a small battery, it is quickly possible to check up on all doubtful points in the apparatus, which is often "old stuff."

BATTERIES, ETC.

As RADIO NEWS has always insisted on the use of batteries for short-wave receiver operation, no discussion of power-units and their possible ailments will be entered upon here. Both dry and storage "B" batteries should be tested with a voltmeter, which may be of the so-called pocket type. This little instrument is obtainable, also, in the form of a volt-ammeter having two scales: one with which to test 45-volt "B" batteries, reading up to 50 volts; and the other having a maximum reading of 35 amperes. The latter scale may be employed to test the strength of a 1½-volt dry cell, of the type often used for filament lighting with a 199 tube. The cell should give a reading of 30 amperes or thereabouts, in order to obtain maximum results; it should not be connected longer than an instant.

A 45-volt "B" battery should give a reading of at least two-thirds of its rated voltage. It should be discarded when it reads anything less than 30 volts; as a depreciated block not only causes a notable increase in the resistance of the plate circuit, due to the increased internal resistance of the cells, but is also the cause of annoying battery noises. The same observation holds true for the storage-type "B" battery, which also may be tested with a low-resistance voltmeter.

While it is true that few short-wave receivers use "C" batteries, and while it is also true that the current drain on these cells is negligible, it is im-

portant that they be tested for continuity; as an open or poor internal connection will cause a mystifying lack of results. A low-reading voltmeter (6-volt scale), is used in testing "C" batteries of the 4½-volt type.

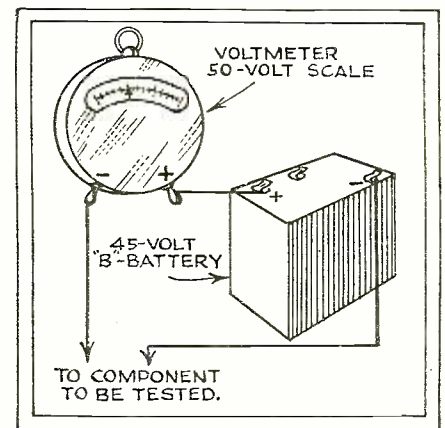

Fig. 6

The experimenter should be familiar with the use of this circuit for general testing.

Filament-lighting storage batteries should be tested only with a hydrometer; a reading of 1150 indicates a completely-discharged battery, and 1300 a maximum charge. Care should be taken that the "A" leads make good contact with the battery terminals, and that no corrosion takes place at the former; this can be avoided by keeping a thin coating of vaseline over the battery posts and the exposed terminals of the "A" leads. Corroded battery terminals may result in high-resistance connections which, in turn, cause flickering filaments and otherwise unsatisfactory results.

TUBES, ANTENNA, PHONES

No difficulty should be encountered in testing tubes; merely insert them in the sockets of the broadcast receiver, if no tube tester is available. Screen-grid tubes (222-type), on the other hand, require a special testing arrangement; no doubt the local

radio dealer is in possession of suitable tube-testing equipment, which he will allow the experimenter to use.

After having tested the accessories as outlined above, the antenna system comes in for its share of analysis. Twenty-five or thirty feet of over-all length is sufficient for the average short-wave antenna; however, it should be clear of all metal constructions, trees, etc., and must be well insulated; for, at these ultra-high frequencies, dielectric losses are much more important than on the broadcast bands.

Spend a bit more than the usual time in

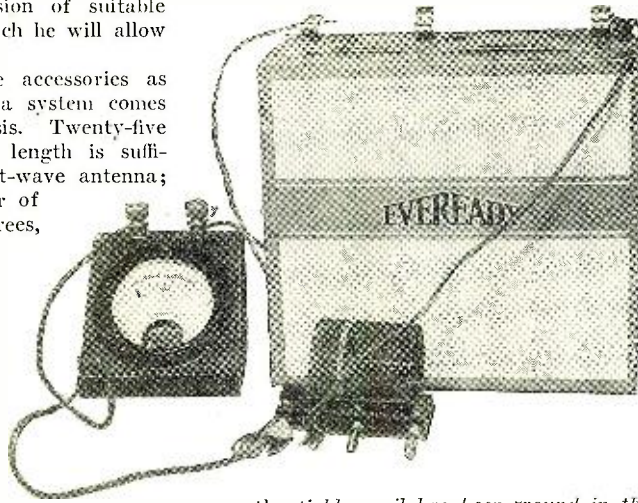

Fig. B
The use of a voltmeter in this way will distinguish open, closed, and high-resistance circuits.

going over the ground clamp or its substitute. Many receiver troubles originate in this device because of its tendency to corrode, due to the moisture formed on water pipes. Wherever possible, solder the ground lead to its ground; the ordinary ground, as a rule, has too much resistance without adding more by means of the high-resistance connection introduced by a corroded ground clamp.

Phones can be tested on the broadcast receiver; however, if one is not at hand, place the tips of the phone cord across a "C" battery or a 1½-volt dry cell. A click in the phones when the circuit is opened and closed indicates that the headphone and its cord are in working order; although this proves nothing as to sensitivity. The latter can be determined only by a comparative test.

THE SET ITSELF

After testing all accessories with satisfactory results, if the constructor still fails to obtain results from the receiver, it is then obvious that the trouble is in the set proper. And therein lies the problem mentioned in the opening of this article. Just what procedure does one follow in troubleshooting a short-wave receiver?

Firstly, the wiring should be checked by a second person who has a knowledge of radio; it is no rarity to have a constructor pass over the same error time and time again, even though it be obvious. If the circuit is found to check with the diagram (granted the diagram is correct) the next step is to isolate the audio amplifier from the detector circuit, to find whether the trouble is in the detector circuit or in the amplifier. (This is, of course, unnecessary if no amplification is used.)

Connect the phone tips to the "P" and "B+" posts of the first audio-frequency transformer; this will feed the output of the detector tube directly into the phones. If signals are then heard, the trouble is in the audio system and should be sought for there. By the same reasoning, if no signals are heard, it is safe to assume that the audio system is receiving nothing from the detector circuit, in which we may then localize our trouble-seeking.

Perhaps the most frequent complaint of short-wave fans is the inability of their receivers to oscillate; this may be due to any number of causes. Chief among them is the reversal of the tickler winding, often experienced with home-made coils. In this

case the tickler coil has been wound in the direction opposite that of the grid or secondary coil: the solution is obvious. In many cases reversing the detector leads to the first audio transformer will bring about regeneration.

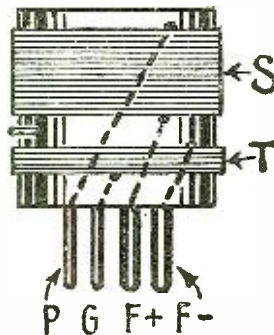

Fig. 5
In a home-made coil, see that tickler leads are connected properly and that there is no high-resistance joint. Do not space windings too far apart, with a small regeneration condenser.

OBTAINING OSCILLATION

If the constructor employs manufactured coils, and has been careful to obtain condensers of the values specified by the coil-maker, no trouble will be experienced with lack of regeneration, due to improper values of condensers or ticklers. However, the home-builder is faced by the problem of making his coils match his condensers. If the receiver goes into oscillation at the slightest touch of the regeneration condenser, substitute a smaller one; on the other hand, a larger condenser is required if the oscillation dial must read 90 or 100 before we have too much capacity, whereas in the other there is a lack of it.

A simpler method of treating the same trouble is that of altering the tickler winding until the proper number of turns to match the capacity of the condenser is found. If the circuit oscillates too strongly, reduce the size of the tickler winding; while insufficient oscillation requires the addition of a few turns on the tickler coil.

Before making any changes in the capacity of the regeneration condenser or the turns on the tickler coil, see if the spacing between the tickler and grid windings is that specified. Too great a separation results in little or no oscillation; while too narrow a space will cause the receiver to "squawk" at the regeneration peak.

AUDIO HOWLING

A constant howl produced by the receiver, upon the addition of a second stage of audio-frequency amplification, may be overcome by placing a 100,000-ohm resistor across the secondary of the first audio transformer. It is also well, when placing unshielded audio transformers upon a narrow baseboard, to see that their positions (i.e., cores and windings, respectively) are

(Continued on page 1133)

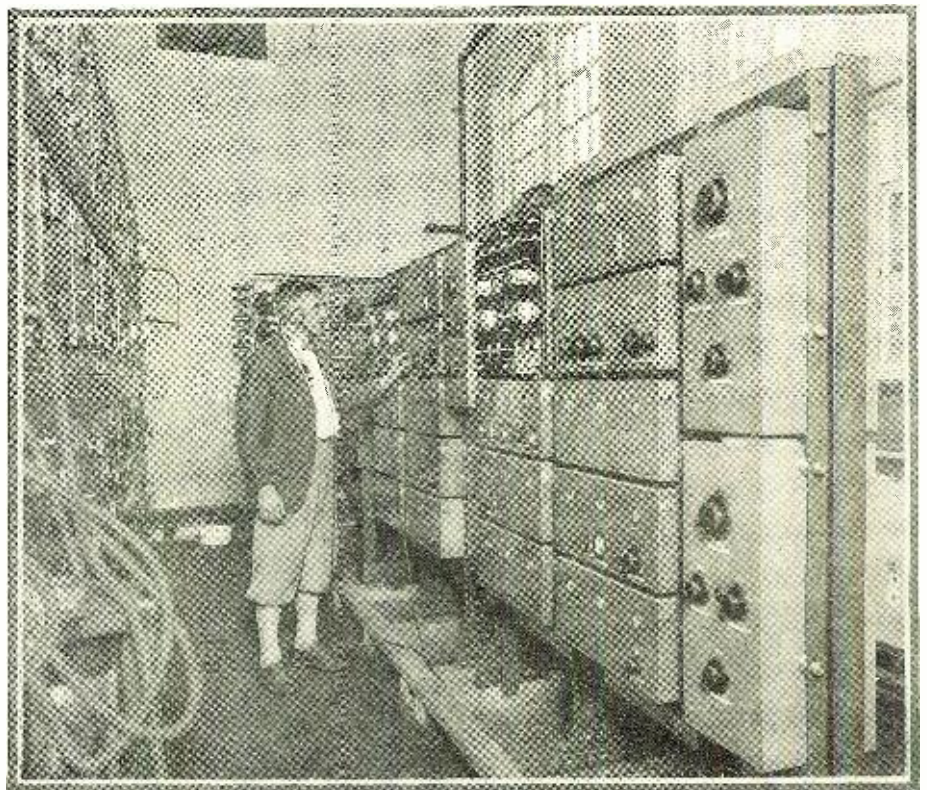

The kind of short-wave receivers engineers build for commercial work; each compartment a shielded stage with a power tube, and one set filling a rack or two. © R. C. A.

The "RE 29" Receiver

The Last and Most Sensitive Model Developed
by the Inventor of this Efficient System

By R. E. Lacaull

WHEN I placed my hand near the antenna binding post of the "R E 29" that I had just completed, there was enough field strength to produce signals from every local station in New York City, proving that the new circuit was amazingly sensitive. And it is in the direction of sensitivity that circuit designers are working, especially when a man is asked to build a set himself; for the inducement is that he shall possess a receiver that will "run rings around" others.

I have bent my energies toward the production of a receiver design that will not only prove dependable and practical, even for the novice, but one that will respond to the faintest impulse that could be expected to produce a signal. More than that, I have endeavored to provide every item of efficiency necessary to exceed even the occasionally unreasonable demands of set builders; and I believe I have succeeded. Never have I tuned a set more sensitive, more satisfactory than the "R E 29."

The circuit is in two parts: the radio amplifier, detectors and first audio, which constitute six tubes, and the push-pull power amplifier and B supply, using two 210 tubes as output and two 281 tubes as rectifiers. Thus the total receiver has eight

tubes and the "B" supply two tubes. In this article I will confine myself to the receiver and with one audio stage, built into a table-model cabinet; while the construction of the power amplifier and "B" supply will be discussed separately.

Screen-grid tubes are used in the modulator and the two intermediate stages of the receiver (for they are, when properly used,

R E. LACAULT, well known to all readers of RADIO NEWS as one of the world's foremost authorities on superheterodynes, was—most unfortunately—to survive but a few days the completion of the receiver described here, which he regarded as his masterpiece, and to which he had devoted his failing strength, but still brilliant genius. The circuit used has enthusiasts throughout the world who regard it as unsurpassed; they will welcome this receiver as one which adds to the sound design and fundamental efficiency of former models the amplification properties of the screen-grid tubes which give it where possible even greater range and efficiency.



The late ROBERT E. LACAULT

the most sensitive tubes extant) an all-sufficient selectivity is attained through proper coil design.

EFFICIENT OPERATION

The modulation system is that which I invented, and which is used now for the first time in conjunction with a screen-grid tube. Although the modulator tube is used in three-element fashion (by joining together the plate and screen-grid) there results a lower plate impedance and improved detecting efficiency. Thus, a sensitivity is developed exceeding that of the leak-condenser method; for negative grid-bias detection is used in the "R E 29." Better selectivity and improved tone also result from

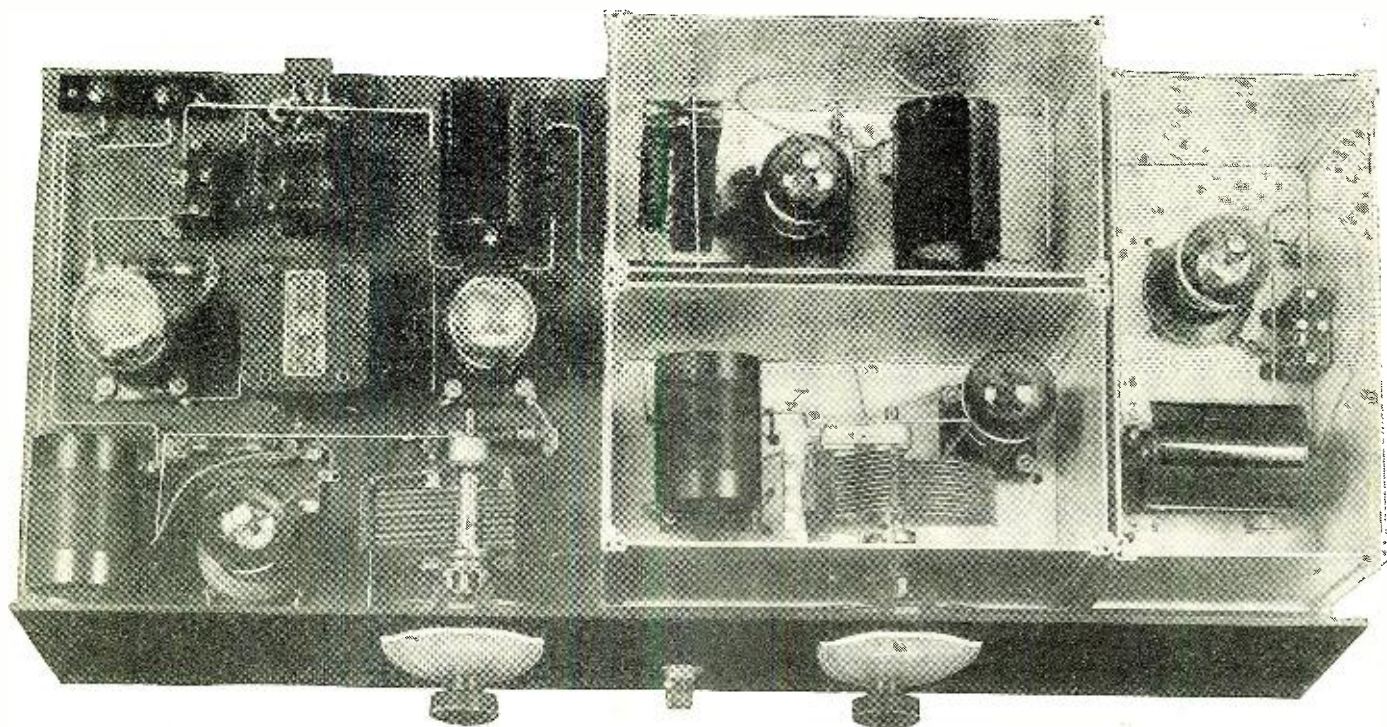

Fig. A

Viewed from above, with the tops only of its shields removed, it may be seen how the new "RE 29" combines effective placement with ample room, required for efficient working of a receiver which is to give enormous amplification of which screen-grid tubes are capable.

grid bias detection. The bias, 2.7 volts, is equal to the drop in R1.

No direct plate current is used on the modulator. This is no novelty to those who have built previous receivers of my design; since the efficiency of the special modulator circuit is abundantly attested by the great distance-getting records established by receivers using this system.

While there is no polarizing voltage on this "plate" (the combination obtained by connecting "G" post and "P" post in V1), there is a high alternating voltage; which frequently rises to many times what would be the polarizing voltage in another circuit.

The alternating voltage in the plate of V1, then, is the resonant radio-frequency voltage across the tuned oscillator circuit

which has in its plate circuit a high-impedance primary, to assure a high gain from the wonderful amplifying tubes used in conjunction with them.

The fifth tube is the true detector—the so-called "second-detector"—and it uses a higher order of bias (5.5 volts effective) than was supplied to the modulator. The "C" battery supplies 4.5 volts, while the extra volt is accounted for by the voltage drop in R5.

An audio transformer couples the detector to V6, the first audio tube. Note that only one lead is shown at the output—the plate lead; the "B+" connection is established at the power-pack's terminal strip, through the primary of a push-pull input transformer.

between the two carriers, so that one station will be very weak; but this does not prevent squealing, because the squeal's intensity is proportional to that of the strong signal, to which the set is tuned. Furthermore, the R.F. tuner cannot discriminate sufficiently well between two frequencies only 60 kilocycles apart.

When the intermediate frequency is 120 kilocycles, (as in the present circuit) the carrier-frequencies which might interfere are 240 kilocycles apart. Even an ordinary R.F. tuner is sharp enough to suppress one of these when the circuit is tuned to the other. And, when the R.F. tuner is very sharp, the interfering carrier is so weak by the time it gets to the modulator that it cannot produce audible disturbance.

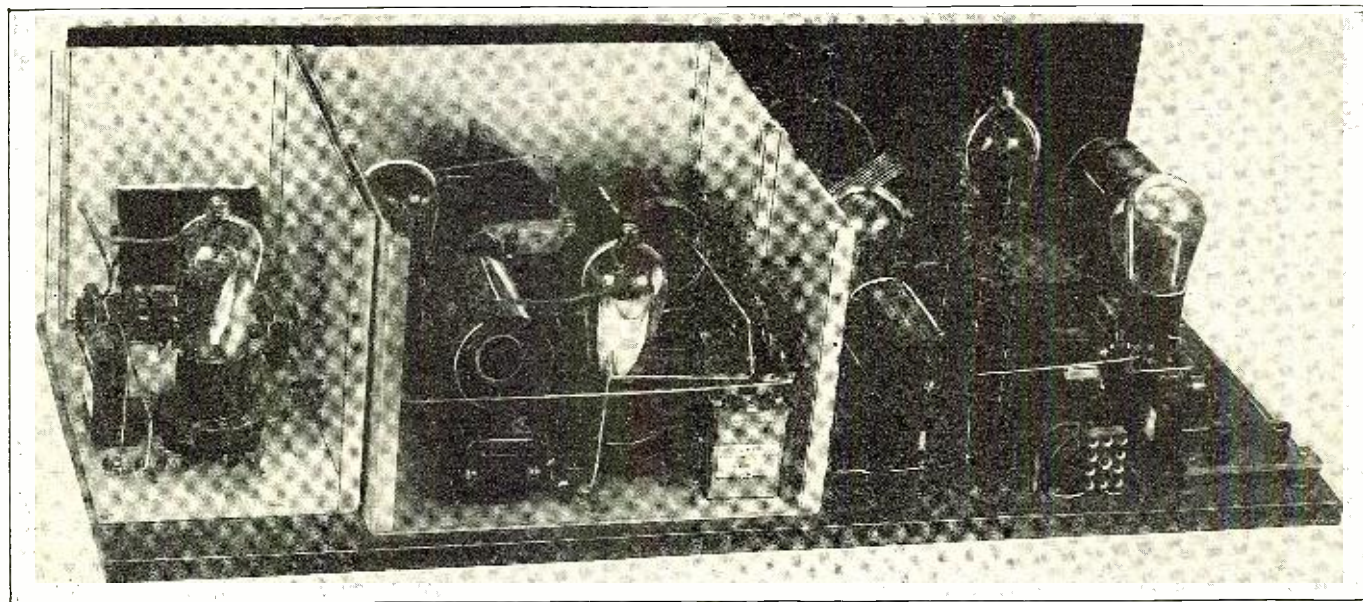

Fig. B

The "RF 29" is shown here with its rear and partition shields removed. The wiring is run with the utmost directness. The first or modulating tube, which in this system is not a "detector," employs its screen-grid and plate as a single element, of high effectiveness.

L2C2. The voltage is alternately positive and negative; the positive loops of this voltage are modulated by the signal impressed on the grid of the first tube.

The modulator (or first detector) establishes a high detecting efficiency because the impedance of the load on the tube is high for the detected frequency and low for the signal frequency. The fixed-tune circuit L3 (primary) C3, is parallel-tuned for the intermediate frequency, and its impedance or resistance is extremely high.

The condition for low impedance at the signal frequency would not be met were not the signal frequency always much different from both the intermediate frequency and the oscillator frequency. Currents of the signal frequency pass through C3 with practically no impedance. Likewise they pass through either C2 or the secondary of L2. If the higher frequency setting of the oscillator is used, the signal frequency is lower, and hence passes through the coil. If the lower oscillator frequency is used, the signal frequency is higher and therefore passes through the condenser C2. This is a band-pass filter action.

LATER STAGES

The next two tubes, V3 and V4, are the intermediate-frequency amplifiers, each of

Besides the foregoing, the circuit diagram reveals filters C8-L6 and C9-L7, to stop radio-frequency currents from entering the "B" supply; an antenna-ground input; shielding of the modulator and intermediate stages (denoted by dotted lines); two dial lights; and a switch.

By making a study of the circuit which is deeper than a bare analysis of a diagram, we ascertain why amazing sensitivity is attained, why selectivity is abundantly present, and why tone quality is preserved all the way through.

I.F. CHARACTERISTICS

A superheterodyne will bring in two different stations, separated by *twice* the intermediate frequency, at the same setting of the oscillator condenser. If the intermediate frequency is low, this will cause much interference. For example, suppose the intermediate frequency is 30 kilocycles; any two stations will then be brought in at the same setting of the oscillator, if the carrier-frequencies of the two stations differ by exactly 60 kilocycles. Since there is now at least one station for every 10 kilocycles, there is practically no chance of getting any station free of all interference.

The radio-frequency tuner discriminates

And that is not all. When a high intermediate frequency is used, there will be a wide band in which there cannot be any cross-talk at all between broadcast stations. Hence the two main advantages of using a high frequency are effectiveness of the R.F. tuner in suppressing any interfering station and the absence of all cross-talk in a certain band.

However, there is a practical limit to the increase in the intermediate frequency. The higher it is, the less will be the amplification and the selectivity, and the lower will be the stability. The frequency selected, namely, 120 kilocycles, is an optimum compromise between the two sets of opposing factors.

From 670 kc. to 550 kc. the oscillator tunes a "one-spot"; that is, there are no repeat tuning points on the oscillator above 670 kc. (447.5 meters).

ANTENNA COUPLING

There has been some loose talk that a superheterodyne cannot be used successfully with an outside antenna, and that a loop must be used. The idea has been disproved many times; and aeriols are coming into use more and more all the time for this type of circuit.

Hence an aerial is used with this receiver

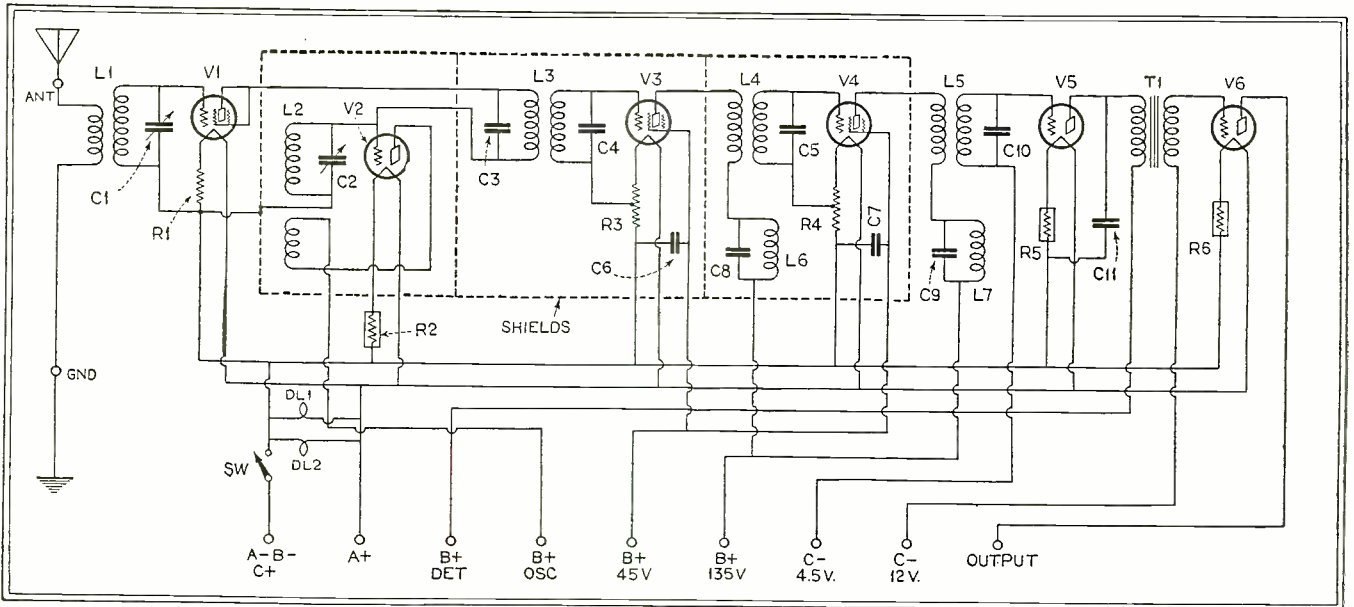

Fig. 1

The "RE 29" utilizes its designer's frequency-changing system, with a modulating tube, on whose plate there is no "B" potential; two screen-grid intermediate-frequency amplifiers; and a single audio stage, adapted for connection to an external power amplifier.

because it is more effective; it eliminates the necessity of another tube; it is much more convenient to use, once it has been installed; and it is less conspicuous in the home.

The antenna coil L1 and the oscillator coil L2 are of special design and are provided with plugs, so that other sizes of coils may be inserted into the circuit to cover other wavelength ranges. These coils are tuned by the .0005-mfd. Hammarlund "Midline" condensers C1 and C2. Note that the rotors of both these condensers are grounded to the shields, so that there will be no body capacity. While this is usual for the antenna condenser C1 it has not been so for an oscillator condenser. One of the chief difficulties with superheterodynes is eliminated by this simple connection.

INTERMEDIATE TRANSFORMERS

The intermediate amplifier consists of two screen-grid tubes and four tuned circuits. The first of the intermediate transformers, L3, is doubly tuned; that is, the primary is tuned by C3 and the secondary by C4. This coil is so constructed that it is a band-pass filter having a suitably wide transmission band. The double tuning insures thorough filtering, as well as a high step-up of the intermediate-frequency voltage.

The coupling coils L4 and L5 are identical in construction and tuning, the secondary of each being tuned. The primaries are wound to match the plate impedance of the screen-grid tubes, and to utilize the amplification of the tubes to a large degree.

All the three coupling devices (L3, L4

and L5) have been constructed to rigid specifications, as dictated by careful laboratory experiments. They provide a highly selective intermediate filter without cutting sidebands, and at the same time they step up very highly the amplification in the transmission band.

All told, the receiver is one I would encourage everybody to build for its distance-getting ability, tone quality, selectivity and ease of operation. Preferably build it as shown—with battery operation of the six filaments, but A.C. operation of the last audio stage from the "B" supply. The volume control will be in the supply unit. You will have a receiver of such extraordinary power that you will feel triply repaid for your efforts.

(List of parts on page 1141)

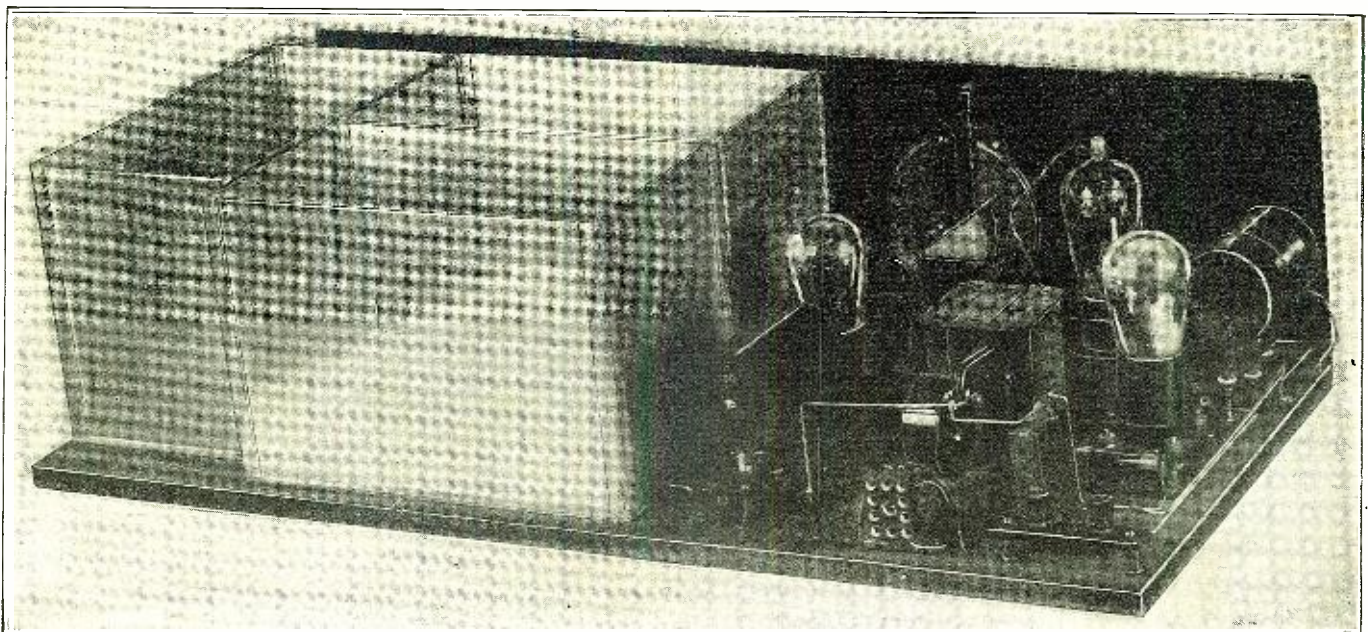

Fig. C

The modulator tube, between its tuning condenser and coil, is in need of no shielding; neither are the second detector and first audio stages, here shown at the rear right. The shielded oscillator is in the forward can; the intermediates in the other two.

Designing a Tuned-Radio-Frequency Transformer for the A.C. Screen-Grid Tube

By Glenn H. Browning

THE screen-grid tube is probably the outstanding development among the radio receiving tubes which has been brought about in the last three years; for, not only does it do away with the problem of neutralization, but it also makes possible greater selectivity than has been practical before. However, the characteristics of this tube are so different from those of others that it necessitates considerable design work on the part of the engineer, in order to realize the possibilities inherent in this new device.

The relative ("factor of") merit of any radio-frequency-amplifier tube is indicated by its amplification factor divided by the square root of its plate resistance. Of course there is also the capacity between the plate and the grid to be considered, for, the larger this is, the greater the tendency to oscillation when the tube is used in a multiple-stage tuned-radio-frequency amplifier. In the case of the screen-grid tube this capacity is very small—a fact which alone is sufficient to strongly recommend its use. The following table gives an idea of the relative merits of the various tubes used as R. F. amplifiers.

"Factor of Merit" of Tubes

Type of Tube	$\mu/\sqrt{R_p}$	Plate-Grid Capacity p.f.
01A076	12.0
22 (D.C. screen-grid)184
26085	12.6
27095	6.6
24 (A.C. screen-grid)485

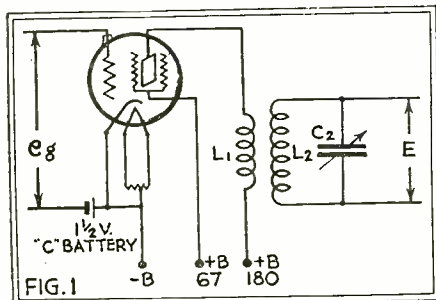

The schematic circuit of a screen-grid stage of R.F. amplification, indicating both input and output voltages.

It will be noted that the new A. C. screen-grid amplifier (the Y-24 type) is more than twice as good as the D. C. screen-grid tube, and five times as good as any of the others. It is also interesting to note that the 27-type is superior to either the 01A or the 26-type; both from the standpoint of the factor of merit and from that of the capacity between plate and grid.

SCREEN-GRID R.F. AMPLIFICATION

There are two methods of using the A. C. screen-grid tube to advantage in a tuned-radio-frequency amplifier; one is by a tuned-impedance system, and the other employs a tuned-radio-frequency transformer. Both of these have the advantage of amplifying while adding selectivity to the circuit. However, a careful study of the two will show that the transformer is superior from the standpoint of selectivity, while it is simpler to use in a kit

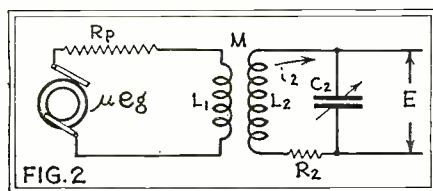

The virtual circuit of Fig. 1, showing the "mu" of the tube as a factor of the input, and its plate resistance at R_p .

set. As the radio-frequency amplifier in any set determines its distance-getting ability as well as its selectivity, the radio-frequency transformer characteristics are important.

The writer has been doing design work for the last five months on radio-frequency amplifying systems for the new screen-grid A. C. tube, and was able, after careful study, to design the transformer, the analysis of which is given further on in this article. With four of these transformers used in a receiver, it not only was sensitive enough to bring in nine California stations in one evening and KFI as early as 10 o'clock (the set was located in Malden, Mass.), but the selectivity was sufficient to cut out the local stations and bring in semi-distant ones where the frequency-separation of the two was only 10 kilocycles. In fact, the set performed so well that it was thought that many of the readers of RADIO NEWS will be interested in its technical development, which is explained below.

ANALYSIS OF THE TUBE CIRCUIT

It is necessary to make a critical analysis of the functioning of the transformer, in order to design one which will give the maximum gain while, at the same time, tuning is of adequate sharpness.

Fig. 1 shows the conventional circuit for A. C. screen-grid tubes used in conjunction with a tuned-radio-frequency transformer: e_g is the voltage put into the grid circuit of the tube, while E is the resultant voltage developed across the coil-condenser system. For analytical purposes Fig. 1 resolves itself into Fig. 2; μe_g is the voltage which, acting in series with R_p (the plate resistance of the amplifier tube) develops the same current through L_1 (the inductance of the primary of the radio-frequency transformer) as would be developed were the amplifier tube present in the circuit. Therefore, μ is the amplification factor of the tube. The other indexes are L_2 (the inductance of the secondary winding); C_2 (the capacity of the tuning condenser); M (the mutual inductance between primary and secondary coils) i_2 (the current flowing in the secondary circuit); and R_2 (the inherent resistance of $L_2 - C_2$ circuit). It is assumed that the capacity between primary and secondary is small.

Then the voltage amplification of the system will be E/e_g .

Where the incoming frequency of the signal, $f = \omega/2\pi$.

$$\textcircled{1} \quad E = L_2 \omega i_2$$

This equation holds true in all cases, provided $(R_2)^2$ is small compared to $(L_2 \omega)^2$. This is always true in any ordinary tuned circuit.

It may be shown that

$$\textcircled{2} \quad \frac{E}{e_g} = \frac{\mu L \sqrt{L_2/L_1}}{\sqrt{\eta_2^2 + (1-\theta^2)^2} \sqrt{\left(\eta_1 + \frac{L^2 \eta_2}{\eta_2^2 + (1-\theta^2)^2}\right)^2 + \left(1 - \frac{L^2 (1-\theta^2)}{\eta_2^2 + (1-\theta^2)^2}\right)^2}}$$



Dr. Browning (left) is well known to our readers as co-inventor of the Browning-Drake circuit. He is exhibiting here a tuning unit with four R.F. stages, using the transformer constants calculated here, and detector. It is designed to feed into the "Velvctone" amplifier seen behind it, and described on page 1099 by James Millen (right).

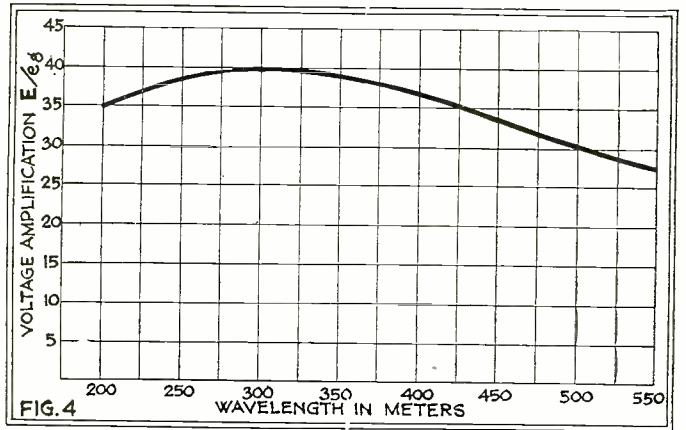
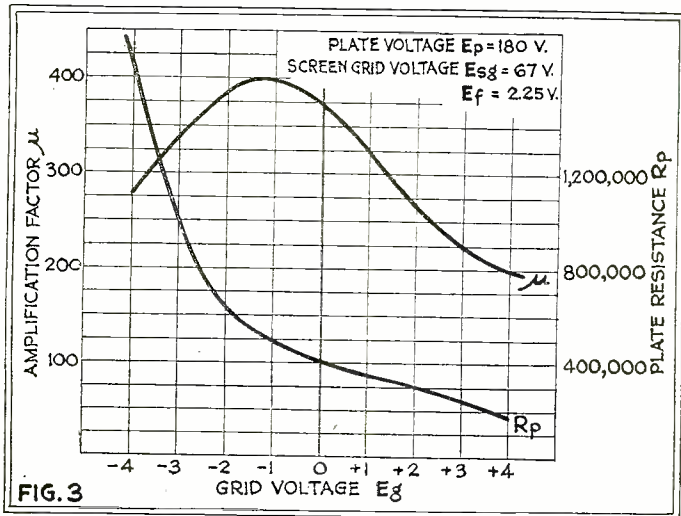

The voltage amplification of the transformer described in this article varies as plotted above over the broadcast band. It is slightly better at 300 meters; dropping off slightly at lower frequencies because the primary turns must be kept down so that the natural frequency will not fall in this band. This is overcome by proper design of the antenna coupling system.

Above, the amplification factor of the A.C. screen-grid tube and its plate resistance are plotted against grid-voltage swing with the normal polarity of 1½ volts on the grid.

where the following abbreviations are used:

$$\bar{\tau} = \frac{M}{\sqrt{L_1 L_2}}; \eta_1 = \frac{R_p}{L_1 \omega}; \eta_2 = \frac{R_2}{L_2 \omega};$$

$$\theta = \frac{1}{\omega \sqrt{L_2 C_2}}; \omega = 2\pi f$$

These abbreviations, besides being convenient, have physical meaning. For instance, $\bar{\tau}$, the co-efficient of coupling, depends almost entirely on the geometric relation of primary and secondary winding, and not on the inductance of either.

η_2 is inversely proportional to the sharpness of tuning of the secondary circuit when the primary is not present. The value of θ gives a very good idea how much off resonance the secondary circuit is, regardless of the waveband being considered. It should be noted then that equation 2 holds true regardless of the waveband, the position at which C_2 is set and the magnitudes of the quantities involved. Only two of the justified assumptions formerly named have been made.

For an incoming signal of given frequency, C_2 may be varied for maximum secondary

current i^2 . To determine this adjustment, differentiate function E/e_g with respect to θ and set its first derivative equal to zero. Performing this operation we find that the proper adjustment is where

$$\textcircled{3} \theta^2 = \frac{\eta_1^2 + 1 - \bar{\tau}^2}{\eta_1^2 + 1}$$

Placing this value for θ in equation (2) we find the voltage amplification at this point to be equal to

$$\textcircled{4} \frac{E}{e_g} = \frac{\mu \bar{\tau} \sqrt{\eta_1^2 + 1} \sqrt{L_2/L_1}}{\eta_2 (\eta_1^2 + 1) + \bar{\tau}^2 \eta_1}$$

Careful observation of equation 4 will show that there is a relation between $\bar{\tau}$, η_1 , and η_2 , that will give still greater amplification. In other words, in a radio-frequency transformer should the primary have one turn or ten? Should the coefficient of coupling be large or small? Should the secondary circuit have as small a resistance as possible? Let us see.

Differentiating E/e_g with respect to $\bar{\tau}$, and setting the derivative equal to zero, we have the

relation between the three quantities that will determine their best values. Performing the above operation we obtain

$$\textcircled{5} \bar{\tau}^2 = \frac{\eta_2}{\eta_1} (\eta_1^2 + 1)$$

if $\eta_1^2 \gg 1$

$$\textcircled{5A} \bar{\tau}^2 = \eta_1 \eta_2$$

Substituting equation (5) in equation (4) we find that the voltage amplification is

$$\textcircled{6} \frac{E}{e_g} = \frac{\mu \sqrt{L_2/L_1}}{2 \sqrt{\eta_1 \eta_2}}$$

Equation (6) is the maximum voltage amplification obtainable with a tuned-radio-frequency transformer after C_2 has been adjusted to its best position, and the proper relation has been obtained between $\bar{\tau}$, η_1 , and η_2 . It might be added that this voltage amplification gives by equation (6) is only obtainable at one definite frequency because η_1 is variable, while η_2 and $\bar{\tau}$ do not appreciably vary with frequency. (Note: The reason that $\bar{\tau}$ and η_2 do not vary is that the former is a geometric ratio, while in the latter R_2 goes up as the frequency increases; so that in a well-designed coil $R_2/L_2 \omega = \eta_2$ remains almost constant.)

However, if the design relations given in equation (5) or (5A) are satisfied for the middle of the spectrum over which the transformer is to operate, almost even amplification will result. Thus, for maximum amplification, we must make $\bar{\tau}^2 = \eta_1 \eta_2$.

In designing the transformer, η_2 is made as small as possible by using a high-grade condenser and a coil whose radio-frequency is as low as possible. This being done, η_2 is fixed. Having done this, the relation alone gives the primary inductance L_1 , for any coefficient of coupling; for

$$\textcircled{7} L_1 = \frac{\eta_2 R_p}{\bar{\tau}^2 \omega}$$

It will be noted that, when $\bar{\tau}$ is large, L_1 is small. From equation (6) we note that L_2 should be made as large as possible consistent with tuning to the highest frequency desired; also, for a given plate resistance R_p , μ should be as large as possible. That is, choose an amplifier tube that has the largest amplification constant per unit plate resistance.

The foregoing equations have given us the complete design data for maximum amplification in a tuned-radio-frequency amplifier, but have left us with one option in equation (7); i.e.,

(Continued on page 1148)

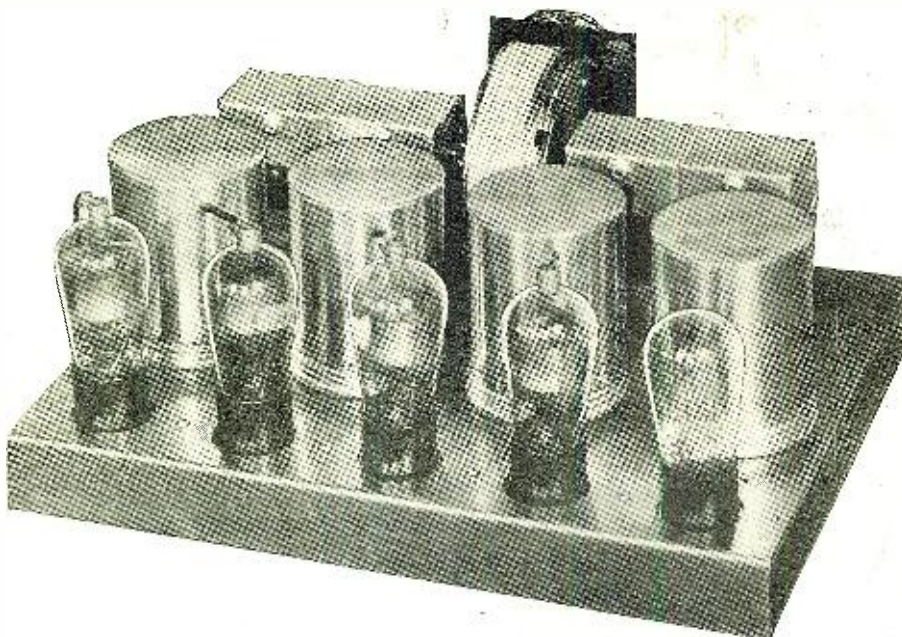

The tuner which will be described in detail in the July issue of RADIO NEWS has an untuned antenna coupling stage, followed by four transformers of the type whose design is dealt with in this article. The four tuning condensers are ganged and operated from a single dial. The shield cans shown hold each a transformer, with a choke coil and by-pass condenser.

The "Explorer Electric Eight"

A Single-Control Socket-Powered Receiver of Unsurpassed Tone Quality and Extraordinary Amplification

By John B. Brennan, Jr.

TO those who have observed the trend of modern receiver design, it is a significant fact that practically all the receivers now in popular use, and being manufactured on any considerable scale, employ a type of circuit that has been known to experimenters for a long time. Rarely is it found that a manufacturer has incorporated a so-called "trick circuit" in the receiver which he produces. The reason is not difficult to find; aside from the fact that conservatively designed receivers are easier to produce from an economical standpoint, they are exceedingly simple to operate, with an assurance of maximum satisfaction in performance, for an unskilled user.

It behooves the professional set-builder and experimenter, then, to benefit by the experience which the manufacturer has gained through years of labor and expense.

It has become an accepted fact that a person can build a better radio receiver than he can buy, and for less money, too. Without going into the economical features of such a discussion, this assertion can be borne out by the fact that a prospective radio set-builder, by virtue of the choice which he can exercise, may select well-nigh perfect units of radio apparatus, put them together in a receiver, and when he has

Essentially the circuit employed in the receiver described here is the same as one used six or eight years ago. Yet it differs in particular from the original in that advantage has been taken of all the more

MR. BRENNAN, the designer of this set, who is well known to most radio set builders by his articles, was for some years the technical editor of Radio Broadcast, and has recently accepted a similar post on Radio News. He describes here a receiver comparable with the highest (not the ordinary) type of commercial product, and above all one of the highest fidelity as a reproducer. Its amplification is all (and more) that can be utilized in ordinary radio locations. For those distance-seekers who are more fortunately located, Mr. Brennan will in a later issue describe a modification of the first stage to introduce another tuning control.

worth-while improvements which have been developed within the past three years.

To bring home to the reader in a completely convincing manner the similarity and

differences between the original and the improved tuned-radio-frequency circuits, it is necessary to digress for a moment and recount briefly the essential details of both.

The original tuned-radio-frequency circuit consisted, mainly, of a number of tuned radio-frequency amplifiers, usually three in number, and each tuned by its own tuning condenser. To such a tuning unit was added some form of accepted audio-frequency amplifier. Customarily, all this apparatus was strewn out on a baseboard, with its coil units arranged at all sorts of queer angles, to get away from interstage coupling. The panel was a veritable monstrosity, looking complicated enough to scare away the uninitiated with its many dials, tap switches and rheostats. In those days it was common enough, considering the tubes available, to build a set having a separate rheostat for each tube used. Wiring was considered an art for appearance sake, and much shiny bus bar with many perfect right-angle bends was the order of the day. While all this looked nice, it did not add materially to the efficiency of the apparatus or cause it to function suitably as a receiver.

In the audio end, small-sized, poorly-made transformers or impedance units served to amplify the received signal; but little or no

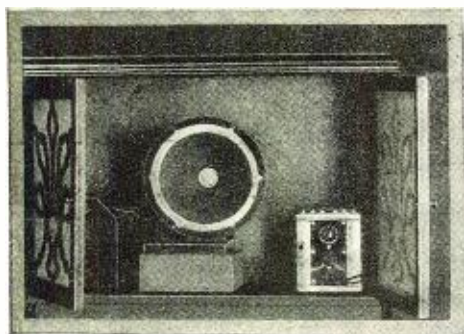

Fig. B

Behind the baffle necessary for low-note reproduction, we have the dynamic speaker and two power supply units, "A" at the right and "B" at the left.

Fig. A
The "Explorer Electric Eight" in its parlor clothes, with the console doors opened. The upper grilles are closed over the speaker baffle; their light silk lends decoration without obstruction.

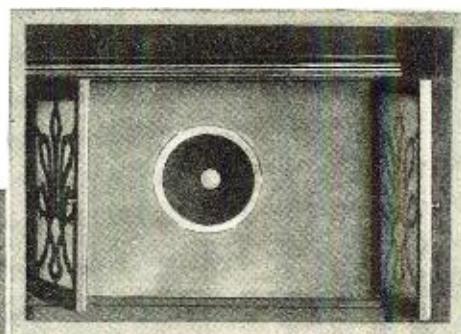

Fig. C

The dynamic cone only is to be seen through the Celotex baffle. Top, bottom and sides of the speaker compartment are lined with the same sound-proof material.

completed the job, rest assured that his product is, in all respects save possibly a few details of finish, superior to a manufactured job. Included in a cabinet which he has selected to harmonize with his decorative scheme, the receiver's appearance is in no way affected by its "works."

MODERNIZING A STANDARD CIRCUIT

With this idea in mind, the writer set about selecting a suitable circuit for an instrument that would have, when completed, all those elements of good sensitivity, fine selectivity and irreproachable tone quality which go to make up the receiver de luxe.



attention was given to the all-important matter of tone-quality reproduction. In the case of resistance-coupled amplifiers, it was not unusual to employ flimsy paper-made resistance units with condensers of not too-efficient characteristics. Yet in spite of all this, we managed somehow to build receivers which worked, and in some cases worked extremely well.

Down through the years the parts manufacturers have, by careful, consistent research and investigation, each in his own field of endeavor, developed units which are undoubtedly more improved and perfected, both electrically and mechanically, than

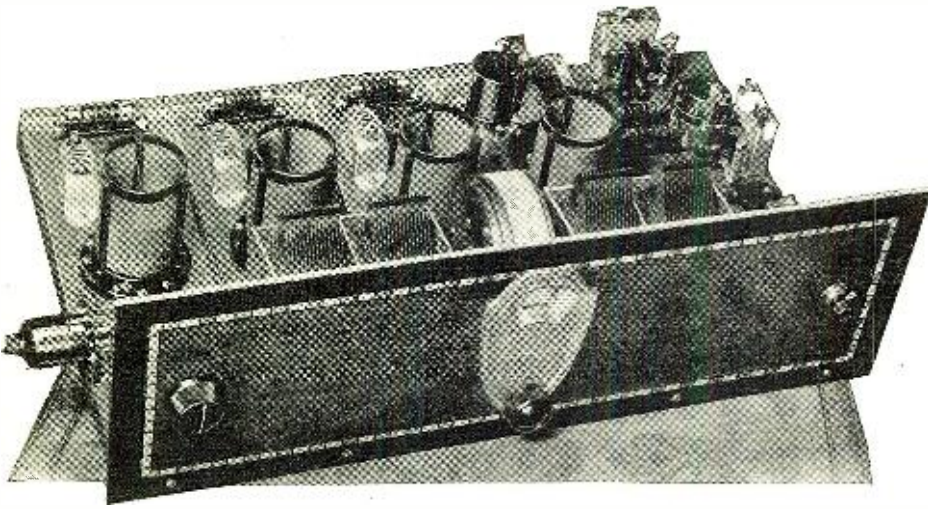

Fig. D

The "Explorer" from the front, with shields removed to show its compact layout.

their predecessors. It is natural to suppose, then, that if these improved units were put together in what was formerly considered a good circuit, the results should be far better than the sets we were accustomed to use a number of years ago. This is precisely what the writer has done and this article describes to you the construction of such a modernized receiver.

THE NEW DESIGN

The receiver described here is similar to the original type of multi-stage receivers in that coils, condensers, sockets, tubes, an audio amplifier, etc., are employed; but there the general similarity stops. Take the condensers, for instance; instead of having three or four separate condensers, each

mounted on the panel and controlled separately by its own dial, the new receiver has two ganged units controlled by one master dial. The coil units are efficiency themselves (being twice matched at both the high and low ends of the frequency range) and are selected for use with the particular type of tube to be used. Each radio-frequency stage is completely shielded with metal cans not only for the purpose of isolating one electromagnetically from the other, but also to shield the entire circuit from external influences. This, for instance, prevents the coil units and associated wiring from picking up signals from a station directly without the aid of an antenna. By some, such a feat is considered an indication of the efficiency of the receiver as a whole; but to those who know and understand the true state of affairs, this is purely an indication that the receiver is operating below par and with the aid of remedying apparatus could be improved.

Intercoupling between R.F. stages can be caused in a number of ways but the two most important are direct electromagnetic coupling between the coil units themselves (when, as is usually the case, they are situated too close to each other) and coupling of the R.F. currents which course through the various battery wires. The coupling in the latter case is due to the closeness and parallel path of two or more wires of sep-

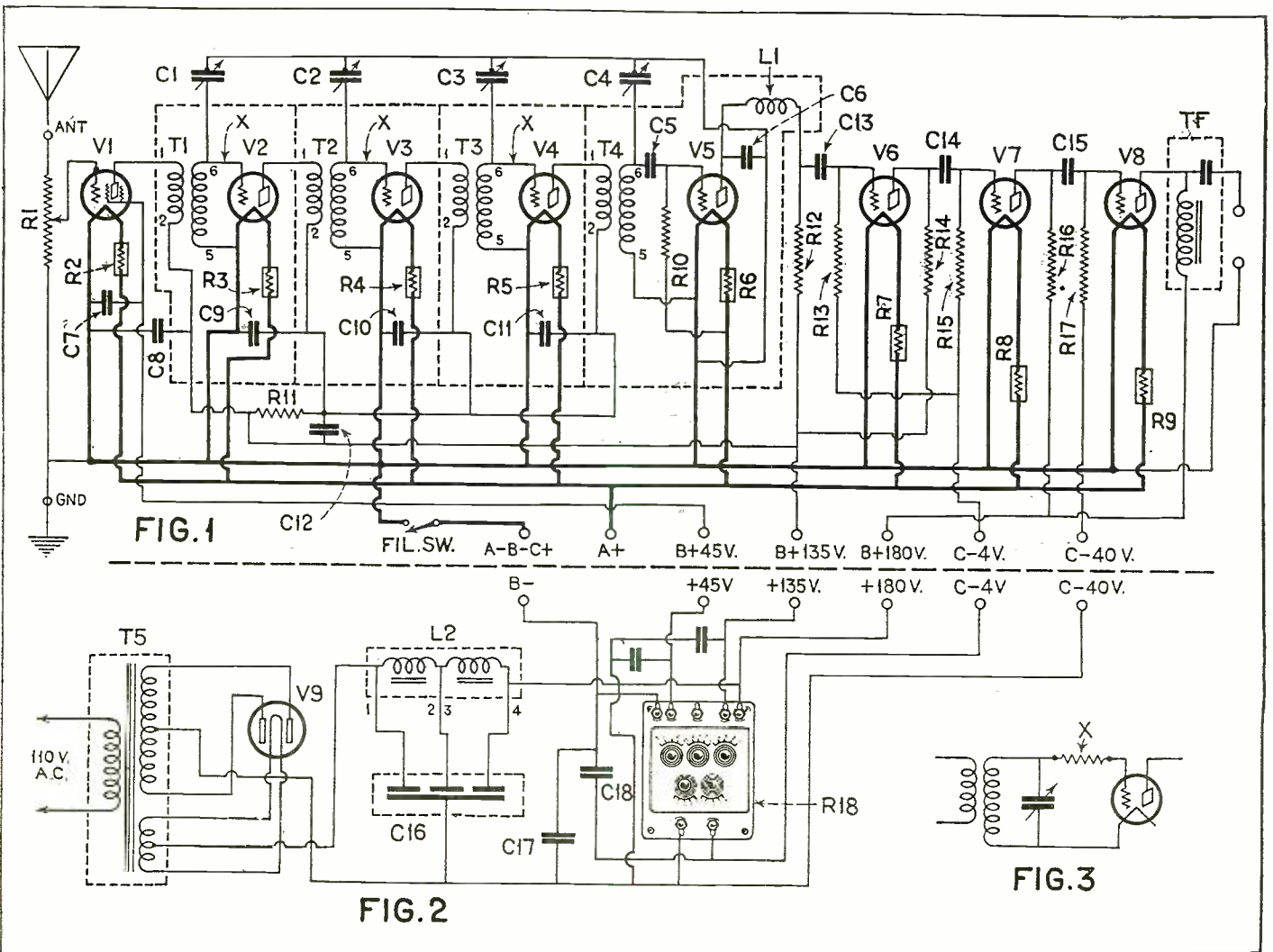

The complete circuit of the receiver proper, above the dotted line, is Fig. 1; that of the "B" unit Fig. 2. The "A" unit is connected across the filament terminals and to "B—" in the usual way. The "X"s in Fig. 1 may require inserted resistors, as shown in Fig. 3.

arate radio-frequency circuits; the actual disturbance being caused by one of the wires being located in and cutting the magnetic field which surrounds an adjacent wire.

The proper use of shield cans will eliminate quite effectively intercoupling between the coil units of the several stages. In the case of intercoupling due to parallel wires, the remedy lies in separating the wires, so that they do not run parallel but rather at

and by-pass condensers are the pieces of apparatus which accomplish this work; the chokes prevent R.F. currents from coursing through the long "B" battery leads, while the by-pass condensers shunt them by a short route to the "-" side of the A supply line.

MULTIPLE TUNING

In present-day manufacture the tendency is more and more toward single-control

then we get away from the single-control feature.

Lately it has become the accepted practice to employ in advance of the tuned stages a tube which functions as a coupling medium between the antenna-ground system and the tuned circuits of the receiver. The writer has employed it in many receivers with excellent success, and it is again used here. To do away with the necessity of employing an untuned coil as a coupling medium between the tube and the antenna, there is here inserted a simple resistance which, at the same time, serves most excellently as the volume control of the receiver. The tube employed is of the 222 type (screen-grid) and, besides serving as a coupling medium, provides also a certain amount of signal amplification which would not be obtained if an ordinary 201A-type tube were used.

Briefly explained, the tuner section of the receiver described here consists of one stage of untuned radio-frequency amplification, employed as the coupling stage, and four tuned stages, three of which are amplifiers and the fourth a non-regenerative detector. Each of the tuned stages, including the detector, is housed in a shield can, with the exception of its variable condenser. In the audio amplifier, separate parts are used to make up a single stage of resistance amplification. That is to say, separate plate and grid resistors are mounted in their individual mountings and separate fixed condensers are employed to couple the several tube circuits together. Although the chances are exceedingly slim that any of these units will go bad during operation, the provision is made; so that, if for any reason, it is desired to make a substitution (for example, let us say, of a coupling condenser) this may be done without having to discard an entire coupling unit, as would have been the case if the old-time units had been employed.

To protect the windings of the loud speaker from burn-out, a tone filter has been located between the plate of the power amplifier tube and the loud speaker itself; which, by the way, must be a good one if

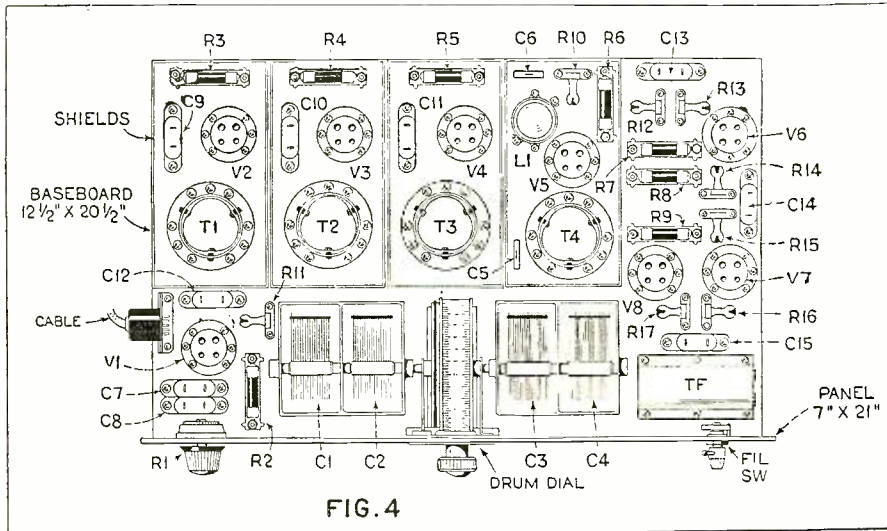

FIG. 4

The layout diagram above, when compared with the list of components on page 1139, and the photographic illustrations, will clearly identify each part.

right angles to each other. Not always is this possible and it is better to eliminate the trouble than merely to apply a remedy. The elimination process consists of keeping the R.F. currents out of those wires which are causing the disturbance. Since, usually, it is found that these offending wires are the "B"-voltage leads to the plates of the radio-frequency amplifier tubes, it is quite a simple job to include in the circuit suitable components to prevent these currents from coursing through these wires and shunt them to their destination by a more direct and less troublesome path. R.F. choke coils

receivers and, naturally, with the addition of each tuned stage of radio-frequency amplification the job of accurately tuning all of the circuits to the same wavelength becomes increasingly difficult. In receivers where the antenna is connected directly to the first tuned stage (either by an inductive or a capacitive coupling) it is well-nigh impossible to make all the tuned circuits peak accurately at the same wavelength; because the first tuned circuit is not working under the conditions which exist in the other associated tuned circuits. A simple expedient is to tune separately the antenna circuit, but

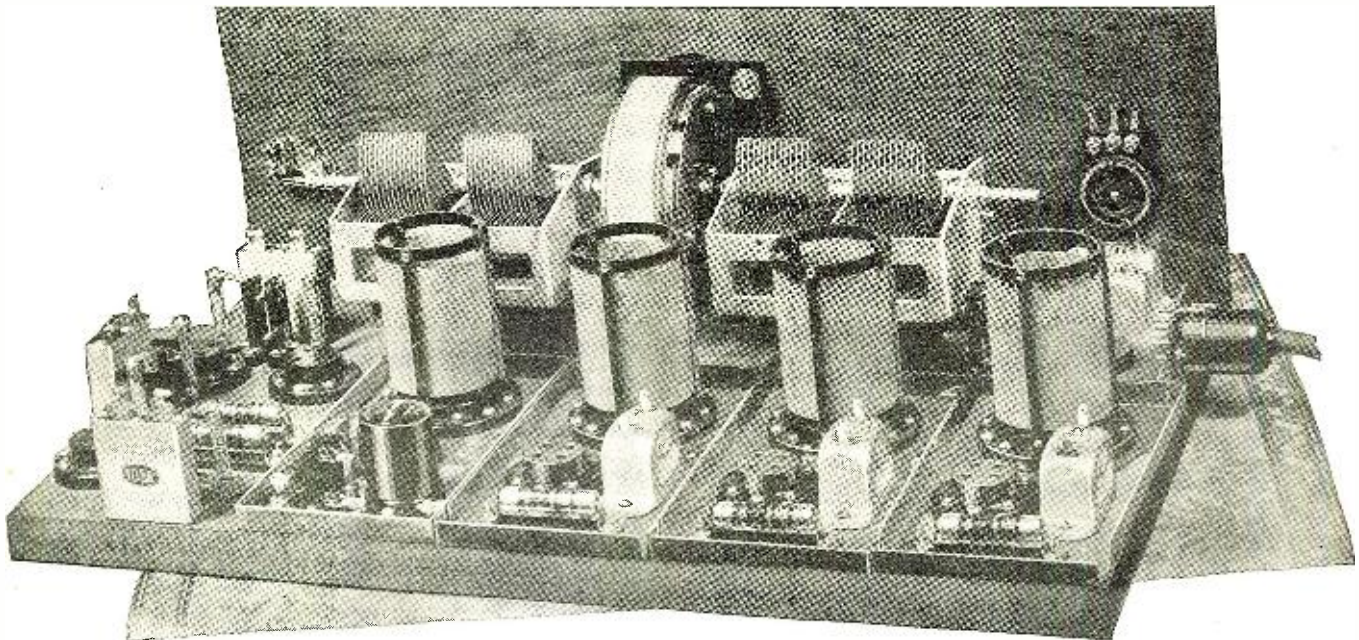

Fig. E

This rear view of the "Explorer Electric Eight," without its shielding, indicates the simplicity and ease of its construction.

we are to realize the highest order of tone quality of which this receiver is capable.

Throughout the receiver, each of the tubes has its filament automatically controlled and adjusted to the correct voltage and current requirements, by the use of a suitable Amperite.

SELECTION OF POWER TUBE

The line drawings accompanying clearly illustrate the several features explained here. As indicated and illustrated, the receiver was first constructed to employ a 171A-type tube in the power amplifier stage of the audio-frequency amplifier, and to protect the cone loud speaker a National tone filter was employed between the power stage and the speaker.

in the circuit, to provide the correct grid-bias voltage for the new tube. In the diagram (Fig. 7) wherein these changes are indicated, a table of values for various grid-bias resistors is given. The value to be used depends on that of the plate voltage which is applied to the plate of the 245 tube. Naturally, since this power tube requires a higher value of plate voltage than can be supplied by the "B" unit originally intended for the 171A tube, there are a number of changes which must be made if the builder desires to employ the 245 power tube. Additional information on this subject will be included in the latter part of this article.

ASSEMBLY AND WIRING

First, lay out the panel as shown in Fig.

In wiring the receiver it is well to follow out a system. First, wire all the filament circuits; then wire all the grid circuits; then wire all the plate circuits and, finally, complete the wiring by finishing all the miscellaneous circuits such as by-pass condensers, etc. The wire used should be flexible and well insulated. This is especially true of the wiring which is to be done inside the shield cans; for there must not be any possibility of short circuits between the wiring and the metal cans. The wire used exclusively by the author was Corwico solid and stranded "Braidite." This is very easy to handle, because the insulation can be slipped back on the wire; whereas it is necessary with other wires to actually strip the insulation from the end of the wire.

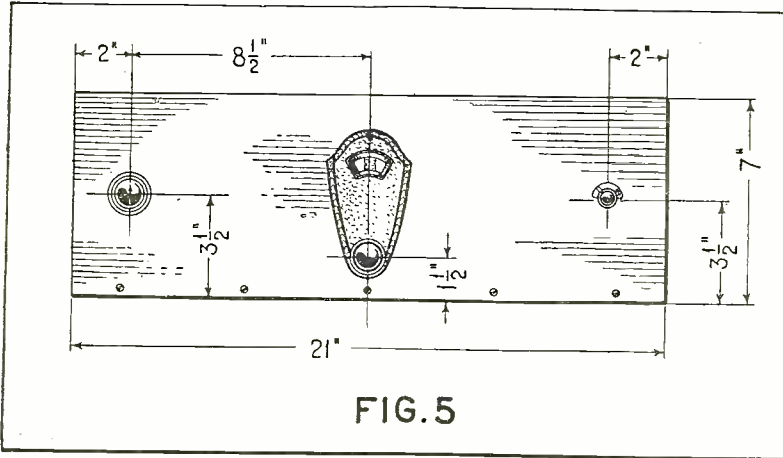

FIG. 5

Above, the panel layout of the "Explorer" receiver; at the right, the layout of parts for the "B" supply unit diagrammed in Fig. 2.

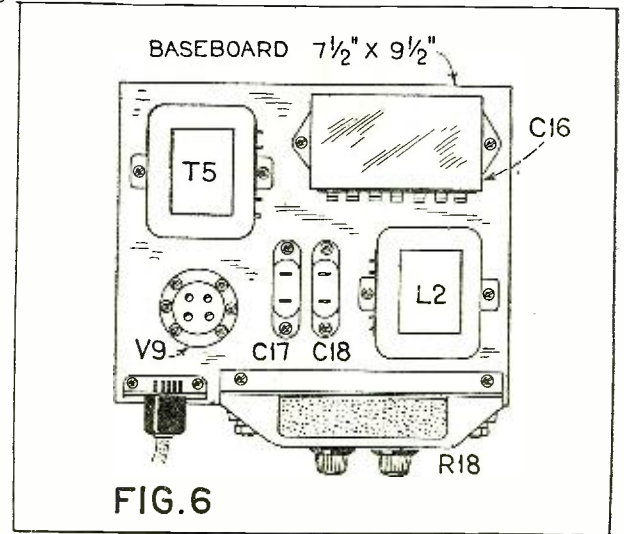

FIG. 6

Since these drawings were made, the original receiver has been altered in several ways. First, it was desired to operate one of the new dynamic loud speakers (in particular the S-M 850) out of the new 2 1/2-volt intermediate power tube, the UX-245. Therefore, since the S-M 850 was already equipped with a suitable speaker coupling transformer, the tone filter unit was eliminated from the receiver. Secondly, to power the 245 tube filament direct from an A.C. source, the filament regulator connected to the power stage socket was removed, together with the regular D.C. filament leads to the socket; and a pair of twisted wires was run to suitable binding posts for connection to the 2.5-volt terminals of a filament transformer. Thirdly, a grid-bias resistor and by-pass condenser were included

5, and then drill. Mount the volume control R1 and also the dial and the filament switch in their places. Next, fasten the panel to the baseboard and then place the two tuning-condenser units in place, so that the shafts fit into the hole in the center of the dial. Then bend and drill a pair of brass brackets for each of the condenser units, so that they are supported from the baseboard. The builder will have to determine for himself the correct height of these brackets since their dimensions depend largely upon the thickness of the baseboard employed.

Next lay out on the baseboard the bottoms of the shield cans and put in place the apparatus which is to be placed in them, in accordance with the basic layout, Fig. 4.

When you are certain that the layout positions have been determined for all this apparatus, then it may be fastened in place. Follow the same procedure with the audio-amplifier apparatus.

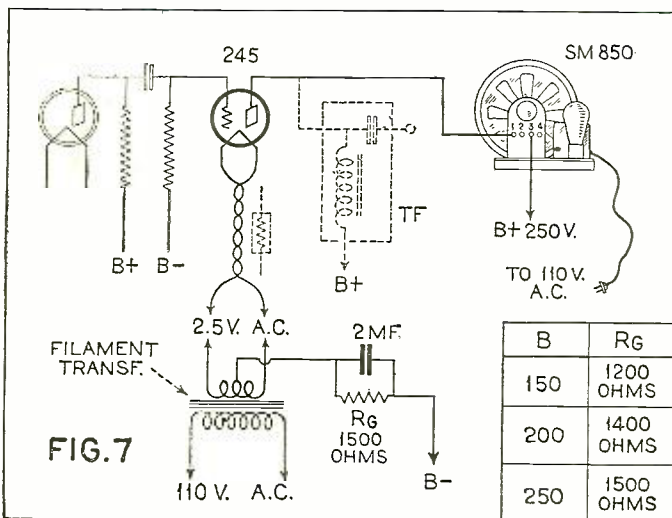

FIG. 7

To use a tube of the new 245 type in the last stage, the circuit must be changed as above. The dotted lines show the previous arrangement. The value of Rg, the resistor which furnishes grid bias for this tube, will be found in the column at the right of the diagram, opposite the value B of the plate voltage applied.

Secondly, by virtue of a good coating of tin on all of the wires, it is made extremely simple to make soldered connections between these and other parts of the circuit. Thirdly, because the wire is flexible, the various long battery leads may be bunched together to form a neat cable.

OPERATING NOTES

The tubes used in the receiver are as follows: R.F. coupling stage, a CeCo "RF22" tube; first, second and third R.F. stages, CeCo "AX" tubes; detector stage, CeCo "H" tube; first and second audio stages, CeCo "G" tubes; third or power audio stage, CeCo "J71" tube or "245" intermediate amplifier tube. The 2,500-ohm "Powerohm" R11 should be inserted in its mount. This resistor is used to "drop" the 135 volts which is supplied to the plate of the R.F. 22 coupling tube to about 90 or 100 volts for the plates of the three tuned-stage R.F. tubes. If all the tuned stages are found to oscillate upon operation of the receiver, it may be necessary to increase the value of this resistor to about 3,500 ohms. If it is found that only one or two of the tuned stages oscillate, then a 300-ohm "grid suppressor" may be inserted into each circuit at the point marked "X" in the circuit diagram, Fig. 1, as further illustrated in Fig. 3. These "grid suppressors" are wire-wound resistors manufactured in a form convenient to use. The resistance wire is wound on a core covered with insulating material, and the whole is cased in cambric cloth. Eyelets are located at the ends of the wire, for ease of connection.

Figs. 2 and 6 are the circuit diagram and base layout, respectively, of a suitable "B" (Continued on page 1139)

The "Velvetone" 245 Push-Pull Amplifier

The Latest Development in Power Tubes Utilized in an Audio Channel and Power Unit Adaptable to Many Purposes

By James Millen

DURING the past four years, since a unit combining an audio amplifier with a socket-power current supply was first described in a radio magazine, the fundamental soundness of such design has become quite firmly established; and today any number of well-known manufacturers are marketing combination amplifier-power supply devices for both radio and phonograph use.

In the past, however, manufacturers as well as experimenters have felt that the alteration of the amplifier's design from, perhaps, a 171A power stage to one employing such tubes as the 210 or, more recently, the 250 entailed too great an outlay for the bulkier and more costly equipment necessarily required to power such tubes.

The new UX-245 power tube with its high power output at low plate voltages now makes possible the design of much more compact and lower-priced "B" power-supply units and amplifiers of this character; and this development will no doubt become, during the coming season, an important factor in stimulating the use of such amplifiers.

But why the combination of audio amplifier and power supply? The question of separating the tuner unit of a radio receiver from the audio "channel" has been argued pro and con by designers, engineers and experimenters; and it is not the intention of the author to pass judgment on such a debatable issue. Suffice it to point out that the demand for combination amplifier-power supply units exists to an overwhelming degree, and this article is intended to describe to the reader the outstanding and important features of commercial units which are now available, together with those of one that can be built at home.

The uses of these power amplifier-power supply devices are many. To the experimenter they offer the important advantage of having on hand a standard audio channel to which can be attached a radio tuner unit of any type with which he may be experimenting at the time. These power packs provide a ready source of plate potential for the tubes external to them, such as those which are used in the tuner. A combination of audio channel and power-supply unit also lends itself admirably to the all-electric reproduction of phonograph records, with the assurance that the tone quality obtained will be far superior to that obtained from the old-time phonographs and will be on a par with that of electric phonographs of commercial types which are now available. (This, of course, necessitates that an electric pick-up of merit and repute should be used with it.) Then, for the fellow who wants to build an outfit consisting of both radio and phonograph units, there is nothing more suitable than just such a combination; for thereby he can, with the aid of a switch, make use of the audio amplifier's power supply for either radio or phonograph use.

There are three major points, not always apparent, but which must be simultaneously

met in the design of a combination amplifier-power supply: the arrangement of the various parts in such apparatus must always meet these three conditions. First, the locations of the various audio and power transformers, relative to each other, must be such to preclude any possibility of

SINCE 1925, when he developed and described what was perhaps the first combination of an amplifier and power pack available to the radio public, Mr. Millen has introduced many carefully-engineered assemblies to the readers of RADIO NEWS and other periodicals. He has been associated for some years with the National Company, to the general management of which he has worked his way, and has been the leader in its engineering work. We are glad to say that other articles from Mr. Millen will be offered to our readers in the next few issues.

stray-field linkage; which would result in either A.C. hum in the output or distortion. Generally, most trouble is encountered in finding the proper location for the first audio transformer; as any A.C. field from the power or filament transformer which links with the windings of this input transformer results in a hum, which is passed through the entire amplifier and thus becomes quite pronounced in the output.

The second and third points which must be given due consideration in locating the various parts are simplicity of wiring and compactness of the completed unit. In the case of the National "Velvetone" amplifier illustrated here, the first condition was met by so placing the various transformers in their containers as to prevent undesirable electromagnetic interaction. Just how successful this procedure turned out to be is illustrated by the entire absence of A.C. hum in the output. As to simplicity of wiring and compactness of design let Figs. A and B speak for themselves.

Fig. A

A front view of the "Velvetone" amplifier assembly. The power transformer, filter chokes and large Mershon condenser are in the rear cases; the three audio transformers in front. The terminals at the side are connected to other apparatus as shown in Fig. 2.

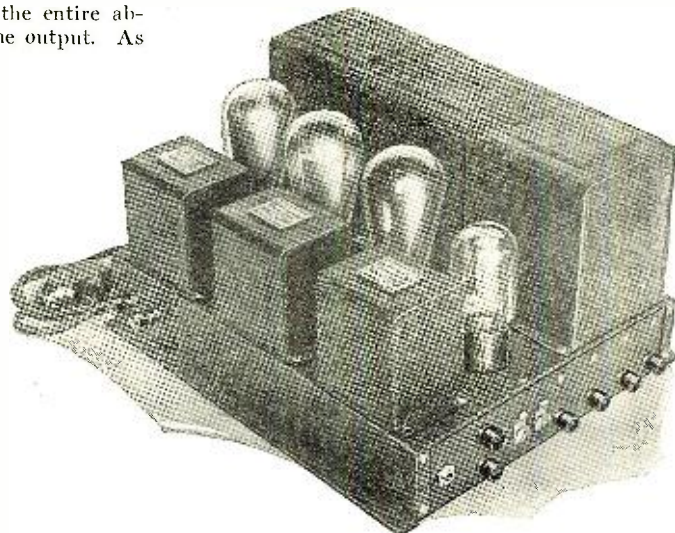

THE NEW POWER TUBES

With the advent of the new UX-245 power tube it now becomes possible to reduce very materially the cost and size of a combination amplifier-power supply, because of the high power output obtainable from this new tube with a low plate voltage. The following table, comparing some of the more important characteristics of the UX-245 with those of earlier types of power tubes, should prove interesting.

Tube	"B" Plate Voltage	Maximum Undistorted Output (Milliwatts)
112A	90	30
	135	120
	180	300
171A	90	130
	135	330
	180	700
210	250	340
	350	925
	425	1540
250	250	900
	350	2300
	450	4600
245	150	400
	200	900
	250	1600

The advantages of the new tube which this table shows are evident. Note that the 210 tube, with 250 volts on the plate, provides an undistorted output of 340 milliwatts; while the 245 with the same plate voltage offers a maximum of 1600, almost five times as much. Compared to the 250 tube, the 245 provides a little less than twice as much undistorted output in milliwatts when operating at a plate voltage of 250. Also, it will be seen from the above table, the 245 with but 250 volts on the plate has a greater power output than the 210 with 425!

Some of the most important advantages resulting from the use of this low plate voltage are the reduction in cost, improved performance and freedom from condenser trouble made possible in the power-supply unit by the use of a Mershon electrolytic condenser in place of the paper condenser necessary at the higher voltages. This type of high-capacity condenser is suited to use in filter circuits supplying under 350 volts and, as the maximum voltage required for the UX-245 is 300 (250 plate plus 50 grid) we are able to operate with a considerable margin of safety.

The UX-245 was designed especially for A.C. operation and, as a result, has a husky low-voltage, high-current, oxide-coated filament with a high "heat-inertia coefficient"; so that it is not adversely affected by ordinary line-voltage fluctuation.

Although the filament voltage is 2.5 (which is the same as that required for the heaters of the UY-227 and the new UY-224) a separate filament winding is necessary for the power tubes. This is to obtain the grid-biasing voltage in the most satisfactory manner and without putting the same high bias on the heaters of the UY tubes; which would result in increased hum and possibly, in some cases, insulation break-down between the UY cathode and heaters.

THE AUDIO TRANSFORMERS

The audio transformers used have cores of the new high-permeability nickel steel; this, in connection with the use of a special type of split-secondary winding, results in a frequency-characteristic which is essentially a straight line over the entire range of audio frequencies now being transmitted by the better broadcast stations. The push-pull transformer has two independent secondaries wound in opposite directions and placed side by side, in order to secure truly balanced performance.

POWER SUPPLY NOTES

Aside from the use of the new triple-section high-capacity Mershon filter condenser

(which is made possible, as pointed out above, by the relatively low plate-voltage requirements of the new power tube) there are several circuit features worth mentioning. Perhaps the most noticeable, from the circuit diagram, is the use of separate filament and plate transformers; which makes possible a reduction in hum, compared with the use of a single transformer for this purpose. Both the plate and filament transformers are wound with wire much heavier than generally customary, in order to supply "A" and "B" voltages for any R.F. amplifier-tuner with which the amplifier may at any time be used.

From the transformers we pass to the UX-280 rectifier, which has recently been improved in design and re-rated for use with transformer-secondary voltages as high as

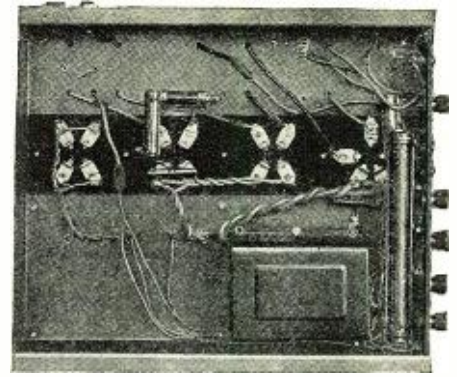

Fig. B
A bottom view of the "Velvetone" chassis showing the voltage-divider and by-passes at the right.

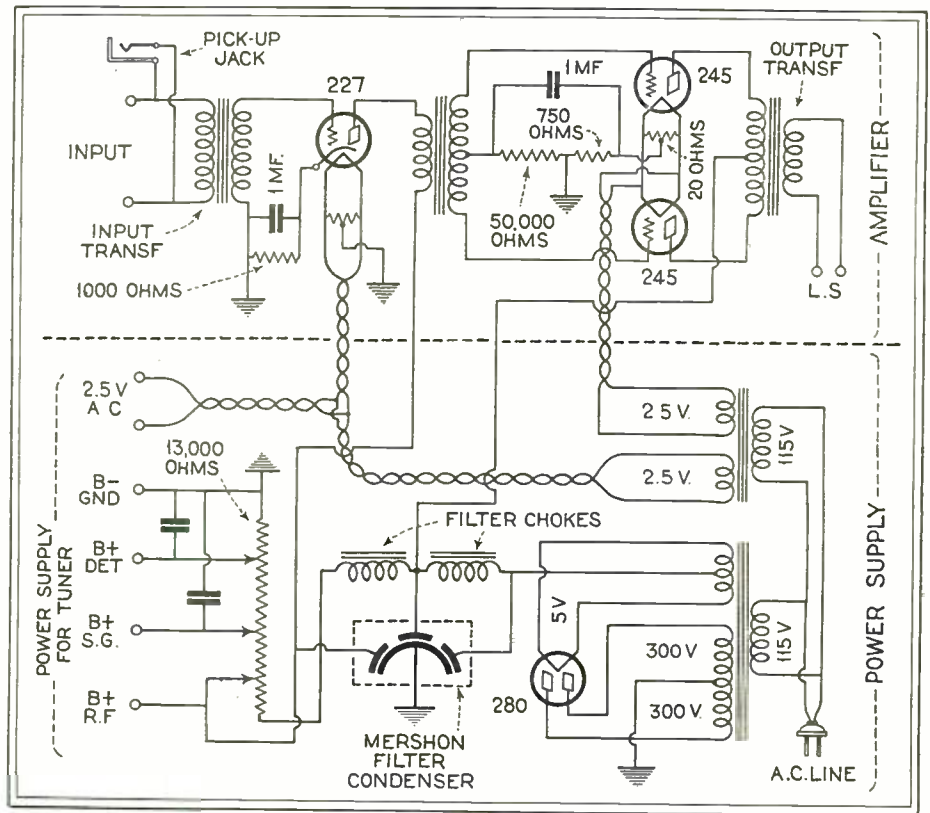

Fig. 1
The "Velvetone" provides 2½-volt filament current for a receiver, as well as for its own tubes, all of which operate on this supply. Note the system of by-passing all stages in this unit.

350. In this instance, the secondary voltage on each side is but 300; so that the tube is being conservatively operated.

Because of the high capacity of the Mershon condenser, a single filter section is ample for the push-pull stage. Another section is then added for the first-stage plate supply as well as the external voltage taps

(all of which should be operated as near hum-free as possible, if there is to be no hum in the loud speaker). A circuit novelty which works out exceedingly well is interposed at this point; it is the manner of connecting the third section of the Mershon condenser so that it provides exceedingly effective by-passing and tank-capacity service for the first audio stage, in addition to its filtering action. Thus, both the push-pull stage and the input stage have their own independent tank condensers; this refinement is found in few amplifiers, but is one of the many little points that must be considered where the best possible tone quality is to be attained. The remaining features of the power system are the output potentiometer (of an adjustable type) which makes it readily possible to secure accurate voltage adjustment for the detector and radio-frequency amplifier without danger of applying excessive voltages to the various tubes; yet, at the same time, there

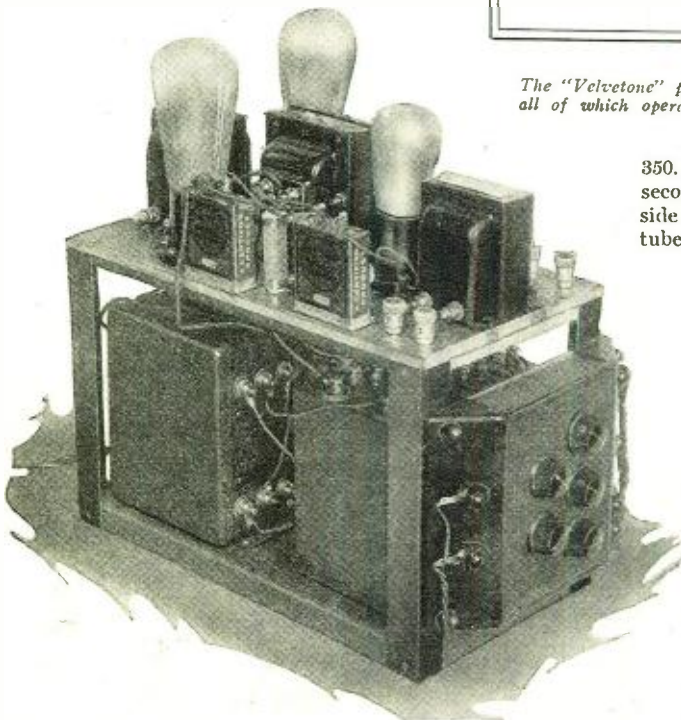

Fig. E
The double-deck amplifier and power pack at the left was designed in the RADIO NEWS Laboratory for home construction. The two decks may be mounted separately.

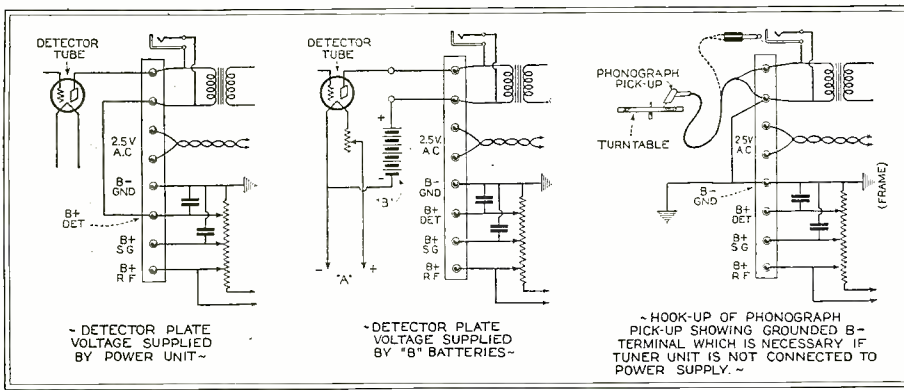

Fig. 2

The "Velvetone" is connected to an A.C. tuning unit externally, as at the left; to a D.C. tuner as in the center diagram; while the connection at the right gives phonograph reproduction of a high quality with volume of any desired amount. It will operate three or more loud speakers.

is certainty that these voltages, when once set, will remain at the selected values.

Fig. 2 shows three ways in which the combination unit may be used. If it is desired to connect to it a tuner unit which has no plate-voltage source of its own, then these various voltages may be obtained from the taps brought out on the terminal board of the power unit. At the left such a circuit is shown; the plate circuit of the detector tube is completed by means of a connection between one of the input terminals on

the terminal board and the "B+Det" post also located here. Plate voltages to other tubes which might be in the tuner are supplied from the other terminals provided. The 2.5-volt A.C. heater line in the tuner

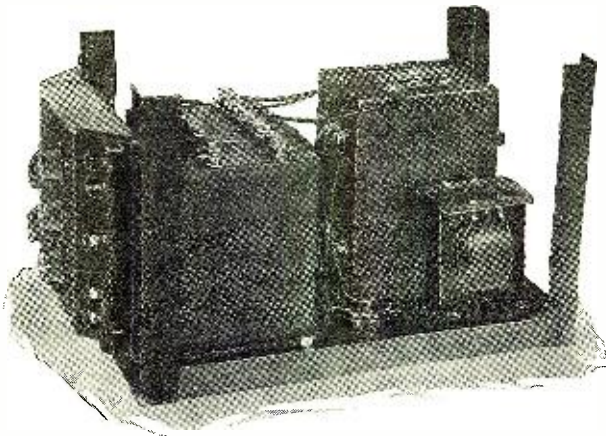

Fig. D

The "B" power section of the double-deck unit illustrated opposite. It will be described in a later issue of RADIO NEWS.

should be examined and, if the mid-points of any of the center-tapped resistors connected across it have been by any chance connected to anything but "B—," they should be disconnected, so that there cannot be any short circuits.

In the center are the circuit connections required when the detector tube of the tuner unit obtains its plate-voltage supply from an external battery source. Note that this makes unnecessary any connection between the input terminals and the terminals supplying plate voltage from the combination unit.

At the right is the connection of a phonograph pick-up to the audio channel of the combined unit. If, previous to the connection of the pick-up, a tuner unit has been connected to the voltage-supply terminals of the power supply, then connection of the pick-up circuit to ground is automatically obtained. If a tuner has not been used or connected, then one of the input terminals, as shown, must be grounded and connected to the "B—" terminal, to avoid the production of hum and high-pitched whistles.

When connections have been completed, and the tubes have had sufficient time to reach their normal operating temperature, the "B" voltage levers should be adjusted so that the tuner is operating at best efficiency. It will generally be found desirable to separate the amplifier and tuner at least two feet. Sometimes improvement in operation results also from changing the angle between the positions of the amplifier and tuner. Because of the incorporation in it of the Mershon condenser, the amplifier should always be operated right-side up.

OTHER APPARATUS

The illustrations accompanying the article show other amplifiers. Fig C is a commercial 245-type combination power amplifier-power supply unit, put out by Ferranti, Inc. (Continued on page 1142)

Ten Instructions for the "DX" Fan

- (1) Good reception begins with the interception of ample signal strength. Therefore, make sure of good aerial and ground connections. Joints should be soldered, or at least taped. A suitable socket antenna plug will sometimes prove more efficient than an outside antenna, particularly in poor radio localities. It may be employed as a "booster," in addition to the usual antenna.
- (2) Reception can be no better than the tubes employed. Tubes, contrary to general opinion, do not last forever; even if they light, that is no indication of their goodness. When tubes have been in use more than a year, they should be replaced with fresh tubes. Only tubes of a reliable brand should be used. Cheap tubes are most expensive in the end.
- (3) Proper "A," "B" and "C" voltages should be applied. In the case of batteries, this may be done by voltage taps. In the case of radio power units, this may be done by employing efficient variable resistors in obtaining precise voltages for all purposes.
- (4) The grid leak in the detector circuit should be adjusted for best results.

- (5) Regeneration is practically essential to real DX results. It can be secured in various ways, for practically every radio-frequency circuit has some form of stabilizer to prevent regeneration, and this can be altered when in search of DX, so as to permit of regeneration or approach to maximum sensitivity.
- (6) A sensitive loud speaker should be employed, or, better still, a pair of headphones, plugged into the first audio stage. Many loud speakers today are relatively insensitive be-

- (7) It is well to change tubes around to determine the best tube for each position in the radio set. There is sufficient variation in most tubes to make some better for one purpose than for another.
- (8) If you are troubled by excessive background noises or microphonic interference, the cause is generally traceable to the detector tube, which should be changed.

(Continued on page 1140)

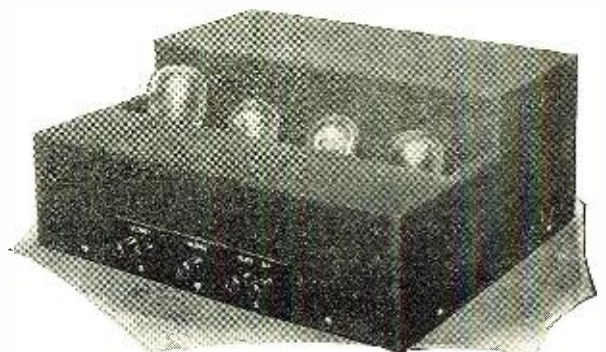
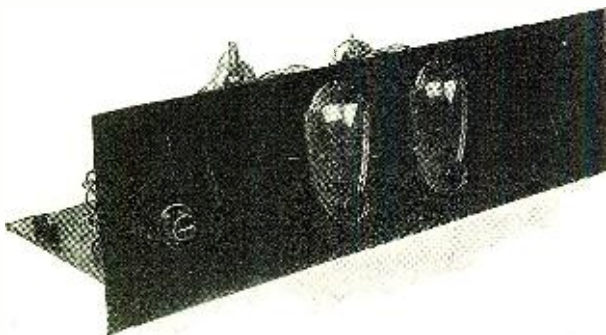

Fig. C

Another of the commercial amplifiers and power units now being placed on the market for the new "intermediate" 245 tube. This is of Ferranti make.

How to Build the New A.C. Screen-Grid "Everyman" Tuner

By Zeh Bouck



The attractive panel appearance of the "Everyman" may be seen at the left, as it appears ready to slip into a suitable console or cabinet.

ONE of the most efficient receivers which has been presented to the constructional fan (and to the average broadcast fan through the efforts of the custom set builder) was the Everyman Five, an exemplification of well-established engineering principles, designed by the radio technicians of the *New York Sun*. The receiver was introduced originally as a battery-operated set, which necessarily limited its popularity in this era of A.C. receivers. However, as a veteran critic of broadcast conditions, the writer has no hesitancy in describing this receiver as almost ideal; its qualifications of relative perfection being simplicity of construction, reasonable cost, flexibility in adaptation to audio channels, and selectivity and sensitivity in the correct degrees.

Appreciating the limitations of the battery-type receiver, he has redesigned the set for Arcturus A.C. tubes, and the resulting

WE describe here the latest of a series of developments of "Everyman" receivers under the auspices of the radio editors of the New York Sun, and in which some of the best engineering brains of the country have cooperated. Mr. Bouck, who has been intimately associated with the progress made in all electric receivers, speaks with authority on the subject; and his contribution is hereby commended to all our readers.—THE EDITORS.

equipment is presented herewith to the readers of RADIO NEWS, in the form of an R.F. tuning unit, complete in itself, and adapted excellently for use with an external amplifier of any desired type. A push-pull audio channel, adapted to operation from the same filament transformer as the tuner, is also shown.

The characteristics of the A.C. Screen-Grid "Everyman" tuning unit are similar to those of the D.C. model, with the exception of its noticeably increased sensitivity—due to the extra amplification effected by the use of an Arcturus A.C. 22 screen-grid tube, the characteristics of which are superior to those of the conventional D.C. four-element tube.

In the A.C. Screen-Grid "Everyman" unit, both selectivity and sensitivity have been refined and emphasized to the last degree compatible with quality; and in this set these characteristics are easily and conveniently controlled. Without recourse to

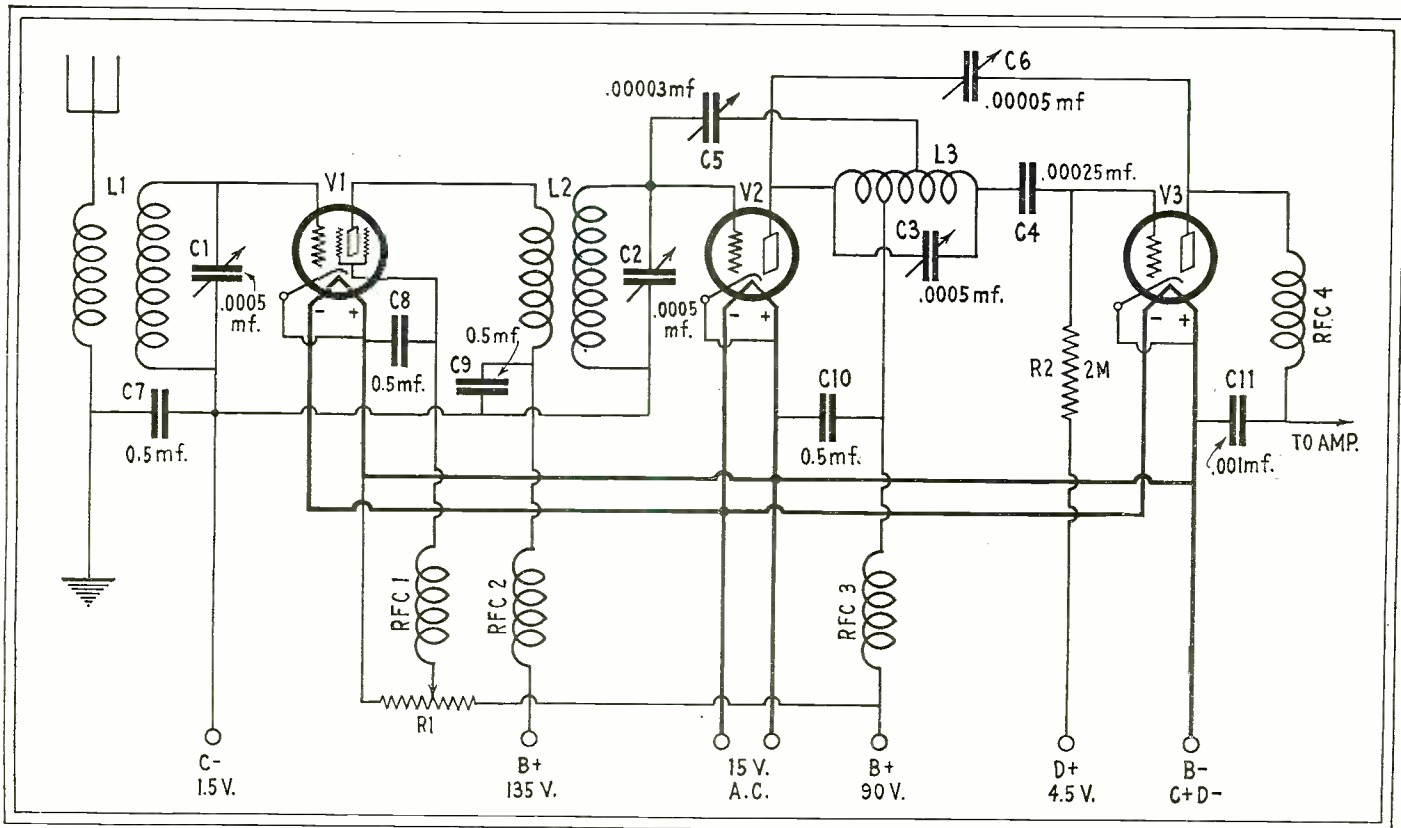

Fig. 1

The "Everyman" Tuner shown here, using three 15-volt A.C. tubes, suitable audio channel, such as that on page 1104, it will operate the first in a screen-grid stage, is a complete receiver. With any speaker selected, and give results of high quality.

regeneration, the sensitivity of the receiver is such that practically all stations, both local and distant, contributing to the average evening's entertainment, can be tuned in on a short indoor antenna. The noise level, under such conditions, is maintained at a satisfactory minimum, and reception comes through unimpaired by background. But when regeneration is introduced, with a turn of the right-hand knob, the sensitivity of the receiver is noticeably increased; and the ratio of noise level to signal strength is the only limit to reception.

FIFTEEN VOLT TUBES

The A.C. Screen-Grid "Everyman" tuner is built around the Arcturus line of 15-volt tubes; these are of the heater-cathode type, yet plug into the standard UX four-prong

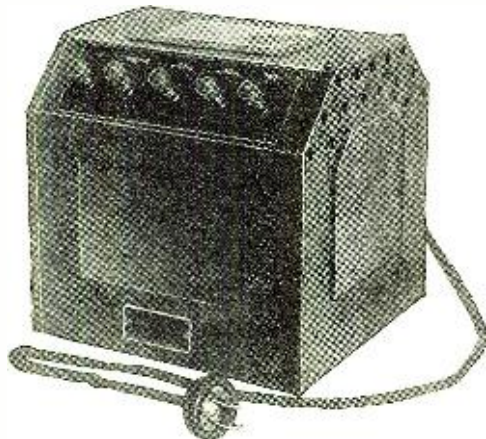

socket. The cathode construction renders them practically humless, and the use of a carbon heater insures a long life measured in thousands of hours.

The schematic diagram of the R.F. and detector stages of the unit is Fig. 1, and the layout of the parts is given in Fig. 2, which may be compared with the reproduced photographs. The first tube (glancing from left to right) is the screen-grid amplifier V1. The second tube V2 is included in a somewhat conventional radio-frequency amplifying circuit and is of the familiar three-element type. The third tube in the R.F. section of the receiver, V3, is the detector, arranged for grid rectification in Fig. 1.

The circuit is stabilized by a semi-permanent adjustment of the duplex Clarostat R1, which controls amplification by varying

the bias on the screen-grid of V1, and by the .00003-mf. balancing condenser C5. When correctly adjusted, the circuit is stable over the entire tuning range with unusual gain characteristics.

Stray coupling effects are reduced to a minimum, without recourse to shielding, by the spacing of the coils, and by the generous use of the radio-frequency choke coils RFC 1-2-3-4, and the by-pass condensers.

THE RADIO-FREQUENCY UNIT

In this article, as will be seen, only the radio-frequency section of the receiver is reconsidered and illustrated in detail. As this receiver will be built almost exclusively by experts and by custom set builders for the broadcast enthusiast, the choice of the audio amplifier is left to individual preference, which will be governed principally by the power desired in the output circuit.

It is in the radio-frequency circuit that the "Everyman Five" differs from the conventional receiver and exhibits its distinct superiorities. The output of the detector can be coupled to any adequate audio frequency amplifier. A preferred design for the audio amplifier will be indicated later on.

Fig. C

A special National "A and B" power unit, designed to powerize the "Everyman" Five.

LIST OF PARTS

The following parts are required to build the A.C. Screen-Grid "Everyman" tuner illustrated here.

- One Set Twin Coupler "Everyman Five" coils (L1, L2, L3);
- One National "Everyman Five" assembly, consisting of two drum dials and three .0005-mf. variable condensers mounted and coupled (C1, C2, C3);
- One .00005-mf. Camfield midget regeneration condenser (C6);
- One .00003-mf. Camfield midget balancing condenser (C5);
- One Muter 2-megohm grid-leak and mounting (R2);
- Three Eby UX sockets;
- One Muter grid condenser, .00025-mf. (C4);
- Four Muter by-pass condensers, 1/2-mf. (C7, C8, C9, C10);
- Four Muter R.F. choke coils, 85-millihenry RFC, 1, 2, 3, 4);

- One bakelite panel, 7x24 inches;
- One Yaxley 7-wire cable and plug;
- One sub-panel or baseboard, 7x23 inches;
- One Duplex Clarostat (R1);

It is recommended that the inductance coils be bought ready-made. However, they may be wound at home, if desired, to the following specifications: There are four distinct coil units: as in L1. The antenna primary and its secondary are separate. The R.F. transformer L2, consisting of primary and secondary, is on one form, as also the coupling coil L3.

All coils are wound on bakelite tubes having an inside diameter of 2 inches; the antenna primary is wound with 18 turns of No. 22 D.S.C. wire, and its secondary with 70 turns of the same. L2 also is wound with 70 turns of No. 22 D.S.C. wire, brought out to lugs on each end of the coil, for the secondary; while the primary is wound over the secondary, in the same direction, with 40 turns of No. 24 D.S.C. wire. The coupler L3 is wound with 70 turns of No. 22 D.S.C., and is tapped at the 21st and 49th turns.

ASSEMBLY

The constructional details of the receiver are sufficiently indicated in the wiring diagram (Fig. 1) and layout (Fig. 2) as well as the pictures of the completed receiver. However, there are one or two points worthy of special emphasis.

The following procedure should be observed in wiring the coils: referring to Fig. 2, when the adjustable primary of L1 is closely coupled to the secondary, its terminal nearest the latter is connected to ground — the other end, of course, being wired to the aerial post. The top end of the primary of L2 (the end of the primary terminating at about the middle of the coil) is connected to the plate of the first R.F. tube V1. The lower terminal of the primary is wired to the choke coil RFC2. The lower end of the secondary (the terminal nearest the low or battery end of the primary) is wired, as indicated, to the "C-L5" terminal of the receiver. The other end of the secondary goes to the grid of the second tube V2. Then L3 is connected as shown in the wiring diagram. As it is symmetrically tapped, only the relative positions of the taps are important and these are indicated in Fig. 1.

In wiring the unit, care should be taken to wire all "F+" terminals together. The

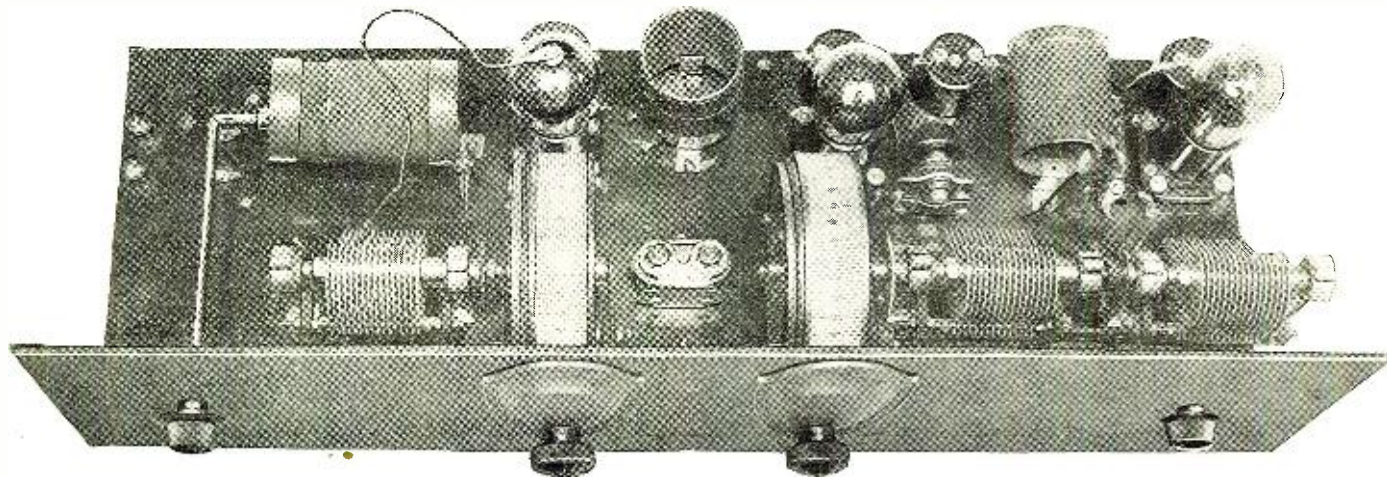

The placement of parts in the "Everyman" Tuner illustrated above is such that every component is given ample room, and interstage

coupling is limited to the minimum without shielding. The receiver is especially adapted to use with a separate amplifier.

cathodes of the tubes are common, with the heater terminal plugging into the "+" prong of the socket. As already stated, the tubes used in the R.F. section of the "Everyman Screen-Grid Five" are all of the Arcturus fifteen-volt type. The first tube is a screen-grid A-C22, the second an amplifying tube, A-C48, and the third the detector tube type A-C26.

These tubes require 15-volt A.C. filament or, rather, heater potential, which is supplied from any suitable step-down transformer, such as the Thordarson type 121.

SPECIAL POWER SUPPLY

The National Company has designed for the "Everyman Five," a special combination "A and B" supply (Fig. C) that incorporates a step-down transformer with a 15-volt secondary for these tubes. Using this power supply, it is necessary only to obtain the "C" and "D" potentials from external sources; these are most conveniently furnished by means of dry cells. The required voltages are 1.5 and 4.5 volts as indicated in Fig. 1. Any combination of supply sources, however, that will furnish the required potentials will be satisfactory.

The designation of the "D" voltage in the detector tube is self-explanatory to those familiar with grid-rectifying circuits employing this 26-type 15-volt tube. It is merely a simple method of placing on the grid of the detector tube the necessary positive voltage which is secured, in battery-operated sets, by bringing the grid return down to the "+" side of the A battery. The "D" battery is merely a 4.5-volt "C" battery turned around.

OPERATION

The main consideration involved in making the preliminary adjustments on this receiver is the stabilization of the radio-frequency amplifier; this is obtained by the correct adjustment of both the balancing condenser C5 and the duplex Clarostat R1. Adjustments should be made on these controls when the receiver is tuned to a broadcast station in the neighborhood of three hundred meters.

The circuit should be so balanced, by adjustments on R1, that it will oscillate when the .00003-mf. balancing condenser is moved in either direction from the stable adjustment. The regeneration condenser C6 should be at minimum capacity during these adjustments. If the line voltage and the step-down transformer are correctly balanced, the tubes will heat to normal operation in exactly

A PUSH-PULL AMPLIFIER

The diagram of Fig. 1A shows an audio amplifying system capable of delivering a large undistorted power output from any adequate input, such as will be obtained from the detector of the A.C. Screen-Grid "Everyman" tuner. This amplifier is conventional, but represents an arrangement that is practically perfect within reasonable

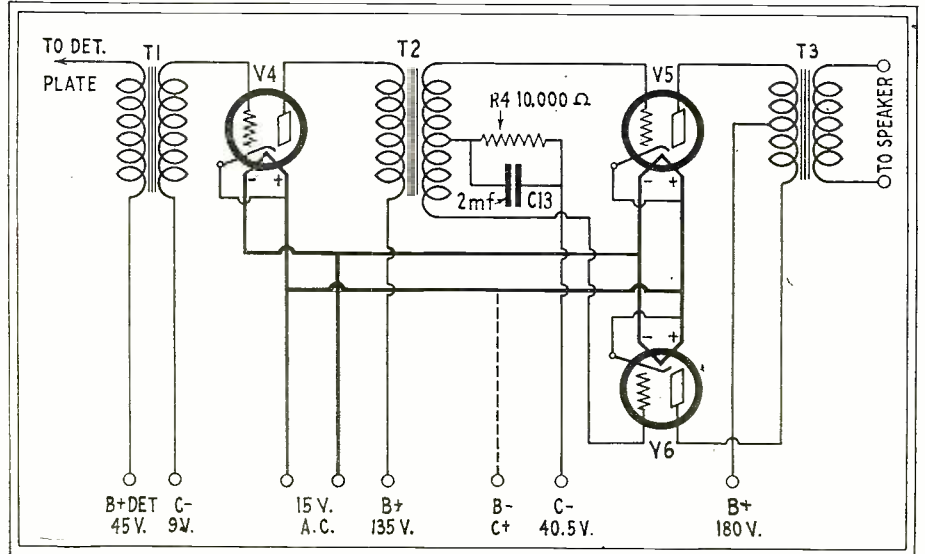

Fig. 1A

The audio amplifier diagrammed schematically here is especially well adapted for use with the A.C. Screen-Grid "Everyman" Tuner; as it also utilizes 15-volt tubes throughout. The output is equivalent to that of 171-type tubes in push-pull.

thirty seconds after the current is turned on. This condition will obtain when fifteen volts is applied to the heaters of the tubes; and it is at this voltage that the tubes are characterized by a life well in excess of two thousand hours. If the tubes heat to normal operation in less than 30 seconds, it is an indication that too much voltage is being applied to them. This should be reduced by putting a low-range power Clarostat or other voltage regulator in series with the line to the primary of the filament-lighting transformer, and adjusting until the proper time-lag is secured.

operating limits. It consists of a standard push-pull power stage preceded by one straight transformer-coupled stage.

Fifteen-volt tubes are used in this amplifier also; thus making it possible to operate the heaters of the entire receiver from a single A.C. transformer. An A-C48 type tube is used in the first audio stage and two type 40 power tubes in the push-pull stage. Transformers recommended are the Amertran De Luxe or the Ferranti, designed for use with the 171 type of tubes. The output transformer should be, of course, adapted to

(Continued on page 1143)

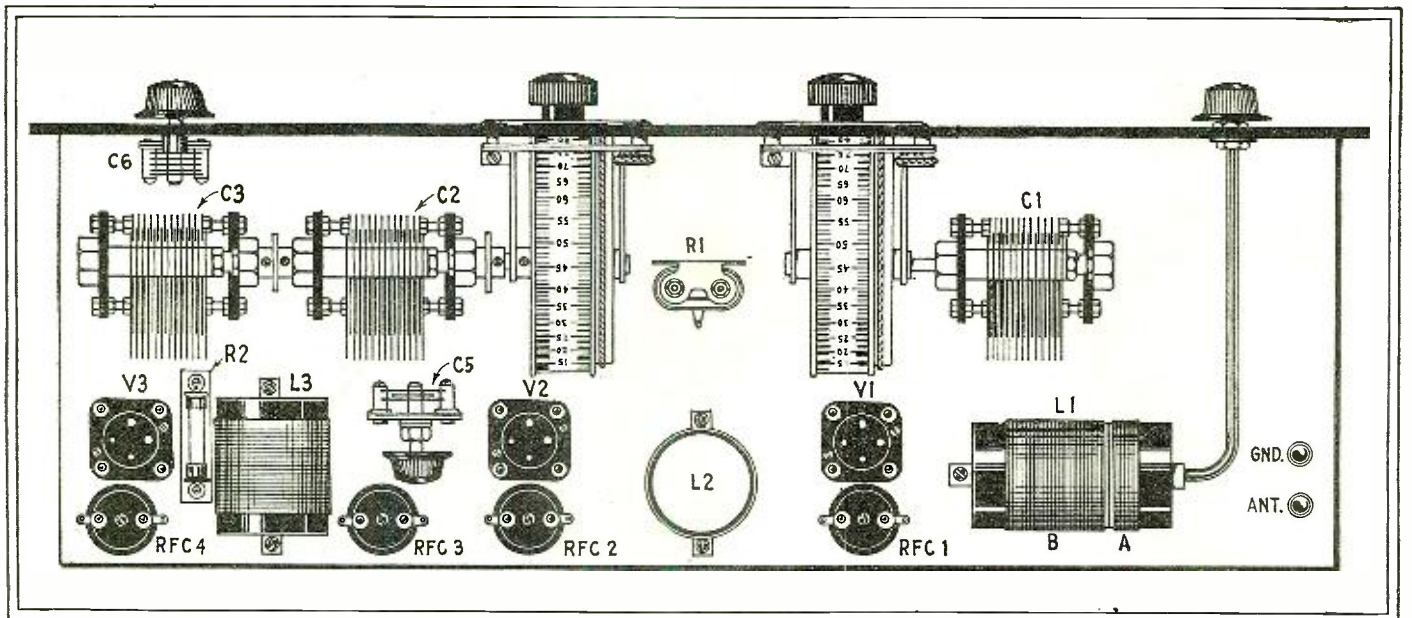

Fig. 2

The layout of parts for the "Everyman" shown here, in combination with the photograph on the preceding page and the schematic diagram (Fig. 1) will give sufficient details for construction; as placement is not critical if care is used to mount the coils at right angles.

"DX" and the "Band-Isolator" Receiver

With an Introductory Survey of Broadcast Conditions

By S. Gordon Taylor

IS good long-distance ("DX") reception possible during the early evening hours? Or has the large number of broadcast stations now on the air made anything but local reception out of the question, unless one is willing to wait until midnight or after, or unless one has a particularly favorable location?

This is a question that has been the subject of much discussion, particularly since the wavelength reallocation which took place November 11 last. It is probably fair to say, the majority of urban fans believe that reception from distant stations is well nigh impossible before midnight. This is particularly true of fans located in the more populous metropolitan centers, where local broadcast stations are numerous and the interference correspondingly great.

Any discussion of this question must necessarily be limited to conditions obtaining in one particular locality. Reception conditions, particularly from the standpoint of local interference, vary so greatly that a general discussion is out of the question. The fan who lives in an outlying section, with the nearest broadcast station perhaps fifty or a hundred miles away, requires only a sensitive receiver to bring in any number of stations throughout the country. For him, good distant reception is always possible.

But, to the fan who lives in the center of a nest of broadcasters (as in New York City or Chicago) conditions are entirely different. Here, with a large number of high-power local stations in simultaneous operation throughout the evening, distant reception becomes a real problem, requiring a receiver with both sensitivity and selectivity of a high order.

Conditions in New York City are probably as bad as (if not worse than) can be found anywhere else in the country. Such being the case, this offers a good location for discussion; if distant reception is possible here it is certainly possible anywhere.

Any discussion, to be worth while, must be based on actual measured performance, not on hearsay or random observations. The facts brought out in this article were obtained through a series of tests conducted for the special purpose of determining the exact degree of distant reception possible in this location. To show the impartial nature of the tests, a brief description of the layout will be of interest.

CONDITIONS ENCOUNTERED

The receiving station was in an apartment in New York City and in a location entirely surrounded by other apartment houses. The aerial employed was seventy-five feet in length, including the lead-in, and was one of forty on the one roof. Some of the other thirty-nine approached within five feet of the test aerial; so it is obvious that the location and the antenna installation were anything but ideal. However, they are typical of the conditions under which most fans labor, if their receivers are located in the city.

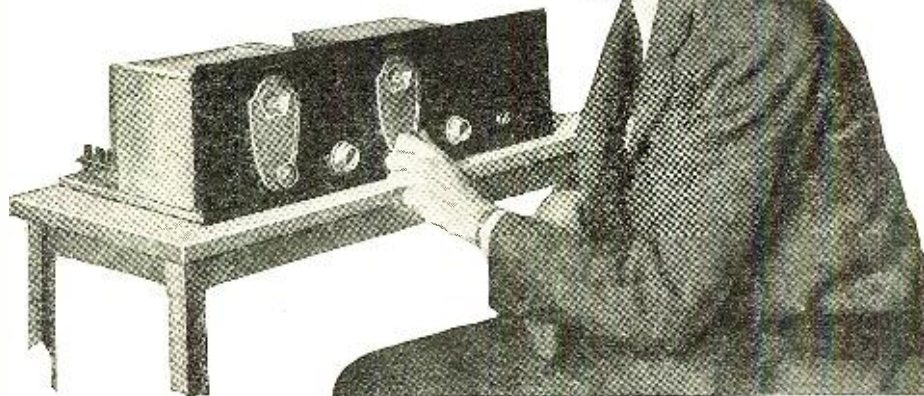

Mr. Taylor with the receiver whose performance and circuit are described below.

All tests were made *between the hours of 7:30 P. M. and 11:30 P. M.*; thus limiting them to the hours when the evening locals were going strong and, incidentally, the most popular hours for reception. From the foregoing, it is evident that all conditions were as truly representative of average New York City reception conditions as could be arranged.

The receiver employed was the only exceptional thing about the tests. It will be described in detail later on in this article, and in the article to follow. Suffice it to say here that it is a receiver designed by the author for use in his home, and incorporates the features most desirable in a good home receiver. But, in addition, it is a receiver which combines extreme sensitivity with an unusual degree of selectivity, as will be shown by the results of the reception tests, as given below.

Two sets of tests were made. The first, just prior to November 11, were to obtain a true picture of conditions existing under the old wavelength assignments and to provide a basis for comparison in determining the effect of the reallocation. The second set of tests was made about a month later; this lapse of time being allowed to permit the stations to get settled down in their new channels. All conditions were identical during the tests, except that the atmospheric conditions improved somewhat as autumn ended and winter approached.

The composite "log" given herewith shows the reception conditions that were found on the ninety channels used by broadcast stations in the United States; both before and after the wavelength changes. During the first tests the local noise level ("man-made static") was very high on the higher-frequency (shorter-wave) channels, which accounts largely for the fewer stations logged on these channels at that time.

BETTER SIGNALS EVERYWHERE

There are several outstanding points disclosed by the figures given here. First is that, during the first tests, signals were heard on 80 of the 90 channels then in use by U. S. broadcasters and, during the second tests, this record was improved by *stations being heard on 85 of the 88 channels then in actual use.* Two channels were

not in use during these tests, pending reconstruction of the stations to which they were exclusively assigned. This does not mean that good, clear reception was obtained on 85 channels. In many cases long-distance reception which would have been amply loud for good loud-speaker reception was so garbled by heterodynes that nothing was clearly distinguishable except a conglomeration of distorted noises and whistles.

The second noteworthy point is found in the fact that only seven of the channels occupied by out-of-town stations suffered interference from local stations operating on adjacent channels. This means that, in spite of the proximity and high power of several local stations, ten-kilocycle selectivity was obtained in most cases; and even the highest-powered locals did not cause interference beyond the adjacent channel on either side of its own.

The third point is in the amount of havoc wrought by the one thing with which receiver design cannot cope—heterodynes. Before November 11 heterodynes completely wrecked programs on 9 channels and heterodyne whistles were heard through the reception on 27 other channels. Thus a total of 36 channels carried heterodynes, or 40% of all channels in use. After November 11 conditions were little improved in this respect for, although heterodynes were heard on a total of only 32 channels, they succeeded in completely ruining reception on 18 of these channels. This increase in the number of channels on which reception was completely garbled by the heterodynes was probably partly due to better reception conditions which permitted distant heterodyning stations to come in with greater intensity; thus causing a stronger heterodyning effect.

The analysis given herewith provides a bird's-eye picture of conditions as they were found to exist. It provides indisputable evidence that the labors of the Radio Commission were not in vain, so far as the new assignments of wavelengths were concerned, in their effect on reception in New York City. Before November 11, out-of-town stations could be brought in entirely free from heterodynes and interference on only 17 channels. After November 11, good, clear distant signals were found on 35

channels. After making due allowance for the local electrical interference that killed reception on a few of the high-frequency channels during the first tests, the improvement in distant reception runs around 75% or higher.

Considering the obstacles to be surmounted, it is rather surprising that this much improvement was brought about by the commission in Washington. With the high number of stations that must be accommodated on the air, it is utterly impossible to eliminate heterodynes. But by limiting some stations to daytime transmission, in other cases requiring a more extensive time-splitting, and by the assignment of exclusive channels, the situation has been cleared up to such an extent that reception conditions, at least in New York City, are better now than they have been in several years.

BETTER RECEIVERS REQUIRED

The objection may be made that the results indicated by the foregoing analysis cannot be obtained with the average com-

mercial or home-built receiver. This is quite true, but after all, the whole burden of improving reception cannot be placed on the broadcast stations or on the Radio Commission. The point is, that these two elements have brought about a condition where reception free from station interference is obtainable on exactly half the number of channels employed by stations of the U. S. if a sufficiently good receiver is used. If a fan employs a receiver which is so lacking in sensitivity and selectivity that he is able to bring stations in on only a part of these channels, he is scarcely justified in placing all of the blame on the broadcast stations.

At the present time it is hard to imagine any further improvement that can be brought about by governmental regulation. It therefore appears that improvement must come in the receiving equipment. This brings us to the discussion of the receiver problem.

It is an unfortunate fact that the average commercial receiver is designed primarily for local reception and incorpor-

ates neither adequate sensitivity nor sufficient selectivity to meet present-day requirements for distant reception particularly in urban locations. Out in the country, where there are few, if any, local stations to cause interference, and where the freedom from surrounding obstructions results in fine reception conditions, the average receiver will usually give a fair account of itself; because under such conditions a receiver can function with no handicaps whatever. But even here a superior receiver will provide correspondingly better results.

This lack in commercial receivers is not the fault of the engineers who design them. It is due partly to production problems and limitations and partly to the public's demand for low prices and small physical dimensions. It has been said that radio manufacturers are individually so obsessed with the idea of becoming the Henry Fords of radio that there is none left to produce the Lincolns and the Cadillacs of the ether. Perhaps there is something in this; but, to an observer who has studied the field, it would seem that more time and thought is being put into cabinets and appearance than into the technical superiority of the manufacturer's product. Thus high prices do not by any means indicate superior sensitivity, selectivity and tone quality.

A SET FOR DISTANCE

In presenting a description of the "Band-Isolator" receiver for those who are interested in constructing, or in having constructed for them, a receiver which will enable them to duplicate the reception shown in the tests just described, the claim is not made that this is the only receiver that will achieve such noteworthy results. But it is an important fact that this receiver was designed to incorporate all of the qualities so necessary to the complete satisfaction of the real radio enthusiast. This means not only unusual sensitivity and selectivity, but also simplicity of operation and the complete elimination of instability or any other factors which might adversely affect tone quality. This last is a most important consideration because, no matter how good the audio amplifier may be, tone quality may be completely ruined as a result of an improperly-designed radio-frequency amplifier.

This receiver does not incorporate any fundamentally new ideas. Rather it is made up of known and tried principles, combined in such a way as to maintain the better qualities of the systems employed and eliminate the objectionable features. Perhaps the best way to explain the circuit and the reasons underlying its superior qualities is to describe the line of reasoning followed in planning the design.

It was realized that, in order to obtain the desired degree of selectivity and sensitivity with any system of tuned radio-frequency amplification it would be necessary to employ three, or more likely four stages; and incur all the accompanying grief of instability, the difficulty in balancing the stages, etc. The only alternative seems to be to employ a superheterodyne circuit, but past experience indicated that good selectivity would be difficult to obtain when using a fair size outdoor aerial, and there would be the other evils of the average super to content with—harmonics, "repeat" points, ragged tuning and instability. Evidently, therefore, the ordinary

Analysis of Composite Log of the "Band-Isolator"

	After		Before	
	Nov. 11, 1928		Nov. 11, 1928	
Total channels in use (U. S.)	*88 Channels		90 Channels	
Stations heard on	85 "		80 "	
Nothing heard on	3 "		10 "	
Stations heard on	85 Channels		80 Channels	
Calls obscured by heterodynes	18 "		9 "	
Calls obscured by fading or noise	2 "		5 "	
Station calls logged on	65 "		66 "	
Station calls logged on	65 Channels		66 Channels	
Accompanied by heterodynes on	14 "		27 "	
Interfered with by locals	7 "		8 "	
Good reception without interference or heterodynes on	44 "		31 "	
LOCAL RECEPTION				
Total channels in local use (evening hours)	10 Channels		19 Channels	
Stations received without interference on	10 "		19 "	
Reception accompanied by heterodynes on	1 "		5 "	
Total channels of pure reception	9 "		14 "	
DISTANT ("DX") RECEPTION				
Total DX channels (total less locals)	78 Channels		71 Channels	
Nothing heard on	3 "		10 "	
Call letters obscured by heterodynes, fading, etc.	20 "		14 "	
Calls logged, but accompanied by heterodynes, on	13 "		22 "	
Interfered with by locals on	7 "		8 "	
Free of interference or heterodynes on	35 "		17 "	

* Two channels temporarily out of use at time of tests.

Geographical Distribution of Stations Logged

Location	No. of Stations	Location	No. of Stations
California	1	Minnesota	2
Colorado	1	Missouri	1
Connecticut	2	New Jersey	3
Florida	1	New York	15
Georgia	1	North Carolina	1
Illinois	8	Ohio	2
Indiana	2	Pennsylvania	4
Iowa	3	Tennessee	3
Kentucky	1	Texas	2
Louisiana	1	Utah	1
Maine	1	Virginia	2
Maryland	1	Wisconsin	1
Massachusetts	1		
Michigan	4	Total channels in 25 states.....	65

superheterodyne and tuned radio-frequency were both somewhat out of question.

Experiments made some time before had brought the conviction that most of the difficulties encountered with superheterodynes (such for instance as the fact that

transformers; because the large inductances and capacities required in tuned circuits to operate at these frequencies (in the neighborhood of 50 or 100 kilocycles) would be prohibitive in size and cost. Furthermore, with tubes of the 301A type, it was

dyne circuit because of the greater stability thus obtainable; secondly, a high intermediate frequency to get away from repeat points and harmonics, and to eliminate the necessity for fixed-tune transformers; thirdly tuned coupling circuits in the intermediate amplifier to permit tuning the intermediate circuits to exact resonance with one another; and finally, screen-grid tubes in the intermediate amplifier, so that high amplification could still be obtained in spite of the use of a comparatively high intermediate frequency.

The first problem was to determine the best intermediate frequency to employ. A little slide-rule manipulation showed that, if an intermediate amplifier is tuned to any frequency above 475 kilocycles, there can be no repeat points and no trouble from harmonics. But, on the other hand, the amplifier must operate anywhere in the broadcast band because of the probability of conflict between the intermediate frequency and the carriers of broadcast stations operating on approximately the same frequency as the intermediate amplifier.

With these general considerations out of the way, the next consideration was that of the details of the circuit parts, particularly the coupling coils and the tuning condensers to be employed with them. Although the intermediate stages are to be tuned, there appeared to be no necessity for using regular variable condensers for this purpose; because only a very limited frequency-variation range was required. Such being the case, it was decided to employ a fixed condenser, shunted by a small variable instrument for tuning each stage. Solenoid coils were then made up, having considerably more inductance than the ordinary tuned R.F. transformer. The oscillator coil had to be of special design, because of the high intermediate frequency employed and the correspondingly higher frequency range required in the oscillator. Other circuit considerations involved the necessity for a pick-up coil of rather un-

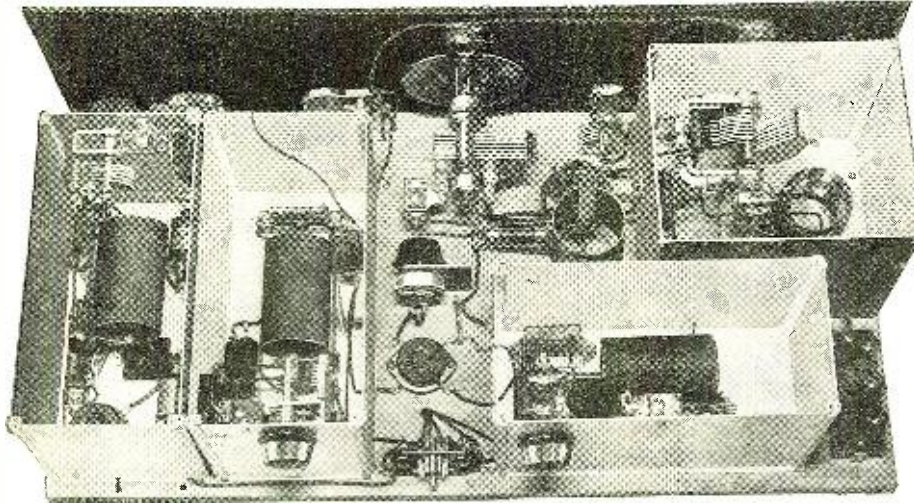

The "Band-Isolator" is shown above with its shield-tops lifted; it will be observed that ample room is given to every coil and condenser. This is a necessity where it is desired to have circuits tuned to cover exactly the full sidebands of each broadcast channel—and no more!

most of them are erratic and that two built from identical parts are likely to give widely varying results) were the result of using a very low intermediate frequency and fixed-tune intermediate transformers. The low intermediate frequency necessarily resulted in the presence of repeat points on the oscillator dial for the same station, and of harmonics which are made known by the presence of "birdie" whistles all over the dials. The fixed-tune transformers make their contribution in the form of broad tuning and, frequently, a lack of sensitivity as the result of poor matching.

The use of a low intermediate frequency practically requires the use of fixed-tune

necessary to employ a low intermediate frequency if adequate amplification were to be obtained, together with at least a fair degree of stability.

Other experiments had proved that a properly designed detector-oscillator circuit will provide in itself a very fair degree of selectivity, and, when used in conjunction with even a moderately selective intermediate amplifier, an unusually high degree of over-all selectivity is obtainable.

HIGH INTERMEDIATE FREQUENCY

The logical conclusion, based upon these observations, was that the proposed ideal receiver should employ; first, a superhetero-

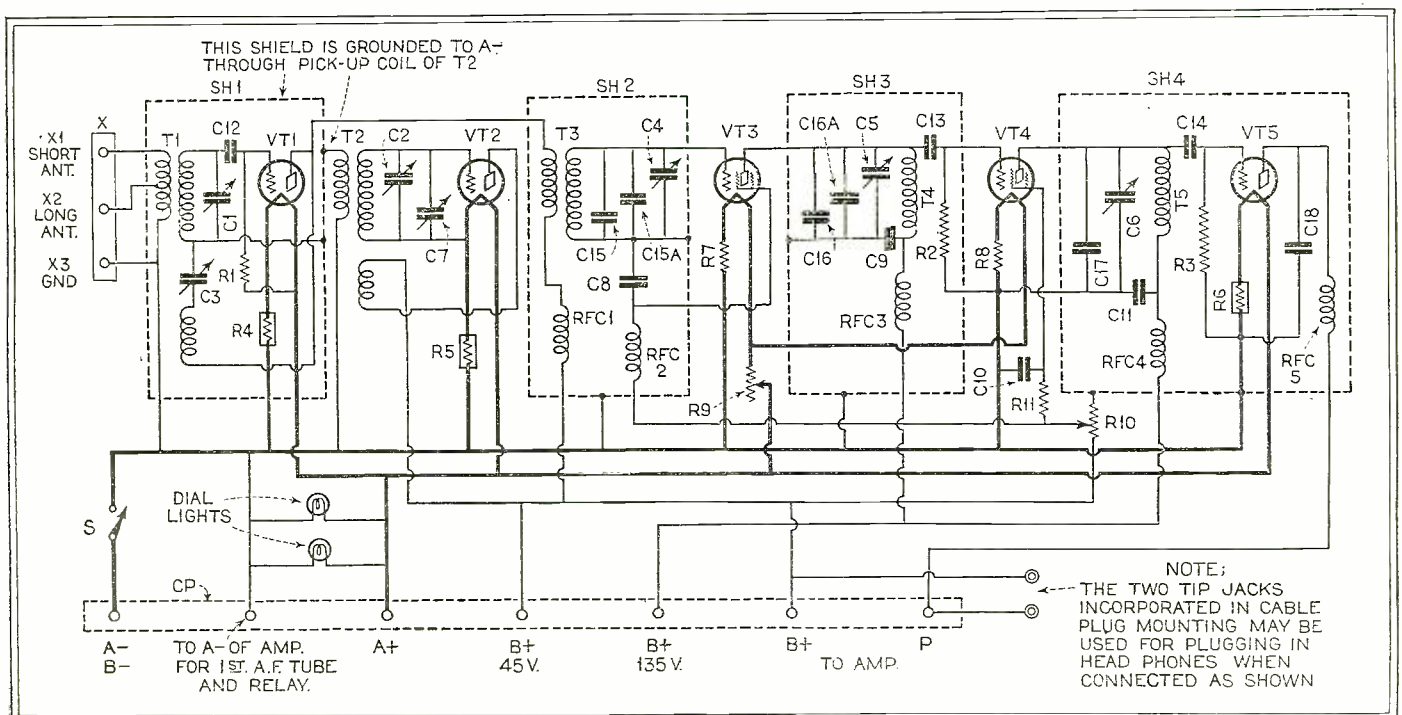

In the "Band-Isolator" circuit, it will be seen, a large number of condensers are used; these, however, are in parallel, to facilitate exact adjustment of the

stages. The feature of the intermediate amplifier is that its tuning is adjustable, to avoid possible station interference.

MR. TAYLOR, known to many of the readers of RADIO NEWS for his contributions to technical literature (including the "Pre-Selector," which appeared in the November, 1928, issue of this magazine), will give constructional details of the "Band-Isolator" in RADIO NEWS for July.

It is designed for the fan who wants distant reception, and also volume and quality. While stations must do their part to maintain frequencies, the set owner can no longer expect to single one out of the many outside his own locality unless he constructs a receiver which will tune to a single carrier and be deaf to whisperings and whistlings outside it. The "Band-Isolator" does this; while its delicately adjusted filter passes the full range of audio frequencies from the selected station.

usual dimensions to be incorporated in the oscillator coil unit. Finally, special coils were made up for the antenna circuit and for the input circuit to the first intermediate stage.

DEVELOPMENT OF THE DESIGN

At this point the first experimental model of the receiver was assembled, with results that were fully up to expectations and rather astonishing. Although the intermediate-amplifier stages were individually shielded for the sake of stability, it had not been considered necessary to shield the first detector or oscillator. It was found, however, that the sensitivity of the model was so great that, with no aerial connected, it was possible to bring in stations 400 and 500 miles away, through the direct pick-up of the unshielded antenna coil. This circuit was therefore shielded and direct pick-up thus effectively eliminated.

From this point on numerous experiments were carried on to determine the best values for the coils, capacities and coupling; and the final model was then built up. At about this time a number of fans who had heard the receiver in operation expressed a desire to build duplicates for their own use but found the necessity for constructing their own coils more or less of a stumbling block, particularly as the coil constants are rather critical. This trouble was eliminated by submitting the coil specifications to the Hammarlund Company, who made up sev-

eral sets for this purpose. Further demand has resulted in this company's manufacturing these coils on a larger scale, with the result that they are now available from a number of jobbers and dealers. Inasmuch as all of the other parts are standard, anyone interested in constructing the receiver will have no difficulty in obtaining all of the parts.

The completed receiver consists of first and second detectors, oscillator, and two intermediate-frequency amplifier stages. Five tubes are required in all. It operates either from batteries or from "A" and "B" power units and employs the usual outdoor aerial and ground. An audio amplifier was not included in the receiver, because it was planned to use an external two-stage push-pull amplifier. By thus excluding the audio end, it was made possible to keep the size of the receiver down to the standard 7 x 24 inch panel size.

The article to follow will describe the "Band-Isolator" receiver in complete detail; so that readers who are interested in duplicating the results shown in the log given here will have all necessary constructional data to build up duplicates of the model receiver.

Need of High Standards in Frequency-Maintenance

By Robert H. Marriott

THROUGH the history of radio development in the United States, increasing accuracy in frequency-measurement and in frequency-maintenance have been necessary developments. A simple example of the value of measurement and maintenance of frequency at the present time is to be found in broadcasting.

About ninety per cent. of the broadcast stations, at present, reduce each other's service ranges; because they do not stick to the frequencies they are assigned to. That is not so apparent in New York; because in the vicinity of New York City, there are enough stations on cleared channels to supply a variety of programs. However, less than ten per cent. of the people of the United States live around the city of New York, and less than ten per cent. of the stations in the United States are on cleared channels.

Consider two stations that are nominally on the same frequency; under present practice, one of these two can exceed its frequency by 500 cycles and the other can fall short of its frequency by 500 cycles. Two stations that are operating that way produce a beat note of 1000 cycles; which will commonly come through a radio receiver and loud speaker and affect the ear as much or more than any other note.

Suppose those two stations that are producing their mutual interference, consisting of a 1000-cycle note, are a thousand miles apart; and either of them is shut down so that the other can be heard satisfactorily for a distance of something over one hundred miles from the station. Then suppose the other station starts up, producing such a heterodyne that everybody beyond about ten miles from the two stations tunes off from those stations. Roughly, in service

range, that means that each of those stations has reduced the service range of the other from about 10,000 square miles to 100 square miles, or from 100 to 1%.

Not only may stations mutually reduce their service ranges, by not sticking to their frequencies, but, if they had been putting on very good programs they may reduce their audiences from millions to thousands, or more than a thousand to one.

VALUE OF EXACT-FREQUENCY WORK

On the other hand, if both of those stations maintained their frequencies within 50 cycles of their assigned frequency, the effect would be quite different; because, with less than 50-cycle variation, the beat note will be below 100 cycles. The ordinary radio receiver, speaker and ear are comparatively insensitive to notes below 100 cycles; therefore, the low heterodyne is not heard, or is not sufficiently annoying to cause people to tune off within the normal service range of the stations.

The common opinion is that there are forty stations on cleared channels in the United States, and that those stations are therefore free from heterodyne interference. That is not the case; on some of those cleared channels there are two stations in the daytime. The continued pressure exerted by broadcasters is to put more than one station on a channel. The General Electric Company forced two stations on one channel for both night and day operation. At the present time there are, apparently, only ten stations on cleared channels for night and day operation.

In considering this problem, it is safer to assume that there are no stations on cleared channels and that, therefore, all broadcast stations to increase their service

ranges should maintain their frequencies accurately.

Not only is frequency-maintenance of broadcast stations, to within fifty cycles, of value to the broadcasters for the purpose of increasing the number of their listeners; but it is also of value to those who make and sell radio receivers and loud speakers, because every position on the dial that brings in a squeal reduces the value of the receiving equipment.

Such accuracy in frequency-maintenance is recommended because it is of service to the listening public, of service to the broadcaster, of service to those who make and sell radio receiving apparatus, as well as another step in radio development.

MR. MARRIOTT, who has the unique honor of being the first president of the Institute of Radio Engineers, and has at present the Federal Radio Commission as a distinguished client for his technical counsel, speaks with unquestioned authority.

One of the facts which has made itself obvious in the course of broadcast regulation is that our central states are most affected by station interference. While neither the Pacific nor Atlantic coasts may suffer from the operation of two stations at once, one on each side of the United States, the complaints from the Mississippi Valley are audible at Washington.

Exact frequency-maintenance, as explained here, will create the equivalent of many new broadcast channels.

The "Super-Wasp"

A New Short-Wave Set
of Striking Effectiveness

By Robert Hertzberg

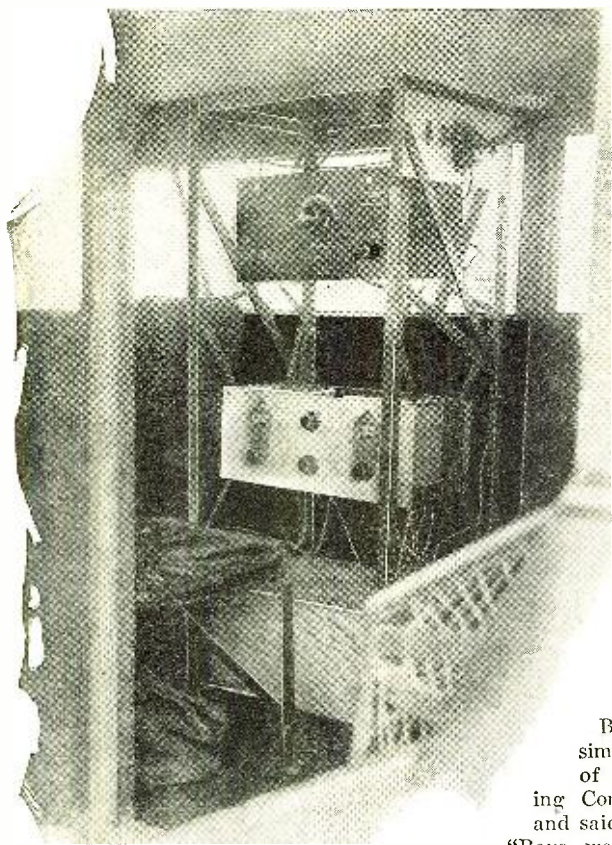

The "Super-Wasp" hung in the center rack of a Stinson-Detroit monoplane "flying laboratory."

amateurs could be buried; and they thought they were getting rid of a bunch of pests when they made a present of those short-waves to the "hams."

Beating this incident and a few similar ones in mind, the officials of the Pilot Electric Manufacturing Company called in its engineers and said:

"Boys, we've been getting requests from all over the world for an improved short-wave receiver—something better than a straight regenerator. We want a tuned screen-grid job, with as much shielding as necessary. We know no one else has done it, but you're going to. Goodbye, and don't bother the cashier until the set is ready."

To make a short story long, the engineers went into a huddle, and under the direction of Robert S. Kruse (who without question is one of the world's foremost authorities on short waves) came out with a tuned screen-grid receiver that marks a real advance in short-wave receptors for the amateur. The 222 not only furnishes real and appreciable amplification, but it tunes sharply, much to the surprise of the many skeptical "hams" to whom the experimental models were demonstrated.

On direct comparison with untuned screen-grid sets of standard make, the new set was so markedly superior that Kruse didn't even bother to record quantitative readings. It worked smoothly from 14½ meters all the way up to 500, and proved to be a fine all-round receiver from every standpoint.

The new outfit has been named the "Super-Wasp," because it is big brother to a three-tube set that has enjoyed widespread success under the name "Wasp."

Signal Corps officers of the Second Area express their approval at a recent meeting of the Hudson Division, A.R.R.L., New York.

THE tremendous interest being displayed by radio experimenters in short-wave reception has served to emphasize the lamentable fact that short-wave receivers have undergone practically no improvement during the past five years. They consist for the most part of straight regenerative detectors, with plug-in coils of one form or another, and one or two stages of audio amplification. They are critical in operation and generally rather difficult to handle because of the tuning effects of the operator's hands. Many a short-wave enthusiast who has spent tense and breathless hours on weak phone stations could give Jimmy Valentine a few lessons and send him away feeling like a rank amateur at dial twirling.

Last season a few kit manufacturers with more courage than the rest stuck a screen-grid tube ahead of the detector, but they left it dangling helplessly in midair, without benefit of either shielding or tuning. The expensive 222 acted as nothing more than a blocking device; furnishing little if any amplification and justifying its existence only by the fact that it eliminated the "dead spots" that appear so mysteriously on the tuning condensers of straight regenerators.

SCREEN-GRID AMPLIFICATION

Many short-wave fans, possessed of considerable experience with complex broadcast receivers, logically inquired why the screen-grid tube couldn't be shielded and tuned, so that some respectable results might be expected from it. Some of the short-wave wisecracks shook their heads dejectedly and said it couldn't be done because the set would be too critical and the 222 wouldn't amplify much anyway. Well, not so very many years ago some pretty smart radio engineers thought the whole short-wave region below 200 meters wasn't anything more than a "graveyard" in which the unwanted

The outstanding features of the "Super-Wasp" are as follows:

Real amplification from the 222 tube, with sharp tuning in the input stage.

Wavelength range from 14½ to 500 meters; two sets of coils.

Doubly shielded; all-aluminum chassis.

Absolutely no hand-capacity effects.

Can really be assembled and wired in one evening.

Furnished in kit form complete from drilled and engraved panels down to the last necessary washer. Assembled with a screw-driver and a single "Spintite" wrench.

Inexpensive—costs less than \$30 in knock-down form.

DESIGN OF THE RECEIVER

The diagram (Fig. 1) shows the circuit of the complete Super-Wasp, while the accompanying photographs give a good idea of the appearance of a set assembled from the standard kit. Electrically, the set is exceedingly simple, the final hook-up having been decided on after four other possible arrangements, very much more complicated, were tested and rejected.

The receiver consists of a front and sub-panel of heavy aluminum and two individual shield cans of lighter stock. The cans are of unique construction in that they split down the center. One half of each is screwed down and all the parts arranged comfortably; then the other half is screwed down and the job is finished.

The left can houses the components of the antenna or R.F. stage. These include an elevated five-prong socket for the antenna plug-in coils, I,1; the midget aerial coupling condenser, C10; a .00016-mf. tuning condenser, C1; the blocking condenser C4; and the screen-grid tube, V1. The right can houses the detector parts, including another elevated socket for the detector plug-in coils, L2, the tuning condenser C2,



and C9 are mounted by means of special lugs, so that there is no connecting wire. The arrangement of the parts in general has been so carefully worked out that there is less wire in the whole "Super-Wasp," a four-tube set, than in many three- and even two-tube sets.

The tickler is series-feed connected, with the reliable condenser method of control. The audio system uses two transformers, with a 100,000-ohm leak across the secondary of the first to eliminate "fringe howl."

Separate "B" and "C" leads for the two audio stages are provided, so that any combination of tubes may be used. The best all-round set-up is a UX-222 for V1, 201A's for V2 and V3, and a UX-112A for V4. The 112A may be used to good advantage, since 135 volts of "B" is needed for the 222 anyway.

An adequate quantity of tinned copper wire and spaghetti tubing is supplied with the kit. The holes that pass wire through the sub-panels are fitted with eyelets, which provide smooth, non-cutting protecting surfaces for the tubing. The eyeletting also distinguishes wire holes from screw holes, and facilitates the assembly of the set.

The operation of the Super-Wasp is quite easy, in spite of the presence of the extra tuning dial. The detector can be thrown into oscillation by means of C3, and then C1 and C2 are turned until a whistle is heard. C3 is then turned down, and C1 and C2 re-adjusted carefully until the signals clear up. Anyone who has handled a Browning-Drake or any of its numerous variations will find the "Super-Wasp" just as simple.

Reception of short-wave broadcasting stations is easier with the "Super-Wasp" than it is with a straight regenerator; for the same reason that a Browning Drake is better than a straight detector. The set is more sensitive and will bring the stations in louder. As for amateur and commercial telegraph stations—they simply flop in by the gross, and with car-splitting volume. The

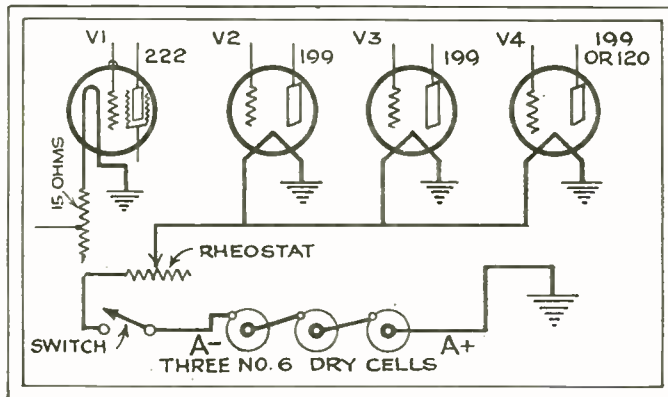

Fig. 2

If the "Super-Wasp" is to be used with dry-cell tubes, the changed voltage requires this connection to bias V1 properly.

writer is half sorry he spent so much time on the development of the set, because soon he will no longer be thrilled by hearing England, Holland, Australia, Canada, Central America, and a few other countries in odd corners of the world. He refers here to broadcast or telephone stations, not merely to the code transmitters. The "Super-Wasp" was designed for the man who doesn't know the code and wants to try his hand at some of that inviting trans-oceanic DX.

THE NECESSARY PARTS

The following Pilot parts are included in the kit for the "Super-Wasp":
 One aluminum front panel, 7½ x 18 x 1/16-inch, drilled and engraved;
 One aluminum sub-panel, 8 x 17 x 1/16-inch, drilled with all mounting and wiring holes;
 Four No. 37 metal sub-panel brackets;

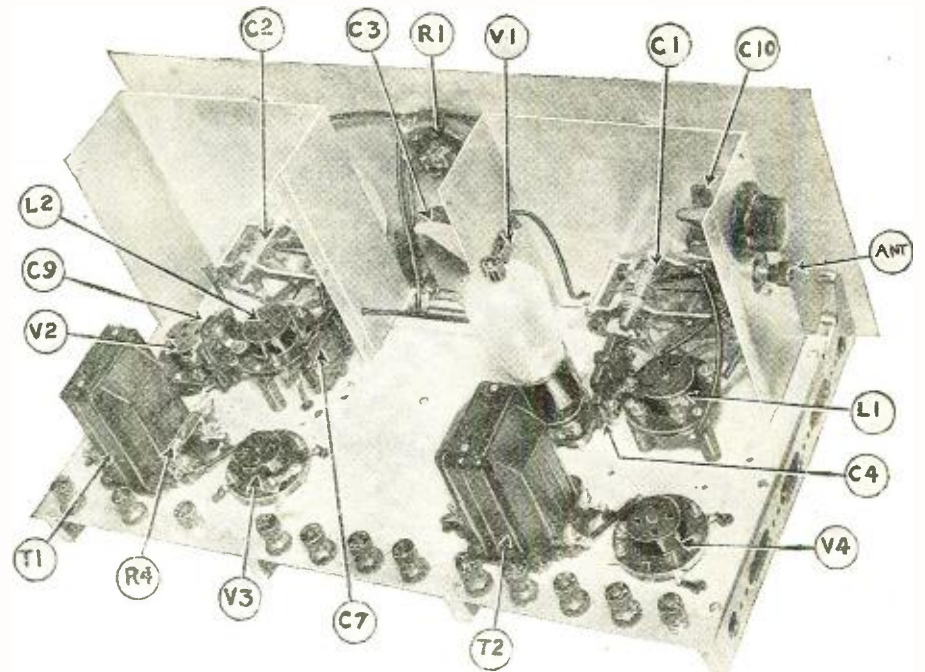

The unusual construction of the "Super-Wasp" is shown more clearly in the illustration above of the set partly assembled. The fitting of the shield cans is effected in the centers, rather than at the corners; the holes in the ready-drilled sub-panel are fitted with protecting eyelets, as an insurance against short circuits. Compare with the illustration on the opposite page.

- Two No. 1608 .00016-mf. variable condensers (C1, C2);
- One No. 1613 .00025-mf. variable condenser, with bakelite knob (C3);
- Two No. 1282 illuminated vernier dials;
- One No. 906 rheostat, 6 ohms (R1);
- One No. 961 tapped resistor (R2);
- Two special "Super-Wasp" shield cans, with all necessary mounting screws;
- One No. J5 midget condenser, 5-plate, with special bakelite mounting strip (C10);

- One package of hardware, including all necessary nuts, bolts and washers for mounting of parts, soldering lugs, and special double-ended lugs for mounting of fixed condensers;
- Two sets of plug-in coils, made especially for the "Super-Wasp," Nos. 600A and 600D (L1, L2).

COIL SPECIFICATIONS

The regular kit of parts includes ten plug-in coils, wound with the proper numbers of turns for their respective wavelength ranges. However, as many short-wave experimenters may want to try the Super-Wasp circuit with other parts of their own, a table giving the details of the coils, as regards numbers of turns, follows. These coils are not interchangeable with those on similar forms, used with receivers previously described in RADIO NEWS constructional articles. The pin numbers refer to numbers molded right into the forms, which are made of black bakelite. The spacing between the primary and the secondary of the blue-ring antenna-stage coil, and that between the grid and tickler windings of the detector-stage coils, is in all cases ¼-inch.

Color of Ring	Turns L1	Turns L2	
		Grid Plate	Coil
Red	3½	3	3
Orange	9½	7	6
Yellow	20	16	8
Green	47	45½	15
Blue	*100	99	27

* Secondary: primary has 27.

- Two No. 931 audio amplifying transformers (T1, T2);
- Two No. 212 UY sockets (for plug-in coils);
- Two No. 206 UX shock-proof sockets (for 222 and detector tubes);
- Two No. 213 UX sockets (for audio tubes);
- Two pairs grid-leak clips;
- One No. 758 3-megohm grid leak (R3);
- One No. 750 100,000-ohm grid leak (R4);
- One No. 50B fixed condenser, .0001-mf. (C9);
- Five No. 59 fixed condensers, .01-mf. (C4, C5, C6, C7, C8);
- One No. 130 R.F. choke coil (RFC);
- Thirteen bakelite-top binding posts;
- Ten sets of insulating bushings for binding posts;

The wire used is No. 24 cotton and silk covered for the four short-wave coils; No. 28 D.S.C. for the blue coil. The pins in the bases of the coil forms are numbered; the top of the winding in the antenna coils L1 is brought to pins 1 and 4; the bottom to pin 2, in the short-wave coils. In the blue coil, the top of the primary is brought to pin 5; the bottom of the primary and the top of the secondary to pin 2; and the bottom of the secondary to pin 1.

OPERATING SUGGESTIONS

Some more detailed advice on the operation of the "Super-Wasp" may be welcomed by builders.

A rheostat is used to control the filaments of the tubes; so that dry batteries instead of a storage battery may be employed for the "A" supply. With three 201A's and one 222, the current drain is a little less than one ampere, which is not too severe for four cells connected in series. Eight cells in series-parallel would be better, of course.

UX-199's instead may be used in the detector and audio positions, and will work very well. However, it will be necessary to take the 222 out of the rheostat circuit and to connect it so that the full $4\frac{1}{2}$ volts of the "A" battery (three cells in series) is placed between the grounded filament and the end of the 15-ohm resistance. The rheostat is left so that it controls the current to the other three tubes.

With this arrangement the rheostat loses its incidental value as a switch, and a separate switch must be provided. This amounts to very little trouble; and is well worth while, considering the fact that the whole set can be operated efficiently on dry cells. There is plenty of room for a small toggle-switch between the rheostat and the regeneration condenser. All four tubes will draw only about one third of an ampere, which is a comparatively light drain for No. 6 dry cells. Six cells in series-parallel will

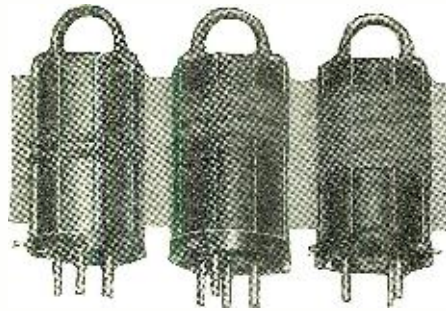

The coils made for the "Super-Wasp" are wound on forms with UY-bases, $\frac{1}{4}$ -inch bakelite with eight ribs increasing the winding diameter to $1\frac{7}{16}$ inches and lessening losses.

give altogether satisfactory service in every way.

A "Super-Wasp" assembled from the standard kit of parts was changed in this respect to make it suitable for use on the Stinson-Detroit airplane operated by the Pilot company as a flying "radio laboratory." It worked very well in the air, the 199's being almost entirely free of microphonics. (This was a surprise, but a pleasant one.) A picture of the set installed in the cabin of the plane is shown in the heading of this article.

Three 45-volt "B" battery blocks are required. As the drain on them is rather light, the small and inexpensive sizes may be used. The "Super-Wasp" is thus a rather eco-

nomical receiver, and is particularly suited to the needs of the man who would like to try his hand at the short waves but does not want to invest a lot of money in battery equipment.

The length of the aerial used with the receiver is not critical. The regular broadcast antenna is all right, providing it does not exceed 150 feet. Almost any wire thirty to fifty feet long will bring in more signals than the operator can record.

The smoothness with which the detector regenerates will depend to some extent on the plate voltage. Frequently $22\frac{1}{2}$ is not quite enough, and 45 is too much; it is therefore a good idea to insert a "universal-range" variable resistor in the "B" detector lead, with a by-pass condenser of any size between .01- and 1.0-mf. across its terminals. The correct voltage is easily obtained with this resistor.

The old advice about switching the tubes around and trying different grid leaks should be heeded. Tubes of the 201A type are not critical in the audio positions, but they vary considerably as detectors. Some fall into oscillation with gratifying smoothness; others are cranky and uncontrollable. The success of any short-wave set hinges to a considerable extent on the functioning of the detector tube, so a little attention should be paid to it.

The writer will be glad to answer queries about the "Super-Wasp." He may be addressed in care of RADIO NEWS.

Radio Regulations Drafted for Air Service

THAT the field of opportunity for the aircraft radio operator and service man will speedily be widened is evident from the proposed regulations which the Airways Division of the Department of Commerce has proposed to the air transport companies. While these may undergo changes in detail before their adoption, they indicate the general principles which will undoubtedly be followed out in the official rules finally adopted—a matter of months only.

Airplanes will thus be protected during flight by the hourly weather report broadcast by airway radio stations and will be in constant communication with these; so that orders to pilots for the protection of planes and passengers may be transmitted while the planes are in flight.

The proposed regulations also call for a radio officer among the complement of the large transport planes and require a constant watch to be maintained while in flight. Aircraft radio operators would be required to have a total of not less than twenty hours of flying and to demonstrate their ability to stand a radio watch on aircraft.

INTERNATIONAL SERVICE

For planes in international service, air transport operators will be required to comply with the international radio convention's regulations. These operators would also be required to comply with all other provisions relative to radio in aircraft in agreements with foreign countries relative to aircraft stations and aeronautical stations engaged in international service.

Air transport operators engaged in national service and in flights not passing beyond the three-mile limit would be required

to equip planes carrying not more than six passengers for hire in interstate commerce over civil airways with radio-telephone receivers in order to take advantage of weather information and orders to pilots.

OPERATOR'S CERTIFICATE

The radio operator would be required to possess a radio-telephone operator's certificate or one of a higher grade, and maintain his watch throughout the flight. Large planes carrying more than six passengers in national service would be required to carry a radio-telephone receiver and either a radio-telegraph or a telephone transmitter powerful enough to communicate at any time during flight or forced landing by voice or telegraph with the nearest aeronautical radio station.

If radio telephone is used, the operator would be required to possess a second-class radio-telegrapher's certificate or one of higher grade.

In accordance with international practice the radio service on a plane in transit would be under the supreme authority of the pilot in charge of the plane, whose position corresponds to a ship captain's.

INCREASING AIR FACILITIES

The new air mail schedules, which went into effect May 1, provide double daily service over the transcontinental system between New York and San Francisco and over four connecting routes. The latter are operated between Salt Lake and Los Angeles, Salt Lake and Pocatello, Idaho, on the Salt Lake-Great Falls route, and between Cleveland and Pittsburgh and Cleveland and Buffalo on the Cleveland-Albany route.

The new route runs from St. Louis to Omaha by way of Kansas City, a distance of 403 miles. The schedule for this route, on a single daily basis, synchronizes with that of the night transcontinental, placing St. Louis within twenty-four hours of San Francisco and Los Angeles.

The night transcontinental air mail leaves New York at 8 P. M. and Hadley Field at 9:35 P. M., arriving in San Francisco at 4:30 o'clock the second morning. Eastbound air mail leaves San Francisco at 8 P. M. and arrives in New York at 6:43 A. M. the second morning. Mail leaving Los Angeles makes connections at Salt Lake City with the eastbound mail; while mail from the East arrives at Los Angeles at 4:15 A. M. the second morning out of New York.

The existing schedule on the Albany-Cleveland route has been changed so that westbound planes, instead of leaving Albany at 10 A. M., hop off at 3:45 P. M. with a much larger accumulation of the day's business mail and in time to connect at Cleveland with the westbound night transcontinental. Eastbound planes pick up mail from the West over the night transcontinental and arrive in Albany at 8:10 A. M., serving Buffalo, Rochester, Syracuse, Rome, Utica and Schenectady en route. The additional service between Cleveland and Buffalo provides planes to leave Buffalo westbound at 10:30 A. M., and Cleveland eastbound at 12:20 P. M.

An additional service provides planes which leave Cleveland at 12:15 A. M., and arrive at Pittsburgh at 1:45 A. M., and in the other direction leave Pittsburgh at midnight and arrive in Cleveland at 1:30 A. M.

Radio Wrinkles

Automatic Tuning Adjustment

ONE of the undesirable peculiarities of the regenerative receiver is the resetting of the tuning condenser made necessary by each adjustment of the regeneration condenser—which accounts for the constant “juggling” necessary when tuning a regenerative receiver. A suggested method of overcoming this condition as shown in Fig. 1.

It is nothing more than a semi-circular piece of bus-bar wire, curved directly over the position occupied by the rotor plates when they are unmeshed, or turned quite out of the stator section of the tuning condenser. Ordinarily it is found necessary in tuning, while reducing the capacity of the regeneration condenser, to increase the capacity of the grid tuning condenser in order to follow the station. This wire, together with the action of the rotor, eliminates this; it serves as one plate of a condenser which automatically increases in capacity as the regeneration condenser decreases in capacity, thereby keeping the wavelength constant.

The exact location, position and size of this wire must be found by experiment. If good results are not obtained, by reason of insufficient capacity of the wire, a piece of sheet brass can be tried; cutting its width down by experiment until the proper results are obtained. Obviously, the “wrinkle” outlined above can be employed only with condensers using semi-circular rotor plates.—Contributed by Martin Mytas.

Bearings for a Tickler Shaft

IN constructing tuning coils with rotor coils, such as three circuit couplers with variable ticklers, trouble is often encountered in making suitable bearings for the rotor coils. A very simple and neat method

is to use the rotor plates of an old variable condenser, cut down as shown in Fig. 2.

When used on a fiber, hard-rubber or bakelite tube, the plate should be cut as shown at “A.” Two machine-screws are passed through the holes in the coil form and bushing, and secured in place. A 1/4-inch shaft passed through the rotor coil and bearings, with suitable washers to keep it centered properly, will provide an excellent means of adjustment.

If a cardboard tube is used for the secondary, or stationary coil, the plate of the condenser may be cut with sharp ends (as at B), which are then pushed through the wall of the tube and bent over. This will provide a solid support without the necessity of drilling the bushing or tube.

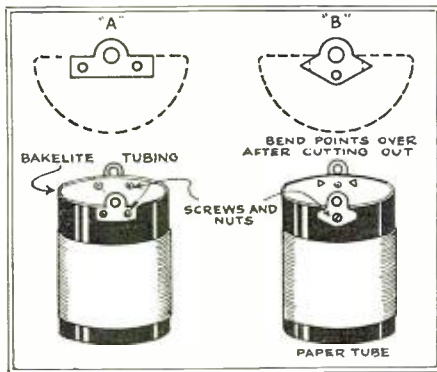

Fig. 2

The discarded rotor plates of an old variable condenser can be converted into mounting for the shafts of several rotary tickler coils.

A single screw placed through the bushing will strengthen it if any strain is placed on the latter.

The washers which were used between the plates in the condenser will serve to center the rotor coil and, in some cases, the shaft also may be utilized for the coil. In most condensers the plates are made of thin sheet aluminum or brass and a pair of tin shears or heavy scissors will cut it with little trouble.—Contributed by D. S. Jenkins.

Mounting Tubeless Coils

CONSTRUCTORS of receivers, either for the broadcast range or the various short-wave bands, will appreciate this simple suggestion for mounting coils. Self-supporting inductors are a great nuisance unless they can be mounted correctly and the distance between the various windings kept constant. A suggested method is shown in Fig. 3.

In making these coils, first procure a fibre or hard-rubber rod about 1/2-inch in diameter and about five inches long. Then, with a hack-saw blade, cut a slit lengthwise through the rod far enough down to hold all the coils of the coupler. Finally, drill a hole at the top of the rod, above the coils, and insert a machine-screw, to hold the coils firmly.

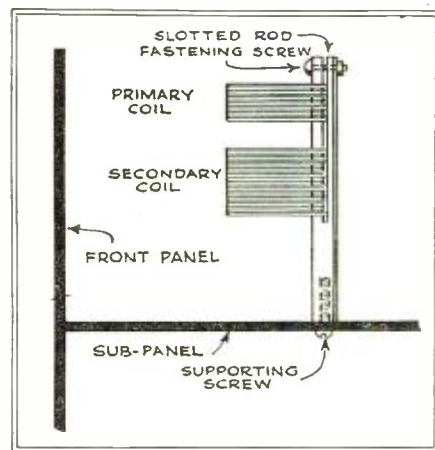

Fig. 3

A small piece of insulation is quickly made into a low-loss, rigid support for coils.

The rod holding the coils may be mounted in any way satisfactory to the constructor.

Perhaps the simplest way is to drill a hole in the end of the rod, lengthwise, and tap the hole for either a 6-32 or 8-32 screw.

When a variable tickler (or other coil) is desired, it may be mounted directly on the panel of the set, with a suitable bushing, and the secondary and primary coils on one of the split-rods, as shown. The correct relation between the coils in a coupler can be obtained by making the slit longer than
(Continued on page 1149)

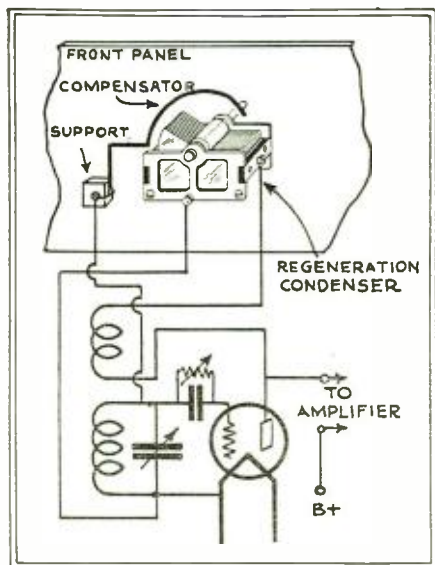

Fig. 1

The ingenious device indicated increases the capacity of the tuning condenser slightly as that of the regeneration condenser is reduced.

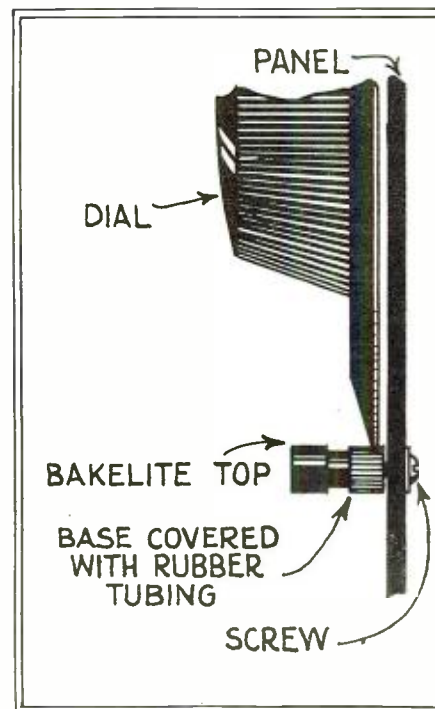

Fig. 4

A vernier adjustment for an old-style plain dial may be improvised from a binding post and a short length of rubber tubing, as shown.

The Principles of Transformer Design



An Explanation in Simple Language, Accompanied by Data the Experimenter Will Find of Practical Value



By R. D. Ross

THE experimenter is often confronted with the problem of designing small transformers to be used in his laboratory. The writer has seen several excellent articles on the subject, but the majority of them have been presented with the assumption that core laminations of any desired size are available. This is not usually the case, and indeed the obtaining of a suitable core is quite a problem. Laminations cut individually from sheet iron are unsatisfactory, and tedious to cut, much material is wasted, they are hard to flatten and consequently make a hunky core, and the magnetic characteristics of the metal are poor, resulting in high losses and heating.

These objections are overcome by the use of a core taken from an old transformer. Burned-out or scrapped transformers can often be purchased for a nominal sum from a power company or a junk yard, and anyone with a little patience can get the laminations out practically intact. These laminations are made from metal especially suited for transformers, they have a low loss, and they can be stacked into a neat and compact pile. Furthermore, the core of a single 5-kva. transformer will furnish enough iron for several smaller ones.

The one serious drawback to the use of old iron is that it is already cut to size, thereby fixing the size of the core. The present article will, therefore, take up the design from the standpoint of a given size of core, and the windings will be figured to give the most compact transformer possible with that core. In order to clarify the detailed design, the general theory underlying transformers will be given, and it is recommended that the reader familiarize himself with this before proceeding further.

WHAT A TRANSFORMER IS

The transformer consists of a magnetic circuit called the core coupled with two (and sometimes more) electric circuits, called the primary and secondary. When the core is in a state of magnetization (such as results

when the primary is connected to a source of alternating current) a voltage is induced in every turn of the windings and this is the same for every turn, regardless of whether the turn is on the primary or secondary.

The strength of this induced voltage *per turn* is dependent upon the intensity of

USUALLY, after an engineer has explained a technical subject to a lay audience, they are more puzzled by the explanation than by the original problem. In this article Mr. Ross, who is a member of the engineering staff of the Westinghouse Company, has explained transformer action in a plain manner which should not be formidable to any experimenter who has passed his examination in long division. The article is practical rather than theoretical, and will answer many questions often asked of our technical departments.

magnetization (called the *flux density*) of the core, and its cross-sectional area. Since a complete winding consists of a number of turns *in series*, the voltage at the ends will equal the product of the number of turns by the voltage per turn. The induced voltage in any winding, then, depends on three things, namely, the number of turns, the area of the core, and the flux density. Generally speaking, the last two factors are constant in any given transformer so that the ratio of the voltages induced in the primary and secondary equals the ratio of the numbers of their turns. Expressing this in the form of an equation, there results

$$\frac{\text{Secondary turns}}{\text{Primary turns}} = \frac{\text{Secondary Voltage}}{\text{Primary Voltage}}$$

So far we have been talking about induced

voltages. In the primary there is not only the induced voltage to consider, but the impressed voltage (line-voltage) as well. These two voltages are very nearly equal and *opposite* to each other, and in transformer design data such as are given here, this is assumed to be so. For instance, if a transformer is to be designed for operation from a 110-volt line, the primary will be designed for an *induced* voltage of 110 rather than an impressed voltage of 110. In other words, the windings are treated as if they were generators giving voltages of the desired values.

Thus we have seen how the transformer changes the voltage. We will next investigate the method of changing the current. The electrical force supplied by the primary to magnetize the core is measured by the value in *ampere turns*, which is the product of the number of turns and the amperes flowing. When the secondary is not loaded, only a few ampere turns from the primary are required to magnetize the core. Under this condition, the transformer draws comparatively little current from the line and consequently consumes only a small amount of power.

When a load is connected to the secondary terminals, current flows through the windings and through the load. The secondary current sets up a force that tends to demagnetize the core. This *magnetomotive* force, as it is called, is dependent upon the number of *secondary* ampere turns. It is the function of the primary to keep the core magnetization constant and, in order to do this it must exert a greater magnetizing force on the core; in fact, the additional magnetomotive force from the primary must just equal that set up by the secondary. Since the number of turns in the primary is fixed, the only way for it to get its additional ampere turns is by drawing more current from the line. Thus we see that, when a current flows in the secondary, the final result is to cause more current to flow in the primary.

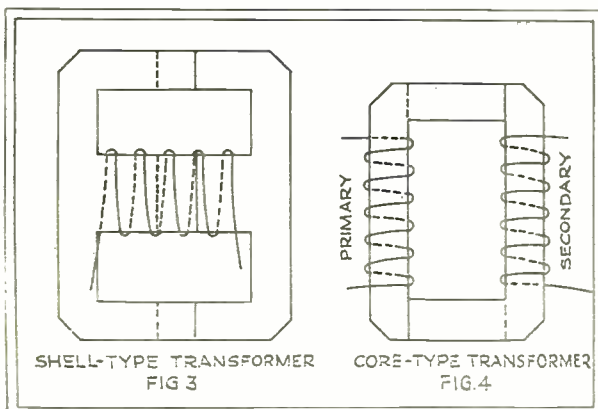

The two principal types of transformers, as they are built up from the punchings in Figs. 1 and 2.

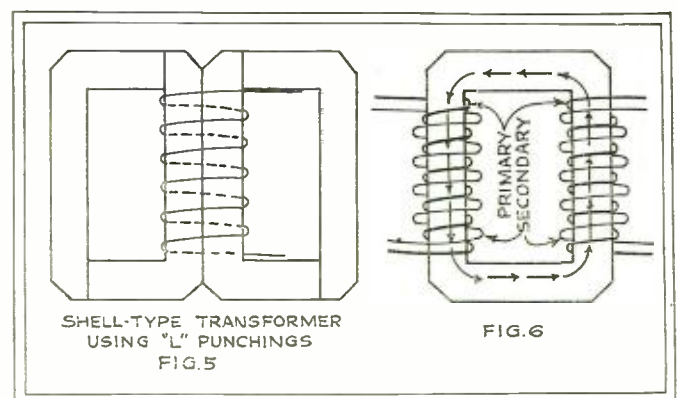

At the left, another way of building a transformer from the "L" laminations. Right, a more effective transformer design.

VOLTAGE TRANSFORMATION

As has been stated, the primary ampere turns must equal the secondary ampere turns, so that putting this in the form of an equation, we have

$$N_p I_p = N_s I_s; \text{ or, } \frac{N_p}{N_s} = \frac{I_s}{I_p}$$

where I_p and I_s are the currents in the primary and secondary respectively. This expression shows that the ratio of current transformation is inversely proportional to the ratio of primary and secondary turns.

As the reader already knows, it is possible to build a transformer to give more than one voltage, either by tapping the windings or by using two or more coils for the secondary. The principles involved may best be seen by comparing the transformer to a battery of several cells. Suppose the battery consisted of 10 cells, each rated at 2 volts and 20 amperes. If all the cells were connected in series the voltage would be 20 and the maximum current rating 20 amps, making the watts output $20 \times 20 = 400$. Now, if it were desired to use only 10 volts, a tap might be taken off after the fifth cell. This would leave half the cells idle however, and the maximum power would be only 200 watts. A better scheme, then, would be to take the second half of the battery and connect it in parallel with the first. Each half could then be called upon to supply its rated 20 amperes, making the total current 40 amperes and the power 400 watts, equal to the original power.

A transformer winding is exactly analogous to the above illustration. If it is desired to build a transformer for two voltages, one twice the other, it is better to make the windings in two parts and connect them in parallel for the lower voltage and in series for the higher. The only drawback to this method is that it precludes both voltages being used at the same time. When this is desired it is necessary to use the tap construction; which is also required when voltages such as 70 or 80 per cent. of the full rated voltage are wished.

A third, or tertiary, winding is sometimes provided to give some other voltage differing widely from the ordinary secondary voltage. This is often done in the case of radio transformers where both plate and filament supply are desired. The tertiary coil may be wound either directly over the secondary or on a separate part of the core.

CORE CONSTRUCTION

We are now ready to proceed to the detailed design. If laminations are used from an old transformer it will be necessary to take them out from the old windings. The whole assembly is usually dipped in a binding gum which penetrates all the cracks and makes a solid mass out of the pile of iron and wire. All supporting members and clamping bolts should be removed, thereby rendering the laminations easy of access. They can then be pried loose in chunks of several at a time, and later separated into individual pieces. A hammer and thin chisel will be found useful in knocking them out, but care must be taken not to mutilate them more than necessary. Each piece should then be scraped lightly to remove any remaining gum. Care must be taken not to cut through the film of oxide too much, or the assembled core will have a high loss, and overheat.

It is probable that the laminations will be either "L" punchings or "E" punchings, as

shown in Figs. 1 and 2 respectively. They fit together, as shown in these figures, to make the completed core. In assembling them, each adjacent layer is reversed to stagger the joints. If "E" punchings are built up and wound with wire, as shown in Fig. 3, the shell type of transformer results; while if "L" punchings are used we have the core type, as shown in Fig. 4. "L" punchings can also be built into a shell-type transformer, as given by Fig. 5. The choice of which type to use is of course determined by the shape of the punchings at hand. However, if either can be had, the

although it can be wound all on one leg if found more convenient.

In the shell-type transformer there is only one possible disposition of the winding, namely, all must be wound around the center leg. This needs no further discussion here.

The question may be raised, whether the primary or the secondary should be put next to the core. In general, the winding of lower voltage should be next the core, on account of the insulation. There are exceptions to this, however; as when it may be desired to adjust slightly the number of turns on the low voltage winding after assembly. This would be impossible were this winding on the inside.

Laminations taken from a commercial transformer are already correctly proportioned and no cutting of them is necessary. However, when the builder cuts his own laminations, there are a few principles that must be observed. These are set forth in the following paragraphs.

DESIGN DATA

Future calculations in this article on the area of the core all refer to the cross-sectional area of the iron where it passes through the winding (such as a section at A-A, Fig. 7A). As mentioned before, there is in this part of the core a certain magnetic flux which generates the necessary voltage; the total amount of this flux being equal to the product of the flux density by the cross-sectional area.

The total flux is a constant quantity; hence it may be seen that, if the area is anywhere reduced, the density must be raised. As increase in the density is not permissible; hence the total cross-sectional area of the core must nowhere be less than that of the part around which the coil is placed. In the shell type of transformer there are two parallel paths for the flux; and, if the core is symmetrical half the flux will flow around each path. This is shown in Fig. 7A, where the arrows denote the paths of the flux. Hence, to keep the flux density constant, the area at sections B-B and C-C is made half that at A-A. Since the thickness t of the laminations is constant, the dimensions b and c are half the dimension a .

In the core type, shown in Fig. 6, there is only one path for the flux; hence the area of all sections is the same. There is no

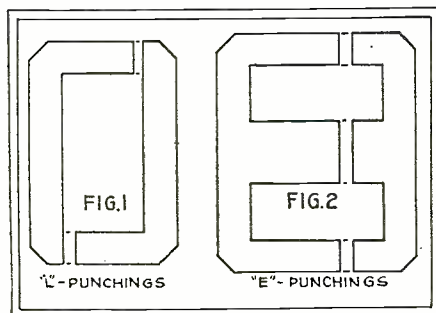

Typical shapes of core-lamination punchings.

choice may be determined by several factors. The shell type is convenient to use for small transformers, of below 1000 volts. It makes a compact job when assembled; the iron surrounds the windings and supports them, and the whole can be easily mounted on brackets. For voltages of more than 1000, the core type is easier to insulate, and is the slightly better form.

On the core type the windings may be disposed in two ways. In Fig. 4, all the primary is on one leg and all the secondary on the other. This method of construction must be used where the secondary voltage is above 5000 (on account of the insulation); but, from other standpoints, it is not as good as the form shown in Fig. 6. Here each leg holds half the primary and half the secondary. This method results in less change in secondary voltage between no load to full load than is afforded by the other type. If a tertiary winding is required, it is best to place half of it on each leg also;

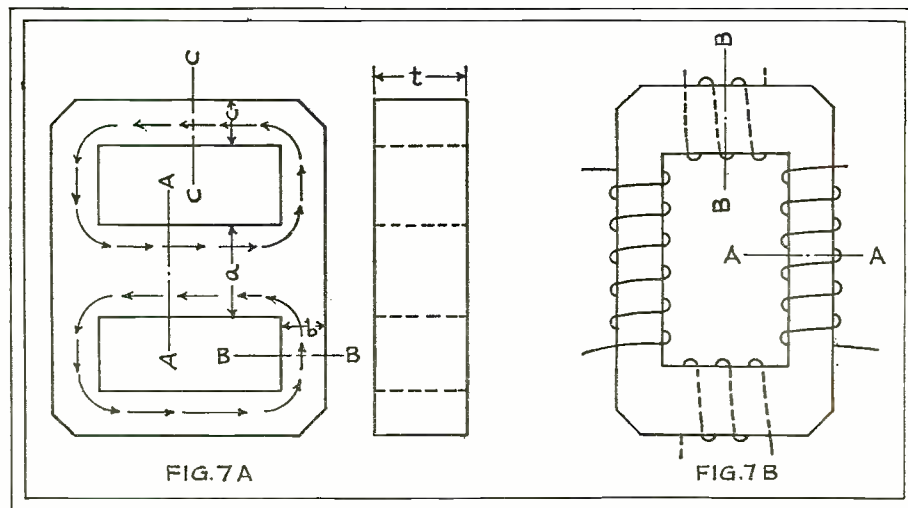

In a well-designed transformer, the amount of metal is uniform throughout the path of the flux. The inmost core of the shell-type is therefore thicker.

objection to winding a core transformer as shown in Fig. 7B, however, and indeed most commercial transformers are like this; for here the flux produced at section A-A by the coil merely spreads out in section B-B, which is permissible. The same core, however, must not be wound with the coils occupying the dotted position.

Calculations as to the gauge of wire are now in order, this depending upon the current to be carried. To find the current in any winding, the power (in watts) which the winding must deliver is divided by the voltage. The necessary cross-sectional area of the winding, expressed in circular mils, is then found by multiplying the current in amperes by 1200. The nearest size of wire corresponding to this area may then be looked up in the wire table. When large currents are involved, the required wire may be too heavy to handle easily; in this case two or more smaller conductors wound side by side may be employed. The area of each should be half the total area as found by computation. In the ensuing calculations, each turn consisting of two wires side by side is to be considered as one turn.

SIZE OF WINDINGS

Referring to Fig. 8, the span included in dimensions mn will henceforth be known as the *core opening*; and the problem with which we are now to deal is to compute the number of turns of wire that can be wound through this opening. The distance m will determine the number of turns per layer of the coil, and n will fix the number of layers; both dimensions being corrected for space taken up by insulation and air ducts. More will be said about this later. The outside diameter of the wire used is found from the table; and dividing this into the corrected value of m will give the number of turns per layer. When using two wires side by side, it should be noted that the effective number

of turns is only half the number of conductors that can be gotten into the distance m . Another way of looking at this is to think of each turn being twice as wide as the diameter given in the table; and, when this double width is divided into the length of one layer, the effective number of turns in this layer will result. The outside diameter of the wire as given in the table is only approximate, as the thickness of the insulation varies somewhat with different manufacturers. It is therefore a good idea to allow for this in the calculations; or else to wind on a small rod an inch of the wire to be used and count the number of turns per inch.

The dimension n , after correction for insulation and space between coils, fixes the number of layers. The actual thickness of each coil will be roughly proportional to the power delivered by the coil. Thus a two-winding transformer has only a primary and secondary; the power of each winding is necessarily equal; and the thickness of the two is the same. Next consider the case of a three-winding transformer, called upon to deliver 50 and 75 watts from its two secondaries. The power to be supplied from the primary will be $50 + 25 = 75$ watts, and the thicknesses of the primary and two secondaries will be respectively proportional to 75, 50, and 25. Thus if the available net winding space (corrected dimension n , Fig. 8) is $1\frac{1}{2}$ inches, the primary will occupy

$$\frac{75}{75 + 50 + 25} \times 1\frac{1}{2}'' = \frac{3}{4}'';$$

one secondary will take

$$\frac{50}{75 + 50 + 25} \times 1\frac{1}{2}'' = \frac{1}{2}'';$$

and the other will take

$$\frac{25}{75 + 50 + 25} \times 1\frac{1}{2}'' = \frac{1}{4}''.$$

(The dimensions found in this way are only approximate and will have to be revised later.)

Next, divide the thickness of the primary, just found, by the thickness of each layer and obtain the number of layers; which, when multiplied by the number of turns per layer, gives the total turns to be wound upon the primary. Then divide the voltage of the primary by the number of turns and obtain the volts per turn. The number of turns to use on the other windings (secondary and tertiary if required) is then found by dividing the volts per turn into the voltage which is desired from them. The number of layers on the secondary should then be calculated from the number of turns per layer and the total turns. This, multiplied by the thickness of each layer as found from the wire diameter, gives the thickness of the coil. As this value may differ slightly from the preliminary one found above, it is a good idea to allow for this by deducting a little extra from the gross dimension n , Fig. 8, when computing the available winding space.

The cross-sectional area of that part of the core which passes through the coil is next found by multiplying the volts per turn by 6.5 for a 60-cycle transformer, the result being expressed in square inches. For 25-, 30- and 50-cycle transformers the multipliers are 15.0, 12.5 and 7.5 respectively. When this is divided by the width of the core (dimension a , Fig. 7a) the thickness t of the pile of laminations which it will be necessary to stack is obtained. As it is not possible to make the laminations lie exactly flat on each other, from five to thirty per cent. must be added to the calculated thickness, depending on their condition.

INSULATION

The subject of insulation is one of great importance; for a breakdown between turns or layers may mean a burnt-up transformer, while a breakdown from coils to core might be dangerous to anyone touching the frame. For these reasons sufficient insulation must be provided between turns, layers, and coils to core. The insulation between turns is formed by the covering on the wire. Single-cotton-covered-enamel wire is here recommended for the average transformer; as the enamel makes a good electrical insulator and the cotton protects the enamel from injury. It is cheaper than other kinds of suitable insulation and has a higher *space-factor*; that is, more turns can be put into a given space than can be done with other coverings. Double-cotton-covered wire may be used but takes more space for a given number of turns. Silk-covered wire is, as a rule, too expensive to warrant its use in the average transformer.

For insulation between layers waxed paper may be used, wrapped three to five times over each layer of wire. The paper not only serves for insulating purposes but also greatly facilitates the winding of the wire in layers, especially when the wire is of small size.

Oiled paper (also called "Empire" paper) makes a very good layer insulation and may be used instead of waxed paper; in which case only one layer of the paper will be necessary between the layers of wire.

Insulation between coils and core is provided by winding the inner coil on a tube which will fit down over the core. As such a square tube is difficult to obtain a very good one may be built up by wrapping

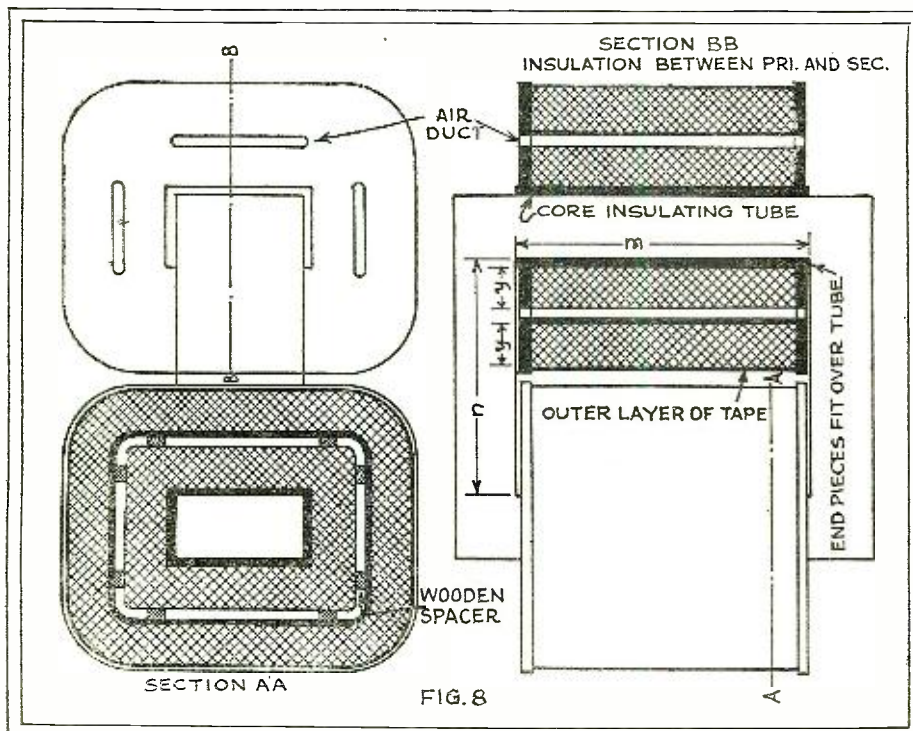
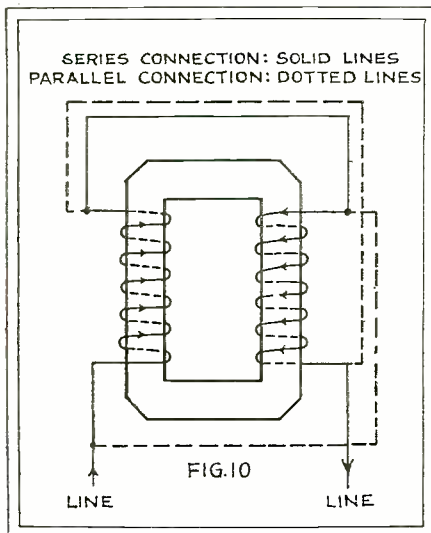

FIG. 8

When calculating the number of turns in the primary and secondary windings of a transformer, and the space they will occupy, it is necessary to make allowances for air ducts, as shown above, in order that the inner wires may not overheat, and to increase the insulation between windings.

In addition to these, the insulation between successive layers must be taken into account.



Series connection gives twice the voltage and half the amperage of a parallel connection.

oiled paper or "fish" paper around a form until a thickness of 1/16-inch is built up. The paper should be shellacked as it is wrapped; the shellac hardening and binding the layers together. End plates should be cut from 1/16-inch bakelite or fiber, and should fit snugly over the tube on which the coils are wound. They will then serve to hold the end turns of the coil in place as well as provide the necessary insulation between the ends of the coil and the core. After the inner coil is wound, three layers of oiled paper or "fish" paper should be wrapped over it before winding on the outer coil. After the last coil is on, two layers of cotton tape should be applied to protect the wire from mechanical injury.

In the case of large shell-type transformers, the thickness of the completed coil is likely to be two or more inches. In this case, *air ducts* should be provided between primary and secondary to prevent overheating of the inner portions of the coil. These ducts are formed by placing six or eight light wooden strips, about 1/8-inch square, over the primary; wrapping two layers of fish paper over them, and then proceeding with the secondary in the usual way.

When computing the net winding space, the thickness of the insulation must be taken into account. The total space occupied by the core-insulating tube, the paper between primary and secondary, the outside tape, and air ducts must be calculated and subtracted from the gross core opening. The thickness of the paper between layers is added to the wire diameter and included in the thickness of each layer.

WINDING

The actual winding of the coil should be done on a wooden form of the same cross-section as the core. The form may be tapered slightly to allow its removal; the insulating tube can then be built up and the wire put on. Some form of winding jig to rotate the coil form is necessary; as otherwise the winding will be tedious and a poor job will result. A hand drill clamped in a vise makes a very good jig, with the form pressed on a nail and supported in the chuck. A tension device should also be provided, to facilitate winding the wire tightly.

It is extremely important to wind the

wire evenly, and to use care at the ends of a layer to see that the turns of one layer do not fall down into one of the preceding layers. As it is very difficult to make fine wire stay in place each layer should be shellacked after winding, and the shellac allowed to harden before proceeding to the next. If a tap is brought off a coil, it should come at the end of a layer if possible. If not, a length of cotton sleeving or spaghetti should be slipped over it. Sleeving should also be used on the leads and should be carried back into the coil for one turn. Each lead should be marked so that it can be identified later. All coils should be wound in the same direction, to facilitate connecting later on.

The core may next be assembled into the coils. The iron is stacked, one piece at a time, until a pile of the calculated thickness is built up. The completed assembly should be clamped in some manner to hold the laminations in place and to form a support for the transformer. Fig. 9 shows a possible method; though of course this may be varied to suit the application. Holes for clamping bolts *must never be drilled through the laminations*. The bolts should be fastened to separate pieces which fit over the laminations instead, as shown in Fig. 9. If the coils do not fit tightly over the core, wooden wedges may be used to tighten them up.

After coils and core are put together, the whole assembly should be dipped in an insulating compound. A mixture of beeswax and resin makes a very good material, but has the disadvantage that it has to be heated. Air-drying insulating varnishes may be purchased at electrical repair shops and serve the purpose admirably. Ordinary enamel may be used also; but the coating formed by it is more brittle than regular insulating varnish. The transformer should be placed in a container and enough varnish poured in to completely cover it; and it is then left to soak for at least four hours. The varnish should be thinned until it flows very freely in order to insure good penetration. After the dip the transformer should be dried and, if desired, may be baked in an oven at about 250° F. to hasten the process.

CONNECTIONS

Connecting and testing are next in order. If the transformer has only one primary coil it will make no difference how it is connected to the line. In the case of core-type transformers with half the primary on each leg, the two coils must be connected in series. If both coils are wound in the same direction the connection is made as shown in Fig. 10, which also applies to the two secondaries. As explained above, however, the secondaries may be connected in parallel if desired, and operated at half

If the transformer is not securely fastened, its vibrations (the core laminations being insulated from each other) will be quite audible. The clamps must also be insulated from the core.

voltage and double current. The parallel connection also is illustrated in Fig. 10. When in doubt about the proper connections a piece of 2-amp. fuse wire may be connected in series with the primary and, if the connection is incorrect, the fuse will blow. In the case of an incorrect secondary series connection no voltage will appear at terminals.

After the coils have been connected properly the transformer should be placed across the line and allowed to operate unloaded for an hour. If during this time the windings get hot, either there is a short-circuited turn somewhere, or there is not enough iron in the core.

The short-circuited turn may sometimes be detected by more or less local heating in a particular spot, soon after the transformer has been connected to the line; while if there is too little core the whole primary will get warm evenly. If the windings get only lukewarm nothing need be done; but if they get hot enough to be uncomfortable to the hand further operation of the transformer is not safe. There is not much that can be done for a short-circuited turn, aside from unwinding the coil until it is located. If the core is at fault, however, it may be possible to stack more iron into it; or the primary voltage may be decreased by means of a suitable resistance in series with it. Caution must be exercised, whenever the transformer is connected to the line, not to come in contact with any high-voltage leads (100-volt and over) as a fatal shock may result from even a small transformer. If leads must be handled, touch the insulated part and use *one hand only*.

AN EXAMPLE IN DESIGN

To further clarify the procedure in design, an example will now be worked out. A transformer is desired for use in a tube-type storage battery charger and is to have two secondary windings; one to give 25 volts and 5 amps. and one to give 2 volts and 15 amps. The primary is to be supplied with 110 volts. Laminations are available such that the dimensions *m* and *n* (Fig. 8), are 4 inches and 2 inches respectively; and the width of the lamination where it passes through the coil is 1 inch.

The power from one secondary is
 25 volts x 5 amps. = 125 watts
 and from the other is
 2 volts x 15 amps. = 30 watts.
 The power to be supplied by the primary, then, is 155 watts and the primary current is

$$\frac{155 \text{ watts}}{110 \text{ volts}} = 1.4 \text{ amps.}$$
 (Continued on page 1142)

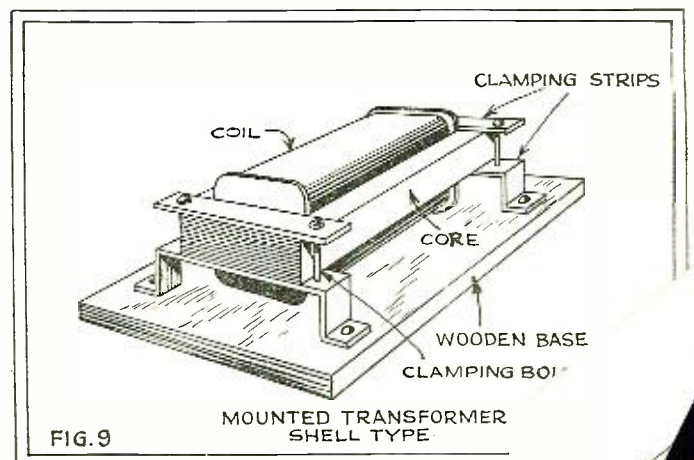

The Service Man

Operation on 32 Volts

Editor, RADIO NEWS:

I am a service man in my spare time, during the evenings and week-ends. I find this work interesting and the compensation is good. I was certainly pleased to see your columns for the service man in the last issue, and I hope that this service will be continued.

Several of my customers are using Delco and similar electric-light plants supplying 32 volts. I have been asked a number of times whether this current could be used for the sets. Of course, I answered that it was not suitable for the plate supply, but I thought that the filaments of the tubes could be operated from this source if the correct arrangement were used for the reduction of the voltage. I wonder if you could design such a unit for me or tell me where I could obtain such information.

J. J. O'BRIEN,
Bluefield, West Virginia.

"The Service Man" department will be continued if dealers and service men show sufficient interest. If you have any hints which are likely to help others who repair sets, we would suggest that you type or write them briefly in ink and send them in, along with any diagrams that you think would help to illustrate your point. If you have any problems, we will be glad to assist you if it is possible for us to do this; but in any case, your interest in this department, as shown by the number of letters received, will be appreciated.

A diagram of a 32-volt filament supply which will usually operate satisfactorily from a farm-lighting plant is shown here (Fig. 1). The current supplied by these units is, usually, sufficiently constant so that very little filtering is necessary. However, in order to keep noise level at a minimum, it is advisable to use a filter of some kind; and, for this purpose, you will find that a choke and two filter condensers are used. The choke will have to be made in such a manner that it will carry three amperes or more at 32 volts, without overheating. In case you cannot obtain a suitable coil, the choke may be omitted and a single 4-mf. filter condenser or larger size may be used for the filter. This method is not as efficient as the first; but it will often operate satisfactorily, especially in the larger installations.

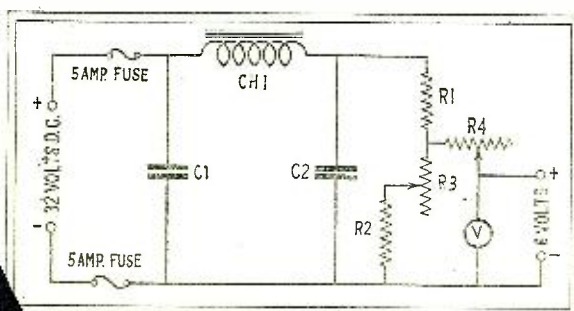

The remainder of the unit consists of the voltage-reducing device, made up of resistors. The first resistor R1 and the second R2 are fixed resistors, the values of which are determined by the type and number of tubes used in the set. If 5-volt tubes are employed, a resistor of 12.5 ohms and a current-capacity of about 60 watts will be suitable for sets using up to 1 ampere. Between 1 and 1.5 amperes, the resistor should have a value of 10 ohms and a capacity of 60 watts; while sets drawing up to 3 amperes should use a resistor with a higher current rating such as 125 watts. The Ward-Leonard type PEB-6.4 resistor is suitable in this case. The resistance value is 6.4 ohms.

For resistor R2, the value is also depend-

SERVICE MEN are invited to send in the "wrinkles" and ideas they have found valuable in daily work. All servicers are not old-timers, nor are all equipped with the complete apparatus to make work easy; so that what seems too simple or too laborious to one may not be so to another. This department is especially for the man who works with sets which others have built; as our other pages are for those who build their own. Accepted articles will be compensated, if short, in the same way as other Wrinkles; if longer, at the regular space rates. What have you found out in your daily work that will be for the good of the servicing fraternity?

ent on the number of tubes used. A current rating of 60 watts will be sufficient for all purposes. A table of resistances follows:

Current drain amperes	R1 Resistance ohms	Rating watts	R2 Resistance ohms	Rating watts
.75	12.5	60	5	60
1.00	12.5	60	7	60
1.25	10.	60	5	60
1.50	10.	60	7	60
1.75	6.4	120	3	60
2.00	6.4	120	3.5	60
2.25	6.4	120	4.25	60
2.50	6.4	120	5	60
2.75	6.4	120	6	60
3.00	6.4	120	7	60

The current drain of the set should be figured from the number and the type of the tubes used, and the corresponding resistors for R1 and R2 should be used.

R3 and R4 are rheostats of

Fig. 1

Many homes in rural and suburban districts have 32-volt light plants. The current, properly filtered, may be used with D.C. tubes and suitable resistors.

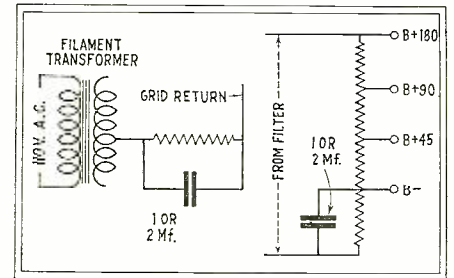

Fig. 2

Adequate by-pass condensers of sufficient capacity must be used in the filament returns of A.F. tubes which depend on resistors to provide grid bias or quality will suffer.

about 6 ohms. They should be made with wire sufficiently heavy to carry 3 amperes without overheating. If 199-type tubes are used, resistor R1 should have a value of 45 ohms and R2 one of 7 ohms. R3 and R4 in this case should have a value of about 20 ohms. In constructing the unit, the two resistors R1 and R2 should be mounted in such a way that they will be well ventilated, so that there will be no danger of overheating. R3 and R4 are adjusted with the set in operation and a voltmeter is used to determine the correct setting. Two 5-ampere fuses should be connected in the circuit and, in some cases, it is advisable to place a one-microfarad condenser in the ground lead of the receiver, to prevent a short circuit in the power-supply unit. The condenser is merely connected between the set and the ground. Its use will not affect the operation of the set.

Adequate By-Passing Needed to Give Quality

Editor, RADIO NEWS:

In servicing many of the commercial and home-made A.C. receivers, I have found that the resistors used for the "C" bias are not by-passed. To me this seems a very important point, and I have often found that the quality and the all-round results were improved by placing a condenser at this point. The reason why this is so important is the fact that the audio-frequency currents must pass through this part of the circuit; and the resistor offers a very appreciable opposition to the flow of these audio currents. The resistor used for the grid bias is usually one with a value between 1,000 and 2,000 ohms. Naturally, this is sufficient to reduce the volume, and it also causes some distortion. I have found that a condenser of about 1-mf. capacity is sufficient to overcome all the difficulties caused in this way.

There are two ways in which the condenser may be connected, depending on the method of obtaining the bias. One arrangement uses a resistor in the lead from the center tap of the filament transformer, or from the center of a tapped resistor across the filament winding; and in this case the condenser is merely connected across the series resistor. The other common method

is to use part of the voltage-divider in the "B" power unit to obtain the necessary voltage drop. In this case the condenser is connected between the "B—" and the "C—" lead or the negative lead from the rectifier in the "B" power unit. The results in either case are the same, except that the need for the condenser is usually greater in the former arrangement.

I have found that the use of a condenser at this point often reduced the tendency of an audio-frequency amplifier to "motorboat" and, in some cases, it has been a complete cure for this trouble.

JOHN BENDER,
Detroit, Michigan.

Radio Service Course

THE first radio course for service men has just been compiled by the Radio Division of the National Electrical Manufacturers Association, in co-operation with the Radio Institute of America, as the answer of national set manufacturers to the increasing demand for fuller information on service problems.

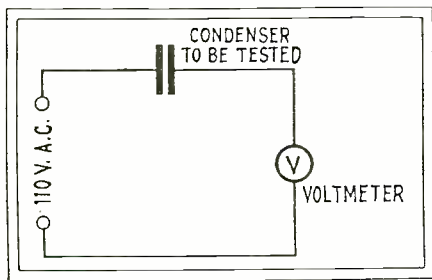

Fig. 3

The reading increases with the capacity.

The course comprises four text books; while, during the course, there are offered four examination papers which may be submitted to the Radio Institute of America for correction and rating.

Technical language has been avoided as much as possible; but fundamental principles, receiving circuits and circuit diagrams, receiving-set components, definitions and ethics of servicing have been treated in sufficient detail to give the radio dealer and his service men an accurate understanding of the essential information required in practical service work.

"What's the Job Worth?"

Editor, RADIO NEWS:

I would like to see published in your magazine an average-charge scale for various operations performed on radios. Of course, I realize that this cannot be given except in a very general way; but, if the service man had some sort of flat-rate scale to go by, it would be a great help in satisfying his customer that he was getting value received; as well as a salve for his own conscience after charging his customer a dollar for soldering one little connection after spending probably ten or fifteen minutes finding it.

These days a rate per hour is hardly fair to the man who has quite a bit of money invested in expensive testing equipment with which he can locate and fix most of the common troubles in a very few minutes. It would seem that if, by modern methods, he locates a high-resistance connection in the

grid lead to the detector in thirty minutes, he is entitled to the same amount of money as the man who spends hours finding it by the old trial-and-error methods and charges his customer a dollar and a half an hour for it.

If you can possibly thrash out a satisfactory solution to this problem, I am sure that we would all appreciate it.

GORDON E. LOCKERD,
Portales, New Mexico.

There is no doubt that this is one of the most important questions facing the service man, who is interested in radio, not as a hobby, but as a means of making a living. He is entitled to be paid, not only for his investment in a testing equipment, but for what the French call *savoir faire*—the knowing how to do things. We may remember the old and impressive (if possibly exaggerated) story of the oculist who justified his high charge for an operation by saying that he had spoiled a peek of eyes learning how to do it. The set owner should be willing to pay for expert knowledge applied to the improvement of his set, but hardly for experiments with it. It is impossible to determine on a standard flat rate for servicing work which would be universally applicable. The cost of doing business varies considerably in the different parts of the country, and even as between locations in the same district. However, anywhere that there are a number of service men doing business in the same city, a get-together movement on their part will be of undoubted value in promoting a better understanding of business problems and a greater insistence on obtaining a fair price for their services, investment in equipment and education considered. Other trades have long since learned that lesson; but to a large extent the radio service men of the country have just "happened" to get into the business. We will be glad to chronicle the organization of local service men's clubs, and such a tariff of minimum charges as they determine to be adequate for their location conditions—as a guide to others.

Measuring Large Condensers

Editor, RADIO NEWS:

In assembling "B" power units and other power devices, one often encounters condenser blocks that are not marked with their capacity. The capacity of such condensers may be measured approximately by the following method (Fig. 3).

Only the 110-volt 60-cycle current found in standard lighting circuits, and a "B" battery voltmeter of the plunger or solenoid type are required. The lighting voltage may usually be relied upon to be fairly constant, and the frequency is kept sufficiently accu-

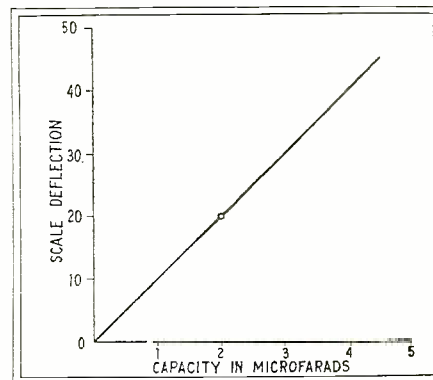

Fig. 4

By charting the meter reading with a condenser of known capacity, a scale like this is made.

rate for this purpose. The voltmeter should have a range of about 0-50 volts; this type of meter can be obtained very cheaply. Since the plunger meter is not polarized, an easy way to recognize the correct type of meter is to connect it across a "B" battery and then reverse the leads. In the plunger-type meter, the deflection is always upward on the scale, regardless of the direction of the current flow. In the polarized meter, the needle will move off the scale when the connections are reversed; such a meter cannot be used.

To measure the capacity of a condenser, connect the condenser and voltmeter in series to the line and note the deflection. The calibration of the meter is accomplished by connecting a condenser of known capacity in the circuit and plotting a curve as shown in the graph above (Fig. 4). Only one point is necessary, as the curve will be a straight line determined by the origin and the point found. The approximate capacity of any condenser of sufficient capacity can then be determined by referring to the curve.

PAUL WIMBERLEY,
New Braunfels, Texas.

This method of approximating capacities is satisfactory, if the condenser is in good condition. If the condenser is short-circuited, a low-voltage meter will be ruined, and the fuses in the house will be blown out; it is advisable for this reason to test the condenser for short-circuit, with a battery, before applying the capacity test.

A somewhat similar method of testing capacities, which is more accurate and is applicable to a wider range of capacities, has been described in the "Aerovox Research Worker" of February 25, 1929. It is in part as follows:

The capacities of the average condenser of from .01- to 10 or more mf. can be measure very easily if the ordinary 110-volt A.C.

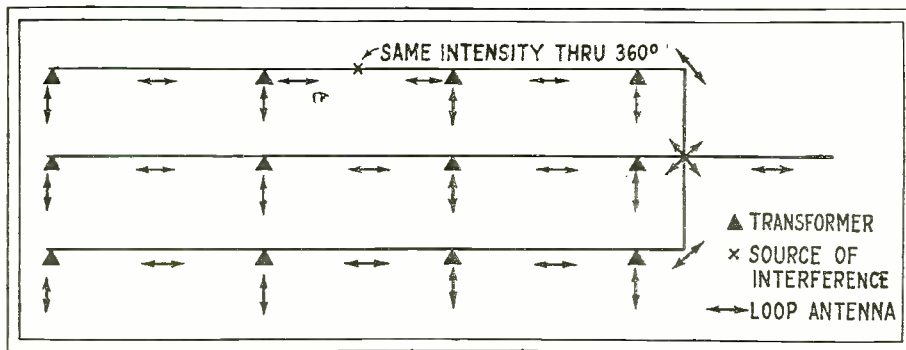

Fig. 6

Following interference along wire lines with a loop is not always successful; see page 1144

current, a high-resistance A.C. voltmeter and an A.C. milliammeter are available. The circuit used to make the measurements is shown; this consists of an A.C. milliammeter A connected in series with the condenser C whose capacity is to be measured, and provides for an A.C. voltmeter V to read the voltage applied to the terminals of the condenser.

The circuit can be connected to the terminals of a standard plug which will serve as a convenient connection to the 110-volt A.C. outlet. The first step in making the test is to be sure that the condenser is not short-circuited, by connecting it into a test circuit, consisting of a battery and voltmeter connected across a battery. If the voltmeter registers, the condenser is short-circuited, and no further time should be spent with it.

After the soundness of the condenser has been assured, it can be connected into the test circuit. The milliammeter reading is then noted and the switch for the voltmeter is closed so that the voltage across the condenser can be read. It will be noticed that, when the voltmeter is connected, a higher deflection is obtained on the milliammeter. This is due to the additional current drawn by the voltmeter and it will be seen that it is important to obtain a reading on the milliammeter before the other meter is connected.

If the voltmeter is connected across the condenser when the milliammeter reading is taken, the results will be erroneous because of the additional current drawn by the volt-

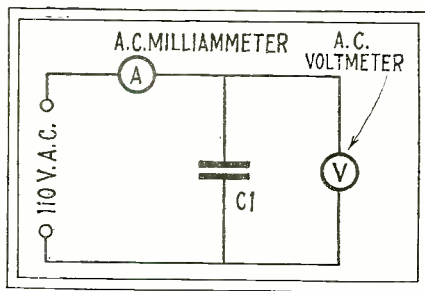

Fig. 5

The circuit above shown requires two meters, but gives more accurate results.

meter over that drawn by the condenser. It might also be mentioned that the voltage reading should be taken immediately after the current reading, to avoid any possibility of error because of a possible fluctuation in the line-voltage after the current reading has been taken. It is advisable to take several current and voltage readings and take the average of them all.

The capacity of the condenser is then determined by using a simple formula and substituting the readings taken on the two meters in it. The actual formula used when I is the reading on the milliammeter, f the frequency of the supplied current and E the reading on the voltmeter, is

$$C = \frac{1000 \times I}{6.28 \times f \times E}$$

It requires only a knowledge of arithmetic to find the capacity of a condenser from

this simple equation. For example, suppose the current reading is 20, the voltage 110 and the frequency of the current 60. Then, multiplying 20 by 1000, and 6.28 by 60 and the result by 110, it is merely necessary to divide one into the other according to the equation, and the result is 0.48 (microfarad).

It must be remembered that both the methods described here for obtaining the capacities of condensers are approximate and neither is absolutely accurate. However, with filter condensers, the exact capacity is not very important. The second method is more accurate than the first and with careful handling the error should not be more than 5%, which is very small when the condenser is a large one. For instance, suppose we have a condenser with a known capacity of 1 mf. and the measured capacity is 1.05 mf., this difference would indicate 5% error.

Editor, RADIO NEWS:

On page 933 of the April issue of RADIO NEWS I note a method of locating sources of radio interference, referred to as "triangulation," using the directional properties of a loop antenna to secure compass bearings. This idea is practical and considerable accuracy results when applied to compass hearings from ship to shore, but it is unreliable on land, and absolutely worthless in a city; due to the following fundamental difficulties.

(Continued on page 1144)

What's New in Radio

(Continued from page 1083)

The Radio Fan's Own Clock

THE two clocks illustrated here are designed for use on or near a radio set; one combines a lamp, a light-socket aerial and a time-conversion scale, while the smaller of the two is not illuminated.

The time-conversion chart incorporated in the face of the clock is very ingenious,



Fig. O

The ornamental clock-lamp shown has also an internal aerial, connected to the binding post.

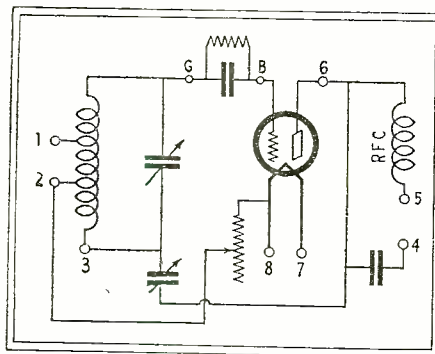

Fig. 4

The circuit of the Walker "Multi-Unit" will indicate some of the many uses to which it has been ingeniously adapted (See page 1083).

giving a direct indication of the time in all parts of the world. This is accomplished by mounting a disc on the hour hand in such a way that it turns with the hand. The disc is marked with the positions of various points in time zones of interest to radio fans. The glass on the front of the clock is drilled through and a corresponding hole is found in the disc. A pin or other sharp instrument may be inserted to turn the disc, so that any of the positions on the globe can be brought directly under the hour hand. When the line of the time zone in which the clock is being used is directly under the hour hand, then the positions of the other points around the disc indicate the corresponding times in other zones.

Metal cases, enamelled to imitate mahogany, are provided; the total heights of the two models being 10 inches and 4 inches re-

spectively. They are manufactured by the Gardner Clock Corporation, New York City

Soldering Fluid is Handy

A SOLDERING fluid which has very good properties of cleaning material to be soldered has been placed on the market by the Resol Products Corp., of Brooklyn, N. Y. The flux is a clear liquid, which makes it more convenient to handle than the usual powdered rosin or pastes.

After soldering a connection in a receiver, it is found that the flux has been evaporated by the heat of the iron.

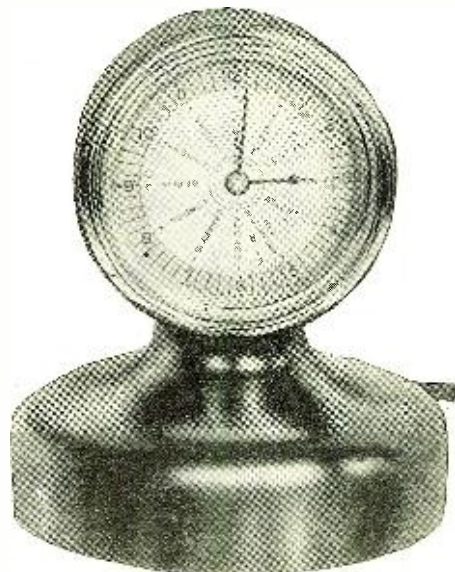

Fig. P

The "Clock of the World" gives all times.

Large Television Images Broadcast by R. C. A.

Views of the New Short-Wave Station W2XBS, From Which Daily Experimental Transmissions Are Now Being Made

SINCE the preparation of the last issue of RADIO NEWS, interesting and enlightening developments in the field of television have transpired. Heretofore this newcomer in the radio field has been considered a mild offshoot of radio and enjoyed a short-lived popularity in the press of the country. As usually the case, it remained for the large corporations having suitable facilities to delve seriously into the mysteries of this new art; though amateurs have been enjoying reception of the images experimentally transmitted.

Recently Dr. A. N. Goldsmith, chief engineer and a vice-president of the Radio Corporation of America, issued a statement outlining the activities, past, present and future, of that company in making television available commercially to the vast radio following.

After a number of years spent in research and development activities, television broadcasting is now being carried on by the R.C.A. from a station in New York City on a regular daily schedule (between the hours of 7 and 9 P. M.) on a frequency channel between 2,000 and 2,100 kilocycles (equivalent to the band of wavelengths from 142.8 to 149.9 meters).

In commenting on the technical aspects of the

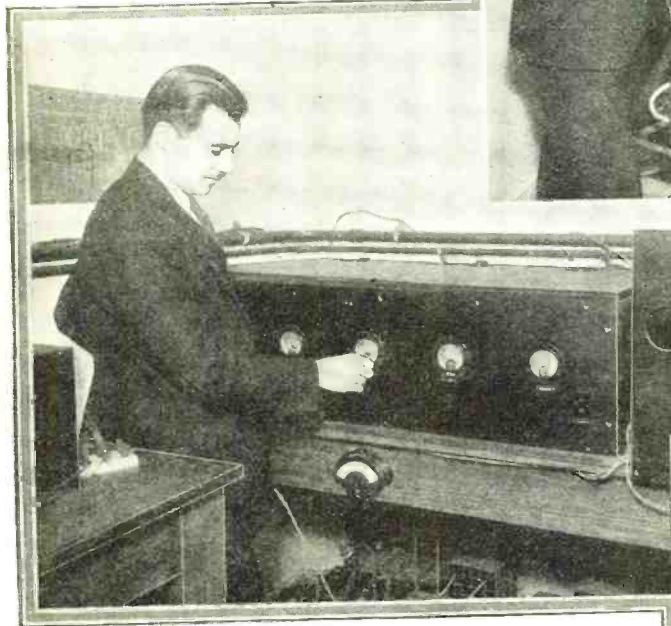
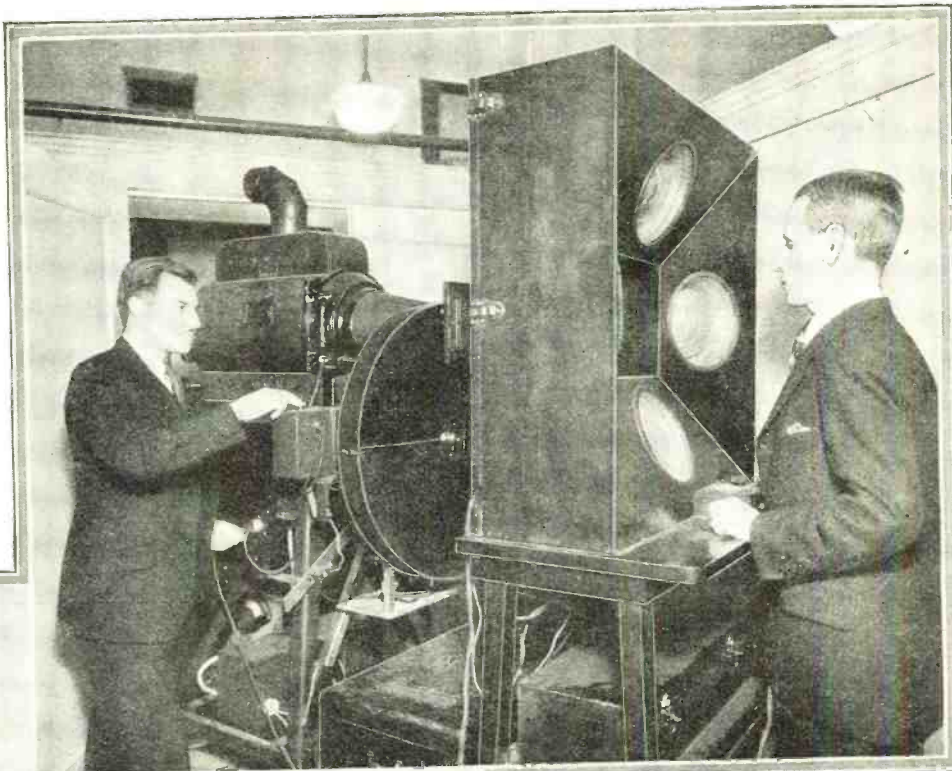

The scanner and bank of cells shown above are of the type already familiar to our readers, utilizing the Ives system of a moving light-spot which crosses the area scanned and is reflected from the subject's face, etc. The disc used here has a larger number of holes than the usual 48.

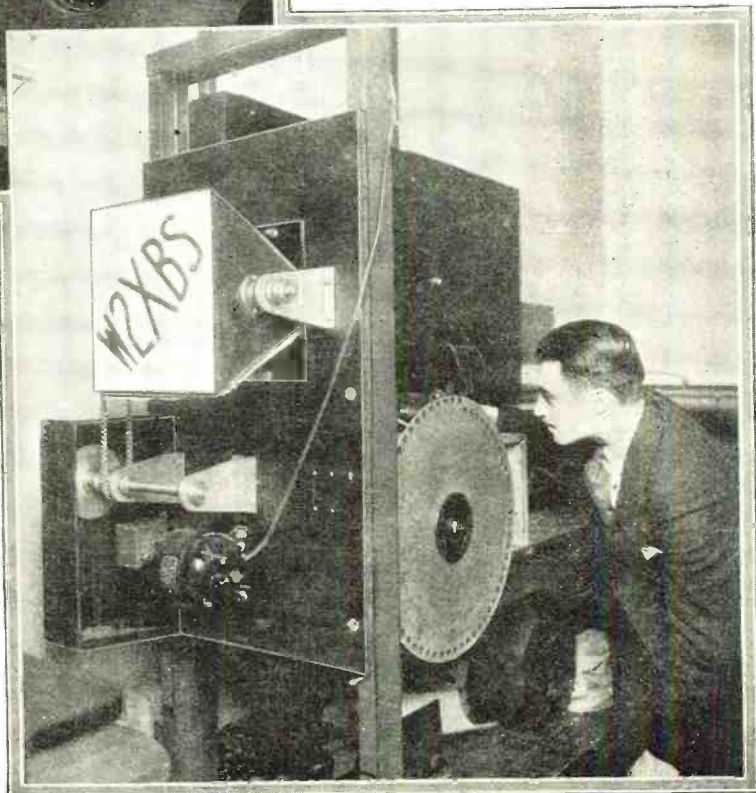

new activity of the company, Dr. Goldsmith stated: "The power employed at present is 250 watts, although it is expected that this will be considerably increased shortly." From this station, W2XBS, pictures are being broadcast which are sixty scanning lines high (vertically) and seventy-two elements wide (horizontally). Twenty complete pictures are transmitted each second, requiring a speed of revolution of 1,200 per minute for the scanning disc.

A number of views of the transmitting equipment of W2XBS are shown here. The uppermost picture shows the scanning equipment, consisting of the light source, the scanner and the bank of photoelectric cells, in that order from left to right. Below is an illustration of the carrier-frequency oscillator and the audio-frequency amplifier which magnifies the minute current impulses generated by the photoelectric cells. At the lower right we have the automatic picture-changer upon which the scanner and photo-cells may be focused. In this view the card bearing the call letters of the station is ready to be scanned, in lieu of making an oral announcement. The card is held in position for eighteen seconds, affording ample time for tuning in at the receiving end.

Developments on the receiving equipment, which are now going forward, will be presented in an early issue of RADIO NEWS.

Beside the amplifier shown at the left in the picture above is the master-oscillator for generating the carrier-frequency for the transmissions. The apparatus in the photo at the lower right is used to transmit the "stills," such as the card with the station call, in order that experimenters may tune in the images and get their receivers in synchronism. The disc at the bottom is that of a "monitor" receiver.

List of Broadcast Stations in the United States

Radio Call Letters	BROADCAST STA. Location	Wave (Meters)	Power (Watts)	Radio Call Letters	BROADCAST STA. Location	Wave (Meters)	Power (Watts)	Radio Call Letters	BROADCAST STA. Location	Wave (Meters)	Power (Watts)	Radio Call Letters	BROADCAST STA. Location	Wave (Meters)	Power (Watts)
KCRC	Enid, Okla.	219	50	KIDO	Boise, Idaho	240	1000	WPAP	Fort Worth, Texas	375	25000	WGR	Buffalo, N. Y.	545	1000
KDB	Santa Barbara, Calif.	219	100	KITB	Portland, Oregon	219	1000	WBAP	Nashville, Tenn.	201	5000	WGST	Amanta, Ga.	337	250
KDKA	East Pittsburgh, Pa.	306	25000	KJBS	San Francisco, Cal.(day)	280	100	WBAX	Wilkes-Barre, Pa.	248	100	WGY	Schenectady, N. Y.	380	50000
KDLR	Devils Lake, N. D.	248	100	KJRW	Seattle, Wash.	209	5000	WBBC	Brooklyn, N. Y. City	214	500	WHA	Madison, Wis.	268	750
KDYL	Salt Lake City, Utah	232	1000	KLO	Ogden, Utah	213	50	WBDM	Richmond, Va.	219	100	WHAD	Millwaukee, Wis. (day)	268	250
KEJL	Los Angeles, Calif.	256	500	KLCRA	Blytheville, Ark. (day)	232	50	WBDR	Chicago, Ill.	389	25000	WHAM	Rochester, N. Y.	261	5000
KELW	Burbank, Calif.	334	500	KLS	Little Rock, Ark.	216	1000	WBBY	Rossville, N. Y. City	231	1000	WHAP	New York City	231	1000
KELV	Portland, Oregon	254	5000	KLZ	Oakland, Calif. (day)	209	250	WBBS	Charleston, S. C.	250	75	WHAS	Louisville, Ky.	366	5000
KFAB	Lincoln, Nebraska	399	5000	KMA	Oakland, Calif. (day)	241	500	WBCTM	Ponca City, Okla.	250	100	WHAZ	Troy, N. Y.	316	500
KFAD	Phoenix, Arizona	484	500	KMB	Shenandoah, Iowa	535	1000	WBCTN	Bay City, Mich.	213	500	WHB	Kansas City, Mo.	251	500
KFB	Great Falls, Montana	220	500	KMBC	Independence, Mo.	316	500	WBCTP	See WENR			WHBC	Canton, Ohio	250	100
KFBK	Sacramento, Calif.	229	100	KMED	Medford, Oregon	229	50	WBCTQ	See WENR			WHBD	Bellefontaine, Ohio	219	100
KFBL	Everett, Washington	219	50	KMIC	Inglewood, Calif.	288	500	WBCTR	Detroit, Mich.	229	1000	WHBF	Rock Island, Ill.	248	100
KFDM	Beaumont, Texas	535	500	KMJJ	Fresno, Calif.	250	100	WBCTU	Fort Lee, N. J.	229	100	WHBP	Sheboygan, Wis.	213	500
KFDY	Brookings, S. D.	345	500	KMNO	Day Center, Neb. (day)	405	1000	WBCTV	New York City	222	250	WHBQ	Johnstown, Pa.	229	100
KFEL	Denver, Colorado	319	250	KMOX	Tacoma, Wash.	275	25000	WBCTW	See WABC			WHBQ	Memphis, Tenn.	219	100
KFEQ	St. Joseph, Mo. (day)	535	2500	KMTR	St. Louis, Mo.	275	25000	WBCTX	Terre Haute, Ind.	229	100	WHBU	Anderson, Indiana	248	100
KFEY	Kellogg, Idaho	248	10	KNX	Hollywood, Calif.	526	1000	WBCTY	Birmingham, Ala.	322	500	WHBW	Philadelphia, Pa.	200	100
KFGQ	Boone, Iowa	229	100	KNX	Los Angeles, Calif.	296	5000	WBCTZ	Wilkes-Barre, Pa.	229	100	WHBY	West De Pere, Wis.	250	100
KFGK	Wichita, Kansas	231	500	KOAC	Denver, Colo.	361	12500	WBCTA	Tilton, N. H.	210	500	WHBY	Calumet, Mich.	219	100
KFHA	Gunnison, Colorado	250	50	KOB	State College, N. Mex.	535	1000	WBCTB	Wellesley Hills, Mass. (Time limited)	384	2500	WHDH	Gloucester, Mass. (day)	361	1000
KFI	Los Angeles, Calif.	463	5000	KOCW	Chickasha, Okla.	214	250	WBCTC	Charlotte, N. C.	278	1000	WHDL	Tupper Lake, N. Y.	211	10
KFIF	Portland, Ore.	211	100	KOH	Reno, Nevada	219	100	WBCTD	Springfield, Mass.	303	1500	WHDC	See WABO		
KFIO	Spokane, Wash. (day)	244	100	KOIL	Council Bluffs, Iowa	238	1000	WBCTE	St. Louis, Mo.	303	500	WHDF	Chicago, Ill.	229	100
KFIU	Juneau, Alaska	229	10	KOIN	Portland, Oregon	319	1000	WBCTF	St. Louis, Mo.	303	500	WHDI	Bluefield, W. Va.	211	100
KFIZ	Fond du Lac, Wis.	211	100	KOL	Seattle, Wash.	236	1000	WBCTG	St. Louis, Mo.	303	500	WHDI	Cleveland, Ohio	216	2000
KFJB	Marshalltown, Iowa	250	50	KOMO	Seattle, Wash.	236	1000	WBCTH	St. Louis, Mo.	303	500	WHDI	Chicago, Ill.	229	100
KFJC	Oklahoma City, Okla.	204	5000	KOOS	Marshallfield, Oregon	219	100	WBCTI	St. Louis, Mo.	303	500	WHDI	New York City	216	2000
KFJL	Astoria, Oregon	219	100	KORE	Eugene, Oregon	211	100	WBCTJ	St. Louis, Mo.	303	500	WHDI	Des Moines, Iowa	300	5000
KFJM	Grand Forks, N. D.	219	500	KOY	Phoenix, Ariz.	216	500	WBCTK	St. Louis, Mo.	303	500	WHDI	Harrisburg, Pa.	210	500
KFJR	Portland, Oregon	231	500	KPCB	Seattle, Wash.	248	100	WBCTL	St. Louis, Mo.	303	500	WHDI	New York City	211	100
KFJS	Fort Dodge, Iowa	229	100	KPFA	Westminster, Cal.	201	25000	WBCTM	St. Louis, Mo.	303	500	WHDI	Ottumwa, Iowa (day)	211	100
KFJT	Fort Worth, Texas	219	100	KPFB	Fresno, Calif.	200	100	WBCTN	St. Louis, Mo.	303	500	WHDI	Madison, Wis.	243	100
KFKA	Greeley, Colorado	341	500	KPFL	Los Angeles, Calif.	280	100	WBCTO	Baltimore, Md.	246	500	WHDI	Elkins Park, Pa. (Sun.)	243	100
KFKB	Millford, Kansas (day)	286	5000	KPJM	Los Angeles, Calif.	280	100	WBCTP	Asbury Park, N. J.	234	500	WHDI	Jackson, Mich.	219	100
KFKU	Lawrence, Kansas	246	1000	KPKN	San Francisco, Calif.	441	1000	WBCTQ	Rapid City, S. D.	250	100	WHDI	Chicago, Ill.	229	100
KFKX	Chicago, Illinois	294	5000	KPOF	Denver, Colo.	341	500	WBCTR	Philadelphia, Pa.	256	5000	WHDI	Stuebenville, Ohio	211	50
KFKZ	Kirkville, Missouri	250	50	KPPC	Pasadena, Calif.	250	50	WBCTS	Philadelphia, Pa.	256	5000	WHDI	Poyneette, Wis.	229	100
KFLV	Rockford, Illinois	213	500	KPRC	Seattle, Wash.	248	100	WBCTT	Greenville, N. Y. (day)	280	100	WHDI	Topeka, Kans.	231	1000
KFLX	Galveston, Texas	210	50	KPSN	Pasadena, Calif.	326	1000	WBCTU	Zion, Illinois (day)	278	5000	WHDI	Utica, N. Y.	250	100
KFMX	Northfield, Minn.	240	1000					WBCTV	Baltimore, Md.	219	100	WHDI	Montgomery, Ala.	200	15
KFNF	Shenandoah, Iowa	337	500					WBCTW	Springfield, Ill.	243	100	WHDI	Bridgeport, Conn. (day)	252	500
KFOR	Lincoln, Nebraska	248	100					WBCTX				WHDI	St. Louis, Mo. (Sun.)	211	100
KFOX	Long Beach, Calif.	240	1000					WBCTY				WHDI	Urbana, Ill.	337	250
KFPL	Dubuque, Iowa	229	15					WBCTZ				WHDI	Wilmington, Del.	200	100
KFPM	Greenville, Texas	229	15					WBCTA				WHDI	Bay Shore, N. Y.	243	100
KFPW	Siloam Springs, Ark. (day)	224	50					WBCTB				WHDI	Philadelphia, Pa.	242	1000
KFPY	Spokane, Wash.	224	500					WBCTC				WHDI	Philadelphia, Pa.	242	1000
KFQD	Anchorage, Alaska	244	100					WBCTD				WHDI	Philadelphia, Pa.	242	1000
KFQU	Helena, Mont.	211	100					WBCTE				WHDI	Philadelphia, Pa.	242	1000
KFQV	Seattle, Wash.	210	100					WBCTF				WHDI	Philadelphia, Pa.	242	1000
KFQW	Hollywood, Cal. (Ltd.)	349	1000					WBCTG				WHDI	Philadelphia, Pa.	242	1000
KFR	San Francisco, Calif.	492	1000					WBCTH				WHDI	Philadelphia, Pa.	242	1000
KFRU	Columbia, Missouri	476	500					WBCTI				WHDI	Philadelphia, Pa.	242	1000
KFSD	San Diego, Calif.	500	500					WBCTJ				WHDI	Philadelphia, Pa.	242	1000
KFSE	Los Angeles, Calif.	263	500					WBCTK				WHDI	Philadelphia, Pa.	242	1000
KFSL	Los Angeles, Calif.	263	500					WBCTL				WHDI	Philadelphia, Pa.	242	1000
KFSP	Colorado Springs, Colo.	236	1000					WBCTM				WHDI	Philadelphia, Pa.	242	1000
KFUO	St. Louis, Mo.	545	500					WBCTN				WHDI	Philadelphia, Pa.	242	1000
KFUP	Denver, Colorado	229	100					WBCTO				WHDI	Philadelphia, Pa.	242	1000
KFV	Venice, Calif. (Ltd.)	422	250					WBCTP				WHDI	Philadelphia, Pa.	242	1000
KFVJ	Cape Girardeau, Mo.	248	100					WBCTQ				WHDI	Philadelphia, Pa.	242	1000
KFVW	Rockford, Illinois	213	500					WBCTR				WHDI	Philadelphia, Pa.	242	1000
KFWB	San Bernardino, Calif.	250	100					WBCTS				WHDI	Philadelphia, Pa.	242	1000
KFWF	St. Louis, Missouri	250	100					WBCTT				WHDI	Philadelphia, Pa.	242	1000
KFWI	San Francisco, Calif.	322	500					WBCTU				WHDI	Philadelphia, Pa.	242	1000
KFWM	Oakland, Calif.	322	500					WBCTV				WHDI	Philadelphia, Pa.	242	1000
KFXD	Jerome, Idaho	211	50					WBCTW				WHDI	Philadelphia, Pa.	242	1000
KFXE	Colorado	313	250					WBCTX				WHDI	Philadelphia, Pa.	242	1000
KFXJ	Edgewater, Colo.	229	100					WBCTY				WHDI	Philadelphia, Pa.	242	1000
KFXR	Oklahoma City, Okla.	229	100					WBCTZ				WHDI	Philadelphia, Pa.	242	1000
KFXS	Flagstaff, Arizona	211	100					WBCTA				WHDI	Philadelphia, Pa.	242	1000
KFYO	Abilene, Texas	211	100					WBCTB				WHDI	Philadelphia, Pa.	242	1000
KFYR	Bismarck, N. D.	545	500					WBCTC				WHDI	Philadelphia, Pa.	242	1000
KGA	Spokane, Wash.	219	100					WBCTD				WHDI	Philadelphia, Pa.	242	1000
KGAR	Tucson, Arizona	219	100					WBCTE				WHDI	Philadelphia, Pa.	242	1000
KGB	San Diego, Calif.	220	250					WBCTF				WHDI	Philadelphia, Pa.	242	1000
KGBU	Ketchikan, Alaska	333	500					WBCTG				WHDI	Philadelphia, Pa.	242	1000
KGBX	St. Joseph, Mo.	219	100					WBCTH				WHDI	Philadelphia, Pa.	242	1000
KGBZ	York, Nebraska	322	500					WBCTI				WHDI	Philadelphia, Pa.	242	1000
KGC	Los Angeles, Calif. (day)	236	50					WBCTJ				WHDI	Philadelphia, Pa.	242	1000
KGCI	San Antonio, Texas	219	100					WBCTK				WHDI	Philadelphia, Pa.	242	1000
KGCN	Concordia, Kansas	211	50					WBCTL				WHDI	Philadelphia, Pa.	242	1000
KGCR	Brookings, S. D.	248	100					WBCTM				WHDI	Philadelphia, Pa.	242	1000
KGCU	Mandan, N. D.	250	100					WBCTN				WHDI	Philadelphia, Pa.	242	1000
KGCV	Vida, Montana	211	100					WBCTO				WHDI	Philadelphia, Pa.	242	1000
KGDX	Del Rio, Texas	219	50					WBCTP				WHDI	Philadelphia, Pa.	242	1000
KGDE	Fergus Falls, Minn.	250	50					WBCTQ				WHDI	Philadelphia, Pa.	242	1000
KGDM	Stockton, Calif. (day)	273	50					WBCTR				WHDI	Philadelphia, Pa.	242	1000
KGDR	San Antonio, Texas	200	100					WBCTS				WHDI	Philadelphia, Pa.	242	1000
KGDY	Oldham, S. D.	250	15					WBCTT				WHDI	Philadelphia, Pa.	242	1000
KGEF	Los Angeles, Calif.	231	1000					WBCTU				WHDI	Philadelphia, Pa.	242	1000
KGEK	Yuma, Colo.	250	10					WBCTV				WHDI	Philadelphia, Pa.	242	1000
KGEL	Portland, Ore.	219	100					WBCTW				WHDI	Philadelphia, Pa.	242	1000
KGEW	Fort Morgan, Colo.	250	100					WBCTX				WHDI	Philadelphia, Pa.	242	1000
KGEZ	Kalispell, Montana	229	100					WBCTY				WHDI	Philadelphia, Pa.	242	1000
KGFF	Alva, Oklahoma	211	100					WBCTZ				WHDI	Philadelphia, Pa.	242	1000
KGFG	Oklahoma City, Okla.	219	100					WBCTA				WHDI	Philadelphia, Pa.	242	1000
KGFH	Glendale, Calif.	300	250					WBCTB				WHDI	Philadelphia, Pa.	242	1000
KGFJ	San Angelo, Texas	229	100					WBCTC				WHDI	Philadelphia, Pa.	242	1000
KGFJ	Los Angeles, Calif.	211	100					WBCTD				WHDI	Philadelphia, Pa.	242	1000
KGFK	Hallock, Minnesota	250	50					WBCTE				WHDI	Philadelphia, Pa.	242	1000
KGFL	Raton, New Mexico	219	50												

Main table listing radio call letters, broadcast station locations, wave meters, and power watts for various stations across the United States.

LIST OF CANADIAN BROADCAST CALLS

Table listing Canadian broadcast calls, including call letters, station names, and locations across various provinces.

LIST OF 'SHORT-WAVE STATIONS OF THE WORLD

(Some calls may have been altered under new international regulations.)

Large table listing short-wave stations of the world, categorized by region (Africa, Australia, Austria, Belgium, British Guiana, Canada, Costa Rica, Dantzic, Denmark, England, Finland, France, Germany, Holland, Italy, Japan, Java, Mexico, Morocco, Norway, U.S.S.R. (Russia), Spain, Sweden, Switzerland, United States).

THIS list of the short-wave broadcast stations throughout the world is not complete, although we have endeavored to list every station of whom we have heard reports; since in many cases reliable information about the programs, wavelength and power of the stations cannot even be obtained from the stations themselves.

(Several short waves are used for transatlantic telephony. This is private business, not broadcasting.)

On the Short Waves

SOME MORE SHORT-WAVERS

Editor, RADIO NEWS:
 "On the Short Waves" is always interesting. By this time enthusiasts have probably discovered W6XN on 23.346 meters relaying KGO. (This station now operates with 5 kw. power from 9.30 A. M. to 1:00 P. M., Pacific time, on Tuesdays, Wednesdays and Fridays. An evening schedule will be arranged later.) Melbourne's 3LO is now on 31.55 meters; CJRX on 25.58; KDKA on 25.24. PHOH has a new call sign PHI, and is very well received here. Another station received with good volume is NRH, Costa Rica.

A6AG, Perth, West Australia, is now on 41.7 meters. Last fall I received it on 32.5 meters. (My reception has been verified.) It is 11,475 miles from Syracuse to Perth.

RAYMOND M. BELL,
 544 Sims Hall, Syracuse, N. Y.

Editor, RADIO NEWS:
 RFM, Khabarovsk, Siberia, has changed the call to RA-station-97, but are still on 70 meters. I can get SSW at 3:00 p. m. P.S.T., and also at 5:00 a. m. Am I getting a signal across the Pacific Ocean?

DONALD F. WRIGHT,
 San Pedro, California.

(The signal in such a case would be coming through the Arctic regions, which were still fairly dark when this letter was written, as explained in the June, 1928, issue of RADIO NEWS.)

William Clifford, of Oneonta, N. Y., sends in a verification from PHI, stating that though they have not a regular schedule, the directors suggest trying for them between 1:00 and 4:00 (A. M.) on Mondays, Wednesdays, Thursdays and Fridays. (We presume this to be Greenwich time, although Holland has its own time, twenty minutes later than GMT.) The station may be addressed at Keizersgracht 723, Amsterdam, Holland. Present time table of PCJ, operated by the same company at Eindhoven, is contributed by several readers as 1800 to 2000 and 2300 to 2400 GMT on Thursday; 2400 to 0300 and 1800 to 2000 GMT on Friday and 2400 to 0600 on Saturday.

Our indefatigable correspondent, Mr. E. T. Somerset, sends in the following data just received from Bandoeng, Java, as to the waves, time and power of the short-wave stations there.

PLE, 15.74 meters, 25 kw.; PLF, 17.4 meters with similar power. PLG, just completed, has 60 kw. power and operates on 18.88 meters; PLR, with 25 kw., works on 27.8 meters.

PLE and PLG test daily with 2ME. Sydney, Australia, from 5:30 to 7:00 a. m. EST. PLE, PLF and PLG start daily (except Sunday) at 7:00 a. m., EST, and work until about 11:00. Then PLR starts and operates until 2:00 p. m., also EST. The Bandoeng stations will be glad to have detailed reports, giving strength of signals, periods of reception and fading, etc.

SHORT-WAVE INTERFERENCE

Editor, RADIO NEWS:
 I hate to kick, but just now I've been endeavoring to separate W8XK and G5SW and so far it

seems to be a pretty even race. With the small number of short-wave stations operating I think there is enough room for all of them and with no interference. Could not your aid be enlisted in this matter? (Sorry, but higher powers have been unable to prevent interference of two high-power stations whose range is world-wide. As the American Federal Radio Commission reported to Congress, it is only in the last few months that it has been realized that the capacities of the short-wave band had been overestimated. And, since the Washington conference, the limits for broadcasting have been sharply curtailed.) Of course, I get the usual run of signals that are mushy and faint but unless a station comes in with enough volume for a speaker I'm not much interested.

J. M. ADAIR,
 U. S. Naval Station, Guantanamo Bay, Cuba.

Editor, RADIO NEWS:
 I have to agree with Mr. Bourne of Barbados

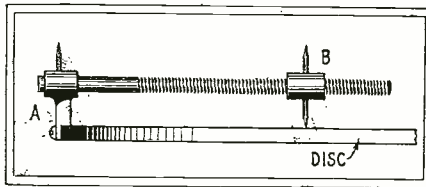

Mr. Caldwell used this method to measure the distances from the rim of the holes in his scanning discs. The pointers A and B are aligned.

with reference to code on the short-wave broadcast bands. For the last few nights WGY, KDKA and CJRX have all been smothered by Morse signals. In KDKA's files there is an overseas cable from me dealing with this very vexing question. All receiving work in this part of the world is done with short waves it is impossible to use the longer wavelengths on account of the heavy tropical static.

A. R. McLEAN,
 Pointe-a-Pierre, Trinidad, B. W. I.

GREENWICH TIME

Editor, RADIO NEWS:
 I have successfully built the "Junk-Box" with two stages of audio. Here's the trick: use a .002-mf. condenser on "P" and "G" of first transformer; then reverse "P" and "B" on second transformer, which is of a higher ratio. (This is a rule which may work in some cases and not in others.) I wish you would publish something on converting G.M.T. to our time.

G. H. SLOANE,
 105 Everett St., Morgan City, La.
 (Greenwich Mean Time is that of Greenwich Observatory, at London, England. It begins at midnight, which is 2400; the next minute is .0001. One o'clock, A. M., is 0100; there is no punctuation between the figures, for convenience in telegraphy. After noon, which is 1200, the hours continue to increase: 1:00 P. M. is 1300, and so on

up to 2400 again. To reduce it to Eastern Standard Time, subtract 500.

Thus 1700 GMT is 12:00, or noon, at New York, 11:00 A. M. at New Orleans, 10:00 A. M. at Salt Lake City, and 9:00 A. M. at San Francisco. East of Greenwich, the hours are added; thus 1700 GMT is 1800, or 6:00 P. M. at Berlin. In Japan it is 0200 the next day (1700+900-2400=0200) or 2:00 A. M. The convenience of "GMT" is that it is everywhere understood. It is necessary only for the receiver to make the correction for his own time zone or local time. See also RADIO NEWS for September, 1927, page 217, where the time zones are given with an explanation of the method of computing time differences.)

RECEPTION IN GUIANA

Editor, RADIO NEWS:
 I would like to tell you, apropos of "skip-distance," that our local station BZL, operating on a wavelength of 43.8 meters, is received on every short-wave set, even crystal ones. Their power is 200 watts and their broadcast is received, without exception, with volume. Can you explain this absence of skip-distance?

(A short-wave station, even of five-meter wave, is received for a certain distance by its direct radiation. After that the skip-distance begins, and is more critical as the wave is shorter.)

We are just about five degrees north of the equator, and I find, as well as others, that your great short-wave stations, KDKA and WGY, are received better on moonlight nights than on dark nights. (Referred to Dr. Greenleaf W. Pickard, who says that the short cycle of radio reception conditions is solar, not lunar. In other words, that changes of reception of this kind will be found to fall in and out of phase with the moon.)

I may mention, that on these nights our electric power station switches off the street lights. Can you explain this? (It might reduce local interference of an electrical nature, but street lights can have little influence on the 2,500-mile journey of the signals.)

I wish to offer, on behalf of myself and fellow radio fans (fully 99.9% of whom here work on the short waves) to KDKA and WGY for their splendid efforts. We simply cannot do without them. It will be a good day (or night) when WEA and WOR commence broadcasting on these shorter wavebands. We in British Guiana are anxiously on the lookout for new S. W. stations to conquer. I am a regular reader of RADIO NEWS and I greatly appreciate the short-wave articles that have appeared recently.

CYRIL N. DUMONT,
 Box 150, Georgetown, British Guiana.

A TEN-METER RECEIVER

Editor, RADIO NEWS:
 What we describe can safely be called a "Ten-Meter Sleuth," being very simple and cheap to construct. With a soldering iron remove the grid, plate and filament wires from the prongs of burnt-out tube bases. Wind coils on these as shown in

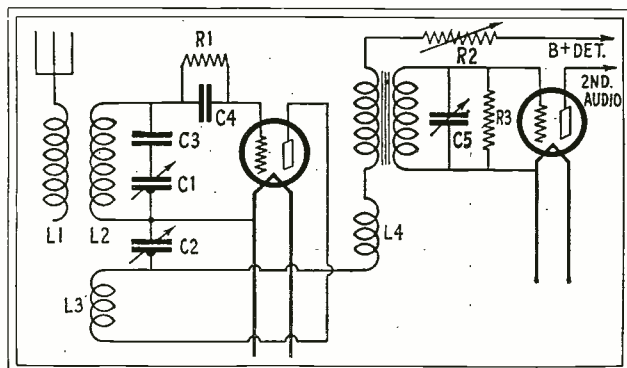

The circuit used by Messrs. Somerset and Powditch: C1, .000125; C3, .0001; C2, .00025; C5, adjustable; C4, .0001; R1, 3-meg. or more; R2, 50,000-ohm; R3, 250,000-ohm; inductors as described.

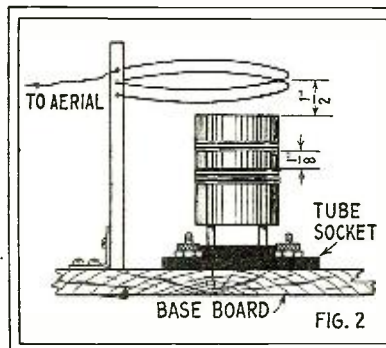

The coils used in ten-meter reception by these English experimenters; the aerial coupler L1 is not grounded. L2 is above on the tube-base form, L3 below. The dimensions are given in the illustrations and text opposite.

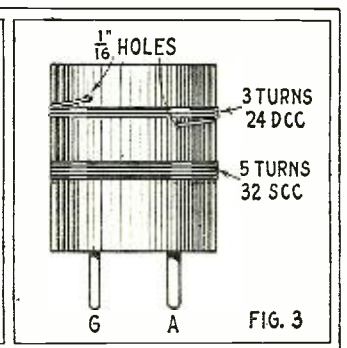
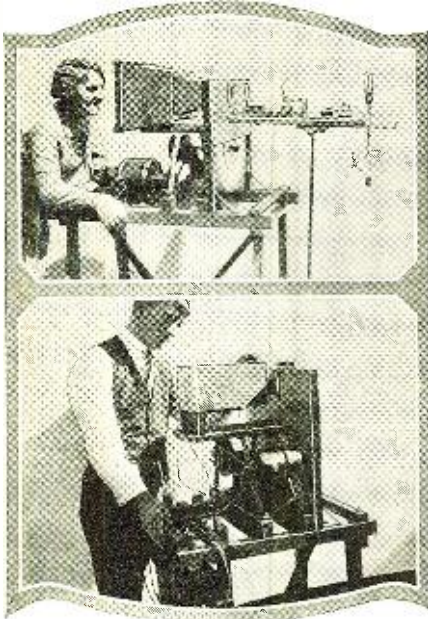

Fig. 3; the high-potential end (e.g., upper end of winding) is soldered into the grid prong, and the other end to the "F—." On the other side of the base and below the level of this winding are the holes for the tickler winding, which is wound in the same direction. Its high-potential end goes to the plate prong, and the other end to "F+."

In Fig. 2, the coil thus made is shown in position in its socket; the aerial coupler consists of two turns of No. 16 bare wire, 2 1/4 inches in diameter and spaced 1/8-inch apart by passing it through small holes in a hard-rubber pillar, which fits and is glued into a hole drilled into the baseboard. It is quite easy to keep the windings in place with a drop of cement at each hole in the pillar. Note that (as shown in the schematic diagram—Fig. 1) no ground is used; this being generally a distinct disadvantage at high frequencies. The R.F. choke L4 is close-wound on a 5/8-inch form with No. 32 S. S. C. wire, two inches long.



Mr. Caldwell's transmitter (above) and receiver (below) show much ingenuity under difficulties.

Attention is directed also to the detector-tube mounting. The average bakelite socket has appreciable capacity; and the best scheme is to cut it out of the layout and solder short flexible leads direct to the grid and plate prongs of the tube itself (taking great care not to run the solder holding the little leads) and busbar to the two filament prongs. The tube can then be mounted vertically, upside down, in a hollow cup cut out of a rubber sponge which is glued to the baseboard. This arrangement is as satisfactory as any other that we know of.

The first thing is to ascertain whether the grid return works best to "A—" or "A+"; and then, by which connection of the aerial coil to the aerial, oscillation is obtained easier. Try both ends.

To obtain oscillation, a high "B" voltage on the detector will be required. There should be a combination of C2 and R2 which gives constant and gentle regeneration; if, later on, R2 is found to affect tuning perceptibly, bridge it with a condenser of any convenient size, between .0001- and .001-mf.

The filter circuit in the first audio stage is optional, but it serves to reduce background noise to a large extent. The ten-meter band makes prominent the variation in tubes; so stick to a good one when you find it.

With the coils given, the capacity of the wiring and components must be the lowest obtainable. If any stray capacities creep in, it may be necessary to alter the three turns of the grid coil to two. If, after doing this, the constructor cannot get down to the ten-meter band, the best thing is to rebuild the receiver, taking very particular care with the wiring, to keep plate and grid leads extremely short and away from "A" leads.

The harmonics of commercial stations working on the 20-meter band will give the top edge of the 10-meter band; these harmonics are nearly half the strength of the fundamentals. A few degrees below will bring in the "ham" transmissions which generally begin at about 8:00 a. m. E.S.T. on Sundays, with a fading period at between 10:00 and 10:30 (this applies to transatlantic working). At about 6:00 a. m., E.S.T., England can often be heard

chatting with India on 10 meters. Signals from close-by transmitters roar in when the distance does not exceed ten miles and, under freak conditions, they sometimes reappear two or three hundred miles away; but they usually skip for more than double this distance. "Come down to earth, little angel," is the cry of ten-meter "hams."

Needless to say, this receiver will, if a six-turn coil be made, be found ideal on the 20-meter band; bringing in the world's amateurs on that band, as well as W2XAD and G5SW.

E. T. SOMERSET,
H. J. POWDITCH.

TELEVISION DOWN UNDER

Editor, RADIO NEWS:

The television transmitting and receiving units, of which I am enclosing photos, are built up from details appearing from time to time in RADIO NEWS, and are being experimented with at my station, VK5BP.

The discs are of 1/16-inch aluminum, supported by suitable brass or gun-metal cheeks and run on a 3/4-inch mild steel shaft. The transmitting disc is driven at a constant speed of 900 r.p.m. by a 1/4-hp. A.C. alternating motor.

The lady shown alongside the transmitter is in position to have her face televised by the indirect scanning method; in this case two photo-electric cells are arranged inside the camera-like box behind the disc, in such manner that the only light reaching them is that reflected from the face of the subject.

The appliance also lends itself to the direct method, whereby the subject stands in front of the disc under a strong floodlight; the reflected light being then focused to impinge directly on a photo cell placed about centrally in the camera box.

The pick-up is of similar mechanical design to the transmitter; except that it is driven by a seven-watt variable-speed sewing-machine motor at a speed of over 1,000 r.p.m. A slight pressure of the hand on the driving spindle will slow down the disc until its speed coincides with that of the transmitter; and a little practice in this manipulation will enable the operator to keep the picture fairly well in view.

The photo cells and neon lamp available here are of a preliminary kind and, until better lamps come to hand, I am afraid I shall have to be content, as hitherto, with the transmission of a still picture; placed as a negative or stencil directly over the scanning window with a small lamp of the arc spot-light type focused directly on the photo cell. Also, transmissions with the small power available are necessarily over short distances.

My discs are 19 inches in diameter, the outer scanning hole being nine inches from the center; and from thence the spiral runs toward the center. There are 36 holes, slightly over 3/64-inch in diameter, the window being about 1 1/2 x 1 1/2 inches.

My method of spacing the holes may be of interest to you. I first marked off the disc into 36 equally spaced sections and drew a radial line at each mark. I then mounted the disc on the spindle and drove it with the 1/4-hp. motor until the extreme edge was turned off true with a suitable tool. All holes were then measured from the outer rim by means of the improvised tool sketched.

By giving the brass nut one complete turn, the scribing point is advanced 1/24-inch toward the center. Marks made in this way were afterwards carefully center-punched and drilled. The scanning window, when viewed afterwards with the disc in motion, showed very little trace of black-and-white streaks.

There is at present no transmission of radio pictures in South Australia; but amateurs here are looking forward with great interest to their advent; and each new issue of your popular magazine is eagerly scanned for the latest in regard thereto.

R. B. CALDWELL,
53 Hughes Street,

North Unley, South Australia.
The RADIO NEWS model of the New York Times short-wave receiver has been enlisted in the Signal Corps of the U. S. Army. Capt. R. E. Stafford (center) gives the new recruit O. K. on examination at an army "ham" meeting in the Army Building, New York City. At his right is his new assistant, Capt. F. W. Hoorn, who succeeds Capt. J. L. Autrey, just transferred to the Philippine Islands. The presentation had just been made on behalf of this magazine by Lt. H. M. Bayer.

ALL-AMERICAN CONCERTS

The programs of Station NAA (operated by the U. S. Navy at Arlington) furnished for the benefit of listeners in other American countries by the Pan-American Union, are to be sent out on waves of 9,550 kilocycle frequency (31.29 meters) to reach those below the equator; and 6,120 kilocycles (48.99 meters) for those nearer by. A beam transmitter will be used for the shorter waves, as its angle will cover the narrow width of temperate South America; and the same program will be available to broadcast listeners in the United States on Arlington's 434-meter wave.

The Pan-American Union has invited each of the other American countries to install short-wave transmitters suitable for the same frequencies; when time can be divided equally, giving two hours a week between 6 P. M. and midnight, for each of the twenty-one republics. The whole of South America, practically, lies in three hourly time zones, two east of Washington; and Mexico and Central America in three time zones, two west of Washington; the time difference, therefore, is not insuperable. The carrying out of this ambitious program will afford constant entertainment to short-wave listeners throughout both continents, many of them removed too far from broadcast stations on the longer waves to have reception.

THE MODERN EXPLORER'S WAY

A triple radio relay will before many months connect New York with the South Pole. Commander Byrd's dog-sledge expeditions, with portable transmitters, communicate with his base at Little America, on the Antarctic coast; and this in turn has kept in touch with the supply ship *City of New York*, with her 550-watt equipment. She in turn has kept in touch with the *New York Times* station in this city (described in the April RADIO NEWS) and other receiving stations, such as Mussel Rock, San Francisco.

The portable transmitters carried by dog team employ only two tubes of the 199 type; while a single wire, supported by two bamboo poles, serves as its antenna. Ten of these, together with receivers, form part of the equipment of the Byrd expedition.

NEW TELEVISION SCHEDULE

With its new higher powered transmitter—5,000 watts—the Jenkins radio-movie transmitter W3NK, Washington, will send out its broadcasts for television fans on the band between 2.850 and 2.950 kilocycles or 101.6 to 105.2 meters. Transmissions will also be made on the band from 2,002 to 2,102 kilocycles, or 147.4 to 148.4 meters, for the benefit of those who are nearer by. It is probable also that, by the time this is published, nightly service instead of alternate nights will be available.

BROADCAST-BAND TELEVISION

The Radio Commission has granted the application of WHAS of Louisville, Ky., to engage in television and picture broadcasting on 366 meters between the hours of 1 and 6 a. m., Central Time. The commission also granted this station a construction permit to increase its power from 5,000 to 10,000 watts.

SHORT-WAVE RELAY BROADCASTING

Relay broadcasting of programs has been thus defined and regulated by the Radio Commission. It



is the transmission over long distances of broadcast programs from one broadcast station to another such station (or stations) which rebroadcast the program to the public on the regular frequency of the receiving station. Licenses will be issued only when applicants agree to arrange for a rebroadcasting on regular broadcast channels of their program transmitted initially on a high-frequency relay channel.

The following frequencies (and waves) have been allocated for this work:

Kilocycles	Meters	Kilocycles	Meters
6020	49.80	11800	25.41
6040	49.64	11840	25.32
6060	49.47	11880	25.24
6080	49.31	15130	19.82
6100	49.15	15170	19.77
6120	48.99	15210	19.71
6140	48.83	15250	19.66
9510	31.53	15290	19.61
9530	31.46	15340	19.55
9550	31.39	17780	16.86
9570	31.33	21460	13.97
9590	31.26	21500	13.94
11720	25.58	21540	13.92
11760	25.49		

It will be observed that, for technical reasons connected with the percentage of frequency regulations available, these channels are 20 and 40 kilocycles wide instead of 10, as on the regular broadcast band.

The use of these frequencies will not be designated exclusively to licensees, but will be shared jointly by the licensees authorized to operate experimental relay broadcast transmitters. The commission requires detailed reports from licensees as to the use made of these frequencies and the results accomplished. Based upon results of the experimental licensees, and others which may be designated, the commission may issue licenses for a longer period than six months to those found qualified after six months' experimental operation. The commission will only issue licenses to applicants who are qualified to operate experimental relay stations over long distances, trans-oceanic or trans-continental, strictly for relay broadcast use or experimental relay broadcasting. The priority of assignment will be given to applicants who present satisfactory evidence that they will provide; ade-

quate power for trans-oceanic distribution; satisfactory programs for trans-oceanic distribution; adequate and regular reception and distribution of their programs.

Since local broadcasting would utilize for short distances radio frequencies which should be reserved primarily for long distances, and would be a duplication of a possible service available by wire lines, applicants for such a service will be considered only in the exceptional cases where wire-line service is not available.

Local broadcasting will not be permitted on these high frequencies, and experimental licenses will be granted only to those who are seriously engaged in improving the technique of the art.

ANOTHER DODGE

Editor, RADIO NEWS:

The short-wave part of your magazine is worth more than you ask for the entire book. I have built a set—that is, it is a combination of several sets I have read about in your magazine. I get KDKA and WGY every day; CJRX comes in just fine. I got WLW all summer but haven't had them of late. I have heard 5SW about six times recently. I use three tubes and a 20-foot vertical aerial, with which I don't have dead spots in any of my coils.

To take the body out of body capacity, saw four 4-inch wheels out of a 3/8-inch board. With two panels, one four inches in front of the other, and by using these pulleys, I have been able to enjoy many hours of short-wave reception. Make the bearings and the shafts out of hard rubber; the front panel is also wood.

H. G. WILLIAMS,
8306 Forty-Ninth Ave., So. Seattle, Wash.

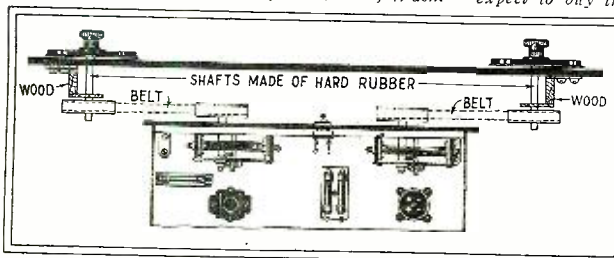

Mr. Williams' arrangement is quite ingenious, as shown at the left. Some other ingenious mechanical arrangements have been proposed; but, as a rule, using long insulating shafts and shielding the panel are sufficient.

A Few Letters from the Editor's Mail Bag

HOW MONEY TALKS

Editor, RADIO NEWS:

The writer, who had been building his latest "Ground-Radio" machine for the detection of buried metals, decided to give it a final test. He drew from the Union Bank of this city \$300 in silver and \$1,000 in gold and returned to his home to make the test. At once he detected a foreign sound, and thought it was some trouble with the machine. After two hours he decided that there must be something wrong with the money; finally he came across a dollar that gave a sound wave as much different from the others as moonlight is from daylight.

On returning the money to the bank, he called the attention of Mr. Theodore Kaufman, who had delivered it to him, to this dollar, which was tested with acid and proved to be counterfeit. He then stamped it "No Good" and expressed his desire to retain it, but was informed by the U. S. Secret Service, to whom the matter was reported, that the government requires its confiscation. The writer made a demonstration to Mr. Langham, of the Secret Service, and Mr. Barrett, a postoffice inspector, of his method of detecting the coin. It was then forwarded to Washington with an explanation, and a request for its return, if permissible; but nothing further has been heard of the matter.

GEO. OSMOND MAHER,

Box 87, Baton Rouge, Louisiana.

(Mr. Maher, who has figured in news dispatches and press photos, one of which appeared in RADIO NEWS a couple of years ago, uses a delicately balanced oscillating system for the detection of buried metals. He states that different metals give out tones which can be distinguished by a practiced operator. However, we know of nothing in the textbooks which would indicate any cause for such an audible distinction between non-magnetic metals, at least.)

A PLEA FROM A JUNIOR

Editor, RADIO NEWS:

We read much about the future of radio, but comparatively little about the men who will make its future. Most boys of today attend school and

therefore cannot work to earn the money with which to buy parts and, in many cases, their parents cannot afford to buy parts for them. I have seen several boys give up radio and, very probably, a chance for success, for financial reasons.

Now, where are the radio engineers and scientists of tomorrow to get their parts to start with, unless some big-hearted set builder gives them some? Nearly every set builder has at his disposal some parts that are useless to him but invaluable to some junior experimenter—and I am sure it would little affect his career, except to help it—to give these parts to an ambitious boy. For the sake of some boy who is up against it—as I was—I hope this letter is worthy of publication.

CHESTER TUCHOLSKI,
Milwaukee, Wisconsin.

The problem our correspondent puts is a serious one. One of the best answers is a good radio course in school for those who will work at it.

TEST YOUR LINE-VOLTAGE

Editor, RADIO NEWS:

I purchased a standard receiver in December, and to date have had to replace six type-227 tubes, an average of one every two weeks. My set is only operated about two hours per day; it is resting on a table without drawers and is rarely touched except to turn it on. I am very much disappointed. An advertisement appearing in a leading newspaper advises set owners to install new tubes once a year; mine will be changed three times a year at the present date. I think the public is entitled to a definite time-life for a tube; just the same as automobile-tire or storage-battery adjustments are made, based on the service given. I have had more tubes defective on the A.C. set in three months than in three years with battery-type tubes. Hoping that you will print this with any comments you care to make.

PERCY W. LLOYD,
Laughead Ave., Linwood, Penna.

(An A.C. tube may be of good quality, and yet have a short life if it is exposed to violent fluctuations of voltage. It is fed from a transformer whose output varies with its input. There are many

AN INDUCTANCE LEAK

Editor, RADIO NEWS:

I was satisfied to stay up on the regular broadcast band until a few months ago, when I got the short-wave fever. After some search, I found the October, 1927, issue containing the RADIO NEWS Special Receiver, with which many were having a great success, and put the outfit together. I didn't use the exact parts specified, but others just as good. I found that the set would not oscillate smoothly over the entire range, and that it was very noisy when tuning in a station. I tried various values of grid leaks, a variable resistor, and fixed condensers, but still the same results.

I happened to have a National "Type 90" choke coil on the table, and thought I would try it in place of a grid leak. I put it between the clips of the grid condenser, and was surprised to find that all my troubles were over. I have never taken the choke coil out of the clips, and I have a set that oscillates smoothly over the range from 19 meters up without dead spots, and no noise when tuning in except the regeneration whistle. I wonder if any other amateurs have tried this? I will be glad to answer inquiries relative to this circuit.

VIALIS F. WALZ,
Bloomington, Wisconsin.

(Other readers who solicit general correspondence include Milton Stein, 1071 St. Nicholas Ave., New York City; Edward Polityka, 410 W. Atlantic St., Shenandoah, Pa.; L. V. Childs, Eldersley, Sask., Canada; Meredith Thomas, 129 W. Minneapolis St., Salina, Kas.; Roland E. Redmonds, Medford, Ontario, Canada; Leslie H. Wass, 11 King Street, Petone, Wellington, New Zealand; C. M. Smith, Jr., Fountain, S. C. Those who write experimenters for more data on apparatus should enclose postage; but solicitors of mere general correspondence must expect to buy their own stamps.)

safety devices; those automatic, which deliver the same voltage, no matter what the input is; and some manually-operated, which cut down the peak input voltage to a safe figure, though reducing lower voltages proportionately. A test of your house lines, at several times during the day and evening, with an 0-150-volt meter will show, in all probability, where the fault lies.)

IS IT CHEAPER TO MOVE?

Editor, RADIO NEWS:

Just another fan writing his favorite magazine. By all means, locality is a lot. I have built dozens of sets, and none of them perk quite like the other fellows'. I always blamed it on myself; but once my friend asked me for the loan of a five-tube regenerative set. He took it home, hooked it up, and it worked like a million dollars. I know my antenna and ground are about 300 per cent better than his, and yet he picked up California, Florida, Texas, Maine and New Mexico, while I was lucky to get 600 miles. It was a battery set, so the trouble was not occasioned by the current supply. If there is any way of improving a locality for radio reception, I certainly want to hear of it.

JOHN DATKO, JR.

323 Monroe St., Youngstown, Ohio.

(So would several commercial radio companies, who would pay a pretty penny for the secret. Ohio is full of good reception spots, but our correspondent seems to have picked a poor one. Of course, an antenna's value is tested by its performance, not its cost.)

LIKEWISE VICE VERSA

Problem in relativity offered by the radio columns of the *Seattle Post-Intelligencer*: "A new battery must be old to be good." And, on the other hand, we have hitherto understood that an old tube should be "rejuvenated" to make it good. How do we inflict premature age on the battery while retaining its youth? Where is that man Einstein when we need him, anyway?—B. A. Oscarson.



Conducted by C. W. Palmer

IMPORTANT NOTICE TO CORRESPONDENTS

BECAUSE of the large influx of mail, RADIO NEWS now finds it necessary to discontinue answering free of charge, all inquiries to this department. With several hundred letters received daily by this department, the editors have been taxed so severely in answering the present mail that the magazine has begun to suffer. Hereafter, therefore, only letters accompanied by our standard fee (which, by the way, covers only the actual writing of letters and stenographic help) can be considered. Kindly note these simple rules, now in effect:

(1) Correspondents asking answers by mail must enclose 25c for each separate question. Simple radio problems will be answered, but for this nominal charge we cannot make long calculations or thorough investigations.

(2) We cannot give blueprints or layouts for commercial apparatus, or data which the manufacturers have kept secret.

(3) We cannot advise, *even confidentially*, on the respective merits of trade-marked apparatus or "what make to buy."

(4) We cannot send either replies, blueprints, books or magazines C.O.D.

(5) When in doubt, please inquire as to the cost for our services, before remitting.

(6) Be brief. Typewrite or write legibly in ink, on one side of the sheet only. *No attention can be paid to pencilled matter.*

REDUCING TROLLEY LINE INTERFERENCE

(2343) Mr. P. Van Doorn, Newark, N. J., writes:

(Q.) "My home is located on a street which has a trolley line on it. For several years I have been bothered by interference from these trolleys and I have spent a lot of time erecting aerials of all types and in all available locations, without being able to overcome the trouble. To be more specific, whenever a car approaches within several blocks of my home, a terrible crackling noise is heard. This continues until the car has passed to a point of several blocks on the other side, when it gradually fades out.

The reception is then very clear until another trolley car approaches. The trouble cannot be due to my set, as I have used several receivers during the time that I have been in the present location and the interference was encountered on each. It has occurred to me that the noise might be reduced by using a ground connection separate from the water pipe. Since the use of aerials placed at right angles to and as far away from the street as possible have only reduced the noise slightly, I believe that the ground may be partly at fault. My reason for believing this is that the water main runs under the tracks and the water pipe from my house runs directly to this main. I wonder if a ground made by driving pipes into the ground in the back of my house would reduce this interference?"

(A.) It would not be possible to say exactly just what effect the new ground connection would have on the volume of the interference. However, we believe from your description, that the use of the ground that you mention would cause a considerable reduction in the volume of the noise. We base this statement on the fact that the usual ground connection is not really at ground potential. If a ground connection is not at zero potential, a potential difference may exist between the two circuits connected to ground.

In this way, a voltage might be set up in the receiver from the trolley and this would be heard in the set as a crackling noise similar to static. By placing the ground connection as far away from the source of this interference as possible and making the connection as perfect as possible, the interference may be either cut out or reduced very much. In making the connection, we would suggest that you drive pipes in the ground as deeply as possible in order to reach the moist earth. The various pipes should be connected together and be used as the ground connection to the receiver.

IMPROVING FILTER FOR "B" POWER UNIT

(2344) Mr. R. Steneffeld, Richmond, Va., writes:

(Q.) "I have heard about several changes that have been made in the filter circuit of the Raytheon type "B" power unit, and before building one of these units I would like to know just what

transformer, and the insertion of condensers at another point in the unit, to accomplish the same results. The advantage claimed for this change is

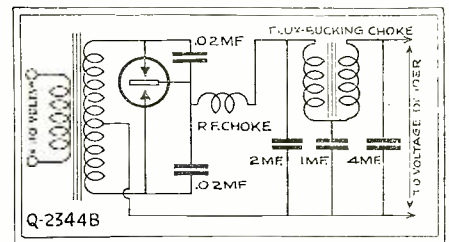

The new method of connecting condensers is more effective with smaller capacities.

in the use of a better position for these buffer condensers. The change in the position of the condensers is shown in the two diagrams, Fig. Q2344A and B. The condensers are placed as close to the terminals of the rectifier as possible.

A radio frequency choke is also incorporated in the line from the rectifier to the filter. This choke tends to keep radio-frequency disturbances out of the filter, which results in better filtering and also reduces the noise level in the set itself. The condensers and choke are fastened directly to the terminals of the rectifier tube socket to provide extremely short leads; as the best results are obtained in this arrangement when the connections are short and direct.

The radio-frequency choke may be home constructed if desired, since it is very simple to make. It consists merely of a coil one-inch in diameter wound with 100 turns of No. 30 to 34 D.C.C. wire.

Another change has been made in the unit, but the construction to the required apparatus is too difficult for amateur construction and unless commercial parts are available, it will not be practical to use this change. It is in the construction and design of the filter circuit. A choke coil arrangement called "a flux bucking choke" is used in place of the usual 30-henry chokes. The advantage of this choke is in the comparatively high saturation point. In other words, the choke is more efficient and economical than the older type. The economy is partly due to the lower capacity of the filter condensers required to give a constant output current.

Although the choke system is not practical for amateur construction (unless manufactured chokes are available), the other changes can be made very easily and they will result in a more effective power unit.

STONE CONTROL IN AMPLIFIERS

(2345) Mr. E. B. Hamilton, Pasadena, California asks:

(Q.) "Can you help me to solve a problem which has been bothering me recently? I have

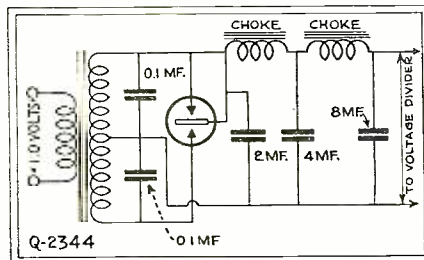

The usual connection of "buffer" condensers

these improvements are so that I can incorporate them in my power unit. Can you help me in this matter?"

(A) In a recent issue of the *Technical Bulletin*, published by the Raytheon Manufacturing Company, several changes in the usual design of the "B" power units employing the gaseous rectifier tubes were described. These changes consisted in the removal of the usual buffer condensers from the secondary of the power

The phenomenon of inductive pick-up accounts for interference, when there is a filter in the light-line; or even when no house-current connection is made. The water pipe, parallel to track and trolley wire, may cause this disturbance to become very strong. A separate ground should be devised in this case.

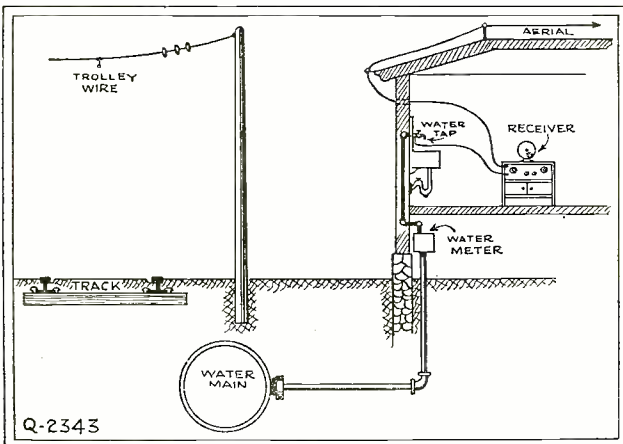

seen in a magazine some time ago, a method of controlling the tone of a radio set, by connecting condensers of different sizes across the audio frequency transformers. I have looked through all of my old copies of RADIO NEWS but I have not been able to find the article in question. As I remember the arrangement, a number of fixed condensers were connected with a switch so that any one of the condensers could be connected across the transformer. I do not remember whether the condensers were connected to the primary or the secondary."

(A.) We are printing two diagrams of tone control arrangements, which you can use to improve the quality of your receiver. It is well known that the tastes of people do not agree as to the quality of receivers, some owners desiring soft low type of tone, in which the low frequencies are comparatively loud, while others desire a sharper type of tone in which the middle frequencies are more predominant than either the high or lower tones.

The use of a condenser of the correct size across the secondary of the first audio frequency transformer will help to change the characteristics of this transformer in such a way that the tones on the correct part of the band are brought out more strongly than the others. This may be done in two ways. The first of these is to try different condensers across the transformer until the best one is found, and the other is to arrange a number of condensers of different sizes with a switch, so that the different capacities may be used by merely shifting the position of the switch. An arrangement of this kind is shown in Fig. Q2345B. An extra contact should be added with no condenser attached so that the amplifier can be operated without the shunt condenser if desired.

The use of the switch method will allow a convenient variation of the tone for different types of programs. In other words, if an orchestra is being received, one type of tone may be desired, while if a lecture is being received, an entirely different type of tone may be preferred.

The capacities needed to supply these different characteristics in the audio amplifier vary between a very small value, about .00005 and a large value. The maximum capacity rarely exceeds .001-mf. and this is the value shown on the accompanying diagram. A fixed condenser can be used in many cases to improve the characteristic of a poor audio transformer, by bringing out the section of the band which is weak, usually the lower frequencies. In using a condenser for this purpose, it is not necessary to use the bank of condensers, unless a change in the tone is desired, as explained above. Fig. Q2345A shows how this is done.

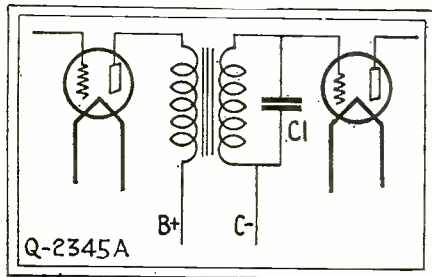

A condenser of suitable capacity (determined by the owner's ear) will improve audio tone.

KILOCYCLES-METERS CONVERSION CHART

(2346) Mr. H. Parkhurst, Denver, Colo. writes: (Q.) "I have just bought a new receiver, but I am having some difficulty because the dials are calibrated in kilocycles and I do not know what the corresponding wavelengths are for the kilocycle readings. If I knew these wavelengths, I am sure that I could tune in more stations than I can get at present. Can you supply me with a list of kilocycles and the corresponding wavelengths?"

(A.) We are printing a chart for the conversion of wavelengths to kilocycles, since this should interest many of our readers. The frequency scale is being used more, at present, than it has been in the past and several manufacturers have put out sets with the dials calibrated in kilocycles. It is quite easy to convert wavelengths to kilocycles by merely dividing the wavelength into 300,000. The wavelength in meters can also be figured in the same manner. The number 300,000 is obtained from the speed of radio waves. In miles per second, this is 186,000 and when this is converted to the metric scale, it is approximately 3,000,000 meters. Dividing the length of one wave into the speed would give the frequency in cycles. Since Kilocycles (which means "thousand cycles"), is more popular than cycles, we divide the 3,000,000 by 1,000

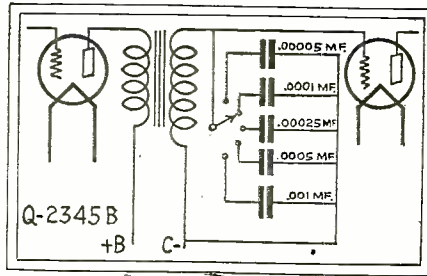

A unit of this type, such as used at one time in a receiver of a well-known make, permits the set operator to make adjustments on the tone quality of a program to his own taste.

which gives the 300,000 originally used. The figure 3,000,000 meters for the velocity of radio waves is only approximate, but the error is very slight and it can be disregarded.

Frequency Kilocycles	Wavelength Meters	Frequency Kilocycles	Wavelength Meters
1500	199.9	990	302.8
1490	201.2	980	305.9
1480	202.6	970	309.1
1470	204.0	960	312.3
1460	205.4	950	315.6
1450	206.8	940	319.0
1440	208.2	930	322.4
1430	209.7	920	325.9
1420	211.1	910	329.5
1410	212.6	900	333.1
1400	214.2		
		890	336.9
1390	215.7	880	340.7
1380	217.3	870	344.6
1370	218.8	860	348.6
1360	220.4	850	352.7
1350	222.1	840	356.9
1340	223.7	830	361.2
1330	225.4	820	365.6
1320	227.1	810	370.2
1310	228.9	800	374.8
1300	230.6		
		790	379.5
1290	232.4	780	384.4
1280	234.2	770	389.4
1270	236.1	760	394.5
1260	238.0	750	399.8
1250	239.9	740	405.2
1240	241.8	730	410.7
1230	243.8	720	416.4
1220	245.8	710	422.3
1210	247.8	700	428.3
1200	249.9		
		690	434.5
1190	252.0	680	440.9
1180	254.1	670	447.5
1170	256.3	660	454.3
1160	258.5	650	461.3
1150	260.7	640	468.5
1140	263.0	630	475.9
1130	265.3	620	483.6
1120	267.7	610	491.5
1110	270.1	600	499.7
1100	272.6		
		590	508.2
1090	275.1	580	516.9
1080	277.6	570	526.0
1070	280.2	560	535.4
1060	282.8	550	545.1
1050	285.5		
1040	288.3		
1030	291.1		
1020	293.9		
1010	296.9		
1000	299.8		

COIL CONSTRUCTION

(2347) Mr. M. Galante, Brooklyn, N. Y. writes: (Q.) "As a constant reader of your radio magazine for the past five years, I would be very much obliged if you could tell me how many turns I should put on a 2-inch tube for the primary and secondary using Litz wire, 20 strands of number 38 wire which is equivalent to number 25 D.S.C. B & S gauge, for UX199 tubes. A .00035 tuning condenser will be used.

I have tried in all the local stores, but I can't find coils for 199's as they do not make them anymore, so I would appreciate if you would send me the above data. If there are any special precautions to be taken when using 199's I would also like you to tell me, so that I can get the best results with my set."

(A.) In winding a coil with Litz wire, the equivalent solid wire may be used as a base for

figuring the number of turns required to cover a certain wave band. In the case mentioned above, the secondary would be wound with 90 turns in order to cover the wavelengths between 200 and 550 meters. The size of the primary depends on the method of balancing or stabilizing the circuit. In using UX199 tubes, a larger primary can be used than with the UX201A type. This is due to the latter type of tube oscillating more freely than the smaller type. With a tube that does not oscillate very freely, a greater amount of coupling can be used without difficulty.

In a set using resistors for suppressing the oscillation, a primary of about 18 turns can be used. In sets of the neutrodyne and similar balancing methods, a primary of up to about 22 turns can be employed with no difficulty, while if no balancing or suppression is used, the primary must be smaller; about 12 to 15 turns. It is advisable to bunch or slot wind the primary in order to keep the capacity between the two coils at a minimum.

In making a set with the UX199 tubes, no special precautions need be taken, except the usual need for short leads in the grid and plate circuits and the placing of the coils in such a way that there is a minimum of coupling between the succeeding stages. The apparatus used in the set should, of course, be the best obtainable, in order to get the best satisfaction.

NEW POWER TUBES

(2348) Mr. A. H. Horlick, Cleveland, Ohio, writes:

(Q.) Some time ago in one of the local papers, there appeared a description of a new power tube, that used a plate voltage of 250 as a maximum and had an undistorted output much greater than the usual 171 tube. I would like to build a power unit and amplifier with these tubes and there is some information that I would like to have before thinking further about building such a power pack. In the first place, the description mentioned that the filament was different than the other power tubes in that a filament voltage of 2.5 is used. Is this correct and how much current is required to operate this filament? In using A.C. current for the filament supply as the article mentioned, what value of resistance would be required for the grid bias, using the common method of employing a resistor in the grid return for the bias. What grid bias is required when a plate voltage of 250 is used? What bias with 180 volts? Will it be necessary to use a special transformer to supply the 250 volts for the plate of this tube?

(A.) The new UX245 power tube is designed to operate with a plate voltage of 250 and supplied and undistorted output of 1600 milliwatts at this plate potential. This output is the same as the UX210 with a plate potential of 425 volts. The filament of the new tube is designed to operate from a 2.5 volt supply, either from a step-down transformer connected to the A.C. power supply or from a suitable battery. The filament current is 1.5 amperes.

The grid bias for the tube is -50 volts when a 250 volt plate potential is used. With 180 volts on the plate, the grid bias is -30 volts. This grid bias can be obtained through the voltage drop in a resistor connected in the grid return of the tube, in the usual way. A resistance of 1,500 ohms is required to give the correct grid potential.

In order to obtain the best results with the new tube, a plate voltage of 250 is required. The usual type of "B" power unit, using the Raytheon BH or the UX280 tube will not supply more than 180 or 200 volts when it is used to supply current to the rest of the set, or in other words, under load and for this reason, a number of new transformers are being designed by transformer manufacturers in order to supply the required 250 volts under load.

A Radio Book Review

A GALLIC WIT LOOKS AT RADIO

"J'AI COMPRIS LA T. S. F.!" by E. Aisberg. Published by Etienne Chiron, 40, Rue de Seine, Paris, France. 7 by 9 inches, 146 pages, soft paper cover.

To those of our readers who remember enough of their high-school or college French to understand a menu card, we



heartily recommend "J'ai Compris la T. S. F.!" (I've Learned Radio). If they care to send to France for a copy, or if they can manage to (Continued on page 1151)

New THORDARSON AUDIO TRANSFORMERS

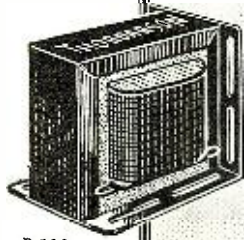

R-100
Universal
Replacement
Audio
\$2.25

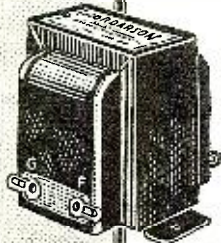

R-260
Audio
Transformer
\$5.00

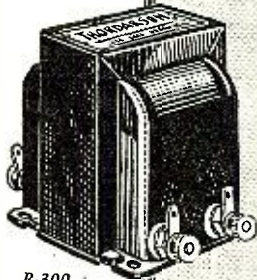

R-300
Audio
Transformer
\$8.00

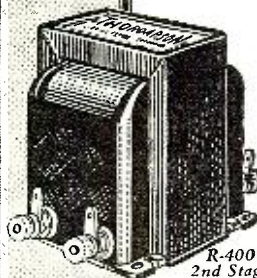

R-400
2nd Stage
A.C. Audio
Transformer
\$9.00

ONCE again Thordarson steps into the foreground, this time with three new audio transformers of unrivaled performance—fitting companions for the Famous R-300.

The R-100 is a quality replacement audio transformer for use by the service man in improving and repairing old receivers with obsolete or burned out audio transformers. The universal mounting bracket of this replacement unit permits mounting on either side or end, and is slotted in such a way as to fit the mounting holes of the old audio unit without extra drilling. List price \$2.25.

The R-260 introduces a new standard of performance for small audio transformers. Wound on a core of Thordarson "DX-Metal" this audio unit is capable of reproducing plenty of "lows." It is entirely devoid of resonant peaks and performs with unusual brilliance over the entire audible band. List price \$5.00.

The R-300 needs no introduction to the discriminating set builder. It is commonly recognized by set manufacturers and individuals alike as the peer of audio coupling transformers, regardless of price. The high frequency cut-off at 8,000 cycles confines the amplification to useful frequencies only. List price \$8.00.

The R-400 is the first and only audio transformer built expressly for use with A. C. tubes. It is similar to the R-300 type in appearance and performance but possesses a better inductance characteristic when working under high primary current conditions such as are encountered in coupling the first and second stages of audio amplifiers using 226 or 227 type tubes in the first stage. List price \$9.00.

For Sale at Good Parts Dealers Everywhere

**THORDARSON ELECTRIC
MANUFACTURING CO.**

Transformer Specialists Since 1895

HURON, KINGSBURY and LARRABEE STREETS

THORDARSON RADIO TRANSFORMERS

S U P R E M E I N M U S I C A L P E R F O R M A N C E

Please say you saw it in RADIO NEWS

You can build!

the R. E. 29

Robert E. Lacault's Greatest Achievement

ROBERT E. LACAULT was in the French Army Signal Corps, under the personal direction of General Ferrie, during the war. At that time he did a great deal of research work which was far in advance of most of the work being done in any other part of the world.

Later, Lacault came to this country and became an Associate Editor of Radio News. His work in that capacity will be long remembered, and his earlier models, the L1 Ultradyne, L2 Ultradyne, the LR4, R.E.L. 9 and Stroboddyne were each an improvement on the one before.

Mr. Lacault died March 12, 1929, just after concluding the work on his latest and by far his greatest receiver.

For sheer sensitivity the screen-grid receiver, the RE29, surpassed any circuit he ever tried, R. E. Lacault said, just before his death. So that this extreme sensitivity could be utilized properly, Mr. Lacault spent many trying months until he developed the circuit to a remarkably high point of selectivity, with utter stability. That done, he knew he had a wonderful receiver, one that his large following, eagerly awaiting a screen-grid adaptation of his original modulation system, would build with delight and operate with ecstasy! The RE29, successor to a long line of successful Lacault receiver designs, is here. His last circuit, his best circuit, may now be duplicated by constructors!

The receiver consists of six tubes (including first audio) in the table chassis and two tubes (a push-pull output) in the B supply and power amplifier. Hence the receiver proper uses eight tubes. Two 281 tubes are used as rectifiers. So well is each independent stage and the group of stages designed that abnormally high amplification prevails. Distant stations "roll in" easily, with volume to spare. The master designer of DX circuits took good care of that!

Build this receiver and the Push-Pull Power Amplifier B supply from the official blueprints.

Send for your free copy of the Builders' Information Sheet today!

BLUEPRINTS!

Build the RE29 and the Push-Pull Power Amplifier B Supply from the official blueprints! The price of the blueprint for the 6-tube receiver RE29 (including first audio) is \$1.50.

The price of the Push-Pull Power Amplifier B Supply blueprint is \$1.00.

All orders filled promptly.

Get your FREE copy of the Builders' Information Sheet TODAY!

All Parts in Stock for Receiver and Amplifier

RE29 BOOK, 50c.

Mrs. R. E. Lacault,
1931 B'way (65th St.), N. Y. City.

- Enclosed please find \$1.50 for which please send at once blueprint of the 6-tube RE29 Receiver.
- Enclosed please find \$1 additional for blueprint of the Push-Pull Power Amplifier B Supply.
- Please send FREE copy of the Builders' Information Sheet on the complete RE29.

Name

Address

City..... State..... RN6

"Up and Going"

(Continued from page 1072)

at your hotel, or at some central point in town, and you are on the way to the airport. The location of airports ten or twenty miles from the cities after which they are named, causing a loss of much of the time gained by air travel, has been a cause of justifiable criticism of passenger aviation in the past. The swift bus you are riding in now is one of the steps taken by the carriers to ameliorate this condition. And they are all bending every effort to find suitable fields close to civic centers. Kansas City's great airport is but six minutes by car from the heart of town; others are almost as favorably placed. And it is the belief of transportation and municipal experts that community business and residential development from now on will gravitate toward airports as in the past they have toward surface transit. However, say you have a fifteen-minute bus ride from your city to the airport; this gives you time to reflect.

So far everything has seemed efficient and businesslike, but you still cling to some doubt. Your impressions of aviation have been largely gained from those fine Sunday afternoons, soon after the war, when you drove the family out to the fair ground or the local flying field.

You would park haphazardly and stroll around, stumbling over children, dogs and spare parts on ground lacking a tuft of grass. You'd wander into a hangar and lift little Clarence up to see the dofunnies in the cockpit; and if no one were watching you'd surreptitiously climb in and do some ground flying.

A student in overalls would importune you to take a trip for \$5. Perhaps you'd finally get the little woman's apprehensive consent, and climb in. You'd be belted by a thick leather strap that reminded you of the electric chair. The cockpit floors and sides were layered with mixed dust and grease. No one would think to lend you goggles. Your eyes, already stuffed with dust, would be stung by the wind. You'd grip the cowling and see nothing.

Eyes bloodshot, ears deafened for lack of a bit of cotton, you'd come down and zigzag back to your admiring family—their hero. Your suit would have to go to the cleaner's on Monday.

You shudder a bit with the vivid memory of your fear and discomfort and dirt—then the stopping of the bus suddenly recalls you to the present. You blink at the unfamiliar surroundings.

"Terminal—all out!" says the bus driver.

Then you are in a waiting-room as clean and well-ordered as the finest railroad station and with all the fittings, from marbled lavatories to news and fruit stands. There is a clock, and a despatcher's bulletin board. When your ship's time goes up you are escorted along a canopied runway at the end of which you make out a portable step-ladder, such as pullman porters use, and an open doorway. It dawns upon you that this must be the plane. The steward shows you to your seat. You are a little overawed by the calm precision of it all, but you did manage, as you stepped in, to catch a glimpse of two heads in an upper compartment, forward of your cabin. The pilots, you tell yourself.

When you and your fellow passengers are comfortably settled in your chairs the starter closes and secures the door, then signals to the pilots, who "rev" up their motors. You know the motors must make a terrific blast—each of them being 400 horsepower or more—yet you scarcely hear it when the windows are closed, for your cabin is insulated. Different ships, different methods—some with rubber sheeting, some with building compositions. Fairchild has developed an exhaust silencer.

You are agreeably surprised to find that you can ask your neighbor for a match in almost ordinary tones. Perhaps you shout at first because you think you have to; then everybody turns to stare at you and the steward comes forward inquiringly.

NO DUST OR SOOT

Before you realize it the huge ship, cushioned on enormous balloon tires, is rolling out upon a grassed, dustless, carefully policed field with red and green lights to regulate downcoming and upgoing traffic and keep the runways safe and clear at all times. Suddenly the ship picks up speed. You are telling yourself, a bit nervously, that you've never before traveled so fast over the ground, when the sensation of speed lessens abruptly. You press your nose to the window, and it dawns upon you that the ship has left the ground. Is *that* all there is to it?

Once aloft there is little sense of motion and none of speed. You are in a well-lighted, well-ventilated cabin with from nine to nineteen companions, each in a deep chair similar to yours.

You are wearing your lightest suit. There is no dust or soot up here, such as begrime you on railroad trains. The motor exhaust is carried far behind the cabin. There is a rack over your chair for wraps and small parcels; your baggage is in the tail of the ship.

The steward, in addition to being a licensed pilot capable of spelling the regular flyers, is an information bureau, a handy man, a waiter, and—a cook! For if your trip is a long one he will prepare a course meal on the electric stove in his pantry and serve it, too.

If you complain that your eggs are underdone he will sigh and scratch his head and explain ruefully that the Fahrenheit boiling point of water, 212 degrees, varies every 300 feet, falling about 16 degrees to each 5,000 feet of altitude.

From time to time one or the other of the pilots comes down into the cabin to chat with you, just as the officers of an ocean liner fraternize in the smoking lounges and dining salons. Perhaps he joins you at this meal. You are filled with the wonder of your experience, and there are a million questions you want to ask him.

"I feel all right now, but I suppose I'll be sick before we land," you begin.

AIR BUMPS IN GUSTY WEATHER

The pilot smiles. "You'll be an exception, if you are. Less than one per cent of the travelers on regular air lines get sick. The things that turn a fellow's stomach—sudden ascents and descents, stunting, and the like—have no part in passenger flying, you see. Why, more than thirty per cent of us professional pilots can't stand acrobatics: that's why not all of us could make good military flyers."

Please say you saw it in RADIO NEWS

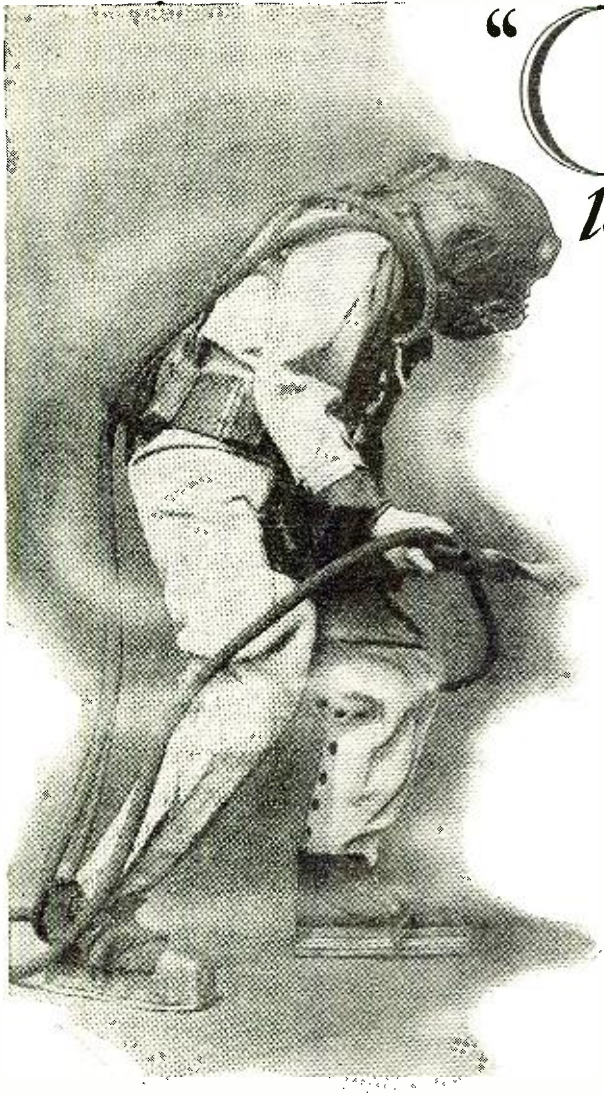

“On the Bottom”
is the GUILD Book
for May

This illustration is a reproduction of a photograph of Commander Edward Ellsberg in a diving rig with an air drill rigged for underwater use
(Description dictated by Commander Ellsberg)

AT last the truth has been told about the sinking, the attempt at rescue and the final salvaging of the ill-fated submarine S-51. Now you can learn, from Commander Edward Ellsberg himself, just what was done to save the men “on the bottom”. You can live with him through *months* of the most nerve-racking toil and hair-breadth adventure. You can go down the swaying ladders with the divers themselves, to the very floor of the sea.

And, through free membership in the Literary Guild, you can get this book as a part of the regular Guild subscription—for much less than the regular retail price.

You can get—not only *this* amazing chronicle of almost superhuman effort in 132 feet of water—but ELEVEN other books through the year all at the same or even a greater saving.

More than 70,000 members already enjoy this service. They receive books like ON THE BOTTOM and AN INDIAN JOURNEY as well as the best fiction, biography, humor and adventure—all for a single, low, inclusive subscription fee. All the books are specially printed and bound for members only. They are delivered to your door, *postpaid*.

Busy Scientists, Executives and Students Everywhere Save Time and Money Through the Guild Plan

No matter what your business is—your hobby or avocation, you relax with a good book as often as you can. But *books* are not your business. You specialize in the things nearest your heart—let the Literary Guild “specialize” in books for you. Let Carl Van Doren and his board of assistants do all the experimenting and let them give you only the books you are sure to want to read—one every month.

The Guild plan is simplicity itself—and *there is no chance of loss to you*. Send for complete details *now*. Subscribe for the next twelve Guild selections, beginning with ON THE BOTTOM by Commander Ellsberg. Pay for your subscription in con-

venient monthly installments if you prefer. Once every month you will receive a book that you are sure to want to read and keep for rereading or constant reference.

If you ever *do* receive a book that you do not want—although the chance of this is extremely improbable—you can exchange it for a book you know you want. Space prohibits a more detailed account of the Guild plan here. We can only say: you get the best books—made especially for you—at a price that is *much lower than you think*—a great deal lower than the price you would have to pay to get these titles in any other way.

Send for the Booklet WINGS Free!



A beautifully printed little book called WINGS is absolutely free to you. It explains how you can save money and enjoy the prestige of knowing in advance what the entire nation will be reading a few weeks later. Rush the coupon for complete details. Then study the Guild offer *selfishly*, with only your own taste and purse in mind.

THE LITERARY GUILD
55 Fifth Avenue Dept. 83 E.P.
New York, N. Y.

THE LITERARY GUILD,
55 FIFTH AVE., Dept. 83 E.P.,
NEW YORK, N. Y.

Gentlemen: I will read WINGS, without obligation, of course. Send it to me, please.

Name

Address

City..... State.....

Here's the Answer

to every question about the principles, methods, or apparatus of radio transmitting and receiving.

THE RADIO MANUAL

A Complete Course in Radio Operation In a Single Volume

A Handbook for Students Amateurs Inspectors

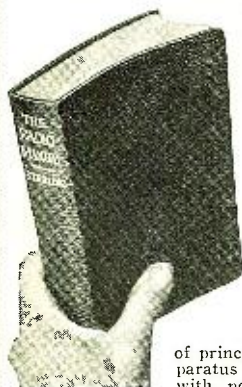

For the first time an entire course of training in one book — the most complete and up-to-date work on radio. Developed simply and clearly from the elementary stage right through all phases of principles, practice, and apparatus so that a beginner with no knowledge of electricity may get all he needs either for amateur operation or to qualify for a government license as operator or inspector.

Prepared by Official Examining Officer

The author, **G. E. Sterling**, is Radio Inspector and Examining Officer, Radio Division, U. S. Dept. of Commerce. The book has been edited in detail by **Robert S. Kruse** for five years Technical Editor of QST, the Magazine of the Radio Relay League. Many other experts assisted them.

16 Chapters Cover: Elementary Electricity and Magnetism; Motors and Generators; Storage Batteries and Charging Circuits; The Vacuum Tube; Circuits Employed in Vacuum Tube Transmitters; Modulating Systems; Wavemeters; Piezo-Electric Oscillators; Wave Traps; Marine Vacuum Tube Transmitters; Radio Broadcasting Equipment; Arc Transmitters; Spark Transmitters; Commercial Radio Receivers; Radio Beacons and Direction Finders; Radio Laws and Regulations; Handling and Abstracting Traffic.

New Information never before available such as a complete description of the Western Electric 5-Kilowatt Broadcasting Transmitter; description and circuit diagram of Western Electric Superheterodyne Radio Receiving Outfit type 6004-C; Navy Standard 2-Kilowatt Spark Transmitter; etc.; etc. Every detail up to the minute.

Free Examination

"The Radio Manual" has just been published. Nearly 700 pages. Profusely illustrated. Bound in flexible Fabrikoid. The coupon brings the volume for free examination. If you do not agree that it is the best Radio book you have seen, return it and owe nothing. If you keep it, send the price of \$6.00 within ten days.

Order on This Coupon

**D. Van Nostrand Co., Inc.,
8 Warren St., New York**

Send me THE RADIO MANUAL for examination. Within ten days after receipt I will either return the volume or send you \$6.00, the price in full. (Radio News 6-29)

Name

St. & No.

City and State

"I climbed a mountain once," you tell him, "and it knocked my wind."

"Sure, great altitude causes shortness of breath and hurried heart action in most people. But these passenger ships will not fly at great altitudes. We probably average between 2,000 and 5,000 feet, and seldom would need to go as high as 10,000 in the East or Middle West. Sometimes in the West the ships have to climb to 15,000 feet to get over mountains, but that's not excessive. In general we don't fly higher than is necessary for safety."

"Somebody told me the air pockets would make me sick," you insist.

"Well, even if you're one of the one per cent that get sick, you'll never be bothered on a quiet day like this. The air is very smooth now. Air pockets are only upward and downward currents of air. They make what we call bumps. When it's gusty there are a lot of bumps. But they're not unpleasant as a rule. They make the ship rise and fall suddenly and roll from side to side. Experiments are being made with the gyroscope to stop rolling. If that doesn't work, Lufthansa is trying a system we may adopt. There's a tube at each chair, which you grab up and suck if you begin to feel rocky. It gives off fumes of oxygen and cinnamon. They quiet the nerves of the diaphragm."

"Well, I have read," you admit reluctantly, "that airsickness at its worst isn't as bad as seasickness. And that one of the reasons the London-Continental lines were heavily patronized from the beginning is that travelers can thus avoid the Channel boat crossing."

"Reminds me of my old friend, Charley Niles," says the pilot. "You may or may not remember Charley, but he was one of the greatest flyers in the early days. Fifteen years ago I stood beside General Leonard Wood as he watched Charley put on an exhibition. Moisant, the famous French builder, was explaining Charley's maneuvers to Wood. The old general looked puzzled and skeptical—this was just a few months before the World War, mind you. Flying upside down and looping were the daredevil stunts of those days, and how Charley loved 'em! He came down O. K. The open exhaust had shot muck all over his freckles and his red hair. While I helped him unstrap he suddenly caught sight of a fellow all alone in a motorboat that was getting quite a tossing out in New York Bay. "Gee," said Charley, 'that fellow's got spunk! I'd hate to be out there. I'd be sick as a dog to my stomach!'"

You are amazed to hear this young-looking pilot talking of things so ancient: "Why, you seem to be just a boy. You don't mean to say you were flying fifteen years ago."

"Just learning," he grins. "I flew all through the war, and in the air mail up to the time I got this job. As a matter of fact our company won't hire pilots who have had less than ten years' experience. I guess there isn't a carrier in the country who'll take on a man who has had less than 1,000 hours."

GO ANYWHERE YOU WANT BY AIR

The pilot saunters away and you settle back feeling much safer. You find an individual ash tray beside your chair; every little appointment, in fact, that you'd have on a fine pullman. You move about the cabin at will; there is a washroom and toilet in the rear.

If you are in the South on the Pan-American lines you will find the cabin finished by interior decorators to complement the semi-tropics: wicker chairs, palm fronds, ceilings done in delicate opalescent tints as if reflecting the shimmering blue and lavender Gulf Stream. On northern runs in winter—Boeing, NAT, Universal, and any of the others—you're cabin will be heated. You will be in an overstuffed chair, with bright reading lights for the dark hours and more than the comforts of home.

You'll be sorely tempted to nap—as some of the old hands are doing. But this first trip is too interesting to waste. You stare down upon the landscape with fascinated emotions and realize that in an hour you've suddenly acquired a better sense of physical geography than all the relief maps in your old school books ever gave you. You trace coast lines and you look down upon the beds of rivers and harbors and roadsteads *forty to a hundred feet below the surface of the water*. In the South you may spot a shark any moment. Presently you ring for the steward and ask him whether he has a general air timetable—you'd like to see the extent of this service you are employing today for the first time. He brings you a fat folder.

You heft it with astonishment—then run over its pages with even greater astonishment. You will find chummy little footnotes that you've always associated with suburban railroad timetables: "F—Stops on signal only." "Daily except Mondays and days after holidays," "Twelve-o'clock run omitted on Sundays," and the like.

You glance at a map attached to the booklet and suddenly appreciate the new destiny the air age holds for certain American cities whose strategic location gives them dominion over vast territories—Chicago, Kansas City, Evansville, Salt Lake City, Los Angeles, Seattle, Dallas, Albany, Cleveland, Hartford, Miami, Atlanta, and Tucson.

You have done a good deal of rail traveling in your day, so you pick through the timetables at random to make comparisons: Denver to Los Angeles is nine hours, by Western Air Express; Kansas City to Los Angeles is twelve. You can fly from St. Louis to St. Paul over the Universal Lines this spring in less than seven hours. The train would take you there in seventeen. You will be able to fly from Los Angeles to Seattle in fourteen hours on the Pacific Air Transport lines; it would take you nearly forty hours by train. So you can skip around the country: New Orleans to Houston in less than four hours. Louisville to Evansville in an hour and a quarter. Nashville to Atlanta in less than three. If you are in Cuba and have business in Porto Rico you can fly it in six hours, whereas heretofore you would have to go back to New York and reship to Porto Rico; time, two weeks or more.

But these are just statistics and they bore you after a while. This timetable has proved to you that you can go nearly anywhere you want by air, about three times faster than by train.

Presently one of the friendly pilots comes down. You try to assume the offhand manner of a veteran as you hail him: "Captain, are we going to land on time?"

"About twenty minutes ahead of time," he smiles: "We've had the benefit of a lively tail wind all the way."

Please say you saw it in RADIO NEWS

"Of course it's a nice, clear day—" you begin deprecatingly.

This seems to be a sort of amiable red flag to the pilot, who lingers, eager to talk to you. Bright, smart fellows in their own right, and full of interesting anecdotes of their barnstorming days, the transport pilots you will encounter in your air travels this year will be salesmen of air-mindedness, under instruction from their companies to be informative as well as courteous. Steeped in the lore of the air and airways, they will in addition be supplied with statistics. Too, they've led a lonely life thus far, these young men—in mail planes on dark, stormy nights over the Alleghenies, with only the sacks for company; in snowy twilights over the Rockies; on hot days over the south-western deserts. They will be glad of your company and your questions. So don't be surprised because you've provoked your pilot into a speech:

A GOOD RECORD FOR THE MAILS

"Flying has been libeled a lot," he smiles. "There are many people who've been led to believe that planes must stay in the hangars if there's a stray cloud around. But did you happen to read in the papers last February what happened in Germany? Some North Sea islands were cut off by gales and blizzards and seas that were too much for shipping. The inhabitants were going hungry. Lufthansa heard about it and sent planes. The pilots dropped food and supplies by parachutes because most of the islands were too small and rough for them to set their ships in."

"But certainly plane service isn't as regular yet as train service?"

"Planes of course can't go out in some weather that doesn't stop the trains, yet in 1927 the air mail planes completed ninety-five per cent of their scheduled flights. Not bad? And I remember a comparison that somebody made a few years ago, when planes and engines weren't as good as they are now. The planes made a six per cent better 'on time' record than the trains.

"Something funny along this line happened last December. I was in Washington at the International Civil Aeronautics Conference, which was timed with the twenty-fifth anniversary of the Wrights' first flight. A couple of hundred aviation chiefs from all over the world were sitting in the Chamber of Commerce building waiting for Orville Wright to show up. He was to be the guest of honor, you know. He was due at ten, but there wasn't any sign of him and everybody wondered where he was, because the weather was O. K.

"After a while Mr. MacCracken—and just let me tell you now, that's the man who is more responsible than anyone else in the

country for the fine passenger service you're getting today—got up. Somebody had just handed him a telegram. He read it, then told us:

"I'm sorry, but Mr. Wright will be delayed four hours. The train he is on is stalled near Baltimore."

FOG IS THE GREATEST ENEMY

"Mr. MacCracken looked at everybody. Then all of a sudden he grinned—that explosive grin of his that makes you expect to see his teeth fly out. Well, everybody grinned back—and you could hear a chuckle running all around the hall.

"Saturday night everybody piled on the boat and went down the Potomac on the way to Kitty Hawk for the final ceremonies. We were due at Norfolk at seven in the morning. At eleven o'clock we were still poking around Hampton Roads, lost in the fog. I was standing near Mr. Wright on deck. I heard him say, kind of gently:

"It seems that airplanes are not the only things delayed by fog."

"I guess that reproach was many years in the making," you smile. "But fog is the airplane's greatest enemy?"

"Yes. But we've a good chance of beating it eventually."

"What's being done to beat it?"

"The government, and many private companies, are conducting all kinds of experiments. Neon lights, buried under iron grilles on landing fields. Theoretically they are visible for many miles through fog. Radio beacons that will draw a pilot in a bee line for his field, while a new kind of altimeter tells him exactly how high he is above the ground, not above sea level, every instant. Then Jimmy Doolittle is making exhaustive blind flying tests for the Guggenheim Fund. Believe me, before long we'll be flying and landing with perfect safety, fog or no fog."

The pilot goes forward to the flying compartment. We're certainly on the threshold of a great age, you tell yourself, and you can feel your blood pounding to the thrill of it.

The next thing you know you are sitting bolt upright with a startled impression of landscape rushing past the windows. Good lord, what has happened? Then you grin sheepishly—you are landing. You must have dozed off.

When you step out at the journey's end you will find the two smiling pilots, in their smart uniforms, waiting to shake hands with you. You assure them that you've never enjoyed anything so much in your life—and you add, looking at your watch, that you never found anything so valuable in point of time.

"I'm going back in a day or two," you tell them, "—by air!"

Making the New Short-Waver "Perk"

(Continued from page 1089)

at right angles to each other. This will minimize the possibility of direct inductive feed-back, producing oscillation in the first audio stages, with whistles and howls.

If the plug-in coils are of the tube-base type, be sure the coil terminals in the base pins are well soldered and are making contact. This is another of the most common difficulties encountered by amateur constructors and, no doubt, accounts for a goodly share of short-wave grief. It can readily be seen that a poorly-soldered tickler terminal will cause a lack of regeneration, and yet evade detection unless care-

fully checked. However, this is true only when working with the tube-base type of coil; terminals on the more conventional types of short-wave coil (employing miniature plugs and jacks) can be checked without difficulty.

A TESTING LAYOUT

An occasion may arise whereby a defective component causes a lack of results. For this reason, it is always advisable to test all parts before incorporating them into a receiver. A simple and reliable checker comprises a voltmeter and a battery wired in series, to indicate whether there is con-

Tone Quality- Sensitivity Volume and Clarity



If you're *tone conscious* you'll sense the finer, purer tone quality that CeCo's provide...the greater sensitivity they give the set ...the greater volume without distortion they afford.

What you will discover also (after you've enjoyed them clear to the end of their long, useful life) is the many extra months of perfect service CeCo's provide.

Hear a set of CeCo Tubes today—most good dealers have them.

Listen to the sparkling program of music and comedy by the CeCo Couriers Monday Evenings—8:30 Eastern Daylight Saving time over WOR and the Columbia Broadcasting System.

CECO MANUFACTURING CO., INC.
PROVIDENCE, R. I.

Used By Millions

A RADIO MYSTERY

For four years or so, we have been experimenting with a device to improve radio reception. Our innumerable tests show, yes prove, that our device has real merit—that it "sweetens" music and the speaking voice, that it stops much, if not all, of the ordinary static—that it increases selectivity—that it sharpens DX reception very perceptibly.

But we are not satisfied

However conclusive our own tests seem, we are not satisfied. We want to find out what happens when you try our device—we want to know how much you can better your radio performance. For want of a call our device better name, we call our device a "static filter". Perhaps "Supertone" more accurately describes its performance. Anyway the price is only \$2.25—a very nominal price, if even a small part of your static interference and noise is eliminated. And you run no risk—for we positively guarantee our "Supertone" device to pass your tests, or we refund your money in full.

Unusually explicit directions accompany every "Filter", and it is easy to install and adjust. Send your \$2.25 today. We will greatly value your judgment.

WIRT COMPANY

Makers of Dim-a-lite and AC Voltage Regulators
5221 Greene St. Philadelphia, Pa.

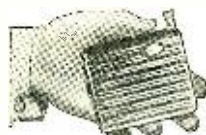

— a clever invention that saves cigarettes

JUST touch the button on the EJECTOR and there's your cigarette—clean, quick, fresh and inviting. Stops muss, fuss and bother of tobacco filled pockets. Eliminates the waste of crushed cigarettes and saves its cost in a short time.

EJECTOR is the only common sense and practical device built for smokers' convenience. Substantial construction and finished in elegance to suit the most fastidious. Sold By All Live Dealers. Unconditionally guaranteed to give full satisfaction or money refunded.

Send \$1.50 for Model "C"
Other models \$3.00, \$4.00 and \$6.00
THE LYONS MANUFACTURING CO.
Dept. J, Mt. Carmel, Conn.

EJECTOR

The Perfect One Hand CIGARETTE CASE



AERO-CALL
Factory - Built, Short - Wave Converter, Filtered - Shielded. Plugs Into Any Radio Set. Two Models, A.C. and D.C., \$25.00. Write for literature
AERO PRODUCTS, Inc.
Dept. 169, Chicago, Ill.

Insure your copy reaching you each month. Subscribe to RADIO NEWS—\$2.50 a year. Experimenter Publishing Co., 230 Fifth Ave., N. Y. C.

tinuity or an "open" in a component; such a tester is illustrated in Fig. A. The meter suggested for "B" battery testing in this article will do in conjunction with a 45-volt "B" battery; the combination of these two will test the workability of any part in a short-wave receiver (or, for that matter, in a broadcast set).

When testing the windings of an audio-frequency transformer, a reading should be obtained; if the meter does not register, it proves that either one of the coil terminals is open or the winding is burnt out. The primary of a transformer is tested by placing the test leads across transformer posts "P" and "B+"; the secondary, "G" and "F—".

Fixed, by-pass and variable condensers should give no meter readings; those that do are short-circuited and may be considered worthless—except in the case of the variable type. In this a defective plate which makes contact with another may be located and straightened.

Placing the test leads across a coil winding should produce a reading; lack of the latter indicates an open circuit. This applies, as well, to the radio-frequency choke coil.

It would be well to remember that lack of regeneration, the "bogey" of the short-wave experimenter, can be traced to a limited number of faults. Incorrect wiring in the plate circuit, such as a defective terminal or a reversed winding on the tickler coil; insufficient "B" voltage on the detector plate or a defect in this connection; insufficient coupling between the grid and tickler coils (due to resistance too high or capacity too low in the plate return; or to tickler windings too few or spaced too far from the grid coil); a defective tube, which may light, but give insufficient emission for the plate current; a short-circuit in the regeneration-control condenser, or an open circuit in the headset; all are to be guarded against. Any one of these defects will prevent regeneration; on the other hand, if all these factors are correct, the receiver must oscillate and, if it does so, it is functioning, no matter how disappointing reception may be.

SOME SHORT-WAVE CIRCUITS

Undoubtedly, one of the most important requisites in short-wave trouble-shooting is an understanding of the circuit being used and the how-and-why of its components. For this reason, several schematic diagrams of typical short-wave circuits most commonly used today are reproduced here. In Fig. 1 we have a basic circuit of the simplest imaginable regenerative type, with the aerial coupled directly to the grid tuning coil S by means of the condenser C3; which may be a three- or five-plate midget condenser, or nothing more than two opposed small strips of metal; to be specific, its capacity should be somewhere about .000015-mf. Any value much greater than that should not be used.

The wavelength range of this set depends on the size of the grid coil and the capacity of the tuning condenser C1 which, in one popular model of this particular receiver (the "Junk-Box"), has a capacity of only .000032-mf. Regeneration is made possible by the tickler coil T, connected in series with the plate circuit elements, and is controlled by the other variable midget condenser C2, which here has the same capacity
(Continued on opposite page)

NEW 90 VOLT POWER UNIT!

Positively Eliminates Hums, Line Noises, etc. Greater Volume and Clarity Guaranteed

Non-acid and noiseless. All detector and intermediate voltages plainly marked. Simpler to hook up than dry cells. Operates 1 to 12 tubes. If not thoroughly satisfied return after using 30 days for complete refund. Guaranteed further 2 years. For 110-120 volts A.C. 25 Guaranteed current, 90 volts, \$12.95; 112 1/2, \$15.25; 135, \$17.50; 157 1/2, \$19.50; 180, \$24.00; 202 1/2, \$26.00 Also built for D.C. current 110 and 32 volts at only \$3.00 additional, any size above. Ample stocks—same day shipments. Simply say—ship C.O.D. or write for my interesting literature, testimonials, etc.

B. HAWLEY SMITH
334 Washington Avenue, Danbury, Conn. U. S. A.

Complete Stock of Silver-Marshall Parts

Including
No. 730 "Round-the-World" 4

We are authorized jobbers of Silver-Marshall apparatus. Complete stock on hand at all times. Special prices on No. 730 Short Wave Receiver.

1929 Catalog—FREE

Includes description and lists complete parts for New H. F. L. Special Shield-Grid Nine, Madison-Moore "A C," New Thordarson Power Amplifier, World's finest Dynamic Speaker.

Discounts for Set Builders

CHI-RAD

CHICAGO RADIO APPARATUS CO.
415 S. Dearborn St., Dept. RN CHICAGO

DRESNER SHORT WAVE CONVERTER

COMPLETE WITH 5 COILS \$16.50

The Only Set with Wavelength Range - 15 to 550 Meters
First time offered! New 1929 model—completely assembled; finished metal cabinet. Highest efficiency at amazingly low price. Gets programs broadcast on short waves by many powerful stations throughout America and Europe. If your dealer cannot supply you, send money order direct and we will ship at once. Guaranteed. (When ordering unit, be sure to specify whether it is to be used on AC or DC set.)

DRESNER RADIO MANUFACTURING CORP.
640 Southern Blvd., Dept. R-6, New York, N. Y.

Improve your reception with the
Carborundum Detector
Reg. U. S. Pat. Off.
Now It's Adjustable—used by noted circuit designers
THE CARBORUNDUM COMPANY
Dept. D-1 Niagara Falls, N. Y.

7 TUBE SUPERPHONIC RADIO \$16.95

An amazing value that can't be beat! Latest 7 tube tuned radio frequency circuit. Send for complete descriptive circular.

RADIO EQUIPMENT CO.
4611 N. Clark St., Dept. 12-F, Chicago

Please say you saw it in RADIO NEWS

RADIO DIRECTORY

Send for This

We have a new illustrated catalog showing our up-to-the-minute stock of kits, parts and sets — everything you want in radio — all at dealers' wholesale prices. Write today for Catalog "B-8."

ALLIED RADIO CORPORATION
711 W. Lake St.
Dept. "B-8," Chicago, Ill.

The Arc Aerial

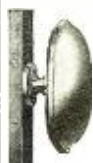

An outside aerial that can be attached in 10 minutes — without climbing on the roof. Write today for details and price.

The Arc-Aerial, Inc.
Green Bay, Wisconsin

Power Amplifiers

The General Amplifier Company specializes in the design and manufacture of power amplifiers. All devices possess unusually good frequency characteristics due to advanced engineering design. Models range from those capable of delivering 25 watts of undistorted energy to the speaker, to amplifiers having a single UX250 power tube in the output stage. Your problems regarding power amplification are solicited. Bulletin A will be sent on request.

GENERAL AMPLIFIER CO.
27 Commercial Avenue
Cambridge, Mass.



Moisture-Proof Extension Cords
Birnbach Extension Cords permit the Loud Speaker to be moved to any room in the house. Attaches instantly. Install a Birnbach Cord and put an end to distortion so often due to badly insulated cords. Your neighborhood dealer has these sizes in stock: 10-20-30-40-50-100 foot lengths. Send for Catalog.

BIRNBACH RADIO CO.
254 W. 31st St., New York

SEND FOR NEW RADIO BOOK

All the new hook-ups. Parts, supplies, A.C. sets, television, short wave, etc. Write for free copy now.

The Barawick Co.
11H Canal Sta., Chicago

Loveless Antenna

DISTANCE - VOLUME - TONE
LESS STATIC



PRICE \$5.00

C.O.D. or check with order
Dealers' discount
LOVELESS ANTENNA, INC.
Box T Bath, N. Y.

SEND NOW for New 1929 WESTERN RADIO'S CATALOG

LATEST and FINEST, nationally known A.C. sets, consoles, cabinets, speakers and accessories at LOWEST PRICES. Catalog sent FREE on request.

WESTERN RADIO MFG. CO.
128 W. Lake St.
Dept. RNC6 Chicago

200,000

RADIO NEWS readers carefully scan the RADIO DIRECTORY every month. Your product here, at the lowest cost in the world's largest and most widely read radio magazine.

Rate per Issue—
\$25.00

No order for less than three insertions accepted.

Write for Information

RADIO NEWS
230 Fifth Ave.,
New York City

The PACENT Super Phonovox

THE WORLD'S LEADING ELECTRIC PICK-UP
PACENT ELECTRIC CO., Inc.
91 Seventh Avenue, New York

C. R. LEUTZ, Inc.
Long Island City, N. Y.

Radio Receivers
"SEVEN SEAS"
"SILVER GHOST"
"PHANTOM"

Literature on request

LOWEST PRICES

GREATEST VARIETY

Dealers, write for catalog.
W. C. BRAUN CO.
552H Monroe St., Chicago

RADIO'S HALLMARK OF QUALITY

DeJUR AMSCO

WORLD'S LARGEST MANUFACTURER OF HIGH GRADE RADIO PARTS

USED BY LEADING SET MANUFACTURERS AND SPECIFIED IN ALL THE BEST CIRCUITS

WRITE FOR CATALOG
DE-JUR AMSCO CORP
BROOME AND LAFAYETTE STS
NEW YORK CITY

FREE Wholesale CATALOG

Send for the most complete book of nationally known Parts, Kits, Cabinets, Consoles, Speakers, Power Units, Sets, etc. All at lowest wholesale prices. Quick service on all your needs. Write now, it is FREE—

Setbuilders Supply Co.
1319 Romberg Bldg., Chicago

LYNCH TUBADAPTA

for Better TONE Prolongs LIFE of Power Tube

Actual tests show that two tubes in parallel almost double the plate current. This eliminates distortion and blasting, and enables dynamic speakers to give amazing results. Write for folder.

ARTHUR H. LYNCH, INC.
1775 Broadway New York

The RADIO DIRECTORY is your buying guide. Space permits display of only one product at a time. Write advertisers for complete catalogue.

(Continued from opposite page)
as C1. Five plug-in coils wound on tube bases are used with this receiver to cover the wave band from 20 to 110 meters.

Rather than the beginner chance problematical results, it was recommended that the radio-frequency choke-coil L2 be purchased; this may be a Hammarlund, National, Pilot, Aero, or Silver-Marshall, as each of these firms makes an excellent choke coil especially designed for short-wave work. While the grid condenser C4 may be of the .00025-mf. type used with broadcast sets, one having a capacity of .0001-mf. is recommended for high-frequency work; the grid leak may be anything from 3 to 5 megohms, depending on the oscillation characteristics of the detector tube. Try several grid leaks, and be sure that you have a good one; a higher value may be used on feeble signals. An old grid leak may often be defective.

In Fig. 2 we have a circuit similar to that of Fig. 1; except that the experimenter has the choice of coupling the grid either directly to the antenna through the condenser C4, or inductively through the primary winding. The latter method may be used where a long aerial is employed for the short waves as well as for the reception of long-wave broadcast frequencies. This circuit, however, is not recommended

for broadcast reception, because of the annoyance it will cause to neighboring listeners; in addition to this, its condensers are too small for good broadcast reception.

THE R.F. STAGE

The receivers mentioned above have the disadvantage of "dead-spot" tuning; that is, there may be points on the dial where the receiver will fail to oscillate, in spite of its efficiency, and the correctness of the circuit. This condition is one which simply must be tolerated in this particular type of receiver, where the antenna is coupled to the detector; it cannot be corrected unless a screen-grid (222-type) tube is added as

indicated in Fig. 3. A 201A tube will not operate satisfactorily here on short waves.

The untuned stage of radio-frequency amplification serves to eliminate "dead-spot" tuning, as well as to increase the sensitivity of the receiver to some extent. The screen-grid tube when incorporated in such a stage may be used without shielding, but should be well by-passed; as indicated by the condensers C5 and C6, which have a capacity of .01-mf. each. These condensers are highly important and must not be omitted.

(Continued on page 1136)

Fig. 1

The simplest short-wave receiver; almost fool-proof if built according to directions, but not suited to some neighborhoods.

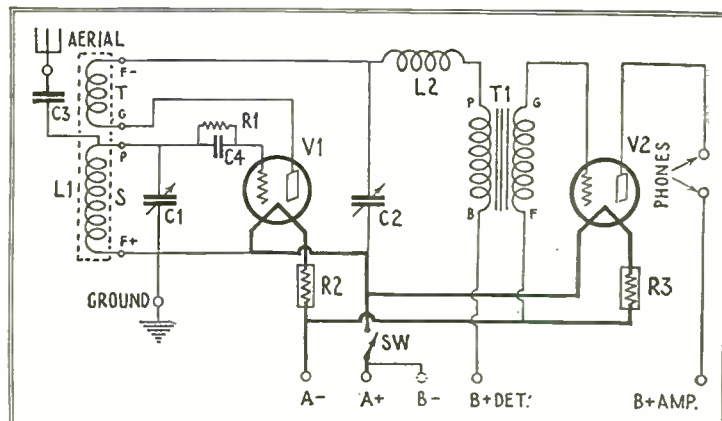

Please say you saw it in RADIO NEWS

HAMMARLUND Knock-Down Aluminum Shields

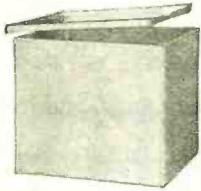

Why make shields for your receiver or laboratory apparatus, when you get these roomy, finely made Hammarlund Aluminum Shields all ready for instant assembly?

The sides are held together by sliding corner pieces which make positive contact, and reducing eddy-current losses to a minimum.

Two sizes: 6"x8"x5 3/8" high and 6"x7"x6" high. Also Model "HQS", 3 3/4"x8 1/2"x5 1/4" high, with one or two compartments.

If your dealer can't supply you, write to us. Write Dept. RN6 for Descriptive Folder.

HAMMARLUND MFG. CO.
424-438 W. 33rd St. New York

For Better Radio
Hammarlund
PRECISION
PRODUCTS

100% VOLTAGE CONTROL

PLUS 5 EXCLUSIVE FEATURES

1. Double Socket Outlet for A.C. Set and Dynamic Speaker or for A and B Eliminators.
2. Antenna and ground connections.
3. Line Switch.
4. Fuse protection of entire set.
5. Perfect Link between your Set and light socket.

X-L LINK

Eliminates all irregularity in line voltage—the bane of A.C. reception. With the X-L Link your tubes last full life and give maximum service because they are protected from the destructive effect of high voltage fluctuations which weaken or burn out the filament. Reception is smooth and clear without strain or distortion.

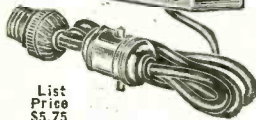

List Price \$5.75

No complicated connections—one wire operates everything including ground and antenna. Perfect, unfailing control of line voltage surges that gives you full reception value. Install an X-L Link and note the difference in tube performance. At your dealer or postpaid on receipt of price. Write for FREE folder. Also Manufacturers of X-L Variodensers and Push-Posts.

XL Radio Laboratories

Dept. A, 1224 Belmont Ave., Chicago, Ill.

ELECTRIC BATTERY
3 yr. guarantee
AC-B \$71.50

30 DAYS FREE
BEFORE YOU BUY

Factory to you. Save 50% on latest AC Electric or Battery Radio. Free return privilege.

Ultra 8
49.88
Lighted 1 dial
MIRACO

Radio's most amazing bargains direct from big, old, reliable maker. Don't buy unless 30 days' use proves entire outfit unbeatable at 2 to 3 times the price, for tone, selectivity, distance, volume.

Catalog and BIG SPECIAL OFFER
MIDWEST RADIO CORPORATION
404-UJ Miraco Bldg., Cincinnati, O.

BIG DISCOUNTS
to User Agents

Making The New Short-Waver "Perk"

(Continued from page 1135)

Another departure in this receiver is the variable resistor employed in series with the "B+" lead to control regeneration; this component also must be by-passed, as shown in the illustration at C4. The antenna resistor or choke, L1, may have a resistance value anywhere from 50,000 to 100,000 ohms, or an inductance from 2 1/2 milli-henries up; its exact value is not important, but it

lead or component by a section of the shield. The latter, especially, should be carefully avoided when constructing the receiver. Other than the stage of tuned radio-frequency amplification, the circuit does not differ from a simple regenerative one.

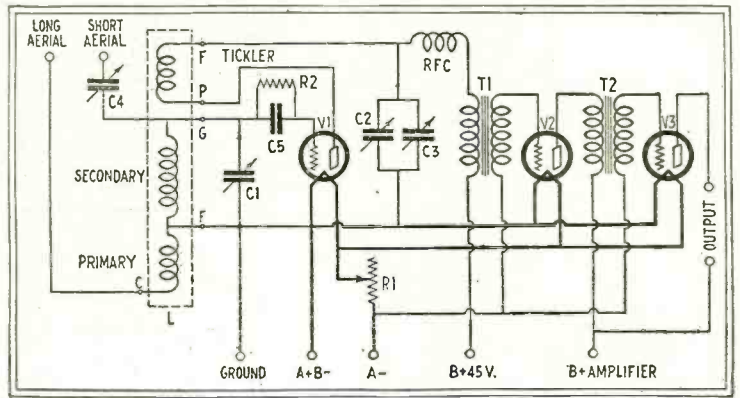

Fig. 2
The "Wasp" circuit, a trifle more elaborate, offers a choice of aerial couplings and greater control of regenerative capacity.

must not introduce any noticeable capacity into the antenna. The voltage on the plate of the screen-grid tube should not be less than 135; otherwise results will be poor. Troubles developing in such a receiver should be sought for just as in the simple regenerative type; except for the screen-grid stage, which really includes nothing to develop trouble

DO NOT EXPECT TOO MUCH

One of the illustrations of this article shows a bank of short-wave receivers employed by the Radio Corporation of America at its Riverhead (Long Island) transoceanic receiving station. This rack, comprising three or four receivers, cost many

thousands of dollars and is considered the last word in short-wave reception. It is safe to say that no engineering ability nor

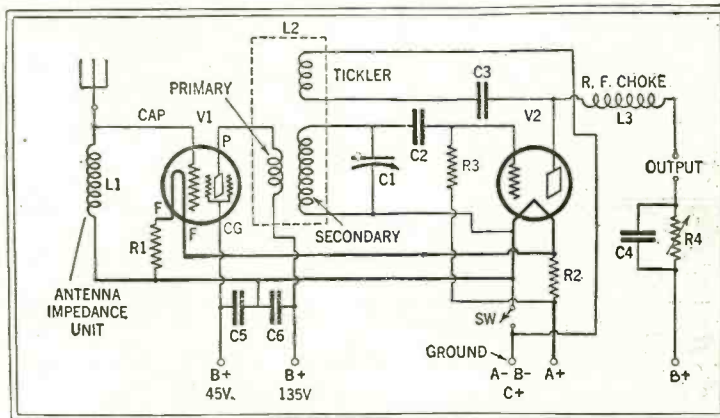

Fig. 3

The introduction of the untuned screen-grid stage gives amplification and prevents radiation also.

but the tube. The latter is of a type which may be rejuvenated if necessary.

An improvement on the last circuit is shown in Fig. 4, wherein the screen-grid input circuit is tuned; thus greatly increasing the sensitivity of the circuit. This type of receiver requires complete external and interstage shielding; otherwise results will be very poor and tuning extremely difficult. Other troubling factors which may be found

money was spared in the effort to produce receivers offering the maximum assurance of consistent transoceanic work. Each shielded stage is given the space of a good broadcast receiver; 210 power tubes are used where the home-built set has 199's or 201A's—and yet even one of these super-sets cannot always insure twenty-four-hour service, every minute of the day, every day of the year!

in this type of receiver are the reversal of the "C" battery in the screen-grid stage, and the unwanted short-circuiting of some

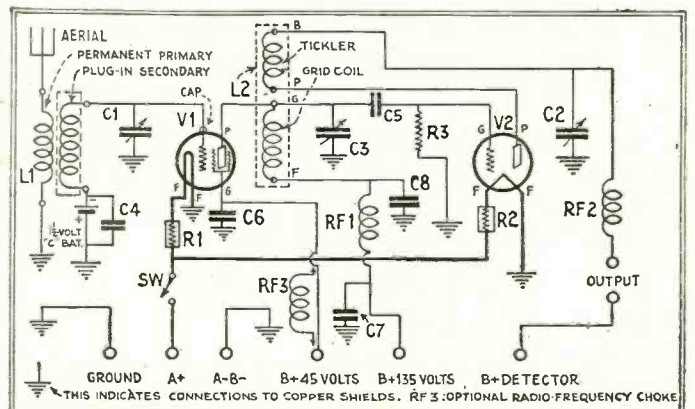

Fig. 4

The latest in short-wave work; tuned screen-grid R.F. amplification. It must be shielded well.

Please say you saw it in RADIO NEWS

Announcing

TRIAD

RADIO TUBES

Achieved at last — the tube perfection for which the radio world has waited! Exhaustive research, a radically new engineering process, greatly advanced laboratory methods, a care in production — from all these has been created an infinitely higher standard in tube quality, a standard which only Triad Tubes offer! Tests have proved their unparalleled clarity of tone, their longer life and their greater sensitivity and volume. ▲▲ Back of every Triad Tube is the personal guarantee of a group of pioneers in the radio industry, whose integrity and resourcefulness has been proved through years of intimate contact with both trade and public. ▲▲ Their product, better tubes could be manufactured, now makes possible a greater and more economical enjoyment of radio reception!



GEORGE COBY
President

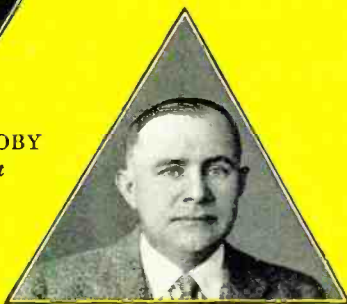

ELY EGNATOFF
Treasurer



WILLIAM CEPEK
Secretary



HARRY H. STEINLE
*Vice-President and
General Sales Manager*



“Quality ▲ Service ▲ Durability”



Dealers!



TRIAD brings you a definite, well-planned policy of sales cooperation. Unequalled quality, a continuous supply, prompt deliveries, close factory contact—in short, every possible bit of assistance will be yours. A tremendous advertising, radio and publicity campaign has been launched that will make Triad the world's most popular tube. Tie-up material will be provided to each dealer in any quantity desired. And there is a generous profit margin with Triad—one that will bring real satisfaction to you with every sale. A greater tube business with greater profits is waiting for you in 1929 with Triad. Write or wire now for the special sales and merchandising proposition we have arranged for you!

The Triad Line—Complete!

A complete line of A. C. tubes is included in the Triad line—also D. C. types, Special Purpose tubes and Television and Photo Electric Cells. The Triad Line enables you to meet your customer's demand instantly—and Triad quality assures absolute satisfaction with every sale.

The TRIADORS will broadcast a popular program every week over a national network. This selling cooperation will mean a steady consumer demand for Triad Tubes.

Triad Publicity

Broadcasting: Fifty-two weeks of broadcasting over a national network, have been arranged. A famous orchestra, stars of the stage and concert world, elaborate presentations of varied nature—all these and many other features will sell Triad Tubes in the homes of every radio owner.

Newspapers and Magazines: An extensive national newspaper and magazine campaign will keep the Triad line constantly before the reading millions in 1929 and 1930. This powerful advertising, together with interesting publicity items will aid materially in building a steady consumer demand.

Dealer Helps: Attractive window strips, fliers and broadsides for counter or mailing purposes, plates and matrixes for local advertising—these are only a few of the many merchandising helps available to every Triad dealer. Every possible aid will be extended in helping the individual dealer to tie up with the national newspaper and radio campaigns.

New! "Tube Insurance"

A certificate is enclosed with every Triad Tube, guaranteeing thoroughly satisfactory service. Here is a unique and valuable Triad merchandising feature! It means satisfaction to both customer and dealer—and a saving in the dealer's selling time and expense. Remember—only Triad offers "TUBE INSURANCE".

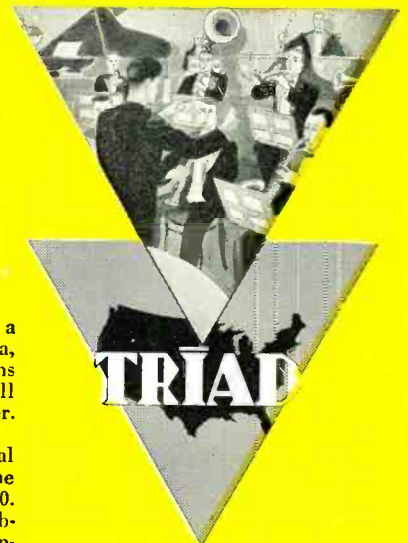

"The Tube in the Triangular Box"



The Triad box itself is of tremendous merchandising value. Its unique shape and design lend themselves easily to spectacular displays. Your trade will soon learn to "Ask for the tube in the triangular box."



NEWSPAPER AND MAGAZINE ADVERTISEMENTS



DEALER'S HELPS

TRIAD MANUFACTURING CO., Inc. ▲ PAWTUCKET, R. I.

This should be especially interesting to those builders of the "Junk-Box" short-wave receiver who write to tell us that, after they have spent \$2.50 for apparatus and devoted an entire evening to assembling the jigger, it failed to bring in London and Australia; and so must be nothing short of a fake! For these exacting readers, we can but point to the photograph we have reproduced and say "Go thou and do likewise."

On the other hand, really remarkable results have been obtained from the little set by many constructors who are in favorable locations and do not suffer from local interference. These results are possible even with simple apparatus under exceptional conditions; they are obtainable with better apparatus in locations where the signal strength of distant stations is not as great. The "Junk-Box" set was designed to introduce the inquiring constructor to the short waves with little or no cost to him; it cannot be expected to give the first-class results of a shielded set which has screen-grid amplification. The remarkable results which many have obtained with it at the first attempt have been a revelation to them; but proficiency in operation on the short waves comes only with practice.

OUTTA LUCK!

The majority of the indignant readers who denounce short-waves as a fake, etc., live in large cities or near broadcast stations, as their letters indicate. In most cases local interference and harmonics, especially with unshielded sets, prevent them from getting the full benefit of their work; while reception even from long-wave broadcast stations is uncertain for residents in a district full of steel buildings. Even for these unfortunate listeners, however, a short-wave receiver will prove when it is in working order by bringing in code messages—which are a source of great interest to those set owners who have made the small effort necessary to learn to read them—as well as the harmonics which we have explained in many previous articles.

If your short-wave set receives code and local short-wave broadcasts (or, even, only harmonics of long-wave stations), it is functioning properly; its inability to pick up distant and transoceanic broadcasts is indicative of either unskillful operation or a poor location. The former can be corrected by infinitely careful tuning, learning the characteristics of the set, and *patience*. The latter trouble is an unfortunate stage of affairs in which nothing can be recommended to the victim but resignation—or moving. Harmonics, with a high-grade shielded set, may be overcome (if they do not come too close to the wave of a wanted station) by a wavetramp; similar to that used with long-wave stations, except that its coils and condensers are smaller.

The question arises "How am I to know which of these two factors (location or poor operation) is preventing me from reaching out?" Perhaps the best method is to obtain a calibrated wavemeter and, with its aid, tune the receiver to a powerful distant station; this test should be carried on over an extended period as, obviously, atmospheric conditions must be taken into consideration. Also, if no success is had on one station, try another. The construction of a suitable wavemeter and its calibration are described in the May issue of RADIO NEWS (page 1066) under the head-

TOBE Filterettes

STOP

RADIO INTERFERENCE

TOBE Filterette

VOL. 1 NO. 2 FEBRUARY, 1929 CANTON, MASS.

INTERFERENCE CLUB AID TO NEIGHBORHOOD
Best Way To Solve Noisy Reception Radio Problems

RADIO STATION PLUS PRESS AID TO LOCAL CLUB
J.W. H. Weir of Pittsburgh Press Finds KDKA Most Effective

"The Power of the Press" has been a familiar phrase in American homes. Today we see it in "The Power of the Radio Station." In the development of interference clubs the great possibilities of the development of such a club with the cooperation of a good radio station and a local newspaper has received scant consideration. This combination is impossible to best and Pittsburgh through KDKA and the Pittsburgh Press is a

SUBSCRIPTION FREE ON REQUEST

Tobe Deutschmann Corporation

FILTERETTE DIVISION
CANTON, MASS.

AMAZING STORIES

has attained a very large circulation, which in itself indicates a demand on the part of the public for the very original type of stories which it gives. Every story is by a good writer. Every story is based to some extent on natural science, giving it an educational value, yet without impairing its literary quality. The magazine is a model repository of short stories. A special department is devoted to letters from readers with editorial comments thereon. This is very popular with our readers. Every story is illustrated.

On All Newsstands, or Write Direct to

EXPERIMENTER PUBLISHING CO.
230 Fifth Avenue New York City

SET BUILDERS
Get this Book

LATEST RADIO GUIDE
FREE

Barawik, the first and oldest radio specialty house, offers you unusual service this year. Bigger stocks, quicker shipments, lower prices. Deal with an old established, reliable house. Get honest goods, honest service, honest prices. Barawik service makes you more money. Send now for big new Catalog showing lowest wholesale prices.

BARAWIK CO. 26-C Canal Sta. CHICAGO, U. S. A.

Mail This Coupon Now for Free Radio Guide

Name _____
Address _____

Insure your copy reaching you each month! Subscribe to Radio News—\$2.50 a year
Experimenter Publishing Co., 230 Fifth Avenue, N. Y. C.

Please say you saw it in RADIO NEWS

NEW
NORDEN-HAUCK
MODELS
ARE
NOW READY

Super Electrophonic
 Shielded Super-10
 Super Dynamic Speakers
 Power Packs
 Short-Wave Apparatus
 Etc.

Write Today for New Literature

NORDEN-HAUCK, INC.
Engineers
 Marine Building
 Philadelphia, Pa.

TRADE-IN-SETS
*Large assortment in stock of
 nearly all standard makes*
 Electric Sets, Battery Sets, Table
 and Console Models
 All used, but in good working
 condition

A few of our present offerings:

Atwater Kent		
Model 10-5 Tube	\$12.50
Model 20-6 Tube	19.50
Compact-5 Tube	22.50
Model 30-6 Tube	27.50
Model 35-6 Tube	29.50
Radiola		
3A-4 Tube	12.50
20-5 Tube	24.50
25-6 Tube	32.50
Semi-portable-6 Tube	32.50
28-8 Tube	60.00
Freshman		
5 Tube	10.00
Franklyn Model-5 Tube	12.50
Masterpiece-6 Tube-1 Dial	17.50
Freed-Eisemann		
NR 5-5 Tube	19.50
NR 7-6 Tube	22.50
10-5 Tube	14.50
Crosley Bandbox-6 Tube	25.00
Atwater Kent Pooley Cabinets, arm- chair model, Japanese Lacquered, with speaker	32.50
Cone Speakers	\$5.00 up
Horn Speakers	3.00 up

Many more styles and makes in stock
 All offerings subject to prior sale.

PEERLESS SERVICE CO.
 91 Seventh Ave., New York, N. Y.

Exide
RADIO BATTERIES
 Manufactured by
THE ELECTRIC STORAGE BATTERY CO.
 Philadelphia

ing "Wavemeter Hints for the Short-Wave Listener." Those who have no desire to construct a wavemeter must be content with whatever their operating technique, patience and location can obtain for them.

On the other hand, there is a class of constructors who appreciate the fact that when they are fortunate enough to be in a good location and the receiver is working efficiently, and atmospherics are not troublesome, and they operate their receiver intelligently—they may, if they have a certain amount of luck, hear a foreign broadcast station. If they are very lucky, they may get it regularly. But the short-wave listener must learn his trade, and *know his set*.

Room at the Top in Radio

(Continued from page 1078)

by the newspapers and magazines without cost to Silver; simply because editors discovered that if—in deference to what are ordinarily considered good principles of journalism—they omitted all mention of manufacturers' names in publishing these articles, the articles thereby became much less interesting to their readers.

But above all, Silver's articles met the final test that every editor always applies to every contribution: "Is it news?" Decidedly, his articles were news, news that the public wanted, and so Silver's writings became more and more in demand. With a little publicity-seeking, Silver's name might have become much more of a household word than it is, but he shunned the spotlight. Unlike many another executive, his name has seldom appeared in print except over technical articles, and until the issuance of the R.C.A. license sent reporters scurrying for "human-interest" stories and pictures, his picture had been seldom published. It was only with considerable effort that material for this story could be drawn from him.

Silver maintains, and apparently with very decided truth, that his success has not been due to any divine inspiration, or any special spark of genius. It has been due rather to the fact that he paid no attention to the five o'clock bell, but worked eight to twelve hours per day for his employers—was often sent home by them so that they could lock up for the night—and eight to ten hours more for himself. Few boys today have the necessary energy and determination to do this—perhaps for the same reason few of them are as far ahead at the age of twenty-six. And, if Silver is correct, then the requisite for success for any boy seems to be only the ability to be intensely interested and curious; for if interested he will work without thought of time, and if curious he will surmount every obstacle to learn.

And, speaking of learning, in the early days when Silver first studied radio there were no radio engineering courses in any of the colleges, and the path to knowledge was a hard and original one. Had there been radio correspondence courses such as there are today, had there been radio engineering college courses, it is difficult to estimate how much faster this young man might have developed.

Silver is a man who never talks about his past successes—he is always living for tomorrow, working for the future. A thing once done is no longer food for his active mind—it is dead, to be put out of his thoughts to leave his mind free for the future. But if

he will not consider what he has already accomplished, others can at least do so; and, judging from his past performance, they prophesy for this young man who has already reached what most men would call the top of the ladder, a future of the most brilliant accomplishment. He has had but a few years; give him a few more, and—but the surprising thing is that almost any boy today can do as much.

**Making the Air Safe for
 Traffic**

(Continued from page 1068)

notes that he is exactly on the course again. He has been checking off his marker beacons, and a glance at his wrist watch tells him that he is making one hundred miles an hour.

IN SAFETY

He whistles to himself with a feeling of absolute security. He knows that he is en route to his destination, following the shortest possible line between the two flying fields. He is at a safe altitude. Science has conquered the menace of the clouds below him. He cannot become lost, the possibility of a forced landing is remote with his three-engined plane and, if worst comes to worst, he and his passengers have their life preservers of the air.

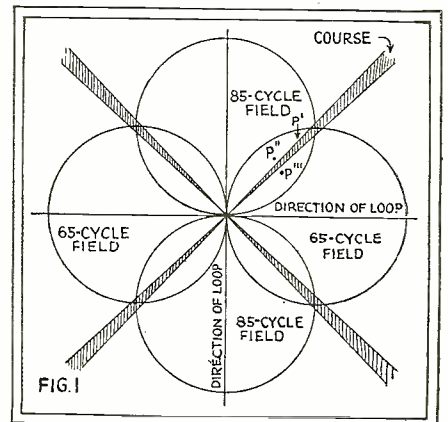

Each loop has a directional field at right angles to the other; in the shaded lines between them where the two fields are of equal strength the pilot finds his course laid out for him.

An hour and a half passes. His co-pilot has been counting the marker beacons as they flashed before him.

"Ten miles more," he says.

The swing of the beacon becomes less pronounced. The white lines become shorter and shorter. Suddenly they cease to move. The plane is directly over the field! Radio-telephone communication with the ground determines the weather conditions below. If the ceiling is above two hundred feet, the plane bores through the clouds and comes in to a conventional landing. If the ceiling is very low, the radio altimeter is used and the pilot knows exactly how far he is above ground, to the foot almost. He circles the field, coming down in a slow spiral. Red boundary lights glim beneath him. He straightens out into the wind, levels the plane off. As it settles, he pulls the control wheel back to his chest. Deft aileron control, with just the proper touch of the rudder, keeps the plane steady, as it glides in to a perfect three-point landing.

In our next flying story we shall tell you how the radio altimeter, the companion instrument to the radio beacon, works.

The "Explorer Eight"

(Continued from page 1098)

power-supply device which may be constructed to furnish the necessary "B" potential to the receiver when the 171A tube is used in the power output stage. These illustrations are self-explanatory; it being necessary only to follow the layout and wiring arrangements shown to obtain satisfactory results.

In Fig. 2 the two condensers at the top of the figure, which shunt the "B+45" and "+135" terminals on the voltage divider R18, though not shown as such, are contained within the "B" block C16 and are each of 1-mf. capacity.

When the "L45" power tube is used in the "B" power-supply unit it will be necessary to substitute for the line transformer T5, one that will deliver greater voltage to the rectifier unit. The S-M 327 power transformer will not only prove satisfactory for this purpose but in addition it will furnish the necessary 2.5 volts for the filament of the 245 tube, from its extra filament windings.

So much of data and diagrams is available from manufacturers, concerning the correct construction of a satisfactory high-voltage "B" power-supply device, that instructions governing its construction will not be given here. Suffice it to say that, in general, the circuit diagram will be similar to that shown in Fig. 2. The only difference will be in the electrical values of the various parts employed, depending, of course, on the maximum output value that is desired.

The several photographic illustrations accompanying were taken from the author's later set-up, wherein the L45 tube was used, together with an S-M 850 dynamic loud speaker; the set being powered from a National "B" supply unit and a Tobe "A" supply device.

In later issues some further suggestions will be given for the constructor who desires to increase sensitivity on weak DX signals by the use of a booster unit or tuned aerial stage at the expense of an added control—as many may do, notwithstanding the very high amplification and keen selectivity already obtained with the four following tuned stages. Some other optional changes will be suggested as well; as, for instance, a 250-type amplifier, should the volume desired be greater than that required for the ordinary home.

LIST OF PARTS

- The following were the components used in the original receiver, here illustrated:
 Two Hammarlund "Battleship" two-gang condenser units, type BSD 50, 0005-mf. (C1-C2, C3-C4);
 Two "Tinytobe" fixed condensers, one .00025-mf. (C5), one .001-mf. (C6);
 Six Tobe by-pass condensers, type No. 300, 1-mf. (C7, 8, 9, 10, 11, 12);
 Three Tobe by-pass condensers, 0.1-mf. (C13, 14, 15);
 Four Aero "Universal" R.F. transformers, type U4 (T1, T2, T3, T4);
 One Electrad "Tonatrol," type A, 0-500,000-ohm (R1);
 Eight "Amperites," one type 622 (R2), six type 1A (R3, 4, 5, 6, 7, 8), one type 1I2 (R9);
 One Durham grid leak, 5-megohm (R10);

BE A RADIO DOCTOR



Radio servicing offers the biggest opportunity for the man interested in radio. About 10,000,000 receivers need service some time or other, many are naturally inefficient and can be improved on. The Radio Doctors, Inc., is the only institution teaching exclusively radio repairs, having specialized on this phase of radio for a number of years.

\$3,000 to \$5,000 per year

The professional "Radio Doctor" receives \$2.00 or \$3.00 per visit and is welcomed in the best of homes—may I tell you more about this new, fascinating and extremely profitable business? Write now for free booklet, "Why the Radio Doctor." (Early inquiries will receive a blueprint of recent well-known manufactured superheterodyne.)

E. W. PARKER, Pres. RADIO DOCTORS, INC.
 Dept. N8, 131 Essex Street Salem, Mass.



You are interested in the Engineering developments in Radio; if you are an engineer, a dealer, technician, service man, or an advanced experimenter

Read further and Use the Coupon

Published Monthly



RADIO ENGINEERING is particularly valuable for those who are now employed in or connected with the radio industry or trade—in fact, the engineering and production personnel of practically every radio manufacturer is on our subscription lists. The editors, Muhleman, McNicol and Lescarbourea, are exceptionally equipped. If you are at present working within the radio field—or if you plan to do so—you ought to be reading Radio Engineering every month.

Well, if you don't use the coupon now, you'll probably forget it.

CONTENTS March, 1929

- Light-Sensitive Cells, Part I—By John Patton Arnold
- Reducing Noise in Broadcast Receivers—By R. Wm. Tanner
- The Kyle Condenser Reproducer—By Colin Kyle, A.B.
- A Remote Tuning Control for Radio Receivers—By Walter Faas
- Radio Receiver Trouble Due to Connection with Light Circuits
- The Engineering Rise in Radio, Part X—By Donald McNicol
- A New Signal Relay—By C. T. Burke
- A New Automatic Voltage Regulator—By Kasson Howe
- Centralized Radio Systems
- Radio Color Curtains

Departments

- News of the Industry
- New Developments of the Month
- Buyer's Directory

Radio Engineering
 is NOT sold on
 newsstands

BRYAN DAVIS PUBLISHING CO., Inc.,
 52 Vanderbilt Avenue, New York, N. Y.

Enclosed find { \$2.00 for 1 year } subscription to Radio Engineering.
 { \$3.00 for 2 years }

Enclosed find twenty-five cents (25c) for which send sample copy of Radio Engineering.

Name

Address

City..... State.....

PLEASE PRINT NAME AND ADDRESS

Please Check Your Classification

Manufacturer

(Please check "M" if you are an executive, production manager, plant superintendent or foreman, service manager or purchasing agent)

Dealer or Distributor

Engineer

Service Man

Technician

Anything Else.....

Please say you saw it in RADIO NEWS

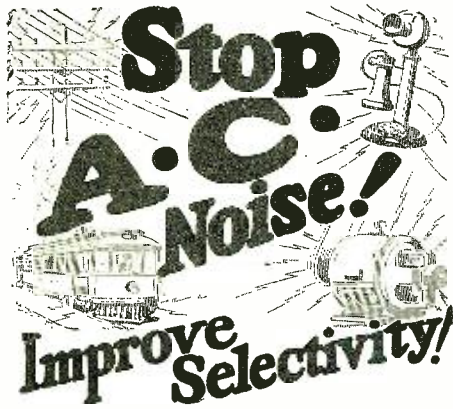

To eliminate "static" from motors, street cars, telephones and electrical appliances, plug in a Falck Claroceptor between wall socket and radio set. This new improvement by a pioneer manufacturer grounds and thus blocks out line interference noise and radio frequency disturbances. Also improves selectivity and distance. Requires no changes in set. Measures just 3½x5½x2½ inches. Thousands all over America now use the Claroceptor for clearer A.C. reception. Get one right away—at radio parts dealers. Write for descriptive folder.



Manufactured by ADVANCE ELECTRIC CO.
1260 W. Second Street Los Angeles, Cal.
JOBBERs AND DEALERs, GET OUR PROPOSITION

THE DRAKE HOTEL is wonderfully located. On the lake, yet within easy walking distance of the heart of downtown Chicago. For tempting food and remarkable service, THE DRAKE is known far and wide. Rates are reasonable—as low as five dollars a day single room with bath, six double. Special discounts for extended stays. Write for Illustrated Booklet, Edition 29.

Under the Blackstone management known the world over

The DRAKE HOTEL Chicago

Put Your Voltage Control Problems up to Electrad
Write Dept. RN6, for useful data

175 Varick St., New York, N.Y.

ELECTRAD INC.

Write for our latest Catalog "B-3," showing big savings in everything for Radio

ALLIED RADIO CORPORATION
711 W. Lake Street Chicago, Ill.

- One Durham "Powerohm," 2500-ohm (R11);
- Three Durham plate resistors, 100,000-ohm (R12, 14, 16);
- Three Durham grid resistors, two 0.5-megohm (R13, R15), one 0.25-megohm (R17);
- Eight Durham single-resistor mounts, for the above;
- Eight Silver-Marshall sockets, type 511;
- One Hammarlund R.F. choke, 85-millihenry, type 85 (L1);
- One National Drum Dial, type F;
- One Yaxley Battery switch, No. 10;
- Two Yaxley cable receptacles, No. 660;
- One Lignole panel, 7x21x3/16-inch;
- One baseboard, 12½x20½x7/8-inch;
- Three boxes Corwico solid "Braidite";
- One National tone filter (TF)—unless dynamic speaker is used;
- Four Electrad wire-wound grid suppressors, 300-ohm, to be used at "X" only if required, as explained above.
- One CeCo "RF22" tube, V1;
- Three CeCo "AX" tubes (V2, V3, V4);
- One Ceco "H" detector tube (V5);
- Two Ceco "G" high-mu tubes (V6, V7);
- One Ceco "J71" power tube (V8).

POWER SUPPLY

- One Silver-Marshall power transformer, type 329A for 71-type tube, or type 327 for 45-type power tube (TS);
- One Silver-Marshall "Unichoke" type 331 (L2);
- One Electrad "Truvolt" voltage divider (R18);
- One Tobe "B" block, type 760, 2-2-8-1-1-mf. (C16);
- Two Tobe filter condensers, 1-mf. (C17, C18);
- One Silver-Marshall UX socket, type 511;
- One Ceco "R80" rectifier tube (V9);
- One baseboard, 8x12x3/4-inch;
- One box Corwico stranded "Braidite";
- One Tobe "A" supply unit.

WINDING SPECIFICATIONS

Diameter of solenoid	2 inches
Number of secondary turns	76
Number of primary turns	15
Size wire (sec.)	No. 20 D.C.C.
Size wire (pri.)	No. 24 D.C.C.

The primaries may be wound on forms slightly smaller in diameter than the secondaries so that they can be inserted at the filament end of the secondary coil; or the primaries may be wound on the same form as the secondaries, a space of 3/16-inch being left between the two coils. The direction of winding for both coils must be the same.

These specifications are for .0005-mf. condensers. Should the constructor desire to use .00035-mf. instruments, he should use 86 turns on each secondary and 20 on each primary.

For the "DX" Fan

(Continued from page 1101)

- (9) By-pass condensers of 1 or 2 mf., connected between "B—" and the various "B+" terminals of the radio set, will improve sensitivity and tone quality of weak signals.
- (10) And in the final analysis, DX is largely a matter of patience and skill; for some fellows can hear* Hong Kong on a crystal detector while others cannot cover 500 miles with an eight-tube superheterodyne.

—Clarostat Engineering Bulletin.

* Those who really do so are, as a rule, in Hong Kong.—EDITOR.

Short - Wave Manual

Prepared by Eminent Short-Wave Experts

Edited by H. M. BAYER

Up-to-the-Minute Data—All Worth-While Circuits

50c

THE COPY

FULL SIZE BLUEPRINTS BOUND IN BOOK

As practically every one today knows, some of the finest programs are being broadcast over the short-wave bands. There are many reasons for this. Paramount among them all is the fact that that entertainment, broadcast in this band, can be received over distances which with the ordinary broadcast receiver would be impossible! Thousands of letters, which pour in an unremitting stream into our offices tell the same tale—it is a common and everyday matter to receive programs from all foreign countries, from the most distant climes. England, France, Germany, towns on the African continent, from every conceivable corner of the globe where a station is located—programs come in with surprising volume and clarity. One would think they were hearing a New York, Chicago or San Francisco station until the voice of the announcer, many thousands of miles away, discloses the true location of station. In the SHORT-WAVE MANUAL you will find complete diagrams, full size blueprints pasted into the book. These tell plainly how to construct all these short-wave circuits, which our tireless laboratory researches have shown to be most efficient. The SHORT-WAVE MANUAL contains complete information on everything concerning Short-Wave reception. Large size book (same size as Radio News) with a beautiful colored cover. Replete with illustrations, diagrams and with FULL SIZE BLUEPRINTS. This big valuable book will show you how to receive all the foreign countries clearly and easily. Write today for your copy.

EXPERIMENTER PUBLISHING CO., Inc.

230 Fifth Avenue New York

Mail This Coupon

EXPERIMENTER PUBLISHING CO.,
230 Fifth Avenue, New York.

Gentlemen:

Enclosed find 50c for which please send me a copy of THE SHORT-WAVE MANUAL.

Name

Address

City..... State.....

Please say you saw it in RADIO NEWS

The "RE 29 Receiver"

(Continued from page 1092)

LIST OF PARTS

- Two Hammarlund .0005-mf. "Midline" tuning condensers (C1, C2);
- Six Sangamo .00025-mf. fixed condensers (C3, C4, C5, C8, C9, C10);
- Two Acme "Parvoly" 0.5-mf. by-pass condensers (C6, C7);
- One Sangamo .001-mf. fixed condenser (C11);
- One Lacault B1 antenna coupler, with base (L1);
- One Lacault B2 oscillator coil, with base (L2);
- One Lacault F2 intermediate-frequency transformer with base (L3);
- Two Lacault SG intermediate-frequency transformers, with two bases (L4, L5);
- Two Lacault CL radio-frequency choke coils (L6, L7);
- One Sangamo type A (3-to-1 ratio) audio transformer (T1);
- One Lynch "Equalizer" No. 22 (R1);
- Three Lynch "Equalizers" No. 4 (R2, R5, R6);
- Two Carter 25-ohm fixed resistors, with a tap on each at 15 ohms (R3, R4);
- One Carter filament switch (SW);
- Six Benjamin sockets (V1, V2, V3, V4, V5, V6);
- Three Carter tube shields;
- Three "Pee-wee" clips;
- Two National Type E dials, with dial lights (D1, D1.2);
- Three "Alcoa" aluminum stage shields;
- Two binding posts, "Antenna" and one "Ground," with 1 x 3 inch bakelite strip and two brackets;
- One Jones "Multiplug," 10-wire;
- One 7 x 24-inch bakelite front panel;
- One 12 1/4 x 25 1/2-inch baseboard;
- One Fritts cabinet (Cat. SS24);

(The full constructional details, with pictorial layout and wiring diagrams, will appear in the July issue of RADIO NEWS.)

40 Non-Technical Radio Articles

every month for the beginner, the layman and those who like radio from the non-technical side.

SCIENCE AND INVENTION, which can be bought at any newsstand, contains the largest and most interesting section of radio articles of any non-radio magazine in existence.

Plenty of "How to Make It" radio articles and plenty of simplified hook-ups for the layman and experimenter. The radio section of SCIENCE AND INVENTION is so good that many RADIO NEWS readers buy it solely for this feature.

Radio Articles Appearing in June
SCIENCE AND INVENTION Magazine

- MAKING AN EXPONENTIAL HORN—By Ernest Romkee
- A RADIO COLOR SCREEN
- A RADIO-PHONOGRAPH COMBINATION
- A RADIO FISH SCREEN
- A TALKING SIGNBOARD
- NEW RADIO DEVICES
- RADIO ORACLE
- LATEST PATENTS

Now FORGET AERIAL TROUBLES!

GET NEW SELECTIVITY and Clarity on Both Local and Distant Stations

Delightful Freedom from Interference—Sweeter Tone



PROOF!

After investigating and making tests with your underground antenna, I find that the results obtained are very satisfactory.

I would recommend it in place of loop aerials, inside aerials or roof aerials because I find we are able to obtain clearer reception, also it reduces outside interference and static, and gives better selectivity. It is easy and convenient for the user to install.

HARRY R. JACKSON,
Radio Engineer.

Why go on listening to terrible static and other maddening outside noises? Now, with this marvelous new Radio Invention, Subwave-Aerial, Radios can get reception—music, singing, speaking—just as clear and sweet toned as if the players were right in the room with you. Reach out and bring in DX Stations crisp and clear that were smothered out by power-line noise and strong Local Station interference without the use of Subwave-Aerial. The air is always full of static and your overhead aerial picks it up and brings it to your speaker. So why stay in the air—when you can get earth-purified ground wave reception with the use of Subwave-Aerial? Reports from Tests and Users prove that a new joy in Radio reception awaits you.

Simple — Convenient

You've no idea how easy it is to install Subwave-Aerial. Takes only about 5 minutes—and you never need to worry about keeping it in order. Old Mother Earth takes care of that! She keeps wind, storms, lightning, power-line noises, rust, corrosion, soot and other roof-aerial evils away—and provides actual scientific protection by "short-circuiting" the electrostatic capacity of the buried aerial. Costs no more than an overhead or loop aerial and less than many. NO UPKEEP COST. Subwave-Aerial is permanent. No trouble — no hard work, or risking your neck on roofs.



Subwave-Aerial Guaranteed for 25 Years

Any Subwave-Aerial which has been installed according to directions and proves defective or deteriorates within 25 years, will be replaced free of charge; also we will pay \$1.00 for installing any such new replacement.

Try Subwave-Aerial FREE

Now you have a chance to prove the merits of this great new radio development for yourself. Try to pick a night when static is bad and make the thrilling test. It's fun. Be sure to send today for the interesting details on Subwave-Aerial and our Free Test Offer.

UNDERGROUND AERIAL PRODUCTS
Suite 618, St. Clair Bldg.
Dept. 827-H.W.
St. Clair & Erie Sts. Chicago, Ill.

UNDERGROUND AERIAL PRODUCTS,
Suite 618, St. Clair Bldg.,
Dept. 827-H.W.,
St. Clair & Erie Sts., Chicago, Ill.

Rush illustrated literature on the new Subwave-Aerial and details of your Free Test Offer.

Name

Address

City..... State.....

Subwave-Aerial



Wire Your Home for Radio

For every radio need, in brushed brass or Bakelite. Fit standard electrical switch or outlet box. Single plates and in gang in many combinations.

- No. 135—For Loud Speaker.....\$1.00
- No. 136—For Aerial and Ground... 1.00
- No. 137—For Battery Connections... 2.50
- No. 138—For A C Connections..... 1.00 (Bakelite, 25c additional per plate)

YALEY MFG. CO.
Dept. N, 9 So. Clinton St., Chicago, Ill.

SET BUILDERS

Get this Book

LATEST RADIO GUIDE **FREE**

Barawik, the first and oldest radio specialty house, offers you unusual service this year. Bigger stocks, quicker shipments, lower prices. Deal with an old established reliable house. Get honest goods, honest service, honest prices. Barawik service makes you more money. Send now for big new Catalog showing lowest wholesale prices.

BARAWIK CO. 26-B Canal Sta. CHICAGO, U. S. A.

Mail This Coupon Now for Free Radio Guide

Name

Address

Please say you saw it in RADIO NEWS

Individual, Independent Speaker Volume Control



Constant Input Resistance.
LIST PRICE \$3.00

The Centralab Constant Impedance Volume Control is the only unit that allows a number of speakers operated from the same amplifier to be controlled individually without affecting the other speakers in the circuit. It is a dual resistance unit

with one resistance shunting the speaker for volume control and the other resistance in series with the line. Adjusting the knob varies both resistances so that while one short circuits the speaker to control volume, the other resistance is added to the line, maintaining a constant impedance. Easy to install, smooth and efficient in operation. Send for interesting booklet of picture and wiring diagrams, "Voltage and Volume Controls—Their Use."



20 Keefe Avenue

Milwaukee, Wis.

SHORT WAVES

without the expense of a new set!

The Submariner



WILL CONVERT YOUR RADIO SET INTO AN EFFICIENT SHORT-WAVE RECEIVER

Simply remove a tube from the set and place it in the socket from which tube was taken, attach aerial and ground to clips of "Submariner." Write for our money-back guarantee. Enthusiastic owners have written us from all parts of the world. Stations 8,000 miles away have been received. Vernier dial 32 to 1 ratio. Users are getting foreign stations the year around. There is very little static and short waves carry a much greater distance.

FOUR MODELS

20 to 65 meters for battery tubes, \$15.00. For all electric, \$17.50. Interchangeable coil model, 10 to 160 meters, \$22.50, for A.C. or D.C. receiver. No. 4 coil, 160 to 340 meters, \$2.00 additional. In ordering, be sure and state name of set and the number on each tube. Ask your dealer for one. If he does not carry them, he will get one for you.

If you are unable to get one locally, it will be sent postpaid upon receipt of money order or certified check. Sent C.O.D. only if \$1.00 accompanies order. This is to insure carrying charges. Price in Canada and some other foreign countries, 60c. additional. Cannot be sent C.O.D. outside U. S. ORDER TO-DAY.

J-M-P MANUFACTURING CO., Inc.
3413 Fond du Lac Ave. Milwaukee, Wis., U. S. A.

Transformer Design

(Continued from page 1117)

The area of the 25-volt secondary wire is then

$$5 \times 1200 = 6000 \text{ cir. mils.}$$

and for the other two windings is 18,000 and 1,680 cir. mils respectively.

Upon looking at the table, the wire gauge for the 25-volt coil it is found to be No. 12. The 2-volt coil should be wound with No. 8; but, as this is too heavy to handle, three No. 12 conductors will be wound in parallel and will have a combined area of 19,600 cir. mils., which is ample. The primary wire size is No. 18.

After subtracting $\frac{1}{8}$ -inch for insulation at the ends of the coil, the net length of each layer is $\frac{3}{8}$ inches or 3.875. The turns per layer for the No. 12 wire then are $3.875 \div .0926 = 41$ and, for the three parallel No. 12s on the 2-volt coil are

$$3.875 \div (3 \times .0926) = 13$$

and for the No. 18 are $3.875 \div .0495 = 78$.

The gross space available for the coils around each leg is 1 inch. From this must be subtracted the insulation; which will consist of a $\frac{1}{16}$ -inch tube around the core, two layers of .008 oiled paper between primary and secondary, two more layers of the same paper between the two secondaries, and a layer of .010 cotton tape, around the outside. A further factor of safety of 0.1-inch should be included. All of this makes the net winding space 1 inch less 0.2-inch or 0.8-inch.

The thickness of each coil is approximately proportional to the power and for the 110-volt coil is

$$155$$

$$\text{---} \times .80 = 0.40\text{-inch}$$

$$155 + 125 + 30$$

and for the 25-volt coil

$$125$$

$$\text{---} \times .80 = 0.32\text{-inch}$$

$$155 + 125 + 30$$

and for the 2-volt coil

$$30$$

$$\text{---} \times .80 = .008\text{-inch}$$

$$155 + 125 + 30$$

The number of primary layers is

$$.40$$

$$\text{---} = 8$$

$$.0495$$

and the total primary turns are $8 \times 78 = 624$ on each leg.

$$55$$

The volts per turn are $\text{---} = .088$

$$624$$

The turns on the 25-volt coil are

$$125$$

$\text{---} = 142$ and the number of layers =

$$.088$$

$$142$$

$\text{---} = 4$ (next integral number).

$$41$$

The thickness of this coil is $.0926 \times 4 = .37$ -inch.

The number of turns required for the

$$1$$

2-volt coil are $\text{---} = 12$; which can be

$$.088$$

wound in one layer making the thickness of the coil = .09-inch.

It will be noticed that in these calculations only half the voltage of the coil has been used. This is because the transformer is of the core type with half the winding on each leg, so that each coil gives half the total voltage that will result when the windings

of each leg are connected in series in the completed transformer.

The total thickness of three coils and insulation is, with the parts taken in order,
 $\frac{1}{16} + .40 + .016 + .37 + .016 + .09 + .01 = .964$ -inch,

which should fit without trouble in the available 1-inch space. Had the thickness been greater than one inch, the net winding space would have to be reduced from .08-inch, to, say, 0.75-inch and the design carried out again from that point.

The required cross-sectional area of the core is $.088 \times 6.25 = 0.55$ -sq. in., and the thickness of the pile of laminations is

$$.55$$

$$\text{---} + 10\% = 0.605\text{-inch.}$$

$$1$$

The coils will therefore be wound on a tube built over a form 1×0.61 -inch, and the iron assembled in them to the required thickness.

If the builder did not wish to wind so many turns of wire, he may use a greater thickness of iron and reduce the number of turns in direct proportion.

TABLE OF MAGNET-WIRE SIZES

Gauge B&S	Diam. D.C.C.	Diam. S.C. Enam.	Ft. per lb. D.C.C.	Ft. per lb. S.C. Enam.	Area Cir. Mils
10	.118	.117	30.9	30.9	10380
11	.105	.104	38.8	38.8	8234
12	.0942	.0926	48.9	49.0	6530
13	.0842	.0830	61.5	61.7	5178
14	.0763	.0745	77.3	78.0	4107
15	.0682	.0670	97.3	98.5	3257
16	.0554	.0600	119	121	2583
17	.0532	.0550	150	154	2048
18	.0500	.0495	188	196	1624
19	.0458	.0443	237	247	1288
20	.0418	.0395	298	311	1022
21	.0382	.0350	370	389	810
22	.0351	.0323	461	491	642
23	.0320	.0292	584	624	510
24	.0298	.0266	745	778	404
25	.0276	.0241	903	958	320
26	.0250	.0221	1118	1188	254
27	.0235	.0202	1422	1533	202
28	.0220	.0185	1750	1903	160
29	.0208	.0170	2207	2461	127
30	.0196	.0155	2534	2893	100
31	.0176	.0145	2768	3483	80
32	.0166	.0133	3137	4414	63
33	.0156	.0123	4697	5688	50
34	.0147	.0114	6168	6400	40
35	.0137	.0106	6737	8393	32
36	.0128	.0099	7877	9846	25

Note: Diameters in the above table are given in inches.

245 Push-Pull Amplifiers

(Continued from page 1101)

In a general way, this unit is very similar to the National device just described; it differs essentially in that no external "B" plate voltages are available for use in operating the tubes of a tuner unit. It employs a 227 tube in the first audio stage and two 245 tubes, arranged in push-pull, in the second or power output stage; the rectifier is a 280 tube. This unit is designed in different models, for use with either magnetic or dynamic loud speakers; that is to say, it comes equipped with an output transformer which is suitable for one particular type of loud speaker. Therefore, when such a unit is selected, it is necessary to determine the type of speaker which is to be used with it;

Used RADIOS AS LOW AS \$9.90 UNHEARD OF VALUES!

Take your choice. All in beautiful fable model cabinets. Lot No. 1 Can hardly be told from new. Guaranteed \$14.90 Lot No. 2 Perfect working order. Guaranteed... 12.90 Lot No. 3 Requires slight adjustment. Sold as is... 9.90 Mail your order today or send for circular. We ship promptly. Upon arrival pay price of set ordered plus a small delivery charge. Foreign countries send money order with order.) CHAS. HOODWIN CO., 4240 Lincoln Ave., Dept. 6 Chicago Dealers in Bankrupt Radio Stocks

so that the correct type of output transformer is included. Combinations employing a pair of 171A tubes in the push-pull stage are also available.

The home-built combination illustrated in Figs. D and E follows rather closely the general circuit details of the National unit but is, of course, far less compact. It is built with a "deck" type of construction; the lower deck holds the power-supply equipment and the upper deck, the complete audio channel. If preferred, the two baseboards may be arranged side by side or end for end. The parts employed are of standard manufacture and are easily obtainable. The first stage of audio amplification has a 227 tube and the second stage, which is a push-pull arrangement, uses two 245 tubes.

The power unit not only supplies "B" potential to the audio channel above but, by means of a "Truvolt" voltage divider, located at one end of the unit, intermediate voltages are made available for any tuner unit which may be used together with this combination. In a future issue, complete constructional details of this home-made combination unit will be given.

A. C. Screen-Grid "Everyman"

(Continued from page 1104)

the speaker which it is desired to use. The "B-" and "C+" returns are indicated by a dotted line in Fig. 1A; when this amplifier is used in conjunction with the "Everyman Five," this terminal is the same as that used with the R.F. tubes.

The writer personally and heartily recommends the A.C. Screen-Grid "Everyman" tuner, and the accompanying amplifier here described, both to the experimental fan, and to the average radio enthusiast through the medium of the custom set builder.

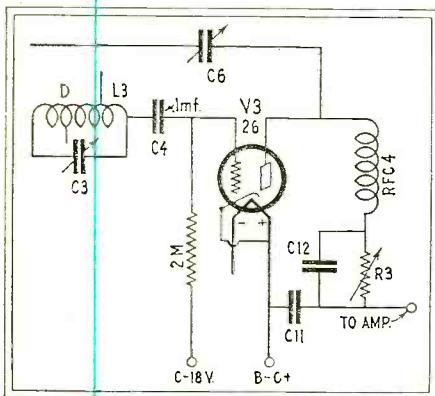

Fig. 3

The method of detection shown will be more satisfactory here; it is practicable only with a receiver having high R.F. amplification, like the "Everyman."

PLATE DETECTION

The writer, personally, recommends a further modification of the original "Everyman" design: thus providing for plate rectification in the detector circuit. This can be secured with the detector used, with practically no loss in sensitivity, yet the usual gain in quality. The circuit of this suggested alteration is shown in Fig. 3. The only changes are the substitution of a 0.1-mf. condenser for the usual grid capacity and the inclusion of a by-passed universal-range Clarostat in the plate circuit of the detector tube. The grid leak is brought down to a negative bias of 18 volts, instead of to a positive "D" terminal. The plate resistor is adjusted for minimum hum and maximum signal response.

MAY, 1929 25 CENTS

RADIO

Extra Special Offer
for 30 Days Only!

Save 50%

READERS of "RADIO NEWS" are given a 30-day opportunity to get in on the following money-saving offer: Send only \$1.00 in full payment — get the next six issues of "RADIO," and the very latest indexed Log Book, showing all of the last minute listings of all broadcast stations in the U. S. and Canada. Printed on heavy stock. Nothing else like it on the market. Spaces for dial loggings. Arranged by meters and kilocycle bands. Directory, data, etc. All in a handy, sturdy INDEXED booklet. You will be mighty pleased with it. And you get the next six issues of "RADIO," a national magazine, established 12 years ago. Regular price for the magazine subscription and the LOG BOOK is \$2.00. You get BOTH for \$1.00, if you mail the coupon NOW. Don't delay. This offer will never be made again.

Send
\$1.00
and the
COUPON

----- COUPON -----

"RADIO," Pacific Building, San Francisco, Calif. RN

Here is \$1.00 in FULL PAYMENT for the next six issues of "RADIO" and a copy of the very latest INDEXED LOG BOOK, which you will send to me by mail at once.

Name

Street and No.....

City and State.....

\$5.50 buys this famous cabinet!

The Iveyline

Sizes range from 7 x 18 x 10 to 7 x 30 x 12. Mahogany finish, \$5.50 to \$8.75. Solid Walnut, \$6.50 to \$10.25. F.O.B. Hickory. Twelve-hour service. Write for Catalog.

Southern Toy Company
Manufacturer
Hickory, N. C.

SET BUILDERS

Get this Book

LATEST
RADIO
GUIDE
FREE

Barawik, the first and oldest radio specialty house, offers you unusual service this year. Bigger stocks, quicker shipments, lower prices. Deal with an old established, reliable house. Get honest goods, honest service, honest prices. Barawik service makes you more money. Send now for big new Catalog showing lowest wholesale prices.

BARAWIK CO. 26-D Canal Sta., CHICAGO, U. S. A.

Mail This Coupon Now for Free Radio Guide

Name.....

Address.....

Please say you saw it in RADIO NEWS

AEROVOX

BUILT BETTER
CONDENSERS AND RESISTORS

Takes Out the Hum in Any Dynamic

IN spite of the many methods utilized to eliminate the hum in A. C. dynamic speakers, many of the best dynamics still have a hum which is sufficiently pronounced to be objectionable, especially during lulls in the program while waiting for announcements.

You will be surprised at the completeness with which an Aerovox 1500 mfd. "A" condenser, connected across the field coil or across the rectifier output, will eliminate the hum and increase the sensitivity of the speaker.

Complete details and comparative data, showing the results obtained when using these condensers to eliminate hum, will be furnished on request.

Send for Catalog

containing detailed descriptions and complete specifications of all Aerovox products. Free on request.

The Research Worker

contains, each month, valuable information on radio design. It will be sent free on request.

AEROVOX WIRELESS CORP.
78 Washington St., Bklyn., N. Y.
PRODUCTS THAT ENDURE

The Service Man

(Continued from page 1120)

The wave from a radio transmitter is distorted by irregularities in the contour of the earth, it is reflected by buildings and is carried over power and communication circuits, to say nothing of the fact that the symmetry of a coil antenna is destroyed by coupling to these circuits.

An interference having its source in a device connected to a power circuit causes very little disturbance due to direct radiation; but can be heard for miles along the power line. This proves the theory that the wave set up by the device is *carrier radio* and not *space radio*. Hence the loop will point *parallel to the line*.

Assume interference having its source in a leaky insulator as pictured in Fig. 1 of the article referred to. The quickest way to locate it is to patrol the line and find a point where the intensity of the noise is at maximum. This maximum is hard to determine at times; because there will be a number of peaks caused by transformer installations, coupling to lightning-arrestor grounds, and reflection at corners. The enclosed sketch shows the bearings taken with the loop during this investigation (Fig. 6).

I believe that the fable of the "leaky transformer" has its origin in the peak of the disturbance at every transformer. Early investigators blamed the transformers, instead of carrying their tests to a conclusion by actually locating the source.

J. H. O'CONNOR,

Radio Engineer, Public Service Co. of Colorado, Denver, Colo.

(We have received from other engineers of lighting and power companies information as to their experiences in the practical location of interference. This will be published, as opportunity affords, for the benefit of our readers; as the subject is compelling lively interest in the radio industry.—EDITOR.)

The Home-Talkie Machine Corporation of New York City has recently perfected a unit consisting of turn-table, electric pick-up, volume control and flexible cable for connection to the reel shaft of the 16 mm. projectors now enjoying wide use among amateur photographers. By its use synchronized home-talkies are now available.

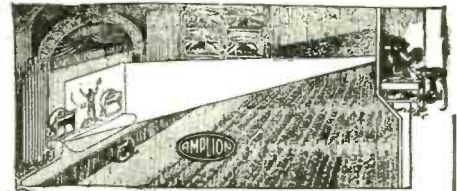

PUBLIC ADDRESS SYSTEMS

installed with AMPLION sound equipment give **PERFECT PERFORMANCE**
With a background of 45 years of success in the acoustic field Amplion is prepared to offer public address equipment of unsurpassed dependability for theatres, hotels, auditoriums, hospitals, clubs, railroad depots, county fairs, etc.

We Have Ready for **IMMEDIATE DELIVERY** and Quick Installation Group Address Equipment as follows:
AMPLION EXPONENTIAL AIR COLUMN HORNS
AMPLION GIANT DYNAMIC AIR COLUMN UNITS
AMPLION EXCITERS AMPLION MICROPHONES
AMPLION ELECT. PHONOGRAPH PICK-UP
AMPLION MICROPHONE AMPLIFIERS
AMPLION MICROPHONE TRANSFORMERS
AMPLION CABINETS FOR MOVING PICTURES
AMPLION is the **ONE** place in America where you can purchase complete installation or any part of the equipment as desired.

Write for new catalog and profitable Amplion proposition to competent engineers.
Wanted We need **RADIO ENGINEERS** in all parts of the country for making Public Address Installations. If interested, file your name, address, training, and experience, together with references, with **PUBLIC ADDRESS DEPT.**

AMPLION CORP. OF AMERICA
133 W. 21st Street New York

Good Buys in "B" Battery Power
100-Volt Edison Element, Non-Disruptive, Rechargeable "B" Battery with charger. Shipped dry, with solution, \$12. 140-Volt with charger, \$17. 180-Volt Power Unit, with Trickle Charger, \$24. **SEND NO MONEY—PAY EXPRESSMAN.**
Write for our Free Literature

SEE JAY BATTERY CO
915 BROOK AVE NEW YORK

MASON, FENWICK & LAWRENCE
PATENT LAWYERS
600 F. ST. N. W., WASHINGTON, D. C.
ESTABLISHED OVER SIXTY YEARS—SEND SKETCHES Electrical and Chemical Inventions Carefully Handled. Practice before the U. S. Courts and the Patent Office.
Prompt and Careful Service **Trade-Marks Registered**

EVERYTHING IN RADIO
AT ATTRACTIVE PRICES. SETS OR PARTS.
Orders shipped exactly as ordered. Prompt Service. Write for Prices. Inquiries invited. Send Your Address.
ALL RADIO COMPANY, 417 North Clark St., Chicago

MORE STATIONS AND BETTER, CLEARER RECEPTION WITH THE CE-LEC-TOR
A TRUTONE PRODUCT
THE ORIGINAL STATION SEPARATOR

The CE-LEC-TOR is a band pass filter with a new, novel and patent method of cutting off infringing side bands, being particularly effective on low wave lengths. It also balances the aerial and tunes the first tube.

The band pass features in the CE-LEC-TOR prevent more than one station being heard at one time. Another great feature of the CE-LEC-TOR is that it reduces static; there is nothing that will entirely eliminate it, but on actual tests the CE-LEC-TOR decreases noises attributed to "static."

EASY TO USE
Absolutely no tools are necessary to attach the CE-LEC-TOR to any radio. At Your Dealer it is only 3 1/2 in. high and 2 3/4 in. diameter. From it are two wires, one to attach to the aerial binding post and the other to the aerial lead-in. Send for Folder. Manufactured and Guaranteed by **TRUTONE RADIO SALES CO.** 114-116 Worth St., New York **\$6.50**

THIS DEVICE CUTS OUT MAN MADE STATIC FROM RADIO RECEPTION

SI-LEN-SER
A TRUTONE PRODUCT
MUSIC CLEARS UP

THE ORIGINAL LINE NOISE ELIMINATOR

Sold under a 100% guarantee. Endorsed by radio editors, engineers, public service corporations, electric ice-box makers, oil-burner companies, etc., etc. **\$12.50** **FREE** Write today for booklet on how to eliminate interference and radio noises.
Manufactured and Guaranteed by **TRUTONE RADIO SALES COMPANY**
114-116 WORTH STREET NEW YORK CITY

Please say you saw it in RADIO NEWS

Automatic Radio Transmitter

(Continued from page 1075)

position superfluous: a ship or an airplane which has a radio set (telegraph or telephone) must carry a licensed operator. But it is possible that a single operator might become disabled at the moment when his services would be invaluable; and the automatic transmitter can send messages, while the operator must leave his key for other duties about his instrument.

The automatic apparatus illustrated here may be set to send out the latitude and longitude of its position; the transmitter's call is built into it, and an "SOS" may be sent out with a procedure as simple as ringing in a fire alarm. In addition to this,

the SOS disc may be replaced readily by another, which will send a three-letter signal in a code previously arranged, and signifying, for instance: "All is well;" "Fine weather;" "Fog;" "We are about to land;" or "We have been forced to land; no immediate danger."

The working parts of this apparatus include (as shown in the rather complicated diagram, Fig. 1) the interchangeable "SOS" disc, and an insulating drum mounting three metal rings which are so cut that they make and break a circuit and form (just as would a hand on the key) the dots and dashes signifying in code the call signal and the position of the ship or plane. The figures signifying the position (in degrees and minutes) of longitude first, and then of latitude, are changed by means of the

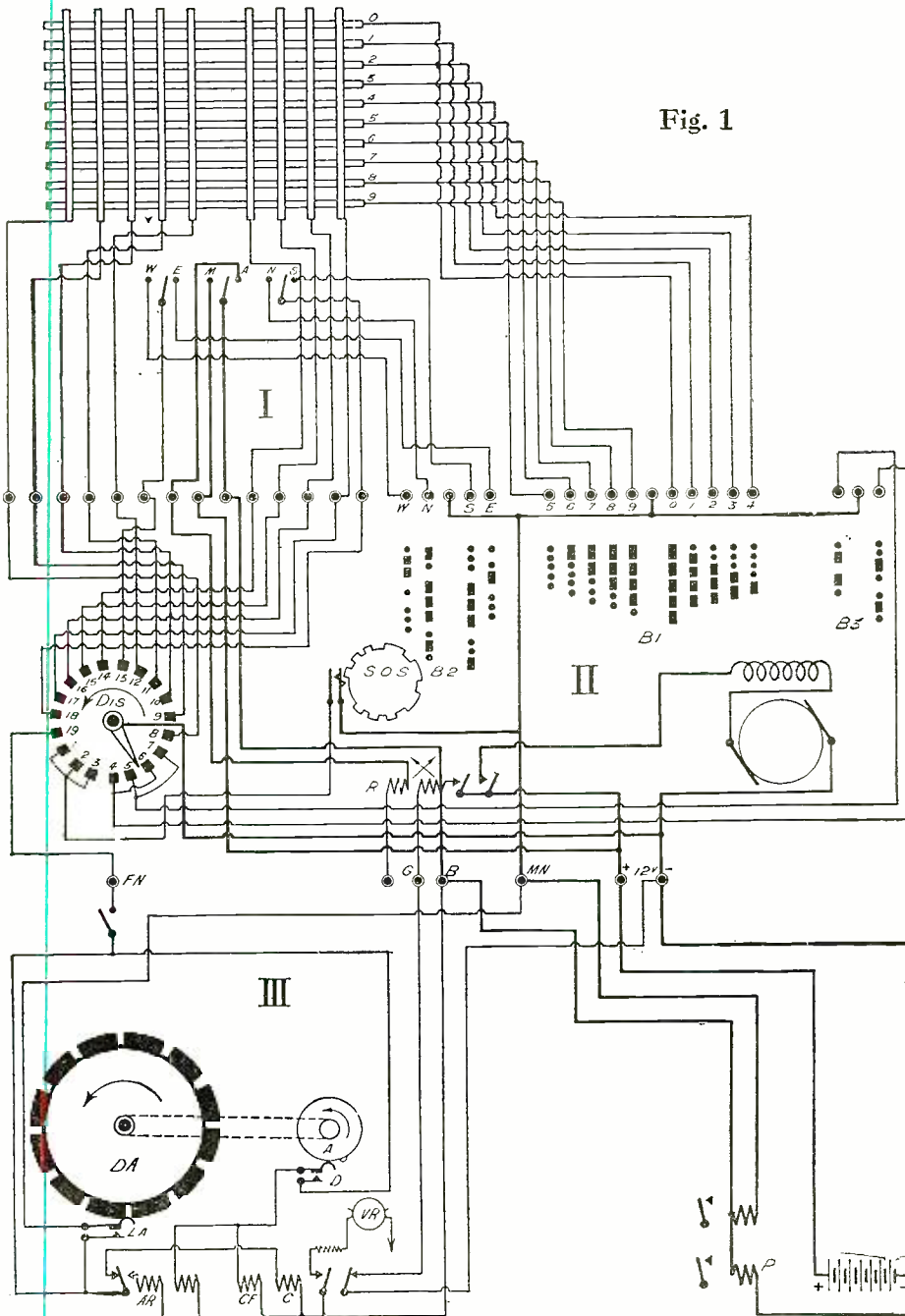

Fig. 1

The schematic arrangement of the automatic transmitter: the distributor "Dis" picks up signals first from the "SOS" disc, which is turned by the drum, then the position indicated by "W, N, S, E," and the figures on the rings, selected by the slides. The call of the ship or airplane, controlled by the rings B3, ends the message, which is repeated so long as the motor continues to revolve.

Please say you saw it in RADIO NEWS



Kester Radio Solder

routs the enemy . . .

CORROSION and LEAKAGE

ENEMIES of the set builder—corrosion and leakage don't have a chance when KESTER Radio Solder is on the job.

With the best flux for radio—ROSIN—contained within the solder itself, you can do a real, professional job of soldering. "A touch of heat and it's done." Rosin flux is non-corrosive and non-conductive. It works in harmony with the insulations of the set.

KESTER Radio Solder (Rosin-core) is the quickest to use and safest for the radio.

Free We will gladly send you a generous free sample and directions for use. Write today!

CHICAGO SOLDER CO.

Established 1899

4206 Wrightwood Ave. Chicago

Obtainable in the handy yellow tin package



KESTER Radio SOLDER
Rosin-Core

M&H

Radio's largest kit supply house

ESTABLISHED 30 YEARS

We Have Complete Kits FOR ALL CIRCUITS

Now appearing or which have appeared in "Radio News" and other publications. Professional Set Builders, write for our **NEW WHOLESALE CATALOG**

Hi-Q 29 Kits in Stock - Silver Marshall Kits - National and Aero Short Wave Kits

Convert your present set to the low-wave bands **Amer-Tran Power Equipment**

Write for FREE BLUE PRINT for the new 250 push-pull power amplifier.

M. & H. Sporting Goods Co.
512 Market St., Phila., Pa.

Send for WESTERN RADIO
New 1929 Catalog

LATEST and FINEST nationally known A.C. sets, consoles, cabinets, speakers and accessories at **LOWEST PRICES**. Catalog sent **FREE** on request.

WESTERN RADIO MFG. CO.
128 W. Lake Street, Dept. RN-6, Chicago

\$1 SAVES YOUR SPEAKER

We guarantee our Dollar Speaker Filter to relieve speaker of plate direct current, up to 250 volts. \$1.00 postpaid. Refund if not satisfactory.

Craftsman Radio Products, 351 Halsey St., Newark, N. J.



ARE you getting full value from screen-grid tubes? Most likely not, for 99 out of every 100 radio men run these marvelous tubes at very low efficiency. Why?

The main reason is failure to bias the control grid at 1 1/2 volt negative potential. Of course that's troublesome if you must use a dry cell in ground lead. Other methods are equally awkward. But now you can use a better way. And here's how:

Try the Clarostat Hum-Dinger as a combination filament resistor and grid bias. Connect between negative A and filament, with center tap to ground side of antenna tuning unit. Adjust for proper grid bias by means of screwdriver, and leave it alone.

Oh! boy! What a difference! And if you want to know why, just look up the characteristic curves of the screen-grid tube.

Of course the Clarostat HUM-DINGER is primarily an improved hum-balancer. Use it with your A-C filament tubes, and forget hum.

WRITE for data regarding the Hum-Dinger and other Clarostat products. There's a Clarostat for EVERY Purpose—adjustable, variable, fixed and even automatic. Ask your dealer about Clarostats.



The Trend is to
RADIO in every ROOM

Tremendous opportunities exist in hotels, apartments, homes for the sale of radio outlets in every room. Broadens your market for speakers. CARTER offers all types of radio outlets in brass, bakelite, statuary bronze. Send for catalog and price list. Go after this business now!



CARTER WALL PLATES

CARTER RADIO CO., Dept. 106,
300 S. Racine Ave., Chicago, Ill.
Please send me illustrated catalog
and price list of Carter Wall Plates.

Name

Street

City

LEARN TELEGRAPHY WITH TELEPLEX

Be an expert Morse or Continental code operator! BIG PAY—TRAVEL—FUN—ADVENTURE. After a few short weeks of practical study with Teleplex you will be an expert operator. This amazing instrument teaches you right in your own home. Works like a phonograph. No knowledge needed—beginners learn at once! NOT A SCHOOL. Free 10 days' trial. Write for FREE booklet E-11.



TELEPLEX CO., 72 Cortlandt Street, New York City

slides which are shown so prominently in the pictures of the transmitters. There are five longitude bars; as longitude reads up to 180 degrees, east or west; and four of latitude, as latitude goes no higher than 90 degrees. The slides move to the figures on their respective bars, and are moved by hand at regular times to keep the position as nearly accurate. In the case of a ship, adjustment every half hour would be sufficiently accurate.

The call signal ring B1 is double; as the call may be too long for a single revolution of the automatic sending apparatus. (This is turned by a motor with reduction gear at a constant speed.) Other rings carry the code abbreviations for "East" and "West" to preface the longitude figures; and "North" and "South" for those of the latitude. These rings rotate under contact brushes which press continually upon them; while the signal is taken from the signal disc and rings successively by the rotating distributor "Dis." This has 19 contact pieces, and moves automatically around them, one step after each revolution of the main drum. From the contact pieces is operated a keying relay, which makes and breaks a transmitter's plate circuit up to 1,200 volts.

When the center switch on the panel is turned, the motor of the apparatus puts the drum in revolution, and it first of all sends out the "SOS" three times; followed by the call, and then by the position. After the nineteenth revolution of the drum, the last minute-figure of latitude has been sent; and the apparatus begins again on the message. This is automatically repeated until the motor is switched off.

The airplane transmitter is built lighter and more compact than that designed for ship use. It is less than 10 x 8 x 5 inches over all, and weighs about 11 pounds.

It will be observed that this differs from a certain automatic alarm sender and receiver system illustrated in our January issue. The latter created only a special signal which was intended to attract the attention of an operator to the fact that an SOS was being sent out nearby on the 600-meter wave. The apparatus illustrated here sends the "SOS" itself, with added data sufficient to locate the position of its transmitter. It cannot, as we have said, replace the regular operator, except in the emergency itself; but it is a very ingenious device, and may, as time goes on and radio flight develops, prove a life-saver many times.

"New Wings for Young Americans"

(Continued from page 1074)

being well done in many sections of the country.

A few days ago, Miss Amelia Earhart, of *Friendship* fame, took her first flight in a glider. She was most enthusiastic for the sport and indicated her intention to follow its progress closely. Miss Earhart is a director of the National Glider Association and will lend her assistance to that organization.

THRILLING—AND EDUCATIONAL

In addition to offering an inexpensive method of flight training, the glider and soaring plane provides a real red-blooded sport for young Americans.

To the reader who may think, at first,

that simply flying a glider down hill would have little thrill for him, the writer can only say that, when poised for his first hop-off in a motorless ship, he rather envied the chap who had only to go over Niagara Falls in a barrel. The flight once made, however, the beginner is anxious to try, try, again. When the time comes that he has mastered the art of motorless flight, he is a confirmed enthusiast. He would rather fly than eat; and is brim full of that kind of zeal and enthusiasm which will go far to carry the message of aviation to the general public.

From the technical viewpoint, the return to the motorless ship will provide a great bulk of scientific data much needed in the motored aircraft industry. The two or three really good light planes that the world has thus far produced have resulted from experimental work carried on with motorless planes; and there is much yet to be learned in the light-plane field.

Young Americans are rapidly becoming "glider wise." The little ships can be purchased at low prices; and the enthusiast who is at the same time a careful workman can build his own ship with good prospects of success.

The significance of this movement may not at once be apparent; but, as soon as we realize that when once fully under way it will rapidly and economically populate this country of ours with large numbers of air-minded citizens who have actually learned to fly, its vast potential value to the nation is easy to see.

What Flying Has to Offer

(Continued from page 1069)

The most exciting time comes when the plane is flying at night or in a fog. Then, the safety of the passengers will be dependent entirely upon the radio operator.

A new system of radio control has been developed by means of which radio stations along the route can plot the course of the plane on a map in the pilot's cabin, even though the plane is hidden from the ground by fog.

Fog, obscuring the ground as well as light beacons from the view of the pilot, is the great menace. Under such conditions, while the pilot can guide the ship easily enough, he cannot tell in what direction he should go. The compass shows only the direction in which the plane is pointed, but a cross-wind may blow him miles off the course.

Again, if the engine falters, or an oil-line breaks, the pilot cannot tell what is beneath until he drops down below the fog. Then, a few hundred feet from the earth, he cannot glide to a safe landing. He may land on trees, houses, or water—he has no choice.

But, with the radio course-plotter to guide him, he knows at five-minute intervals where he is, by referring to marks on his map. Thus he cannot lose his way. If the engine goes wrong, he can go on or turn back to the nearest emergency field. Flying at 10,000 feet, he can glide for at least 12 miles in either direction.

The airplane radio operator will be a more heroic figure in that ship than the operators who already have the saving of hundreds of lives to their credit.

Suppose you want to take part in this new radio field, how should you go about it? What will you have to know?

Please say you saw it in RADIO NEWS

BREAKING INTO AVIATION RADIO

It isn't going to be as difficult to get in it as you might expect. The airplane work isn't going to be done by any super-radio men. The best places will go to the young men who know their radio.

If you want to be a ship operator, you don't go to sea for a few years first. You do the very obvious thing, which is to learn the fundamentals of radio theory and practice. Radio isn't any different, doesn't follow any sea-going rules, just because it is used on shipboard.

So it is with airplane radio. Men who will install, operate and maintain the ground and plane equipment will be men who have learned the business.

As in all new and highly-specialized fields, airplane radio men will be very highly paid. Operators will make about a hundred dollars a week, with higher wages for the supervisors. This is based on the estimate that they will rank just under the pilots.

But high-salaried positions will carry the requirements of study and knowledge. To prepare yourself accordingly, start on a course of study that will give you the most complete ground work. Don't begin at the middle, for you will discover that the things you neglect to learn are always needed.

To start now is none too soon. And suppose that, after you have invested the time and money in radio study, you decide later that you don't want to go in for airplane radio after all?

If you should change your mind, you won't have wasted a minute or a nickel; for the same principles of radio you have been studying will be just as applicable to every other branch of radio science, and just as useful in work on broadcast receivers, broadcast transmitters, television, or talking movies.

"The Beginner's Three"

(Continued from page 1087)

but in most cases the click from the secondary is weaker than that from the primary. It may be better to use a "B" battery for testing the audio transformer, so that the click will be louder. If no click can be heard, the transformer is defective. In testing condensers, the click is very weak and no continuous noises are heard. In some cases, as in the variable condensers, it is necessary to disconnect the part from the set; because the coils or other apparatus are shunted across the condenser and it will appear to be short-circuited.

If the trouble is not found by these tests, it is advisable for the novice to call some one in who is more familiar with sets and their troubles, in order to locate the difficulties. It is well, in fact, to have any installation checked by an older head. The above suggestions should not keep any one from undertaking the "Beginner's Three"; as the possibilities of encountering trouble in a set of this type are very slight, if the instructions are followed exactly. They are merely given so that if the omission of something causes trouble, the reader will have some means of locating it before calling for outside assistance.

"RESOID" is the new word to describe the class of molded products such as bakelite, formica, insuline, micarta, celeron, etc., according to the decision and \$250 prize award of the NEMA.

The New THRILL BOX

*Loud Speaker Operation on
Both Broadcast and Short Waves*

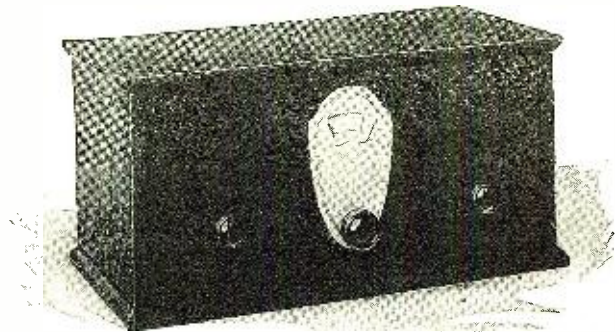

*It gets short waves
AND Broadcasts
All in One*

*Operates from
NATIONAL
Velvet-B*

*Write us today
for full details*

Tune in on a concert from Europe,—a code message from New Zealand,—or a favorite program from a nearby broadcast station. Broadcast or short-wave, they're all the same to this latest NATIONAL achievement. You will get a brand new kick out of the fine tone and different performance of this

NATIONAL

4 Tube THRILL BOX S. G. 4

NATIONAL CO. INC., Malden, Mass.

Est. 1914

CODE LEARNED EASILY AT HOME

Has Helped Thousands to Better Positions in Radio and Telegraphy



The OMNIGRAPH Automatic Transmitter will teach you the Wireless or Morse Codes, easily, quickly and cheaply. Start now. Ideal opportunities for you as an operator, broadcaster, experimenter or railroad official, etc. U. S. Army, Navy, radio schools and scientific institutions throughout the world use the OMNIGRAPH. List your friends in every corner of the world. Catalog G3. OMNIGRAPH MFG. CO., 810 E. 39th Street, Dept. M, Brooklyn, N. Y.

FREE Wholesale Radio Catalog

Set Builders-Dealers! Save Money!

Send for the most complete book of nationally known Parts, Kits, Cabinets, Consoles, Speakers, Power Units, Sets, etc. All at lowest wholesale prices. Quick service on all your needs. Write now, it is FREE—

SETBUILDERS SUPPLY CO.
Dept. 1318 Romberg Bldg. Madison and Market Sts. CHICAGO, ILL.



SENSATION OF THE NATION

Polk Binding Post

Insulated—No holes to fish for—Insert wire in any position—Quick action and holds tight.

J. L. POLK

41 Belle Ave. Troy, N. Y.

DO you know why the soprano is disliked as a radio broadcaster? A full and detailed analysis of the soprano as a radio broadcaster and why her broadcast is unfavorably received, is discussed in the Summer edition of RADIO LISTENERS' GUIDE & CALL BOOK.

Do you know the difference between the various types of electrical meters? . . . You should know the difference in construction because this data affects the utility.

The design of permanent magnet, movable coil and movable iron meters is discussed in detail in the Summer edition.

Intelligent service and repair work necessitates the use of an audio oscillator, as a source of audible frequencies. . . .

Such a generating unit, of the beat note type, with full constructional details is described in the Summer edition of RADIO LISTENERS' GUIDE & CALL BOOK.

All of these will appear in the next issue . . . watch for it!!

Did You Get the Spring Edition of RADIO LISTENERS' GUIDE & CALL BOOK

Get your copy NOW!!

ALL ABOUT

Superheterodyne Band Pass Filters!
Speech Amplifier Installation!
Equipment for the Talkies!

The H.F.L. Special A.C. Nine!
Eliminating Man-Made Static!
How to Sell Custom-Built Sets!

A Receiver with a Band Pass Filter!

And many other excellent features!

ON ALL NEWSSTANDS, OR WRITE DIRECT

CONSRAD COMPANY

230 Fifth Avenue, New York, N. Y.

50c

THE COPY

PHONO Radio Consoles

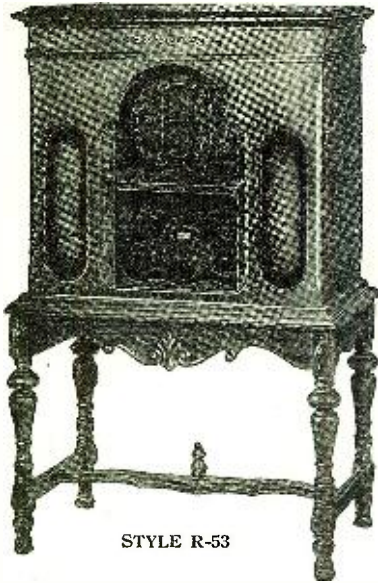

STYLE R-53

For Radio or Phono-Radio Combination. A beautiful Walnut Cabinet with sliding doors of matched Butt Walnut. Ample space for Receiver, Speaker, and Phonograph equipment.

A descriptive bulletin of new 1929 styles sent free on request.

EXCELLO PRODUCTS CORPORATION
4832 West 16th St., Cicero, Illinois

A. T. R. F. Transformer

(Continued from page 1094)

in regard to whether we shall make the coefficient of coupling large and the primary inductance small, or vice versa.

Let us now consider the question of selectivity of the transformer; for then the above question will be answered.

The selectivity of a tuned circuit depends upon its resistance. Thus, were the primary not present, the value of R_2 would determine how sharp the secondary would tune. However, instead of R_2 , let us consider the more accurate selectivity factor η_2 . It may be shown that, because of the effect of the primary, the effective resistance in the secondary circuit is increased. Call the effective resistance in the secondary circuit due to its resistance plus the effective of the primary $R\frac{1}{2}$ and let

This is now the selectivity factor of the system, and should be as small as possible.

$$\textcircled{8} \quad \eta_2^{\frac{1}{2}} = \eta_2 + \frac{L\eta_1}{\eta_1^2 + 1}$$

Maximum amplification—see equation (5)—has given a certain relation between \bar{i} , τ_1 and τ_2 which must be satisfied. Placing this in equation (8) we obtain

$$\textcircled{9} \quad \eta_2^{\frac{1}{2}} = \eta_2 + \frac{\eta_2}{\bar{i}}$$

This gives a measure of the selectivity of the circuit when the radio-frequency transformer is designed for maximum amplification. For maximum selectivity, $\eta_2^{\frac{1}{2}}$ must be as small as possible. Now we have already, by using a condenser and coil whose losses are low, reduced

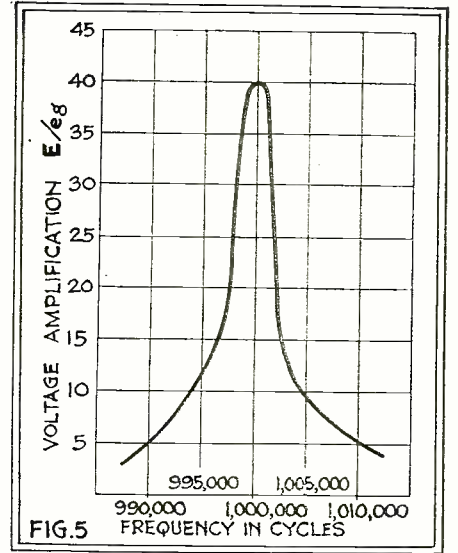

Above, the curve of a transformer designed as described here. In the complete tuning, four of these are used, their peaks staggered to give a band-pass effect

τ_2 as much as possible and fixed its value. However, if we make \bar{i} large, $\tau_2^{\frac{1}{2}}$ will be smaller (\bar{i} has a maximum value of 1.0). Thus, if $\bar{i} = 1.0$, $\tau_2^{\frac{1}{2}} = 2 \tau_2$.

If \bar{i} were only 0.5 (about the usual value in a radio-frequency transformer), the selectivity is 50% poorer.

Therefore, from the standpoint of selectivity, \bar{i} should be large.

Thus the option left us in equation 7 before mentioned has now been answered when the problem of selectivity is considered. The above equations give rise to the following statement:

INDEX TO ADVERTISERS

PAGE		PAGE		PAGE		PAGE	
A		E		M		S	
Advance Electric Co.	1140	Electrad, Inc.	1140	M & H Sporting Goods Co.	1145	See Jay Battery Co.	1144
Aero Products, Inc.	1134	Electric Specialty Co.	1149	Mason, Fenwick & Lawrence....	1144	Setbuilders Supply Co.	1135-1147
Aerovox Wireless Corp.	1144	Electric Storage Battery Co....	1138	Midwest Radio Corporation	1136	Silver-Marshall, Inc.	1061
Allied Radio Corporation....	1135-1140	Excello Products Corp.	1148	N			
All Radio Co.	1144	F		National Co., Inc.	1147	Smith, B. Hawley	1134
American Sales Co.	1151	Franklin Institute	1149	National Radio Institute....	Back Cover	Southern Toy Co.	1143
Amplion Corp. of America	1144	G		National School of Visual Edu- cation	1149	Supreme Instruments Corp. Inside Front Cover	
Arc-Aerial, Inc., The	1135	General Amplifier Co.	1135	Norden-Hauck, Inc.	1138	T	
B		H		O			
Barawik Company 1135-1137-1141-1143-1151		Hammarlund Mfg. Co.	1136	Omnigraph Mfg. Co.	1147	U	
Birnback Radio Co.	1135	Hoodwin Co., Chas.	1142	P			
Braun Co., W. C.	1135	I		Pacent Electric Co., Inc.	1135	Underground Aerial Products....	1141
C		International Resistance Co.	1150	Peerless Service Co.	1138	V	
Carborundum Co., The	1134	J		Pilot Electric Mfg. Company Inside Back Cover		Van Nostrand Co., D.	1132
Carter Radio Co.	1146	J-M-P Mfg. Co., Inc.	1142	Polk, J. L.	1147	W	
CeCo Mfg. Co., Inc.	1133	L		R			
Celeron Co., The	1152	Lacault, Mrs. R. E.	1130	Radiall Company	1151	Western Radio Mfg. Co.	1135-1145
Central Radio Labs.	1142	Leutz, Inc., C. R.	1135	Radio	1143	Wirt Company	1134
Chicago Radio Apparatus Co....	1134	Literary Guild, The	1131	Radio Training Association of America	1057	X-Y-Z	
Chicago Solder Co.	1145	Loveless Antenna Co.	1135	Radio Doctors, Inc.	1139	X-L Radio Laboratories	1136
Clarostat Mfg. Co., Inc.	1146	Lyons Mfg. Co.	1134	Radio Engineering	1139	Yaxley Mfg. Co.	1141
Coyne Electrical School	1059	Lynch, Inc., Arthur H.	1135	Radio Equipment Co.	1134		
Craftsman Radio Products	1145			Radio Institute of America....	1063		
D							
De Jur-Amsco Corp.	1135						
Deutschmann Co., Tohe	1137						
Drake, The	1140						
Dresner Radio Mfg. Corp.	1134						

Please say you saw it in RADIO NEWS

In a tuned-radio-frequency transformer with a fixed secondary winding, working in conjunction with a given amplifier tube, the selectivity for a given voltage amplification depends upon the coefficient of coupling.

It is now necessary to examine the characteristics of the A. C. screen-grid tube in order to determine the values of plate resistance and amplification factor. Fig. 3 gives these quantities.

It will be noted that the plate resistance, instead of being about 10,000 ohms (which is the case in the 01A-and 27-type tubes) is about 500,000. This means that the primary inductance of the radio-frequency transformer must be increased accordingly. Unfortunately, there is a very definite limit to the amount of inductance that may be used for the primary; for, if too many turns are used the primary will be tuned to some definite point in the broadcast range by the distributed capacity of the winding and the capacity in the screen-grid tube which is directly across the primary. Therefore, it is necessary to increase the coefficient of coupling as much as possible.

The writer worked some time on this problem and was able by careful design to obtain values of coupling up to 90 per cent. With this high coupling factor, and as many turns on the primary as possible consistent with keeping the tuning of the primary below 200 meters, a transformer was designed that performed unusually well, from the standpoints of both amplification and selectivity. This may be observed by an examination of Fig. 4, where the voltage amplification of the A. C. screen-grid used with the transformer described is plotted against wavelength. An average amplification of about 32 is obtained, as compared to an amplification of about 15; the latter is all that can be obtained when the 01A tube is used with a well-designed radio-frequency transformer. Thus we have secured twice as much gain with the A. C. screen-grid tube as it was possible to get before its introduction and, if the circuits are properly shielded, no neutralization problem confronts us.

The selectivity of the transformer is shown graphically in Fig. 5. This is also slightly better (considering the amplification obtained) than is the case where the 01A tube is used as an R. F. amplifier. This may be contrary to the opinion prevalent among radio fans, but shows up readily in the analysis and is substantiated in practical laboratory measurements.

(In the July issue of RADIO NEWS the five-stage tuning unit, illustrated in this article, will be described. The first stage is aperiodic; the three following R. F. stages and the detector are tuned by a single dial operating a four-gang condenser. The peaks of the transformers are so adjusted that they amplify the signal to a high degree while preserving the tone quality.)

Radio Wrinkles

(Continued from page 1113)

desired and then shifting the coils until the correct relation is secured. After the coils have been placed in the required positions, the machine screw at the top is tightened, to keep them in place. By employing some other method of securing the rod to the baseboard or sub-base, which will allow the coils to be removed more easily, this scheme can be used also for plug-in short-wave coils.—Contributed by William H. Dobson.

A Quickly-Made "Vernier"

THE wrinkle presented in Fig. 4, though nothing new, retains its merits because

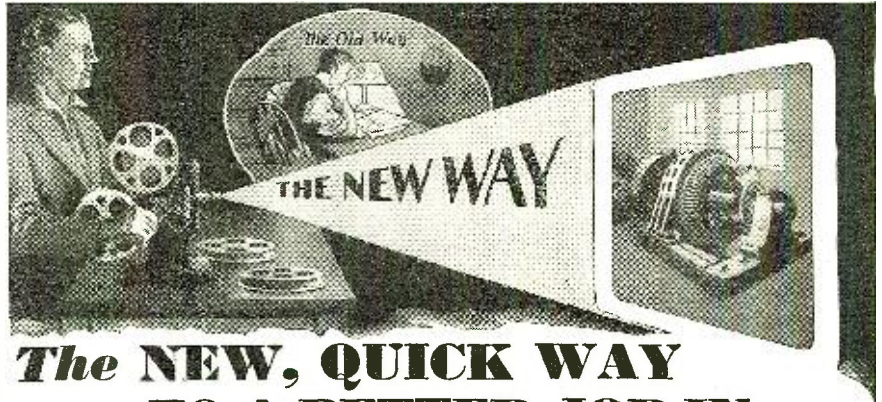

The NEW, QUICK WAY TO A BETTER JOB IN ELECTRICITY

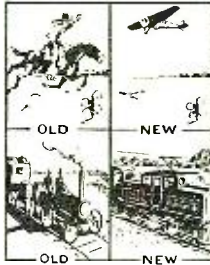

New Way Is Far Easier
 "I finished Reel Lesson No. 3 today and certainly can understand now why you claim your course is so easy to learn because of its simplicity and clearness. The films make it easy to grasp any point."
 E. A. B., Brooklyn, N. Y.

Now you learn from motion pictures, instead of books. It's the new, modern way of teaching quicker, better—thoroughly. Right in your home, in your spare time you see all electrical machinery in operation, you see animated diagrams, you master Electricity completely, ready to step into a "Big Pay" Electrical job, earning \$60 to \$150 or more per week. You get a \$75 DeVry Motion Picture Projector to keep at no extra cost. Thousands of feet of film are furnished. We help you get the job you want. We pledge to give you the training and employment service necessary to get the right job and the right pay, or you need not pay a cent.

Write for FREE BOOK

Send immediately for the new FREE Book, "The Film Way to Bigger Pay," that tells you how we use movies to teach you in spare time at home for a big pay job. Act quickly, mail coupon TODAY!

The NATIONAL SCHOOL of VISUAL EDUCATION

"The Film Way to Bigger Pay"

Take the Film Way to Bigger Pay

THE NATIONAL SCHOOL OF VISUAL EDUCATION
 537 S. Dearborn St., Chicago, U.S.A. Dept. 6N
 Send book, "The Film Way to Bigger Pay," with facts about this new, easier way to master electricity.
 Name _____ Age _____
 St. or R.F.D. _____
 City _____ State _____
 Mail This Coupon

Any A. C. Socket Power Set can be used on D. C. supplies— if an "ESCO" Motor Generator or Dynamotor is used

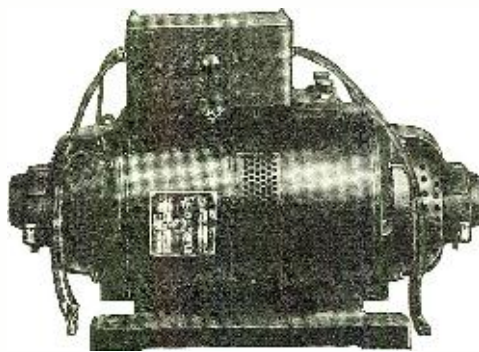

Motor Generator with Filter For Radio Receivers

Machines for operating 60-cycle A. C. Radio Receivers, Loud Speakers and Phonographs from Direct Current Lighting Sockets Without Objectionable Noises of any Kind.

The dynamotors and motor generators are suitable for radio receivers and for combination instruments containing phonographs and receivers. Filters are usually required. The dynamotors and motor generators with filters give as good or better results than are obtained from ordinary 60-cycle lighting sockets. They are furnished completely assembled and connected and are very easily installed.

These machines are furnished with wool-packed bearings which require very little attention, and are very quiet running. Write for Bulletin No. 243-C.

ELECTRIC SPECIALTY COMPANY

211 South Street

Stamford, Conn., U. S. A.

TRADE "ESCO" MARK

Manufacturers of Motors, Generators, Motor - Generators, Dynamotors and Rotary Converters for Radio and other purposes

Travel for "Uncle Sam" RAILWAY POSTAL CLERKS MAIL CARRIERS

\$1700 to \$3000 Year

TRAVEL—See your country on government pay
 MEN—WOMEN, 17 UP SHOULD MAIL COUPON IMMEDIATELY
 Steady Work No Layoffs Paid Vacations



COUPON
 FRANKLIN INSTITUTE
 Dept. S182, Rochester, N. Y.
 Sirs: Rush to me, WITHOUT CHARGE, FREE 32-page book with list of U. S. Government positions open to men and women, and full particulars telling how to get them.
 Name _____
 Address _____

Please say you saw it in RADIO NEWS

OPPORTUNITY AD-LETS

Follow these advertisements every month. Reliable advertisers from all over the country offer their most attractive specials in these columns. Classified advertising rate twenty-six cents a word for each insertion. Names and addresses must be included in the above rate. Cash should accompany all classified advertisements unless placed by an accredited advertising agency. No advertisements for less than 10 words accepted. Objectionable or misleading advertisements not accepted. Advertisements for the August issue must reach us not later than June 1st.

CIRCULATION LARGER THAN THAT OF ANY OTHER RADIO PUBLICATION
 EXPERIMENTER PUBLISHING CO., INC., 230 Fifth Avenue, New York, N. Y.

Agents Wanted

Guaranteed Genuine Gold Leaf Letters anyone can put on store windows. Large profits, enormous demand. Free samples. Metallic Letter Co., 422 N. Clark, Chicago.

\$50.00 Weekly. Men wanted to demonstrate and take ten orders daily direct from motorists. Amazing Magnetic Trouble Light. Sticks anywhere! More orders, bigger pay. Write for demonstrator and particulars. Magno, Beacon Bldg., Dept. 795, Boston, Mass.

Business Opportunities

Amateur Cartoonists: Sell Your Cartoons New Plan. Smith's Service EN1194, Wenatchee, Wash.

Amazing screw-holding screw driver! New patented invention! Removes, inserts screws instantly inaccessible places. Sells \$1.50, 100% profit. Factories, mechanics, garages, radio electricians buy on sight! Exclusive territory. Jiffy, 1072 Winthrop Bldg., Boston.

Free Book. Start little Mail Order business. Hadwil, 5A-74 Cortlandt Street, N. Y.

Inventions Commercialized. Patented or unpatented. Write, Adam Fisher Mfg. Co., 278 Enright, St. Louis, Mo.

Correspondence Courses

Used correspondence school courses sold on repurchase basis. Also rented and exchanged. Money-back guarantee. Catalog free. (Courses bought). Lee Mountain, Pisgah, Alabama.

Detectives

Detectives Needed Everywhere. Travel. Experience unnecessary. Particulars Free. Write, American Detective System, 2190 Broadway, N. Y.

For Inventors

Inventions Commercialized. Patented or unpatented. Write, Adam Fisher Mfg. Co., 278 Enright, St. Louis, Mo.

Help Wanted—Instruction

Wonderful Opportunities in Government Jobs for Men—Women, 18-55; \$125-\$250 month. About 40,000 openings yearly. Are you eligible? We advise you Free. Write, Instruction Bureau, 251, St. Louis, Mo.

Male Help Wanted

A Paying Position open to representative of character. Take orders shoes-hosiery, direct to wearer. Good income. Permanent. Write now for free book, "Getting Ahead." Tanners Shoe Mfg. Co., 2356 C St., Boston, Mass.

Firemen, Brakemen, Baggage-men (white or colored), Sleeping Car, Train Porters (colored), \$150-\$250 monthly. Experience unnecessary. 237 Railway Bureau, East St. Louis, Ill.

Miscellaneous

Forms to Cast Lead Soldiers, Indians, Marines, Trappers, Animals, 151 kinds. Send 10c for illustrated Catalogue. H. C. Schierde, 1034 72nd St., Brooklyn, N. Y.

Inventions Commercialized. Patented or unpatented. Write, Adam Fisher Mfg. Co., 278 Enright, St. Louis, Mo.

Patents

Inventions Commercialized. Patented or unpatented. Write, Adam Fisher Mfg. Co., 278 Enright, St. Louis, Mo.

Patent Attorneys

Patents procured. Particular attention to radio, television, aircraft cases. Low rates. H. Sanders, 536 So. Clark St., Chicago, Ill.

Patents—Write for Free Instructions. Send Drawing or Model for Examination. Carl Miller, Registered Patent Attorney (former Patent Office Examiner), 262 McGill Building, Washington, D. C.

Patents—Send for form "Evidence of Conception" to be signed and witnessed. Form, fee schedule, information free. Lancaster and Alving, Registered Patent Attorneys in United States and Canada, 269 Ouray Bldg., Washington, D. C.

Inventors—Should write for our Guide Book, "How to Obtain a Patent," and Record of Invention Blank, sent Free. Send model or sketch of inventions for our inspection and instructions free. Radio, Electrical, Chemical, Mechanical and Trademark Experts. Terms Reasonable. Victor J. Evans & Co., 922 Ninth, Washington, D. C.

Patents—Send drawing or model of your invention for examination and instructions. Advice and booklet free. Highest references. Best results. Promptness assured. Watson E. Coleman, Patent Lawyer, 724 9th Street, N.W., Washington, D. C.

Printing, Engraving and Multigraphing

Multigraphing, two dollars thousand. Miscellaneous Printing. Mayer Ray Corporation, Monmouth, Illinois.

Your Own Correspondence Stationery. Name and address on 125 DeLuxe lettersheets and 125 envelopes \$2.20 postpaid. Oberman Company, Box 1042, Chicago.

Radio

Bargains, used radios. Guaranteed perfect working order. Blue Ribbon 5 tube, 2 dial, Console, \$19.95. Freshman, \$14.95. Atwater Kent, \$19.50. Many famous makes. Send money order with order. Bargain list on request. Surplus Radio Co., Dept. 2-F, 4611 N. Clark St., Chicago.

Sonatron Tubes. Fine Dependable tubes. Longer satisfactory service. Quality Performance UX199, \$1.80; UX120, \$2.00; UX201A, \$1.20; UX200A, \$3.20; UX201B, \$2.40; UX112A, \$2.20; UX226, \$1.80; UY227, \$3.20; UX171A, \$2.20; UX171A, \$3.60; UX401, \$3.10; 216, \$7.20; 250, \$8.80; 280, \$3.40; 281, \$6.00; SH85, \$3.60; 222AC, \$5.60; 222DC, \$5.20; Postpaid. Money refunded for unsatisfactory tubes not abused. Philadelphia-Sonatron, Phila., Box 452, Philadelphia.

Neptune 5 Tube Receiver, completely wired chassis. Direct from factory. \$10.95. Neptune Radio Company, 334 Pearl, New York.

Build Your Dynamic Speaker. Machines castings, blueprint, instructions, \$8.50. A. C. Klein Co., 1058 N. 10th, Reading, Penna.

Salesmen Wanted

Big Ohio Corporation wants county manager. \$50 weekly commission. Earnings start immediately. Good for \$5,000 yearly. We furnish everything, deliver and collect. Capital or experience unnecessary. Fyr-Fyter Co., 1884 Fyr-Fyter Bldg., Dayton, Ohio.

Song Poems

Song Poem Writers: "Real" Proposition. Hibbler, DTX, 2104N. Keystone, Chicago.

Song Writers

Songwriters: Substantial Advance Royalties are paid on publisher's acceptance. Write for Free Booklet on developing ideas for song words or music required by Talking Pictures. Newcomer Associates, 1674 Broadway, New York.

Song-poem writers. Address, Monarch, 236 West 55th Dept. 322, New York.

Stamps and Coins

Stamp Collectors—Phillips' Monthly Bulletin (illustrated) offers over 2,000 bargains, sets, packets, etc., each issue. Free. Phillips, Box 1012, Hartford, Conn.

Telegraphy

Telegraphy—Both Morse and Wireless taught thoroughly. Big salaries. Wonderful opportunities. Expenses low, chance to earn part. School established fifty years. Catalog free. Dodge's Institute, Cour St., Valparaiso, Ind.

The New
Improved Powerohms

*1 and 2 watt --- Range
 500 to 200,000 ohms in
 power types --- 1 to 1.00
 megohms in resistor types*

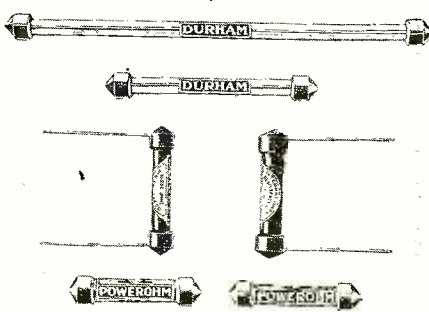

DURHAM
 METALLIZED
 RESISTORS & POWEROHMS

INTERNATIONAL RESISTANCE CO.
 2006 Chestnut Street, Philadelphia, Pa.

Please say you saw it in RADIO NEWS

of its simplicity and efficiency with low cost; as it requires nothing more than an ordinary bakelite binding-post. This inexpensive item is capable of making a vernier dial out of any plain bakelite dial.

To make one, first find the radius of the metal base of the post and drill a hole in the panel directly under the dial at that distance from the bottom edge of the dial. The diameter of the hole should be slightly larger than the screw of the post, as this must turn freely. The dial should then be moved away from the panel until it touches the juncture of the base and the bakelite head of the post. If there is too much space between the dial and the post, this may be corrected by winding some friction tape on the post until the desired pressure is obtained.—Contributed by Milton D. Rubin.

RADIO BOOK REVIEW

(Continued from page 1128)

pick one up locally, they will spend a most amusing evening reading it, or at least guessing at the contents.

The book takes the form of a series of dialogues between a 16-year-old boy and his 35-year-old uncle. The boy is a radio bug of the first water; the uncle is a radio engineer possessed of a delicious sense of humor and the ability to explain things in a wholly unpedagogic manner. The boy asks a question and the uncle answers it by drawing analogies to common objects. For instance, he represents the attraction between positive and negative charges as similar to that between a man and a woman enclosed in facing telephone booths and trying to kiss each other through the glass windows. Also, he shows the electrons inside a vacuum tube as taxis going over a one-way street from the filament to the plate. The book is a thorough course of instruction in radio, its humorous features detracting nothing from the accuracy of the explanations.

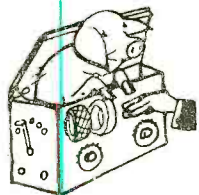

The little thumbnail sketches that line the margins of the pages are very clever, and can be appreciated even by a person who knows nothing of French. A couple of them are reproduced herewith. The little pig in a box at once identifies the character of the set used; and the dog chasing his tail is obviously regeneration.

AMAZING STORIES In Our June Issue

The Radio Telescope, by Stanton A. Coblenz. With characteristic imaginative foresight, the author of "The Sunken World" gives us, in concentrated form, an extremely well-written story full of plausible science.

The Mongolians' Ray, by Volney G. Mathison. A capital scientific story that would have done O. Henry honor for its rare surprise ending.

Fingers of the Mist, by Peter Brough. Synthetic life is no novelty in the laboratory. Scientists claim to have come pretty close to the secret of life, although only microscopic living beings seem thus far to have been produced.

The English at the North Pole, by Jules Verne. (A Serial in 2 Parts.) Part II. Now that the expeditionists have reached 73 degrees North, the excitement and adventure start and we learn a great deal about the territory in the neighborhood of the North Pole—much of it proven fact. Both the story and scientific interests are fully sustained in the concluding chapters of this story.

And, in honor of Sir Hubert Wilkins' contemplated trip to the North Pole in a submarine, we include in this issue half the sequel, which shows these English forging further and further north, almost in line with Sir Hubert's plans.

MOST ASTOUNDING RADIO VALUE!
KOLSTER ELECTRO DYNAMIC SPEAKER

COMBINED WITH

210 Power Amplifier and "B" Supply Unit

This famous genuine Kolster K-5, AC Electro Dynamic Speaker is complete with a 210 Power Amplifier and "B" Supply Unit all self-contained on a steel frame. A real fine matched rugged Unit, weighing 45 pounds without Cabinet. The Cabinet is handsome, being Pencil Striped Walnut, designed with cathedral grille.

This Dynamic Speaker can replace the last audio stage of any set or be used in conjunction with all the tubes of any battery or electric set and operating this Speaker with any radio set will bring out wonderful tone quality and volume, no note is obscured—everything is clear. Will modernize any radio receiver.

Uses 2 UX-281, 1 UX-210 and 1 UX-874 Tubes. A 20-foot cable supplied.

Operates direct from 110-120 volts, 50-60 cycle AC current.

OUR PRICE \$54.00 (without tubes)

Brand new in original factory cases and guaranteed.

Every Speaker is serial numbered and has factory guarantee tag.



MODEL K-5

LIST PRICE \$175.00 (without tubes)

The Power Amplifier in addition to performing its normal duties in conjunction with the Dynamic Speaker, if desired, will also supply "B" voltage, and is tapped at 22, 67 and 90 volts for any receiver using up to 8 tubes.

This Unit uses an automatic voltage regulator tube, UX-874, in order to keep the "B" supply silent and steady.

AMERICAN SALES CO., 19-21 Warren Street, New York City

Enjoy Dependable Electrified Radio at Amazing, Low Cost!



Do you know that your present good set is capable of giving you quiet, dependable, more enjoyable reception direct from the light socket? Don't think of discarding it when you can electrify it for only \$6.85!

New Radio Thrills!

No need now to put up with the shrieks, howls and inconvenience of dying Batteries. You will see how easily you can electrify your set when you write us for proof and the truth about all-electric radio. Get more volume without hum, sweeter tone, crystal clarity, surprising distance. New radio pleasure.

Over 100,000 Townsend "B" Power Units Now in Use

Hooked up in a few minutes—use same tubes—no changes. Over 100,000 Townsend "B" Power Units in use and giving satisfaction. Approved and passed by the rigid laboratory tests of Radio News, Popular Radio and other authorities.

TRY IT FREE We are so sure the Townsend will do all we claim for it that we give you the privilege of testing it out for ten days at our risk. A new radio joy awaits you. Don't put up with second rate reception any longer. You don't have to—when you can have electric reception with a Townsend "B" Power Unit for the astounding low cost of \$6.85. Mail coupon for complete information TODAY!

TOWNSEND LABORATORIES
725 Townsend Street Chicago, Ill.

RESULTS

Have had wonderful reception with your "B" Eliminator on my AT-WATER KENT for two years now. C. E. Smith, Snyder, N. Y.

Am entirely satisfied with Eliminator purchased from you last summer. Am getting many Florida stations we did not get before. Geo. Cadman, Hamilton, Ont.

Your Eliminator has given us perfect service for over a year on our STEWART-WARNER model 300. Fred S. Kattelman, Glendale, Calif.

Your Eliminator very satisfactory. Has saved me the price of buying a new set. Have had it almost a year and it performs as well as any \$35 Eliminator. Fred Kosanovic, Fairchance, Pa.

TOWNSEND LABORATORIES,
725 Townsend St., Chicago, Ill.
Please send me full information on the Townsend "B" Power and Free Trial Offer.
Name
Address
City..... State.....

For ANY Tube D.C. or A.C.
AMPERITE automatic filament control increases tube efficiency and lengthens tube life. \$1.10 with mounting (in U. S. A.)
Radiall Company, 50 FRANKLIN ST., NEW YORK
FREE New "Amperite Blue Book" of latest radio information and circuit diagrams. Write Dept. R.N. 6
AMPERITE
The "SELF-ADJUSTING" Rheostat

SET BUILDERS
Get this Book
LATEST RADIO GUIDE FREE
Barawik, the first and oldest radio specialty house, offers you unusual service this year. Bigger stocks, quicker shipments, lower prices. Deal with an old established, reliable house. Get honest goods, honest service, honest prices. Barawik service makes you more money. Send now for big new Catalog showing lowest wholesale prices.
BARAWIK CO. 26-A Canal Sta., CHICAGO, U. S. A.
Mail This Coupon Now for Free Radio Guide
Name
Address

Please say you saw it in RADIO NEWS

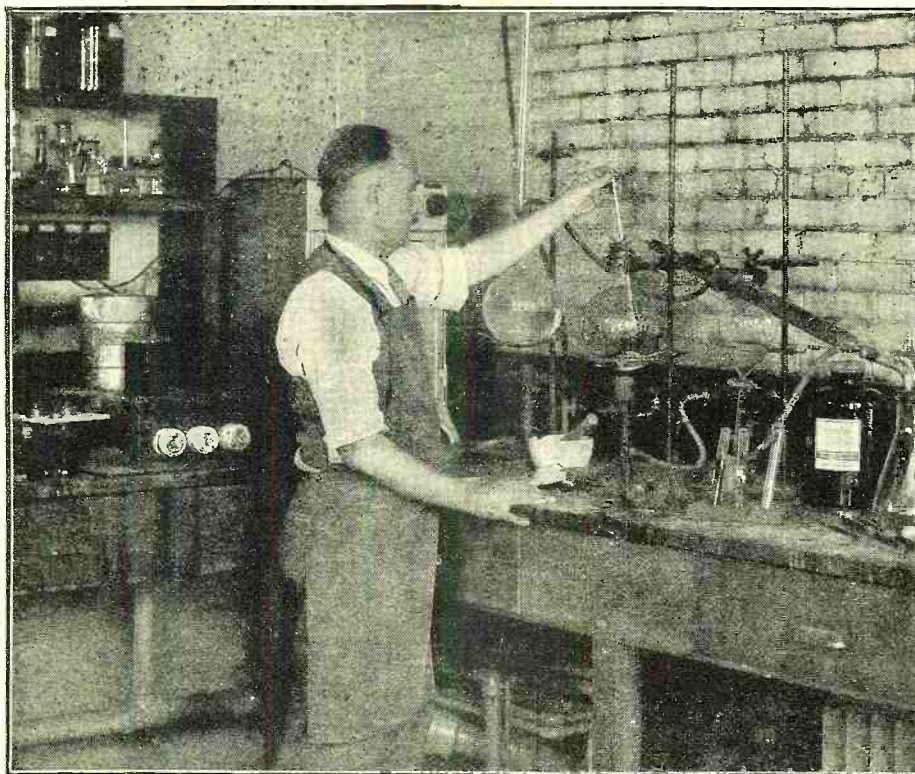

OUR LABORATORY

but dedicated to your interests



ALIKE AS TWO PEAS—to the naked eye, perhaps. But the microscope detects things about the physical nature of the basic materials used in Celoron, that may mean the saving of thousands of dollars to Celoron users.



WHAT IS GOING TO HAPPEN? One of the departments of the Celoron Laboratory where theory is subjected to the acid test of actuality—where new resin compounds for the improvement of Celoron Molding Powders are tested out.

Manufacturers and molders, who have adopted Celoron Molding Powders, know the vital service that the Celoron Laboratory is rendering their businesses.

For they realize that years of study, research and experiment must have been necessary for the development of such an improved plastic material, so well adapted to their requirements.

They know that the uniform high quality of Celoron Products could only be maintained through the most exacting laboratory control of every phase of the

great Celoron Plant's production.

They welcome the untiring pioneering spirit with which Celoron scientists, engineers and chemists labor on to produce still greater improvements for the future. To produce new products, new methods, new standards of quality. To offer these advantages to Celoron customers—first.

THE CELORON COMPANY
 Bridgeport . . . Pennsylvania
 In Canada: 350 Eastern Ave., Toronto

CELORON PRODUCTS
 Celoron Molding Powders; Impregnated Fabric and Paper for Molding; Synthetic Resins, Varnishes and Cements; Laminated Celoron sheets, rods and tubes for radio, electrical and industrial purposes; Celoron Silent Gears.



CELORON MOLDING PRODUCTS

Please say you saw it in RADIO NEWS