

TELEVISION

RADIO'S GREATEST MAGAZINE

RADIOVISION

# RADIO NEWS

REG. U.S. PAT. OFF.

JANUARY  
25 Cents

Over 200  
Illustrations



Edited by HUGO GERNSBAEK



A BROADCAST  
ENGINEER'S  
CHRISTMAS

EXPERIMENTER PUBLISHING COMPANY, 230 FIFTH AVENUE, NEW YORK

RADIOVISION

# \$62.50 Buys This

## MARVELOUS 8 TUBE ALL ELECTRIC

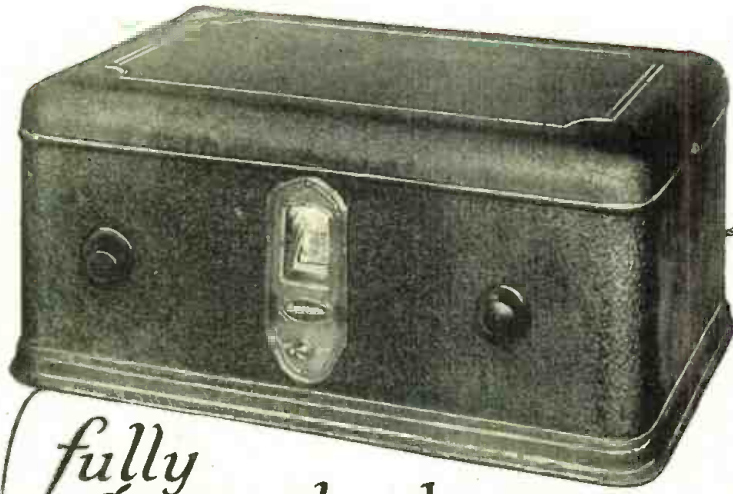

### RADIO

*Complete With*

## SPEAKER

*and*

## 8 TUBES

*fully  
guaranteed*

*You Get the Dealer's Profit!*

This is the MEL-O-RAD humanized tone, 19 inches high MAGNETIC CONE SPEAKER matched to every receiver.

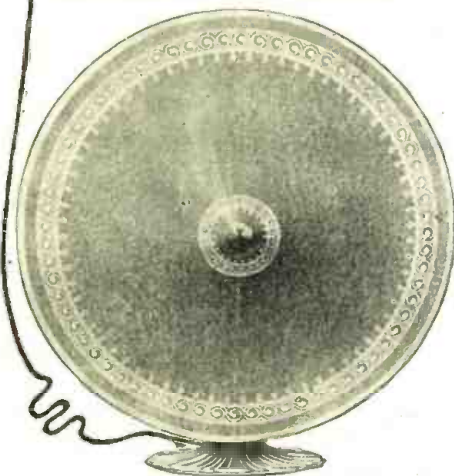

A radio set manufacturer, a tube maker, and a producer of cone speakers, all well and favorably known throughout the industry for the quality and efficiency of their products, have combined to make it possible for everyone everywhere to own an electric radio. They have organized their own selling agency, eliminating distributors, jobbers and dealers, and pass the savings along to the public.

The result is the most phenomenal offer ever made in the history of radio—an 8 tube all electric, one dial control radio with all necessary tubes and a life-like reproducing magnetic cone speaker complete with nothing else to buy, ready to plug in and operate, for only \$62.50, less than the regular retail dealer's price for a radio set alone, and—the entire outfit is absolutely guaranteed.

#### Set, Tubes and Speaker Matched for Perfect Performance.

Before shipment, each and every tube is thoroughly tested and matched for the set in which they are to be used. The same test is given to the magnetic cone speaker, so that the complete outfit, the set, the tubes and the speaker are scientifically matched for the most perfect reproduction of voice and music.

The receiver itself is a thing of beauty, size 19½ by 12½ by 18½ inches, housed in a most attractive Aquatex metal cabinet which harmonizes with the furnishings of any home. One illuminated dial simplifies operation and brings in station after station, clearly, distinctly and with all the volume desired.

#### Satisfaction Guaranteed or Money Refunded.

Take advantage of this unusual radio offer now. Send us your check or money order and complete outfit will be shipped to you ready for immediate operation. There is nothing else you need to buy. Everything you need is included at our more than 50% off list price offer.

Simply plug into your electric light socket, turn on the switch and you will hear a most perfect radio performance. Order your Melorad Radio Outfit today, and if after two weeks you are not perfectly satisfied, just say so and your money will be cheerfully refunded.

#### Here's What You Get.

One Melorad 8-tube All Electric Radio Receiver with Phonograph Pick-up, Regular Retail Price .....	\$ 75.00
Eight Guaranteed Tubes as follows: Five 226-A-C, One 227 A-C, One 171-A and One 280, Regular Retail Price .....	24.50
One Magnetic Cone Speaker, Height 19 Inches, Regular Retail Price .....	25.00
One Complete Aerial Kit, including Approved Lightning Arrester ..	2.50
<b>Total Regular Retail Selling Price .....</b>	<b>\$127.00</b>
<b>Our Direct from Factory to Public Price .....</b>	<b>\$ 62.50</b>
<b>You Save (MORE THAN 50 per cent) .....</b>	<b>\$ 64.50</b>

#### Mail This Coupon Order Now

Artee Radio Sales & Mfg. Corp.,  
206 Broadway, New York City, N. Y.

Enclosed find money order for \$62.50, for which please ship me one 8-tube All Electric Melorad Radio Receiver complete with all necessary tubes and magnetic cone speaker. It is understood that if after two weeks trial I am not perfectly satisfied, I may return the outfit and my money will be refunded.

Name .....

Street No. ....

Town and State .....

If you desire further particulars check here

## Artee Radio Sales & Mfg. Corp.,

206 Broadway,

New York, N.Y.



**Send Coupon Below for  
FREE Radio  
Idea Book**

# 5 Easy Ways to Make \$300 an hour in Your Spare Time in RADIO

Each of these plans, developed by the Radio Association of America, is a big money-maker. Set owners everywhere want to get rid of static, to have their sets operate from the electric light socket, the tone improved, and the volume increased, and transformed into single-dial controls. Phonograph owners want their machines electrified and radiofied. If you learn to render these services, you can easily make \$3.00 an hour for your spare time, to say nothing of the money you can make installing, servicing, repairing, building radio sets, and selling supplies.

Over \$600,000,000 is being spent yearly for sets, supplies, service. You can get your share of this business and, at the same time, fit yourself for the big-pay opportunities in Radio by joining the Association.

## Join the Radio Association of America

A membership in the Association offers you the easiest way into Radio. It will enable you to earn \$3.00 an hour upwards in your spare time—train you to install, repair and build all kinds of sets—start you in business without capital or finance an invention—train you for the \$3,000 to \$10,000 big-pay radio positions—help secure a better position at

bigger pay for you. *A membership need not cost you a cent!*

The Association will give you a comprehensive, practical, and theoretical training and the benefit of its Employment Service. You earn while you learn. Our cooperative plan will make it possible for you to establish a radio store. You have the privilege of buying radio supplies at wholesale from the very first.



### Earned Over \$500.00 In His Spare Time

*Frank J. Deutsch, Penn.: "I have made over \$500 out of Radio in my spare time. Yours is a great plan for ambitious men."*

### A Radio Engineer In One Year

*Claude DeGraves, Canada: "I knew nothing about Radio when I joined the Association a year ago. I am now a member of the engineering staff of the DeForest Company and my income is 225% greater than at the time I joined."*

### Doubles Income In 6 Months

*W. E. Thon, Chicago: "You have an excellent plan. Six months after I enrolled I secured the managership of large Radio store and doubled my income."*

## ACT NOW—If You Wish the No-Cost Membership Plan

To a limited number of ambitious men, we will give Special Memberships that may not—need not—cost you a cent. To secure one, write today. We will send you details and also our book filled with dollars-and-cents radio ideas. It will open your eyes to the money-making possibilities of Radio.

**Radio Association of America  
4513 Ravenswood Ave., Dept. RN-1 Chicago, Ill.**

**Radio Association of America  
Dept RN-1 4513 Ravenswood Ave., Chicago, Ill.**

Gentlemen: Please send me by return mail full details of your Special Membership Plan, and also copy of your Radio Idea Book.

Name.....

Address.....

City..... State.....

# RADIO NEWS

Volume 10

January, 1928

Number 7

HUGO GERNSBACK, Editor-in-Chief  
ROBERT HERTZBERG, Managing Editor

C. P. MASON, Associate Editor

BERYL B. BRYANT, Laboratory Director

C. WALTER PALMER, Director Information Service

## Contents of This Issue

"Mysteries" of Radio By Hugo Gernsback	619	For the Beginner—The "Bloopless" One-Dial, Two-Tube Receiver	642
Human Radio Reflectors, or Everyone His Own Aerial—By A. Binneweg, Jr.	620	Some Hints on the "Junk-Box" Receiver	646
Automatic Receiver "Listens" for "SOS" (Pictorial)	622	The "Lamp-Socket Five"—A Simple A.C. Set By Beryl B. Bryant	647
Radio Does Not Change the Weather By B. Francis Dashiell	623	End of Monthly Constructional Prize Contest	651
What's New in Radio	626	Radio Wrinkles	652
Television—The Latest Developments in the Field By Robert Hertzberg	630	On the Short Waves	654
High Frequencies for Color Television By C. Sterling Gleason	632	New List of Broadcast Station Calls	656
Giving Television the "Last Touches" By C. P. Mason	634	RADIO NEWS Laboratories	658
New Television Systems (Pictorial)	637	The Radio Constructor's Own Page By Himself	660
Some "Foolish" Questions and Their Answers By H. M. Bayer	638	I Want to Know By C. W. Palmer	661
The Dark Side of Radio By Dorothy Gernsback	641	Tubes in a Class with the Pullman Cars	668
		Review of Recent Radio Literature By H. M. Bayer	689
		RADIO NEWS Free Blueprint Coupon	701

## In Our Next Number

**THE A.C. SCREEN-GRID PERIDYNE:** The latest and most advanced model of a set well-known to our readers. An all-electric, completely-shielded broadcast receiver, self-contained in a metal cabinet. High sensitivity, selectivity and superb tone quality are its features. A fine set for the custom radio builder. Free Blueprints of this set will be available.

**A HEAVY-DUTY AMPLIFIER AND POWER PACK:** Attached to the detector tube of any set,

this unit will furnish signals strong enough to fill a theatre and clear enough to satisfy the most critical music lover. Uses a 250-type power tube—the largest receiving tube made. Another Free Blueprint article.

## Blueprint Notice

Readers desiring free blueprints of the sets described in this issue must use the coupon on Page 701. No blueprints will be sent without it.

RADIO NEWS is published on the 10th of each preceding month. There are 12 numbers per year. Subscription price is \$2.50 a year in U. S. and possessions. Canada and foreign countries, \$3.00 per year. U. S. Coin as well as U. S. Stamps accepted (no foreign coins or stamps). Single copies, 25 cents each. Checks and money orders should be drawn to order of EXPERIMENTER PUBLISHING CO., INC.

All communications and contributions to this journal should be addressed to Editor, RADIO NEWS, 230 Fifth Ave., New York, N. Y. Unaccepted contributions cannot be returned unless full postage has been included. All accepted contributions are paid for on publication. A special rate is paid for novel experiments; good photographs accompanying them are highly desirable. Publishers are not responsible for loss of manuscripts, although every precaution is taken with such manuscripts, upon receipt thereof.

RADIO NEWS. Monthly. Entered as second-class matter, July 12, 1924, at the Post Office at New York, N. Y., under the Act of March 3, 1879. Additional entry at Dunellen, N. J. and San Francisco, Calif. Title registered U. S. Patent Office, Copyright, 1928, by The Experimenter Publishing Co., Inc., 230 Fifth Ave., New York. The contents of this magazine are copyrighted and must not be reproduced in the United States without giving full credit to the publication. Translation into foreign languages must not be made unless permission is obtained from the publishers. Copyrighted in Germany. Reproduction of articles in Germany is reserved for Radio, Berlin 42.

obtained from the publishers. Copyrighted in Germany. Reproduction of articles in Germany is reserved for Radio, Berlin 42.

RADIO NEWS is for sale at all newsstands in the United States and Canada, and at Brentano's, Ave. de l'Opera, Paris, France. European agents: S. J. Wise Et Cie, 40 Place Verte, Antwerp, Belgium.

**HOW TO SUBSCRIBE FOR RADIO NEWS.** Send your name, address and remittance to Experimenter Publishing Co., 230 Fifth Ave., New York. Mention the name of the magazine you are ordering. We also publish SCIENCE AND INVENTION, RADIO LISTENERS' GUIDE and AMAZING STORIES. Write clearly.

**RATES AND TERMS.** The subscription rate for RADIO NEWS is \$2.50 per year. (12 numbers). When remitting do so by check, money order, or registered letter if cash is enclosed. Avoid sending cash through the mail if possible. Subscriptions for less than one year are not accepted. Subscription may be made in combination with SCIENCE & INVENTION, RADIO LISTENERS' GUIDE, and AMAZING STORIES.

**POSTAGE.** We prepay postage in all parts of the United States, Mexico and island possessions. For foreign or Canadian subscriptions we require 50 cents in addition to the subscription price for additional postage charge.

**CHANGE OF ADDRESS.** Notify us as far in advance as possible. It requires several weeks to make an address change on our records. Always write clearly.

The contents of RADIO NEWS are indexed in the Industrial Arts Index, copies of which can be found in every library.

Published by **Experimenter Publishing Company, Inc.**

H. GERNSBACK, President      S. GERNSBACK, Vice-President and Treasurer      IRVING S. MANHEIMER, Secretary  
Member: Audit Bureau of Circulations      Radio Magazine Publishers Association  
Advertising Representatives: RHODES & LEISENRING  
New York Offices: 624 Graybar Building      Chicago Offices: 307 North Michigan Ave

Editorial and General Offices      230 Fifth Avenue, New York City

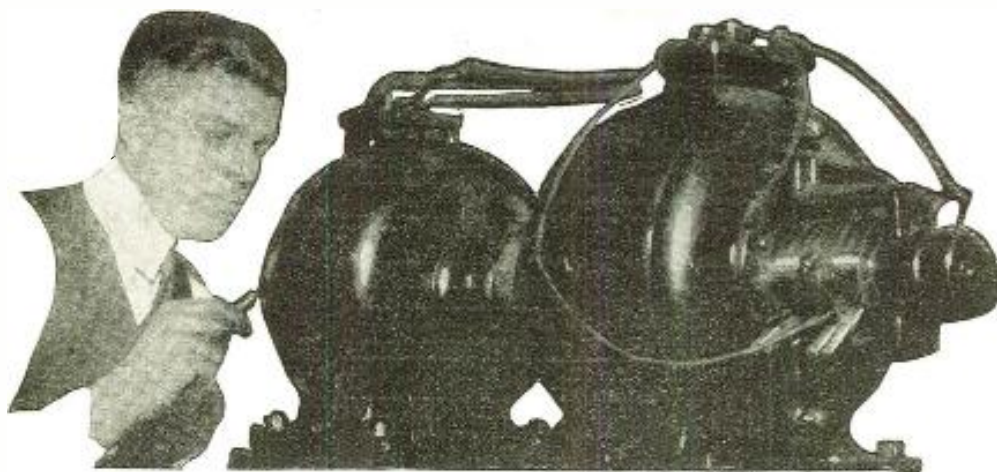

# Amazingly Easy Way to get into ELECTRICITY

Don't spend your life waiting for \$5 raises in a dull, hopeless job. Now... and forever... say good-bye to 25 and 35 dollars a week. *Let me show you how to qualify for jobs leading to salaries of \$50, \$60 and up, a week, in Electricity*—NOT by correspondence, but by an amazing way to teach, that makes you an electrical expert in 90 days! Getting into Electricity is far easier than you can imagine!

## Learn Without Books in 90 DAYS

Lack of experience—age, or advanced education bars no one. I don't care if you don't know an armature from an air brake—I don't expect you to! I don't care if you're 16 years old or 48—it makes no difference! Don't let lack of money stop you. Most of the men at Coyne have no more money than you have. That's why I have worked out my astonishing offers.

### EARN WHILE LEARNING

If you should need part-time work, I'll assist you to it. Then, in 12 brief weeks, in the great roaring shops of Coyne, I train you as you never dreamed you could be trained... on the greatest outlay of electrical apparatus ever assembled... costing hundreds of thousands of dollars... real dynamos, engines, power plants, autos, switchboards, transmitting stations... everything from doorbells to farm power and lighting... full-sized... in full operation every day!

### No Books - No Classes

No books, no baffling charts, no classes—you get individual training... all real, actual work... building real

**Prepare for Jobs Like These**

Here are a few of hundreds of positions open to Coyne-trained men. Our free employment bureau gives you lifetime employment service.

Armature Expert	\$100 a Week
Substation Operator	\$65 a wk.
Auto Electrician	\$110 a Week
Inventor	Unlimited
Maintenance Engineer	\$150 a Week
Service Station Owner	\$200 a Week
Radio Expert	\$100 a Week

batteries... winding real armatures, operating real motors, dynamos and generators, wiring houses, etc., etc. That's a glimpse of how we make you a master electrician in 90 days, teaching you far more than the average ordinary electrician ever knows and fitting you to step into jobs leading to big pay immediately after graduation. Here, in this world-famous *Parents school*—and nowhere else in the world—can you get such training!

### Job - Pay - Future

Don't worry about a job, Coyne training settles the job question for life. Demand for Coyne men often exceeds the supply. Our employment bureau gives

you lifetime service. Two weeks after graduation, Clyde F. Hart got a position as an electrician with the Great Western Railroad at over \$100 a week. That's not unusual. We can point to Coyne men making up to \$600 a month. \$60 a week is only the beginning of your opportunity. You can go into radio, battery or automotive electrical business for yourself and make up to \$15,000 a year.

### GET THE FACTS

Coyne is your one great chance to get into electricity. Every obstacle is removed. This school is 30 years old—Coyne training is tested—proven beyond all doubt—endorsed by many large electrical concerns. You can find out everything absolutely free. Simply mail the coupon and let me send you the big, free Coyne book of 150 photographs... facts... jobs... salaries... opportunities. Tells you how many earn expenses while training and how we assist our graduates in the field. This does not obligate you. So act at once. Just mail coupon.

### Now in Our New Home

This is our new, fire-proof, modern home wherein is installed thousands of dollars' worth of the newest and most modern Electrical Equipment of all kinds. We now have the largest variety of floor space devoted to the exclusive teaching of practical electricians in the world. Every course and arrangement has been arranged to make you happy and contented during your training.



### Get This FREE Book



**H. C. LEWIS, President**  
Coyne Electrical School, Dept. 19-77  
500 S. Paulina St., Chicago, Ill.

Dear Mr. Lewis:  
Without obligation send me your big free catalog and all details of Free Employment Service, Radio and Automotive Courses, and how I can "earn while learning." I understand I will not be bothered by any salesman.

Name.....  
Address.....  
City..... State.....

**COYNE ELECTRICAL SCHOOL**  
H. C. LEWIS, Pres., Dept. 19-77  
500 S. Paulina Street Established 1899 CHICAGO, ILLINOIS

Please say you saw it in RADIO NEWS

# INDEX TO ADVERTISERS

<p><b>A</b></p> <p>AcoustiCone Labs. .... 677</p> <p>Aerial Insulator Co. .... 677</p> <p>Aero Products Inc. .... 678</p> <p>Aerovox Wireless Corp. .... 701</p> <p>Allied Radio Corporation.....670-678-680-683-704</p> <p>American Radio &amp; Merc. Co. .... 684</p> <p>American Sales Company ..... 676</p> <p>American Transformer Co. .... 679</p> <p>Arcturus Radio Corp. .... 690</p> <p><b>B</b></p> <p>Barwick Co., The ..... 670-677-680-684-687-689-690 694-695-697-698-700-702-703</p> <p>Birnback Radio Company ..... 677</p> <p>Bodine Electric Company ..... 677</p> <p>Braun, W. C. .... 677</p> <p>Browning-Drake Corp. .... 694</p> <p><b>C</b></p> <p>Carborundum Co., The ..... 703</p> <p>Carter Radio Co. .... 684</p> <p>CeCo Mfg. Co., Inc. .... 670</p> <p>Central Radio Labs. .... 690</p> <p>Chemical Institute of N. Y., Inc. .... 672</p> <p>Chicago Radio Apparatus Co. .... 698</p> <p>Chicago Salvage Stock Store ..... 615</p> <p>Chicago Stock Gear Works ..... 691</p> <p>Clark &amp; Tilson, Inc. .... 612-690-698</p> <p>Clarostat Manufacturing Co. .... 698</p> <p>Coats, Fred. R. .... 670</p> <p>Conrad Co., Inc., The..... 676</p> <p>Cornish Wire Co. .... 677</p> <p>Coyne Electrical School ..... 611</p> <p>Craftsman Radio Products ..... 691</p> <p>Cunuingham, Inc., E. T. .... 668</p> <p><b>D</b></p> <p>DeForest Radio Co., The ..... 698</p> <p>DeJur-Amsco Corp. .... 677</p> <p>Dresner Radio Mfg. Co. .... 678</p> <p>Dubilier Condenser Corp. .... 699</p> <p><b>E</b></p> <p>Electrad, Inc. .... 681-695</p> <p>Electric Specialty Co. .... 703</p> <p>Elkon, Inc. .... 663</p> <p>Excello Products Corp. .... 668</p>	<p><b>F</b></p> <p>Fansteel Products Inc. .... 677</p> <p>Ferbend Electric Co. .... 677</p> <p>Ferranti, Inc. .... 700</p> <p>Freshman Co., Inc., Chas. .... 694</p> <p>Fritts, H. D. .... 677</p> <p><b>G</b></p> <p>General Radio Company ..... 674</p> <p><b>H</b></p> <p>Hammarlund Mfg. Co. .... 685</p> <p>Hammarlund-Roberts, Inc. .... 618</p> <p>Hoodwin Co., Chas. .... 690</p> <p>Hotel McAlpin ..... 674</p> <p><b>I</b></p> <p>Illinois Transformer Co. .... 684</p> <p>Independent Electric Works ..... 684</p> <p>Insuline Corp. of America ..... 677</p> <p><b>J</b></p> <p>J-M-P Manufacturing Co., Inc. .... 701</p> <p><b>K</b></p> <p>Karas Electric Co. .... 674-693-703</p> <p>Kelsey Company ..... 694</p> <p>Kilo Radio Company ..... 680</p> <p>Knapp Electric Company ..... 668-673-684-694-697-698-700</p> <p><b>L</b></p> <p>Lacey &amp; Lacey ..... 678</p> <p>Lee House ..... 694</p> <p>Leutz Inc., C. R. .... 693</p> <p>Lincoln Radio Corp. .... 697</p> <p>Littelfuse Laboratories ..... 697</p> <p>Lund Mfg. Company, I. A. .... 677</p> <p><b>Mc</b></p> <p>McSweeney Electrical School ..... 691-699</p> <p><b>M</b></p> <p>M. &amp; H. Sporting Goods Co. .... 681</p> <p>Mertz Specialty Company ..... 677</p> <p>Mason, Fenwick &amp; Lawrence ..... 701</p> <p>Midwest Radio Corporation ..... 665</p> <p><b>N</b></p> <p>National Company, Inc. .... 689</p> <p>National Radio Institute ..... 616-617</p> <p>National School of Visual Education..... 664</p> <p>New England Mills Company ..... 698</p> <p>Newark Electric Company ..... 677</p> <p>Norden-Hauck, Inc. .... 683-691</p>	<p><b>P</b></p> <p>Per-Con Manufacturing Company ..... 677</p> <p>Pilot Electric Mfg. Company ..... Back Cover</p> <p>Pohl Bros. .... 689</p> <p>Polk, J. L. .... 681</p> <p>Potter Company, The ..... 678</p> <p>Premier Electric Co. .... 687</p> <p>Press Guild, Inc., The ..... 674</p> <p><b>R</b></p> <p>Radiall Company ..... 690</p> <p>Radiart Labs. .... 677</p> <p>Radio Association of America..... 609</p> <p>Radio Doctors, Inc. .... 685</p> <p>Radio Equipment Company ..... 694</p> <p>Radio Institute of America ..... 613-671</p> <p>Radio Producer Company ..... 680</p> <p>Radio Specialty Company ..... 669</p> <p>Rawner Radio Company ..... 677</p> <p>Raytheon Mfg. Co. .... 697</p> <p>Royal Eastern Electric Supply Co. .... 683</p> <p><b>S</b></p> <p>Samson Electric Company ..... 677</p> <p>Scott Transformer Company ..... 678</p> <p>See Jay Battery Company ..... 690</p> <p>Shanklin Mfg. Company ..... 693</p> <p>Silver-Marshall, Inc. .... 614</p> <p>Smith, B. Hawley ..... 680</p> <p><b>T</b></p> <p>Teleplex Company ..... 699</p> <p>Televocal Corporation ..... 694</p> <p>Terlec Radio Mfg. &amp; Sales Co. .... Inside Front Cover</p> <p>Thordarson Electric Manufacturing Co. .... Inside Back Cover</p> <p>Townsend Laboratories ..... 687</p> <p>Transformer Corporation of America ..... 670</p> <p>Twin Coupler Company ..... 677</p> <p>Tyrman Electric Corporation ..... 675</p> <p><b>U</b></p> <p>Underground Aerial Systems ..... 617</p> <p><b>W</b></p> <p>Walker Co., The Geo. W. .... 666</p> <p>Western Radio Manufacturing Co. .... 677-699</p> <p>Wholesale Radio Service Company ..... 684</p> <p><b>X-Y-Z</b></p> <p>X-L Radio Laboratories ..... 668</p> <p>Yaxley Manufacturing Company ..... 695</p>
---	---	--

# SM

**\$150**  
**Reception**  
**at a**  
**\$50**  
**Price**

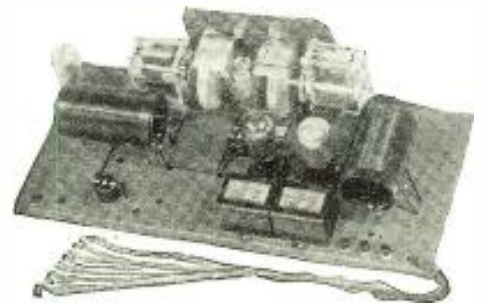

TO the thousands of fans for whom the four-tube, R. F. amplifier, regenerative detector and two-stage audio amplifier is the time-tested standard of receiver comparison, the new Silver-Marshall Coast-to-Coast Four offers the finest performance yet attained with this remarkable circuit. A screen grid R. F. amplifier stage, immeasurably finer coils than ever before, the new Clough high-gain audio system, and an all-metal assembly like those of the finest of ready-made sets, make the "740" the biggest \$51.00 worth of radio set you've ever listened to.

The Coast-to-Coast Four, at Chicago, plays on the speaker New York, Florida, Texas, and California stations, cutting through local Chicago interference only 10 or 20 kc. away. Its tone quality is such as only S-M transformers can provide. Housed, like the 720 six, in the new S-M 700 table-model metal shielding cabinet,

it harmonizes beautifully with any home-furnishings.

Despite this demonstrated superiority, in every respect, over all other sets in its price class against which we have tested the 740, the complete kit of all approved parts costs but \$51.00 or the 740AC kit, \$53.00 complete. The 700 cabinet is \$9.25 additional, or is included with 740 wired, \$75.00; and 740AC wired, \$78.00.

We go emphatically on record that no matter what set you build or buy, the 740 Coast-to-Coast Four is the best dollar for dollar value you can find around fifty dollars. It goes together easily and simply, performs with a vengeance, and for the professional set-builder provides a low-priced set that will out-demonstrate ready-made sets at twice its price.

## S-M Parts Always in Stock

We always have a large stock of S-M kits and parts, as well as other high-quality apparatus. Send the coupon for our catalog. Discounts to dealers. Try us for quick service.

# CLARK & TILSON

122 Chambers Street

New York, N. Y.

CLARK & TILSON  
22 Chambers St., New York, N. Y.

Please mail your catalog showing S-M parts and kits, and other high-quality radio apparatus, as advertised in January Radio News.

Name.....

Address.....

City..... State.....

Please say you saw it in RADIO NEWS

# "How I Laughed Myself Into Success in Radio"

by Howard Clark

"I'm sitting on top of the world! My bank account is growing fatter every day . . . my home is all paid for . . . I've just ordered a new car . . . and my wife and I can at last enjoy life in real style. It sure feels great to be earning big money. And to think how it all came about!"

. . . .

IT happened on a rainy Monday night. I was reading a magazine while Mary was clearing away the supper dishes. Suddenly a funny cartoon caught my eye . . . and I laughed out loud.

"Jim, you make me sick!" she cried. "How can you laugh while I'm nearly dying of weariness!"

"But Mary dear—"

"Don't dear me, you idiot!"

I was alarmed. "Great heavens, what's wrong?"

"Wrong?" she screamed, "here I drudge all day, do my own housework, wash all the clothes, take care of the baby, and worry about your meals. I never get a moment of freedom . . . and haven't a decent thing to wear even to church . . . yet you never seem to care!"

### I was ashamed!

A feeling of shame swept over me. So that was why she seemed so "moody" the last few days! Like a good sport she had suffered in silence until she couldn't keep it in any longer. Poor kid!

For hours after Mary had gone to bed that night I kept staring into space. What a mess I had made of our lives . . . What a slave I had made of her.

Listlessly I kept thumbing the pages of the magazine . . . thinking . . . thinking. Was there no way out of it?

Then suddenly . . . as if by some kind act of Providence . . . I stopped before a story. It told of a fellow who had made quite a fortune in an uncrowded profession. Fascinated, I read on. It told of the brilliant opportunities in the radio industry . . . of the big incomes fellows like myself were earning . . . and of the ease with which expert radio training could be acquired. But what impressed me most was the



fact that success was practically assured by means of a new home-study laboratory method sponsored by three of America's great corporations.

With gigantic enterprises like these behind a school I needed no greater guarantee . . . so without a second's further hesitation I tore the coupon and mailed it.

### A lucky event that changed my life

It sure was my lucky day, when the first lessons came in. I never dreamed that learning radio was so easy. I didn't know the first thing about it when I started. Yet before many months were over I was able to solve many of the problems which command big pay.

Each subject was explained in simple word and picture form. It carried me along like a novel. From magnetism and electricity the lessons took me step by step through trouble-finding and repairing—through ship and shore and broadcasting apparatus operation and construction—through photoradiograms, television and beam transmission.

I didn't have to give up my regular job. I stayed right at home and learned

during my spare time. I actually learned by doing. With the lessons I received a complete, expensive storehouse of apparatus with which I was able to build radio circuits and sets of almost every description. Yet it cost me absolutely nothing extra.

As a result of this practical, technical working out of big radio problems with a fine home-laboratory, I was able to earn good money even before I had completed my course! And it wasn't long before I was able to quit my regular work entirely . . . and branch out for myself in big paying radio jobs.

Today, I have more work than I can take care of. And I often make more money in a day than I used to earn in a week.

### Read this thrilling Free Book

Howard Clark's story is typical of the success which scores of other men have achieved . . . through the "big-league" training given by the home-study course of the Radio Institute of America . . . the only school in America sponsored by RCA, General Electric and Westinghouse.

Radio needs you. Manufacturers, dealers, broadcasting stations, ships . . . all need trained radio experts. The pay is big. The opportunities are limitless . . . The work is thrilling! Find out all about it. The Institute has prepared an interesting, illustrated booklet telling you all you want to know about this vast industry and about the remarkable home-study course that can fit you for a brilliant radio career. Just mail the coupon below . . . the booklet is absolutely free. Radio Institute of America, 326 Broadway, New York.

### Mail this coupon



Radio Institute of America  
Dept. RN, 1,326 Broadway, New York

Gentlemen: Please send me your big FREE 50-page book which tells about the great opportunities in Radio and about your famous laboratory-method of radio instruction at home.

Name.....

Address.....

# SM

**Volume to Fill Any House**  
**—the Last Word in Realism**  
**—from Any Phonograph [Radio]**

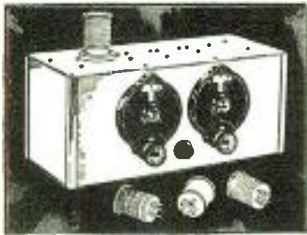

**Listen-In  
 on London  
 with the  
 Round-the-  
 World Four**

**NOT** with any ordinary radio receiver, of course—the Atlantic is too wide for regular broadcast receivers to bring you London programs. But turn on your S-M "Round-the-World" set some night. Don't be surprised if the language you hear is a foreign one, or if the announcer mentions "Paris" or "Amsterdam," or "London" instead of the cities you are accustomed to hear from. Call your neighbors to listen if you want to—but be cautious about calling anyone who has already explored the mysterious short-wave channels with an S-M set—your wonders might sound very tame to him. Perhaps by this time he is only interested in New Zealand and Japan! For in short-waves almost anything is possible; amazing feats of distant reception are becoming a matter of common knowledge. (See prices on opposite page).

**with  
 this →  
 and  
 this**

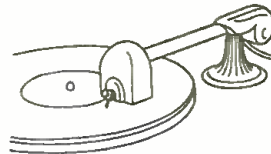

**and  
 this →**



The new 2-stage S-M 678PD Phonograph Amplifier is priced so low that, while particularly adapted for dance halls and small theaters, it is ideal for the home also. Used with any 110 volt D.C. dynamic speaker, it takes input from any magnetic phonograph pickup, or from the detector tube of a broadcast or short-wave receiver, and, by means of its S-M Clough-system audio transformers, supplies to the speaker undistorted the full power output of its 250-type tube. All input power is taken from the 110 volt A.C. house-lighting mains. Price, wired, \$73.00; complete kit, \$69.00.

Or you can get 250-tube power right in your present set by inserting a 250 tube (with an adapter) in the last socket of the set, and using the S-M 675ABC Power Supply—which furnishes ABC power for the 250, and B power to the entire set (or full ABC power to A.C. tube sets). Price, 675ABC kit, \$54.00, or factory-wired, \$58.00.

## True Tone Quality from New S-M Audios

Are you receiving "The Radiobuilder" regularly? No. 6 tells all about the new S-M Public Address Amplifier. No. 7 describes two interesting short-wave developments, and a new S-M 750 volt power supply. To all Authorized S-M Service Stations, it comes free of charge; to others a nominal charge is made. Use this coupon.

If you build professionally, write us about the Service Station franchises. Or if you don't build, yet want your radio to be custom-made, S-M will gladly refer your inquiry to an Authorized Silver-Marshall Service Station near you.

S-M Clough-system audio transformers are guaranteed unconditionally to give better tone quality than others, with higher amplification, regardless of size, weight, or price. They sell in tremendous quantities, by simply comparing results with others in the comparison amplifiers used in S-M demonstrations at recent radio shows.

In the curves at the right E is the two-stage curve for the large-size transformers (S-M 225, 1st stage; and 226, 2nd stage, \$9.00 each), D is that of the smaller ones (S-M 255 and 256, \$6.00 each). Note the marked advantage over A, B, and C—all standard eight and ten dollar transformers under equal conditions.

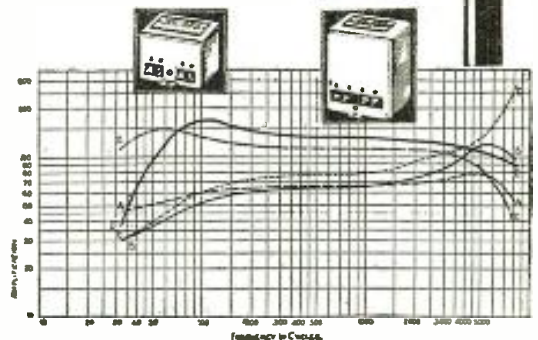

- Silver-Marshall, Inc.  
 848 W. Jackson Blvd., Chicago, U. S. A.  
 ...Please send me, free, the complete S-M Catalog; also sample copy of The Radiobuilder.  
 For enclosed.....in stamps, send me the following:  
 ....(50¢) Next 12 issues of The Radiobuilder  
 ....(\$1.00) Next 25 issues of The Radiobuilder  
 S-M DATA SHEETS as follows, at 2c each:  
 ....No. 1. 670B, 670ABC Reservoir Power Units  
 ....No. 2. 685 Public Address Unipac  
 ....No. 3. 730, 731, 732 "Round-the-World" Short Wave Sets  
 ....No. 4. 223, 225, 226, 255, 256, 251 Audio Transformers  
 ....No. 5. 720 Screen Grid Six Receiver  
 ....No. 6. 740 "Coast-to-Coast" Screen Grid Four  
 ....No. 7. 675ABC High-Voltage Power Supply and 676 Dynamic Speaker Amplifier  
 ....No. 8 Sargent-Rayment Seven  
 ....No. 9 678PD Phonograph Amplifier

.....Name  
 .....Address

**ONE** of our cooperating distributors, whose announcement directly follows, joins us in presenting a descriptive summary of some of the outstanding receiver and amplifier values to be found in the new S-M line.

**SILVER-MARSHALL, Inc.**  
 848 West Jackson Blvd., Chicago, U. S. A.





# MORE MONEY

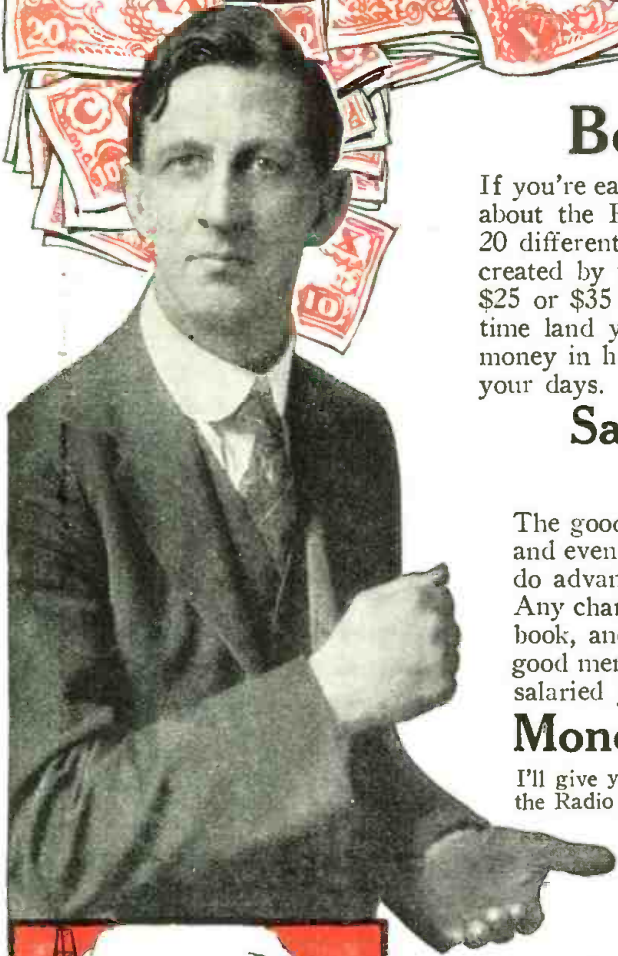

## Be a Trained Radio Expert

If you're earning a penny less than \$50 a week, get my free book of information about the Radio business. Trained Radio Experts are needed in more than 20 different lines of this new and growing profession (300,000 new openings created by the swift growth of Radio in past few years). Why go along at \$25 or \$35 or \$45 a week all your life? Study Radio and after only a short time land yourself a REAL job with a REAL future! Be a man who has money in his pocket and in the bank—don't scrimp and scrape for the rest of your days.

## Salaries of \$50 Up to \$250 a Week Not Unusual in Radio

The good positions in Radio pay all the way from \$50 on up to \$150, \$200, and even \$250 a week. Suppose you don't climb to the very top, but that you do advance to a position that pays you \$125 a week, year in and year out. Any chance to make that much where you are now? Then send for my free book, and learn about a field where there's some *real opportunity*. Where good men, *if they have the right training*, can work their way into really big-salaried jobs!

## Money Back If You Aren't Fully Satisfied

I'll give you all the training you need to get into any line of the Radio business. And I back up this training by a signed agreement to refund every penny you pay me if I don't give you exactly the training you need. After you finish my training, you'll be the judge. If you think I've earned my tuition fee, I keep it. If not, ask for it and you'll get it right back.

## Six Big Practical Outfits Given You to Help You Learn

I teach you both the "why" and the "how" of Radio. You learn to DO a thing, and you learn WHY it's done. I send you, WITHOUT EXTRA COST with your course, six big practical outfits of material to experiment and work with. These outfits are the real thing—not toys. The parts they contain will build approximately 100 different Radio circuits. With all this material you do practical work from start to finish of your training. You get your hand in, and you get confidence in yourself. Then when you run into a Radio problem later on, on the job, you KNOW you can do it because you've already done it—with these six outfits of practical material. With me you don't learn to be a "paper Radio Expert"—you learn to be the kind of expert that shows his worth on the payroll. Full details in my big book—sent free.

Send for Free Book of Information.

### GET BOOK!

Find out for yourself about the bigger pay waiting for you in Radio! From \$2,000,000 in 1920 to \$504,000,000 in 1926—that's the record of the Radio Industry! Plenty of big Radio jobs are waiting for the man who KNOWS! John Fetzer sent for my free book—now he's Chief Engineer at WEMC and designs and builds broadcast stations. T. M. Wilcox sent for the book—now he's in his own Radio business and reports profits as high as \$70 in one day! All information will be sent to you free, without any obligation—just mail coupon on opposite page.

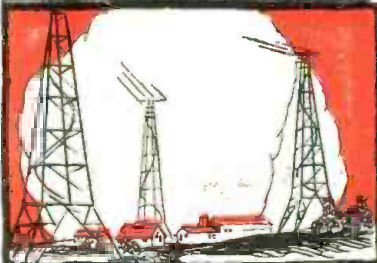

Broadcasting and commercial Radio land station work appeal to a lot of men—it's a big, growing field and fascinating work. My course prepares you thoroughly to get into this field and make good.

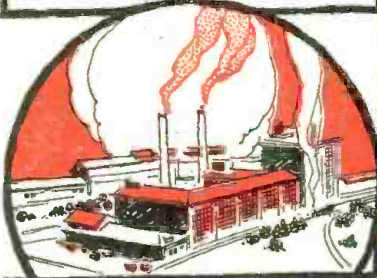

Radio manufacturing has grown faster in the last 6 years than any other big business ever did. It's 250 times as big as it was. That means lots of good chances for the trained Radio Expert.

Six million Radio receiving sets in use in the United States means millions of dollars are going to Radio Service and Repair men everywhere. For this work you must be trained.

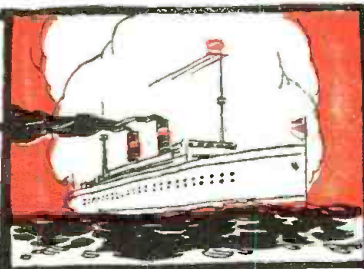
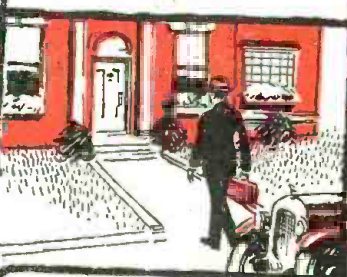

Radio operators on board ship go everywhere—see everything. You sail the world over, all your expenses paid, and draw a good salary besides. It's the life of Reilly.

see coupon next page

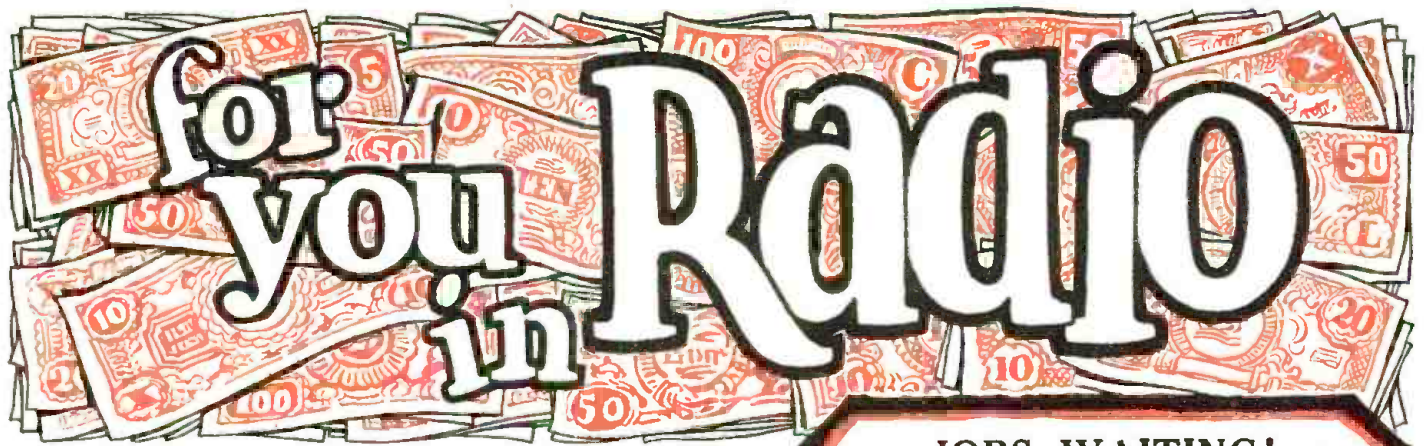

**LEARN QUICKLY, EASILY  
Train at Home in Spare Minutes**

Stay home! Hold your job! I'll bring your Radio training to you, and you can learn in your spare time after work. No need to go to a strange city and live for months on expense when you learn my way. You study in the quiet of your own home. As for this training—it's written just as I would talk—in straightforward, everyday, understandable language. You'll get it, and you'll get it quickly—in a few months' spare time—because I've made it so clear and interesting! No particular education needed—lots of my successful students didn't finish the grades.

**Earn \$15, \$20, \$30 Weekly  
Right Away "On the Side"**

Deloss Brown, South St., Foxboro, Mass., made \$1,000 from spare-time Radio jobs before he even finished my course. H. W. Coblentz, Washington, averaged \$45 a week; Leo Auchampaugh, 6432 Lakewood Ave., Chicago, made \$500 before graduation; Frank Toomey, Jr., Piermont, N. Y., made \$833 while taking the course. All this done IN SPARE TIME away from the regular job, while these fellows were still studying the course—and they're only a few of hundreds. As soon as you start this training I begin teaching you practical Radio work. Then a few weeks later, I show you how to make use of it in spare time, so you can be making \$15, \$20, \$30 a week "on the side," all the while you're learning.

**64-Page Book Sent Free for the Asking**

My big book of Radio information won't cost you a penny, and you won't be under any obligation by asking for it. It's put hundreds of fellows on the way to big pay and brighter futures. Sending for it has been the turning-point where many a man has made his start toward real Success. Get it. See what it's going to mean to you. Send coupon TODAY!

**Address: J. E. SMITH, President,  
National Radio Institute,  
Dept. 9MT, Washington, D. C.**



**Send No Money**

J. E. SMITH, President,  
National Radio Institute,  
Dept. 9MT, Washington, D. C.

Dear Mr. Smith: Kindly send me your big free book, "Rich Rewards in Radio," giving all information about the big-money opportunities in Radio and how you will train me to take advantage of them. I understand this places me under no obligation, and that no salesmen will call on me.

Name .....

Address .....

Town ..... State .....



This big 64-page book, printed in two colors, crammed with interesting facts and photos about money-making opportunities in Radio, sent free to everyone who clips the coupon. No obligation by sending for the book—it's absolutely free. One of the most valuable books about Radio ever written.

**JOBS WAITING!**

In 7 short years—300,000 new jobs in Radio! Lots of jobs open right now, for those who have the training. The Radio industry has grown by leaps and bounds—so fast it has had to take whatever sort of men it could get. Such men, if they haven't trained themselves in the meantime, are losing out and will keep on losing out. They'll be replaced by men with the KNOW-HOW. But it's trained men ONLY that are needed.

**Over 1,000 Openings for Trained Men NOW!**

One great Radio manufacturing concern alone has over 1,000 openings to give my graduates this year. These men will be needed all over the United States. Any graduate of mine who stands well in his home town is eligible for this work. The head of the above mentioned concern—one of the biggest Radio organizations in the country—is a graduate of mine. He knows what my training did for him. When he wants new men for his organization he wants men with the same training.

I can't possibly graduate enough men this year to fill these openings. So there will be more openings with this one concern than there will be graduates to accept them.

But there are other openings to choose from, too. My school has trained more Radio Experts than any other school in the world. It's the oldest and largest Radio home-study school in the world. There are N. R. I. trained men in almost every Radio concern of any importance in this country. Many Radio employers are themselves my graduates.

That's where you get your "stand-in" as an N. R. I. graduate yourself. Every graduate of my course is entitled to Life-Time Employment Service, without a penny's charge, from my helpful Employment Department.

Full Information Sent with Free Book

My Free Book contains full information about the Radio employment situation, and the advantages I'm in a position to give you. Also about my Life-Time Employment Service, and Life-Time Consultation Service, too.

Mail Coupon Today!

Please say you saw it in RADIO NEWS

Great Features  
Tell You Why  
**6000**

RADIO-TRICIANS  
Are Offering  
These

# NEW HI-Q RECEIVERS

NO man can use the title "RADIO-TRICIAN" unless he can qualify as a radio expert. So when we tell you that 6000 authorized "RADIO-TRICIANS" throughout the country are building the new Hi-Q 29 Receivers you must agree that these receivers MUST have outstanding qualities.

The biggest advance of the year in radio design is the "Band Pass Filter"—a system which effects absolute FLAT TOP *square cut-off* TUNING with positive 10 K. C. selectivity. This is the big feature of Master Hi-Q 29 Receivers. No other set in the world has it to our knowledge. It eliminates "cross talk" even in crowded areas which

*Custom-Built to  
Any Pocketbook!*

have many powerful stations and gives a Super-sensitivity and Super-selectivity which assures coast-to-coast reception. Further than this, it produces a quality of tone which we have never heard equalled in any receiver!

For 1929 there are FOUR Models of Hi-Q Receivers—for battery or A. C. operation. All are the joint creation of ten of America's leading parts manufacturers. All are stage-shielded and built on steel chasses from only the finest parts available in the radio industry.

You should own one of these wonderful receivers. Build it yourself or have it built for you by your local RADIO-TRICIAN.

Write For  
This New  
80-page  
Construction  
Manual



The biggest and most complete book of its kind ever published. Tells how to build the 4 new Hi-Q Receivers. Photos and diagrams illustrate every detail. Covers power amplifiers, tube and battery combinations, antennae, installation, short-wave adapters, house wiring and a wealth of other data on the custom-built Hi-Q. Price 25 cents including postage.

1. 10 K. C. SELECTIVITY
2. ABSOLUTE FLAT-TOP Square Cut-off TUNING
3. SCREEN-GRID TUBES
4. STAGE-SHIELDED STEEL CHASSIS
5. CONCEALED WIRING
6. SIMPLIFIED OPERATION
7. NATURAL REPRODUCTION
8. COAST-TO-COAST RECEPTION

**4**  
MODELS  
for Battery or  
A. C. Operation

**HAMMARLUND-ROBERTS, Inc.** 1182-C BROADWAY NEW YORK CITY

Associate Manufacturers



Please say you saw it in RADIO NEWS



Editorial and General Offices, 230 Fifth Avenue, New York

Vol. 10

JANUARY, 1929

No. 7

## “Mysteries” of Radio

By HUGO GERNSBACK

I HAVE often made the assertion that very little is actually known about radio today; and, while we know some of the instrumentalities that make radio possible, a good-sized library could be filled with volumes on the various aspects of radio about which we know little or nothing as yet. Every once in a while, we hear about some new radio “mystery” that leaves our scientists up in the air. Immediately, a good many theories are propounded as to the how and why of such phenomena; but, in the end, we are about as wise as we were before.

The press very frequently reports some of these mysterious occurrences, and many of them seem to be well authenticated. For instance, not so long ago, there was a report from Boston that a water faucet had started, for no apparent reason, to give out radio music from a radio station about a mile and a half distant. How the faucet can do this, no one knows; various theories have been propounded, but none seem to be fully satisfying. In order to receive radio waves, and make them audible, we must first “detect” them electrically and then transform the electrical impulses into sound. As a detector we usually use an imperfect-contact or crystal-type rectifier, or a vacuum tube, and for the sound-producing medium a loud speaker. A more or less complicated array of instruments is required to reproduce radio music clearly in a fair-sized room; but in the Boston case, evidently, there were no such technical instrumentalities. Evidently Mother Nature, through a happy train of circumstances, took charge and produced the mystifying results. Just what was the detector and what the amplifier, no one seems to know.

This odd occurrence, however, does one thing; and that is to give the radio engineer abundant food for thought, and prove to him conclusively that there is a good deal to learn about radio, not yet contained in any text book. Perhaps ten years from now we will be using such simplified radio sets; and, while we may possibly not use a faucet with running water as our loud speaker, we may take advantage of similar principles. In the Boston case, if my memory serves me right, the music stopped when the water was turned off.

A similar radio mystery was encountered in London, when a lamp post in one of the busiest thoroughfares started to give out radio music, including announcements of the local station, whose sounds were reproduced. Whether the arc lamp contained in the lamp post was the detector in this case, or whether the switching arrangement inside acted as an amplifier, no one seems to know. Which is a pity; because, here again, there seems to be another radio principle involved, which calls for a theory entirely different from that of the water-faucet phenomenon.

Similar mysterious occurrences happen from time to time, and they are usually well authenticated; but it would seem that none of the different occurrences can be brought under any regular classification as far as the method of operation is concerned, or only roughly so. This again proves how little we actually know about radio.

Some years ago, when the design of audio transformers had not reached its present perfection, you could often hear radio music from your set without loud speaker or telephone receivers. In other words, the whole set apparently became a musical instrument.

In this case, the mystery was not quite so deep, because here the music can be traced immediately to its source; it has been shown that an audio transformer, unless the laminations of its iron core are quite tightly packed, will emit sounds corresponding to the currents passing through it. Perhaps this will give someone a good idea of a way to build a new type of loud speaker; which may or may not be more efficient than those we have today.

Then, of course, there is another well-known type of unexpected happening, which, however, is not so puzzling as those previously cited; and that is, when your receiving set becomes a broadcast station. It has more than once happened in the past that, while a radio set was turned on, people several miles away were able to listen in with their own radio sets to the conversation going on in the room in which this particular radio set was located.

A great deal of wonderment has been caused by this sort of thing, but it is really no great mystery at all. Some radio sets, as a matter of fact, are transmitters, as perhaps most people already know. If the set is in an oscillating condition and has a loud speaker connected to it, under certain circumstances this loud speaker will become a microphone; and anything spoken in the room will be put “on the air” by this particular set. If a neighbor one or two blocks away has his radio turned on and is fishing for a station, he will sooner or later come across the wave emitted by the oscillating receiver down the street. He will hear voices, perhaps familiar ones, and may pick up a lot of gossip that was not meant for his ears.

Of course, a thing of this kind is usually done unconsciously and, as a rule, a great to-do is made when it happens. The newspapers begin to feature the existence of a “secret broadcaster” and, if the condition persists, it is even carried to the Radio Commission at Washington. The “mystery” is not a mystery, and there is no secret broadcaster; but a set owner who might better be called an innocent or ignorant broadcaster.

Of course, such an involuntary broadcast will not happen every time you talk in front of your set; there must be a long train of fortuitous circumstances making it possible, or it will not happen. And incidentally, when it does happen, you are violating the Federal Radio Law, and you are liable to get into trouble with the authorities. So the remedy for this particular “mystery,” which might better be termed a “nuisance,” is *not to allow your set to oscillate*.

Then there is a “mystery” of another sort, where there is no offending radio set, yet your loud speaker suddenly blurts forth a complete telephone conversation, as it is being carried on by a number of neighbors. The latest gossip from the town begins to sizzle over your speaker, hot and heavy, and you do not miss a single luscious bit of information. All this goes on, incidentally, without the two gossipers on the party line being aware that any one is eavesdropping. Indeed, there is seemingly no electrical connection; yet the dialogue with all its poignant results is coming out of the loud speaker, loud and clear.

This, too, is not a deep mystery and, fortunately, it is rare. It happens usually when one line of the telephone circuit becomes grounded, and we get the phenomenon of so-called “rising currents.” This used to be the nightmare of telephone engineers when the telephone was younger, and when the ground was used universally for the return. In these days, where practically every telephone line has two solid copper wires, the phenomenon is somewhat rarer; but, very often, a phone or line becomes grounded and, if the circumstances are right and the distance is not too great, the above-described results follow. Very often, however, the cause may be simply the inductive effect between a telephone line and an aerial running parallel to each other for some distance; or it may be a combination of this with a common ground that does the trick. If you were required to duplicate the results somewhere else, it would probably take a lot of engineering and a great deal of apparatus to do so. The conditions must be just so, otherwise no “results” appear.

These are only a few of the better-known radio “mysteries.” If our readers know of any others, we should be glad to hear the details from you; and if they are authenticated, RADIO NEWS will be glad to publish them.

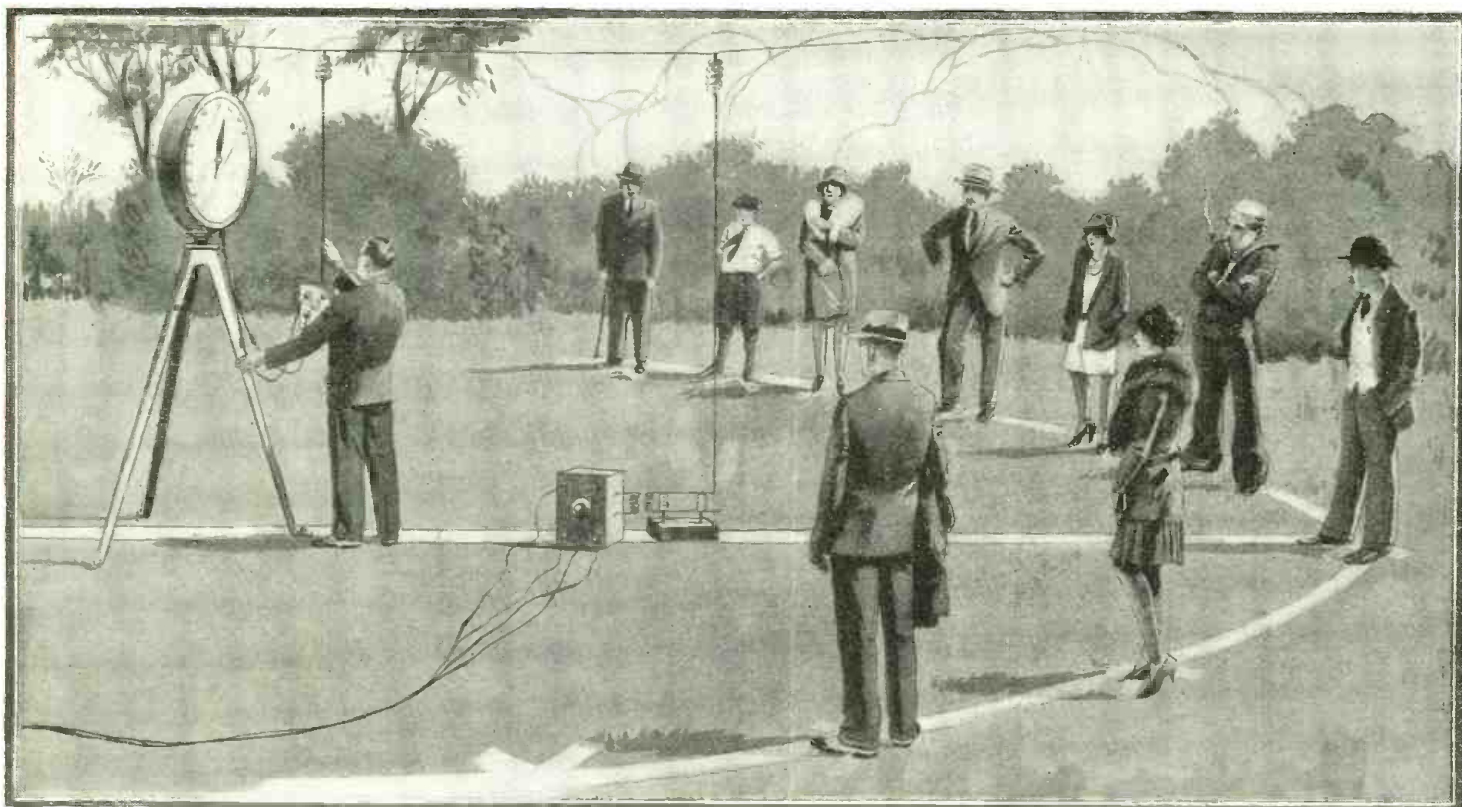

Each individual who steps into the line increases the strength of the signal received on the receiving aerial alongside of the indicator, which, as a matter of fact, could be put much farther away. Each individual is a re-radiating aerial for the ultra-short waves.

## Human Radio Reflectors, or Everyone His Own Aerial

Interesting Tests Give Remarkable Results on Short-Wave Transmissions

By A. Binneweg, Jr.

**S**TUDENTS at the University of California have discovered that the human body acts as an efficient radio reflector. In actual tests, the approach of a human body toward a wire, suspended in space, has been made to actuate a powerful electric horn. Several persons standing around a three-meter transmitting aerial

have served as a radio reflector to direct transmission in the opposite direction.

The effect is a mysterious one, since the spectators cannot see what takes place. One walks up to such a system of wires and hears the horn sound but cannot in any way feel the presence of the radio waves actually reflected from the body, nor see

any of the apparatus used, if it is placed behind a screen. At certain definite fractions of a wavelength from the antenna, the presence of a body causes the horn to sound and, if the adjustments are sufficiently sensitive, the device will operate while the approaching person is still at a considerable distance from the transmitting equipment. The experiment is an extremely novel one and, when performed before a group of visitors, always proves of exceptional interest.

It is well known that radio waves may be directed in a given direction by suitably arranging a system of wires around the transmitting aerial. At a wavelength of about three meters it has been found that these wires can be replaced by human bodies and the same effect will result. Some persons are better "reflectors" than others, when a definite wavelength is used; and each person has his own "natural frequency" at which reflection will be a maximum. In the future, who knows but that the police may classify criminals, not by their fingerprints alone (although perhaps these will also be used), but by their "natural frequencies"?

As the human body grows, its natural frequency decreases in value and thus a growing person "tunes" his body over a definite wavelength range. A baby has a much higher natural frequency (perhaps this explains the reason of those high-pitched "squeals") for given conditions, than an adult. This fact may prove of considerable value to the medical profession, as will be explained later.

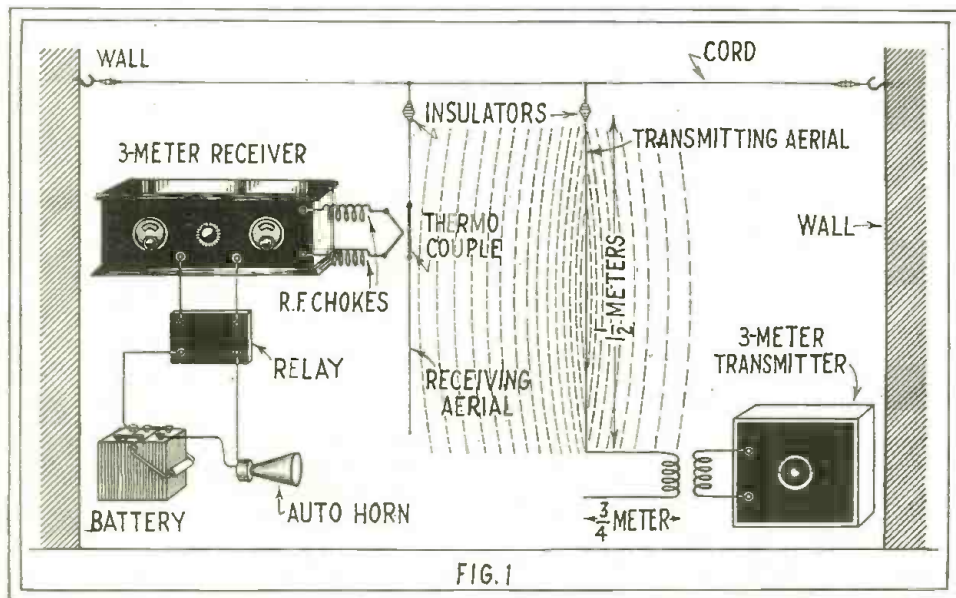

In this case, a blank wall reflects the short waves and, at the right distance, will send them back in phase with the transmission. The thermocouple in the resonant aerial then generates a current amplified through the receiver.



# Automatic Receiver "Listens" for "S O S"

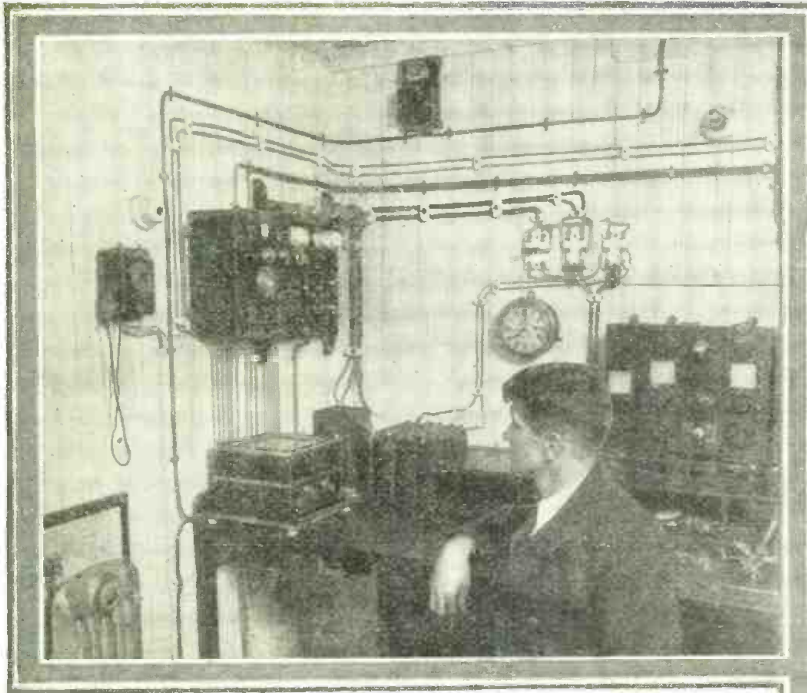

When Radio Shouts the Sea's Call of Distress, This Apparatus Responds Like a Fire Alarm When a Box is "Pulled"

"Sparks," the ship's operator, must sleep at times, and thus relax his watch for the calls of ships in distress. When he lies down, however, he knows that the ringing of the bell above his head will mean an "SOS," and that it will then be up to him to do his bit in keeping up the record which the radio men of the sea have made in the hours of emergencies. Another bell is ringing in his transmitting room, and a third on the bridge, informing the officer on duty that he must expect startling news. It may be explained, however, that this signal is not the "SOS" (. . . — — . . .) itself, but a preliminary to the announcement giving the name and position of the ship in distress. The photograph was posed by Operator F. R. Hughes of the SS. Cedarbank, one of the first on which the automatic "SOS" alarm was installed.

Above, the radio room of the Cedarbank, showing the automatic receiver on the wall at the left, above the operator's table. The second signal bell is at the right and above it, at the center of the top line of the picture. This receiver is permanently tuned to the band 15 meters on either side of the 600-meter wavelength on which the "SOS" is sent out. As there is much calling near this wave, a distinctive signal, 12 four-second dashes spaced one second each, is used in this system. When such a signal is picked up by the receiver, which is of the three-tube regenerative type, it sets in action the polarized relay and selector on the table below it, which can be seen in more detail in the picture below at the lower left.

The alarm device used to send the special call is made in two types, each of which has a timing device so that it will send out the signal in the exact method which will operate the selector at the receiver shown below. It is rated as having a range of 200 miles; but would undoubtedly be audible much further in many receivers. It is not impossible, of course, that near shore powerful land stations might cause a false alarm; but there would seem to be little danger of this at sea.

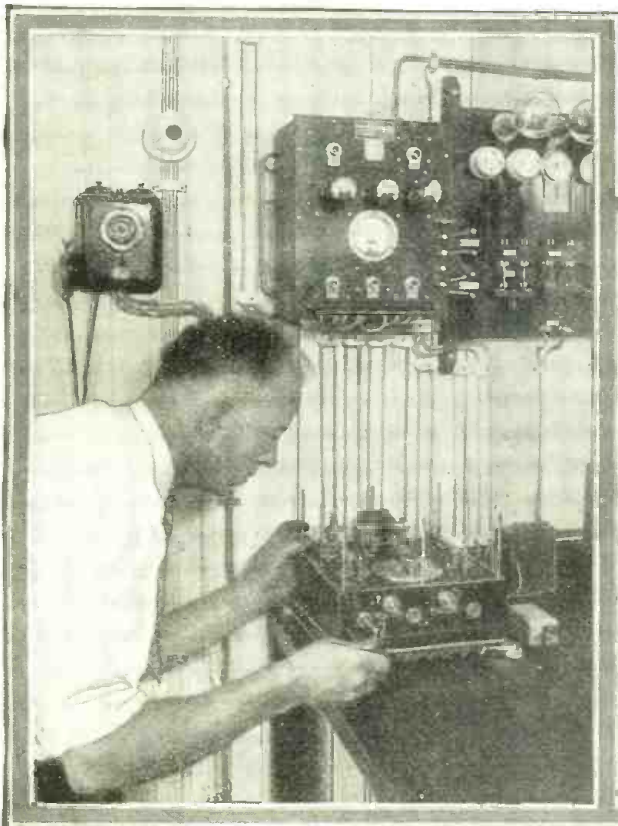

We have below a close-up of the receiver itself, with its three tubes mounted horizontally on the front panel. There are no dials on the set, but only keys for adjustment, as it is to be kept in fixed tune. The switchboard of the power supply is alongside of it, and the telephone to the bridge at the left. All passenger liners and all freighters with a crew of fifty or more, under the British flag, must carry this safety device; and endeavors are being made to bring about similar regulations by other nations.

Illustrations (C) Herbert Photos, Inc.

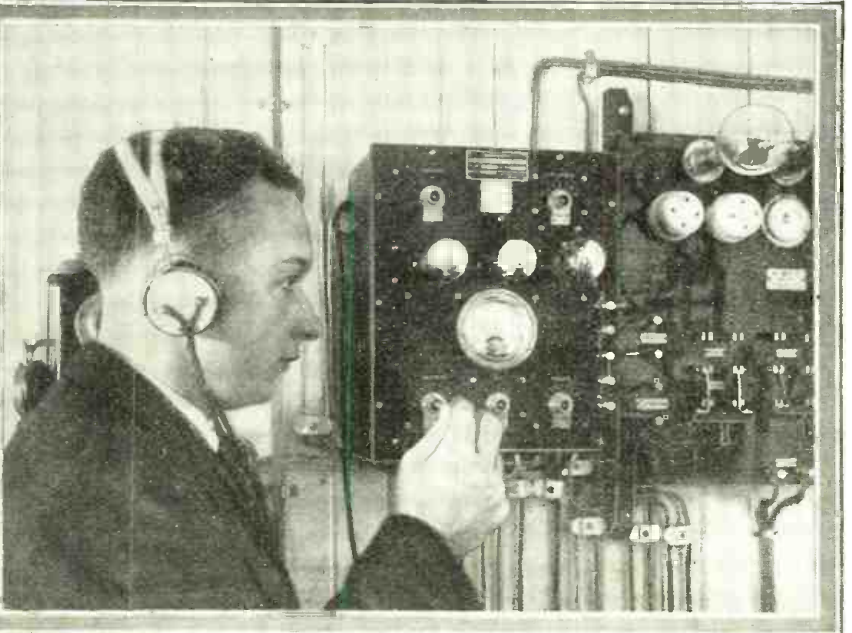



# Radio Does Not Change the Weather

A Popular Theory That Broadcasting Brings Rain and Wind Is Disproved by a Reference to the Records of the Past Fifty Years

By B. Francis Dashiell\*

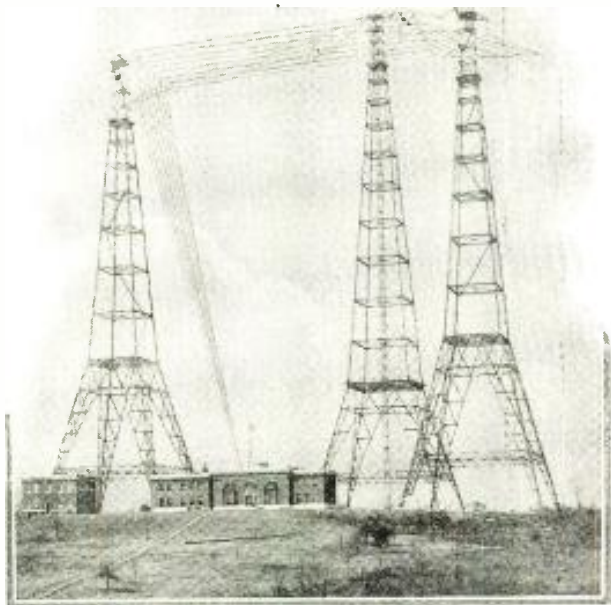

The great towers of the naval radio station N1A, at Arlington, Va., opposite Washington, carry the aerial wires of many powerful radio transmitters. Does the energy which they hurl into the air have any effect on the weather?

IT is unfortunate for radio that many otherwise well-informed persons should advance radical theories, to the effect that much of our unusual weather is due to radio activities in the ether. Such rumors are being given wide publicity, and the belief that radio is changing our weather has rapidly spread among many credulous folk. Recently, no less a personage than the captain of the White Star liner *Homeric* stated: "Radio waves precipitate rain and contribute to the strength of gales and other disturbances of the elements." The tendency to indict radio whenever weather conditions are unsatisfactory makes it very difficult for a radio man to refute completely such allegations unless he has actual technical theories and facts at hand. Radio engineers and meteorologists actually know, however, that radio cannot affect the weather in any way; but, on the contrary, the weather often stirs up all sorts of trouble in the radio world. The trained meteorologist will not place any blame on radio, but the radio engineer has a right to blame much on the weather.

Recently, according to press dispatches, the residents of the English town of Matlock framed a petition asking that radio activities be suspended so that excessive local rainfall might be checked. A farmer in a Southern state sent an urgent telegram to Washington, pleading for a cessation of all radio broadcasting so that a drought then existing could be broken. Others say that, while radio has been developed and perfected, so have our varied weather phenomena increased in violence. Still other persons blame radio for everything, such as increased illness, lawlessness, accidents, and even insanity.

#### LOOK UP THE RECORDS

The *New York Times* is gifted editorially to comment on events which are of more than passing interest. In a conservative statement the *Times* has this to say about the charges of the captain of the *Homeric*, and radio indictments in general: "One suspects that, if the weather reports for the last generation were examined, it would be found that, long before Marconi and his

followers began to shake the ether, there were prolonged periods of stormy weather at sea."

Mark Twain once remarked that while everybody talked about the weather, nobody did anything about it. If we have an unusual change in the weather, it becomes the sole topic of conversation, but nothing is done about it. Modern science can as yet do nothing to stay the actions of the weather. But the weather furnishes a topic about which many who are very ignorant believe they are very wise, and they immediately divulge all sorts of pseudo-scientific reasons; the greatest sport at present is to blame all climatic vicissitudes on radio!

Many believe that the seasons are changing; we often hear the expression: "The winters are not what they used to be." It is true that the weather has undergone changes during the habitable state of the earth; but these changes have been so gradual that many generations of people could notice no difference. Without knowing the length of time which has elapsed since the beginning of man's reign on earth, it is impossible to estimate the rate at which the climates of the earth have changed. Climatological records have not been kept systematically throughout long periods of years, and we have no direct way of knowing how the weather affected the lives of primitive men; though Biblical history tells us of weather changes which had important bearings on the destinies of the human race.

Within the present era, however, there are records of "years without summers," seasons of drought and famine, of floods and disaster, of hurricanes and tidal waves,



Dr. Scarr, whose frank comment on the folly of the "radio-weather" theory appears on the following page, is here observing the automatic machines which make a record in ink of every minute's weather at New York, year in and year out.

(Photo © Underwood & Underwood.)

\*Member, American Meteorological Society.

as well as all other weather variations. Most of these, however, are the extremes of weather which occur at infrequent and irregular intervals and are not changes in the established normal climate of any locality.

#### WEATHER IN THE OLD DAYS

Long before radio was dreamed of, any unusual weather created consternation and excitement among the populace. This was due to the greater ignorance prevailing, and the fact that no records were to be had of previous similar events. We find that the River Thames, in England, in the 17th century, froze over solidly, a rare and almost unknown occurrence. In 1703 a great storm raged over Europe, and in England it was more destructive than any storm experienced either before or since. In 1545 a hail-storm pelted people and animals to death and stripped the trees of their foliage. Other great hailstorms happened in 1829 and 1838 in Spain and India, and blocks of ice, weighing nearly five pounds, fell to earth, doing great damage.

Two great hurricanes of modern times occurred in 1889 and 1900; the former, the memorable Samoan hurricane, is said to have averted a war when it destroyed thirteen American, British and German warships. The Galveston hurricane was in 1900. The 1926 Miami hurricane has been exceeded many times previous by greater hurricanes, and the Porto Rican hurricane of September, 1928, has counterparts before the days of radio.

The year 1816 is popularly described as "the year without a summer"; a recurrence of this summerless year was predicted for 1927, but it failed to materialize. It is not known whether the sensational sponsor of that prediction based all his calculations on radio or not. The year of 1900 goes down in history as having the most extended heat wave known to our country.

Our weather is extremely versatile over short periods. There is no doubt, however, that, if regular climatological records had been kept for several thousand years, the

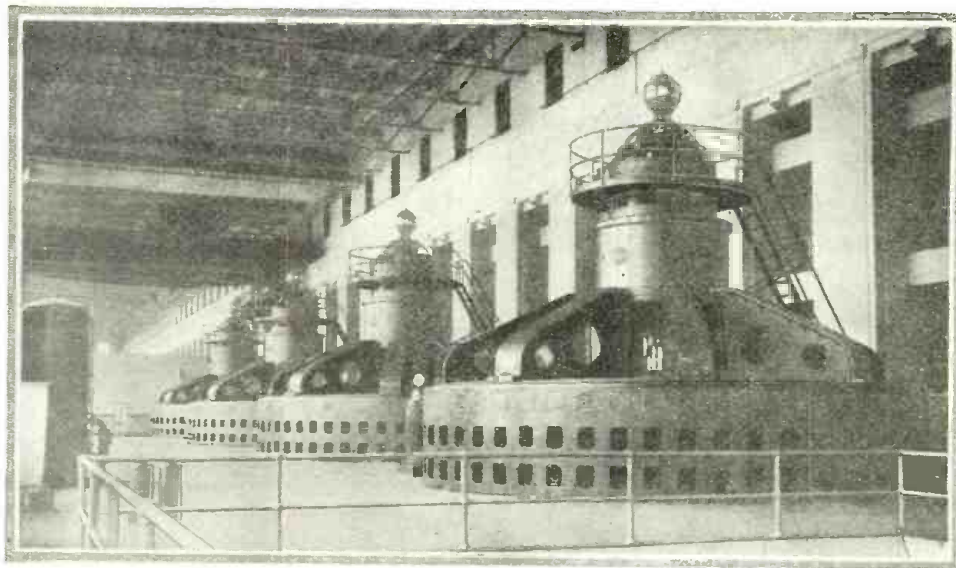

On these two pages is a study in contrasts, to make the reader appreciate more fully what "superpower" is. The gigantic turbine generators at Muscle Shoals, pictured above, are part of a 650,000-horsepower (500,000-kilowatt) plant, more powerful than all radio apparatus together.

#### The Weather Man Prefers His Fiction Straight

"DOES radio transmission effect weather conditions? Certainly not! I have been told that the combined power sent into the air by all the transmitting stations would not be sufficient to run an electric toy—much less affect weather conditions. The fable that radio affects weather conditions is merely part of the scientific fiction we read today. Entertaining, but nothing else.

"We are constantly being deluged by weird plans or devices for the prevention of bad weather, for bringing on rain, and for a thousand and one other purposes concerning the elements. As theories they are interesting; but when advanced as facts with offer of proof, they are ridiculous.

"Perhaps the best example is that of the young man who came to my office to inform me that a friend of his had invented a method of preventing rain. When I asked him for some tangible proof, he said: 'Do you remember that past few days when you forecast rain and it failed to do so?' I answered in the affirmative. 'Well,' said he, 'your forecasts would have come about but for my friend—who prevented it by means of his rain-preventer!'"

—DR. JAMES H. SCARR,

Principal Meteorologist, United States Weather Bureau.

average of the various weather phenomena of the present age would vary but little

from the normals established by the records of the many centuries past. Regular records have been kept during the past fifty years of the existence of the U. S. Weather Bureau; a period quite short in comparison with the recorded history of man. However, a definite, normal weather year for many places has been computed from these fifty years' records; so that any single year may be accurately compared to determine whether it is above or below the average.

Radio activities have existed for but a few years; the last six or seven registering the greatest development. There have been more severe weather events during the years before radio than have occurred since. The accurately-kept daily records of the weather in the United States for the past fifty show no departures from normal in the past ten or twenty which can be taken by the most prejudiced person as indications that radio is causing variations in our seasons and climate.

#### AMERICAN WEATHER HISTORY

For the purpose of fair comparison the computed weather averages or normals for Boston, Mass., Charleston, S. C., Chicago, Ill., Denver, Colo., Miami, Fla., Memphis, Tenn., New Orleans, La., New York, N. Y., Portland, Me., San Francisco, Calif., Seattle, Wash., and Washington, D. C., have been used. These places were selected because they have a fairly regular geographical dis-

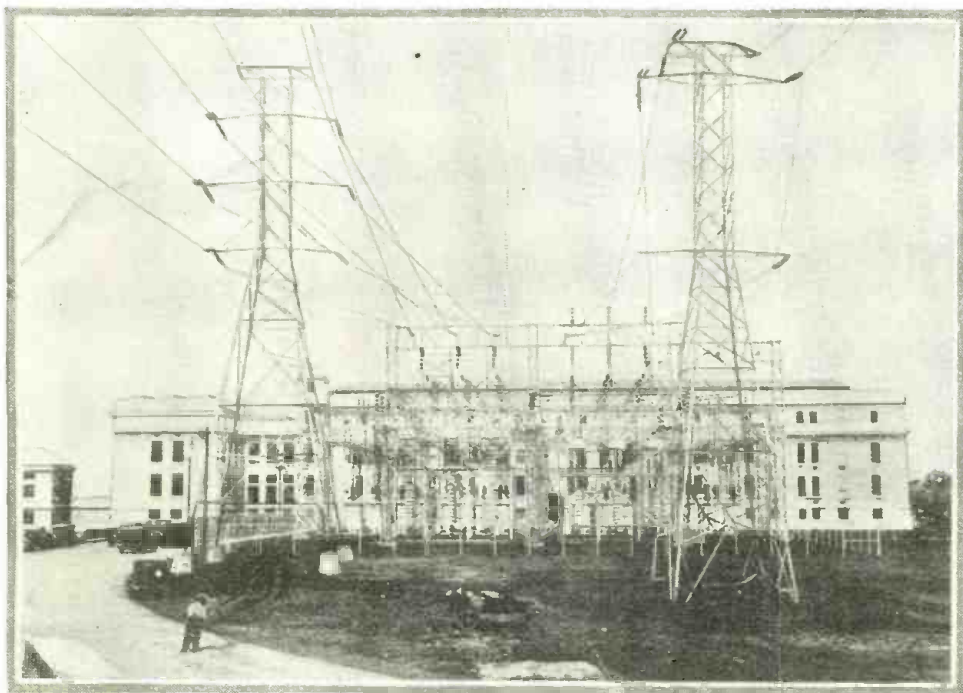

Above, the high-voltage lead-ins of the transmission lines at Muscle Shoals. The power which these lines unavoidably leak into the air is enormously greater than that of the highest-powered radio stations; but no one suggests that it affects the weather.

(Photos courtesy General Electric Co.)

tribution with generally different climates, and are also centers of extensive radio activities.

The lowest temperatures of record seem quite remarkable, since very few have been indicated during recent years. The latest record which was broken was at Boston, in 1918, when a temperature of 14° below zero was registered. Other record-breaking low temperatures are as follows: Chicago, 23° below zero in 1872; Denver, 29° below zero in 1875; New York, 13° below zero in 1917; and San Francisco, 29° in 1888. All the other selected places experienced record-breaking low temperatures in 1899, when a severe cold wave swept over the east and south. With the coldest years occurring as far back as 1875, and low temperatures mostly in 1899 and before, it is obvious that radio cannot be charged with causing unusually cold weather.

Let us apply the same yardstick to hot-weather records. We find that the highest

temperature been more than 4 degrees below the normal annual mean. This is quite remarkable, and surely indicates that departures from normal are slight and that temperature changes over 50 years have been negligible.

The annual rainfall reaches its greatest amount at Miami, with 60 inches, and its least at Denver, with 14 inches. Of course, there are other places having greater and less amounts, but they are not included in this selected list of cities. At times the farmers suffer from dry years, when the rainfall is too little for growing crops. Years having record-breaking scanty rainfalls occurred at Chicago in 1901; Miami in 1907; New Orleans in 1899; New York in 1916; Portland in 1883; Seattle in 1911; and Washington in 1894. Rainfall at other places was nearly normal, but was deficient mostly before 1907. Wet years have not been so excessive, and have not been considered.

Radio is exonerated, however, of being the cause of droughts and ruinous crop years. And when farmers consider the records as they are, and look back over the time as they remember it before the days of radio, they will be glad of radio, for the benefits it brings to them.

Now let us take up the length of the growing season; that portion of the year after the last "killing" frost in spring and before the first one in the fall. This season ranges from 160 days at Denver to practically the entire year of 365 days at Miami. Records for the shortest growing seasons were made at Charleston in 1916, and in 1875 at Denver and New York. In the central agricultural belt, records for short growing seasons were made more than 30 years ago—in 1895 at Chicago, and 1893 at Memphis.

New York City is a great center of radio activity; more power is radiated into the air within a hundred miles of New York than at any other one place in the world. The records for a "cold year" and a "short summer" were established at New York about 50 years ago. The highest temperature was recorded seventeen years ago, and the lowest temperature eleven years ago. The lowest rainfall was in the year 1916, or twelve years ago. Other less important weather records show no particular events in recent years, and the established weather normal has been followed very closely.

Near the most powerful radio stations known, when great power (as radio goes) is being radiated from the antenna system, no changes in temperature, humidity, barometric pressure, or air movements can be detected with the most accurate instruments. Except for the usual results of electric induction, there is no indication that the radio station is radiating any energy. So, why blame radio for unusual weather changes?

*(For the same reason that people who have "aural hallucinations"—that is, hear imaginary voices—now blame radio. The reason is simply that the critics do not know what they are talking about.—ERROR.)*

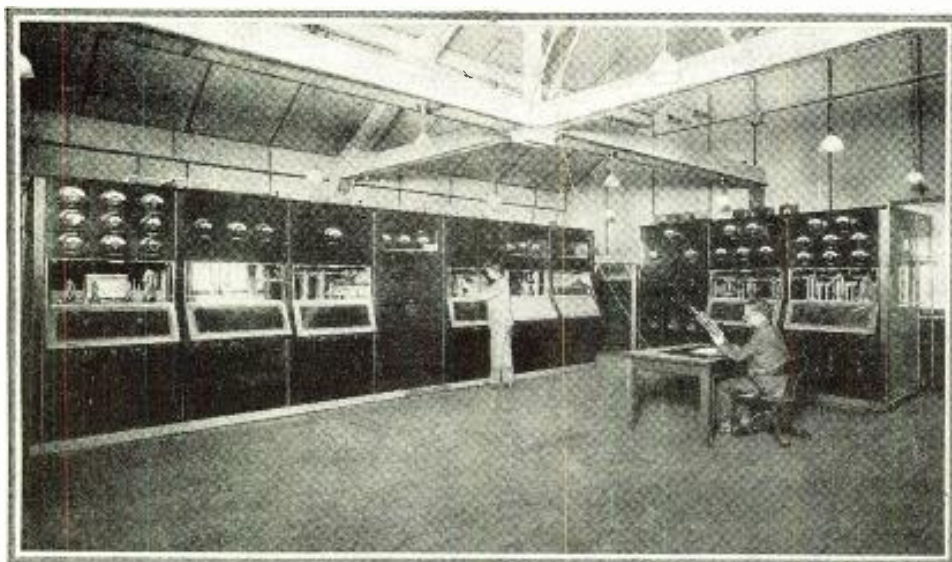

The scene above is the control and transmitter room of the experimental station 3XN, Whippany, New Jersey; the equipment has just been transferred to WLW, Cincinnati. This "superpower" station is heard half-way round the world; its "superpower" is nearly seventy horsepower!

temperatures of record occurred as follows: Boston, 104° in 1911; Charleston, 104° in 1879; Chicago, 103° in 1901; Denver, 105° in 1878; Memphis, 104° in 1901; Miami, 96° in 1907; New Orleans, 102° in 1915; New York, 102° in 1911; Portland, 103° in 1911; San Francisco, 101° in 1904; Seattle, 98° in 1903; and Washington presents the most modern record of all, with 106° in 1918. Thus, radio has not been associated with any of the extreme high temperatures of record.

#### LITTLE YEARLY VARIATION

If we take the average or "mean" temperature for one year at a time, at any place, and compare it to the "normal" temperature (the average for many years) we find that some years will be either above or below the average. We are concerned mostly with those which might be termed "coldest years," when the mean temperature was lower than the established normal temperature. We see that such years occurred prior to 1917; at that time the mean low temperature was only 1 degree below the normal at Miami. At Chicago and Washington, record below-normal temperatures occurred as far back as 1875; at Memphis in 1886; San Francisco in 1888; and at the remaining places mostly in 1899, 1904 and 1916. In no case has the record annual low

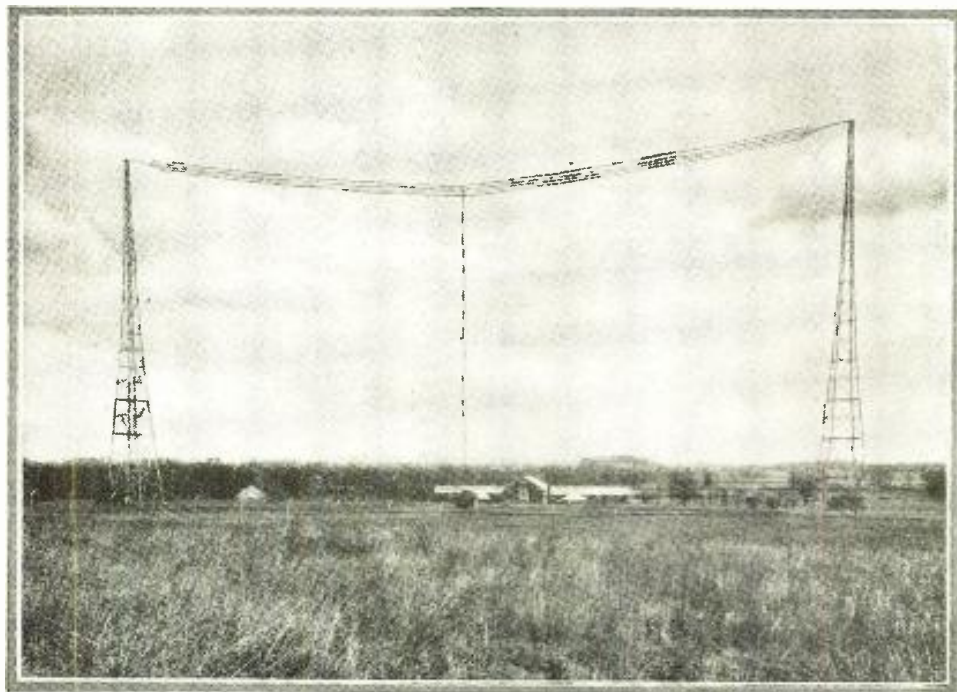

An external view of the towers and slender aerial of 3XN; judge how feeble is the energy it can handle, compared with the great power plants. At a few miles from these aeriels, the energy which can be detected is too small to be described in "flypower."

(Photos courtesy Am. Tel. & Tel. Co.)

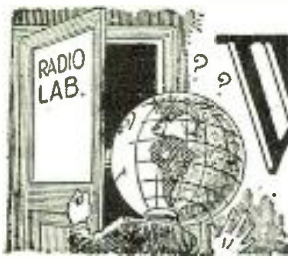

# What's New in Radio

All apparatus described in this department has been tested in the RADIO NEWS Laboratories and found of high quality in design and construction.



## A Power-Amplifier Suited to Public-Address Purposes

THE present wide popularity of the dynamic speakers which require field-coil excitation with 110-volt direct current, and the recent innovation of adding power amplifiers to phonographs, have led to the design of a neat, compact amplifier, which may be purchased either completely assembled or in kit form. Its components are being marketed by the designers and manufacturers, who have been active in the quality-amplification field for some time past.

This amplifier is particularly adapted for use with a phonograph and an ordinary magnetic pick-up; used in this manner, it has been found to give excellent reproduction of electrically-cut records, with sufficient volume to fill a small theater at orchestra volume.

Supplied with current from the house wiring at any voltage between 105 and 120 alternating at 50 to 60 cycles, the amplifier compact delivers the necessary rectified current to the dynamic speaker's field coil, and supplies all necessary "A," "B" and "C" power to its own two amplifying tubes. With its input side connected either to the detector tube of a radio set or to a magnetic phonograph pick-up, and its output side across a good dynamic speaker, the result is undistorted reproduction with a volume running, under control, to the full capacity (approximately 5,000 milliwatts) of the 250-type tube.

The audio-frequency transformers used in this amplifier are of the "Clough" type, rated by the manufacturer as having practically a straight-line characteristic from about 50 cycles to the upper limit of the audible frequency range. The design of each transformer comprises an auto-transformer, a resistor and a blocking condenser, all mounted in one case and connected in circuit. External connections are made just as to any transformer of the conventional

Standard parts are used in the construction of the amplifier, which is built into a crackle-finish steel case 3-3/8-inches wide, 5 1/4 inches high, and 17 inches long. All connections are made to a small panel at one end of the case, and the three tubes project through the top of the case to facilitate their heat radiation. The latter are a 281-type rectifier tube, a 226-type amplifier tube in the first stage, and a 250-type amplifier tube in the last stage. The amplifier will operate one speaker with a 90-to-120-volt field, while a second (of the 110-volt A.C. type) can be added if desired.

During the early days of the

The external appearance of the new power amplifier shows its compactness; its super-power tube makes it capable of serving a large hall.

broadcast era, the criterion of a receiver's quality was the greatest distance at which one could stand from the loud speaker and still hear its reproduction. Circuits, tubes and speakers were designed and marketed on the ability to have their particular blasts heard above the roar of the others, which were blasting away with the same purpose in view. Naturally, under those conditions, quality was a secondary consideration.

Proper appreciation of fidelity in reproduction was born with the development of the power tube, the production of wide-range audio-frequency transformers (a rarity in the early broadcast days), and the concentration on the problems of tone quality by the loud-speaker engineers. The first power tube to be marketed aroused no great comment, aside from that generally accompanying a new article of commerce; but the real niche it occupies in radio's Hall of Fame is that of the progenitor of "B" power units. So long as two blocks of "B" batteries were sufficient to operate the average set, there had been no

great demand for a substitute; however, upon the arrival of the power tube, with its higher voltage requirements and its heavier drain from the batteries, the development of power units was rushed to keep up with the industry's tube developments.

The first power unit was a "hummy" affair; it generally employed as the rectifier a 201A-type tube which aided in supplying a problematical voltage of 90 or thereabouts.

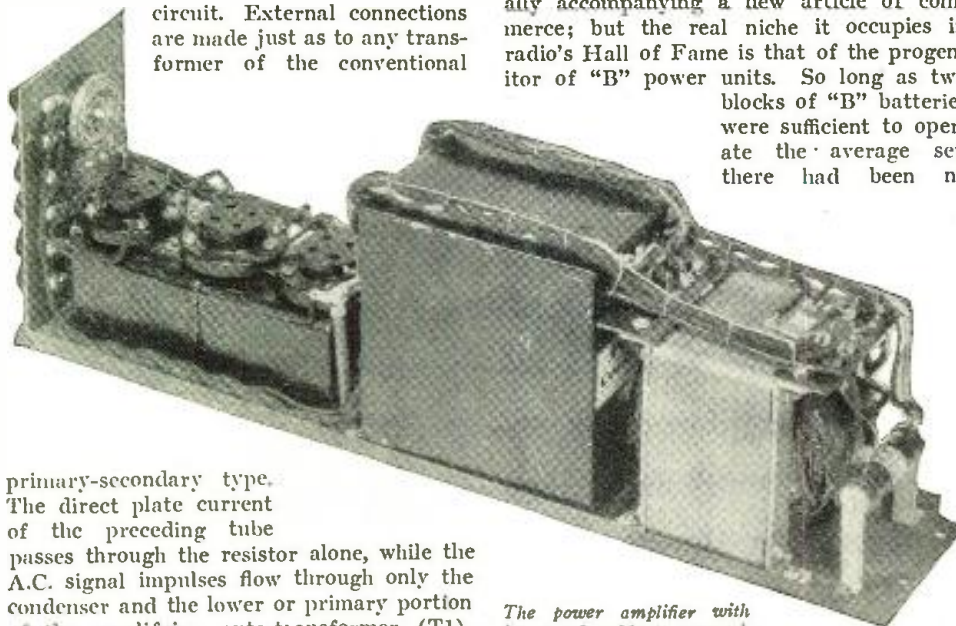
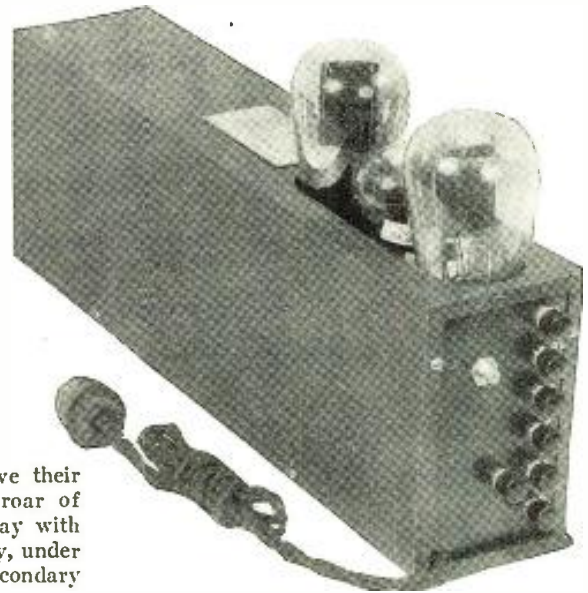

The power amplifier with its metal cabinet removed.

Condenser manufacturers answered the call with the only products they had on hand—by-pass condensers! This was before they had a chance to study properly the effects of high-voltage surges on condensers when employed as filters in power units. The results are well known to a good many readers—condensers popped with gusto and sociability, producing a subsequent discouraging effect on the morale of the constructors.

Time ironed out the engineering difficulties and, by the time the third power tube (the 171) was developed, its requirement of 180 volts was met by the manufacturers with designs in a state of electrical and mechanical perfection which spoke well for the further development of power amplifying units. When the next power amplifier tube developed (the 210) required a plate potential of 400 volts, the question was raised again as to the ability of the available apparatus to withstand the brute force of that voltage and its surges. It did so and, for that matter, still is giving service.

The development of the amplifier described in this section was the continuation of the above-mentioned pioneering. As can be seen in its circuit diagram (next page) it comprises two stages of audio-frequency amplification; the second of which includes a 250-type tube. The plate voltages for

primary-secondary type. The direct plate current of the preceding tube passes through the resistor alone, while the A.C. signal impulses flow through only the condenser and the lower or primary portion of the amplifying auto-transformer (T1).

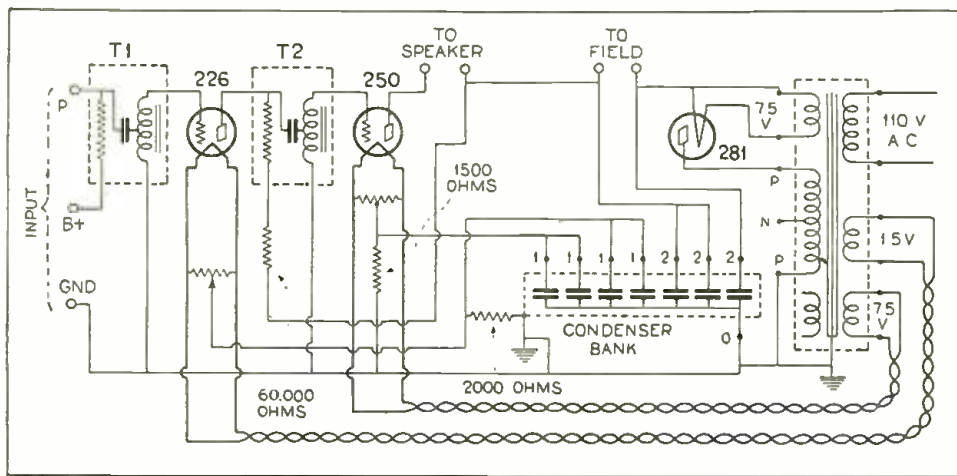

The schematic diagram of the 250-type power amplifier described on the previous page shows that it is self-contained; in addition to supplying direct current for an electrodynamic speaker, the field winding of which serves as part of the filter system. It will operate from a phonograph pick-up.

to tuning the receiver—merely place the aerial lead on the adapter's binding-post. It is necessary in this case to tune the adapter like a short-wave set for "zero-beat" reception. See page 553 of our December issue.

As can be seen from the illustrations, simplicity marks the construction of this adapter. All parts are mounted on a black bakelite panel, which is set into the top of a cabinet measuring only 7 x 5½ inches on the base and 2¾ inches high. Vernier control is provided for the tuning condenser, while the regeneration condenser is controlled by a knob, no fine control of oscillation being necessary.

In following the circuit lettering, L1 is the antenna winding placed permanently about the base of the coil form; L3 is a radio-frequency choke coil of standard inductive value; R1 is a 7-megohm grid leak; C3 a .00025-mf. grid condenser, and P the adapter plug which is inserted into the R.F. or detector socket of the broadcast receiver.

The type of coil used can be seen from the external illustration of the adapter: Nos. 1 and 3 being indicated by A; No. 2 is shown in its socket, in the position of use.

Manufacturer: A-C Dayton Company, Dayton, Ohio.

### New A. C. Tubes of High-Mu Type for R. F. or A. F.

NEW "high-mu" tubes which differ from others previously available, in that the filaments are heated by alternating current, like the 226-type, are now available for incorporation in electric sets, either as R.F. or A.F. amplifiers, particularly for use with impedance or resistance coupling. Inasmuch as these tubes have a rating of 1.05 amperes at 1.5 volts, the filament wiring of a set designed for direct-current tubes may not have sufficient carrying capacity for the relatively heavy current and it is frequently necessary to rewire this portion of the set. Over line-voltage variations to an extent which may be expected reasonably, no appreciable change occurred in the characteristics of the tube. The recommended filament voltage for this tube is 1.35 volts and,

these tubes are supplied by a step-up power transformer; the filaments of the three tubes (250, 226, 281) in this unit are heated by three suitable windings on the power transformer. A novel feature of the filter system employed in this unit is that the field winding of the dynamic speaker is used as the choke coil. A variable potentiometer across the filament of the first amplifier tube (226-type) is used to control the hum.

Manufacturer: Silver-Marshall, Inc, Chicago, Ill.

### A Short-Wave Converter for the Parlor Receiver

WITH the present interest in short-waves and the commercial demand for a short-wave unit adapter that can be connected to the amplifier of the average broadcast receiver with little or no change in wiring, there have appeared on the market a number of such items well suited for the purpose in view.

Among these is the adapter illustrated herewith. It employs the conventional regenerative circuit with a semi-aperiodic primary, and a fixed tickler which is capacitively tuned, as indicated in the circuit diagram, by the midget condenser, C2. This method of controlling regeneration is practically trouble-proof and the one generally employed by the majority of short-wave experimenters.

It can be used with any broadcast receiver using a UX socket in the first radio-frequency or detector stage. Three plug-in coils are supplied with each adapter; coil No. 1 has a wavelength range between 17 to 29 meters. Coil No. 2 covers from 27 to 48 meters, and coil No. 3 is from 47 to 84 meters. Thus, it can be seen, with the set

the adapter has a complete coverage of the channels ranging from 17 to 84 meters.

Should the wavelength range of the receiver be found insufficient, additional coils may be wound on a standard UX tube base, providing care is exercised in the proper wiring of connections to the prongs.

Installation on the average run of tuned-radio-frequency receivers, whether battery or A.C. operated, is a simple matter; first

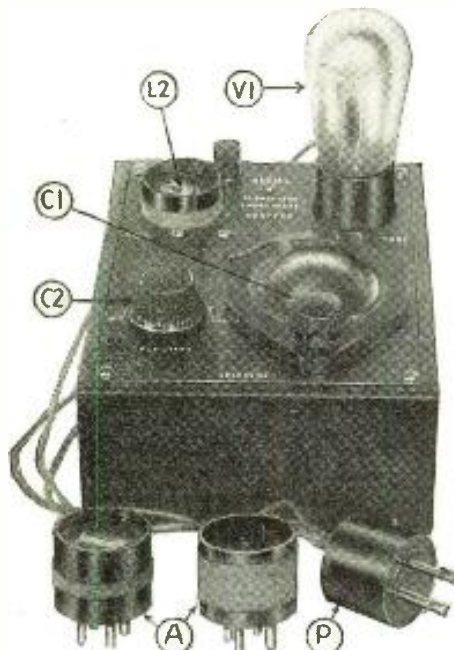

The adapter is compactly cased in a small box, which may be laid on a table or on the receiver cabinet. Extra coils A fit into the socket L2, to change over three wavebands.

adjust the receiver to a high wavelength, with all dials tuned in and all controls set, just as though a distant station was being tuned in; use any wavelength between 450 and 500 meters where no local station is received. Remove the first R.F. tube and insert the cable plug of adapter in its socket, and then place the tube in the adapter socket. The aerial lead must be removed from the receiver and connected to the "antenna" binding-post on the adapter, which is then ready for tuning. The adapter then operates as a frequency-changer, and the R.F. unit as an intermediate amplifier.

When adapting a regenerative receiver, insert the adapter's plug into the detector socket and the tube into the adapter's socket, making sure to provide the plate of the detector with 22½ or 45 volts "B" supply. No adjustments need be made here as

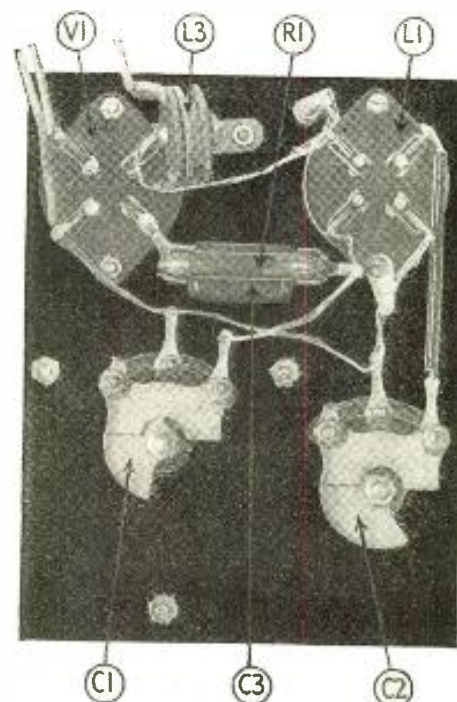

All parts of the adapter are mounted on the panel, a back view of which is shown above. It will be seen how simple is the construction; the two condensers are the only controls.

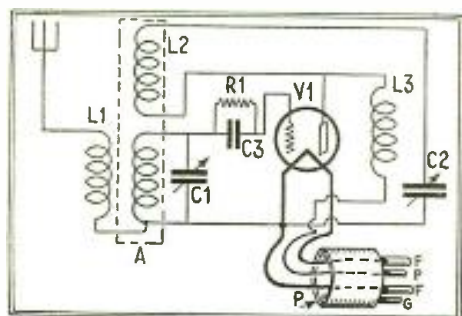

The circuit of the adapter, above, is that of a standard short-wave set, from which it differs only in using an external amplifier—that of the receiver with which it is used.

if the tube is burned at a higher voltage than this, some increase in signal strength will result; but the useful life will be shortened. Wherever it is used, a center-tap resistor or the potentiometer method is necessary to bring the grid return to electrical center. As much as 8% unbalance will result in a noticeable ripple voltage. The tube should not be used without applying a grid bias, the proper value of which may be determined from an accompanying curve.

Manufacturer: CeCo Manufacturing Co., Inc., Providence, R. I.

### Short-Wave Kit Contains Parts for Screen-Grid Tuning Unit

RADIO fans who desire to assemble short-wave receivers with a minimum of effort and bother will find a very satisfactory answer to their requirements in a kit of parts recently placed on the market by a New England manufacturer; it contains the components necessary for an excellent two-tube tuner, to which may be added an external audio-frequency amplifier of any of the standard types. The first tube, of the 222 (screen-grid) variety, acts as a radio-frequency amplifier, and the second, a standard 201A, as a regenerative detector.

The kit contains the following parts: a 7 x 12-inch front panel, drilled for a vernier dial, a filament switch and a variable resistor; a 9 x 11-inch base panel, drilled for binding posts and by-pass condensers, fitted with receptacles for tubes and a plug-in coil, and clips for filament ballast resistors, grid leads and R.F. choke coils; a tuning condenser of .00014-mf. capacity, with an illuminated vernier dial; four plug-in coils to cover the short-wave bands from 15 to 150 meters; and two R.F. choke coils. To complete the tuner, the constructor must have also two filament-ballast resistors, a grid leak, eight binding posts, five small fixed condensers, a filament switch, a universal-range variable resistor (0-to 100,000 ohms) and, of course, the 222 and 201A tubes.

The front panel holds only the tuning condenser C1 (or rather the vernier dial to which the condenser is mounted) the filament switch SW, and the regeneration-control resistor R4. The base panel is fastened to the upright one by means of

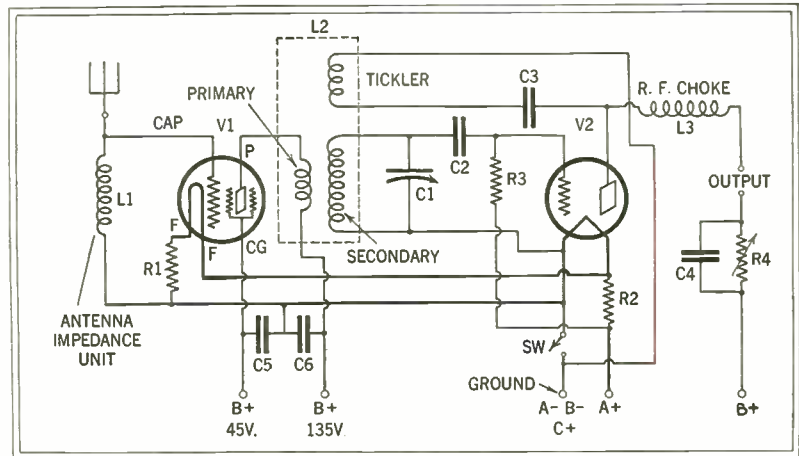
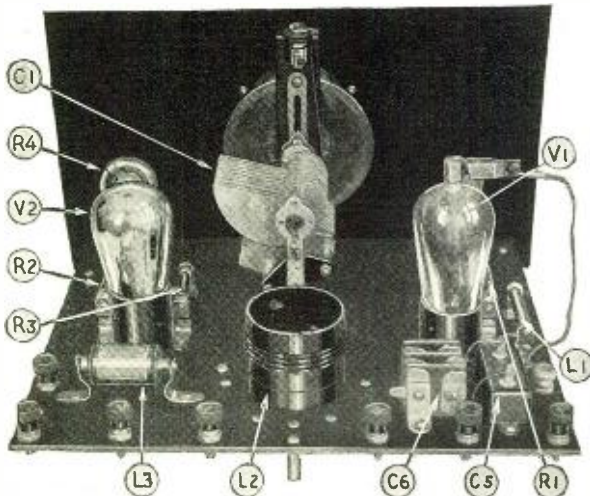

A feature of this short-wave set is the use of the special inductor L1 in the aperiodic R.F. stage, which is made advantageous by the use of the high-amplification screen-grid tube V1. The by-pass resistor R4 is the regeneration control, the tickler coil being fixed.

two small brackets and, also, the frame of the tuning condenser.

One by-pass condenser, C4, connected to the variable resistor R4, is mounted on the under side of the base panel, and is not visible in the photographs reproduced here.

The binding posts are mounted along



The short panel, with handsome illuminated vernier dial, and the two controls required by every regenerative circuit.

the back edge of the base panel. The two other by-pass condensers C5 and C6 are behind the screen-grid tube V1, and one R.F. choke coil, L3, is behind the detector tube V2. The receptacle for the plug-in coils is directly behind the variable condenser; in the accompanying back view of a completely-assembled tuner, one of the coils, L2, is shown in its receptacle.

A special R.F. choke coil, L1, which resembles a grid leak, is mounted in a pair of cups at one side of the screen-grid tube. Particular attention is drawn to this choke, because it seems likely

to be confused with a grid leak or a filament resistor.

With practically no exposed wiring, the set built from this short-wave kit is especially neat in finish. The plug-in coil L2, clear of other parts, is easy to grasp and remove or insert when desired.

to be confused with a grid leak or a filament resistor.

The parts on the base panel are laid out in such a manner that most of the connections in the set are only an inch or two long; the longest wires are in the filament circuit, where length is not so detrimental a factor. All the wires, except the short one running to the cap of the screen-grid tube, are on the under side of this panel, and do not show.

The wiring diagram of the tuner is shown on this page. It will be seen that the grid circuit of the screen-grid tube V1 is not tuned; the aerial and ground being coupled to it directly by the antenna impedance unit (R.F. choke) L1. The screen-grid tube is coupled to the detector tube, V2, by one of the plug-in coils; each of which contains three windings: primary, secondary and tickler. A complete coil is shown within the dotted rectangle marked L2. The plate of the screen-grid tube is fed 135 volts through the primary, and the screen-grid electrode is fed 45 volts, directly. These two "B" leads are by-passed by the 0.5-mf. condensers C6 and C5, respectively.

The detector circuit is one of the usual regenerative type. The tickler is fixed (being one of the three windings on the plug-in coils), and regeneration is controlled by the variable resistor R4, in the plate circuit. The tickler is in shunt with the plate circuit, the condenser C3 (.006-mf.) being inserted to prevent the "B" battery from short-circuiting through the tickler to the filament. The R.F. choke L3 keeps the R.F. component of the plate current out of the "B" leads, and makes it stay in the tickler circuit.

The complete tuner shown in the accompanying photographs was assembled in the RADIO NEWS Laboratories from a foundation kit supplied by the manufacturer. It worked very well, its operation being particularly pleasing in that there were no "dead spots" in the tuning. Although the screen-grid tube is not shielded and its grid circuit is untuned, it furnished a definite amplification on all frequencies with the range of the plug-in coils.

A neat metal cabinet for this receiver is available.

Manufacturer: The National Company, Malden, Mass.

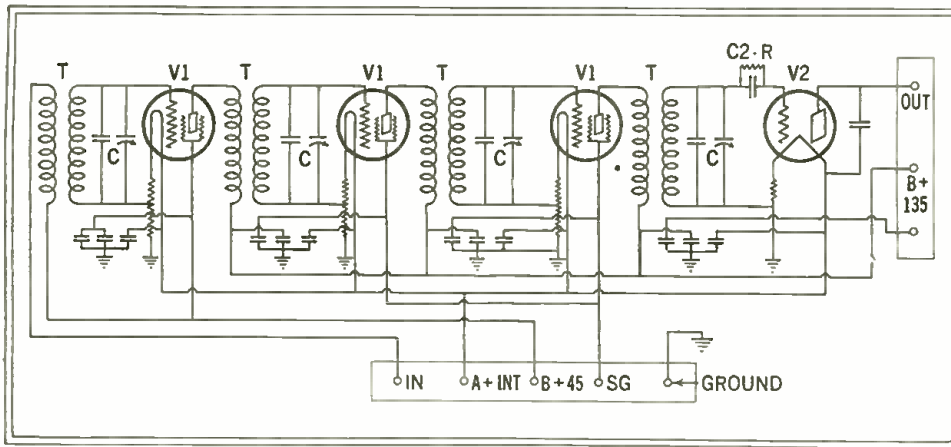

The diagram of the screen-grid intermediate amplifier and fundamental connections; each stage, of course, is fully shielded. The amplification obtained is enormous, being sufficient to bring up the faintest signal that can appear above the noise level. The high intermediate frequency, 450 kc., is such as to give a one-spot effect over the dial when tuning in stations on the broadcast band.

### An Intermediate Amplifier of Distinctive Character

A SCREEN-GRID intermediate radio-frequency amplifier for superheterodyne operation has been marketed for the benefit of the constructor who wishes to design and assemble his own superheterodyne receiver. The components which make up the amplifier are assembled on a metal chassis and have individual copper shields for each stage of amplification, as well as for the second detector, which is included in the assembly. The intermediate amplifiers operate on a frequency of 450 kilocycles and are stated to give a measured gain of 65 per stage under actual operating conditions. The complete unit is arranged for sub-panel wiring, and is obtainable completely wired and assembled; its over-all size is  $11\frac{1}{2} \times 5\frac{1}{4} \times 6\frac{1}{2}$  inches. Three 222-type screen-grid tubes and one 112A-type are required for the operation of the unit.

As shown in the diagram, the circuit is that of the conventional intermediate amplifier except that, instead of the usual three-element tubes, screen-grid tubes are used. The substitution of these for the 201A-type makes for a noticeable increase in amplification per stage; providing the proper precautions are taken to come up to the engineered specifications of the tube manufacturer.

In each of the first three shields (the three intermediate stages), are found a special intermediate-frequency transformer (T), a miniature condenser block containing three by-pass condensers, and a tube socket of the standard UX-type. Mounted upon each transformer is a small variable condenser of the screw-adjustment type (C1), by means of which the transformer is tuned to resonance. Extending from the first three intermediate transformers are shown three caps (indicated as S) which slip over the metal caps of their respective tubes; this tube cap, the distinctive feature of the screen-grid tube, is the external connecting post for the control-grid of the tube. The tuned air-core transformers T have duo-lateral primary and secondary windings of No. 32 S.S.C. wire, each on the usual wooden slotted-bobbin form. The arrangement gives very short leads.

The fourth and last shield houses the second detector circuit and, like the others, contains a triple condenser block and an intermediate-frequency transformer with its compensating condenser. However, since this tube functions as a detector, a grid-

condenser (C2) and a grid-leak (R) are included in the circuit. No screen-grid cap is found in this shield, as the tube used here is a 112A (V2) of the regular UX type.

Additional components for the assembly of a complete receiver include a suitable center-tapped loop tuned by a .0005-mf. variable condenser, which is connected across the terminals of the loop; a 201A-

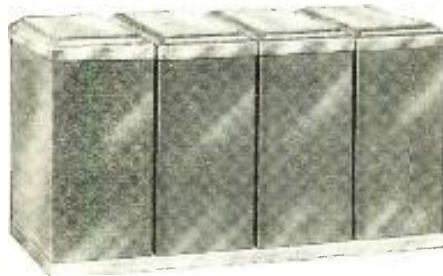

The illustration of the assembled amplifier fails, however, to give the striking appearance of the burnished-copper individual-stage cans.

type tube, serving as a first detector, to which the loop is connected directly; and a 25,000-ohm potentiometer. An oscillator coil, which is required to make up the distinctive circuit of every superheterodyne, may be obtained from the same manufacturers. It consists of three windings on a  $1\frac{1}{2}$ -inch diameter tube; No. 30 enameled wire is used for the three windings—32

turns for the grid coil, 30 turns for the plate coil and a four-turn pick-up coil is wound between the two with a  $\frac{3}{8}$ -inch space on each side of the center coil to separate the three. A .00025-mf. variable condenser connected across the grid and plate coils is used to control the oscillator which, like the detector, employs a 201A-type tube.

In connecting the oscillator coupler, the outside terminals of the coil should be connected to the plate and grid terminals of the oscillator socket, or the oscillator condenser itself; and the inside terminals of the respective coils connected to the filament and "B+" supply. One end of the pick-up coil connects to the center-tap of the loop antenna, and the other to the "A-" battery line.

The output terminal strip shown in the circuit diagram includes an unmarked post, which is connected to an unused 1-mf. section of one of the by-pass condensers. The other side of this section is connected to the negative battery line within the amplifier, and the constructor may use this capacity for whatever purpose he desires. The other two posts on this strip are connected to the primary of the first audio-frequency transformer, if a coupling of this type is added to the assembly; the "Out" post goes to the "P" post of the transformer, and the "B" post of the latter is connected to the "B 135" post on the terminal strip and the corresponding voltage supply:

Manufacturer: High Frequency Laboratories, Chicago, Ill.

### New Outlet-Control Designed For Built-In Radio Wiring

A NEW item, though not radically new in design, is a piece of apparatus designed for the use of those who may wish to wire a building for a number of loud speakers and desire an individual volume control with each speaker. It is especially convenient for apartments, hospitals and hotels where multiple outlets with separate controls are required. The plate measures  $5\frac{1}{2} \times 23\frac{1}{4}$  inches and is finished in statuary bronze with an artistic scroll effect. The volume control is obtained by a standard midget variable resistor, of a type which has been marketed by the manufacturer for some time past, and is well known for its durability and electrical efficiency. The

(Continued on page 664)

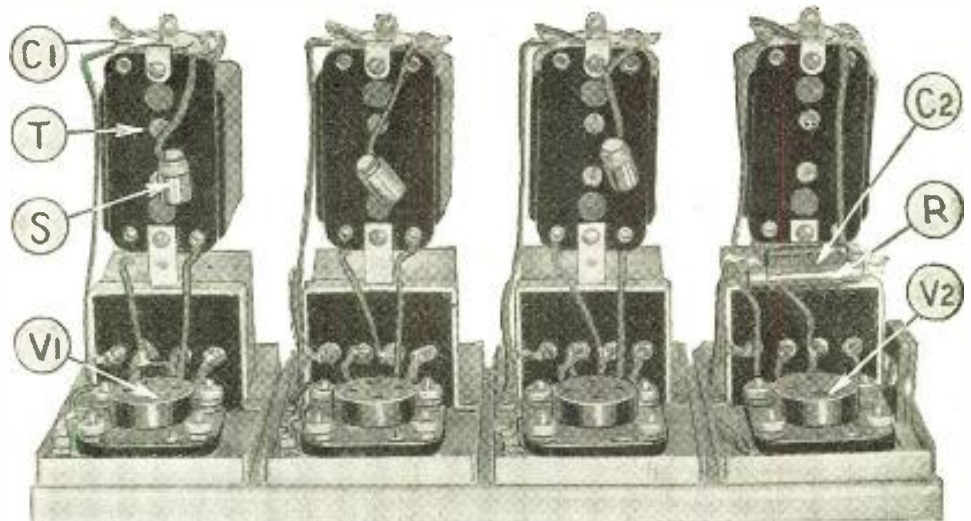

A view of the amplifier on its base, with the shield cans removed; the by-pass blocks are behind the tube sockets. The tuned transformers T are behind their bakelite covers; the screen-grid clip leads S, like all other connections, are very direct. Condensers C1 are adjustable.



# Television



## The Latest Developments in the Field

By Robert Hertzberg

**T**HE television plans of numerous stations have been seriously disrupted by the recent order of the Federal Radio Commission calling for an entire rearrangement of the broadcasting situation in the United States. Practically none of the broadcasters escaped some change in wavelength, power or hours of operation; and, as a result, the managers of those stations still "on the air" are very much "up in the air" regarding their general programs. At the time this article was written, the order had not yet gone into effect, and very few stations knew just what they would be doing after it did go into effect.

This state of temporary uncertainty has naturally had a reaction upon designers and manufacturers of television apparatus. It has made some manufacturers delay their plans for the production of television receivers and accessories for home use; but it has by no means halted the progress of the art.

### THE FIRST TELEVISION CONFERENCE

That television is actually emerging from the laboratory stage and developing into a commercial proposition is made evident by the recent action of the Radio Manufacturers Association in forming a Television Standardization Committee; the announced purpose of which is to suggest standards of television equipment and definitions of television terms, in order to relieve some of the confusion now surrounding the art.

The committee, of which Mr. D. E. Replegle is chairman, met for the first time in Chicago on October 9, 1928, during the week of the Chicago radio show, and did some commendable work. The limitation of

its activities was acknowledged by those present, but it was the unanimous opinion that a great deal of immediate good would be done for both the industry and the public if even temporary standards were drawn up and adopted. Mr. C. Francis Jenkins, of Washington, D. C., the noted inventor, described the exactly parallel efforts of motion-picture pioneers during the early days of the "movies," and stated that the motion-picture business had benefited greatly by eventually adopting the suggestions of a committee of cinema experts similar to the television committee of the R. M. A.

*ON November 2, 1928, the Federal Radio Commission issued an order restricting the hours of still-picture and television broadcasting, at least until January 1, 1929, when the commission will again take under consideration the value of this service to the advancement of radio.*

*Picture and television broadcasting is permitted on frequencies above 1,500 kilocycles (below 200 meters) only by special authorization of the commission, which will determine the exact frequencies to be used. In addition, such broadcasting will be allowed to a limited extent on the 200-550-meter broadcast band. For the latter range, the commission orders: (1) that the band of frequencies occupied by any such transmission shall be not wider than ten kilocycles; and (2) that such picture and television broadcasting be limited to periods of not more than one hour per day, and forbidden between 6 and 11 p. m.*

### "STANDARDIZING" TELEVISION

The first problem taken up was the direction of scanning. The fact was brought out that there is no difference in actual efficacy between the top-to-bottom and bottom-to-top methods; although most of the present television systems use the former. It was suggested that the scanning be done just as one reads a book; so, accordingly, the committee agreed on the following:

*"SCANNING: It is recommended that scanning at the receiving end be from top to bottom and from left to right, as the observer would see it." This was amended later to read: "SCANNING: It is recommended that scanning at the receiving end be from left to right and from top to bottom in uninterrupted sequence."*

The next matter was that of the number of lines per "frame"; the word "frame" first being defined as the scanned area. It appeared that few experimenters are using the

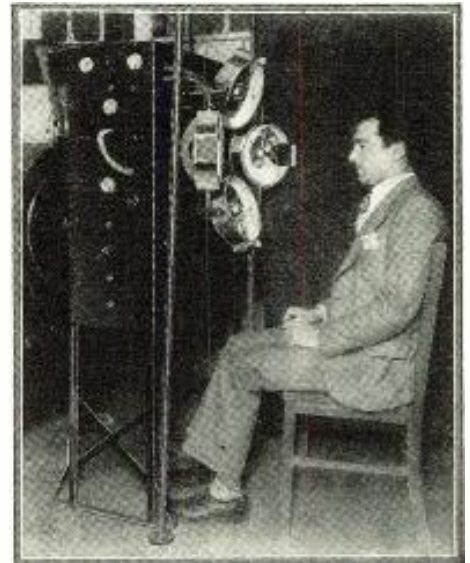

*In general construction, the television transmitter using the light reflectors greatly resembles the machine in daily use at WRNY. Above: Mr. E. Manuel showing how the subject poses before the bank of photoelectric cells.*

same number of holes in their scanning mechanisms, the actual figures ranging from 24 to 60. It was thought that a 48-hole disc is more flexible than the others, so the committee decided on the following:

*"LINES PER FRAME: It is recommended that the number of lines per frame in a television system be 48."*

The matter of disc speed, or rather the number of frames per second, was made the subject of considerable discussion. It was agreed that it would be better to adapt existing motors to the needs of television, rather than to force motor manufacturers to produce special machines. Mr. Jenkins stated that ordinary synchronous motors are highly satisfactory for the purpose, and can be adapted readily to television scanning mechanisms with the aid of inexpensive gears. A standard 1,800-r.p.m. synchronous motor, for instance, working through 1:2 reduction gears, will turn a scanning mechanism at 900 r.p.m., producing 15 frames per second. Mr. Jenkins voiced the opinion that, inasmuch as the standard motion-picture projection rate is 16 per second, a rate of 15 frames per second would be entirely acceptable; the slight difference not being at all serious from the standpoint of the moving image. Since the 15 frame-per-second rate is so conveniently obtained with widely available synchronous motors, this number was accepted. The formal statement reads:

*"FRAMES PER SECOND: It is recommended that 15 frames per second be adopted as the standard rate."*

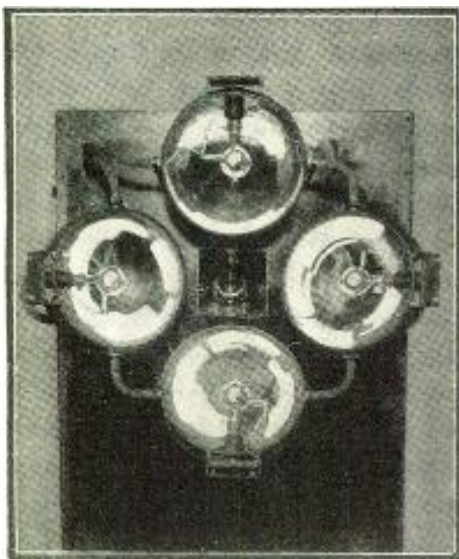

*What you would face if you were being televised. The polished reflectors catch the rays of light reflected from your head, and concentrate them on the photoelectric cells.*



### Television Broadcasting Schedules

THE stations listed below are known definitely by RADIO NEWS to have television transmitters. Because of the temporary confusion into which the American broadcast stations have been thrown by the new wavelength-allocation order, complete hour-by-hour schedules cannot be printed in this issue. Consult your local newspaper for last-minute changes.

WRNY, Coytesville, N. J.: 297 meters; single-spiral, 48-hole disc, 450 r.p.m.

W2XAL, same location and schedule as WRNY: 30.91 meters.

WCFI, Chicago, Ill.: 309 meters; single-spiral, 48-hole disc, 900 r.p.m.

W3XK, Washington, D. C.: 46.72 meters; Jenkins "radio movies"; can be picked up with single-spiral, 48-hole disc, 900 r.p.m. From 8.00 to 9.00 p. m., E. S. T., on Monday, Wednesday and Friday nights.

WIXAY, Lexington, Mass.: 61.5 meters; television and "radio movies"; single-spiral, 48-hole disc, 900 r.p.m.

WGY, Schenectady, N. Y.: 380 meters; single-spiral, 24-hole disc, 1,200 r.p.m. Also W2XAF, 31.40 meters, and W2XAD, 21.96 meters, associated with WGY.

WIBO, Chicago, Ill.: 526 meters; three-spiral disc, 15 holes per spiral, 900 r.p.m.; Sanabria system.

WMAQ, Chicago, Ill.: 447.5 meters; three-spiral disc, 15 holes per spiral, 900 r.p.m.; Sanabria system.

A number of other stations in various parts of the country are supposed to have television transmitters in operation; but are not listed above because they have not answered, or even acknowledged, telegraphed requests from RADIO NEWS for information about their apparatus.

#### WHAT IS TELEVISION?

The next matter brought up was that of the definition of television terms. A dozen different definitions of the word "television" itself were offered, but all were too long or unwieldy. They were finally condensed into three words: *vision by radio*; this definition being adopted tentatively by the committee.

Mr. Replogle voiced the opinion that it would be desirable to classify the different existing systems of television transmission, in order to clarify television articles and aid engineers in their considerations of amplifiers and other equipment. After much discussion the following recommended definitions were agreed upon:

"DIRECT FLOOD LIGHTING: A system wherein the object is flooded with light which passes through it into the transmitter pick-up." (This covers certain "radio-movie" transmitters.)

"INDIRECT FLOOD LIGHTING: A system wherein the object is flooded with light which is reflected into the transmitter pick-up." (This takes in some of the Baird machines, and the one described by Theodore H. Nakken on page 20 of RADIO NEWS for July, 1928.)

"DIRECT SPOT LIGHTING: A system wherein a spot of light passes through the object into the transmitter pick-up." (Included in this category is the Jenkins "radio-movie" outfit described in RADIO NEWS for August, 1928.)

"INDIRECT SPOT LIGHTING: A system wherein the object is scanned by a spot of light which is reflected into the transmitter pick-up." (This takes in the commonest type of television machine, such as those used by WGY, WRNY, WIBO, WMAQ and others.)

The last matter discussed by the committee was the choice of a suitable name for the source of illumination in a television receiver. *Television lamp* was finally chosen as the simplest and most suitable term.

RADIO NEWS, as the most widely read radio magazine in the world, is glad to adopt for its own use the terms and definitions listed herein, and wishes to congratulate the Television Standardization Committee on its initial efforts.

#### A NEW DISC SYSTEM

Shortly before this number of RADIO NEWS went to press we received a statement from the Kodel Electric and Manufacturing Company of Cincinnati, Ohio, announcing the development of a "new and entirely different method of television which has been perfected to the point whereby it is now up to the manufacturers of photoelectric cells to build a new cell of sufficient sensitivity to answer the requirements of this new principle of television." The apparatus is still in the experimental stage and no illustrations of it can be published in this number. However, we expect to show some as soon as they are made available. To quote the statement further:

"This new principle overcomes the disadvantages of the scanning disc, in that it is

unlimited so far as size is concerned and would permit the broadcasting by television of pictures which could be reproduced on a screen the size of a standard motion-picture screen in any theatre; or on the other extreme, as small as desired in any home; and permits the reproduction of the finest of details, action and proper perspective of any object.

"The new invention uses five or any other uneven number of photoelectric cells, mounted upon the periphery of a heavy cast-aluminum disc. This disc differs from the usual scanning disc previously employed in that it revolves both on its axis and longitudinally therewith; giving the effect, when in motion, of a revolving globe. On the outside edge of this disc, which may be of any size, depending on the dimensions of the television pictures to be transmitted, are mounted super-sensitive photoelectric cells or glow lamps which revolve with it.

"A commutator is arranged to connect only that cell passing through the 'sphere of vision' in the transmitting or receiving circuit. This sphere of vision is a portion of the revolving outer globe-surface, upon which the image to be transmitted is focused by means of a high-speed photographic lens or reproduced by the receptor through variations in light intensity of the glow-lamps as they pass through this sphere of vision.

"The ratio of the revolutions of the revolving disc around its center and the revolutions of the revolving fork or axle carrying the same (which revolves at right angles thereto) is *uneven*; so that each successive tube as it enters and moves across the sphere of vision does not travel in a straight line, but develops several spirals due to the combination of movements. Since each successive tube enters this sphere of vision slightly out of place from the preceding one, this causes a complete overlapping of the various spirals produced by the cells in their travels; and due to the combined speed of the disc movements and number of cells employed, an enormous number of closely in-

(Continued on page 666)

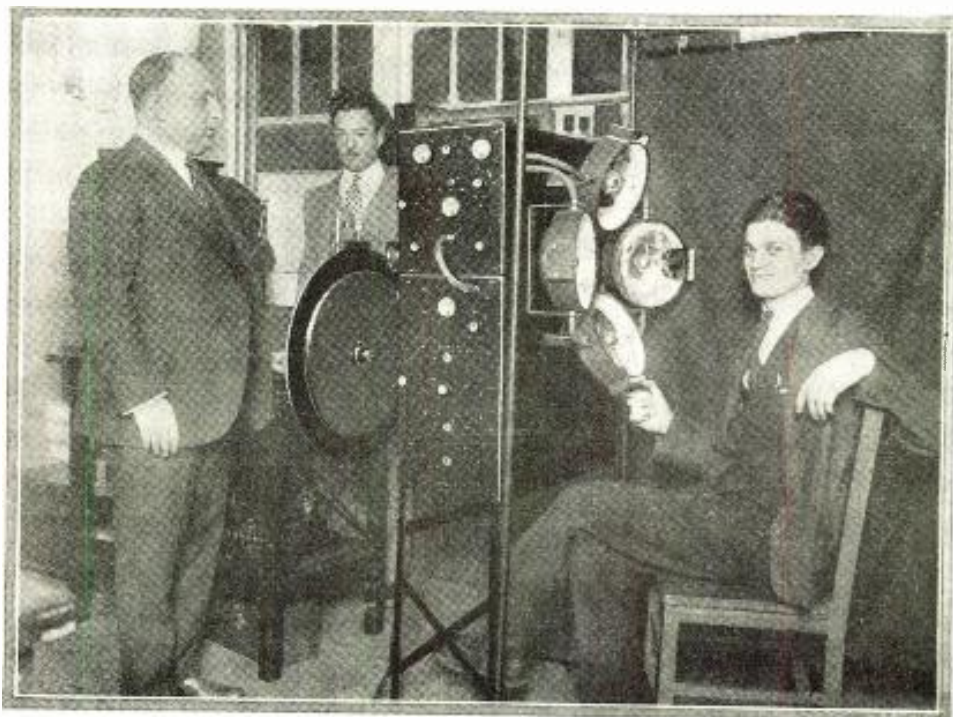

The new television transmitter constructed by John Geloso (right, seated) is extremely compact, but as efficient as many larger machines. Mr. I. Goldberg, president of the Pilot Electric Mfg Co., is standing in front of the arc light, resting his hand behind the scanning disc. The amplifier is built into the vertical panel.

# High Frequencies for Color Television

Mechanism Required to Produce Images in True Colors Will Present Few Difficulties, But Great Width of Frequency Bands Will Create Some Problems of Transmission

By C. Sterling Gleason

SOME day television will not be limited to the dull monotony of mere black and white, but will be accomplished in all the colors of the rainbow. A short time later, some manufacturer will place upon the market apparatus for transmitting images in their natural colors, and the reproduction will be so life-like and realistic that everyone will admit that radio, so long in its infancy, has grown to full stature, to take its place beside interpretative dancing, china-painting, bridge, the movies, and other full-fledged arts and sciences.

This possibility is not as remote as it may seem at first glance. Color television meets obstacles not greatly different from nor more difficult than those which now prevent the extensive application of television. Ordinary television outfits can be adapted to color vision simply by the addition of some mechanism which will analyze each elementary area of the picture as to its color and tone intensity; so that at the receiving end the proper color will be selected and thrown upon the screen in the necessary intensity.

## A SIMULTANEOUS METHOD

How could this be accomplished? A method is suggested by the fact that various materials showing photoelectric properties respond most strongly each to a certain color or frequency of light. For each material there is a definite frequency of light at which photoelectric activity commences, and this activity reaches a peak at a critical frequency. If this selective effect can be intensified and regulated, by means of color filters or otherwise, three photoelectric cells, each sensitive to one of the primary colors, might be connected to three separate television transmitters. If, then, three receiving outfits were arranged to throw their light upon the same screen, the combined images, each representing the amount of a primary color in the original scene, would be superimposed to reproduce the image in its natural colors. At each moment, the light falling upon an elementary area of the screen would be the resultant of whatever red, yellow, and blue light was being projected from the three receiving sets; and the quantity of each color of light would be that dictated by that particular receiving connection or channel.

Such a method is, of course, so complicated, and would require such an accuracy of synchronization, as to be entirely out of the question. Just as the first suggested television system (requiring as many separate photoelectric cells and connecting circuits as elementary areas of the screen) was too complicated; so this color system would allow too many possibilities of error in synchronization and in getting the right proportions of color to be practical. Now the great advance, by which the objections to the early method were escaped from, was



Mr. Gleason is well known to our readers as a contriver of humorous stories, each of which, however, is based on a phenomenon of radiation. This article is a serious consideration of the scientific side of color television.

the use of the "scanning disc," by means of which all the unit areas of the screen are covered in rotation instead of being presented independently and simultaneously; thus enabling a single photoelectric cell and transmission channel to handle all the vision impulses. It is made possible by the tendency of the eye to "hold over" after being stimulated. So long as the entire image is presented, serially or as a unit, at least fifteen times per second, the eye will fuse the individual impulses into a complete picture.

## SUCCESSIVE COLORED IMAGES

Here is a key to color television. If the eye will blend fifteen short flashes a second into a continuous picture, it will surely fuse colored fragments as well. Suppose, then, that the transmitter is equipped with a device causing it to respond first to the reds in the image, then to the yellows, then to the blues. The receiver synchronously reproduces the image according to the relative strength of the impulses it receives; presenting it first in red, then in yellow, then in blue. The whole cycle repeats itself often enough to allow the eye to blend the impressions into a smooth picture. Since red and yellow make purple, yellow and blue make green, and red, yellow and blue make grey or a neutral color, the combination of the primary colors in varying proportions will cause the image to be reproduced in its natural colors.

But how can the transmitter analyze the colors of the object? We may image a scene being "televised" in colors by an operator sitting, microphone in hand, beside an ordinary television outfit, and describing each dot or unit area of the picture as it came opposite the aperture. "Red, red,

green, blue, yellow, orange, violet, brown—" he names the colors and, as he calls each, an operator holds before the television lamp by which the received picture is built up, a transparent screen or slide of that color, so that the light, whose intensity is automatically regulated by the televiser itself, is given the proper color. Such a scheme would work very well—if it were fast enough. But in television, the whole image, consisting of many thousand unit areas, must be scanned several times each second. This means that hundreds of thousands of dots must be analyzed, transmitted, and reproduced every second—a rapidity far beyond human possibilities.

Before considering the method of translating color into electrical impulses let us recall a simple fact in optics. Every woman knows that cloth purchased in the store under artificial illumination often appears entirely different in daylight. The reason is that daylight contains all frequencies of light, while in the artificial light, certain wavelengths predominate, others often being entirely absent. A colored picture viewed under red light appears all out of proportion—certain portions receive undue prominence, others are thrown into obscurity. If the same picture is seen under a blue light, its aspect is entirely different. Areas which under red light were dim are now accentuated, other portions which were bright are darkened. Why? Simply because, under red light, the portions of the picture normally red reflected the light to the eye; those colored otherwise absorbed it. When blue light is used, those portions responsive to that region of the spectrum come into prominence, the light being "re-radiated" to the eye, while other portions absorb it.

Suppose a white object—that is, one which reflects all frequencies of light—is viewed first under red light, then under blue, the two colors being alternated very rapidly. Because the eye continues to respond to the light for a fraction of a second after the stimulus is removed, the two colors are blended into one—a purple. Let three colors be alternated—red, green, and blue-violet, the optical primary colors—and the resulting color is some shade of grey, some neutral color; its exact shade depending upon the relative proportions of the mixture. It is apparent that, by rapidly alternating the primary color, we may obtain the effect of any color we wish, just as an artist mixes pigments to get the desired tones.

## TRIPLE COLOR ANALYSIS

This, then, is our method: to illuminate the object being televised with light of the three primary colors—alternated. Each portion of the object responds to its own color, and reflects more or less light to the photoelectric cell, thereby translating the image into variations corresponding to the light and shade values of that particular

color. So far as the electrical characteristics of the output are concerned, the transmitted rendition of the image is not different from ordinary black-and-white-image currents. The coloring is entirely an illusion of the eye, just as the motion in motion pictures is purely imaginary. The receiver gives the primary colors synchronously with the transmitter, the photoelectric cell regulates the amount of each color going into the combination, and the rapidity with which the alternation occurs enables the eye to fuse the separate impulses into a composite image in natural colors.

Let us visualize the operation of a transmitter operating according to these principles. Instead of the standard scanning disk of black-and-white television, let us use one of the same design, except that instead of each of the spiralled holes through which the light passes (in many systems containing a lens to focus the light), it contains three; those of each trio being close together and equidistant from the center. The line traced by a scanning hole is thus covered three times in succession. Before each of these holes or lenses is set a colored, transparent disc or screen of one of the primary colors, so that the light is colored in passing. A single hole in the scanning disc comes opposite the aperture, admitting a thin pencil of light—red light, which is reflected to the photoelectric cells in amounts depending upon the amount of red contained in each unit area of the object. As the ray reaches the edge of the field and is cut off by the aperture, another simultaneously appears and retraces the line in green. This, in turn, gives way to a ray of blue-violet, and the same line takes on a still different aspect as the darker shades of the spectrum come into prominence. This cycle has taken the same time as to scan one line, in ordinary television. The next trio of holes now comes into play, and a line parallel to and just below the previous line is scanned in the three primary colors. The spiral of the disc moves on, until the whole of the picture has been covered, and the rotation brings the first trio

into play once more. (The reader will at once note the identity of this layout with the Baird color-television system, described in our October issue; the details of which had not been published when this manuscript was received.—EDITOR.)

At the receiving end, the motor, running in synchronism with that at the sending station, carries upon its shaft a disc exactly similar to that used for transmission. Out of the ether comes an electrical impulse which, traveling swiftly through the amplifier and associated circuits, flashes the television lamp behind the scanning disc. Colored by the glass slide or transparent screen, through the hole in the scanning disc at that moment before the aperture passes a ray of red light, which fluctuates from bright to dark, exactly as the photoelectric cell of the distant transmitter analyzes the object. A single line of the picture is built up in red, then immediately in green, then in blue-violet. In a fraction of a second the whole picture has been traversed—too rapidly for the eye to see each change individually. It sees, not a rapidly-changing series of lines in primary colors, but the result of blending of these colors into their proper proportions: a picture in the true colors of Nature!

REFINEMENTS OF THE METHOD

Let us simplify this method still further. In front of the ordinary scanning disc of black-and-white television, let us place a circular disc of a transparent material (Fig. 1) divided into three pie-shaped sectors, each of a primary color. This disc, geared to revolve at a speed one-third that of the scanning disc, colors the light passing through. Now the whole picture is scanned while the coloring disc makes one-third of a revolution; and as each color occupies one-third the area of the disc, the entire picture is scanned in one color before the next sector has come opposite the aperture. Three times the operation repeats itself, rendering three versions of the picture, each entirely in terms of a primary color.

The receiver (Fig. 2) carries a tricolored

transparency identical with that at the transmitter, and of course revolving synchronously, so that the picture is viewed through the right color at the right time. Thus, the three versions of the picture are superimposed, resulting in the reconstruction of the picture in its natural colors.

Still another method is conceivable. Let the light, after passing through the scanning disc and lenses, be directed into a prism, which breaks it up into its constituent colors, producing a rainbow-like spectrum. A revolving disc passes between this prism and the photoelectric cell, traversing the spectrum so that the passage of light of one color only is permitted at a time. The receiver employs a similar arrangement. The light passing from the local source (which, unlike a neon lamp, must be white) is broken into its constituents; the disc then allowing each color to emerge in its turn. The slotted disc is geared to advance one color each time the picture is scanned. This method, while possibly resulting in greater fidelity of color, would not only be much more critical of adjustment, but would require an enormously high speed of scanning to prevent flicker. Since a series of color gradations must intervene between the reproductions of corresponding points in successive cycles, the eye would have to hold over the images a comparatively long time; while at the same time each color is shown for so brief a time that the illumination of the whole picture is reduced.

These systems seem delightfully simple in theory. The actual application is, of course, another matter. The advantages resulting from the use of color television are obvious; but what about the difficulties?

RADIO PROBLEMS

The first and probably most important problem to be solved is the same as that now foremost in the minds of those working with television: namely, the width of channel necessary for transmission of the vision current. In order to understand the relation between the size of the image and (Continued on page 678)

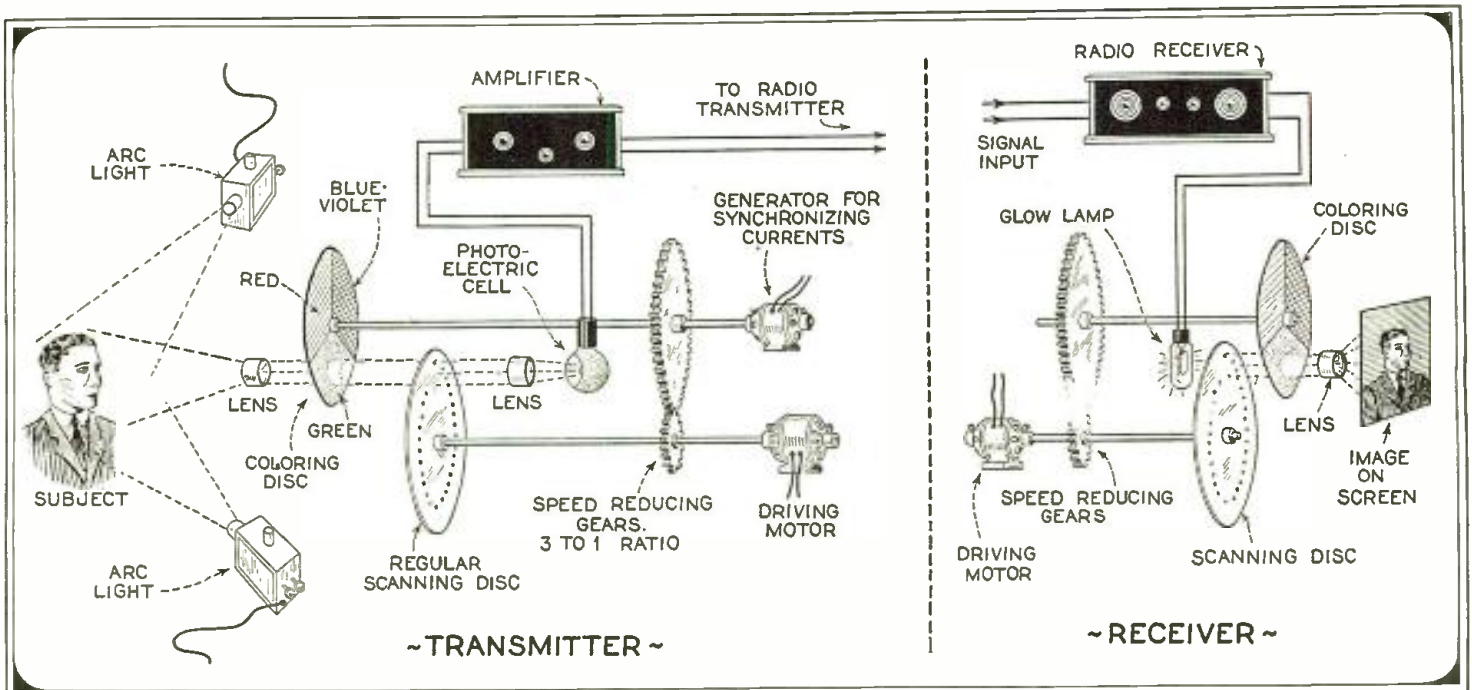

Fig. 1. The elements of the color-television transmitter. The scanning disc is run at high speed, and its revolutions alternately transmit the red, green and blue of the image. The cells used must respond well to all three of the primary colors.

Fig. 2. The reproducing televisior also produces red, green and blue images, all blended by their speed. The lamp light must be white.

# Giving Television the "Last Touches"

A Consideration of the Practical Problems which Beset the Perfectors of an Art Whose Theory Seems Simple Enough

**T**HE noteworthy success—speaking relatively—which was attained in the demonstrations of television by various systems in the past few months has been heralded throughout the world as a sure forerunner of the immediate introduction of television into the home, as well as its employment for wholesale public entertainment. A press dispatch quotes an unofficial expression of the Bureau of Standards, to the effect that television "is no longer a question of radio, but one only of optics." It is quite probable, however, that considerable work will be done along both lines before the baseball fan settles back into his armchair to watch the World Series shown on the screen of his parlor television.

There is a popular tendency to regard great inventions as the work of an inspired genius, and to imagine that "only the first step counts." The reader's fancy is caught by stories in the schoolbooks, of Newton aroused by the apple falling on his head, and Watt observing the lid of the teakettle. Of the laborious calculations and trials which intervened between these boyish speculations and the demonstration of the law of universal gravitation, or the operation of the double-acting steam engine, there is no room in the text books to tell, and there is none here. But it is beyond doubt that many mute, inglorious Newtons and Watts indulged in the same first speculations, but did not "follow through."

It is a common thing for a correspondent to write to the editor of RADIO NEWS and say: "Here is an idea which may be of some value. I have not the time nor the resources to work it out in detail; but if you will do so, we will divide the credit and the profits of the invention." All editors, of scientific or technical magazines, and all well-known inventors have had the same experience. In at least ninety cases out of a hundred, the impracticability of

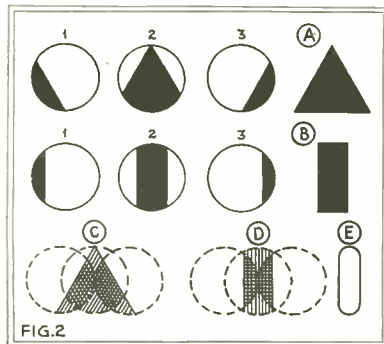

The photoelectric cell receives the same amount of light through the hole whether it is scanning the triangle A or the oblong B, and does not discriminate as to the shape. The slot E would cause a more accurate response, but would require both more light and a higher frequency of transmission.

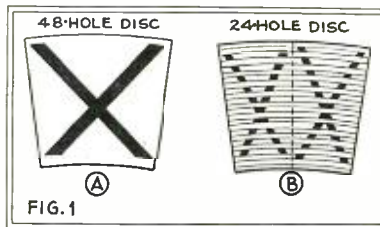

If a 48-hole disc is used at the transmitter and a 24-hole disc, revolving at the same speed, at the receiver, we shall split the reproduced image somewhat in this manner.

the idea is apparent at a glance. In another nine, undoubtedly, it could be determined by careful study. The hundredth case is one of merit, perhaps; but the labor of reducing it to a working basis is the true "invention." There are, of course, men who have the ability to make all the necessary calculations of a new invention, without the capital at hand to put it into actual operation; and such men are perforce necessitated to interest prospective associates in the development of their work. However, the high cost of inventing is not the most formidable obstacle to the garret inventor—it is the fact that the simple ideas are already familiar to men of technical education and he must, therefore, first educate himself to the general level of modern science and then specialize in his line of endeavor.

It is true also that a principle may be exceedingly simple, and yet the development of technique sufficient to put it in operation a very slow and tedious process. The idea of breech-loading guns occurred almost simultaneously with the invention of cannon; Christopher Columbus had cannon that loaded from the breech. Yet it took about four hundred years for mechanical technique to reach a stage where it made the advantages of the breech-loader over the muzzle-loader in every way apparent. Hertz worked with the short waves when he discovered radio forty years ago; but the short waves are just coming into their own. So, if it is to be five years, or ten, before radiovision reaches the stage of practicability pictured on our recent covers, the delay will be due only to the work of practical development of the details which may seem so unimportant, compared with fundamental principles, but which are essential to its successful operation.

We have seen television progress to a stage where an image three feet square has been produced, but coarse in detail; we can obtain smoothness of the picture only by reducing it. To say that we have only to construct apparatus making larger pictures in more detail is something like saying that we have airplanes which can go nearly three hundred miles an hour—why not make them go ten thousand miles an hour? Doubtless, it is not impossible: but

much must be learned and put in practice, in order to make it feasible.

## PROBLEMS OF FREQUENCY

To increase our television images in size or fineness, we must have special channels for transmitting the corresponding impulses: if we are to depend on radio broadcasting instead of multiple-wire systems (as we must to make television available in every home) it will be necessary to have bands of frequencies, allotted for the purpose. We must have receiving apparatus capable of being tuned with the utmost precision, and amplifiers capable of stepping up irregularly-fluctuating signals with the highest degree of uniformity.

It is possible that the system of television transmission finally developed will require a frequency which is the speed of scanning the picture; in other words, the image frequency will be the carrier frequency itself.

To explain this expression: as radio operation is carried on at present, an arbitrarily-designated carrier frequency is generated at a broadcast station. This frequency is modulated by the irregular interruptions of the impulses from the photoelectric cell which is responding to the alternations of light and darkness obtained by scanning the image. The result is a modulated wave which causes either odd noises in a loud speaker, or an image in a television receiver operated in synchronism with the transmitter. Held down by the "traffic rules" of radio, the television

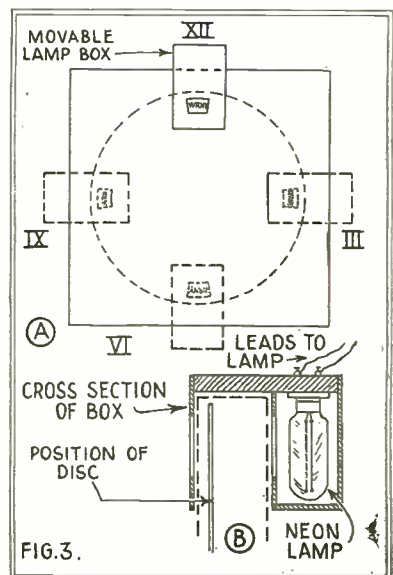

A detachable unit containing a neon lamp will give us the ability to scan the received image in several ways. By applying it to the other side of the disc, the apparent direction of the rotation might be easily reversed.

broadcaster may send out only images which keep within his "channel;" he must not introduce a note of more than 5,000 cycles into the broadcast band; on the short waves, he is given more latitude, but the highest frequency yet allotted, whether used or not, is 100,000 cycles.

Now, let us consider the case of a television transmission which is to enable us to watch an athletic event, a pageant, the take-off of a world flight, etc. A 48-line image gives us little more than a head; suppose we set the requirements of our television image for outdoor events at 250 lines by 350. We are to take pictures in color, or at very high speed. Twenty-four pictures a second, eight in each color, are needed for persistence of sharp vision.

The image-frequency for which we must

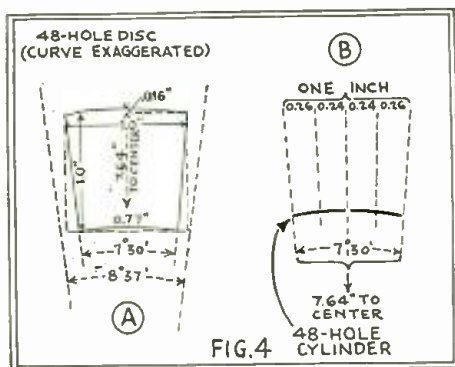

The scanning disc has a curved, tapering frame which can be made square only by altering the spacing of the holes. Though the cylinder scans horizontally, it spreads the image sideways.

34,560 cycles, or even more) regardless of whether or not the image is fine or coarse. The frequency of a circuit determines its speed of response; the less inductance and capacity it contains, the higher its frequency, and the less the lag in registering each impulse.

Let us look at Fig. 2. The circles shown at A indicate what happens when a round hole in a scanning disc passes over a black triangle; those at B the effect of a black rectangle of similar area. (It will be noted that the photoelectric cell "sees" the hole as a unit, depending on the amount of light reflected through it; not the shape inside it. This would be true, even if the scanning disc were stopped; and the cell too has a "persistence of vision," though trifling compared with ours.) The hole does not stop—it keeps on going—and in the time this aperture takes to cover its own width, the current in the circuit of the flash lamp at the receiver must fall till the lamp goes nearly out, if the television screen is to record the presence of a dark spot. If we increase the sharpness of the image by narrowing the slot as at E, we must double the illumination of the object and double the frequency of our apparatus. (It will be noted that, when it is said above that the transmitter and the receiver must record an impulse in the same time, the same length of time is meant. Though, to human senses, transmitter and receiver are acting instantaneously; when their functioning is timed in terms of radio frequencies, there is a lag in every circuit through which action is transferred, as well as in the "ether" through which the waves travel.) It seems doubtful whether any system of televising a ball game will permit us to follow the ball through the air.

Now, if our image is composed of solid dark masses, the fundamental image-frequency of which we have spoken will not be created by the alternations of light and darkness; but it would be, if the image scanned were broken up by a screen—as in

the process of making half-tone pictures—into detached elements. We may even suppose this operation to be performed, without a screen, electrically, by suitably proportioning the amplitude of oscillating current. In this manner, perhaps, the television impulses of a large detailed image might be confined within a narrow band, even though their frequency would be far from that of the oscillating circuit on which they would be based. But the receivers of today cannot amplify and separate such complex impulses.

PROBLEMS OF SCANNING

Yet, even after the radio problems had been solved, we would be faced with the optical problems of which the Bureau speaks. In this respect, we are compelled to choose between simplicity of mechanism and the size and exactness of reproduction. Most of our readers can readily point out the inherent defects of the scanning disc, and many, no doubt, can suggest mechanical and optical arrangements more suitable for the purpose of resolving and analyzing images. The only trouble is that these require highly-skilled mechanics with precision instruments to make the parts and assemble them; while anyone can set up a disc receiver that will function after a fashion. As John L. Baird has observed, in canny Scots manner, "A hole is cheaper than a lens."

First of all, the disc does not scan the image in straight lines and, if its holes are set at equal angles apart, the image must narrow toward the bottom. This, however, is not vital, especially as the image will be true to the one at the transmitter, if the scanning apparatus at both ends covers corresponding portions of the images in the same order and at corresponding instances. If we substitute a cylinder for the disc, we obtain lines which cross the image parallel to its top and bottom, but the image tends to be out of proportion at both sides. This

prepare is 2,100,000 cycles, or 2100 kilocycles—a high radio frequency in itself. This corresponds to a wavelength of less than 143 meters. If we should attempt to modulate a higher frequency—say 20-meter waves—with such an image frequency, no devisable circuit could be tuned anywhere near to the carrier wave and to both sidebands at once. But we might broadcast the image frequency itself as an interrupted continuous wave. Whether (the interruption being of a supersonic or super-audio frequency, on a picture taken with such a speed as this) it would be possible to modulate the wave with an audible program also, without doing violence to either, and to unscramble them at the other end, is a delicate problem. Perhaps it is not impossible of solution.

THE DETAILS OF A PICTURE

It should be pointed out that, in the present system of television modulation, the carrier is not modulated at any definite frequency. Each image impresses its own characteristics upon the wave. For instance, take the St. Andrew's cross shown in Fig. 1 at A. Each time the scanning spot passes over one arm of the cross, the photoelectric current drops; each time it emerges again upon the white background, the current rises; but even with a 48-hole disc and say, 1/15th-second images, the current would drop and rise again only about 1150 times a second. With a single irregular black mass in the center of the screen, the rate of interruption would fall to about half this.

It should be pointed out here the frequency required to produce an image at a given rate of speed should remain the same (for a speed such as that above, about

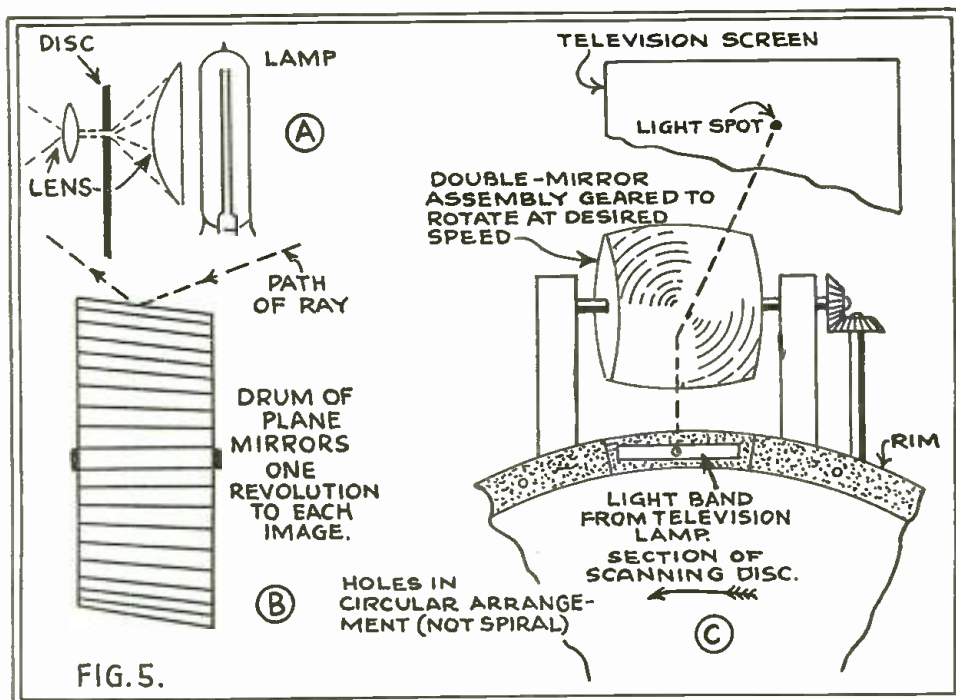

In A we see indicated a "plano-cylindrical" lens which will concentrate the whole light from a lamp's plate on the path of a circular row of holes. At B is indicated a mirror-drum, which causes every spot to sweep a different path; one is pictured on the next page. At C we have a suggested arrangement by which universal reception might be obtained; as the number of mirrors is increased, of course, and the number of holes, distortion will be reduced. One of the problems in a cabinet receiver must be the difference in the angles of projection between "camera" and reproducer.

point (Fig. 4 at B) will be brought up again a little later on, however, to show that it is not so important as it may seem.

Also, there is lack of uniformity in the various scanning systems employed, as regards the "resolution" or "analysis" of the images; and this presents an annoying problem to the experimenter, some of the implications of which have been discussed in our November issue (Page 429). For the present, it is possible that there may be some standardization—on a 48-line disc, for example—for broadcast experiments; but the limitations of this method show clearly that it will not be the final form used in radiovision. And, if the frequency used in transmitting an image and the frequency with which it is scanned are to bear a close relation, as suggested above, then each television broadcaster will have to employ a slightly-different system. How may this confusion be overcome?

#### PROBLEMS OF ADJUSTMENT

Let us consider some of the present differences. If we have a 48-hole disc and a 24-hole disc, as in Fig. 1, and revolve the first as a scanner (seen at A) at the transmitter, and the other before the lamp at the reproducer, we shall produce there a peculiar effect, as at B. (Incidentally, this may give an opportunity to the experimenter who has one of the 24-hole discs described in our October issue a chance to make a test on one of the 48-hole transmissions. It may be possible, with the aid of a card held to the nose, to divide the two halves of the image, one to the right eye and the other to the left, to get an effect akin to the "stereoscopic" one described in our November issue, on page 418. Owing, however, to the sharp curve of the spiral when the disc has so few holes, the two images cannot be expected to coincide exactly. Yet we may see the possibility of transmitting images to be reconstituted in a different order by other systems of scanning.)

The effects of reversing the motion of the disc, or the direction of its spiral, have been described in the same issue. Yet, when

we consider the effort needed "to reverse the direction of rotation of the disc, and also remove the disc from the shaft and turn it around with the other side out," it might seem somewhat simpler to transpose the positions of the neon lamp and the viewing hood to the opposite sides of the disc.

While American pictures, as a rule, have been scanned from side to side, the illustrations and descriptions in foreign magazines indicate that the top-to-bottom method is more in favor there. Let us suppose our television disc and motor enclosed in a cabinet with four cut-outs, so that we can apply the detachable lamp and hood at top, bottom, or either side at will. (See Fig. 3) We can have our option of scanning the picture in any direction; and, if our lamp and hood can also be placed on the other side of the cabinet, we can produce the effect of reversing the image. If we can rotate the lamp assembly around the edge of the disc—and any mechanic will see how this could be done—we can produce any adjustment we like. This method of keeping the picture "in frame" will have some advantages, as well as the disadvantages of more complicated construction.

#### PROBLEMS OF LIGHT

In all the popular systems of television as yet described, one great defect has been the limited amount of light available at the receiver. One 2304th part of the light from one neon lamp, not brilliant at best, is little enough to keep an image illuminated. We may, of course, construct larger lamps, but these involve the use of larger discs. A smaller disc may be used, by concentrating the light of one or more lamps upon it with lenses; but we must then magnify the image again, and this dims it. There is no multiplication of light energy, any more than of mechanical energy, through arrangements of apparatus.

However, we are not bound to let the unused light go to waste. We may adopt the system of a single light-spot, into which is concentrated all the energy of a lamp,

and which is caused to sweep over the entire image. This principle is used in the Belin and the Alexanderson systems, and is evidently very effective to cover a large area. The mirror-drum used, however, must be made with great precision, and will therefore be too expensive in manufacture to recommend itself for individual use. It will find its place in theatres, etc. The practicability of controlling several light-spots at once makes it possible to present very large moving images, if suitable channels of transmission can be obtained. (See Fig. A., below.)

We may imagine a device not dissimilar, but somewhat simplified, in the form of a flanged wheel, with a rim which passes before the neon lamp. The rim is perforated, not spirally, but in a circle, with holes which keep within the narrow width of a beam of light concentrated on them by a lens which is cylindrical instead of spherical in its curvature (like some reading glasses now available, which magnify a line of type only in the direction of its height and not from side to side. (See Fig. 5A.) Opposite each hole is its own mirror, formed by cutting into the flange a groove, with a lathe tool which continually changes its angle through the proper number of degrees. From the bright surface of the bottom of the groove, each successive spot of the image is reflected upon a screen.

It may be noted that the ordinary form of glass mirror is not well suited for work of such precision, because it offers two reflecting surfaces, one in front and one behind, and creates two parallel images. The mirror, to throw a small spot of light with great speed and precision, should have a polished silver surface—presumably treated against tarnishing.

With this system, we can greatly increase the amount of light available from a given tube, though not as much as by using the drum of mirrors. But our flanged disc will be still quite expensive, and not suited for use on transmissions of varying complexity and speeds. Let us see if we can devise a universal system of reception in small compass.

#### PROBLEMS OF SYNCHRONISM

We have, as before, a revolving disc pierced with a circle of small holes, on each of which is concentrated, when it passes over its scanning range, the full light of the television lamp, so far as may be done. The smaller the angle through which the hole moves, the more the concentration of light and the straighter the line which it draws across the image.

Behind the disc is a double convex mirror—one composed of two identical reflectors of large curvature, fastened back to back, revolving steadily and nearly at right angles to the disc. The speeds of the disc and mirror shafts have a variable ratio. (Fig. 5C). The light from the successive holes in the disc passes across the mirror, each casting upon it a thread of light which is reflected to the televisior screen and appears magnified. Each successive hole casts its rays upon the mirror at a varying angle, and consequently follows a different track across the screen. When one image has been scanned, the mirror has turned half-way round, and the mirror on its back commences the production of the following image.

It should be noted that the mirrors will have to rotate past their junction at the  
(Continued on page 681)

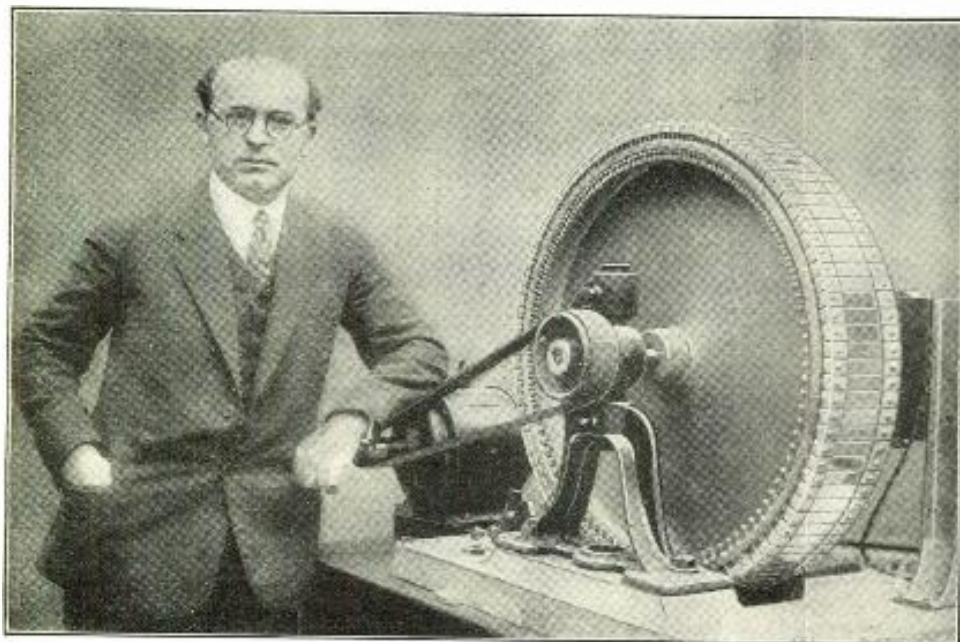
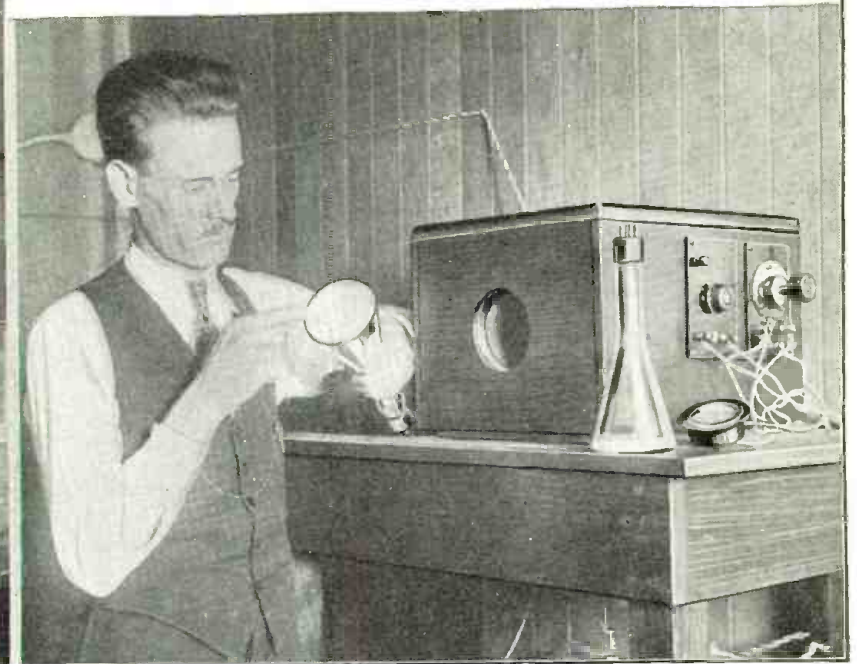

Fig. A Dr. Karolus, one of the world's leading television experts, with the "mirror-drum" of the receiving apparatus which he exhibited at the Berlin Radio Fair.

© Underwood & Underwood

# New Television Systems



Press dispatches report that Philo T. Farnsworth of San Francisco has made a demonstration of a television system which employs no machinery. RADIO NEWS has been unable to obtain any details by direct inquiry, but these illustrations have been released, indicating that a cathode-ray system is employed, on a principle like that described in RADIO NEWS for July, 1928 (page 22). At the upper left, Mr. Farnsworth is shown with his "camera" at the transmitter. At the upper right, the receiver; Mr. Farnsworth holds a "Braun tube." © P & A Photos.

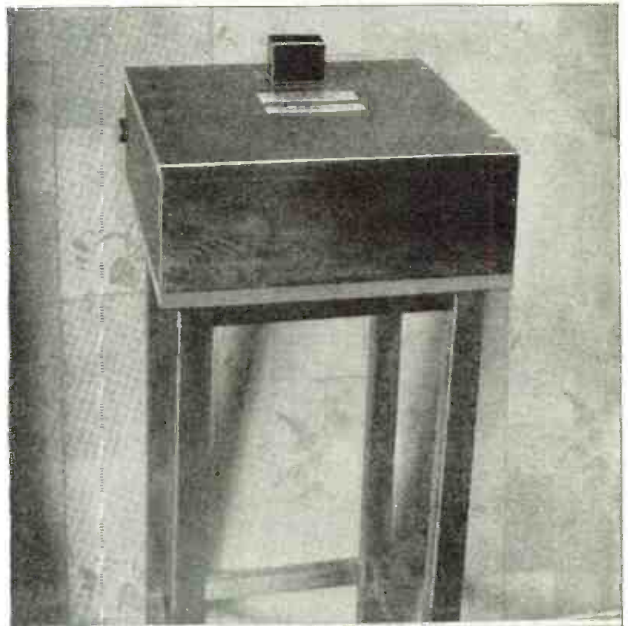
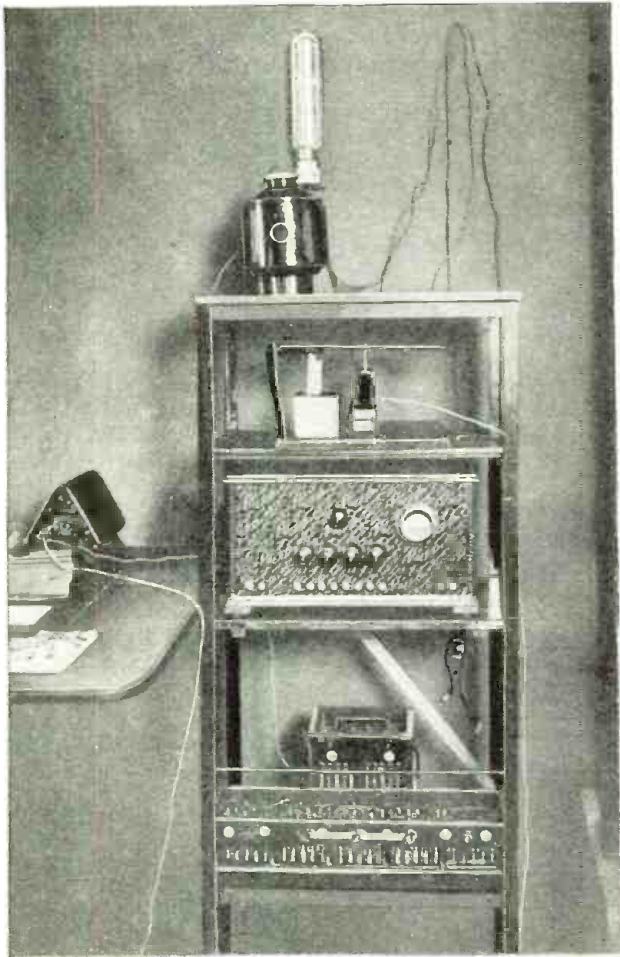

The three lower photos illustrate the Mihaly television apparatus exhibited at Berlin. In the right center, the receiver; the box, 10 x 12 inches, contains a horizontal scanning disc and a special "Wolfram" (tungsten) television lamp which is the distinctive feature. The construction is said to be very inexpensive. Center left, the transmitter with its horizontal disc and photoelectric cell in the upper compartment; light-source and lens above. Lower right, the Latour wheel which synchronizes the system. © Underwood and Underwood

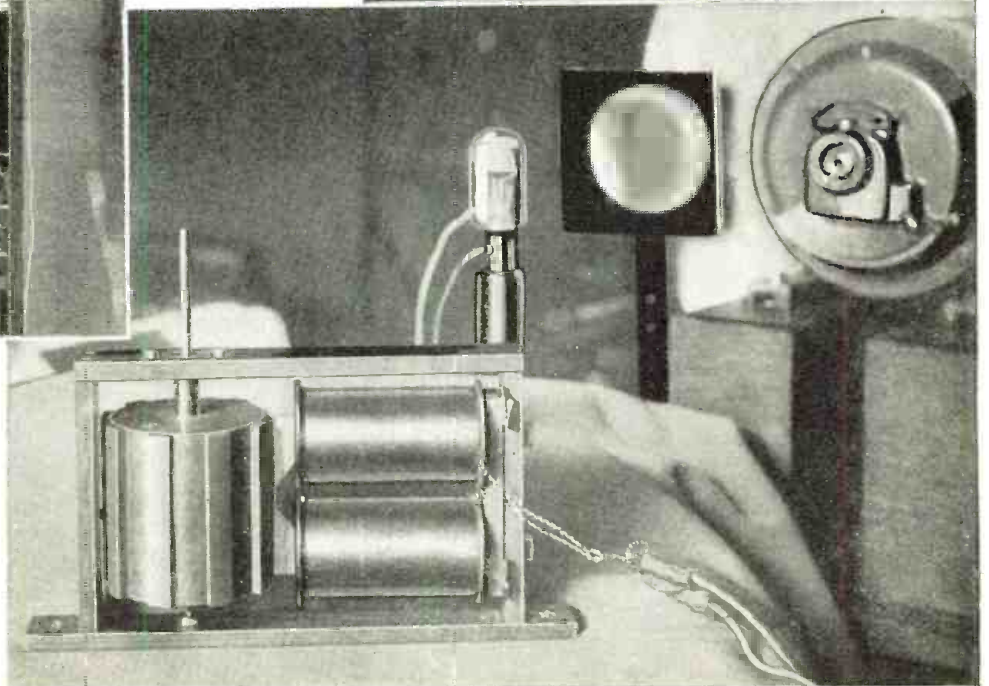

# Some "Foolish" Questions and Their Answers



Simple Things About Radio That Do Not Puzzle You, Kind Reader, But May Prove Stumbling Blocks for Many Beginners



By H. M. Bayer

THE story is told of a young lady who phoned the radio editor of her local paper and seriously inquired where she could purchase some new wavelenghts with which to replenish her radio receiver. Upon questioning her, the astonished editor was told a friend had informed the young lady that her particular type of receiver occasionally ran out of wavelenghts and would therefore require recharging.

The above, you will probably say, was a mighty silly question; but, as a matter of fact, it was perfectly logical—logical for the reason that to this young lady radio is as unknown a subject as geology may be to a good many radio fans. Furthermore, in a science such as radio, there is no such thing as a "silly" question. All questions, regardless of the manner with which they are put, may be answered to the educational advantage of the questioner. Just how and by whom these questions are classified as "silly" may be explained by the reply of Mr. Brown, a builder of four radio sets, who, when asked by Mr. Smith what radio is, replied: "Why, radio is er—er, why radio is er—now let me see—um-m-m—radio is—er—why, good heavens, man, you don't mean to tell me you don't know what radio is!"

The key to the above situation is perfectly obvious. To the learned Mr. Brown, Smith's question was just "too silly for words," for the simple reason that it stumped him! It is very evident that, had he been capable of putting forth a plausible answer, he would have done so, if only for the purpose of impressing his friend with his erudition.

In all cases the questioner is to be complimented on his admission of pardonable ignorance and his desire to learn. He is the person who actually learns; wherein the "know-it-all" is compelled to wave aside as trivial those questions that baffle him. It is well to remember that there is no such thing as a "silly" question in connection with any science.

On that basis there have been collected for this article a number of radio queries, many of which a radio "expert" might consider too "foolish" to explain; when in reality they comprise a goodly share of the very essence of fundamental radio. They have been chosen because of the frequency with which they are asked and, also, because their answers will enlighten the beginner as to many of the basic fundamentals of radio which should be absorbed before any attempt is made to enter into the constructional field.

## WHAT IS STATIC

Question: "How can I eliminate static?"

Answer: *Up to the present writing science has devised nothing that will eliminate static.* There is no such thing, and, to all appearances, will not be for some time, a static eliminator. Many devices have been designed to *diminish* the static nuisance, but these have been either too complicated or too uncertain in their action to be of high commercial practicability. Static may be classified, loosely, as Nature's Radio Wave, and, as such, it passes through the radio receiver in identically the same manner as a radio wave emanating from a broadcast

transmitter. Therefore, to eliminate static would mean the elimination of the radio signal as well.

One of the numerous forms of apparatus designed to diminish static is an "acoustical chamber" or sounding-box, coupled to a horn unit and so designed that it passes sound waves only of a frequency or tone to which it is adjusted. For example, if a signal of 500-cycle sound waves is being received, the acoustical chamber is adjusted to pass just that frequency and no other; static of a lower frequency, or any other signal not of that frequency to which the chamber is tuned, will not be heard to any annoying degree. The disadvantages, however, of this system are obvious, so far as broadcast reception is concerned; but it is of value to the telegrapher.

"Atmospherics" (static) in the temperate zones are most pronounced during the summer months, when electrical storms are more prevalent than at any other period during the year. For this reason radio reception in the tropical zone is indeed a matter of endurance, except on the ultra-short waves.

Static during the winter months is a comparative rarity, and is often confused with power-line noises, near-by trolleys, power-transformer leaks, adjacent electric motors, electrical vibrators, X-ray machines and numerous other sources of what is generally known as man-made static.

## WHAT ARE KILOCYCLES?

Question: "What is the difference between kilocycles and meters in discussing the wavelength of a station? What relation have they to each other?"

Answer: This subject is one of the largest thorns in the listener's side. It has a knack of taking on a deeper tinge of mystery with each new attempt at explanation and yet, like most problems, is exceedingly simple once the idea is grasped.

Wavelength has nothing to do with the power or the transmitting range of a broadcast station. Radio waves are in some ways similar to water or sound waves, though radio waves cannot be seen like a water wave, and sound waves are likewise invisible; yet it is known that a tuning-fork when struck sends out waves of sound, which go out into the air in all directions.

Likewise, an electric current flowing in a wire causes an *alternating* or changing electrical pressure in the "ether" about the wire, just as a piano wire when struck causes a to-and-fro motion of the air. A complete pair of alternations (see Fig. 1) is called a *cycle* and the number of these cycles per second is known as the *frequency* of the wave.

The reader must not get the idea that this picture of a radio "wave" represents any actual motion in the air about him. It is an engineer's way of drawing a diagram showing how the *voltage* changes at points in the path of a wave. The "wave" causes

No, it is not necessary to open the window to let in radio waves; they pass through stone, brick, wood and glass. But, on the other hand, metal, such as structural steel, deflects them and often causes "freaks" of reception, especially in cities.

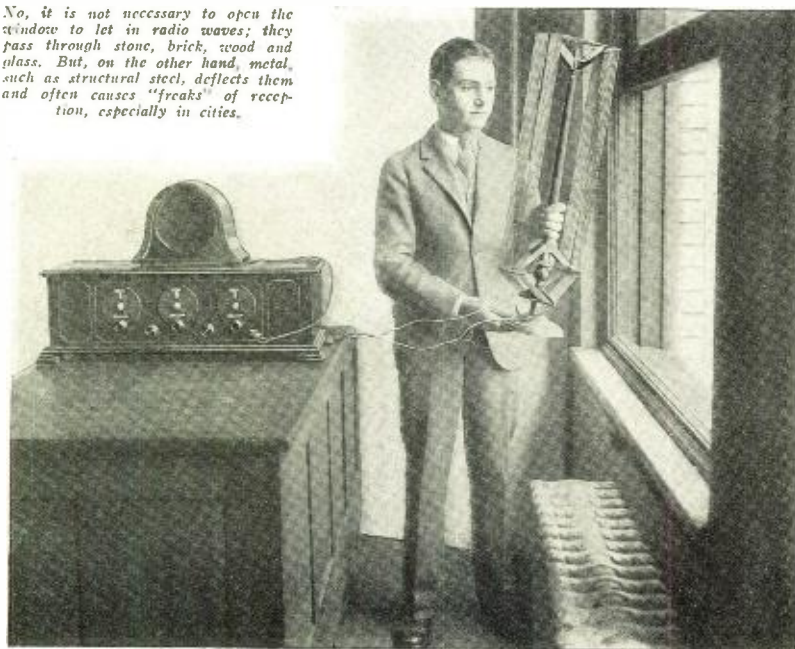



the voltage to rise and fall as shown at points in its path; and this causes a very slight current in your aerial, producing the "signal" received by your set.

The scale of the diagram may be one of time; and in that case, the number of crests of the wave on a line representing one second is the frequency. The distance between the nearest crests is one "cycle."

But the rise and fall of voltage caused by the "wave" takes place at slightly different distances from the transmitter. All experiments indicate that it takes the wave one second to go 186,000 miles, in round numbers, or 300,000,000 meters. For that reason we often divide the speed of "propagation" of the wave by its frequency and arrive at a (more or less) exact figure which we call the "wavelength." If we have a sufficiently long wire stretched in the direction from which the signal is coming, we may apply methods of measurement, showing the "wavelength" to be the distance between two points on the wire at which the wave tends

the human eye, which responds to the waves of light, and of that which is sensitive to the long waves of radio.)

**WALLS DO NOT CONFINE RADIO**

Question: "Must the window of the room in which the receiver is located be kept open when an indoor or loop antenna is being used?"

Answer: Radio receivers have been placed in mines, and even in steel vaults, and reception was successfully accomplished there. Radio waves can and do penetrate mountains in their travels through space, and most certainly can penetrate the walls of a home. There may be loss of energy, due to the absorptive qualities of the metal used in the construction of the building; but, of course, this will not be noticed by the listener in an average home. An "absorption-and-grounding" system is put to use in many cases where delicate experiments require absolute shielding from any external electrical disturbances except that of the

drives a dynamo (a "motor-generator" combination). In the Radio News Laboratories, to obtain alternating current, a motor-generator is used which runs from the direct-current lighting supply furnished in parts of New York City.

The fan, however, who does not care to go to this expense must use batteries, at least to supply such plate current as his receiver requires at more than 90 volts. He cannot, as many ingenious questioners suggested, put one tap from the 110-volt D. C. line in series with another to make 220 volts; a short-circuit would be the result.

**"FILAMENT EMISSION"**

Question: "How is it possible for a radio tube to light brilliantly, and yet be 'dead' for use in a radio set?"

Answer: There are a number of causes for the refusal of a vacuum tube to function while its filament still glows with normal brilliancy. One of these is the short-circuiting (or making a contact not called for in the design of the tube) of two internal elements; as between the plate and the grid or the grid and the filament. In the latter case the filament usually is destroyed immediately after the current is turned on; in the former, the tube will refuse to function, yet the filament will probably last its normal life.

The most prevalent tube ailment, however, sets in after a tube has been in service for some time, usually a year. At this time a marked weakening of signal strength, inability to get DX with the same ease as when the set was new, and perhaps some degree of distortion, may take place. The cause of this is the burning down of the filament to a point where the amount of "electrons" it gives off, when heated, to complete the "plate" or "B" battery circuit, is considerably lessened, with a resultant drop in efficiency of operation. As the tube depends upon the filament's discharge of electrons

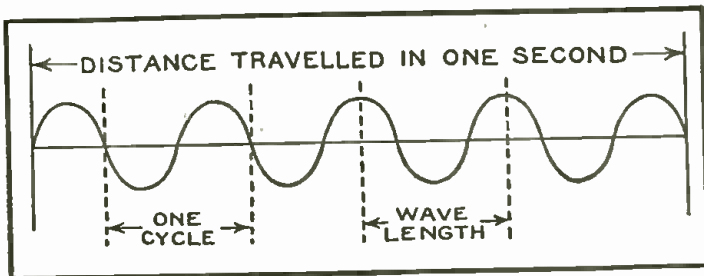

Fig. 1

If we divide the speed of radio by the "frequency" of a wave, we get the "wavelength." This, however, is a diagram of an electrical condition, and not a picture of any "waves" that really exist in the air.

to cause a similar voltage in the wire. With waves such as broadcast transmitters send out, this is rather difficult; but with short-wave apparatus, such as amateurs use, this experiment is easily performed. (A description of such an experiment, by John L. Reinartz, appeared in Radio News for October, 1927.)

**FIGURING THE FREQUENCY**

The "wavelength" of radio is therefore a number which always comes to the same figure when multiplied by the "frequency"; that unchanging figure is the speed of the "wave," which is the same as the speed of light. The speed, or "velocity," of the wave is 300,000 "kilometers" a second ("kilometer" is short for a thousand meters, just as "kilocycle" is short for a thousand cycles). Then:

The frequency (kilocycles) times the wavelength (meters) equals the velocity of radio waves (300,000 kilometers); 600 kilocycles is the figure you find in broadcast stations lists opposite 500 meters, and their product equals 300,000.

The velocity of light divided by the kilocycles equals the meters: 1,250 kilocycles, therefore, must be 240 meters, because 1,250 goes into 300,000 just 240 times.

The velocity of light divided by the meters equals the kilocycles; to find the frequency of a 200-meter wave, we divide 300,000 by 200. The answer is 1,500 kilocycles, of course.

(We may note here that heat, light and X-rays are also electro-magnetic effects, like radio; but their waves are almost inconceivably shorter, and their frequency is incomparably higher. The wavelength of ordinary yellow light is about one two-millionth of a meter or one forty-three-thousandth of an inch, and its frequency over 512,500,000,000 cycles or half a trillion kilocycles. It will be seen how different must be the tuning of apparatus, such as

signal to be received. In this case, the room in which the receiver is located is completely shielded by means of copper screening placed on the walls, the ceiling and the floor. The six screens are then connected together and grounded, thus providing a system whereby the unwanted impulses are picked up by the screens and directed to the ground before they can be picked up by the coils in the receiver. The antenna used with the latter, of course, is of the external type.

**IT CAN'T BE DONE!**

Question: "How can I arrange a transformer to step up 110-volt direct current for my "B" supply?"

Answer: You can't! The action of the transformer, by which voltage is increased or reduced, depends upon the alternation or, at least, pulsation of the current. Steady, direct current will not operate a transformer.

It would be possible, with the aid of large condensers, to build an apparatus resembling the "hydraulic ram" to cause the necessary pulsation in a supply of direct current; but it would be too expensive and uneconomical for use. It is, however, practicable to run a direct-current motor which

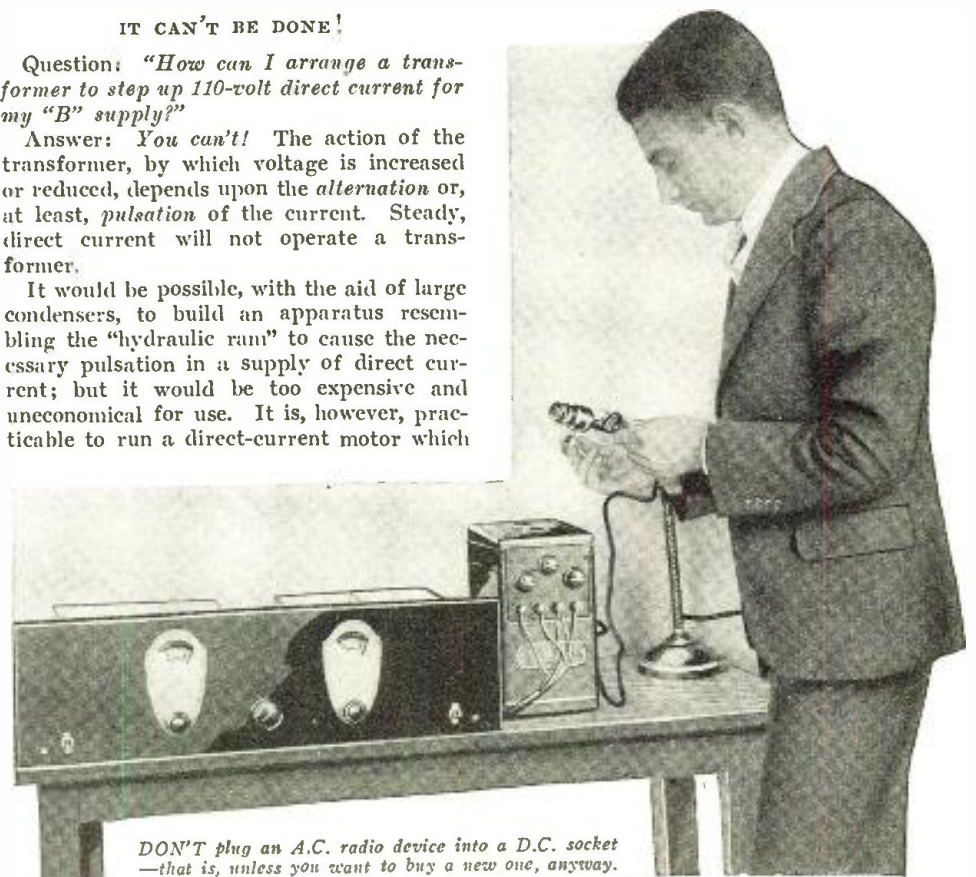

DON'T plug an A.C. radio device into a D.C. socket—that is, unless you want to buy a new one, anyway.

for its operation, the manufacturers coat the filaments with an "element" known as *thorium* which aids in giving off a stream of electrons sufficient for the successful operation of the tube.

After the tube's normal service the thorium is fairly well burned off, thus decreasing the number of electrons flowing from the filament to the plate. It is this weakening of the filament's operating efficiency which causes the unsatisfactory performance of the set. At times this condition will come upon a comparatively new tube—a fault known as "paralysis." To correct this, and also the weakening in old tubes, we may employ a process known as "rejuvenation" or making youthful again.

This rejuvenation is carried out on the theory that there is additional thorium distributed through the metal of the filament; and it is often possible to form a new surface layer from this reserve supply, so that the tube will operate as well as when new. The process has proved itself fairly successful in the majority of the cases when rightly carried out. It consists of two successive treatments known as "flashing" and "baking." In the first, a high voltage (much higher than the normal) is applied to the filament for only a short and definite period of time, usually specified by the manufacturer. After this the tube is "baked" by applying the normal heating voltage to the filament for a definite period of time. While performing these operations no "plate," or "B," voltage is used.

#### RADIO AND AUDIO FREQUENCIES

Question: "If radio waves are always in the air, why can't I hook a pair of phones to an aerial and hear the signals?"

Answer: Because the radio signal is sent through space on a "carrier-wave" whose pitch is from ten to a thousand times too high to be heard by our ears. This is done because "audio-frequency" currents—electric currents alternating at the same rapidity as the vibrations of the air which make sounds that we can hear—do not carry well over long distances; and if they did, a radio receiver would pick up all the radio conversation in the world at the same time.

The use of "radio-frequency" carrier waves makes it possible to select one radio message out of the thousands in the air, and also to transmit the signals with low power.

The "modulator" of a broadcast station, where audio-frequency currents are ampli-

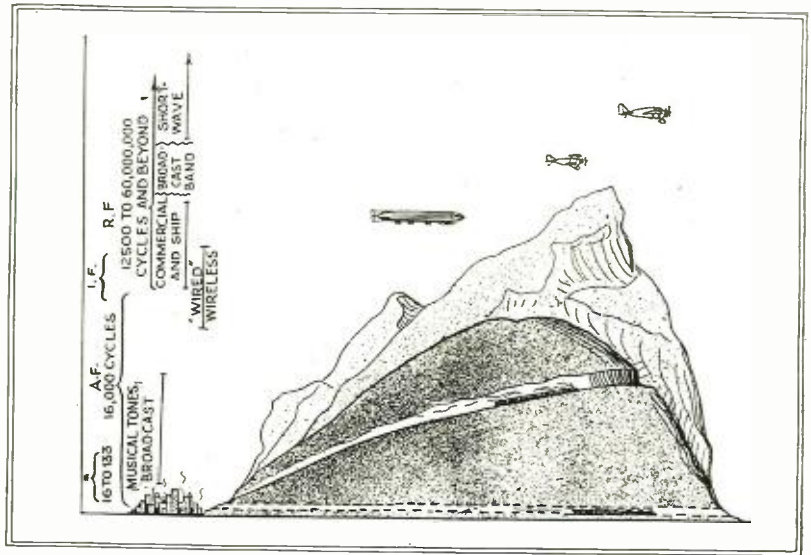

Fig. 2

The respective positions of audio and radio frequencies in the scale are shown above, though not on an arithmetical basis. The frequencies of A.C. machinery are indicated by a \*, those of a superheterodyne's intermediate stages by I.F. The carrying power of electrical frequencies, to a certain limit, at least, increases as the frequency increases—and the wavelength shortens.

fied to very high power, sometimes causes the programs to be heard in telephones nearby, but it would not be practicable to have reception of this kind at any great distance, and no sharp tuning would be possible.

The audio-frequency currents can be carried a long distance over wires; but even with the aid of these, for very distant conversation, it is desirable to use "carrier-currents" (of very low radio frequencies, as explained in the article "Wired Wireless," in October Radio News).

We cannot hear even "audio-frequency" currents directly; it is necessary to have telephones, a loud speaker, or some such device, to turn the electrical into mechanical vibrations which can affect our ears.

We could not hear radio-frequency vibrations if the telephone were connected in a radio-frequency (R. F.) circuit of sufficient power; first, because the diaphragm of the telephone and its coils are not designed for vibration at such high frequencies (100,000 to 100,000,000, and more, times a second). Secondly, our ears cannot hear vibrations of more than 10,000 to 20,000 times a second, no matter how powerful they are; they do not produce a sensation of sound.

#### WHY "R. F." AND "A. F.?"

Every radio receiver comprises three parts, more or less complicated; an R.F. end, in which the currents alternate and flow at the same frequency at which they are picked up by the antenna; a detector, to remove the high-frequency (R. F.) "component" of the current, which was put in at the transmitting station; and an audio-frequency (A. F.) end, in which the currents are again at a frequency low enough to produce sounds in the phones or speaker. In some receivers there are one or more "intermediate frequencies"—but these are also radio frequencies.

Fig. 2 indicates graphically a comparison which is not exact, but which gives an idea of the use of the respective frequencies. We wish to send a shipment from a station on one side of a mountain range to a station on the other. If we wish to do so without

raising the load from its original level, we must tunnel the mountain. This corresponds in a way to the use of telephone wires to carry sounds at the original audio (voice or music) frequency. It is expensive and limited in scope.

If we are content with a moderate elevation, we may send the freight over a railroad at the lowest height of ground we can find in the range. This may be taken to correspond to a "wired-wireless" carrier frequency, which is a very low radio frequency; but it also requires a continuous line of apparatus from the point of transmission to the point of reception.

Or we may put the goods in question on an airplane and fly over the mountains. This corresponds to our broadcast radio frequency. The farther we have to go, probably, the higher it will be desirable to fly. But, whether by the second method or the third method, what goes up must come down. So it is with the radio signal, which must be "detected"—in a word, brought down from the high radio frequency to the original audio frequency.

#### HOW MUCH WIRE ON A COIL?

Question: "How many inches of wire do I wind on a coil to add another meter of wavelength?"

Answer: This is a very proper question, which constructors often ask. To answer it here, however, is impracticable. The rules for calculating the wavelength of a coil from its size, turns, etc., are so complicated that ordinary arithmetic is not enough for working them out. A high degree of engineering education is necessary. For that reason, it is easier to find out by experiment what results are obtained with a coil of a given size and a condenser of a given size. The coil sizes which are given for a given condenser to cover a given range of frequencies (and, of course, the corresponding wavelengths) will be suitable for use in another circuit with a condenser of the same size. Such figures are given from time to time in Radio News (see, for instance, page 1255 of the

(Continued on page 676)



Even if the phones could vibrate with radio waves, the frequency is far too high to hear.

# The Dark Side of Radio

By Dorothy Gernsback

**T**HE spirit of Christmas had even descended upon the Soakem Radio Company, and in their extreme though somewhat frugal magnanimity, they had made at least one poor soul happy. Ulysses Grant Rasby, general porter and all-around man for the Soakem Company, had been worshipping, from afar and from every other angle of proximity, a long discarded and neglected shop-worn crystal outfit, which he secretly hoped would be his some day. True, this outfit had all the earmarks of a "has-been," with its cat-whisker somewhat shrivelled from long usage, and the crystal almost worn down to a grain. That he had hoped to resuscitate it from its present derelict state when opportunity called can be proved by the inclusion of this hope in his regular Sunday prayers. "O, good Lord," he would pray, "You sho' can save dat from fallin' into blasphemousin' hands. If Yo' is hankerin' to do some good to dis heah baby, put Yo' kind O.K. on papa heah fo' a prospectus candidate for dis heah set."

Opportunity did knock on Christmas day, and Ulysses was almost knocked over with surprise and delight, when one of the head Soakems invited him to cast his eye in the direction of the abandoned pile of scorned and antiquated outfits. To Ulysses this was the first approach to heaven, and it didn't take him long to get there; for with one leap and bound, as they say it in stores (the "bound" should really be left out of it, for he got there with one leap, to be exact) he reached and held in his ebony hands that precious crystal set, plus a pair of headphones, deaf in one ear and catarrhal in the other, but serviceable, nevertheless.

If you wish to know anything further about Ulysses Grant Rasby, just follow along to 9934 East 135th Street, climb up two ramshackle flights of stairs that creak and groan with age, knock on the door and wait. If you are at all interested in our hero, you'll do this; because the knock will bring his kind but elephantine mammy to the door. She'll ask you in, wipe the dust from an almost dustless chair with her clean checkered apron, and tell you all about her first, last and only son. She'll tell you that Ulysses spends his spare time a-riggin' up all kinds of bells that bring out funny and spooky noises, that there isn't a thing he couldn't make out of a few screws or old tin cans. She'll tell you perhaps that there's not another boy as good as hers, that every cent of his fifteen dollars per goes to her, and so forth.

To come back to Ulysses Grant Rasby, who had by this time arrived home in an utterly breathless state, carrying with great pride and care his precious crystal set and earphones. In the twenty-three years of his uneventful life, never before had he felt such joy, and it did not take him more than a second; for with three steps at a bound he reached the ground floor of the house in which he lived. And why the ground floor, you ask. The reason is that Landlord Small Snigsbie had his bachelor quarters installed there.

"See heah, Small Snigsbie," our hero says

to his landlord, "ah craves to make speech with yuh."

"By which yuh means yuh is cravin' a favah from off mah hands," hisses the landlord.

"Not from your hands, Small Snigsbie, foh anything comin' from off'n yoh hands an dirt black, but what ah does need is yoh roof foh mah aerial, as dey calls it."

"Niggah, yoh speaks woids dat means nothin' to dis heah baby. Yoh acryial can get de air for all ah cares, but not dis roof heah dat holds mah morgages. And ah speaks finality when Ah says NO with a capital W."

From which conversation you can glean the character of Landlord Small Snigsbie. To describe him would be a waste of time and space. He is not even worthy of description, so I will leave him to the imagination of my readers.

Now Ulysses Grant Rasby is a good and timid young man when unmolested, but when his African is aroused, watch out. Especially when it concerned his radio set, the object that caused the whites of his eyes to shine with a belladonna lustre.

Then again, another very good reason for his desire to rig up his radio set without further delay, and a very good reason at that, was that Nitrate Eliza Pepp of the "Lookin' Wild" company was to sing her song hit on the morrow into the cold, hard ear of Station WBUM. That this meant a great deal to Ulysses can be only measured by the rapturous glances he fixed upon each and every photograph of Nitrate which bedecked his room. To hear Eliza's voice meant music to his ears. No, he simply must fix up that radio. He would swallow his pride, and go down again to his heartless landlord with perhaps an inducement or two, for the favor of installing the aerial.

Part way down the stairs he heard a voice of exquisite sweetness which seemed to meet him, yet no one was to be seen. Suddenly, a dark figure approached him and in a sweet womanly voice called out, "Ulysses Grant Rasby, is dat you, yo'self dat I makes speech with, or is you somebody else besides yo'self?"

Coming closer, Ulysses espied a figure and recognized it at once. "Sambo Brown, you sho' did fool me fo' a minute. And what old tricks are you up to, anyway? The next thing yo' know, Mr. Keith gwine give yo' a million col' cash fo' your dis hear ventriloquism act, or whatever yo' gwine calls it."

"I'se gwine think about yo' suggestion," parts back Sambo: "but why you goin' around with a face dat looks most unnatural like? Maybe yo' gwine seen the fiery cross of the Ku Klux. But make light of it, brother Rasby, make light of it, and tells yo' friend heah what dat pallbearer physiognomy is done got behind it."

To which advice given gratuitously and with such wise philosophy, friend Ulysses responds, and tells him all about Landlord Snigsbie and his mean disposition. Let us leave our friends to their own wise counsel, and wander back to Landlord Snigsbie.

To proceed: Landlord Snigsbie had parted most sorrowfully only a few days ago with fifty paper doubloons for a six-tube Niggadyne set. You see, Nitrate Eliza Pepp had smiled him into it, and he sure did like to receive one of her smiles, providing it didn't cost too much. Nitrate had presented him that day with an autographed photograph of herself, because you see Nitrate knew a well-filled pocketbook when she heard of one. To have the neighbors come in and envy his radio set would partly

(Continued on page 684)



"He pulled it out bodily by its roots, with the entangled wires hanging limp and in disgrace, and flung it through the door, followed by the loud speaker."

# The Radio Beginner

## The "Bloopless" One-Dial, Two-Tube Receiver\*

THE two-tube receiver described in this article was designed for the radio beginner who holds in awe the construction of vacuum-tube receivers. It will prove to him that the constructional difference between a crystal receiver and the set herein described is but a matter of a few additional wires to be soldered and the mounting of a few more simple parts; while the same assertion holds true of the difference between a two-tube set and a five or six-tube set.

There is nothing new in the circuit of this set; nor are any recent inventions employed in its assembly. As the title implies, it is about the simplest possible two-tube set, designed solely for the benefit of recent initiates into the radio builders' guild, and those who are contemplating hopefully the possibilities to be worked out with the screwdriver and pliers. For the latter class, especially, this little set offers an excellent beginning because of the theoretical ground-work which can be obtained while building and experimenting with this receiver. It is the simplest form of vacuum-tube set which is fit for an experimenter's use in ordinary broadcast reception.

For a preliminary explanation, Fig. 1 gives a schematic diagram of the simple detector circuit which is found in every vacuum-tube receiver, regardless of the complexity of the circuit or the number of tubes. It is, in itself, the simplest vacuum-tube receiver which can be assembled for the reception of radio signals. It comprises

**No. 71**



The "Bloopless" Two is about the simplest possible set, either to build or to operate, and will not radiate. Large blueprints of this set, with the list of parts originally used, will be sent free of charge, postpaid, to any of our readers applying for them on the Free Blueprint coupon which appears on page 701 of this issue. Ask for Blueprint No. 71.

a coil of wire, or inductor (commonly, though inaccurately, called an "inductance") with which to "load" the antenna; a variable condenser to "tune" this coil, so that stations transmitting on different wavelengths may be "tuned in," at different settings of the condenser dial; a grid condenser and a grid leak, (which are necessary if the tube is to function as a detector); and requires also suitable batteries and a pair of headphones to reproduce the radio "signals" which have been made audible by the action of the detector tube. These components make up the basic unit of every radio receiver employing vacuum tubes, and it is this unit which is so often referred to as the "heart" of the set.

### WHAT HAPPENS IN THE TUBE

When functioning as a detector, in either a one- or a multi-tube set, the tube serves as a rectifier. When it serves in that capacity the signals, after passing from the tuning unit and through the grid condenser, are impressed upon its grid in positive and negative alternations.

While this action is going on in the grid circuit a constant flow of electrons is leaving the filament of the tube and bombarding the plate. The latter has an electrical attraction for the flow of electrons (which are negative electricity) due to the fact that the plate is kept at a positive potential by means of the "B" battery. For this reason the positive, or "+" post of the "B" battery is always connected to the plate of the tube; either directly, when there is another tube following it, or, as in this case, through the headphones, or loud speaker, the other terminal of which is connected to the plate. (The readers who desire to know more about this are recommended to read "What a Radio Tube Is and What It Does," on page 1124 of the April, 1928, issue of Radio News, and "What Is Detection?" on page 1151 of the same issue.)

This filament-to-plate flow of electrons provides a circuit which will allow an electric current to flow in only one direction; it is this characteristic which gives the vacuum tube its properties as a rectifier of alternating current. The two-ele-

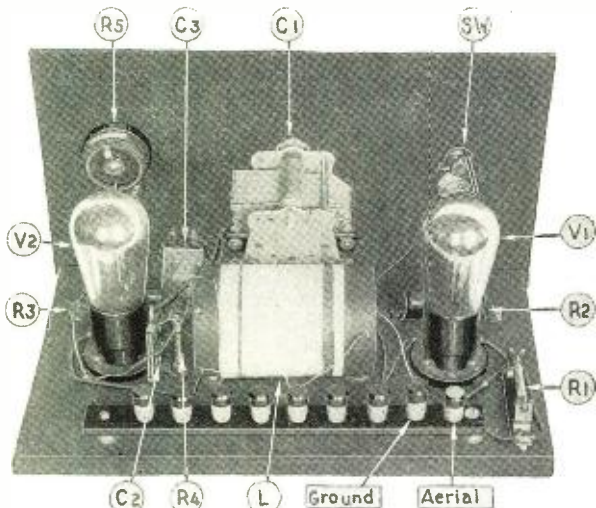

This rear view of the "Bloopless" receiver shows how simple is its construction. The coil L is home-made, the parts are few. The addition of a two-tube amplifier gives speaker volume.

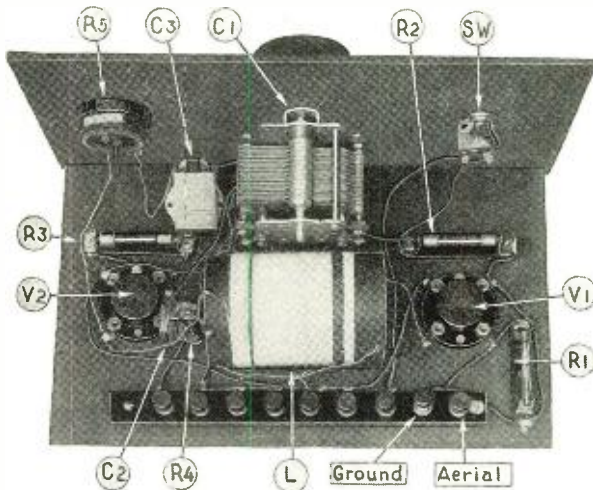

Another view, from a higher angle, shows all the wiring of this set; a wooden baseboard is used, saving the trouble of drilling. The symbols are given in the diagram and parts list, page 645.

\* RADIO NEWS Free Blueprint Article No. 71.

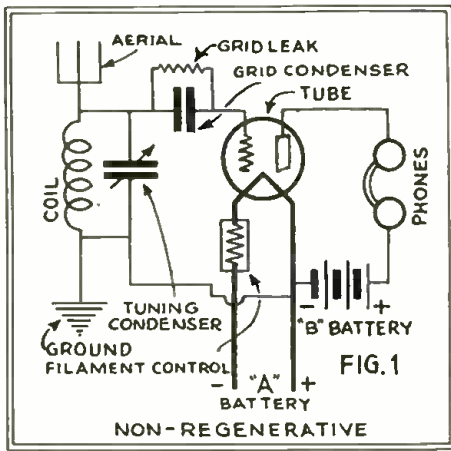

The simplest tube circuit. It does not radiate, but has little amplification or sensitivity.

ment tube is used extensively for this purpose, in modern electric sets.

It was Dr. Lee de Forest who discovered that by inserting the third element, the *grid*, he could control this flow of current. The grid consists of a very fine wire spirally arranged, with wide spaces between the turns; so that the electrons can pass between them on their way to the plate. De Forest found that a negative charge on the grid reduces the strength of the filament-plate flow, while a positive charge tends to increase this flow; this is based on the electrical law that *opposite charges attract, while like charges repel*. For example, the negative electrons leaving the filament on their way to the positive plate which is attracting them, are driven back by the grid when it is negatively charged. And, in accordance with the above-mentioned law, the electrons are aided on their way to the plate when the grid takes on a positive charge.

It can be seen, therefore, that the grid acts as a *control* of the current flowing from the plate of the tube into the phones or loud speaker. No matter how rapid the fluctuations that are impressed on the grid, the plate current imitates these in accordance with whatever voltage variations are present in the original wave from the broadcast station. Furthermore, since a very small charge on the grid has a relatively large effect on the plate current, the tube *amplifies* the small electrical impulses which are impressed on the grid. Thus it can be seen that the tube both detects and amplifies.

THE OSCILLATING DETECTOR

The simple one-tube receiver shown in Fig. 1 employs a non-regenerative circuit; that is, no electrical or mechanical method which would cause the detector to oscillate has been included in the set. An explanation of the theory of regeneration may be a bit complicated for the average beginner; suffice to say, in brief, that "regeneration" is putting back into the *grid* circuit of a tube a portion of the energy in the *plate* circuit. But, whenever a tube is working naturally, the energy in the plate circuit is liberated in spurts corresponding to those in the grid circuit, but greater in value. Therefore, the action of regeneration is to build up an ever-increasing amount of energy flowing back from

the plate to the grid. (This is not perpetual motion; the power is supplied from the "B" battery or power unit). But, unless this process is checked by limiting the flow of current—either in the filament, in the grid, or in the plate—the tube will get beyond the control of the grid and will "run away" or "race"; just as an engine will when its governor is put out of commission. Then the tube is "oscillating" and pouring power backward into the aerial, if it is connected to the latter, as well as ahead into the audio stages, unless they contain chokes to keep it back. If the tube is connected to an aerial of suitable *resonance*, it then becomes a transmitter; and as such, operating on the broadcast band, a single one-tube set will cause disturbance in broadcast receivers at a distance of ten miles or more.

Regeneration, however, produces the effect of increasing the strength of the signals by apparently reducing the resistance of the circuit. It also greatly increases the *selectivity* of the circuit and makes possible the reception of distant signals which ordinarily

The diagram given as Fig. 2 shows a simple regenerative circuit employing the old-time "Ultra-audion" hook-up; it will be noticed that the tube is brought to a state of oscillation simply by connecting the "filament" return of the inductance coil to the *plate* of the tube instead of to the filament, as commonly done; a variable condenser in series with this lead controls the regeneration.

In Fig. 3 we have a regenerative circuit employing a separate winding, the "tickler," to bring about a state of oscillation in the detector. This method of obtaining regeneration is known as "inductive feedback" because the energy from the plate circuit is returned to the grid circuit, by virtue of the close proximity of the tickler or plate coil to the tuning or grid coil and the "mutual inductance" of the two windings. Quite often the tickler winding is so designed that its position can be varied in relation to the grid coil. When provided with this mechanical means of variation, the tickler is described as *loosely coupled* or *variable*.

However, this method of controlling regeneration has the disadvantage, for a beginner, of introducing mechanical difficulties, such as the construction of a suitable shaft and mounting device; furthermore, this method falls short when critical con-

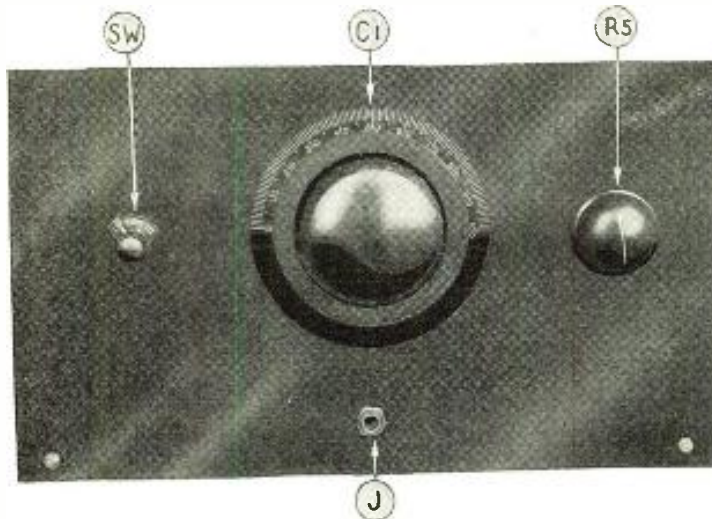

At the left, a view of the panel of the two-control "Bloopless" set. The condenser C1 tunes the receiver, R5 is the necessary regeneration and volume control. SW shuts off the battery and J is the jack for phones, which may be used for distance work, even if an amplifier is added.

cannot be heard with a non-regenerative receiver. (Readers will find a more extended explanation in "Regeneration—What It Is and What it Does" on page 1234 of RADIO NEWS for May, 1928; and the articles in last month's issue, "How to Succeed in Short-Wave Operation" on page 552 and "Some Easy Experiments with Oscillators," page 554, explain in what manner oscillation may be put to use.)

control is desired. Far better results have been obtained with a *fixed* tickler winding employing as its means of control a variable condenser.

Still another method of controlling a fixed tickler winding is that comprising a variable high-resistor, either in series with the tickler or shunted across it. This method has lately come into favor both with broadcast and short-wave fans; for it has sta-

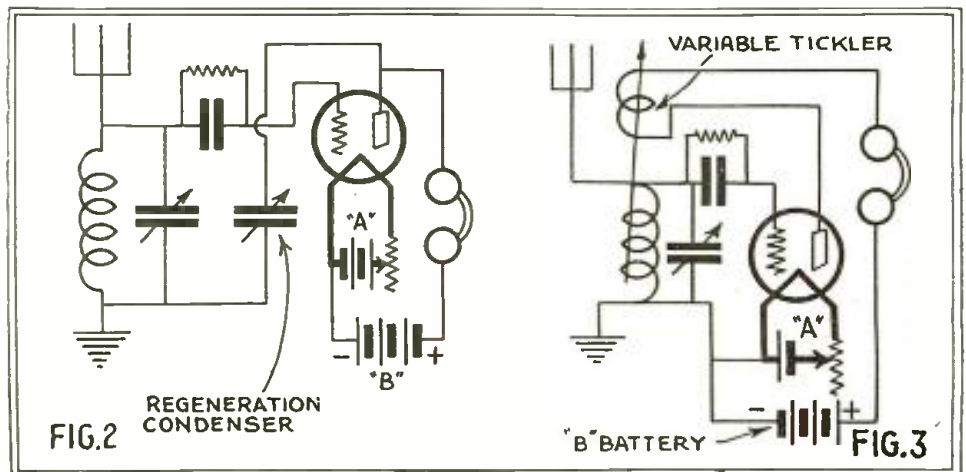

These regenerative detectors use capacitive (Fig. 2) and inductive (tickler, Fig. 3) regeneration control, giving great sensitivity; but, as shown, they are public nuisances. An untuned R.F. stage takes away the curse.

bility, ruggedness and offers the desired degree of fine control. Employing either capacity (condenser) or resistance control of a fixed tickler winding does away with the necessity of improvising mechanical means of variation, such as a tickler coil wound upon a separate form and rotated within the tuning coil by means of a shaft; which, at best, is none too exact a control.

**WHY ONE-TUBE SETS ARE ILLEGAL**

Before proceeding with the constructional details of this two-tube receiver, the reason for the second tube should be explained; and the reader should commit to memory the following instruction and take a solemn obligation never to transgress it himself, and to do what he can to restrain others from doing so.

*Operating a straight regenerative circuit, the detector of which feeds directly back into the antenna, on the broadcast waves, indicates gross lack of consideration for others or a malicious intent to annoy; and willful oscillation is punishable in the Federal courts as the crime of generating a source of radio interference.*

In keeping with the policy of RADIO NEWS,

Fig. 6

The layout and wiring diagram of the "Bloopless" set; panel and baseboard are separated for convenience's sake. Run over each "lead" with a pencil as it is wired; and you will have no trouble in following it.

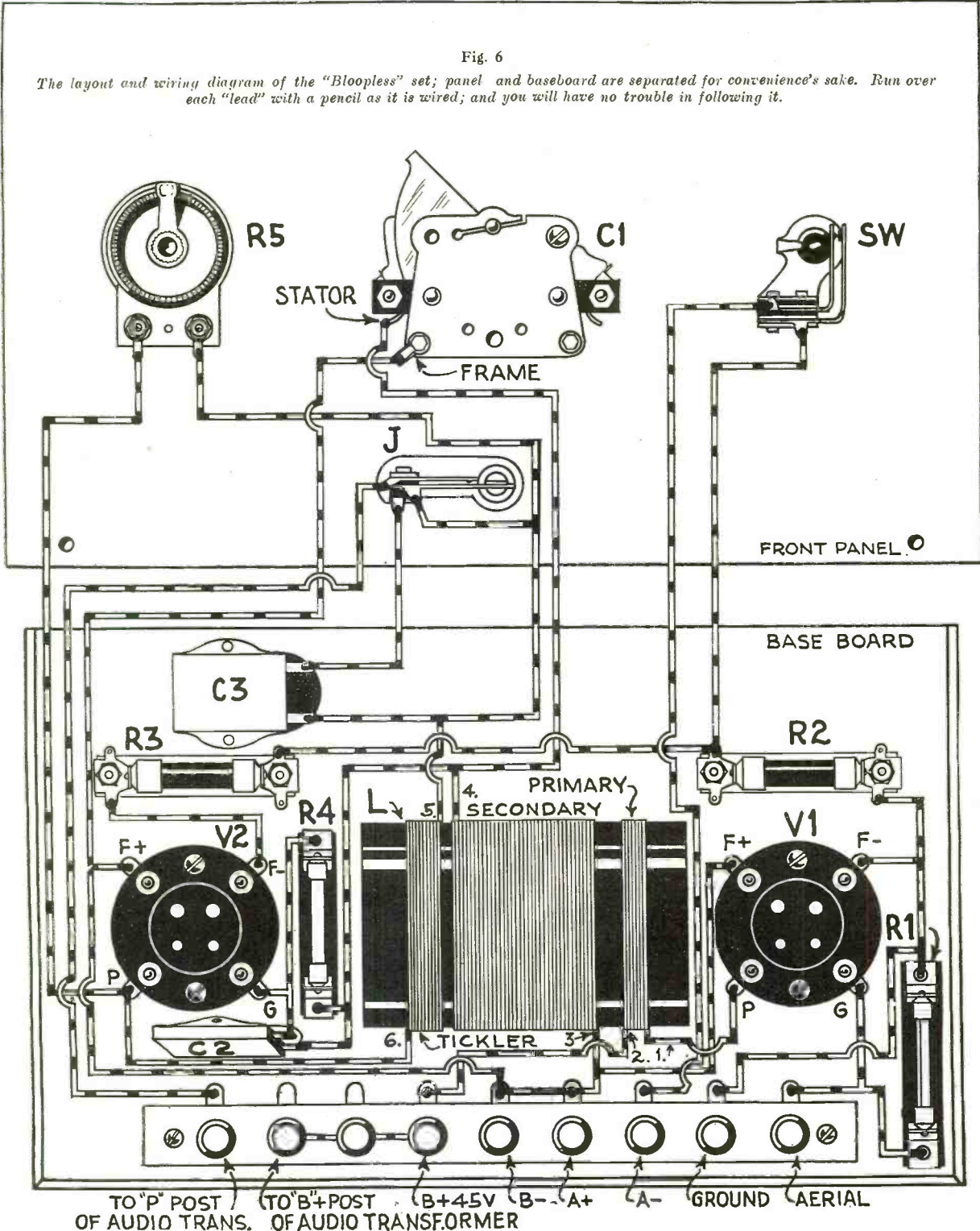

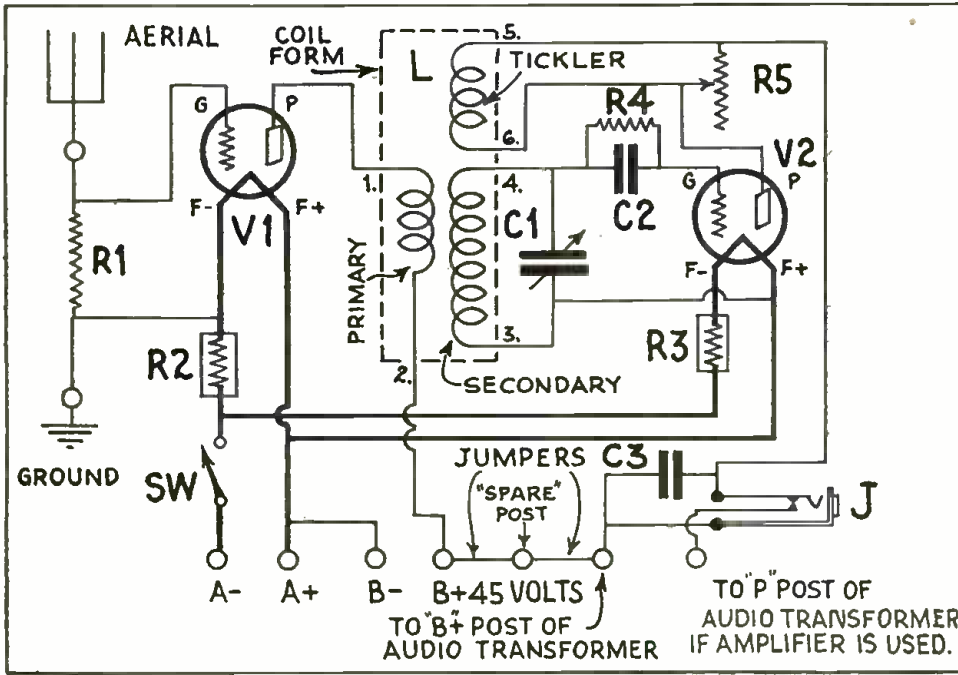

Fig. 5

The schematic diagram of the "Bloopless" set shows the circuit in a form easy to read; many constructors prefer to build from a schematic. The resistor R1 saves making another coil.

not to publish or give out constructional information describing the circuit of a regenerative broadcast receiver where the aerial is coupled to the grid of the detector tube, the set described in this article was designed with a stage of untuned-radio-frequency amplification between the antenna and the detector tube. While the value of this extra tube as an amplifier is problematical, it serves the purpose for which it was included in the hookup; and that is to prevent any "whistles," "bloops" or "howls" from passing into the aerial from the detector. Serving in this capacity it is referred to as actually, a "choker" tube—the name being self-explanatory.

With the exception, perhaps, of the regeneration control, the apparatus for this receiver could be assembled from the spare-parts box of the average experienced experimenter; even if the parts have to be purchased they will cost little more than a good crystal receiver. At that, each part purchased will be an investment in future constructional work, for the simple reason that every part specified for this set can be used in any of the advanced five- or six-tube receivers; with the exception, of course, of the panel and baseboard. The following list of parts is in addition to the "accessories," which will be described toward the end of this article:

FEW PARTS REQUIRED

- One hard-rubber panel, 7 x 12-inch;
- One wooden baseboard, 11½ x 7 x ½-inch
- One variable condenser (C1) .00035-mf;
- One variable high-resistor (R5), 0-2000-ohm type;
- One filament switch (Sw), panel type;
- One closed-circuit jack (J), (three-blade);
- Two filament-ballast resistors (R2, R3) ¼-ampere type;
- One fixed (by-pass) condenser (C3), .0005-mf.;
- One grid condenser (C2), .00025-mf.;
- One grid leak (R4), 2-megohm;
- One antenna resistor (R1), 100,000-ohm;
- Two grid-leak mountings, for antenna resistor and grid leak;
- Nine binding posts, either push-type or spring-type.
- One dial, 4-inch, bakelite;
- One binding-post strip, bakelite, 9 x ¾-inch;
- One 4-inch length of 2-inch bakelite tubing, for coil.

Fig. 7

At the right are the necessary details for making the coil L to be used with a .00035-mf. condenser. Follow directions carefully.

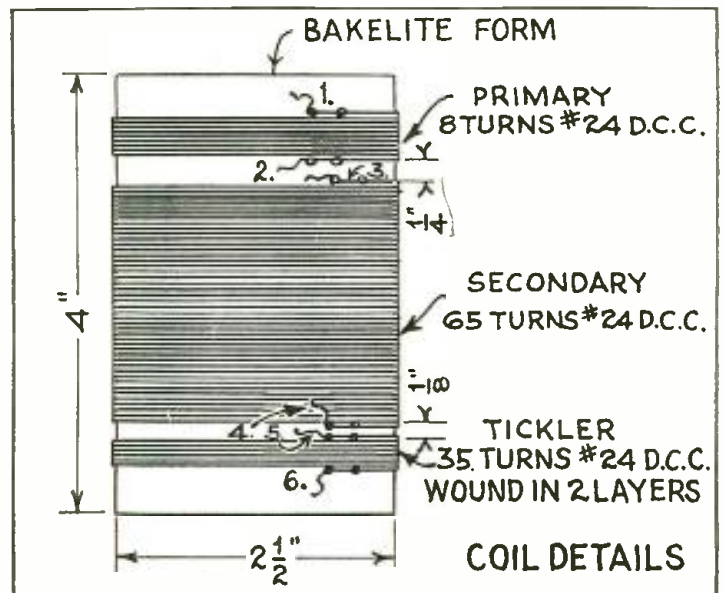

One quarter pound No. 24 D.C.C. wire for coil; hook-up wire, push-back type; screws, etc.

The first step in building this receiver is to wind the coil, which is to have the primary, secondary and tickler windings on the same "form." Two small holes are drilled in the tube about half an inch from one end; these are to secure the terminal of the primary winding, and two such holes should be drilled at each beginning and ending of each winding. After securing about six inches of the end of the wire through the two-hole "grip," wind the primary; as may be seen from the drawing of the coil details, this winding comprises eight turns. After these have been wound evenly and securely, run a sufficient length of wire through the two-hole "grip;" so that connections from the coil to the other components can be made without recourse to needless splicing. This should be done with both ends of each of the three windings: about six inches at each winding terminal will suffice for this purpose. Follow the details shown in Fig. 7 for all three windings. Care should be taken, also, that the windings are wound on the form in the same direction; if any of the windings are reversed, they will "buck" each other and there will be no results.

ASSEMBLY AND MOUNTING

It will be noted that a two-layer winding is specified for the tickler; this construction is merely to save space and has nothing to do with the electrical action of the receiver. Before mounting the coil on the baseboard, it will be found more convenient to place the necessary apparatus on the panel, and then fasten the panel to the baseboard. If the coil were mounted first it would prove somewhat inconvenient to solder leads to the jack, which is slipped under the tuning condenser and behind the coil.

When fixing the coil on the baseboard, mount it upon two half-inch supports; in this particular set two large binding-post tops were used for this purpose. The same type of "elevators" was used when mounting the binding-post strip, directly behind the coil and at the rear edge of the baseboard. However, if the constructor desires even more simplicity than is offered in the layout of this receiver, he may substitute spring-type binding posts for those speci-

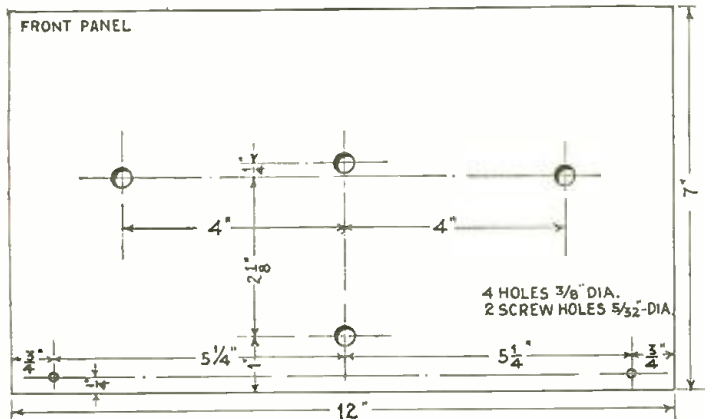

Fig. 8

Only six holes need be drilled, as shown.

fied here, and mount them directly on the baseboard.

As for the other components, the layout diagram (Fig. 6), is sufficiently explanatory to indicate the manner in which they are mounted and wired. In the same diagram will be seen a jumper connecting posts Nos. 2, 3 and 4 (counting from the left); when adding audio amplification for loud-speaker operation, a lead is run from post No. 2 to the "B+" post of the first audio-frequency transformer, and another lead from post No. 1 to the "P" post of the same transformer. Binding post No. 3 is used only if the constructor desires to experiment with different "B" voltages on the plate of the first tube, V1; otherwise, ignored.

"ACCESSORIES"

The operation of the set requires: one storage or "A" battery, one 45-volt dry-cell or "B" battery, two 201A-type tubes, a headset, and a suitable aerial and ground. After these accessories have been added to the receiver and the filament switch is turned on, a turn of the tuning dial should bring in some signal. If nothing is heard, turn the knob of the high-resistor R5 until a rushing sound is heard in the phones; this indicates that the detector is regener-

ating. When this stage is reached, turn the tuning dial slowly until a whistle is heard, which is the sign of a broadcast station being heard when the receiver is oscillating. Tune the whistle until it is loudest in the phones, and then turn the knob of the regenerator until the whistle disappears; then the music or voice will be heard.

No mention has been made of dry-cell (199-type) tubes for the reason that the constructor, even though he is a beginner in radio, will eventually need a storage battery as well as the storage-battery tubes (201A-type) which are specified for this set. If such are his expectations, the purchase of 199-type tubes and the necessary dry-cells will be somewhat in the form of a needless waste—not to mention the fact that better results are obtained with the larger tubes. However, if circumstances, such as lack of electric power, etc., necessitate the use of 199-type tubes, all that need be done to adapt the receiver to them is to substitute the proper filament-ballast resistors for those specified and, of course, employ three dry cells to light the filament of the tubes in place of the storage battery. The use of dry cells to light the filaments of 201A-type tubes is not recommended, for obvious reasons of economy.

THE ANTENNA

Much has been written about aerials and grounds; yet, judging from many of the installations that are still being made, a hasty observer would think that no authority had ever said a word about this very important part of a radio installation. It is here emphasized again, or yet, that the best results cannot be obtained from a receiver unless particular care is exercised when erecting the aerial and making the ground connection.

(Continued on page 670)

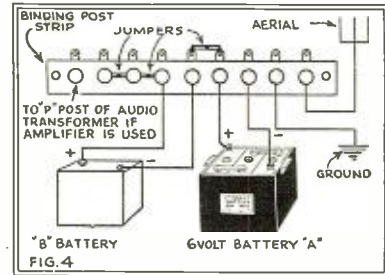

The way to hook up the "Bloopless" to the batteries, aerial and ground is very simple.

## Some Hints on the "Junk-Box" Short-Wave Receiver

By Robert Hertzberg

MOST of our readers who made "Junk-Box" short-wave receivers according to the description contained in our July, 1928, number are now enjoying satisfactory—in some cases, really remarkable—results from this now famous little outfit. However, as might be expected when several thousand people using different parts endeavor to follow one design, many are reporting trouble. For their benefit we offer here a few hints which may be of value in correcting the difficulties.

Fully 90% of all the troubles reported originate in the plug-in coils. The "Junk-Box" constructional article advised a separation of one quarter of an inch between the grid and tickler windings on the tube bases; but, judging from our heavy correspondence, as well as examination of several sets sent in to us for test, the complaining constructors are disregarding the

instruction by increasing this space, till the coupling is ineffective. The windings on one set of coils examined in our laboratory were separated fully five eighths of an inch.

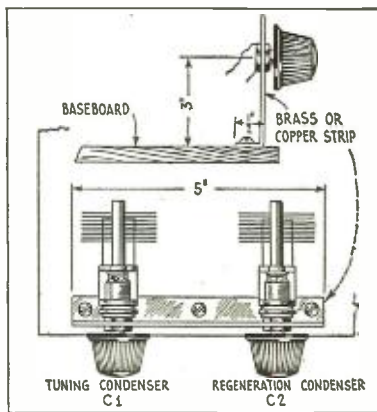

Close coupling between the grid and tickler windings is necessary to allow the detector tube to regenerate. If the feedback condenser used (C2) were larger, the coupling would not be so critical; but since the condenser has a capacity of only 32 mmf., we are not allowed much leeway in the coupling. Some experimenters replaced this small condenser by a larger one, say 64 mmf., and are thus able to obtain smooth regeneration with less trouble. However, we wish to emphasize the point that, with the coils made as specified and with 32-mmf. condensers, the set should and does work perfectly.

REGENERATION CONTROL

A short-wave receiver is worthless if its regenerative action cannot be controlled smoothly. If the set falls into oscillation

with a strong "pop," the operator will be able to distinguish only the squeal of the carrier wave of a broadcast station; this squeal is the result of the carrier heterodyning or "beating" with the oscillations generated in the set. By adjusting the receiver so that it is oscillating at exactly the same frequency or wavelength as the carrier of the transmitting station, it will become possible to hear the voice of the announcer, although the reproduction will sound slightly "mushy." This method of tuning is known as "zero beating," and is very effective for the reception of weak broadcast stations.

If the set is actually "zero beating," you will hear it squeal when you turn the tuning condenser, C1, either up or down; in the critical center position of the condenser the squeal is absent.

As remarked in the original article, the ticklers specified for use on the tube-base plug-in coils are really larger than necessary. Very few of the inquiring constructors seem to have followed the important advice given in the first article, so it will be repeated here.

With any one of the coils in the socket, turn the tuning condenser C1 all the way in, and start turning in the regeneration condenser. The set will fall into oscillation at some setting of the latter condenser, probably when it is about half-way in. This means the tickler is too large. With the tuning condenser at maximum, the set should begin to oscillate when the regeneration condenser is turned to its maximum; when this condition is reached, the receiver will fall into regeneration with a smooth "hushing" sound at all the lower settings of the tuning condenser.

REGENERATION VS. OSCILLATION

One of the things that many people do not seem to understand is the difference (Continued on page 671)

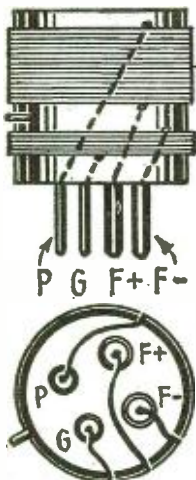

At the right, a simple way to shield the "Junk-Box" condensers against hand capacity, which so many constructors find a problem.

The original diagram of the coils of the "Junk-Box." This was published in the first article, though not reproduced as a blueprint. Both original article and blueprints give the numbers of turns in each coil. Observe the comparatively narrow spacing between windings.



# The "Lamp-Socket Five"—A Simple A. C. Set\*

Incorporating the Latest Refinements, A Happy Medium Between Big and Small Sets, Easy to Build, Handy to Operate, and Attractive in Appearance.

By Beryl B. Bryant

THE number of inquiries for full constructional data of a five-tube set employing A.C. tubes has led the staff of RADIO NEWS to design the receiver described in this article. There is nothing new about the circuit, nor does it contain any mechanical innovations; it is nothing more than a conventional, tuned-radio-frequency receiver employing A.C. tubes. It comprises two stages of tuned radio frequency using 226-type tubes, a detector using a 227-type, and two stages of transformer-coupled audio amplification—the first comprising a 226-type and the second stage a 171A-type power-amplifier tube.

This receiver has been engineered especially for use with the "B" power unit described in the December issue of RADIO NEWS (page 544). Though this assembly was described in the Beginner's department, it is nevertheless a very efficient power unit of the latest design and, probably, the most flexible in the matter of voltage output, yet available for home construction. The real reason for its publication in the Beginner's department was that it requires exactly eleven wires to complete the entire assembly which comprises seven components. A complete set of constructional blueprints is available for free distribution to our readers if they will use the Blueprint Coupon in this issue (page 701) to ask for set No. 70.

In the design of this receiver, as many conventional features have been incorporated as would be useful to the average constructor. For example, though much has been said in recent months about the superior importance of tone quality over distance-getting ability in a receiver, the thrill of DX-hunting is still very much with us and, according to all evidence, will be so for some time to come. With this fact in mind, a regeneration control (PH in the diagrams and pictures) has been included in the second radio-frequency circuit. By this control the second R.F. stage can be brought to the actual state of oscillation, which is quite effective for successful distance reception.

### PHONOGRAPH CONNECTION

Another handy addition is the pick-up jack, J3, which automatically places a phonograph pick-up across the primary of the first audio transformer when the plug, to which the pick-up is attached, is inserted in this jack. In this way the amplifier system of the set becomes a tone-quality power amplifier for the phonograph and allows the reproduction of records through the loud speaker of the receiver. All the apparatus required for this is a simple phonograph turntable with a motor (either electric or spring-wound), and a pick-up of one of the types specified for use with radio amplifiers, of which there are many makes now being marketed. A convenient arrangement is to incorporate the receiver and

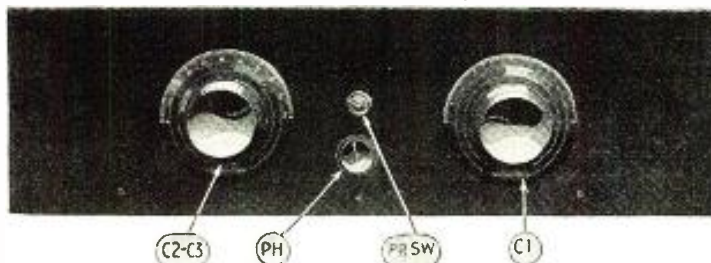

phonograph turntable in a cabinet of the console type, for greater ease of operation.

Of course, if the constructor has already a phonograph of the cabinet type, all he need do is remove or swing to one side the arm holding the sound-box so that it cannot interfere with the movement of the pick-up device as it travels across the face of the record. An extension cord leading from the pick-up to the radio set completes this arrangement.

### CIRCUIT IS SIMPLE

Studying the circuit diagram from antenna to speaker, we find first the antenna stage of tuned radio frequency with its coil L1, its single tuning condenser C1 and the variable resistor R1, which serves as an oscillation suppressor; the last remains in a fixed position after it has been adjusted to the desired point. Then follows the second radio-frequency stage which contains the oscillation control PH; this stage is tuned by one section C2 of the two-gang condenser, the other section of which, C3, tunes the detector circuit. Two convenient vernier dials operate the condensers.

In the detector stage the cathode-heater type tube (227-type) is used; this tube differs from the 226-type in that the alternating current is not applied directly to the filament of the tube, as in the latter, but the heating element is electrically separate from the cathode, which is the electron-emitting element (instead of a filament). A return lead must be brought to the cathode to complete the grid circuit; for this reason a fifth prong is added to the tube base, thus originating the common description, "a five-prong tube," for the UY-type. In the detector circuit we find, also, the conventional grid condenser and grid leak (C7-R2); and in the plate circuit of the detector tube, the radio-frequency choke coil RFC bypassed by the fixed condenser C6. In this circuit is found also the closed-circuit jack J3 which disconnects the radio-frequency section of the receiver from the amplifier

**No. 72**

**THE "Lamp-Socket Five" represents our response to a wide demand from our readers for a set of the all-around type, with a moderate number of tubes, yet giving an amount of amplification that will ensure good distance in any fair radio location, and providing excellence of reproduction with volume enough for any home on a good loud speaker. The wiring is simple, and the list of parts, though long, includes few of any high cost; unless the constructor wishes to invest in the highest tone quality which the best transformers make available. It should be operated with a "B" power unit, such as that described in last month's RADIO NEWS, or any other of good quality.**

*Any reader who wishes to construct this receiver can obtain—postpaid and without charge—a set of Free Blueprints (including full-sized drilling layouts and the list of parts originally used, with their list prices) by filling out the coupon on page 701 of this issue, checking "No. 72—The Lamp-Socket Five," and mailing it to the office of RADIO NEWS.*

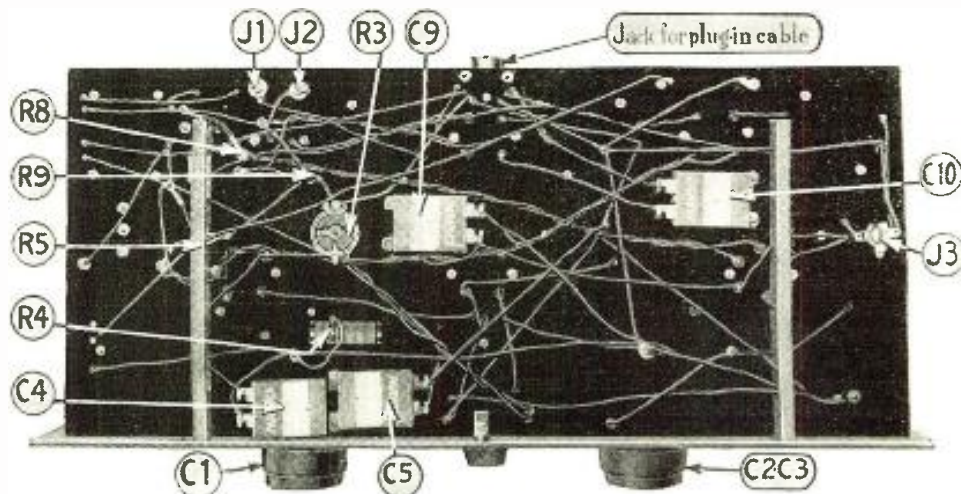

The "Lamp-Socket Five," the neat, simple panel appearance of which is shown at the top of the page, has practically the whole of its wiring run under the bakelite sub-panel, as shown here.

\* RADIO NEWS Free Blueprint Article No. 72.

when the phonograph pick-up plug is inserted into the jack.

Following the detector circuit are the two stages of audio-frequency amplification, comprising one 226-type tube in the first stage and a 171A-type tube in the second, with their respective transformers, T1 and T2. To prevent any damage to the speaker windings, a filter system composed of the choke coil L4 and the by-pass condenser C8 is inserted in the plate, or high-voltage circuit of the last amplifier tube; these two components are connected to the phone-tip jacks (J1-J2) into which the tips of the loud-speaker cord are inserted.

**POWER SUPPLY**

The various windings within the dotted lines indicating the filament transformer supply the filament voltages for the tubes in the receiver proper. As there are three distinct types of tubes there are three secondary windings on the transformer; the first supplies the 226-type tubes with 1½ volts, the rated filament potential required for the operation of this tube. In series with one side of this winding are three filament-ballast resistors, R6, designed to stabilize the voltage being fed to the tube. Across this winding is the V-type resistor R5, which is mounted beneath the sub-panel; its center tap is connected to the variable potentiometer R3, which serves as a biasing resistor for the 226-tube grids, and is by-passed by the condenser C9.

The next winding supplies 2½ volts to the heater of the 227-type detector tube. As with the first winding, the filament-ballast resistor R7 is employed here to keep a constant voltage across the heater; the center-tapped resistor R8 connects to "B+22½" to prevent hum from the heater of V3. The third winding is for the 171A-type power-amplifier tube in the last socket, which requires five volts for filament lighting; this winding, like the others, is equipped with a constant-voltage filament-ballast resistor R10 and a center-tapped resistor R9, which in turn is connected to another resistor R4 by-passed by the condenser C10. The last-mentioned resistor provides the grid-biasing potential for the power tube.

**CONSTRUCTION VERY EASY**

At first glance, the reader may believe that the construction of this receiver is complicated; it is not. After all the apparatus has been mounted on the front panel and sub-panel, it is a simple matter to run the leads as shown in the layout and pictures. Obviously, with this type of wiring, it is extremely important that well-insulated hook-up wire be used; in building the laboratory model of this receiver a solid wire protected by a covering of the "push-back" type was used, and proved very efficient as well as easy to handle in work.

The specifications of parts listed below offer the constructor a wide choice of manufacturers; however, he is advised to purchase the best material within his means. Alternating-current operation is a "ticklish" proposition and requires tried and tested apparatus to insure the desired results. For example, in choosing the audio-frequency transformers, the builder should bear in mind that these two components will do more to establish the quality of the receiver's reproduction than any other apparatus in the set; therefore should be the very best he can afford to purchase. When selecting the filament transformer, resistors, condensers and other components on which

some electrical load is impressed, quality should be taken into consideration with these items, just as with the audio-frequency transformers. It is rather poor economy to save a few pennies on a component which has a replacement value of dollars.

As it would be a waste of space to go

into a post-to-post wiring description of the receiver, because all details are plainly shown in the pictorial wiring diagrams below, the constructional features which may offer some concern to the builder will be described instead. The layouts (they are supplied as full-size working templates with

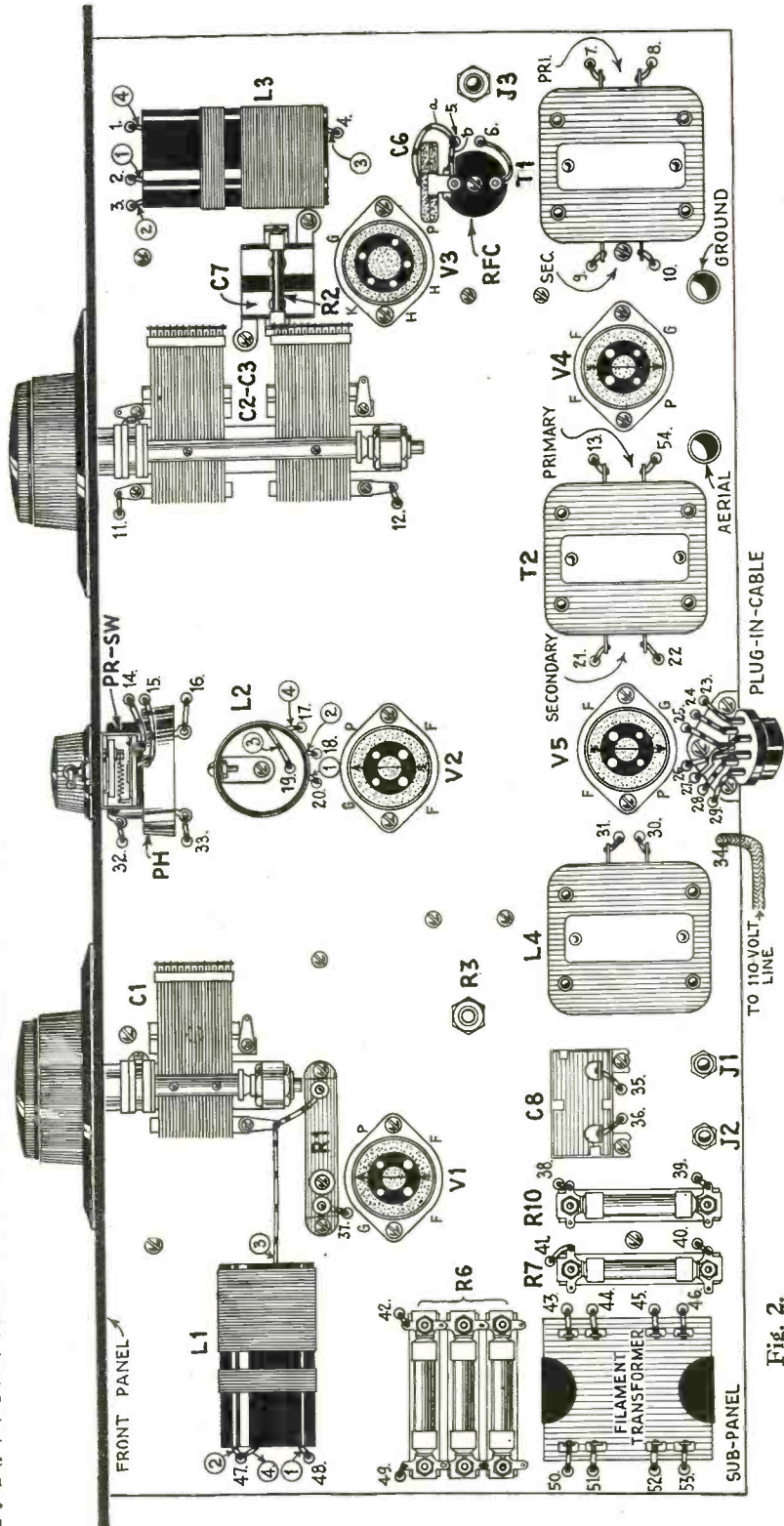

Fig. 2. Instrument layout and wiring connections above the sub-base panel of the "Lamp-Socket Fire." See underside arrangement below.

the Free Blueprint sheets) for the front panel and sub-panel are self-explanatory; however, the sub-panel brackets used to support the sub-panel are not recommended as home-constructed components. It is far simpler and cheaper to purchase them ready-made, as at present there are any

number of types and styles on the market.

Some readers may prefer to equip the receiver with binding posts instead of the recommended plug-in cable used on the set; if preferred, this may be done without any difficulty. Merely ignore the cable in the

diagram and run the leads to standard binding posts which may be mounted on the rear edge of the sub-panel; though, as evidenced by the pictures, their mounting may cause a good deal of crowding. Therefore, we suggest that the constructor include the plug-in cable in his assembly; it is well worth the difference for the convenience, neatness and fool-proof safety it offers.

LIST OF PARTS NEEDED

- One bakelite front panel, 7 x 24-inch;
- One bakelite sub-panel, 10 x 24-inch;
- Two bakelite sub-panel brackets, 8½ x 1 x ¾-inch;
- Nine inches of bakelite tubing, 1½-inch diameter;
- Two dials, vernier type;
- One variable condenser, .0005-mf., C1;
- One double variable condenser, .0005-mf. each section, C2-C3;
- Two audio-frequency transformers, T1-T2;
- One 30-henry audio-frequency choke coil for output, L4;
- One filament transformer, with three windings to give 1½, 2½ and 5 volts;
- Four sockets, UX-type;
- One socket, UY-(5-prong-) type;
- One oscillation control (phasatrol), PH;
- One variable resistor, 0-1,000-ohm, wire-wound, R1;
- One grid condenser with grid-leak clips, .00025-mf., C7;
- One grid leak, 3-megohm, R2;
- One radio-frequency choke coil, 80-milli-henry, RFC;
- One fixed condenser, .001-mf., C6;
- Four by-pass condensers, paper-type, 0.5-mf., C4-C5-C9-C10;
- One by-pass condenser, paper-type, 1.0-mf., C8;
- One resistor, 0-2,000-ohm, 5-watt, R3;
- One resistor, semi-variable, 0-3,000-ohm, 5-watt, R4;
- One resistor, center-tapped, "V"-type, 10-ohm, R5;
- One resistor, center-tapped, "V"-type, 20-ohm, R8;
- One resistor, center-tapped, "V"-type, 100-ohm, R9;
- Three filament-ballast resistors, 226-type, R6;
- One filament-ballast resistor, 227-type, R7;
- One filament-ballast resistor, ¼-ampere, R10;
- One plug-in cable, seven-pin type;
- One power switch, 110-volt type, PrSw;
- One closed-circuit jack, three-prong, J3;
- Two phone-tip jacks, for loud speaker, J1-J2;
- Two binding posts, for aerial and ground leads;
- One quarter-pound No. 30 D.C.C. wire for coils;
- Two 25-foot rolls hook-up wire, push-back type;
- Three vacuum tubes, UX-226- (A.C.) type, 1½-volt filaments, V1-V2-V4;
- One vacuum tube, UY-227- (A.C.) type, 2½-volt filament, V3;
- One vacuum tube, UX-171A-type, V5;
- Six feet silk-covered lamp cord, for 110-volt input to filament transformer.

MAKING THE COILS

It is best, perhaps, when assembling the receiver to get the coils wound and out of the way so that they can be mounted in position at the proper time, and wired into the circuit upon the completion of the assembly. The first step is to cut the nine-inch bakelite tube into shorter lengths, three inches each; of course, if these tubes have

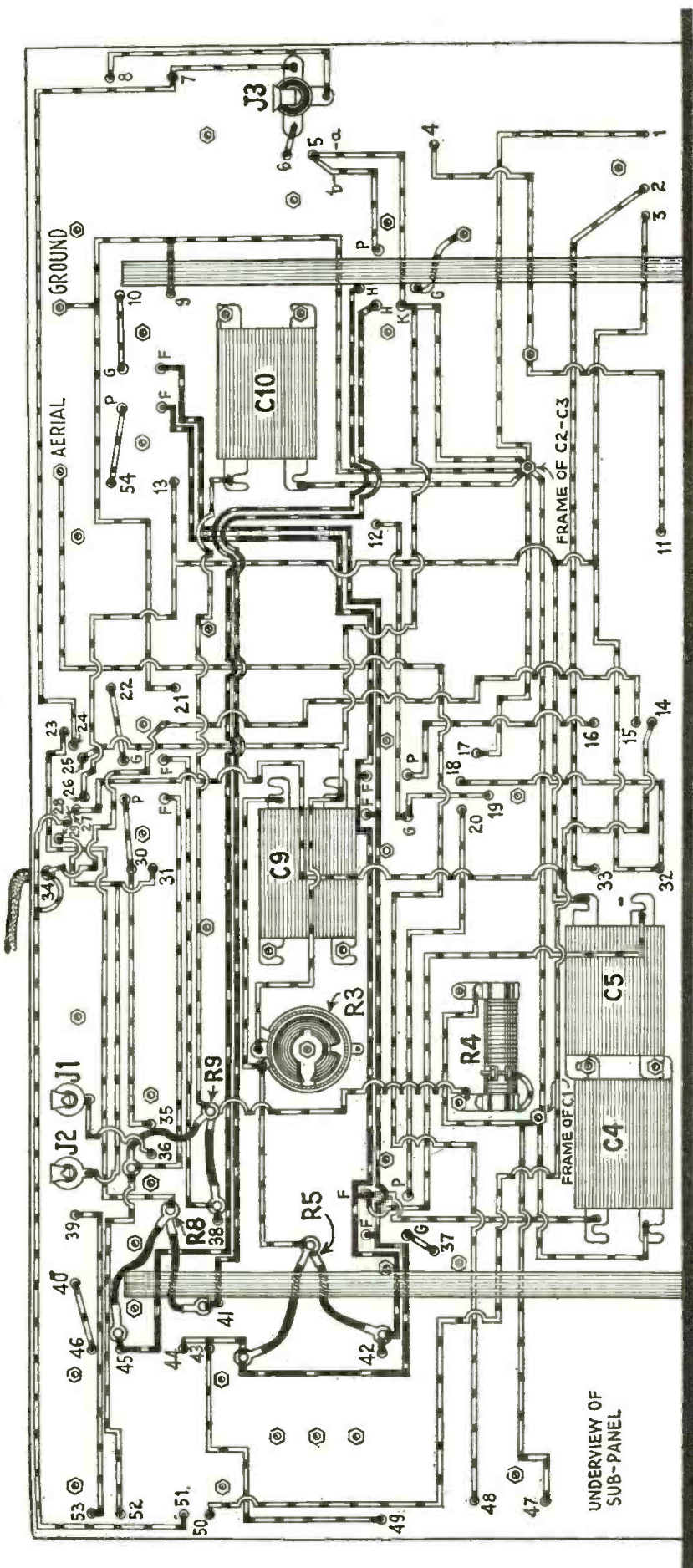

Fig. 3.

The lower side of the sub-base panel of the "Lamp-Socket Five"; the holes are numbered exactly as in Fig. 2, above. Heavily-shaded leads in pairs are the A.C. filament wires, which should be twisted. R4 is to be left set at the resistance which gives best loud-speaker results.

been obtained cut to size, so much the better. When winding the coils, first drill two small holes about half an inch from one end of the tube; this is to secure the terminal of the wire while the coil is being wound and also after the coil has been completed and wired into the circuit. These holes for fastening should be drilled about an eighth of an inch apart, so that the end of the wire can be inserted into the form at one hole and out at the other; when doing this, be sure to leave about six inches free to make connections easily.

Wind 75 turns for the secondary, taking care that none of the turns overlap; after this number of turns has been wound, drill two holes as at the beginning of the winding, and secure the winding in the same manner. Leave the same amount of free end for the connection. The primary is wound with 20 turns of the same gauge of wire as the secondary (No. 30 D.C.C.); and the same method of securing the terminals is employed with this as when winding the secondary. Prepare L1, L2 and L3 in the same manner.

After the other components have been so mounted that the assembly is ready for the mounting of the coils, the forms may be secured to the sub-panel by means of two straight Z-brackets, one at each end of the coil form, or with two 1-inch brass pillars. The angles of mounting the coils, shown in the illustrations accompanying this article, are different to prevent inter-coupling of their magnetic fields. Placing two coils with their axes in line, or parallel, will bring about such coupling between the two coils; this condition is undesirable because it results in inability to control the oscillation of a receiver. For this reason, it will be noticed, the coils placed at the ends of the sub-panel are mounted horizontally at right angles, and the center coil L2 vertically.

Fig. 5

At the right, the way in which the "Lamp-Socket Five" is connected to the Adjustable "B" power unit described in our December issue, and which is well suited to the purpose. The "C" terminals are not used because suitable resistors, with the needed balancing arrangement, are provided in the set.

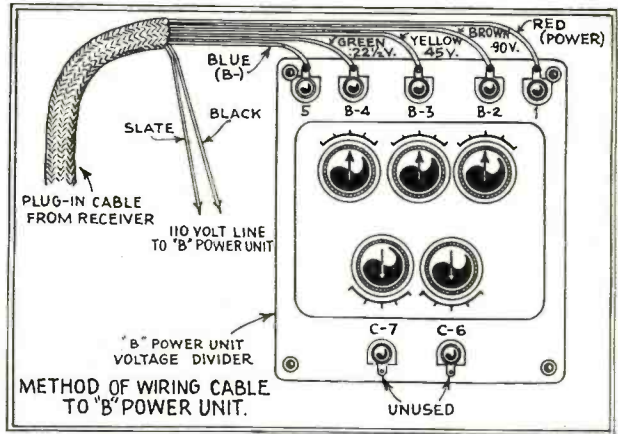
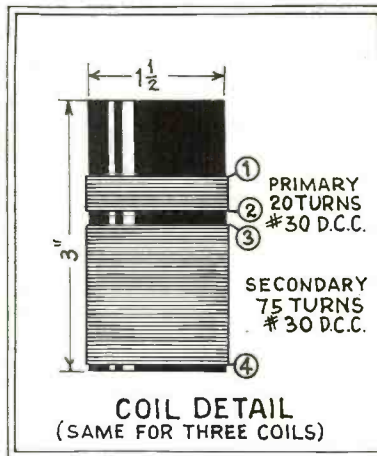

Fig. 4

Below, details of R.F. coils to tune with .0005-mf. condensers. The windings are spaced about a quarter-inch apart. Ample room for mounting is left at one end.



ASSEMBLY AND WIRING

It is suggested that the radio-frequency, detector and audio-frequency circuits be wired first and then the filament circuits; this will add no difficulty to the wiring and will help to produce a neater and more efficient job. After the radio- and audio-frequency circuits have been wired and checked, the A.C. lines can be added. When doing this note in the circuit diagram that the filament leads are twisted; this construction creates a capacity which obviates the necessity of placing condensers across the leads to by-pass out the 60 cycle-hum. The leads requiring this twisting are so indicated on the circuit diagram; do not overlook this part of the job. Often a receiver with all circuits testing correctly will have a hum which will defy trouble-shooting; merely because of the simplicity of the cause—straight, parallel A.C. leads.

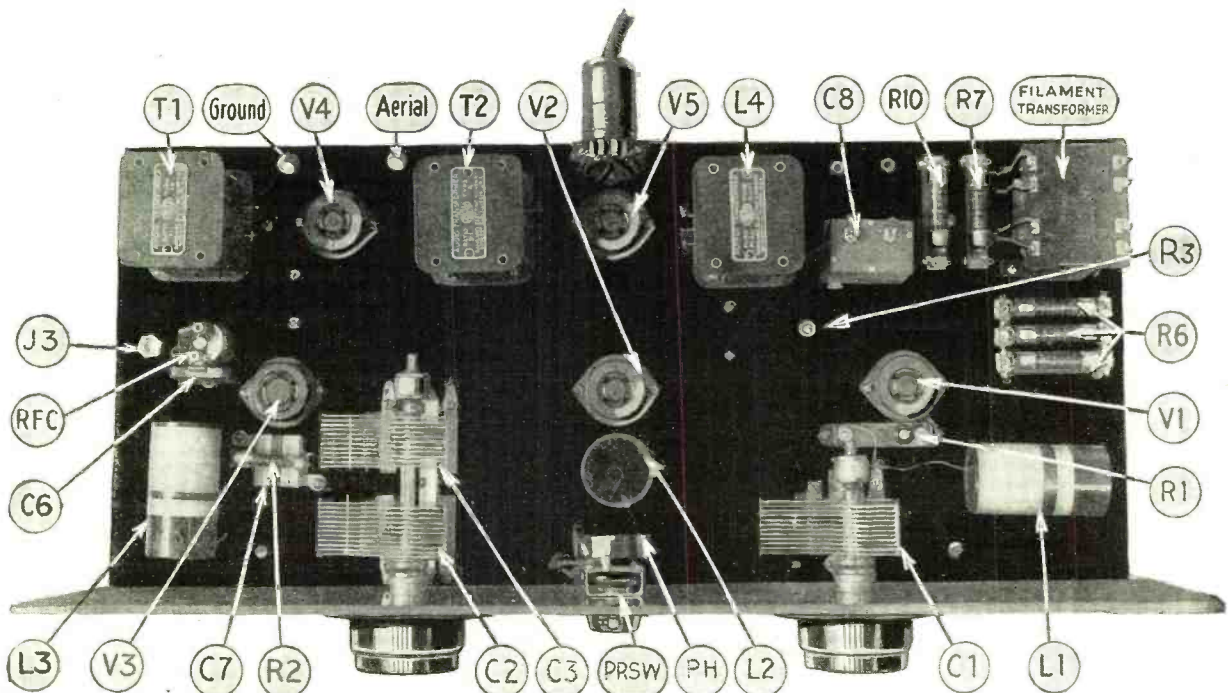

With practically every length of wire, except two, run beneath the panel, the "Lamp-socket Five" has an especially attractive appearance when the cabinet cover is lifted. Lined up at right angles, as shown, the small coils do not require shielding under ordinary

reception conditions. Both within and without, this set is a most attractive one; and, if it is built with component parts of good quality, the results which the builder may expect are very good. The design shown is a safe one to follow.

**SEND THE COUPON IF YOU WISH FREE BLUEPRINTS!**

SO many thousands of Free Blueprints are mailed each month by RADIO NEWS that the total cost is too high to waste any. Originally, each request was accompanied by ten cents, which did not cover the cost. Since then, this service has been made gratis; and it has been necessary to reprint edition after edition of the more popular blueprints.

The sole purpose of this unusual offer was to encourage home radio building—which it has evidently done. But, as each article carries the circuit diagrams, etc.—everything in fact but the drilling layouts, manufacturers' names, and other purely constructional details—there is no good reason why anyone should send for a Free Blueprint unless he intends to build, and not to use it for wallpaper. To build, he must have the magazine containing the complete article.

For that reason, in requiring that applicants for Free Blueprints in the future use the coupons contained in the same issue of RADIO NEWS in which the descriptive article is published, we do not put a hardship on any bona-fide constructor; but will assure the distribution of the blueprints only among those who will put them to practical use, warranting the cost of their printing and distribution. The Free Blueprint coupon covering apparatus discussed in this issue is on page 701. Readers seeking other diagrams and information are referred to the notice at the head of the "I Want to Know" department, on page 661.

*No Further Blueprints Can Be Sent Free Without Coupon*

**TESTING AND OPERATION**

After all wiring has been completed and the subsequent thorough checking has proved that every circuit is as it should be, the various colored leads of the plug-in cable are connected to their respective posts on the voltage-divider of the "B" power unit. A short study of the diagram illustrating these connections (Fig. 5) will simplify matters. After all external connections have been made the switch is turned on; but the set is not yet ready for operation. That is, it will bring in signals, but not with the fullest efficiency or anywhere near it; for the simple reason that the "B" power voltages must be checked with a 0-200 high-resistance voltmeter in order that the constructor may know exactly what potentials are being applied to the receiver. It must be remembered that the power unit here recommended for this receiver (see RADIO NEWS for December, 1928, page 544) employs a set of variable taps on its resistors which control very nicely the voltage output of the unit; most surprising readings can be obtained from the voltage-divider posts after one adjusts

it by ear (that is, by the quality of the speaker's reproduction) if he then takes voltmeter readings of his final adjustments. The experiment will be a revelation as to the absolute necessity of meters.

This receiver requires approximately 30 seconds to "warm up"; or, in other words, the heater of the 227-type detector tube requires that length of time to heat up to the temperature where the cathode will begin to function. However, this time-lag characteristic applies only to the detector and not to the other tubes in the set, which begin functioning almost instantly with the turn of the switch.

The ground and ground connection for this set must be as nearly perfect as the constructor can manage with whatever is at his disposal. Since the early days of radio, a good ground has meant good reception, and a poor ground little reception or none at all. Even more care must be employed when using A.C. units and, especially, A.C. tubes. Where buried plates or wires cannot be used, experiment with the various grounds at hand; for example, run a wire to the cold-water pipe, the steam radiator pipe, try each one and then combinations. Probably the best way to do this is to tune in a weak station and then try the various grounds and combinations till you find one giving the best signal strength; this will indicate the ground with the least resistance and, obviously, the one to be used.

Do not overlook the importance of the aerial; because of the sensitivity of this receiver it is highly important that the aerial and lead-in be well insulated from any other objects. For the aerial wire solid No. 14 enamelled is recommended because acid-smoke and soot, which generally attack and corrode bare copper wire and thus lower its efficiency, cannot affect enamelled wire. Also, because of the sensitivity of the set, the length of the aerial need not be near as great as that required by the general run of battery receivers. It must be remembered that, the longer the aerial, the greater the pick-up of electrical noises as well as signals. Seventy-five feet should be sufficient for all purposes.

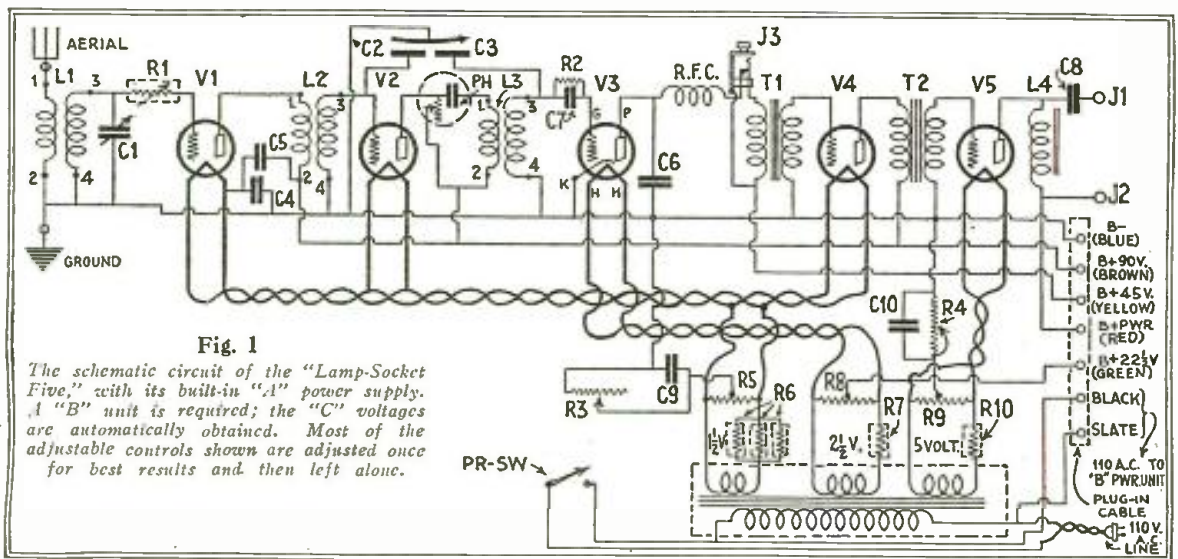

**Fig. 1**  
The schematic circuit of the "Lamp-Socket Five," with its built-in "A" power supply. A "B" unit is required; the "C" voltages are automatically obtained. Most of the adjustable controls shown are adjusted once for best results and then left alone.

**End of Monthly Constructional Prize Contest**

RADIO NEWS regrets that it must announce the discontinuance of the Hundred-Dollar Constructional Prize Contest inaugurated with its April, 1928 number. Although a large number of entries have been received, so few of them conform even to the mechanical requirements of the competition that it has been impossible for the editors to award the prizes to more than four contestants during a period of seven months. The awards went to W. Francis Goodreau, of Providence, R. I., for his "R.F. Short-Wave Broadcast Receiver"; to David Grimes, of New York City, for his "R.F. Booster Unit"; to Herbert J. Reich, of Ithaca, N. Y., for his "Neutroheterodyne"; and to

W. H. Scheppele, of Waterloo, Iowa, for his "Combine" receiver.

The rules of the contest stated very plainly that no one would be eligible for a prize unless some experimental work had been done and the practicability of the device had been demonstrated by the builder. Most of the entries consisted merely of ideas or suggestions, accompanied by the request that RADIO NEWS do the experimental work necessary for their full development. Many correspondents who claimed they had new circuits did not trouble to send in even the diagrams, without which the editors could not possibly determine the patentability, or even the practicability, of the ideas. One man even neglected to include his ad-

dress in his first letter, and became very indignant because it was not answered.

The receipt of all communications relative to the contest was acknowledged very promptly, by special cards. If any readers submitted entries and received no word of their fate, they failed to indicate adequate return addresses, or their own stamped and addressed envelopes were incorrectly made out. The editors are helpless in cases of this kind, for they cannot be expected to know the addresses of such correspondents.

A number of the entries in the contest could not be considered as prize winners, but are nevertheless deserving of some space in the magazine. These will be published and paid for at a special rate.

# Radio Wrinkles

## A Self-Supporting Winding

THE art of winding radio coils has indeed undergone a change since the days when coil winding was a matter of starting work at the end of the table where one end of the coil form was located and, after many days of painstaking turn-by-turn labor, finally arriving at the other end of

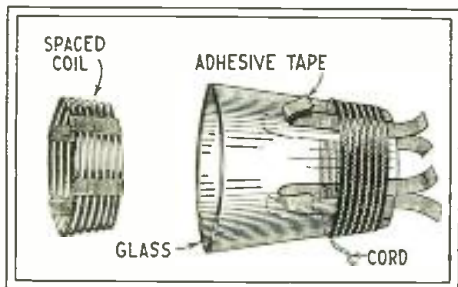

Fig. 1

A space-wound R.F. inductor made on a tumbler like this is easily slipped off the form.

the table, where the other terminal of the form was located. This coil form averaged some three feet in length, absorbed for its winding sufficient wire to reach from here to yonder and, after receiving a half-inch coating of shellac, was mounted in an upright position on the operating table so that one's hat could be tossed conveniently over the form upon entering the room.

As will be seen from the illustration of an ingenious wrinkle (Fig. 1) herewith coil construction has taken (paradoxically) a turn for the better in these soft, luxurious years. In this method four strips of adhesive tape are placed upon a common tumbler as shown, and the winding placed over them. The alternate layer of twine is used to space the windings, to reduce the distributed capacity, and thereby increase the efficiency of the coil. After the required number of turns have been wound, the ends are cut (leaving sufficient length for hook-up), the adhesive-tape tabs are folded back and secured, and the self-supporting coil is then readily removed from the tumbler for use.

## A Double-Ended Plug-In Coil

WHAT might be termed a double-action plug-in coil is herewith submitted for the "wrinkle" fan with an eye for labor-saving devices. Before proceeding with the constructional data, it may be well to advise the builder that ample space should be left between the two sets of windings, and that care should be taken to see that, while the two windings of each set should be wound in the same direction, the two sets should be wound oppositely.

A bakelite, or heavy cardboard, tube 6 or 7 inches in length with an inside diameter of 1-3/8 inches, so that it fits over the average UX base, is obtained for the coil forms. On one end wind a tickler, providing for the terminals by drilling or punching a hole at each end of the winding; so that the terminals may be brought down through the inside of the form, into the tube base and so through the prongs. These terminal leads, or loose ends of windings,

should be at least 4 or 5 inches in length so that they can be worked with some wire to spare. The grid coil is wound, a quarter of an inch above the tickler winding, with the same procedure as to leads outlined above. Leave an inch and a half or two inches between the sets of windings, ar-

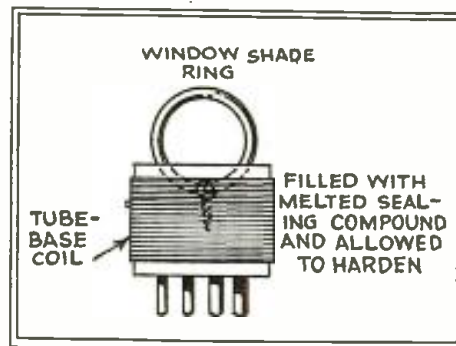

Fig. 2

This is a very convenient way to put a practical handle on a tube-base plug-in coil.

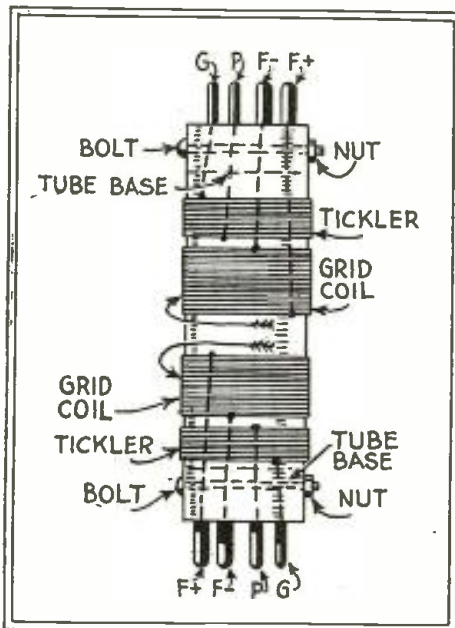
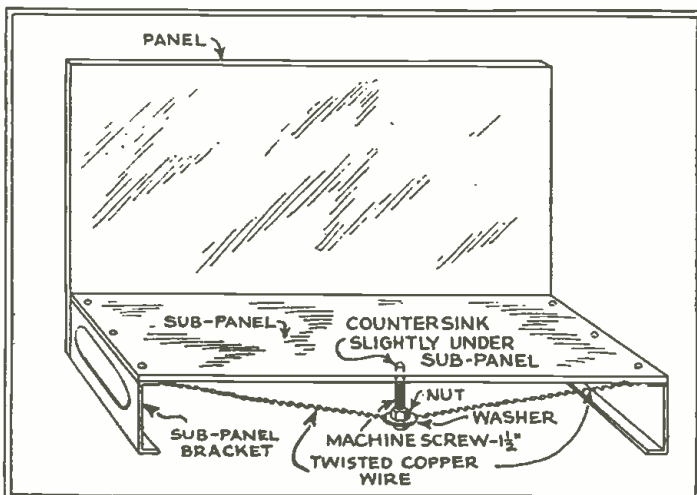

Fig. 3

The use of tube-base coils for Junk-Box and other sets is commending itself to constructors. You can now buy forms without waiting for a tube to blow. This stunt results in just half as many coils to paw over when changing waves.

Fig. 4

A long panel is apt to develop what engineers call a buckle. The author of this wrinkle applies a course in structural design to the problem of preventing any such occurrence.



ranging for the terminals of the second in the same manner as in winding the first coil. (See Fig. 3.)

After both sets of windings have been completed, you should have four long terminals projecting from each end of the tube. It is then a simple matter to pass these ends through the tube prongs; after the bases have been fitted to the form, the leads are cut to the required length and soldered. It is advisable to pass a bolt through the form and the base as suggested in the drawing. The top of each grid coil is connected to the grid condenser, and the bottom to the filament return.—Contributed by Archie Mares, Cheney, Washington.

## Putting a Handle On It

A THOUGHT for the short-wave listener who builds his coils on tube-bases has been submitted by a constructor of the "Junk Box" short-wave receiver, who probably ran into the difficulty of having his coil windings slip off their forms every time they were roughly handled. Obviously the way out of this difficulty is to fasten some gripping device to the coil forms, so that they can be pulled out of their socket without touching the winding. However, the "rub" in that idea is that the average tube-base has very thin walls and requires delicate handling when drilling large holes, such as are needed for a suitable grip and still avoid tampering with the base, our contributor suggests the following:

Take some of the sealing compound from the top of an old discarded "B" battery, melt it and pour the mixture while hot into the tube base; while it is still in a liquid or semi-liquid state insert a window-curtain ring in the position shown in Fig.

2, opposite. Allow the sealing compound to harden; the portion of the ring sticking out of the compound after it has cooled makes a very convenient handle by which the coil can be safely inserted or withdrawn from the socket.—Contributed by D. M. Brown.

**A Simple Vernier-Compensator**

A SIMPLE, but effective, vernier control can be constructed in little time with parts usually found in the experimenter's spare-parts box. A strip of zinc

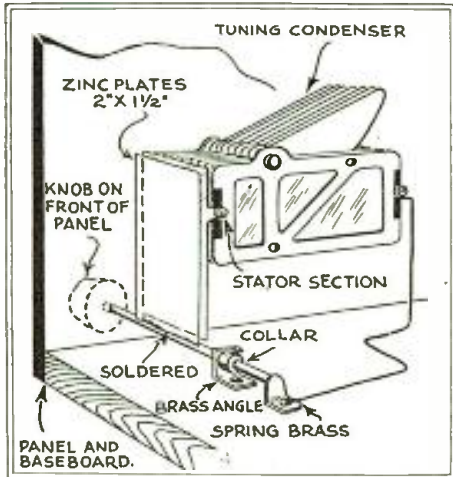

Fig. 5

This "book-type" condenser is easily made and will be useful with many old-style condensers and for other purposes around a set.

or sheet brass is soldered to the stationary section of the condenser which makes contact with the stator, or fixed plates of the instrument; and is placed in a position perpendicular to the condenser base, as shown in the illustration (Fig. 5). The second, or movable, plate is soldered to a shaft so that, at maximum, there is an air space of about an eighth of an inch between the two plates.

The details of the shaft mounting are self-explanatory; a standard rheostat knob equipped with a set-screw fastener is used on one end of the shaft, which is restrained from undue motion by means of the brass angle, mounted on the baseboard, and a collar. A strip of spring brass aids in this control and serves also as a wiping contact for the movable plate of the vernier. This contact should exert a pressure heavy enough to prevent the plate from moving of its own weight after it has been brought to the desired position. The approximate size of the vernier plates is 2 x 1 1/2 inches.—Contributed by Walter Fisher, New Haven, Conn.

**A Double-Receiver D.T. Switch**

THE popularity of the shorter waves has brought about a rather heavy demand for short-wave receivers; which demand, in turn, has presented a good many minor problems to the builder. Many of these have been solved by the manufacturers—such as the design of a short-wave adapter which is plugged into the regular broadcast receiver, and makes use of that set's amplification system. Other systems permit a choice of long or short-wave reception, by means of switches which throw in or out of the circuit suitable inductances and capacities to bring about sufficient wavelength changes. However, one of the best methods, from the standpoint of efficiency, is to employ two separate receivers

with a switching circuit (as shown in Fig. 8) by means of which either receiver may have its filaments lighted and be connected to the aerial without disturbing the settings of the other receiver.—Contributed by Dwight P. Carpenter, Peekskill, N. Y.

**Laying Out a Scanning Disc**

THOUGH Radio News does not recommend the building of television scanning discs by the experimenter—unless he is an expert in precision machine work and possesses the necessary power drills—there are a good many amateurs who desire to "roll their own," in spite of some very good and obvious reasons why they should not. However, here is a scanning-disc method that might give some results; and, though its meeting with success cannot be guaranteed by this magazine, it is published for the handy constructional hints it contains for those who would care to try their hand at drilling a home-made disc or two.

First, obtain a large phonograph disc with one-side recording (a two-side record can be used by sandpapering the grooves out off one side), and place a 7/16-inch mandrel in the center hole of the disc. A piece of string is then wound a number of times about the mandrel, bringing the end of the string near the edge of the record, after a loop is tied in the string and a pencil placed in the loop; then one more turn is wound

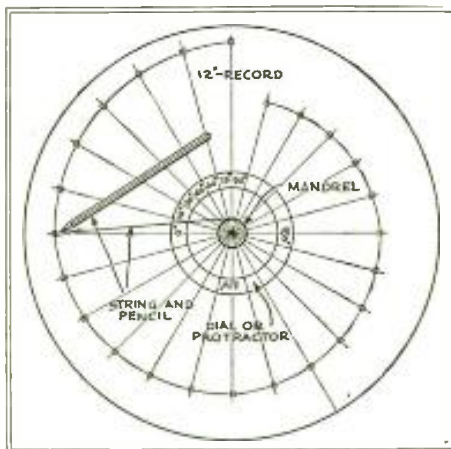

Fig. 6

If the Radio News television disc blueprints do not suit, you can design your own by the simple method above. (We dare you to try it!)

about the mandrel, giving the line for the scanning holes. To insure even spacing of the scanning holes, place a 360-degree dial over the exact center of the record and secure it so that it will hold its position until no longer necessary. It is then a simple matter to draw 48 or 24 radial lines from the dial divisions. Where each intersects the line drawn with the pencil in the looped string, drill a hole 1/16-inch for a 24-hole disc, 1/32 for a 48-hole disc. After completing the drilling, and finishing with sandpaper, it may be advisable to fasten the dial to the record; so that the dial may serve as a motor-shaft coupling.—Contributed by George Minty, Victoria, B. C., Canada.

Fig. 7

Throw open this switch and oscillate to your heart's content. (A double-throw switch and jumper would provide also a good ground for the aerial when not in use.)

**Stiffening the Sub-Panel**

AS a rule, lengthy sub-panels—at least when weighed down by transformers of the type found necessary for the quality of reception desired these days—develop

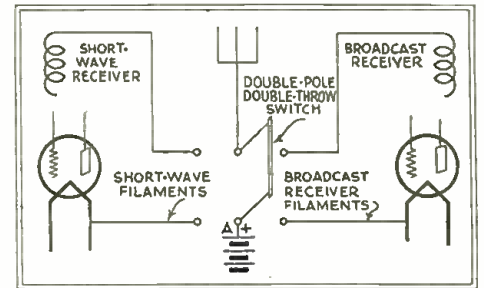

Fig. 8

"Combine" receivers grow in popularity. The simple switching device above is convenient.

indentations amidships which are everything but artistic, and often disastrous. While a third, or even a fourth, sub-panel bracket may be installed to overcome this sagging tendency, the idea of so much additional equipment may not appeal to the average constructor. Furthermore, the more brackets one adds to the underside of a sub-panel, the greater the difficulty in wiring the receiver.

Fig. 4 shows a way of preventing sag in sub-panels which is both simple and cheap. Some readers may recognize this wrinkle as a miniature of the familiar one employed to keep the aerial mast from bending with the stress of the antenna. This sag-preventer offers, not only a secure brace, but also a convenient means of grounding the various "A—" leads on a common lead, providing the support wire is of copper.—Contributed by E. K. Jewett.

**Bloop to Yourself Alone**

AT last! Use has been found for the "squeal of the pig!" Just at the time when great heads are huddled in an effort to concert a mighty heave, so that it may be sufficient to toss all regenerative receivers in the ocean, a use is found for their "squeals." The suggestion outlined below was hit upon by a would-be transmitting "ham" who desired to learn the code and did not care to use a buzzer because of its "far-away" sound, when used without phones, and its uncomfortable, squawky note when used with phones. Beside the standard regenerative receiver, the accessories required are, a pair of phones, (Continued on page 675)

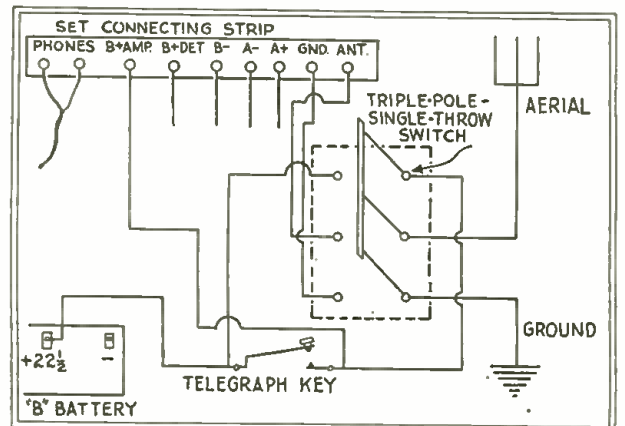



# On the Short Waves



## FANS HEAR THE WGY CALLING ITS MATES

Short-wave fans throughout the world have had the opportunity to hear a three-way conversation between America, Java and Australia by phone. During recent experiments between W2XAF, Schenectady, on 31.4 meters and A2ME, Sydney, Australia, 28.5 meters, two-way conversation was conducted with the greatest of ease in the early morning at the American station—which corresponded to late in the evening in Australia.

On October 17 the announcer at 2ME, R. E. Farmer, informed the American announcer, A. B. Hitt, that the Dutch station ANE, Bandoeng, Java, 15.9 meters, desired to come into the discussion; and, with the aid of two short-wave receivers at each station, the parley was held as familiarly as over a party telephone line. The Australian station is nearly ten thousand miles from Schenectady, the Javanese station about as far, and the two latter are over three thousand miles apart. The short-wave conversation was heard by listeners in Peru, and probably in most other parts of the world.

On October 26 WGY rebroadcast one of these conversations during the half-hour between 6:30 and 7:00 a.m., which is the most favorable time for communication with Australia; and on October 31 prominent Americans and Australians exchanged verbal greetings, which were also broadcast. The short-wave reception, though at times wonderfully clear, is not uniform, and at times fades greatly. This effect varies also with the wavelength; so that the reception may be perfect from one direction and almost unintelligible from the other.

## SHORT WAVES GIVE SURPRISES

Editor, RADIO NEWS:

Like the many readers of your noted magazine, I'm an addict to the short-wave field, and growing more enthusiastic everyday; and I'm one of the great majority who find the RADIO NEWS far out-distances any other in radio research. That now well-known Junk-Box has received many comments, but all will have to be going some to feel so elated as I. It's a real *humdinger*. I've tried quite a number of hook-ups but the J.B., gives the 'Sailor's Farewell' to the rest. Got them all beat. I have rebuilt it time and time again and I'm sure that as she is will give me all satisfaction for the winter. I now find very little of the well-condemned body capacity, the only reasons that I can presume—rubber feet on baseboard and your jocular wooden spoons.

The many stations I've received include Holland

RADIO NEWS will welcome any definite information from our readers about unlisted stations which you may hear putting on programs, only if you hear the call or the announcement of location. Please give the wavelength as closely as you can estimate it. Because of the number of experimental transmissions by amateurs and others, we cannot undertake to list such stations in the short-wave broadcast list on another page, unless confirmation is received of their having a regular schedule; but all definite information received will be published here. Please consult data we have published before writing for information; we have no way to identify a station by its program or language, since many foreign stations transmit in several languages; nor even by its approximate wavelength, unless it is one of the larger and best-known transmitters.

and Chelmsford, England, and hosts in these United States. WGY and CJRX are my most consistent, others to boot are WSGH, WABC, KDKA, WLW, WOC, KSTP, Long Beach—and to many to mention—not forgetting WRNY, our own RADIO NEWS station. But of all these the first two are the only ones with creditable clarity, and they come good. New York and London come in very good in their two-way conversation, and indeed interesting to a short-wave snooper. Phone stations are hot. I have reached out to Santa Barbara, Georgetown (British Guiana) AGB prefixed with C, this latter station near to 29 meters; they come in quite regular. And now, in inquiry, I wonder if any readers have ever received a phone station with call OCYA? I question its whereabouts. And I presume there were many searching the air when the Graf Zeppelin came this way. Sunday, October 11, I tuned in a phone station which repeated messages in English and German from the Graf Zeppelin; each message being preceded with "JAA—KUN/KLL;" later "JAN—ZSS—KUN/KLL." Where was I? By the dials, somewhere close to 20 meters. I'm sure it wasn't NAA, one of the regulars. I stayed with this station from 4:45 p.m. until 5 a.m. next morning.

At present, on the higher waves, I am using

the Pacent Ultimax. For tone and volume this is the best five-tube hook-up I've handled. However it holds one disagreeable feature, its oscillations in the lower channels. This set being something out of the ordinary, I'm at a loss as to how I can insert a control.

GEO. H. CARTER,

308 Mulberry Terrace, Albion, Mich.

(A high-resistor in the "B+" lead of the R.F. amplifier is a simple means much favored at the present time. From 0 to 100,000 ohms is a good range.—EDITOR.)

## RECEPTION ON A.F. STAGE

Editor, RADIO NEWS:

Kindly publish a few hints on short-wave troubles. (See page 646) I constructed the "Junk-Box" but I can't get anything; it sounds like the ocean roaring. Batteries, tubes, phones and parts used in set are all O.K. Now here's the mystery. I can pick up Base 9, Coast Guard short-wave station at Lewes, Delaware, without any plug-in coils in the sockets. What's the reason for this? (The audio-frequency tube is oscillating and there is sufficient pick-up to get the nearby short-wave station from this tube acting as a detector. Test the A.F. transformer.) I used these same parts (without the transformer) but made a short-wave converter and plugged into my receiver and had plenty of whistles.

EDWARD J. BROCKAWAY.

Wildwood Annex, Wildwood, N. J.

## A "JUNK-BOX" CONVERTER

Editor, RADIO NEWS:

I stated that I couldn't get anything outside the states on my "Junk-Box." The tables have turned. I made it into a short-wave converter for my Browning-Drake and got XDA, Mexico City; SPU, Santa Cruz, Bolivia; SPW, SPX, Rio de Janeiro; ABG, Nauen; GBH, Grimsby, England; 7NR, Seldovia, Alaska; EAM, Madrid, Spain; NPM, Honolulu, and AND, Tjellin, Java. They are all code stations; besides these I have got a batch of unidentified stations. I believe the reason that I cannot get voice as yet is that I use only 45 volts on the plates of three tubes.

Of course, making it into a converter wasn't the only thing I did with the set; the principal improvement was the grounding of the other end of my aerial. It worked wonders with my Browning-Drake, allowing it to receive KFI with but 45 volts on the plates, and with volume enough to operate a speaker satisfactorily. With the "Junk-Box" it has helped me to get many code stations.

The next improvement was the complete elimination of hand capacity; I use a copper panel and mount the condensers directly on it. The making of a short-wave converter from it is another simple matter. I disconnected my audio amplifier in the "Junk-Box," made a plug of an old tube base with leads to the prongs, and attached my lead from the R.F. choke to the "P," and the filament leads in the same manner. I insert the plug into the detector socket of my B-D. (any receiver will work) and put the tube removed from it into my converter. The aerial and ground are connected to the converter and the speaker to the B-D., and there I have a first-class short-wave converter. It is so compact that the longest lead is three inches; and the whole set could be placed in a cigar box, with enough space for another like it. I would like to hear from builders of the "Junk-Box" who have either good or bad luck with it, and exchange ideas. If anyone can tell why I can't get the foreign broadcasts, I wish they would tell me why and what to do. I am about to break into ham transmission and would like to hear from hams who have established records with 199s and would be willing to help out a beginner.

CHESTER TUCHOLSKI,

1012 Bremen St., Milwaukee, Wis.

## A BRITISHER CHATS ON SOUTH AFRICAN RADIO

Editor, RADIO NEWS:

Here is the circuit of a really successful screen-grid tube to place before the RADIO NEWS Short-Wave receiver. As it has been drawn, it uses the British S625, which I know—this is of course a six-volt tube—but doubtless the UX-222 will do

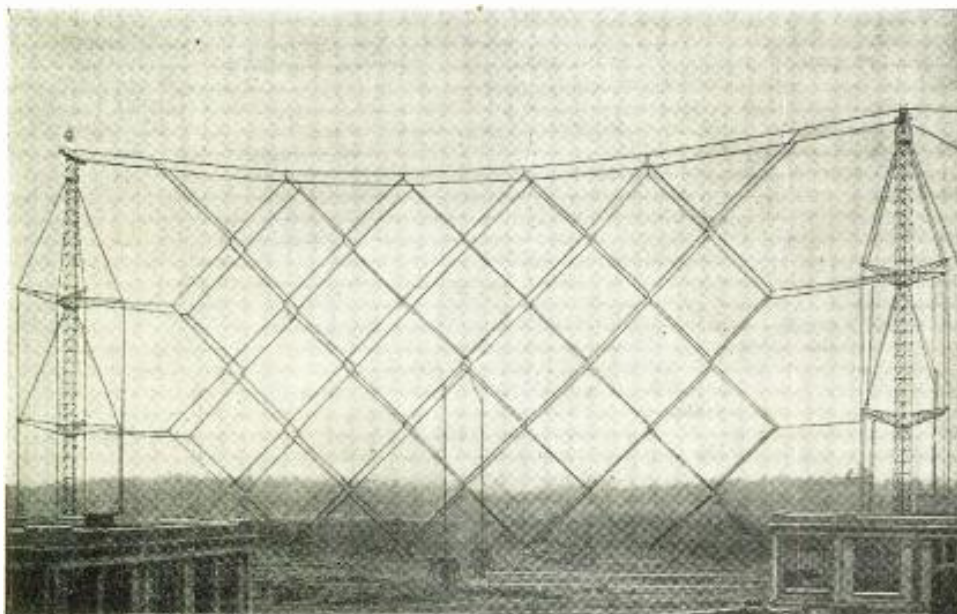

Half the 15.45-meter directional antenna of the Sainte-Assise transmitter of the Societe Francaise Radio-Electrique, near Paris. The "bales" or networks are double, a quarter wavelength apart, and the squares are half a wavelength on an edge; the vertical center lines are feeders. Only the middle of the aerial is directly excited. Results obtained with ultra-high speed messages to Argentina warrant the prediction of "the use in the near future of these short waves for television."





# New List of Broadcast Stations in the United States

Radio Call Letters	BROADCAST STA. Location	Wave (Meters)	Power (Watts)	Radio Call Letters	BROADCAST STA. Location	Wave (Meters)	Power (Watts)	Radio Call Letters	BROADCAST STA. Location	Wave (Meters)	Power (Watts)	Radio Call Letters	BROADCAST STA. Location	Wave (Meters)	Power (Watts)	
KDKA	East Pittsburgh, Pa.	306	25000	KGO	Oakland, Calif.	380	10000	WBAB	Harrisburg, Pa. (day)	268	500	WGHP	Mt. Clemens (Detroit)	242	750	
KDLR	DeVils Lake, N. D.	248	100	KGRS	San Antonio, Texas	319	100	WBAL	Baltimore, Md.	285	10000	See WLB				
KDYL	Salt Lake City, Utah	232	1000	KGRS	Amarillo, Texas	213	1000	WBAP	Fort Worth, Texas	375	5000	WGMS	Chicago, Ill.	416	25000	
KEJK	Los Angeles, Calif.	240	500	KGTT	San Francisco, Calif.	211	500	WBAX	Nashville, Tenn.	301	5000	WGN	Buffalo, N. Y.	545	750	
KEKW	Burbank, Calif.	384	500	KGU	Honolulu, Hawaii	319	500	WBAX	Wilkes-Barre, Pa.	248	100	WGR	Atlanta, Ga.	337	500	
KEX	Portland, Oregon	254	5000	KGW	Portland, Oregon	484	1000	WBBC	Brooklyn, N. Y. City	214	500	WGST	Schenectady, N. Y.	380	5000	
KFAB	Lincoln, Nebraska	389	5000	KGY	Lacey, Washington	250	10	WBBL	Richmond, Va.	219	100	(Time limited)				
KFAD	Phoenix, Arizona	484	500	KHJ	Los Angeles, Calif.	353	1000	WBMM	Chicago, Ill.	389	25000	WHA	Madison, Wis.	526	750	
KFAU	Boise, Idaho	240	1000	KHQ	Spokane, Wash.	508	1000	WBMR	Rossville, N. Y. City	231	1000	WHD	Milwaukee, Wis. (day)	263	250	
KFB	Hartford, Conn.	251	100	KICK	Cadillac, Mich.	211	100	WBMY	New York City	250	100	WHAM	Rochester, N. Y.	261	5000	
KFBK	Sacramento, Calif.	229	100	KJBS	San Francisco, Calif. (day)	273	100	WBMY	Charleston, S. C.	250	75	WHAP	New York City	231	1000	
KFBL	Everett, Washington	219	50	KJR	Seattle, Wash.	309	5000	WBZZ	Ponca City, Okla.	250	100	WHAS	Louisville, Ky.	366	5000	
KFBV	Laramie, Wyoming	500	500	KKP	Seattle, Wash.	211	15	WBCN	See WENR			WHAZ	Troy, N. Y.	231	500	
KFCB	Phoenix, Arizona	229	100	KLCN	Blytheville, Ark. (day)	232	50	WBET	Boston, Mass.	220	500	WHB	Kansas City, Mo.	316	1000	
KFCR	Santa Barbara, Calif.	200	100	KLDS	Independence, Mo. (Ltd)	316	1000	WBIS	Boston, Mass.	244	500	WHBC	Canton, Ohio	250	10	
KFDM	Beaumont, Texas	555	500	KLRA	Little Rock, Ark.	216	1000	WBMMH	Detroit, Mich.	229	100	WBBD	Bellefontaine, Ohio	219	100	
KFDX	Shreveport, Louisiana	248	100	KLS	Oakland, Calif. (day)	208	250	WBMS	Union City, N. J.	207	250	WBFB	Rock Island, Ill.	248	100	
KFDY	Grand Forks, N. D.	408	500	KMO	Cadillac, Mich.	341	500	WBMY	New York City	222	250	WBFB	Shelbyville, Wis.	213	500	
KFEK	Portland, Oregon	319	500	KMZ	Denver, Colo.	535	1000	WBQ	See WABC			WBHP	Johnstown, Pa.	229	100	
KFEL	Denver, Colorado	319	250	KMA	Shenandoah, Iowa	322	500	WBOW	Terre Haute, Ind.	229	100	WBHQ	Memphis, Tenn.	219	100	
KFEQ	St. Joseph, Mo. (day)	535	2500	KMBC	See KLDS			WBRE	Birmingham, Ala.	322	500	WBHU	Anderson, Indiana	248	100	
KFEY	Kellogg, Idaho	214	10	KMED	Medford, Oregon	211	50	WBRL	Wilkes-Barre, Pa.	229	100	WBHW	Philadelphia, Pa.	200	100	
KFGQ	Boone, Iowa	229	10	KMIC	Inglewood, Calif.	268	500	WBRS	Tilton, N. H.	210	500	WBHY	West De Pere, Wis.	250	50	
KFH	Wichita, Kansas	231	1000	KMJJ	Fresno, Calif.	450	50	WBSD	Wellesley Hills, Mass.	(Time limited)	384	100	WBHD	Minneapolis, Minn.	213	500
KFHA	Gunnison, Colorado	250	50	KMMJ	Clay Center, Neb. (day)	405	1000	WBT	Charlotte, N. C.	278	10000	WBIB	See WABO			
KFIB	Los Angeles, Calif.	408	5000	KMO	Tacoma, Wash.	224	500	WBZ	Springfield, Mass.	303	15000	WBIC	Chicago, Ill.	229	100	
KFIF	Portland, Oregon	211	50	KMOX	St. Louis, Mo.	275	25000	WBZA	Boston, Mass.	303	500	WBK	Cleveland, Ohio	216	1000	
KFIO	Spokane, Wash. (day)	244	100	KMTR	Hollywood, Calif.	526	1000	WBZC	Storrs, Conn.	225	500	WBK	New York City	297	250	
KFIU	Juneau, Alaska	229	10	KNRC	Santa Monica, Calif.	384	500	WBZD	Cancon, N. Y. (day)	246	500	WBK	Des Moines, Iowa	300	5000	
KFIZ	Fond du Lac, Wis.	211	100	KNX	Los Angeles, Calif.	286	5000	WBZE	Pittsburgh, Pa.	246	500	WBK	New York City	211	10	
KFJB	Marshalltown, Iowa	250	100	KOA	Denver, Colo.	361	12500	WBZL	Columbus, Ohio	210	250	WBK	Chicago, Ill.	203	5000	
KFJF	Oklahoma City, Okla.	204	5000	KOAC	Corvallis, Oregon	535	1000	WBZM	Lincoln, Neb.	508	500	WBK	Philadelphia, Pa.	219	100	
KFJI	Astoria, Oregon	219	50	KOBE	State College, N. Mex.	254	10000	WBZP	Camden, N. J.	214	1000	WBK	Cumtwa, Iowa (day)	211	100	
KFJM	Grand Forks, N. D.	408	500	KOH	Chickasha, Okla.	219	100	WBZQ	Baltimore, Md.	500	250	WBK	Madison, Wis.	248	100	
KFJR	Portland, Oregon	231	500	KOIN	Rego, Nevada	219	100	WBZR	Asbury Park, N. J.	234	500	WBK	Elkins Park, Pa. (Sun.)	332	50	
KFJV	Fort Dodge, Iowa	229	100	KOIS	Council Bluffs, Iowa	238	1000	WBZS	Rapid City, S. D.	250	100	WBK	Jackson, Mich.	219	100	
KFJZ	Fort Worth, Texas	219	100	KOIN	Portland, Oregon	319	1000	WBZT	Philadelphia, Pa.	256	5000	WBK	Chicago, Ill.	526	5000	
KFKA	Greeley, Colorado	341	500	KOMO	Seattle, Wash.	326	1000	WBZU	Burlington, Vt.	250	100	WBK	Stuebenville, Ohio	211	50	
KFKB	Milford, Kansas (day)	265	5000	KORE	Eugene, Oregon	211	100	WBZV	Philadelphia, Pa.	250	100	WBK	Elizabeth, N. J.	207	250	
KFKC	Lawrence, Kansas	246	1000	KOVB	Denver, Colo.	216	500	WBZW	Carthage, Ill. (day)	280	100	WBK	Poynter, Wis.	229	100	
KFKD	Chicago, Illinois	294	5000	KPCB	Seattle, Wash.	218	100					WBK	Topeka, Kans.	251	1000	
KFKE	Kirksville, Missouri	236	50									WBK	Utica, N. Y.	250	100	
KFKF	Rockford, Illinois	213	500									WBK	Montgomery, Ala.	200	15	
KFKG	Galveston, Texas	219	100									WBK	Bridgeport, Conn.	210	500	
KFKH	Northfield, Minn.	240	1000									WBK	St. Louis, Mo.	222	1000	
KFNI	Shenandoah, Iowa	337	500									WBK	Bay Shore, N. Y.	248	100	
KFOA	Seattle, Wash.	236	1000									WBK	Miami Beach, Fla.	242	1000	
KFON	Long Beach, Calif.	240	1000									WBK	Philadelphia, Pa.	492	500	
KFOR	Lincoln, Nebraska	248	100									WBK	Milwaukee, Wis.	268	250	
KFPL	Dublin, Texas	229	15									WBK	Waco, Texas	242	1000	
KFPM	Greenville, Texas	229	15									WBK	Norfolk, Neb. (day)	283	500	
KFPW	Siloam Springs, Ark. (day)	224	50									WBK	Kokomo, Ind.	229	50	
KFPY	Spokane, Wash.	216	500									WBK	Waterloo, Iowa	250	100	
KFQB	Fort Worth, Texas	242	1000									WBK	Providence, R. I.	337	250	
KFQD	Anchorage, Alaska	244	100									WBK	Pittsburgh, Pa.	232	1000	
KFQF	Holy City, Calif.	211	100									WBK	Jacksonville, Fla.	238	1000	
KFQW	Seattle, Wash.	211	100									WBK	Wilmington, Ohio	207	500	
KFQZ	Hollywood, Cal. (Ltd.)	353	1000									WBK	Chicago, Ill.	263	5000	
KFR	San Francisco, Calif. (Ltd.)	492	1000									WBK	St. Petersburg, Fla.	297	250	
KFRU	Columbia, Missouri	476	500									WBK	LaSalle, Ill.	250	100	
KFRS	San Diego, Calif.	500	500									WBK	Red Bank, N. J.	248	100	
KFSG	Los Angeles, Calif.	268	500									WBK	Ypsilanti, Mich.	219	50	
KFUL	Galveston, Texas	232	500									WBK	Decatur, Ill.	250	100	
KFUM	Colorado Springs, Colo.	236	1000									WBK	New Orleans, La.	219	100	
KFUD	St. Louis, Mo.	545	500									WBK	St. Paul, Minn.	248	100	
KFUF	Denver, Colorado	229	100									WBK	Lebanon, Pa.	219	100	
KFUG	Ogden, Utah	219	50									WBK	Lewisburg, Pa.	248	100	
KFV	Venice, Calif. (Ltd.)	428	250									WBK	New Orleans, La.	250	30	
KFVS	Cape Girardeau, Mo.	248	50									WBK	Gadsden, Ala.	248	50	
KFW	Los Angeles, Calif.	316	1000									WBK	Mooseheart, Ill. (Ltd.)	254	20000	
KFWC	San Bernardino, Calif.	250	100									WBK	Gary, Ind.	220	500	
KFWF	St. Louis, Missouri	250	1000									WBK	Detroit, Mich.	400	5000	
KFWG	San Francisco, Calif.	322	500									WBK	Washington, D. C.	205	10000	
KFWH	Oakland, Calif.	322	500									WBK	New York City	395	25000	
KFWI	Avalon, Calif.	200	100									WBK	San Juan, Porto Rico	317	500	
KFXD	Jerome, Idaho	211	15									WBK	East Lansing, Mich.	288	500	
KFXE	Denver, Colorado	319	250									WBK	Laconia, N. H.	229	50	
KFXF	Edgewater, Colo.	229	50									WBK	Joliet, Ill.	229	100	
KFXG	Oklahoma City, Okla.	229	50									WBK	Birmingham, Ala.	229	10	
KFXH	Flagstaff, Arizona	211	100									WBK	Wester, Mass.	250	100	
KFXI	Breckenridge, Texas	211	100									WBK	Indianapolis, Ind.	214	500	
KFY	Bismarck, N. D.	545	500									WBK	La Crosse, Wis.	217	1000	
KGA	Spokane, Wash.	204	5000									WBK	Chicago, Ill.	229	50	
KGAR	Tucson, Arizona	219	100									WBK	Youngstown, Ohio	526	500	
KGB	San Diego, Calif.	220	250									WBK	Jersey City, N. J.	207	250	
KGBU	Ketchikan, Alaska	333	500									WBK	Battle Creek, Mich.	211	50	
KGBV	St. Joseph, Mo.	219	100									WBK	New York City	222	250	
KGBW	York, Nebraska	322	500									WBK	Cashmere, Ind.	229	100	
KGBX	Decorah, Iowa (day)	236	50									WBK	New York City	211	50	
KGBY	Oklahoma City, Okla.	219	50									WBK	Brookville, Ind.	200	100	
KGC	San Antonio, Texas	219	100									WBK	Buffalo, N. Y.	204	5000	
KGCN	Concordia, Kans.	211	50									WBK	Ladington, Mich.	200	50	
KGCR	Brookings, S. D.	248	100									WBK	Buffalo, N. Y. (Ltd.)	288	1000	
KGCU	Mandan, N. D.	250	100									WBK	Lancaster, Pa.	250	50	
KGCX	Vida, Montana	211	100									WBK	Cincinnati, Ohio	545	500	
KGDA	Del Rio, Texas	219	15									WBK	Albama City, Okla.	333	1000	
KGDB	Barrett, Minn.	250	50									WBK	Nashville, Tenn.	201	300	
KGDM	Stockton, Calif. (day)	261	50									WBK	Louisville, Ky.	250	300	
KGDP	Pueblo, Colorado	248	10									WBK	Minneapolis, Minn.	240	1000	
KGDR	San Antonio, Texas	200	100									WBK	Muncie, Ind.	229	50	
KGDY	Oldham, S. D.	250	15									WBK	Kansas City, Mo.	211	100	
KGEF	Los Angeles, Calif.	281	1000									WBK	Petersburg, Va.	250	100	
KGEH	Yuma, Colo.	250	10									WBK	Farmington, N. Y.	214	500	
KGEI	El Centro, Calif.	250	15									WBK	Stevens Point, Wis.	211	30	
KGER	Long Beach, Calif.	219	100									WBK	(day)	333	5000	
KGEV	Fort Morgan, Colo.	250	100													

Main broadcast station list with columns for Radio Call Letters, Broadcast Sta. Location, Wave (Meters), Power (Watts), and multiple columns for other stations.

LIST OF CANADIAN BROADCAST CALLS

Table of Canadian broadcast calls including call letters, locations, and power/wave information.

LIST OF SHORT-WAVE STATIONS OF THE WORLD

Stations will prefix their calls with their allotted national letters on or before January 1, 1929.

Large table of short-wave stations categorized by continent (Africa, Australia, Austria, Belgium, Canada, Costa Rica, Danzig, Denmark, England, Finland, France, Germany, Holland, Italy, Japan, Java, Mexico, Morocco, Norway, U.S.S.R. (Russia), Spain, Sweden, Switzerland, United States).

THIS list of the short-wave broadcast stations throughout the world is not complete, although we have endeavored to list every station of whom we have heard reports; since in many cases reliable information about the programs, wavelength and power of the stations cannot even be obtained from the stations themselves. (See page 654)



# Radio News Laboratories



**R**ADIO manufacturers are invited to send to RADIO NEWS LABORATORIES samples of their products for test. It does not matter whether or not they advertise in RADIO NEWS, the RADIO NEWS LABORATORIES being an independent organization, with the improvement of radio apparatus as its aim. If, after being tested, the instruments submitted prove to be built according to modern radio engineering practice, they will each be awarded a certificate of merit; and that apparatus which embodies novel, as well as meritorious features in design and operation, will be described in this department, or in the "What's New in Radio" department, as its news value and general interest for our readers shall deserve. If the apparatus does not pass the Laboratory tests, it will be returned to the manufacturer with suggestions for improve-

ments. No "write-ups" sent by manufacturers are published in these pages, and only apparatus which has been tested in the Laboratories and found of good mechanical and electrical construction is given a certificate. As the service of the RADIO NEWS LABORATORIES is free to all manufacturers, whether they are advertisers or not, it is necessary that all goods to be tested be forwarded prepaid, otherwise they cannot be accepted. Apparatus ready for, or already on, the market will be tested for manufacturers free of charge. Apparatus in process of development will be tested at a charge of \$2.00 per hour required to do the work. Address all communications and all parcels to RADIO NEWS LABORATORIES, 230 Fifth Avenue, New York City. Readers will be informed on request if any article has been issued a Certificate of Merit.

### FIXED RESISTORS

The "Eminent" resistors shown here, submitted by Paul Zollner, Berlin S14, Kommandantenstr. 51, Germany, are of the grid-leak type. The resistive material is a carbon composition which is



coated in an even layer on a 1/4-inch porcelain rod 1 inch long; the latter is provided at each end with brass springs which are in turn soldered to the brass end caps. The resistance element is protected by a molded hard-rubber tube; different resistance values are obtained by various widths of spiral grooves cut out of the composition. The assembled resistor is 1 3/4 inches long and 1/4-inch in diameter, and will fit easily into a standard resistance mounting. Samples of different values were submitted for test, and their resistance were found within 10% of the rated values.

AWARDED THE RADIO NEWS LABORATORIES CERTIFICATE OF MERIT NO. 2451.

### VARIABLE CONDENSERS

In the triple-gang condenser (Type No. 1703) shown, submitted by the Pilot Electric Mfg., Co., Inc., 323 Berry St., Brooklyn, N. Y., each stator section is provided with a small compensating condenser of the mica-spring type, with a maximum capacity of 20-mmf.; which permits of balancing the circuits to compensate for capacity changes introduced by the wiring. The maximum capacity of each unit was found within 5% of the rated value, .00035-mf., and the minimum was equally accurate; the individual sections of the gang condenser match to within 1%. The plates are shaped to give a capacity variation-characteristic midway between those of the SLF and the SLV types. The stators are supported by molded bakelite strips, one of which is used to mount the compensating condensers. The instrument is designed for either one-hole panel mounting, or fastening to the sub-panel. The rotor is of the floating type, allowing interchange of shafts; the removable shaft is 7 inches long. The condenser requires a back-of-panel space 3 1/2 x 6 inches; it is arranged to allow either clockwise or counter-clockwise tuning.

AWARDED THE RADIO NEWS LABORATORIES CERTIFICATE OF MERIT NO. 2454.



The same manufacturer submitted also a "Type 1702" twin or two-gang condenser, otherwise similar to the instrument described above. The capacity values were found of the same accuracy as those of the three-gang condenser. The plates are of the "centraline" type, allowing even separation of stations throughout the entire broadcast band. Either one-hole panel mounting or sub-panel mounting, as preferred, is possible; the sub-panel space required is 4-11/16 x 3 1/2 inches.

AWARDED THE RADIO NEWS LABORATORIES CERTIFICATE OF MERIT NO. 2455.

"Type 1701," single unit of the same capacity and general construction as those described above,

was submitted by this manufacturer. It is not provided with a compensating condenser, as are the others.

AWARDED THE RADIO NEWS LABORATORIES CERTIFICATE OF MERIT NO. 2456.

### TUNING CONDENSER

The "Type 320" tuning condenser shown, manufactured and submitted by Silver-Marshall, Inc., 846 West Jackson Blvd., Chicago, Illinois, is of low-loss construction, with plates shaped to give a modified SLF tuning curve. The condenser has a maximum capacity within 5% of its rated value; the measured minimum capacity is 2 mmf. The stator plates are accurately spaced and rigidly supported by hard-rubber strips which are riveted to the metal and plates of the condenser. The condenser is provided with a rotor stop, which serves also to hold the end plates together at the top. The condenser is of the one-hole-mounting type; the back-of-panel space occupied is approximately 3 inches square. The plates and condenser end-pieces are die-stamped from hard aluminum alloy.

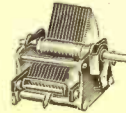

AWARDED THE RADIO NEWS LABORATORIES CERTIFICATE OF MERIT NO. 2457.

### RADIO-FREQUENCY COILS

The "AC17" R.F. coil submitted by the Hammarlund Mfg. Co., Inc., 424 W. 33rd Street, New York, N. Y., has been designed for use either as an antenna coupler or as an interstage coupler for 226- and 227-type A.C. tubes. It is of low-loss construction; the 84 turns of the secondary are space-wound and supported by a thin cylinder

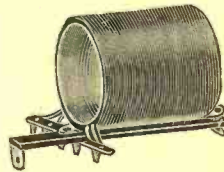

of celluloid. Green silk-covered wire is used for both the primary and secondary windings. The primary of 30 turns, tapped at the 7th and 15th, is wound on a smaller sleeve of celluloid, which is fastened inside the secondary form at its filament end. The coil assembly is secured to a strip of bakelite, at the lower end of which is a bracket for vertical mounting of the coil; the leads of the primary and the filament end of the secondary are fastened to a five-lug terminal strip for convenient wiring into the circuit. When used in connection with a 350-mmf. tuning condenser, this coil will tune over the broadcast waveband from 200 to 550 meters.

AWARDED THE RADIO NEWS LABORATORIES CERTIFICATE OF MERIT NO. 2461.

The "Type SGT17" R.F. coil submitted by the same manufacturer has been designed for use as an interstage coupler for 222-type (screen-grid) tubes. Its general appearance and construction is the same as that of the previous item, except for a larger primary winding. The primary winding, 100 turns of fine green-silk-covered wire, is approximately 1 1/2 inches in diameter and placed inside the secondary at the filament end. The design of the special primary winding allows the tapping-off of any desired plate-load impedance for

the optimum operation of the screen-grid tube. When properly shielded, very great amplification (due to the low-loss construction of the coil) was obtained over the waveband from 200 to 550 meters; the secondary was tuned with a 350-mmf. condenser. Various degrees of increased selectivity, with a corresponding decrease in amplification, were obtained.

AWARDED THE RADIO NEWS LABORATORIES CERTIFICATE OF MERIT NO. 2462.

### FIXED CONDENSER

The "Type 1460" fixed condenser shown, submitted by the Aerovox Wireless Corp., 70 Washington Street, Brooklyn, N. Y., is of the molded bakelite-mica type. It is, approximately, only 1 1/2 inches long, 3/8-inch wide and 7/32-inch thick; and has been designed for mounting on metal sub-panels. Special insulated holes, drilled at each end of the condenser, allow the passage of 6/32 screws. Tinned terminal lugs are provided at each end of the condenser for soldering though, if desired, machine screws may be used for connections. The condenser is made in various capacities from 40 to 3000-mmf. (.00004 to .003-mf.) with a rated tolerance of 10% of the nominal capacity; the 150-mmf. sample submitted for test has a capacity 5% below the nominal rating.



AWARDED THE RADIO NEWS LABORATORIES CERTIFICATE OF MERIT NO. 2463.

### POWER RESISTORS

The "Truvolt" resistor shown, submitted by Electrad, Inc., 175 Varick Street, New York, N. Y., is designed for use in "B" power units, or wherever a heavy-duty resistor is needed. The resistance element consists of nichrome wire wound on a core of asbestos which, in turn, is spiraled over a core of enameled copper wire; this assembly is then wound around a grooved or threaded isolantite tube, 2 inches long. This construction exhibits greater cooling surface for the dissipation of heat. The unit is assembled in a special mounting support, on which is provided a lever varying the resistance. The mounting support contains a bushing for one-hole panel mounting; a bracket also is provided for baseboard or sub-panel mounting. A perforated metal housing, to protect the resistance element from damage, is fitted around the end brackets of the mounting support. The measured resistance of the 2000-ohm sample submitted for test was 1960 ohms, and it varied less than 2% from its measured no-load value under a load of 25 watts for one hour.

AWARDED THE RADIO NEWS LABORATORIES CERTIFICATE OF MERIT NO. 2464.



No. 2464

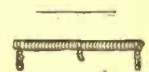

No. 2465

The "Type D-80" fixed power resistor shown, submitted for test by the same manufacturer, embodies the same construction as the variable "Truvolt." The resistance element is wound on a grooved isolantite tube 6 inches long; at the ends are metal clamps which serve both to fasten the wire in position and to provide a means of obtaining good contact with the resistance element. A center

tap is included in the sample submitted for test. The resistance at its rated load of 75 watts for one hour exhibited a change of less than 2% from the rated value of 8000 ohms.

AWARDED THE RADIO NEWS LABORATORIES CERTIFICATE OF MERIT NO. 2465.

**VARIABLE RESISTORS**

The "Tonatrol Type WS" variable resistor, submitted by the same manufacturer, is designed for use as a volume control and incorporates a filament switch. The measured resistance is 0 to 500,000 ohms, with smooth variation throughout its range. Contact with the resistance strip is made by a special contact element, which consists of a spaced winding of wire on a fiber strip; this winding is split on one side, isolating each individual turn. The resistance and contact elements are then assembled between a bakelite outer ring, which serves also as a protection to the resistance element, and a central disc, which also carries the bushing for one-hole mounting. The bushing is provided with a shaft, for the control knob, and an arm of spring

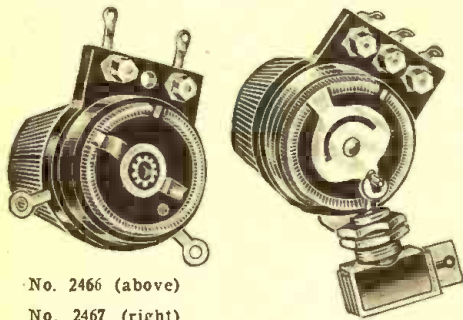

No. 2466 (above)

No. 2467 (right)

metal designed to maintain constant contact with the wire contact element, whether rotating or in any fixed position. The filament switch, contained in the base of the resistor, is operated by a portion of the variable-contact arm which applies pressure or releases a small plug of insulating material. The latter opens or closes the switch to which two lugs extending from the base provide connection. The switch is in the "off" position when the variable arm is at zero resistance.

AWARDED THE RADIO NEWS LABORATORIES CERTIFICATE OF MERIT NO. 2466.

The "Tonatrol Type AP" has been designed for use as a volume control or panel-mounting resistor, from which a variation of 0 to 10,000 ohms may be obtained, and is combined with a 110-volt snap switch for power control. This product is similar in construction to the "WS" type except that the power switch is fastened to the resistor's base by a special bracket and operated by a pin located on the variable arm. The snap switch is in the "off" position when the resistance is at zero value.

AWARDED THE RADIO NEWS LABORATORIES CERTIFICATE OF MERIT NO. 2467.

**VACUUM-TUBE DETECTOR**

The Model UX-200A" vacuum tube shown, submitted for test by the Prexto Manufacturing Company, 676 Euclid Street, Beaumont, Texas, is a special detector with a standard UX-type molded-bakelite base. The characteristics of this tube were found those of standard tubes of the 200A type; so that a grid return to "A—" is required. Its operation as a sensitive and powerful detector was found satisfactory.

AWARDED THE RADIO NEWS LABORATORIES CERTIFICATE OF MERIT NO. 2469.



**LINEN DIAPHRAGM LOUD SPEAKER**

The "Model B" loud speaker, submitted by the Browning-Drake Corp., Cambridge, Mass., is of the single-linen-diaphragm type. A balanced-armature unit of excellent mechanical and electrical design and construction is supported by cross pieces attached to the wooden frame of the speaker. The apex of the linen diaphragm is fastened to the driving pin of the unit, stretched tightly to the edges of the wooden frame, and tacked in place. After the linen is stretched it is "doped" several times in order to produce a tighter and more rigid surface. The diaphragm is 24 inches square and its depth is approximately 2 inches at the apex. The wooden frame, of walnut finish, is 28 inches high over all, 24 inches wide and 8 inches deep. The back is enclosed by a stiff board in which there is a circular aperture to allow adjustment of the unit. This speaker gave almost equal repro-

duction over the audio-frequency range with ample volume.



AWARDED THE RADIO NEWS LABORATORIES CERTIFICATE OF MERIT NO. 2475.

**A.F. TRANSFORMER**

The "Technica" A. F. transformer shown here, submitted by Radio Vertriebs Gesellach, Vienna IX, Porzellang 14, Austria, has a winding ratio of 1 : 3. Mechanically and electrically, this transformer is well built; and, when it was used with a 201A-type tube, good amplification was obtained from 160 to 8,000 cycles. The core and coil are enclosed in a molded brown bakelite housing and are hermetically sealed in position by a resinous insulating compound. The base dimensions for

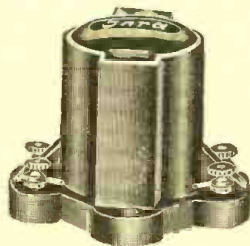

mounting are 3 by 3 inches, and the height is 2½ inches.

AWARDED THE RADIO NEWS LABORATORIES CERTIFICATE OF MERIT NO. 2476.

**A.F. TRANSFORMERS**

The "No. 900" audio-frequency transformer, submitted by the Remler Division of the Gray and Danielson Mfg. Co., 260 First Street, San Francisco, Calif., has a winding ratio of 1 : 3½, and has been designed for use as a first-stage transformer when preceded by a 201A-type detector, and with a 201A or 112 as the first stage. The transformer is well built mechanically and electrically, giving a factor of amplification almost constant from 32 to 5,000 cycles. The core and winding are enclosed in a die-stamped iron housing and sealed hermetically in position by insulating compound. The base dimensions required for mounting are 2½ by 3 inches, and the height is 4 inches.

AWARDED THE RADIO NEWS LABORATORIES CERTIFICATE OF MERIT NO. 2477.

The "No. 901" audio-frequency transformer, submitted by the same manufacturer, has a winding ratio of 1 : 3½ and is designed for use as a second-stage coupling transformer, with a 112- or 171-type tube in the second A.F. stage. When it was used in an amplifier in which the No. 900 transformer was employed in the first stage, a flat

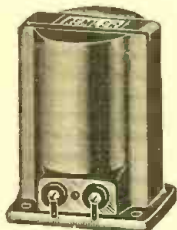

Nos. 2477-78-79-80-81

frequency-characteristic from approximately 32 to 5,000 cycles was obtained. The physical dimensions are the same as those of the No. 900.

AWARDED THE RADIO NEWS LABORATORIES CERTIFICATE OF MERIT NO. 2478.

The "No. 920" audio-frequency transformer, made by the same manufacturer, has been designed for use in amplifiers where greater gain is desired; this transformer has a winding ratio of 1 : 4½. The frequency-characteristic of this transformer is such that, at the lower end of the audio range, slightly greater amplification is obtained. The physical dimensions are the same as those of the Nos. 900 and 901.

AWARDED THE RADIO NEWS LABORATORIES CERTIFICATE OF MERIT NO. 2479.

The "No. 921" audio-frequency transformer,

made by the same manufacturer, has been designed for use as the second-stage transformer when the No. 920 is employed in the first stage. The winding ratio of this transformer is 1 : 6½, and the frequency characteristic falls off below 100 cycles; when it is used with the No. 920, the over-all frequency-characteristic will be nearly flat. This transformer has been especially designed to serve as the input to a 250-type power stage, when the detector's voltage output is low. Its physical dimensions are the same as those of the other transformers above described.

AWARDED THE RADIO NEWS LABORATORIES CERTIFICATE OF MERIT NO. 2480.

The "No. 922" output transformer, submitted for test by the same manufacturer, has been designed as an output transformer for the 112-, 171- or 210-type power tubes. The inductance of the secondary is of such value as to insure the proper operation of the usual horn or cone-type reproducer. The primary winding will carry safely 40 milliamperes, and the core is of such size to prevent saturation under that current; although the manufacturer recommends that the plate current should not exceed 20 milliamperes. When it was used in the plate circuit of a 171-type power tube excellent reproduction was obtained.

AWARDED THE RADIO NEWS LABORATORIES CERTIFICATE OF MERIT NO. 2481.

**A.C. ELECTRIC RECEIVER**

The "Model 7-70" radio receiver shown, submitted by the Bremer-Tully Mfg., Co., 520 So. Canal Street, Chicago, Illinois, is of the all-electric type and operates directly from 110-volt 60-cycle house current; it comprises three 226-type tuned R.F. stages, two 227-type (detector and first A.F.) and a 171A-type push-pull last stage. A full-wave rectifier of the 280 type, with output well filtered, supplies the various "B" voltages; the filament current is supplied from special windings of the power transformer. A single tuning control operates four tuning condensers which are ganged on a single shaft. The small-field inductors, which are partially shielded, are mounted directly below their respective tuning condensers, in individual shielded compartments. The tuning dial is of the drum type; a trimmer or compensating condenser for the antenna is provided, directly below the scale window. A knob for volume control is provided at the left of the scale window while that for operating the ganged condensers is found on the



right. Two panel switches are provided, one controlling the power and the other acts as an additional volume control by switching out the first audio stage. The receiver and power unit are assembled on a cast-aluminum chassis, which is enclosed within a polished walnut cabinet of pleasing design; its actual size is 21 inches long, 12 inches deep and 10 inches high. A 10-foot extension cord is provided for plugging into the light receptacle, and another to make the ground connection; while that to the aerial is made by a binding post. This receiver is sufficiently sensitive and selective, and gave excellent reproduction over the audio range.

AWARDED THE RADIO NEWS LABORATORIES CERTIFICATE OF MERIT NO. 2482.

**A.C. ELECTRIC RECEIVER**

The "Balkite Model A" A.C.-operated receiver, submitted for test by the Fansteel Products Co., of North Chicago, Ill., operates directly from the house-lighting circuit on 110 volts, 60 cycles. Five 227-type and two semi-power (112A-type) tubes are employed, in three stages of radio frequency, detector, a transformer-coupled first stage of audio frequency, and a push-pull power stage. The



receiver is of chassis construction; the coils (of small-field type) and condensers (which are ganged to a single control) are completely shielded.

(Continued on page 703)

# The Radio Constructor's Own Page

Wherein Custom and Home Set Builders and Experimenters  
All Over the World Swap Experiences and Suggestions About  
Hookups and Accessories

## PREFERS EXTRA TUBE

Editor, RADIO NEWS:

Having just read Mr. J. G. Miller's suggestion as to installing a phonograph switch-over (which converts the detector tube into the first audio stage) in the November RADIO NEWS, I would like to

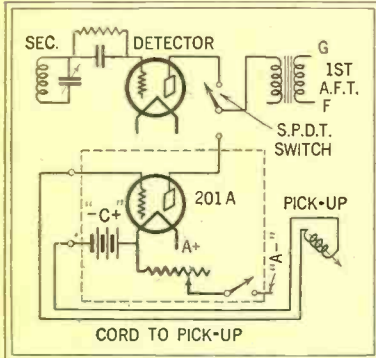

Mr. Lahmann's phonograph pick-up is provided with a stage (A.F.) of its own to use before his set's amplifier. The reader will see that a D.P. D.T. switch would give also a choice of R.F. and pick-up filament circuits.

point out that the adoption of this idea may cause trouble.

All radio engineers are doing their utmost today to keep R.F. grid leads as short as possible, and run them direct to the connection. In the proposed hook-up, they are led to the switch and back; and it is readily easy to see what will happen when the points of the jack begin to corrode.

I submit a drawing of a hook-up which will save the same purpose and will give no "after effects;" in the hope that it will be taken, not merely as a criticism, but as a possible assistance to the experimenter.

FRANCIS J. LAHMANN,  
309 No. Noble St., Indianapolis, Indiana.

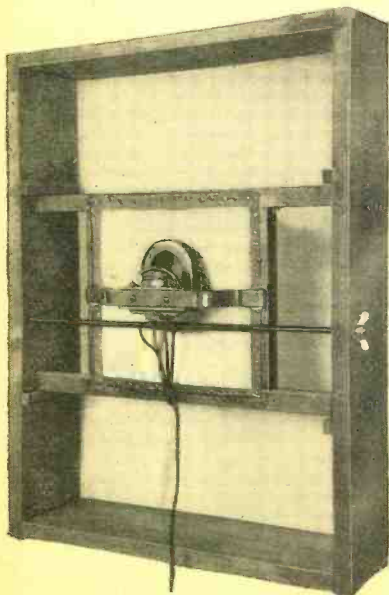

This rear view of Mr. Ulrich's linen-speaker shows very clearly the adjustments described. The assembly is held tight by cramping the large frame on the cross-pieces with the nut of the threaded rod, at the right.

## A CONVENIENT SPEAKER ADJUSTMENT

Editor, RADIO NEWS:

The desirable feature of the linen-diaphragm type of speaker is that it is nearly as good as the modern dynamic, and at a cost considerably less; while it is readily constructed by almost anyone capable of using a few simple tools. It can be made almost any shape or size to fit certain unused space in the room, or to fit into any console. I am at present engaged in building a round one, 24 inches in diameter and 6 inches deep. The wood is laid on in segments, glued, and turned in a large lathe. This makes an exceedingly solid frame.

The accompanying photographs show an improvement I have made in the speaker which is, so far as I know, original with me, as I have not heard or read of it elsewhere. The frame of the speaker illustrated is 18x24 inches, 5 deep, and made of 3/8-inch pine; corners lapped and nailed, with metal corner braces screwed inside. The back frame is 1 1/4x1 1/4 stock, ash; use anything a little harder and more rigid than soft pine. The cloth, front and back, is airplane linen; a thinner and lighter grade has been recommended for the front, but I have no experience of it. The back frame is located between guide strips and can be pulled back until the cloth is perfectly tight; it is held in place by 3/8-inch round brass pins, running through the sides of the frame from

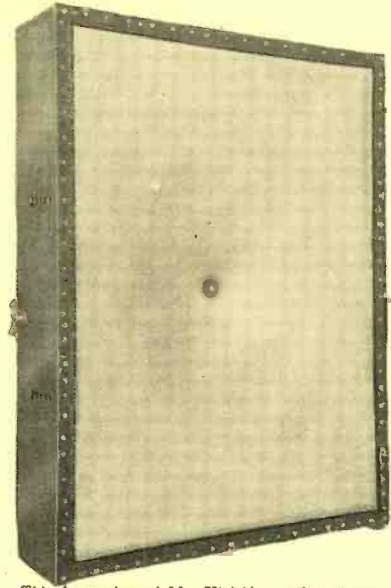

This front view of Mr. Ulrich's speaker shows the holes in the side frames, which admit stop-pins to regulate the adjustment of the linen diaphragm's tension, as explained.

**I**NQUIRIES for information not given here should be sent, not to RADIO NEWS, but to the constructor direct—but he should NOT be asked to furnish data already published, here or elsewhere, or for instructions that an experienced builder should not need; for this is not a beginners' department. Courtesy demands that such requests should be accompanied by postage; as they are often very numerous. Reply coupons can be obtained from the postoffice for international inquiries. On the other hand, readers who solicit general correspondence must expect to bear their own share.

This department is for free discussion to the extent that space permits; but RADIO NEWS accepts no responsibility for the opinions of readers as to the relative merits of apparatus and circuits.

Letters describing good results, but which do not explain the system used, are unsuited for publication; as they entail too much needless correspondence for the editors and the contributors. Give the details the first time.

the outside, through holes bored about 1/2-inch apart. The cloth is stretched back one notch at a time, as required. When it is as taut as desirable, and the sidepins are holding it, the thumbscrews on the long 3/8-inch rod are drawn tight, compressing the sides of the large frame against the ends of the smaller one and holding the assembly solid. The center of the rod is tied down to a screw eye so that it will not vibrate; the rod must be far enough below the center to clear the loud-speaker unit. It might even be better to use two rods, one above and one below. The side pins, it should be understood, do not go into the ends of the small frame, but just in front of them, so that the tension of the cloth holds the frame firmly against them. They extend through about 3/4-inch on the inside to form a sufficient stop for the frame to rest against.

In building the frames, lap, dovetail or miter the corners to make a perfectly solid joint; leave nothing loose to vibrate. There is not much to be gained by making it larger than 24 inches square; this will cover the broadcast frequencies perfectly. It is from 5 to 8 inches deep, according to size. The small frame is made with its two crossbars enclosing an opening about eight inches square; and of such length that it fits closely, but not too tightly for adjustment, inside the large frame. Tack the linen on both frames, stretching it tightly, with tacks about one inch apart, as the strain on the cloth is considerable. Place the small frame between the centered guide strips on the sides of the large frame; find the exact

center of the cloth and work a small hole through without cutting or breaking any threads of the linen. Fasten in the apex with an extra washer cut out of airplane cloth, which will help to protect the diaphragm against cutting. Draw the diaphragms together and pull back the small frame until you can place the holding pins at about the first holes, or perhaps the second, without undue strain. Then give the cloth about five coats of airplane dope, drying well between applications (keep it away from fire!). Center and mount the driving unit on the back of the small frame; see that the pin is centered squarely with the apex, and then draw back the small frame, one side at a time, as far as it will go. Pin it in place and then tighten the thumb nuts on the long rod until the assembly is solid. Lastly, tighten the apex on the unit's driving rod—it must always be loosened before an adjustment of the diaphragm is made. Frame and cloth may be decorated to suit, remembering that nothing should be left loose to vibrate.

VICTOR A. ULRICH,  
97 Cook Street, San Francisco, Calif.

## THE LOVELESS AERIAL AGAIN—OR YET

Editor, RADIO NEWS:

I find that by connecting the outside coil of a Loveless antenna to ground only and leaving the ground connection on the set open, I get very fine results. I am using a 6-tube set with two stages of R.F.; storage "A" battery and Sterling 135-volt power unit.

J. S. MARTIN,  
2626 Euclid Avenue, Cleveland, Ohio.

## TOOK THE PRIZE

Editor, RADIO NEWS:

I was so impressed with the possibilities of your "All-Wave Circuit" in your April, 1928, issue, that I have been working steadily on it. I was so pleased with the result that I entered it in the show of the Montreal and District Radio Club held here recently. I am pleased to say that I was awarded third in class A; which I think you will agree was a creditable performance in such good company. I carried out the idea with panel, sub-panel and all parts, including Phasatrol and Tonatrol, in black bakelite; every part bolted firmly to sub-panel with brass bolts and nuts. This, with Ambassador push-pull transformers in blue and

(Continued on page 691)



Conducted by C. W. Palmer

We cannot supply blueprints of manufactured apparatus; only RADIO NEWS blueprints, which should be asked for on the coupon printed elsewhere. We cannot send magazines, books, dia-

grams, etc., C. O. D. Please read the instructions and do not use pencil or postal cards. RADIO NEWS sells no apparatus, does no custom building, and can not advise "the best set to buy."

RADIO NEWS readers send in every month an average of 5000 letters asking information on every phase of radio theory, construction and operation. We can only print the five or six replies which are of widest general interest.

those asking for sketches, diagrams, data, etc., should send TWENTY-FIVE CENTS FOR EACH QUESTION: failure to enclose this will cause delay. We cannot answer for this sum questions requiring original research, intricate calculation, or patent investigation; we cannot compare the merits of trademarked apparatus, or give constructional data on apparatus whose makers withhold it. We cannot undertake to answer more than three questions in each letter. If you inquire concerning a circuit which is not a standard, enclose a diagram to save delay.

Other letters will be answered by mail, if inquirers observe these rules: BE BRIEF: TYPEWRITE OR WRITE LEGIBLY IN INK ON ONE SIDE OF THE SHEET ONLY: ENCLOSE A STAMPED ENVELOPE ADDRESSED TO YOURSELF. Many letters are not readable. Simple questions will be answered free;

REPAIRING "B" POWER UNITS

(2320) Mr. J. R. Cliffman, Rochester, N. Y., writes:

(Q.) "I am a custom builder and repair man. In repairing sets I often encounter trouble in 'B' power units and, up to the present, I have never seen any information for locating trouble in these units. This is especially true of the units using the gaseous rectifiers; since there is no filament to tell when the tube is operating correctly."

"I am also at a loss when one tap of the unit will not supply any current, while the rest of the power unit works satisfactorily. I would appreciate any information that you can give me in this matter."

(A.) Although there are few causes for trouble in the standard "B" power units, trouble does occur sometimes; and a few simple tests will enable the experimenter to locate and correct it.

The diagram of the most common type of unit, employing the gaseous-conduction type of rectifier tube, is shown in Fig. Q2320. This diagram will be followed in making suggestions, although other types of units can also be tested by the same methods. Test with set connected:

No Voltage at a Given Tap

If no voltage can be read with a high-resistance voltmeter from one of the taps of the unit, the logical point to look for trouble is in the resistor bank. Then, if the trouble is not located, the parts should be tested back from this point until the defective part is found. When making the tests, first look at the rectifier tube to make sure that it does not appear to be damaged. Then make sure that current is flowing through the primary of the transformer.

An open-circuited or burnt-out resistor will result in no current flow at the tap that it controls; for instance, if the resistor R1 in Fig. Q2320 becomes open-circuited there will of course be no voltage at the "B+Det." tap. On the other hand, if R2 is broken, the detector voltage will immediately increase. In receivers of some types this would result in a decrease of the volume; while sets with regenerative detectors would get out of control.

The simplest method of locating a defective resistor is to connect a high-resistance voltmeter to each tap in turn. A meter of this type is almost essential when a unit of this type is used; both for measuring the output, in order to get the best results from a set, and for testing defective units. In the absence of a voltmeter, a 15-watt 220-volt electric-light bulb may be employed; it should be connected like the voltmeter, between the negative terminal and each of the positive terminals in turn. It should glow a dull red on the high and intermediate taps and, with the detector resistor turned all the way in, a dull glow should be obtained on this tap also. If the detector lights the bulb with brightness equal to that obtained from the other taps, the 10,000-ohm resistor (R2) is open or defective.

No Voltage from any Terminal

This trouble may be due to an open circuit in the windings of the power transformer or in one of the choke coils; or it may be due to a broken-down condenser in one of the filter circuits, or to a broken wire.

If the tap voltages are found correct and the

set does not operate well, the trouble may be due to the development of a defect in a by-pass condenser, or to a faulty construction of the unit, omitting a condenser where it is needed.

In testing for these breaks the following method

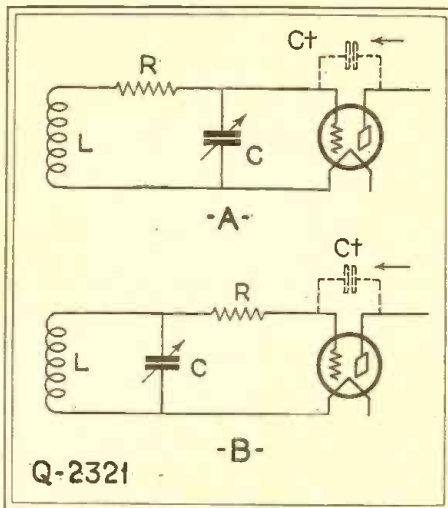

A resistance in the tuned circuit, as at A, broadens the tuning; while one outside it, as at B, does not affect selectivity, but "damps" oscillation through the tube capacity, Ct.

may be used. Disconnect the power supply from the unit; then connect a pair of phones, with a battery in series, between the plate terminal of the rectifier tube and the positive output terminal. (Remove the rectifier tube before testing these

circuits.) You should hear a click on making contact; and also, on testing, between either of the filament terminals on the rectifier socket and the negative terminal of the unit. The clicks from both of these binding posts should be of equal strength; if one is stronger than the other, the trouble is generally due to a defect in one of the buffer condensers (C5 and C6 in the diagram). If no click is heard from one terminal, either the secondary winding of the transformer is open or the center tap does not connect to the negative terminal.

The secondary winding of the transformer can be checked by first removing the tube from the socket and then connecting the primary of the power transformer to the line through a 25-watt 110-volt lamp, in series with one of the leads. If the secondary is in good order, the lamp will not glow at all, or a very dull glow may be seen. If the lamp glows brightly, either the secondary is broken down or one of the buffer condensers is short-circuited. On replacing the rectifier tube in its socket, the lamp in the primary lead will glow brighter. The buffer condensers should be disconnected, in order to test them separately. The test described above will also serve to gauge the operation of the gaseous tube since a poor tube will not show an increase in the light of the lamp.

A gaseous-conduction rectifier tube will usually give about 1,000 hours of service before trouble is encountered. When the tube becomes old, the output voltage gradually falls off and it is necessary to keep turning up the resistors to maintain the correct voltages. When the resistors can no longer be adjusted to give the required voltage, a new tube must be used. The gaseous tube becomes quite warm when operating correctly and this fact often serves to indicate whether or not the tube is in good condition.

Excessive Hum

This may be caused by a filter condenser's becoming open-circuited, or by an open lead to one of the condensers; it might also be due to a short-

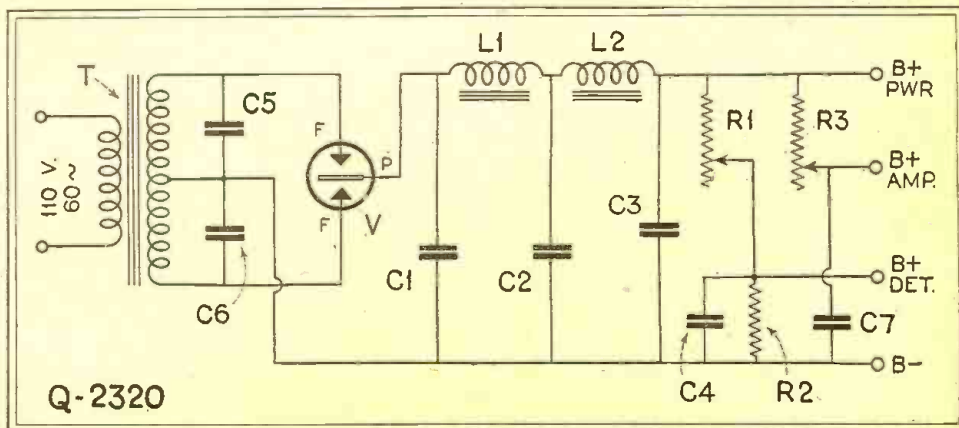

The circuit of a typical "B" power unit employing a gaseous rectifier tube. A brief study of this will determine what irregularity in the voltage at any terminal means. If a resistor breaks between a higher and a lower voltage, the voltage above increases; that below is cut off.

circuited choke coil or to the usual causes of hum in the receiver itself. The action of the choke coils may be tested by short-circuiting each of them in turn.

If both chokes are functioning correctly, the hum will be increased when either is short-circuited. If no difference is noted when one of the chokes is shorted, the connections should be checked and, if they are found correct, a new choke should be inserted. In some installations, although the power unit is in apparently good working order, the hum will be objectionable. In such case, it may usually be reduced by increasing the size of the filter condensers, C2 and C3.

The electrolytic condenser is particularly adapted to this purpose because of the high capacity of condensers of this type, compared to their size. The electrolytic condensers should be used to replace the paper condensers or connected in parallel with the filter condensers already in the unit, if this is more convenient.

**GRID SUPPRESSORS**

(2321) Mr. A. B. Webster, Washington, D. C., writes:

(Q.) "I have noticed that quite a number of sets are using resistors connected in the grid circuits, to prevent them from oscillating. It appears to me that this would reduce the amplification and efficiency of the set a great deal. Is this correct, or is my statement incorrect? Can you explain the action of these resistors?"

(A.) The "grid suppressor" is a very much misunderstood device. Some people class it with the "losser" methods of controlling oscillation in R.F. amplifiers, but strictly speaking it is not in this category. In "losser" systems, the resistance

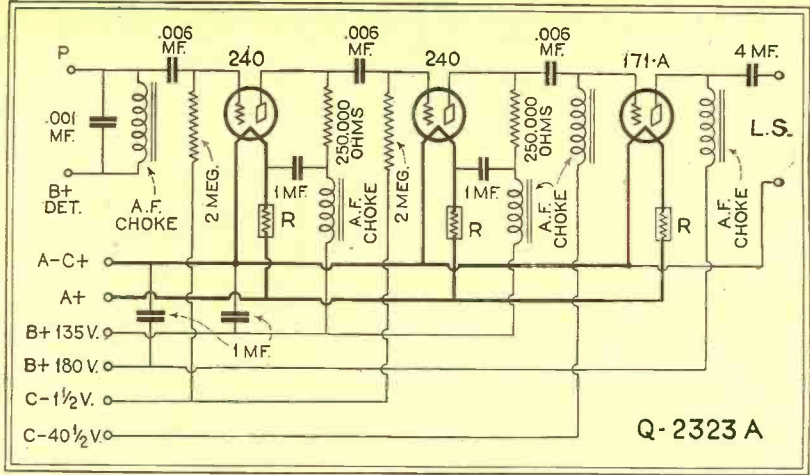

This resistance-coupled amplifier with two high-mu tubes in the first two stages is designed for high quality and well adapted for television work; the chokes prevent "motorboating."

the current developed by the normal regenerative action of most R.F. circuits. This current, which starts in the plate circuit of each tube, flows back into the grid circuit through the small

Fig. Q. 2321A) connected in series with the tuning coil and condenser (L and C) will accomplish this wasteful purpose and, incidentally, will tend to broaden the tuning very considerably.

If we move this resistor out of the actual tuned circuit, and place it between that circuit and the grid of the tube (Fig. Q.2321B), its action becomes altogether different. It is now directly in the path of the troublesome feed-back current which is coming through the tube capacity Ct, and limits the flow of that current before it gets to the oscillatory circuit LC.

Notice that the resistor, not being in the oscillatory circuit proper, does not affect its tuning characteristics in the least. The "suppressor" is actually in series with the almost infinitely high resistance formed by the grid and filament in the tube, and its few hundred ohms resistance is of little consequence.

The value of the grid suppressors in any receiver depends, of course, on the tendency of the circuits to oscillate. The purpose of the resistors is not to eliminate entirely the feed-back current, but merely to suppress it, as their name indicates. A limited amount of feed-back is highly desirable, as it increases the sensitivity of the receiver a great deal.

Suppressors usually range in value between 200 and 1,000 ohms. It is practically impossible to recommend specific values for particular sets or circuits; the only thing to do is to try different values until the receiver becomes stable in oscillation.

The resistors must be of the non-inductive type. Those sold for the purpose are identical in appearance with grid leaks, and fit in standard clip-mountings.

**ATWATER KENT CIRCUIT**

(2322) Mr. H. Webb, Yonkers, N. Y. writes:

(Continued on page 693)

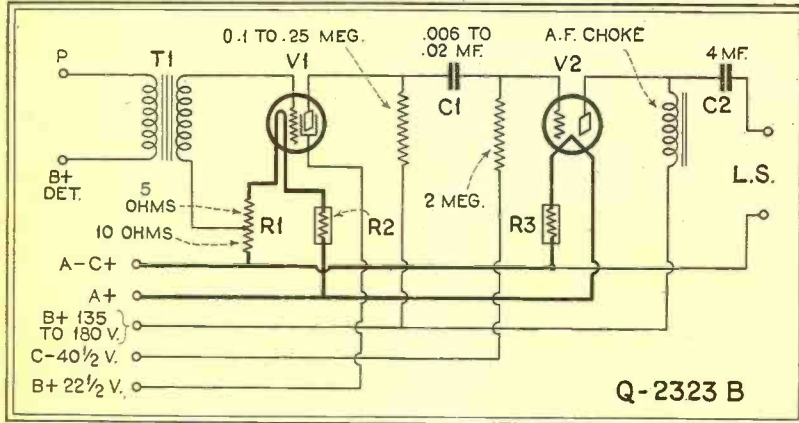

This amplifier, with the amplification factor of a screen-grid A.F. tube, will give an extremely flat frequency curve. R1 is tapped for the right grid bias; R2 is about 6 ohms.

of the tuned circuits (comprising the secondaries of the R.F. transformers and their associated variable condensers) is deliberately raised to such a value that the circuits cannot oscillate by their own resonance; in spite of the fact that they tend to do so because of the "shocking" effect of

capacity formed by the grid and plate elements (Ct in Q. 2321A) of the tube itself. When the feed-back current gets into the oscillatory circuit formed by the transformer secondary and tuning condenser, it merely dissipates itself in the high resistance of that circuit. A simple resistor (R in

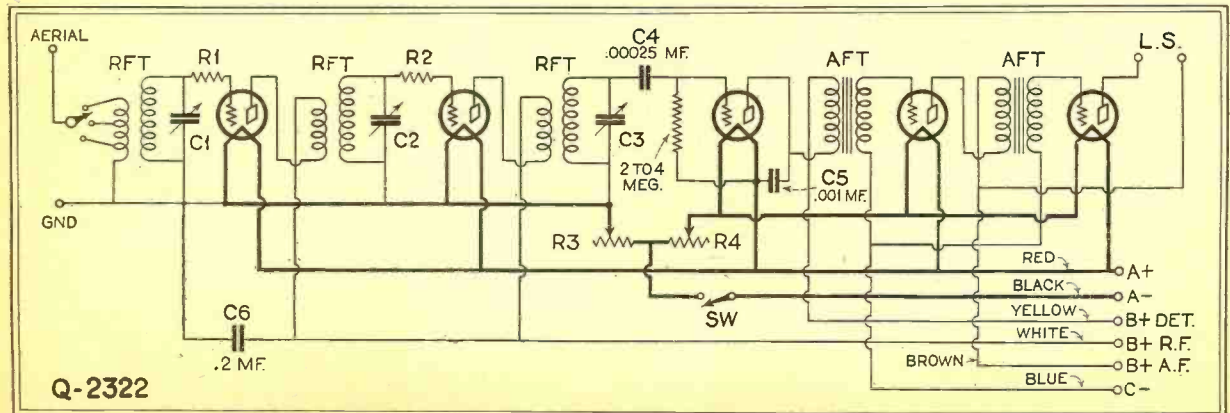

The Atwater Kent "Model 20," one of the most popular receivers ever built, in its day, used the circuit shown above. In the July, 1928, issue of RADIO

NEWS (page 44) will be found an article on adapting this receiver to modern conditions with an added power stage for a large cone speaker.



# THE NEW 5000 HOUR ELKON METALLIC RECTIFIER FOR "B" ELIMINATORS

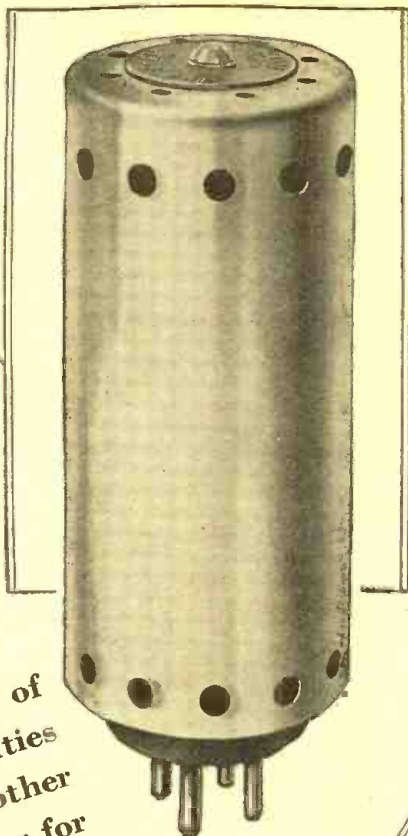

At last a dry high-voltage rectifier! All of the advantages of a tube—none of its frailties—much longer life—more efficient—smoother power—no noise—now as perfect a rectifier for the "B" end as the Elkon "A" Rectifier—stand the Elkon Rectifiers are Self-Healing—surges or accidental overloads are automatically taken care of—no permanent injury is done.

The Elkon EBH replaces BH type tubes in "B" Eliminators. Simply take out the fragile 1000 hour tube and plug in the husky Elkon EBH 5000 hour Rectifier. Same characteristics, but what an improvement.

Use the Elkon EBH Rectifier! Eliminate all uncertainty of life, of successful operation. Build your own new "B" Eliminator or convert the one you have to up-to-the-minute radio efficiency.

**ASK ABOUT THE OTHER ELKON RECTIFIERS, TOO**  
M-16 for "A" Eliminators and 3 ampere chargers.  
Y-4 for trickle chargers— and the authorized Bulrite Replacement Rectifiers  
BNK and BJ.

Radio Department  
**ELKON, Inc.**  
Division of P. R. Mallory & Co., Inc.  
350 Madison Avenue, N. Y. C.

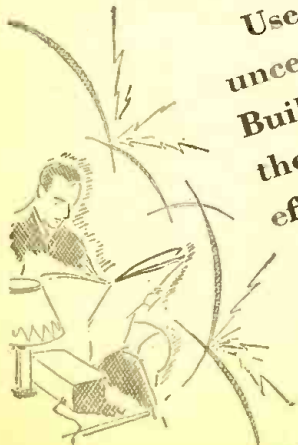

ELKON, Inc., Dept. E-26  
350 Madison Avenue, N. Y. C.  
Kindly send me complete information on Elk on Quality Radio Products.

Name .....  
Address .....

Please say you saw it in RADIO NEWS

Actual Movie Films we supply you, showing electrical machinery in operation and animated diagrams, make electricity easy to understand.

## Learn ELECTRICITY by Actual Movies

REAL moving pictures, in your own home, make the facts about electricity easy to grasp and fascinating as seeing a movie in your favorite theatre! You learn quickly, prepare for a big pay job in this ever-growing field.

### Everything Supplied, No Extra Cost

Standard DeVry Movie Projector, so simple anyone can operate it immediately without experience. Used with regular light connection, farm lighting equipment, or auto battery. Thousands of feet of film—all supplied to every student at no extra cost.

### Only School Using Real Movies

Nowhere else can you get real movie instruction in your home. Electricity, automotive electricity, and drafting all included in this wonderful course. Prepares you for all kinds of electrical work in aviation, radio, switch-board, power plant operation, contracting, etc.

### A Better Job at Bigger Pay

We pledge to give you the training and employment service which helps you get a better job and more money or you need not pay a cent. The moment you enroll we begin helping you make your training count in more dollars. Employment service gets you in touch with employers who want Film-Way trained men.

### Drafting Set Given

Complete professional outfit, including fine set of instruments, drawing board, rules, scales, etc., everything needed for drafting work included in this course given at no extra cost.

**FREE** THREE Lessons and our new book "The Film Way to Bigger Pay"

Get in the big pay ranks. Send the coupon for information about this new, easier way to learn electricity.

You Use This DeVry Projector

The NATIONAL SCHOOL of  
**VISUAL EDUCATION**

"The Film Way to Bigger Pay"

537 S. Dearborn St., Chicago, Ill., Dept. 1-D

Without obligation, send three free lessons and your new book, "The Film Way to Bigger Pay"

Name.....

St. or R.F.D.....

City.....

State, County.....

## What's New in Radio

(Continued from page 629)

word "Volume" is neatly etched over a mahogany knob controlling the resistance; and the word "Radio" over the midget plug mounted under the control. Series wiring is used between receiver and volume control, requiring only two posts for connections.

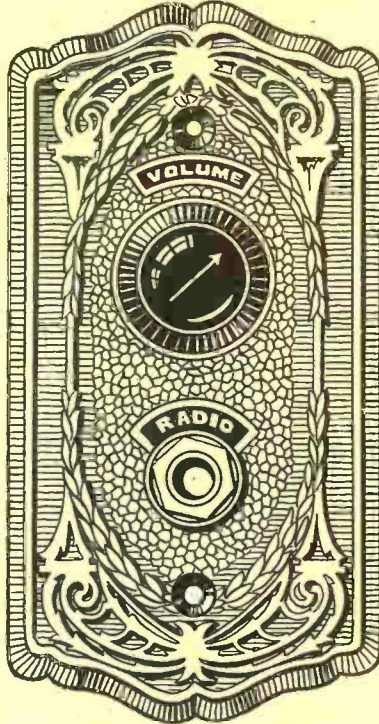

This attractive wall fixture provides a connector for any room in which a loud speaker is to be operated by a remote-control receiver.

Manufacturer: Carter Radio Co., Chicago, Ill.

### A Line-Voltage Safeguard

A NEW device, the use of which owners of receivers using A.C. tubes will find valuable as a protective measure, is now being marketed in a convenient form. The object is a highly nickeled plug-in instrument with a self-contained and variable resistor intended to reduce the line voltage, should it be too high. This instrument is cleverly designed as to appearance and operation, and has the advantage of being inconspicuous, a factor generally desired by the average set owner, as well as convenient to adjust.

Manufacturer: The Wirt Company, Philadelphia, Pa.

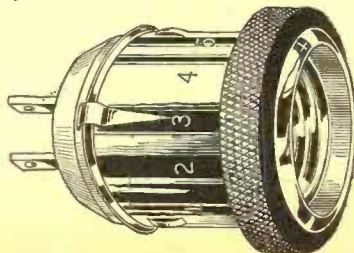

A very handy voltage control which plugs into the light-socket operating the set.

## Broadcastatics

### OF THE HARD-BOILED VARIETY

THE BUTCHER:  
"What can I do for you this morning, sir?"

ELDERLY CUSTOMER: "My wife told me to stop in and get some meat for dinner; and I thought for a change we would try a pound of that radio 'ham' I have read about so often."—Alfred M. Spaner.



### NO OLD STOCK

MRS. FAX (who is doing a bit of shopping for hubby on the side): "I want to buy a radio battery, too."

CLERK: "Storage?"

MRS. FAX (indignantly): "No, of course not! I want a good fresh one!"

—Melvin Nordstrand.

### HE KNEW HIS RADIO

TEACHER OF ALGEBRA (to inattentive student): "Johnny Jones! What is the result if I add minus A to plus A?"

JOHNNY (whose dad is a set builder): "I know, Miss Cyphers! A short circuit!"—Michael Cherkolo.



### HOW TIMES HAVE CHANGED

IN 1924: "Gee, that's a fine radio you've got: sounds like a phonograph."

IN 1928: "Say, that phonograph's the cat's, all right; sounds just like the radio."—Leo Hostensky.

## 40 Non-Technical Radio Articles

every month for the beginner, the layman and those who like radio from the non-technical side.

SCIENCE AND INVENTION, which can be bought at any newsstand, contains the largest and most interesting section of radio articles of any non-radio magazine in existence.

Plenty of "How to Make It" radio articles and plenty of simplified hook-ups for the layman and experimenter. The radio section of SCIENCE AND INVENTION is so good that many RADIO NEWS readers buy it solely for this feature.

Radio Articles Appearing in  
January Science and  
Invention Magazine

SURVEYING BY RADIO  
APARTMENT HOUSE AERIAL

—By S. R. Winters

A.C. SET HINTS—By Paul L. Welker  
NEW RADIO DEVICES  
RADIO ORACLE  
LATEST PATENTS

Please say you saw it in RADIO NEWS

FACTORY TO YOU—SAVE 50%—COMPARE WITH COSTLIEST OUTFITS BEFORE YOU BUY

# Enjoy a powerful new Miraco <sup>set or complete outfit</sup> 30 DAYS FREE

AC Electric or Battery

**3 Year Guarantee**

**Get Our Send No Money 9th Anniversary Offer!**



**Built like, Looks like, Performs like a \$200 set**  
 Marvelous new 3-year guaranteed, lighted 1-dial control. All metal Super Shielded Miraco set, removed from cabinet. Front switch, phonograph pick-up connection and all latest features. Built in power section on AO models.  
**The Latest, Finest and Costliest Construction**

**\$49<sup>88</sup>**  
 COMPLETELY ASSEMBLED

8 tube *one dial* Electric Lighted

# MIRACO

TRADE MARK REGISTERED

**CATHEDRAL TONED, SUPER SELECTIVE, POWERFUL DISTANCE GETTERS**

Celebrating its 9th successful year, America's big, old, reliable Radio Corporation springs a genuine sensation in high-grade sets. With its latest, Super-powered, 1-dial Miracos—the All Electric wholly self-contained, hum-free, AC-8 and AC-9, using AC tubes or the new 8-tube models

hum-free operation, tremendous "kick" on distant stations and razor-edge selectivity—with its costly sturdy construction, latest features, including phonograph pick-up connection, ease of tuning, beauty, and economy—a Miraco will make you the envy of many whose radios



**AC-8—\$71.50**

Unbeatable value in a 3-year guaranteed Super Shielded Metal Chassis.



**Also New, More Powerful Battery Sets**

The newest and latest in battery operated sets, designed with same advanced features used in electric sets! Same wide choice of cabinets. Highest quality, amazingly low priced!

cost 2 to 3 times as much! Many thousands of Miracos—bought after 30 day home comparisons—are cutting through locals and getting coast to coast with the tone and power of costly sets, their delighted users report. Miracos are laboratory-built with finest parts, and embody 9 years' actual experience in constructing fine sets. Approved by Radio's highest authorities.

**Deal Direct with Big Factory**  
 Everything reaches you splendidly packed and rigidly tested to insure your instant enthusiasm. Enjoy the outfit 30 days—then decide. Liberal 3-year guarantee on each set. Play safe, save lots of money, and insure satisfaction by dealing direct with Radio's old, reliable builders of fine sets—9th successful year.

for batteries or Eliminators—you are guaranteed values and savings unsurpassed in the fine set field. Compare a Miraco with highest-priced radios, for 30 days in your home. Surprise and entertain your friends—get their opinions. Unless 100% delighted, *don't buy it!* Return everything—the complete outfit—at our expense. Your decision is final—absolutely!  
 Only exceptionally fine radios, of the very latest approved type, at rock-bottom prices, could possibly back up so liberally unconditional a guarantee. Send coupon now for **Amazing Special Factory Offer!**

**Don't Confuse with Cheap Radios**  
 With its rich, clear Cathedral tone,

**Miraco Outperforms 'em All In Chicago**  
 On the Miraco Unitone, to start with, will say: I got to date 61 stations outside of Chicago, from the Pacific Ocean to the Atlantic Ocean, and from Anchorage, Alaska, to the Gulf of Mexico, and I tried the set with 3 different antennas. That is an outside aerial 152 feet, an inside aerial 20 feet, and

light socket. I want to say that your set does outperform the other sets I have. I put it up against a World Record Super 9 and beat that one. Then I put it up against a (names expensive make), and beat that one. Next I put it up against a Neutrodyne and beat that one. HARRY KOPP, 6555 South Peoria Street, Chicago, Illinois.

**MIDWEST RADIO CORPORATION, 404-RJ Miraco Building, Cincinnati, Ohio**

**BEAUTIFULLY ILLUSTRATED CATALOG, AMAZING SPECIAL FACTORY OFFER, TESTIMONY OF NEARBY USERS**—All the proof you want—of our honesty, fairness, size, financial integrity, radio experience and the performance of our sets—including Amazing Factory Offer—sent with catalog.



**Free!**

**MIDWEST RADIO CORPORATION**  
 Pioneer Builders of Sets—9th Successful Year  
 404-RJ Miraco Bldg., Cincinnati, Ohio

**THIS COUPON IS NOT AN ORDER**

WITHOUT OBLIGATION, send free catalog, Amazing Special Factory Offer, testimony of nearby users, etc.  User  Agent  Dealer  
 Check here if interested in an EXCLUSIVE TERRITORY PROPOSITION  
 NAME ADDRESS

**NEW LOW FACTORY PRICES SAVE 50%**

**Wide Selection of Beautiful Cabinets AC or Battery Sets**

**30 DAYS HOME TRIAL**

Richly designed, genuine walnut console of finest type. Electro-dynamic or magnetic power cone, or long air column speaker. Marvelous value.

A popular walnut Hi-Boy Console, with drop-leaf desk. Beautiful two-tone finish. Rare bargain!

Beautifully graceful Spinnet console, genuine two-tone walnut. Choice of speakers. Also comes in Electric Phonograph-Radio Combination.

A new-type arm-chair console. Genuine walnut. Very pretty. Low priced. Electro-Dynamic or Magnetic-Power Speakers.

At right, a Lo-Boy console, walnut finish, that costs little. A gem!

Above, popular inexpensive combination. Set on Table Speaker (sold separately).

Metal or wood compact style cabinets. Wood cabinets in walnut or new shaded silver-chrome finishes. Cathedral Electro-Dynamic or Magnetic-Power Speaker to match!

## Until You Have Heard the 1929 A.C. Victoreen

You Have Not Heard  
The Best



This marvelous new Super Circuit, developed and perfected in the Victoreen Laboratory, is by long odds the most sensitive and selective ever offered the set builder and radio "fan." It literally bristles with new features, any one of which would be considered sensational in an ordinary circuit.

By all means have a new Victoreen, if you want to enjoy real radio reception. Either build it yourself in a few pleasant hours, or have it built for you. It will bring you distance, selectivity and tone quality such as you have never known before.

Part of the wonderful improvement is due to changes in the circuit itself, and part to the redesigned R.F. Transformers. These Transformers, tuned and matched to a precision of 1/3 of one per cent, are years ahead of their time. They perform equally well in either the A.C. or D.C. circuits.

### Blue Prints FREE

Together with full constructional data. We've made it easy for anyone to assemble a Victoreen. State whether you are interested in the A.C. or D.C. circuit.

To get the utmost in results  
from any receiver, use the new

### VICTOREEN "B" Power Supply

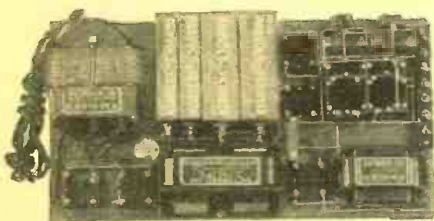

Here is the last word in "B" Supply and Power Amplifiers. Uses either a UX 250 or 210 in the last stage. Two voltage regulator tubes accurately control the 90 and 180 volt taps, thus making possible accurate determination of proper "C" voltages. There is also a 0 to 90 volt tap, variable; also 450 volts for the power tube.

BLUE PRINT IS FREE, together with list of parts and complete assembly instructions. Write for it today.

The George W. Walker Company  
Merchandisers of Victoreen Radio Parts  
2825 Chester Ave., Cleveland, Ohio

# Victoreen

Quality Radio Parts

## Home-Made Dynamic Speakers In Favor Abroad

"HOW can I make a loud speaker of the dynamic type?" This question is being asked with increasing frequency by readers of RADIO NEWS, whose letters plainly indicate that there is considerable interest in the subject.

The answer is that *you can't unless you have a complete set of special iron castings for the framework.* Once you obtain such castings, the rest of the construction will present no difficulty if you possess a high degree of patience and a fair amount of skill in the handling of ordinary hand tools. You will have to wind an endless lot of fine wire on one of the castings for the field magnet, and you will have to mount the cone and its attached moving coil rather carefully; but there is nothing particularly complicated about these operations. The problem is to get the castings.

In Great Britain several radio manufacturers have found it profitable to put complete sets of castings for dynamic speakers on the market and, according to the British radio magazines, many constructors have successfully assembled very satisfactory reproducers. However, in the United States the effective demand for such castings is not yet heavy enough to encourage manufacturers to go into production on them. If any manufacturer should decide to make them available for the benefit of individual radio fans, RADIO NEWS will be glad to inform its readers thereof. Meanwhile, the only answer to the question from an American fan, "How can I make a dynamic speaker?" is "You can't."

## Latest Developments In Television

(Continued from page 631)

terwoven and overlapping spirals are produced each second, producing in the receptor using neon glow-lamps a luminous or glowing field, with sectional variations depending on the intensity of light impressed upon the corresponding photoelectric cells at the transmitter by the reflected object.

"A model developed in the laboratory is approximately 18 inches in diameter, with a sphere of vision 10 inches in diameter. Careful study has revealed the fact that, when the revolving disc turns upon its axis at a speed of 1,000 r.p.m. and the fork hub carrying same revolves at 3,600 r.p.m., the five cells individually and separately will pass through the sphere of vision and make 18 complete spirals per revolution; a total of 18,000 spirals per minute or 300 per second."

This system sounds very interesting, but it also appears to be rather complicated from the mechanical standpoint. As soon as further data on it are released or demonstrations given, RADIO NEWS will report them in full detail.

### INCREASING PHOTOELECTRIC-CELL EFFICIENCY

With the newly-created interest in television, as well as in sound-reproducing films and other developments calling for the translation of light intensities into corresponding electrical intensities, the photoelec-

tric cell has become an object of more than usual interest on the part of designers of vacuum tubes. The huge ten-and twelve-inch cells formerly found necessary for efficient television transmission are giving way to comparatively tiny ones—only two and three inches in diameter, but possessing equal or, in some cases, superior light-sensitivity. The advent of these cells will mean a considerable reduction in the size and expense of television machines, and an advantageous increase in their range and flexibility.

In a new experimental television transmitter constructed by John Geloso, who is responsible for WRNY's successful television, four three-inch cells are used with a system of reflectors which makes them as responsive as the big twelve-inch cells now in regular use at WRNY. The reflectors are of polished metal, about eight inches in diameter, and look exactly like automobile headlights without the front lenses. A cell is mounted at the *focus* of each reflector, with its sensitive side ("window") facing the surface of the latter, and with its opaque side facing the person being televised.

As the television is of the "indirect-spotlighting" type (see definition in a previous paragraph) the light reflected back from the subject hits the polished surface of the reflector, which in turn throws it into the photoelectric cell. As the light-gathering surface of the reflector is considerable, the small cell produces an output equal to that of the larger cells. Several views of this transmitter are shown on pages 630 and 631. The apparatus was exhibited at the Electrical Show held in New York last October, and proved to be one of the main attractions of the show.

### FOREIGN TELEVISION ACTIVITIES

In Great Britain the company exploiting the inventions of John L. Baird, the noted Scotch television expert, has displayed a number of complete television receivers intended for the commercial market; but just what any purchaser can do with them, in the absence of actual television broadcasting, is highly problematical. The company has definitely promised a television service but, because of the peculiar status of broadcasting in Great Britain, we do not see how it can proceed with its plans until either the British Broadcasting Corporation or the British Post Office changes its mind.

The British Broadcasting Corporation, universally known as the B. B. C., has a monopoly on broadcasting in England,

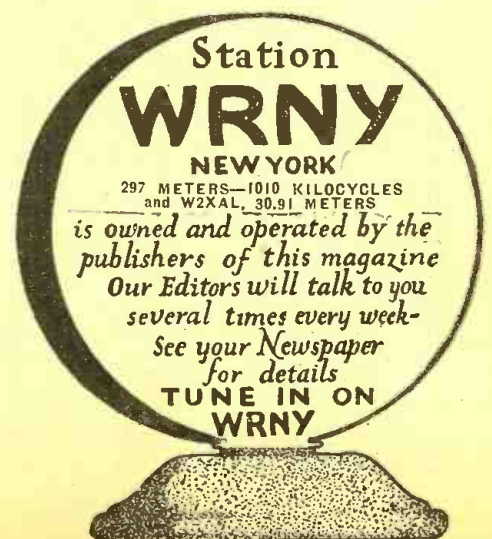

Please say you saw it in RADIO NEWS



# AVOID STATIC- DISTORTION- INTERFERENCE-

## Now Make Your Radio Clear As a Bell With Marvelous New Underground Aerial!

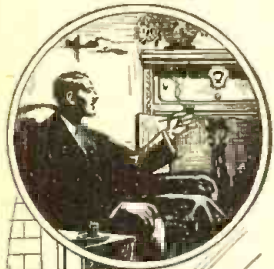

Did you know that radio waves go through the ground just as they do through a building? If you had your set down in a deep mine, you'd get the program just as you do at home! In fact—and here's the surprising discovery that is revolutionizing radio reception—you'd probably get much better results. Scientists say that when the receiving antenna is below the surface of the ground, the earth absorbs practically all the static and other interference, and allows practically only the clarified tone to reach the set. Starting from that important fact, radio engineers worked out the SUB-AERIAL. Set owners everywhere are now enjoying real radio pleasure with this marvelous new invention.

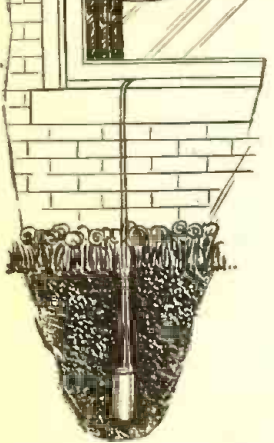

### How SUB-AERIAL Works

Anyone can install the SUB-AERIAL in a few minutes. Simply bury it about two feet below the surface of the ground and bring the lead-in wire to your set. SUB-AERIAL then takes the radio waves from the ground and brings them to you sweet toned and clear as a bell. Howls and shrieks due to static-laden air conditions are reduced and your *real* radio enjoyment begins. SUB-AERIAL never needs to be touched again.

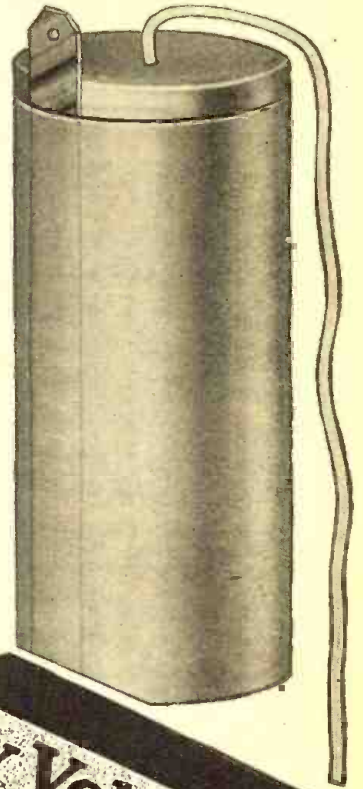

### PROOF

Test after test has been made with SUB-AERIAL with amazing results. Radio engineers, magazines and fans heartily endorse SUB-AERIAL.

May 8th, 1928.  
"I am very glad to state that after testing many aerials in my Laboratory I find your Sub-Aerial is the best for clarity of tone and elimination of static, also for greater volume and selectivity."

"Your Sub-Aerial will fill a long-felt want among the Radio Fans."

A. B. Johnson,  
Radio Engineer.  
August 31st, 1928.

"I received my Underground Aerial all O. K. It has any aerial beat I have ever seen. I have used every aerial on the market since I have been a radio fan. The first day I installed it I got distant stations that my set had never touched before. It wasn't good radio weather either. I got stations in the East that I had never dreamed of getting and with absolute clearness and without static or interference. I heartily recommend your instrument to any lover of good radio reception."

A. N. Whitane,  
Box 665, El Reno, Okla.

### 25 Year Guarantee

Any SUB-AERIAL installed that proves defective either in workmanship or materials or which deteriorates within 25 years will be replaced free of charge; also we will pay \$1.00 for any such new replacement.

### TRY IT FREE!

Don't hesitate to send for SUB-AERIAL on Free Trial. You take no risk. When you get it, test it against your overhead aerial and compare the two. If you are not astonished at the difference—if SUB-AERIAL does not bring in reception with marvelous tone value, clear as a bell—if it doesn't give surprising volume and distance—if you are not more than satisfied you don't pay us a cent. Send coupon for the fascinating story of SUB-AERIAL. Do it NOW!



Mail This  
Coupon Today

**UNDERGROUND AERIAL SYSTEMS**  
St. Clair Bldg., Dept. 827-A.S. Cor. St. Clair & Erie Sts., Chicago, Ill.  
*Get Reception You've Always Wanted*

UNDERGROUND AERIAL SYSTEMS, Dept. 827-A.S.  
St. Clair Bldg., cor. St. Clair & Erie Sts., Chicago, Ill.  
Send me complete information on Sub-Aerial and Free Trial Offer. No obligation.

Name .....  
Address .....  
City .....  
State .....

# with SUB-AERIAL



## Cunningham RADIO TUBES

carry you safely  
to all "Front-  
page" events

With a new, wide-  
awake Cunningham  
Radio Tube in every  
socket of your set you  
are "among those  
present" whenever  
and wherever things  
happen. With these  
faithful sentinels on  
duty, you are reli-  
ably radio-informed.

Look for the mono-  
gram  on the top  
of each tube and in-  
sist on them by name.

E. T. Cunningham, Inc.  
NEW YORK - CHICAGO  
SAN FRANCISCO

granted by the government. It has refused to co-operate with the Baird company because its engineers do not believe that Baird's system has reached the stage where it can be considered a public utility. The Baird people have proposed to erect broadcast stations of their own, but the Postmaster General, who is charged with the administration of England's radio laws, has refused them the necessary license, on the same technical grounds presented by the B. B. C. As the Baird company displayed its machines at the recent annual London radio show, and has already issued printed catalogs, the situation is somewhat muddled.

The Baird company has a New York office, but little information about the company's American plants can be obtained from it. A secret laboratory, in which development work on the Baird system is being carried on, is supposed to exist somewhere in this city, but nothing definite is known about it. RADIO NEWS in the past has devoted a great deal of space to Baird's television achievements, and will continue to describe them if he releases the technical data on them.

In Germany, at the recent Berlin radio fair, the Karolus and Mihaly systems were exhibited and aroused public interest fully equal to that which huge crowds exhibited at the American and British expositions of television. Some illustrations of apparatus used by these methods appear on pages 636 and 637 of this issue.

### Tubes in a Class with the Pullman Cars

INVENTIVE progress is perpetually putting a strain on the corners of new words, as witness the increasing complexity of tubes. The new five-element tube, described in the October issue of RADIO NEWS, is now quite the latest fad among British experimenters. The "pentode," with an amplification of 60 to 80, must follow the detector, giving a single stage of audio with a powerful output. Its additional element, another grid next the plate, is at filament potential and prevents the return of electrons from that element. (This tube is not yet available in the United States!)

We now have as a possibility in a radio set the following:

- Monodes (one-element) .....Dial lights
- Diodes (two-element) .....Rectifiers
- Triode (three-element) .....Detector
- Tetrode (four-element)

Screen-Grid R.F. Amplifiers  
Pentode (five-element) .....A.F. Amplifier

If the same inventive genius continues to exert itself, we may have (6) hexodes, (7) heptodes, (8) octodes, and so on to the  $n+1$ st "ode."

But let us consider the further possibilities; the filament and plate are the "cathode" and "anode," as many know; and our British contemporaries suggest that the first grid is appropriately the "mesode" or middle element. This smacks of the geologist's vocabulary. How are we to name the multiple strata of grids which the tube of the future will have? Cenode, Eode, Pliode, Pleistode, Holode, and perhaps Jurassode and Silurode?

It is none too soon for the radio engineer to start dusting off his Greek dictionary, which has lain on the shelf since the last "dyne" was christened.

## EXCELLO Radio Consoles

Designed for Atwater-Kent, Crosley and all standard A.C. Receivers.



STYLE R-48  
Size 51 in. x 26 in. x 16 1/2 in.

Highest quality cabinet work, all panels five-ply walnut, doors matched butt walnut. Receiver compartment is sliding drawer; accommodates set and speaker. Walnut finish, hand rubbed.

At your dealers or write for complete catalog of many styles.

Excello Products Corp., 4832 W. 16th St.  
Cicero, Ill. (Suburb of Chicago)

## X-L LINK



List  
Price  
\$5.75

THE ONLY UNIT  
THAT COMPLETELY  
LINKS THE RADIO  
SET TO THE LIGHT  
SOCKET

Supplies the following to any receiver: Antenna and Ground from shielded light wires. Voltage Regulation protecting tubes and set. Double Socket provides outlet for Dynamic Speaker. Complete Fusing eliminates fire hazard. Control Switch for power unit set or Dynamic Speaker installed in a moment. No wiring or changes in set. Unqualifiedly guaranteed.

IF YOUR DEALER OR JOBBER CANNOT SUPPLY  
YOU ORDER DIRECT.

## XL Radio Laboratories

Dept. A, 1224 Belmont Ave., Chicago, Ill.

### Before Buying

Any "A" Eliminators

Write me about the discount card which enables you to purchase the new and improved

Knapp "A" Power Kit  
at a liberal discount.

The most complete "A" Power Kit ever offered—Address for details of plan—

David W. Knapp, Pres.  
Knapp Electric, Inc.

Room 417, 350 Madison Ave., N. Y. C.

Insure your copy reaching you each month. Subscribe to RADIO NEWS—\$2.50 a year. Experimenter Publishing Co., 230 Fifth Ave., N. Y. C.

# WHOLESALE PRICES

for Dealers, Community Set Builders, General Repairmen and Agents!

NEW ISSUE!  
JUST OFF THE PRESS!

BIG PRICE CUTS

New 75 HOOKUPS  
1500 ILLUSTRATIONS



Our new, HUGE 260 PAGE WHOLESALE CATALOG No. 19 enjoys the enviable distinction of being universally accepted by the RADIO TRADE in the same manner that a school treasures the Dictionary and Encyclopedia Britannica—or the home the Bible and Almanac!!

The preparation and distribution of this MAMMOTH Catalog COSTS A TREMENDOUS SUM—the huge volume of business derived from it warrants this cost as well as the genuine pleasure it gives us to know that those “in the know” regard our catalog AS THE OFFICIAL ORGAN OF THE 1929 RADIO SEASON!!!

This FREE CATALOG is literally a most valuable ENCYCLOPEDIA—YOU cannot well afford to be without one—and, you do not have to. Your request for one is all that is needed! A day or two later, it is in your possession. Surely, a TEST OF OUR PROMPTNESS PLEDGE!

And we are right on the job, ready to supply television apparatus, too! We list more such parts than appear in any other Radio Catalog.

Those having No. 18 Catalog should immediately send for No. 19. ALL PRICES HAVE BEEN REDUCED TREMENDOUSLY!

We can supply any parts and kits described in this issue.

Send for prices at once!

THIS 260 PAGE RADIO CATALOGUE FREE

## BUY from Radio's Oldest Mail Order House!

In these many years we have been in the Radio Mail Order Business, we have learned from EXPERIENCE, how such an organization must be efficiently run in order to GAIN AND RETAIN THE GOOD WILL OF OUR CUSTOMERS. In this, our DETERMINED GOAL, RADIO SPECIALTY COMPANY OFFERS TO SHIP ALL ORDERS IN FROM 6 TO 24 HOURS—OFFERS YOU 100% QUALITY MERCHANDISE ON A STRICT MONEY-BACK BASIS IF NOT THOROUGHLY SATISFIED—AND OFFERS YOU ALL MERCHANDISE AT ABSOLUTE ROCK BOTTOM NET PRICES! Our employees—our executives, are all pledged to handle your every order and inquiry in an intelligent manner. Our 24-HOUR SHIPMENT SCHEDULE MUST BE UNSERVEDLY MAINTAINED! And to this pledge, we owe our daily increasing patronage. It will pay YOU to be numbered among our many thousands of customers! A trial is all we ask!

### "RASCO" has it

And, if we do not list in our catalog your Radio requirements, WE WILL OBTAIN SUCH PARTS, BILLING YOU AT THE USUAL TRADE DISCOUNTS!

OUR CATALOGUE CONTAINS THE LARGEST ASSORTMENT OF RADIO MERCHANDISE IN THE COUNTRY. Only the most successful manufacturers' products are listed—such lines as PILOT—SILVER-MARSHALL—CARTER—AERO—YAKLEY—TOBE—HAMMARLUND—AMETRAN—CUNNINGHAM—DONGAN—THORDARSON—MUTER, etc., etc. THE LATEST IMPROVEMENTS IN RADIO ARE LISTED AND THOROUGHLY DESCRIBED IN THIS GREAT CATALOG: A.C. ALL ELECTRIC Sets with self-contained ABC power supply—Public Address Amplifier systems—A.C. Set Converters—A and B eliminators—Dynamic Speakers and Units—Magnetic Speaker Chasses—250 Tube Amplifiers—Airplane Cloth Speakers—Push-Pull Tower Amplifiers—Electric Phonograph Turn-Tables—Combination Radio and Electric Phonograph Consoles—Speaker Tables—Short Wave Sets and Adapters—Shield Grid Tube Kits—Television Parts. LOGICALLY, HOW CAN YOU AFFORD TO BE WITHOUT OUR CATALOG—SEND FOR ONE NOW!



# Radio Specialty Co.



98W PARK PLACE, NEW YORK

Please say you saw it in RADIO NEWS

Thousands ~  
call **CeCo** the  
clearest toned  
longest life -  
tube on the  
market



...and it ought to  
be—here's why

THE finest materials skillfully  
employed by able craftsmen  
and the foremost laboratory ex-  
perts give CeCo marked advan-  
tages over other tubes.

They have not only a purer,  
clearer, more pleasing tone, but a  
longer, more serviceable life.

Try them! Sold everywhere.

CeCo Mfg Co., Inc. Providence, R. I.

**CeCo** Radio  
Tubes

The Radio Beginner-The  
"Bloopless" Two

(Continued from page 646)

It has been found that the best all-around  
aerial for broadcast reception is a single  
wire, 75 to 100 feet in length, and elevated  
50 or 60 feet above the ground. Either  
solid or stranded enamelled wire may be  
used—whether the gauge is 12 or 14 makes  
hardly any difference—with a strong recom-  
mendation of the solid wire if the aerial  
is to be erected in a congested area, such  
as a large city, where excessive acid-fumes,  
smoke and soot will eventually coat the  
wire with a high-resistance layer which is  
detrimental to efficient reception. Wherever  
possible, the aerial should be erected clear  
of any surrounding trees, buildings, etc.,  
and the same advice applies to the lead-in;  
which should come down from the aerial  
at a 45-degree angle rather than make a  
straight drop parallel to the side of the  
building.

It hardly pays to economize on insulators  
when these handy little articles mean so  
much toward an efficient installation. They  
should be used wherever there is possibility  
of any part of the antenna coming in con-  
tact with any section of the structure. Us-  
ing a piece of wood to keep the lead-in  
from touching the side of the building is  
nothing more than providing an excellent  
short-circuit for the aerial should it rain  
or snow. A piece of twine or rope, often  
used in place of a piece of wood, is just  
as bad.

Installing the ground should be in the  
nature of a ceremony. There is no doubt  
that the best ground comprises a number  
of large copper plates buried six to ten  
feet underground in moist soil. However,  
to the city dweller this may sound like sci-  
entification; in his case it is best to test every  
available pipe in the house to see which one  
gives the best results. For example, the  
average city home has water and steam-  
radiator pipes. Of the two, the water pipe  
is usually better; but this does not mean  
that the other should not be tried. It may  
be found that a certain combination wherein  
two are joined together is better than using  
only one. When connecting the ground lead  
to the pipe, try soldering it; though some  
difficulty may be experienced with iron pip-  
ing. When such is the case, an ordinary  
"ground clamp" will give good service if  
the section of pipe it is to be wrapped about  
is thoroughly cleaned and scraped until the  
bare metal shines. A ground clamp secured  
about a water pipe should be examined and  
cleaned at least every three months. (Warn-  
ing: do not use the gas pipe as a ground.)

MURDER! HELP! POLICE!

SLUGGE: "The  
Mothproof Hosiery  
Co. is sponsoring the  
broadcast of the big  
fight tonight."

SLAMME: "Ah,  
putting the socks on  
the air, eh?"—Wm.  
G. Mortimer.

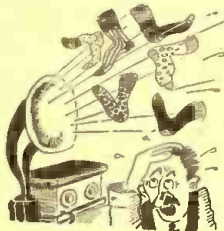

A TOP-NOTCHER

THE MUSICAL SAW: "That announcer  
thinks quite a bit of himself, doesn't he?"

THE UKULELE: "Rather! He won't an-  
nounce for a station unless they have an  
exclusive wave!"—Wm. G. Mortimer.

Make Your Set a Modern  
A. C. Power Receiver

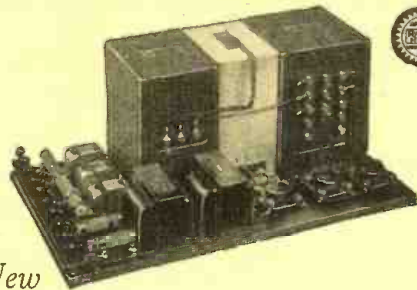

New

AMPLIPACK

A Complete A. C. Power Supply—"A" and "B" and  
"C"—Makes any D. C. Set into an Ultra-Modern A. C.  
Receiver. Uses two 210 type tubes in Push-pull; or  
one of the new 250 type tubes. Power Amplification  
gives perfect reproduction over the entire musical scale  
range.

QUICKLY ASSEMBLED

You can assemble an Amplipack easily  
in one evening. We supply complete  
layout diagrams. Simple to install.  
Attached to set in three minutes. Con-  
sumes no more current than an ordinary  
50-watt light. Cool, quiet, dependable.

ASK YOUR DEALER

Leading dealers can give you full details  
and our simple assembly diagrams.  
Don't be satisfied with out-of-date recep-  
tion—build an Amplipack tonight!

FREE  
Booklet

Write for our  
new Free Book-  
let—the latest  
word on Power  
Amplification  
and A. C. Con-  
version.

TRANSFORMER CORP. OF AMERICA

1428-1432 Orleans Street, Chicago, Ill.  
Manufacturers of the T. C. A. Line of Power Transformers,  
Audio Transformers, Chokes, Power Packs and Power Amplifier  
Packs.

**Wholesale  
Prices**

Tremendous stock and sales vol-  
ume, with rapid turn-over to the  
thousands of radio dealers we  
serve enables us to make you  
worthwhile savings at lowest  
wholesale prices. Write for lat-  
est, new illustrated Catalog "B-3"

**Allied Radio  
CORPORATION**  
711 W. LAKE STREET, CHICAGO

**More Profits To Set Builders**

One good radio idea may be worth  
millions. Barawik has thousands of ideas  
for radio set builders to make more money.  
Barawik's Big Radio Book will help you  
while elections are on and big national  
events stir the world.

Send for your copy today - NOW.  
**BARAWIK CO.** 21E Canal Station,  
CHICAGO, U. S. A.

Mail This Coupon Now! For Free Copy!  
Name .....  
Address .....



## Hints on the "Junk-Box"

(Continued from page 646)

between *regeneration* and *oscillation*. When the regeneration condenser C2 is turned up slowly, the operator will begin to hear a soft, "hushing" sound. At a critical point this "hush" will flare out into a quick "plop." Now, during those few degrees of condenser movement when the set is making the "hushing" sound, it is said to be *regenerating*, and in this condition it is extremely sensitive to voice and music signals. When the "hush" breaks into a "plop," the set is said to have started *oscillating*; that is, it is now generating radio-frequency oscillations or current of its own. These currents by mixing, or "heterodyning," with the radio-frequency currents picked up by the aerial and already present in the circuit, produce the whistles and squeals so characteristic of short-wave operation. The difference between regeneration and oscillation is one merely of circuit adjustment; but though the two conditions are very closely related, they serve two distinct purposes.

For the reception of voice and music signals, as transmitted by broadcast stations, the set should be regenerating as strongly as possible *without actually breaking out into oscillation*. It will not squeal when it is regenerating; if it does squeal, you may be sure it is then oscillating. Picking up distant short-wave broadcast stations is entirely a matter of the operator's skill in adjusting the regeneration control, in this case the little variable condenser C2. As remarked previously, the set may be thrown into oscillation and the incoming signal "zero-beat," but this requires a little practice.

To locate a broadcast station, the easiest thing to do is to throw the set into oscillation and then to hunt for squeals. As soon as one is heard, the setting of the tuning condenser should be carefully noted, and the regeneration condenser slowly turned down. As the set goes out of oscillation and back into regeneration, the squeal will disappear. With a slight readjustment of the tuning condenser, made as the regeneration control is juggled, the voice and music should become understandable. If the signals are very weak, zero-beating is usually the best thing to attempt.

### TUBES ARE TEMPERAMENTAL

Smooth regenerative action depends to a great extent on the characteristics of the particular detector tube used, the value of the grid leak, and the amount of "B" voltage applied to the plate of the tube. A number of tubes that seem to be identical in operation in regular broadcast receivers will be found to differ markedly when they are tried in a short-wave set. Some tend to break into oscillation quite violently; others refuse to oscillate at all. Before rejecting any one tube as unsuitable for use as a detector, the experimenter should try reducing or increasing the "B" voltage, and also grid leaks of different values. The original specifications for the set call for a three-megohm grid leak, but in many cases a five-megohm will work better.

Another trick that will often be effective to aid the regenerative action of the set is that of connecting a .001-mf. fixed condenser across the primary of the audio transformer. The self-capacity of the primary windings of most transformers is

# Yours FREE



## THE SHORT-CUT to BIG MONEY in RADIO

"WORTH over \$5,000 to me!" "Never so thrilled in my life!" "Never dreamed Radio was so easy to master!"

So scores of men write of this wonder-book which tells how to achieve brilliant success in Radio. Send for your copy—it's Free!

### Glorious New Opportunities

Radio needs you! Over 30,000,000 sets need servicing. Over 2,000 ships carry radio apparatus. There are 50,000 radio dealers, 4,000 radio manufacturers, scores of broadcasting stations. And now Television, trans-Atlantic Radio Telephony, and Photoradiograms open up brilliant new possibilities! The Free book tells all about them. It tells also how you can make your spare time prepare you for success through a revolutionary new method of training.

### Learn at Home with This Big Laboratory Outfit

You get the "how" as well as the "why" of Radio with this fine training. Only an hour a day—in spare time—is all you need to devote! As part of your course, you receive absolutely free of extra charge—a magnificent outlay of apparatus. With this outfit you learn to build fine sets and solve every problem in repair work. That is why our graduates have the confidence and ability to command big pay. That's why they're in big demand everywhere!

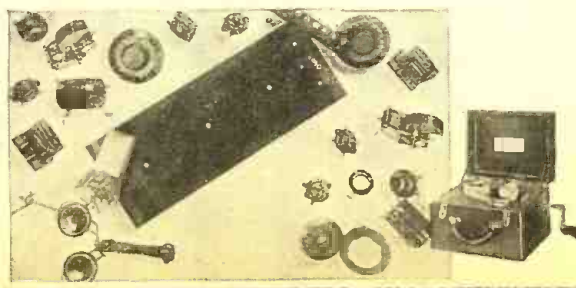

### Training Sponsored by RCA... General Electric...Westinghouse

Our graduates enjoy greater success because they're posted right up-to-the-minute in everything in Radio. Radio's greatest achievements originate in the gigantic laboratories of RCA, General Electric and Westinghouse. These three Radio organizations stand back of every lesson in the course.

### Money Back if Not Satisfied

The course prepares you for success in all phases of Radio—manufacturing, servicing, selling, ship and shore broadcasting, and many others. Includes Television, Photoradiograms, and radio equipment. A signed agreement assures you of complete satisfaction upon completion of the course—or it won't cost you a single penny!

Send for this Free book now. Why struggle along on less than \$45 a week? Why wait years for success that can be yours in only 9 months? Read this Free book. It gives you the real dope about Radio and tells you all about the famous course that has enabled us to place thousands of our students in fine positions, usually from 3 to 10 days after graduation! Mail coupon now. Radio Institute of America, Dept. WS-1, 326 Broadway, New York.

RADIO INSTITUTE OF AMERICA, Dept. WS-1, 326 Broadway, New York

Gentlemen: Please send me your big FREE 50-page book which tells about the great opportunities in Radio and about your famous laboratory-method of guaranteed radio instruction at home.

Name.....  
Address.....



# Dr. T. O'Connor Sloane will teach you **CHEMISTRY**

Right in your own Home



## Good Chemists Command High Salaries



**T. O'CONNOR SLOANE**  
A.B., A.M., LL.D., Ph.D.

Noted Instructor, Lecturer and Author. Formerly Treasurer American Chemical Society and a practical chemist with many well known achievements to his credit. Not only has Dr. Sloane taught chemistry in the classroom, but he was for many years engaged in commercial chemical work.

Industrial firms of all kinds pay tempting salaries to get the right men. Salaries of \$10,000 to \$12,000 a year are not unusual for chemists of exceptional abilities. Chemistry offers those who are ambitious and willing to apply themselves conscientiously the greatest opportunities of any vocation. Why be satisfied with small pay and hard, thankless work—learn the profession of Chemistry and your salary will depend only upon your own efforts and your own abilities.

The work of the chemist is extremely interesting. If you are fond of experimenting, if you like exciting and fascinating work, take up Chemistry. To the man who is dissatisfied with his present job, to the young man just deciding on his life work, Chemistry holds alluring charms and countless opportunities. If you want to earn more money, the way is open through our course in Chemistry.

### NOW IS THE TIME TO STUDY CHEMISTRY

Never before has the world seen such splendid opportunities for chemists as exist today. The war has awakened the United States to the need of trained chemists and chemical engineers. Everywhere the demand has sprung up. In factories, mills, laboratories, electrical shops, industrial plants of all kinds, chemistry plays a vital part in the continuation and expansion of the business. In every branch of human endeavor the need for chemists has arisen. No profession offers such alluring opportunities, and the next ten years are going to show the greatest development in this science that this country has ever seen.

Those who have the foresight and ambition to learn chemistry now will have the added advantages and greater opportunities afforded while the chemical field is growing and expanding.

## You Can Learn At Home

Ability to Understand Plain English the Only Requirement

Dr. Sloane will teach you Chemistry in a practical and intensely interesting way. Our home study course written by Dr. Sloane himself is practical, logical and remarkably simple. It is illustrated by so many experiments that are performed right from the start that anyone, no matter how little education he may have, can thoroughly understand every lesson. Dr. Sloane teaches you in your own home with the same individual and painstaking care with which he has already taught thousands in the classroom. He will, in addition, give you any individual help you may need in your studies. This personal training will be of inestimable value to you in your future career.

### Experimental Equipment Given to Every Student



We give to every student, without additional charge, this chemical equipment, including fifty pieces of laboratory apparatus and supplies and thirty-nine different chemicals and reagents. The fitted heavy wooden box serves not only as a case for the outfit but also as a laboratory necessary for performing countless experiments. Full particulars about this special feature of our course are contained in our free book "Opportunities for Chemists."

Don't Wait--Mail the Coupon NOW!

**CHEMICAL INSTITUTE of NEW YORK, Inc.**  
16-18R EAST 30TH STREET Home Extension Division 1 NEW YORK, N. Y.

### What Well-Known Authorities Say About Our Course

From Hudson Maxim:

"Dr. Sloane has done a much-needed work in a much better way than anything of the kind has, heretofore, been done."

"Dr. Sloane has a remarkable faculty of presenting Science for self-instruction of the student in such a clear and understandable way as to be most readily grasped and assimilated. I, therefore, unreservedly recommend and place my highest indorsement on his work."

From Dr. W. W. de Kerlor:

"I can not recommend your course too highly and I congratulate both you and Dr. Sloane on same."

From John A. Tennant:

"This is something which has long been needed. Your long experience in the teaching of chemistry... assurance that the course will be practical as well as plain to the untrained students."

### What the Students Say:

"Your course has been worth \$50,000 to my concern."

"This is just like reading some fascinating fiction story."

"I have just been made assistant chemist of my concern."

"You may be pleased to learn that I have re-entered the laboratory of my former employers as their chief chemist. The work under my care involves several hundred thousand dollars a year."

"I am going to keep right at the study, for it has helped me greatly. It is really the knowledge I have gained from it that made it possible to hold the job I have at present."

"Let me state that I have obtained a new and better position; this is with the Heller and Merz Aniline Dye Co. in their main laboratory. Thanks to your course I am well prepared and able to hold same."

"Let me state that I have obtained a new and better position; this is with the Heller and Merz Aniline Dye Co. in their main laboratory. Thanks to your course I am well prepared and able to hold same."

"I now have a fine position as chemist at the Du Pont Dye Works. It was thru your course alone that I have been so successful."

"I have written to different people about your course and they speak very highly of same."

"If I don't learn it isn't your fault for I find that your lessons contain a whole lot."

(Names and addresses on request.)

### DIPLOMA AWARDED TO EACH GRADUATE

Upon graduation each student is awarded our Diploma in Chemistry, certifying that he has successfully completed his studies. Your name on this certificate will be a source of pride to you all your life, as well as an aid to obtaining a position in Chemistry.

### Easy Monthly Payments

You do not have to have even the small price of the course to start. You can pay for it in small monthly amounts or earn it as many others are doing. The cost is very low, and includes even the Chemistry outfit—there are no extras to buy with our course. Write us and let us explain how you can qualify for a trained technical position without even giving up your present employment.

### MAIL THE COUPON FOR FREE BOOK

Your name and address on the coupon will bring you by return mail our interesting free book, "Opportunities for Chemists" and full particulars about the course and what it will do for you. You owe it to yourself to get this book. Send the coupon right now while it is fresh in your mind. Or just write your name and address on a postal and mail it to us. But whatever you do, act today!

**CHEMICAL  
INSTITUTE  
OF NEW YORK**  
Home Extension  
Division 1  
16-18-R East 30th St.,  
New York, N. Y.

Please send me at once, without any obligation on my part, your free book, "Opportunities for Chemists," and full particulars about the Experimental Equipment given to every student. Also please tell me about your plan of payment.

NAME.....

ADDRESS.....

CITY.....STATE.....

R. N.-1-29

Please say you saw it in RADIO NEWS

usually sufficient to by-pass the radio-frequency component of the detector plate current; but often the condenser will be a great help.

**AERIAL AND GROUND**

For short-wave reception the aerial need not be a very long one. In fact, a thirty-foot length of bell wire, thrown out of the window, will produce as good results as many longer and higher aerials, and will probably give less trouble with "dead spots" in the tuning condenser. As a matter of further fact, the "Junk-Box" outfit will work perfectly well without any aerial at all. When experimenting with the original coils for the set, the designer, who knows how to read radio code, picked up amateur stations all over the United States and Canada and from numerous foreign countries including Australia and New Zealand, all with the aerial post left absolutely unconnected. This reception was accomplished in New York City.

If the constructor does not wish to disturb the aerial he is using with his regular broadcast receiver, he can erect a fine aerial for the "Junk-Box" set by merely tacking some No. 24 magnet wire around the walls of his room, near the floor. Most directions for the erection of indoor aerials call for the picture molding as the best place to hang this wire, but it is a great deal easier to fasten the wire along the floor level, where it will work just as well. The regular insulation on the wire, if it is double-cotton, is sufficient protection against grounding.

The normal ground should be made in all cases, to the most convenient water or steam pipe. If such a pipe is removed several rooms from the location of the short-wave set, fasten the ground wire around the nearest electric-light fixture. This makes a rather good ground and, contrary to expectations, does not introduce hum in the receiver.

**THE CONDENSERS**

Hand-capacity effects seem to be giving some people trouble. With the rotors of the two small variable condensers properly connected to the filament end of the circuit, this should not be serious. Some types of condensers, however, are more troublesome in this respect than others. The easiest thing to do is to mount them on a sheet of brass or copper, about five inches long and three inches high, and "ground" this to the filament circuit. The sheet will replace the two L-shaped mounting brackets now supporting the condensers.

The aerial series condenser (C3) shown in the "Junk-Box" blueprints is so simple that many people actually do not understand how it is made. This sounds paradoxical, but it is true nevertheless. The condenser consists merely of two flat pieces of brass, facing each other. The plates are movable, so that the distance between them, and hence the capacity, may be readily changed. Any arrangement at all by which two pieces of metal, each about half an inch square, may be moved in relation to each other will be satisfactory. The setting of this tiny condenser is not critical, and will depend on the size of the particular aerial.

The "Junk-Box" receiver has proved to be one of the most popular radio sets *RADIO NEWS* has described during the ten years of its existence. More than nine thousand free blueprints showing its construction have been distributed to readers all over

**Now...4 or 6 Volts**  
with the  
**Improved**  
**Knapp**  
**"A" POWER**

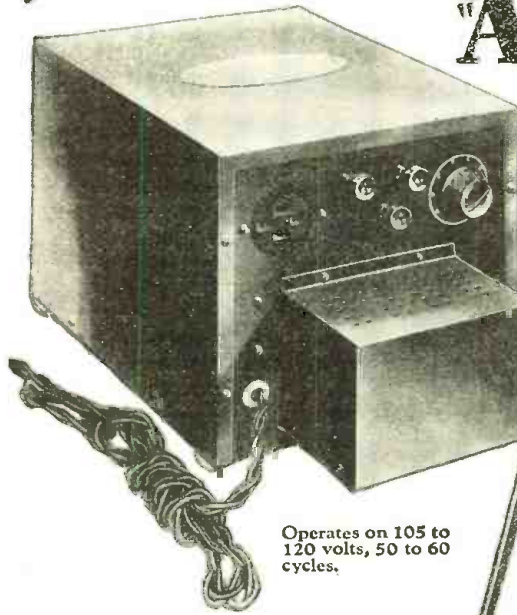

Operates on 105 to 120 volts, 50 to 60 cycles.

- 10**  
**Improvements**
1. Two taps for 4 or 6 volts operation.
  2. Larger filter system.
  3. Three Elkon Dry Condensers instead of two.
  4. Improved Choke Coils.
  5. Pendant Switch Controlling "A" Power, "B" Eliminator and Set.
  6. Dial for Regulating Voltage.
  7. Celeron Front Panel.
  8. Baked Finish.
  9. Heavier Gauge Metal Cover.
  10. Die Cast Base Plate instead of wood.

**The only "A" Power Suitable for all Sets**

**— Irrespective of number of tubes — including SuperHets, Short Wave and Television receivers**

**T**HE new Knapp "A" Power is designed for the most exacting service — super-hets, short wave and television receivers included. I knew that if it would perform satisfactorily with these receivers that there could be no question as to its efficiency on ordinary broadcast signals. The three Elkon dry condensers, the improved choke coils and the special Elkon dry rectifier make the difference between ordinary and Knapp performance.

**No Change in Price**

Even with these wonderful and costly improvements, there has been no advance in price—due to the tremendous volume going thru my plant. Remember that the Knapp is the fastest selling "A" Power on the market.



David W. Knapp, Pres.

**KNAPP ELECTRIC, Inc.**  
—Division of P. R. Mallory & Co., Inc.—  
350 Madison Ave., New York City

**See your dealer today**

Go to your dealer today. Most of the good ones carry the Knapp in stock. Do not accept a substitute—because only in the Knapp will you get full satisfaction as typified by the famous Knapp "A" Power. If your dealer cannot supply you send the coupon.

Mr. David W. Knapp, Pres.,  
Knapp Electric, Inc., Dept. K-26  
350 Madison Ave., N. Y. C.  
Send me complete information on the Knapp  
"A" Power.

Please say you saw it in *RADIO NEWS*

# Enjoy LOUD SPEAKER OPERATION from a CRYSTAL

NO "TUBES" - NO "B" BATTERIES - NO COSTLY "ELIMINATORS"

## WITH THE SKINDERVIKEN TRANSMITTER UNIT

Simple microphone unit provides a most effective and inexpensive way to satisfactory speaker operation. Easy to build and operate circuit.



Everybody can do this now with a Skinderviken Transmitter Unit. The unit is fastened to the diaphragm of the speaker unit. It will act as a "microphonic relay." Every time an incoming signal actuates the diaphragm, the electrical resistance of the microphone unit will be varied correspondingly and the current from the battery, in series with it and the loud speaker, will fluctuate accordingly. Thus the problem of securing sufficient power to actuate the loud speaker is simply and adequately solved.

The results from this very novel and simple unit will astound you.

The expense of this hook-up is trifling compared to the elaborate tube circuits that give no greater actuation of the speaker.

Besides this there are many other valuable uses in Radio Circuits for this marvelous little unit. Every builder of Radio sets should have a few on hand.

### LISTENING THROUGH WALLS

This Unit makes a highly sensitive detectaphone, the real thing—you listen through walls with ease. Plenty of fun and real detective work too.

### CONDUCTING SOUND THROUGH WATER

Make yourself a miniature submarine signaling apparatus like those used during the war. Simple circuit with this microphone unit gives splendid results.

12-PAGE INSTRUCTION BOOKLET containing suggestions and diagrams for innumerable uses, furnished with each unit.

### P. G. MICROPHONE TRANSFORMER



A Modulation Transformer specially designed for use with the Skinderviken Transmitter Unit. Has many other uses. Primary resistance, 1/2 ohm; secondary, 55 ohms. **\$2**

FOR SALE AT LEADING DEALERS

Or Order Direct, Using Coupon Below

## SEND NO MONEY

When the postman delivers your order you pay him for whatever you have ordered, plus a few cents postage.

PRESS GUILD, INC. R.N.-1-29  
16-18-R—East 30th St., New York, N. Y.

Please mail me at once as many of the following items as I have indicated.

... Skinderviken Transmitter Units at 95c. for 1; \$1.75 for 2; \$2.50 for 3; \$3.20 for 4.

... P. G. Microphone Transformers at \$2.

When delivered I will pay the postman the cost of the items specified plus postage.

Name.....

Address.....

City.....State.....

the world, and requests are still pouring in. A few blueprints are left; if you want to try your luck in the short-wave bands without spending more than about two dollars for a set, write in for a set of the Junk-Box prints. They are free, but you must use the coupon on page 701 of this issue. Check off Blueprint No. 58, and write your full name and address clearly.

## Human Radio Reflectors

(Continued from page 621)

ferent received strengths will therefore be obtained from different people. By bending over when approaching the transmitting aerial, the effect is greatly decreased, since the body has then a different natural frequency, and is also not so well exposed to the waves from the transmitting aerial.

In the May, 1928, issue of RADIO NEWS, the reader will recall there appeared an article which explained the temperature rise experienced by the human body when near a powerful ultra-high-frequency oscillator. This is due to the currents which are caused to circulate on the surface of the skin, and which cause heating if strong enough. Medical men have talked of producing artificial fevers in this way, but the apparatus is usually quite expensive. However, if the frequency of the transmitting set is adjusted to the natural frequency of the human body, a maximum effect will be produced and smaller powers can be used for a given result, thus simplifying the arrangement and reducing the cost.

It is a simple matter, too, to arrange a burglar alarm with two wires. This should be so arranged that the relay will remain closed, if once thrown. Moreover, the relay can be adjusted so that only a definite range of natural body-frequencies will cause operation. The expense is small, and the wires can be arranged inside the building; the presence of a body outside will operate the alarm.

Big-game hunters may desire, in the future, to use such a system. It would require a really clever animal to detect, at a distance, the presence of a small amount of electrical equipment. Such a system might be used to operate any other device by using suitable relays. It is interesting to think of the many other possibilities of this newly discovered effect.

## What is a "Dynamic" Speaker?

TO assist the public in its purchases of loud speakers, as well as to guide radio manufacturers, distributors and dealers in their advertising, the Radio Manufacturers Association has adopted the following definition of the "dynamic" speaker:

"A dynamic speaker is one in which a portion of the conductor carrying the alternating signal current is a part of the moving system, the force producing the motion being due to the location of this conductor in a magnetic field."

This definition was adopted by the R.M.A. at a meeting of its board of directors held in Chicago on October 11th, 1928, upon its presentation to the board by Mr. H. B. Richmond, director of the R.M.A.'s engineering division. It was developed by the committee on aural devices, of which Mr. Paul G. Andres is chairman.

# \$2,000,000

## and how the Hotel McAlpin is spending it.

An improvement program that will make the McAlpin a NEW Hotel—inside and out . . . .

Luxurious NEW carpets, draperies and furniture throughout—bright, cheerful, interior decoration—spacious, IMMACULATE rooms, all with modern tiled baths—high-speed, electric, self-leveling elevators—and a NEW type of courteous, efficient hotel service that enthralls the most critical guests.

We invite you to visit the McAlpin and inspect the NEW rooms—several of which are already completed.

All improvements are being effected without the slightest interruption of service.

FRANK A. DUGGAN  
President and Managing Director

# HOTEL M<sup>c</sup>ALPIN

ONE BLOCK from PENNSYLVANIA STATION  
B'WAY at 34th ST.

## FREE BOOK

New Hook-ups. This book shows how to make Short-Wave Receivers, and Short-Wave Adapters. How to use the new screen-grid tube in D.C. and A.C. circuits.

How to build Power Amplifiers, and ABC Eliminators. Up-to-the-minute information on all new radio developments. Set Builders, Fans, Dealers, send for it today!



Write for it!

KARAS ELECTRIC COMPANY 4038A1  
4038A1 N. Rockwell St., Chicago, Illinois  
Please send me your Free Book!

Name.....  
Address.....  
City.....State.....

Quality Apparatus  
Our latest bulletin No. 929 describing our complete line of quality apparatus is yours for the asking. Write for it today.  
GENERAL RADIO CO.  
30 State St., Cambridge, Mass.

Please say you saw it in RADIO NEWS

## Radio Wrinkles

(Continued from page 653)

a telegraph key and a triple-pole single-throw switch. After all connections are made as shown in Fig. 7 (page 653) open the three-pole switch, don the phones, turn on the filament current, hold down the telegraph key and turn the tickler control until the note is heard in the phones which is most pleasing to the code student.

The builder should be warned that this arrangement, with aerial and ground attached to the receiver, would be nothing less than a low-power transmitter, and as such come under the terms of the Federal law governing radio communication, which prohibits the sending of radio messages unless one holds both an operator's and a station license. So, even though you have an amateur's license, if you make use of this arrangement with a broadcast receiver and fail to open the three-pole switch, you are probably transmitting on a wave, anywhere from 300 to 600 meters, which is illegal for an amateur.—Contributed by Warren Tuthill, Orient, N. Y.

Our readers are invited to contribute ideas. A year's subscription to Radio News will be given in compensation for each accepted item. If the author of the wrinkle is already a subscriber, his subscription will be extended one year or he may accept a one year's subscription to Science and Invention or Amazing Stories, both published by the Experimenter Publishing Co.

### Dealing with Interference Inside the Building

THERE is no doubt that the following bit of information has been anxiously sought by many a harassed listener. Our contributor chanced upon a case where it was necessary that the set be located in a foyer which was within a few feet of an elevator, bringing about interference from that source, subsequently most unpleasantly apparent. After much moving about it was discovered that circumstances about the interior decorations made it quite impossible to place the set anywhere but in the foyer; whereupon invention as the child of necessity was called upon, with the following results:

An antenna coil was substituted for the loop and carefully shielded; an outside aerial erected as far as possible from the elevator. The lead-in consisted of BX (armored) cable, which was placed under the floor, and used only as far as necessary to get outside the zone of interference; the surface of the cable was grounded. This method was employed on an extremely sensitive superheterodyne, and no doubt will function equally as well on the average receiver. The only precaution necessary is to make sure that enough BX cable is used to get outside the zone of interference, the limits of which may be found by testing the receiver in various positions throughout the home until the position is found where the noise is no longer picked up; it may then be taken for granted that this is the limit of the zone.—Edward R. Jahns.

# NEW!

EDITION

## TELEVISION

*A Magazine for the Experimenting Fan*

"TELEVISION" is a magazine pledged to further the art of the infant industry for which it is named, and to supply the "fans" with the latest information and developments in this fast-growing field. Television, as a science, occupies the same position today as radio did ten years ago. Like the radio fans of years back, enthusiasts of this new field have had to fight for whatever meager knowledge they have been able to obtain. This magazine, then, comes as manna to the information-hungry fan. It is our purpose to keep these enthusiasts constantly informed, through "TELEVISION," of each new development. The second issue of "TELEVISION" is now on the newsstands.



You will find below a partial list of its interesting contents

In the Television field there are all of the thrills that the radio fan knows so well. Get on the band wagon with your fellow enthusiasts. Be the first in your neighborhood to own a television set. Obtain a copy of "TELEVISION"; it will show you how to build a real Television receiver.

The first Television magazine was published by the EXPERIMENTER PUBLISHING COMPANY about a year ago. Over 50,000 copies of this magazine, "TELEVISION," have since been sold. This, alone, is sure proof of the popularity of this interesting new art.

### Partial List of Contents

New Jenkins Radio Movies  
New Belin Photo Transmitter  
Vacuum Cameras to Speed Up Television  
Infra-Red "Eye" Sees at Night  
Valensi Television  
Connection of Photo-Electric Cell

Practical Demonstrations Scheduled for Station WRNY  
Campbell Swinton Television System  
Quartz Crystals Synchronize Television Sets  
Baird Optical Lever Increases Speed  
Recording Pictures with Air Jet  
How to Build a Radio Photo Recorder

and many other articles of equal interest

AT ALL NEWSSTANDS

THE **25c** COPY

OR WRITE DIRECT

EXPERIMENTER PUBLISHING CO., INC., 230 Fifth Ave., New York, N. Y.

EXPERIMENTER PUBLISHING COMPANY, INC.  
230 Fifth Avenue, New York City, N. Y.

Gentlemen: Please forward to me a copy of TELEVISION. Enclosed find 25 cents.

Name.....

Address..... City..... State.....

Please say you saw it in RADIO NEWS

# 8 POPULAR MODERN MOVIE NOVELS \$1.00

## GREATEST OFFER EVER MADE

Take Advantage of This Amazing Bargain

Eight full size books for one dollar. Never before has an offer of this kind been made. Only quantity production permits us to make this astounding offer now. Take advantage of it while you have the opportunity. Needless to say these modern up-to-date movie hits cannot last long at this tremendous bargain price. Each book contains at least two color "stills" of an actual scene from the photoplay. Don't hesitate. Mail this coupon now. Every story based on an actual moving picture triumph. The greatest book bargain of the age.

Titles of This Tremendous Bargain Offer

20. The Cohens and Kellys in Paris
21. The Divine Woman
22. Jazz Mad
23. The Crimson City
24. You Can't Beat the Law
25. Tillie's Punctured Romance
26. Forbidden Hours
27. The Cossacks
28. The Play Girl
29. The Man Who Laughs
30. The Hawk's Nest
31. Streets of Shanghai

8 BOOKS FOR \$1.00  
Your Choice

An Addition To Your Library

These books will be a worthwhile addition to your library. You will find many hours of truly enjoyable reading in each beautiful volume. Printed on fine paper with large clear type. Beautiful colored covers of flexible durable material. These books are undoubtedly one of the greatest values ever offered at this amazingly low price.

Write Now! Don't Wait! This bargain cannot last long at this price

CONSRAD COMPANY, INC.

230 FIFTH AVENUE

NEW YORK, N. Y.

CONSRAD COMPANY, INC., 230 Fifth Avenue, New York, N. Y.

Gentlemen: Enclosed find \$1.00. Kindly send me the books listed by number herewith:

Numbers.....

Name.....

Address.....

City.....State.....

### A REAL SPECIAL OFFER!!



#### UNI-RECTRON POWER AMPLIFIER

Ideal for use with Dynamic Speakers)

Model AP-935



List Price \$88.50  
(without tubes)

Special - \$19.75 ea.

Every one new and packed in original factory carton

AMERICAN SALES CO., 19-21 WARREN ST., NEW YORK CITY

As the Uni-Rectron stands it is a super-power amplifier, which can be used in connection with any radio set and loud speaker. Binding posts are provided for input to the Uni-Rectron and output to the speaker.

Requires no batteries for its operation. It obtains its power from the 110 volt, 60 cycle alternating current lighting circuit of your house.

The UX-210 super power amplifying tube and the UX-216B or 281 rectifying tube are used with this amplifier, which cannot overload. From the faintest whisper to the loudest crash of sound—R. C. A. Uni-Rectron amplifies each note at its true value. High and low notes are all treated alike. The volume and quantity delivered will be a revelation.

### "Foolish" Questions

(Continued from page 640)

May, 1928, issue), and can be conveniently saved for reference. The constructor who keeps such data handy will not be under the necessity of writing in for data on coils to use in a new circuit.

#### HOW FAR CAN I RECEIVE?

Question: "What is the distance range of a four-tube receiver?"

Answer: No one can say just what distances a certain receiver can cover. There are so many controlling factors that enter the matter that it is practically impossible for anyone to state with certainty the normal range of a receiver. Weather conditions have a good deal to do with distant reception; and so have the condition of the batteries, the tubes, the sensitivity and tuning ability of the receiver, the quality and condition of the antenna structure, and the efficiency and condition of the ground connection. Furthermore, there are certain areas in the country known as "dead spots," in which reception of anything but powerful local stations is extremely difficult, even with the most elaborate receivers.

Another controlling, and very important, factor is the operator. He is responsible, to a great extent, for the results obtained. Keeping the set and accessories at maximum efficiency, a good location, fair weather conditions, a good knowledge of the tuning temperament of the receiver, and saintly patience, must eventually be rewarded with the desired "DX," as reception of stations at an unusual distance is called.

#### WHAT IS AN "A.C. TUBE"?

Question: "Does the 'A. C. tube' operate entirely on alternating current?"

Answer: No. Alternating current is used only to light the filament, or the "heater" element which heats the filament, depending upon the design of the tube. As the modern A. C. tube requires anywhere from one and a half to fifteen volts of alternating current to heat the filament, it is necessary to "step down" the usual 110 volts of the house line by means of a small step-down transformer. However, to supply the "plate" voltage, or "B" voltage, direct current, obtained from a "B" socket-power unit or from batteries, must be used.

Because receivers today use plate voltages ranging as high as 400, it is necessary that the 110 volts obtained from the house line be first "stepped up" to the required voltage. After this the increased current must be "rectified" from alternating to direct current, as the receiver cannot function with alternating current on the plates of the tubes. After rectifying the increased current, we find that there is still a noticeable hum present in the speaker, due to the characteristics of alternating current. This hum is "ironed out" by an apparatus known as a "filter"—a combination of condensers and choke coils. The entire combination of the step-up transformer, rectifier and filter system goes to make up the "B" voltage-supply unit, without which no radio receiver can operate. In the case of a modern A. C. set, this unit is incorporated in the design of the set, so that it is really an integral part of the receiver and is usually so considered.

Please say you saw it in RADIO NEWS

# RADIO DIRECTORY

**RADIO-LITE-TENNA**



Write for details

**AERIAL INS. CO.**  
GREEN BAY, WIS.

**Send for This**

We have a new illustrated catalog showing our up-to-the-minute stock of kits, parts and sets — everything you want in radio — all at dealers' wholesale prices. Write today for Catalog "B-3."

**ALLIED RADIO CORPORATION**  
711 W. Lake St.  
Dept. "B-3," Chicago, Ill.



**ACCUСТИ-CONE**  
(Double Diaphragm)  
Aeroplane Cloth Speaker

Truly a revolutionary step in radio reproduction! Send for catalog.

**Accusti-Cone Laboratories**  
One No. Seventh St., Phila., Pa.



**BIRNBACH**

**Moisture-Proof Extension Cords**

Birnbach Extension Cords permit the Loud Speaker to be moved to any room in the house. Attaches instantly. Install a Birnbach Cord and put an end to distortion so often due to badly insulated cords. Your neighborhood dealer has these sizes in stock: 10-20-30-40-50-100 foot lengths. Send for Catalog.

**BIRNBACH RADIO CO.**  
254 W. 31st St., New York



**PER-CON COLLAPSIBLE RADIO GROUND**

A perfect efficient and noiseless ground. Consists of three sections. Drive one at a time. Easy to drive. Any length required. Contact point copper, to which is soldered lead-in wire. Drive in basement or in close places.

**PER-CON MFG. CO.**  
Richmond Indiana

**FREE Wholesale CATALOG**

Send for the most complete book of nationally known Parts, Kits, Cabinets, Consoles, Speakers, Power Units, Sets, etc. All at lowest wholesale prices. Quick service on all your needs. Write now, it is FREE—

**Setbuilders Supply Co.**  
139 Remberg Bldg., Chicago



**HELLO JAPAN!**

Hello China: Hello Australia: Hello New Zealand: Hello Ireland: Hello Danzig, 9,000 miles away; Hello Iceland, 10,000 miles away. All confirmed Reception. Most amazing performance of any Radio Receiver ever designed. U. S. Stations all locals on the Magnaformer 9-8. Write today for FREE X-RAY Wiring Diagram and Instruction Sheet.

**Radiart Laboratories Co.**  
1012 Assn. Bldg., Chicago, Ill.



**BODINE ELECTRIC TURNTABLE**

For radio-phonograph combinations — no brushes, no commutators, no sparking. Positively no interference in the loudspeaker. Write today for full information on this big new development.

**BODINE ELECTRIC CO.**  
2264 West Ohio St., Chicago, Ill.

**Shield Grid PLUG-IN KIT**

No. 222

An efficient shield grid plug-in kit consisting of two units Nos. 222A and 222C for use in the form of most shield grid circuits. Write for literature.

**Twin Coupler Company**  
Poughkeepsie New York

**HERE IT IS!**

**SILVER MARSHALL 630 SHIELDED GRID SIX**

The Radio Set with Distance and Tone to spare. List \$99.00.

Your Cost while they last, \$36.95.

**RAWNER RADIO & TELEVISION CO.**  
142 Liberty Street  
New York City

**SPEAKER TABLE**



Beautiful Colonial design. Solid walnut, hand rubbed. Size, 30" x 12 1/2" and 31" high. Made with Temple Air-Chrome speaker or for dynamic speaker. This is only one of many beautiful Fritts creations for this year. Write for full particulars and free catalog.

**D. H. FRITTS & CO.**  
604 Hearst Bldg., Chicago

**200,000**

**RADIO NEWS** readers

carefully scan the **RADIO DIRECTORY** every month.

Your product here, at the lowest cost in the world's largest and most widely read radio magazine.

No order for less than three insertions accepted.

Write for information.

**RATE PER ISSUE**

**\$25.00**

**RADIO NEWS**

230-5th Avenue New York City



The human ear could not detect further tone improvement than is given by

**Samson Symphonic Transformers**

Send for full information

**SAMSON ELECTRIC CO.**  
Canton, Mass.

**SEND NOW for New 1929 WESTERN RADIO'S CATALOG**

LATEST and FINEST, nationally known A.C. sets, consoles, cabinets, speakers and accessories at **LOWEST PRICES**. Catalog sent **FREE** on request.

**WESTERN RADIO MFG. CO.**  
128 W. Lake St.  
Dept. RNC1 Chicago



**DEALERS, write for catalog.**

**W. C. BRAUN CO.**  
552 Monroe St., Chicago

**NOPHONIC TUBE CAPS**



Stop That Howl!

To get the best from your set, be sure that all tubes employ all vibration of the filament.

**Nophon Tube Caps. Stops all vibration of the filament.**  
List Price..... 25c

Ask your dealer or write direct

**MERTZ SPECIALTY CO.**  
1306 Stockton Street  
Wilmington, Del.



**CORWICO**

**BRAIDITE Hook-Up Wire**

"The Braid Slides Back" Make your connection, solder it and the insulation slides right back into place. If your dealer can't supply you, order direct

25 Ft. Solid, 30c  
25 Ft. Stranded, 35c

**CORNISH WIRE CO.**  
32 Church St., New York

**LUND RADIO CABINETS**

Our line includes twenty different models. There is a suitable cabinet or table for every set and every requirement. Write for complete illustrated catalog.

**L. A. LUND CORP.**  
1018 S. Wabash Av.  
CHICAGO

Model 5, Walnut  
Price \$25.00



**HEAVY DUTY "B" POWER — \$18.50**

Complete with Tube. Delivers up to 180 volts on any set. Dry — no liquids. Write for literature.

**FERBEND ELECTRIC CO.**  
425 W. Superior St., Chicago, Ill.

**TELEVISION Kits and Parts**

Complete receivers assembled in 15 minutes. 5 models from \$37.50 up.

**DISCS MOTORS NEON TUBES AMPLIFIERS** and other parts

Write for Catalog

**Insuline Corp. of America**  
78-80 Cortlandt St., N. Y. C.

**Television Tubes**



This marvelous new Raytheon Kino-Lamp, which radio engineers call the greatest development in television, is now in stock. Be the first in your locality to build a television receiver. Send money order NOW.

**\$7.50**

**Newark Elec. Co.**  
226 W. Madison St.  
Chicago, Ill.



**DE JUR VITREOUS ENAMELED POWER RESISTANCES**

For "B" eliminators, power amplifiers and electric sets. These resistances are backed by 16 years of continuous, satisfactory service to the radio public. Write for catalog.

**DeJUR-AMSCO CORP.**  
199 Lafayette St., New York, N. Y.

**SEND FOR NEW RADIO BOOK**

All the new hook-ups. Parts, supplies, A.C. sets, television, short wave, etc.

Write for free copy now.

*The Baravik Co.*

11a Canal Sta., Chicago

Set Builders! Mfrs.! Experimenters! Save Labor and Dealer Profits by Buying Direct

**QUALITY A. C. Filament Transformers**—Input; all types 115 volts, 60 cycles. **RCA**—Supplies six 226s, two 227s, and two 171s. **ARCTURUS**—supplies nine or less Arcturus 15-volt tubes. **KELLOGG**—supplies ten 3-volt filaments.

State type wanted. List price \$8.00. **Factory to You Price—\$3.90 prepaid.**

**Quality Transformer Co.**  
Box 135 Oak Park, Ill.

**Balkite Radio**

In cabinets by Berkey & Gay



**Fansteel Products Co., Inc.**  
NORTH CHICAGO, ILL.

The RADIO DIRECTORY is your buying guide. Space permits display of only one product at a time. Write advertisers for complete catalogue.

# Potter Condensers



**T**HE selection of leading manufacturers for the finest radio receivers. Insure the operation of your radio set or power amplifier with Potter condensers, which are known for their quality—uniformity—long life—economy.

Potter T-2900 Condenser Block for the single 250 type tube amplifier—\$20.00.

Potter T-2950 Condenser Block for the push-pull 250 type tube amplifier—\$22.50.

Potter T-2098 Condenser Block for the single 210 type tube amplifier—\$20.00.

Potter T-280-171 Condenser Block for a power-pack with 280 type tube rectifier for a 171 type tube power tube—\$18.00.

Potter by-pass and filter condensers are available in all capacities and working voltages.

## Potter Interference Eliminator

Enjoy radio broadcast programs normally spoiled by interference from oil burner, ice machine motors, fans, violet rays, vacuum cleaners, etc.

Simply connect a Potter interference Eliminator to the line circuit at the point where interfering device is connected and your troubles will be over.



# The Potter Co.

North Chicago, Illinois

A National Organization at Your Service

## Everything in Radio at Wholesale

We supply every radio need from our mammoth stock of kits, parts and sets of latest design. Lowest wholesale prices. Expert attention; immediate service. Write for big, illustrated Catalog "B-3."

## Allied Radio CORPORATION

711 W. LAKE STREET, CHICAGO

Insure your copy reaching you each month. Subscribe to RADIO NEWS—\$2.50 a year. Experimenter Publishing Co., Inc., 230 Fifth Avenue, New York City.

# Color Television

(Continued from page 633)

the width of the sideband, let us think of the picture as composed of a great number of unit areas. For a picture of a quality comparable with half-tone engravings, about 10,000 areas or dots per square inch will be necessary. The larger the screen, the more are the elementary areas necessary for the same fineness of texture or grain. This means that a great many more unit areas must pass before the aperture each second for a large picture than for a small one.

Now it is evident that, for each two successive areas passing before the aperture, the photoelectric current will pass through one cycle of change; that is, the greatest possible variation in current will be produced by the change from a unit of solid color to one completely dark. According to engineers of the Bell Telephone Laboratories, the highest frequency necessary to be transmitted per second is equal to half the number of dots or areas scanned per second; any change smaller than from one area to another is too small to be of consequence. The 50-line picture used by Bell engineers required a transmission channel of which the highest frequency was half the unit-frequency of 40,000 areas per second, or 20,000 cycles. Actually, an even narrower channel was found to give satisfactory results. Now, with a system whereby each line is successively traced in the primary colors, the number of fluctuations per picture would be tripled—and hence, the width of sideband. The same would be true of the others, especially of the prism method last outlined. Here is room for much experimentation; will it be necessary to scan each line successively in each color, or to complete a picture in one color before beginning another? Will the speed of scanning need to be greater than that of black-and-white television, or would a lower speed prove satisfactory? Experiment alone will tell.

### WIDE CHANNELS SCARCE

The use of a sideband wider than 5,000 cycles is prohibited by the regulation prescribing ten-kilocycles separation between broadcasting channels. Technical difficulties also make the use of an extremely wide sideband difficult. Modern receivers now represent a compromise between selectivity and quality: that is, a receiver must separate stations ten kilocycles apart without cutting sidebands. A set which is tuned sharply to 1,000 kilocycles practically rejects frequencies of 1020 kilocycles. What, then, if the sideband is widened even more than that required for ordinary television? A single receiver can respond to frequencies of only a limited width without attenuation of the higher frequencies, which means coarsening of grain and loss of detail. Single-sideband transmission, much advocated as a panacea for the crowded conditions prevalent on the broadcast waves, is much too complicated for general use; as are also double-modulation schemes and others which require an accuracy of adjustment beyond the abilities of the average listener. Short waves offer a less difficult problem, so far as the problem of sideband is concerned; for at 1,000 kc. (300 meters), 20,000 cycles constitutes a 2% sideband, while at 4,000 kc. (75 meters) it is merely 1/2 of 1%. But the short waves are already facing a con-

# AERO KITS



## INTERNATIONAL Short-Wave Converter

Will Add Thousands of Miles To Your Receiving Range

Broadcast reception on short waves is remarkably clear and free from static. Programs are brought in from greater distances with the utmost simplicity of control. You can easily build the Aero International Short-Wave Converter and receive short-wave programs on your present set. No changes in wiring necessary. Just plug into detector socket.

AERO KIT No. 9.....\$38.90

### THE "STANDARD"

No extra tube is needed for this Aero Short-Wave Converter. Plug into detector socket of your receiver and insert the tube which you removed from set into the Converter. Kit is complete with all parts. Can be assembled in a few minutes. For A.C. or D.C. receivers.

Price—\$32.00



Write for information about the New 1929 Aero Green Book

## AERO PRODUCTS INCORPORATED

Dept. 119, 4611 E. Ravenswood Ave., Chicago, Ill

# DRESNER Shielded SHORT WAVE CONVERTER

16<sup>50</sup> Complete with 5 COILS



The Only Set with a Wave-length Range 15 to 550 Meters

First time offered! New model—completely assembled; may be used on any set; built in beautiful mahogany finished metal cabinet. Highest efficiency at amazingly low price. Gets stations broadcast on short waves by many powerful stations throughout U. S. and Europe.

If your dealer cannot supply you, send money order direct and we will ship at once. Guaranteed. (When ordering unit, be sure to specify whether it is to be used on AC or DC set.)

DRESNER RADIO MANUFACTURING CORP. 640 Southern Blvd., Dept. R1, New York, N. Y.

## BUILD THE ALL-ELECTRIC SCOTT SHIELD GRID 9

Now this famous 9,400-mile receiver is offered—ALL-ELECTRIC! Build it in four hours—and dial your stations from world-wide radts. Practically unlimited in range, the Scott "Nine" challenges any existing set to equal it in volume, tone, selectivity and extreme sensitivity. Get facts today, including FREE circuit diagram, DX verifications, etc.

SCOTT TRANSFORMER CO.

4448 Ravenswood Ave. RN1 CHICAGO, ILL.

# INVENTORS

who derive largest profits know and need certain simple but vital facts before applying for Patents. Our book Patent-Sense gives those facts; sent free. Write LACEY & LACEY, 631 F St., Washington, D. C. Established 1869



gestion hardly less acute than that on the higher wavelengths.

When television is perfected to the point that it no longer requires studio lighting conditions, one of its chief values will be as a field reporter of important events. Chain broadcasting, also, will be highly desirable. Both of these require telephone circuits for long-distance connection. The limits of present long-distance wire transmission circuits do not allow the use of a channel wider than 40,000 cycles. Thus a large panorama, such as a football game, pageant, or any large spectacle would necessarily be reduced to a small size, or else detail would be negligible. To be sure, the frequency range can be divided; so that different wide circuits might transmit various portions of the spectrum, the sections being separated by band-pass filters for transmission and re-assembled at the receiver. But the expense and the difficulty of such arrangements would be tremendous. Radio re-transmission from field cars is perhaps less expensive, but no less complicated, to say nothing of hiccups such as selective fading, static, etc.

THE EYE AND THE CELL

A peculiarity that will perhaps need to be compensated for in design is the distortion resulting from the response-characteristics of the photoelectric cell; i. e., the selective effect mentioned early in this article. Since the photoelectric cell is not uniformly responsive to all colors, certain portions of the picture would be over-emphasized; thus altering the relations between colors. This distortion might be compensated, either by the use of a number of photoelectric cells of differing characteristics, or optical means, such as regulating the transmission properties of the transparencies used for coloring.

An interesting physiological question suggests itself with regard to the visual response to color television. The nerve cells of the eye which respond to light waves are of two kinds, the "rods" and the "cones." Color vision is accomplished by the cones, light and shade by the rods. How quickly do the cones respond to color changes? This element might affect considerably the speed necessary for color television.

A set receiving pictures in color would produce queer effects if slightly out of synchronism with the transmitter. A picture "out of frame" would also be out of the right relation with the coloring disc at the transmitter, and hence, the order of the colors would be transposed. Our favorite soprano might surprise us with a blue face, red eyes, green lips, and white hair. Static would show up as a purple blush or a row of yellow dots sweeping across the screen. Any transient variation in atmospheric conditions would throw the colors out of their correct proportions. This latter effect would probably be slight; because a momentary discoloration would be quickly covered up as the scanning beam swept over the screen again, smoothing out and concealing the discolorations.

A phenomenon that has caused noticeable distortion in television is the so-called "envelope delay," which is due to the difference in time required for currents of differing frequencies to traverse the filters and various circuits encountered in transmission and reception. A group of closely-related frequencies suffers a distortion of wave form because of the altering of phase relations between the various frequencies. With color

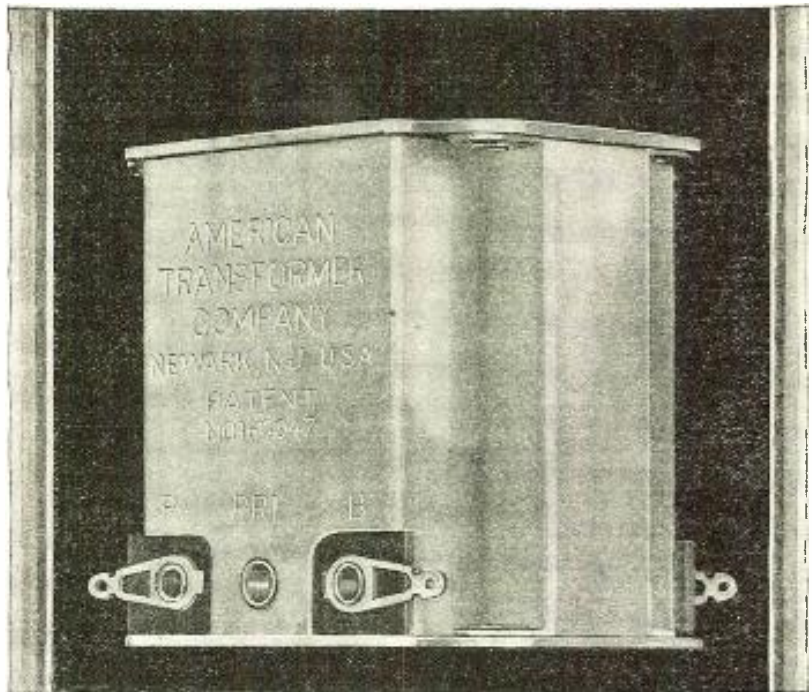

AmerTran DeLuxe Audio Transformer, Standard of Excellence 1st Stage; Turn Ratio, 3: 2nd Stage; Turn Ratio, 4. Price, each \$10.00.

**AMERTRAN**  
TRADE MARK REG. U.S. PAT. OFF.

Quality Radio Products

Standards of Excellence for Radio Reproduction

THE real worth of any radio set depends upon "tone quality"—the ability to reproduce music as it is broadcast from the studio. The problem has never been one of refining the radio frequency amplifier—it has always been the manufacturers of audio systems who have had to develop their products to reach the pinnacle of natural reproduction.

Long before broadcasting was thought of, The American Transformer Company had gained a reputation of manufacturing quality products. Since the era of broadcasting, this company has occupied a unique position in the development of quality products for radio reproduction. AmerTran products have been considered too expensive for set manufacturers to use in their commercial receivers, so it has developed a clientele of set builders who want, first of all, *natural reproduction.*

AmerTran products are never built down to a price—the procedure has always been reversed—"How good can it be made—then reduce the cost by applying economies in manufacture."



AmerTran ABC Hi-Power Box—500 volts DC plate voltage, current up to 110 ma; AC filament current for rectifier, power tubes and sufficient 226 and 227 AC Tubes for any set. Adjustable bias voltages for all tubes. Price, east of Rockies—less tubes—\$95.00.

The products shown on this page are but a few of the thirty odd AmerTran devices in the field of radio reproduction, each of which has attained the degree of perfection necessary to be introduced as an AmerTran product. The facilities of our engineering department are at the service of every one interested in better radio reproduction. We will answer to the best of our ability any question in the audio or power fields.

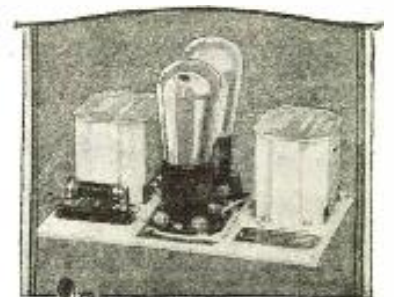

AmerTran Push-Pull Power Stage (illustrated above)—completely wired with input transformer and a choice of 4 output transformers depending on speaker and power tubes. Adaptable to 171 or 210 tubes, codes or dynamic type speakers. Price, east of Rockies—less tubes—\$36.00.

American Transformer Company

Transformer Builders for more than 28 years

30 Emmet Street

Newark, N. J.

Push-Pull Amplifier, ABC Hi-Power Box and Push-Pull Power Stage licensed under patents owned or controlled by RCA and may be bought complete with tubes.

# Radio HEADQUARTERS

The newest radio wrinkles—A-C, grid tube, short wave, television, dynamic speakers, newest tubes and circuits—anything and everything in radio—are now ready for you at Barawik's. With elections, football, National broadcasting, Roxy and other big doings filling the air, thousands of newcomers will take to radio this year as never before. Business will be good—Set builders will make money. You can clean up big by buying from Barawik—the oldest, biggest, most reliable radio house in the world. Let us prove it. Send now for the Big Book—all ready for you—free. Get the latest radio information and lowest prices.



**BARAWIK CO.**  
11 B CANAL STA.,  
CHICAGO, U.S.A.

This Big Book Sent to You Free

Name.....  
Address.....  
City.....

## NEW! 90 Volt Power Unit

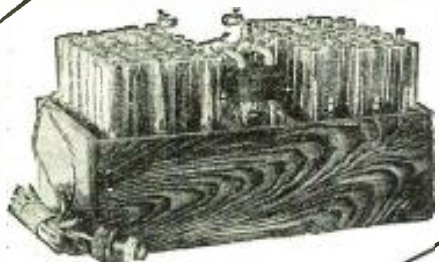

Positively Eliminates Hums, Line Noises, etc. **\$12.75**  
Greater Volume and Clarity Guaranteed

Non-acid and noiseless. All detector and intermediate voltages plainly marked. Simpler to hook up than dry cells. Operates 1 to 12 tubes. If not thoroughly satisfied return after using 30 days for complete refund. Guaranteed further 2 years. For 110-120 volts A.C. 25 to 60 cycle current, 90 volts, \$12.75; 112½, \$15.25; 135, \$17.50; 157½, \$19.50; 180, \$24.00; 202½, \$26.00. Also built for D.C. current, 110 and 32 volts at only \$3.00 additional, any size above. Ample stocks—same day shipments. Simply say—ship C.O.D. or write for my interesting literature, testimonials, etc.

**B. HAWLEY SMITH**  
334 Washington Ave., Danbury, Conn., U.S.A.

### This Wholesale Catalog Will Save You Money

Write today for our large illustrated new Catalog "B-3," showing how this organization of men with years of experience in Radio can give you personal service.

**Allied Radio CORPORATION**  
711 W. LAKE STREET, CHICAGO

television, this would not only result in distortion and poor resolution of images, but cause an aberration from the true color relations. Bell engineers have compensated this distortion by balancing against it another distortion opposite in its nature; that is, what is called "aperture distortion." After the edge of a single hole of the scanning disc comes opposite an illuminated spot, more and more of the hole gradually permits the passage of light; that is, the hole does not fall into position instantaneously, but gradually, and as a result, the photoelectric current from a given image-area builds up gradually instead of rising to its full value instantaneously. In color television, will this compensation be possible? Experiment alone will tell.

Lest he be misunderstood, the writer wishes to make clear that he does not believe it likely that practical television in natural colors will be possible tomorrow, that next year's television receivers will be provided with color attachments such as described above. He does maintain, however, that, when the obstacles above sketched are overcome, and television on a commercial scale is actually accomplished, color television will represent merely a refinement of detail, a further development along the same lines that make universal television possible. If a picture of 240,000 dots per second can be successfully transmitted in black-and-white, surely our engineers can produce a picture of one-third the size in three colors. It seems hardly likely that television will be applied on a universal scale until some major advance overcomes the chief difficulties mentioned above; but when such an advance is achieved, the possibilities of the future seem unlimited. Meanwhile, television rests upon the knees of the gods.

### A "Wireless" Relay

A CURIOUS contrast to American methods is shown by a dispatch from Beziers, France, stating that its broadcast station has been hindered in an endeavor to present programs, by remote control, from the Roman amphitheatre in that city, through the refusal of the "P.T.T." (French governmental telephone monopoly) to allow the use of telephone lines for the purpose; and the Beziers broadcasters will be compelled to fall back on a short-wave radio relay for the purpose of getting the program to the studio.

### A Couple of Ear Twisters

WHAT words do you think would be the best to test transmission and reception? In the Bell Telephone Laboratories, where telephones are tested, two sentences are repeated over and over by phonographs: "Joe took father's shoe bench out," and "She was waiting at my lawn." The radio "ham" who can get these across by phone to his fellow-workers may know that his modulation is good.

### FORCE OF HABIT

HAMLET (bitterly): "This bunch out in front tonight must be a crowd of radio fans."  
POLONIX: "Why, what gives you that notion?"  
HAMLET: "Because they just sit there like Stoughton bottles and don't give you a peep of applause!"—(Miss) Micky Burke.

## BUILD YOUR OWN Exponential Horn



This marvelous 17x21-in. exponential horn with a 36-in. air column can be easily built of ½-in. soft wood by any amateur. It produces the most wonderful tone quality. We furnish you with a set of FULL-SIZED PATTERNS, which have been accurately and scientifically worked out according to the exponential principle. Simply saw out the wood to the size and shape of the patterns and nail and glue together and you have the latest and

**MOST EFFICIENT TONE PRODUCER AN IDEAL XMAS GIFT**

Send \$2.00 for a set of these full-sized patterns and complete instructions, or we can furnish you the COMPLETE KIT, which includes the wood cut to fit, the nails, the glue, our large-sized CONCERT UNIT, and full instructions. All complete with postage prepaid for \$11.75 in the United States and \$12.75 in Canada.

**RADIO PRODUCER COMPANY**  
1245 Jefferson Bldg. Peoria, Ill.

## TUNE IN ON THE SHORT WAVES

### Ki-Lowave Adapter



Can Be Used on Any Set.  
**Price \$19.50**

Very simple to attach. Furnished complete with 4 plug-in coils, wavelength range 14 to 210 meters. Instantly converts your present set into a Short-Wave set by simply inserting Adapter plug in place of a tube, no extra tubes, batteries, etc., required; no changes in wiring of set necessary. REACH OUT. Hear the U. S. and Foreign Short-Wave Stations as many others are doing. The thrill of listening to real DX reception is yours with Ki-Lowave Adapter attached to your set. Very neat and compact in size, dimensions 7½x7½x3½ inches, contained in a beautiful piano-finished cabinet; with its bronzed etched illuminated vernier dial it makes a handsome addition to any set. Complete instructions furnished with each Adapter. Fully Guaranteed. When ordering specify whether for AC (All Electric) or DC (Battery or Eliminator operated sets). Price \$19.50 Postpaid anywhere. Enclose express or money order, or if you prefer send \$1.00, with order balance C.O.D. plus postage.

KILO RADIO CO. 1722 Pallister, Detroit, Mich.

## The FUTURE By Professor A. M. Low

"THE FUTURE" is one of the most remarkable books of the age. Professor Low, the author, is a scientist of international reputation, also an experimenter and inventor in the many branches of science. This book written by him has aroused wide-spread interest. It deals with the world of the future, certainly an unusually absorbing subject. Written in the popular, non-technical fashion, "The Future" reveals the many advances and changes that are in store for humanity in a new life to come. This book has received favorable comment in book reviews the world over. Do not neglect to read this treatise on the future by Professor A. M. Low. It is a literary treat for everyone.

Mail your order now! Don't wait, everybody is reading this remarkable book.

**Price—\$2.00**

Experimentor Publishing Co.  
230 Fifth Ave., New York, N. Y.  
Gentlemen: Enclosed find check or money order (check which) for \$2.00. Kindly send me a copy of Prof. A. M. Low's new book "THE FUTURE."

Name.....  
Address.....  
City.....State.....

## Television's "Last Touches"

(Continued from page 636)

beginning—or end—of each image, thus interrupting the reproduction slightly. This period may be used to send a synchronizing signal which will correct the rotation of both disc and mirror gears. There is nothing, of course, to prevent the use of three or more mirrors, backed at equal angles against the revolving shaft, and their reduced curvature would lessen distortion. However, in all these systems discussed, whatever we gain in improved results, we pay for in additional electrical and mechanical complexity.

### PROBLEMS OF DISTORTION

By separating the drive of the disc and the mirror, we introduce complexity, but we gain flexibility. For instance, suppose our disc has 48 holes. We desire to receive a 36-hole transmission which has a speed of 12 images a second, or 720 a minute. Our disc revolving 9 times a second, or 540 times a minute, will scan the picture with the same rapidity; our pair of mirrors revolving 360 times a minute will direct the rays from top to bottom of the screen in the same time as at the transmitter. The shape of the image may be slightly distorted, but the action will be clearly recognizable.

We cannot escape a certain amount of distortion, caused by each reflection or refraction, although the skill of the optical designer may succeed in limiting it. For instance, the disc and the mirror are revolving simultaneously; the mirror will throw the course of each line down, toward the side of the image which the light-spot reaches last. If this corresponds to the condition at the transmitter, where the selection of spots scanned is made at a similar angle, the picture will be correct.

It may be suggested by the ingenious reader that, instead of a disc, we have a perforated plate sliding back and forth, and that each movement shall turn the mirror through a predetermined angle, as the carriage lever of a typewriter turns its platen. This would be an obvious suggestion to adopt at lower speeds, such as we might use to transmit a still picture; but, at speeds of 2,400 a second or so, ordinary mechanical devices fail. Even the greatest concentration of light may not make it possible to produce a scanning disc capable of being revolved safely at a speed as great as we may require. That is why televisionaries are looking forward to the development of some undiscovered properties of matter, or the adaptation of those which have not been hitherto used for the purpose, to obtain an enormous speed of image-scanning without the use of mechanical parts.

Again, as shown in Fig. 2, we encounter the problem of the ambiguity of image impulses. This, however, will be overcome by the increasing speed of transmission, and the inaccuracy of the eye itself—another of those mechanisms which rejoice in complexity. Each of its defects will counterbalance one in our television apparatus.

There is, as we said before, always a certain amount of distortion introduced when we cast a ray obliquely on a flat surface. Suppose that the rays at their fullest extent cover nearly a right angle.

# Best For Radio Control!



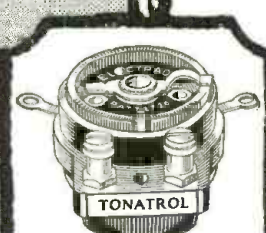

Exclusively Licensed by Technidyne Corporation Under U. S. Patent Nos. 1,593,053, 1,034,103, 1,034,104



U. S. Patent 1,676,869 and Patents Pending

## TONATROL

Trade-mark

### A Complete Line of Volume Controls

Controlled volume means improved tone. Tonatrols control volume perfectly, adapting reception to the occasion and personal tastes. They come in types to meet the specific requirements of all circuits—battery or A.C. power—in standard types, or with filament or power switch attached. \$1.50 to \$3.00.

## TRUVOLT

Reg. U. S. Pat. Off.

### ALL-WIRE RESISTANCES

Unexcelled for voltage control in B-Eliminators. Made with a high factor of safety to carry much heavier current loads. Truvolt Variables simplify B-Eliminator construction by eliminating difficult calculation and making all adjustments easy. 22 stock sizes—\$3.50 each. Truvolt Fixed Resistances are adjustable to different set values by the use of sliding clip taps—an exclusive Truvolt feature! Made in all desirable resistance values and current ratings. Electrad specializes in a full line of Controls for all Radio Purposes including Television. Mail coupon for full information.

CUT HERE

ELECTRAD, INC., Dept. N-1, 175 Varick Street, New York.

Please send me descriptive circulars on the following products and put me on your mailing list for similar literature.

....General Circular	....Tonatrol Volume Controls	....Phasatrols
....Royalty Variable Resistors	....Truvolt Divider	...."Electrad Control Manual" (enclose 10c for mailing)
...."What B Eliminator Shall I Build?" (enclose 10c for mailing)		

I am particularly interested in .....

Name .....

Address .....

# ELECTRAD

Inc.

## M&H

### Radio's largest kit supply house

ESTABLISHED 30 YEARS

We Have Complete Kits For All Circuits  
Now appearing or which have appeared  
in "Radio News" and other publications.  
Send for Circuit Booklet & Catalog

M. & H. Sporting Goods Co.  
512 Market St., Phila., Pa.



PATENTED

### POLK

#### BINDING POST

Insulated. No holes to fish for. Insert wire in any position. Quick action and holds tight. Standard markings.

J. L. POLK  
41 Belle Ave. TROY, N. Y.

15 Cts. Each

Please say you saw it in RADIO NEWS

# Books no home should be without

## HOUDINI'S SPIRIT EXPOSES and DUNNINGER'S PSYCHICAL INVESTIGATIONS

By JOSEPH DUNNINGER

In this remarkable new book the voice of Houdini has been resurrected, as though from the dead, and can be heard to echo again in sullen denunciation of the ever-increasing number of spiritualistic mediums who, since his decease, have been parasitically bleeding the innocent public of its choicest possessions whilst posing in the sacrilegious guise of the living dead.

Joseph Dunninger, famous magician, Chairman of the Science and Invention Investigating Committee for Psychical Research and the author of several notable works on magic, was a close personal friend of the late Harry Houdini. All the data appearing in this book was taken from the personal notes of the dead magician now in the possession of Dunninger. These and the accompanying remarkable conclusions drawn from the various successful exposés of Houdini, together with the tremendously interesting revelations contained in Dunninger's Psychical investigations, make this a book that all should read. Over 116 pages. Large 9x12-inch size.

Only

50c

Per Copy

At all newsstands  
or write direct

## BEAUTY SECRETS

By EVA NAGEL WOLF

This book, by Eva Nagel Wolf, prominent editor of the beauty column of one of the leading women's magazines and internationally known authority, divulges to seekers of beauty the true secrets of their type—just what is necessary to make themselves most attractive. "BEAUTY," says Miss Wolf, "is not difficult to obtain once you have learned the simple secrets of type." It is the purpose of this book to pass on to every woman these secrets—to show her the quickest and easiest way to genuine beauty and attractiveness.

There is nothing left unsaid—every phase of beauty culture is fully treated. The art of make-up, care of the hands,

the hair, the eyebrows and lashes adding that extra pound or taking off excessive weight—all is covered.

BEAUTY SECRETS should be every woman's constant companion at the boudoir. Critics the country over have claimed that a fair price for a book of this kind would be from three to five dollars. However, due to our unique way of publishing, we are able to give this book to you at the phenomenally low price of—

50c

Per Copy

Sold at all newsstands or  
write direct—112 pages—fully  
illustrated—large magazine size

## POPULAR CARD TRICKS

By WALTER B. GIBSON

Pleasant Entertainment for All

Walter B. Gibson has written what is conceded to be the most complete book of card tricks ever published. There are literally hundreds of these clever little tricks. You need not be a professional in order to work them out. There is no sleight-of-hand required. You can do any of them with little or no practice. Simple to perform—difficult to guess. Complete instructions—hundreds of illustrations.

Once you have mastered a few of the tricks that this book contains you will become extremely popular—always entertaining. Imagine the fun you can have at a party. Just nonchalantly pick up a deck of cards and inquire if anyone has "seen this one." Then while all attention is focused on you do these tricks one after another to the admiration and wonderment of all.

This big book of entertainment,  
fully illustrated—large  
magazine size

Only

25c

Per Copy

At all newsstands  
or write direct



# EXPERIMENTER PUBLISHING Co., Inc.

230 Fifth Avenue  
New York, N. Y.

EXPERIMENTER PUBLISHING COMPANY, Inc.  
230 FIFTH AVE., NEW YORK, N. Y.

Gentlemen:  
I desire the books checked below and am enclosing \$.....  
in full payment of same.

Houdini's Spirit Exposés  
 Popular Card Tricks  
 Beauty Secrets

Name .....  
Address .....  
City ..... State .....

Please say you saw it in RADIO NEWS

Then the ray at the margin of the picture will spread out to a width about double that of the ray at the center, or four times its area.

This is not a grave fault when the image at the transmitter is scanned at the same angle. In that case, the television is finer in detail at the center than at the margin of the image—*exactly as in the case of the same scene when it is scanned by the human eye.* In order to see more clearly at one side or the other, the eye must turn—just as does the camera of the newsreel photographer. The televistician who takes the "scanner" out of the studio for a job must develop a technique for most effective "pick-ups," just as his brother who "spots the mikes" has done.

We can now say with confidence that, to make television a domestic utility rivaling the radio-phonograph combination and the electric refrigerator, there is nothing lacking *except* the perfection of a few little details of electrical and optical adjustments. If you have the necessary ideas to supply one or more of them, use "all due diligence" to perfect them and get your "evidence of conception" in written form right away; there a lot of other inventors on the same job and working away for dear life. We shall be very glad to see your *working model.*

**Loftiest Tower Planned**

**B**ARCELONA (Spain) plans the erection of a 400-meter (1,312-foot) radio tower for its coming exposition. This would be the loftiest structure on the globe, exceeding the Eiffel Tower by several hundred feet. The design gives it a circumference of six hundred feet, and includes hotels, a theatre, a museum and a library, as well as the radio transmitters for broadcasts and telegraphy.

**Cuckoo! Cuckoo!**

**A**NOTHER polyglot transmitter recently opened is Laibach, (Jugoslavia) on 570 meters, 2,500 watts, which announces in Serbian, English, French, German and Italian. European stations identify themselves by various distinctive sounds—musical or otherwise—between numbers; and "Radio Ljubliana" has adopted the cuckoo's note as its call.

**MARRIAGE A LA MODE**

**JACK:** "Was your wedding reception a big success?"

**JILL:** "You bet! Why, we got Hollywood on the loud speaker!"—*Leslie Carpenter.*

**THE RADIO SERVICE**



"That's a good sermon—"  
"Spades are trumps—and it's a grand organ!"  
—"Funkalmanach 1928," Berlin Radio Exposition.

**NORDEN-HAUCK  
NEW 8 TUBE  
AC ELECTRIC MODEL**



**FOR  
1929**

Size 8x11x22

Weight 35  
lbs.

Wave length  
range 200 to  
550 meters.

The Norden-Hauck Electrophonic is an entirely new and superior broadcast Receiver operating directly from house current. It is well built, handsomely finished and compact. Truly it represents the highest type of efficiency obtainable in point of range, selectivity and simplicity combined with utmost quality of reproduction.

**10 OUTSTANDING FEATURES**

**ELECTRIC.** The Electrophonic is all electric operated and self-contained. No Eliminators or batteries whatever. Employs standard Radiotron or Cunningham alternating current tubes.

**CIRCUIT.** The Electrophonic employs an 8-tube circuit; three stages direct tuned radio frequency amplification fully neutralized, detector, and three-tube power audio amplifier push-pull type.

**SHIELDING.** The Electrophonic is totally shielded. Complete inter-stage shielding permits high amplification not obtainable otherwise.

**SIMPLICITY.** The Electrophonic has but one control for wavelengths, one control for volume. Illuminated drum dial calibrated in degrees and in kilocycles.

**SENSITIVITY.** The Electrophonic has carefully balanced radio frequency tuning circuits which with superior quality of materials and workmanship combine to make the Norden-Hauck Electrophonic a long distance Receiver.

**SELECTIVITY.** In the Electrophonic total shielding and carefully balanced circuits and quality permit unusual selectivity so necessary in congested districts.

**QUALITY.** The Electrophonic is of the highest quality of construction and design throughout. Comparable only with costly custom built Receivers.

**FINISH.** The Electrophonic has a exquisite solid mahogany cabinet, brown finish. Heavy cast bronze escutcheon plate and tuning knobs lend to the rich appearance of the Receiver which will fit in any surroundings. Cabinet high French polish and full piano hinge. Back removable and ventilated.

**GUARANTEE.** The Electrophonic material and workmanship are fully warranted against any defects whatsoever.

**PRICE.** The Norden-Hauck Electrophonic Receiver is moderately priced at \$125.00. Packed for shipment.

List Price **\$125<sup>00</sup>** f.o.b. Phila.

COMPLETE illustrated literature gratis. Write, telegraph or cable today.

**NORDEN-HAUCK, INC., ENGINEERS**

MARINE BUILDING, PHILADELPHIA, PA.

Builders of the Highest Class Radio Apparatus in the World.

**E  
L  
E  
C  
T  
R  
O  
P  
H  
O  
N  
I  
C**

**WRITE  
TODAY**

Send for large, new illustrated Catalog "B-3," showing the latest of everything in radio at wholesale prices.

**Allied Radio  
CORPORATION**  
711 W LAKE STREET, CHICAGO

**FREE TO SET BUILDERS  
AND DEALERS  
NEW 100 PAGE CATALOG**

HAMMARLUND OFFICIAL DISTRIBUTORS  
SILVER - MARSHALL KIT HEADQUARTERS  
NATIONAL COMPANY AUTHORIZED JOBBERS  
AERO SHORT-WAVE AND DAVEN TELEVISION  
We are ready to ship all kits or parts produced by the above manufacturers as well as any others specified in any radio publication.

**31 Years of Service to the Trade**  
**ROYAL-EASTERN PAYS THE FREIGHT**  
**Lowest Wholesale Prices**

Send for your copy of our catalog

ROYAL-EASTERN ELECTRICAL SUPPLY CO.  
20 West 22nd Street, New York City, N. Y.

Insure your copy reaching you each month. Subscribe to Radio News—\$2.50 a year.  
Experimenter Publishing Co., 230 Fifth Avenue, N. Y. C.

Please say you saw it in **RADIO NEWS**

**A MARVELOUS MONEY-MAKING OPPORTUNITY**

on  
**LAFAYETTE**  
**Electric RADIOS**  
*for Agents & Dealers*



**30 DAY FREE TRIAL**

Get your copy of our new 1929 Radio Catalog just off the press.—It beautifully illustrated pages, containing a wealth of money makers for you in Super-value Radio Sets and nationally advertised equipment, featuring 14 NEW Lafayette ALL-Electric Radio models,—at bona fide WHOLESALE prices to you.

*Complete with Cabinet*

**Built In Our Own Factory!**

Lafayette All-Electric Radio Receivers modernly, scientifically perfected,—present a record achievement in super quality throughout. Amazing in tone and volume reception.

**POWERFUL · SENSITIVE · SELECTIVE**  
Introducing exclusive improvements:  
8 tubes, two 171A Power tubes in dynamic "A" metal push and pull audio amplification, single dial illuminated drum control, and all parts perfectly balanced and matched, attachable to your home electric light current.

**BONA FIDE GUARANTEES**  
Every Lafayette Receiver is unconditionally guaranteed to be free from defects in workmanship and material. Should at any time some parts prove defective, we will replace them without cost to you.

Wholesale Radio Service Co.  
6 Church Street New York City

**FREE!**  
This 1929 Catalogue sent on request

**WHOLESALE RADIO SERVICE CO.**  
1929

**More Profits To Set Builders**

One good radio idea may be worth millions. Barawik has thousands of ideas for radio set builders to make more money. Barawik's Big Radio Book will help you while elections are on and big national events stir the world.

Send for your copy today — NOW.

**BARAWIK CO.** 21F Canal Station, CHICAGO, U. S. A.

**LATEST RADIO GUIDE**

Mail This Coupon Now! For Free Copy  
Name .....

Address .....

**Before Buying any "A" Eliminator**

Get my authorized Discount Card and complete description of the finest "A" Power Kit ever offered.

**DAVID W. KNAPP, Pres.**  
**Knapp Electric, Inc.**  
Division of P. R. Mallory & Co., Inc.  
Room 417, 350 Madison Ave., N. Y. C.

**AUDIO TRANSFORMERS 97c**

Think of it! A \$4.00 audio transformer—a genuine Illinois "all frequency" unit of the finest musical capability, ordered direct from the factory for only 97c each. A real bargain opportunity. Thousands have bought them. Sold with positive guarantee of satisfaction or money back. Supplied in ratios of 1½ to 1, 3 to 1, and 5 to 1. Order now. **ILLINOIS TRANSFORMER CO.** Dept. 111 223 W. Elm St. Chicago, Ill.



**The Dark Side of Radio**

(Continued from page 641)

repay him for the undesirable expenditure. He would have them all come in on the morrow to listen to Nitrate sing her "Oh, Honey, Won't You Be My Sugar Man," sung to an audience of nearly 5,635,999 people. Let his neighbors all know how important Landlord Snigsbie was in the community.

Now this is not intended to be a love story. A woman is usually the incentive to a crime, and as the French say "*Cherchez la femme*," Nitrate was the explosive as far as our hero was concerned. He simply had to hear the voice of his adored, although unadoring, Nitrate over the radio.

The dots to denote a lapse of one day.

Scene: Landlord Snigsbie's parlor. It seemed as though Snigsbie had invited half of the colored section of Harlem to witness his triumph. He would show his guests how democratic and sociable he could be despite his wealth. He passed around a tray of chewing gum, each package of gum loosened into individual pieces for the sake of economy. Another tray of cigarettes, whose burden of white thin paper filled sparsely with tobacco lay white and anemic, Snigsbie passed around with proud ownership. "Don't gwine stint yo'self," he said invitingly to his guests, "Partake freely off'n mah bounty. Dat gum is de bestest chewing vital dat money can buy, nothing else but. Dem heah cigarettes have been rolled by dis heah very fingers dat am holding dem. So help yo'self ladies and gennmen."

A smile and a snicker passed from one guest to another. Snigsbie had made sure that no one save the socially elect would be there. There were the Jonah Trumps, M.D.; he specializing in the aches and pains of participants in the daily crap games and their usual aftermath. She, a buxom but kindly soul, who helped the stork to fulfill its duty, sat ensconced in a stuffed chair of doubtful origin. The pressure and weight of the kindly lady was beginning to prove too much for it, and with open rebellion it was beginning to sag at the bottom and shed its stuffing bit by bit. Uriah Jingle, a flawlessly dressed young bachelor who had one of the leading pharmacies in the front of his store, but in the rear a dice shooting gallery of infinite proportion. It was he who was called the "Diceiple" of Harlem and, while the drugs he dispensed consisted of ham sandwiches and coffee over the soda counter, still the greater amount of his income was derived from the variegated manipulation of the bones by expert hands.

The Aesop Porters, he a lawyer of no mean ability. He was a past master of nonfeasance and his court cases were always *in transitu*, if you know what I mean. He it was who won the decision for Mabel Smith with a six-cent verdict in the breach-of-promise case of Smith vs. Sapp. And while Mabel acquired a fit of hysterics, he, Lawyer Porter, acquired a nice fat fee which, *en passant*, went as if with the wings of an angel into the pot-pourri of the "Diceiple's" crap game.

Then there was the Rev. I. M. Bosh, whose sermon "*Quos Deus Vult Perdere, Prius Dementat*" (Those Whom God Wishes to Destroy, He First Makes Mad") created such a furore in his congregation; for the simple reason that the richest member of the congregation, Brother Snigsbie, was as

**Finish the Job!**



CARTER

—With a Carter Radio Outlet Plate. Fifteen different styles and combinations planned to satisfy every possible condition. Specified and used by leading architects and contractors.

Finish the job with a Carter Plate.

Alert Dealers and Jobbers can supply.

CARTER RADIO COMPANY  
300 South Racine Avenue, Chicago, Ill.



**Wholesale RADIO Prices on RADIO**

Get our big new 1929 Radio Catalog—hot off the press. Contains thousands of amazing bargains. Latest, nationally advertised Radio equipment. Latest in Ham Transmission equipment. Everything at lowest wholesale prices.

**NEW RADIO CLUB—Big Prizes**

Get all the facts about "Ether Trappers' Club, now, No dues. Many advantages. Write for FREE Membership at once. **FREE**

This Big Book of money-saving bargains is yours FREE. A regular Radio encyclopedia. Write today for your copy of this book.

**AMERICAN RADIO & MERC. CO.**  
Dept. 10  
American Radio Building  
KANSAS CITY, MO.



**\$75 to \$125 Weekly**

**Charging Batteries Starts You**



Let me show you how to make big money right from the start. I've prepared a FREE book explaining all details. First week's profit pays for all equipment. You can get all the battery charging business in your community with my Service Station Charger—it's years ahead of ordinary chargers—handles 50% to 70% more batteries. I explain everything—start you in a business of your own and put you on the way to big money. Write for FREE BOOK.

**C. F. HOLMES, Chief Engineer, Dept. R.N.**  
Independent Electric Works  
5116 Ravenswood Ave. Chicago, Ill.

**FREE BOOK—Just Out**



Don't Miss  
**AMAZING STORIES**

"The magazine of scientific adventure, excitement and romance"

At All Newsstands

mad as a bull pup against every other member of that very worthy congregation.

Lorelei Gatsby, whose only claim to distinction was the patented liquid to remove the kink from the otherwise curly heads of her sister sufferers, which she had discovered.

Lor' bless us! There's Hiram Ketchem, the real estate magnate of vast proportion and circumference. He it was who created the slogan, "I Ketchem Young. If I don't someone else will." To his mind he was the wit of Harlem. Where there is ignorance there is bliss!

To come back to Landlord Snigsbie's parlor, and Snigsbie. Here he is standing in front of the radio set with deep palpitation of his heart. It was seven o'clock. Time for his "chocolate drop" to come on. The radio dealer had sent a boy for two hours yesterday to fix up the machine, and had told him exactly how to work it. Says he: "Now Mr. Snigsbie, yo-all gwine have a good time tomorrow night if yo' gwine do just as ah tells yo', and nothin' else but. Now don't you go a-foolin' round this heah contraption until tomorrow night at 'xactly seben o'clock, when yo' wants to hear yo' baby lamb croonin' to de honorable Snigsbie."

And so he obeyed orders. The boy had told him if he would turn the knob and put the plug in, all would be well. Now was the big moment. He inserted the plug, turned the dial. There was a tense silence only broken by a strange hum of the machine. Suddenly a voice, "This is Station WBUM. You will now hear the "Honey Blues" sung by the inimitable Nitrate Eliza Pepp of the "Lookin' Wild" Company. Click. Then: silence; next, a voice. A sweet feminine voice. It did sound like Eliza's. Snigsbie turns to his guests and in a "high hat" manner smiles graciously and nods his head to each one of his guests with an "I know what a great man I am" manner. And then the feminine voice oozing out from the body of the loud speaker:

"Small Snigsbie, can yo' hear me? Ah knows yo' is lisenin' to me, so I'se gwine treat yo' to a few most choisest woids dat I'se been cravin' to expedite to yo' craminum fo' a long, long time. Colored nian, keep yo' ears wide open, for what I'se gwine to say is dat yo' is so mean yo' would take de nails off a dead man's fingahs and use 'em fo' carpet tacks. Yo' is so low, yo' can put your shoes on standin' up. Yo' is a niggah with a natural proclivity to do mean things, 'cause they gwine mean nothin' to you. Yo' name is Small, but yo' is smaller den what yo' name gwine imply. . . ."

By this time, Landlord Snigsbie was fast reaching the lunatic stage. His face was red with rage, and his voice and hands shook as if with a palsy. There were shouts of laughter which proved so hilarious that three or four of the guests who were rocking back and forth with such intensity that the old and feeble furniture gave way and they found themselves in intimate companionship with the none too attractive looking floor. The room was in an uproar, but the worst was yet to come. Snigsbie in his uncontrolled wrath opened the door, and going over to the radio, he pulled it out bodily, by its roots, with the entangled wires hanging limp and in disgrace. He flung it through the door, followed by the loud speaker. As if to rid himself of this terrible demon with all its belongings, he grabbed one "B" battery after another and, with blasphemy upon his purple lips, threw

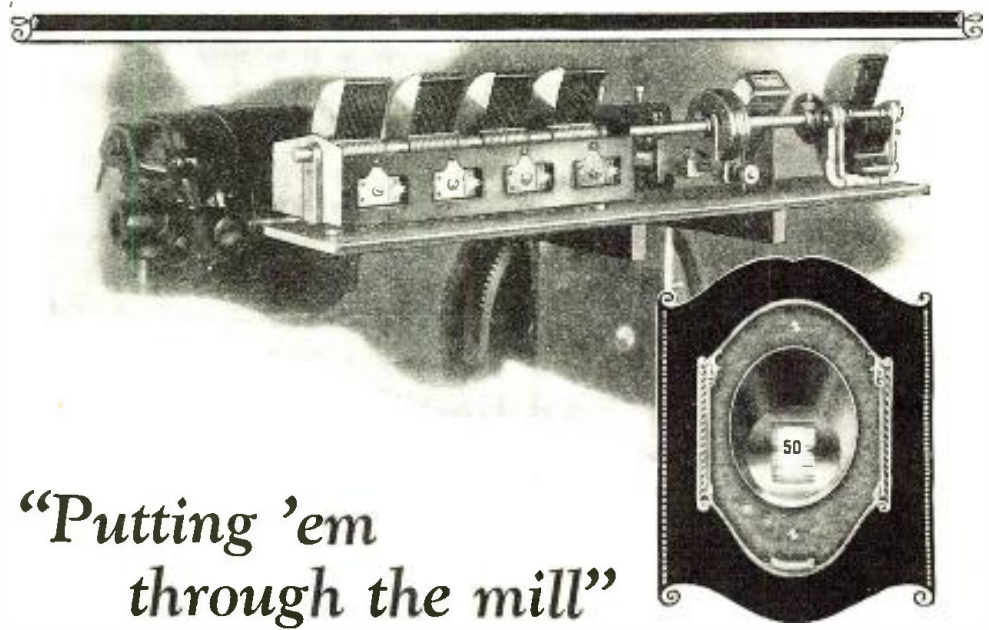

## "Putting 'em through the mill"

**H**AMMARLUND laboratory and shop tests leave nothing to guess-work. All possible worry and regret are taken out of Hammarlund products—their soundness is proved before you can buy them.

That is why the name "Hammarlund" stands pre-eminent in the radio world for quality of equipment that serves more faithfully and lasts longer than you will probably ask of it.

In tests, made on the machine pictured above, the special silk

and linen cable that drives the new Hammarlund drum dial withstood 363,600 full-range movements of a heavy, four-gang condenser — more than fifty years of normal use.

And under such treatment, the condenser bearings, plate alignment and pigtail connections have ample opportunity to show up any weakness of design or workmanship.

You can rely on Hammarlund Products because reliance is built into them.

Fill in and mail the coupon below

HAMMARLUND MANUFACTURING COMPANY

424-438 W. 33rd Street, New York

For Better Radio  
**Hammarlund**  
PRECISION  
PRODUCTS

Enclosed 10c for Short-Wave Manual  
 Enclosed 25c for "HI-Q29" Manual  
 Send other Hammarlund Folders.

Name.....  
Street.....  
City.....  
State.....

## BE A RADIO DOCTOR



If you are interested in radio, the quicker you decide to make radio your life work the sooner you will be assured of success and Big Money.

**\$5,000** a year is possible for men connecting at once with our big National Radio Service organization.

**I Need 1200 Men at Once for Chain Service Stations** Don't be a "tinkerer," get in on the ground floor with a big proposition. Investigate at once.

"Have a licensed Radio Doctor fix it" is the slogan where our men operate.

Write today for our free booklet, "Why the Radio Doctor"

E. W. PARKER, Pres. RADIO DOCTORS, INC.  
Dept. N4, Essex St., Salem, Mass.



Insure your copy reaching you each month. Subscribe to Radio News—\$2.50 a year. Experimenter Publishing Co., 230 Fifth Avenue, N. Y. C.

Please say you saw it in RADIO NEWS

# FANS! third big edition

Don't  
Miss  
This  
Big  
Issue  
!

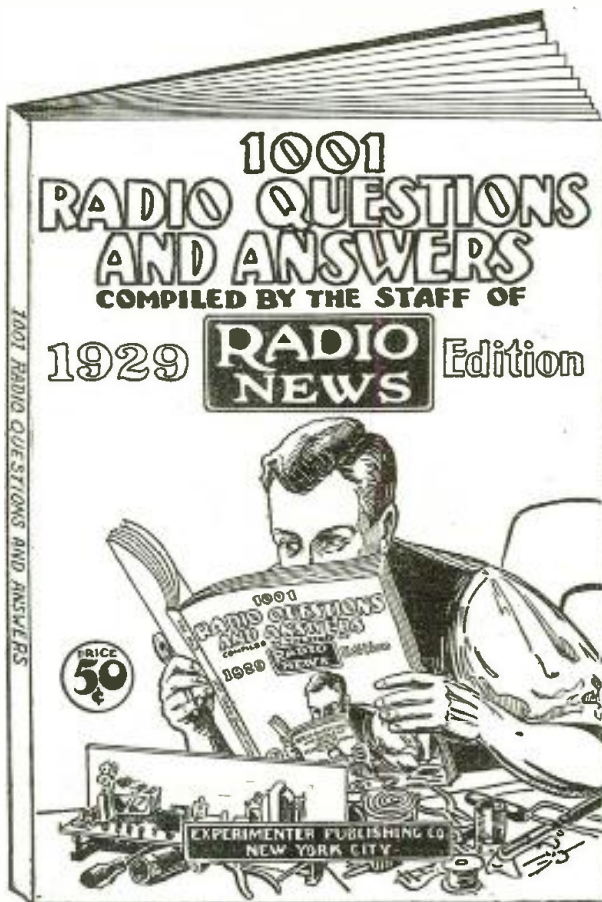

Over  
150,000  
Copies  
Already  
Sold  
!

Compiled by the Staff of RADIO NEWS

## Completely Revised-Up-to-the-Minute

1001 RADIO QUESTIONS AND ANSWERS, the most sensational seller in the radio field, is now in its third new and revised edition. No one interested in radio should be without a copy. The staff of RADIO NEWS, the leading fan magazine, has striven to make 1001 RADIO QUESTIONS AND ANSWERS the foremost work of its kind available. There is a full and complete explanation of every worthwhile circuit that has appeared since the beginning of radio, not only the explanation, but also complete diagrams from which the set can be con-

structed. Concise, authentic answers to every question that can possibly be asked concerning the many and varied branches of radio reception on both short-wave and broadcast bands.

**FANS! Don't hesitate! Get your copy today! Over 112 pages — fully illustrated—large magazine size**

# 50c

THE COPY

ASK YOUR NEWSDEALER OR WRITE DIRECT

**EXPERIMENTER PUBLISHING COMPANY, INC.**  
**230 Fifth Avenue, New York, N. Y.**

**Mail This Coupon NOW!**  
 EXPERIMENTER PUBLISHING CO., INC.  
 230 Fifth Avenue, New York, N. Y.  
 Gentlemen: Enclosed is 50c. Please forward me a copy of 1001 RADIO QUESTIONS AND ANSWERS.  
 Name .....  
 Address .....  
 City .....  
 State .....

Please say you saw it in RADIO NEWS



it with a ferocity never before equalled by him, alongside the bruised and battered radio set lying helpless and forlorn somewhere in the dark and dreary hall.

But not for long, my friends. For Ulysses Grant Rasby and Sambo Brown, lurking in the dark recesses of that hall and still in the throes of some unaccountable mirth, rescued the poor and blameless radio set from its disgrace. After a few hours of repair work it was properly placed on the table in Ulysses' room. They connected it to the borrowed aerial that once upon a time—only that very evening—belonged to Landlord Snigsbie. The plug in its proper setting, the dial turned, and then the catchy strains of the "Honey Blues" came pouring forth in all its glory from the silver throat of his beloved Nitrate, now broadcasting from a night club.

\* \* \* \* \*

The rear of Uriah Jingle's drug store was filled with the gentry of the ivory. For once there was a lingering hush in the exciting crap game. Bits of conversation.

"Lor' almighty, dat sho' was puttin' one over Landlor' Snigsbie." Peals of laughter.

"Yo' all knows what dat radio boy done went an' done to Snigsbie's radio, ah reckon? He jes' cut dat dere aerial loose from de set, an' den ventriloquism hopped on de loud speaker an' did de rest." Hilarious laughter.

"Sambo Brown sho' done give a good imitation of Nitrate's voice, an' nothin' else but."

"An' say, brother, I'se gwine laugh until I'se hear from Ulysses' own ivories how he done went and done dat mean trick, and if he gwine come heah tonight, what say we give him dis heah what you call "proceeds" of this crap game. All yo' brothers in favoh say "ay."

"AY!"

## AMAZING STORIES

In Our January Issue:

**The War of the Planets**, by Harl Vincent. In this sequel to "The Golden Girl of Munan," the author outdoes himself. It is full of action, excitement, adventure and hero-worship.

But never does the author forget the importance of science in his tale, and there is hardly any limit which scientists, bent on revenge, might not reach.

**The Roger Bacon Formula**, by Irvin Lester and Fletcher Pratt. Roger Bacon, an eminent scientist of the 13th Century, expounded theories so far in advance of his time, that he was accused of working with black magic. This is an unusual interplanetarian story that will be enjoyed even by those who are not "interplanetarian story fans."

**The Sixth Glacier**, by Marius. (Part I.) According to geologists, the earth has been visited by five glacial periods in the dim past. If there were glacial periods in the past, why not in the future?

**Cauphul, the City Under the Sea**, by George Cookman Watson. This story is written by a newspaper man, who has taken the trouble to get his information from authentic sources. That he also draws on his imagination, only enhances the interest.

And others.

# over 100,000

## Townsend "B" Power Units Now in Use --they must be good!

They ARE good! Besides full tone, clarity and volume, you get the thrill of startlingly clear long-distance reception. Never in radio history has anything given such sensational results for such a low price. UNSURPASSED QUALITY built in with money saved by unified production methods and low merchandizing costs. New thousands of set owners learning amazing value of this Unit.

Utmost economy and convenience. Plug into light socket and forget it. Delivers up to 100 volts on any set on D.C. or A.C.—any cycle. YOU TAKE NO RISK. Sold on real GUARANTEE—it must satisfy or money paid us will be returned.



### APPROVED

and passed by the rigid laboratory tests of "Popular Radio" and "Radio News."

**SEND ONLY \$1.00** Fill in coupon and send with only \$1.00. Prove this marvelous value to yourself. Use it ten days. Then if it fails to do everything we say, return it and money paid us will be refunded. Make a REAL receiver of your set.

### From This Month's Mail

Your Eliminator has been in use for two years at an average of 8 hours a day on my 5-tube Stewart-Warner and am well satisfied with it.

Clifton E. Palmer,  
Highland Park, Mich.

Have had your Eliminator in service for a year and it is still going strong. Three friends have also purchased one and are equally pleased.

Walter P. Benisch,  
So. Pasadena, Calif.

Your Eliminator far superior to "B" batteries. Attached to my 5-tube Radiodyne it is as good as any All Electric set I have yet heard.

Leo Pfeffer, Alton, Ill.

Have had your Eliminator in use for over a year and it has proven very satisfactory.

Irving J. Scherer,  
Detroit, Mich.

Have been using your Eliminator for almost a year and it is giving fine service.

G. D. Murray, Roanoke, Va.

Your Eliminator has given excellent and satisfactory results. Also increased volume and improved tone.

E. J. Luken, Louisville, Ky.

I have used your Eliminator for a year and am very well satisfied with it and have recommended it to many in this city.

Donald J. Scott, Lansing, Mich.

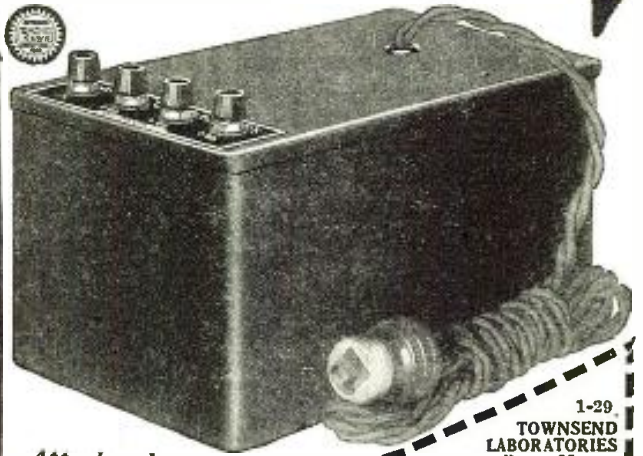

Attach only \$1.00 to this coupon

1-29  
TOWNSEND LABORATORIES  
Dept. 25,  
713 Townsend St.,  
Chicago, Ill.

Gentlemen: Attached find \$1.00. Kindly send at once Townsend "B" Socket Power Unit, C.O.D. \$5.85, plus postage, on guaranteed 10-day Free Trial.

Name.....

Address.....

City..... State.....

## GENUINE Nathaniel BALDWIN Famous Type C HEADPHONES



We offer several thousand genuine Nathaniel Baldwin PERFECT type C headphones fresh from the factory in original sealed cartons at a fraction of their cost. Never before sold for less than \$9. Price while they last only \$5.50. Satisfaction guaranteed or money refunded.

### BALDWIN HEADPHONES

hold all long distance records, you simply cannot get distance stations by any other means. An operator at San Francisco picked up a code message from Bagdad, Turkey—half way around the globe, a world's record. Whether you are a professional operator, set builder, or H.C.L. these are the headphones you need.

OUR PRICE \$5.50 ORDER NOW

PREMIER ELECTRIC CO. 150 Nassau St. New York

## SET BUILDERS Get this Book



Barawik, the first and oldest radio specialty house, offers you unequal service this year. Bigger stocks, quicker shipments, lower prices. Deal with an old established, reliable house. Get honest goods, honest service, honest prices. Barawik service makes you more money. Send now for big new Catalog showing lowest wholesale prices.

**BARAWIK CO. CHICAGO, U. S. A.**

Mail This Coupon Now for Free Radio Guide

Name..... Address.....

Please say you saw it in RADIO NEWS

# Prices Slashed!

## Order Today!

OFFER MAY BE WITHDRAWN  
IN THIRTY DAYS

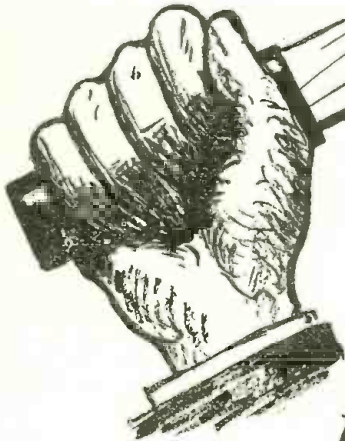

Your  
Favorite Magazines  
at  
Record-Making Reductions.

No. 30

(THE GRADE "A" SPECIAL)

AMAZING STORIES } ALL 3  
RADIO NEWS . . . } ONLY  
SCIENCE & } \$5.75  
INVENTION }

YOUR CHOICE OF ANY ONE OF THE FOLLOWING:

- RADIO NEWS . . . . . 1 Year
- OR
- SCIENCE & INVENTION . . . . . 1 Year
- OR
- AMAZING STORIES . . . . . 1 Year
- AND

ANY ONE OF THE OFFERS LISTED BELOW:

OFFER 1		ALL 3
YOUTH'S COMPANION . . . . .	1 yr.	ONLY \$5.25
PICTORIAL REVIEW . . . . .	1 yr.	
OFFER 2		ALL 3
GOOD HOUSEKEEPING . . . . .	1 yr.	ONLY \$6.25
MODERN PRISCILLA . . . . .	1 yr.	
OFFER 3		ALL 3
COSMOPOLITAN . . . . .	1 yr.	ONLY \$6.25
MODERN PRISCILLA . . . . .	1 yr.	
OFFER 4		ALL 3
PICTORIAL REVIEW . . . . .	1 yr.	ONLY \$4.00
McCALL'S MAGAZINE . . . . .	1 yr.	
OFFER 5		ALL 3
PATHFINDER . . . . .	1 yr.	ONLY \$4.40
MODERN PRISCILLA . . . . .	1 yr.	
OFFER 6		ALL 3
AMERICAN MAGAZINE . . . . .	1 yr.	ONLY \$5.50
McCALL'S MAGAZINE . . . . .	1 yr.	
OFFER 7		ALL 3
DELINEATOR . . . . .	1 yr.	ONLY \$4.50
MODERN PRISCILLA . . . . .	1 yr.	
BIG FAMILY BARGAIN No. 29		
MOTHERS HOME LIFE . . . . .	1 yr.	ALL 7 ONLY \$3.00
ILLUSTRATED MECHANICS . . . . .	1 yr.	
TODAY'S WOMAN & HOME . . . . .	1 yr.	
HOUSEHOLD GUEST . . . . .	1 yr.	
POULTRY TRIBUNE . . . . .	1 yr.	
AMERICAN FARMING . . . . .	1 yr.	

Offer No.		Both for only
8-	AMERICAN BOY . . . . .	1 yr. \$4.00
9-	AMERICAN MAGAZINE . . . . .	1 yr. 4.50
10-	BETTER HOMES & GARDENS . . . . .	1 yr. 2.85
11-	CHILD LIFE . . . . .	1 yr. 5.60
12-	COLLEGE HUMOR . . . . .	1 yr. 4.00
13-	COLLIER'S WEEKLY . . . . .	1 yr. 3.75
14-	COSMOPOLITAN . . . . .	1 yr. 4.75
15-	DELINEATOR . . . . .	1 yr. 3.00
16-	ETUDE (for music lovers) . . . . .	1 yr. 4.00
17-	EVERY CHILD'S MAGAZINE . . . . .	1 yr. 3.50
18-	FOREST & STREAM . . . . .	1 yr. 4.00
19-	GOOD HOUSEKEEPING . . . . .	1 yr. 5.50
20-	LITERARY DIGEST . . . . .	1 yr. 6.50
21-	McCALL'S MAGAZINE . . . . .	1 yr. 3.00
22-	McCLURE'S MAGAZINE . . . . .	1 yr. 4.75
23-	MODERN PRISCILLA . . . . .	1 yr. 3.50
24-	PATHFINDER . . . . .	1 yr. 3.00
25-	POPULAR SCIENCE MONTHLY . . . . .	1 yr. 4.50
26-	PICTORIAL REVIEW . . . . .	1 yr. 3.00
27-	SMART SET . . . . .	1 yr. 5.25
28-	YOUTH'S COMPANION . . . . .	1 yr. 4.25

EXPERIMENTER PUBLISHING CO., 230 Fifth Ave., New York City. Date.....

Gentlemen: I am returning this coupon with \$..... for which I am to receive your OFFER NO. .... and

PUT X IN BOX  
OPPOSITE YOUR CHOICE.

RADIO NEWS . . . . . 1 yr.  
 SCIENCE & INVENTION . . . . . 1 yr.  
 AMAZING STORIES . . . . . 1 yr.

NAME .....  
ADDRESS .....  
CITY..... STATE.....

IF THE MAGAZINE YOU ARE INTERESTED IN IS NOT LISTED HERE, WRITE US FOR COMBINATION PRICE.

Please say you saw it in RADIO NEWS

## Review of Recent Radio Literature

By H. M. BAYER

THE RADIO MANUAL by George E. Sterling, edited by Robert S. Kruse. Published by D. Van Nostrand Company, Inc., New York City. 8 x 6 inches, 666 pages; halftones and diagrams. Price \$6.00.

Though the preface of this work introduces it as "a guide and text book to those who expect to enter the radio profession as engineer, inspector, commercial or amateur operator," a reading of this book proved that it should take its place in every radio experimenter's library—that of a text for the study of radio as it should be studied.

It is, indeed, a remarkable book from which nothing relating to radio has been omitted. As specified in the preface, it has been written for everyone connected with or interested in radio. Especially to the "old timer" and the transmitting "ham" should it appeal with its profuse diagrams and photographic illustrations, covering a really comprehensive course in the study of commercial transmission apparatus. In this matter, the subject is not only covered in language sufficiently simple for the average experimenter, but with a thoroughness that convinces the reader he has received a complete education in everything pertaining to commercial radio. If the truth must be known, to our knowledge it is the only text offering so thorough and lucid a course on modern radio apparatus and its application.

In the first chapter, 49 pages are devoted to the study of elementary electricity, magnetism and the study of capacity and resistance in radio. The manner in which these subjects are presented is alone worth the purchase of the book; it is in itself a concise preparatory education with which every experimenter should equip himself. This chapter covers the subjects of potential, current, conductors and non-conductors, resistance, production of electric current; elementary calculations; the complete theory of magnetism with its various branches; voltmeters and ammeters; the study of inductance; condensers and their calculations; alternating current, impedance, reactance, phase-displacement; design of transformers and how various types are hooked up; and, to top this excellent basic education, an enlightening discussion on the propagation and characteristics of radio waves, and simple calculations in wavelength and frequency.

The next chapter should be read by every amateur who contemplates or is experimenting with television; here the author deals with motors and generators—the theory connected with their operation, care and maintenance, the circuits of various types and their starting systems.

Then follow invaluable chapters on the theory of the vacuum tube; fundamental circuits, modulating systems, vacuum-tube transmitters; radio broadcasting equipment, arc and spark transmitters, commercial radio receiver; marine and aircraft beacons and direction finders; amateur short-wave receivers and transmitters; and, for the commercial operator and student, a complete course in the handling of commercial traffic entering into numerous details involved.

Included in the appendix is a kilocycle-meter conversion chart which gives reciprocal values for every ten kilocycles or meters between the limits of 10 and 30,000. Of course, there is a great deal more to this book than this review has space for; but it is the reviewer's conclusive contention that, for the subjects it undertakes to cover, it is the best book written.

CONCERNING PRECISION AUDIO RESISTANCE AMPLIFIERS FOR TELEVISION AND LABORATORY EXPERIMENTERS, by Joseph Morgan. Published by International Resistance Company, Philadelphia, Pa. Pamphlet, 9 x 6 inches; 9 pages; diagrams and curves. Free distribution.

In the letter accompanying this pamphlet the publishers, well-known manufacturers, make mention of the fact that the author's name as given in the above descriptive paragraph is the *nom de plume* of a well-known professor of engineering at present occupying a chair in a famous Eastern university. Just who this personage may be, it must be confessed, perplexed the reviewer even more than the average broadcast fan may be puzzled to obtain 455 volts "B" battery, as recommended by the author for the amplifiers described in this booklet.

Nevertheless, a better idea of the subject can be

# Java for Breakfast with The Thrill Box

**BANDOENG TO BOSTON**

Radio Department  
Christian Science Monitor:  
I have heard Bandoeng, Java (AKE) on my NATIONAL Short Wave Set as described in the Monitor for August 10, 1928, from my home, bringing in the broadcast of speech and music clear as a bell from 8:00 a. m. to 8:30 a. m. (Eastern Standard Time). I also use this receiver regularly in connection with my Amateur Code work and maintain two way communication with all parts of the world.

GEORGE HINCKLEY, W-1GA  
25 Stiller Road,  
West Roxbury, Massachusetts

12,500 miles

**NATIONAL THRILL BOX**

NATIONAL Short Wave Equipment enabled Mr. Hinckley to hear Java broadcasts half way around the world.

You are missing a pack of thrills if you don't own a

## NATIONAL THRILL BOX

Complete Kit in factory-sealed carton, less tubes

\$36.00

Metal Cabinet, black moire finish, extra \$6.50



Write us for our Short Wave Bulletin No. 128RN.

NATIONAL CO. INC.  
MALDEN, MASS.  
W. A. Ready, Pres.

Build it yourself in one short evening

## SET BUILDERS Get this Book

LATEST RADIO GUIDE

FREE

Barawik, the first and oldest radio specialty house, offers you unusual service this year. Bigger stocks, quicker shipments, lower prices. Deal with an old established, reliable house. Get honest goods, honest service, honest prices. Barawik service makes you more money. Send now for big new Catalog showing lowest wholesale prices.

**BARAWIK CO.** 21H Canal Sta., CHICAGO, U. S. A.

Mail This Coupon Now for Free Radio Guide

Name \_\_\_\_\_  
Address \_\_\_\_\_

### TELEVISION SCANNING DISCS (Pioneers)

Composition Scanning Discs ready for motor shaft mounting, with either 24, 36, 45, 48, 50 or 60 holes on spiral. 12", each, \$1.00; 16", each, \$2.00; 21", each, \$3.00. Standard Aluminum Scanning Discs ready for motor shaft mounting, with either 24, 36, 45, 48, 50 or 60 holes on spiral. 12", each, \$4.00; 16", ea., \$5.00; 24", ea., \$6.00. Neon Lamps, plate 1 1/2" x 1 1/2", each, \$6.00. Small Motors for 12" Composition Disc, each, \$7.00. Also large size Motor for Aluminum Discs each, \$22.00. Television Reproducer Essential Kit, 24" Disc, \$38.50. Television Reproducer Essential Kit, 12" Disc, \$38.00. Television Reproducer, ready to connect to your Broadcast Radio Receiver, enclosed in Cabinet, with 12" Composition Disc gives picture 1 1/2" x 1 1/2". F.O.B. Detroit, Mich., \$30.00. With 24" Aluminum Disc gives picture 1 1/2" x 1 1/2" and larger, F.O.B. Detroit, Mich., \$60.00. Get ready now, for your local broadcaster will soon transmit Television on regular schedule. Remember we are Pioneer Television Apparatus makers. We guarantee results with all our apparatus. Send 10 per cent. of purchase price on C.O.D. orders. POHL BROTHERS, 3541 Michigan Ave., Detroit, Mich.

Insure your copy reaching you each month. Subscribe to Radio News—\$2.50 a year. Experimenter Publishing Co., 230 Fifth Avenue, N. Y. C.

Please say you saw it in RADIO NEWS

### Individual, Independent Speaker Volume Control



Constant Input Resistance. LIST PRICE \$3.00

The Centralab Constant Impedance Volume Control is the only unit that allows a number of speakers operated from the same amplifier to be controlled individually without affecting the other speakers in the circuit. It is a dual resistance unit

with one resistance shunting the speaker for volume control and the other resistance in series with the line. Adjusting the knob varies both resistances so that while one short circuits the speaker to control volume, the other resistance is added to the line, maintaining a constant impedance. Easy to install, smooth and efficient in operation. Send for interesting booklet of picture and wiring diagrams, "Voltage and Volume Controls—Their Use."



20 Keefe Avenue

Milwaukee, Wis.

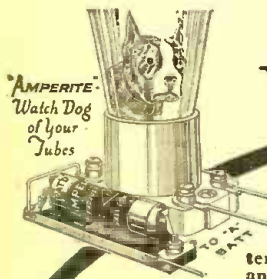

### Never Wears Out

Your first cost is the only cost. Then why not enjoy permanently the better tube performance and prolonged tube life alone offered by

## AMPERITE

The "SELF-ADJUSTING" Rheostat

Keeps filament voltage constant despite "A" battery variations. Simplifies wiring, panel design, tube control, tuning. Insist on AMPERITE. Nothing else can possibly perform as well. Unconditionally guaranteed.

Price \$1.10 with Mounting, (in U. S. A.) For sale by all dealers.

RADIALL CO. 50 Franklin St., N.Y.

FREE

"Amperite Book" of latest circuits and construction data. Write Department RN-1

### More Profits To Set Builders

One good radio idea may be worth millions. Barawik has thousands of ideas for radio set builders to make more money. Barawik's Big Radio Book will help you while elections are on and big national events stir the world.



Send for your copy today - NOW. BARAWIK CO. 216 Canal Station, CHICAGO, U. S. A.

Mail This Coupon Now! For Free Copy

Name .....

Address .....

offered by quoting a goodly share of the all-too-short text.

"The familiar form of straight resistance-coupled amplifier is known to everyone. It has two great disadvantages which have militated against its use. First, the large number of high voltage 'B' and 'C' batteries necessary; second, its instability."

"An amplifier which minimizes these difficulties was recently designed in England. Extensive experimentation was done to adapt this principle to the standard American vacuum tubes, with the result that two very stable amplifiers have been developed which give an excellent gain on direct voltages and audio-frequency voltages up to 10,000 and 30,000 cycles per second, respectively, with good uniformity."

And that, in short, is the key to the pamphlet's contents. To quote any more, we fear, would mean the publication of the entire text in this column. It is unfortunate, indeed, that with text of so interesting a nature so brief an exposition was written for this type of amplification; which, doubtless, is the prince of audio-amplification systems when properly designed and operated.

Two resistance-coupled amplifiers are described; the first describes a set-up employing the 201A-type tube with power amplification in the third stage, and the other one using the screen-grid tube with a 171A-type in the last stage. Sufficient constructional data are offered for the experimenter who may desire to build these amplifiers.

THE OUTLINE OF RADIO, by John V. L. Hogan. Published by Little, Brown and Company, Boston, Massachusetts. 7 1/4 x 5 1/4 inches; 267 pages, halftones and diagrams. Price \$2.00. Third edition.

The name of the author should need no introduction to radio fans; if by any chance there is any forgetful one, it is suggested that he lift the lid of his radio receiver (if it is a commercial model) and, the chances are, he will find inscribed on the patent notice, among other things, a line attesting the fact that certain features in said receiver have been made possible by the inventive genius of one Mr. John V. L. Hogan—the author of the book in question.

Mr. Hogan could not have employed simpler language had he tried; and yet he has written a book which, with all its simplicity, fulfills its purpose—and that is to popularize the science of radio transmission and reception for the uninitiated by the simplest and most readable explanations. In his introduction the author accounts for his work, in a manner which covers his motive in a nutshell.

"Imagine," he says, "that you are spending the week-end at my home; that we have drawn our chairs before the fire; and that you have asked me, 'Just what is this radio, anyway? How did it happen? What makes it work?'"—and that, after a long pull at my pipe, I've said, 'Well it's like this . . .'"

PATENTS—LAW AND PRACTICE, by Oscar A. Geier. Fourth Edition. Published by Richards & Geier, New York City. Cloth bound, 9 x 6 inches; 46 pages; no illustrations. Office distribution.

The author of this booklet has compiled just those questions most often asked by those interested in obtaining patent papers, and has performed the task of writing a study of a legal subject so that it makes interesting reading for the layman. The following heads are covered: The Law; Nature of a United States Patent; Who May Obtain a Patent; What May be Patented; Application for Patent; Claims; Attorneys; Reissues; Appeals; Infringements; Disclaimers; Infringement Suits; Injunctions; Validity and Infringement Searches; Interfering Patents; Shop Rights; Employer and Employee; Design Patents; Trade Marks; Copyrights; Foreign Patent Laws, including a schedule of charges for obtaining a patent in any foreign country. The information in this booklet may be accepted as authoritative, considering the fact that the publishers are patent attorneys of many years' standing.

### YOU CAN'T FOOL US, MISTER

The new and flickering art of television is still suspect by many people—who are of the same opinion as the farmer who looked at the camel and declared positively "There ain't no such animal!"—Among them, no doubt, the radio editor of the San Francisco Chronicle who declares, as of Oct. 14, that in the Cooley system "the slight lag of the corona \* \* did not mar DECEPTION to any great extent."—Herbert F. Ross.

### Arcturus Has It!

## A 7-Second Detector

IT'S the fastest-acting Detector in the world—the Arcturus #127. No other Detector on the market brings programs in so quickly, so clearly.

Put Arcturus A-C Long Life Tubes in every socket—for increased, undistorted volume—for better all-around reception—to end frequent tube replacements! Ask for the blue Arcturus Tubes—#127—#126—#071—#180. — Arcturus Radio Company, 220 Elizabeth Avenue, Newark, N. J.

## ARCTURUS A-C LONG LIFE TUBES

### 5 TUBE SETS \$14.90

In beautiful walnut cabinets



THE MOST ASTOUNDING OFFER Ever made in radio Tuned radio frequency circuit

GUARANTEED for Tone Quality and Selectivity These are used sets and were taken in trade for A.C. sets.

If after trying out one of these sets, you do not find that this is the most wonderful buy you ever saw in a radio set, we will cheerfully refund your money.

We are also offering to dealers and set builders the following accessories: Audio Transformers \$0.75, Crosley Cone Units \$2.50, UX380 B Eliminator Tubes \$1.75, 30 Henry Chokes \$1.00, 2 Mfd. Condenser Blocks \$0.60, Sockets \$0.15, Rheostats \$0.25, Potentiometers \$0.35, Cables \$0.35, Glo-Dials \$0.85, Radiola Loop Antennas \$1.65, Crosley or Atwater-Kent walnut panels, size 9 x 26 inches \$0.85, Output transformers for dynamic speakers \$0.95, Panels 6 x 10 1/2 \$0.35, Variocouplers \$0.65, Kodak B Eliminators \$3.90, Kodak A Eliminators \$3.90. These eliminators require slight repairs. Electrical pick-ups \$8.85, Deresnydyne walnut cabinets \$8.45, Peanut Tubes UV199 and UX199, 75 cents each. Send money order with order.

CHAS. HOODWIN CO. Dept. H, 4240 Lincoln Ave. CHICAGO, ILL. DEALERS IN BANKRUPT STOCKS

### DEPENDABLE "B" BATTERY POWER

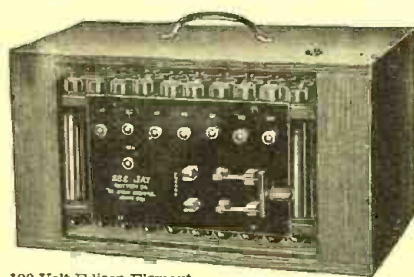

100 Volt Edison Element. Non-Destructive, Rechargeable "B" Battery with charger. Shipped dry, with solution, \$12. 140 Volt with charger, \$17. 180 Volt Power Unit, with Trickle Charger, \$24.00.

SEND NO MONEY—PAY EXPRESSMAN Write for our Free Literature SEE JAY BATTERY CO., 915 Brook Ave., New York

**SM DEALERS and SETBUILDERS**

Complete stock of nationally known parts and accessories. Send for illustrated catalog and discount sheet.

Radio Exclusively Since 1921

**CLARK & TILSON, INC.**

122 CHAMBERS STREET NEW YORK

The Nationally Known House

### The Constructor's Page

(Continued from page 660)

gold, makes an attractive and rigid set. It works wonderfully on the broadcast band, though I have not had time to test thoroughly on the short wave. In conclusion, I may say, it was only your blueprints (No. 52) which pulled me through. They gave me the fine points of the game; I stuck close to them and everything is as it should be. Had I been able to afford it, I should have used better variable condensers; but evidently the circuit won on its merits. Allow me to thank you.

W. J. KEMPSON,  
49 Dorothy Avenue, Ville Emard,  
Montreal, Quebec, Canada.

#### A LONG JOB

Editor, RADIO NEWS:

It is almost an impossibility to express in mere words my grateful appreciation of the noble way in which I have been assisted, through the medium of RADIO NEWS. I am ever grateful to you and the hundreds (I have received 153 letters to date) who have answered my appeal in the October issue. I am endeavoring to answer each and every individual letter, but it takes time.

JACK N. PETERSON,  
El Salvador, Central America.

#### UNTUNED AERIAL COUPLERS

Editor, RADIO NEWS:

I have been a reader for the past four years; before you changed your policy, I missed a copy of RADIO NEWS occasionally, but since then, not one. It is just what I think a radio magazine should be, and I do not believe a radio constructor or experimenter can afford to be without it. I have several of your blueprints, which I consider alone worth more than the price of your magazine.

I would appreciate it if you will publish in the near future detailed instructions for making a choke to be used as an untuned antenna coupler in the grid circuit of a 222-type tube.

(For the broadcast band, a choke with around 80 or 85 millihenries inductance is suitable. A satisfactory choke can be made by winding 300 turns of No. 32 D.C.C. wire on a wooden or fiber spool, 1/2-inch in diameter. For short-wave work, a coil with between 100 and 150 turns will be sufficient. The choke should be "jumble-wound."—EDITOR.)

I would like very much to know what kind of set Mr. Aikman of Salem, Ill., is using for coast-to-coast reception without aerial or ground. I am using a set of Browning-Drake variety, with a 180-volt "B" unit and I can receive WLW, WSAI, WLS, WMAQ without aerial or ground. But, to get KFI, I have to have about 100 feet of aerial and a good ground. I would like to hear from experimenters who have tried methods of untuned aerial coupling for broadcast receivers.

REX BRUMBACH,  
812 Ruddle Ave., Anderson, Indiana.

#### QUITE SATISFACTORY

Editor, RADIO NEWS:

I would like to express my appreciation of a description of a cone speaker that appeared in the article on page 46 of the July, 1928, issue by L. C. Dilatash. I made up the cone and departed slightly from the procedure in the article; as I mounted the cone on thick cardboard and cut the center out. I then made cross arms to which I screwed the unit; and the cardboard, which had the cone cemented to it, was then attached to the cross-arms. What an eye-opener! I was dumbfounded with the results, and a gathering of my musical and radio friends unanimously pronounced my speaker perfect. It was tested against several manufactured speakers, and everyone gave mine the belt. I have since made eight to order; hence my appreciation.

J. J. C. SHARP,  
3 Search St., Caulfield, Victoria, Australia.

#### QUITE INCORRIGIBLE

Editor, RADIO NEWS:

The articles "A Britisher Chats on Radio" are, as a rule, to the point and have, as some of us say, "a kick" in them. So much so that, at times, I am inclined to think he is an American, as I have never known a Britisher to be so "snappy." Let him write some more; I like his humor.

E. LINDERGREN,  
2362 Ryer Ave., New York City.

(In spite of all temptations to belong to other nations, Mr. Blake remains an Englishman.—EDITOR.)

# New Admiralty Model NORDEN - HAUCK SHIELDED SUPER-10

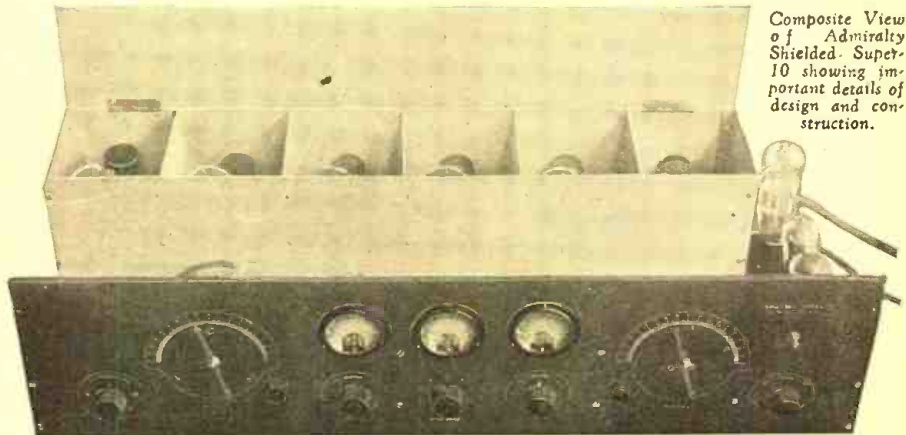

Composite View of Admiralty Shielded Super-10 showing important details of design and construction.

This great new Receiver is far in advance of competition. It is a powerful 10-tube model incorporating the most complete and up-to-date principles. Using the new screen grid tubes in the R. F. amplifier and push-pull audio system, make this new model the outstanding development in Receiver design for years.

### Features

10 tubes used. Five 222 screen grid R. F. amplifiers, 200A detector, two 240 Hi-Mu's and two 210 tubes in the power audio amplifier.  
Extremely sensitive—long range.  
Totally shielded.  
Super-selective—10 Kc. separation.  
Perfect quality of reproduction.

Indicating Meters on Panel.  
Removable R. F. Transformers for all wave lengths up to 25,000 meters.  
Electric or Battery operated.  
Simple to operate—only two major tuning controls.  
A laboratory precision Instrument built according to U. S. Navy Standards.

Complete attractive illustrated literature sent upon request. Full size genuine Blue Prints and constructional data \$2.00 Postpaid.

Write, telegraph or cable today.

## NORDEN-HAUCK, Inc., Engineers

Marine Bldg., Philadelphia, Pa.

Builders of the highest class radio apparatus in the world.

Cable—Norhauck

## \$1 SAVES YOUR SPEAKER

**THE CRAFTSMAN DOLLAR SPEAKER FILTER** is Guaranteed to relieve your Speaker of the plate D.C. (180 to 250 volts). It reduces overloading, giving Speaker a chance to operate at its best. Can be used as a headphone coupling. Complete protection, \$1.00 prepaid. Invest NOW and prevent Speaker trouble and expense.

CRAFTSMAN RADIO PRODUCTS, 351 Halsey St., NEWARK, N. J.  
Improve reception with our Solid Resistors, 30c each.



## JOBS Open IN ELECTRICITY!

90 days fits you for big pay  
ELECTRICAL job at \$50 to \$200  
A week. All practical work on real equipment. MONEY-  
BACK GUARANTEE. Free Radio Course. WRITE for  
60-page FREE BOOK, and remarkable tuition offer.  
McSweeney Electrical School, Dept. 76-AW, Cleveland, O.



## GEARS—All Kinds—Small

The most accurate made and prices reasonable. We carry a complete line of gears in stock for immediate shipment. Can also quote on special gears of all kinds. Send us your inquiries.

Write for Catalog 40  
Chicago Stock Gear Works  
105 So. Jefferson St., Chicago

Please say you saw it in RADIO NEWS

# WILBUR C. WHITEHEAD'S *new* "Picture Method" teaches **BRIDGE**

Drawing for partners.

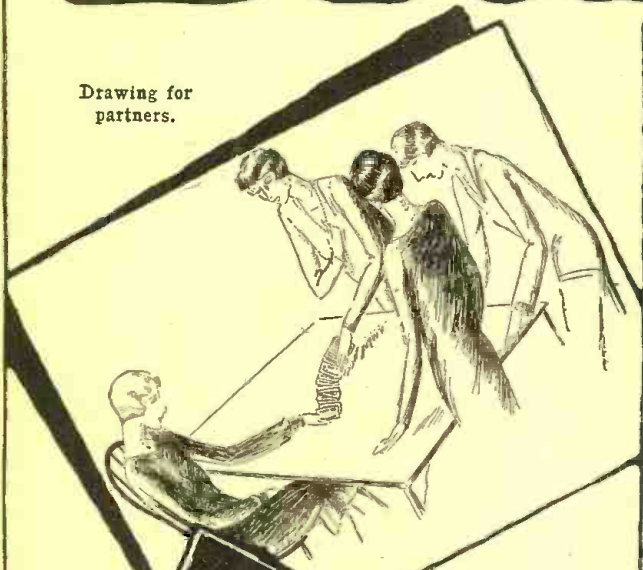

An example of the way in which each hand is illustrated.

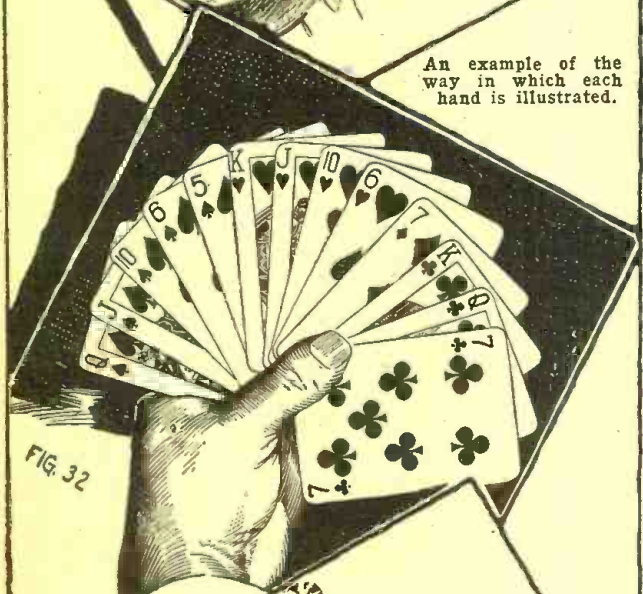

FIG. 32

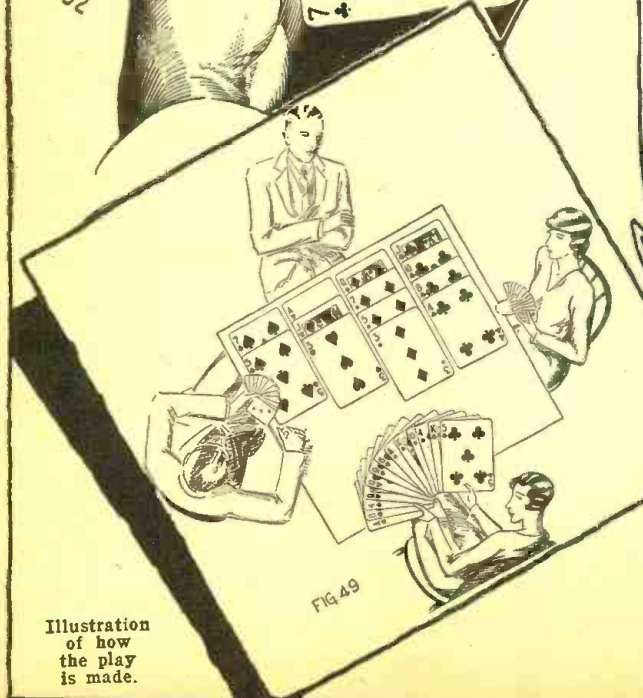

FIG. 49

Illustration of how the play is made.

**easily and quickly.**  
Printed in **2 COLORS** Red and Black Cards

WILBUR C. WHITEHEAD, the world renowned bridge expert, has written this interesting instruction course for you. *BRIDGE by Whitehead* is unique in that it teaches the entire game of bridge by a new and original form of illustration known as Whitehead's "PICTURE METHOD." Every hand is illustrated, each card in its proper color, red or black as the case may be. Thus the beginner, or even the most seasoned player, has an actual illustration of the manner in which the play is made always before him.

Whitehead, whose reputation as the foremost authority, national or international, on the game of bridge, is one whose advice cannot be taken lightly; he knows the game as few others know it. In this book he passes on to his readers, in an easily understandable fashion, his picture method—that made him a success. Get your copy of *BRIDGE by Whitehead* today—100 pages—9" x 12" size. Beautiful colored cover. Each point illustrated.

**50c**  
THE COPY

At All Newsstands or write direct  
**EXPERIMENTER PUBLISHING CO.**  
230 Fifth Ave., New York, N. Y.

**MAIL THIS COUPON NOW**

EXPERIMENTER PUBLISHING CO.  
230 Fifth Avenue  
New York, N. Y.

Gentlemen: Enclosed find 50c, for which please send me a copy of *BRIDGE by Whitehead*,

Name .....

Address .....

City..... State.....

Please say you saw it in *RADIO NEWS*

## I Want to Know

(Continued from page 662)

(Q.) "I have an Atwater Kent "Model 20 Compact" set. Will you print in your next issue of RADIO NEWS, a wiring diagram of this set with "C" battery connections? At times it plays; but it goes off with a roar every once in a while."

(A.) You will find the diagram of this set in Fig. Q.2322 (on page 662). By referring to the diagram, you will see that the set contains two stages of tuned-radio-frequency amplification, a detector and two stages of audio frequency. Transformer coupling is used in the audio-frequency amplifier and grid resistors are used for stabilizing the radio-frequency amplifier. The set is equipped with a cable for the battery connections, and the colors of the various wires are indicated on the diagram. Two filament resistors are used; one controls the radio-frequency tubes and the other, the audio tubes and the detector.

Probably the trouble with your set is due to a loose connection or to a defective tube. First go over the wiring carefully, and bend up the prongs in the tube sockets. Then test the transformers and the fixed condensers with a battery and a pair of phones. When the phones are connected across the windings of the transformers, a distinct click will be heard, if the windings are good. The small fixed condensers will not give a very noticeable click if they are in good condition; while the filter condenser will give a click but no continuous noises. If all of the connections appear to be good and the parts test satisfactorily, the tubes and batteries should be tested and finally the aerial and ground should be checked.

### BUILDING A RESISTANCE AMPLIFIER

(2323) Mr. D. W. Brown, Niagara Falls, N. Y., writes:

(Q.) "I am going to build a resistance-coupled amplifier for my tuned-radio-frequency receiver. I want to use the amplifier also for receiving television signals with the unit described in the November issue of RADIO NEWS. I am afraid that I will have trouble with motorboating when trying to use the amplifier with a 'B' power unit, and I am writing to find how I may make the amplifier so that I will not have any trouble from this score. By using choke coils in the correct combination with by-pass condensers, I believe an amplifier could be constructed with no tendency to motorboat."

"I would also like to get some information for constructing a resistance-coupled amplifier using a screen-grid tube in the first stage and a power tube in the second stage. If this can be done, will you supply any information possible for the construction of one?"

(A) "Motorboating" in an amplifier is simply a condition of oscillation brought about by the feeding back of energy from the output circuit of an amplifier to the input. The feed-back currents usually occur through "B" power units or run-down "B" batteries. In the older types of audio transformers, where the bass-note response was poor, these feed-backs were usually in the form of high-pitched whistles. In the newer transformers and in the impedance- and resistance-coupled systems, the feed-back usually appears in the form of low humming noises or the well-known "putt, putt" of motorboating, which is really only a very slow oscillation.

In a regular three-stage amplifier using any of the common types of coupling, it will be found that the signal-current or A.C. component (this should not be confused with the direct current in the plate circuits, which is read with a D.C. meter.) will be in phase or traveling in the same direction, in the detector plate circuit and the plate circuit of the second A.F. stage at a given instant. The current in the first and third stages will be out of phase with the former, or traveling in an opposite direction at the same moment. The direction of the currents in these circuits is not important if new batteries are used because of their relatively low impedance; but, if the impedance of the batteries or power unit is relatively high, two effects are possible. The first and second A.F. currents are opposing, giving a slight reduction in the signal strength; but, what is more important, the detector and second stages are in phase, which will cause regeneration.

Both effects are due to the impedance of the "B" supply being common to all the plate circuits. The regenerative effect to the second stage from the detector will increase as the impedance of the "B" supply increases, and also as the signal strength increases; and, if the combination of the two is large enough, the regeneration of the system

# In Response To Popular Demand

## CHARLES R. LEUTZ

announces



# A NEW BROADCAST RECEIVER

LEUTZ Broadcast Receivers are known all over as the "Highest Grade Radio Receivers in the World." In proportion to their price, there is more money spent on material and labor than in any competitive make, this means you get QUALITY.

The LEUTZ organization has always led the field in new and original features in their designs. Many of this year's sales points in competitive makes, are features which were original with Leutz two and three years ago. In a Leutz receiver, you obtain an instrument scientifically correct, the best that engineering skill can produce.

The present two models, the Universal Transoceanic "PHANTOM" and "SILVER GHOST" are continued as before, for the clientele that insist on the best with no limitations of size, simplicity or cost.

In response to the many inquiries for a popular priced broadcast receiver, simple to operate and scientifically designed to give superior performance, LEUTZ offers a new SINGLE CONTROL CONSOLE. The result is not just another console, but an instrument original in many details. The wonderfully efficient Screened Grid Tubes are used in the radio frequency amplifier. A very powerful Push-Pull power audio amplifier is provided to operate an improved type of Dynamic Speaker which is built in the console. All electric operation is obtained at a very economical figure. The console itself is a fine example of woodworkers' craftsmanship.

The design and construction throughout is to the typical Leutz high standards, the performance sets new ideals.

We will be very glad to send you the new literature on this new console, you will find it very interesting, write now.

### C. R. LEUTZ INC.

195 PARK PLACE

LONG ISLAND CITY, N. Y.

Cables "EXPERINFO" N. Y.



THE Shanco Battery Clip design assures free and uninterrupted flow of electrical current. No springs to heat up, burn or drop out. Made of powerful tension, tempered spring steel solidly riveted together. All parts electroplated before assembly (not galvanized or tinned), acid-resisting. Jaws open wide and are easily applied. The Griptite bulldog teeth "stay put" and bite right through corroded bars and terminals. Clip cannot fall over and "short" your battery.

Write Dept. 74 for free literature and prices.

SHANKLIN MANUFACTURING CO.  
Dept. 74, Springfield, Illinois



### SEND FOR NEW RADIO BOOK — IT'S FREE!

New hook-ups. This book shows how to make short-wave receivers and short-wave adapters. How to use the new screen grid tube in D. C. and A. C. circuits. How to build power amplifiers, ABC eliminators. Up-to-the-minute information on all new radio developments. It's free. Send for copy today.

KARAS ELECTRIC COMPANY

4038A2-North Rockwell St., Chicago, Ill.

Name.....

St. and No.....

City and State.....

4038 A2

Insure your copy reaching you each month. Subscribe to Radio News—\$2.50 a year.  
Experimenter Publishing Co., 230 Fifth Avenue, N. Y. C.

Please say you saw it in RADIO NEWS



The finest receiver can be improved with Televocal Quality Tubes. All standard types. Ask for them at your dealers.

**Televocal Corporation**  
Televocal Building  
Dept. A-6  
588—12th Street  
West New York, N. J.

**Televocal**  
Quality Tubes

**GET MY DISCOUNT CARD!**  
Before buying a **KNAPP "A" POWER KIT**  
Absolutely dry—Magically silent—the finest "A" Power adaptable to Short Wave, Super-Heterodyne and Television reception.

**WITH THE 10 NEW IMPROVEMENTS**  
Write me today for details of this money saving plan and get your discount card. Address

**DAVID W. KNAPP, Pres.**  
**Knapp Electric, Inc.**  
Division of P. R. Mallory & Co., Inc.

Room 417, 350 Madison Ave., N. Y. C.

**NEWS to Set Builders**

**LATEST RADIO GUIDE**

Barawik offers set builders bigger bargains — bigger opportunities to make money this season. New sets, new kit ideas, all the leading parts, dynamic speakers, supplies, etc. Lowest rock-bottom prices. Bigger stocks, quicker service. Send for Big Bargain Book today—free.

**BARAWIK CO.,** 210 Canal Sta., CHICAGO, U. S. A.

Mail This Coupon Now! For Free Copy  
Name .....

Address .....

may overcome the resistance of the circuits and the amplifier will oscillate.

The logical way to prevent these oscillations is to separate the plate circuits of the amplifier tubes, and the easiest way to do this is to insert audio-frequency choke coils and by-pass condensers in each of the circuits to prevent any feeding back of these currents.

**Constructing the Amplifier**

In Fig. Q.2323A you will find the schematic diagram of an amplifier with resistance coupling, incorporating the chokes and condensers recommended in the discussion above. Two other A.F. chokes are inserted in the circuit, one in the grid circuit of the last audio tube and the other in the plate circuit of the detector. Both of these chokes will help to stabilize the amplifier and also in preventing motorboating. The first two tubes in the amplifier are high- $\mu$  tubes of the 240 type. The last is a power tube of the 171 or 210 types. The values of the grid and plate resistors are indicated on the diagram. The audio-frequency chokes in the detector plate, first and second amplifier plate, and third grid circuits, may be the secondaries of audio-frequency transformers or they may be obtained for the purpose. The choke in the plate of the power tube should be suitable for the plate current of this tube. The coupling condensers have a capacity of .006-mf. A .001-mf. fixed condenser is shown across the first impedance unit, but is not necessary if the detector in the set is already provided with a condenser in the plate circuit.

**Screen-Grid Amplifier**

(A2.) The 222-type screen-grid tube may be used in a resistance-coupled audio-frequency amplifier if a lower screen-grid voltage than usual is used. When it is used in this way a voltage amplification of about 35 per stage can be obtained and, with the proper coupling condenser, a flat frequency-characteristic from 50 cycles, or lower, up to 10,000 cycles can be realized.

Fig. Q.2323B shows the connections of such an amplifier; the input is coupled to the 222 tube through an audio-frequency transformer or a resistance coupler. The first tube is coupled to the second through condenser C1, which has a capacity of .006 to .02-mf.; while the output of the power tube V2 is coupled to the speaker through the usual condenser and output choke. The filaments of the tubes are equipped with ballasts, R2 and R3. The screen-grid tube V1 also uses the usual tapped resistor to reduce the voltage and obtain the correct bias for the control grid.

The voltage on the screen grid should be about 22 volts, which is lower than the usual value (45 volts). The plate voltage may be between 135 and 180 volts and if a 171-type tube is used in the last stage the same tap may be used for both tubes. The binding post P is connected to the plate of the detector tube in the set, and the batteries are connected in the usual manner; that is, if the "A+" and "B—" are connected in the set, these connections should also be used for the amplifier.

**On the Short Waves**

(Continued from page 665)

they come on the air at about midnight G.M.T. they should be useful to American "fans." Being experimental, they are, of course, not very regular, but I believe that Tuesday and Thursday mornings (i.e., Monday and Wednesday evenings in America) are the times at which to catch them. They are anxious to know how their transmissions come through and give announcements in English, Danish, French, German and Dutch.

I notice in the October issue of RADIO NEWS that reference is made to the practice adopted by 5SW (Chelmsford, Essex, England) when closing down. The 12 "strokes of the gong" referred to are of course the chimes from Big Ben, the well-known clock on the House of Parliament at Westminster Bridge, London, tolling out midnight.

As a matter of general interest, the procedure for 5SW appears to be to relay the London program from the regular medium-wave station 2LO until midnight on those nights when it closes down at that hour, which are, or at any rate, were recently, Tuesdays, Thursdays and Saturdays. 2LO signs off at midnight by superimposing the chimes from Big Ben on the dance music which is taken after 10:30 to 11 p.m. from one of London's fashionable clubs or hotels, and the "Goodnight" is said actually before switching over. The announcement heard at midnight is given by 5SW itself. At 12:30 a.m. 5SW can often be heard giving a recital of gramophone records, which lasts until 2 a.m.; i.e., from 7:30 to 9:00

**Single dial control**

**7 TUBE SUPERPHONIC RADIO**

All parts mounted

Only **\$16.95**

**COAST to COAST RECEPTION**

**Superphonic 7 is a world beater! An exceptionally high grade receiver that is amazing the Radio World.** Latest 7 tube tuned radio frequency circuit, using 4 radio frequency amplifiers, detector and 2 stages of audio. Power tube can be used in last audio stage. Extremely selective, marvelous sensitivity. Single drum dial control. Straight line wave length condensers permit accurate, equally spaced tuning over entire wave band. All sockets spring cushioned to eliminate microphonic noises. Bakelite subpanel (8 1/2" deep) insures minimum dielectric losses. Clear and realistic reception guaranteed. An exceptionally beautiful, walnut finish, metal front panel 7" x 18". Complete chassis. No extra parts to buy. All parts mounted ready to wire. No special tools needed. All hook-up wire and colored battery cable included. Value \$60.00; our price \$16.95.

**TESTED AND APPROVED**

Severe laboratory tests have proved the remarkable efficiency of this set. Owners everywhere are sending us letters praising its wonderful receptive qualities.

**SIMPLE WIRING DIRECTIONS**

Very easy to wire this set with the instruction we furnish. Just connect a few wires. All you have to do is to follow numbers. Simple as adding 2 and 2. Can be wired in a few minutes by anyone. No radio knowledge needed. Make money by wiring these sets in your spare time and selling them to your friends.



**SEND NO MONEY**

Just write your name and address on a post card and ask us to send you this wonderful outfit. We ship right away. Upon arrival pay only \$16.95 plus a small delivery charge. (Foreign countries send \$19.50 with order. We pay shipping charges.)

**RADIO EQUIPMENT CO.**  
549 S. Wells St., Dept. 12-A CHICAGO, ILL.

**Come to Washington**

The educational advantages of a visit to the Capital of our Nation are of inestimable value

Stop at  
**The LEE HOUSE**  
15th and L Streets, N.W.

Three squares to the White House. A new and modern Hotel. Refined environment.  
250 ROOMS — 250 BATHS

Rates:

Single room .....	\$ 3.50 daily
Double room .....	5.00 "
Single room (with meals) ..	6.00 "
2 persons (with meals) .....	10.00 "

**ROBERT BLOCK, President**

**Custom Set Builders**

Browning-Drake has an interesting and unusual proposition. Take advantage of the fact that more Browning-Drakes are built than any other.

Write today

**BROWNING-DRAKE CORP.**  
CAMBRIDGE, MASS.

**FRESHMAN**  
YOUR ULTIMATE RADIO

AT ALL  
**AUTHORIZED DEALERS**

**Print Your Own**

Cards, Stationery, Circulars, Paper, etc. Save money. Print for others, big profit. Complete outfits \$8.85. Job press \$11.25. Rotary \$149. All easy, rules sent. Write for catalog presses type etc. **THE KELSEY CO., P-72, Meriden, Conn.**



p.m. E.S.T. Its wavelength is 24 meters and its power 20 kilowatts. It does not transmit on Saturdays and Sundays. Reception here is usually pretty good, about R4 or R5 on two tubes.

I might mention that here in Aruba, which, incidentally is a small coral island in the Caribbean 2,000 miles from New York, I get regular reception from KDKA, W2XAF and W2XAD, and last but not least, W2XAL, the RADIO NEWS station. The first three are particularly good; being at times of sufficient strength to be audible on the loud speaker on even two tubes. Bearing in mind the fact that W2XAL only uses 1/100th the power of the other stations mentioned, it comes through wonderfully well; but unfortunately is usually accompanied by a background of two or three spark sets, and a heterodyne whistle possibly from W2XAF.

The value of the excellent programmes sent out by these short-wave stations to somewhat remote tropical spots like this cannot be over-estimated; and, although I have no wish to criticise a service which is the only reward we get for straining our ears and tubes night after night, news items are, unfortunately, rather scarce. KDKA transmits news items regularly at about 4:30 p.m. E.S.T. (5:15 p.m. here) at present on 25.4 meters; but surely these must be read to an almost absent audience, and would be of much greater service if given with one of the later baseball announcements or when signing off. Now and again news is heard in the evening, but WGY apparently has no regular service at all and, if KDKA goes over now to 4:30 p.m. E.S.T. that will be our lot. A news service after the style of that given by the English stations could not fail to be extremely appreciated by the thousands of listeners whom these short-wave stations must have between 40° and 120° W. of Greenwich, and particularly in the tropical belt where anything above 60 meters is spoiled by static. News given at 8:00 p.m. E.S.T., for instance, would be available on the Pacific Coast between 5 and 6, here at about 8:45 and at Pernambuco at about 10:30; which would cover the North American Continent, and the West Indian and South American tropical belt at times convenient to everybody.

As for curtailing the hours of transmission from these stations, surely there is plenty of room for adjustment amongst the other six hundred odd broadcasters without interfering with these pioneers who are doing so much to break down the barrier of silence between former inaccessible regions and the outside world, and whose call signs are by-words in radio everywhere.

I hope that you are able to find space for at least a part of this communication, and that the stations referred to may be able to do something in the direction indicated; which, I am certain, would still further add to their great popularity particularly amongst those listeners to whom their voices alone are able to penetrate. Why not fill up one or the other of those frequent pauses for "station announcements" which so seldom have any significance, with news items?

Anyhow, the best of luck to the American short-wave stations, and particularly those referred to, and many thanks for the great service they are rendering to us here.

IVAR THYDEN,  
c/o Arend Petroleum Maatschappij, Aruba,  
Dutch West Indies.

**PREFERS USE OF COIL FORMS**

Editor, RADIO NEWS:

My experience with short-wave radiophone reception started about the month of April, 1926, when the only short-wave radiophone stations who could be consistently received were KDKA and WGY. To be perfectly frank, those two stations are the only ones which I have been able to receive consistently since that time. However, it seems that other stations will be as easy to receive this winter as are those two.

The other evening I received for the first time the new 2-kw. short-wave station, CJRX. Their signals were not particularly strong, and their wave is so near the 26-meter wave of KDKA that KDKA spills over into CJRX's program. However, at my first session with CJRX I was able to hold them for about fifteen minutes around 5:30 p.m.

From time to time I have listened to WLW's short-wave radiophone station and to others whose call letters I could not identify because of local noise or inaudibility. These may have been short-wave radiophone stations, or harmonics of powerful stations in the broadcast wave bands.

My first short-wave receiver employed low-loss coils of the basket-weave type. Later these were mounted on burnt-out-tube bases for convenience in changing them in the receiver. These were entirely successful but wouldn't "stay put," so I started winding my short-wave coils directly on the tube bases using smaller wire. These were

**Come  
Out of the Maze  
in Building  
Power Units**



**TRUVOLT DIVIDER**

Reg. U. S. Pat. Off.

**A Universal Voltage Separator**

With the New Electrad Truvolt Divider, you can easily build a better eliminator than you can buy, in much less time than you could construct the unit using many separate unrelated resistances.

This device is a complete Truvolt wire-wound resistance, so arranged with adjustable contacts that proper grid and plate voltages are delivered for operation of any receiver of present or anticipated design.

By dividing the filtered voltage into usable values, it eliminates all necessity of mathematical calculations in constructing a power pack. It does away with a great deal of wiring and the need of voltage regulator tubes. It makes it possible to build a power supply device which is universal in its application.

The Truvolt Divider provides the important link which has heretofore been missing in power plant construction. It takes all guesswork out of eliminator building—makes it possible for the non-technical fan to build a high-grade power pack. Also any power plant can be built around it. Case made of genuine bakelite, it will add a smart appearance to any

unit. Five potentiometer type control knobs show values on a scale of high visibility. Can be mounted on baseboard or sub-panel, or used as the front panel on a metal cabinet, at the same time providing binding posts for all B and C voltages. **PRICE \$12.50**

*Electrad specializes in a full line of Controls for all Radio Purposes, including Television.*

Mail coupon for full information.

**ELECTRAD, INC.**  
Dept. NA-1,  
175 Varick St., New York, N. Y.

Please send me FREE my copy of the Electrad Truvolt Divider Manual and put me on your mailing list for Circuit Data and information.

Name .....

Address .....

City..... State.....

**ELECTRAD** Inc.

**Build it  
Right**

This New Catalog of

**YAXLEY**



parts and accessories will help you. Yaxley products are used in vital places in many of the most prominent and successful sets on the market today. Send for the new catalog.

**YAXLEY MFG. CO.**  
Dept. N-9 So. Clinton St., Chicago, Ill.

**SET BUILDERS  
Get this Book**



Barawik, the first and oldest radio specialty house, offers you unusual service this year. Bigger stocks, quicker shipments, lower prices. Deal with an old established, reliable house. Get honest goods, honest service, honest prices. Barawik service makes you more money. Send now for big new Catalog showing lowest wholesale prices.

**BARAWIK CO.** 21-1 Canal Sta., CHICAGO, U. S. A.

Mail This Coupon Now for Free Radio Guide

Name.....

Address.....

Please say you saw it in RADIO NEWS



# AERO MECHANICS—THE BOOK OF THE AGE

The greatest book on modern aviation ever published. The many ramifications of the aeronautical field that it covers can be better appreciated by a glance at a synopsis of its contents.

### CONTENTS IN BRIEF:

- Theory and Fundamental Principles of Flight.*
- Stability—How an Aeroplane Flies.*
- Complete Design, Construction and Assembly.*
- Scale Drawings—Names of Parts.*
- Flying Instructions—How to Become a Flyer.*
- Motors—Latest Inventions—Instruments, Use and Function.*
- Radio Installations.*
- Gliders.*
- Airports and Lighting.*
- Glossary of Aeronautical Terms.*
- The Aeroplane Mechanic.*
- Model Making.*



MR. AUGUSTUS POST  
Editor of AERO MECHANICS

Mr. Augustus Post, editor of AERO MECHANICS, has been prominent in aeronautical circles throughout the country for over twenty years, his experience and adventures have made aviation history and placed him in a position to pass on to the readers of AERO MECHANICS honest, accurate and entirely dependable information on every phase of Aviation. Says the *North American Review* of Mr. Post: "No man in America has been more continuously at the centre of aeronautic activities in this country, and in touch with more history-making airmen here and abroad, than has Augustus Post who, besides having the "history of the air" in his head, has personally participated in some of the most thrilling adventures of aviation."

AERO MECHANICS, written by Augustus Post, is the most complete treatise of its kind ever published. It deals with every phase of aeronautical construction and operation, and its entire contents is passed upon by Mr. Post, who is one of the best known pioneers of aviation. Learn all about this great new field. Obtain your copy of AERO MECHANICS today. Over 112 pages. Fully illustrated. Large 9" x 12" size.

**THE 50c COPY**  
At All Newsstands, or Write Direct  
**Experimenter Publishing Co., Inc.**  
230 Fifth Avenue, New York City

EXPERIMENTER PUBLISHING Co., Inc.  
230 Fifth Ave., New York City, N. Y.

Gentlemen:  
Enclosed find 50c, for which please send me a copy of your remarkable new book, AERO MECHANICS.

Name .....

Address .....

City..... State.....

Please say you saw it in RADIO NEWS

# COAST TO COAST

With Tremendous Volume  
Is the Report of Every Builder of

THE LINCOLN 8-80  
ONE SPOT SUPER

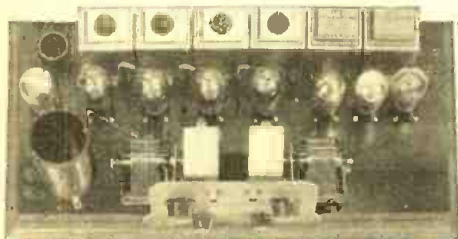

## 75 STATIONS LOGGED THRU CHICAGO LOCAL

report set builders in Chicago, the worst city in the United States for DX reception.

Here's the reason—note these exclusive features:

ONE SPOT—10 KC SELECTIVITY WITH FULL POWER;

FOUR SCREEN GRID TUBES WITH NEW INTERMEDIATE MANUALLY TUNED, GIVING TREMENDOUS AMPLIFICATION;

REGENERATION ABSOLUTELY ELIMINATED;

NO SQUEAL POSSIBLE;

MARVELOUS TONE;

CLOUGH SYSTEM OF AUDIO.

If you want performance you never knew was possible, write us at once for full information.

Lincoln Radio Corporation

Corner Wood and Ogden  
CHICAGO, ILL.

— Established 1923 —

Send 25c for booklet giving constructional data and complete story of development of the Lincoln 8-80.

**NEWS to Set Builders**

**LATEST RADIO GUIDE**

Barawik offers set builders bigger bargains—bigger opportunities to make money this season. New sets, new kit ideas, all the leading parts, dynamic speakers, supplies, etc. Lowest rock-bottom prices. Bigger stocks, quicker service. Send for Big Bargain Book today—free.

**BARAWIK CO.,** 218 Canal Sta., CHICAGO, U. S. A.

Mail This Coupon Now! For Free Copy

Name .....

Address .....

**IT!!!!!!**

**LITTELFUSES HAVE IT**

**THAT EXTREME QUICKNESS**

of action necessary to protect radio and rectifier tubes, filter circuits, galvanometers, milliammeters, etc. (1" x 1/4" dia.). Approved by leading radio laboratories. Mount as shown or hang directly in the line by pushing on a pair of GRYP-CONNECTORS.

Prices, postpaid (C.O.D. or cash unless rated):

Littelfuses, 1/32, 1/16, 1/8, 1/4, 1/2, 1, Ea.	Doz.	Per 100
2, 3 amp.	.....\$ .15	\$1.50
Mounting Blocks	..... .20	2.00
GRYP-Connectors—In Pairs	..... .15	1.50
Littelfuse Laboratories, Dept. 4, 1772 Wilson Av., Chicago		10.00

**SET BUILDERS**

write for

**Discount Card**

Enabling you to purchase the new and Improved Knapp "A" Power Kit at big discount—Write for full particulars.

**DAVID W. KNAPP, Pres.**

**Knapp Electric, Inc.**

Division of P. R. Mallory & Co. Inc.

Room 417, 350 Madison Ave., N. Y. C.

successful but not to be compared with the low-loss coils of basket-weave type. The coils I use at the present time for the 30-meter band are wound of No. 16 D.C.C. wire on low-loss forms with a diameter of 1 3/8 inches. The turns are slightly separated (the width of ordinary string which holds the turns in place) and the whole is given a coating of Dupont's household cement to hold the turns rigidly and to exclude moisture.

I note that many new short-wave radiophone fans experience difficulty with body capacity. I did, too, until I learned to keep the rotor plates of my tuning condensers at ground potential or as near ground potential as possible. Also I have read in most of the radio magazines published (and I get most of them) that short-wave receivers would not work well on a "B" unit. I not only use a "B" unit but have done so for at least a year and a half and further I use a semi-power tube in the last stage of a two- (or three-) stage audio amplifier, lighting the tube filaments with alternating current. This of course is the usual practice now with receivers for the broadcast band but I doubt very much whether many experimenters are doing this with short-wave receivers using head sets. The hum resulting from use of alternating current on the filament of this last audio stage is practically inaudible; but an adjustable resistor is necessary for both the center tap of the filament lighting transformer and the grid-bias resistance. Furthermore a 226-type tube works better than a 112 here, as far as hum is concerned, and gives nearly as much volume. A VT-1 works as well as the 226 and better than the 112. Anyone who wants to use VT-1's as power tubes or for any other purpose, should remember that the filament voltage should not exceed four, and should be less if long tube life is desired.

I read of short-wave fans hearing the foreign stations but so far I have not heard them. Here's hoping!

CLINTON A. ANDERSON,  
215 Red Rock Bldg., Atlanta, Georgia.

### THE S.W. SUPER

Editor, RADIO NEWS:

I have built several receiving sets, all from data in RADIO NEWS, from a one-tube up to a nine-tube superhet and have so far had very good results with them all. My latest is the short-wave super described in the October issue. (*I Want to Know*, page 351); I used three intermediate stages instead of two and left out the external oscillator; for I have found that by advancing the potentiometer to allow the intermediates to oscillate, the C.W. sigs come in very well, with a slight decrease in volume, of course. My advice to all short-wave fans who want a real loud-speaker set on foreign stations is to spend a few bucks on a good 30-kc. intermediate kit and build this super.

My location is a poor one for reception, because the local powerhouse is almost in my back yard; yet I bring in 5SW with very good volume on the speaker almost every night when conditions are fair. With the ordinary three-tube regenerative I can barely hear it with the phones.

The set is very easy to tune; all done, practically, with the antenna tuning dial once the set is oscillating.

I think RADIO NEWS is a wonderful magazine for both the layman and service man; as well as for the amateur set builders who play with radio for the pure joy and satisfaction of making your own and having it work. I will say we cannot get along without it. The short-wave section is excellent and I hope it will grow.

THOMAS MERCIER,  
85 Sumner St., Fitchburg, Mass.

### AN ELABORATE SHORT-WAVE ANTENNA

Editor, RADIO NEWS:

The following data may be of interest to builders of the "Junk-Box" receiver. I have made several changes in construction which seem to make a great improvement. In place of the filament-ballast resistors, I use one 30-ohm rheostat for the two (three) tubes. I cut out the switch, and inserted the rheostat in the "A-." This seems to give me a much better control of regeneration.

I have added an extra stage of audio, and get 5SW, PCJJ, PCLL, KDKA, W2XAF, and W2NE on the loud speaker nearly every night.

My aerial (which has been in use over five years) consists of 29 feet of what was once stranded bare copper wire, with a 25-foot bell-wire lead-in; 30 feet high at one end, 25 at the other. The far end is grounded to a three-foot pipe set in the ground, by 25 feet of No. 24 D.C.C. wire.

For a ground I use several water pipes, five or six two-foot pipes driven deep into the soil, and a vertical counterpoise consisting of about 30 feet of No. 16 D.C.C. wire.

I wound a smaller coil on a 199 base, and suc-

# How Many Lives has a TELEVISION TUBE?



List Price  
\$7.50

## Raytheon Kino-Lamp

The name Raytheon on any type of tube assures a service-life so long that it is often equivalent to the lives of two or three ordinary tubes.

The principles of sturdiness and strength developed in the production of Raytheon sound-reception tubes have been applied to the manufacture of Raytheon television tubes.

The Raytheon Kino-Lamp is the long-life television receiving tube—adapted to all systems, and made in numerous types.



## Raytheon Foto-Cell

The long-life television sending tube, in either hard-vacuum or gas-filled types, and in two sizes of each.

Information and Prices upon application

Correspondence is invited from all interested in television

**RAYTHEON MFG. CO.**  
CAMBRIDGE · MASS.

# ANOTHER ACHIEVEMENT



by **Dr. Lee DeForest**

With the same creative enthusiasm that produced the first radio vacuum tube (1906) Dr. DeForest has now developed the perfected Audion.

When you replace your tubes with DeForest Audions you will experience a new enjoyment in clarified reception.

Send today for your free copy of the interesting booklet by the "Father of Radio."

## DeForest Radio Co. JERSEY CITY ~ N.J.



Improved socket antenna plug—correctly built. New type brass-plate and mica blocking condenser. 10-ft. connecting cord. Neat compact. Safe. Works anywhere. And only \$1.50!

## For DX Results

You must have maximum signal pick-up. Don't depend on skimpy antenna. Don't be discouraged by "dead spots." Just use a Clarostat Antenna Plug, alone, or as a "booster." You'll be surprised!

Also, use proper grid leak value—from 2 megohms or less for "locals," to 10 megohms for DX. The GRID LEAK CLAROSTAT provides precise values at all times.

And be sure you have correct "B" and "C" voltages. Several types of Clarostat will attend to that.

Write for literature describing complete line of Clarostats and how to improve your radio results. Or ask your dealer about Clarostat radio helps.

CLAROSTAT MFG. CO., INC. Specialists in Variable Resistors



281 North Sixth St. Brooklyn, N.Y.

### CLAROSTAT

Reg. U. S.

Pat. Off.

ceeded in getting PCLL, and a station I am pretty sure was ANH, Malabar, Java, as well as numerous commercial code stations.

Some of the ham received on this set is; ea, eb, ec, ed, ee, ef, eg, ei, ek, em, en, ep, oh, fm, fq, aj, na, all nc districts, nj, nm, nn, np, nq, nr, all nu districts, nz; also KHAH, the monoplane "Greater Rockford."

I would like to hear from fellows of 15 to 18 in this country or foreign, who are interested in ham radio, short waves, or "Junk-Box" construction.

THOMAS L. SIGLIN, JR., W1CPH,  
23 Norwich Ave., Providence, R. I.

### BATTLESHIP STYLE

Editor, RADIO NEWS:

For the past two months I have been using the RADIO NEWS short-wave receiver (blueprint No. 52) with splendid results, using only the detector and two stages of audio (General Radio 1:5 and 1:3) Using a steel panel one quarter-inch in thickness, no body capacity is noticeable. Foreign stations received regularly are 5SW, CJRX, 2ME and PCJJ.

R. H. ADDISON,  
28 Armandine St., Dorchester Center,  
Boston 24, Mass.

(Our correspondent goes in for substantial construction; as a matter of fact, a very thin sheet of metal forms a practically perfect shield against capacity, though not against a strong magnetic field.—EDITOR.)

### AN ELABORATE COMBINATION

Some time ago I was flooded with requests from other readers, for particulars of my short-wave set. Unfortunately, circumstances did not allow me the time to answer, and in the meantime I have developed a set that will be of great interest to the advanced amateur and, more especially, the owner of a superheterodyne. With this I listen regularly to Chelmsford and the Dutch, French and German short-wave broadcast stations.

The long-wave side is exceedingly efficient, and one wonders why some sets cannot bring in stations clearly on the lower end of the broadcast band; as when tuning with this set we get a great number of stations below WPG, and distance well around 11 p. m. Pacific Coast reception is quite frequent.

The combination comprises (a) a short-wave single-circuit regenerative unit with plug-in coils; (b) a one-dial R.F. amplifier and detector unit; (c) an oscillator unit; (d) two I.F. stages with filter; (e) an A.F. amplifier, one stage transformer-coupled, two stages resistance-coupled, and an output stage of two 210 tubes in push-pull with 300 volts on the plates.

Now, there are two controls for the long-wave set, one for the short-wave set, and a D.P.D.T. Yaxley jack switch. The oscillator condenser for short-wave work becomes the oscillator condenser for the long-wave super by throwing the switch. There is one combination rheostat and potentiometer, and one master battery control. I used a former Freed-Eiseman panel.

This set, with its interchangeable coils, will tune from 17 to 24,000 meters; it is a real DX getter, is very selective and gives assembly-hall volume. What I consider very important is that the 23-control set, with its battery troubles, has been reduced to not more than three controls at one time and operated from the house-current supply. When changing from one waveband to another, the filaments of the side which is not in use are automatically cut out.

On account of the great distance from broadcast stations here in the Far North (120 miles north of Quebec) shielding was not necessary; but it was provided to see what the difference would be. A slight gain in selectivity was observed, and when it was operated with the battery in a shielded container and cabled underground antenna, static was reduced to practically nil.

For my intermediate and R.F., I used "peanut" tubes to save space. The R.F. coils are placed under the three-gang variable condenser and the peanut tubes between the different sections; so that the two sets, one with nine tubes available for short waves, the other with twelve for long waves, are contained in a cabinet 7x9x30, and are so simple to control that a child can operate them.

The short-wave super has been designed for broadcast reception only, and is a combination of the sets described in RADIO NEWS for July, 1927, and October, 1927 and the short-wave superheterodyne described in the February, 1927 issue of the same magazine, where all data as to coils, etc., can be found. I have eliminated the regenerative detector for code reception. For the broadcast band (200-600 meters) I have found that a very selective single-control receiver loses its selectivity on account of the difficulty of tuning the first

## Write for this Discount Card NOW!

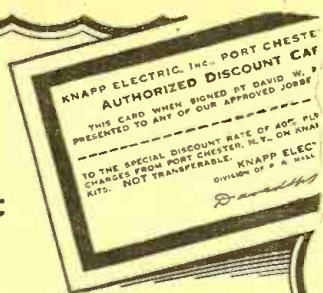

It will enable you to purchase the New and Improved

## KNAPP "A" POWER KIT at a liberal discount

The new Knapp "A" is the finest and most complete kit ever offered. It is the only "A" Power adaptable to Short Wave—Super Heterodyne and Television reception.

Take advantage of the wonderful offer today—write

David W. Knapp, Pres.

Knapp Electric, Inc.

Division of P. R. Mallory & Co., Inc.

Room 417, 350 Madison Ave., N. Y. C.

### Complete Parts for

## New TYRMAN IMPERIAL "80"

Complete A-C Socket Power Operation. Uses A-C Shielded Grid and A-C Heater Type tubes. Fully described in our free catalog.

### 1929 Catalog—FREE

Includes description and complete parts for H. F. L. Isotone, Madison-Moore "A C" New Thordarson Power Amplifier, World's finest Dynamic Speaker.

Discounts for Set Builders

### CHI-RAD

CHICAGO RADIO APPARATUS CO.

415 S. Dearborn St., Dept. RN CHICAGO



## NEWS to Set Builders

Barwik offers set builders bigger bargains—bigger opportunities to make money this season. New sets, new kit ideas, all the leading parts, dynamic speakers, supplies, etc. Lowest rock-bottom prices. Bigger stocks, quicker service. Send for Big Bargain Book today—free.

ZIA Canal Sta. BARWIK CO., CHICAGO, U. S. A.

Mail This Coupon Now! For Free Copy

Name .....

Address .....



## This Book Brings Dealers BIGGER PROFITS

Matchless bargains in radios and accessories. Full line of Sleeper Browning Drake, Carter, Utah, Tower Speakers, Temple, Majestic, Kodol, G.E. Tungar, Burgess, Jewell, Belden, Cunningham tubes, nationally advertised parts, storage batteries, chargers, etc. Big opportunity for live ones who can sell radio. Double sales quick. Use your letterhead. Exclusive territories open. Act—NOW!

NEW ENGLAND MILLS COMPANY  
Distributors of Nationally Advertised Radio Lines  
Dept. R200 851-55 Washington Blvd. Chicago, Ill.



## DEALERS and SETBUILDERS

Complete stock of nationally known parts and accessories. Send for illustrated catalog and discount sheet.

Radio Exclusively Since 1921

CLARK & TILSON, INC.

122 CHAMBERS STREET

NEW YORK

The Nationally Known House

Please say you saw it in RADIO NEWS

stage. So I added one tube ahead of the three tuned circuits; its amplification peaks between 400 and 600 meters. This permits the three following stages to tune very sharply, and adds also somewhat to amplification at the higher wavelengths. I find the 100,000-ohm resistor indispensable in this circuit; because, even without an aerial, powerful stations like WGY, KDKA, WJZ and others come in with such tremendous force as to be too loud even for a big hall. The Peridyne principle of stabilizing has been added, as well. The set permits the reception of code on the short-wave set by using the potentiometer on the intermediate stages and permitting the set to oscillate.

The condenser C, which serves as the short-wave condenser or oscillator condenser, depending upon how the switch is turned, is .0005-mf., and might be as high as .001-mf., improbable as this might seem, provided its minimum is low enough. I use a Remler for the purpose and can go as low as 13 meters. By putting a .0005-mf. fixed condenser in series with the "short-wave" set's secondary, that set can be made to oscillate up to 24,000 meters using a 1200-turn duo-lateral coil. Although the circuit seems terribly complicated, if properly placed it is simplicity itself and can be enclosed in a cabinet 24x12x8 without undue crowding. Of course, in this out-of-the-way part of the world, where radio is our only amusement, distance-getters are welcomed and I have so far changed three standard sets for friends of mine. With this set we have music, speech or lectures during all hours of the day and cover both continents as well. I am enclosing a letter of verification from the British Broadcasting Company, London, on 5SW.

Coil data can be found by those desirous of building this set in any good radio hook-up. However, to help those who have no time to look it up, here goes.

Coils V, 50 turns Advance resistance wire on a half-inch spool. Coils M ("binoculars" 1 1/4 inches in diameter each section) have 50 turns on each of good No. 22 enameled wire—wound in the same direction. The primaries have each 40 turns of No. 38 S.S.C. wire inside the binoculars close to the filament terminals. These coils with their 400-turn chokes and .0005-mf. condensers are enclosed in a copper box; the tubes are mounted on top of this box and the triple condenser at the side. No leads are longer than half an inch. On the other side of this condenser are the I.F. section and three tubes: the Yaxley switch and the oscillator condenser are at the right of these, and finally the A.F. amplifier is at the end of the baseboard. The three dials are thus in a row on the panel, which carries also the two resistor controls, and the jack switch above the oscillator condenser. This is all except for the filament switch at the right.

I have also found a pronounced improvement in short-wave reception which may be of interest to readers in the use of a 171A as the detector;

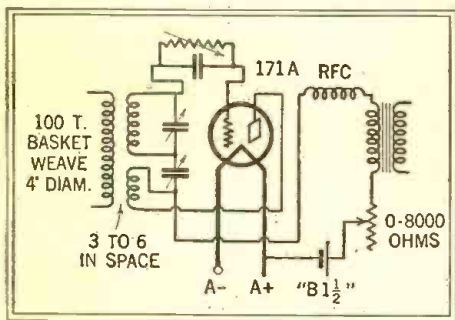

Fig. 2

Mr. Van Koolbergen uses 1 1/2 volts on the plate—plus, of course, half the "A" voltage, as compared with the center of the filament.

not with the usual 45 volts upward, which caused the signals to be mushed, but by using a 1 1/2-volt "C" battery in series (Fig. 2). With this, instead of aerial and ground, I use a basket-weave coil 4 inches in diameter and having 100 turns. With this three inches from the grid coil, and the circuit led into the intermediate and R.F. amplifier and a dynamic speaker, yesterday we had a hand concert all day, to the surprise of the villagers—at least, to the owners of \$500 sets.

J. H. VAN KOOLBERGEN,  
Port Alfred, Quebec, Canada.

**LABOR BRINGS THE DX**

Editor, RADIO NEWS:

The letter in the November issue from J. W. Manning of Florida interested me quite a little. At the time I read his letter I decided he was a little more successful in logging distance stations than I was.

When I constructed the Junk Box receiver in

**"You Can Forget the Condensers—If They Are DUBILIER'S"**

Type PL 1120 especially designed for the Thordarson types R-480 and R-280 Power Compacts, used with 171 type tubes and the 280 type tube Rectifier or the Elk-on E-80 metallic Rectifier. Price \$15.50

**There is No Substitute For Quality!**

**N**O amount of lurid claims by nimble-penned advertising writers will take the place of quality in the final analysis—the operation in your power supply.

Ever since the advent of Radio, Dubilier has been the manufacturers' standard—and the set builders' stand-by. Built in every Dubilier Condenser is a factor of safety which is your safeguard for years of service without failure.



**Dubilier Light Socket Aerial**  
— "A Moulded Bakelite Product"  
Bring in programs with a minimum of interference. Simply attach to the set and plug into the nearest light socket. Uses no current. Sold by all good dealers. Price \$1.50.



Write to Dept. 11 for free catalog

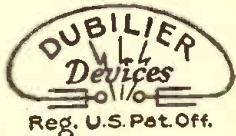

10 East 43rd Street

New York City

**Dubilier**  
**CONDENSER CORPORATION**

**Send for WESTERN RADIO**

**New 1929 Catalog**

DEALERS AND SETBUILDERS

THE NEW 1929 Catalog is crammed full of the FINEST, NEWEST, nationally-known A.C. sets, consoles, cabinets, dynamic speakers, kits, eliminators, and accessories at LOWEST PRICES. Largest stock of Radio Parts. Prompt delivery. Write for our FREE catalog.

WESTERN RADIO MFG. CO.  
128 WEST LAKE ST. Dept. RN-1 CHICAGO, ILL.

**"The Big Friendly Radio House"**



**Be an Expert RADIO OPERATOR**

Fascinating work. Wonderful opportunities. Good pay. **Teleplex Code Sender** teaches you at home in half the usual time. Reproduces actual sending of expert operators. Sends you messages, radiograms, etc.—regular code traffic anywhere, any time, any speed. U. S. Navy and leading schools endorse Teleplex as quick, easy, thorough. Complete set instruction tapes supplied at no extra cost. Write for Booklet NR.

TELEPLEX COMPANY  
76 Cortlandt St., New York, N. Y.



**REAL JOBS OPEN**  
Now in **ELECTRICITY**

90 days fits you for big pay ELECTRICAL job at \$50 to \$200 a week. All practical work on real equipment. **MONEY-BACK GUARANTEE.** Free Radio Course. Write for 60-page FREE BOOK, and remarkable tuition offer. McSweeney Electrical School, Dept. 76-W, Cleveland, Ohio

Please say you saw it in RADIO NEWS

# FERRANTI

Audio Frequency  
TRANSFORMERS  
and  
RADIO PRODUCTS  
*receive preference*  
by engineers who KNOW

Real audio transformers with flat curves. Special output transformers for all speakers and tubes. High grade iron core chokes for "B" Eliminators. Three range portable meters. 1,000 ohms per volt. 10/50/250 scale. Three range portable meters. 200 ohms per volt. 150/7½ volt and 15 Mill. scale with switch. By-Pass condensers—2MF—400 volt and 200 volt.

Circulars sent on request.

Send 15c in coin for copy of 1929 Ferranti Year Book.

FERRANTI, INC.

130 W. 42d St., New York, N. Y.

FERRANTI, LTD. FERRANTI ELECTRIC  
Hollingswood, England LIMITED  
Toronto, Canada

**Send For This Book—  
It Offers More Prof-  
its to Set Builders!**

## BARAWIK, THE OLD RELIABLE RADIO SERVICE

Radio Fans, from "way back when," will remember the exceptional service that Barawik rendered when getting radio parts was like pulling hen's teeth. First upon the scene, Barawik was always ready to deliver the newest developments in radio to its customers in the days when chances were fast and furious.

Today Barawik has grown to be a mighty institution in the radio world. Here you can secure the proved, reliable merchandise of the world's leading radio manufacturers—everything from complete sets to the smallest, individual parts so necessary to the set builder. You can depend upon the reliability of Barawik's goods. You can depend upon Barawik's ability to deliver the kind of service that means time saved in waiting. You can depend upon Barawik's honesty, ability and willingness to serve you—And, last, but far from least, you know that Barawik's big discounts assure you of the lowest prices always—prices that mean huge savings to you in everything you buy.

The newest in radio sets, parts, kits, supplies—all under one roof—ready for you now. Send coupon now for big new Catalog—Free.

**BARAWIK CO.**

11 C Canal Sta.,  
CHICAGO,  
U. S. A.

Mail this Coupon Now for Barawik's Big Free Bargain Book.  
Name..... Address..... City.....

### More "A" Power For Less Money!

With the Set Builders discount card you can purchase a

**KNAPP "A" POWER KIT**  
at a liberal discount.

Write me today for full details telling about this new money-saving plan for set builders.

**DAVID W. KNAPP, Pres.**  
Knapp Electric, Inc.

Division of P. R. Mallory & Co., Inc.

[Room 417, 350 Madison Ave., N. Y. C.]

## FREE Wholesale Radio Catalog

Set Builders-Dealers! Save Money!

Send for the most complete book of nationally known Parts, Kits, Cabinets, Consoles, Speakers, Power Units, Sets, etc. All at lowest wholesale prices. Quick service on all your needs. Write now, it is FREE—

**SETBUILDERS SUPPLY CO.**

Dept. 13 8 Romberg Bldg. Madison and Market Sts. CHICAGO, ILL.

August I had no luck at all. Could only get a few stations on this side. I corresponded with a couple of fans and compared notes and then set to work again. Went over all connections (even the springs in the tube sockets.) Distant stations were still going right by my set. Then one night I got 5SW and the next night I got PCJJ. Since then I have logged them quite a lot. Plenty of volume.

From my experience I would say that most short-wave operators fail to receive distance because of one of the following reasons: (1) all connections are not tight; (2) they do not use care enough in tuning the set; (3) they listen in at the wrong time.

In place of the condenser mentioned in the July issue I use a small balancing condenser in the aerial lead. I do not notice much body capacity. Care should be taken to see that the rotor plates of both tuning condensers connect with the filament. I find that the signal is just as strong and the ground hum is decreased a lot if the ground wire is disconnected.

One thing I do not understand however is the fact that I receive 5SW on 12 using the seven-turn coil. All the coils tune much higher than the article mentions.

ARTHUR F. BROWN,

50½ Conant Street, Danvers, Mass.

(On short waves, a slight difference in the self-capacity of the coils, which is governed by the spacing, and of the leads will produce a considerable difference in the range covered by the coils. The condensers, also, may have a larger capacity than specified.—EDITOR.)

### HOW TO SUPPRESS CAR NOISES

Editor, RADIO NEWS:

N. J. K. of Salinas, Kansas, who writes in the November issue of RADIO NEWS, is harboring a resentment against the amateur which is entirely without foundation. His theory of eliminating interference by eliminating the amateur is a poor one and does not show a co-operative spirit. The amateurs are bothered by broadcast-station harmonics, yet we cannot use malicious methods to remove them. Whenever a Ford goes rattling by the house, there is a louder rattle in the phones, due to the sparking between the coil points. The railroad crossing signal is another source of interference. Any of these things can cause the operator's hair to whiten; but we cannot use strong-arm methods against them.

The amateur bands are narrow, and after January 1 very narrow; and there are several thousand stations in each of them. If some of your interference is from short-wave navy stations, what do you propose to do?

I would advise Mr. K. to visit some nearby amateur station, and read the license with regard to silent hours. They are effective only when a written notice has been received from the supervisor of radio. Sunday silent hours are in the morning and not in the afternoon. When W. J. K. suggests the "vacuum-sweeper" stunt, I get the impression that he is about eleven or twelve years of age. Perhaps he would remove a rail from the car track in order to insure peaceful slumbers.

In short, the amateur is blameless in this instance; his transmitter is operating in the authorized bands. Our critic's receiver is what's wrong. As long as it receives his main wave, how can he expect the ham to remedy the trouble? That was a bad bedtime story; it didn't put us to sleep.

Please accept my thanks for printing C. Sterling Gleason's stories; he can certainly write in an amusing manner. I wish you would print "The Wonderful Battymeter," by this author (We do not know it—has Mr. Gleason been holding out on us?)

I am glad you are not disregarding the amateur as many other magazines are. We are willing to co-operate with the B.C.L.s but, if we do not know that we are interfering until we get a letter from the supervisor, how are we apt to improve our sets?

ROY A. JENKINS, W6CBY,

1449 Warren Ave., Long Beach, Calif.

### AMATEUR SHORT-WAVE BANDS

The new radio amateur regulations, for the first time, make provision for television and operation of picture-transmission apparatus, which is to be permitted in the bands between 60,000 and 56,000 kilocycles (5 to 5.35 meters) and 2,000 to 1,715 kilocycles (150 to 17½ meters.)

No change is made otherwise in the bands assigned to amateurs, which are: 401,000 to 400,000 kilocycles (0.7477 to 0.7496 meters); 64,000 to 56,000 kilocycles (4.69 to 5.35 meters); 30,000 to 28,000 kilocycles (9.99 to 10.71 meters); 16,000 to 14,000 kilocycles (18.70 to 21.40 meters); 8,000 to 7,000 kilocycles (37.5 to 42.8 meters); 4,000 to 3,500 kilocycles (75 to 85.7 meters), and 2,000 to 1,500 kilocycles (150 to 200 meters). The bands for

## SAVE YOUR MONEY! BE YOUR OWN SERVICE MAN

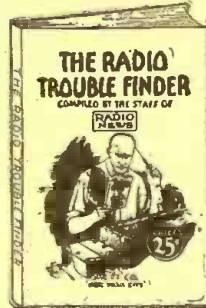

### THE RADIO TROUBLE FINDER

Even the highest-priced radio set occasionally develops a fault and that at a time when you least expect it—maybe right in the middle of an interesting program. But, a handy copy of

*The Radio Trouble Finder* is the simple means for tracing every defect and remedying it in the easiest manner possible. There is no mishap that could befall a radio, but what is fully covered in this valuable book.

*The Radio Trouble Finder* is edited by men fully versed in the subject covered—men with years of actual experience behind them—and who have grown to prominence since the infancy of radio.

Don't wait till your set goes bad—get your copy of this remarkable guide to radio trouble now. Fill in the coupon and we will send you by return mail a copy of *The Radio Trouble Finder*, a money-saving investment. You can be your own service man.

The **25c** Copy

## BUILD YOUR OWN RADIO SET

### 150 RADIO HOOK-UPS

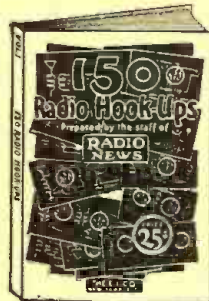

This is the latest issue of this remarkable book. Absolutely new and up-to-date. All the best circuits of the day. Full instructions on how to build. Make your own set from the diagrams shown in *150 Radio Hook-Ups*. Write today—pick the set you want to build and make it. Then you are sure to be satisfied with the results you get.

*150 Radio Hook-Ups* was prepared by the staff of Radio News. An accurate guide to better set construction for the radio "fans."

The **25c** Copy

MAIL THIS COUPON NOW

**CONSRAD CO., INC.**

230 FIFTH AVENUE NEW YORK, N. Y.

CONSRAD COMPANY, INC.

230 Fifth Avenue, New York, N. Y.

Gentlemen:

Kindly send me a copy of 150 RADIO HOOK-UPS... THE RADIO TROUBLE FINDER... (check which or both).

Enclosed find..... cents in full payment.

Name.....

Address.....

City..... State.....

amateur radio-telephone operation remain, as heretofore, from 64,000 to 56,000 kilocycles (4.69 to 5.35 meters), 3,550 to 3,500 kilocycles (84.50 to 85.7 meters), and 2,000 to 1,715 kilocycles (150 to 175 meters).

An amateur station is defined by the commission as a station operated by a person interested in radio technique solely with a personal aim and with no pecuniary interest. Amateur licenses will not be issued to stations of other classes.

Amateur stations are authorized for communication only with similarly licensed stations, on wavelengths or frequencies within the bands set and at all times unless interference is caused with other radio services; in which event a silent period must be observed between the hours of 8 and 10:30 p.m. local time, and on Sunday during local church services. Spark transmitters will not be authorized for amateur use.

Amateur stations must use circuits loosely coupled to the radiating system, or devices that will produce equivalent effects to minimize key impacts, harmonics and plate-supply modulations. Conductive coupling, even though loose, will not be permitted; but this restriction shall not apply against the employment of transmission-line feeder systems to Hertzian antennas.

Amateur stations are not permitted to communicate with commercial or Government stations unless authorized by the licensing authority, except in an emergency or for testing purposes. This restriction does not apply to communication with small pleasure craft, such as yachts and motor boats holding limited commercial station licenses, which may have difficulty in establishing communication with commercial or Government stations.

Amateur stations are not authorized to broadcast news, music, lectures, sermons, or any form of entertainment, or to conduct any form of commercial correspondence.

No person shall operate an amateur station except under and in accordance with an operator's license issued to him by the Secretary of Commerce.

**JUNIOR CORRESPONDENCE SEEKERS**

Editor, RADIO NEWS:

I am a short-wave fan of sixteen years and greatly enjoy "On the Short Waves." I have a special set made here in Cuba to tune short as well as long waves, and a Grebe S.W. set too. I would like to correspond with other short-wave fans of any age or experience, as I know something about radio.

SILVIO HERNANDEZ,  
Calle 27, No. 89, "entre D y E," Vedado,  
Habana, Cuba.

Editor, RADIO NEWS:

I would like to correspond with experimenters in radio and its associated sciences, especially television.

J. R. HARRISON, JR.,  
216 Lorraine Ave., Upper Montclair, N. J.

Editor, RADIO NEWS:

I would like to exchange letters with boys of about 13.

DONALD BUZZELL, Leaf River, Ill.

**TELEVISION EXTRAORDINARY**

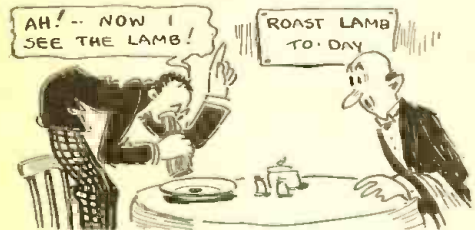

Operating hint from the *New York Times* of August 26: "To reverse the manner in which the neon LAMB plate is scanned—" Or, as the poet has it:

"Mary has a little lamb;  
Whose fleece looks pink as neon;  
It televises just that way,  
Whichever side you see on."  
—Rudolf Sturm.

**QUIT YOUR CROWDING, BACK THERE!**

We are anticipating some development along the line of television that will bring it right to the front in public interest, since reading this in the *Philadelphia Inquirer* of September 16: "Radio Equipment: BATH-TUB, enameled, awning of canvas, store front size, good cond., cheap." Yes sir, when these bathing beauties come on the screen, the other stations may as well stand by.  
—Charles Meister, Jr.

**Tune In on the Short Waves**

Get distance—escape static on the long wave broadcast band. See Call Book for short wave stations. SUBMARINER wave band includes all powerful stations that broadcast programs on short waves—thousands of SUBMARINERS now in use—short waves are the new adventure—a new thrill awaits you.

**Short Waves Popular**

The SUBMARINER has taken the country by storm. Nothing made like it. Many users have been getting London, England; many get Holland, even in summer. Short waves are great distance carriers, with less static.

**Best of All**

Your present radio receiver, whether battery operated or all electric, will bring in short wave broadcasting when used with

**THE SUBMARINER**

It is easy to connect a SUBMARINER. Simply remove a tube from receiving set and place in SUBMARINER socket; then insert SUBMARINER plug in place of tube. Attach regular aerial and ground to clips on SUBMARINER. That's all. No changes in wiring of set necessary. No additional tubes or batteries required. If set operates a loud speaker, it will do so with SUBMARINER. We guarantee that the SUBMARINER will operate within the wave band covered equal to any short wave receiving system known when attached to your receiver. Completely shielded metal cabinet. Fine tuning dial, ratio of 32 to 1. Get the short wave musical programs and other activities, including television signals. Never before has so much in radio been offered for so little money! Order a SUBMARINER now!

**FOUR MODELS**

20 to 65 meter range—for battery operated radios, \$15.00. For all electric radios, \$17.50. 10 to 160 meter range—for battery operated radios, \$22.50. For all electric radios, \$25.00. 10 to 160 meter range models have three interchangeable coils.

If your dealer does not carry, order direct from factory. Sent anywhere in the U. S. postpaid upon receipt of price. Canada and Foreign, 60c additional. Money order only. Also sent C.O.D. plus postage in U. S. If \$1.00 accompanies order to insure carrying charges. In ordering be sure to name set and tubes used, such as UV-199, UX199, 201A, UX226, or UY227. See dealer or order direct today.

**J-M-P MANUFACTURING CO., Inc.**

3405 Fond du Lac Ave.

Milwaukee, Wis., U. S. A.



**AEROVOX** Makers of high quality resistors and condensers that are Built Better—to endure. Write for The Research Worker. A free monthly publication. AEROVOX WIRELESS CORPORATION 68 Washington Street Brooklyn, N. Y.

**MASON, FENWICK & LAWRENCE** PATENT LAWYERS 600 F. ST. N. W., WASHINGTON, D. C. ESTABLISHED OVER SIXTY YEARS—SEND SKETCHES Electrical and Chemical Inventions Carefully Handled. Practice before the U. S. Courts and the Patent Office. Trade-Marks Registered Prompt and Careful Service

**RADIO NEWS FREE BLUEPRINTS Nos. 71, 72, 70, 55 and 58**



TO encourage the construction of radio apparatus illustrated in this magazine, and make it easier for our readers, RADIO NEWS makes up each month large blueprints of the diagrams which accompany the principal constructional articles; these sets include full-sized drilling templates, coil data, etc., where required, and in each case a list of the apparatus originally used, with full specifications. Several thousand of these have been distributed each month.

If you desire a set of blueprints for any or all of the apparatus described in this month's Free Blueprint articles, fill out the enclosed coupon as directed and send it in. The blueprints requested will be mailed to you without charge, postpaid. We cannot send blueprints with magazines, or accept indefinite requests for blueprints to be issued in the future. Delay will be caused by failure to use this form, as this publishing office has many departments.

Blueprint Department, RADIO NEWS: (B) 230 Fifth Avenue, New York, N. Y. (U. S. A.)

I am interested in constructing the following apparatus described in RADIO NEWS for January, 1929. Please send me a free set of large blueprints for each of the items checked.

- No. 71 The "Bloopless" One-Dial Two-Tube Set.
- No. 72 The "Lamp-Socket Five."
- No. 70 An Adjustable "B" Power Unit.
- No. 55 An "Extension" Two-Tube Audio Amplifier.
- No. 58 The "Junk-Box" Short-Wave Receiver.

Name .....

Street Number .....

Postoffice .....

State (Province, etc.) .....

(Please typewrite your name and address or print it with a pen—not a pencil—as many signatures cannot be read. This will avoid errors in addressing the mail.)

Please say you saw it in RADIO NEWS

# OPPORTUNITY AD-LETS

Follow these advertisements every month. Reliable advisers from all over the country offer their most attractive specials in these columns.

Classified advertising rate twenty-six cents a word for each insertion. Names and addresses must be included in the above rate. Cash should accompany all classified advertisements unless placed by an accredited advertising agency. No advertisements for less than 10 words accepted.

Objectionable or misleading advertisements not accepted. Advertisements for the March issue must reach us not later than January 1st.

### CIRCULATION LARGER THAN THAT OF ANY OTHER RADIO PUBLICATION

EXPERIMENTER PUBLISHING CO., INC., 230 Fifth Avenue, New York, N. Y.

#### Agents Wanted

SI Pays \$20.00. Start This Fastest Big Money Business making World's newest selling specialties. Have others sellings them. Eye-opening literature describing Guaranteed Formulas. Latest Valuable Trade Processes Free! Small Investment. Profit Immense. Start Anywhere. Miller, Chemist, 706-R Jetton, Tampa, Florida.

Guaranteed Genuine Gold Leaf Letters anyone can put on store windows. Large profits, enormous demand. Free samples. Metallic Letter Co., 422 N. Clark, Chicago.

Agents—\$50. Weekly Selling Shirts. No capital or experience needed. Commissions in advance. Samples Free. Madison Products, 560 Broadway, New York.

#### Books

Books, Magazines, Art Publications in French, Spanish English. Photo novelties, samples, lists, etc., 20 cents stamps. Villaverde Co., Dept. 211, Box 1329, Havana, Cuba.

#### Business Opportunities

Free Book. Start Little Mail Order business. Hadwil, 5A-74 Cortlandt Street, N. Y.

Amateur Cartoonists: Sell Your Cartoons New Plan. Smith's Service EX1194, Wenatchee, Wash.

Inventions Commercialized. Patented or Unpatented. Write Adam Fisher Mfg. Co., 278 Enright, St. Louis, Mo.

#### Chemistry

Learn Chemistry at Home. Dr. T. O'Connor Sloane, noted educator and scientific authority, will teach you. Our home study correspondence course fits you to take a position as chemist. See our full-page ad on page 672 of this issue. Chemical Institute of New York, 16 E. 30th Street, New York City.

#### Correspondence Courses

Used correspondence school courses sold on repurchase basis. Also rented and exchanged. Money-back guarantee. Catalog free. (Courses bought). Lee Mountain, Pisgah, Alabama.

#### Detectives

Detectives Needed Everywhere. Travel. Experience unnecessary. Particulars Free. Write, American Detective System, 2190 Broadway, N. Y.

#### Esperanto

Send for free illustrated sample lesson of the International language, Esperanto. It immediately enables you to correspond with all nations of the world. Benson School of Esperanto, 518 Broad Street, Newark, N. J.

#### For Inventors

Inventions Commercialized. Patented or Unpatented. Write Adam Fisher Mfg. Co., 278 Enright, St. Louis, Mo.

If you have a good invention, write Hartley, Box 928, Bangor, Maine.

#### For Sale

Alfalfa Seeds, hardy common varieties \$3.40, \$10.20, \$12.60 bushel; Grimm variety Alfalfa seed \$18. Scarified sweet clover \$3.90, \$5.20; Alsike or red clover \$15. Bags Free. Send for samples and catalogue. Kansas Seed Co., Salina, Kan.

#### Help Wanted—Instructions

Wanted Immediately, names of hard-working men and women, 18 to 55, who want to make more money. Write, Instruction Bureau, 251, St. Louis, Mo.

#### Instruction

Learn Chemistry at Home. Dr. T. O'Connor Sloane, noted educator and scientific authority, will teach you. Our home study correspondence course fits you to take a position as chemist. See our full-page ad on page 672 of this issue. Chemical Institute of New York, 16 E. 30th Street, New York City.

#### Male Help Wanted

Firemen, Brakemen, Baggage men (white or colored), Sleeping Car, Train Porters (colored), \$150-\$250 monthly. Experience unnecessary. 237 Railway Bureau, East St. Louis, Ill.

#### Miscellaneous

Forms to Cast Lead Soldiers, Indians, Marines, Trappers, Animals, 151 kinds. Send 10c for Illustrated Catalogue. H. C. Schlercke, 1034 72nd St., Brooklyn, N. Y.

Inventions Commercialized. Patented or Unpatented. Write Adam Fisher Mfg. Co., 278 Enright, St. Louis, Mo.

Copyrighted game awaits manufacturer. Two thousand cash. Darrel Fessel, Amsden, Ohio.

Guaranteed Solder for Aluminum, Mail, \$1. Pierman, Belmar, N. J.

#### Motorcycles

Used Motorcycles. Low Terms. Also Parts. Accessories. Catalog Free. Western Motorcycle Co., 946 East 15th St., Kansas City, Mo.

#### Old Money Wanted

\$2 to \$500 each paid for hundreds of Old or Odd Coins. Keep all old money, it may be very valuable. Send 10c for New Illustrated Coin Value Book 436. Guaranteed prices. Get posted. We pay Cash. Clarke Coin Company, 14 Street, LeRoy, N. Y.

## Read!

### Opportunity Ad-Lets

Who knows but that the opportunity of your lifetime may be hidden in one of them. Read them each month—they can easily be turned to earning dollars and cents for you.

#### Patent Attorneys

Patents procured at reasonable rates with time to pay. Sales negotiated. Staff of registered attorneys and engineers. A complete service for inventors. Write for particulars. Inventors Service Bureau, Union Trust Bldg., Washington, D. C.

#### Patent Attorneys (Cont.)

Patents—Send drawing or model of your invention for examination and instructions. Advice and booklet free. Highest references. Best results. Promptness assured. Watson E. Coleman, Patent Lawyer, 724 9th Street, N.W., Washington, D. C.

Patents—Free instructions. Former Patent Office Examiner. Moderate terms. Booklet. Albert Jacobs, 740 Barrister Bldg., Washington, D. C.

Patents—Send for form "Evidence of Conception" to be signed and witnessed. Form, fee schedule, information free. Lancaster and Allwine, Registered Patent Attorneys in United States and Canada, 209 Ouray Bldg., Washington, D. C.

#### Patents

Inventions Commercialized. Patented or unpatented. Write Adam Fisher Mfg. Co., 278 Enright, St. Louis, Mo.

#### Printing, Engraving and Multigraphing

200 Letterheads and 100 Envelopes, \$1.10, postpaid. Oberman Company, Box 1042, Chicago.

#### Radio

Edison Storage B. Batteries 100 volts Kits \$6.50 A-Eliminators Cost \$35.00, \$9.00 B-Eliminators 150 volts \$12.50 Battery chargers \$3.50 cost \$13.50 Cone Speakers. Units \$1.00, Motors ¼ Horsepower \$7.00. 904 North Fifth, Philadelphia.

One Peridyne and one Ultradyne cheap. F. L. Hanson, Ilion, N. Y.

Radio Troubles are frequently caused by tarnish on plugs or tube prongs. Jasper Polishing Powder is ideal for cleaning contacts. 4 oz. can 35c., Postpaid. Jasper 100 Co., Jasper, Minn.

Dri "A" Eliminator, \$16.00; ABC, \$20.00; B-Eliminator, \$16.00; ABC, \$20.00; B-Eliminator, 4 taps, 180 volts, \$10.00, 50 milliamperes. Lowest prices in America. Above are set builders' discounts. Catalog 58. Electro-Chemical Company of America, Indianapolis, Ind.

Bargains, used radios. Guaranteed perfect working order. Blue Ribbon 5 tube, 2 dial, Console \$19.95. Freshman \$14.95. Atwater Kent \$19.50. Tubes included. Many famous makes. Send money order with order. Bargain list on request. Surplus Radio Co., Dept. 2, 549 S. Wells, Chicago.

Wanted: Men to work with National Radio Service organization. No selling scheme. Radio Doctors, Inc., Dept. N. Essex St., Salem, Mass.

#### Representatives Wanted

Representatives Wanted for B power based on a new principle. Patented and guaranteed. Ideal for all sensitive receivers including screen-grid and short-wave sets. Cole Manufacturing Co., 27 Homestead Ave., New Haven, Ct.

#### Song Writers

Song Poems Wanted: Write at once. Valuable instruction book given free! Bell Music Co. D-11, St. Louis, Mo.

#### Telegraphy

Telegraphy—Both Morse and Wireless taught thoroughly. Big salaries. Wonderful opportunities. Expenses low, chance to earn part. School established fifty years. Catalog free. Dodge's Institute, Cour St., Valparaiso, Ind.

LATEST RADIO GUIDE

## NEWS to Set Builders

Barawik offers set builders bigger bargains—bigger opportunities to make money this season. New sets, new kit ideas, all the leading parts, dynamic speakers, supplies, etc. Lowest rock-bottom prices. Bigger stocks, quicker service. Send for Big Bargain Book today—free.

BARAWIK CO., CHICAGO, U. S. A.

21C Canal St.

Mail This Coupon Now! For Free Copy

Name .....

Address .....

Patent Sense—Valuable book free. See Lacey's ad, page 678. Lacey & Lacey, 631 F. St., Washington, D. C. Established 1869.



### Radio News Laboratories

(Continued from page 659)

tuning control is a drum approximately 5 inches in diameter; the volume-control knob is found at the left and the power switch is located on the right side. The three R.F. tubes and detector are provided with special shield cans to prevent electrostatic coupling. Provision is made on the chassis for supplying direct current at 100 volts to a dynamic speaker. The chassis is enclosed within a brown crystalline sheet steel case, the top of which is removable. Connection to the antenna, ground, and loud speaker is made by pin tip jacks. An extension of ten feet is provided for connection to the light circuit. The housing is 21½ inches long, 9½ inches high and 13 inches deep. Ample selectivity and sensitivity was demonstrated with excellent reproduction over the audio frequency scale.

AWARDED THE RADIO NEWS LABORATORIES CERTIFICATE OF MERIT NO. 2483.

#### MICROPHONE

The microphone submitted by Ferdinand Schuchardt, Berlin S.O. 16, Germany, is of the six-button carbon-diaphragm type; the diameter of the diaphragm is 1½ inches. With the application of 50 milliamperes through the various buttons, they did not pack; while the sensitivity is such that external noises were not prominent. The measured



resistance of the submitted sample is 117 ohms; when it is used with the companion modulation transformer, a variable resistance of 100 ohms should be employed to insure the proper sensitivity of operation. The six buttons are mounted, and protected from injury by enclosure, in a molded composition housing, having an aperture of 1¼ inches in its center. The housing is 5½ inches in external diameter and ¾-inch thick. A foot, 1½ inches in height and 3¼ inches in diameter, is fastened to the housing; a double connection cord, six feet in length, is fastened to a terminal block inside the foot. When used in connection with the microphone very good reproduction of speech and music was obtained from the audio-frequency amplifier of a radio receiver.

AWARDED THE RADIO NEWS LABORATORIES CERTIFICATE OF MERIT NO. 2484.

#### MODULATION TRANSFORMER

The modulation transformer submitted by the same manufacturer has been designed for use in connection with the microphone described above.

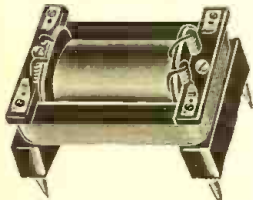

It has a winding ratio of 1 : 50, and is of the unshielded, shell-core type. The D.C. resistance of the primary was found to be 44 ohms, and the resistance of the secondary 12,500 ohms. It is mounted to a base board with the wood screws provided. When it was used as recommended, the audio-frequency voltage amplification was found to be practically the same at all frequencies.

AWARDED THE RADIO NEWS LABORATORIES CERTIFICATE OF MERIT NO. 2485.

#### AMID THE BURNING LOGS

Warm Southern welcome was given to the Radio Commission's new list, as the *Jacksonville Times-Union* testifies: "The reallocation plans of the federal body were FIRE announced in the Tuesday edition of the *Florida Times-Union*." Or, perhaps, allusion is made is to some of the stations which were eliminated from the ethereal realms on high. —R. H. Rice.

**NOW-**  
**IT'S ADJUSTABLE**

**CARBORUNDUM DETECTOR**  
REG. U.S. PAT. OFF.

TURN of the pressure screw gives you perfect tone balance. Then, position is fixed by adjusting lock nut, so that pressure remains permanently sensitive. Just another improvement to further insure the Perfect Tone Quality you always get with the Carborundum Detector—and tone quality is everything. Recommended by noted radio-circuit designers.

DEALER OR DIRECT—\$1.50 IN U. S. A.  
Send for Free Book "Carborundum in Radio" D-1

The Carborundum Company, Niagara Falls, N. Y.  
Canadian Carborundum Co., Ltd., Niagara Falls, Ont.

(Carborundum is the Registered Trade Mark of The Carborundum Company for its Silicon Carbide and is its exclusive property)

## Synchronous Motors for Television

In addition to building reliable and satisfactory motor generators, "Esco" has had many years of experience in building electric motors for a great variety of applications.

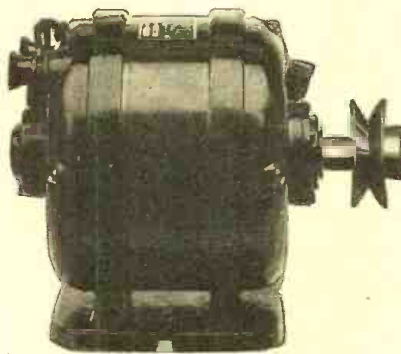

Synchronous motors, small, compact, reliable, self-starting are now offered for Television equipment. They require no direct current for excitation, are quiet running and fully guaranteed.

Other types of motors suitable for Television may also be supplied.

Write us about your requirements.

### ELECTRIC SPECIALTY CO.

211 South St. Trade "ESCO" Mark Stamford, Conn.

## SET BUILDERS

Get this Book



Barawik, the first and oldest radio specialty house, offers you unusual service this year. Bigger stocks, quicker shipments, lower prices. Deal with an old established, reliable house. Get honest goods, honest service, honest prices. Barawik service makes you more money. Send now for big new Catalog showing lowest wholesale prices.

**BARAWIK CO.** 21K Canal Sta., CHICAGO, U. S. A.

Mail This Coupon Now for Free Radio Guide

Name \_\_\_\_\_  
Address \_\_\_\_\_  
City \_\_\_\_\_

## FREE BOOK



Newest radio hook-ups. This book shows how to make Broadcast and Short-Wave Receivers, and Short-Wave Adapters.

How to use the new screen-grid tube in D.C. and A.C. circuits.

How to build Power Amplifiers, and ABC Eliminators. Up-to-the-minute information on all new radio developments.

Set Builders, Fans, Dealers, send for it today!

Write for it!

KARAS ELECTRIC COMPANY 4038A3  
4038A3 N. Rockwell St., Chicago, Illinois

Please send me your Free Book!

Name \_\_\_\_\_  
Address \_\_\_\_\_  
City \_\_\_\_\_ State \_\_\_\_\_

Please say you saw it in RADIO NEWS

# 164 PAGES

This big catalog places before you one of the country's largest — and most complete stock of radio kits, parts, accessories and consoles as well as one the season's outstanding lines of both A-C and D-C receivers. Every set builder — every dealer, in fact all those interested in radio should send for their copy of this immense catalog.

# WHOLESALE PRICES

## On Everything in RADIO

# RADIO

MODERN RADIO SETS  
ACCESSORIES KITS AND PARTS

# 1929

## RADIO SERVICE

Allied Service will prove a revelation to you in what radio service can really be. Allied Executives backed by years of training in radio, are practical men. They know radio. Their vast experience has built up around them an organization trained to serve. Months of effort have built up a tremendous reserve of stock that makes for prompt shipments; and this stock is new stock comprising the season's pick of such prominent manufacturers as Silver-Marshall, Tyrman, Aero, Hammerlund-Roberts, etc.

### SET BUILDERS!

Set Builders, Amateurs and so-called "Hams" will delight in the *unusual variety and remarkable values* that are offered in standard kits and parts. Tremendous stocks — *real organization* — prompt shipping service all combine to make Allied your ideal source of supply.

### RADIO DEALERS!

The live radio dealer — the man who keeps pace with the rapid advance of radio — will find much of *real interest* in the Allied Catalog. New A-C Sets, D-C Sets, Dynamic and Magnetic Speakers, Television equipment, in fact *everything* an impatient radio public is demanding.

*Write for Catalog Now!*

CONFIRM  
WHOLESALE  
PRICES

# ALLIED RADIO CORPORATION

711 W. LAKE ST. CHICAGO, ILL.

# Allied Radio CORPORATION

711 W. LAKE ST. Dept. B-3 CHICAGO

Please say you saw it in RADIO NEWS

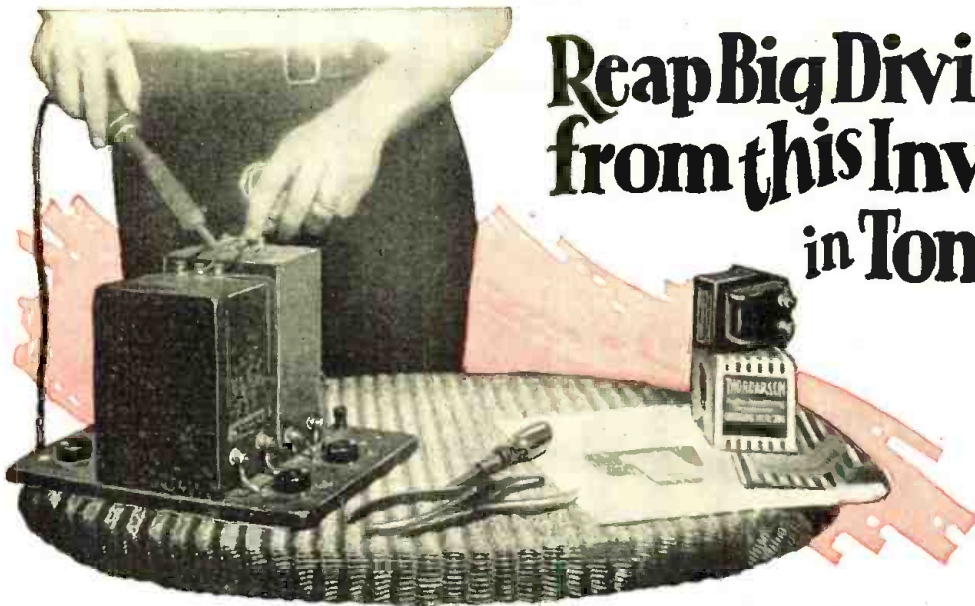

# Reap Big Dividends from this Investment in Tone Quality

## A Thordarson Power Amplifier (Home Constructed) Will Transform Your Radio Into a Real Musical Instrument

WITH the insistent demand for quality reproduction, power amplification has become a vital radio necessity. Today, it is hard to find a radio set manufacturer who does not employ one or more power tubes in the output stage of his receiver.

There is no need, however, for you to discard your present radio instrument in spite of the fact that it is out-classed by newer models with power amplification. You can build a Thordarson Power Amplifier which, attached to your receiver, will provide a fullness and richness of reproduction that will equal or surpass the finest offerings of the present season.

Thordarson Power Amplifiers are exceedingly easy to assemble, even for the man with no previous radio experience. Only the simplest tools are used. Specific instructions with clear-cut photographs, layouts and diagrams insure success in home construction.

Whether your present receiver is factory made or custom built one of these amplifiers may be attached with equal ease. In fact, most Thordarson Amplifiers require absolutely no changes in

the wiring of the receiver itself, attachment being made by means of a special plug which fits the last audio socket of the receiver.

Thordarson Power Amplifiers for the home constructor and professional set builder range from the simple plate supply unit up to the heavy-duty three stage units employing the 250 type power tube in push-pull arrangement. These power amplifiers cover the requirements for every purpose and every pocket-book. They may be used with any type of horn, cone or dynamic speaker.

With a background of over thirty-three years manufacturing quality transformers, it is only natural that so many manufacturers of receiving sets of undisputed superiority have turned to Thordarson as the logical source of their audio and power supply transformers. The discriminating home constructor will do well to follow the lead of these manufacturers when buying his power amplifier.

Write to the factory today, enclosing 25c for the new "Power Amplifier Manual"—just off the press.

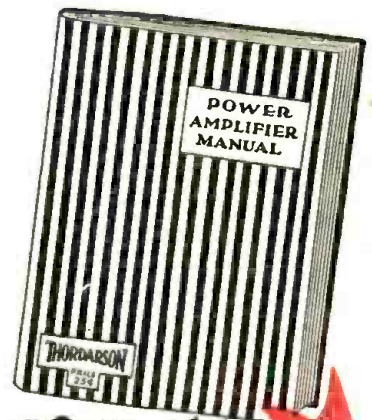

*New!*

No Amateur or Professional Set Builder Should Be Without This Book—

"POWER AMPLIFIER MANUAL"

A simple, yet complete, treatise on the subject of audio and power amplification, including full information on building, servicing, and testing power amplifiers in general. Also contains detailed specific construction data on twelve individual power units, with clear-cut layouts and diagrams of each.

25c

Send 25c in Cash or Stamps for This New Book—  
Just Off the Press!

# THORDARSON RADIO TRANSFORMERS

SUPREME IN MUSICAL PERFORMANCE

**MAIL THIS COUPON TO-DAY!**

THORDARSON ELECTRIC MANUFACTURING CO.  
500 West Huron Street, Chicago, Illinois

Gentlemen: Please send me your new "Power Amplifier Manual" for which I am enclosing 25c.

Please send me free of charge your instruction sheet on the amplifier I have checked below:

171 Single  171 Push-Pull  210 Single  210 Push-Pull (1 Stage)  210 Push-Pull (2 Stage)  250 Single (1 Stage)  250 Single (2 Stage)  250 Push-Pull (3 Stage)  210 Phonograph Amplifier

Name.....

Street and No.....

Town..... State.....

3588 L

Radio Manufacturers Since 1908



TRADE MARK  
REG.

## PILOT Protects Radio Parts Buyers

The name PILOT stamped on a radio part guarantees scientific engineering and precision manufacture. You can secure Pilot Precision Radio Parts only at the better type dealers.

**RADIO DESIGN**  
Fifty cents coin or stamps brings you this Bigger and Better Construction quarterly for one entire year.

**RADIO DESIGN**  
103A Broadway  
Brooklyn, N. Y.



**PILOT**  
ELECTRIC MFG. CO., INC.

323 Berry Street  
Brooklyn, N. Y.

World's Largest  
Radio Parts Plant