

RADIO'S GREATEST MAGAZINE

RADIO NEWS

REG. U.S. PAT. OFF.

JANUARY
25 Cents

Over 200
Illustrations



Edited by HUGO GERNSBACK



OLGA STECK
on WOR Chain

EXPERIMENTER PUBLISHING COMPANY, NEW YORK, PUBLISHERS OF
SCIENCE & INVENTION - RADIO LISTENERS' GUIDE - SPARE-TIME MONEY MAKING - FRENCH HUMOR - AMAZING STORIES

Cunningham RADIO TUBES

SINCE 1915

STANDARD FOR ALL SETS

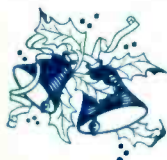

GIFTS

*that bring happiness at
Christmas time and
throughout the year*

Radio sets and radio equipment make immensely popular Christmas gifts.

To assure the utmost in Yuletide radio enchantment, see that Cunningham Radio Tubes are on duty in every socket. Every owner of a radio will be delighted to receive a set of new tubes.

Buy them in combinations of five or more. Your dealer will tell you the correct types of Cunningham Radio Tubes for which any radio is designed.

*Don't use old tubes with new ones.
Use new tubes throughout.*

E. T. CUNNINGHAM, INC.
NEW YORK CHICAGO
SAN FRANCISCO

Again The *THRILL* of Building a *New* Circuit!

SUPER HILODYNE *The MODERN RADIO CIRCUIT*

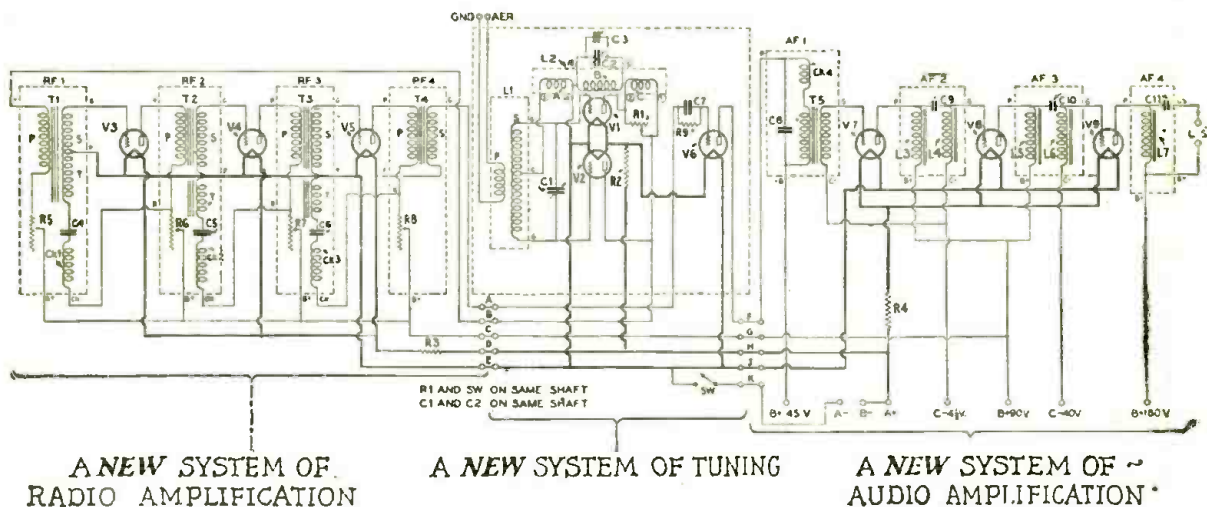

HERE at last is the circuit radio fans everywhere have been waiting for! Thousands of radio fans will experience a new THRILL in building the SUPER HILODYNE. This marvelous circuit, which has been developed by Fred A. Jewell after five years of exhaustive research and experiment, does NOT combine the better features of bygone popular circuits, but is itself an entirely NEW creation. The SUPER HILODYNE is a revolutionary piece of engineering and is, we believe, the nearest approach to the perfect circuit.

The SUPER HILODYNE gives reception hitherto undreamed of in the world of radio. It re-creates every sound sent into the microphone with absolute fidelity throughout the ENTIRE tone range. Super selectivity is here an actual fact. The SUPER HILODYNE tunes out interfering stations with unparalleled ease. Volume

can be had in abundance for dancing and concerts. GENUINE single dial tuning is used. ANY set can be improved by incorporating the SUPER HILODYNE system of tuning, radio frequency amplification, or audio amplification, parts for which can be obtained in separate units.

The SUPER HILODYNE does not infringe in any way upon existing patents. Its design is so scientific, so sound, that its ENDURANCE is assured.

We Want

REPRESENTATIVES

In every community throughout the world where broadcast programs penetrate, we want representatives. The SUPER HILODYNE will be manufactured and distributed in Complete Sets, Chassis, Units, and Knockdown Kits. We have a plan which we believe will interest every PROFESSIONAL SET BUILDER. Write for further details today. Dept RN-128.

ALGONQUIN ELECTRIC COMPANY, INC.

Leo Potter, President

245 Fifth Avenue

::

New York City

RADIO NEWS

Published by EXPERIMENTER PUBLISHING COMPANY, Inc., Publishers of "Radio News," "Science and Invention," "Radio Listeners' Guide," "Amazing Stories" and "French Humor."

H. GERNSBACK, President
Member: Audit Bureau of Circulations
Editorial and General Offices

S. GERNSBACK, Treasurer
Radio Magazine Publishers Association
230 Fifth Avenue, New York City

VOLUME 9

JANUARY, 1928

NUMBER 7

Contents of This Issue:

Our Mysterious Waves, By Hugo Gernsback	733	The Tyrman Shielded-Grid Seven. By A. Van A. Sommers	764
Putting Broadway on the Air, By G. C. B. Rowe	734	Operation and Accessories of the Peridyne Five, By Hugo Gernsback	769
The Listener Speaks	736	The Karas A. C. Equamatic, By Fred H. Canfield	770
The Happiness Boys. By Lucille Husting	740	The Story of Metallized Resistors, By Francis R. Ehle	775
The Girl on the Cover—Olga Steck	740	An A. C. Phonograph Amplifier, By James Millen	776
"Lopez Speaking." By Julia Shawell	741	A Sturdy and Simple "A" Power Unit, By Herndon Green	780
Housekeeping by Radio, By Mary Jordan	742	Two Answers to the Exponential Horn Problem. By Wendell P. Graham and F. G. Schoenfeld	782
Love in the Air, By A. M. Jones	743	The Search for the Perfect Detector, By Sydney P. O'Rourke	783
Broadcastatics	744	A High-Low-Tone Loud Speaker, By Arthur L. Kaser	784
Making the Whole House Talk and Sing. By Knox Baxter	745	An Experimental Second Detector, By Leslie R. Jones	785
Shall There Be a Radio Censorship?—A Debate, By Rep. Emanuel Celler and Hugo Gernsback	746	A Study in Radio-Frequency Amplification, By Harold A. Zahl	786
Radio Novelties at Home and Abroad	748	Hook-Up Review	788
The Problem of Synchronism in Television. By A. Dinsdale	750	Radiotics	789
The Radio Beginner—How to Begin. By Armstrong Perry	752	Radio Wrinkles—Awards of the \$50 Prize Contest	790
Electrical and Mechanical Resonance, By Clyde A. Randon	754	RADIO NEWS LABORATORIES	792
Producing Radio Power from Heat or Daylight, By S. R. Winters	755	Letters from Home Radio Set Constructors	794
Wanted, Suitable Aerials for Airplanes!	755	I Want to Know, By C. W. Palmer	795
What's New in Radio	756	Higher Voltage for Power Tube	841
List of Broadcast Stations in the United States	760	Radio "Bugs"	853
American Radio Is More Difficult to Tame, By S. R. Winters	761		
Further Notes on Fading, By S. R. Winters	762		
The Shielded-Grid Tube at Last Arrives	763		

In Forthcoming Issues:

THE EFFECTS OF BROADCASTING ON RELIGION

By Arthur T. Brown

An interesting account of how religious programs are received by the listening public, and of how radio is bringing religious enlightenment into isolated places.

THE ELECTRIFIED PERIDYNE FIVE

By Hugo Gernsback

Full details of how this popular receiver is adapted to tubes of the alternating-current filament type. Only a few simple changes are made in the original wiring.

THE CAPITOL FAMILY CELEBRATES ITS FIFTH RADIO ANNIVERSARY

By Julia Shawell

Interesting highlights of the radio activities of Major Edward Bowes' Capitol Theatre "Family," one of the most popular of all broadcast features.

RADIO NEWS is published on the 10th of each preceding month. There are 12 numbers per year. Subscription price is \$2.50 a year in U. S. and possessions, Canada and foreign countries, \$3.00 per year. U. S. coin as well as U. S. stamps accepted (no foreign coins or stamps). Single copies, 25 cents each. Checks and money orders should be drawn to order of EXPERIMENTER PUBLISHING CO., INC.

All communications and contributions to this journal should be addressed to Editor, RADIO NEWS, 230 Fifth Ave., New York, N. Y. Unaccepted contributions cannot be returned unless full postage has been included. All accepted contributions are paid for on publication. A special rate is paid for novel experiments; good photographs accompanying them are highly desirable.

RADIO NEWS, Monthly. Entered as second-class matter, July 12, 1924, at the Post Office at New York, N. Y., under the Act of March 3, 1879. Additional entry at Long Island City, N. Y., and San Francisco, Calif. Title registered U. S. Patent Office. Copyright, 1927, by The Experimenter Publishing Co., Inc., 230 Fifth Ave., New York. The contents of this magazine are copyrighted and must not be reproduced in the United States without giving full credit to the publication. Translation into foreign languages must not be made unless permission is obtained from the publishers. Copyrighted in Germany. Reproduction of articles in Germany is reserved for Radio, Berlin 42.

The contents of RADIO NEWS are indexed in the Industrial Arts Index, copies of which can be found in every library.

General Advertising Dept., 230 Fifth Avenue, New York City

ADVERTISING REPRESENTATIVES

L. F. McCLURE, 720 Cass Street, Chicago, Ill.
DAVIES, DILON & KELLY, 15 West 10th St., Kansas City, Mo.
T. F. MAGRANE, Park Square Bldg., Boston, Mass.

HARRY F. HYDE, 218 Drexel Building, Philadelphia, Pa.
A. J. NORRIS HILL CO., 5 Tird St., San Francisco, Calif.
412 West 6th St., Los Angeles, Calif.
Leary Building, Seattle, Wash.

RADIO NEWS is for sale at all newsstands in the United States and Canada, and at Brentano's, Ave. de L'Opera, Paris, France. European agents: S. J. Wise Et Cie, 40 Place Verte, Antwerp, Belgium.

HOW TO SUBSCRIBE FOR RADIO NEWS. Send your name, address and remittance to Experimenter Publishing Co., 230 Fifth Ave., New York. Mention the name of the magazine you are ordering. We also publish SCIENCE AND INVENTION, RADIO LISTENERS' GUIDE, AMAZING STORIES and FRENCH HUMOR. Write clearly.

RATES AND TERMS. The subscription rate for RADIO NEWS is \$2.50 per year (12 numbers). When remitting do so by check, money order, or registered letter if cash is enclosed. Avoid sending cash through the mail if possible. Subscriptions for less than one year are not accepted. Subscription may be made in combination with SCIENCE & INVENTION, RADIO LISTENERS' GUIDE, AMAZING STORIES and FRENCH HUMOR.

POSTAGE. We prepay postage in all parts of the United States, Mexico and Island possessions. For foreign or Canadian subscriptions we require 50 cents in addition to the subscription price for additional postage charge.

CHANGE OF ADDRESS. Notify us as far in advance as possible. It requires several weeks to make an address change on our records. Always write clearly.

Amazing New A C radio tubes eliminate batteries by use of electric house current

NEW RADIO TUBES TO USE ORDINARY HOUSE CURRENT FOR POWER

NEW YORK, Jan. 3rd.—Much interest was aroused in radio circles today by the announcement that a radio tube had at last been perfected which used ordinary electric house current in the operation of its plate circuit.

NEW RADIO TUBE WILL OBSOLETE BATTERY POWER

WASHINGTON, Mar. 5, 15th.—Persons who from the earliest date have waited for a radio set that would run on house current are now satisfied.

ELECTRICAL WIZARD RUNS RADIO WITH ORDINARY HOUSE LIGHTING CURRENT

—A radio receiver is now being built which will run on ordinary house lighting current.

in the CROSLYVAC BANDBOX 6 tubes Genuine Neutrodyne

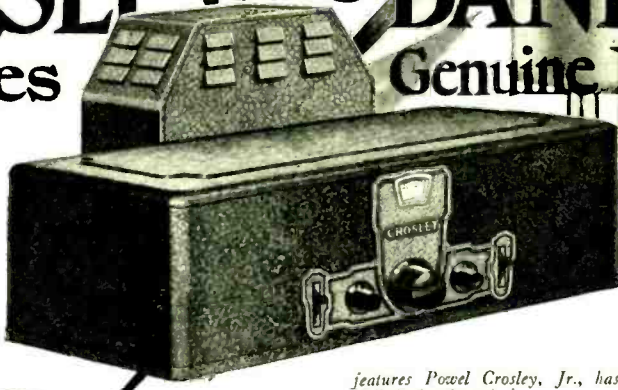

STORIES in regard to the coming of A.C. tubes which would operate from house lighting circuits have appeared in various newspapers, arousing a climax of anticipation in the public mind last spring.

With the acquisition of a license by the Crosley Radio Corporation under a large group of patents controlled by the Radio Corporation of America, American Telephone and Telegraph Company, General Electric Company, Westinghouse Electric and Manufacturing Company, etc., the Crosley AC Bandbox is possible through the use of the new R.C.A. alternating current tubes, UX226 and UX227. These tubes utilize for their filament and heating regular alternating current from the house-lighting circuit.

The current is stepped down by means of a transformer without need of rectifiers to supply the heat necessary for the functioning of the tubes. The converter box, which is included with the Crosley AC Bandbox, can be tucked away out of sight. It is connected to the Bandbox by a cable and also supplies the current for the plate voltages on the tubes, replacing

Now \$110 without tubes

"B" batteries. Thus the Crosley AC Bandbox functions entirely from the regular house lighting current without need of batteries, battery chargers, or any of the usual paraphernalia which requires attention, care, and early replacement.

The Crosley AC Bandbox with the alternating current tubes is truly revolutionary, and brings to the radio user an entirely new conception of care-free radio. This AC model, together with the battery type BANDBOX which works with standard power supply units and storage batteries, is the country's most talked-of radio! The popularity centers around two major factors:

1. The imposing array of patents under which it is built.
2. The number and quality of the

Montana, Wyoming, Colorado, New Mexico and West, prices slightly higher.

- features Pavel Crosley, Jr., has built in for the price!
- And what value Crosley has added in:
1. Complete shielding of all elements.
 2. Absolute balance (genuine Neutrodyne.)
 3. Volume control.
 4. Acuminators for sharpest tuning.
 5. Single cable connections.
 6. Single station selector.
 7. Illuminated dial.
 8. Adaptability to ANY type installation.

Today's radio must be adaptable to the home. It must fit into all kinds of conditions. Perhaps you have a bookcase corner—a desk compartment—a chest—or even a bureau drawer where it could be tucked away. Maybe you want it to be part of the furnishings, as an impressive console or credenza cabinet. The Bandbox fits in everywhere. The metal outside case is easily and quickly removed. The set is solidly mounted on a stout steel chassis. As all controls are

assembled together in the front, cabinet panels are easily cut to allow their protrusion. The metal escutcheon is screwed on over the shafts and the installation has all the appearance of being built to order. Two large furniture manufacturers have designed console cabinets in which the Bandbox can be superbly installed.

(Shower Bros. Mfg. Co. of Bloomington, Ind., and the Wolf Mfg. Ind. of Kokomo, Ind.) Pavel Crosley, Jr., has approved them mechanically and acoustically and has seen to it that the famous Crosley Musicones are built in them so that the best type of loud speaker reproduction may be insured. This is the kind of a radio you have been waiting for—the real direct electric set that requires absolutely no attention. What if it does run all night! Who cares? No run-down batteries to greet you in the morning. You owe it to yourself to see the Bandbox and listen to its remarkable performance. If you cannot easily locate the nearest Crosley dealer, his name and address will be supplied on request. Write Dept. 22.

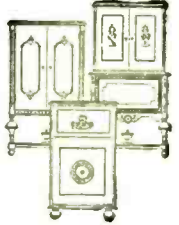

CROSLYVAC RADIO

THE CROSLY RADIO CORP.
Pavel Crosley, Jr., Pres.,
Cincinnati, Ohio

"You're there with a Crosley"

Crosley is licensed only for Radio Amateurs, Experimental and Broadcast Reception

INDEX TO ADVERTISERS

A	Page
Abox Co., The.....	732
Acme Apparatus Corp.	819
Acme Electric & Mig. Co. 824	
Acme Wire Co.	842
Acme Wire Co.	845
Aero Products, Inc.	802
Aerovox Wireless Corp.	850
Algonquin Electric Co. Inc. 721	
All Radio Co.	829
Allan Mig. Co.	827
Allen-Bradley, Inc.	855
Alter Co., The Harry.....	850
American Auto & Radio Mig. Co. 806-810-848-853-855	
American Bosch Magneto Corp.	835
American Hard Rubber Co. 802	
Amad Corp.	844
Arcturus Radio Co., Inc.	730
Aristocrat Corp. of America	830
B	
Belden Mig. Co.	812
Benjamin Electric Mig. Co. 806	
Bernard Furniture Co.	836
Bogue, B. N.	842
Boudette Mig. Co.	840
Brady, John B.	837
Browning Drake Corp.	843
Bryant & Lowry.....	829
C	
C. E. Mfg. Co., Inc. Back Cover	
Cable Supply Co., Inc.	804
Cameron Mig. Co.	826
Camfield Radio Mfg. Co. ..	814
Carborundum Co., The.....	815
Carter Radio Co.	814
Central Radio Labs.	853
Chaslyn Co., The.....	810
Chemical Institute of N. Y. Inc.	811
Chicago Radio Apparatus Co.	819
Chicago Stock Gear Works 845	
Clark & Tilson, Inc.	810
Cloverleaf Mig. Co.	856
Consrad Co., Inc. 812-816-830-834-846	
Consumers Radiø Co.	846
Cooperative Radio Doctors 834	
Cornish Wire Co.	849

D	Page
Coyne Electrical School.....	824
Craftsman Radio Products 842	
Crosley Radio Corp.	723
Cunningham, Inc., E. T. Inside Front Cover	
Curtan Mig. Co.	835
D	
Daven Radio Corp.	800-852
Detroit Radio Labs.	829
Deutschmann Co., Tobe.....	846
Dubilier Condenser Corp. ..	808
Duro Metal Products.....	814
E	
Eby Mig. Co., Inc., H. H. 850	
Electrad, Inc.	840-848-855
Electric Specialty Co.	847
Electro Chemical Co. of America	840
Elliott Radio Corp.	801
Erie Fixture Supply Co.	836
F	
F. & H. Radio Labs.	815
Fanspeaker Radio Co.	824
Fansteel Products Co., Inc. 797	
Fast & Co., John E.	855
Ferbend Electric Co.	827
Ferranti, Inc.	852
Flechtheim Co., Inc., A. M. 821	
Formica Insulation Co., The 825	
Freshman Co., Inc., Chas. 833	
Frost, Inc., Herbert H.	839
G	
G. R. P. Products Co., Inc. 820	
Gardiner & Hepburn, Inc. 851	
General Electric Co.	831
General Radio Co.	849
Grigsby-Grunow-Hinds Co. 845	
Guaranty Radio Goods Co. 804-820-848-850	
H	
Hammarlund Mig. Co.	837
Hammarlund-Roberts, Inc. 835	
Hammer Radio Co., S.	848
Hampton-Wright	840
Harco Co.	835
I	
Independent Electric Works 819	
International Accountants Society, Inc.	823
International Resistance Co. 848	

J	Page
J-M-P Mig. Co.	826
Jewell Electrical Inst. Co. 834	
K	
Karas Electric Co.	824-833
Kelsey Co., The.....	848
L	
Lacault Radio Elec. Labs. R. E.	833-839
Lacey & Lacey.....	851
Langbein - Kaufman Radio Co.	836
Leutz, Inc., C. R.	825
Lignole Corp., The.....	814
Mc	
McSweeney Electrical Schools	848
M	
M. & H. Sporting Goods Co.	844
Mack Co., Inc.	831
Magnavox Co.	793
Master-Crait Products Co. 851	
Metro Electric Co.	725
Midwest Radio Corp. Inside Back Cover	
Muter Co., Leslie F.	834
N	
National Co., Inc.	834
National Radio Institute 728-729-816	
New York Telegram.....	807
Niagara School of Music....	840
Norden Hauck, Inc.	839
North American Bretwood Co.	844
North Shore Radio Labs. 804-835	
O	
Omnigraph Mig. Co.	825
P	
Palmer & Palmer.....	817
Parker, C. L.	836
Peridyne	731
Pilot Elec. Mig. Co.	803
Press Guild, Inc.	826

R	Page
Radiall Co.	840
Radio Association of Amer- ica	727
Radio Equipment Co.	802
Radio Specialty Co.	809
Raytheon Mig. Co.	853
Rowan Battery Supply Co., Walter	851
S	
S. R. S. Co.	825
Samson Electric Co.	845
Setbuilders Supply Co.	843
Shieldplate Grid Corp.	813
Shure Radio Co.....	829
Silver-Marshall, Inc.	841
Smith, B. Hawley.....	853
Southern Toy Co., Inc.	846
Sovereign Elec. & Mig. Co.	826
Starrett Mig. Co.	848
Sterling Mig. Co.	820
Strauss & Schram.....	844
T	
Telephone Maintenance Co. 840	
Teleplex Co.	846
Televocal Corp.	806
Temple, Inc.	829
Thompson Radio Corp.	837
Tower Mig. Co.	851
Townsend Laboratories.....	821
Triple-A Specialty Co.	810
Tyrman Electric Corp.	813
W	
Walker Co., The Geo. W. 849	
Warren Electric Co.	851
Western Radio Mig. Co.	814
Westgale Electric Co.	806
Westinghouse Elec. Mig. Co.	799
West Side Y. M. C. A. Ra- dio Institute	817
Wirthmore Co., The.....	804
Woolf, J. W. & W. L.	810
World Battery Co.....	804
X-Y-Z	
X-L Radio Labs.	814-855
Yaxley Mig. Co.	814
Zenith Radio Corp.	805

All Electric Radio

Single Dial 7 Tube Set—30 Days Free Trial

**Agents!
Dealers!
Big Profits!**

Make Big Money taking orders for Metrodynes—all or part time. Metrodyne All Electric Radios are in a class by themselves. Unequaled for quality, performance and price. Demonstrate at home and take orders. Lowest wholesale prices. Your Demonstrating Set on 30 days' FREE trial. Mail the coupon below for complete details.

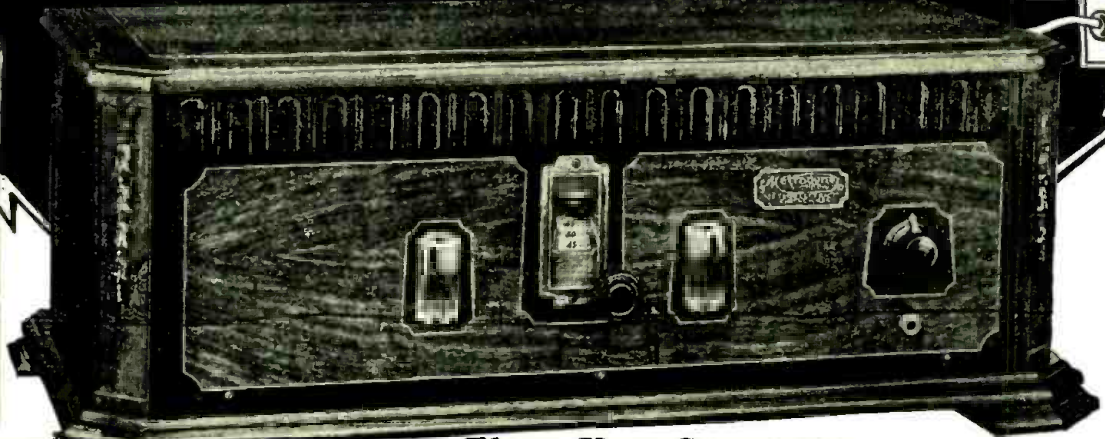

Three Year Guarantee

Metrodyne

ALL ELECTRIC RADIO

"Simply press the switch button and it's on"

NOW! A real electric radio set! Costs less than most battery sets. No batteries—no chargers—no eliminators—no acids—no liquids! Shipped direct from our factory at rock bottom prices and on 30 DAYS' FREE TRIAL.

At last! The radio you've dreamed about! If you have electricity in your home you can now really enjoy coast to coast radio reception without the care, bother and muss of batteries, chargers, eliminators, etc. The Metrodyne All Electric is a real, genuine batteryless radio set. Simply insert the plug in the socket, press the switch button and "tune in." You could not possibly buy a better radio set than the Metrodyne All Electric, no matter what price you paid.

Metrodyne All Electric, no matter what price you paid.

COSTS LESS THAN MOST BATTERY SETS

Do not confuse the Metrodyne All Electric radio with ordinary light socket sets, because the Metrodyne is truly an all electric radio—consumes less than 2c worth of electricity a day. Comes to you direct from the factory. Its low cost brings it down to the price of an ordinary battery set. We are so confident that you will be delighted with this wonderful, easy-to-operate batteryless radio that we offer to ship it to your home for thirty days' free trial—you to be the judge.

no
~~A-Batteries~~
~~B-Batteries~~
~~C-Batteries~~
~~Eliminators~~
~~Chargers~~
~~Acids~~

30 DAYS FREE TRIAL

We are one of the pioneers of radio. The success of Metrodyne sets is due to our liberal 30 days' free trial offer, which gives you the opportunity of trying before buying. Thousands of Metrodynes have been bought on our liberal free trial basis—Write Today!

GORGEOUS CONSOLE ELECTRIC RADIO

Here is the Metrodyne All Electric Console Radio—a gorgeous, genuine walnut cabinet, in a beautiful two-tone finish. Has a built-in genuine Metro-Cone large size speaker. Brings in programs with great volume, reproducing the entire range from the lowest to the highest notes with remarkable clearness and distinction. All metal parts are finished in old gold. Wonderful electric radio, in a cabinet that will beautify the appearance of any home.

BEAUTY—EFFICIENCY DEPENDABILITY

The Metrodyne All Electric table model Radio is a 7 tube, single dial set. Only the highest quality low loss parts are used throughout. Solid walnut cabinet, beautiful two-tone effect, with handsome gilt metal trimmings. Size of cabinet, 28 inches long, 13 inches deep, 10 inches high. Has electrically lighted dial—easy to log stations, even in the dark. Only one dial to tune in all stations. Excellent tonal qualities—wonderful volume—very selective.

Mail This Coupon

Learn all about the marvelous Metrodyne All Electric Radio before buying any radio set. Let us send you the proof of quality. Read the letters from thousands of enthusiastic owners. Get our rock bottom direct-from-factory prices and our liberal thirty days' free trial offer.

FREE TRIAL COUPON

METRO ELECTRIC COMPANY

2165 N. California Ave., Dept. 606
Chicago, Illinois

Gentlemen:

Send me full particulars about Metrodyne All Electric Radio and your thirty days' free trial offer.

Name _____

Address _____

If you are interested in AGENT'S proposition place an "X" in the square

METRO ELECTRIC COMPANY

2165 N. California Ave. Dept. 606 Chicago, Illinois

Buy or BUILD with confidence and Insure Permanent Enjoyment of Your Radio Set!

USE "THE DIRECTORY OF STANDARD RADIO SETS"

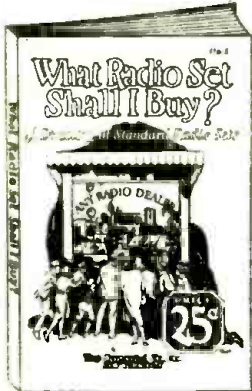

for
buying

THERE is one easy—simple way to decide on what Radio Set to buy. If you are particular as to the style of the set, the power, the sensitivity, the price, or anything that has to

do with a manufactured set you will find a complete answer in the "DIRECTORY OF STANDARD RADIO SETS."

Photographs of all standard manufacturers are shown together with an exhaustive printed description furnished by the manufacturers themselves.

This book is absolutely impartial. It is the only printed book in existence that gives you this information.

40 pages of descriptions and illustrations, size 6 x 9 inches with handsome colored cover. PRICE 25c.

USE "HOW TO TUNE YOUR RADIO SET"

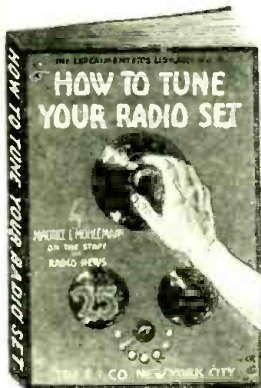

to
enjoy all
programs

RADIO Receivers know no rules of etiquette—they cannot be taught to act on best behavior when company and friends are judging them—but they can be made to act properly if the operator understands the few simple factors that effect tuning or the proper adjustment of the Receiver's controls.

Be one of those on the safe side. Don't be afraid to invite friends and show them that good tuning means good reception and enjoyable programs.

The 64-page, illustrated book on "How to Tune Your Radio Set" (Consrad—25c) is a carefully prepared, yet simplified, instruction book on tuning alone.

Receivers of different types, individual characteristics, are handled separately. All there is to know, all that must be known before one can really say to understand the tuning of a set—is given in this book.



only
\$100

buys an entire set of these four books of vital importance to every one owning or contemplating the purchase of a radio set.

They can be bought separately if desired at

25c each

Fill out the coupon below and mail it with your remittance today.

All orders filled promptly.

USE "THE RADIO TROUBLE FINDER"

to insure
permanent
satisfaction

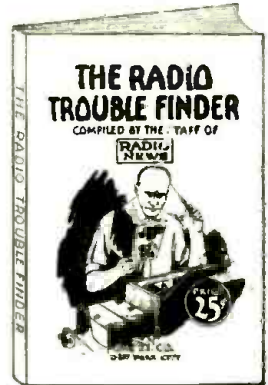

THE "RADIO TROUBLE FINDER" is a book prepared by a Radio Expert with many years of practical experience. It is a proven fact that 99 out of every 100 complaints from Radio set owners can be traced to simple and minor troubles that a child could repair with a simple book of instructions—and only once in a lifetime the average man need pay an expert to repair his set—if he has a copy of the "RADIO TROUBLE FINDER."

This simplified 64-page book charts all troubles and how to correct them. It is the simplest thing imaginable to use it. Even the more difficult jobs of changing internal mechanism of the set can be accomplished successfully.

The "RADIO TROUBLE FINDER" contains 64 pages, many of which are illustrated. It is size 6 x 9 inches, with a colored cover.

PRICE, 25c.

USE "150 RADIO HOOKUPS"

for
BUILDING

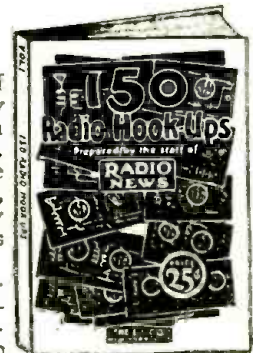

THIS 68-page book of the Consrad Company is the latest compilation of Hookups in Radio. The Hookups are those that have been tried, tested and perfected by time and by thousands of Radio Listeners.

This priceless book contains: 18 Crystal Detector Circuits, 39 Regenerative, 21 Reflex, 23 Radio Frequency, 10 Super-Regenerative, 10 Amplifier and Oscillator, 5 Super-Heterodyne and other valuable Hookups.

All circuits are shown by simplified drawings and each is explained in detail. The book is 6x9 inches in size, illustrated, and is contained in a special attractive 2-color cover.

PRICE, 25c.

CONSRAD CO., INC., 230 5th Ave., New York.

Gentlemen: I enclose \$..... for one copy of

- Directory of Standard Radio Sets.
- Radio Trouble Finder.
- How to Tune Your Radio Set
- \$50 Radio Hookups.

Name.....
 Address.....
 City, State.....



EARN \$75⁰⁰ a week — in Your Spare Time

JOINING the Radio Association enables you to cash in on Radio *now!* Follow its success-proven plans and you can earn \$3 an hour, in your spare time, from the very first. Over \$600,000,000 is being spent yearly for sets, supplies, service. You can get your share of this business and, at the same time, fit yourself for the big-pay opportunities in Radio.

Founded on a New Idea

Members of the Association do not wait for months before they make money out of Radio. Without quitting their jobs, our members are earning \$25 to \$75 a week spare time by building "tailored" radio sets, serving as "radio doctors," selling ready built sets and accessories, or following one of the many profit-making plans of the Association.

Earned \$500 in Spare Hours

Hundreds earn \$3 an hour as "radio doctors." Lyle Follick, Lansing, Mich., has already made \$500 in spare time. Werner Eichler, Rochester, N. Y., is earning \$50 a week for spare time. F. J. Buckley, Sedalia, Mo., is earning as much in spare time as he receives from his employer.

We will start you in business. Our cooperative plan gives the ambitious man his opportunity to establish himself. Many have followed this plan and established radio stores. Membership in the Association has increased the salaries of many. Scores are now connected with big radio organizations. Others have prosperous stores.

A year ago Claude De Grave knew nothing about Radio. Today he is on the staff of a famous radio manufacturer and an associate member of the Institute of Radio Engineers. He attributes his success to joining the Association. His income now is 350% more than when he joined.

Doubled Income in Six Months

"I attribute my success entirely to the Radio Association," writes W. E. Thon, Chicago, who was clerk in a hardware store before joining. We helped him secure the managership of a large store at a 220% increased salary.

"In 1922 I was a clerk," writes K. O. Benzing, McGregor, Ia., "when I enrolled. Since then I have built hundreds of sets—from 1-tube Regenerative to Superheterodynes. I am now operating my own store and my income is 200% greater than when I joined the Association. My entire success is due to the splendid help it gave."

Easiest Way Into Radio

If ambitious to become a Radio Engineer, to fit yourself for the \$3,000 to \$10,000 opportunities in Radio, join the Association. It gives you a comprehensive, practical and theoretical training and the benefit of our Employment Service. You earn while you learn. You have the privilege of buying radio supplies at wholesale. You have the Association behind you in carrying out your ambitions.

ACT NOW—if you wish Special Membership Plan

To a limited number of ambitious men, we will give Special Memberships that may not—need not—cost you a cent. To secure one, write today. We will send you details and also our book, "Your Opportunity in the Radio Industry." It will open your eyes to the money-making possibilities of Radio. Write today.

What a Membership Can Do for You

- 1—Enable you to earn \$3 an hour upwards in your spare time.
- 2—Train you to install, repair and build all kinds of sets.
- 3—Start you in business without capital, or finance an invention.
- 4—Train you for the \$3,000 to \$10,000 big-pay radio positions.
- 5—Help secure a better position at bigger pay for you.
- 6—Give you the backing of the Radio Association.

A MEMBERSHIP NEED NOT COST YOU A SINGLE CENT

RADIO ASSOCIATION OF AMERICA,
4513 Ravenswood Ave.,
Chicago, Ill.

Dept. RN-1

Gentlemen:

Please send me by return mail full details of your Special Membership Plan and also copy of your book, "Your Opportunity in the Radio Industry."

Name.....
Address.....
City..... State.....

More Money

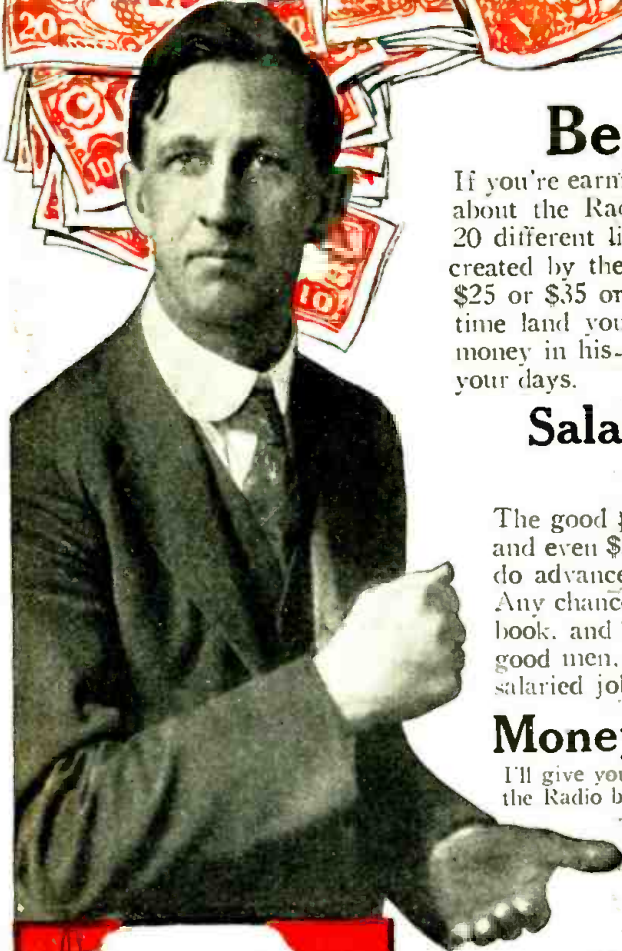

Be a Trained Radio Expert

If you're earning a penny less than \$50 a week, get my free book of information about the Radio business. Trained Radio Experts are needed in more than 20 different lines of this new and growing profession (300,000 new openings created by the swift growth of Radio in past few years). Why go along at \$25 or \$35 or \$45 a week all your life? Study Radio and after only a short time land yourself a REAL job with a REAL future! Be a man who has money in his pocket and in the bank—don't scrimp and scrape for the rest of your days.

Salaries of \$50 Up to \$250 a Week Not Unusual in Radio

The good positions in Radio pay all the way from \$50 on up to \$150, \$200, and even \$250 a week. Suppose you don't climb to the very top, but that you do advance to a position that pays you \$125 a week, year in and year out. Any chance to make that much where you are now? Then send for my free book, and learn about a field where there's some real opportunity. Where good men, if they have the right training, can work their way into really big salaried jobs!

Money Back If You Aren't Fully Satisfied

I'll give you all the training you need to get into any line of the Radio business. And I back up this training by a signed agreement to refund every penny you pay me if I don't give you exactly the training you need. After you finish my training, you'll be the judge. If you think I've earned my tuition fee, I keep it. If not, ask for it and you'll get it right back.

Six Big Practical Outfits Given You to Help You Learn

I teach you both the "why" and the "how" of Radio. You learn to DO a thing, and you learn WHY it's done. I send you, WITHOUT EXTRA COST with your course, six big practical outfits of material to experiment and work with. These outfits are the real thing—not toys. The parts they contain will build approximately 100 different Radio circuits. With all this material you do practical work from start to finish of your training. You get your hand in, and you get confidence in yourself. Then when you run into a Radio problem later on, on the job, you KNOW you can do it because you've already done it, with these six outfits of practical material. With me you don't learn to be a "paper Radio Expert"—you learn to be the kind of expert that shows his worth on the payroll. Full details in my big book—sent free.

Send for Free Book of Information

GET BOOK!

Find out for yourself about bigger pay waiting for you in Radio! From \$2,000,000 in 1920 to \$504,000,000 in 1926—that's the record of the Radio Industry. Plenty of big Radio jobs are waiting for the man who KNOWS! John Fetzer sent for my free book—now he's Chief Engineer at WEMC and designs and builds broadcast stations. T. M. Wilcox sent for the book—now he's in his own Radio business and reports profits as high as \$70 in one day! All information will be sent to you free without obligation. Send me coupon on opposite page.

see coupon next page



Broadcasting and commercial Radio land station work appeal to a lot of men—it's a big, growing field and fascinating work. My course prepares you thoroughly to get into this field and make good.

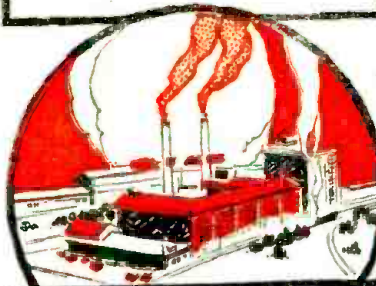

Radio manufacturing has grown faster in the last 6 years than any other big business ever did. It's 250 times as big as it was. That means lots of good chances for the trained Radio Expert.

Six million Radio receiving sets in use in the United States means millions of dollars are going to Radio Service and Repair men everywhere. For this work you must be trained.

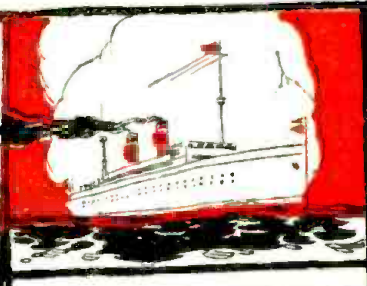

Radio operators on board ship go everywhere—see everything. You sail the world over, all your expenses paid, and draw a good salary besides. It's the life of Reilly.



LEARN QUICKLY, EASILY

Train at Home in Spare Minutes

Stay home! Hold your job! I'll bring your Radio training to you, and you can learn in your spare time after work. No need to go to a strange city and live for months on expense when you learn my way. You study in the quiet of your own home. As for this training — it's written just as I would talk — in straightforward, everyday, understandable language. You'll get it, and you'll get it quickly—in a few months' spare time—because I've made it so clear and interesting! No particular education needed—lots of my successful students didn't finish the grades.

Earn \$15, \$20, \$30 Weekly Right Away "On the Side"

Deloss Brown, South St., Foxboro, Mass., made \$1,000 from spare-time Radio jobs before he even finished my course. H. W. Coblentz, Washington, averaged \$45 a week; Leo Auchampaugh, 642 Lakewood Ave., Chicago, made \$500 before graduation; Frank Toomey, Jr., Piermont, N. Y., made \$833 while taking the course. All this done IN SPARE TIME away from the regular job, while these fellows were still studying the course—and they're only a few of hundreds. As soon as you start this training I begin teaching you practical Radio work. Then a few weeks later, I show you how to make use of it in spare time, so you can be making \$15, \$20, \$30 a week "on the side," all the while you're learning.

64-Page Book Sent Free for the Asking

My big book of Radio information won't cost you a penny, and you won't be under any obligation by asking for it. It's put hundreds of fellows on the way to big pay and brighter futures. Sending for it has been the turning-point where many a man has made his start toward real success. Get it. See what it's going to mean to you. Send coupon TODAY!

Address: J. E. SMITH, President,
National Radio Institute,
Dept. 1-S, Washington, D. C.

JOBS WAITING!

In 7 short years—300,000 new jobs in Radio! Lots of jobs open right now, for those who have the training. The Radio industry has grown by leaps and bounds—so fast it has had to take whatever sort of men it could get. Such men, if they haven't trained themselves in the meantime, are losing out and will keep on losing out. They'll be replaced by men with the KNOW-HOW. But it's trained men ONLY that are needed.

Over 1,000 Openings for Trained Men NOW!

One great Radio manufacturing concern alone has over 1,000 openings to give my graduates this year. These men will be needed all over the United States. Any graduate of mine who stands well in his home town is eligible for this work. The head of the above mentioned concern—one of the biggest Radio organizations in the country—is a graduate of mine. He knows what my training did for him. When he wants new men for his organization he wants men with the same training.

I can't possibly graduate enough men this year to fill these openings. So there will be more openings with this one concern than there will be graduates to accept them.

But there are other openings to choose from, too. My school has trained more Radio Experts than any other school in the world. It's the oldest and largest Radio home-study school in the world. There are N. R. I. trained men in almost every Radio concern of any importance in this country. Many Radio employers are themselves my graduates.

That's where you get your "stand-in" as an N. R. I. graduate yourself. Every graduate of my course is entitled to Life-Time Employment Service, without a penny's charge, from my helpful Employment Department.

Full Information Sent with Free Book
My Free Book contains full information about the Radio employment situation, and the advantages I'm in a position to give you. Also about my Life-Time Employment Service, and Life-Time Consultation Service, too.

Mail Coupon Today!



This big 64-page book, printed in two colors, crammed with interesting facts and photos about money-making opportunities in Radio, sent free to everyone who clips the coupon. No obligation by sending for the book—it's absolutely free. One of the most valuable books about Radio ever written.



Send No Money

J. E. SMITH, President,
National Radio Institute,
Dept. 1-S, Washington, D. C.

Dear Mr. Smith: Kindly send me your big free book "Rich Rewards in Radio," giving all information about the big-money opportunities in Radio and how you will train me to take advantage of them. I understand this places me under no obligation, and that no salesmen will call on me.

Name

Address

Town..... State

For These Four Reasons

Arcturize your present Radio Set—enjoy all the benefits of A-C Power from your light socket with

ARCTURUS A-C TUBES

Detector / Amplifier / Power



Arcturus A-C Tubes

Have 4 Outstanding Features

1. Exceptional tone quality, volume and sensitivity.
2. Readily adaptable to all circuits using standard sockets.
3. Perfect operation under all normal line voltage variations.
4. Free from hum.

If you have been awaiting the perfection of A-C Tubes before modernizing your present set, send at once for detailed information on the operating characteristics of Arcturus A-C Tubes.

Ask Your Dealer

It doesn't take long or cost much to install Arcturus A-C Tubes in your present set. Your dealer's service man can get engineering instructions for the few simple changes in wiring that are necessary. Always remember that in changing over your set for A-C operation, Arcturus A-C Tubes require the least changes in wiring.

For the Technical Man

The unique advantages which we claim for Arcturus A-C Tubes are directly traceable to unique features of construction and exceptional operating characteristics.

The exceptional long life of Arcturus Tubes is due to the enormous electron supply resulting from the heater operating at a low temperature.

The highly efficient cathode is responsible for the unusual sensitivity of Arcturus A-C Tubes, and for the exceptional volume and tone quality which their use insures. This cathode produces:

1. A high amplification factor

(10.5). 2. A low plate impedance (9,000 ohms). 3. A high mutual conductance (1160 micromhos).

Since the base of the Arcturus A-C Tube is of the standard four prong type, no additional terminals are required, making Arcturus Tubes adaptable to existing circuits with all the simplicity of D-C tubes. No center taps or balancing are required. A common toy transformer may be used. Filament voltage is the same (15 volts) for all types—detector, amplifier and power.

The freedom from hum which is one of the most important features of Arcturus A-C Tubes

is due to the use of low A-C current, only 0.35 ampere. (Disturbing electro-magnetic fields are proportional to alternating current—not voltage.) Arcturus Tubes in all stages are four element tubes with indirectly heated cathodes.

Normal variations in line voltage do not affect the operation of Arcturus A-C Tubes. The amplification factor is practically constant over a wide range of filament voltages—13.0 to 18.0 volts.

The use of a heavy carbon filament enables Arcturus A-C Tubes to withstand even an unusual overload.

ARCTURUS RADIO COMPANY, INC.

253 Sherman Avenue, Newark, N. J.

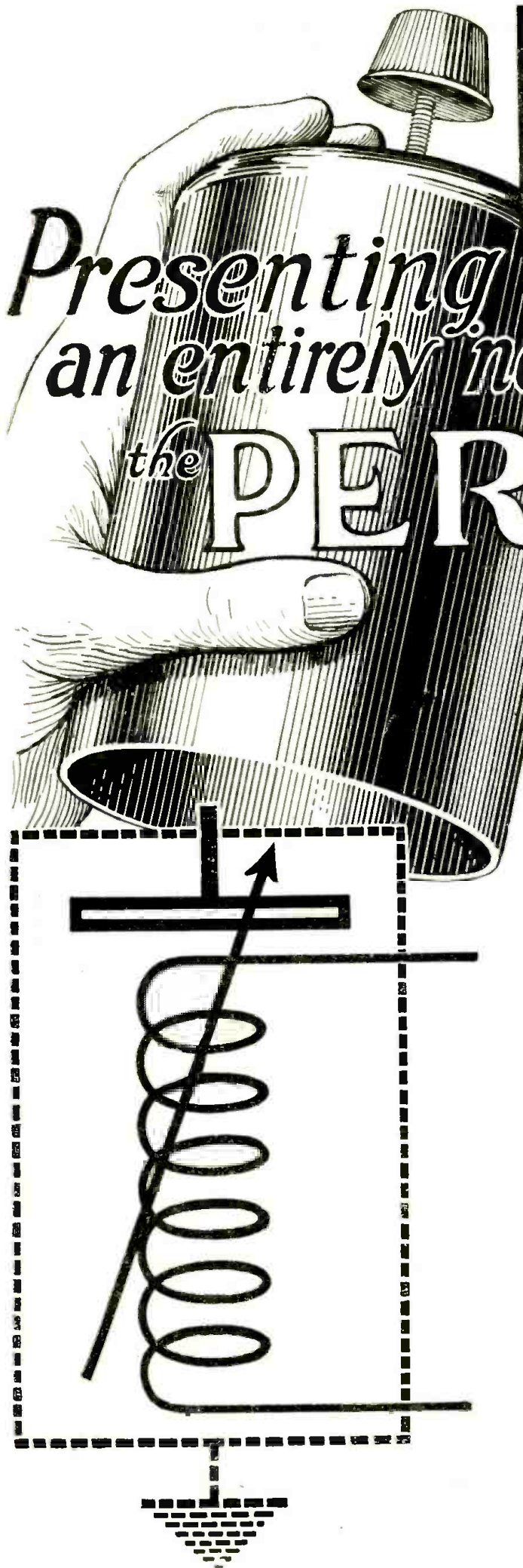

Presenting an entirely new circuit the PERIDYNE

WHAT RADIO NEWS SAYS ABOUT THE "PERIDYNE"

RADIO NEWS says: The "Peridyne" receiver is revolutionary. It embodies an entirely new principle in what we have named the "Peridyne" method of shield-tuning.

A new radio symbol, the "Peridyne" character, had to be created by the author, as no symbol for this arrangement is provided in the present radio practice.

We predict great commercial possibilities for this invention, which makes it possible to bring a single

dial set into perfect interstage resonance and consequently to operate it at the maximum possible efficiency.

The "Peridyne 5," a receiver you can easily build yourself, is a five-tube set, by means of which the author in New York receives Pacific Coast stations several times during the week, even during the summer.

RADIO NEWS further says: The "Peridyne 5" is the greatest 5-tube DX set that has ever been described anywhere.

You can easily build this new remarkable circuit. It has been designed by Mr. Hugo Gernsback, Member of the American Physical Society, Member of the American Association for the Advancement of Science, Editor of Radio News, Science and Invention, and a dozen or more scientific and practical Radio Books. It presents the one TRUE, and most effective receiver for perfect Inter-stage Resonance on Single Control giving the maximum efficiency possible in this type of Receiver.

There is a reason—an obvious reason, apparent at a glance, for the unmatched efficiency of this remarkable receiver. The "Peridyne" employs a new principle, the circuit of which is shown in the lower left-hand corner of this page. By means of this simple, yet amazing instrument, Mr. Gernsback has combined the two principal means employed today to obtain True Interstage Resonance. The "Peridyne" is the perfect one-control set—the perfect distance receiver. The official parts listed below have been combined to work most effectively in the "Peridyne." This combination of quality parts endows the "Peridyne" with its remarkable performance. The cost of building the "Peridyne" is astoundingly low for the results achieved.

OFFICIAL LIST OF PARTS FOR THE "PERIDYNE"

- | | |
|---|---|
| 1 Amsco Triple Var. Cond. .0005 mf. each section | 1 Yaxley Jack, Single-circuit type |
| 3 Hammarlund R. F. Transformers, Special (Special Peridyne units) | 1 Yaxley Jack-Switch, Two-circuit-type (D. P. S. T.) |
| 3 Silver-Marshall Coil Shields, Special (Special Peridyne units) | 1 National Vernier Dial |
| 2 Silver-Marshall A. F. Transformers 3:1 ratio | 5 Benjamin Sockets, UX type |
| 2 Allen Bradley Rheostats, Carbon type | 4 X-L Binding Posts |
| 1 Centralab Variable Resistor 0-100,000 ohms | 1 Am. Hard Rubber Panel, 7x24x3/16 inches |
| 1 Carter Switch-Rheostat, 30 ohms; combination instrument | 1 Am. Hard Rubber Sub-Panel, 8x23x3/16 inches |
| 1 Amperite, 5 volts, 1/2 ampere type | 4 Am. Hard Rubber Brackets, 6"x2 inches, hard rubber |
| 1 Amperite, 5 volts, 1/2 ampere type | 1 Belden Battery Cable, with fuse, 7 wires |
| 1 Carborundum detector, Carborundum type | 4 E. T. Cunningham Vacuum Tubes 201-A type |
| 1 Samson R. F. Choke, 85 millihenries | 1 Cunningham Vacuum Tube, 112 type |
| 1 Aerovox Fixed Condenser, .001 mf | 1 Am. Hard Rubber Terminal Strip, 7"x1x3/16 inches |
| 1 Jewell Voltmeter, 0-8 volts | 4 Acme Rolls Hook-up Wire, Black, Yellow, Red and Green |
| 1 Jewell Voltmeter, 0-150 volts | |

The coupon below, with 50c. will bring you the official Construction Book, for the "PERIDYNE," including full sized blueprints and detailed instructions to make it.

"PERIDYNE"

1150 BROADWAY - - NEW YORK, N. Y.

"PERIDYNE," 1150 Broadway, New York, N. Y.
Gentlemen: I enclose 50c. Kindly send me one copy of the Official Sixteen-page "PERIDYNE" Booklet, with full-sized Blueprints.

Name.....
Address.....
City..... State.....

Abox

"A" BATTERY ELIMINATOR

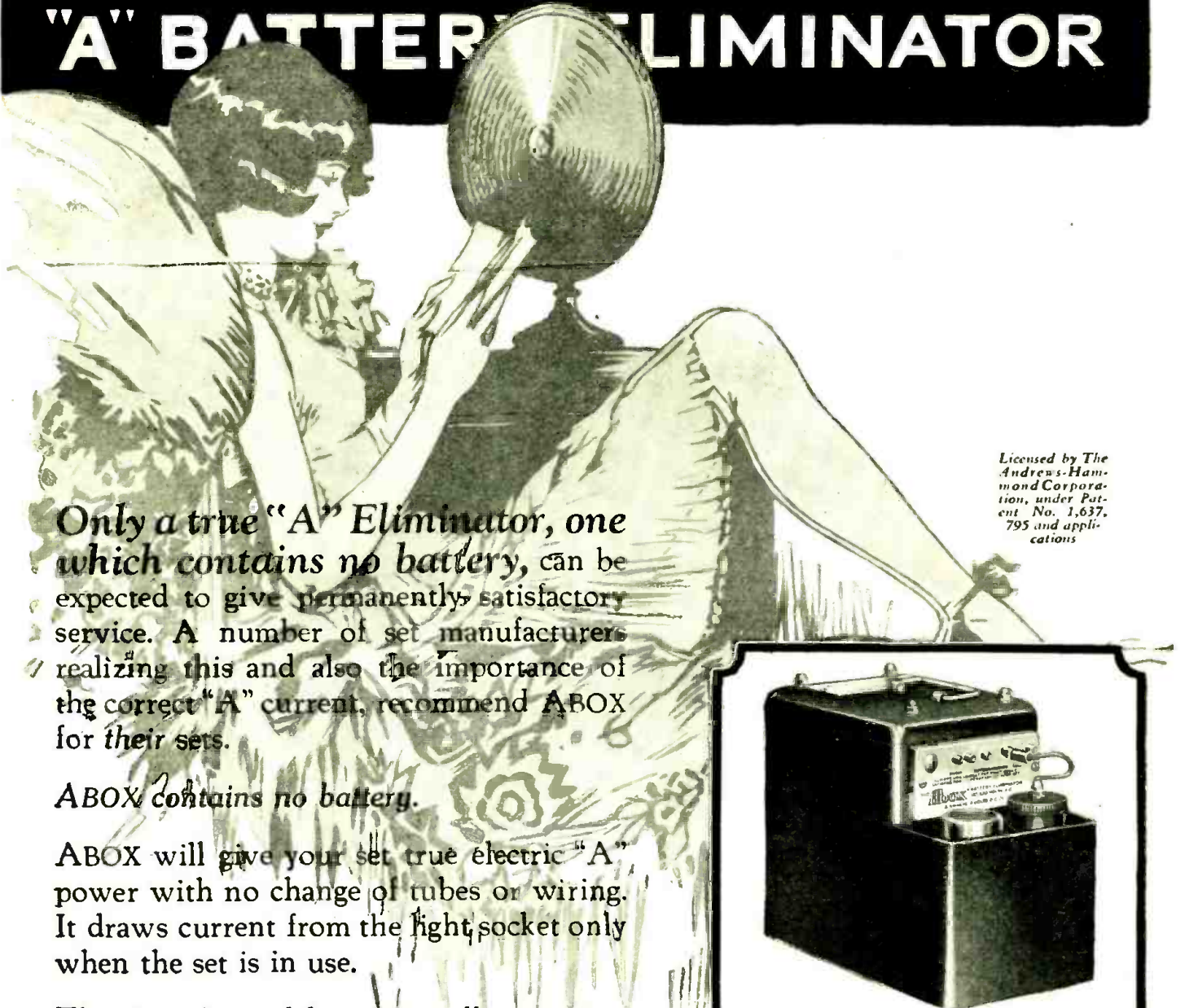

Licensed by The
Andrews-Ham-
mond Corpora-
tion, under Pat-
ent No. 1,637,
795 and appli-
cations

Only a true "A" Eliminator, one which contains no battery, can be expected to give permanently satisfactory service. A number of set manufacturers realizing this and also the importance of the correct "A" current, recommend ABOX for their sets.

ABOX contains no battery.

ABOX will give your set true electric "A" power with no change of tubes or wiring. It draws current from the light socket only when the set is in use.

The six-volt model operates all sets using eight or less 1/4-ampere tubes. The four-volt model operates any set using type 199 tubes, and will fit into the battery compartment of Radiola receivers.

[[Send for interesting booklet,
"ABOX and The Light Socket"]]

The Abox Company

215 North Michigan Avenue

Chicago, Illinois



\$3-2-50

Slightly higher west of the Rockies
Input—110 volts, 50-60 cycles A. C. Output—6 volt direct current,
2 amperes. Shipping weight, 25 lbs. Unlimited shelf life.

4-volt model for Radiola sets or
any receiver using small tubes **\$2750**

The ABOX FILTER can be used to filter the output of your battery
charger if you have one. The combination is equivalent to the
complete Abox eliminator. Ask for special circular. Price, \$19.50.
Slightly higher west of the Rockies.



RADIO NEWS

HUGO GERNSBACK.
Editor and Publisher

Editorial and General Offices, 230 Fifth Avenue, New York

Vol. 9

JANUARY, 1928

No. 7

Our Mysterious Waves

By HUGO GERNSBACK

ONE of the peculiar facts about radio is that we really know so little about certain phases of this new science. We have arrived at a stage where we possess a good deal of knowledge about the operation of the various instruments that make up our radio transmitters and our radio receiving instruments; and, though we do not know all about radio by any means, and as a matter of fact have only superficial knowledge, still a great many facts have been accumulated. But when it comes to the activities of radio waves, that is, during the interval after the wave leaves a radio transmitter, such as that of a broadcast station, and until it reaches your antenna, practically nothing is known.

It may be predicted safely, however, that, during the next twenty years, many new and important discoveries will be made, all based upon the now mysterious journey of radio waves, after we get to know more about this.

The distances covered by radio waves are practically infinite. When an ultra-short-wave radio station broadcasts a program, it may be reasonably assumed that its waves pass through the so-called "Heaviside layer" and speed on through space, never to stop. While it is true that, out in open space, the waves gradually get weaker, just as do the light waves, nevertheless, the fact remains that they speed on practically forever with the speed of light. It is not impossible that someone, in some other world, would be able to pick up, years after it had been broadcast, a radio program which originated on the earth. That, at least, seems theoretically possible. Radio waves have the same speed as light waves (about 186,000 miles a second) and would therefore reach our nearest star system, *Alpha Centauri*, some four years after the wave had left our broadcast transmitter.

Another interesting possibility is presented; that, if we ever make radio contact with a neighboring planet (let us say Mars), then, when the radio announcer on the earth speaks into the microphone, it will take from three to twenty-two minutes for the wave to traverse the distance between the earth and Mars (all depending on how far apart the two planets are then situated); and then it will take, of course, the same length of time for the message to come back, if there is a reply. Thus, if you spoke into a microphone on earth, you could not reasonably expect a reply from Mars before, at the best, six minutes had elapsed. It will be seen, then, that a two-way conversation would be rather tiresome.

And then, of course, all this conjecture really depends upon whether the waves actually pierce the Heaviside layer. It is now thought that the waves do so on a short-wave broadcast; but we are not absolutely sure. Coming nearer home, we note, today, for a fact, that practically every broadcast wave travels around the entire earth. For that reason, nowadays, no matter where you are, the waves of practically every broadcast station will vibrate in your own body. Right at this second, broadcast stations located in China and Australia, or for that matter in every part of the globe, are sending waves right through you. Of course, these waves, by the time they reach you, are of such infinitesimal amplitude that the effect is practically nil. Nevertheless, if you had a super-sensitive radio receiver in a favorable location, that receiver could, even today, with our present-day apparatus, receive every wave from almost any station that was broadcasting at the time. That does not mean to say that it would be possible to hear them on the loud speaker; but the fact remains, that if you have an aerial attached to the set, the waves are received, even though not detected, by the set. Some day, and possibly within the next twenty years, our receiving sets will be so sensitive, that it will be possible to receive every station on this planet from any point on earth. If we knew more about the mysterious action of the waves, we could do so this minute.

Every radio man knows striking instances of the "freak" actions of radio waves.

There are certain localities where it is easy to receive radio signals that cannot be heard in other localities, even nearby. For instance, not far from New York City there is an amateur station where one of the editors of *RADIO NEWS* has actually heard the broadcasts from Australian stations on a three-tube receiver. They are received, not once in a while, but as a matter of routine; and by the way, in New York, reception from Australia is about as far as you can reach out on this planet. It is nearly half-way around the earth, and farther than that you cannot go. There is nothing mysterious about this apparatus; it is a common, everyday receiver. Whether it has a favored location, influenced by the magnetic field of the earth or something, we do not know and can only guess. The fact remains, that there are spots of this kind all over the earth that favor radio reception from great distances; while other spots, although apparently of equal advantages, are not so favored. Once we know more about such things, the whole art of radio may change.

Then, of course, we have the mysterious action of "fading." You are listening to a certain station that comes in loud; when suddenly it will fade away to practically nothing, only to come up in volume again, periodically. We have learned much about this mysterious fading action during the past few years, and we are continuously learning more about it. While it seems almost impossible at the present time to assure that this condition can be done away with, still radio engineers are hopeful that the problem is not insoluble. There may be a remedy applicable, once we know more about the actions of the waves in free space.

Theoretically, at least, it should not be possible to receive radio broadcasts with a loop or interior aerial inside a steel-framed building. The prevailing theory is that the radio wave is grounded in the metallic framework. Nevertheless, we are able to receive broadcasts, although to a limited degree; the more sensitive a set becomes, the easier it is to pick up broadcast waves inside such a structure. No exact explanation has been forthcoming as to why this is at all possible; because the fact remains that the waves are short-circuited and are absorbed by the steel frame. Whether a secondary wave is generated within the open spaces inside such buildings, or what other action there may be, is not known. At first, it might be thought that a loop-aerial set placed near an open window would be in the best location. This is not a fact, however. As a rule, the best location of such a set is near a steel girder; usually in the corner of the room, where such a beam passes. Often the best reception obtained is near a radiator. No sufficient explanation of these phenomena is known.

When it comes to the effectiveness of the power emitted by broadcast stations, we encounter the definite fact that often a 500-watt transmitter is heard further than a 5000-watt. For instance, a certain mid-western station which at one time operated on 500 watts was easily received in New York practically every night. This broadcaster has since installed a higher-powered transmitter of 5000 watts; but now the station is hardly ever heard in New York. Here is a seeming paradox and an unsolved problem. If the station had changed its location, this would offer an explanation; but the station and its towers remain exactly where they always were.

Then there is the matter of "dead spots." While the interposition of great steel masses, as in a big city, accounts sometimes for absorption of the waves, there are many dead spots, even in flat, open country.

The study of radio waves is pregnant with dozens of discoveries; and only by learning more about these various phenomena can we be enabled to upbuild, slowly, this new and important art.

... Wherein the Editor comments on the enormous mass of practical radio knowledge which is yet to be discovered by scientists and experimenters—and particularly the profound ignorance which prevails at present as to the movements of radio waves in space—the possibility that they may be traveling to infinite distances in starry space—and the certainty that they are passing at this moment unfelt and unhindered through our very bodies—the singularity of the manner in which they seem to appear at one place but not another—and how the explanation of these seemingly capricious phenomena will enlarge most effectively our mastery of radio.

Mr. Hugo Gernsback speaks every Tuesday night at 9.30 P. M. (E.S.T.) from station WRNY on various radio and scientific subjects.



Times Square, the heart of New York's "Great White Way," and its riot of colorful electric signs.

"AND I says to him, lissen, big boy, I don't care if you are stage-manager of this show, you can't pull that stuff on this kid—Didya see the hat she had on? Right off Ninth Aynoo—Is Mac all set out in that box with the mike?—Where's that continuity—Yeh, and he wanted me to do that dance in the third act and I says to him, alright, I'll do it for fifty bucks a week more and then he says—How did that last rehearsal go down in the dressing room this afternoon?—Hey, where's Eddie?—Didya hear the one about the traveling salesman that—HEY, SHUT UP OUT THERE!—And he says to me—QUIET! OVER-TURE!!—"

While this is going on "backstage" in one of Broadway's theatres, with a Saturday audience awaiting the tap of the orchestra leader's baton, a vaster audience is being told what is in store for them. In thousands of homes are lovers of the theatre who are gathered about loud speakers, listening to the radio announcer telling the story of the play, and awaiting the same tap of the leader's baton.

Then, backstage, comes the quieting call of "Overture" and the two audiences are swung into the atmosphere of the play by the music. Then the call of "Curtain!" and the "fourth wall" of the stage slides smoothly up, disclosing a stageful of singing beauties dancing to the latest tune that Broadway is humming and (seemingly) forgetful of bickerings before the rise of the curtain.

After the music of the opening scene, the radio audience is told about the beauties of the costumes, the gorgeous stage setting, the famous stage folk and all the other "trim-min's" that go to make up a Broadway musical production. Then the microphone

in the backstage studio is switched on and a duet, which comes in one of the later acts of the play, is sung for the radio listeners; for only a portion of an act can be put on the air because of the shortness of the allotted time.

Back again to the stage the radio audience is whisked, to listen to one of the song hits of the show, now being sung by a couple of the principals and the chorus. Back and forth for an hour—from dressing rooms, where stars are making quick changes of costume, to "out front," where these same stars are heard delighting an audience vaster than any they have ever looked upon.

TECHNIQUE AND DIPLOMACY

The question naturally arises, "How is all this done?" To tell the truth, it is a real job, not merely from the technical angle, but also because the human equation enters to a very great extent. Ordinarily, in the studio of a broadcast station whence well-known stars are put on the air, it is very seldom that more than one appears on the same program. But in the theatre it is entirely different; for there may be as many as five or six stars or featured players in the one production. It is natural that the radio audience is anxious to hear as many of these well-known actors and actresses as possible; and the broadcasters are just as anxious to give their audience what it desires.

Here it is that the much-discussed "artistic temperament" comes to the fore and causes trouble to the arranger of the broadcast program. One star refuses to follow some other in the radio arrangement, because her name is in larger type on the theatre program and therefore she should be allowed to precede her rival on the radio program. But the other lady refuses to come after

Number One, because—and so on, *ad infinitum*.

However, the announcer and the "continuity man" are persons who would make the ordinary smooth diplomat appear as rough as a rasp. They have to be ambassadors of good-will to the Nth degree; for it is up to them to iron out the many difficulties that are bound to arise when temperaments clash. It is an interesting thing to note that, the bigger the star, the less trouble he or she gives the program arrangers. This has proved true in nearly a dozen of the plays already put on the air.

MYRIAD DETAILS TO CONSIDER

The continuity man, after witnessing a regular performance of the play, writes out the various announcements, descriptions and synopses necessary to give the radio audience an idea of what it is all about. Then comes one of the most difficult parts of the entire job—that of timing. Ordinarily, in a studio program, it is necessary only to have the grand finale occur on the even hour or half hour; but in a program of this kind, when the audience is taken from the front of the house to a dressing-room studio and back again, twenty-five times, the entire broadcasting must be timed correctly to the minute. Otherwise, someone will not be able to sing or a number will have to be cut short. In fact, during the broadcasting of "Just Fancy," one of the principals was put on the air while making a change of costume, for that was the only time during the hour that he was off the stage.

An inconsistency that has been found in actors and actresses is that, in many cases, they are afraid of the microphone. It seems very strange that actors, who daily face hundreds of people in a theatre, should have such bad cases of "mike-fright." In fact, next

to temperament, the broadcaster's worst enemy in the theatre is this peculiar kink. One actor expressed his opinion that the reason for this reaction is the fact that, when speaking or singing into a microphone, the actor, used to seeing how the audience was reacting to his "stuff," could not know how his work was getting across. Doubtless that accounts for some of the very mediocre work put on the air by some of Broadway's favorite stage people; although in the main, this fright lasts only a little while.

For a week before the broadcasting the technicians haunt the theatre, deciding where the many necessary microphones will be located; where the backstage studio will be placed; the best position for the announcer, so that he will be in touch with both the stage and studio; the best way to run the power lines and all the other numerous little details that are bound to crop up in each installation. For example, in the Casino Theatre, from which the musical play, "Just Fancy" was recently broadcast, the studio had to be located in the basement next to the boiler room. This, though not ideal from the viewpoint of temperature, was yet excellent for acoustical purposes, and that, of course, was the main consideration.

Perhaps the most important problem for the engineer is the choice of the locations for the microphones about the stage. It must be remembered that these instruments must be so placed that they are not visible to the audience in the theatre and yet so that, no matter whereabouts on the stage the action is taking place, one or two microphones will be in the vicinity to pick it up. Sometimes as many as fifteen microphones are scattered about the stage and in the orchestra pit. These do not include the "mikes" for the studio and the announcer.

CELEBRITIES APPEAR

One of the outstanding programs from Broadway was the broadcasting of a portion of the second act of Florenz Ziegfeld's world-renowned *Follies*. This took place on the evening when Mayor James J. Walker of New York was being welcomed back to his native Broadway on his return from Europe. The very appropriate stage setting was a reproduction of the steps of New York's City Hall, where all visiting celebrities are welcomed officially by the Mayor. Eddie Cantor had the role of the Mayor and his Committee of Welcome was made up of the most beautiful specimens whom Mr. Ziegfeld glorifies so well. Cantor first welcomed the heavy-



Graham McNamee announcing from a stage box at one of the theatrical broadcasts.

weight boxing champion of the world, and then the spot-light was thrown on Gene Tunney, who was in the audience. Then a channel swimmer was welcomed, then a European queen and then a crowd of transatlantic flyers. To each a key of the city and a medal were presented. Last, but not least, the actor-mayor pinned a medal on himself, saying he had just returned from Europe. Then the radio audience had the pleasure of listening to the real Mayor of New York make one of the witty speeches for which he is famous.

Another remarkable broadcast was that of *Just Fancy*, given from the stage of the Casino Theatre, which is one of New York's oldest playhouses. Mrs. Thomas Whiffen, the octogenarian actress, who has been on the

stage for sixty-five years, said in her talk to the radio audience that she was at that moment fulfilling one of her two lifelong ambitions; the other one being to go up in an airplane. Shortly after the termination of the hour's broadcast, an airplane company in the vicinity of New York called the station on the phone and asked them to inform Mrs. Whiffen that she would be taken for a ride in one of their planes at any time she so desired.

Needless to say, broadcasts of this nature have a tremendous popular appeal. Approximately seventy-five thousand letters of commendation have been received by the stations through which the "Old Gold" hours have been put on the air. These letters are all interesting and are from people in all walks of life; from all parts of the United States and Canada. Portions of some of them follow:

"Words can hardly express my keen enjoyment of the broadcasting of *The Circus Princess* last night," writes M. L. G., of Halifax, Nova Scotia. "The songs and music direct from Broadway were a revelation to me, as I have not heard the like since I made my last visit to New York in 1905."

"The broadcasting of Ziegfeld's *Follies* the other night brought tears to my eyes," wrote an old *Follies* Girl. "I am out here on a farm, seventeen miles from the nearest railroad station, and it's been eight years since I last saw the curtain go up on a Broadway production. My heart went almost as fast as it did the first night I danced behind the 'foots' as a *Glorified Girl*."

From Vancouver, E. T. writes, "I have read many stories about theatrical life on the Great White Way, but I never expected to actually hear one of the plays. You can not imagine how much we all enjoy your broadcasts. Please give us lots more musical comedies."

"I am an old actress who played with Mrs. Thomas Whiffen more than forty years ago," runs another of these letters, "and when I heard her speak from the Casino Theatre last Saturday night I felt as though I was once more face to face with her. Your theatrical hours are very well done."

And thousands more of letters along the same lines.

There is no doubt that people like to go to the theatre by radio, if it is impossible for them to go see the play in person. This manner of putting Broadway on the air is most assuredly bringing the utmost pleasure to thousands of radio enthusiasts; and above all to the many shut-ins who, because of illness and infirmities, cannot visit theatres in person.

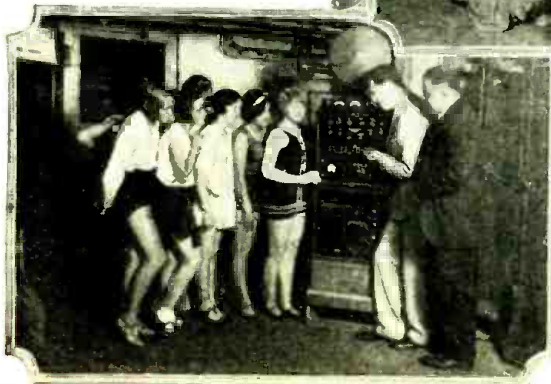

Above, Graham McNamee is explaining to the artists the position of the microphone in the footlights. Left, a control board, backstage, by which the radio audience is switched from "out front" to the impromptu studio and back. Right, six of the famous "Follies" beauties surrounding Eddie Cantor (left), and Leslie Joy, announcer (right), at the "mike." (Lucky fellows!)



A CENTRAL CLEARING HOUSE OF APPLAUSE

Editor, RADIO NEWS:

I was very much interested in the article in the November issue under the caption "Applause." The artists and sponsors of these marvelous free concerts certainly are at least entitled to know that some sets have been tuned to their frequency while they were broadcasting. I know how they feel after finishing an unusually fine piece of work to be greeted with only silence. It is like a prayer without the "Amen." The applause following a number is as much a part of the rendition as the music itself. We applaud them—many times literally clap our hands, but they cannot know it. On the other hand, in a moment of enthusiasm I have grabbed a piece of paper and written such a glowing appreciation (which, of course, cannot be answered or even acknowledged) that, after it was mailed and I was back to normal, I felt the recipient would think me a complete idiot.

Most people are fair and would like the broadcasters to know that their efforts are enjoyed, but unfortunately, most people are lazy, mentally and physically, and writing to a station is one thing that don't have to be done. Also, most radio sets are owned and operated by men, and men are notoriously poor letter writers. The women, no doubt, would write, but they feel that it's something they have nothing to do with—the man of the house tuned in the concert—it's his set—let him write.

Do you think this plan worthy of consideration—its principle being to make applauding much easier, so that the inherent desire which every listener feels to applaud, will produce the slight effort necessary to accomplish it? My thought is to have the broadcasters establish a central bureau or clearing house for receipt of mail from listeners. Then have printed cards with the address also printed, such cards to be distributed through the trade in such manner that they would be available in sufficient number for all set owners to have a supply to keep right at the set. Have the card so printed that the information desired by the broadcaster can be furnished with a minimum of effort on part of the listener—for instance, space for station letters, time, date, program, fair, good, excellent, and possible condition of weather affecting reception. Maybe, also, kind of set. Perhaps, also, the large number of cards distributed to large cities might justify printing name of city. Then the announcers could ask that the card be checked and mailed. Even if the listener did not take the trouble to sign it, it would still have a value to the station. Such plan would leave the listener only the trouble of a few pencil marks and the slight expense and trouble of mailing, and I believe that a sufficient number of people would take care of this to make the plan of value. Of course, it would cost the broadcasters some money; but they would be getting a return for their expense, which is very much desired.

One thing seems certain—the problem will have to be approached from a standpoint of standardization. Things that everyone does are popular for no other reason. If some such plan were worked out and drilled until

it got to working, probably the average set owner would not care to acknowledge that he did not, at least occasionally, mail the cards. Also, while there would be some clerical work involved, the tabulation of such cards at a central bureau might furnish facts that would go beyond the mere applause idea and be of value from a scientific and commercial angle as well.

As for myself, I do not just see what the

(No article published in RADIO NEWS for years has drawn such a flood of letters to this office, and most of them from people who have given the matter careful consideration. A large number suggested various prize offers, stamps, etc., which would undoubtedly draw replies, but do not answer the real problem—that of obtaining applause for the program's sake, by which its effect upon the radio audience could be best judged. A few extracts from other letters are given here. To publish all the good letters received would require a section, not a page.—EDITOR.)

A New Addition to RADIO NEWS

SINCE this magazine was established in 1919, it has become the most important in the radio field in this country, if not in the world. RADIO NEWS has been read, not only by the radio amateur, the set builder and the set owner, but by practically everyone who is interested in radio. More than 30,000 of these readers are radio manufacturers, distributors, jobbers and retailers. So great has been the growth of this circulation, that it has been found necessary to issue a trade section of this magazine, to be known as

Radio News Dealers Personal Edition

This section is for the radio trade ONLY, as its entire contents will be of interest to those who are in the radio business, but not to anyone who is deriving his livelihood from other activities. For this reason, it will not be put on sale at the newsstands, but distributed solely through the mail to the radio trade.

The publishers will be only too glad to send you, without charge, a copy of the new DEALERS PERSONAL EDITION, if you are a radio manufacturer, distributor, wholesaler or retailer. You can obtain it only by asking for it—ON YOUR BUSINESS LETTER-HEAD—and you are cordially invited to do so. See page 822 of this issue, and

WRITE FOR YOUR COPY NOW!

broadcasters are getting out of it, but they have my heartfelt gratitude for many hours of wonderful entertainment, and the artists surely know that, while they can neither see nor hear their audience, that audience is none the less responsive to their golden voices and marvelous skill. The irresistible tempo of the jazz time sets thousands of feet tapping, and the thrill of a soprano or the sweet song of the strings slips out of the studio with the speed of light, to reach the hearts of listeners all over the world.

R. R. SMITH,
Indianapolis, Ind.

FROM THE HEART

Editor, RADIO NEWS:

I have written many letters and have felt as if everybody would be laughing at me at the postoffice; and have often wondered what you do with the applause mail. Do you file it, or put it in the wastebasket? If we knew that they were filed, or that you made any use of them, I am sure that many more would write; but many people do not know that they help the broadcaster. The first I knew of it was by reading that article.

Why not broadcast that message and tell everybody what good these applause letters do? Most of us who write do so because we appreciate these concerts and wish to give our thanks; but many say "What's the use of writing? These letters are only thrown in the waste basket," so the majority do not write. I wish to suggest that a good way to insure billions of letters would be to stop all radio programs for a few days. Then you surely would be swamped. I surely am a radio fan, and, if my health were better, I would learn more of it and go in for salesmanship. Sincerely,

Mrs. M. SHORES.

231 Myrtle Street, Rockland, Mass.

(Few fans appreciate so well the wonders which our American broadcast system has made available; and, as excellent programs seem more and more an everyday affair, they are less inclined to write. This condition is not confined to America; we read the other day an interview with an English station director who remarked, that, when people accept radio as a matter of course, they cease to write. His station, with a large service area, averages about a letter a day, two-thirds appreciations. In England, however, listeners pay to support their stations; while in the United States they are asked only for applause. Surely, as Mrs. Shores puts it, a little silence would draw a great many letters.—EDITOR.)

FROM A SINGER

Editor, RADIO NEWS:

Mr. Sowers' article opened my eyes, as I hadn't thought of things that way. I have done a lot of singing in my time, and I admit that a full house and lots of applause always gave me a thrill; and the same thing applies to broadcast artists. They are singing and playing to an unseen audience, but they know nothing of the applause they get in the various homes, unless that applause is voiced by a written message of appreciation. I ought to say that I am only a novice in the ranks of radio fans, having only had

(Continued on page 798)



Ann Mack

*A product of radio
who has become a
well-known concert
soprano. - She has
sung on a number
of Atwater Kent
hours*

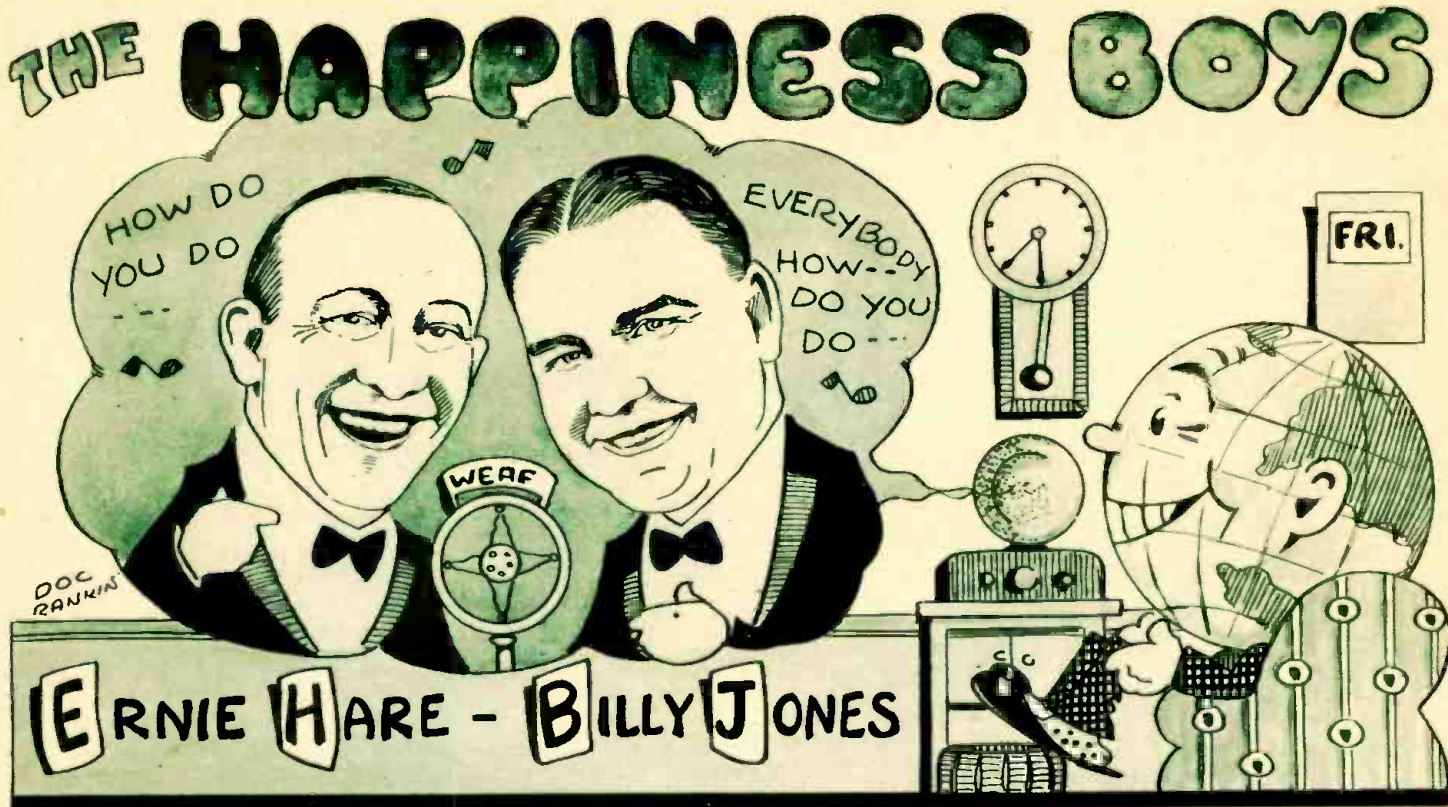

LIKE millions of other radio listeners in the United States, we have long enjoyed the Friday evening programs of Ernie Hare and Billy Jones. "The Happiness Boys," who broadcast from WEAF in New York and its associated stations under the auspices of a chain of candy stores. We have been asked by so many people about them and how they work, that we finally decided to seek out the "boys" and to get their own story from them. We felt that every member of the WEAF chain's audience would be interested in it, as Ernie and Billy are certainly one of the most popular teams that ever faced a microphone.

THE WORK SHOP

On the seventh floor of a huge Broadway office building we found the work shop of The Happiness Boys.

We were led into a private office, where Mr. Hare and Mr. Jones awaited us. It was, undoubtedly, just an ordinary office, con-

By LUCILLE HUSTING

taining the necessary desks, chairs, books, papers, and stacks of music in addition to a piano, but it seemed otherwise to us. Rain was pouring outside, it was dark and gloomy, but the office seemed filled with all the sunshine and cheeriness that our Broadway outside, was missing. The "Happiness Boys" certainly radiated all the joy and happiness that their name implies. They are two of the most invigorating personalities it has ever been our pleasure and privilege to meet.

We asked—first of all how their partnership was formed, just how they "got together;" for their work is indeed a perfection of showmanship and co-operation. They met, eight years ago, at a time when both were making phonograph records. Both boys were individually successful, and it was suggested to them that they "get together"

and record duets. They did and have been together ever since.

EARLY DAYS

Ernie Hare is a native of Norfolk, Virginia, and started his musical career in a Baltimore church. He then came to New York and appeared in ten Winter Garden shows; during which time he was continually making records. The early career of Billy Jones is very similar, as he too began his musical activities as a boy singing in a church choir. He also has been a "trouper," touring the United States with everything from minstrel shows to vaudeville and "legitimate" (dramatic) productions.

Mr. Hare recalled one of his famous "one-night-stand" theatrical tours, when he served as the company understudy. The first in the company to become ill and unable to go on for a performance, was the "female impersonator;" so Mr. Hare, duly dressed in feminine clothing, appeared as the fair
(Continued on page 814)

The Girl on the

A CLEAR trilling coloratura voice, that was once a regular feature on the air, is to return when the charming, talented Olga Steck will be a special feature in a Columbia Chain "Intimate Hour" early in January, according to Major J. Andrew White.

Miss Steck, who played the title role in *China Rose* and who has had a brilliant career as a prima donna in the *Follies* and many other Broadway successes, was one of the very first girls in radio. Back in January, 1922, when the radio was largely dominated by mere males, the extremely personable Miss Steck began her career, which was at that time sandwiched in between her Broadway engagements.

She was so widely beloved, and there was such a flood of protests when she gave up the microphone temporarily to fulfill her stage contracts, that a special series of 11:30 p. m. concerts was arranged for her, at



Cover - Olga Steck

which she sang after finishing her "in person" appearances.

Although one other girl appeared before a microphone prior to Miss Steck's appearance, Miss Steck claims the distinction of being the first to establish for herself a real air following.

Aside from the beauty of her voice and her charming manner of singing, Miss Steck possesses a knowledge of microphone singing which gives radio audiences the chance to hear her to best advantage. Her absence from radio, Major White decided, had lasted too long, and he arranged to bring her back as a special feature of the Columbia chain's "Intimate Hour."

Miss Steck's Broadway successes include her appearance as prima donna in *The Matinee Girl*, *Sue Dear*, *Little Jessie James*, *Ziegfeld's Follies* and *In Springtime of Youth*, and *China Rose*.

"Lopez Speaking"

By JULIA V. SHAWELL

ONE summer day when radio was young, when microphones were crude contraptions, mysterious and ugly, when studios were holes in the walls and announcers were a newly-discovered species, a young pianist-director went to the top of the Westinghouse building in Newark, N. J. and in the little booth that was then the WJZ studio sent out the first orchestral selection that the ether waves ever carried on a regular broadcast program.

When the last note died away, Thomas Cowan, the announcer, pointed to the microphone and said to the leader, "Tell them who you are." A good-looking, dark, sleek-haired young man, considerably flustered, floundering for words, emitted a tremulous:

"Lopez speaking."

He's been telling that to the world ever since. Those two words spoken by Vincent Lopez, in the desperation of his first and only attack of microphone fright, have made him an international figure. They are his trademark in a field that has made him famous. In the entire radio world, there is no better example of the result of fame grasped out of the air than Mr. Lopez. Broadcasting has lifted him from the ranks of promising musicians to a place among the best known orchestra leaders in the world.

And he has no hesitancy in placing the credit where it belongs. He knows that radio had a big part in his career and he was the first person to emphasize the value of broadcasting to an artist. There is no individual who has ever sent out entertainment from a metropolitan broadcast station who is more appreciative of what the program will do for him. He might break a professional engagement if it were necessary; but it would have to be something extraordinary to keep him away from the "mike."

THREE FIRSTS IN BROADCASTING

There are three high lights in the career of Lopez in radio. The first marked his introduction to the WJZ microphone, an event that was also the

mike's maiden meeting with a dance-orchestra leader.

The second epoch-making event was when WEAF ran a wire into the grill room of the Pennsylvania Hotel, and that station for the first time carried a program of dance music by remote control.

As broadcasting grew in importance and scope, the Lopez orchestra was the instrument of another experiment, serving as the first dance aggregation to be put on a chain of stations for a hook-up program.

Wherever Vincent Lopez goes, his voice is already there—and so are some of the most unusual correspondents in the world. There are thousands who write to many artists; but evidently there is something particularly friendly about the way Vincent says "Lopez speaking," since it draws an unusually heavy correspondence to the stations on which he is heard. In every state in the union maiden hearts have beaten a little faster when the well-known voice has gone out on the waves and in a thousand towns feminine hands have tried to pen some of their admiration captured by a voice. They sit at loud-speakers in all corners of the country and build up illusions around the oral personality that is the ethereal Lopez.

THE PURSUED OF ALL PURSUERS

Thousands of letters—commonly known

as "mash notes"—have been received by the National Broadcasting Company and marked "Lopez." The multitudinous mail he receives is from men, women and children; written from homes, hospitals and jails by people in all conditions and circumstances in life. These letters are to him a criterion of the reception his music receives from listeners all over.

Although reticent about this type of fan mail, the young orchestra leader would have one believe that it is just a passing comment from the listening public, as far as he is concerned. Confidentially, he gets a "kick" out of reading from Rosie O'Grady in Omaha that his voice "just thrills me every time I hear it." He doesn't want his friends to know it; but when some sweet young thing gushes over seven pages, worrying because his "voice-sounded blue last night," he sort of likes it.

These writers are rather unknown quantities, but their personal words of praise make them very real to Mr. Lopez. Thousands he has never seen, as many more he never will see, take a keen interest in what he says, how he says it; they want to know all about his life, they inquire about his likes and dislikes, they want to know him. And whether he tells you so or not, the fact that so many take enough trouble to make these inquiries is part of the satisfaction he gets from being a famous band leader.

Sometimes, in the most unexpected place, he comes across some young woman, who is one of this army of correspondents. One morning he was ordering breakfast in a restaurant of a small mid-western town where he and his boys were playing a concert engagement. While he was talking, something in his voice caught the attention of the waitress. She looked at him closely and suddenly remarked, "I know you. You're Vincent Lopez." When he admitted his identity, she blushed and stammered, "Did you

(Continued on page 849)



Lopez announcing before the microphone of WEAF



Vincent Lopez and his orchestra as they appear in Lopez' own night club in New York City.

Housekeeping by Radio

By MARY JORDAN

RADIO has brought cheer to thousands of hospitals; it has broken the monotony of days spent in isolation; it has taken the companionship of human voices to far-off places of loneliness; it has helped to educate children, given to workers new ideas in their jobs, filled colorless nights with colorful entertainment; but what it has done for the housekeepers of this country is one of the most interesting stories in the development of broadcasting.

Only the studio executives, who get the reactions of countless housewives, realize the far-reaching influence of even the most apparently insignificant advice and entertainment sent out on the ethereal waves from the metropolitan broadcast stations.

Radio has made a big culinary classroom out of the kitchens of America; it has made thousands of women students of housekeeping and homemaking. It has taken the deadening monotony out of keeping house and has broadened the vision and understanding of countless women whose back doors had formerly closed the whole world away from them. Women who know how to do things in the right way have told these housewives how; and the homes that have profited thereby are more than can ever be counted. Women who have accomplished much, in careers which have taken them into the outside world, have been an inspiration for the others whose homes and families have been their whole existence, for those who have found their careers in further the ambitions of their children.

THE GREATEST SCHOOL

Broadcasting has reached out in a practical way and has revised the whole household regime of more women than can be imagined. It is no exaggeration to say that the programs sent out especially for women listeners have given a new impetus in their daily work to those who have taken them seriously. Where schools are

unavailable and where new systems and ideas could never reach before, radio has carried help to women who needed it most.

Broadcasting in its particular appeal to the feminine home interests has broken down the confining limitations of the four walls of the home; it has given to myriad housekeepers a wider vision; and in many instances, as letters have testified, it has inculcated a new spirit of interest and efficiency in domestic tasks.

The importance of feminine interest in radio is acknowledged by every radio man-

One young wife followed a broadcast dinner menu; but it was a terrible failure; and her husband was so angry that he promised dire happenings.

manufacturer, in his efforts to make of receivers attractive furniture that will harmonize with the decorations of the home. But the broadcast stations know as fully radio's value to the women who already have sets in their homes, and the potential scope of future radio programs when millions more women have realized how much help they can snatch out of the thin air any morning when they choose to turn their dials.

LETTERS FROM THE HEART

The National Broadcasting Company, with WEA and WJZ as its "key" stations, in countrywide hook-ups, has received letters from the most remote cor-

ners of every state; some humorous, some eagerly inquiring, and some pathetic in the feeble, groping effort of their writers. Wives and mothers, who have sacrificed years to keeping and caring for their homes and raising large families, had cut themselves off from all outside contact, until the radio gave them a pioneering spirit in their own little fields. Women on farms, actually many miles from the centers of population and in spirit a thousand miles away from the urban activities of their sex, write appealingly for advice on how to sew, how to redecorate their homes, how to cook new dishes—how to do everything about which they hear on the radio.

Every other station has the same sort of mail. Mrs. Isabelle J. Turner, who books features on WRNY, was probably the first program director in the East who gave special attention to the feminine interest at the listening end. When WOR was first broadcasting daily programs, Mrs. Turner, as feature director, took famous cooks, well-known designers and household experts to the microphone and had them tell in a plain, understandable way about the new ideas that are simplifying and revolutionizing the routine duties of caring for a home.

Since that time the woman's programs have developed into an important feature on all broadcast schedules. Bertha Brainard, who is now eastern program director for the National Broadcasting Company, devoted her early service in radio to the feminine interests. Terese Rose Nagel, woman's director of WGBS, was another pioneer in this effort to reach the home women of the country through the medium of radio.

(Continued on page 828)



He had a night job and was taking care of his home and four children; it was a great thing for him to obtain practical ideas by tuning in to the first programs of the day.

Love in the Air

By A.M. Jones



"Good evening, lads and lassies of radioland. This is your Big Brother Ben speaking. And how are all my little lovebirdies tonight? I have a delightful little story for you this evening."

BENJAMIN F. Burt, newspaper reporter and chief announcer of the *Telegram-Press* radio station, twiddled his cigar nervously between two puffy fingers. The small alarm clock on his desk tinkled melodiously, indicating the arrival of six p. m., and so Benjamin gathered the microphone to his breast with a weary gesture. On his placid face was a pained look, and he shook his head sorrowfully. Above his bald head a tiny red light flashed on. Benjamin spoke into his desk phone.

"All right, Joe. Cut us onto the air."

The little light flashed again and below it appeared an illuminated sign which requested silence. Benjamin spoke into the microphone, his voice muffled to a warm, soothing baritone.

"Good evening, lads and lassies of radioland. This is your Big Brother Ben speaking to you. And how are all my little lovebirdies tonight?—Good, that's fine!—I have a delightful little story for you this evening. It is called the—er—"

He fumbled at the papers in his hand—what was the name of the darn thing? He chewed fiercely on his cigar—and then with the ready genius of the true radio announcer he rustled the papers before the microphone.

"Listen, kiddies," he said playfully, "and you may hear the rustling of the fairies' wings as they come to tell your big buddie the name of the story. Oh, yes, here's the darn—that is, the nice tale! It is called the "Three Bears." Now, once upon a time there were three bears. One was a big bear, the second—"

And he proceeded with the narrative of the various bears, meanwhile waving his cigar in unappreciated gestures and thinking to himself many dire things concerning the future destiny of the author who had devised those three characters of animal fiction.

Not always had Mr. Burt been a radio announcer. For many years he had been one of the most prized "leg-men" of the *Telegram-Press*. He was known as "Ben, the hard-boiled egg." Among he-men of his sheet he was a sort of tradition. Fat, good-natured, uncouth, unmarried, swearing, clever, hoofing newspaperman! That was Burt of the *Telegram-Press*.

When his paper had succumbed to the general fever for broadcast stations and had installed a high-powered set, Burt's boss had called him into the office.

"Ben," said he, "we've put in one of those radio stations."

"Well," said Ben sourly, "and what has that to do with me?"

"You are selected to be the chief announcer."

"The devil I am!"

"The devil, perhaps, you may be," admitted his boss, "but notwithstanding that characteristic they have picked you for the job."

"Um," said Ben. "What is the financial inducement?"

"Thousand a year more than you're getting."

"Um-hum. And what is a radio announcer, if I may ask?"

"Well, so far as I can make out, he's the guy that stands up behind the thumamajig and says, 'This is radio BVD, etc.' He introduces the singers, occasionally makes speeches, and generally messes around. A good announcer, I understand, ought to have a pleasing voice, a wide general knowledge of everything, and a fair amount of intelligence. Personal beauty does not matter."

"Thanks," said Benjamin coldly: "Well, since I seem to be the only one in this mess of news-jerking cubs who has any intelligence to speak of and a voice which doesn't sound like a raven after a severe attack of bronchitis, I guess I am the man for the position."

"I'm glad such a modest, unassuming chap is to get the job," observed the editor.

"Yes," said Ben equably: "It is nice, isn't it?"

That had been several months ago, but Ben was still a bit uncertain whether he liked this job of radio announcing. One thing he did know: this evening bed-time story telling was no cinch! If there was one thing that he detested it was the telling

of children's stories. And when you had to cackle to them about being their "Big Brother Ben!"

It being his job, however, he kept his pleasant voice through the episode of the various sized soup-plates, the chairs, and the beds; but it was with a genuine sigh of relief that he finally announced:

"And now, kiddies, it's time for you to trot off to bed and let mamma tuck the covers around your teeny-weeny toes. Your big brother has to go home, too. But he doesn't have any mamma or wife or anything to put him to bed! And sometimes he gets very, very lonely!" This last with a vast amount of pathos!

In reality he was thinking of the "Girly's Revue," which he was to review that night for his paper; but of course it wouldn't do to mention that to his little listeners. Not that they would understand precisely the nature of a "Girly's Revue"—but still, parents had an annoying habit of listening sometimes to the radio and then phoning in complaints regarding alleged attempts to pervert their dear infants' morals! And so, with a sigh of relief, he pushed the cut-off button and extracted from his vest pocket a fresh and very vile cigar.

At the same instant, in a distant portion of the city, one Ellen Johnson—sedate and capable cook for a private family—pulled the receivers from her ears and sat gazing at her little radio receiver with large, dreamy eyes.

"Big Brother Ben," she murmured. "What a very nice voice he has! And so he is all

(Continued on page 817)





Broadcaststatics



WHAT DID BILLY POSSUM SAY?
SON: "Where is that lady telling the bedtime story?"
DAD: "In the WXYZ Studio."
SON: "What is a studio?"
DAD: "A studio is like a small theatre."
SON: "Why do they make the children sleep in the theatre?"—*A. Taggard.*

*But there came a day, so the natives say,
 When he reached the end of his rope;
 And learned, too late, his financial state
 Was four times worse than broke.*

CLINKI CLINKI CLINKI!
ANNOUNCER: "This is KDKA, Pittsburgh."
NEW FAN: "What does he mean, payday in Pittsburgh?"—*Ona Campbell.*



AN EYE FOR BUSINESS
CRABSHAW: "I can't afford to buy you a radio set, Willie."
WILLIE: "It will pay for itself over and over again, dad. Just buy me one and I'll radio Santa Claus for the finest bunch of Christmas presents you ever set eyes on."
 —*J. J. O'Connell.*



*Then a maid found out, as she cast about
 For ways to wreck men's hearts;
 That a swell head-dress, as perhaps
 You'll guess, could be formed of
 radio parts.*

MANY HAPPY RETURNS
SANDY had borrowed a neighbor's set to surprise his wife on her birthday, and hooked it up, but it would not perk. At last he exclaimed in disgust, "What kind of a radio is this?"
"Scotch, of course," rejoined the aggrieved lady of the house: "You can't get anything out of it!"
 —*Mrs. E. H.*

A VOICE FROM NEXT DOOR
*"Now, Pa, you turn that football off,
 and tune in 'Styles by Lady Goff!'"*
 —*P. M. Leaver.*

BY THE BAMBOO TREES
A Zulu chief once courted grief. By owning a radio; for he bought a set that was geared to get ten thousand miles or so

*Note, it may seem queer, but a bright idea,
 Was born to the Zulu bold;
 For he opened a store on the ocean's shore
 And bartered his "parts" for gold.*

*So they crowned him king of the radio ring,
 With eight new waves to squeeze;
 While they fanned the groom with a golden plume,
 In his hut by the bamboo trees.*



—*Roy Coleman.*

A DEED OF DARKNESS
AN English set owner landed before the bar of justice the other day in the Southend police court, according to *Popular Wireless*. He was charging his "B" battery on the power circuit (current for which is cheaper than that for lighting) and had a lamp in the circuit as a resistance. On the facts, he was acquitted; but supposing he had been reading the programs when the constable entered!



*And what he heard so tickled this bird,
 In his hut by the bamboo trees;
 That he'd buy on sight with a rare delight,
 All kinds of accessories.*



*And his wifely crew of thirty-two
 Were forced to pawn each trinket,
 While he took a look, in a shady nook,
 At the book on "How to Sink It."*



*For parts in bales, came over the trails,
 Consigned to this woolly young gent;
 While the wives stripped down to a dismal frown
 To furnish the money he spent.*

THIS page is devoted to humor of purely radio interest; and our readers are invited to contribute pointed and snappy jokes—no long-winded compositions of an original nature. For each one of this nature accepted and printed, \$1.00 will be paid. Each must deal with radio in some of its phases. Actual humorous occurrences, preferably in broadcasting, will be preferred. Address Broadcaststatics, care **RADIO NEWS, 230 Fifth Avenue, New York City.**

TWO DOLLARS, PLEASE!
DICK: "What station do you listen to most?"
VICK: "The service station."
 —*Albert T. Jackson.*

STATIC?
HARRY: "Isn't that pretty good music for a simple hook-up?"
CARRIES: "Oh, I suppose, but I wish you would do something to eliminate that simple hic-cup."
 —*Gleason Pease.*

CHAIN BROADCASTING IN SCOTLAND
"The Aberdonians have given up buying eggs. They now send the shells to the B.B.C. and have them relayed."—*Daily Mirror, London.*

WHAT THE W. D. SCORER WILL WEAR
ANNOUNCEMENT from the WEAF broadcast of the Harvard-Dartmouth game on October 22nd:
 "The official scorer or announcer—Mr. Humphreys, no doubt—is wearing a red sweater, a white cap and white shoes." Chilly costume for a fall day, say we.
 —*Harry Weinstein.*

RADIO RHYMES.



WHAT DO THESE DOTS AND DASHES MEAN THAT RIDE THE ETHER WAVES UNSEEN?



OUR HERO STARTS TO LEARN THIS MODE OF DISCOURSE BY THE WIRELESS CODE.



AND IN FIVE MINUTES TIME, ABOUT HE KNOWS THE WHOLE THING INSIDE OUT!



AND NOW HIS KNOWLEDGE HE WOULD MATCH AGAINST A NAVY YARD DISPATCH!



Making the Whole House Talk and Sing



Novel Experiments Easily Performed with a Loud-Speaker Unit

By KNOX BAXTER

ALTHOUGH comparatively few people realize the fact, loud speakers may be created in many forms other than the conventional cone or horn types. By the application of a powerful speaker unit, many common objects may be made to sing and speak with reproduction nearly as faithful as that obtained with regular speakers.

If the theory of loud speakers is briefly reviewed it will be readily seen that there is no reason why various materials, generally thought to be very solid, cannot function as reproducers. In the horn speaker we have an electrical driving unit, magnetically coupled to a small diaphragm which vibrates the air column confined in a horn. In the cone speaker an electrical driving unit is coupled mechanically to a diaphragm of large diameter. In this case no horn is used, the entire mass of unconfined air surrounding the diaphragm being moved. It can be seen that the essential difference between the horn and cone speakers is a me-

chanical one. In one case, the speaker is coupled to the air through a horn, and in the other through an oversized diaphragm.

The volume of air moved depends primarily on the size of the diaphragm, and the intensity or loudness of the sound is dependent on the distance through which the diaphragm vibrates. (For example, a cone loud speaker, such as that developed by Rice and Kellogg, has only a six or seven-inch diaphragm; but when large amounts of power are employed the diaphragm will vibrate as much as a quarter of an inch.) Therefore, if we select for our diaphragm an object having a large area, such as a floor, a door, or a window pane, etc., it will vibrate through a very small distance; but, the vibrating area being so great, a large mass of air will be set in motion.

EXPERIMENTS WITH A UNIT

In order to test some of the suggestions that are depicted herewith, a powerful loud-speaker unit such as that ordinarily used for driving a cone speaker should be used; as it must be coupled *mechanically* to the several objects. It is a good plan to mount the unit on a slab of hard wood, slightly larger than the unit itself and at least an inch thick. An extension cord should be connected to the unit, so that it may be moved to different parts of the house without disturbing the receiver.

Many of the installations shown will provide a good deal of amusement, as in many instances it is impossible to tell the direction from which the music is coming. If the unit is pressed against the ceiling of the cellar and held in position, as shown in Fig. A, the floor of the room above will act as a diaphragm, providing music of good volume: that is, of course, assuming that sufficient power is supplied to the unit. A
(Continued on page 840)

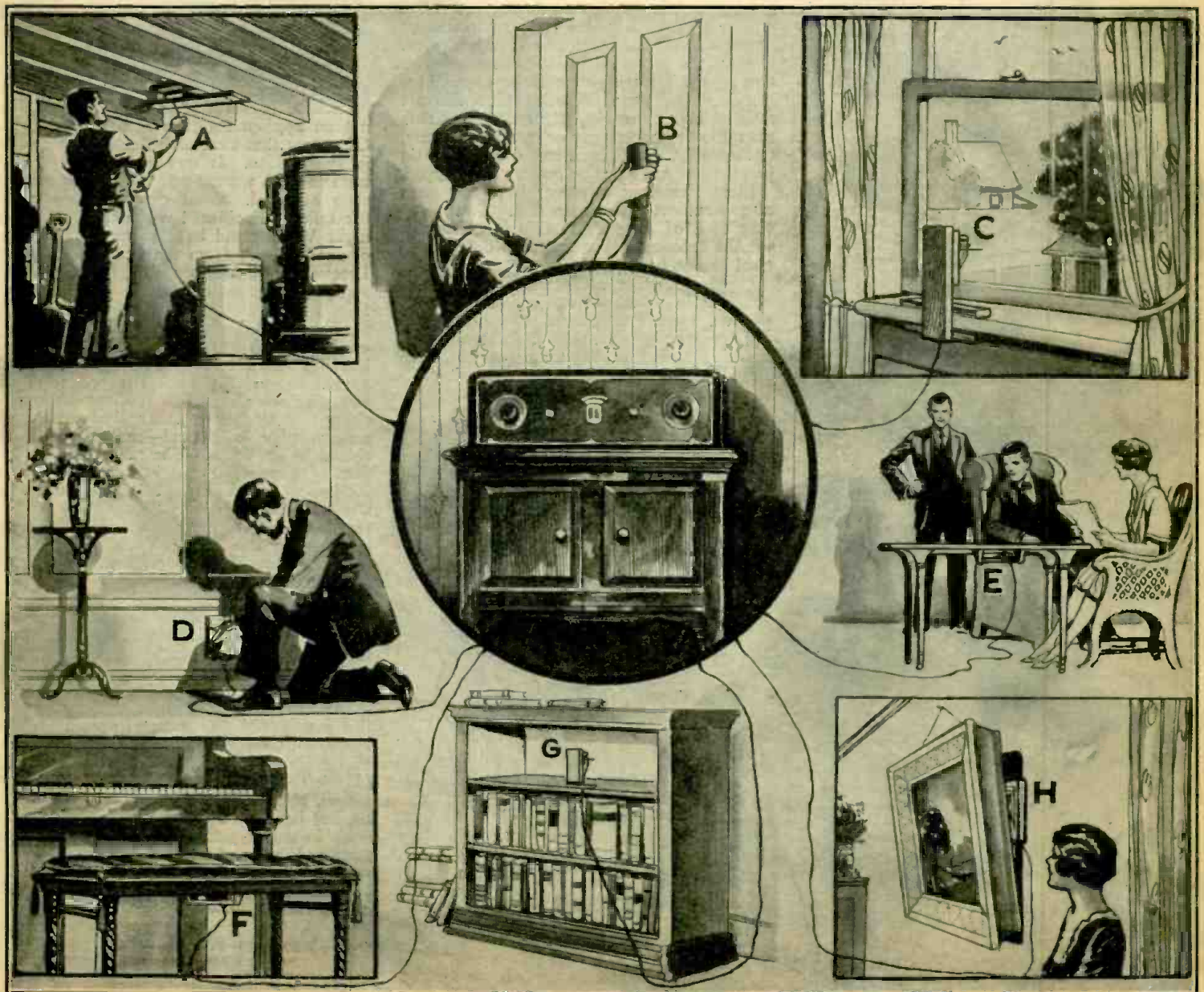

Different methods of utilizing structural portions of the house, or pieces of furniture, as loud speakers are illustrated here and can be applied by anyone possessing a loud-speaker unit suitable for driving a cone speaker.

Shall there be a A Debate by Radio, Broadcast

Freedom of the Air for All Opinions—A Plea for Fewer Restrictions

THERE are over six million receiving sets in the United States, and the radio audience is well above twenty-six million. When the radio bill of 1927 was passed, there were 730 broadcast stations. The industry serving radio is vast, the wealth involved therein stupendous; furthermore, radio will continue to grow, and probably change the course of its own development many times during the next few years. It is a powerful medium of mass appeal, uniting all of the United States, and connecting us with Canada, Alaska, Central

**By Rep. EMANUEL
CELLER***

and South America, and with many of our insular possessions.

It is an activity as sensitive as the movement of a tiny Swiss watch, yet transcendental as the ether which is its medium. It is a vehicle of education, entertainment, commerce, diplomacy and national defense. Photogram and television are its handmaidens. It has many unlocked secrets. The art of radio is still in its infancy. It must, therefore, be permitted to grow with as little unnatural and legislative interference as possible.

But this does not mean that radio broadcasters must be a rule unto themselves. They are on trial. They will have an avalanche of regulation from congress if they do not conduct the operations of their stations with due regard for the public interest, and in a spirit of fair play. Whether the radio art is in its infancy or not, whether the business of radio is stupendous or small, congress, undoubtedly, will legislate unless certain practices of radio station owners are stopped.

Most European countries have a system of government radio censorship. To me, the very idea of state censorship is abhorrent, yet the broadcasters seem to be doing their level best to bring it about.

Quite a number of incidents have lately occurred in broadcast stations, which have shocked us out of our usual complacency, and have provoked much thought and discussion and, indeed, in certain quarters, have induced the demand for public censorship.

CENSORSHIP OF POLITICAL EXPRESSION

Permit me to relate a few of these instances:

(1) A Smith College professor was compelled to delete a part of his address in criticism of the government in its Near East policy;

(2) The General Electric Company refused to permit President DeValera to broadcast from KOA at Denver, because portions of his talk were anti-British.

(3) Norman Haggood was refused the opportunity of replying to William J. Burns;

(4) Mrs. Mary H. Ford recently spoke at a dinner given as a farewell to Mille Gade Corson, who departed for Europe to swim the English Channel again. Mrs. Ford expressed her admiration for Mrs. Corson and rejoiced that she came from Denmark, a country of peace; the speaker then made a pacifist argument against war. To her discomfort WGL then cut her off from the radio audience. The station manager explained that while he believed in free speech, he hushed her talk because, he said, it was not an appropriate time for such remarks. Of course that kind of belief in free speech is Pecksniffian. It was in exceedingly bad taste to cut a woman off. It showed a timid state of mind. What especial harm could her talk on Pacifism have done? The next night WGL could have procured a battery of spell-binders from the National Security League, to dilate upon the glories of war, and thus have neutralized the effect of Mrs. Ford's talk;

(5) WEAF was deterred from broadcasting the play "Spread Eagle." WGL likewise failed to broadcast it after it had agreed to do so. Thus the producers of this play were denied a medium of advertising that is open to other producers. Suppose a play is radical—surely, that side should be set forth. The radio should play fair. Otherwise it will in time lose its effectiveness as a means of free discussion of any important question. "Spread Eagle" has for its text the sordidness of war, and shows how a war with Mexico could be promoted to serve the selfish ends of a millionaire oil producer. Conceding, but by no means admitting, that the play is false—what of it? Cannot other material be sent over the air to counteract its effect? But the play is not false. It is true, it ought to be broadcast. The public should not be denied the pleasure of hearing it;

(6) I was censored by a dull-witted station manager at WEAF and prevented in a speech on George Washington from quoting Mark Twain's facetious remark that he (Mark Twain) was a better man than Washington, because Washington could not tell a lie, but he (Mark Twain) could, but would not. In other petty ways my speech was tampered with and changed by one who knew no more history than a cow, and whose knowledge of Washington was limited to the cherry-tree myth.

DEMAND FOR GOVERNMENT REGULATION

These examples of censorship are now everyday occurrences. They present a problem that must be solved.

(Continued on page 831)



* Tenth Congressional District of New York, Brooklyn, N. Y.

Radio Censorship?

from Station WRNY, Nov. 9, 1927

Consider the Radio Public's Rights Against the Pressure of Propagandists

A RADIO broadcast station does not differ very materially from a newspaper; but in the very nature of things, it must be understood at once, there are different types of newspapers, just as there are different types of broadcast stations. There are first-class newspapers with a character, and there is the yellow press. There are broadcast stations with a lofty purpose, and there are, among the smaller fry, irresponsible stations.

Congressman Celler admits, that like every newspaper man, a broadcaster must edit what goes out on the air—but what, after all, is editing? Is it not a form of censorship? It will be found by the most superficial observer, that a great metropolitan newspaper, for instance, censors a good deal of copy. Thus you will find that the "tabloids" of New York City use a good deal of scandalous and sensational copy. This material is presented also to the other and more serious papers; yet our great metropolitan dailies use very little such copy. In other words, the editing has become censoring. Not every divorce case, not every unsavory bit of scandal, not every minor political talk is published by our great dailies. It is the editor who determines what sort of material is fit to go to the readers.

A radio station closely parallels a newspaper in this respect. The greater and more important the station, the less likely it is that such a station will broadcast questionable material. Like a newspaper editor, the broadcaster must know, and does know, what will be acceptable to the radio audience and what will not. It is admitted that, once in a while, a broadcaster makes a mistake and uses poor judgment in refusing to broadcast certain talks. It is also a fact, that such censoring is by no means as frequent as it used to be. For one thing, broadcasters are becoming better educated. Second, through long experience, they are finding out—little by little—just how far they can go, one way or another.

But the broadcaster has a far more difficult time of it than the newspaper; for, in the very nature of things, he does not always know in advance *exactly* what is to be broadcast. Not every talk can be submitted in advance. For instance, most banquets cannot secure all the speeches in advance, and they are certainly not always as submitted. Some speaker may start in making remarks that seem to the broadcaster to be offensive to the radio audience; and for this reason it has happened that a talk has been curtly cut off the air. But, and I emphasize the fact, this happens very rarely. It happens even with newspapers that the first edition will sometimes carry certain news matter which, on second thought, after the attorney of the newspaper has seen it, will be missing from all the subsequent issues of the same day. Yet there is no talk of forcing the newspapers to publish anything and everything that is submitted to them. Why, pray, is a broadcaster different?

INTIMACY OF RADIO

Then, on the other hand, a most important factor which a broadcaster must consider is that he goes right into the very sacredness of the home, into the privacy of a lis-

By HUGO GERNSBACK*

tener. A man may read a newspaper and get a certain reaction, but if the self-same language is broadcast in a private home, where the entire family is assembled, there is immediately a huge difference. For one thing, there may be children about for whose ears a particular talk is not meant. If the broadcaster has any idea that the matter is not fit for broadcasting, after it has once started, he has no other recourse but to cut off the rest of the talk; discourteous as this action may seem, and, as a matter of fact, is. The broadcaster feels, however, that he has no other choice in the matter. But, I repeat, that such cases are extremely rare.

Then again, censorship is often largely a matter of opinion. If this were not so, every large metropolitan daily would print exactly the same news as every other one; but a survey will show that no such thing ever happens. One daily may publish a piece of news that another one does not think fit to print and vice versa. Why expect that the radio broadcaster should be more expert than the experienced editor of a great newspaper?

Congressman Celler presents a number of cases denouncing certain stations for mis-using censorship. It should be noted that, as I said before, just as there are good newspapers and good broadcast stations, there are poor newspapers and poor stations—newspapers with unwise practices and broadcasters with unwise practices. These we will have with us always, even though congress should enact a law for censorship; which, in my humble opinion, I doubt very much can ever come about.

Congressman Celler says that the broadcaster has received a franchise and that the operations over his station are not unaffected by public interest; that consequently, the pub-

lic cannot be hornswoggled out of its rights in that regard, and these include the right to hear both sides of the question, as well as the right to hear the truth, no matter whom nor how it hurts.

I doubt very much whether the public is interested to hear both sides of every question; particularly, when the question in the first place is not fit to be broadcast, because it holds no general interest. Newspapers do not always present all sides of a case, if the matter is not of sufficient interest. I know of no first-class station in the country that will not gladly broadcast both sides of any question, providing it is of sufficient

(Continued on page 833)

—And everyone has also a right of equal importance — not to be compelled to listen to unwelcome expressions of sentiment.



* Editor of RADIO NEWS, President of Station WRNY, New York.

Radio Novelties At Home

In Broadcasting and Short-Wave Transmission

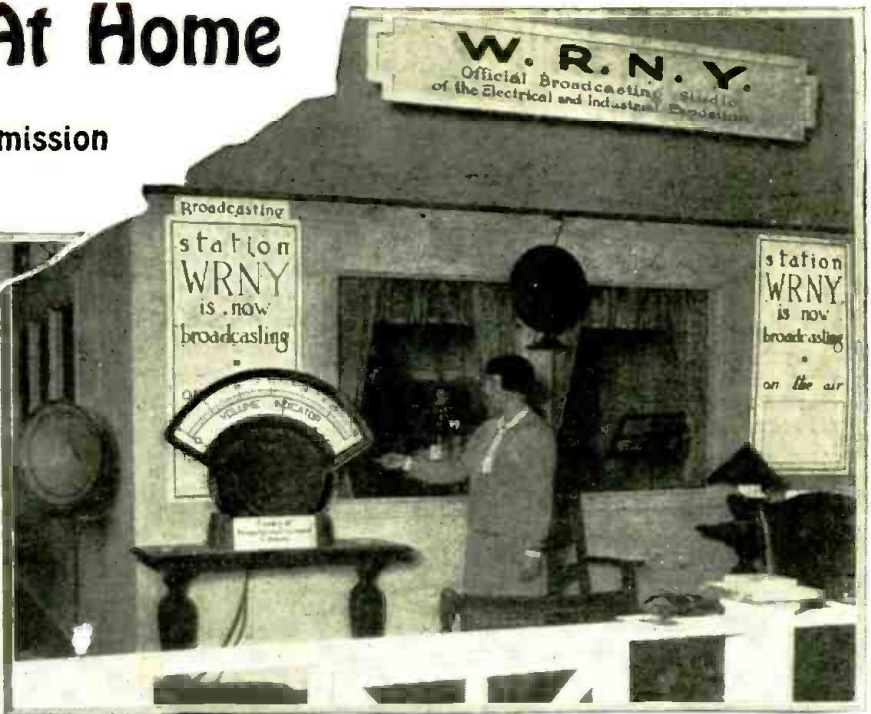

During the recent Electrical Show at the Grand Central Palace in New York City, station WRNY broadcast from the studio on the third floor of the building. The giant milliammeter shown at the left in the upper illustration was connected in the microphone circuit of the transmitter of WRNY and attracted a great amount of attention, as the needle would vary with every sound made before the microphone. At the left is shown Hugo Gernsback, Editor of RADIO NEWS, broadcasting a lecture on unusual noises before the microphone in the Grand Central Palace studio. Joseph Kraus, Field Editor of SCIENCE AND INVENTION, is seated before the table preparing the special microphone which was used to broadcast the noise made by fishes swimming in the bowl. James Maresca, engineer of WRNY, is in the background.

On October 21, Thomas A. Edison gave an interview, which was broadcast over the Red and Pacific radio networks from Edison's library. Left to right: J. W. Lieb, New York Edison Co.; E. W. Rice, Jr., honorary chairman of the board, General Electric Co.; Mr. Edison; G. F. Morrison, vice-president, and Gerald Swope, president of the General Electric Co.

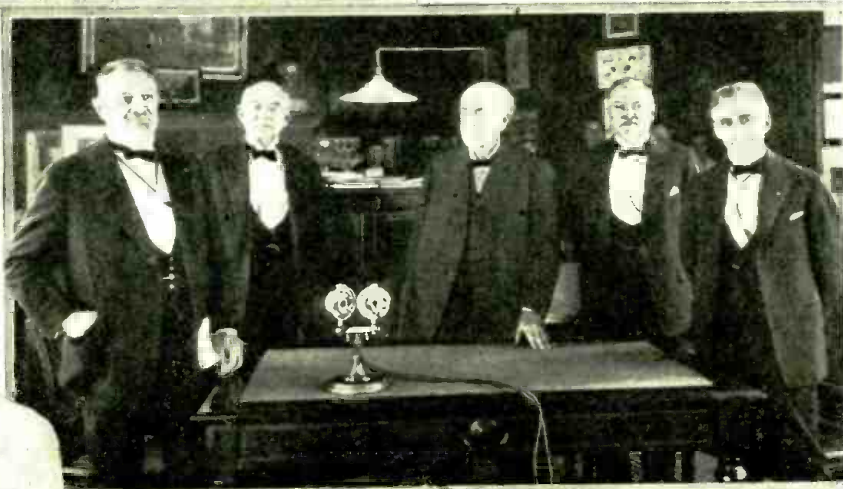

One of the most interesting studies that the engineers of the General Electric Company have undertaken is that of transmission and reception of radio signals on ultra-short wavelengths, in the order of five meters. It has been found, during the experiments, that radio waves at these high frequencies behave more nearly as do light waves, in that they tend to travel in a straight line. Therefore, in order to transmit a message on this wavelength over a distance of thirty miles, it was necessary to construct a transmitter that could be raised to the top of one of the masts—about 75 feet high—at the South Schenectady experimental field. The wavelength of the set can be regulated from the ground, by means of the cord shown, which operates a pulley to which is attached the shaft of the variable condenser. The leads for the necessary power supply may be seen in the illustration at the right, also the antenna system, which is about six feet long. In the illustration at the left is the five-meter receiver, in which are used N-tubes, a detector, and a stage of audio-frequency amplification. Signals were heard when this receiver was located on top of a hill with the transmitter in sight; but, as the receiver was carried down the hill, the signals became fainter, and finally faded out altogether, when the bottom was reached and the transmitter out of sight.

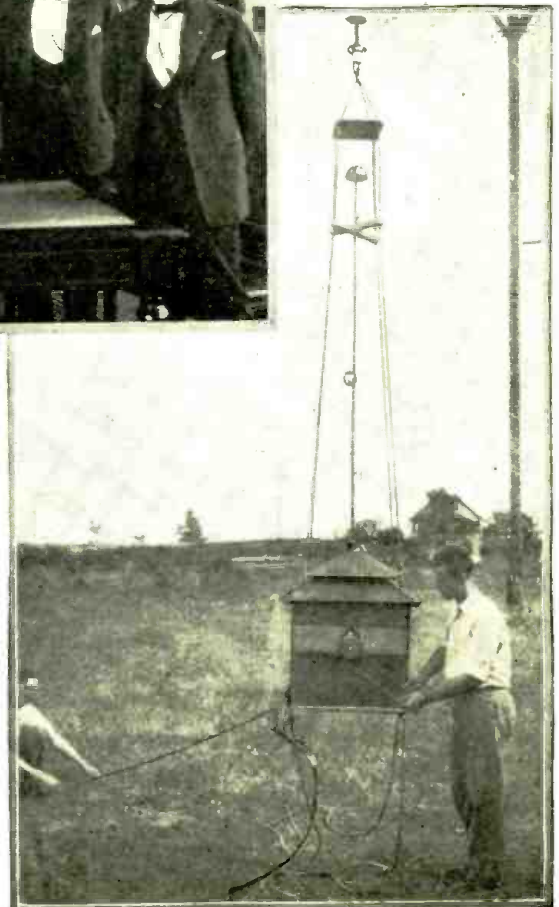

-AND ABROAD

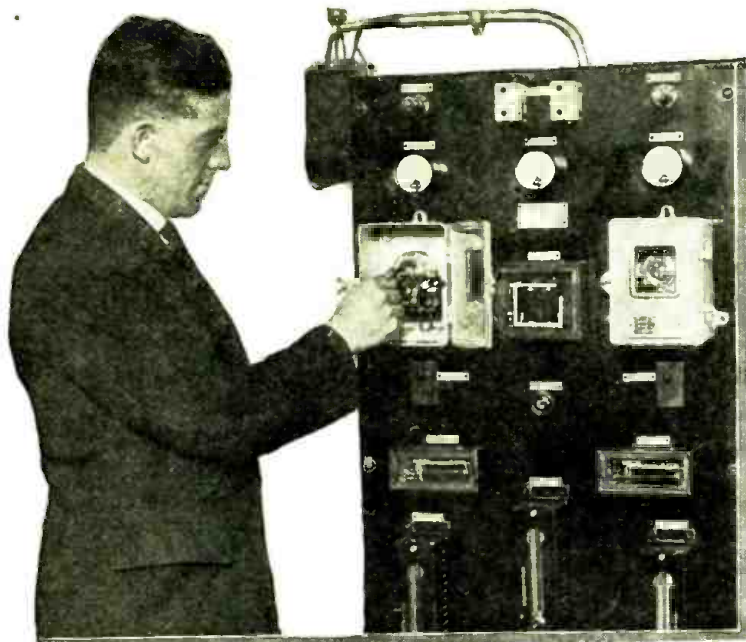

© P. & A. Photos.

The only attention that the automatic receiver (above) needs is the winding once a fortnight of two clocks, which takes but three minutes. It is these clocks which are a marvel of ingenuity, that control the switching on and off of the receiver.

In the Lambeth Hospital, Kensington, London (England), has been recently installed a radio receiver which is entirely automatic in operation. This has been installed so that the patients can enjoy the broadcasting; and, as this has a certain curative effect, two birds are killed with the same stone. Physicians, to a great extent, have agreed that if the minds of patients are kept occupied on something other than their ailments, their recovery is almost certain to be more rapid. The hospital's officials can address the 1,400 inmates simultaneously by the use of a microphone in the hospital office; and all sorts of programs can be received by all the patients, for there are 400 pairs of 'phones and 67 loud speakers. Several times as many could be operated, if so desired.

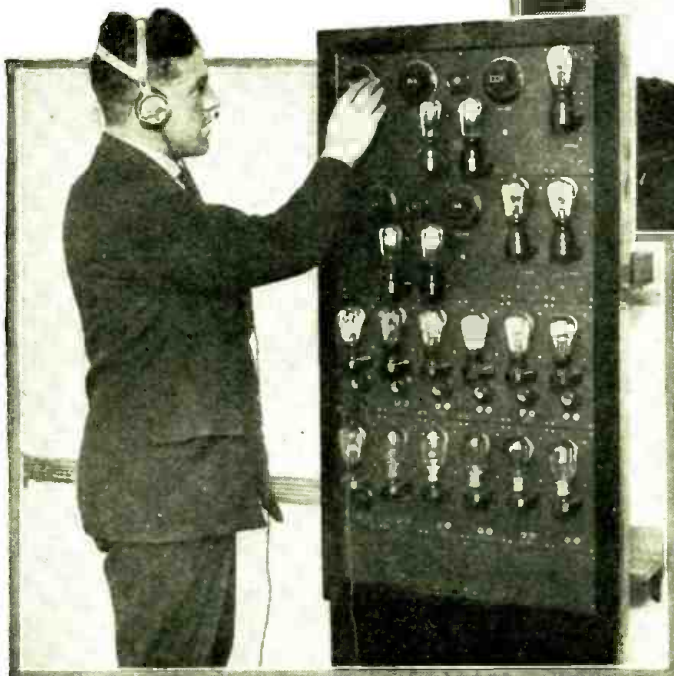
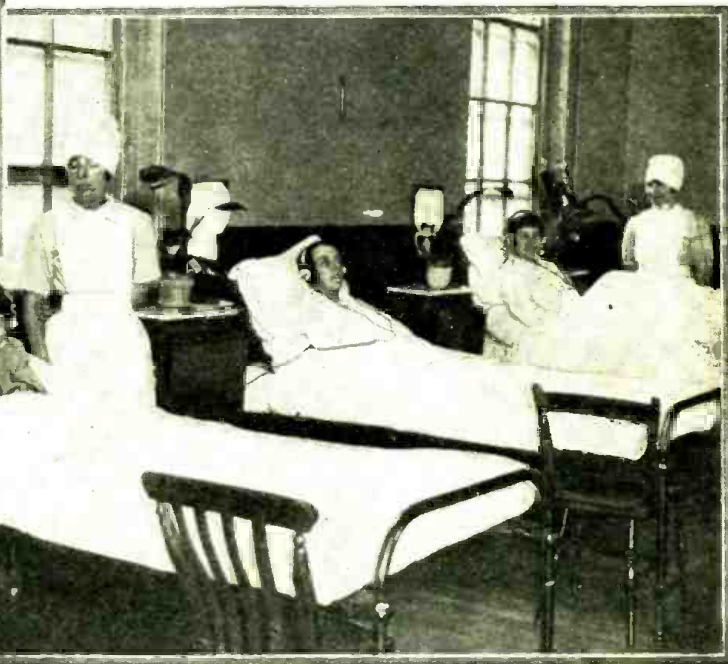

Incorporated in this automatic receiver are the two sets of dials shown at the left, which are turned to receive the programs of the Daventry and London broadcast stations. The cost of the whole equipment was about \$7,500.

Below is the control room of the Chinese station XOL, revealing the cosmopolitan nature of the radio material selected for its use. European and American radio apparatus are rivals for favor in the awakened East.

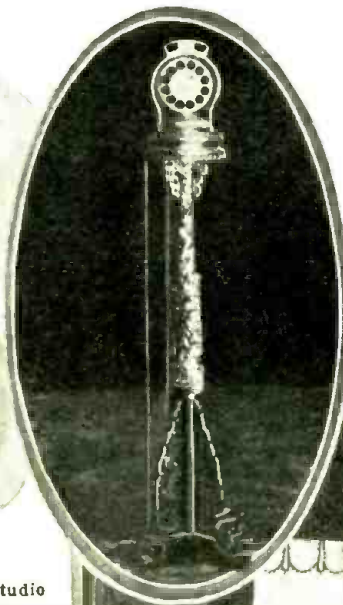

Broadcasting in China, so long restrained, has leaped to the front. The Chinese government has established a station at Tientsin, near Peking, which has been given the call letters XOL, and broadcasts on 480 meters. Its power is 500 watts. At the left is shown the sumptuously-decorated microphone stand in use in its principal studio, a picture of which is also reproduced below.

Right, the studio of XOL. There are now but three stations in North China, but additions and a great field for radio apparatus are to be looked for in the near future.

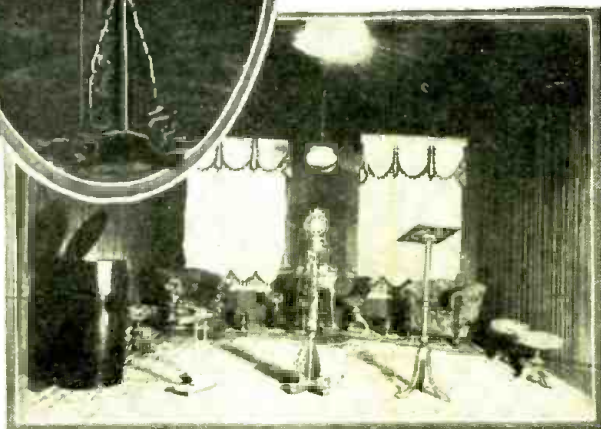

The Problem of Synchronism in Television

A Description of the Method which has been Adopted in John L. Baird's Apparatus

By A. DINSDALE

ONE of the greatest problems of television is that of securing and maintaining *synchronism* between the transmitting and receiving mechanisms. In phototelegraphy, as distinguished from television, the problem is relatively simple, for the speed of transmission is so very much slower that greater errors in synchronism are permissible. Also, as will be made clearer later, synchronism in phototelegraphy need only be carried out in what might be described as a single dimension; whereas, in television, it must be carried out, in a sense, to two dimensions.

In phototelegraphy the problem resolves itself into the rotation at precisely equal speeds of two cylinders, one at the transmitter and one at the receiver. Simultaneous starting can be effected by a prearranged signal.

The maintenance of equal speeds of rotation can be accomplished in several ways, the commonest being by means of electrically-operated tuning forks or clockwork-operated pendulums. Whichever system is employed, it is caused to send perfectly timed electrical impulses to the receiver, and at the receiver these impulses are caused to control the speed of rotation of the receiving cylinder.

At the end of the transmission of a picture, and before commencing to transmit another, the two remotely separated mechanisms can, if desired, be stopped and simultaneously restarted, thus ensuring that the receiving mechanism starts at the beginning, in step with the transmitter.

In television, however, both mechanisms are running continuously, and sixteen complete pictures are transmitted per second. Under these conditions it is possible that both mechanisms may run at the same speed and still the image will be incorrectly received at the distant receiver.

RESULTS OF IMPERFECT SYNCHRONISM

This difficulty has given rise to a common misunderstanding, prevalent even in technical circles, which, in turn, has caused the difficulty of synchronism in television to be, to some extent, overrated.

Quite commonly the statement has appeared that a difference of phase of only one per cent between the transmitter and the receiver is sufficient to spoil the definition of the received image. Were such a statement true, the problem of synchronism would indeed be one of almost insurmountable difficulty.

Fortunately, however, an analysis of the facts shows that if the transmitting and receiving mechanisms are out of phase the image is not blurred, but merely displaced; the clearness is not altered. The effect is that the image of a man's face, instead of being visible squarely in the center of the receiver screen, is displaced to right or left, so that his face appears to be cut off vertically, say, by the nose. On the other side of the screen the other half of his face is visible, also cut off by the nose. In the center of the screen his right and left ears will almost touch each other.

In phototelegraphy a similar effect would be obtained if, on starting the transmitting cylinder at the beginning of a picture, the receiving stylus were set, not at the proper end of the cylinder, but somewhere in the middle. If, when the recording stylus reached the end of the cylinder, it were to be lifted and set at the other end of the cylinder, the correct starting point, the result would be that the left half of the face would be at the right of the picture, and *vice versa*.

The distortion, or blurring of a television image is caused only by different speeds prevailing at the transmitter and receiver, that is to say, by lack of *isochronism*. The problem of isochronism is much simpler of solution than that of synchronism. Possibly these words are not familiar to readers, and it is not out of place to define them here.

ISOCHRONISM AND SYNCHRONISM DEFINED

When two mechanisms are said to be running in *isochronism*, what is meant is that they are running at the same speed, but are out of step. For example, two clocks which are running at the same rate would be in exact isochronism, although the hands of one might point to 2.30 and the hands of the other to three o'clock. To be in *synchronism*, the hands of both clocks must indicate exactly the same hour.

When the first efforts were made to achieve television, attempts were made to obtain isochronism by means of the methods used in phototelegraphy; *i.e.*, by means of pendulums and tuning forks. Such methods, however, do not lend themselves to television, for they are not sufficiently accurate.

By using synchronous motors, however, perfect isochronism can readily be obtained, and the mechanical and electrical arrangements involved are not so complicated as is the case with the other methods. It was with the aid of such motors that the first successful results in television were achieved by John L. Baird, the British inventor.

One of these motors comprises, essentially, an armature, or rotor, supplied with an alternating current, and a stator supplied with direct current. Or the rotor may be supplied with D.C. while the stator takes the A.C. The speed at which such motors run is dependent entirely upon the periodicity, or frequency, of the alternating-current supply, and upon the number of poles in the rotor or stator, whichever is receiving the A.C.

At first glance it might be supposed that synchronism between two television mechanisms could be obtained by using two exactly-similar motors, controlled by rheostats and run at exactly the same speed, as indicated by a form of speedometer. This can not be done, however, for ordinary electric motors continually vary in speed, due to small variations in the supply current and other reasons. This habit of variation is known as "*hunting*," and, before television can be successfully achieved, the hunting propensities of at least one of the motors must be brought under exact control. The task of the synchronous motor is to act as controller.

HOW ISOCHRONISM IS OBTAINED

At the transmitting end the image-exploring mechanism is driven by an ordinary electric motor, either A.C. or D.C., depending upon the supply available. Mechanically coupled to the same shaft is a small A.C. generator. The periodicity of the output of this machine may have any convenient value; but the higher it is, within very reasonable limits, the better are the results.

This A.C. output is then conveyed (as will be discussed later) to the receiver, where it is caused to drive a synchronous motor which is mechanically coupled to the same shaft as the main driving motor which operates the image-exploring mechanism of the receiver. This main driving motor, like the main driving motor at the transmitter, is

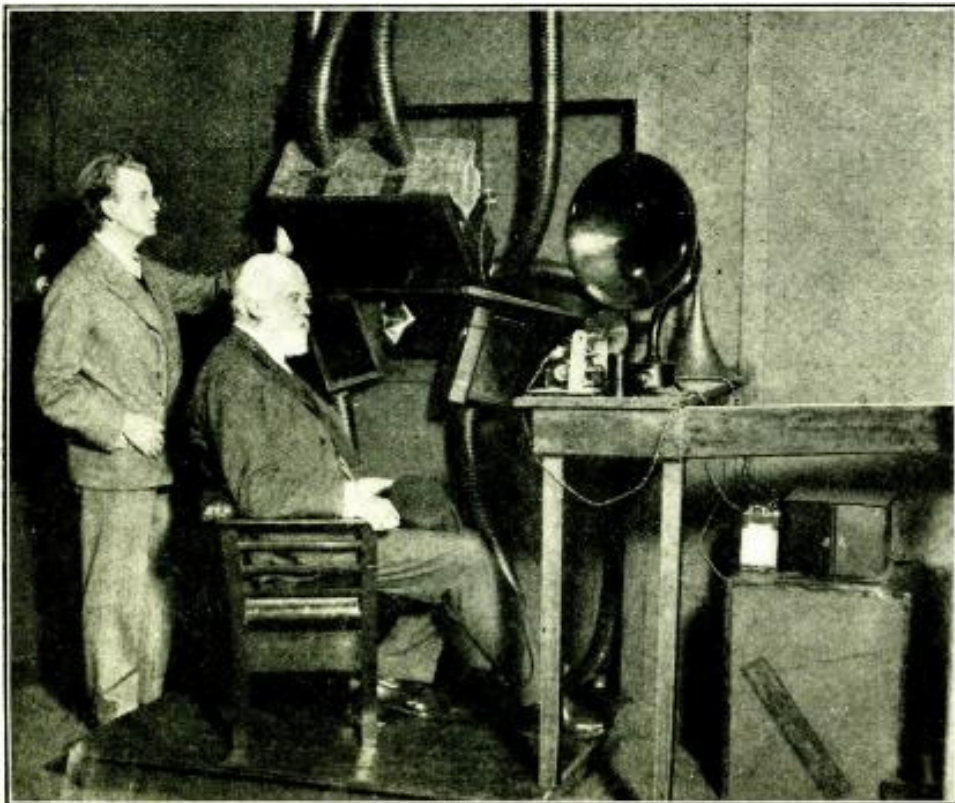

Sir Oliver Lodge, the eminent British scientist, posing before the television transmitter, which is being operated by its inventor, John L. Baird.

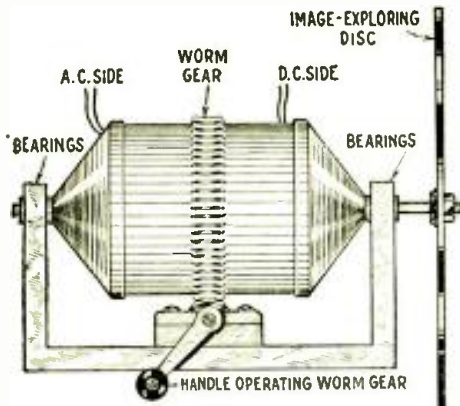

Fig. 2
The outer view of the driving motor and synchronous motor, which can be adjusted by means of the worm gear.

an ordinary electric motor operating off any convenient supply.

The main driving motor at the transmitter has the usual tendency to "hunt," and it is allowed to do so unchecked; the periodicity of the A.C. generator coupled to it varies in accordance with its speed wanderings.

At the receiver, however, the main driving motor is not allowed to hunt independently. Its speed is under the absolute control of the synchronous motor coupled to it; and as the speed of the latter varies in exact sympathy with the periodicity changes of the distant A.C. generator, it follows that the main receiver motor must at all times be revolving at exactly the same speed as the main transmitter motor. The fact that they both hunt slightly does not matter, for they hunt in unison. Therefore, isochronism is achieved.

There remains now the question of synchronism. That is to say, although we have the two machines running at exactly the same speed, we have, as yet, no means for keeping them in the same phase relation.

OBTAINING SYNCHRONISM

As stated previously, a difference of phase does not cause blurring or loss of definition. It merely causes a shift of the image as a whole, and this image shift is very simply rectified by the expedient of rotating the receiver's driving mechanism as a whole about its spindle until the picture comes into view in its proper place.

The action may be compared to that performed by the operator of a moving picture projector when the picture appears with people's feet at the top of the screen and their heads at the bottom, with a dividing line across the middle. All that is required is simply an adjustment to bring the picture properly into its "frame." The descriptions given above will be understood more clearly if reference is made to the accompanying diagrams.

In Fig. 1 a cross-sectional view is given of the receiver's driving mechanism. At the extreme right-hand end of the shaft is the image-exploring disk. Further to the left, within the "carcase" (frame) is the D.C. main driving motor. To the left of that is the synchronous motor, which controls the speed of rotation of the D.C. motor, giving isochronism.

The carcase of these motors is mounted on bearings, so that it can be rotated bodily by means of a handle operating through a worm gear. This feature is more clearly shown in Fig. 2.

It will be seen that this mechanism has the merit of extreme simplicity, and it seems to work extremely well in practice; for it is essentially the method used not only by Mr. Baird, but also by the American Telephone & Telegraph Co. in their recent demonstration of television between Washington and New York.

Mr. Baird's British patent (No. 236,978, of March 17, 1924) describes this device

for rotation of the mechanism; although it is questionable if any patent involving the use of a synchronous motor as a means of obtaining synchronism can be considered valid, because the synchronizing principle, to use the phraseology of the Patent Office, has been "long known to the art." However, to Mr. Baird belongs the credit of being the first successfully to apply this principle.

THE TRANSMISSION MEDIUM

It has been mentioned that the output from the A.C. generator at the transmitter is "conveyed" to the receiver.

It is, of course, impossible at the present time to transmit power by radio or over a telephone line. Therefore, some other means must be provided to supply the A.C. impulses to the receiver. This is done by causing the A.C. to modulate either the carrier current, in the case of wire communication between the two points, or the carrier wave, in the case of radio communication. This modulation, of course, takes the form of a continuous note of audible frequency, corresponding to the periodicity of the generator output. It can, without difficulty, be carried over the same channel which carries the television impulses, filter circuits being used at the receiver to separate the two sets of impulses.

At the receiving station the synchronizing note, after being filtered out from the trans-

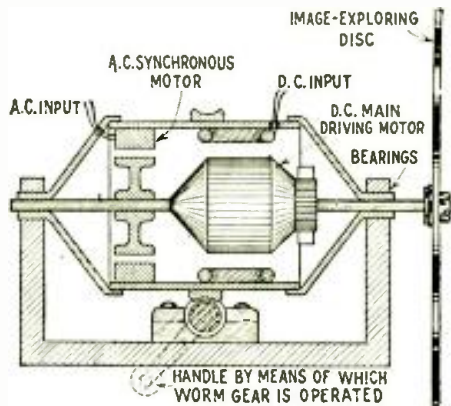

Fig. 1
A cross-sectional view of the motor, showing the relative position of the D.C. and A.C. units.

mission channel, is amplified and used to control the supply of the A.C. synchronous motor.

To make the operation clear to our readers, we will describe the exact apparatus used at one of Mr. Baird's first public demonstrations, given in London in April, 1925. At this demonstration, which was an early effort with crude apparatus, only silhouettes were shown, and two separate channels were used, one for the television impulses, and one for the synchronizing impulses. However, the method of synchronism employed was essentially the same as that described above.

The transmitter was connected to two small loop antennas, one of which transmitted the television signals, while the other transmitted the note caused by the A.C. generator. At the receiving station, which was at the other end of the same room, two similar loops were employed to pick up the two sets of impulses.

BAIRD'S ORIGINAL APPARATUS

The note, after being picked up by the loop and its associated tuning apparatus, was passed through a 3-tube A.F. amplifier, the output of which was connected to a telegraph relay. The amplified alternating current caused the reed of the relay to make contact first in one direction and then in the opposite direction. That is to say, the reed was caused to vibrate, or oscillate, between the two fixed contacts set on either

side of it. The output of the relay was therefore an alternating current, directly in phase with the alternating current generated at the transmitter.

In order to synchronize the two machines, the receiver's main driving motor was first run up to speed, under the control of a rheostat. The input to the synchronous motor was controlled by means of a double-pole switch, which connected it to the output of the relay. Across the poles of the switch were connected two little lamps.

As the synchronous motor and the output of the relay came into phase the lamps flickered, the flickering becoming less and less as the speed of the synchronous motor (driven by the receiver's main driving motor) approached that of the generator at the transmitter. When the speeds became exactly isochronous the flickering ceased and the lamps went out entirely. At that instant the switch was closed and the current from the relay fed to the synchronous motor. This current was sufficient to prevent the synchronous motor creeping out of phase, which, in turn, prevented the main driving motor from hunting.

The above method is essentially similar to that used by Baird at present, with the exception that the telegraph relay is, it is understood, no longer employed. The output of the last tube of the amplifier is now applied direct to the synchronous motor.

It will be understood, of course, that the synchronizing current is almost infinitesimally small; but where well-balanced mechanisms are used, only a very small synchronizing current is necessary to keep the main driving motor of the receiver from hunting.

As already explained, any convenient supply may be used to run the main motor. Mr. Baird uses D.C. motors, because the current supply to his laboratory happens to be direct. The A. T. & T., whose synchronizing methods are essentially the same as Mr. Baird's, used A.C. motors, simply because the power supply was in that form.

During the course of his original experiments, Mr. Baird used a synchronizing frequency of 60 cycles; but, as already mentioned, the higher the periodicity used, within limits, the better the results; and I understand that at present Baird is employing a synchronizing frequency in the neighborhood of 200 cycles. The employment of this frequency enables him to obtain a much finer degree of synchronism, and this improvement, in conjunction with greatly-perfected and better-finished mechanisms, has resulted in a vast improvement in the quality of the received image.

Whereas his original television images were somewhat lacking in detail and marred by a constant flicker, his present-day results are remarkable for their improved detail and the almost complete absence of visible "grain" and flicker. To these improvements the writer can personally testify, having witnessed both the earliest and the most recent demonstrations given in Mr. Baird's laboratories.



The receiver of Mr. Baird's television system, which is used with great success, it is stated.



The Radio Beginner



How to Begin at the Beginning In Radio

By **ARMSTRONG PERRY**

MOST of the readers of RADIO NEWS are on the inside of radio, looking out; but we know that this magazine will fall into the hands of many who are on the outside, looking in. For that reason, it is our policy to carry regularly articles which explain some of the details of radio in the simplest language; so that a reader who knows absolutely nothing of the science of radio will gain some useful information from these. This article of Mr. Perry's is an invitation to those who know little or nothing of radio to acquaint themselves with it, to their own pleasure or profit; and any of our readers who wishes to do such a friend a favor can do so by lending a copy for his reading.

—EDITOR.

A FEW months ago I received a letter from a young man. He was a tuberculosis victim who, by following the instructions of his doctor and nurse, had overcome the disease to some degree. He was not entirely out of danger but the bacilli were out of his system.

He was weak, and out of money, but he had an ambition to do something in radio. He wanted to know how to start.

One morning as I was wondering what to say to those who are still hesitating about making a beginning in radio. I received another letter from the same young man. "Poor fellow," I thought as I opened it, "he needs sympathy."

But there was nothing in the letter that appealed to sympathy; on the contrary it was full of inspiration. He had secured a book that was suggested and built a receiver that was described in it. He had learned to copy code, slowly but with increasing speed. A radio school in a city had accepted his application for enrollment and he had the promise of a job that would enable him to

earn a large part of his expenses. By keeping books for a local concern he had earned and saved enough money to make up the difference and take a full course.

HOW THESE MEN BEGAN

Thousands of persons are convinced that they ought to have radio sets, but are procrastinating about beginning. They are as bad as the hound dog who sat on a thistle and howled because it required less effort to howl than to get off the thistle. Being without radio while so many of the neighbors are receiving its incomparable benefits is irritating; but not always distressing enough to produce action in some folks.

The way to begin is to begin. Clerk-Maxwell, without anyone to nag at him, figured out that when a condenser discharged there must be a radiation of waves in the ether. That was an important beginning for radio.

Hertz read Clerk-Maxwell's theory and, without anyone to goad him to action, built the apparatus and made the experiments that proved the theory to be correct. He produced radio waves and picked them up with an antenna.

Marconi concluded, from these and other evidences, that if energy could be produced and sent through space without wires it could be made to carry messages. It is not recorded that anyone gave him a kick to start him to keep him going.

Dubilier heard there was to be a radio lecture for adults only. Being a boy at that time, and therefore ineligible to attend, he

went in through a window to save the door-keeper the pain of kicking him out—or for some similar reason. He followed the lecturer all over town until the poor man had to use him as an assistant to get rid of him. Today Dubilier is making millions on radio condensers.

Sarnoff started to work for nothing, just to have a chance to learn radio. Now he heads the Radio Corporation of America.

DeForest waited on tables to help pay his way through Yale, and then invented the three-element vacuum tube which is used by millions.

These men were no more fortunate than anyone else in the beginning; they merely started and kept on until they arrived. Anyone can do that, but not without starting.

WHAT ODDS CAN BE OVERCOME

Some persons can begin in radio as Reuben Harrison did, in Virginia. He was a cripple, having hurt his back while jumping into a haymow when he was a boy, and was in bed for seventeen years before broadcasting started. He was paralyzed, and all he could use was his arm and hand on one side and just the hand on the other.

Before he heard of radio, he built a typewriter table that would swing over his bed, and learned to type. The letter that he sent me describing his start in radio was typed and spelled better than many that I have seen executed by stenographers who had the full use of arms, legs and jaws. He built receivers and learned more radio than the average radio service man. His information came from reading magazines and books, studying wiring diagrams, writing to radio editors for information and listening to broadcasts.

WHY NOT START NOW?

The greatest enjoyment that can be derived from radio is found in building apparatus. There are more than 20,000 enthusiastic radio amateurs who build transmitters as well as receivers. There are thousands of set builders who finance their hobby by selling one set to raise money for the next. Some develop it into a business and make large incomes.

Whether a man is interested in radio as recreation, or in the education to be derived from the broadcasts, or in scientific research and experience that will lead him into a good position, the way to begin is to buy or build a receiver, use it as much as possible, supplement experience with reading and study, and have a definite goal toward which some progress is made every day.

There is an old saying: "A bad beginning often makes a good ending;" a good beginning is much more likely to result well. But no end that is worth while can be reached without starting. The way to begin is to begin.

HOW TO LEARN HOW

Plans for building and mounting parts to make a complete radio receiver can be obtained in many places and at small expense. There are plenty of good ones in the back



One of the best ways for the beginner to acquire insight into the arrangement and workings of a radio set, is to put one together. He can buy a complete kit, which is easy to assemble after a little study of the accompanying directions and diagrams.

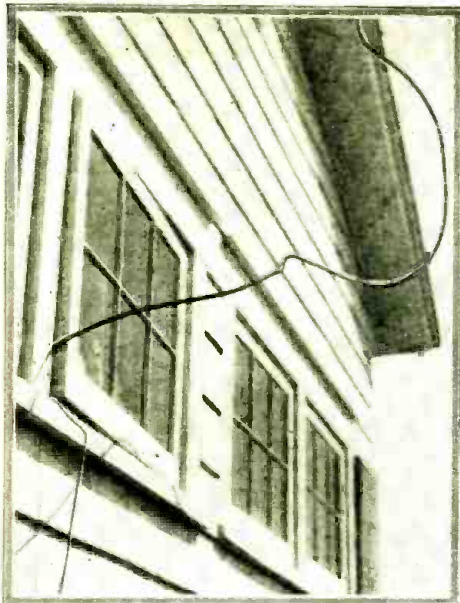

A slovenly, inefficient, and improper way of bringing the aerial into the house.

numbers of this magazine, and more to come. Most public schools and libraries have books on radio and a list of good elementary books will be mailed to any reader who writes to the editor of *RADIO NEWS* and asks for it. The catalogues of manufacturers show diagrams and give instructions that are clear and complete. Blueprints and instructions come with the kits. Novices everywhere have assembled even the largest and most complicated receivers with complete success, by following the printed directions.

The Superintendent of Documents, Government Printing Office, Washington, D. C., will send free of charge a list of government publications containing directions for building sets of different types at very small expense. The pamphlets cost only from 5c to 25c each.

Many colleges and universities have issued pamphlets instructing the public how to build receivers and bring in the broadcasts from stations operated by these institutions. State-supported colleges, in particular, feel under obligation to render such service to tax payers and all citizens.

One of the best and nearest sources of information is the local radio dealer. He sells factory-made receivers and often has parts for home-made sets. If not, he can secure whatever is wanted with little delay.

His experience gives him wide information concerning the results obtained locally with apparatus of different kinds. It is to his interest to give present and prospective customers all the assistance possible. Often he has catalogues and pamphlets for free distribution.

Kits for five-tube sets cost from \$25 up. In fact, some factory-built receivers that have been supplanted by improved types can be purchased for less than that amount. I have one that cost \$2.95; not many months ago it was listed at \$24. It works as well now as it did when it cost eight times as much.

Even the latest and best sets are within easy reach. It is not necessary to pay more than \$200—and it can be paid in easy installments—for receivers of the latest designs. They are beautiful enough for any home; although some who want exclusive, *de luxe* outfits pay as much as \$2,500.

HOW RADIO WORKS

It is hardly necessary in these days to know any radio theory to assemble a receiver kit; but the first principles are interesting because they are so simple as compared with the marvels that radio accomplishes.

The ether is full of radio waves produced by transmitting stations. As these waves pass any piece of metal, they tend to produce a current of electricity in it. If the metal is properly connected with any circuit in which electricity can flow, these waves will start in it a current which can be led into a radio receiver.

This current will have characteristics similar to those of the current that started the radio waves from the transmitting station; thus the vibrations of voice and music are sent through space on the radio waves. It is *oscillating* current and changes its direction many times per second. Every time it changes its direction, it makes fields of magnetic force around any metal through which it is flowing. These lines of magnetic force can transfer some of the energy of the current from one conductor to another; even though the conductors are separated so that the electric current itself cannot pass between them.

The amount of energy gathered from the radio waves is greatest when the receiver is

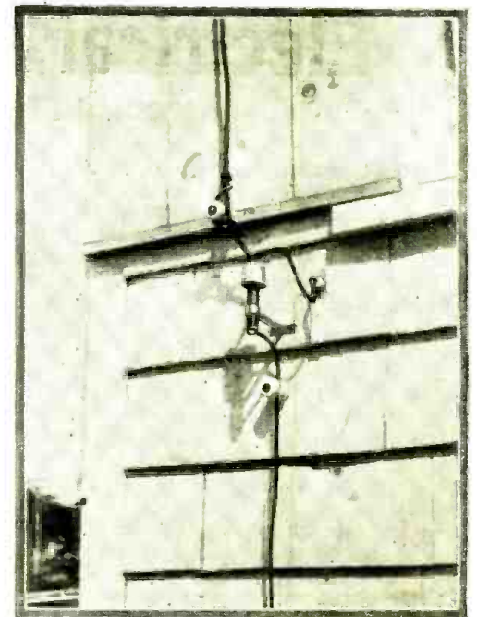

Install the aerial lead-in this way, with an efficient lightning arrester. It will then be safe.

in tune with the transmitter. They are in tune when the *wavelength* of the receiver is the same as that of the transmitter; in other words, when the number of oscillations per second is the same in both the transmitter and the receiver. Tuning a violin with a piano is similar to tuning a radio receiver to a transmitter, for the object is to have the violin string and the piano string oscillate the same number of times per second. (In another page of this issue is an article entitled "Resonance," explaining this more fully.)

The radio receiver is tuned principally by two devices, called inductance coils and condensers. A circuit containing a *variable* inductance coil, or a *variable* condenser, or both, may be tuned by varying the coil or condenser, or both. Usually the variations are made by turning a knob or a drum, in a manner familiar to all.

Having captured the energy from the radio waves and led it into a tuning device to utilize as much of it as possible, the next step is to change the electrical energy into sound. Sound is the effect of the motion of air waves on the nerves with which we hear; so, first, the electrical energy must be changed to motion. The human ear can

(Continued on page 827)

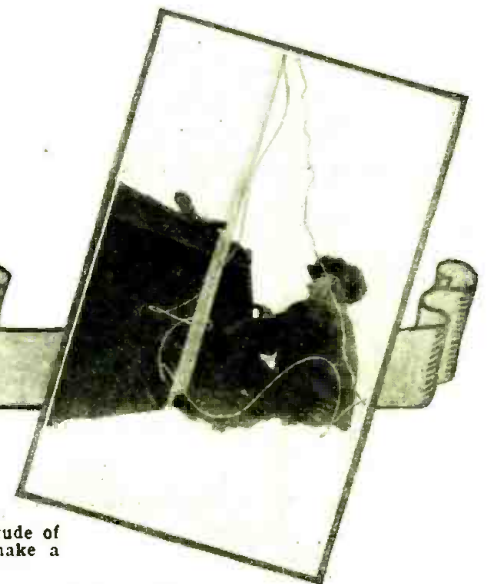
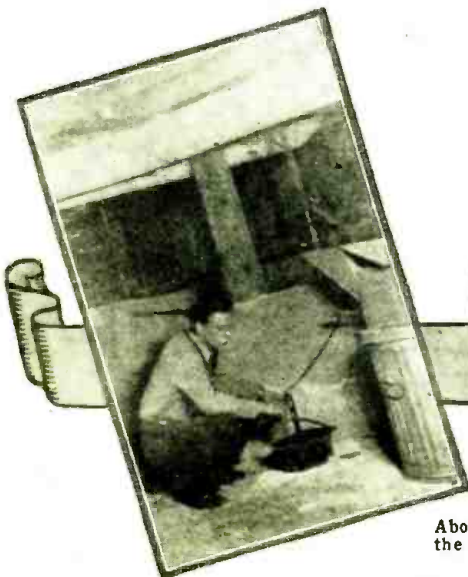

Above and right, work of aerial installation. The magnitude of the task varies at different seasons; but it pays to make a good, substantial job that will be permanent.

A good ground connection is one of the important things about a radio installation. The young man illustrated has driven a pipe through the bottom of the kettle, four feet into the ground. His receiver's ground wire is soldered to the pipe; keeping the kettle full of water insures a better ground. (See the picture at the left.)

Electrical and Mechanical Resonance

Interesting Phenomena which Explain Tuning In a Radio Receiver

By CLYDE A. RANDON

TO the average radio listener, "resonance" means very little, but in view of the fact that all reception and broadcasting depends on it, one should become well acquainted with the use of this term. Resonance, in radio, is simply a condition existing in a number of electrical circuits which allows the action of one to cause the greatest possible response in another. When circuits are in resonance, they are said to be "tuned," and one will then have the maximum effect upon the other. When you turn the dials on your receiver, you are simply bringing your set into resonance with the broadcast frequency; that is, you are tuning the circuits in the set to the same frequency to which the circuits at the broadcast station are tuned and, therefore, bringing your set into a condition which will allow the maximum effect to be produced. The phenomenon of resonance exists also under many other circumstances.

A spring suspended from the wall and

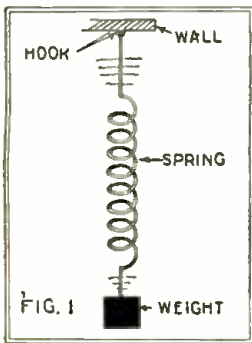

The maximum response of an oscillating system, such as that shown on the left, depends upon several factors; i.e., the weight of the suspended mass, the tension of the spring, etc. This corresponds to the effects of inductance and capacity in an electrical circuit.

made to vibrate at different periods will vibrate with a maximum amplitude (up and down motion) at a definite resonance frequency, depending on the material of which it is constructed, its length and the weight of the object which is suspended from its end (see Fig. 1). Maximum response is obtained at resonance.

AN OPTICAL ILLUSTRATION

Ordinary "white" light is composed of all colors of the rainbow and is easily broken up into these constituents by a glass prism; the prism refracts the different light wavelengths to different angles, and the light which comes through the prism is separated into the different colors, or frequencies. If such a prism be arranged to throw the rays on a screen, the different colors will appear in a "spectrum," one blending into the other, in rainbow fashion. Let us say that this

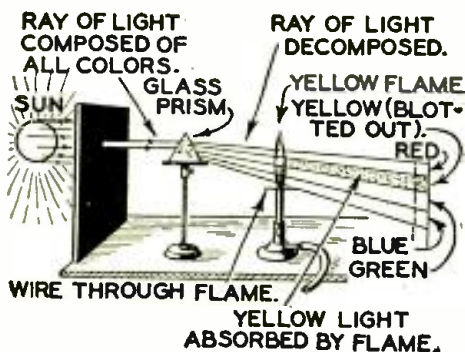

FIG. 2.

How sunlight can be broken up into the different colors and how the yellow, for instance, can be removed by passing the beam through sodium vapor, obtained by holding a salt-covered wire in a gas flame.

represents the condition in an untuned antenna; all frequencies entering the antenna flow in it, and no particular frequency is favored in this case. The prism, in the light analogy, serves merely to show that all these frequencies (corresponding to the various colors revealed by the prism) are present.

Suppose that one places a sodium flame (giving a yellow color) between the prism and the screen, so that the various colors must pass through the flame. It will be found that the part of the image on the screen which was yellow before the flame was introduced, has been darkened; the yellow flame has actually *absorbed* the yellow light from the colors passing through it. Since the various colors represent different wavelengths, or frequencies, it is evident that the yellow light of the flame is "tuned" to the yellow light of the sun or is in resonance with it and thus has absorbed it. The frequency of the yellow light in the flame is determined by certain constants of the atoms in the flame; the yellow light passing through the flame is influenced by the vibrations and thus does not proceed through.

This is an excellent example of resonance and of a wavetrapp. In Fig. 2 is diagrammed apparatus for studying this effect and in Fig. 2A is shown a similar condition; an antenna circuit which normally carries all the different frequencies emitted by the different stations operating at the same time, short-wave one included, contains a tuned circuit which selects one frequency.

The yellow flame "absorbs" the yellow light, that is, the light to which it is tuned. In the electrical case, the system LC "absorbs" the frequency to which it is tuned, the "vibrations" of the electrons in the wave-

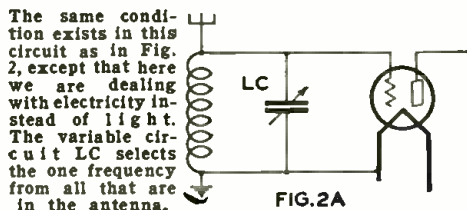

The same condition exists in this circuit as in Fig. 2, except that here we are dealing with electricity instead of light. The variable circuit LC selects the one frequency from all that are in the antenna.

trap being increased. If we introduce a green flame so that the light has to pass through it also, the green light will be absorbed in the same way. In our electrical analogy, this is equivalent to introducing a wavetrapp which is tuned to a different frequency.

At resonance, the energy flowing through a circuit is expended in increasing the vibration in the particular tuned system and thus is used up without flowing through. Undesired stations can thus be excluded by employing a wavetrapp which absorbs the transmitted frequency. By using this simple light analogy this effect is easily pictured.

This is perhaps the simplest explanation of the action of the ordinary wavetrapp, which absorbs one frequency or wavelength but which does not absorb any other. While on the subject of light, it may be well to point out that vision depends upon resonance. The human eye resonates to but a limited frequency-range; that is, we can see only the colors (corresponding to the different wavelengths) which are within the frequency range of the eye (see Fig. 3). The eye resonates only to a limited range of wavelengths. The infra-red, which is beyond the extreme limit of the red light shown so beautifully in the rainbow, the human eye

cannot see. Waves considerably longer than these are used in broadcasting, but all are simply electromagnetic waves.

Fundamentally, the "light" and the radio waves are the same. Ultra-violet radiation, (corresponding to wavelengths just below violet), the human eye cannot "see", for it is not in resonance with these frequencies. The photographic plate can be used to "see" waves in this region, whereas radio apparatus is used to detect waves such as used in broadcasting. It is readily seen that resonance is a most important phenomenon.

SOUND WAVES

Caruso was able to shatter thin wine glasses with his powerful voice by singing at a certain pitch. He chose this pitch (pitch in sound corresponds to different wavelengths) so that it would be resonant with the natural vibrating period of the glass (see Fig. 4). The glass, therefore, would vibrate sympathetically and with maximum response, which was sufficient to shatter it to bits. It should be noted that sound waves are waves set up in the air, whereas light and other electromagnetic waves are often considered as traveling in an invisible theoretical medium called the "ether."

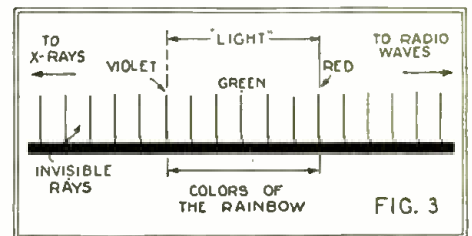

Chart showing the relative position of the visible rays to the X-rays and radio waves in the scale of frequencies.

In the radio set, the natural frequency (in this case "electrical frequency," but all resonance is in principle the same, as will be seen later) of the circuits is adjusted to the frequency of the incoming signal; and at resonance maximum response is secured.

Some interesting experiments illustrating the important phenomenon of resonance can be performed easily at home, and will be described here.

Lift the cover of your piano, if you have one, and, starting with the voice at a low pitch, gradually sing up the scale. Certain notes will cause certain strings in the piano to vibrate sympathetically. If exactly the correct pitch is chosen a good note will issue from the string; the voice should be directed at the strings; and sing quite loudly.

(Continued on page 802)

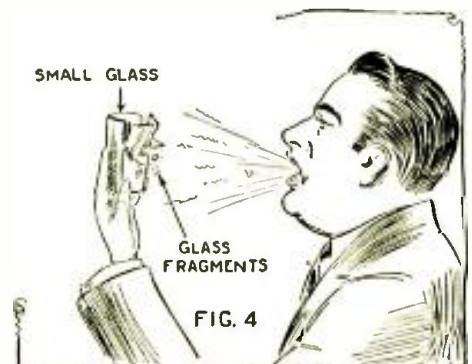

If a certain pitch is sounded strongly enough, it is possible to shatter a thin glass by means of the voice. Its fundamental note causes the glass to vibrate so violently it will break.

Producing Radio Power from Heat or Daylight

The Possibility of Obtaining "A" and "B" Current Without Batteries or Outside Wires

By S. R. WINTERS

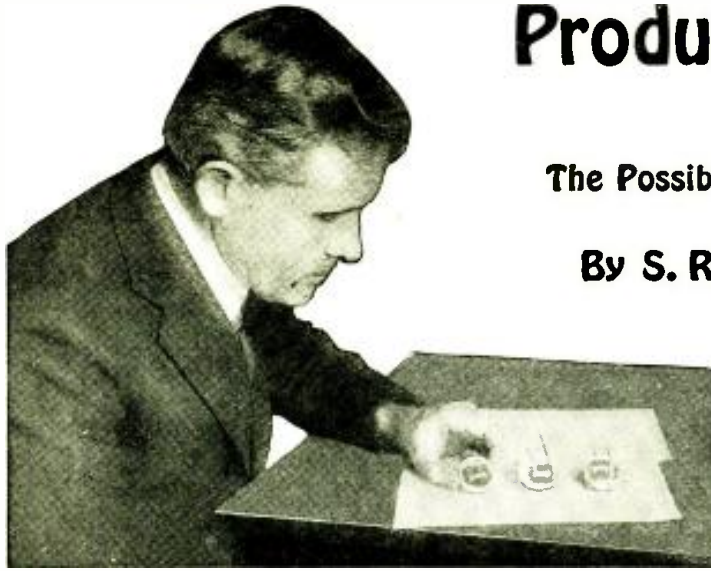

Dr. William W. Coblentz of the Bureau of Standards, with specimens of molybdenite, which, he has discovered, convert light energy into electricity. A peculiar property of this mineral is that it reacts to only certain wavelengths or colors of light.

"CAN we dispense with 'A' and 'B' batteries and operate our radio receiving sets from electric current produced by the direct action of heat?" is, in effect, the question being asked daily of the Bureau of Standards. This inquiry is being received from radio fans with such consistent frequency that the pyrometry section is contemplating the issuance of a circular letter, or other blanket method, in which thermoelectric generators will be discussed fully.

While the Bureau is inclined to discourage the application of this method as a source of power for radio receivers, the production of electric current by the direct action of heat—for example, the unequal heating of a circuit composed of two dissimilar metals—is in accordance with an established scientific principle. In putting a soft pedal on this method of generating electricity for radio purposes, the experts are mindful of the skill required in operating thermoelectric generators and the accurate control necessary in applying such current to the practical

operation of radio receiving sets. For the veteran experimenter, however, thermoelectricity offers a fruitful field of research.

The radiometry section has been investigating the phenomenon of molybdenite, a rare mineral, which possesses not only thermoelectric and photoelectric properties,

The instrument at the right is a thermopile, generating electric currents from a very slight amount of heat. It was used by Dr. Coblentz in determining the temperature on the planet Mars.

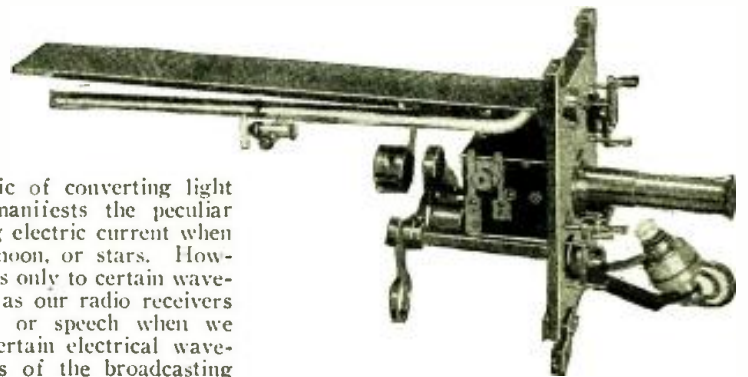

but the uncanny magic of converting light into electricity. It manifests the peculiar property of generating electric current when exposed to the sun, moon, or stars. However, molybdenite reacts only to certain wavelengths of light; just as our radio receivers will reproduce music or speech when we have them tuned to certain electrical wavelengths or frequencies of the broadcasting stations.

A PECULIAR SUBSTANCE

Radio experimenters, if so fortunate as to obtain specimens of this rare mineral, can apply their inquisitive minds with considerable zeal in exploring into the thermoelectric or actinoelectric properties of molybdenite. The specimens investigated by the Bureau consisted of thin cleavage pieces, some of the sheets being $2\frac{1}{2}$ inches or more in length. To the ends were attached fine copper wires, which formed the "thermojunctions;" thus producing electricity by the unequal heating of two dissimilar metals. The measurements, on samples from various sources, gave values of plus 690 microvolts (.00069-volt) through zero thermal electromotive force to minus 1,040 microvolts. In one sample, one end gave plus 510 microvolts and the other end gave minus 1,040 microvolts, in contact with copper at 28 degrees Centigrade (82.4° Fahrenheit).

(Continued on page 847)

Wanted--Radio Aerials for Airplanes!

A RADIO receiving set remotely-controlled or, at least, so simply manipulated as to require merely the pressing of a button or twisting of a knob is the desideratum confronting research laboratories in developing equipment for use on aircraft. This need includes not only a one-dial receiver, tuned to a particular wavelength and locked in position, but also an automatic device for reeling out and reeling in the trailing wire antenna, which must have a protective feature to prevent the "fish" or lead weight of the antenna from whipping itself to pieces against the flying machine.

The pilot, with enough controls on the instrument board of the airplane to appreciate the advantage of a "spare" hand, cannot with safety operate a multiplicity of radio dials and pay out and wind up the trailing-wire antenna. This is particularly true in emergencies when neglect of the airplane-controls would endanger the life of pilot and passengers; and yet a similar neglect of radio receiving equipment is likely to disrupt communication facilities, while the dangling lead weight beats the antenna into fragments. This condition lends considerable significance to a recent statement of the Radio Laboratory of the Bureau of Standards, that the development of a simple, automatic receiving set is the outstanding

problem in the perfection of radio beacons for guiding airplanes.

A self-winding trailing-wire antenna will be an invention of equal value with the designing of a receiving set suitable for aircraft radio. In fact, progress is being made in development of the latter. The Radio Laboratory is experimenting with a receiver which has only a volume control, employing both tuned radio-frequency amplification and some audio-frequency amplification. This outfit is so designed that the wavelength or frequency settings are made within the receiver; which is so constructed that changes in the antenna system will not influence the frequency setting. This model receiver for the reception of radiotelephone speech has been installed in the tail of an experimental airplane at College Park, Maryland.

RADIO "ROAD SIGNS" OF THE AIR

The location of this receiver is such as to obviate the cluttering up of the cockpit with radio apparatus, leaving only the headphones and the visual-indicator unit in the cockpit. This method of installation, the Radio Laboratory anticipates, will permit simultaneous reception of ground radiotelephone transmitting stations (the signals from which would be received, of course, by headphone) and of the beacon signal, which operates a visual-type unit. The latter, which for the

first time permits a pilot to keep to a zone of safety by the guidance of colored lights, consists of a 3-inch needle-type indicator mounted on the instrument board of the airplane.

The latter automatic device, though reasonably satisfactory in preliminary experiments, is subject to criticism in some engineering quarters as to its practicality when the United States will have been criss-crossed with forty or more radio beacon stations along the 8,234 miles of civil airways. These critics contend that nothing less than the human ear can discriminate between the different signals, coming from so many radio beacon stations, and thus unerringly determine by radio the zone of safety for an airplane in fog, darkness or other adverse conditions. A visual indicator, it is contended, would (figuratively) become so dumbfounded by such a confusion of signals as to flash a motley of colors on the airplane's instrument board, or become altogether inoperative.

A COMPACT AIRPLANE SET

The General Electric Company has developed for the Lighthouse Service a radio receiver which is said to combine the desired features of compactness, reliability, and

(Continued on page 848)



What's New in Radio



A COMPACT "A, B AND C" POWER UNIT WITH AUTOMATIC RELAY

THIS apparatus comprises a storage battery, a trickle charger, a power-control relay, and a plate-supply device with provision for obtaining grid potentials. It provides a compact, automatic accessory suitable for electrifying any type of radio receiver using standard 6-volt tubes. The unit requires practically no attention, it has ample power for all types of receivers, and its operation is controlled by the battery switch on the panel of the receiving set.

Dry electrolytic-rectifier cells are used in the trickle-charger circuit of the power unit. These cells are very convenient, for they do not require any attention, such as adding water, etc. A step-down transformer connected in the 110-volt, 60-cycle power circuit supplies the low-voltage alternating current used by the rectifier; and after it has been converted into pulsating direct current, the rectifier delivers this current to the storage battery. The storage battery used is a small 6-volt, low-capacity unit.

In the operation of this unit the storage battery is kept at full charge at all times. This is accomplished automatically by a unique automatic power-control relay, which functions in this manner:

In construction the relay consists of four coils: a series-set coil, a shunt coil, a lock coil and a potential-relay coil. When the filament switch of the receiving set is turned

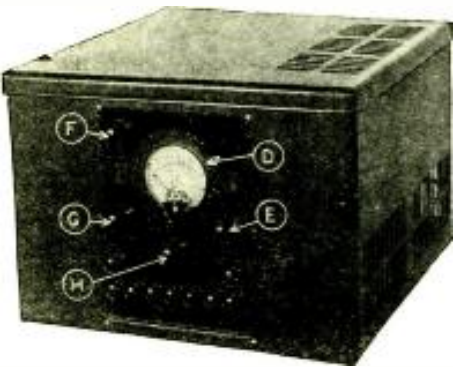

All controls are located on front panel of the power unit. E, F, G and H are voltage controls for the output, grid, detector and amplifier circuits, respectively. D is a 0-250 volt voltmeter.

on, current passes from the storage battery to the tubes; and this current energizes the series-set coil which is connected in this circuit. When the series-set coil is energized, it brings the armature up to the core and this connects the shunt coil directly across the "A" battery. When the shunt coil is connected, its core attracts the rocker arm, and this operates a switch which connects the "B" unit to the 110-volt supply. When the filament switch is again turned off the series-set coil is de-energized, breaking the contact to the shunt coil and causing the rocker arm to assume its natural position; thus disconnecting the power line from the "B" supply circuit. The power control also places the battery on charge and connects the potential-relay coil across the battery terminals. Upon the building up of potential in the battery, as the result of charging, the core of the potential-relay coil attracts the armature. At a fixed potential, determined by means of the screw upon the armature

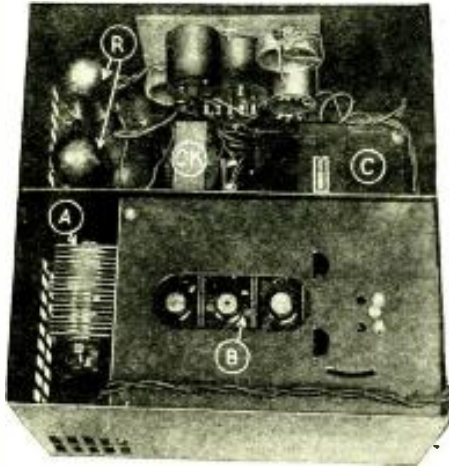

With its cover removed, the apparatus in the "A, B, C" power unit is visible: A, trickle charger; B, battery; C, condensers; CK, choke coil; R, rectifiers.

Illustration courtesy Sentinel Mfg. Co.

spring, the armature of the potential relay moves and discontinues the charging of the battery.

In the "B" power-supply circuit there is a standard type of step-up transformer which supplies two half-wave rectifier tubes of special design. The filter circuit is standard, consisting of a condenser block and two iron-core choke coils. In the voltage-dividing circuit there are three variable resistors, regulating the potentials delivered to the detector, the radio and audio amplifiers, and the grid of the power tube.

Still another variable resistor is connected in series with the filament circuit of the rectifier tube, and used to control the output voltage of the entire plate power-supply unit.

The power available in the plate-supply ("B") circuit is ample, even for the operation of large receivers. The plate voltage is more than is required for the operation of a set using a 171-type power tube, and the grid bias is adjustable up to 40 volts. On the front panel is placed a meter which enables the owner to check up on the voltages of the various circuits.

DOUBLE POWER SWITCH FOR USE WITH "A" AND "B" POWER UNITS

ANY set owner who contemplates the purchase of "A" and "B" power units for the purpose of electrifying the receiver should consider the problem of turning the set off and on. When a storage battery is



Sketch shows appearance of a simple power switch which may be used for controlling operation of both "A" and "B" power units.

Illustration courtesy The Abox Company.

not used it is impossible to control the set with a power-control relay, as the current must be turned on in the lighting circuit. Also, it is not possible to utilize the usual panel switch, as this is connected in the filament circuit and is not rated for use in 110-volt circuits.

If it is not desirable to make changes in the wiring of the receiver, the switch illustrated in these columns will be found very convenient. It is provided with a double receptacle into which the plugs of the "A" and "B" power units are inserted, a long cord which is connected with the lamp socket and another cord with a switch attached.

In operating the set with this switch, the power units are connected as described and the cord with the attached switch is placed in a position convenient to the front panel. To turn on the set, it is necessary only to press the switch and power is delivered to the primary windings of the power units. To turn off the set the reverse procedure is followed.

MOTOR GENERATOR PROVIDES ALTERNATING-CURRENT SUPPLY

Direct current may be converted into 60-cycle alternating current, to operate alternating-current radio receivers, with the device pictured in this column. It is a recently-perfected dynamotor especially designed for use in radio laboratories and demonstration rooms of radio dealers. Many useful appli-

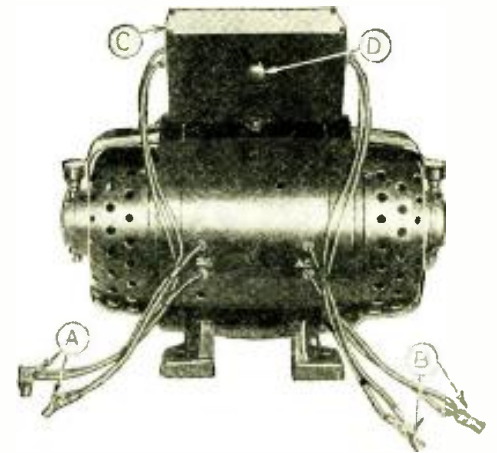

This small D.C. motor generator will provide power for operating A.C. radio receivers. A, input wires; B, output wires; C, filter box; D, ground connection.

Illustration courtesy Electric Specialty Company

cations will be found for it in districts where direct current only is available; many music stores, for instance, find it valuable for operating electric phonograph apparatus for demonstration purposes.

From the viewpoint of the radio user, the most interesting feature of this dynamotor is the filter which is supplied with it. Certain electrical and mechanical features of the device, together with the filter supplied, prevent objectionable noises in the output. The machine operates at 1800 revolutions per minute, and is furnished with ball bearings, which operate very quietly, and with a minimum amount of attention.

The machine is small and compact in size, and comparatively light in weight. The filter, which consists of a choke-coil-and-con-

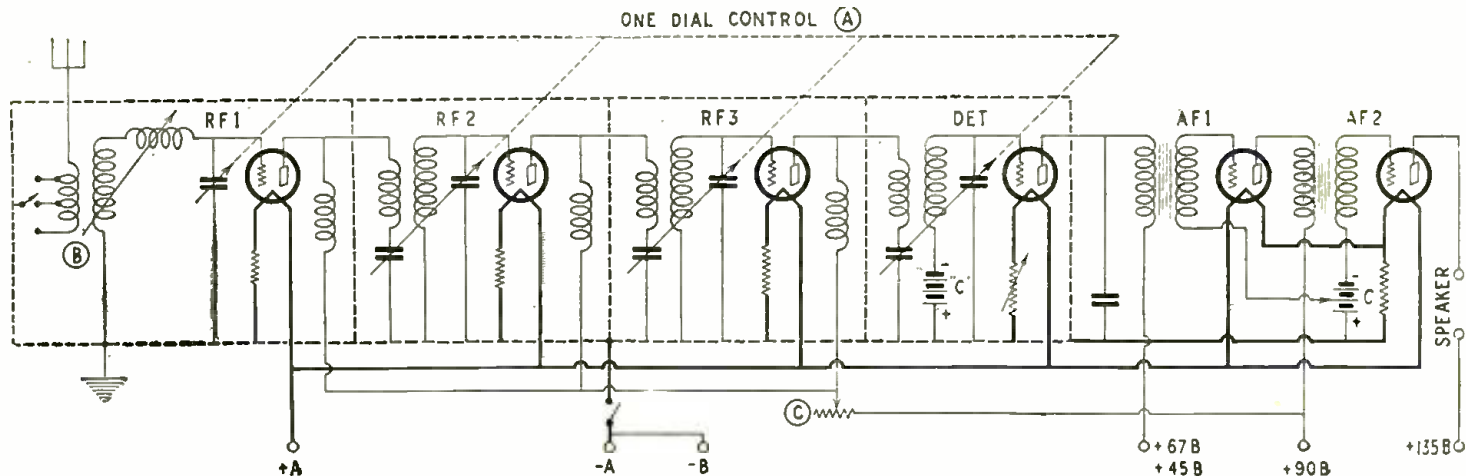

Complete schematic wiring diagram of a new six-tube radio receiver with novel R.F. circuit in which the constant-capacity-balance scheme of neutralization is used. RF1, RF2 and RF3 are the first, second and third R.F. stages, respectively; DET is the detector circuit; AF1 and AF2 are the first and second audio stages; A is the wavelength control; B is the sensitivity control, and C the volume control.

denser system, is built-in and connected. Suitable wires are brought out at the motor and generator ends of the unit, so that they can be installed by anyone who is even slightly familiar with such apparatus.

The machine illustrated above operates from 110-volt direct current and provides 110-volt 60-cycle alternating current; it has a rated output of 300 watts, which is ample for the operation of the largest existing types of radio receivers and electric phonographs. Smaller and larger models also are available for special purposes.

INTERESTING RECEIVER WITH A SEVEN-IN-ONE TUNING CONTROL

An interesting example of modern radio design is found in the all-metal construction of the totally shielded, six-tube receiver illustrated on this page. Not only is the mechanical design of the receiver modern, but the circuit is also new. It employs three stages of tuned radio-frequency amplification, a non-regenerative detector and two stages of transformer-coupled audio frequency amplification. In the operation of the set, one tuning dial is used to control the wavelength of all circuits.

Many interesting features will be discovered upon examination of the schematic wiring diagram. In the radio-frequency circuits a constant-capacity-balance scheme of neutralization is employed. The method incorporated here requires the use of seven variable condensers, in the case of a three-stage tuned-radio-frequency receiver. One variable condenser is connected in the grid circuit of each stage in the usual manner, making a total of four condensers; and a condenser is connected in series with the plate winding of the radio-frequency transformer in each of the three radio frequency stages. This arrangement makes necessary also the use of radio-frequency choke coils in the circuit delivering plate current to the tubes. In the detector circuit of this set the

plate method of rectification is employed; this helps to overcome overloading in the detector circuit and as a result prevents distortion on loud signals.

SIMPLE CONTROLS

In the front-panel view of the receiver the arrangement of controls is clearly shown. The scale which indicates the settings of the condensers is located in the middle of the panel and this is governed by the knob which is mounted directly below it. The scale is illuminated, and calibrated in degrees, meters

and kilocycles. The knob is the only wavelength adjustment on the receiver, as it controls the condensers used in all radio-frequency circuits.

MECHANICAL DESIGN

When the front panel of the receiver is removed it is possible to see the method utilized for securing one-control operation. In each stage where two condensers are used a double unit is employed to simplify the arrangement. A link motion connects the four condenser shafts and this is attached to the illuminated scale. A gear on the shaft of the knob couples the scale and the link motion to the knob. This view of the receiver shows also the all-metal construction of the set. It will be noticed that each stage is individually shielded and that the four stage shields are mounted on a metal chassis. For additional rigidity, a metal panel has been mounted between the shields and the link motion.

In the top view of the receiver, the covers to the stage shields have been removed in order to show the arrangement of apparatus in each stage. Except in the first, two condensers are used in each radio-frequency shielding compartment including the detector; one condenser tunes the grid circuit and the second is connected in series with the plate winding of the radio-frequency transformer. The first radio-frequency stage is similar to the others, but its compartment has the additional feature of the variometer compensator. This instrument consists of a small coil of wire mounted on a shaft and located at the base of the antenna coupler. This coil acts as the rotor winding and the



Illustrations courtesy Stewart-Warner Speedometer Corp. Front view of receiver shows arrangement of controls on front panel. A, wavelength control; B, sensitivity control; C, volume control.

and kilocycles. The knob is the only wavelength adjustment on the receiver, as it controls the condensers used in all radio-frequency circuits.

In the lower right corner of the panel is located the volume control and battery switch, a combination instrument operated with one knob. The volume control consists of a variable high resistor connected in the plate supply circuit of the radio-frequency tubes. The switch is mounted on the end of the volume-control shaft, and so arranged that, when the knob is turned all the way to the left, the set is automatically turned off.

In the lower left corner are a knob and switch, used for making special adjustments

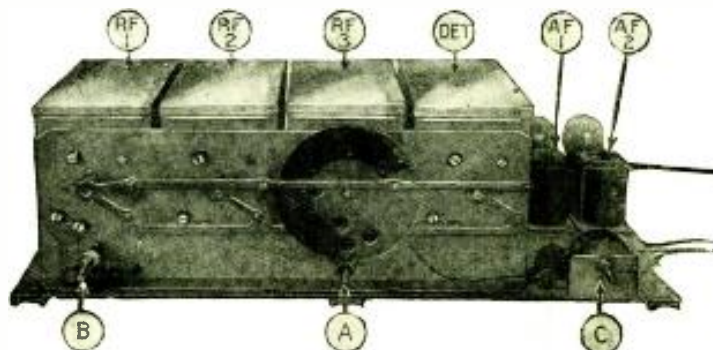
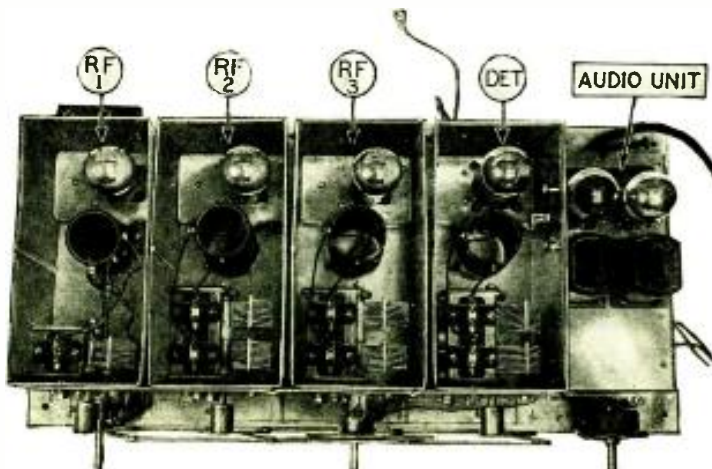

Two views of the interior of the set show details of chassis construction and total shielding. In these pictures all symbols correspond to similar lettering on schematic wiring diagram.

secondary of the antenna coupler serves as the stator winding.

The audio-frequency amplifier of the receiver is mounted to the right of the chassis. It consists of two audio-frequency transformers and two tubes.

Reverting to the subject of its external appearance, the receiver is very pleasing in design. It is housed in a table-type, brown-walnut cabinet 11½ inches high, 14 inches deep and 26 inches wide. The front panel of the set also is of the same wood, and is 7¾ inches high by 20 inches wide. The metal finishings of the cabinet are of bronze.

From the mechanical viewpoint there are other interesting details of the cabinet. The chassis of the receiver is securely bolted in place, but thoroughly insulated by rubber strips from loud-speaker vibrations, which would be apt to cause microphonic noises. Also, if it is necessary to make any repair or adjustment the chassis can be removed without difficulty. The tuning knobs, the back of the cabinet and six bolts which secure the chassis to the base are removed and then the entire chassis may be taken out of the cabinet. However, it will be seldom necessary to remove the chassis from the cabinet, as the top is hinged and with the top open almost any kind of adjustment may be made.

POWER SWITCHES FACILITATE ELECTRICAL SET OPERATION

TWO new switches, which answer the requirements of the person who is building an A.C.-operated receiver, have recently been placed on the market. These switches make it possible to turn on any type of receiver from the panel of the set without the necessity of an automatic power-control relay. Also, control of the current in both the filament and plate circuits is accomplished with one operation.

One of the switches mentioned above is illustrated in these columns; it is a snap switch which may be used in either 110-volt A.C. circuits, or regular 6-volt filament circuits. It is of the latest quarter-turn construction and is very compact. From an electrical viewpoint it has several valuable features; as its metal frame is insulated from both terminals and this makes it possible to mount the switch on the metal panel of shielded receivers without insulation difficulties. Also, it makes a positive electrical connection, due to the action of the efficient double contact and the strong spring.

In the second switch an additional feature is found which makes it possible to use this instrument in place of an automatic power-control relay. It is provided with two sets of contacts, one of which may be used in the 110-volt A.C. circuit for the operation of the



Illustration courtesy Carter Radio Co.

Two views of a new, 110-volt, panel mounting type power switch are shown above; details of the double contact are given in the lower sketch.

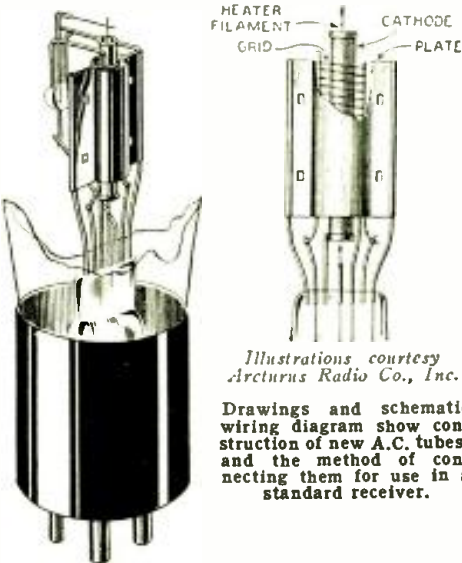
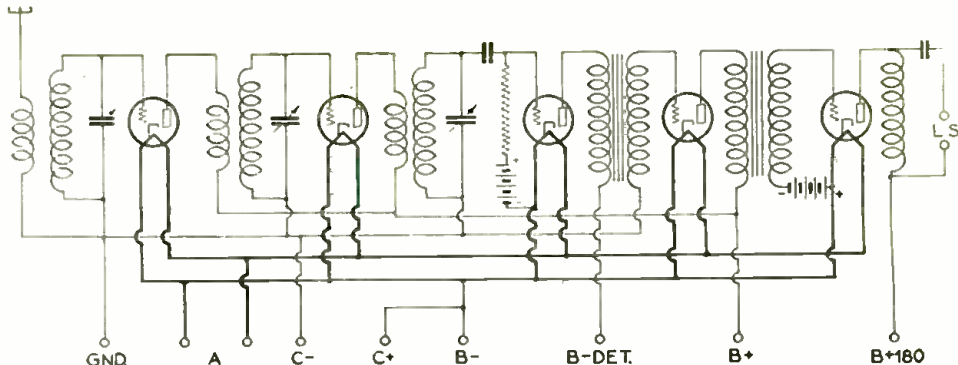

Illustrations courtesy Arcurus Radio Co., Inc.

Drawings and schematic wiring diagram show construction of new A.C. tubes, and the method of connecting them for use in a standard receiver.

plate-socket power unit, and the other to turn the 6-volt storage battery on and off.

Both switches are very small in size and either may be installed in the place occupied by the old-type battery switch on any receiver. They are of the one-hole-mounting type, and this makes it unnecessary to drill any additional holes in the front panel. However, it should be remembered that, when 110-volt A.C. wires enter the radio cabinet, they are apt to cause a hum to be heard in the loud speaker, unless they are twisted together. When this precaution is taken, however, difficulty is seldom experienced.

ALTERNATING-CURRENT TUBES SIMPLIFY RECEIVER CONVERSION

AN entirely new type of alternating-current tube has recently been introduced. It is available in three types, detector, amplifier and power tube, and it will fit in the standard UX tube socket. Any receiver of standard type may be rewired to operate with tube of this and the changes which are necessary can usually be accomplished in a few minutes' time. Also, after the set has been wired to operate with the A.C. tubes, it will be possible to use a battery again for the tubes, without making any changes in wiring.

The electrical features of the new tube are interesting. It is of the heated-cathode type, and the cathode is connected to one terminal of the heater, thus reducing the number of required connections to four. Alternating current of 0.35 amperes at a potential of 15 volts is used to supply the heater with power. The heater itself is a carbon filament which has a life of over 1,000 hours under average operating conditions. The tubes have been designed with a full appreciation of the improved characteristics of modern coils, circuits and practice; and, as a result, may be used in any re-

ceiver without loss of sensitivity, selectivity or quality.

The circuit diagram on this page shows how the average five-tube tuned-radio-frequency receiver should be rewired when the new A.C. tubes are used. The circuit is not entirely complete, but shows merely the essential parts and the complete battery circuits. While it is beyond the scope of this article to describe in detail the changes necessary in all types of receivers, a short outline of the steps which must be followed in remodeling the average receiver may be of interest.

First, it is necessary to eliminate all grounds to the filament circuit, and all rheostats or voltage regulators, such as fixed resistors or amperites. Next, examine the filament wiring carefully and see that the wires run close together. When convenient, it is highly desirable to twist the wires together.

All grid returns, except from the power tube, are grounded and the necessary biases (excepting that on the detector) are secured by connecting the biasing potential to ground and the other side of the battery to the plus filament post or posts on the tube or tubes to be biased.

A positive bias of 4.5 to 9 volts is applied to the grid of the detector tube through a five-megohm leak. (The negative post of the battery is connected to the cathode, through the plus filament post on the socket.) A grid condenser is used, in the conventional manner, detection still being effected by grid-current rectification.

The power tube is biased in the usual way. 22.5 volts is applied to the grid, with a plate voltage of 180.

It is impracticable to use a rheostat with A.C. tubes. Also any volume control, such as a potentiometer, which functions by varying the grid bias to the R.F. tubes, will introduce hum on certain adjustments.

Efficient control of regeneration and volume can be effected by placing a variable high (zero to 200,000-ohm) resistor across one R.F. secondary.

COMPACT LOUD SPEAKER HIDES EXPONENTIAL TONE CHAMBER

The new type of reproducer illustrated on this page is not a cone, nor a horn in the ordinary understanding of the word. It is a drum speaker, which embodies new and

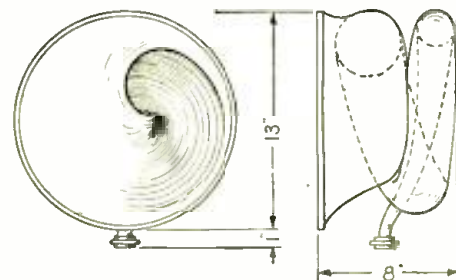

This exponential-horn speaker provides a 54-inch tone chamber in compact space, as illustrated above.

scientific principles of sound reproduction, and which combines in a compact form a loud-speaker unit of improved design and an exponentially-curved tone chamber.

Fifty-four inches of travel is available for the sound in the tone chamber of the speaker —yet the exterior dimensions approximate those of the conventional cone speaker of the same general appearance. The unit is 16 inches in diameter, 10 inches deep, 18 inches high, and stands on a base 6¼ by 9 inches. The case of the speaker is made of metal finished in an attractive dark brown. The front of the speaker is covered with a wire grille which has been placed over a silk mesh. The speaker stands on four rub-



Illustrations courtesy Newcombe-Hawley, Inc.

Front view of the new drum speaker, which conceals a 54-inch exponential-curve tone chamber. The unit is made of metal and finished in an attractive brown.

ber feet which tend to prevent microphonic noises resulting from vibrations when the speaker is placed near the radio cabinet.

Experimenters should not compare speakers of the exponential type with the old horn-type loud speaker, as the former is capable of giving far superior results. When properly designed the exponential speaker will reproduce the entire band of sound frequencies without any appreciable distortion of the music.

SIMPLE PICK-UP CONNECTS ANY PHONOGRAPH TO RECEIVER

A VERY simple and inexpensive device, which may be used for "electrifying" old-type phonographs, is illustrated in these columns. It is a pick-up unit of the electromagnetic type, small in size, light in weight,

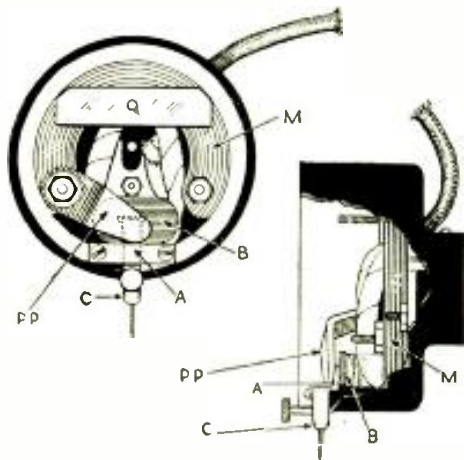

Illustrations courtesy The Alden Mfg. Co.

All important details of the new phonograph pick-up unit are illustrated in the above drawings, which clearly show the construction.

and will fit on the tone-arm of any standard talking machine.

From the electrical viewpoint the phonograph pick-up unit may be described as a device which converts the mechanical vibrations from the record into electrical energy. The two output wires of the pick-up are connected with the primary winding of the first-stage transformer in the audio amplifier of a radio receiver, and the energy delivered by these wires is amplified by the tubes and reproduced by the loud-speaker.

Electrical reproduction of phonograph records has many advantages over the mechanical method, if efficient apparatus is used throughout. The audio amplifier and loud-speaker of the average radio receiver are capable of better reproduction than the old fashioned phonograph horn and, therefore, able to provide better results. Secondly, greater volume is obtainable when using an audio amplifier; and thirdly, it is possible to have a gradual control of volume from practically zero to maximum.

In the drawings on this page the construction of the phonograph pick-up under discussion is clearly illustrated. It is housed in a composition case, 2 inches in diameter and 1 inch deep. On the rear of the case there is a bushing with a set screw for attaching the unit to the phonograph tone-arm. When the front of the case is removed a large horseshoe magnet (M) and a small coil bobbin (B) may be seen. The phonograph needle is inserted in the chuck at C and from it the vibrations are transmitted to the armature (A), where they cut the lines of magnetic force between the coil and the pole piece (PP) of the magnet, thus producing an electric current.

LOUD-SPEAKER UNIT EMPLOYS PUSH-PULL PRINCIPLE

USE of apparatus in push-pull arrangement seems to be the latest fad in radio. The new super-hilodyne circuit incorporates a push-pull radio-frequency circuit, some of the new superheterodyne receivers provide a push-pull detector circuit, and a large number of the new audio amplifiers have a push-pull circuit in the last stage. Also, in rectifier circuits, a push-pull or full-wave arrangement is often employed; and now there is on the market a push-pull type loud-speaker unit.

In all cases where apparatus is used in push-pull, many claims are made for the system; greater and more uniform output are usually the most important advantages.

The same rule seems to apply to the push-pull loud-speaker unit. In this device, which consists of two loud-speaker units mounted on one frame, and driving the diaphragm through one pin, the inventor has endeavored to obtain more uniform results by adjusting the two sections so that the peak performance of each is at a different frequency. In this way it is possible to obtain a uniform response

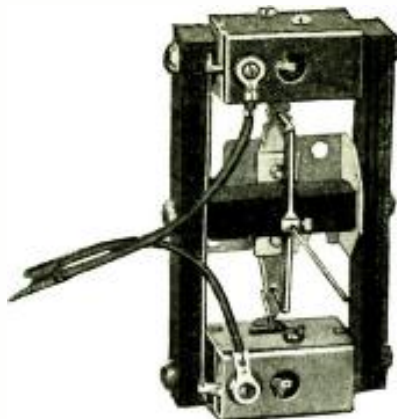

A

Two new loud-speaker units of novel design. The one on the left is a "push-pull" combination; that on the right is a single unit.

Illustrations courtesy The Ferguson Company

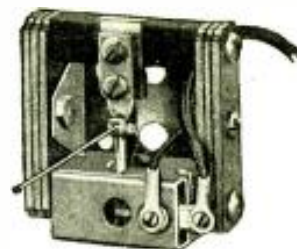

B

response from the loud speaker over a much greater band of frequencies.

Other claims are also made for the push-pull loud-speaker driving unit. It is explained that, in units where but a single drive is used, the motion of the driving pin is not uniformly back and forth, but tends to be circular. This places a strain on the paper cone and may be a cause of poor reproduction. In units where there is a double drive this fault is absent.

The construction of the push-pull loud-speaker unit is shown in A of the accompanying illustration, and B is a single speaker unit, of similar design, which is made by the same manufacturer. It will be noticed that the double unit consists of two single magnets mounted in the same frame with the driving members connected. The windings of the two units are connected in series, but they have a total resistance which is equivalent to the average speaker unit.

FILTER DEVICES KEEP AUDIO CURRENTS IN PROPER CHANNELS

TWO new parts, which may be used to advantage when modernizing the audio-frequency amplifier of an old receiver, are illustrated on this page. Each type of unit contains an audio-frequency choke coil and a by-pass condenser, but is used in a different part of the circuit. The one on the left is known as a clarifier, or output filter, and that on the right is called an "audichoke."

The output filter is designed to prevent the high-voltage plate-supply current from passing through the windings of the loud speaker, and at the same time to assist the output signal energy of the receiver to build up and operate the speaker unit to the fullest advantage. When the loud speaker is connected directly in the plate circuit of the tube, as in a majority of receivers, the speaker unit is partially paralyzed as a result of the high value of the current passing through the windings. Therefore, when a filter is used, the quality of reproduction is usually improved; and, in addition, the life

(Continued on page 836)

These two units may be used to improve the efficiency of audio-frequency amplifiers. A, output filter; B, "audichoke."

Illustrations courtesy Leslie F. Muter Co.



A



B

List of Broadcast Stations in the United States

Radio Call Letter	BROADCAST STA. Location	Wave (Meters)	Power (Watts)	Radio Call Letter	BROADCAST STA. Location	Wave (Meters)	Power (Watts)	Radio Call Letter	BROADCAST STA. Location	Wave (Meters)	Power (Watts)
KDKA	East Pittsburgh, Pa.	**316	50000	KGER	Long Beach, Calif.	216	100	KWJJ	Portland, Ore.	229	50
KDLR	Devils Lake, N. D.	231	15	KGES	Central City, Neb.	204	10	KWJL	(Also 53.54 meters, 100 watts)		
KDYL	Salt Lake City, Utah	258	100	KGEU	Lower Lake, Calif.	227	50	KWKK	Kansas City, Mo.	222	100
KELW	Burbank, Calif.	229	*500	KGEV	Fort Morgan, Colo.	219	*100	KWKH	Shreveport, La.	395	1000
KEX	Portland, Ore.	240	2500	KGEZ	Denver, Colo.	201	250	KWLC	Decorah, Iowa	248	50
KFAB	Lincoln, Neb.	319	5000	KGFH	Kallisell, Montana	294	100	KWSC	Pullman, Wash.	395	500
KFAC	Phoenix, Ariz.	273	500	KGFB	Iowa City, Iowa	224	10	KWTC	Santa Ana, Calif.	222	100
KFAU	Boise, Idaho	285	*2000	KGFG	Alva, Oklahoma	205	25	KWUC	Le Mars, Iowa (day)	**244	1500
KFBB	Havre, Mont.	275	100	KGFG	Oklahoma City, Okla.	216	50	KWWG	Brownsville, Texas	278	500
KFCB	San Diego, Calif.	248	100	KGFH	La Crescenta, Calif.	224	250	KXA	Seattle, Wash.	349	500
	(Also 65.18 meters)			KGFI	San Angelo, Texas	220	15	KXL	Portland, Ore.	220	50
KFBK	Sacramento, Calif.	535	100	KGFK	Los Angeles, Calif.	208	100	KXRO	Aberdeen, Wash.	227	50
KFBL	Everett, Wash.	224	50	KGFL	Hallock, Minn.	224	50	KYA	San Francisco, Calif.	309	500
KFBW	Laramie, Wyo.	484	500	KGFM	Raton, N. M.	222	50	KYV	Chicago, Ill.	526	100
KFCR	Phoenix, Ariz.	211	125	KGFN	Yuba City, Calif.	211	15	KZM	Oakland, Calif.	246	100
KFDM	Santa Barbara, Calif.	211	50	KGFO	Aneta, N. Dak.	200	15	NAA	Arlington, Virginia	**434	1000
KFDM	Beaumont, Texas	484	500	KGFP	Los Angeles, Cal. (port.)	204	100	WAAD	Cincinnati, O.	268	25
KFDX	Shreveport, La.	236	250	KGFP	Mitchell, S. Dak.	213	10	WAAF	Chicago, Ill.	389	500
KFDY	Brookings, S. D.	545	500	KGFX	Ravenna, Neb.	297	10	WAAM	Newark, N. J.	263	500
KFDZ	Minneapolis, Minn.	216	10	KGGF	Ple rye, S. D. (day)	254	200	WAAT	(Also 65.18 meters, 50 watts)		
KFEC	Portland, Ore.	214	50	KGGH	Picher, Okla.	207	100	WAAT	Jersey City, N. J.	246	300
KFEL	Denver, Colo.	248	250	KGGI	Cedar Grove, Ia.	213	50	WAAW	Omaha, Neb. (daytime)	441	500
KFEQ	St. Joseph, Mo.	231	1000	KGGM	Logueville, Calif. (port.)	204	100	WABC	Richmond Hill, N. Y.	309	*2500
KFEJ	Kelso, Idaho	242	10	KGGH	(6XAL, 66.04 meters, 50 watts)			WABF	Princeton, Pa.	205	250
KFGQ	Boone, Iowa	210	10	KGHG	Honolulu, Hawaii	227	250	WABI	Princeton, Pa.	205	250
KFH	Wichita, Kan.	246	500	KGHF	Slayton, Minn.	210	15	WABJ	Baltimore, Md. (Sundays)	389	100
KFHA	Gunnison, Colo.	254	50	KGHF	Pueblo, Colo.	210	250	WABO	See WHEC		
KFHL	Oskaloosa, Iowa	213	10	KGHP	Hardin, Mont.	263	50	WABQ	Philadelphia, Pa.	224	500
KFI	Los Angeles, Calif.	468	5000	KGO	Oakland, Calif.	**384	5000	WABW	Wooster, Ohio	248	50
KFIF	Portland, Ore.	214	50	KGRG	San Antonio, Texas	220	50	WABY	Philadelphia, Pa.	248	50
KFIO	Spokane, Wash.	246	100	KGRS	Amarillo, Texas	244	150	WABZ	New Orleans, La.	245	500
KFIZ	Juneau, Alaska	295	10	KGTI	San Francisco, Calif.	207	50	WADC	Akron, Ohio	231	100
KFJB	Fond du Lac, Wis.	**268	100	KGTU	Honolulu, Hawaii	270	600	WADF	Dayton, Ohio	500	500
KFJF	Marshalltown, Iowa	248	100	KGW	Portland, Oregon	492	1000	WAGM	Royal Oak, Mich.	225	50
KFJF	Oklahoma City, Okla.	273	*750	KGY	Lacey, Wash.	244	50	WAIT	Taunton, Mass.	214	10
KFJI	Astoria, Ore.	250	15	KHAC	(airplane) San Francisco	204	50	WAIV	†Columbus, Ohio	283	5000
KFJM	Grand Forks, N. D.	333	100	KHJ	Los Angeles, Calif.	416	500	WAIZ	Appleton, Wis.	227	100
KFJR	Portland, Ore.	283	100	KHMC	(Also 104.1 meters; 50 watts)			WALK	Willow Grove, Pa.	201	50
KFJY	Fort Dodge, Iowa	232	100					WAMD	†Minneapolis, Minn.	225	500
KFKZ	Fort Worth, Texas	256	50								
KKA	Cheyenne, Colo.	246	200								
KKBK	Midford, Kansas	242	*1500								
KKBU	Lawrence, Kansas	251	500								
KKCK	Chicago, Ill.	526	2500								
KKXZ	Kirksville, Missouri	225	15								
KKLV	Rockford, Ill.	268	100								
KKFLX	Galveston, Texas	270	100								
KKFM	Sioux City, Iowa	232	100								
KKFN	Northfield, Minn.	246	500								
KKFN	Shenandoah, Iowa (day)	461	2000								
KFOA	Seattle, Wash.	447	1000								
KFON	Long Beach, Calif.	242	500								
KFOR	Lincoln, Neb.	217	100								
KFOX	Omaha, Neb.	258	100								
KFOY	St. Paul, Minn.	285	250								
KFPJ	Dublin, Texas	275	15								
KFPK	Greenfield, Conn.	231	15								
KFPR	Los Angeles, Calif.	232	250								
KFPW	Cartersville, Mo.	263	50								
KFPY	Spokane, Wash.	246	250								
	(7XAL, 105.9 meters, 50 watts)										
KFQA	St. Louis, Mo.	248	50								
KFQB	Fort Worth, Texas	333	1000								
KFQC	Anchorage, Alaska	315	100								
KFQU	Holy City, Cal.	250	100								
	(Also 3, 53.63, 106 meters, 50 watts)										
KFQW	Wenatchee, Wash.	217	100								
KFQZ	Hollywood, Calif.	232	100								
	(Also 108.2 meters, 50 watts)										
KFRG	San Francisco, Calif.	454	1000								
KFRU	Columbia, Missouri	250	500								
KFSD	San Diego, Calif.	441	500								
KFSG	Los Angeles, Calif.	275	500								
	(Has short-wave transmitter)										
KFUL	Galveston, Texas	258	500								
KFUO	Colorado Spgs., Colo.	283	1000								
KFUQ	†Chlorado, Mo.	545	1000								
KFUP	Denver, Colo.	227	100								
KFUR	†Oregon, Utah	225	500								
KFUS	Oakland, Calif.	231	50								
KFV	Salt Lake City, Utah	250	50								
KFVD	Venice, Calif.	208	250								
	(Also 105 meters, 50 watts)										
KFVE	St. Louis, Mo.	234	*1000								
KFVG	Independence, Kan.	225	50								
KFVI	Houston, Texas	238	50								
KFVW	Cape Girardeau, Mo.	*224	50								
KFWB	Los Angeles, Calif.	261	500								
	(Also 105 and 40 meters, 50 watts)										
KFWC	Glendora, Calif.	222	100								
KFWF	St. Louis, Mo.	214	250								
KFWH	Eureka, Calif.	254	100								
	(Also 108.2 meters, 50 watts)										
KFWI	San Francisco, Calif.	268	500								
KFWM	Oakland, Calif.	236	*500								
KFYD	Avon, Calif.	306	250								
KFXD	Jerome, Idaho	204	15								
KFXF	Denver, Colo.	283	250								
KFXJ	Edgewater, Colo. (near)	216	500								
KFXR	Oklahoma City, Okla.	224	500								
KFYX	Flagstaff, Ariz.	205	25								
KFYO	Breckenridge, Tex.	211	50								
KFYR	Bismarck, N. Dak.	250	*250								
KGA	Spokane, Wash.	261	2000								
KGAR	Tucson, Ariz.	234	100								
KGBS	Seattle, Wash.	203	100								
KGBU	Ketchikan, Alaska	229	500								
KGBY	St. Joseph, Mo.	288	100								
KGBZ	Columbus, Nebraska	203	50								
KGC	York, Nebraska	213	100								
KGC	Decorah, Iowa	248	10								
KGC	Oklahoma City, Okla.	216	50								
KGC	Wayne, Nebraska	294	250								
KGCI	San Antonio, Texas	220	15								
KGCL	Seattle, Wash.	231	50								
KGCN	Concordia, Kansas	208	50								
KGCR	Brookings, So. Dak.	208	15								
KGCU	Mandan, N. Dak.	210	100								
KGCX	Wells, Montana	244	10								
KGDA	Well Rapids, So. Dak. (daytime)	254	15								
KGDE	Barrett, Minn.	205	50								
KGDJ	Cresco, Iowa	203									

American Radio Is More Difficult to Tame

Doctors of Radio Argue Over Contradictory Behavior of Waves Here and In Europe

By S. R. WINTERS

THE discussions of the International Union of Scientific Radiotelegraphy, which met recently in Washington, D. C., were conspicuous for their disagreement as to the behavior of radio waves in different countries of the world. The vagaries of electromagnetic waves are proverbial; but it is reasonable to suppose that these whims should vary little in their nature between America and England, for example. Lack of accord on the underlying theories of radio, however, was the rule rather than the exception among world scientists at their 1927 international meeting.

Notable among the discordant viewpoints, are those of the theoretical effect of cold weather in strengthening radio signals. In America, this is such a commonly-accepted phenomenon that we time our radio shows, introduce new models in receiving sets, curtail the use of automobiles, and furbish our corroding antennas on the fall of temperature in October. The tendency of cold weather to boost the strength of radio signals, both day and night, is so pronounced that, if summer lasted twelve months, all of the "DX" hunters in the United States would die a natural death.

Yet representatives from England, France, Italy, Germany, other European countries and Japan, attending the meetings of the International Union, expressed the opinion that this relationship between temperature and signal strength is confined to America. "Another effect," epitomize these world scientists, "which has been observed in America but apparently not in other countries of the Union is the tendency for signal intensities to rise both by day and night when the temperature falls."

THE RECORDS DISAGREE

The early experiments of Dr. I. W. Austin at Brant Rock, Mass., and Arling-

ton, Va., indicated a consistent decline with the distance in the strength of signals over salt water in the daytime, for wave-lengths of 1,000 to 4,000 meters. Recent daylight experiments on a wavelength of 14,000 meters in Europe, produced evidence of interference between ground and sky-reflected waves, with the result of well-defined maxi-

um and minimum intensities instead of a proportional decrease with increased distance. In the final analysis, this meant that the intensity of the signal received at Aberdeen, Scotland, at a distance of 620 miles from the transmitter, was three times as great as the field strength of the received signal at Manchester, England, at a distance of only 400 miles. Measurements made in Washington, D. C., on signals of the transatlantic stations at New Brunswick, N. J., Tucker-ton, N. J., Rocky Point, Long Island, and Marion, Mass., have not indicated any periodic relation of intensity to distance, at least in the daytime.

"At night," reports Dr. Austin, "there is plenty of evidence of interference; as the signals from the stations at 270 miles and 410 miles have fallen, with considerable regularity, far below their day values during the past summer, while those from the two stations at 175 miles have risen at night, or remained fairly constant. The conditions of these experiments are, of course, somewhat different from those in England; inasmuch as the signals are measured at one point and the transmitting stations at the various distances transmit on different wave-lengths. Nevertheless, since these experiments, some of which have been continued over many years, indicate a regular falling-off of intensity with the distance in the daytime, it would seem that they must be held to be in disagreement with the English results. Therefore, it would seem very desirable to carry out, in other places, further measurements, some of which might well be on signals over water, as well as over land of different characteristics."

OLD SOL—GUILTY OR NOT GUILTY

In America, observations made by the Bell Telephone Laboratories have indicated a connection between magnetic storms and transatlantic radio transmission, resulting in a reduction of signal strength at night and a probably slight increase in the day. Dr. Greenleaf W. Pickard has produced what appears to be convincing proof of the dependence of radio vagaries on the activity of the sun. His observations at Newton Centre, Mass., showed a decrease in signal strength at night, with increasing numbers of sunspots within the broadcasting band of wavelengths, and an increase in signal strength at the extremely short waves or high frequencies.

In direct antithesis to this American conclusion is the experience of savants in France, who have failed to establish any relationship between radio phenomena and solar activity or magnetic storms. The English scientists, on the other hand, have noticed a relationship between magnetic storms and the signals emanating from stations at distances from 60 to 190 miles, but not at greater distances.

The United States Bureau of Standards, to contribute further to the confusion of viewpoints, has shown that the long-wave, transatlantic daylight signals, when averaged by months, follow in a general way the sunspot numbers with the changing 11-year cycle. "This conclusion," indicates the Bureau, by way of modification, "can be stated only as probable from 1915 to 1922, on account of possible errors in the signal measurements; but since the beginning of 1922, the increase of signal intensity with increasing solar activity seems certain."

"In regard to the effect of magnetic storms on transmission at distances of from 185 to 620 miles," reports Dr. Austin, "the French observations at Meudon on the transmitting stations at Bordeaux and Nantes (317 and 223 miles distant, respectively) are in agreement with the British and at variance with the American observations. Our impression is, however, that the conclusions, which can be drawn from the American observations, are somewhat less positive in regard to all these statements than those expressed in the British report.

(Continued on page 844)

If summer lasted twelve months, all the "DX" hunters in the United States would die a natural death.



ton, Va., indicated a consistent decline with the distance in the strength of signals over salt water in the daytime, for wave-lengths of 1,000 to 4,000 meters. Recent daylight experiments on a wavelength of 14,000 meters in Europe, produced evidence of interference between ground and sky-reflected waves, with the result of well-defined maxi-

Europeans express the opinion that this relationship between temperature and signal strength is confined to America.



Further Notes on Fading



Findings of the Experiments and Tests Made by the Bureau of Standards

By S. R. WINTERS

THE waxing and waning of radio signals, an exasperating experience of such common occurrence to broadcast listeners, is a phenomenon better understood as the result of findings of the Bureau of Standards and twenty-three co-operating laboratories, those of telephone, telegraph and radio companies, universities and individuals. While, admittedly, no cure is offered for fading, the additional information imparted as to cause and effect is inspiring to the scientist and interesting to the layman.

If you live in a zone between 60 to 125 miles from a broadcast station, the fluctuation of signals will be observed in its most aggravating form. If you are listening to an address by the President, his remarks will be intermittently punctuated with silence; thus (to the listener) breaking the continuity of thought. Or, if you are listening to a musical program, the swinging of the intensity of the music from maximum to minimum may cause you to wonder whether the position of the microphone is being changed or the strings of the musical instruments have been broken.

The Bureau of Standards and its co-operators found corroborating evidence to support the theory that fading is due to irregular absorption of the radio waves in the ionized upper atmosphere, and is therefore a condition beyond the control of the transmitting and receiving stations. These continent-wide observations discovered nothing that would disturb the previously accepted facts as disclosed by a similar investigation in 1920 and 1921; namely: that the

fluctuations of signals are erratic, varying in duration from one second to several minutes; that fading is independent of weather conditions; and that the waxing and waning of the intensity of music or speech are not simultaneous, or similar, at two receiving points in close proximity.

The conclusions drawn by the Government and co-operating laboratories are based upon a hundred and fifty graphic fading records, and the geographical distribution of the observing stations embraced an area extending from Ottawa, Canada, to Hamilton in Bermuda, and from East Lansing, Michigan, to Newton Centre, Massachusetts.

This investigation confirms certain beliefs about fading which had heretofore been surmised. For instance: The waning of the signal over several minutes is due to the variable absorption of the radio waves in the atmosphere, and the fading of very short duration—only a few seconds—at distances less than 125 miles from the transmitting station, is attributable to interference between the ground-transmitted wave and the wave which has traveled to the Kennelly-Heaviside layer and undergone variable changes of intensity, phase, and polarization. There is a degree of regularity in the average intensity during conditions of fading which has not hitherto been suspected—the ratio of average night to day intensity has a logarithmic relation to distance—this relation gives quantitative indication that the absorption of radio waves by the earth which is

effective in the daytime disappears at times during the night, and permits calculation of the "absorption coefficient."

HIGH POWER NOT A CURE-ALL

That high power is a cure for fading is a plausible supposition, but finds no support

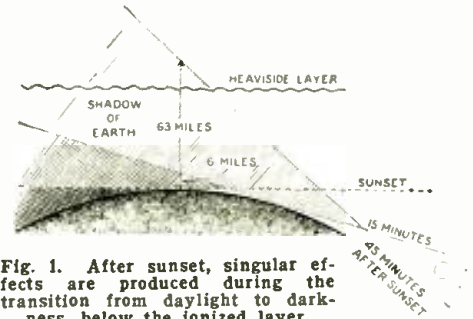
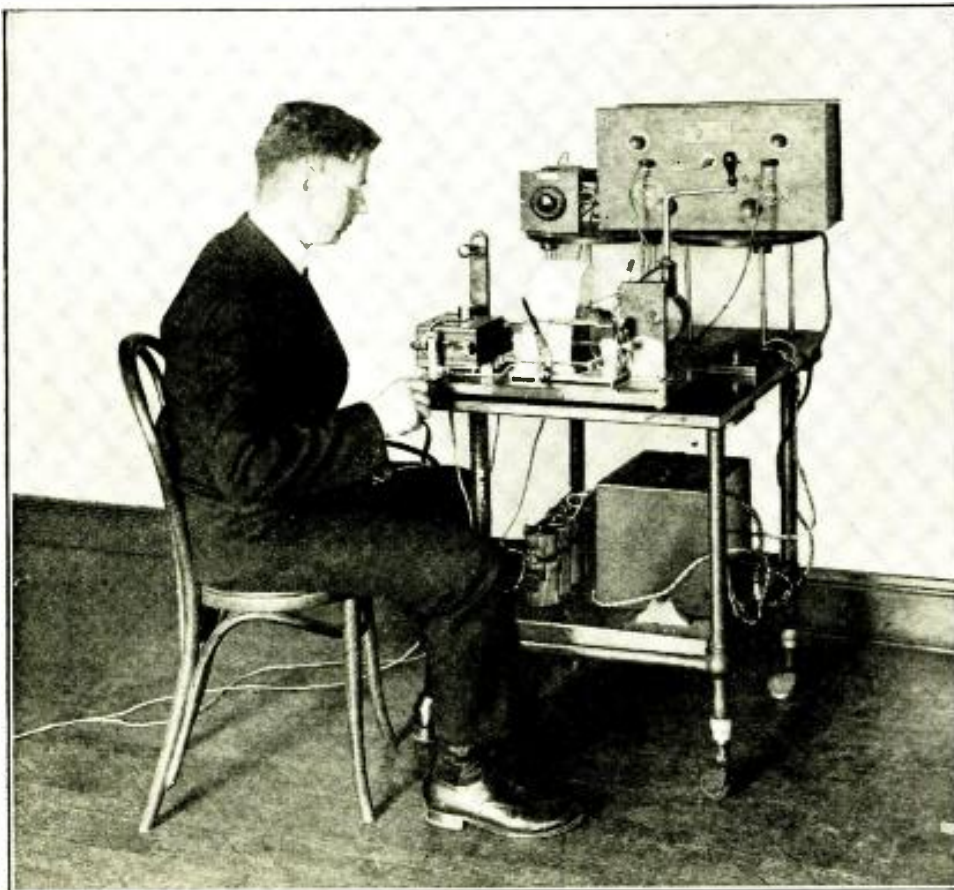

Fig. 1. After sunset, singular effects are produced during the transition from daylight to darkness, below the ionized layer.

in the conclusions of this investigation; for the two broadcasting stations using the greatest amounts of power—KDKA and WGY—suffer most from this phenomenon of the waxing and waning of signals. "The very large fluctuations of intensity averaged the same on high and low power," reports the Bureau of Standards, "although, for any one place or time, the average fluctuation might be greater for either the low or the high power. This conclusion, based on actual analysis of the records, means that fading fluctuation is unaffected by variations of transmitting power."

Fading is a vagary in itself but this phenomenon seems to possess certain other peculiarities that would identify it as the foster father of vagaries. For example, these observations showed that there is sometimes a special periodic type of fading of great regularity, beginning about 15 to 20 minutes after sunset, the periodicity of which shows a correlation with the distance between the transmitting and receiving points, and which is evidently due to an interference phenomenon. "This phenomenon," states the Bureau of Standards, "is the only instance known in which fading occurs of a character suggesting wave interference of a highly-regular type similar to optical interference. This interference is apparently associated with the passing of the sunset shadow-plane, for it appears at no other time on any of the records. It begins about 15 minutes after sunset, at which time the tangent rays of the sun pass 10 kilometers (6¼ miles) above the earth's surface; it ends at about 45 minutes after sunset, when the tangent rays pass about 100 kilometers (62 miles) above the surface (96 kilometers for transmission from Schenectady, N. Y., to Washington, D. C., for example)." (Fig. 1. See also "The Cause and Elimination of Fading," page 635, December RADIO NEWS.)

In conclusion, "The results of 150 graphic records made by the co-operating observers established definitely a number of facts about fading that had been only surmised or guessed previously. In addition, a number of new facts about fading and other vagaries of radio waves were brought to light. Fading is at its worst about 60 to 125 miles from a broadcasting station; for greater distances it diminishes, but then increases again with distance, and has repeated maxima and minima for greater distances. There are two readily distinguishable kinds of fading, a fairly slow and a relatively rapid fluctuation."



T. Parkinson, of the Bureau of Standards, Washington, D. C., operating his new static and fading recorder and measurer of station-signal strength, used in the tests described herewith.

The Shielded-Grid Tube At Last Arrives

Fourth Element. A Double-Screen Grid. Overcomes Troublesome Grid-to-Plate Capacity Effect: Amplification Factor Is 250;

A NEW four-element amplifier tube, using a double screen-grid to shield the regular grid electrode, has just made its advent on the American market. It should be of great interest to all radio constructors and experimenters, because it possesses unusual characteristics that make it far superior to the ordinary three-element valve for radio-frequency amplification and because it represents what is probably the only real advancement in receiving-tube principles since the invention of the triode by Lee de Forest, in 1907.—EDITOR.

DURING the past twenty years, de Forest's three-element tube, which is directly responsible for the tremendous growth of radio in general and for the very existence of broadcasting itself, has been undergoing gradual improvement in mechanical construction and electrical efficiency; but, because its original filament-grid-plate arrangement has been faithfully retained, its fundamental principles of operation have not changed in the slightest. The addition of the fourth electrode has produced an entirely different tube of unique features, just as de Forest's addition of a grid between the filament and plate of the old Fleming valve created a device of radically different nature.

The *shielded-grid* tube (which may also be designated as a "shielded-plate" tube) opens a new and entrancing field in radio-frequency amplification, a field which the home experimenter as well as the laboratory engineer can explore for diversion, edification or profit. The technique of the tube is altogether different from that of its predecessor: it requires the use of special circuits designed to take advantage of its peculiar operating characteristics.

Although the new tube is a noteworthy development, it must not be expected to revolutionize the industry, or to render obsolete receiving sets of the types now in use. It does give greater radio-frequency amplification per tube than former types; but a certain number of tuned circuits must nevertheless be used, under present-day broadcast conditions, to obtain satisfactory selectivity.

APPEARANCE OF THE TUBE

The shielded-grid tube greatly resembles, externally, one of the ordinary 201A type; it is of about the same diameter, but slightly longer. It is equipped with a standard four-prong UX base, the fifth connection being made to a small brass cap which is mounted on the top of the glass bulb. The glass appears to be partially silvered on the inside, as do most tubes because of certain chemical treatments which they undergo during evacuation.

The cut-away view of the tube, which appears on this page, shows very plainly the internal construction and the arrangement of the four elements. Starting at the very inside, we first observe a vertical filament, F, which is stretched taut by its supporting brace wires. Surrounding this filament is a spiral grid, G, about one eighth inch in diameter, and having a pitch of about a sixteenth of an inch. So far, the tube is identical with the standard

triode. The ends of the filament are connected to the two heavy contact pins in the tube base, while the grid, which is the normal control-electrode, is connected to the upper brass cap on the glass.

THE FOURTH ELEMENT

The screen-grid is structurally double, consisting of two spirals of fine wire, SG. They are connected together, to act as one element, by a small metal disc which forms a sort of cap for the whole internal assembly. It will be noticed that the inner screen-grid (the turns of which are much closer together than those of the

for this purpose it is not interchangeable with general purpose three-element tubes, and cannot be used to replace them in standard receiving sets. It has a theoretical voltage-amplification factor of about 250, which makes possible an actual voltage amplification of about 20 to 30 per stage (depending on circuit losses), as compared with about 4 to 6 per stage, with ordinary three-element tubes.

The tube may be used also as a "space-charge" tube in audio circuits, and is useful for other experimental circuits in which a double-grid, four-element tube is required.

The filament of the new amplifier draws 0.132 ampere at 3.3 volts, making it equivalent in this respect to a tube of the 120 type. The plate voltage is 135; this is the recommended and the maximum value. When used in conjunction with storage-battery tubes of the 201A type, which have five-volt filaments, each shielded-grid tube should have a 15-ohm resistor in series with its negative lead. The resistor and filament may then be connected directly in parallel with the five-volt filaments of the other tubes and operated from the same rheostat. Of course this arrangement may easily be modified to suit other conditions of operation, as the only change necessary is in the value of the series resistor. In calculating rheostat resistance, it will be convenient to consider two shielded-grid tubes, with resistors, as drawing the same current as a 201A.

When the shielded-grid tube is used in dry-battery operated receivers, no filament resistor other than the customary rheostat is necessary, and its filament may be connected directly in parallel with filaments of the 3.0-3.3-volt type. In the calculation of rheostat resistance, the filament current may be considered equal to that drawn by two 199-type tubes.

WIRING CONNECTIONS

When used as a screen-grid radio-frequency amplifier the new tube is operated under the following conditions: plate voltage 135, connection through plate prong in base; the screen-grid (SG), 45-volt positive bias, through grid prong in base; the control grid (G), 1 to 1.5 volts negative bias with respect to the negative side of the filament, through metal top cap; filament, 3.3 volts. Neither plate nor screen-grid voltage is critical; the same bank of batteries may be used for both by merely taking off a 45-volt tap for the screen grid.

The bias for the control-grid may be obtained either from a separate 1.5-volt dry cell or from the voltage drop across a portion of the filament resistor when the tube is used on a six-volt "A" supply.

The internal shielding of the electrodes by the screen-grid makes neutralization of the plate-to-grid capacity unnecessary. However, every precaution must be taken to shield the control-grid circuit from other circuits. This is best accomplished by surrounding the grid coils, condensers and other grid-circuit components with metal shields. The shielding is further aided by keeping the lead from the control-grid (the wire running to the metal cap on the top of the tube) as short and as direct as possible; in some cases it may be necessary to surround the grid lead by a grounded metal sheath. Armored flexible cable, such as

(Continued on page 826)

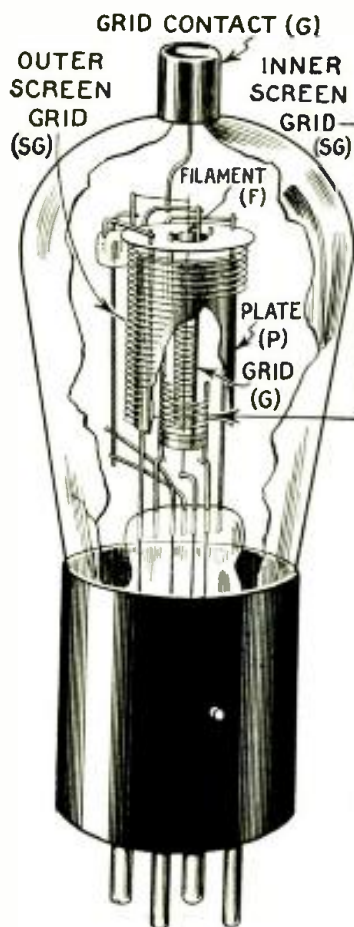

This cut-away drawing clearly shows the internal construction of the new shielded-grid tube.

control-grid, G), is located between the latter grid and the inner surface of the cylindrical plate; while the outer screen surrounds the outer surface of the plate. The screen-grids, so named because of their obvious resemblance to screens, are connected to what is normally the grid pin on the tube base; the plate goes to the regular plate pin. The end view of the base shows these connections.

The outer screen-grid shields the outer surface of the plate against the capacity effect of its surface in relation to the connecting wires in the tube.

ENORMOUS AMPLIFICATION

The shielded-grid tube is designed primarily for use as a radio-frequency amplifier in circuits designed to make use of its high voltage amplification and its low feed-back capacity between the plate and the inner (control) grid, G. When used

The Tyrman Shielded-Grid Seven

A Superheterodyne Obtaining Enormous Amplification from Three R. F. Stages
Incorporating Tubes of New Type

By ASHUR VAN A. SOMMERS

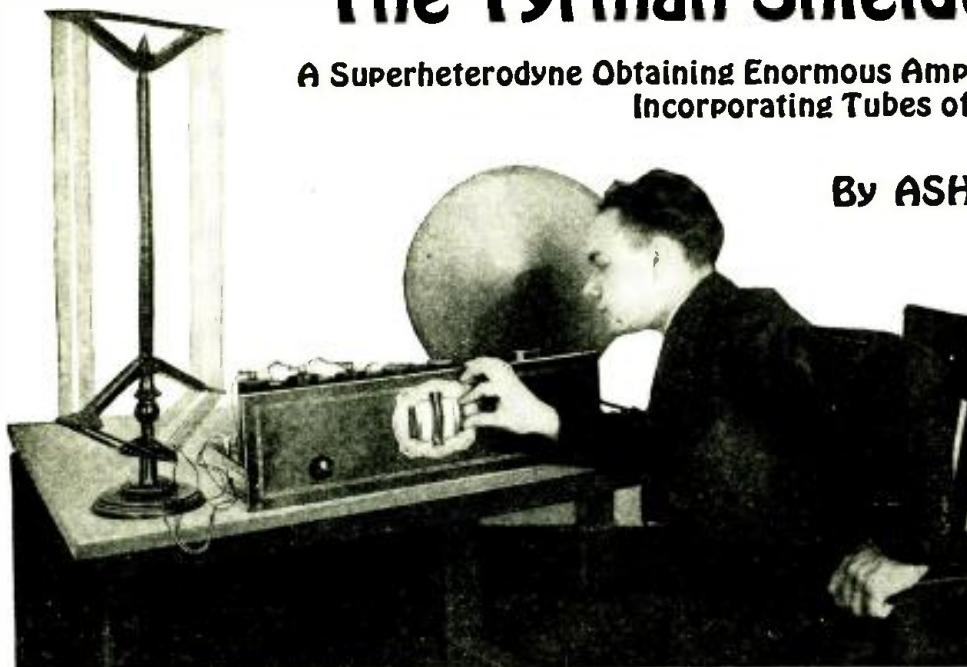

The Tyrman Shielded-Grid Superheterodyne, under test in the RADIO NEWS LABORATORIES.

THE remarkable possibilities of the shielded-grid type of tube, with its practical elimination of inter-element tube capacity, and the enormous amplification with stability in the high-frequency circuits, have appealed to radio fans, long before this new addition to radio facilities emerged from the laboratory. In this article there is now made available for the first time a circuit designed to take full advantage of the possibilities of this tube, in producing a 7-tube receiver of extraordinary sensitivity and ease of control, equalling in amplification the possibilities of a combination of many additional tubes and avoiding the complications introduced by the latter. The constructor will find it easy to build and highly satisfactory in operation.

—EDITOR.

SINCE the beginning of broadcasting, no radio development submitted to the public has farther-reaching possibilities than the newest shielded-grid tube. To what extent this new invention will affect the design and efficiency of radio receivers cannot be predicted at this time; but it is safe to say that the tube is capable of providing enormous amplification in specially-designed radio-frequency circuits. Therefore, it may be destined to revolutionize radio receiving apparatus.

Previous to the publication of this article the shielded-grid tube has been the toy of radio experimenters and engineers. For months laboratories throughout the country have been busied in improving circuits in which the tube may be used, and in making comparisons between standard receivers and those using the new shielded-grid principle. However, amateurs have not been able to share in this experimental work, but have had to content themselves with reading enthusiastic laboratory reports which state that it is possible to secure amplification ten times greater than that obtained with other systems.

Shielded-grid tubes are now available for the home constructor and experimenter, and the tubes are identical with those which have produced such phenomenal results in research laboratories. As the interest, which has been already manifested in this direction, indicates that there are thousands of readers who are anxious to start experimental work with the new tubes, two articles containing much helpful information are published in this issue.

SET EMBODIES NEW PRINCIPLE

In the following pages the construction of a seven-tube superheterodyne receiver, using three of the new shielded-grid tubes in the intermediate-frequency circuits, is described in detail. It is believed that this is the first receiver of this type to be made available for home construction. The article on the page preceding this one gives complete operating data for the new tubes and will be found of great value when experimenting with circuits other than the one described in this article.

This receiver, which is known as the Tyrman Shield-Grid Seven, is not an experiment or a laboratory design, but is a finished product which is known to operate satisfactorily. It is the result of sev-

eral months of intensive experimental work, and provides an ideal set for one who desires the utmost in sensitivity. Another feature is that standard parts are used throughout in the construction.

Various pictures which appear in these pages show all details of the completed receiver. From these illustrations it may be seen that the set presents the appearance of a well-designed factory receiver. The apparatus used in the construction is mounted on the front and sub-base panels in a symmetrical arrangement which is pleasing to the eye.

SIMPLICITY OF CONTROL

In the front view of the set the arrangement of controls is shown. Although the set incorporates entirely new principles, the operation is not difficult. The only wavelength tuning control of the set is the double drum dial in the center of the panel. In actual practice the two drums of this dial have practically identical settings for all wavelengths within the broadcast band. The knob in the lower right corner of the panel operates a combination instrument which serves as a volume control and control switch. The control at the left of the panel operates a switch, which need seldom be used when tuning the receiver.

The arrangement of apparatus mounted above the sub-base panel is shown in the top view of the receiver. On the rear edge of the sub-base are six octagonal containers of identical appearance. The three on the left contain the R.F. apparatus, and the three on the right the audio apparatus. Directly in front of these units the seven sockets of the set are mounted. Each socket is equipped with a special shield and these add to the efficiency as well as the appearance of the receiver.

In wiring the receiver all connections are made under the sub-base panel, as may be seen in another view of the set. This feature also adds to the business-like appearance of the set. In addition several small parts, including fixed resistors and

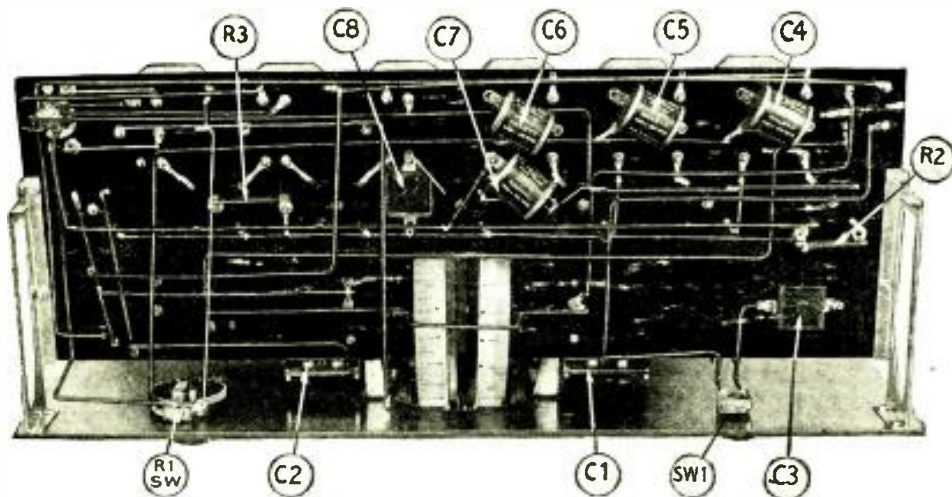

All the wiring of the receiver and eight small parts are located under the sub-base panel. C4, C5, C6 and C7 are 1-mf. by-pass condensers; C3 and C8, mica fixed condensers; R2 and R3, filament resistors.

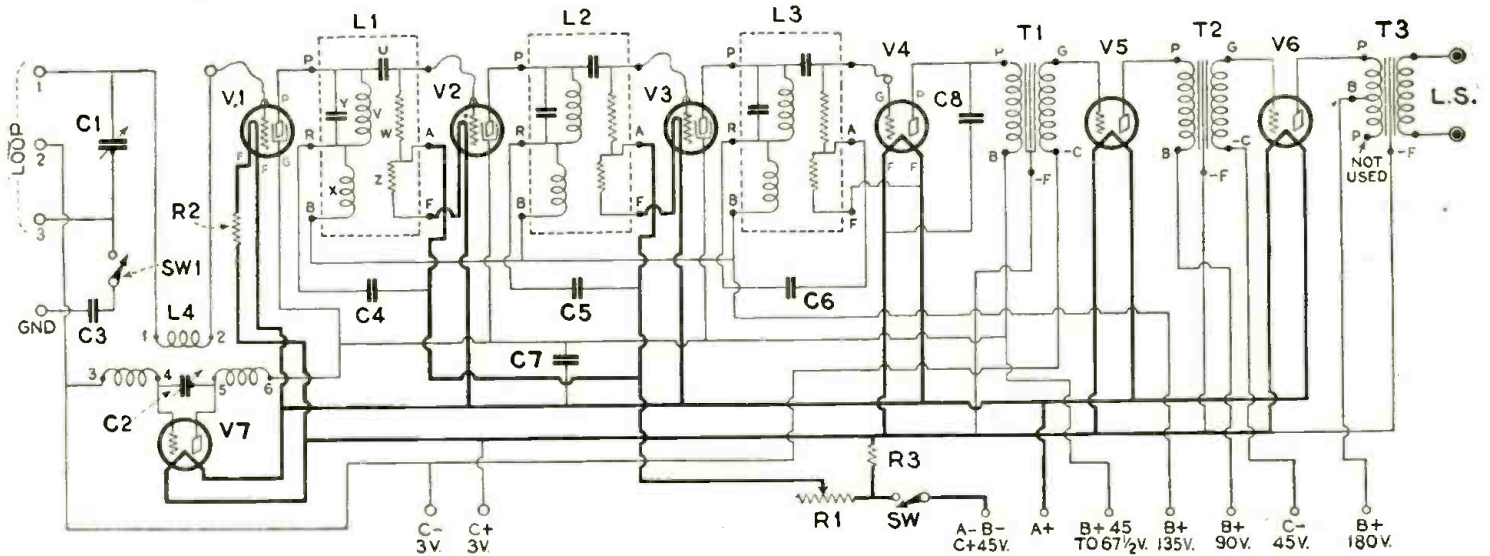

Fig. 1. Complete schematic wiring diagram of the Tyrman Shielded-Grid Seven, giving details of all connections. The symbols which are used to identify the various pieces of

apparatus in the circuit correspond to those used in the list of parts and the other illustrations which accompany this article.

fixed condensers, are mounted under the sub-base panel.

ELEMENTS OF THE CIRCUIT

Before entering into a description of the construction of this receiver the circuit will be considered. This will be found in Fig. 1. It will be noticed that the receiver consists of a circuit employing an oscillator, a first detector, two stages of intermediate-frequency amplification, a second detector and two stages of audio-frequency amplification. Although three stages of intermediate-frequency amplification are required in the average superheterodyne receiver it has been found that two stages are more than ample when shielded-grid tubes are employed.

The three shielded-grid tubes are shown in the diagram as V1, V2 and V3, and are used in the first-detector circuit and the two intermediate-frequency stages. V4, the second detector, may be a stand-

ard 200A- or 201A-type; V5, the first audio tube, and V7, the oscillator tube,

are standard 201A-type tubes; and V6, the second audio tube, is a type-171 power tube.

The schematic diagram of the shielded-grid tube shows that it has one more element than the standard tube. In construction the filament of the tube is similar to the one used in the 120-type power tube. It draws a current of 0.132 amperes and its maximum operating voltage is 3.3 volts. The filament is a single straight wire, surrounded by the circular grid of the tube. This grid corresponds to the grid of the average tube, but it will be called the control-grid in this article. The fourth element of the tube, i.e., the screen-grid, is a double spiral enclosing the plate. It is placed between the plate and the control-grid and outside the plate.

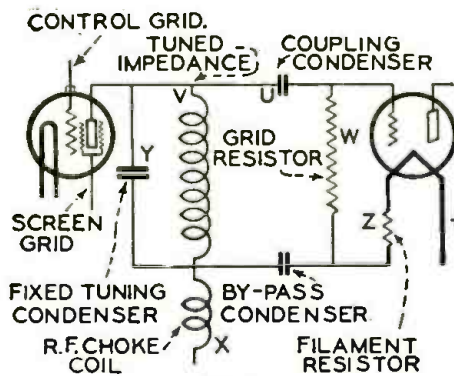
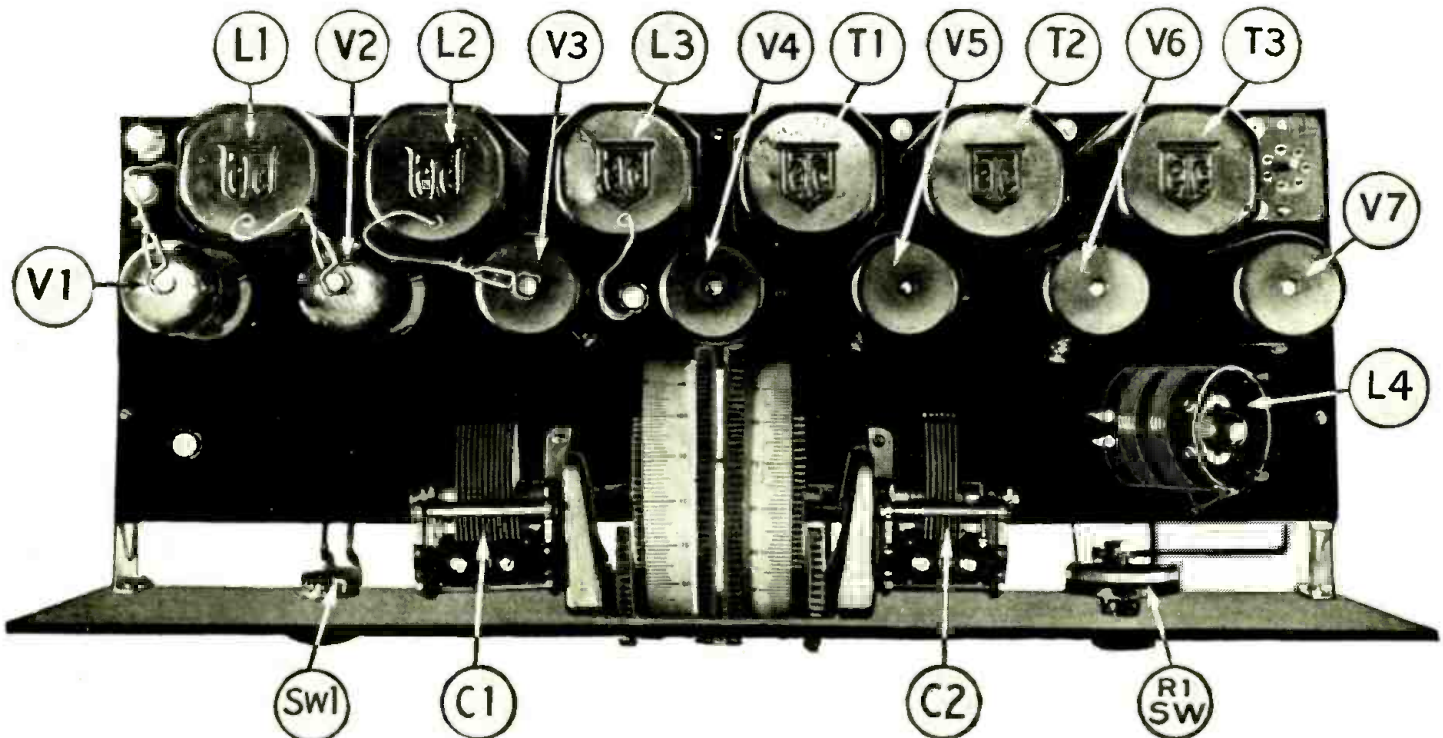

Fig. 2

Wiring diagram of an intermediate-frequency stage, which may be used in receivers employing shielded-grid tubes.

GRID LEAD ABOVE TUBES

The addition of a fourth element to the new tube makes necessary five terminals



This picture shows the arrangement of parts on the top of the sub-base panel. L1, L2 and L3 are impedance units; T1 and T2, audio transformers; T3, output transformer; L4, oscillator coupler; C1 and C2, tuning condensers;

R1-Sw, rheostat-switch; SW1, S.P.S.T. switch; V1, first detector; V2 and V3, intermediate-frequency amplifiers; V4, second detector; V5 and V6, audio-frequency amplifiers, and V7, oscillator.

to each tube. The tube is mounted in a standard UX base and the terminals are connected as usual, except that the screen-grid is connected to the grid terminal and the control-grid is connected to a special terminal which has been mounted on the top of the tube. When the tube is used in a receiver connection to the control-grid is usually made with a flexible wire and a clip.

A theoretical explanation of the operation of the tube would be too lengthy to include in this article. However, it may be explained that the use of the fourth element reduces the internal capacity of the tube to a minimum and eliminates oscillating disturbances in R.F. circuits without the necessity of neutralization. The plate resistance of the tube is approximately 500,000 ohms when a potential of 135 volts is used on the plate and a potential of 45 to 50 volts is applied to the screen-grid. The negative bias potential applied to the control-grid is from 1 to 3 volts.

To obtain the highest possible efficiency when using tubes of the shielded-grid type an external shield must be placed around each stage. This was found necessary in order to avoid oscillations and to obtain maximum amplification. A comparison between a standard receiver and one using shielded-grid tubes will show the outstanding advantage of the latter. When 201A-type tubes are used in an R.F. amplifier, it is difficult to obtain a gain greater than seven per stage; but properly-designed circuits using the shielded-grid tubes will give an R.F. amplification of thirty per stage, and considerably more when lower frequencies are used as in all intermediate-frequency circuits of super-heterodyne receivers.

HIGH INTERMEDIATE AMPLIFICATION

Figure 2 shows a highly-satisfactory circuit for use with shielded-grid tubes when they are employed in the intermediate-frequency amplifier of a super-heterodyne receiver. It will be noticed that the tuned-plate-impedance system was selected as best suited to the characteristics

In the pictorial wiring diagrams, which appear on this and the following page, complete details of all connections are given. The novice will find the construction of the set greatly simplified, if these illustrations are followed.

of the shielded-grid tubes; and for maximum efficiency a frequency of 350 kilocycles should be used. With this arrangement it is possible to obtain an amplification of fifty per stage.

In actual practice the plate impedance may consist of a solenoid coil (V) of the proper inductance shunted by a fixed condenser (Y) which tunes the circuit to the desired frequency. To prevent inter-stage coupling a 1-mf. by-pass condenser is connected between the inductor and the filament, and a radio-frequency choke coil (X) is connected in series with the plate supply wire. When a six-volt battery is used for heating the filament a resistor (Z) must be connected in the negative filament lead to reduce the voltage. The bias for the grid of the tube is obtained by connecting a resistor between the grid and the negative terminal of the battery, thus utilizing the voltage drop across the filament resistor. The grid

- ~COLOR CODE FOR CABLE ~**
 ① GREEN, B+180V. ② BROWN, B+90V.
 ③ RED, A+ ④ BLACK, A-B-C+45V.
 ⑤ YELLOW, C-45V. ⑥ BLUE, B+45 TO 67½V.
 ⑦ GRAY, B+135V. C-3V.

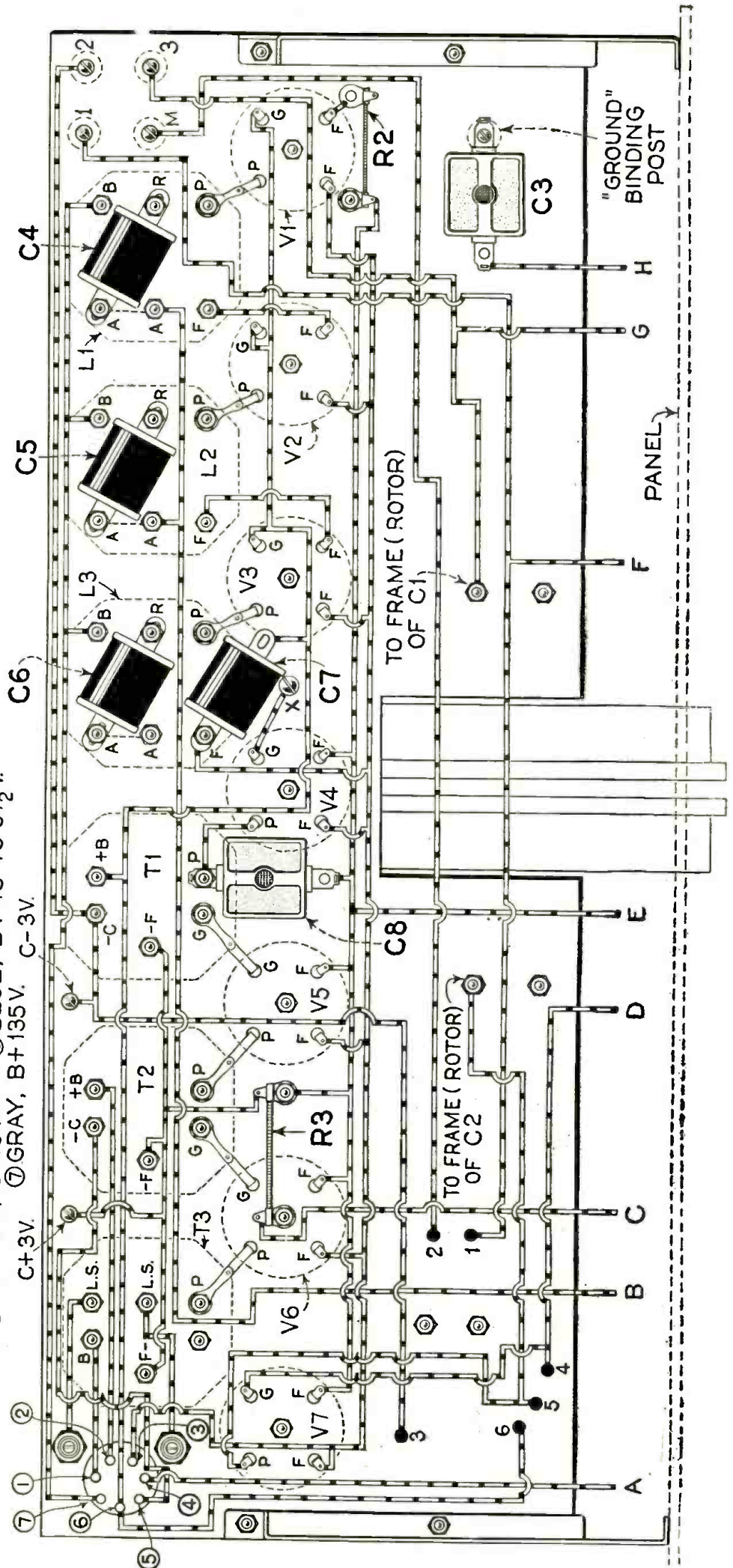

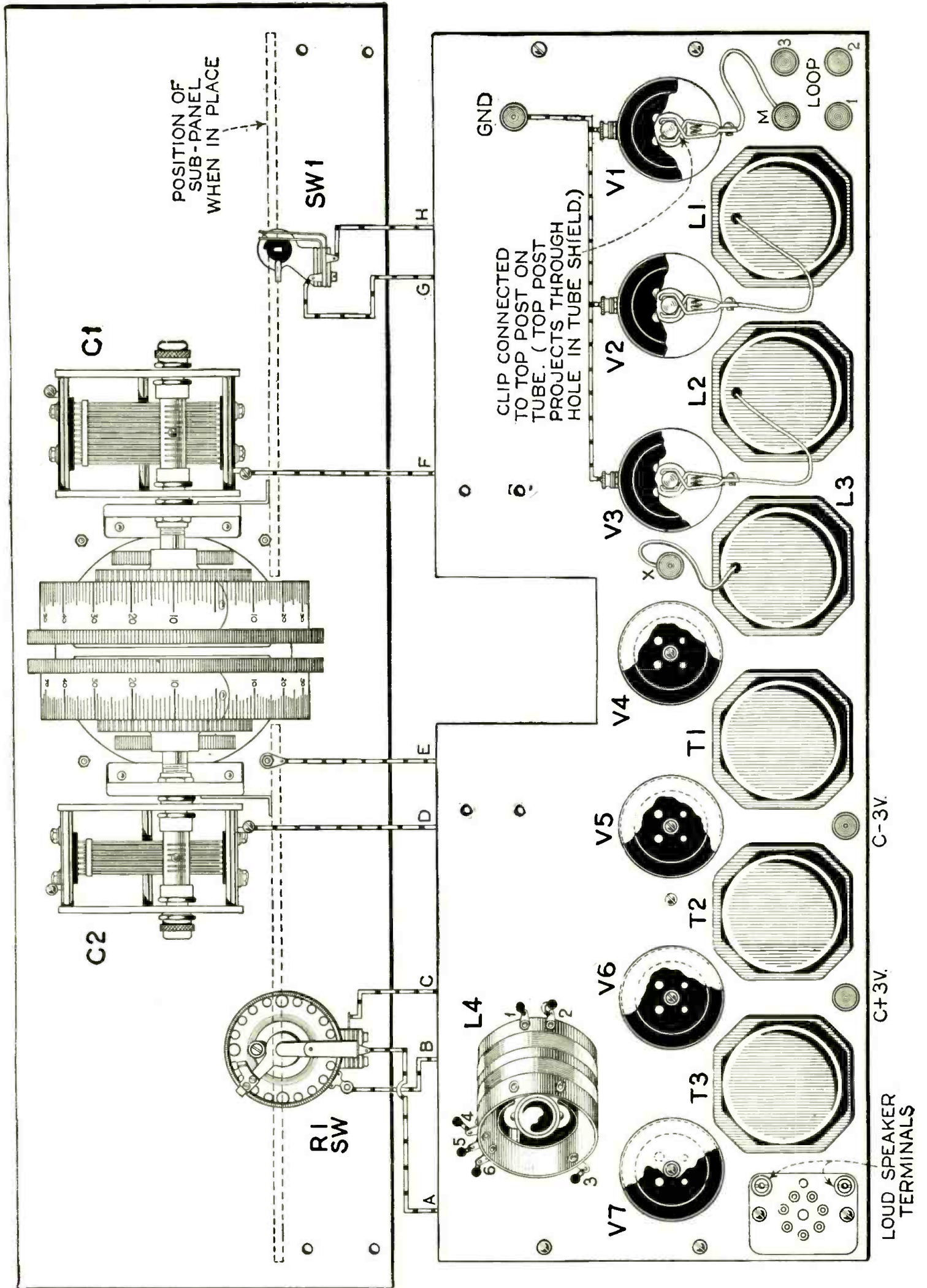

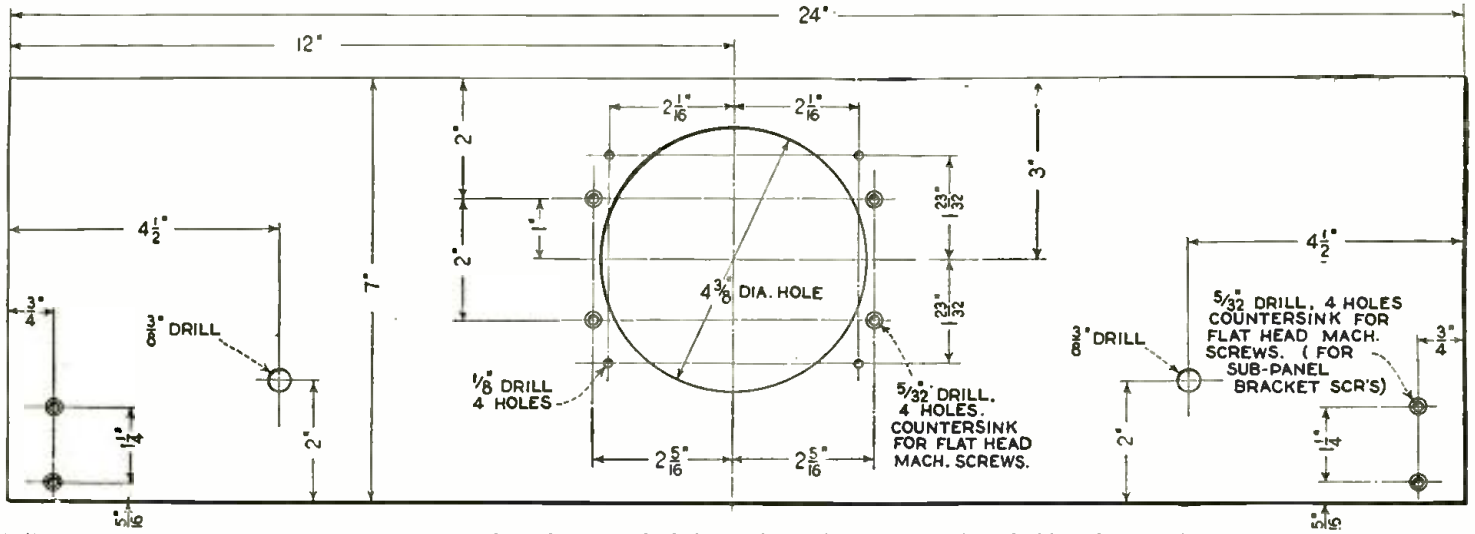

A 4 3/8-inch circular hole must be cut in the center of the front panel of the set, to accommodate the large drum-type tuning control. The above drawing shows the exact location of this hole and gives also details of all others which are required.

resistor (W) has a resistance of 2 to 3 megohms. The grid and plate circuits are coupled by a fixed condenser (U) having a capacity of .0001 mf.

In the receiver under discussion the arrangement shown in Fig. 2 is used in each of the intermediate-frequency circuits. Although it would be possible for the experienced experimenter to assemble a coupling unit of the type described, it would require considerable experimental work. Also, it would be very difficult, if not impossible, to build three matched units without the proper measuring instruments. For this reason it is usually advisable to employ a factory-built coupling unit.

Fig. A is an interior view of one of the units used in this receiver. In this picture V is the plate inductor, which is tuned by the fixed condenser marked Y. The radio-frequency choke coil is located above the plate impedance at X and the grid resistor is mounted on the top of the assembly at W. The grid coupling condenser is located at U and the filament resistor is on the base at Z. The 1-mf. by-pass condenser, which is shown connected between the inductor and the filament in the diagram, is connected externally to the unit. When the unit is enclosed in its shield, it measures 2 1/2 x 2 1/2 x 4 inches.

The two advantages of this type of unit are that it contains all the essential parts of an intermediate-frequency stage, and that it is completely wired. The terminals used for connecting the unit into a receiver are seven in number, and six of these are on the bottom, thus allowing invisible sub-base wiring. The seventh terminal connects with the control-grid of the tube, and this connection is made with a flexible wire attached to the top of the transformer. This arrangement is very satisfactory, as connection to the control-grid of shield-plate tubes is made to the metal cap on the top of the tube.

In connection with the second detector and audio amplifier circuit it is not necessary to enter into a lengthy description of the apparatus used, as it is similar to the standard design. The two audio transformers and output transformer are connected in the usual manner, except that the core is grounded to the filament in each case. A glance at the diagram will show also that one terminal on the output transformer is not used.

LAYOUT AND ASSEMBLY

When building the set, it is wise to start work on the sub-base panel. Panels which have been drilled for the apparatus used in this receiver are available; or it is possible to drill any 8 x 23 x 3/16

inch panel by following the drilling layout which is published in these pages. When mounting the apparatus on the sub-base the two brackets should be placed in position before mounting any of the parts. Next, the three impedance units used in the intermediate-frequency amplifier may be mounted on the top of the sub-base; and at the same time the four cylindrical 1-mf. by-pass condensers should be fastened in place under the sub-base, with the proper terminals of the impedance units as indicated in the picture diagram.

It will also be noticed that one of the terminals of the first audio transformer is used to support a small fixed condenser under the sub-base. However, when the second audio transformer and the output transformer are mounted, it is necessary only to place a soldering lug under each nut.

In mounting the tube sockets only one mounting screw is required, as the terminals of the socket take the form of soldering lugs and holes are drilled in the sub-base for these to pass through. In one case a socket mounting-screw is used to fasten a resistor (R3) under the sub-base. After the sockets are in place the mounting of apparatus on the sub-base may be completed by fastening the two

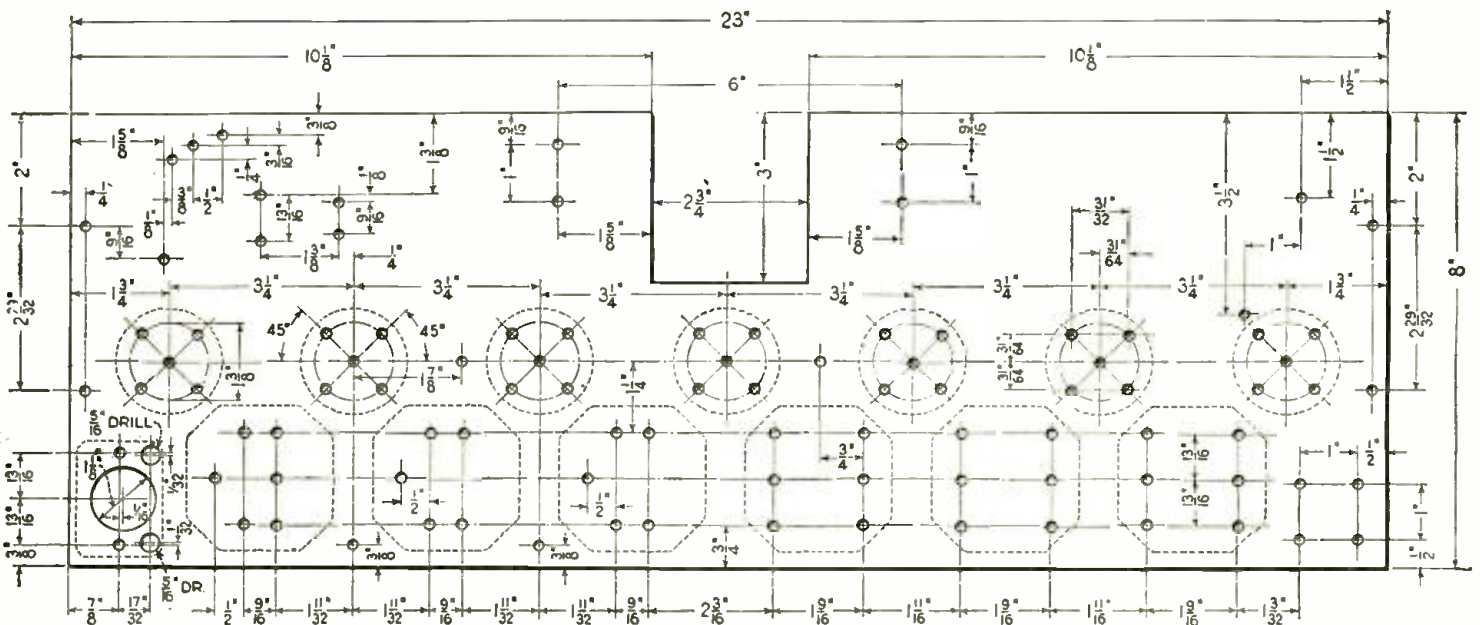

The sub-base-panel drilling layout shows the exact location of all parts in dotted lines, and indicates the exact positions of all holes required for mounting the various pieces of apparatus.

variable condensers, the oscillator coupler, the cable plug and eight binding posts on top of the sub-base, and the fixed condenser C2 and resistor R2 under the sub-base. The position of these parts is clearly illustrated in the various drawings accompanying this article.

WIRING

It is wise to wire as much of the set as possible before fastening the front panel in place. As only a few wires connect with instruments on the front panel, this method is not apt to confuse the constructor. In wiring the set, if the pictorial wir-

Table with columns: SYMBOL, Quantity, NAME OF PART, REMARKS, MANUFACTURER. Lists parts like impedance units, transformers, condensers, resistors, sockets, vacuum tubes, and antennas.

NUMBERS IN LAST COLUMN REFER TO CODE NUMBERS BELOW.

Table of manufacturer codes with columns for code numbers and manufacturer names, such as '1. Bergen Electric Company', '2. Canfield Radio Mfg. Company', etc.

★ THE FIGURES IN THE FIRST COLUMN OF MANUFACTURERS INDICATE THE MAKERS OF THE PARTS USED IN THE ORIGINAL EQUIPMENT DESCRIBED HERE.

If you use alternate parts instead of those listed in the first column of manufacturers, be careful to allow for any possible difference in size from those originally used in laying out and drilling the panel and sub-base.

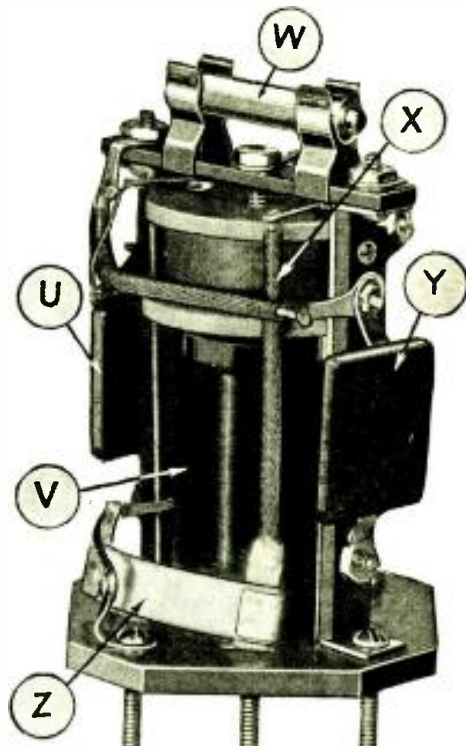

Fig. A. This picture shows the arrangement of parts inside an impedance unit, of the type employed in the intermediate-frequency amplifier of this set.

ing diagram is being followed, it is highly important to make sure that all parts are mounted in the proper position. This applies particularly to the tube sockets and the octagonal amplifying units.

The diagrams clearly point out the wiring and a point-to-point description of the connections is unnecessary. However, connections to the cable plug should be explained. This device facilitates connecting the receiver with the batteries and has provisions for seven wires. Each of the seven terminals is marked with a color

(Continued on page 851)

Operation and Accessories of the Peridyne Five

By HUGO GERNSBACK

THE description of the Peridyne Five, constructional details of which were published in the December number of RADIO NEWS, has already elicited several hundred inquiries from radio fans; I shall try to answer most of them here. Although I was rather explicit in my former article, there seems to be still some misunderstanding as to the variable-shield tuning. Perhaps the word "tuning" in itself was not a particularly appropriate one; because quite a number of builders (who, I believe, are probably new at the game) want to know if it is necessary that the shields should be adjusted for every wave-length.

The answer is that the Peridyne shields are tuned once; they are not touched after the set has once been balanced. Once you have found the best (optimum) positions of the Peridyne shields, they are left in those positions and are not disturbed.

USE OF INDOOR AERIAL

I wish to emphasize again the fact that, for best results, the set should be balanced by means of the Peridyne shields only while it is tuned to a distant or otherwise weak station. There is a little trick, to which you can easily resort, making the tuning much sharper; and that is to disconnect the outdoor aerial and use an indoor one. I have repeatedly been able to receive (in New York) stations located in Chicago and Canada, by using a 30-foot indoor aerial, stretched along the hall. Although I am

located in a twenty-story steel building, the indoor aerial works nicely, even for DX work.

IN the next issue of RADIO NEWS the author will describe the "electrified" Peridyne Five, using tubes of the A.C. filament type. The installation of the tubes that have been selected involves few changes in the old wiring of the receiver. The power pack which supplies the "A" and "B" current is unusually small, measuring only 10 by 8 by 6 inches over all, it is one of the smallest units of its kind ever described. The change-over from battery to lamp-socket operation can be made easily by anyone. The DX ability of the receiver remains unaffected, while the quality of reproduction and the volume have actually been increased; the volume is at least 50% greater than that of the battery-operated set.

—EDITOR.

Using such a short indoor aerial, it becomes simple to tune the Peridyne shields

and bring the set to its highest efficiency. As a matter of fact, I have found that in large cities (such as New York, Chicago, San Francisco, etc., where there are many local stations) the outdoor aerial, as a rule, brings in the stations uncomfortably loud on this set; and for that reason I prefer to use an indoor aerial on locals, switching over to the outdoor one when I want to listen to DX stations.

OUTDOOR INSTALLATION

For outdoor use with this set, I recommend the use of a single-wire aerial, with a total length of not more than 100 feet or, better, 80 feet. The set is so sensitive that, if too long an aerial is used, one gets a very large amount of interference; and, besides this, stations come in uncomfortably loud, even without a power tube. This is true, of course, if you are located somewhere within fifty miles of strong local broadcast stations.

If you are located in the country, a hundred miles or so away from the nearest broadcast station, then, of course, as you wish to receive stations with good volume, an aerial of 100 feet will be desirable. Under these conditions, I would recommend the use of a two-wire aerial, which naturally will collect more energy than a single-wave one, and consequently result in apparently stronger signals. This will result in better reproduction from DX stations.

(Continued on page 798)

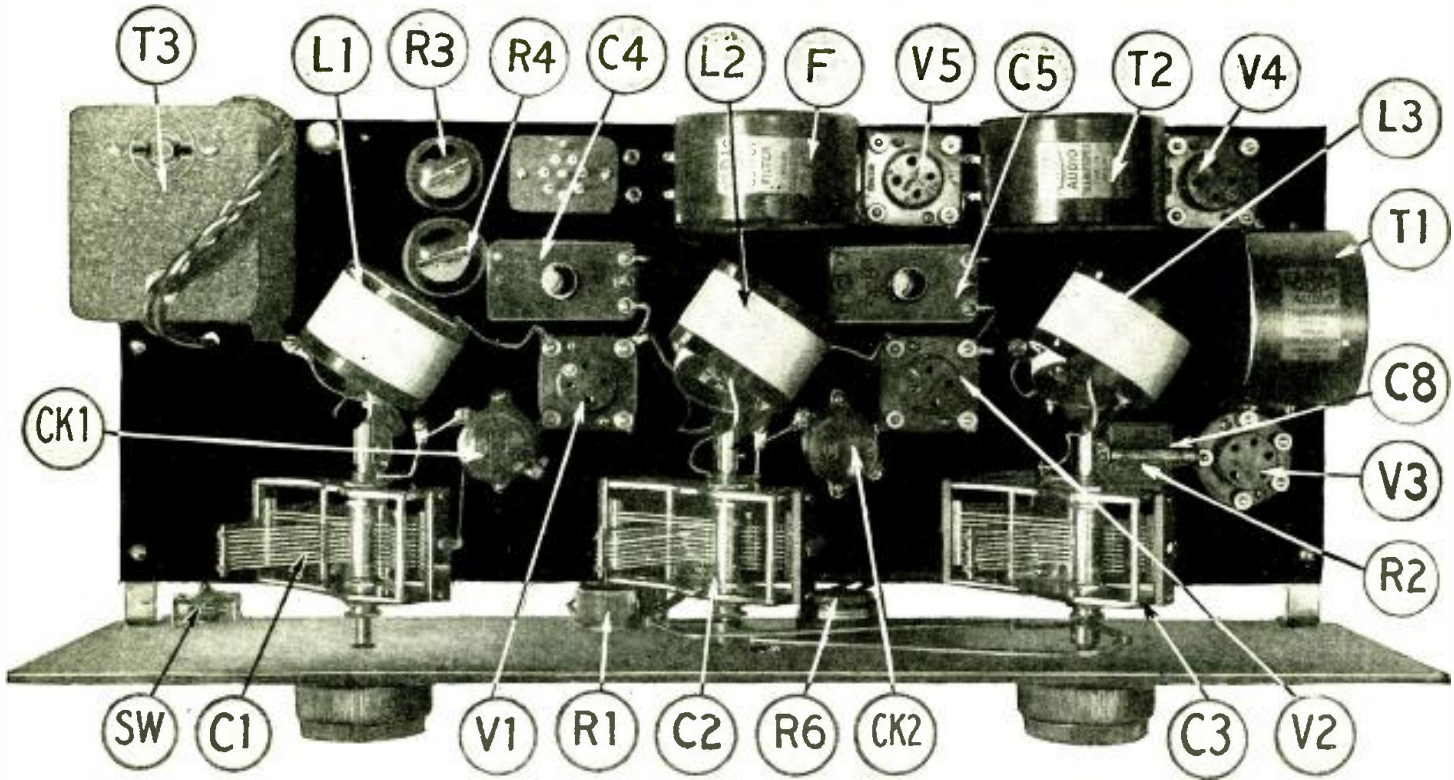

FIG. B

The top view of the sub-panel: T3, power transformer; L1, L2, L3, R.F. transformers; CK1 and CK2, choke coils; C1, C2, C3, variable condensers; V1 and V2, R.F. amplifier sockets; V3, detector socket; V4 and V5, A.F. amplifier sockets; C4 and C5, neutralizing condensers; SW, switch.

The Karas A. C. Equamatic *

Constructional Details for a Lamp-Socket-Operated 5-tube Receiver Possessing Good Quality

WHEN building the laboratory model of this receiver the designers endeavored to combine as many desirable features in as compact a space as possible. That they have been successful in their attempt will be granted by even the most skeptical radio engineer after hearing a demonstration of the finished product. Taking into consideration size, weight, cost of assembly, cost of operation, number of accessories, etc., this receiver provides a radio installation for the average home which closely approaches the idea. Also, the set is not beyond the reach of the layman radio-set builder.

The title of this article, "The Karas A.C. Equamatic," clearly states the most interesting feature of the set; namely, that it is alternating-current operated. However, this fact is only a small part of the story.

By FRED H. CANFIELD

The system of electrification is probably the newest, simplest and most efficient method thus far developed. The new 226-type A.C. tubes are used in both R.F. and one A.F. stage, a 227-type (heated-cathode) tube in the detector circuit, and a 171-type power tube in the last audio-frequency stage.

In the operation of the set alternating current, obtained from a small transformer, is supplied directly to the filaments of all tubes, and the plate current is provided by a "B" socket-power unit of standard design. The various values of grid bias required by the tubes of the receiver are secured through the voltage drop across fixed resistors installed in the set proper. With this ap-

paratus there is a continuous source of power available at all times, the alternating-current hum is reduced to an almost negligible value, the necessity of batteries in any form is completely avoided, and the entire installation requires practically no attention or replacement of parts.

AUTOMATIC COUPLING ADJUSTMENT

As the second vital feature of the receiver the system of reception should receive consideration. In this year's model of the Karas Equamatic the same highly efficient radio-frequency circuit, which gained nation-wide popularity last season, is employed. Amplification, which is practically uniform over the entire broadcast waveband, complete and perfect neutralization or balance on all dial settings, and high efficiency are the important advantages of the radio-frequency circuits of the set.

The fact that uniform amplification is obtained on all wavelengths might lead one to believe that the adjustment of the R.F. circuit is complicated; but such is not the case. A simple mechanical device accomplishes the effects described, and the set is no more difficult to build, adjust or operate than the average tuned R.F. receiver. Two dials, which follow each other closely over the entire scale, are the only wavelength controls for the set and after the desired station has been tuned in with these dials, only the volume controls remain to require adjustment.

Automatic variation of coupling between the primary and secondary coils of the R.F. transformers is the characteristic of the circuit which makes possible uniform amplification on all waves. The primary coils of the transformers are mounted on the shafts of the condensers in such a way that the rotation of the condensers causes the exact change of coupling required in order to maintain a uniform transfer of energy. (See page

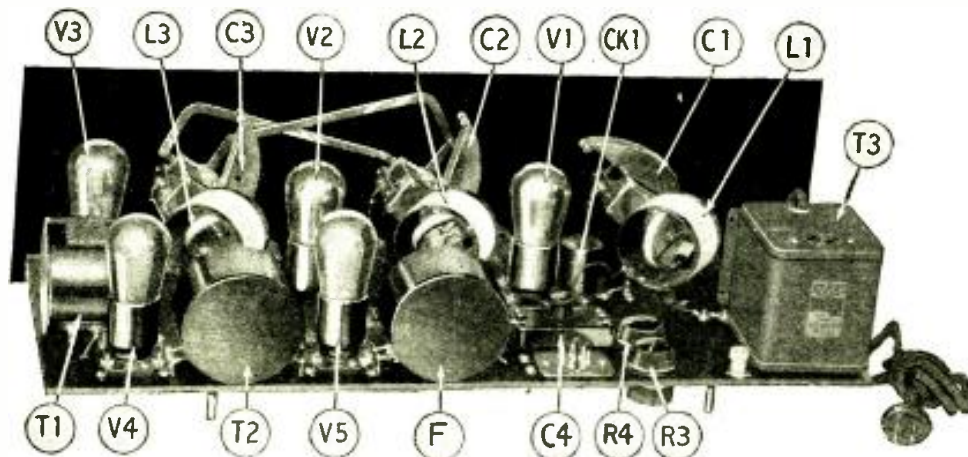

FIG. D

T1 and T2, A.F. transformers; F, output filter; R3, "C" bias rheostat; R4, filament rheostat; The schematic diagram of the receiver will be found on page 771, the symbols being the same as those in the above illustrations.

*RADIO NEWS Blueprint Article No. 41

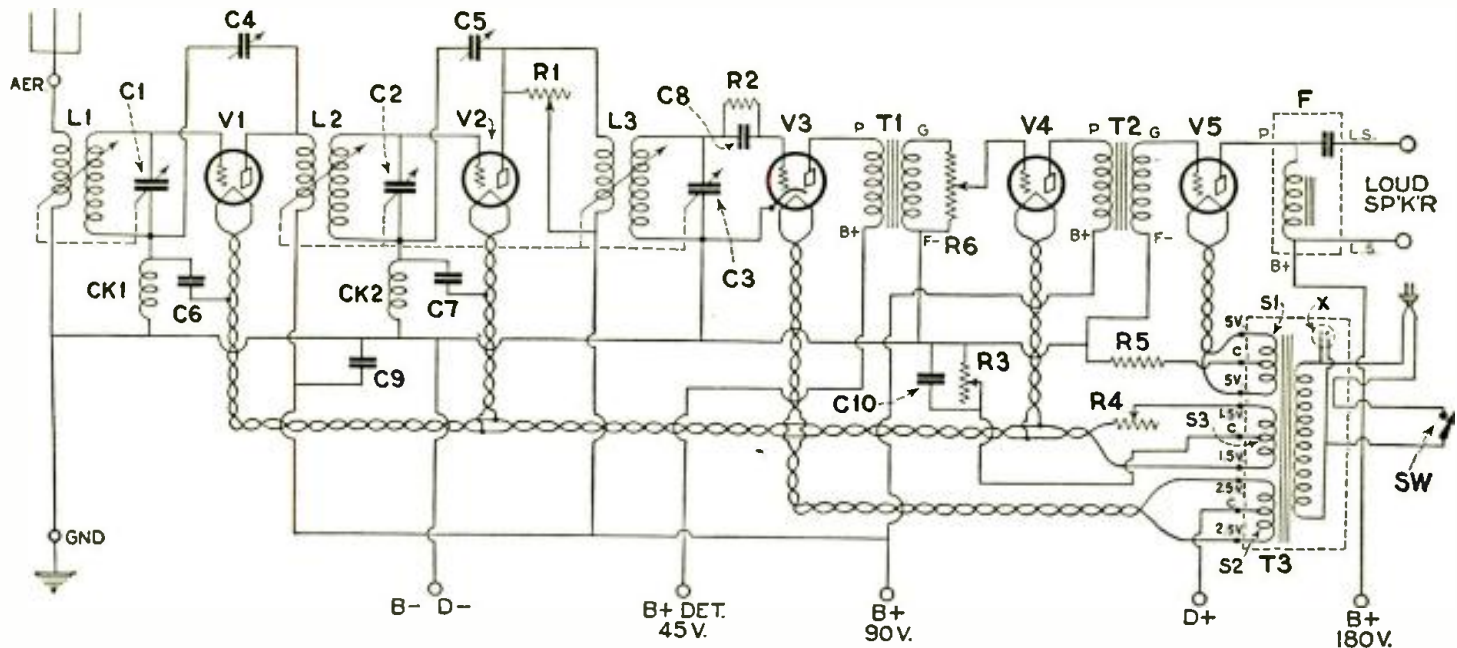

FIG. 1. The schematic diagram of the Karas A.C. Equamatic Receiver, in which all the parts bear the same symbols as those designating the same parts in the other illustrations.

636 of RADIO NEWS for December for an explanation of the system by which this is brought about.)

To appreciate fully the value of uniform amplification on all wavelengths, it is necessary to compare the operation obtained from an Equamatic with those secured from an ordinary tuned-R.F. set in which no provision has been made for coupling compensation.

In the tuned-radio-frequency receiver, the efficiency is highest when the dials are tuned to the lowest wavelength; and, as the wavelength is increased, the efficiency decreases steadily. The result is that, on the waves between 400 and 500 meters, where most of the listening actually takes place, the sensitivity of the set is often only one-third of maximum. On the other hand, with the Equamatic system, the efficiency on short waves is maximum, but the coupling between the two coils of the transformer is minimum. As the wavelength is increased the efficiency remains near maximum because of the fact that the coupling between the coils is increased. The result is that, on the high waves, the set often has three times the efficiency of other receivers. When one takes into consideration the large number of high-quality programs which are broadcast on the highest wavelengths, the importance of the above will be more thoroughly understood.

THE AUDIO AMPLIFIER

In this day and age a receiver is of little value if serious consideration has not been given to the audio-frequency amplifier. Distortionless reproduction is a modern necessity, and it can be obtained only by using the best quality modern apparatus.

In the receiver under discussion two high-quality amplifying transformers are used in the audio circuit and these are followed by an audio filter in the output circuit. Ample available power is assured by the use of a power tube in the output stage, and distortion due to overloading is prevented by the resistors which apply a bias of the correct value to the grid of each tube.

The type of volume control used also helps to prevent distortion. A variable resistor, which serves as a sensitivity control, is employed in the R.F. circuit; and this makes it impossible to overload the detector, if it is properly adjusted. The second volume control is in the audio

circuit and consists of a high-resistance potentiometer connected across the secondary of the first audio transformer in

ONE of the outstanding sets of the last season was the 5-tube Equamatic, the striking feature of which was a novel system of controlling coupling in the tuned-radio-frequency transformers by a mechanical attachment, governed by the condenser shafts. High sensitivity over the broadcast range was thus obtained with simplicity of operation. To the features of that set are added the elimination of one tuning dial, and the use of the new A.C. tubes; enabling this set to be operated from the lighting socket, with a minimum of apparatus and attention and a high degree of efficiency. This new A.C. model will be of the greatest interest to the set constructor who is on the lookout for the newest improvements.
—EDITOR.

such a way that the grid potential of the tube may be varied.

THE CIRCUIT

Before continuing with a description of the receiver it is necessary to examine the schematic wiring diagram in Fig. 1. After a thorough study of the circuit used it will be seen that the R.F. end of the set is a standard two-stage tuned-R.F. amplifier to which many refinements have been added. This is followed by a standard tuned detector circuit and two stages of transformer-coupled audio-frequency amplification.

In the R.F. circuits the condensers C1, C2 and C3 control the wavelength of all stages. The arrow which passes through the condenser and transformer in each case indicates that both the condenser and the coupling between the coils are varied by the same dial as described in the early part of this article. The dotted line which connects condensers C2 and C3 indicates that both are tuned with the same dial. The three tuning condensers are of identical construction, each having 17 plates, or a capacity of .00035 mf.

To prevent oscillation in the R.F. circuits the condensers C4 and C5 are used. These are the standard fixed-adjustable neutralizing condensers and are connected in the conventional manner. Interstage feed-back in the radio-frequency stages is prevented also by the condensers C6 and C7 and by the radio-frequency choke coils

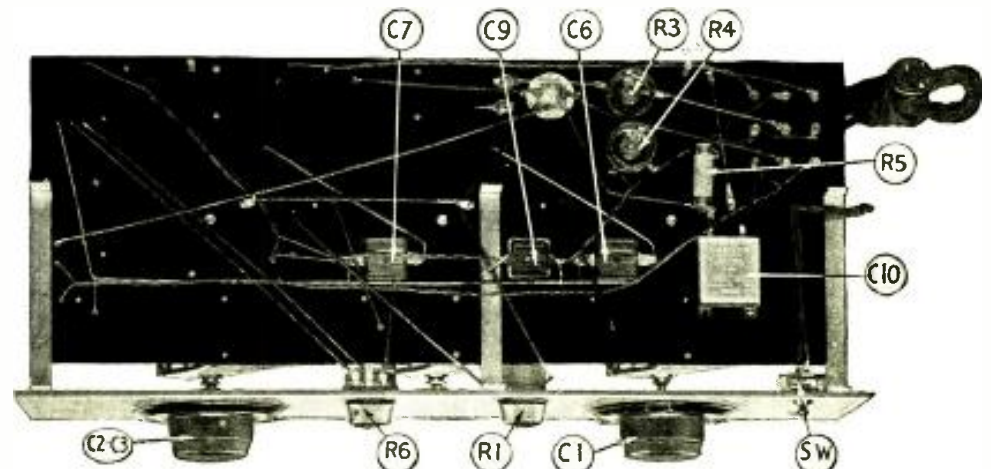

Fig. C The under view of the sub-panel, showing the wiring. R3, "C" biasing rheostat; R4, filament rheostat; R5, resistor, C6, C7, C9, C10, condensers.

Ck1 and Ck2. The condensers allow the radio-frequency currents to pass directly to the filament circuit without entering the biasing resistor, and the two choke coils provide a path for the biasing potential, which is applied to the grids of the two R.F. tubes. The two condensers used for this purpose are of the fixed-mica variety and each has a capacity of .00015 mf. The two choke coils have an inductance of 85 millihenries each.

In the second radio-frequency stage a very interesting feature is to be found. A 75-ohm rheostat (R1) is connected across the primary coil of L3. This rheostat may be used as an auxiliary volume control when loud local stations are being received, and will prevent distortion by the detector tube, which would occur if it were overloaded.

In the detector and audio-frequency circuits of the set the wiring is practically standard and the few changes which have been made were made necessary by the special alternating-current tubes. In the detector the usual grid leak and condenser method of detection is employed.

ADAPTATION TO A.C. TUBES

When taking a quick glance at the circuit it appears different from the average; it is the use of the A.C. tubes which makes this difference so noticeable. In the diagram it will be seen that the filament wiring is represented by three sets of twisted wires and these wires terminate at three separate secondary windings of the transformer.

This is the power transformer which provides filament current for the entire receiver. As each of the various types of tubes used in the set requires a different filament voltage, three different secondary windings are needed on the transformer. Also, each winding has a center tap in order that a zero-potential point may be obtained.

Winding S1 provides the filament current for the 171 tube, in the last stage of audio amplification, which requires 1/2 ampere at a potential of 5 volts. Winding S2 has an output of 2.5 volts for the heater-element of the type-227 detector tube; and winding S3 is used to heat the filaments of all of the 226-type amplifier tubes, which require 1.5 volts.

Usually, when operating tubes from alternating current, a rheostat is not required; as the transformer provides exactly the voltage desired. However, in the case of winding S3, as several tubes are heated from the same source, it was considered advisable to include one. The rheostat used, R4, is a small wire-wound unit with a total resistance of 0.2 ohms.

BIASING VOLTAGES

Many readers will probably ask themselves how the grid potential is obtained for the various tubes of the set. Batteries cannot be used for the purpose, as the set has been designed for complete A.C. operation; nor can the desired voltages be obtained from the power unit, as the set been designed for operation with any standard "B" socket-power unit. The method used utilizes the voltage drop which takes place across R3 and R5.

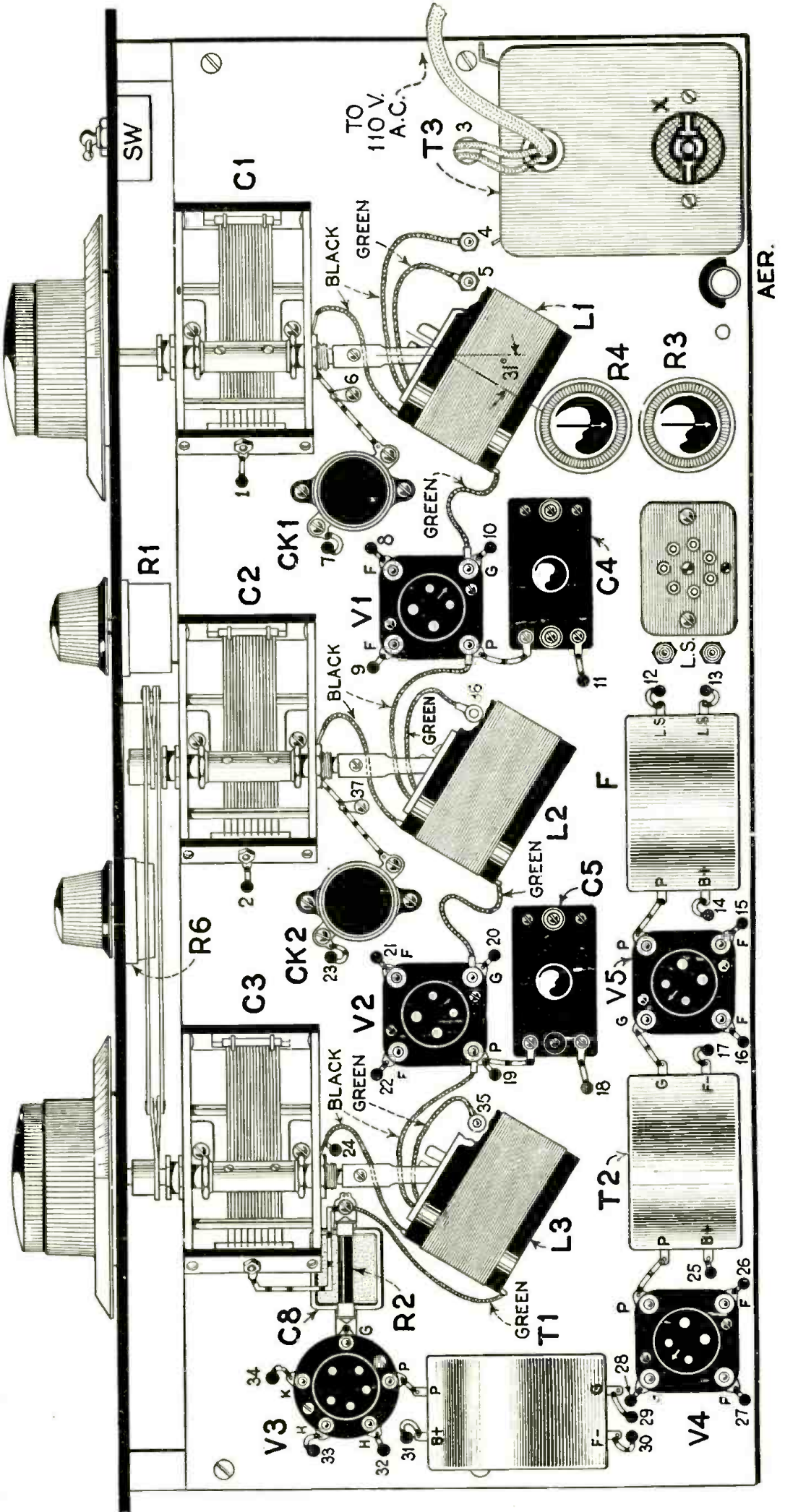

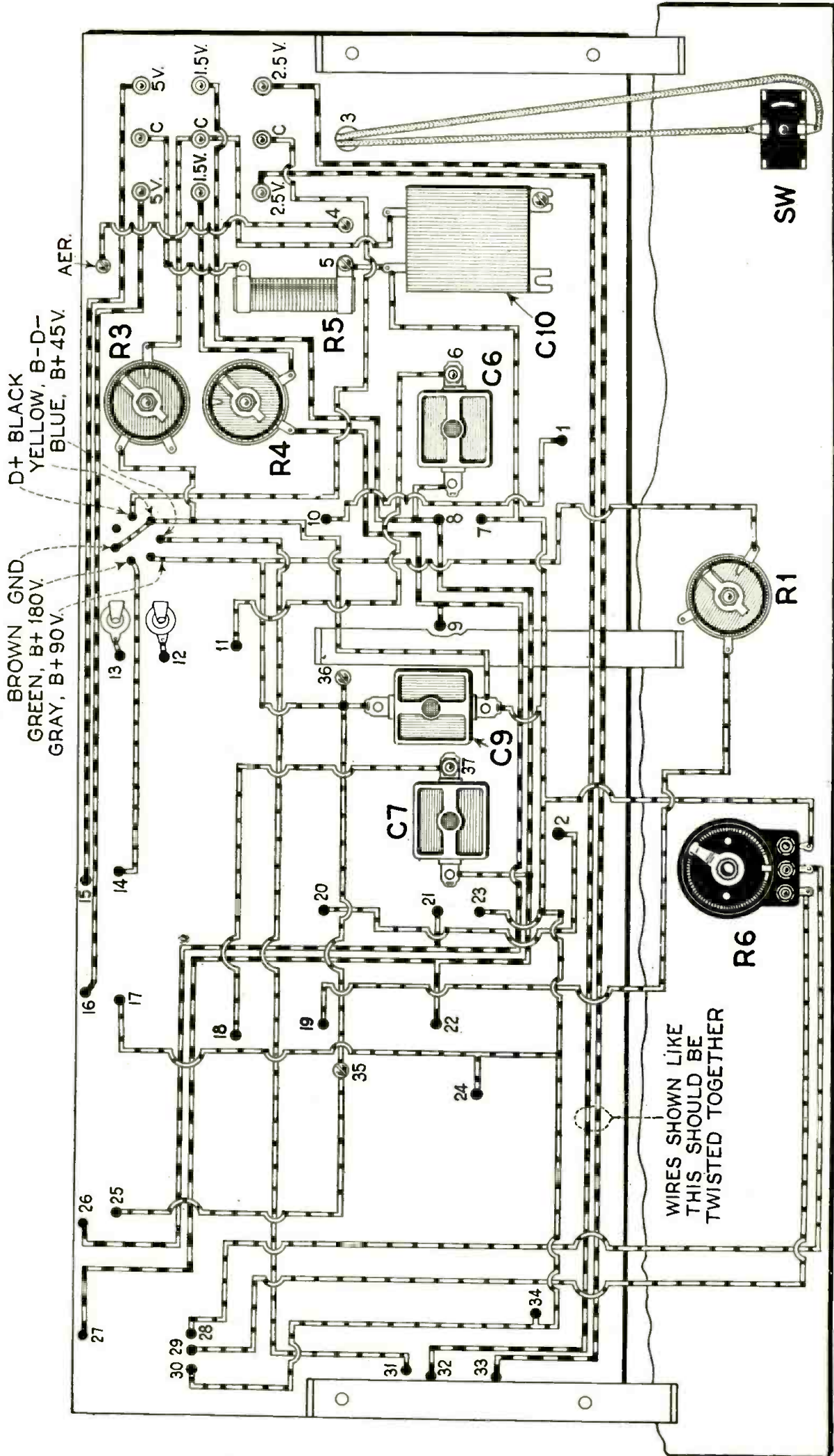

On the preceding page and on this one are the top and under sides, respectively, of the sub-panel on which are mounted the instruments for the Karas A.C. Equamatic Receiver. The wiring of the different instruments is clearly shown and, where the connecting wires should be twisted in pairs, it is so indicated in the diagram. It will be seen that a number of holes in the sub-panel are numbered. These are for the connecting wires to be run from instruments on the top of the sub-panel to those beneath. In the two drawings these

holes are numbered correspondingly; so that there is little chance for the constructor to go wrong in the wiring. It should also be noticed that a portion of the front panel of the receiver is shown in the top view, while the part of the front panel that is under the sub-panel is shown in the drawing on this page; although the instruments that are on this lower portion are indicated in the upper drawing.

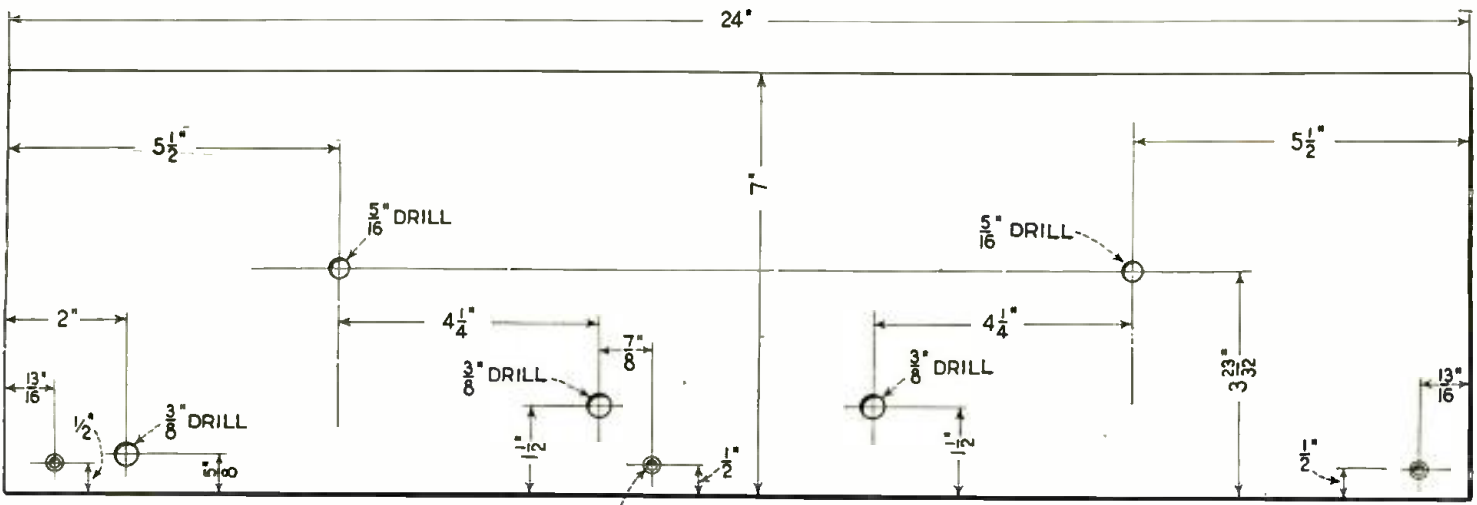

5/32" DRILL AND COUNTERSINK, 3 HOLES

The drilling details for the front panel of the A.C. Equamatic Receiver. Those for the sub-panel are shown at the bottom of the page.

Careful examination of the circuit will show that the grid-return wire of each tube is connected to the ground, which is also the "B—" wire. Also, the resistor R3 is connected between the ground and the center tap of filament winding S3, and the resistor R5 is connected between the ground and the center tap of S1. Therefore, it may be seen that the drop in voltage between the filament winding and the ground provides the desired bias.

In the case of the power tube a variable bias is not necessary; as the value of this potential is not critical and it has been found that in most cases a 2,000-ohm resistor provides the correct potential. The bias for the R.F. tubes, however, is more critical and for this reason a 2,000-ohm variable resistor is used. In addition the by-pass condenser C10, with a value of 1 mf., is connected in shunt with this resistor to reduce the resistance to high-frequency currents.

EXTERNAL APPEARANCE

Fig. A shows the arrangement of controls on the front panel of the set. The two large dials are the wavelength con-

trols and of the vernier type, although they present the appearance of standard dials. The one at the left tunes the antenna coupler and that to the right tunes the second R.F. stage and the detector circuit. The knob slightly to the left of the center is the 75-ohm rheostat R4, which serves as a sensitivity control, and the knob on the right of the panel is the volume control R3, which is a 500,000-ohm variable high resistor.

At the extreme left of the panel, the off-and-on switch is located. This switch is connected in the 110-volt house-lighting circuit, in series with the plate-power-supply unit and the filament transformer. The front panel is 7 x 24 x 3/16 inches, and a panel drilled for the apparatus used in this receiver is available on the market. However, those who wish to drill their own panels will find in these pages a diagram showing the necessary holes.

Fig. B shows the appearance of the receiver when viewed from above. The power transformer which supplies current for the filaments will be found on the rear edge of the panel, at the extreme left. It will be noticed that there is a

standard 110-volt receptacle on the top of the transformer; this is used for connecting the plate socket-power unit with the house current. When the plug from the power unit is inserted in this receptacle the operation of the unit is automatically controlled by the switch on the front panel. In addition to the wire from the filament transformer which goes to the light socket, the wires which go to the switch are also provided and properly connected inside the unit.

On the right of the filament transformer are two knobs which control the variable resistors R3 and R4; the former is the resistor nearest the rear edge of the baseboard. These two units are located under the sub-base panel.

For making connections between the receiver and the plate-power unit, a connector plug and battery cable is employed. The socket of this plug is located at the right of the two resistor knobs. When using a plug and cable of this type, the power unit is connected to the battery cable in the usual way; but, to connect the set with the battery cable, it is necessary only to insert the plug in the socket mounted on the sub-base panel. This

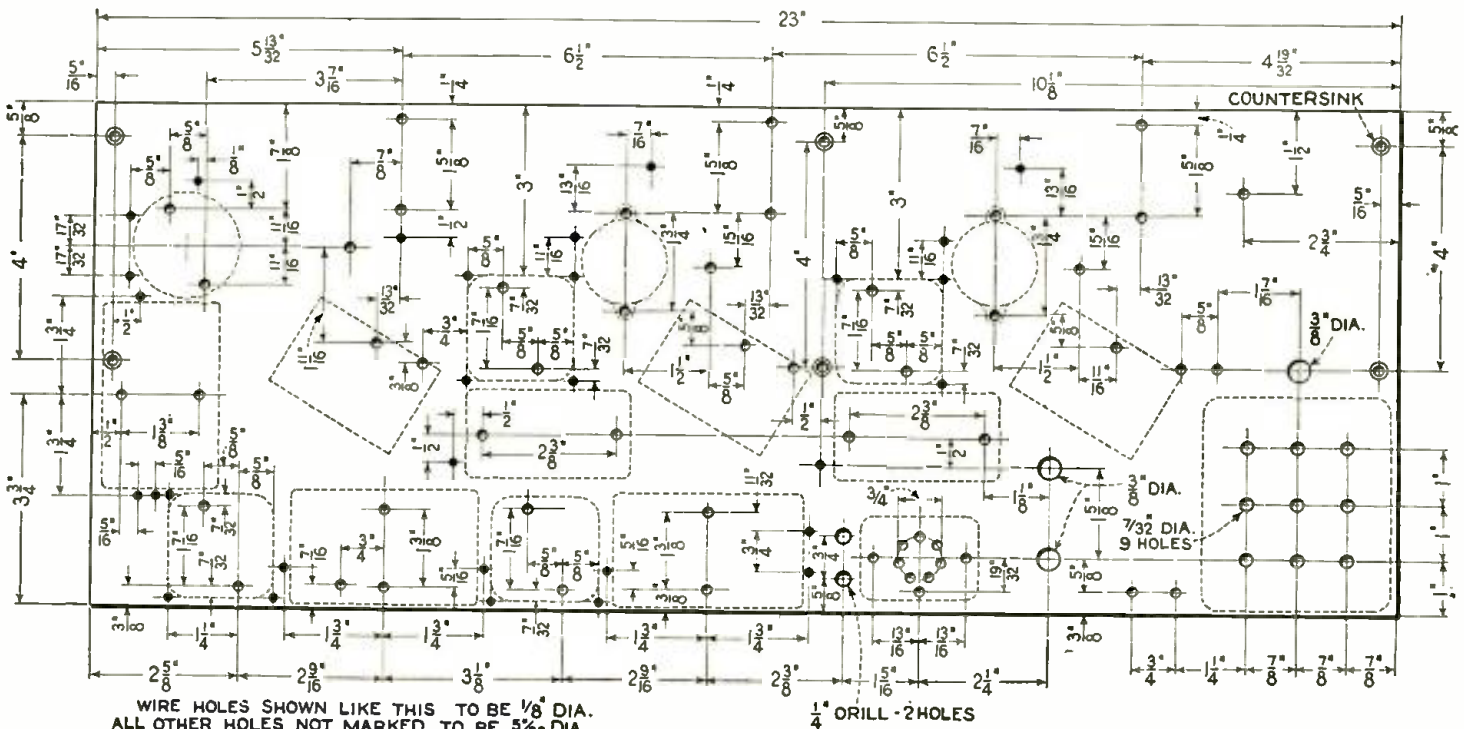

WIRE HOLES SHOWN LIKE THIS TO BE 1/8" DIA. ALL OTHER HOLES NOT MARKED TO BE 5/32" DIA.

1/4" DRILL - 2 HOLES

The above illustration indicates the proper positions for the instruments mounted on the sub-panel, as well as the necessary holes.

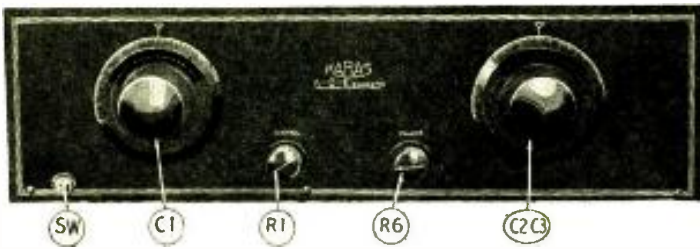

Fig. A

The front panel view of the Karas A.C. Equamatic Receiver. SW, the switch; C1, C2-C3, variable-condenser controls; R1 and R6, volume controls.

facilitates connecting and disconnecting the receiver and also avoids errors. It will also be noticed that to the right of the cable socket two small tip jacks are provided for the loud speaker.

OTHER LAYOUT ARRANGEMENTS

The remaining apparatus on the rear edge of the sub-base is in the audio circuit. The parts are, from left to right; output filter, power tube, second-stage transformer and first-stage amplifier tube. The first-stage transformer is located in front of the first-stage tube.

All the apparatus in the radio-frequency circuits is located on the front edge of the baseboard. The components on the left of the sub-base, consisting of a variable condenser, radio-frequency transformer, R.F. choke coil, neutralizing condenser and tube, make up the first R.F. stage. A similar group of apparatus in the middle are the parts for the second stage; and the condenser, R.F. transformer, tube, grid leak and grid condenser on the right of the panel are in the detector circuit.

In an effort to give the receiver as commercial an appearance as possible the designers have placed most of the wiring and many parts under the sub-base panel. This is clearly shown in Fig. C. Three brackets are used to fasten the front panel to the sub-base, and two metal pins are mounted on the rear edge of the sub-base to support the weight at this point.

WIRING SYSTEM

The most important point of interest under the sub-base is the filament wiring, which is twisted. This is necessary in order to reduce the A.C. hum in the output. It will be noticed that the filament transformer is mounted so that the low-voltage terminals pass through the sub-base, and the twisted filament wires connect directly with these posts.

Contact is made also to the terminals of the cable socket under the baseboard. Each terminal of the socket is given a color different and this color corresponds to that of the wire in the cable with which it connects. When connecting this socket with the power wires of the set the following system should be followed: "B+ Power" connects with green; "B+ Amp."

connects with pale green, "B+ Det." connects with blue, "B-," "D-" and Ground connect with yellow and brown, "D+" connects with Black; and the red termi-

nal of the socket is not used. In addition to the parts mentioned, several fixed condensers and resistors are mounted under the sub-base.

Fig. D shows the receiver as viewed from the rear; in this picture the system employed for ganging the two variable condensers is illustrated. After the condensers have been mounted, and before the front panel has been fastened in place, the coupling unit is passed over the shafts of the two condensers. The condensers should be adjusted so that their plates are in the same relative position and then

(Continued on page 838)

SYMBOL	Quantity	NAME OF PART	REMARKS	MANUFACTURER *
C1, C2, C3	3	Variable condensers	.00035-mf. with extended shaft (special)	1
L1, L2, L3	3	R.F. transformers	Equamatic type (special)	1
T1, T2	2	A.F. transformers		1 3, 12, 16, 24, 26, 27, 28
F	1	Output filter		1 16, 25
C4, C5	2	Neutralizing cond.	.00002-mf. to .00015-mf.	2 5, 9
C6, C7	2	Fixed condensers	.00015-mf.	3 4, 10, 11, 13, 14, 15, 16, 17, 36
C8	1	Fixed condenser	.00025-mf.	3 4, 10, 11, 13, 14, 15, 16, 17, 36
C9	1	Fixed condenser	.006-mf.	3 4, 10, 11, 13, 14, 15, 16, 17, 36
C10	1	By-pass condenser	1-mf.	3 4, 10, 11, 13, 14, 15, 16, 17, 36
R1	1	Rheostat	75 ohms	3 28, 26, 36
R2	1	Grid leak	3-megohm	35 4, 14, 17, 18, 23, 36
R3	1	Variable resistor	2,000 ohms	3 23, 27, 28, 36
R4	1	Rheostat	0.2 ohms (special)	3
R5	1	Fixed resistor	2,000-ohms	4 27, 28
R6	1	Potentiometer	500,000-ohms	4 27, 28
Ck1, Ck2	2	R.F. Choke coils	85 millihenries	5 2, 24
V1, V2, V4	3	A. C. tubes	224 type	6 18, 19, 20
V3	1	A.C. tube	227 type	6 18, 19, 20
V5	1	Power tube	171 type	6 18, 19, 20
T3	1	Filament transformer	(special)	1
	4	Tube sockets	UX type	7 21, 22, 23, 24, 26
	1	Tube socket	UY type	7 21, 22, 23, 24, 26
	1	Cable plug	7-wire	8 39
	1	Front panel	7 x 24 x 3/16 inches	31 32, 33
	1	Sub-base panel	9 x 24 x 3/16 inches	31 32, 33
	3	Brackets	For sub-base panel (special)	1
	1	Link motion	2-dial control (special)	1
	2	Tip jacks		8 26, 28
	1	Binding post		9 22, 23
S9	1	Switch	110-volt type	3 28
	2	Dials	Vernier type	1
		Hook-up wire		29 30, 34

NUMBERS IN LAST COLUMN REFER TO CODE NUMBERS BELOW.

1 Karas Electric Company	2 Samsco Electric Company	3 Carter Radio Company
4 Electrol, Inc.	5 Hammarlund Mfg. Company	6 Radio Corporation of America
7 Benjamin Elec. Mfg. Co.	8 Yaxley Mfg. Company	9 XL Radio Laboratories
10 DuBilier Condenser Corp.	11 Aerovox Wireless Company	12 Hazlett Electric Company
11 Tube Deutschland Co.	14 Polymet Mfg. Company	15 Samsco Electric Company
16 Leslie F. Muter Co.	17 Wicamold Radio Corp.	16 Irvon Radio Corp.
19 C. E. Manufacturing Co.	20 E. T. Cunningham, Inc.	21 Air-Map Products, Inc.
21 H. E. Ivy Mfg. Co.	21 Ameco Products, Inc.	24 Silver Marshall, Inc.
25 The National Company	26 General Radio Company	27 Central Radio Laboratories
28 Herbert H. Frost, Inc.	29 Helden Wire Company	30 Acme Wire Company
31 Wicoria Fabricators	32 Permac Insulation Co.	33 American Hard Rubber Company
34 Cornish Wire Company	35 International Radio, Co. (Dartm.)	36 Federal Radio Corp.
37 American Transformer Company	38 Parranti, Inc.	39
40	41	42

* THE FIGURES IN THE FIRST COLUMN OF MANUFACTURERS INDICATE THE MAKERS OF THE PARTS USED IN THE ORIGINAL EQUIPMENT DESCRIBED HERE.

If you use alternate parts instead of those listed in the first column of manufacturers, be careful to allow for any possible difference in size from those originally used in laying out and drilling the panel and sub-base.

© 1927, E. I. Pub. Co.

The Story of Metallized Resistors

By FRANCIS R. EHLE*

SOME seven or eight years ago a professor of chemistry in one of our larger universities was experimenting with the rare element germanium, a by-product of zinc ore. At the time, this metal sold at from \$8.00 to \$10.00 per gram (\$3,600 to \$4,500 a pound) and its use was largely confined to medical purposes. However, the professor was bent on finding new uses for it.

In the course of his experiments, the professor soon discovered that germanium could be made to form exceedingly hard and practically indestructible deposits on various substances. At the time, the needs of radio reception in the matter of high resistors were being poorly met by heavily-inked strips of paper, but it did not occur to the

experimenter that he was working on metallized resistors, which would be of great value. Still, he was interested in the electrical features of these deposits or coatings and, with that thought in mind, he consulted the professor of electrical engineering at the same university in order to have certain tests made of the electrical properties of his thin metallic films.

Tests disclosed that these metallic deposits had an extremely high resistance. Soon it was suggested that the requirements of radio resistors, in the order of magnitude of 100,000 ohms and up, might perhaps be met by such metallic deposits on a suitable support.

The first metallic resistors made up with germanium consisted of glass tubes with the metallic deposits on the inside walls. This

form, however, did not prove satisfactory, since it was found practically impossible to control the resistance value when coating such supports; and, furthermore, the resistance was not stable, but changed gradually in time.

Films of germanium were formed also on rods of small cross-section or filaments of glass, but these units were also found to be unstable. Meanwhile, further experiments with conducting substances of all types developed new and better resistant materials than the original form of germanium; until, today, just two colloidal solutions are employed in making metallized resistors.

The metallized resistor has been worked out as a highly efficient product to supply the

(Continued on page 838)

* President, International Resistance Company

An A. C. Phonograph Amplifier *

Constructional Details of a High-Quality Unit Operating from House Current

By JAMES MILLEN

THE phonograph and the radio set are companion entertainers, and each renders a particular service which cannot be performed by the other. Audio amplifiers and sound reproducers of similar design may be used by both; and, with the new electrically-made records, the modern phonograph provides high-quality reproduction, like the best radio receivers.

This article describes the construction of a high-quality A.F. amplifier, suited for use with either a radio set or a phonograph; it is A.C.-operated and provides ample volume for all requirements, with practically undistorted rendition. Properly installed, it will modernize old-type radio sets and phonographs.

—EDITOR.

industry did not, however, end with the development of an entirely new system of sound reproduction.

BETTER RECORDING METHODS

In former times, the recording artist, or group of artists, while making a phonograph record, had to huddle in a congested, uncomfortable and unnatural fashion before a large horn into which they played or sang; those in front, singing or playing unnaturally low, and those behind them unnaturally loud, in an attempt to produce an even balance of volume on the finished record. Large bands, choral groups and symphony orchestras were of necessity greatly curtailed in order to get within an effective range of the recording "funnel."

Now, however, one can scarcely distinguish between a phonographic recording salon and a radio broadcast studio. There is no funnel; no crowding; no unnaturalness on the part of the artists. Instead, they perform in their most natural way, while the microphones are placed to pick up each voice or instrument in its proper relation to the others.

In fact, the output of the electric phonograph, when one gets right down to the matter, is but a standard broadcast program which, instead of being sent over the air, is recorded and delivered to the consumer without picking up static or other disturbances en route.

The acoustical difference between the same piece, played by the same orchestra over a high-grade broadcast station on a quiet night and played on an electric phonograph is nil; assuming, of course, that the audio-frequency amplifier and loud speaker used in both instances are of similar quality.

EACH TO ITS PLACE

With these improvements, and one other—the elimination of the record scratch—the



The electrified phonograph in its cabinet. The output may be connected to either the balsa-wood speaker on the wall or the cone in the cabinet.

modern phonograph becomes a highly desirable companion to the modern radio receiver. Static and SOS signals no longer need spoil an evening's entertainment. Favorite selections, beautifully rendered and reproduced, are available at a moment's notice, when the radio program is not tempting.

But do not understand this article to be an argument in favor of the phonograph over the radio. The phonograph can never take the place of the radio. First, the radio brings into the home news and entertainment as it actually occurs; banquets, speeches, sporting events and many others; and secondly, radio supplies its own program. Its repertoire is not limited by the number of records in the album. But, as a companion to modern radio, there is a distinct service to be performed by the electrically-operated phonograph.

Let us divide the electrical phonograph

EVEN with the present high development of radio broadcasting, and the excellent diversified programs always available, there are bound to be times when one would prefer a program of his own arrangement; perhaps just a few favorite selections. Or again, if there is an electrical storm or if reception for some one reason or other is not up to standard, then a whole evening's entertainment may be desired. But who, after becoming accustomed to the well-nigh perfect—as far as the ear can tell—fidelity of reproduction of which the modern radio is capable, is content with an old-time phonograph?

But while radio has been making rapid strides toward that much-sought goal—"perfect tone quality"—phonograph and acoustical engineers have not been asleep. They have, themselves, investigated the new fields of electrical magnification and reproduction of sound opened up for them by radio invention. They have taken the best of radio amplifiers and speakers, and developed "pick-ups", needle-scratch filters and other necessary paraphernalia for converting the minute vibrations, which the phonograph record imparts to the needle, into pulsating electrical currents, which can be fed into the audio end of a conventional radio set.

Radio's contribution to the phonograph

T1 and T2, power transformers; CK1, choke; R6, potentiometer; R7, R8, R9 and R12, fixed resistors; C4 and C5, filter condensers.

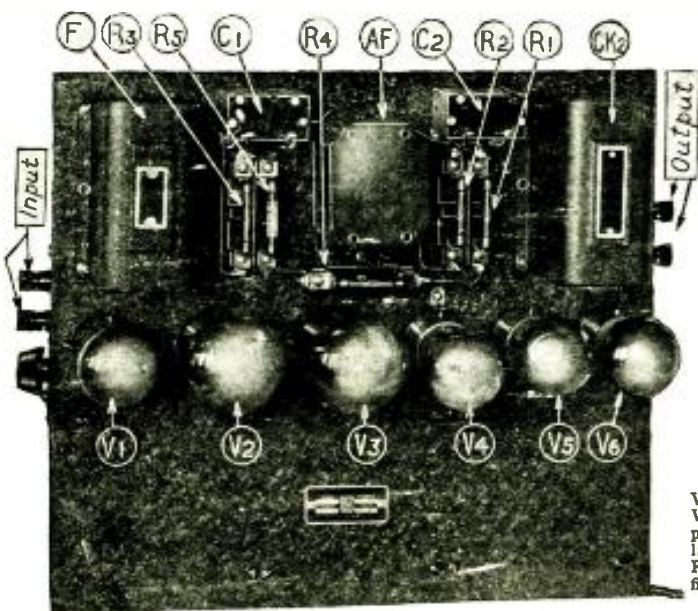
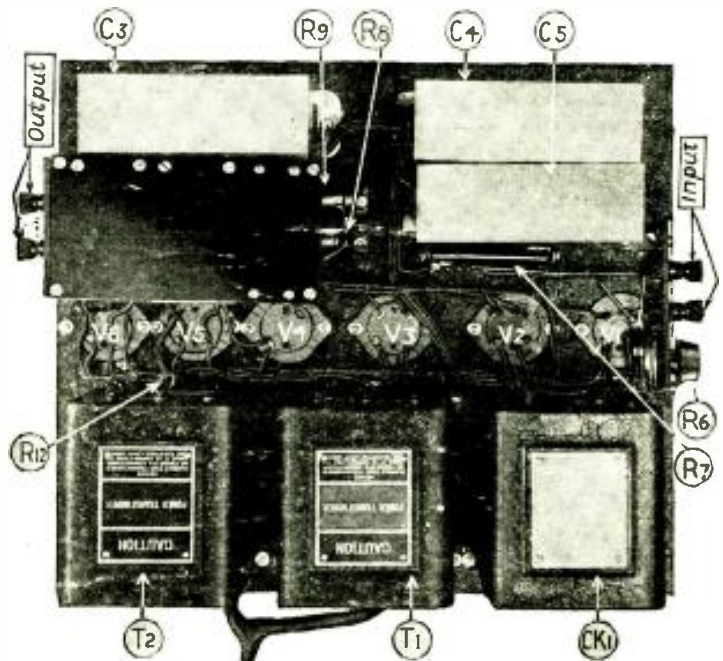

V1, A.F. amplifier; V2 and V3, power amplifiers in push-pull; V4, voltage-regulator; V5 and V6, rectifiers; F, scratch-filter; R1 to R5, fixed resistors; and CK2, plate-output impedance.

into its several component parts and consider each by itself.

THE PICK-UP

The pick-up is the device which converts the mechanical vibrations, imparted by the record to the needle, into electrical vibrations. There are at least four different types of pick-ups.

*RADIO NEWS Blueprint Article No. 42.

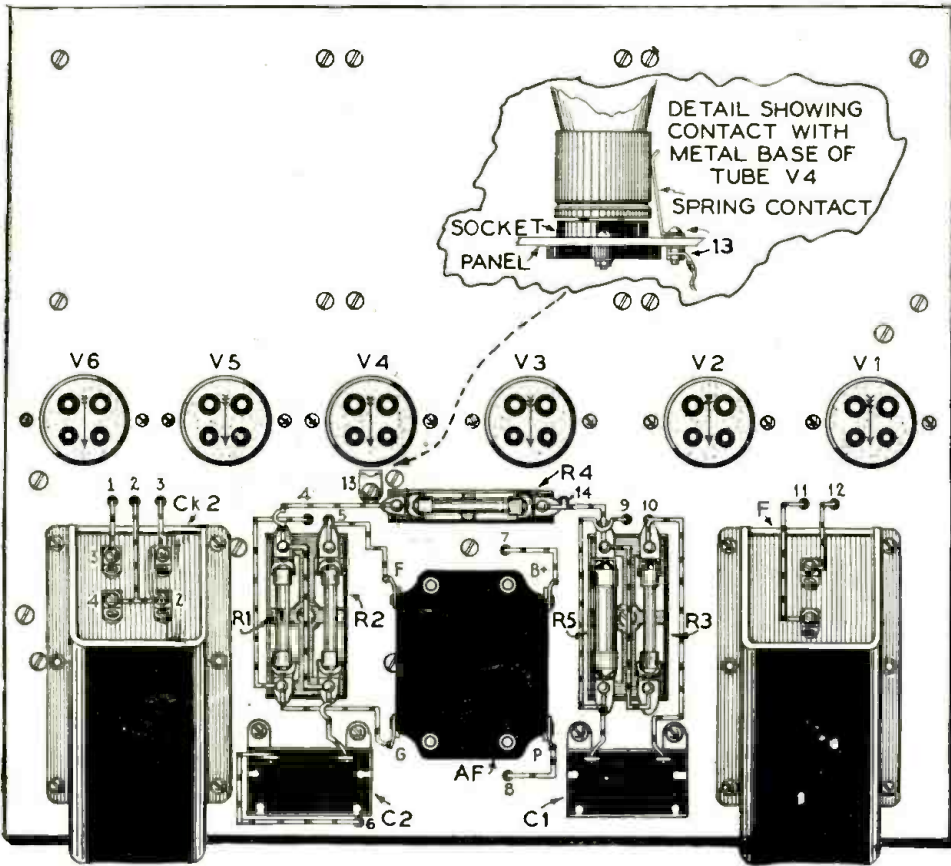

expensive; and, in addition they require a small storage battery or several dry cells for their operation. Even so, no commercial models which have yet made their appearance can equal, in tone quality, the performance of some of the better electromagnetic devices.

Of the capacity type, much has been said in recent issues of *RADIO NEWS*. Such a pick-up is capable of very excellent tone quality and is less expensive than a really good electromagnetic type, but has the rather serious disadvantage of requiring a pair of separate vacuum-tube oscillators, with their attendant "A", "B" and "C" supplies.

There are, however, available on the market at the present time, at quite reasonable prices, several very excellent pick-ups of the electromagnetic variety. This pick-up consists, essentially, of a permanent magnet of the horseshoe type, between the poles of which are located the pair of double pole-pieces, the balanced armature and the armature coil. Movement of the armature, at one extremity of which is located the needle, results in a variation in the flux passing through the armature, and thus linking with the turns of fine wire on the coil. This variation in flux, in turn, induces a varying or alternating voltage in the coil.

VOLUME CONTROL

As the output of the pick-up is alternating current, any device which will provide a ready method of controlling the magnitude of this voltage without in any way distorting its wave form, or altering the load impedance into which the pick-up works, will prove satisfactory. Fortunately, a simple, inexpensive device which meets these requirements is the high-resistance type of potentiometer used in many radio sets. Fig. 2 shows how the potentiometer is connected in the circuit. Most commercial pick-ups are supplied complete, including a volume-control potentiometer having the proper load impedance for the pick-up with which it is to be used.

The wiring diagram of the A.C. Phonograph Amplifier, showing the leads connecting the instruments located on the top of the panel. Note detail of connection to base of the voltage-regulator tube.

The electromagnetic and piezo-electric or crystal types function by generating electrical currents of their own; while the capacity and the carbon-grain forms operate by variation in the impedance of a circuit in which they are placed. All of these four different

types have at one time or other made their appearance in commercial form.

The present crystal types, while capable of excellent quality, are expensive and fragile. Those of the carbon type, when constructed to give really good quality, are also

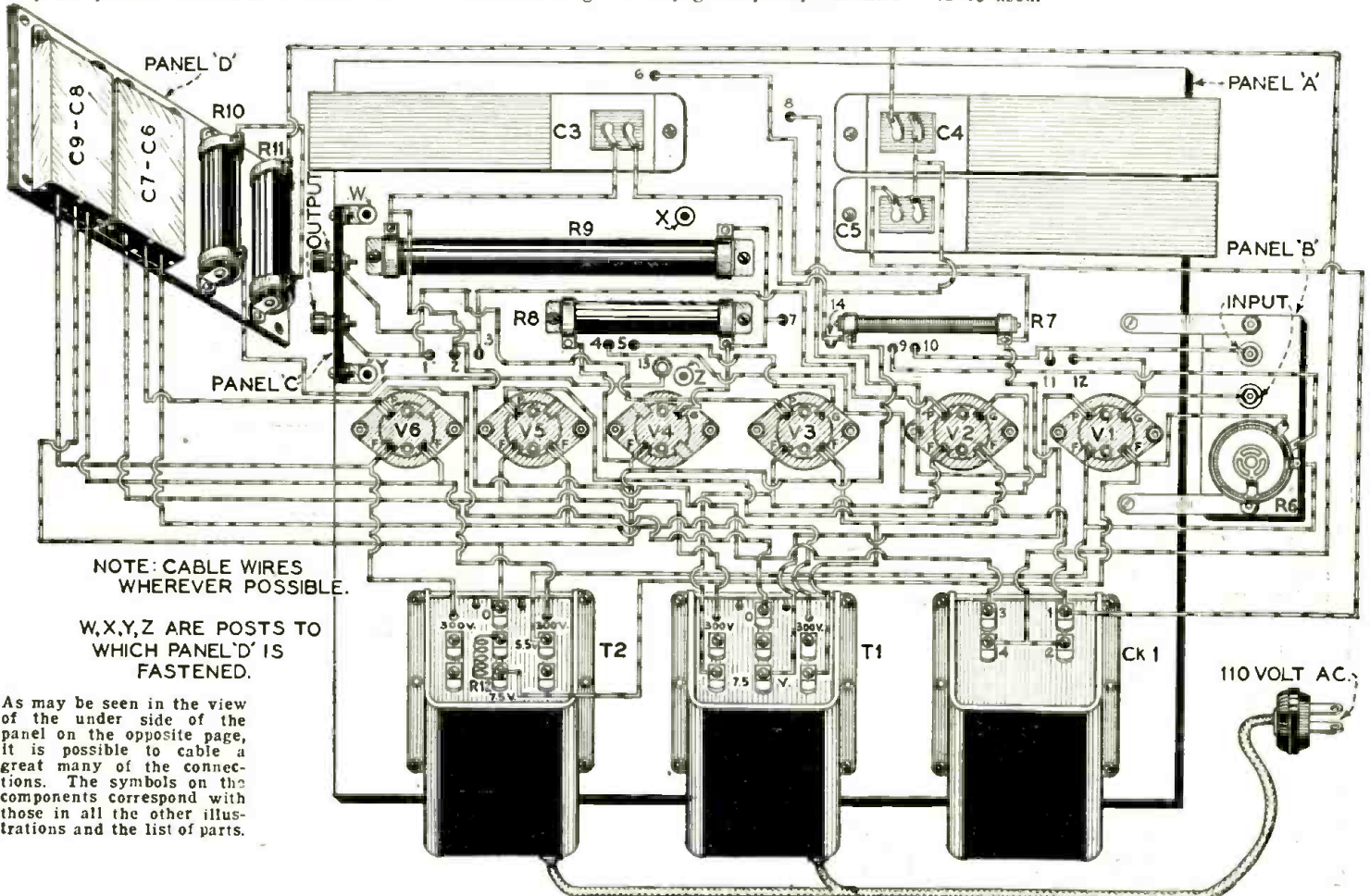

NOTE: CABLE WIRES WHEREVER POSSIBLE.

W, X, Y, Z ARE POSTS TO WHICH PANEL 'D' IS FASTENED.

As may be seen in the view of the under side of the panel on the opposite page, it is possible to cable a great many of the connections. The symbols on the components correspond with those in all the other illustrations and the list of parts.

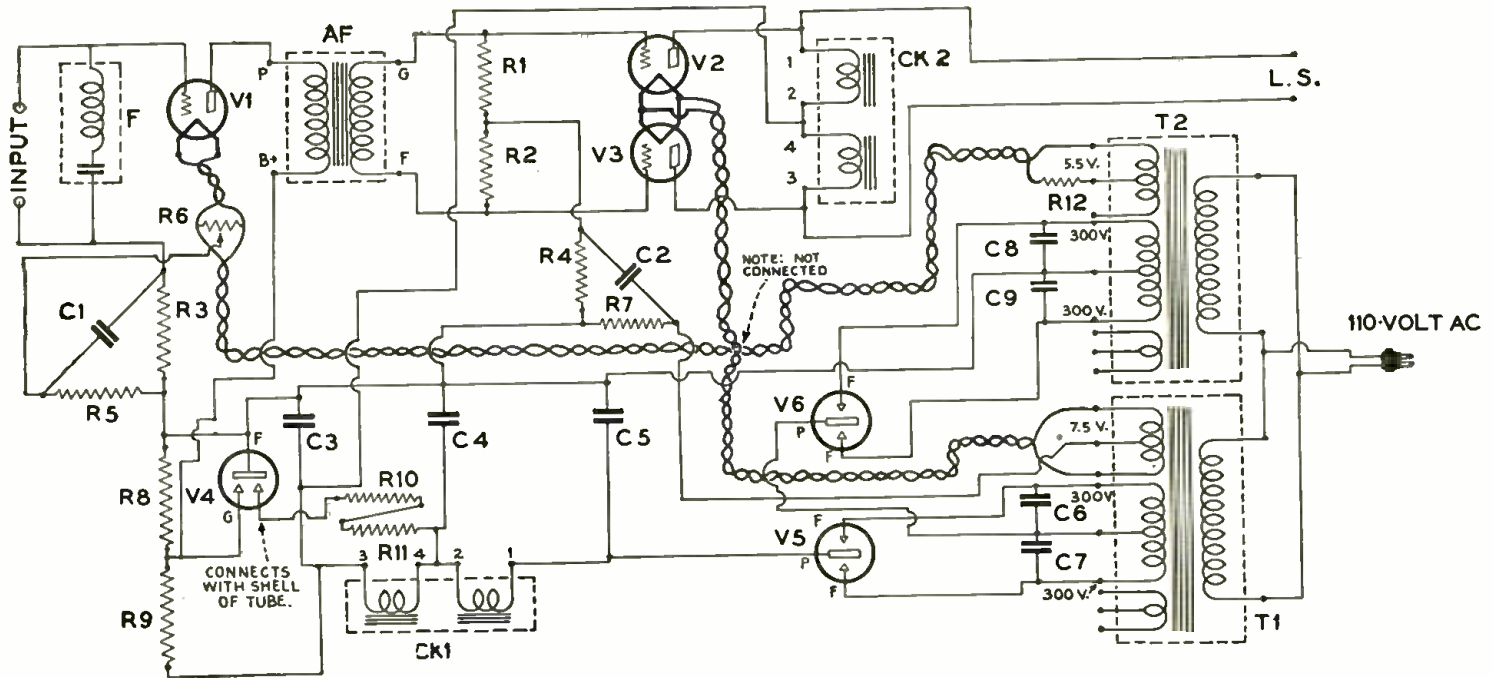

The schematic diagram of the Phonograph Amplifier, which, as may be seen, is entirely operated from the A.C. power mains.

THE SCRATCH FILTER

Aside from tone quality, one of the outstanding achievements in the new phonographs is the elimination of surface noises and needle "scratch." The use of a new material for the manufacture of records has done much to mitigate this annoyance of the past; but its final and complete elimination is accomplished by means of an electrical filter circuit, so tuned as to suppress scratch frequency. Such an electrical filter is connected between the pick-up and the amplifier. The filter is so located before, rather than after the amplifier, in order to prevent unnecessary overloading of the latter.

While the connection of a .006-mf. fixed condenser across the output of the pick-up (or input to the amplifier) will remove this noise, such an arrangement will at the same

time remove many of the higher audio frequencies and thus lower the quality of reproduction. For this reason an electrical filter tuned to stop the passage of only those currents in the neighborhood of the scratch frequencies is used.

The difficulty in completely eliminating the scratch lies in the fact that it is not of any one frequency, but covers quite a wide band. If, however, the filter circuit is tuned to approximately 4500 cycles, the greater part of the scratch noise is removed without sacrifice of tone quality. The residual hiss is practically unnoticeable when a scratch filter is employed, and cannot be detected except for the first few seconds or so before the music starts.

Such a device may either be purchased as a complete unit or may be home-constructed

from a choke coil and condenser, so selected as to be most effective at about 4500 cycles. This frequency peak should be somewhat "broadened" by the use of a very small quantity of iron in the construction of the inductance unit.

While an electrical filter circuit of the type indicated in the diagram will remove objectionable scratch from the music issuing from the loud speaker, it will not prevent one from hearing the unamplified scratch noise directly from the record. For this reason the lid of the turntable compartment should be kept closed while records are playing.

THE AMPLIFIER

Amplifiers of many different types are suited for electrical phonograph use; the audio end of almost any high grade radio set is capable of quite excellent results. The author has, however, designed primarily for phonograph use the amplifier hereinafter described, and has incorporated in the design several features which particularly fit it for such use.

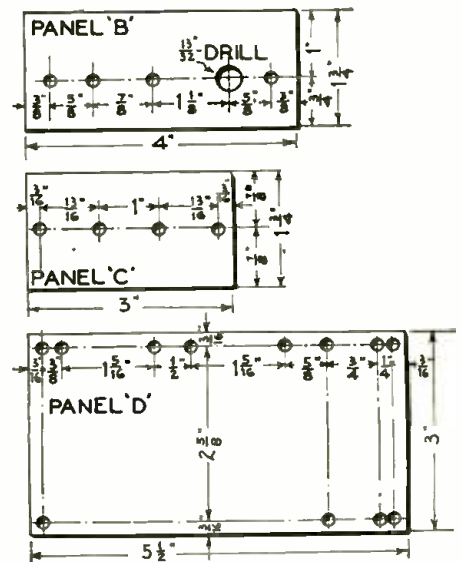
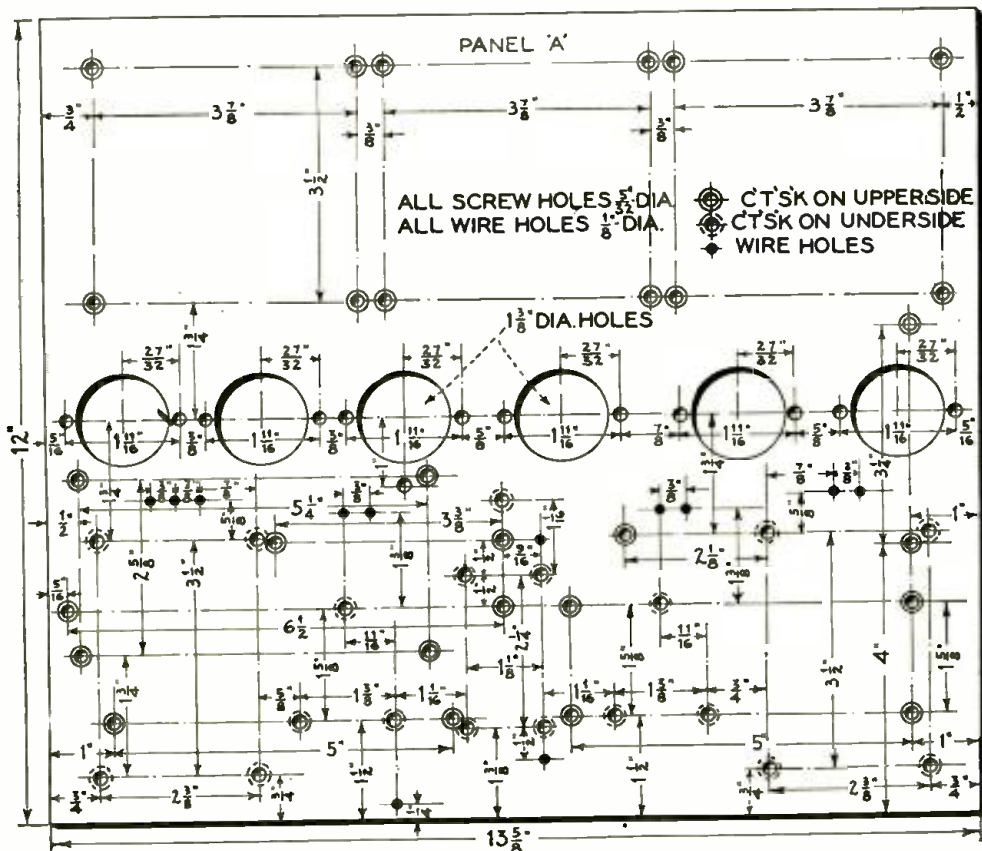

NOTE: ALL SCREW HOLES 5/32\"/>

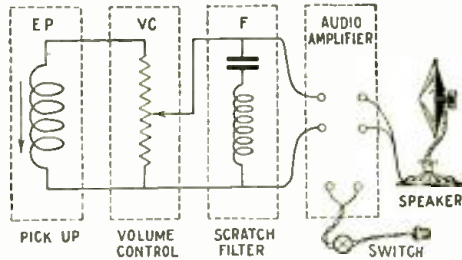

Fig. 2
This diagram illustrates the electrical circuit of the pick-up, the volume control and scratch filter.

First, it is all A.C. operated, no batteries of any kind being necessary. Second, by the use of two of the 210-type power-amplifier tubes in a push-pull amplification circuit, an unusually high undistorted watt-output is obtainable. This is essential for natural reproduction of the lower tones and musical notes at full volume. Furthermore, the use of a push-pull circuit reduces to an entirely negligible value the slight A.C. hum that would otherwise result from the heating of the power-tube filament by means of raw alternating current.

A standard high-quality audio transformer (AF) has been adapted to the push-pull circuit by the use of two 500,000-ohm resistors (R1 and R2) across the transformer secondary to establish the electrical equivalent of a center-tap.

In the input stage is employed an A.C. tube (V1), which overcomes much of the trouble experienced with former amplifiers employing the fragile and highly-microphonic 199-type tube for such a purpose. Current for the filament of this tube is obtained from the five-volt secondary winding of transformer T1, and a short length of resistance wire (R12), removed from an old rheostat, is connected in the circuit to reduce the voltage. The correct amount of wire needed for this purpose is determined by experiment.

The power supply section of the amplifier also boasts of several innovations. One is the use of two full-wave 300-volt gaseous-conduction rectifier tubes (V5 and V6) connected with their outputs in series; the necessary 600 volts is thus supplied by the full-wave filamentless rectification method, with but two inexpensive and long-lived tubes. Another innovation is the use of the 3-element voltage regulator (V4), described by the author in detail in the October issue of RADIO NEWS. Aside from stabilizing the operation of the amplifier and maintaining the "B" and "C" voltages at their proper values regardless of line-voltage fluctuations, the regulator tube also contributes largely to the lack of hum and to the good tone quality, due largely to its action as the equivalent of a 50 to 60 microfarad condenser across the high voltage plate supply.

FEATURES OF THE DESIGN

The somewhat unusual layout and assembly employed in the amplifier are also the result of an attempt to improve its performance and otherwise better adapt it for phonograph use.

First of all, the power supply is located below the heavy steel base plate (panel A); while the audio channel is located above, in order to reduce the amount of stray magnetic flux from the power transformer and first filter choke, which might otherwise be picked up by the audio transformer or the grid circuits of the amplifier tubes.

Secondly, all unprotected high-voltage leads are below the base plate. In fact, everything has been removed from in front of the row of tubes in order to facilitate their replacement, when necessary, without any attendant danger of shock.

Incidentally, placing the hot tubes above and the filter condensers, with their impregnation of low-melting-point paraffin, below, overcomes one of the most troublesome and

common faults of a great many amplifiers in which the rectifier or power tubes are placed quite close to the filter condensers. This results in an exceedingly short life for, not only the condensers, but generally much other apparatus in addition. A shorted filter-condenser will in many cases wreck the power transformer and rectifier tube at the same time.

Still another rather important point that has been given due consideration is physical size. The amplifier is sufficiently compact to fit readily into the average phonograph console in place of the old horn below the motor, avoiding the sacrifice of record storage space to house the electrical equipment.

THE LOUD SPEAKER

As the final component in the line-up of apparatus employed for the electrical reproduction of phonograph records, we have the loud speaker.

Anyone of several of the better types of loud speakers now available may be employed with most satisfactory results, where the device is not to be built directly into the cabinet. In the case of the console illustrated, two distinct types of built-in loud speakers are employed, with suitable switches for using either or both, as desired. One consists of a baffle-board type of electro-dynamic cone, with its field coil connected in series with the second filter inductor of the amplifier's power supply. This baffle and cone are mounted in the opening in the front of the console, which results when the

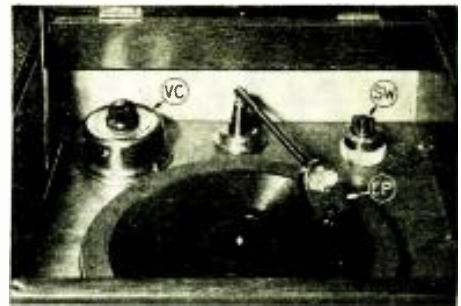

VC is the volume control, EP, the pick-up, and SW, the switch, which are placed in the turn-table compartment.

old wooden horn is removed to provide space for the amplifier. The rear of this compartment should be provided with a rather large opening, in order to prevent excessive "air clamping" of the cone. The baffle is a piece of 1/2 inch white pine, fastened in place with glue and long, thin wood screws.

The other speaker is of the balsa-wood type, shown from one of the kits now available on the market, hanging from the wall, where it presents a decorative effect, similar to a picture. The frame of an undecorated speaker of similar type may be readily suspended from and parallel to the bottom of the cabinet, thus being hidden from view.

After the above changes have been made, we will have an instrument truly modern as far as performance is concerned; the only (Continued on page 830)

SYMBOL	Quantity	NAME OF PART	REMARKS	MANUFACTURER *
T1, T2	2	Power transformers	300-volt secondary with center tap	1 11, 12, 13, 14, 15, 16, 17, 32
Ch 1	1	Filter choke	Two coils in one unit	1 11, 12, 13, 14, 15, 16, 17, 32
Ch 2	1	Plate choke	Two coils in one unit	1 11, 15
F	1	Scratch filter		1
AF	1	Audio transformer	Second stage type	2 11, 12, 13, 14, 15, 16, 17, 18, 34
C1, C2	2	Filter condensers	1 mf., 450-volt rating	3 5, 17, 19, 20, 21, 22, 23
C3	1	Filter condenser	4 mf., 1,000-volt rating	3 5, 19, 20, 21, 22, 23
C4, C5	2	Filter condensers	2 mf., 1,000-volt rating	3 5, 19, 20, 21, 22, 23
C6, C9	2	Buffer cond. units	Two .1 mf. condensers in each unit	3 5, 17, 19, 20, 21, 22, 23, 34
R1, R2	2	Fixed resistors	.5 megohm, grid-leak type	4 3, 17, 22, 23, 24, 25, 26, 36
R3, R4	2	Fixed resistors	.1 megohm, grid-leak type	4 3, 17, 22, 23, 24, 25, 26, 36
R5	1	Fixed resistor	1,000 ohms, cartridge type	4 3, 5, 17, 22, 23, 24, 25, 26, 36
R6	1	Potentiometer	30 ohms	5 14, 22, 32, 35
R7	1	Fixed resistor	750 ohms, wire wound, 10 watts	4 5, 22, 23, 24, 25, 26, 28
R8	1	Fixed resistor	10,000 ohms, 20 watts, wire wound	4 5, 17, 22, 23, 24, 25, 26, 28, 34
R9	1	Fixed resistor	12,000 ohms, 20 watts, wire wound	4 5, 22, 23, 24, 25, 26, 28
R10, R11	2	Fixed resistors	40,000 ohms, 20 watts, wire wound	4 5, 22, 23, 24, 25, 26, 28
V1	1	Amplifier tube	216 type	6 25, 29, 30
V2, V3	2	Power tubes	210 type	6 25, 29, 30
V4	1	Voltage regulator	Three-element type	7
V5, V6	2	Rectifier tubes	Full-wave gaseous type	7 6, 31
	6	Tube sockets	UX type	8 12, 14, 17, 26, 32, 33, 34, 35, 37, 45
	4	Binding posts		8 26, 32, 34, 38
	2	Resistor mounts	Double	4 17, 22, 23, 24, 25, 26, 28, 34
	1	Resistor mount	Single	4 17, 22, 23, 24, 25, 26, 28, 34
		Hook-up wire	Insulated	10 20, 40
EP	1	Phonograph pick-up	Magnetic type	9 35, 32, 39, 41
R12		Resistor wire	(See text for description)	
VC	1	Volume control	Potentiometer type	9 39, 41
SW	1	Switch	Standard 110-volt snap switch	
A	1	Steel chassis	13 1/2 x 12 x 1/8 inches	
B	1	Panel	1 1/2 x 4 inches	42 43, 44
C	1	Panel	1 1/2 x 3 inches	42 43, 44
D	1	Panel	3 x 5 1/2 inches	42 43, 44
WYZ	4	Brass posts	3/16 x 1/2 inch tubing	

NUMBERS IN LAST COLUMN REFER TO CODE NUMBERS BELOW.

1 National Company, Inc.	2 American Transformer Company	1 Tube Distributor Company
4 Arthur H. Lynch, Inc.	5 Carter Radio Company	6 G. F. Fig. Company, Inc.
7 Raytheon Manufacturing Company	8 H. H. Fyfe Mfg. Company	9 American Beach Magneto Corp.
10 Cornish Wire Company	11 Samsco Electric Company	12 Silver-Marshall, Inc.
13 Dungen Electric Mfg. Company	14 General Radio Company	15 Jefferson Electric Mfg. Co.
16 Thornderson Electric Mfg. Co.	17 Leolis F. Muter Company	16 Ferranti, Inc.
19 Dubilier Condenser Corporation	20 Acme Wire Company	21 Patent Manufacturing Co.
22 Polymet Manufacturing Company	23 Aerovox Wireless Corporation	24 International Bus. Co. (Rushmore)
25 Davon Radio Corporation	26 Amaco Products, Inc.	27 Ward-Lantern Elec. Co.
28 Electrad, Inc.	29 Radio Corporation of America	30 E. F. Cunningham, Inc.
31 Q.R.R. Music Company	32 Electrical Research Lab. (E.R.L.)	33 De Jur Products Company
34 Pilot Electric Mfg. Company	35 Herbert H. Frost, Inc.	36 Allen-Bredley Company
37 Benjamin Elec. Mfg. Co.	38 XL Radio Laboratories	39 Patent Electric Company
40 Belden Manufacturing Company	41 Brooklyn Metal Strapping Co.	42 Micarta Fabricators
43 American Hard Rubber Company	44 Formica Insulation Company	45 Air Cap Products, Inc.
46	47	48

* THE FIGURES IN THE FIRST COLUMN OF MANUFACTURERS INDICATE THE MAKERS OF THE PARTS USED IN THE ORIGINAL EQUIPMENT DESCRIBED HERE.

If you use alternate parts instead of those listed in the first column of manufacturers, be careful to allow for any possible differences in size from those originally used in laying out and drilling the panel and sub-base.

Patent Copyright, 1927, E. P. Co.



A Sturdy and Simple "A" Power Unit*



Constructional Details of A Device Supplying Suitable Filament Current from the A. C. House Socket

By HERNDON GREEN

THE "A" power unit described in this article is a simple apparatus which may be used to replace the storage battery of a radio installation. It obtains its power from the 110-volt A. C. lighting circuit, and it has a D. C. output of 6 volts at 2 amperes. Therefore, it may be employed for heating the filaments of any set using eight or less 201A type tubes.

Even the novice will find the construction of the device very simple, and should experience no difficulty in completing the assembly in less than an hour's time. Only five parts are used and ten wires complete the wiring.—EDITOR.

MOST readers of this article are aware of the steady march toward simplicity and ease of operation, in the field of radio engineering. There has been a continual development from multi-control receivers to those of but one or two dials. Plate ("B") socket-power units, requiring little or no attention of replacement, have taken the place of batteries, in many cases. And, this year, one of the most outstanding features in radio design is the advent of complete light-socket operation. Some manufacturers have attained this end by incorporating plate-power units in their sets and by making use of the new A.C. tubes—others by employing both filament and plate socket-power units. For the fan who already owns a satisfactory radio receiver, and who does not feel ready to invest in parts for a new set this year, completely batteryless operation is entirely feasible, and without the slightest change in the wiring of the set, or change in tubes. Any of a great number of standard "B" power units will provide the plate circuits with direct current; while the device which may be used to accomplish the electrification of the filament circuit is a simple homemade "A" power unit, having a direct current output of 2 amperes at 6 volts. This unit may be used for the operation of any

standard receiver using eight or fewer 6-volt, ¼ ampere tubes, and to provide "A" current for tubes of the 201A, 200A, and 112, 171, 240 types.

EXTREME SIMPLICITY

Upon examination of the simple wiring diagram, Fig. 1, the principles employed in the design of this unit will be entirely clear to the technical fans. The house-lighting potential is reduced to the required voltage by the step-down transformer T, which is the first unit of the circuit. The output of this transformer is then changed from an alternating current to a pulsating direct current, through the use of the rectifier tube V, which is of the two-element type. This current then enters the filter circuit where it is "smoothed out" to pure direct current for the operation of the receiver. The filter circuit consists of the choke coil L and the condenser unit C1-C2, which has two sections. The advantage of the system is that, aside from the current used, there is no expense for upkeep; and there is never a time when the receiver must be out of commission because of lack of "A" voltage; for as long as there is power in the light socket there will be ample current available for the operation of the receiver.

The power transformer T has but two windings; one primary which is connected directly in the house-lighting circuit, in series with a switch for turning the filament current off and on; and a secondary which provides the current for the receiving set and also for heating the filament of the rectifier tube V. The output voltage of the secondary is 7½, and the tap for the rectifier filament is at 1½ volts. The transformer is enclosed in a complete shield which prevents the alternating-current field from being picked up by the receiving set and thus introducing hum.

The rectifier tube V is of the 2-ampere tungar type and fits into a special socket which is somewhat similar to the standard 110-volt receptacle, but has provision for making three connections to the tube. When

connected in the circuit the tube acts as a half-wave rectifier. With the tube, the small by-pass condenser C3 is used in the rectifier circuit. It has a capacity of 0.25 mf. and is connected between the plate and filament of the tube.

THE FILTER CONDENSER

For the filter circuit a condenser bank of the electrolytic type (C1 and C2) is used in connection with a heavy-duty choke coil (L). The enormous capacity of the condenser is the secret of the success of this simple filter system. It is estimated that the two sections have a combined capacity of 250,000 mf.

In construction the condenser consists of two sets of plates submerged in an electrolyte in a metal container. The metal container serves as the common electrode for the two condensers, and wires connected to the plates provide the other two necessary contacts. The electrolyte, which is a solution of potassium hydroxide, is covered with a film of oil which prevents excessive loss from evaporation. As a result, it is seldom necessary to add water to the cell and there

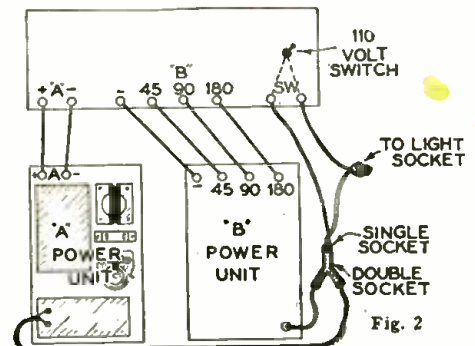

Fig. 2. An approved method for controlling the operation of both "A" and "B" power units is shown above. Devices of this style must be operated with a 110-volt switch in the lighting circuit, and the set's battery switch discarded.

are no offensive odors or destructive gases which might cause damage to the interior of cabinets. The choke coil L in the filter circuit is very compact, as may be seen.

Examination of the accompanying picture and drawings will show the simplicity of construction. All apparatus is mounted on a wooden baseboard, 7x12x¾ inches, and all wiring is above the base. In constructing the entire unit only twelve separate wires are used. The average radio fan should find it possible to complete the entire assembly and wiring in less than one hour's time.

EASY ASSEMBLY

When constructing the power unit it is advisable to follow the arrangement of parts shown in the drawing; all apparatus should be fastened to the baseboard with wood screws. If any other arrangement of parts is desired, do not place the transformer in a position which is near to the wires which connect with the filament binding posts of the receiving set. The transformer sets up a magnetic field, which is confined as much as possible by the metal case; but the leads to the rectifier tube and choke coil might have sufficient effect upon the output wires to cause a hum to be heard in the receiver, if the two were in close proximity to each other.

The wiring of the unit is so simple that it is unnecessary to give complete directions for making each connection. However, it is important to remember that all wires

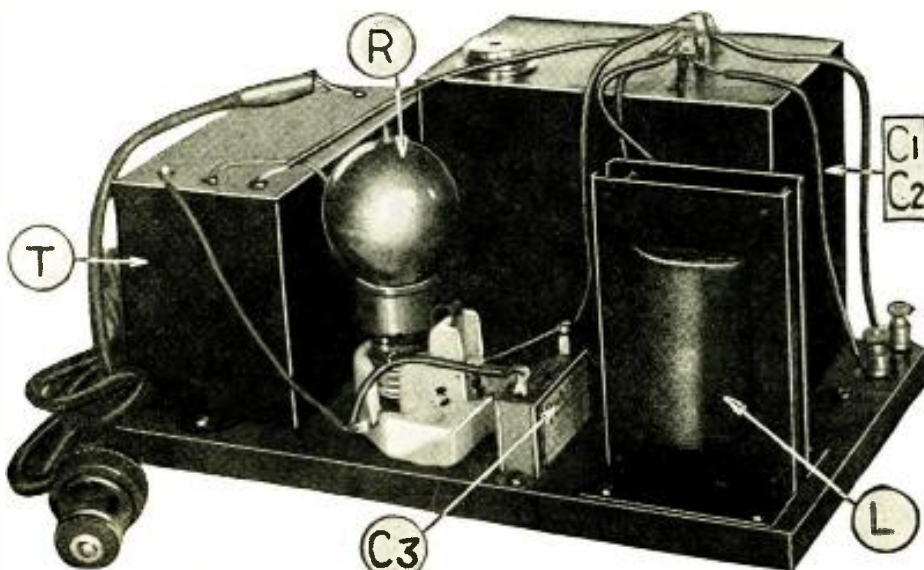

The simplicity of the "A" power unit described is shown. All parts are mounted on a small wooden base and a few flexible wires are the only connections necessary. The letters designate the parts listed opposite.

*RADIO NEWS Blueprint Article No. 43

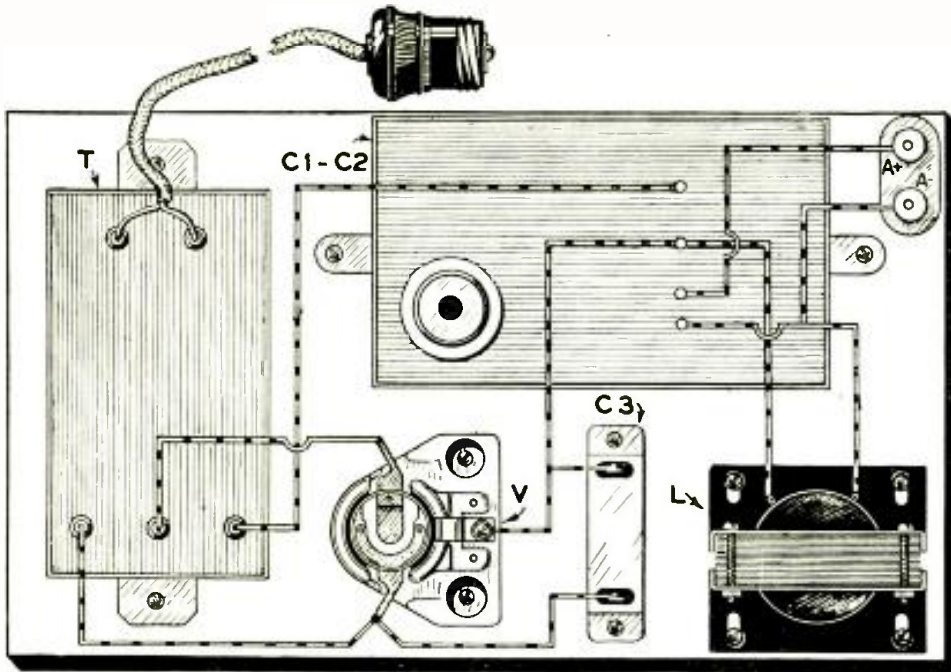

In this pictorial wiring diagram the exact arrangement of parts and methods of wiring the "A" power unit are shown. All parts and wiring are located above the base, which is a block of wood 12 x 7 x 3/4 inches. Also, when making connections heavy, flexible, insulated wire should be used.

carry currents of large values, and, therefore, it is advisable to use fairly heavy wire in order to reduce resistance losses. Also, remember that the unit is power apparatus, and take particular care to see that it is well insulated.

PREPARING THE CONDENSER

In preparing the unit for operation after the construction has been completed, the first step is to add water to the electrolytic condenser. Proceed as follows: Remove the cork from the filler opening and throw it away. Next, pour half a pint of distilled water into the opening and allow the unit to stand for approximately ten minutes. It will become warm, because of the chemical action which results when the salts in the condenser are dissolved. After ten minutes, add sufficient distilled water to bring the liquid level up to the cross bar, which is plainly visible in the filler opening. Now rock the condenser gently, to help dissolve the chemical, and to assist the liquid in entering the spaces between the condenser plates. Upon examination it will probably be found that the liquid has gone down and, if such is the case, it will be necessary to add more distilled water in order to bring the level up to the cross bar. The rocking operation may be repeated again and then the condenser should be allowed to stand for fifteen minutes. Before using the unit, examine the liquid level again and fill with additional distilled water, if necessary. However, do not fill the condenser above the cross bar. Also, do not place the cork in the filler opening but use the nickel filler cap which is supplied with the condenser.

POWER SWITCH REQUIRED

After the condenser has been prepared as described above, the rectifier tube may be inserted in the socket and the "A" power unit may be considered ready for use. However, provision must be made for turning the unit on and off, and a battery switch must not be used for the purpose. If the builder wishes, he may add two extra binding posts to his receiver and connect them to a 110-volt switch which may be mounted on the front panel; or he may turn the unit on and off at the light socket. In either case it must be remembered that the filament switch on the panel of the set can no longer be used to turn the set on and off. It is a wise plan to join together the two wires

going to this switch, and remove the switch from the panel. If desired, the 110-volt switch may be mounted in the same space after the old switch has been discarded.

When both "A" and "B" power units are used for the operation of the receiver, still another problem presents itself. Both of these units are turned on in the 110-volt

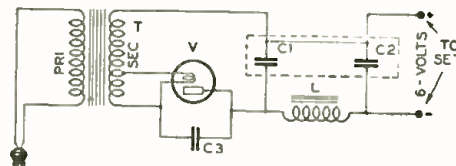

Fig. 1

The above schematic wiring diagram shows the complete circuit of this simple "A" power unit. The parts indicated follow: T, power transformer; V, rectifier tube; C1-C2, electrolytic-condenser bank; C3, by-pass condenser; L, heavy-duty choke coil.

circuit, and they may be operated with the same switch. In the small picture diagram (Fig. 2) a suitable circuit is shown. The plugs of the "A" and "B" power units, which ordinarily go to the light socket, are connected together in a double socket; the double socket is placed in an ordinary receptacle; one wire from the receptacle connects directly with the light socket, and the other wire connects with the switch and then with the light socket.

HINTS ABOUT OPERATION

If, after the unit has been placed in operation, a hum is noticeable in the loud speaker, there are several places to look for trouble. In the first place, make sure that the 110-volt wires do not come in close proximity to the 6-volt wires which go to the receiver. Also, all pairs of wires in the 110-volt A.C. circuit should be twisted. Secondly, the liquid in the condenser cell may be low, and if this is the case distilled water should be added. Lastly, the power unit may be located too close to the detector and audio circuits of the set. It is wise to try moving the unit, as a more satisfactory position may be found.

In connection with the operation of this unit there are several other things which should be remembered by the constructor. The power transformer of this device handles a large amount of current, and as a result becomes hot after continued operation. In normal operation it is too hot to touch.

The liquid in the electrolytic condenser will damage carpets or furniture, if spilled on them. If any of the liquid is accidentally spilled it should be neutralized at once with vinegar and washed off. If it is spilled on the hands, they should be washed immediately with soap and water.

If the liquid of the condenser becomes too low, no harm is done; but the unit will cease to function. It is usually possible to tell by an increase in the hum, when additional water is required. However, on an average, it is wise to add water twice each year.

Frequently it will be unnecessary for the radio fan to buy all of the parts listed below when building this unit. If an old battery charger is available, this may, sometimes, be used in place of the rectifier tube and transformer. Most battery chargers consist of a transformer and rectifier, and if one is of efficient design, a filter system of the type used in this circuit will convert it into an "A" power-supply unit. However, the mechanical or vibrating type of charger should not be used, as it will not give satisfactory results. Chargers which are best suited for this purpose should use a rectifier of the tungar-tube, electrolytic-cell, dry-electrolytic, or cartridge type.

If a battery charger is used, in place of the transformer and rectifier of the power unit, the constructor should discover whether a transformer or an auto-transformer is used, by testing the windings with a pair of phones and a battery. If it is found that a connection exists between the primary and secondary windings, the device is an auto-transformer; and in this case the receiver should be operated without a ground connection. This change will not reduce the efficiency of the receiver, as a ground connection will exist through the lighting circuit.

SYMBOL	Quantity	NAME OF PART	REMARKS	MANUFACTURER *
T	1	Power transformer	Tapped 7 1/2 volt secondary (special)	1
C1, C2	1	Filter condenser	Electrolytic type	2
L	1	Choke coil	Heavy-duty type (special)	1
C3	1	By-pass condenser	.25 mf.	3 6, 7, 8, 9, 10
V	1	Rectifier tube	2-amperes type	4 11
	1	Porcelain socket	Three-contact type (for rectifier tube)	1
	2	Binding posts		5 12
		Hook-up wire	Spaghetti covered	6
	1	Baseboard	12 x 7 x 3/4 inches (wood)	

NUMBERS IN LAST COLUMN REFER TO CODE NUMBERS BELOW.

1 Setbuilders Supply Co., (Setco)	2 The Box Company	3 Dubilier Condenser Corp.
4 General Electric Company	5 H. H. Ehr Manufacturing Co.	6 Acme Wire Company
7 Tele Deutschmann Company	8 Potter Mfg. Company	9 Polymet Manufacturing Co.
10 Aerovox Wireless Corporation	11 Featherhouse Electric Mfg. Co.	12 X.L. Radio Laboratories
13	14	15

* THE FIGURES IN THE FIRST COLUMN OF MANUFACTURERS INDICATE THE MAKERS OF THE PARTS USED IN THE ORIGINAL EQUIPMENT DESCRIBED HERE.

If you use alternate parts instead of those listed in the first column of manufacturers, be careful to allow for any possible difference in size from those originally used in laying out and drilling the panel and sub-base

Two Adaptations of the Exponential Horn

A TEN-FOOT CURVED HORN FOR CABINET USE

By WENDELL P. GRAHAM

THE exponential horn, described in RADIO NEWS for October, gives splendid results. However, as the lady of the house may object to a megaphone horn in the living room, a speaker that can be built into a cabinet might be more desirable. The horn described here may be built

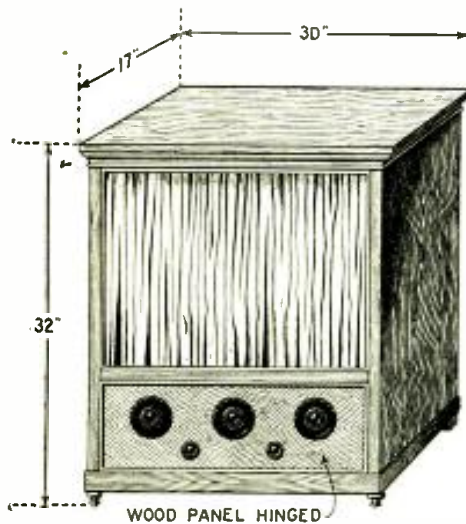

Dimensions and appearance of the cabinet enclosing a 10-foot home-made horn.

at home, with hard wall plaster as a material; it has an air column of ten feet and will go into a cabinet thirty inches wide, thirty-two inches high and seventeen inches deep. It cost the writer less than one dollar for material.

The first step is to construct a form upon which to make the plaster horn. For this the following material is required: some jute sacking; a two-foot wooden rod, such as a window-blind roll—a piece of 1/4-inch iron rod about eight feet long; and some short ends of lumber to form the mouth of the horn, which is 20x24 inches. Also, a sack of sawdust, a sack of shavings, some cord, wrapping paper and glue will also be used. The measurements of the horn are similar to the one described in the October issue of RADIO NEWS, but the units of length are made 20 inches in place of a foot; and the jute is cut in one piece. The measurements are approximately as shown in the diagram.

In cutting out the jute, allow an inch on each side for a seam. The jute is now stitched up and turned inside out. Now take the piece of window shade roller and taper it to 3/8-inch at one end; bore a 3-16-inch hole in the large end of the stick, and drive it on the 1/4-inch iron rod for a distance of about three inches. The purpose of the iron rod is to hold the smaller part of the form in shape when bent. Now shove the wooden rod into the smaller end of the jute cone and fill this with sawdust; this has to be worked in a little at a time at the small end or it will jam part way down. Shavings are used at the large end of the horn form. After the form is filled with sawdust, a wooden frame 20x24 inches is made and the jute mouth of the form is nailed around it.

When the above has been completed fasten

wooden strips, 1/2x1 inch, around the edge of the form with screws. The idea here is that, when removing the mold, there will be less danger of breaking the plaster horn; as you can unscrew the strips and cut the jute with a sharp knife and remove the wooden form.

The next thing is to shape the horn. By working carefully from the large end it will not be difficult to get the required shape.

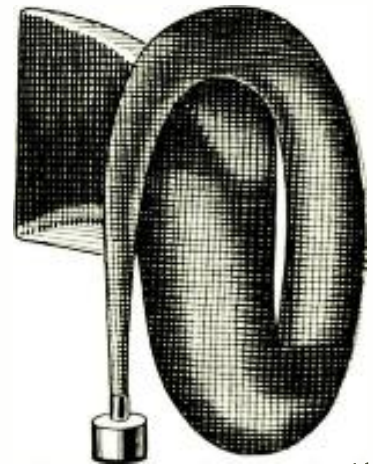

This shows the shape of the horn, to which a bag of coarse cloth is curved as a pattern.

There will probably be a sharp angle near the mouth, on the underside, but this can be filled with plaster. Old clothes-line, strips of burlap and small cord, may be used to shape and stiffen the mold after it is bent (Continued on page 845)

A SIX-FOOT DUPLEX STRAIGHT HORN

By F. G. SCHOENFELD

ABOUT three years ago RADIO NEWS published an article on the construction of a speaker of the horn type. The design called for an inner and outer horn of a total length, if combined, of about 2 feet, and having an outlet throat area of 1 square foot. The horn was to be constructed of 1/4 inch spruce or white pine.

The writer built the horn at that time and has used it ever since, having found it superior to any other horn-type speaker on any basis of comparison. A Baldwin unit (type C) was used.

More recently, he read with much interest the articles by Major J. S. Hatcher on "The Passing of Canned Music," C. R. Hanna on

the theory of the exponential horn and, with special interest, that by T. H. Millar describing the construction of a 6-foot horn of square cross section. While the exponential horn described by Mr. Hanna is no doubt excellent, its construction cannot be undertaken by the average experimenter. The horn described by Mr. Millar is too bulky to match the rest of the average radio equipment; and it cannot be made ornamental enough to offset its size.

Wishing to limit the height to three feet and the outlet to about fifteen inches square, the writer used the dimensions as given by Mr. Millar to construct a horn of the type mentioned at the beginning of the article. Allowance has been made, in the cross-sectional area of the outer horn, for the area occupied by the inner horn. The results have been well worth the effort in building, as the music produced has a depth and fullness of tone comparable only to the best type of talking machine. Orchestra instruments never heard with an ordinary horn are especially noticeable.

DESIGN OF THE HORN

Both inner and outer horn were made of 1/4 inch white pine (Fig. 1). When constructing the outer horn it was not possible to obtain material 15 inches wide; so two pieces 8 inches wide were used, cut to size, glued and attached to the 1/2x1 1/2-inch batten strips with 3/4-inch wire brads and glue. One end of the batten strip was attached even with one edge of each section, while the other end was extended 3/4 inch beyond the edge of each section to allow for lap and

nailing to batten strip on each succeeding section (Fig. 1A). Brads of the same size were used to fasten sections of inner and outer horn together.

The dimensions of the sections of the inner and outer horn are shown in Fig. 2. As 1/4 inch material was used, this quarter inch (Continued on page 846)

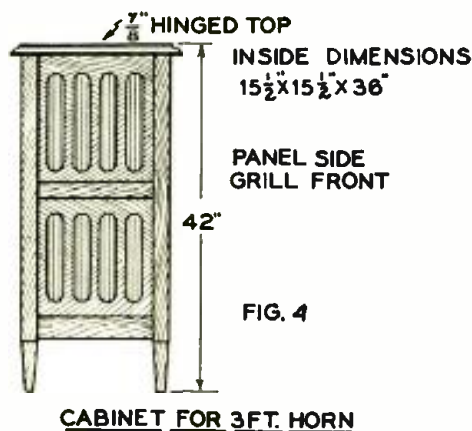

External appearance of a console built around this six-foot horn.

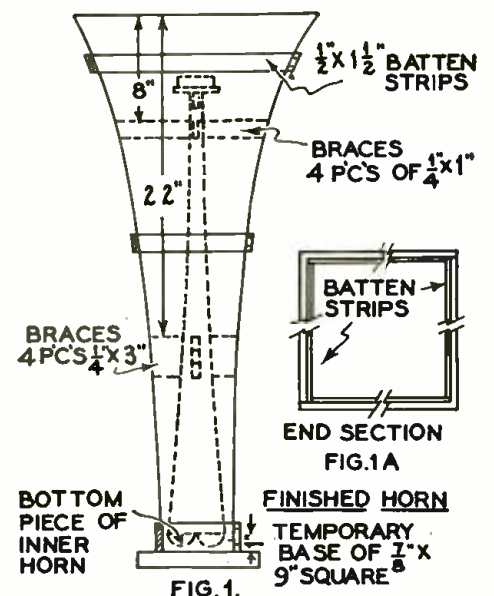

By dividing the straight horn into two sections, the problem of its length is overcome.

The Search for the Perfect Detector

A Practical Discussion of the Relative Merits and Demerits of Three Systems of Detection

By SYDNEY P. O'ROURKE

NOWADAYS, the praiseworthy craze for perfection in reproduction has led experts to investigate every portion of a receiving circuit which may be at all a likely cause of distortion, in order to provide that ideal at the output, which should be merely a perfectly magnified form of the input.

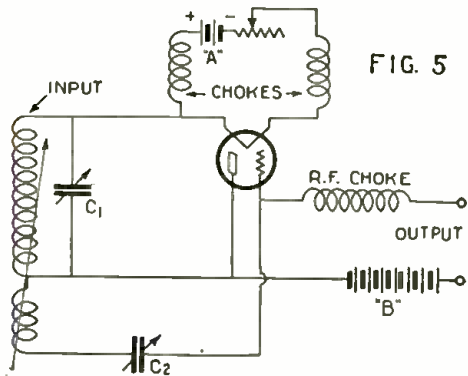

The input is here connected to the filament and the grid to the source of high positive "B" potential. This circuit functions very well with certain tubes.

Let us take for instance a typical five-tube set, comprising two neutralized R.F. stages, detector and two A.F. stages. We may reasonably presume that no distortion of any consequence to audio frequency takes place in the R.F. stages, if they are correctly designed. We may pause, however, at the detector stage, for here the trouble begins. It is obviously rather useless going to any trouble over the A.F. stages, if their input has been distorted by the detector in the first instance; and in a great many cases this is exactly the place in which distortion may and will occur most easily.

Up to the present, set designers, in designing a set for distance work, include grid-leak-and-condenser rectification; for quality reproduction they specify a tube working on its "lower bend," commonly termed plate-bend rectification. This article proposes to deal with detectors employing, first, grid input; second, plate input; and third, filament input, in an endeavor to find a detector more perfect than is at present in common use.

We may first conveniently deal with the results of applying the tuned R.F. input to the grid of an ordinary tube, in order to convert it to a train of low-frequency pulsations, capable of energizing a loud speaker or a pair of telephones. The general theory is that the negatively-charged electrons emitted from the hot filament are attracted with great force by the positively-charged

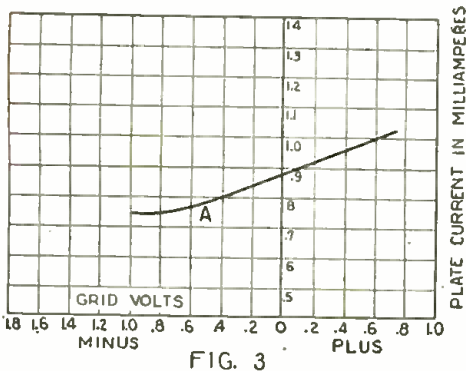

The grid-voltage, plate-current characteristic curve, which is typical of many detector tubes.

plate. The grid between the two, being charged alternately positively and negatively by the incoming train of R.F. oscillations, acts as a "traffic controller" and alternately aids or repels to some extent the stream to the plate.

The two most common forms of detector circuits, apart from supers, utilizing the input to the grid, namely, "leaky-grid" and "plate-bend," are shown diagrammatically in Figs. 1 and 2. Little need be stated here regard-

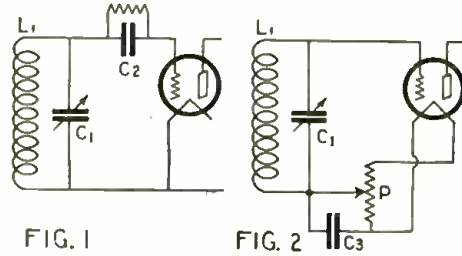
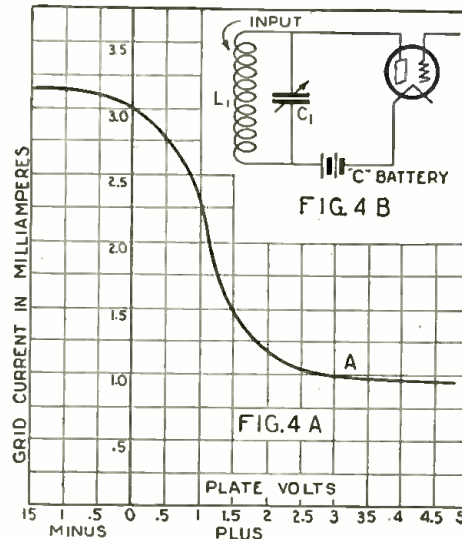

FIG. 1 The two commonest detector circuits, the "leaky-grid" in Fig. 1 and the "plate-bend" in Fig. 2.

ing the theory of such circuits. Many articles have been written on the above in past issues of RADIO NEWS, and the interested reader is referred back particularly to Mr. L. W. Hatry's article in the September, 1927 issue entitled "Experiments with Methods of Detection."

These circuits seem to have gained enormous popularity presumably on account of their very simple nature and moderate efficiency.



When the grid is positively charged, very efficient rectification takes place, as shown by the curve A. Note values of grid current compared with plate current of Fig. 3. 4B is the circuit used.

Leaky-grid rectification requires that the tube be operated on the straight portion of its characteristic curve; so that there is some amplifying action in addition, depending on the tube in use, and therefore its efficiency for weak inputs is very good. In its rectifying action, however, grid current must flow and this has a marked damping effect on its associated tuned circuit, spoiling selectivity and making the matching of preceding radio-frequency stages a rather diffi-

cult business. A condenser, C2 in Fig. 1, is also involved and, since its impedance varies with changing frequencies, some distortion of wave form must occur; though if values are properly chosen, such distortion is very slight.

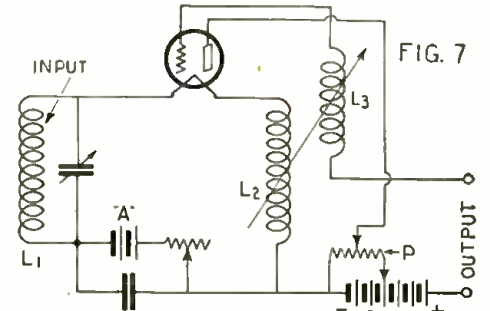

In this unusual circuit, 199 or 201A type tubes can be used with good results.

The circuit of Fig. 2 is provided with a potentiometer at P, so that the potential of the grid may be varied to work the tube on the lower bend A of the grid-voltage-plate-current characteristic of Fig. 3, which is typical of many detector tubes.

Provided the grid and plate voltages are correctly chosen, no flow of grid current will take place; thus giving better selectivity and making the matching of the tuned circuit with preceding R.F. stages a fairly simple matter, often eliminating one or two controls. In addition, no serious distortion will result, provided the largest grid input-voltage swing is allowed for by a sufficiently high plate voltage.

This method is defective in its poor sensitivity to weak signals. It is comparable to the crystal detector in that its efficiency is directly proportional to the square of the input voltage. Therefore, its efficiency is poor unless a strong initial signal is obtainable, or if the signal is weak, a stage or so of R.F. amplification.

APPLYING INPUT TO PLATE

It has been shown above that, provided the input is above a certain value, bottom-bend rectification may give a practically perfect output. This statement does not hold for a small input, however, since true linear rectification is not obtainable with such circuits. Now it has been found that, if a relatively-high positive potential is applied to the grid, the filament voltage being turned down a little below its normal value, as soon as the plate becomes slightly positive a very large current flows to it; while when it becomes negative, very little change will

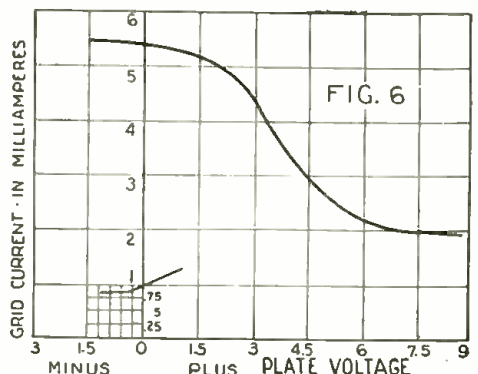

Curve obtained by circuit in Fig. 5. Observe in lower left the characteristic of the same tube used in grid-input circuit and drawn to same scale.



A High-Low-Tone Loud Speaker



Details of an Ingenious and Simple Reproducer of Wide Tone Response

By A. L. KASER

ONE of the difficult problems confronting the radio engineer today is that of perfecting the loud speaker. The aim is to design a speaker that will respond faithfully to the full frequency range covered by musical instruments. Many manufacturers claim that their particular products will do this; but still there is a tendency on the part of some speakers to favor either the treble or the bass clef. The perfect loud speaker should respond fully to the lowest tone of the bass viol, which is about forty cycles. On the other hand, the speaker should take care of the highest tone that the broadcast station is capable of transmitting. The latter handicap is not so very difficult to overcome; but to enable the speaker to operate on the lower frequencies, equally as well as on the higher frequencies, is taxing the engineers' ingenuity.

In the race for supremacy in full-musical-range reproduction the old type of horn speaker is fast losing ground, and the cone type is, without a doubt, a popular favorite. It seems now as if there is more time spent on ornamenting the speaker than in its further mechanical development. Often a speaker reminds one of a beautiful but uneducated girl; nice to look at but not so pleasant to listen to.

The writer has spent much time on the development of the loud speaker about to be described, and, although it is not a panacea for all the ills of radio, he does claim that it takes care of the musical range in a more efficient manner than any other speaker to which he has ever listened.

To begin with, the construction is quite simple, and the cost of materials, exclusive of the unit, can be covered by a two-dollar bill; wood, paper, tacks, and glue. All the wood in parts are one-half inch thick; that is, the rings and discs are one-half inch thick, and the dowels are one-half inch in diameter. The dowels may be purchased cheaply at any woodworking shop, and no doubt the rings and discs may be sawed out at the same place for about seventy-five cents, including material. The same kind of paper is used throughout as in cone speakers, and may be purchased at most radio stores.

Almost any type of good unit may be used; the writer utilized a Baldwin Type C unit that had been discarded some time before on account of a broken diaphragm. As the diaphragm must necessarily be removed be-

base, and "B" base, respectively. Fig. 2 and 5 show two others, "A" top and "B" top, which are duplicates of the bases, respectively, except that a hole 6 inches in diameter is made in each piece. These pieces, as before stated, are all 1/2-inch thick. On a radius of 4 1/2 inches, as illustrated in Figs. 1 and 2, drill six holes 1/2-inch in diameter and 3/8-inch deep; the drill should be rather flat on the cutting end.

Next lay "A" base on the bench with the holes up and directly in the center of it fasten "B" base either with glue or screws. This will give it the appearance shown in Fig. 8. Do the same with "A" top and "B" top; being careful not to split "B" top if screws are used.

The next operation is to fasten the loud-speaker unit securely to "B" base. Whatever type or kind of unit is used, it must be located on "B" base so that the driving pin comes exactly in the center of the base, and elevated so that the top of the unit is about 3 1/2 inches above the top of "B" base. If possible have a jeweler thread a stiff piece of 1-32-inch wire for a distance of about 1/2-inch, the wire being long enough over all so that when it is soldered to the unit's vibrating arm it will extend upwards about 1 inch above the top of the unit. This will bring the top of the driving pin in the neighborhood of 4 1/2 inches above the "B" base; different types of units will call for different methods of securing it to "B" base. Next, run the wire leads from the unit through the bottom of the base at some convenient point.

Before going further, six dowels must be cut, 12 3/4 inches long, and as stated before, 1/2-inch in diameter. Place a little glue in each of the six holes in "A" base and insert a dowel in each hole; drive them down so that all are of the same height. Next, put glue in the holes in "A" top and fit the free ends of the dowels in these holes. Place a small board on top and drive the top down as far as it will go; being careful that the top is perfectly level before setting it back to dry.

(Continued on page 816)

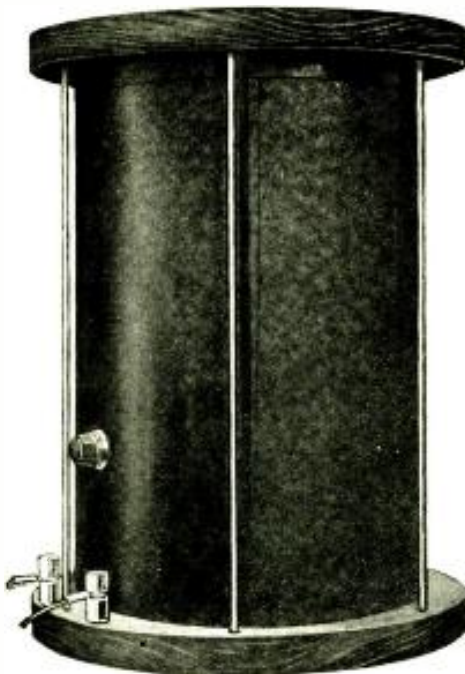

The appearance of Mr. Kaser's loud speaker after completion. In this model an adjustable unit was used; its knob is visible on the left side of the drum.

fore incorporating the unit in this type of speaker, the expense of a new unit was nil.

PREPARING THE FRAME

As will be noted in Fig. 1 and 4, there are two discs, one 10 inches in diameter and one 8 inches in diameter, designated as "A"

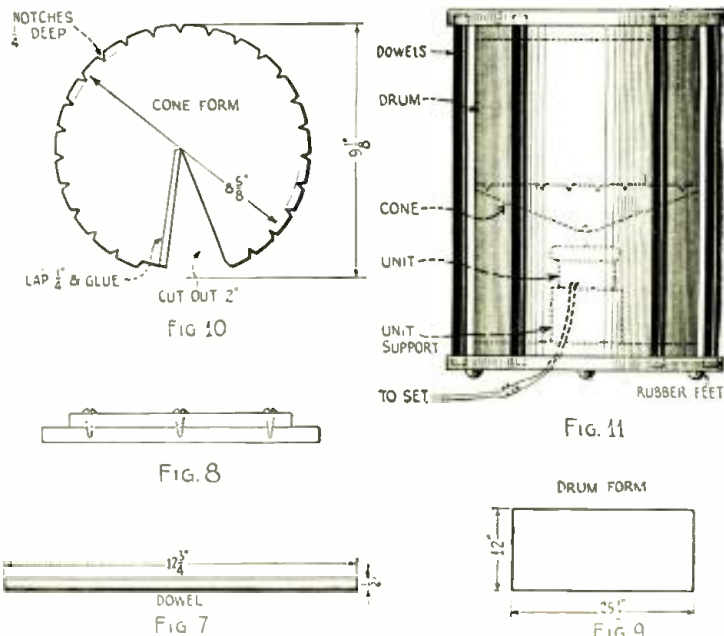
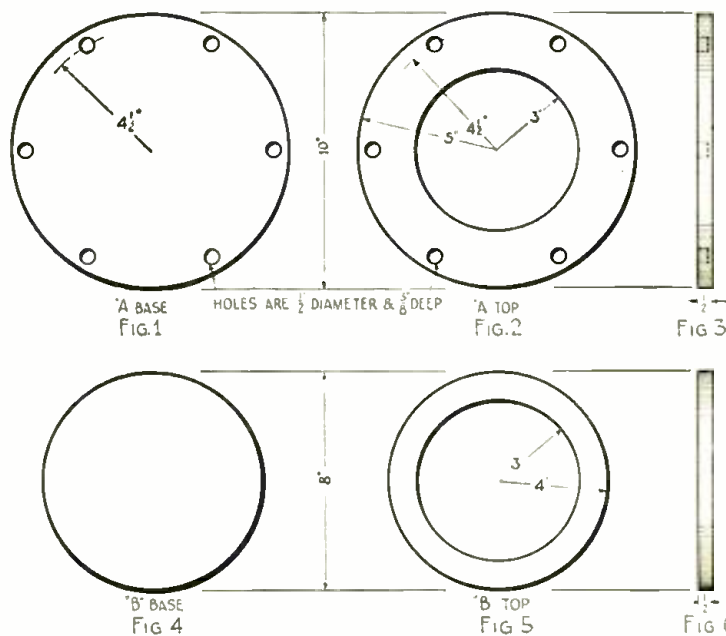

Figs. 1 to 7 show the size of the wooden parts for the loud speaker; Fig. 8, how the bases and tops are fastened together; Figs. 9 and 10, the paper

forms for the drum and cone, respectively, and Fig. 11, the assembly with the unit and cone in position.

An Experimental Push-Pull Second Detector

Details of a Novel Detector and an A. F. Amplifier that are well adapted for Superheterodynes

By LESLIE R. JONES

It is a well-known fact that the second detector and the audio end of the average superheterodyne are overloaded easily. Ways and means of overcoming this trouble are numerous, especially with the new power tubes now available.

Some interesting results have been obtained from experiments and tests with the detector circuit and amplifier described in this article. This amplifier is designed especially for the superheterodyne, where the best tone quality is wanted, and where ability to handle *power volume* is desired also.

This amplifier can be built with ordinary apparatus, and will prove exceptional in many ways. It may be well to state here that it was not the writer's object during these experiments to conserve tubes. The fact is, that the contrary was true; as many tubes as were needed to carry out the design were used, regardless of the number. However, in spite of the increase in the number of tubes over the ordinary amplifier, everyone who has heard an amplifier of this type working properly was astounded at the results. For those who want to experiment, to achieve unusual tonal quality and power volume, this outfit will produce the goods.

Let us look over the circuit, Fig. 1, see wherein it differs from the regular arrangements, and discuss some of the features incorporated in this circuit and their theory and practice.

PROBLEMS OF TONE

As a result of three years' extensive study of superheterodynes, the writer is firmly convinced that the fundamental circuit of the

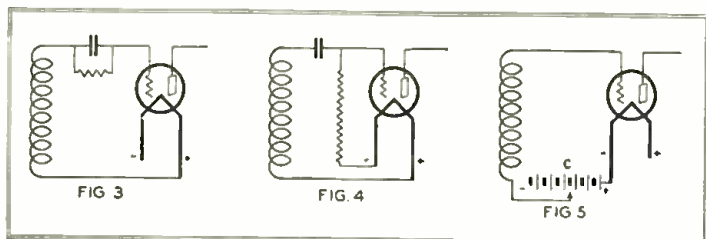

Fig. 3 is an easily-overloaded detector circuit. Fig. 4 has the grid-leak connected to the negative filament and when properly balanced, will handle more power than Fig. 3. The circuit of Fig. 5, with "C" bias for detection, will handle more power than either of the others.

superheterodyne is capable of producing signals of excellent tonal quality. Extensive tests in my laboratory have shown that, providing correct engineering practice is incorporated in the construction and design, the superheterodyne has many distinct advantages, wherever power-handling ability and heavy full tone are required in the output to the loud speaker.

After much consideration of the audio and intermediate sections of the superheterodyne, I centered my attention on the detector action, especially in the second detector.

At this point in the superheterodyne it was found that the tube (the second detector), generally of the 201A type, was frequently overloaded by a moderate output of the intermediate amplifier. In fact, if the intermediate stages are worked near the limit of their output (as they easily can be when properly biased and controlled), this is certain to cause serious overloading which, in turn, produces distortion.

In general practice, in order to overcome this overloading, a potentiometer is used to control the intermediate amplifier. While the result is satisfactory to a certain extent, it is accomplished only at a sacrifice of working efficiency in the intermediate amplifier.

Many times this overloading and the resultant distortion are blamed on the audio amplifier, when the chances are that they are caused right at the second detector.

A study of the action of the detector tube will reveal that, for either plate or grid recti-

fication, the output voltage varies in proportion to the *square of the input voltage*; or nearly so, depending upon the circuit's characteristics and its adjustments, such as grid bias, plate voltage, etc. This relation does not hold on extremely strong signals; hence, the distortion we observe when the input into the detector is too large. (See Fig. 2.)

One remedy that suggests itself is to use larger tubes, and another, to employ plate rectification, with a corresponding "C" bias of from 1 to 4½ volts on the grid. This unquestionably increases the power-handling ability of the tube, but the result of experiments seems to be that, whenever the grid is violently biased, the delicate overtones and the faithfulness of weak or medium signals are sacrificed. This is not desirable. Theoretically, this method may solve the problem, but actual tests, with the use of the best cone-type speaker and a standard amplifier manufactured by a large telephone company, leave no doubt in the writer's mind as to the effect on the tonal quality when this practice of using a heavy "C" bias is applied to detector tubes. (See Figs. 3, 4 and 5.)

USE OF PUSH-PULL PRINCIPLE

Experiments with "push-pull" circuit, changed to meet the needs of detection, proved interesting. It is well known that, through the rectifying action of the detector tube, one-half of the radio wave is practically eliminated. As with the action of a half-wave rectifier used in "B" socket-power

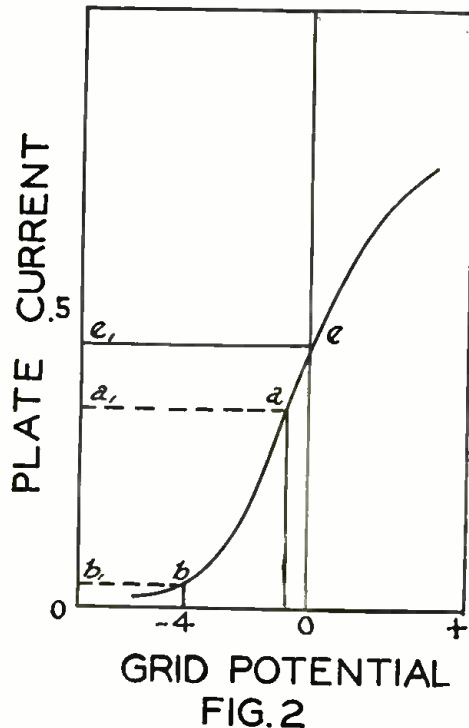

FIG. 2

Detection should take place on the lower bend of this characteristic curve. A comparison of plate responses can be had by reference to the curve at a, e and b, and the corresponding plate-current variation at a1, e1 and b1.

circuit have proved beyond a doubt that it is not only workable, but that it has advantages; chiefly, an increased output without any sign of overloading, and the elimination of the "rasping" detection so common to many superheterodynes.

The circuit for the second detector is shown in Fig. 1. The action is such that the input voltage is divided equally between the two tubes, each tube receiving one-half of the input; the outputs are added together and passed on to the first audio transformer, AF1. The full input voltage from the intermediate amplifier is easily handled and the quality of tone is simply astounding. In a pair of phones the signals are of crystal clearness, being enhanced with deep, full tones having greater volume than the ordinary arrangement of one tube.

SPECIAL APPARATUS

In the circuit variable grid leaks are (Continued on page 843)

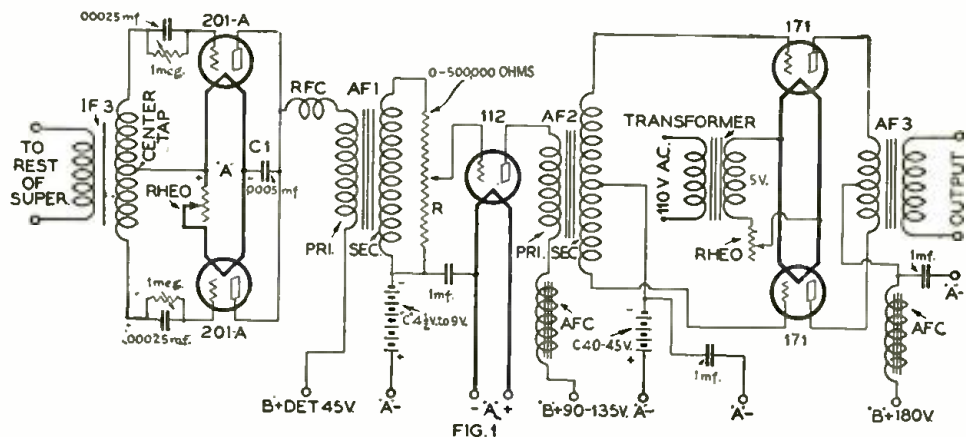

The schematic diagram of the "push-pull" second detector and the audio-frequency amplifier, which the author recommends for superheterodyne receivers.

A Study in Radio-Frequency Amplification

Findings of Experiments on Radio-Frequency and Intermediate-Frequency Transformers

By HAROLD A. ZAHL

THE interesting data contained in this authoritative article are the result of experiments covering more than a month's time. The transformers worked with are representative of the various types of radio-frequency and intermediate-frequency instruments now on the market. Each curve shown represents an average obtained from several transformers of the type indicated.—EDITOR.

IN all the history of radio, one of the most conspicuous impediments to its development has been in connection with amplification of short waves—or radio-frequency amplification. It is one of the most important factors with which the radio engineer has had to contend. In fact, until recent years R.F. amplification was confined chiefly to the laboratory experimenter; and even now, although—thanks to the genius of research engineers—R.F. amplification has been placed on a practical or commercial basis, it has not yet reached anything near perfection.

(It is the author's opinion that, eventually, more efficient R.F. amplification will result in the discarding, practically, of audio-frequency amplification, or at least in limiting it to be used for only the weakest signals.)

This advance in the development of R.F. amplification, which received a great deal of impetus during the World War, is continually going on; the latest step being the Stroboddyne, which is capable of producing remarkable signal strength while using only a very small loop and one stage of audio-frequency amplification.

By the perfection of R.F. amplification, the ability of a receiver to obtain the much-desired distance will be greatly multiplied; for the detecting efficiency of a tube increases approximately as the square of the input voltage.

CAPACITY EFFECTS

The chief difficulty encountered in R.F. amplification is the presence of undesirable capacities. A capacitor is a conductor of varying currents, especially at radio frequencies, where its conducting power is very great. The undesirable capacities show up chiefly in the tubes, and the distributed capacities of the coils and in the wiring of the set.

Though the grid-filament capacity is generally quite small under static conditions, it increases considerably under operating conditions. In spite of the precautions taken in the construction of a transformer, the voltage across the grid falls to a low value, because the reactance of this capacity is in parallel with the grid-filament circuit. As the alternating voltage produced at the output terminals of the tube becomes greater, the capacity reactance of the input circuit becomes less.

In order to overcome this difficulty, tubes are constructed with as small a grid-area as possible; the grid leads are kept short and isolated as far as possible; and tubes having low amplification factors are used.

The ideal R.F. transformer would be one in which the inductance is as great as possible for the frequency transmitted. The greater the inductance of a resonant circuit, the smaller the capacity required to maintain resonance. If we plot the resonance-curves obtained by passing a given frequency through tuned circuits having different amounts of inductance, we will find that the circuit having the greatest amount of inductance shows the sharpest resonance peak and greatest amplification.

Unfortunately, there is a limit to the amount of inductance which may be practically used. As we increase the size of the

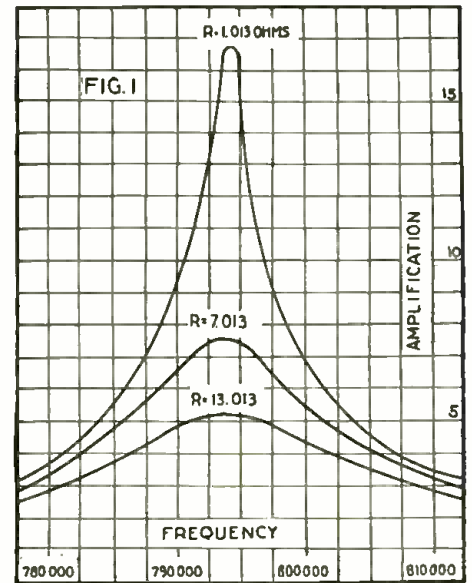

These curves illustrate the importance of keeping the resistance as low as possible.

CHARACTERISTICS OF INDUCTORS

There are three general classes of inductance coils, under one or another of which practically every type of R. F. transformer may be classified. They are the single-layer, the flat spiral or pancake, and the multiple layer. Modifications of these types, such as the spider-web, honeycomb, and bank-wound, are the results of efforts to reduce the undesirable distributed capacity of the coils.

The single-layer solenoid and the flat-spiral type have less distributed capacity than the multiple-layer coil. This is true, because in the case of a single-layer solenoid, or pancake coil having n turns, only $1/n$ th of the total potential acting upon the coil exists between adjacent turns. In the case of a multiple-layer coil, in which one layer is wound first, and then the second on top of the first, the first and last turns of the coil will be adjacent and the total voltage of the coil will be impressed upon them. Bank-winding reduces this fault.

The capacity of a coil or transformer may generally be considered as a highly-absorbing condenser. Due to this capacity, there sets in an increase of phase-difference which may appreciably increase the resistance of the transformer. This increased resistance has the effect of broadening the peak of the resonance curve and lowering the amplification factor of the transformer. The sharpness of the peak of a resonance curve is directly proportional to the reciprocal of the phase-difference, because of the resistance of the circuit. (See Bureau of Standards Circular, No. 74, page 36). The resistance of a coil may be increased also by using large wire, the "skin-effect" causing the additional resistance. In fact, the resistance of a coil at high frequencies may be many times greater than its direct-current resistance, on account of this tendency of high-frequency currents to travel on the surface of the wire.

The importance of keeping the resistance of a tuned circuit low is shown by the



Fig. A. The apparatus used by the author in obtaining the data which is herein presented.

coil, we also increase the distributed capacity of the coil. This means that, in connection with a tuning condenser (the distributed capacity acting in parallel), the frequency-range of the unit is narrowed and shifted, which is generally not desirable.

Compared to the capacities of the tuning condensers used in the ordinary receiver, the inductors necessary to cover the broadcast frequencies have small distributed capacities, close to the value of 2 or 3 micromicrofarads. The distributed capacity of a coil becomes less important, then, when one considers that the average tube capacity is something like 10 or 15 micromicrofarads.

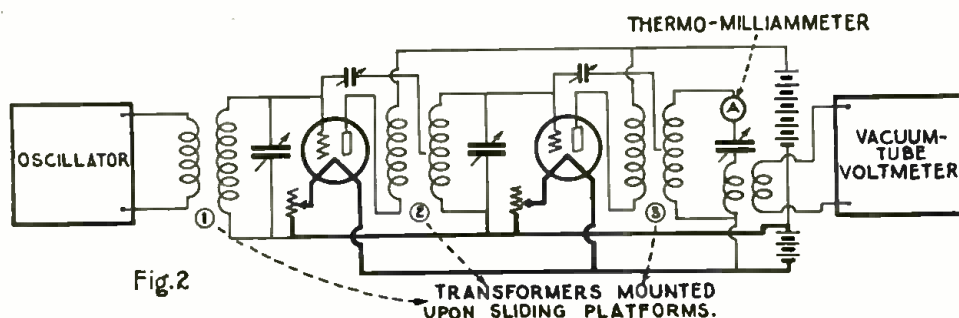

The schematic diagram of the author's testing layout, for the study of radio-frequency transformers.

curves in Fig. 1. The direct-current resistance of a R. F. transformer (secondary coil) was measured at 1.013 ohms. Curves A, B, and C show the relative decrease in efficiency when the secondary resistance was increased in steps of 6 ohms.

CONTROLLING FEEDBACKS

The capacity effect of the wiring is something which every experimenter is familiar with. From the day when the vacuum tube was first introduced, down to the present, we have been told to isolate the grid and plate leads from each other. In reality, grid and plate wires running parallel with one another form a small condenser which creates an effective path for the return of currents from the output back to the input circuit. This may be considered as a medium for regeneration and must be avoided or controlled; for, otherwise, we may have undesirable oscillations.

Generally, when one first constructs an R.F. amplifier, the feed-backs due to various capacities are sufficient to cause oscillation, which must be suppressed by means of what is known as neutralization. There are as many methods by which this may be accomplished as there are types of R.F. amplifier. The simplest method is, of course, the varying of the filament and plate currents. Incidentally, this method is the least effective and reduces greatly the amplification which should be obtained from the amplifier. Other common methods include use of a potentiometer, mechanical control of coupling (such as in the equamatic and auto-coupling systems), resistors in the grid circuit, Hazeltine's neutrodyne method, reversed tickler, bridge circuits, absorption methods, etc.

An R.F. amplifier which cannot be brought into oscillation is not worth much. These various methods mentioned above are merely means of controlling the feed-back, so that the tube can be operated at a point just below that where oscillation sets in.

It is in the proper neutralization of his R.F. amplifier that the experimenter has a great deal of trouble. It is often the case that all the trouble in a R.F. amplifier may be traced back to the improper position of the parts; in particular, the transformers. Though correct shielding may help to eliminate this, there are many receivers being built without shields, and proper placement of the transformers is of paramount importance.

The writer has made a study of the three types of transformers employed in modern R.F. amplification, noting the effects of the transformers upon each other, and upon the operation of the amplifier as a unit.

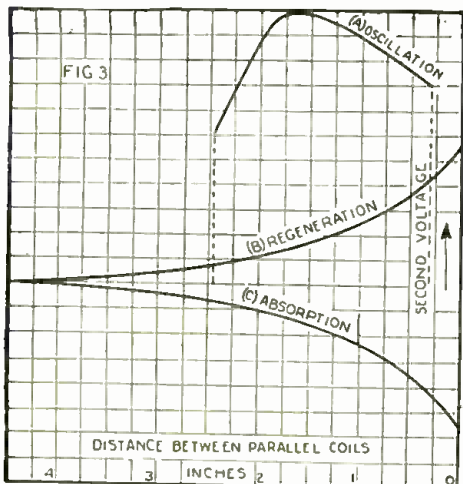

The three curves shown above were obtained when the second and third transformers were kept parallel and their coupling varied.

The apparatus used in obtaining the data to be presented was laid out as shown in Fig. A. (For a complete discussion of the oscillator and the vacuum-tube voltmeter used, the reader is referred back to articles by the author in the July and December, 1927, issues of this magazine.) The two-stage R.F. amplifier used was unique, in that all the transformers were mounted upon sliding platforms, so that the distance separating them could be varied at will. Besides this, a swivel arrangement was provided for each transformer, so that angular variations also could be made. The voltage from the pick-up coil of the oscillator, which was impressed upon the grid of the first amplifier tube, had an amplitude approximately equal to that obtained from local broadcast stations, which was less than one volt. In addition to provision for measuring the output voltage of the amplifier, a sensitive thermomilliammeter was placed in the circuit so that current measurements could also be made.

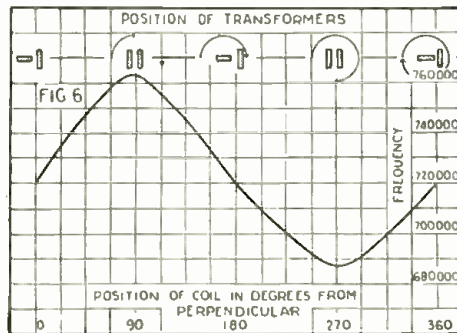

This curve illustrates the frequency variations as one transformer is rotated through a complete circle.

The purpose of this study was to observe quantitatively what happens when R.F. transformers are brought into the so-called "forbidden zone" of location. We have been told never to place one transformer too close or parallel to another because of the interference of their fields. In what form this interference presents itself is shown in the accompanying curves.

OSCILLATION AND ITS CURE

When an R.F. amplifier goes into oscillation, in a two-stage amplifier, it is generally the second tube which goes first and causes

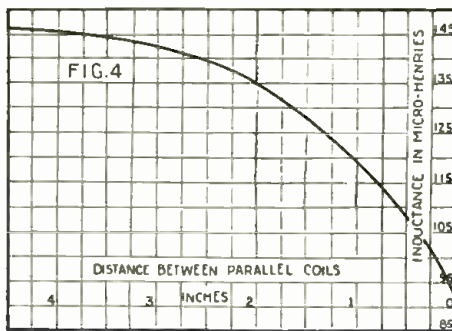

Variation in apparent inductance as shown when the coupling of basket-weave R. F. transformers was varied.

most of the trouble. By observing an ordinary R.F. amplifier hook-up, as shown in Fig. 2, we note that each tube has two inductors, which, together with the circuit capacities, comprise the oscillatory circuit of the tube. Paradoxically speaking, there is first the secondary of the resonance transformer on the grid side—and second the primary of the next transformer—in the plate circuit. It is the coupling between these two inductors which is the cause of considerable grief to many experimenters. If the coefficient of coupling between the

two coils is sufficiently large, enough energy is fed back to produce a "negative-resistance" effect in the grid circuit. When the grid circuit reaches this point of negative resistance, oscillation occurs. The aim in transformer placement is to reduce this coupling to a minimum. This is the reason why transformers are placed at right angles to each other, or shields are placed between them, to prevent interstage coupling.

But, if the mutual inductance is of the proper polarity, the *cmf.* fed back, instead of aiding oscillation, may oppose it. A modification of this principle is known as the "reverse-feedback" system of neutralizing.

On bringing together the second and third transformers (we shall study the case in which the effect is most marked) while keeping the coils always parallel, we may have the conditions which are shown in Fig. 3. Curve A represents the case in which the filament and plate voltages are sufficiently high to cause oscillation; as the mutual inductance, between the secondary of the second and the primary of the third transformer, is increased towards unity. In this case we are considering the tube only from the standpoint of oscillatory action. Starting at approximately zero coupling (maximum separation) a value is reached where oscillations suddenly begin. By increasing the coupling, a point is reached where the oscillation has a maximum amplitude. Tightening the coupling still further results in a decrease in amplitude until a point is reached where the oscillation ceases abruptly.

Curve B shows the effect of regeneration, or the building up of the signal strength. In this case oscillation is not present and we have maximum voltage transfer when the coupling is as close as we can make it. It is evident that, if we could operate a receiver (or rather an amplifier) at this point, its efficiency would be greatest.

REVERSAL OF POLARITY

Curve C shows the case opposite that of curve B; i.e., the absorption which takes place when either of the two coils is reversed. In this case the *cmf.* from the plate circuit opposes oscillation and an absorptive action takes place. There is a decrease in the voltage transmitted.

The set builder who has trouble in neutralizing his amplifier would do well to reverse the leads to one of the above-mentioned inductors and see whether it increases the stability of his receiver.

Increasing the coefficient of coupling between these two inductors, besides producing an effect upon the voltage transmitted, results in a marked change in the resonance-frequency of the unit.

For the sake of avoiding a complicated treatment, quite beyond the scope of this (Continued on page 812)

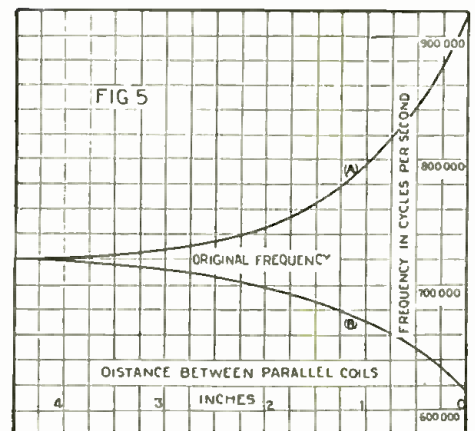

The change in resonance-frequency caused by varying the coupling of the second and third transformers while keeping the coils parallel.



Hook-up Review



Readers desiring more complete information about any of the sets described below can obtain it by writing to Hook-Up Review Editor, RADIO NEWS.

ALL-WAVE SUPERHETERODYNE —AN EXAMPLE OF FINE ENGINEERING

MANY new and interesting features are found in the Improved Laboratory Model Receiver, which employs eight tubes in a specially-developed, totally-shielded superheterodyne circuit. A few of the advantages made possible by the design follow: wavelength range of 30 to 3,000 meters with standard interchangeable plug-in coils; maximum sensitivity and amplification, due to

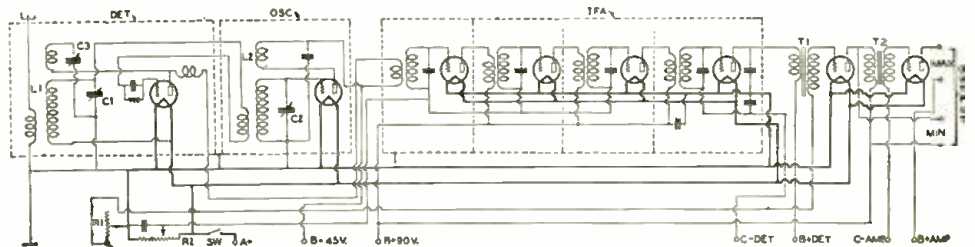

The Improved Laboratory Superheterodyne is divided into four sections: Det., the detector unit; Osc., the oscillator unit; I.F.A., the intermediate-amplifier unit; T1-T2, the audio unit. Parts are marked with similar symbols in the two illustrations.

control of regeneration and an antenna-coupling adjustment. Both the detector and oscillator circuits are enclosed within individual shields. The three transformers and the filter of the intermediate-frequency amplifier are matched and tuned to 112 kilocycles. The audio amplifier is of the usual design and uses high-grade transformers.

As compared with many designs of superheterodynes, the tuning of this receiver is very simple. Two knobs, which operate illuminated vernier drum indicators, control the wave-length adjustments of the set. In addition there are three other non-critical adjustments on the front panel; these control regeneration in the detector circuit, volume, and filament current. The battery switch is the only other component on the front panel.

From a mechanical viewpoint, the inside appearance of the receiver is very pleasing. (Continued on page 806)

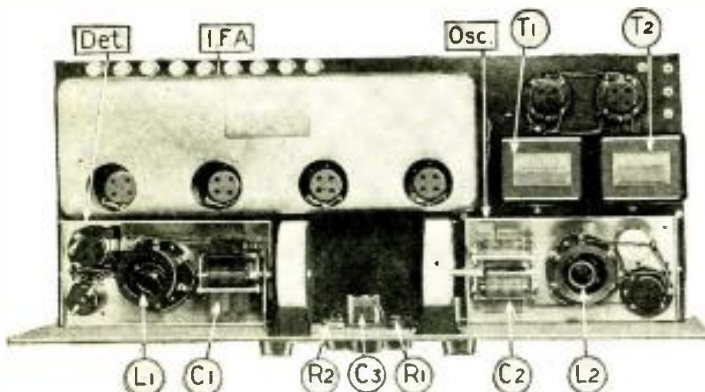

the use of a factory-adjusted, intermediate-frequency amplifier unit, and great ease of assembly which results from the use of a pierced-metal panel and chassis and a com-

pletely-wired intermediate-frequency amplifier.

Electrically the circuit of the new receiver consists of a regenerative first detector, oscillator, three-stage intermediate-frequency amplifier, second detector, and two-stage, transformer-coupled, audio-frequency amplifier. In the detector circuit there is a con-

AN EIGHT-TUBE SUPERHETERODYNE DESIGNED FOR QUICK ASSEMBLY

AN entirely new conception of superheterodyne construction is found in the new "Eight in Line" receiver. This set may be made from standard parts, which are obtainable at most radio stores, and it may be assembled and ready for operation in approximately one hour. Also, the construction of the receiver is so simple that it is practically impossible to make a mistake which would effect the electrical efficiency of the set. Therefore, this design makes it possible for anyone, regardless of the extent of his radio experience, to construct a superheterodyne, and at the same time know that he will be successful in his attempt.

From an electrical viewpoint, this receiver is very similar to the average set of this

type. It employs a first detector, oscillator, three stages of intermediate-frequency amplification, second detector, and two stages of audio amplification with a power tube in (Cont. on page 806)

Construction of the "Eight in Line" receiver is simplified by the special superheterodyne unit (SU). Three tuning condensers (C1, C2 and C3) and a switch-rheostat (R1-Sw) are the only other parts required. The complete set may be built in an hour's time.

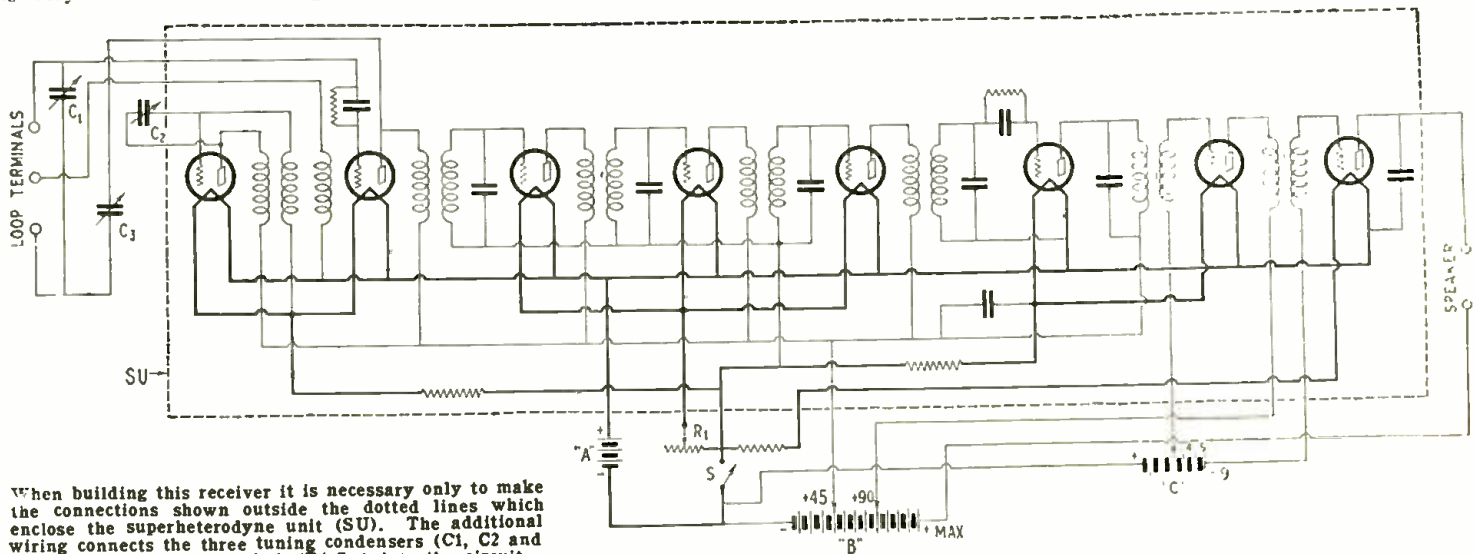
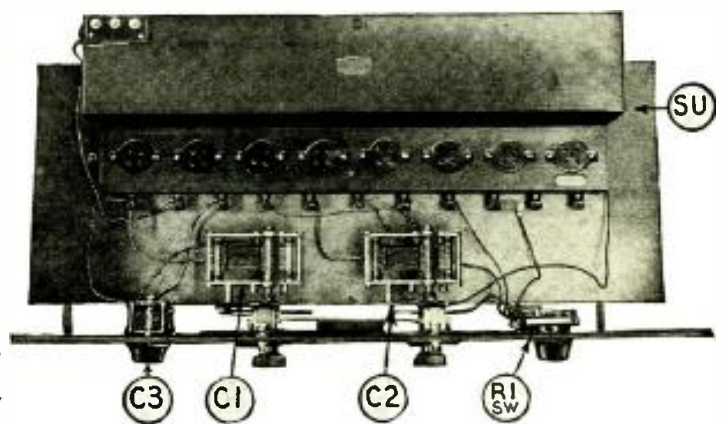

When building this receiver it is necessary only to make the connections shown outside the dotted lines which enclose the superheterodyne unit (SU). The additional wiring connects the three tuning condensers (C1, C2 and C3) and the rheostat-switch (R1-Sw) into the circuit.

Radiotics

UXORIOUS HUSBANDS! (Page Mr. Webster)



General note from the Des Moines Sunday Register of Sept. 25: "Broadcasters are jealously tearing each other to pieces, and regard their WIVES as more sacred than the rights of a long-suffering public." We are indeed glad that these gentlemen of the "mike" cherish their helpmates to such an extent. What are the public's rights, anyway?

Contributed by J. E. Reizenstein.

THIS WASN'T POLITE

Gentle bit of razzing found in the Indianapolis Star of August 30: "In maintaining Frequency WGY's ENGINEERS have been assisted by the engineers of the laboratory . . . It seems as though the poor station engineers always do get it in the neck; and we herby enter a protest against this practice of slipping them the razz."

Contributed by Ernest Koskey.



AWAY WITH "A" BATTERIES!



Starting statement by a correspondent in the Wireless World (London) of September 7: "For some time past I have been using three of these COLLS for lighting the valves of my 4-valve set, my H.T. supply consisting of large-size dry cells." Mike is leaving on the next transatlantic ferry to get us some of these current-giving coils. We need 'em.

Contributed by Chas. R. S. Moon.

PAGING MR. ALADDIN!

Modern miracles of this great age of science, reported in the Boston Globe of Sept. 27: "A second stage creates nothing but a great big TOWN." We knew well that radio is blamed for a lot of things, but when they wish on it a job like this, that would make Old Man Maddin get sick, we think it's time to stop.



Contributed by Clifford W. Allwood.

DO THEY SATISFY?



The influence of Mistress Nicotine on radio is evidenced in Hamilton-Carr's latest catalog, wherein are advertised: "CORK-TIP jacks of longer and heavier construction." We must admit that we are more or less old-fashioned and that we prefer either Camels or Sweet Caporals, instead of these radio cigarettes. Hey, gotta match?

Contributed by J. Walter Briggs.

C'MON, BABY NEEDS SHOES!

African gesture made in the Philadelphia Inquirer of October 9: "Present-day vacuum CUBES have thoriated tungsten filaments, the action of which . . . is not appreciated by the average listener!" Believe us, some cubes we have met did not perform in a way we appreciated—and we walked home.

Contributed by Frank M. Walling.



MAKE THEM STOP



Roughneck item in the Chicago Daily News of October 1: "The provision of carefully specified INSTANTING coverings for all wires and other current-bearing parts." Honestly, folks, can you beat such goin'-on? Here we are paying good money for wire and the manufacturer is carefully looking for a covering that will insult us. We give up!

Contributed by W. L. Hadlock.

HELPING HAND FOR DX WORK

This advertisement from the Toronto Evening Telegram of Oct. 15: "One set Bremmer P.U.L.E.Y coils, cheap." Mike of the Investigation Dept. reports that these are used for pulling in the far-away stations, in case there should be any trouble in picking up signals over 3,000 miles away.

Contributed by L. E. Lewis.



GULLIVER, PLEASE NOTE



Gargantuan battery described in the catalog of the Roycraft Co: "A Super B battery. Depth 4 1/2 ft., height, 7 1/8 ft., width, 8 1/4 ft., weight 16 pounds. 45 volts. List price \$5.00."

We would be willing to give five bucks for a battery that size but the manufacturer would have to throw in a house for us to keep it in.

Contributed by Chas. Pilgrim.

THE 99'S A LADY

New light on the domestic life of radio accessories, from Radio World for October 15: "HE thermionic vacuum tube is growing by adding one element after another." Undoubtedly these husky fellows like the 210S, with a big output, are the representatives of the more virile half of the radio family; but this is news about the 222s.



Contributed by B. Goldman.

THIS HAS A SPANISH TOUCH



In the Daily Record and Mail, (Glasgow), of Sept. 23 we find this item, in reference to people wishing to help (?) listeners. "Offers to sit up and help have been numerous; particularly by those dear people whose knowledge of OX work is touchingly nil." We wonder if, really, "radio doth make liars of us all."

Contributed by David M. Zack (Scotland)

WE GUESS "NO"

Inquiry from the Buffalo Evening News of Oct. 1: "I have included a 77-PLATE variable condenser to help tuning, where it is shown in the hookup just before the ground. Is this condenser necessary?" As a general rule, in playing with condensers, tubes, resistors and what-not we have found that such condensers are just a mite too large; not very much, just a little.



Contributed by Stephen Sholtz.

HOW DO THEY DO IT?



Latest advances in radio from an advertisement in The Listener in (Melbourne) of July 7: "The Advance Equamatic Coil gives RESULTS WOUND ON BAKELITE." Can't you just picture some young fellow pulling in a DX station and getting the output of the loud speaker all messed up, while trying to get it on the bakelite? Not for us, thanks.

Contributed by John W. Corpe (Australia)

A PUZZLER

In the Inquirer of the City of Brotherly Love, for Sept. 25, we have this puzzling announcement from the Radio Commission: "WCSH, Portland, Me., authorized to SEPARATE on 700 keys or 428.3 meters (Experimental for 30 days)." The eminent Commission neglected to state, however what WCSH was to separate from.

Contributed by Mrs. Mary Lutz



LOOKING BACKWARD



The latest in radio from the Land of Shamrocks is found in the Irish Radio Journal (Dublin) Mid-September issue: "The coming radio opera season beginning this month and extending into the summer of 1923. . . ." This, ladies and gents, is a gadget that enables you to hear things that have occurred in the past. Great stuff eh? It beats television.

Contributed by Arthur P. Cullen (Ireland).

IS IT A PH. D.?

Educated receiver mentioned in the Eveleth (Minn.) News of Oct. 27: "The Tigerlyne-six tube, single dial—full MENTAL shielded set \$49.50." At last, the set that has only to be told what to do is with us. All shielded so that no disturbing thoughts can get in and mess up the works.

Contributed by C. H. Maynard.





First Prize

AUTOMATIC SWITCH-STAND FOR ELECTRIC SOLDERING IRON

By C. A. OLDROYD

THE greatest help to quick and efficient wiring is undoubtedly a good electric soldering iron. Always ready for service, it develops no fumes or smell and automatically attains the required temperature. However, unfortunately, the electric soldering iron suffers from two defects; first, after some time the heater element is liable to burn out; and second, the current consumption is constant whether the iron is used or not.

In commercial shops the latter fact is no drawback, as the operator keeps his iron busy all day long; but the home builder must necessarily proceed at a much slower rate, with the result that the soldering iron often has long periods of rest while the current is turned on. As the heater element develops constant heat the iron becomes very hot when it is not used for soldering; and, as a result, the wire of the heater is very liable to burn out.

To lengthen the life of the heater element and to cut down the current consumption considerably, a simple automatic switch has been devised. This device is illustrated in the accompanying drawing and the experimenter who wishes to possess one may build one at home quickly and inexpensively by the following directions given here.

The switch forms a rest for the soldering iron; when the iron is lifted off the stand the full 110-volt current passes through the iron; but, as soon as the iron is returned to the stand, a lamp is automatically placed in series with the electric iron. This cuts down the current consumption to one-half or less, as the iron has now merely to keep hot.

The switch mechanism is quite simple to make, as the necessary parts can be taken from a discarded electric bell. All we need is the armature with flat spring and hammer. The hammer rod is bent to suit the diameter of the heater barrel of the electric iron, which will rest in the bend at M when the iron is not used.

The flat spring at the other end of the iron armature is mounted on a small wood block. To make the rest more steady, the hammer is used as a stop to the movement

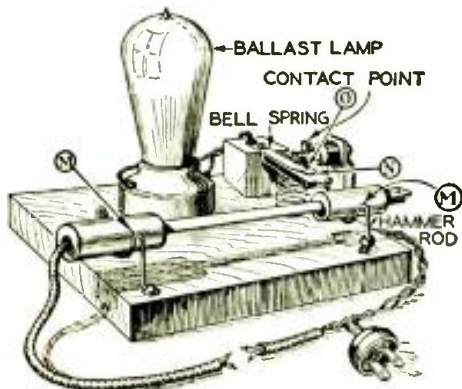

This soldering-iron stand is also an automatic switch which inserts a ballast lamp in series with the heater when the iron is not in use.

Prize Winners

First Prize \$25

AUTOMATIC SWITCH STAND FOR ELECTRIC SOLDERING IRON

By C. A. OLDROYD,
127 Abbey Road, Barrow-in-Furness,
Lancashire, England.

Second Prize \$15

IMPROVING SMALL CONE SPEAKERS

By P. T. CROSBY
329 East D Street, Oklahoma City, Okla.

Third Prize \$10

PARALLEL TUBE MOUNTING

By FRANK L. THOMAS
1244 Irving St., N.W., Washington, D. C.

All published Wrinkles, not winning prizes, will be paid for at a rate of two dollars each.

The next list of prize winners will be published in the March issue.

of the contact gear. The end of the hammer rod is bent down, as shown in the sketch, and a positive bed for the hammer is provided by a hole countersunk in the base.

To make the action of the switch more certain without having to rely entirely on the strength of the flat spring, a strong spiral spring is mounted under the iron armature, forcing the latter upwards.

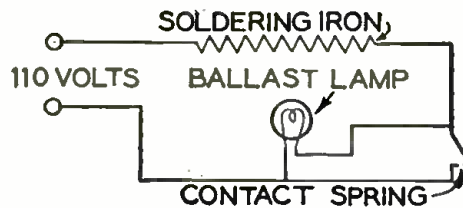

Schematic diagram of the automatic switch-stand.

Immediately above the contact point of the armature N lies a contact screw, also taken from an old bell. This is held in position by a metal strip screwed to the side of the wooden base. Care must be taken to get the contact points N and O properly lined up.

The connections are shown in the sketch. One of the 110-volt leads goes directly to the soldering iron, the other to the contact screw. The other lead to the soldering iron starts from the flat spring of the armature. The lamp is connected between the contact and the flat spring.

When the iron is placed on the bent part of the hammer-rod, its weight forces the armature down, thus breaking the contact N-O, and the lamp is automatically connected in series with the iron. When the latter is lifted off, the armature swings up and shorts out the resistance lamp.

The most suitable size for the lamp depends upon the consumption of the iron; for

a small iron a carbon lamp of about 100 watts may prove all right. The lamp can be mounted on the base itself, thus making the wiring shorter and simpler, or it can be located some distance from the iron and stand, say on a shelf or on the wall.

To prevent breaking off any of the leads, it is advisable to tape them to the wood block and brass strip.

Second Prize

IMPROVING SMALL CONE SPEAKERS

By P. T. CROSBY

IN this day of high-quality broadcasting, the listener using a speaker that does not reproduce the entire musical scale, or nearly so, is missing a great part of the joys of radio. The broadcasting stations have improved the quality of their transmitters, until present-day programs are practically perfect; and radio reproduction is excellent—providing the receiver and reproducer are of the proper design.

The large cone speaker is capable of reproduction of the highest order, and when driven by a good radio receiver, will please the most critical. The users of the thousands of small, free-edge cone speakers sold during the past two years will be interested in learning of a simple, inexpensive way to transform these speakers into reproducing mediums that will compare very favorably with any of the speakers recently placed on the market.

The drawing will serve to show the constructional details of the small cone speakers

The tone-range of a small free-edge cone may be improved by the substitution of an eccentric-cone diaphragm, as shown by dotted lines in Fig. 1. The details for cutting this are given in Fig. 2.

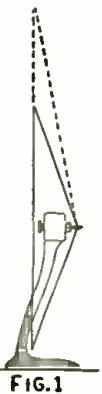

FIG. 1

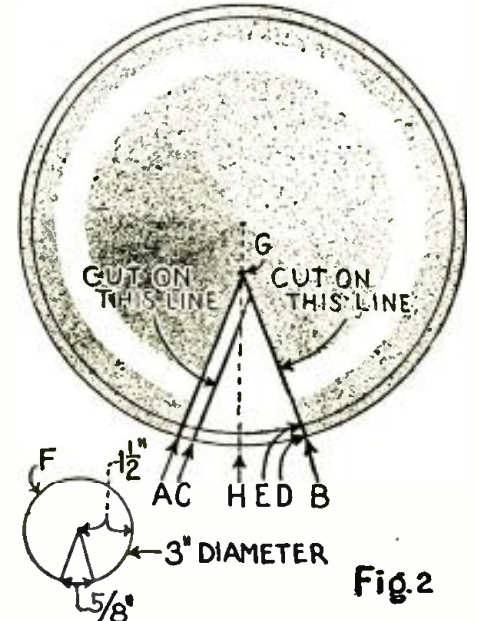

Fig. 2

referred to, all of them being constructed in this manner, or one similar. In all instances, the paper cone is as large as permissible, extending down to the base of the speaker. At first thought, it would seem the cone could not be made larger, because of this fact. However, by using a cone of the eccentric type, this obstacle can be overcome. With the peculiar shape of the eccentric cone, it need not be as large as the usual circular cone to achieve the same result from a musical standpoint.

In the table below the dimensions for any desired size of cone are given. As the "short" side of the cone can extend down only to the base of the speaker, the cone conforming to this limitation should be chosen. For best results, the cone should be constructed of the special paper made for this purpose. However, any paper heavy enough to be self-supporting will serve quite well.

The paper should be spread out on a smooth surface, and secured by a tack in each corner. The circular outline "D" is then drawn with a pencil, using a piece of string as the compass. The circle "E" is scratched on the surface of the paper, using a large blunt-pointed nail as the scratching tool. This line must be scratched quite deep; care being taken to see that the paper is not cut through, however. The paper is glued together along lines "A" and "B," and the outer edge of the resulting cone is then bent back to about a 45-degree angle along line "E," thereby making it self-supporting. Finally, the small cone "F" is glued to the apex of the large cone, which will then be ready for use.

The following dimensions will be found suitable for the respective sizes of speakers:

Diam Cone Inches	Line "H" to "G" Inches	Lines "A-H" and "B-H" Inches
20	8	2
22	8 3/4	2 1/4
24	9 1/2	2 1/2
26	10 3/8	2 3/4
28	11 1/4	3

The distance from "E" to "D" is 1/2-inch regardless of the size of the cone; and the small apex cone "F" is also of the same dimensions in all cases.

The improved reproduction obtained by the use of the larger cone will repay the builder many times over for the time spent in remodeling the speaker.

Third Prize

TWO DETECTOR TUBES MOUNTED IN PARALLEL IMPROVE QUALITY

By FRANK L. THOMAS

IN a superheterodyne receiver, when four stages of intermediate frequency amplification are employed, the quality of reproduction is frequently rather poor, simply because the second-detector tube is overloaded. A method of overcoming this difficulty is to use two tubes, connected in parallel, in the second-detector circuit; but this is difficult, as in many cases it requires rewiring the receiver.

A simple method for connecting two tubes in parallel, without making any changes in the wiring of the receiver is illustrated in the drawing on this page. The parts used are as follows: two standard UX-tube sockets; one panel, 5 1/2 x 2 1/2 inches; one tube base and three machine screws and nuts.

In building the device mount the two tube sockets on the ends of the panel as illustrated and mount the tube base with a long machine screw in the center of the panel on the under side. Holes are then drilled in the panel, for bringing wires from the terminals of the tube base to the terminals of the two sockets. The method of wiring is clearly illustrated.

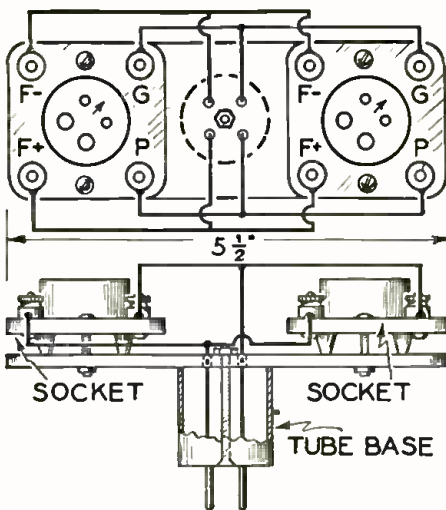

This mounting makes it possible to use two tubes in a stage without changes in the wiring of the set. It is easy to build, and prevents overloading.

The two sockets are connected in parallel to the corresponding prongs of the tube base; i.e., the wire from the grid terminal of the tube base connects with the grid binding post of each of the tube sockets, etc. Insulated wire should be used in making all connections, in order to prevent wires from short-circuiting in the tube base.

After the unit has been constructed as described, the tube base is inserted in the receiver's second-detector socket, and a suitable detector tube is inserted in each of the sockets of the unit. Provision must be made also for supplying the extra current for the second tube; that is, if a filament ballast is employed a larger size must be substituted or, in the case of a rheostat, it must be readjusted.

A CONVENIENT MULTIPLE SWITCH FOR TESTING LOUD SPEAKERS

A LOUD-SPEAKER control switch which makes it possible for the radio amateur to change from one speaker to another instantly, and without the bother of making new connections, is a handy piece of apparatus for the experimenter and also for the radio dealer. It enables one to make

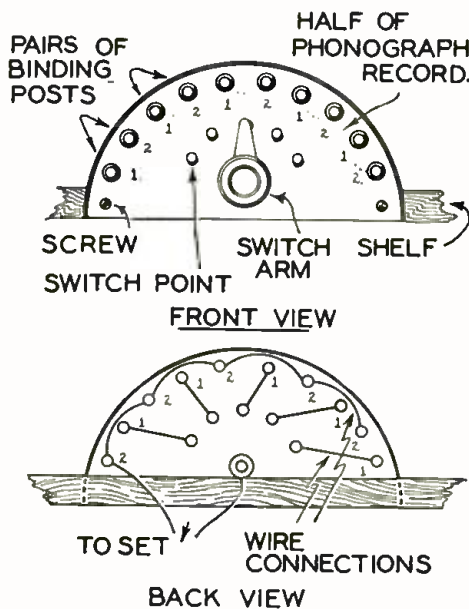

The switch illustrated above shows one way in which old phonograph records may be used; with this it is possible to change from one speaker to another almost instantly.

more accurate comparisons when testing speakers, because of the quickness with which the change may be effected, and is ideal in sales demonstrations. In the home it may be used to connect loud speakers in different rooms of the house.

The illustration herewith shows a simple switch of this type which may be constructed in any home workshop. Five loud speakers may be connected to the unit described and, if desired, it may easily be made larger. The parts used in the construction are as follows: one discarded phonograph record; ten binding posts; one switch arm and five switch points.

When constructing the switch, the phonograph record is first cut in half, and one half is discarded. Next, ten holes are drilled at equal distances around the rim of the record and the ten binding posts are mounted. For installing the switch a 1/4-inch hole in the central portion of the record is required and five holes for the switch points must be drilled in the semicircle made by the contact arm. An additional hole may be drilled in each of the lower corners of the record for mounting purposes.

The wiring of the switch is clearly shown in the drawing. First, starting at the left mark every other binding post "1," and then mark the remaining binding posts "2." Now connect each of the switch contacts with one of the binding posts marked "1," and connect together all the binding posts marked "2." When connecting the switch to the receiver, use the switch arm as one terminal and a wire joining the binding posts marked "2" as the other.

In operating the switch as many as five loud speakers may be connected at one time. One terminal of each loud speaker is connected to a binding post marked "2," and the other terminal to a binding post marked "1." By changing the position of the switch arm any one of the five loud speakers may be connected with the radio receiver.

—Contributed by L. B. Robbins

A SIMPLE AND INEXPENSIVE BATTERY CHARGER

IT is no longer necessary for the amateur to have a discharged storage battery, even if he cannot afford to buy a battery charger. By using the circuit illustrated in these columns it is possible to assemble a battery charger at practically no cost. The rectifier may be a burnt-out tungar-type tube which has been discarded; and the only other apparatus which it is necessary to purchase is a Ford spark coil. This can be obtained for a few cents from any dealer in second-hand auto parts.

In place of using a step-down transformer to reduce the voltage of alternating current to the value required for charging a storage battery, an electric iron is connected in series with the 110-volt circuit. The size of the electric iron used will determine the current received by the battery. Irons consuming between 200 and 600 watts may be used for the purpose.

In wiring the charger the primary winding of the spark coil is connected across the storage battery with a small switch in series to complete the circuit. The secondary winding of the coil is connected in shunt with the filament terminals of the rectifier tube. To place the charger in operation, connect the 110-volt A.C. circuit by closing the switch Sw 1. Next, close the switch Sw 2 until the high voltage from the spark coil causes an arc to bridge the break in the filament. Now the switch Sw 2 may be opened; as the house current, which is passing through the rectifier, will keep the filament hot.

When using this charger it is important that the storage battery be entirely disconnected.

(Continued on page 824)



Radio News Laboratories



RADIO manufacturers are invited to send to **RADIO NEWS LABORATORIES** samples of their products for test. It does not matter whether or not they advertise in **RADIO NEWS**, the **RADIO NEWS LABORATORIES** being an independent organization, with the improvement of radio apparatus as its aim. If, after being tested, the instruments submitted prove to be built according to modern radio engineering practice, they will each be awarded a certificate of merit; and a "write-up," such as those given below, will appear in this department of **RADIO NEWS**. If the apparatus does not pass the Laboratory tests, it will be returned to the manufacturer with suggestions for improvements. No "write-ups" sent by

manufacturers are published in these pages, and only apparatus which has been tested in the Laboratories and found of good mechanical and electrical construction is described. As the service of the **RADIO NEWS LABORATORIES** is free to all manufacturers, whether they are advertisers or not, it is necessary that all goods to be tested be forwarded prepaid, otherwise they cannot be accepted. Apparatus ready for, or already on, the market will be tested for manufacturers free of charge. Apparatus in process of development will be tested at a charge of \$2.00 per hour required to do the work. Address all communications and all parcels to **RADIO NEWS LABORATORIES**, 230 Fifth Avenue, New York City.

A.C. TUBE

The vacuum tube (type M-26 shown) submitted by the C. E. Manufacturing Co., Inc., 702 Eddy Street, Providence, is of the A.C. type and uses the A.C. house-lighting current, stepped down to 1 1/2 volts, for the direct heating of the filament. The normal filament cur-



rent is 1.05 amperes. The tube's amplification constant, taken from a set of six, is 8.2 and its plate impedance at 90 volts is approximately 11,000 ohms. This tube has a standard UX base and can be used successfully as an amplifier either in radio- or in audio-frequency stages. AWARDED THE RADIO NEWS LABORATORIES CERTIFICATE OF MERIT NO. 2149.

RECTIFIER TUBE

The rectifier tube (type R-80 shown) submitted by the same company, is of the full-wave type. Its oxide-coated filament operates normally at a dull red heat and requires 2 amperes at 5 volts. This rectifier



is designed to be used in radio power-supply units and has a rated maximum output of 125 milliamperes. Its rated maximum plate voltage is 300 volts, per plate. It is equipped with a standard UX base.

AWARDED THE RADIO NEWS LABORATORIES CERTIFICATE OF MERIT NO. 2150.

CAPACITY CONNECTOR

The capacity connector shown, submitted by the Tyrman Electric Corporation, 143 W. Austin Avenue, Chicago, Illinois, is designed to simplify the varying problems of wiring radio receivers and to avoid, to a certain extent, the use of additional by-pass condensers. It consists of

six thin brass strips, each approximately 4 1/2 inches long and 1 inch wide, all molded in bakelite and



forming a rigid bar. Each of the brass strips is intended for a lead from one terminal of a battery ("A", "B" or "C"), and is provided on both sides with lugs 1 inch long for the connection with the transformers and sockets. The capacity between each two consecutive strips is approximately .002 mf. This capacity connector allows quick receiver assembly and protects to a considerable extent against errors in wiring.

AWARDED THE RADIO NEWS LABORATORIES CERTIFICATE OF MERIT NO. 2155.

VACUUM TUBE

The vacuum tube (type UX-281) submitted by the Radio Corporation of America, 233 Broadway, New York City, is of the half-wave rectifier type. Its ribbon filament is of the oxide-coated type and operates at red heat. The heating current is 1.25 amperes at 7 1/2 volts A. C., to be obtained from one of the windings of the same transformer which supplies the plate



voltage. The maximum rated plate voltage is 750 volts A. C. and the maximum output is 110 milliamperes D. C. This rectifier is designed for "B" power-supply units operating on A. C. For full-wave rectification two tubes must be used. Although intended for use in devices with a heavier output, the UX-281 may be used successfully in power units designed for the UX-216. Like the UX-280 described above, this rectifier has a large RCA standard UX base, which fits either the navy- or the push-type sockets.

AWARDED THE RADIO NEWS LABORATORIES CERTIFICATE OF MERIT NO. 2180.

VACUUM-TUBE SOCKET

The tube socket shown, submitted by the American Radio Hardware Company, 135 Grand Street, New York City, is of the spring suspension type and of extremely simple construction. The four specially-shaped, tuned phosphor-bronze

springs are riveted to a small bakelite disc which is provided with holes for the tube prongs. Two holes at the other end of each spring permit the attachment of the socket to the baseboard or sub-panel by screws or rivets. This socket is designed for tubes with the standard UX base,



and insures a perfect contact with the prongs of the tube.

AWARDED THE RADIO NEWS LABORATORIES CERTIFICATE OF MERIT NO. 2188.

RADIO SUB-PANEL

The radio sub-panel shown, sub-



mitted by the Uradio Units Company, P. O. Box 84, Salt Lake City, Utah, is of hard rubber, 6x16x3/16 inches. It is drilled and provided with phosphor-bronze springs for seven tubes. The grid and plate springs are designated on the bottom of the panel in order to facilitate wiring.

AWARDED THE RADIO NEWS LABORATORIES CERTIFICATE OF MERIT NO. 2189.

AERIAL KIT

The "Aero" indoor aerial kit shown, submitted by Swan-Flaverstick, Inc., Trenton, N. J., consists of 100 feet of specially insulated cord and a set of 12 enameled-head tacks. The cord is made of 12 tinsel strands covered with braided insulation, and is extremely flexible.



AWARDED THE RADIO NEWS LABORATORIES CERTIFICATE OF MERIT NO. 2194.

LAMP-SOCKET ANTENNA

The lamp-socket antenna shown, submitted by the same company, comprises a receptacle formed on a standard lamp-socket plug, and a special plug therefor, containing a fixed condenser and provided with two binding posts for the leads to the receiver. The results obtained, by connecting several receivers successively, through this device to the house lighting line, were satisfactory.



AWARDED THE RADIO NEWS LABORATORIES CERTIFICATE OF MERIT NO. 2195.

HEAVY-DUTY RHEOSTAT

The midget type heavy-duty rheostat shown, submitted by the Carter Radio Company, 300 S. Racine Avenue, Chicago, Illinois, is of the one-hole-mounting type, and is constructed almost entirely of metal. The



resistance strip is 3/4 inch wide and has a thin flat resistance wire. The rheostat is rugged and compact and capable of carrying relatively heavy currents without overheating. The contact arm runs very smoothly and provides a very good contact with the resistance wire. This rheostat has a value of approximately 1/2 ohm and especially adapted to radio receivers using the new A.C. tubes of the low-voltage type.

AWARDED THE RADIO NEWS LABORATORIES CERTIFICATE OF MERIT NO. 2191.

GRID STABILIZER

The grid stabilizer shown, submitted by the Daven Radio Corporation, Newark, N. J., comprises an enameled resistance wire, wound on



a glass tube 1 1/2 inches long and 1/4 inch in diameter; at its ends the tube has two brass caps to which are soldered the ends of the resistance wire. Any standard grid-leak mounting can be used in connection

with this unit. This stabilizer is available in different resistance values, from 200 ohms up to 750 ohms. The measured values have been found to be very close to the rated; the maximum deviation from the average did not exceed 1/2 per cent.

AWARDED THE RADIO NEWS LABORATORIES CERTIFICATE OF MERIT NO. 2197.

SUB-PANEL BRACKET

The sub-panel bracket shown, submitted by American Radio Hardware Company, 135 Grand St., New York City, is stamped from sheet



aluminum 1/32 of an inch thick, is 11 inches long and 2 inches high. This bracket is sturdy and will meet the needs of a radio set builder using a wide sub-panel.

AWARDED THE RADIO NEWS LABORATORIES CERTIFICATE OF MERIT NO. 2198.

FIXED CONDENSER

The fixed condenser shown, submitted by the Carter Radio Company, 300 S. Racine Avenue, Chicago, Illinois, is of the mica type. The capacity element is molded entirely in bakelite which protects it from moisture, and changes of temperature. The lugs of this condenser may be



soldered, or connected with screws and nuts to the wiring of the circuit. The measured capacity has been found to be close to the rated value. This component is available in different capacity values.

AWARDED THE RADIO NEWS LABORATORIES CERTIFICATE OF MERIT NO. 2199.

LONG-WAVE R.F. TRANSFORMER

The radio frequency transformer (type 8-80 shown) submitted by the Tyrman Electric Corporation, 143 W. Austin Ave., Chicago, Ill., is of the air-core long-wave type, and can be used in receivers of the superheterodyne type. The primary and secondary are wound on two concentric bakelite tubes, each two inches long, and respectively 13/16 inch and 1 inch in diameter. The fixed condenser across the secondary tunes it very sharply to approximately 346 kc. This transformer is enclosed in a neat bakelite casing and has its terminals so spaced that it will allow the use of the capacity connector mentioned above.



AWARDED THE RADIO NEWS LABORATORIES CERTIFICATE OF MERIT NO. 2200.

R.F. TRANSFORMER

The radio-frequency transformer (type 8-70) submitted by the same company, is identical in appearance with the 8-80, and differs from it only in the winding. Its primary consists of a few turns of very fine enameled wire wound on the inner tubing, while the secondary has 124 turns and is wound on the outer bakelite tubing. The inductance of the secondary is approximately 280 microhenries, and it covers the broadcast-band range in connection with a .00035-mf. condenser. It is designed for use in tuned-radio-frequency stages.

AWARDED THE RADIO NEWS LABORATORIES CERTIFICATE OF MERIT NO. 2201.

OSCILLATOR COUPLER

The radio-frequency transformer (type 8-71) submitted by the same company, is similar in construction to the 8-70, but has a different wave range. It covers, in connection with its .00035-mf. condenser, a band between 160 to 360 meters; and it may be used successfully as an oscillator coupler in circuits of the superheterodyne type equipped with long-wave transformers of the 8-80 type.

AWARDED THE RADIO NEWS LABORATORIES CERTIFICATE OF MERIT NO. 2202.

VACUUM TUBE

The vacuum tube shown, submitted by W. T. Grant Company, 455 Seventh Avenue, New York, N. Y., is of the 201A type and has a standard UX base. The characteristics



of this tube are those of standard tubes of the same type; and its operation, either as a detector or amplifier in audio or radio stages, is satisfactory.

AWARDED THE RADIO NEWS LABORATORIES CERTIFICATE OF MERIT NO. 2203.

GRID LEAK

The grid leak shown, submitted by Gardiner & Hepburn, Inc., 21st & Washington Avenue, Philadelphia, Pa., is of the adjustable type. A glass tube, approximately 1 1/2 inches long and 1/2 inch in diameter, is hermetically sealed at both ends with

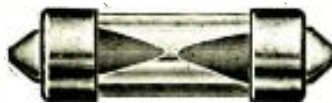

metallic caps, and is partly filled with a highly resistive liquid in which are immersed two concave triangles which are soldered to the caps. Under operating conditions, this device is kept in a horizontal position by its grid-leak mounting. By rotating the tube around its horizontal axis, the degree of immersion of the triangles is varied, thus causing a variation of the resistive path between the caps. This grid leak permits of very fine adjustment and is noiseless. It fits almost any standard type of grid-leak mounting.

AWARDED THE RADIO NEWS LABORATORIES CERTIFICATE OF MERIT NO. 2204.

MULTIPLE SPEAKER SWITCH

The "Comparator" shown, submitted by Temple, Inc., 213 South Peoria Street, Chicago, Illinois, is a device very useful in comparing different loudspeakers or phones. The conical, molded bakelite housing has five pairs of Carter tip jacks, arranged in two rows. One wire of the connecting cord is attached to all the jacks of the lower row, while the other wire of the same cord can be connected in turn to any of the jacks of the upper row through a rotating switch, which insures a very good contact.



AWARDED THE RADIO NEWS LABORATORIES CERTIFICATE OF MERIT NO. 2205.

BATTERY SWITCH

The battery switch shown, submitted by Einar Letzen, Nordana, Sweden, is light and very well built. The interesting feature about it is that it is equipped with a fuse be-



tween the connections to "B-" and to the "A" battery, to protect the tubes from burning out in case of an accidental wrong connection.

AWARDED THE RADIO NEWS LABORATORIES CERTIFICATE OF MERIT NO. 2206.

AUDIO-FREQUENCY TRANSFORMERS

The audio-frequency transformer (type A.F. 3 shown) submitted by Ferranti, Inc., 130 West 42nd Street, New York City, is of excellent mechanical and electrical design. It has a very large core and its windings are sub-divided in order to reduce the distributed capacity. The amplification characteristic of this transformer, tested in connection with a 201A tube between 128 and 5,000 cycles, has been found to be very good. This transformer is enclosed in a neat black pressed-steel case, and has a built-in by-pass condenser across the primary.

AWARDED THE RADIO NEWS LABORATORIES CERTIFICATE OF MERIT NO. 2207.



The audio-frequency transformer (type A.F. 4) submitted by the same company, is similar in construction to the A.F. 3, except that it is slightly smaller in dimensions. Within the limits of the most-used audio frequencies its amplification performance is very good.

AWARDED THE RADIO NEWS LABORATORIES CERTIFICATE OF MERIT NO. 2208.

OUTPUT TRANSFORMER

The output transformer (type OP1 shown) submitted by the same company is constructed on the same principles as the transformers described above. It has a ratio of 1:1 and is designed for use in the plate circuit of the last audio tube, in order to prevent the relatively-heavy D.C. component of the last tube from flowing through the loud speaker windings. In this way, this transformer protects the windings from burning out and prevents the continuous pull on the armature which would be caused by the direct current from the plate.

AWARDED THE RADIO NEWS LABORATORIES CERTIFICATE OF MERIT NO. 2209.

LOUD SPEAKER

The "Sensory" loudspeaker shown, submitted by the Heinemann Elec-



tric Company, 1736 N. Fifth Street, Philadelphia, Pa., is of the cone type. The paper cone, which is 8 1/2

inches in diameter, is partly covered with a felt cloth; it is of the free-edge type and protected from injury by a metallic housing, of simple and pleasing appearance. The reproduction of speech and music is very satisfactory.

AWARDED THE RADIO NEWS LABORATORIES CERTIFICATE OF MERIT NO. 2210.

LONG-WAVE R.F. TRANSFORMER

The "Magniformer," type R.F.-61 shown, submitted by the Radiart Laboratories Company, Chicago, Illinois, is a long-wave radio-frequency transformer of the air-core type, with a secondary, tuned by a built-in fixed condenser, to approximately 70 kc., and may be used conveniently in radio receivers of the super-



heterodyne type. This transformer is very well built and is of very neat appearance.

AWARDED THE RADIO NEWS LABORATORIES CERTIFICATE OF MERIT NO. 2211.

A.C. TUBE

The "Magnatron" tube (type 226 shown) submitted by the Conwy Electric Labs., Magnatron Bldg., Hoboken, N. J., is of the A.C. type; its filament operates from the house lighting line through a step-down transformer. The heating current is 1.05 amperes, with 1 1/2 volts across the filament. The amplification constant is 8 and the plate impedance approximately 11,000 ohms. The outstanding feature of this tube is that the filament leads are not soldered to the heavy prongs, but connected to two binding posts on the



rim of the bakelite base; the filament prongs make no connection to the elements. This arrangement allows the use of those tubes in almost any set built for D.C. operation, without complicated changes in the wiring of the set.

AWARDED THE RADIO NEWS LABORATORIES CERTIFICATE OF MERIT NO. 2212.

VACUUM TUBE

The vacuum tube shown, submitted by the Jaeger Research Laboratories,



Inc., Weehawken, N. J., is of the 201A type and uses a standard UX base. It operates very satisfactorily as either a detector or an amplifier, in radio or audio stages.

AWARDED THE RADIO NEWS LABORATORIES CERTIFICATE OF MERIT NO. 2213.

Letters from Home Radio Set Constructors

GETTING A NEW KICK OUT OF RADIO

Editor, RADIO NEWS:

I finished building the "Special Short-Wave Broadcast Receiver," shown in the October issue of RADIO NEWS, last Sunday. I hooked it up, using three 201A tubes with 99 volts "B", and listened to Marconi station 5SW for three hours. The music and announcing came in perfectly. Thanks for interesting me in short-wave receiving.

ALAN M. PAINTER,
43 East Elm Street, Wollaston, Mass.

Editor, RADIO NEWS:

I have built the RADIO NEWS Short-Wave set and have had very fine results. I had 5SW, Chelmsford, England, three times in a week on two tubes. On one of these occasions he was loud enough to be heard distinctly on my loud speaker. I am using Pilot condensers and home-made coils.

The December RADIO NEWS is certainly a deluxe number. The article on "Old Sleuth, the Milliameter" is worth twice the price of the copy.

CARL W. BEESE,
146 Market St., Hamilton, Ont., Canada.
(This station is working in connection with the British Broadcasting Company, in experiments leading toward relays of programs across the Atlantic for rebroadcasting in America. It is reported operating on 24 meters, and has an input of 25 kilowatts, maximum.—Editor.)

EVERY CIRCUIT HAS ITS DAY

Editor, RADIO NEWS:

Just a note of appreciation of your magazine. I am a radio repairman, and work for one of the

LETTERS for this page should be as short as possible, for so many are received that all cannot be printed. Unless a set is made from a published description, a schematic sketch should be sent; photos can be used only to illustrate a novelty, and then only if large and very clear. Inquiries for information not given here should be sent to the constructor direct; but he should NOT be asked to furnish data already published, here or elsewhere.

This department is for free discussion to the extent that space permits; but RADIO NEWS accepts no responsibility for the opinions of readers as to the relative merits of apparatus and circuits.

large battery companies here; so I have a better chance to compare sets than the average individual.

Leaving supers out of the argument, I find that tube for tube, the old three-circuit tuner has no equal. I sat down tonight and over the phones picked up some 35 stations, not high-power; most of them I could have switched to the loud speaker. I am using three stages of A.F., first stage Atwater Kent and last two Karas, and the volume is terrific, and not much distortion except on very strong Chicago and St. Louis stations. I find a variable grid leak helpful and almost necessary on extreme DX. I have verifications from PAN, Havana, and a bunch of others, and have picked up Alaska and Mexico City; so others can have their T. R. F. and neutrs, etc.; and I will stick to the old three-circuit tuner.

I have been reading RADIO NEWS for a long time, and commend you on the way you get it up and the way of presenting circuits you adopted last year. I think it was a great step forward in encouraging the home constructor; and also the review of circuits published in other magazines. Thanking you for the best radio magazine going.

EDWARD A. RUTLEDGE,
803 West Monroe St., Bloomington, Illinois.
(Though, in the matter of getting distance, nothing has ever exceeded the simple regenerative set in the hands of an expert, so much interference with reception has been occasioned by its misuse in the hands of the unskillful that RADIO NEWS
(Continued on page 852)

LIST OF BROADCAST STATIONS IN THE UNITED STATES

(Continued from page 760)

Radio Call Letter	BROADCAST STA. Location	Wave (Meters)	Power (Watts)	Radio Call Letter	BROADCAST STA. Location	Wave (Meters)	Power (Watts)	Radio Call Letter	BROADCAST STA. Location	Wave (Meters)	Power (Watts)	Radio Call Letter	BROADCAST STA. Location	Wave (Meters)	Power (Watts)
WJBU	Lewisburg, Pa.	214	100	WLS	Chicago, Ill.	**345	5000	WQAI	San Antonio, Tex.	500	5000	WRM	Urbana, Ill.	273	*500
WJBY	New Orleans, La.	238	30	WLSI	See WDFW			WQAN	Lawrenceburg, Tenn.	285	250	WRMU	New York, N. Y. (port)	201	100
WJBY	Gadsden, Ala.	231	50	WLTH	Brooklyn, N. Y.	256	250	WQAX	Trenton, N. J.	240	500	WRNY	Ship, 105.9 meters, 100 watts		
WJBJ	Chicago Heights, Ill.	208	100	WLTS	Chicago, Ill.	484	100	WQBY	New York, N. Y.	309	500		New York, N. Y.	326	500
WJJD	Mooseheart, Ill.	**366	1000	WLW	Chilcinnati, Ohio	428	5000	WQBR	Shelby, Ohio (portable)	204	10		(Also 30.91 meters, 500 watts)		
WJKS	Gary, Ind.	232	500	WLWL	(Also 52.02 meters, 250 watts)			WQBT	Union City, Tenn.	205	15	WRPJ	Terre Haute, Ind.	208	100
WJFW	Ashtabula, Ohio	208	30	WLMW	Kearney, N. J.	370	2000	WQBU	Charleston, W. Va.	268	50	WRR	Dallas, Tex.	461	500
WJR-WX	Pointe, Mich.	441	5000	WLMC	Cazenovia, N. Y.	225	500	WQCV	Davenport, Iowa	375	5000	WRRS	Racine, Wis.	248	50
WJZ	(Also 32 meters, 75 watts)			WMAF	So. Dartmouth, Mass.	416	500	WQCL	Jainestown, N. Y.	253	25	WRSC	Chelsea, Mass.	211	100
	(New York, N. Y.)	**454	30,000	WMAK	Tonawanda, N. Y.	545	750	WQDA	Patterson, N. J.	294	1000	WRST	Bay Shore, N. Y.	211	250
	(3XL, 59.96 meters, 30 k.w.)			WMAL	Washington, D. C.	242	500	WQI	Ames, Iowa	265	*2500	WRVA	Richmond, Va.	254	1000
WKAQ	San Juan, Porto Rico	322	500	WMAN	Columbus, Ohio	234	50	WOK	Chicago, Ill.	252	5000	WSAI	Chilcinnati, Ohio	361	5000
WKAR	East Lansing, Mich.	285	*500	WMAQ	Chicago, Ill.	**447	1000	WOKR	Peekskill, N. Y.	216	250	WSAJ	Grove City, Pa.	224	250
WKAV	Laconia, N. H.	224	50	WMAZ	St. Louis, Mo.	248	100	WOKT	Rochester, N. Y.	210	500	WSAN	Allentown, Pa.	222	100
WKBB	Joliet, Ill.	216	150	WMB	Macon, Ga.	270	500	WOMT	Manktowec, Wis.	222	100	WSAR	Fall River, Mass.	252	100
WKBC	Birmingham, Ala.	219	10	WMB	Newport, R. I. (port)	204	100	WOO	Philadelphia, Pa.	349	500	WSAX	Chicago, Ill. (port)	201	100
WKBE	Webster, Mass.	229	100	WMBE	Chicago, Ill.	252	5000	WOD	Grand Rapids, Mich.	261	500	WSAZ	Huntington, W. Va.	212	100
WKBF	Indianapolis, Ind.	252	250	WMBD	Detroit, Mich.	214	100	WOQ	Kansas City, Mo.	341	*250	WSE	Atlanta, Ga.	476	1000
WKBG	Chicago, Ill. (portable)	201	100	WMBE	Peoria Heights, Ill.	235	250	WOR	Kearney, N. J.	422	5000	WSEC	Chicago, Ill.	232	500
WKBH	La Crosse, Wis.	220	500	WMBE	St. Paul, Minn.	208	10		(Also 65.4 meters, 50 watts)			WSET	St. Louis, Mo.	258	250
WKBI	Chicago, Ill.	216	50	WMBF	Manli Beach, Fla.	381	500	WORD	Batavia, Ill.	252	5000	WSBT	South Bend, Ind.	238	500
WKBL	Monroe, Mich.	205	15	WMBG	Richmond, Va.	212	50	WOS	Jefferson City, Mo.	361	500	WSDA	see WARS.		
WKBN	Youngstown, Ohio	214	50	WMBH	Joplin, Mo.	204	100	WOW	Omaha, Neb.	508	1000	WSEA	Virginia Beach, Va.	263	250
WKBS	Jersey City, N. J.	500	500	WMBI	Addison, Ill.	**263	5000	WOWO	Fort Wayne, Ind.	**2500		WSFX	Springfield, Tenn.	213	150
WKBT	Battle Creek, Mich.	213	50	WMBJ	Monessen, Penna.	232	50		(Also 22.8 meters, 1000 watts)			WSK	Bay City, Mich.	273	500
WKBU	New York, N. Y.	219	500	WMBL	Lakeland, Fla.	229	50	WPAP	see WQAO			WSM	Nashville, Tenn.	357	2500
WKBS	Gatesburg, Ill.	217	100	WMBM	Mempbis, Tenn.	210	10	WPCC	Chicago, Ill.	224	500	WSMH	New Orleans, La.	297	500
WKBT	New Orleans, La.	252	50	WMBN	Auburn, N. Y.	220	100	WPCH	New York, N. Y.	326	500	WSMK	Dayton, Ohio	297	200
WKBV	Brookville, Ind.	217	100	WMBP	Brooklyn, N. Y.	204	100	WPFC	Waukegan, Ill.	216	250	WSOE	Milwaukee, Wis.	270	250
WKBW	Buffalo, N. Y.	217	*500	WMBR	Tampa, Fla.	252	100	WPG	Atlantic City, N. J.	273	5000	WSRO	Middletown, Ohio	236	100
WKBX	Ludington, Mich.	200	15	WMBT	Lemoine, Pa.	234	250	WPGC	Harrisburg, Pa.	210	100	WSSH	Boston, Mass.	288	100
WKBR	Kenosha, Wis.	248	15	WMBU	Youngstown, Ohio	214	50	WPCS	State College, Pa.	300	500	WSUF	see WTAR.		
WKBN	Kenmore, N. Y.	204	250	WMBV	Memphis, Tenn.	517	500	WPSW	Philadelphia, Pa.	203	50	WSUI	Iowa City, Ia. (day)	476	500
WKBC	Lancaster, Pa.	252	50	WMBW	New York, N. Y.	370	500	WPTF	Raleigh, N. C.	545	500	WSUN	St. Petersburg, Fla.	508	750
WKCR	Chilcinnati, Ohio	246	500	WMC	Saginaw, Mich.	219	250	WPUB	New York, N. Y.	236	500	WSVS	Buffalo, N. Y.	204	50
WKY	Oklahoma City, Okla	288	150	WMC	Boston, Mass.	211	50	WQAA	Parkersburg, Pa.	216	500	WSYR	Syracuse, N. Y.	225	500
WLAC-WAD	Nashville, Tenn.	225	1000	WMP	Lapeer, Mich.	234	30	WQAE	Springfield, Vt.	250	50	WTAD	Quincy, Ill.	236	*250
WLAP	Louisville, Ky.	268	*30	WMPR	Jamaica, N. Y.	207	40	WQAM	Miami, Fla.	384	750	WTAG	Worcester, Mass.	517	500
WLB	Minneapolis, Minn.	246	500	WMPB	Wethersfield, Conn.	207	500	WQAN	Bennington, Pa.	231	250	WTAL	Toledo, Ohio	240	250
WLBC	Muncie, Ind.	240	50	WMPD	Norman, Okla.	240	500	WQAO-WPAP	Yolinsville, N. J.	395	500	WTAM	Cleveland, Ohio	**400	*3500
WLBG	Kansas City, Mo.	210	50	WMPK	Omaha, Neb.	258	250	WQBA	Tampa, Fla.	238	250	WTAP	Eau Claire, Wis.	254	500
WLBG	Petersburg, Va.	214	100	WMPQ	(Also 105 meters, 50 watts)			WQBC	Utica, Miss (day)	216	100	WTAR-WVSU	Norfolk, Va.	236	500
WLBH	Farmington, N. Y.	232	30	WNAT	Philadelphia, Pa.	288	100	WQJ	Chicago, Ill.	447	500	WTAS	Batavia, Ill.	275	500
WLBH	East Wrenona, Ill.	238	250	WNAX	Yankton, S. D. (day)	278	250	WRAF	Laporte, Ind.	208	100	WTAW	College Station, Tex.	484	500
WLBK	Stevens Point, Wis.	333	*1000	WNBA	Forest Park, Ill.	208	200	WRAC	Providence, R. I.	200	250	WTAX	Streator, Ill.	248	50
WLBK	Cambridge, Mass.	231	50	WNBB	Endicott, N. Y.	267	50	WRAL	(Has short-wave transmitter)			WTAY	Richmond, Va.	220	15
WLBK	Chicago, Ill. (portable)	217	100	WNBH	New Bedford, Mass.	261	250	WRAM	Galesburg, Ill.	248	50	WTFI	Mt. Vernon Hills, Va.	204	50
WLBQ	Atwood, Ill.	203	25	WNBL	Knoxville, Tenn.	207	50	WRAN	Yellow Springs, Ohio	297	100	WTFN	Tocosa, Ga.	210	250
WLBK	Rockford, Ill.	248	15	WNBM	Washington, Pa.	211	15	WRAP	Reading, Pa.	238	100	WTHS	Atlanta, Ga.	270	200
WLBK	Crown Point, Ind.	248	50	WBNB	Rochester, N. Y.	203	15	WRAX	Philadelphia, Pa.	213	250	WTIC	Hartford, Conn.	535	500
WLBW	Mansfield, Ohio	207	50	WBNB	Memphis, Tenn.	229	20	WRBC	Vulparaso, Ind.	238	250	WTMJ	Milwaukee, Wis.	294	1000
WLBW	Oil City, Pa.	204	500	WNB	Elgin, Ill. (time sigs.)	35.5	500	WRC	Washington, D. C.	*468	500	WTRR	Midland Park, N. J.	207	15
WLBX	Long Island City, N. Y.	204	250	WNB	Carbondale, Pa.	248	5	WRCC	Raleigh, N. C.	217	250	WWAE	Chicago, Ill.	227	500
WLBX	Iron Mountain, Mich.	210	50	WNB	Springfield, Va.	242	10	WRCD	Norfolk, Va.	210	100	WWJ	Detroit, Mich.	353	1000
WLBZ	Dover-Foxcroft, Me.	208	250	WNB	Saranac Lake, N. Y.	232	10	WREC	Memphis, Tenn.	254	50	WWNC	New Orleans, La.	275	100
WLBI	Ithaca, N. Y.	248	50	WNB	Newark, N. J.	268	250	WREN	Lawrence, Kan.	254	750	WWL	Asheville, N. C.	297	1000
WLBI	Lexington, Mass.	216	5	(Has short-wave transmitter)				WRES	Quincy, Mass.	217	50	WWR	Woodstock, N. Y.	200	100
WLBI	See WGN			WNOX	Knoxville, Tenn.	265	1000	WRFH	Washington, D. C. (day)	322	150	WWVA	Wheeling, W. Va.	517	250
WLIT	Philadelphia, Pa.	405	500	WNRC	Greensboro, N. C.	224	500	WRHM	Minneapolis, Minn.	261	1000				

*Allowed higher daylight power. **Standard or constant-frequency transmission. †Remote Control.

LIST OF CANADIAN BROADCAST CALLS

CFAC	Calgary, Alta.	435	500	CHGS	Summerside, P. E. I.	268	25	CJOR	Sea Island, B. C.	291	50	CKOC	Hamilton, Ont.	341	100
CFCA	Toronto, Ont.	357	500	CHIC	Toronto, Ont.	357	500	CKRM	Moose Jaw, Sask.	297	500	CKPK	Preston, Ont.	248	8
CFCF	Montreal, Que.	411	1650	CHMA	Edmonton, Alta.	517	250	CJSC	Toronto, Ont.	357	500	CKPR	Midland, Ont.	268	50
CFCH	Incoquois Falls, Ont.	500	250	CHML	Mt. Hamilton, Ont.	341	50	CJWC	Saskatoon, Sask.	330	250	CKSH	St. Hyacinthe, Que.	312	50
CFCL	Calgary, Alta.	435	1800	CHNL	Toronto, Ont.	357	500	CJYC	Saskatoon, Sask.	330	250	CKSM	Toronto, Ont.	291	1000
CFCC	Vancouver, B. C.	411	10	CHNS	Halifax, N. S.	322	100	CJYD	Montreal, Que.	411	1200	CKUA	Edmonton, Alta.	517	500
CFCT	Victoria, B. C.	330	500	CHOB	New Boston, B. C.	411	1000	CKCD	Montreal, Que.	411	1000	CKW	Vancouver, B. C.	411	50
CFCH	Charlottetown, P.E.I.	312	100	CHRC	Quebec, Que.	341	5	CKCI	Quebec, Que.	341	23	CKY	Winnipeg, Man.	384	500
CFCC	Brantford, Ont.	297	50	CHSC	Unity, Sask.	248	50	CKCK	Regina, Sask.	312	500	KNRA	Moncton, N. B.	322	500
CFJC	Kamloops, B. C.	268													



I Want to Know

Conducted by C. W. Palmer

THIS Department is conducted for the benefit of our Radio Experimenters. We shall be glad to answer here questions for the benefit of all, but we can publish only such matter as is of sufficient interest to all.

1. This Department cannot answer more than three questions for each correspondent. Please make these questions brief; if the inquiry is concerning a circuit other than a standard, published one, delay will be prevented by enclosing a diagram and other necessary information.
2. Only one side of the sheet should be written upon; all matter should be typewritten or else written in ink. No attention paid to penciled matter.
3. Sketches, diagrams, etc., must be on separate sheets. This Department does not answer questions by mail free of charge.
4. Our Editors will be glad to answer any letter, at the rate of 25c. for each question. If, however, questions entail considerable research work, intricate calculations, patent research, etc., a special charge will be made. Before we answer such questions, correspondents will be informed as to the price charge.

SHORT-WAVE TRANSMITTER

(Q. 2261.) Mr. L. W. Errick, San Antonio, Texas, asks:

Q. How can I construct a low-wave transmitter which will be very light, compact and can be carried by one person alone, with a pack and camping utensils? We are contemplating surveying a certain section of open country and would

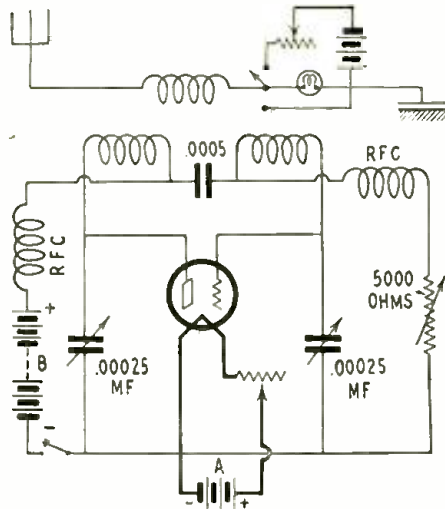

Fig. Q. 2261. This shows how the short-wave transmitter is connected. The R.F. choke coils are used to isolate the radio frequency in the grid and plate circuits and prevent losses.

useful for communicating purposes. The transmitter described here is built around a 199-type tube, assembled in as compact a form as practicable, using two receiving-type (air-dielectric) variable condensers, two small inductance coils, and a small fixed condenser. This diagram is shown in Fig. Q. 2261. Radio-frequency choke coils, in series with the "B" battery feed and with the grid-leak resistor, prevent losses of the high-frequency energies in these circuits. A third small inductance coil placed between the other two couples the energy to the antenna circuit. This transmitter is suitable for continuous-wave transmission using the International Morse Code.

List of Parts

- The components are as follows:
- Two variable condensers, .00025-mf.;
- One fixed mica condenser, .0005 or .001-mf.;
- One secondary inductance coil, 7 turns;
- One plate inductance coil, 7 turns;
- One antenna coupling coil;
- One 1X-199 tube;
- One grid leak, 5,000-ohm maximum;
- One filament rheostat, 30 ohms;
- Two radio-frequency chokes;
- One telegraph key;
- OneBradleystat;
- One flashlight bulb;
- Batteries to supply "A" and "B" current.

The grid and plate inductance coils should be made of edgewise copper ribbon with a 3 inch diameter, or of No. 14 or heavier bare copper wire. Seven turns will be required on each coil, and one-half inch spacing left between turns. The antenna coupling coil is made of No. 14 or heavier copper wire and is wound two inches in diameter. The actual number of turns used depends on the antenna system used in the individual case. If a loop aerial is used, a single turn of wire will be sufficient for the antenna coupling coil. The radio-frequency choke coils contain 40 turns each of No. 22 D. C. C. wire; they are wound on a basket-weave form with 8 pins spaced around a 1 3/4"-diameter form. In winding these coils the wire should be carried over one pin and under two.

Antenna Design

Several antenna systems can be used satisfactorily with this transmitter. One satisfactory method is to use a small antenna having a natural frequency approximately the same as that at which it is desired to transmit, i. e. 40 meters. For this system, a single wire about 33 feet long, erected as nearly vertical as practical should prove effective. If a counterpoise is used instead of ground it should have approximately the same dimensions as the aerial. A series antenna condenser of about .00025-mf. capacity may be connected between the counterpoise and the coupling coil. Another method is to use a larger antenna and tune it to exactly three or five times the wave length of the transmitter. This has sometimes been termed "transmitting on a harmonic," and can be used very effectively in connection with this transmitter.

Probably the best method, when using the transmitter for portable work, is a coil antenna or loop. A single-turn loop, three feet on a side, in series with a three-plate variable condenser, and a single-turn two-inch diameter coupling coil, will tune to the 40-meter band. With this aerial system, signals may be heard over three or four miles.

This transmitter may be easily adapted for phone transmission, since batteries are used throughout and naturally a very pure note is obtained. The circuit diagram in Fig. Q. 2261A shows how a Heising modulation system can be added to the "baby transmitter" for the transmission of voice. It will be necessary to add another tube for this purpose. A microphone transformer will be required; although this may be replaced by a low-ratio audio-frequency transformer or a Ford spark coil. The microphone may be any good hand microphone. An ordinary telephone microphone will also work effectively in this circuit. The "C" battery should be of the ordinary 4 1/2-volt type, and the audio choke coil should be 1 henry or larger. The primary of an audio-frequency transformer would be satisfactory for this purpose.

Operating Adjustments

For convenient operation, it is best to connect a switch somewhere in the lead to the "A" battery for cutting off the current to the tube filaments.

like to take portable radio equipment, so that the various parties can keep in communication with each other. Unfortunately, we are unable to use automobiles or pack animals; so the apparatus will have to be carried entirely by the members of the various surveying parties.

A. Probably the best arrangement that you could use would be one similar to the "baby transmitter" which the Burgess Laboratories have recently developed for experimenting with low-power, short-wave transmission. This transmitter uses a modified Colpitts circuit with a small receiving-type tube operated by small dry cells.

The principle used in operation is well known to most radio fans. Every one who operates a radio receiver, except at some isolated point, is familiar with the interference caused by other receivers which radiate. The energy from these interfering receivers, generally called "bloopers," is great enough to carry for many city blocks and cause whistling and squealing noises in the receivers of others. Ship operators have reported that, after leaving port and reaching distances from land as great as 30 miles, the "bloopers" could still be heard. When a receiver is sending out a signal in this manner, it is functioning as a radio transmitter and deriving its power from the "A" and "B" batteries which are connected to it. The circuits and arrangements of a receiver, however, are not usually such as to make an efficient transmitter. For best receiver action, the receiving tubes are arranged to generate feeble radio currents and are very loosely coupled to the antenna system.

If the circuits associated with the small receiver tubes were made highly efficient and properly coupled to an antenna system, it would be reasonable to expect that the whistling would be heard in receivers at much greater distances, and become

Fig. Q. 2261A. The short-wave transmitter is shown here with a Heising modulator for phone transmission. The tubes used in this unit are both of a small (dry-cell) receiving type. The plate and filament currents are supplied from dry batteries.

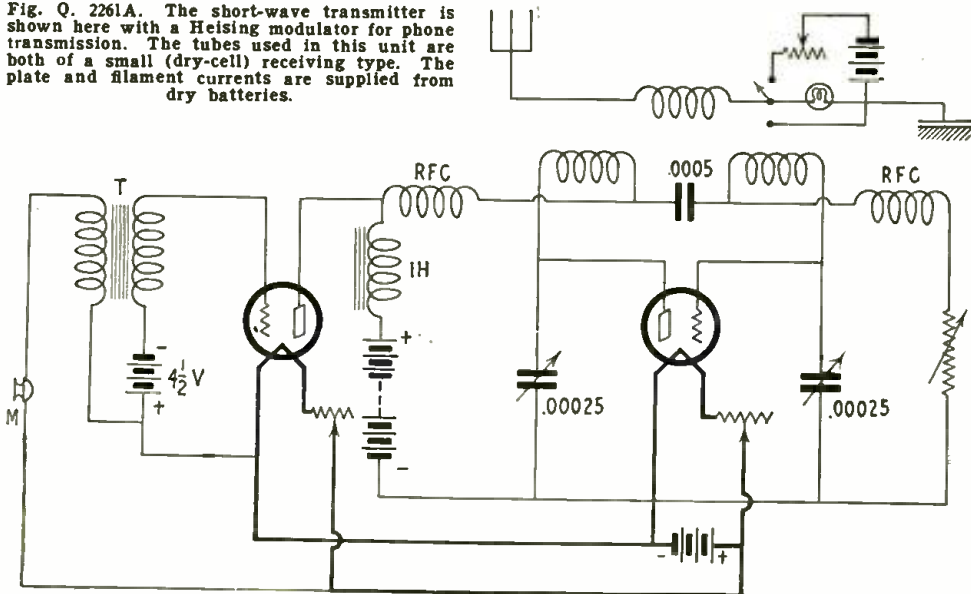

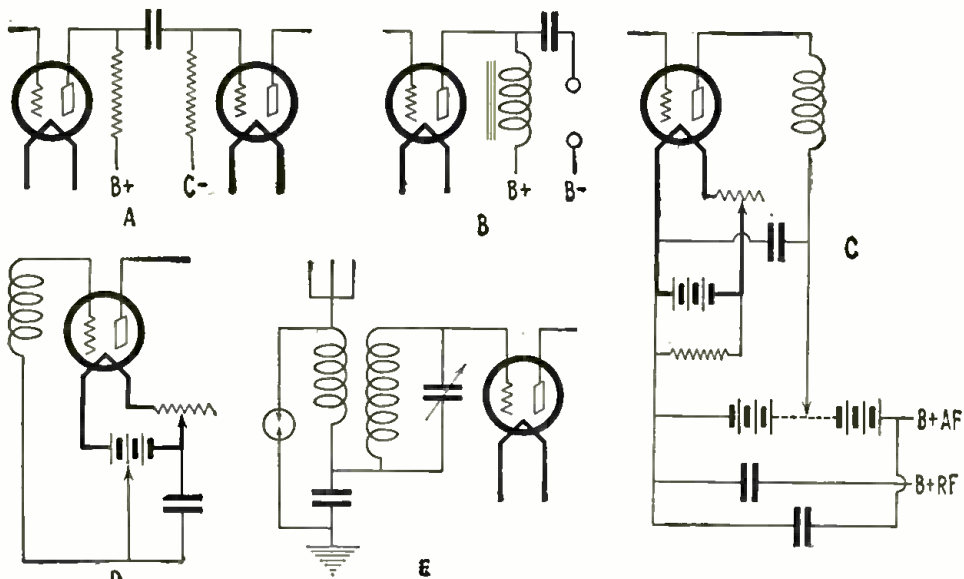

really satisfactory results. It may be necessary also to connect two 1-mf. condensers in series across the input to the driving motor and ground the center tap, in order to suppress the interference caused by sparking or poor contact in the commutator.

USES OF HIGH-CAPACITY CONDENSERS

(Q. 2263.) Mr. E. J. Schofield, Chicago, Illinois, writes:

Q. Very often I have noticed the use of large filter condensers in receiving sets for various purposes, and I would like to know just why and how these are used.

A. It is very important to determine the proper sizes of large-capacity fixed condensers in a receiver; since, if these are not of the correct capacity, the operation will be affected to a remarkable degree. One of the first uses of fixed condensers of high capacity, of the order of 0.5 to 1 mf., is for by-passes in radio-frequency circuits. In the average tuned-radio-frequency circuit, a fixed condenser of at least 0.5 mf. should be connected across the "B" battery. Where no high-resistance stabilizer is used in the radio-frequency stage, the fixed condenser should be connected between the "B" positive and "B" negative terminals of the receiver.

The increase in popularity of resistance-coupled audio-frequency amplifiers has brought another use for large-capacity fixed condensers, of values ranging from 0.1 to 1 mf. In resistance-coupled amplifiers such condensers are used as coupling and stopping condensers between the plate and grid resistors, as shown in Fig. Q. 2263A. In its functioning as a coupling condenser, it serves to couple together the plate and grid circuits; so that the voltage variations in the plate circuit are reproduced in the grid circuit of the succeeding tube to act on the grid of the tube. The condenser acts also as a stopping condenser to prevent the grid of the tube from being made strongly positive; as it would be if the positive "B" battery terminal were connected directly to the grid of the tube. This action applies also in choke-coil-coupled amplifiers.

With the increased plate voltage required by the new power tubes, the problem of keeping the plate current out of the speaker windings to prevent burning them out, and obviate distortion due to the saturation of the loud-speaker core, is brought up. A very effective circuit for overcoming this difficulty is shown in Fig. Q. 2263B. In this case the direct current flows through the choke coil, whose windings are designed to stand up under heavy current. When this circuit is used, it is very important to use a fixed condenser which is made to withstand any high voltage which may be applied to it; as a breakdown of this condenser will result in a short circuit of the "B" battery.

By-Passing Improves Receiver Performance

When potentiometer control is used in the plate circuit of the detector tube, the by-pass condensers in the detector and other circuits should be connected, not across the "B" power supply, but between the positive "B" terminals and the positive "A" battery lead, as shown in Fig. Q. 2263C. When potentiometer control is used for stabilizing radio-frequency amplifiers, a fixed condenser should be connected between the movable arm of the potentiometer and the negative "A" battery lead, as shown in Fig. Q. 2263D. In this way, the radio-frequency current in the grid circuit is by-passed across the high resistance of the potentiometer. A little-understood function of the by-pass condensers, when connected across the "B" battery lead, is their effect in minimizing the troubles due to the use of long battery leads when the batteries are located at some distance from the receiver. The use of such long leads tends to produce instability of operation, due to the high resistance placed in the radio circuits by the long leads, and also the tendency of these leads to act as miniature antennas. The use of the by-pass condensers eliminates the high-frequency resistance, and also limits

(Continued on page 839)

Fig. Q. 2263. Some of the uses of large-capacity condensers are diagramed here. A shows the condenser used for coupling amplifier tubes, B how the loud speaker is protected by using a large condenser. In C and D are shown radio frequency by-pass methods and, in E, a method of isolating receivers from the ground, to prevent a D.C. short circuit.

Since an equal number of turns is used in each of the secondary inductance coils, the two variable condensers should be adjusted to approximately equal setting. When the tube filament is lighted and the modulator working, or the key closed, the transmitter will oscillate constantly. The condenser settings are then varied until resonance with the antenna circuit is obtained. This resonance may be indicated by a number of methods. A thermogalvanometer, such as that ordinarily used in wavemeters, may be inserted in series with the antenna and used as an antenna ammeter; the maximum deflection denoting resonance. A D.C. milliammeter having a scale of 0 to 20 or 50, connected in series with the "B" batteries, will show resonance by rising sharply as the resonance point is passed over when tuning.

If no meters are available, a 2.5-volt flashlight bulb may be connected in the antenna circuit, as shown in the schematic diagram above. To find resonance, the switch is thrown to connect the battery to the lamp. The rheostat is adjusted until the lamp filament just begins to glow. When the transmitter is carefully tuned to resonance with the antenna circuit, the slight amount of energy radiated will noticeably brighten the lamp filament. To prevent the unstable action that may occur between coupled tuned circuits, it is best to adjust the transmitter to a point slightly one side of the point at which maximum radiation is obtained. After the adjustments are completed by means of the lamp, the single-pole double-throw switch should be thrown to the side where the lamp is disconnected from the battery and shorted out of the circuit, thus removing this resistance from the antenna circuit.

When operating any type of transmitter, it is necessary to obey the laws of the United States, which require that all radio transmitting stations should be licensed. Such station licenses are issued by the Department of Commerce, and copies of the laws may be obtained from the Superintendent of Documents, Government Printing Office, Washington, D. C.

POWER TUBE OPERATION FROM D. C. CURRENT

(Q. 2262.) Mr. J. Halesky, New York City, writes:

Q. I desire your criticism on the following device for raising the voltage of a 120-volt D.C. line so that it will satisfactorily operate a radio set on high voltage. As you know, a Wehnelt interrupter is a device working on a chemical principle which, when connected to a source of direct current, interrupts or breaks it at the rate of about 1,000 times per second. My idea is to connect this pulsating current to an ordinary "B" power step-up transformer, the necessary choke coils and condensers being used to filter out the current. I would like to know if it would work.

A. This method would work if a very large condenser was connected across the primary of the transformer used. This capacity would have to be enormously high, probably over 10,000 microfarads, and the results obtained with the system would be very poor and inefficient. There are several other methods that may be used to boost the voltage of a D.C. line for operating radio receivers.

There has been recently placed on the market a generator and filter system which consumes 110 to 120 volts D.C. and supplies 110 volts A.C. This generator system is used with an ordinary A.C. "B" power unit for supplying the necessary high voltage. Another method is to use a D.C. "B" power unit for supplying the current to the radio-frequency and detector tubes in your receiver, and connect several "B" batteries in series with this voltage to supply the higher voltage necessary for power tubes. Another variation of this method would be to use storage "B" batteries in series with a D.C. power unit; and, when the set is not being used, employ the voltage of the "B" power unit for charging the storage "B" batteries.

If you wish to experiment with another method, you will be able to get a high voltage by connecting the shafts of two D.C. motors together and using one as a motor and the other as a generator. At normal speed, the output voltage of the motor would be approximately the same as that at which it normally operates. In other words, if a 220-volt motor is used and operated at normal speed, it will deliver 220 volts at the output. It will be necessary to use a rather large filter system, if this method is used, to suppress the commutator ripple and voltage variation due to the use of such a small generator system. It would be advisable to use voltage regulator tubes at the output to obtain

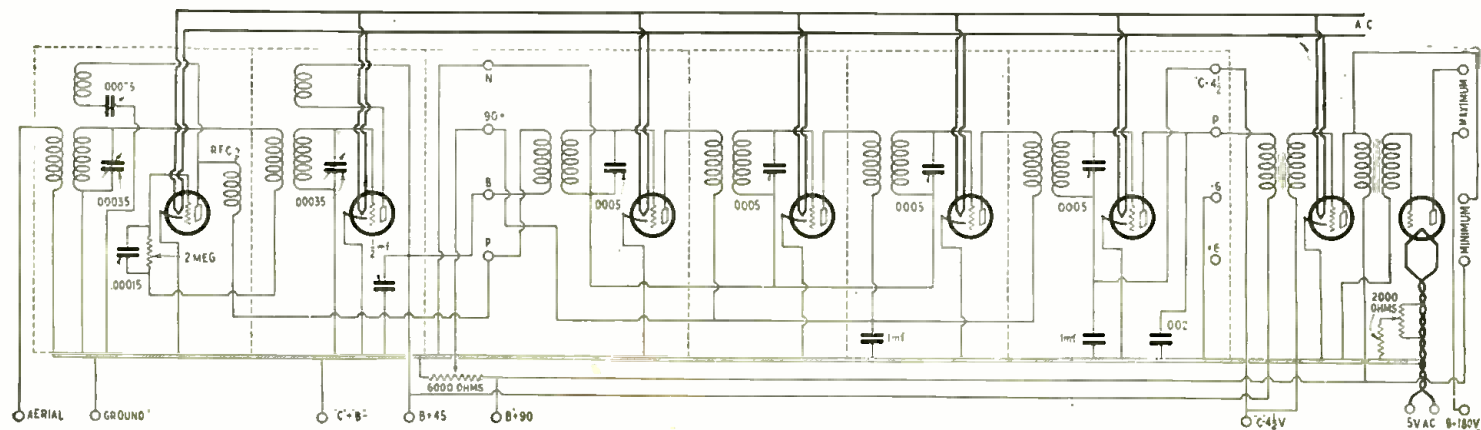

Fig. Q. 2264. The new Laboratory Superheterodyne, using the time-signal amplifier, is shown adapted for operation with the heater type of A.C. tubes. The power tube is of the 171 type and operated from the five-volt secondary of the heater transformer. The grid bias for the last tube is obtained automatically.

The great improvements in radio power have been made by Balkite



Licensed under Andrews-Hammond patent

Balkite "A" Contains no battery. The same as Balkite "AB," but for the "A" circuit only. Enables owners of Balkite "B" to make a complete light socket installation at very low cost. Price \$35.00.



Balkite "B" One of the longest lived devices in radio. The accepted tried and proved light socket "B" power supply. The first Balkite "B," after 5 years, is still rendering satisfactory service. Over 300,000 in use. Three models: "B".W, 67-90 volts, \$22.50; "B"-135, 135 volts, \$35.00; "B"-180, 180 volts, \$42.50. Balkite now costs no more than the ordinary "B" eliminator.



Balkite Chargers

Standard for "A" batteries. Noiseless. Can be used during reception. Prices drastically reduced. Model "J,"* rates 2.5 and .5 amperes, for both rapid and trickle charging, \$17.50. Model "N"* Trickle Charger, rate .5 and .8 amperes, \$9.50. Model "K" Trickle Charger, \$7.50.

*Special models for 25-40 cycles at slightly higher prices. Prices are higher West of the Rockies and in Canada.

FIRST noiseless battery charging. Then successful light socket "B" power. Then trickle charging. And today, most important of all, Balkite "AB," a complete unit containing no battery in any form, supplying both "A" and "B" power directly from the light socket, and operating only while the set is in use. The great improvements in radio power have been made by Balkite.

The famous Balkite electrolytic principle

This pioneering has been important. Yet alone it would never have made Balkite one of the best known names in radio. Balkite is today the established leader because of Balkite performance in the hands of its owners.

Because with 2,000,000 units in the field Balkite has a record of long life and freedom from trouble seldom equalled in any industry.

Because the first Balkite "B," purchased 5 years ago, is still in use. Because to your

radio dealer Balkite is a synonym for quality.

Because the electrolytic rectification developed and used by Balkite is so reliable that today it is standard on the signal systems of most American as well as European and Oriental railroads. It is this principle that does away with the necessity of using tubes for rectifying current—that makes all Balkite Radio Power Units, including the new Balkite "A" and "AB," permanent equipment with nothing to wear out or replace.

Balkite has pioneered—but not at the expense of the public.

Radio power with batteries or without

Today, whatever type of radio set you own, whatever type of power equipment you want (with batteries or without) Balkite has it. And production is so enormous that prices are astonishingly low. *Your dealer will recommend the Balkite equipment you need for your set.*



Licensed under Andrews-Hammond Patent

Balkite "AB" Contains no battery. A complete unit, replacing both "A" and "B" batteries and supplying radio current directly from the light socket. Contains no battery in any form. Operates only while the set is in use. Two models: "AB" 6-135, 135 volts "B" current, \$64.50; "AB" 6-180, 180 volts, \$74.50. Special model for Radiola 28, \$63.50.

FANSTEEL PRODUCTS COMPANY, INC., NORTH CHICAGO, ILLINOIS

Licenseses for Germany:
Siemens & Halake, A. G. Wernerwerk M
Siemensstadt, Berlin

Sole Licensees in the United Kingdom:
Messrs. Radio Accessories Ltd., 9-13 Hythe Rd.
Willesden, London, N.1W. 10

FANSTEEL

Balkite

Radio Power Units



Operating the Peridyne Five

(Continued from page 769)



Dynamic Power Speaker for new All-Electric A C Sets

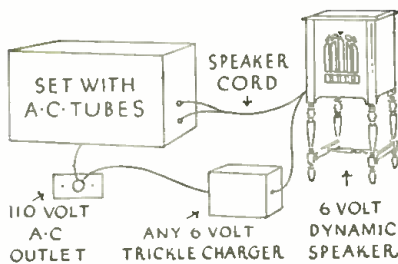

HOOK it up like this sketch, because the 6-volt rectified output of any standard trickle charger or "A" rectifier will energize the field of the Magnavox 6-volt Dynamic power speaker unit.

Aristocrat Model speaker (complete unit), illustrated above. \$85

Beverley Model—table type, complete. \$65

Unit only (Type R-4, 6 volt) \$50
(Fits any standard cabinet)

Only the Dynamic type speaker can bring out the full qualities of reproduction demanded today.

Write for Speaker Bulletins

THE MAGNAVOX CO.
OAKLAND, CALIFORNIA

CHOICE OF A CRYSTAL

In the Peridyne Five, my well-known Interflex system is used. As I have stated before, the carborundum type of detector is neither fussy nor critical; yet the characteristics of different carborundum crystals vary a good deal. I maintain that the heart of the entire set is right in this crystal. Some specimens are astonishingly sensitive in the Peridyne Five, while others are not nearly as much so. I would suggest that at least three different carborundum crystals be procured; and, after all have been tested for DX, that which proves the best one should be retained. It need never be changed afterwards, and will outlast most vacuum tubes. An important point to remember, with the carborundum type of detector, is that it will work better in one direction than in another. This is to be found out by experiment; try reversing the crystal, end for end, in its mounting.

FILAMENT VOLTAGE CRITICAL

I have stated, in my original article, that the two radio-frequency tubes are highly sensitive to filament voltage. As a matter of fact, when it comes to DX, the proper adjustment of the filament voltages of these two tubes is of the greatest importance; the setting of the two rheostats that control them is so critical that even a quarter of a turn of a rheostat knob will often throw the set into violent oscillation, or quiet it. Therefore, watch these two rheostats carefully. Better results can often be obtained by switching around these two tubes or substituting other tubes in the set.

The Listener Speaks

(Continued from page 736)

my set four months; but I am most enthusiastic. The reception has been wonderful and we have received some very educational, recreational and illuminating programs. We have our favorites, of course, but who has not?

ARTHUR HAMBLETON,
New Glasgow, Nova Scotia.

APPLAUSE CARDS C.O.D.

Editor, RADIO NEWS:

I would suggest that a committee representing the broadcast stations of the United States arrange with the Post Office Department that any letter addressed to a broadcast station, bearing only the station's call letters, should be sent to the station without stamp or date on it. This will save a lot of work at the post offices, and it will interest the postoffice to charge a small fee, which will be paid by the station according to the weight received each day. It will be only a short time before the people get used to it.

ARIE LIBERMAN.

129 S. Ferguson St., Shenandoah, Pa.

(The suggestion has been made from time to time by direct-mail advertising men that the government accept C.O.D. post cards in some such fashion as this; but an amendment in the postal laws will first be necessary. It would certainly stimulate the return of filled-out cards; though the question of cost would be an important one. At this point, we should give honorable mention to one fan who provides his own applause cards, illustrated with photographs of his family and his set, and thanks to the station whose program is attractive. He is Eden E. Eaton,

Another important point to remember is, that the vacuum tube that follows the crystal detector is not a detector, but really a *detector-coupled first audio amplifier*. Very often, this tube becomes critical, and the rheostat, R4, must be adjusted most carefully to get the best results. If you hear a sound like escaping steam in your loud-speaker, this is a sign that too much filament voltage is used on this tube; also that distortion exists. By carefully manipulating this rheostat, you will be able to obtain the best quality.

In building a number of the Peridyne Five receivers, it was found that, on this first audio-amplifier tube, a voltage of 22½ is best, as a rule. If, however, the "steaming" sound persists in the loud-speaker, try 16 volts; and the quality will undoubtedly improve and the unpleasant sound disappear.

SELECTION OF PLATE VOLTAGE

Referring back once more to the two radio-frequency amplifier tubes; if the set oscillates too violently, and cannot be controlled by either the rheostats R1 and R2, or the Peridyne compensators, reduce the "B" voltage of these tubes from 90 to 67½ or even to 45. Of course, this will necessitate the readjustment of the rheostats R1 and R2; but it gives a means of controlling the set very nicely, to bring it to its highest point of efficiency.

The Peridyne shields are, as you know, grounded. If the threaded rod that goes through the top of the can becomes loose, you will get a microphonic contact, and a rattling noise will be heard in the loud speaker. Be sure, therefore, that the screws that hold the Peridyne shields are *always tight*, and that a good contact is made. The can must make good contact with the bottom part of the shield; be sure that the two all external noises.

of 1811 Armstrong Avenue, Kansas City, Kansas.—EDITOR.)

FROM THE PLACE WHERE THE DAY ENDS

Editor, RADIO NEWS:

I was much interested in your leader in the Sept. number, entitled "A Radio Utopia." I agree that it would be a good thing if your scheme for high-powered stations could be brought about. At the same time I think that you hardly do justice either to your existing broadcast stations, or to listeners in foreign parts. I am situated in the South Seas, with no station nearer than IYA, Auckland, New Zealand (1,600 miles) so you will see that I have to reach out. I use an Atwater Kent 32, a 7-tube model with four stages of R.F., 201As, a CX300A, and a 112 in last audio with 90 volts "B"; three aeriols, one 200 feet, one 40 feet, and a loop with 75 feet of No. 22 D.C.C. This last is used when static gets too bad. My aeriols are strung between coconut trees, by which I am surrounded. Every night I get anything up to a dozen U. S. stations; not all on the coast as you will see from the following list. I have received confirmation of them all.

KFON, KFSD, KHJ, KFVB, KFI, KGO, KNRC, KPO, KFVD, KFWI, KNX, KMOX, KYA, CNRV, KGW, KFWM, WJAZ, all on Speaker.

I am now waiting for replies from WHO, WTAG, WJBT, and from the Bell Telephone experimental station at Whippany, N. J. This last station I have heard the last five Friday nights; on Oct. 7 I held it for four hours, and at times had it on the loop.

You will see that these are not freak, but consistent receptions; and this letter is written not in a boasting spirit, but to return thanks for benefits received in a lonely part of the world. There is nothing unusual about my set. Short-wave broadcast, of course, comes in on my 2-tube Aero set, but

With the Rectigon Home Charger *you can trickle charge too!*



THE Rectigon Battery Charger gives you two charging rates—you can use it both as a “trickle” charger or for high-speed charging of wet “A” and “B” cells. Under ordinary conditions, Rectigon’s trickle rate will replace all the “A” power your set uses. Then, when unusually long hours of reception have so weakened the battery that a trickle charger can’t restore it, just shift over to Rectigon’s high rate terminal

3 Ampere Rectigon

~~\$18.00~~
now

\$14.00

5 Ampere Rectigon

~~\$28.00~~
now

\$24.00

and store away a full charge quickly.

Rectigon is made by workmen who know radio—the organization that put the first broadcast entertainment on the air. Rectigon is safe, compact, simple—has no moving parts to break and wear out—uses no liquids of any kind. Will do no harm if you absent-mindedly tune in, or if the house current fails, while charging. Get Rectigon, the *two-rate charger*, at your dealer’s.

Westinghouse Rectigon Battery Charger

WESTINGHOUSE ELECTRIC & MANUFACTURING COMPANY, EAST PITTSBURGH, PA.
Offices in All Principal Cities / Representatives Everywhere
Tune in with KDKA—KYW—WBZ—WBZA

Rectox—for trickle charging only. Just attach the leads to your “A” battery and connect Rectox to the light line. Left permanently on charge at either ½ or ¾-ampere charging rate, it keeps your battery powerful and peppy. No messy acids, no moving parts. At your dealer’s.



Besides Rectigon and Rectox for better battery charging, Westinghouse also makes Micarta panels and tubing for better insulation, and radio testing instruments for better reception.



NO OPEN CIRCUITS
with the
New



all duty

DAVOHM

After months of research, Daventhe Resistor Specialists, are giving to the Radio Fans of America what they honestly believe to be the most perfect wire wound resistor—Davohm.

Davohms are built to the most exacting specifications. The enamel is a special composition which resists the highest temperatures. Davohms will not open circuit. Davohms will carry their full rated current capacity, plus an overload safely without excessive heat.

Constant Efficiency

Davohms are accurately rated when you buy them—and they remain accurate. If you draw 125 milliamps from a Davohm, it will continue to deliver 125 milliamps—indeinitely. No other resistor that we know of will give the same unchanging efficiency as Davohm.

For All Power Packs, A, B or C Eliminators Using 171 or 210 Tubes

Davohms are made in 4 sizes; in values from 500 to 25,000 ohms, and for all current carrying requirements, dissipating all wattages specified in power packs and eliminators, using 171 or 210 Tubes.

The Resisto Prop

The Resisto-Prop, an exclusive Daven product, makes mounting a simple matter.

The Sine of Merit

DAVEN RADIO CORPORATION
Resistor Specialists

147 Summit St., Newark, N. J.

DAVOHM

I depend on the "legitimate," every night from 6 p. m. to 9.20 p. m. Wishing your journal every success.

BRIAN G. THOMPSON, M.D.

Rarotonga, Cook Islands, South Pacific.
(Our readers may be interested in locating Dr. Thompson's home on the map; we spotted it at once—within three thousand miles! Incidentally, there have been a lot of reports of this new station 3XN. It has 50 kilowatts power, so it gets out well. Operating after midnight, it is comfortably early for Rarotonga, which is just about three thousand miles south of Hawaii.—EDITOR.)

FROM "SHUT-INS"

Editor, RADIO NEWS:

We received a wonderful radio today, and it sure was a beautiful one—a five-tube Freshman Masterpiece. It is quite impossible for us boys to try and express our gratitude in mere words, but we want you to know that we really appreciate your gratuity. Just as soon as we can procure batteries and tubes, we shall have your station and enjoy your programs, which I can assure you will help us pass away the monotonous hours of our duress.

The boys were surely delighted in receiving such a wonderful set and wish to thank you again and hope you have luck and success with your station. They wish to sign their names and show their appreciation. I sincerely hope that you realize our gratitude.

(The signers of this letter are inmates of the Missouri State Penitentiary at Jefferson City. Their heartfelt thanks are hereby referred to the Charles Freshman Company, by whose liberality this gift was made. At this season there is a special opportunity for the charitable to give to those who are in confinement, whether by illness, old age, or otherwise, the kindest gift which can be made to those so circumstanced—freedom of the mind to travel abroad on the wings of radio.—EDITOR.)

RADIO IN FLIGHT

Editor, RADIO NEWS:

When on the morning of October 13 the steamer *Barendrecht* sighted Miss Elder's plane, *The American Girl*, the radio operator was called from breakfast, hurried to his apparatus, and started immediately to call the plane, sending in a slow tempo.

But he didn't get any answer. Why didn't Mr. Haldeman use the emergency set he had with him? "We didn't need it, because we had sighted you," he told us afterwards. But he wanted to know his position and the distance to land, and asked us for it by throwing a written message abroad. It took time to paint the answer on the deck. After they had read it, one of the flyers called out that they were going to land alongside; but we did not understand and took it for a good-bye.

So, when the plane landed, we were all a bit upset, and it took some time to launch a boat. Meanwhile our ship had gone on for a little distance. Had Mr. Haldeman warned us by radio, all would have been ready, and there would have been less risk of the flyers being drowned, if the plane had sunk immediately, as was possible.

All ended well, however, and the fliers came aboard. Just a few minutes after she had been escorted to the cabin, Miss Elder called for the radio operator to send some message to reassure, first her mother, and then the rest of the world. About the same time, the operator handled a press message from Nauen, telling the world that a crowd of 10,000 had waited vainly at Le Bourget field, Paris, for Miss Elder's arrival, and that it was feared that *The American Girl* was lost in mid-ocean.

From the moment the first QST was sent, and the first message had been QSR to a land station, congratulations rained on the *Barendrecht's* antenna, and receiver and key

THIS department belongs to the readers of RADIO NEWS. It is theirs for the purpose of discussing fairly and frankly the needs of broadcasting from the standpoint of the great public who listen in. The letters represent not necessarily the editorial opinion, but that of the writers, who are, in the editorial belief, fairly typical of groups of opinion among the radio public. Make your letters concise and offer constructive criticism when you can; remembering always that there is something to be said for the other fellow's side.

Address The Editor, RADIO NEWS, 230 Fifth Avenue, New York City.

were busy for about forty hours, handling the traffic to and from Miss Elder, stopping only for a short time when the motor generator ran too hot. Before landing at Horta in the Azores, Miss Elder knew already that she was no longer a shipwrecked girl, but the heroine of a whole world arranging to shower welcome on her. That was all radio could do for her—and did.

F. HEDER.

Operator, S.S. "Barendrecht."

(A ship's operator is always liable to figure in a romantic adventure; even though for him it will mean only hard, steady work at his key, and demands for cool, quick thinking and resourcefulness. Like the operator of the "Barendrecht," however, we may wonder that radio was not used for the purpose for which it was carried on the airplane. It is certain that, before airplanes become everyday utilities for long flight, they will be well equipped with radio apparatus, for both guidance and communication, and that an experienced operator will be on duty at all times on such craft.—EDITOR.)

IN AN APARTMENT HOUSE

"SILENTLY, silently steals the night,"
*The poet pens—before he
Rhymes more, the radio to the right
Begins a bed-time story.*

**"Hushedly, hushedly doth the moon
Conclude her silvery journey . . ."**
*The radio, left, comes in with a tune
Broadcasted by Ben Bernie.*

"Quietly, quietly wakes the dawn,"
*Our hard apostrophizes—
Above a radio turning on
The morning exercises!*

—John McColl.



Brings You Guaranteed **Electrifies Any Radio**
"A" or "B" Eliminator

Completely Replaces Batteries



**No Battery
 No Charger
 No Bulbs
 No Hum
 Nothing to
 Wear Out
 Or Replace**
 COMPLETE
\$32⁵⁰

**Completely
 Replaces
 "B"
 Batteries**
**Easy to At-
 tach Plug
 Into Electric
 Light Socket**
 COMPLETE
\$29⁵⁰



Super-Power "A" Eliminator

UNCERTAIN storage batteries with their changing power, chargers and other bothers and expenses are done away with. This eliminator is **not a battery charger combination but completely and permanently replaces "A" Batteries.** It consists of a large capacity rectifier which changes the alternating house lighting current into direct current. Then a highly efficient heavy duty filter system of extremely high capacity changes the pulsating direct current from the rectifier into smooth, even current for lighting the filament in the radio tubes. Smooth, constant, unvarying, humless current for your radio. Anyone can install this eliminator in a few minutes. Simply connect between electric light socket and the radio and your set is instantly supplied with current used only when it is in use. Works perfectly whether used daily or only at long intervals. No moving parts to wear out. Operates from light socket 110-120 volts, 50-60 cycle A. C., output 6 volts for all sets up to 10 tubes with or without power tubes. Fool-proof in operation. Now sold direct at astonishingly low price.

Super-Power "B" Eliminator

Used with any good "A" Eliminator, this "B" Eliminator completely electrifies any radio. Battery troubles are forever ended. You operate your radio as easily as you turn on a light.

Complete with Raytheon Tube — This Super-power "B" Eliminator can be used with any set up to 12 tubes. It comes complete with full wave rectifying 85 mil. Raytheon tube, making possible the delivery of great current at a high voltage. This Raytheon tube has indefinite life as it has no filament to burn out. Delivers up to 180 volts.

The case is beautifully finished in olive green Duco, with black panel etched in gold. Equipped with rubber-covered cord and socket plug. High voltage taps and variable adjustments enable the use of new power tubes. Operates from 110-120 A. C., 50-60 cycle current. Has tap for intermediate voltage on which 67½ to 90 volts may be obtained. The detector tap will supply 22½ to 67½ volts. Variable adjuster will deliver any desired detector voltage. On and off switch and high and low voltage switch are integral parts of the eliminator. No additional switches or cords are necessary.

Only \$1.00 Down—Then Test Before You Buy

Indicate on the coupon below which eliminator you wish. Pin a dollar bill to the coupon and mail it to us. We will send you the Eliminator you want to test. If you want both eliminators send two dollars and mark coupon accordingly. You test them for 30 days before you pay another cent. Balance on easy installments when you are satisfied.

New Low Prices

Our great buying power and direct sales method enables us to offer both eliminators at tremendous savings. The "A" Eliminator easily worth over \$40.00 and more can be had here for \$32.50—only \$1.00 and balance on easy payments. The "B" Eliminator sells for the cash price of \$37.50 and more but by buying direct on easy payments you can have it for only \$29.50.

Elliott Radio Corporation

709 West Lake St. Dept. 377. Chicago, Illinois

Mail
 Coupon
 NOW!

Mail This Coupon NOW!

**Elliott Radio Corporation, Dept. 377
 709 West Lake Street, Chicago, Ill.**

Attached find \$1.00 for which you agree to send me () "A" Eliminator at \$32.50 () "B" Eliminator at \$29.50 (send \$2.00 if both are desired) as described in your ad. Full particulars will be sent me by return mail and my money refunded if I do not accept your offer.

Name.....
 Address.....
 City..... State.....

NEW AERO KITS USED IN IMPORTANT CIRCUITS

The Improved Aero-Dyne 6, the Aero 7 and Aero 4—all popular new circuits—are built around these marvelous coils

You Should Learn About Them NOW!



AERO Universal Tuned Radio Frequency Kit

Especially designed for the Improved Aero-Dyne 6. Kit consists of 4 twice-matched units, adaptable to 201-A, 199, 112, and the new 240 and A. C. tubes. Tuning range below 200 to above 550 meters.

This kit will make any circuit better in selectivity, tone and range. Will eliminate losses and give the greatest receiving efficiency.

Code No. U-16 (for .0005 Cond.)..... \$15.00
Code No. U-163 (for .00035 Cond.)..... 15.00



AERO Seven Tuned Radio Frequency Kit

Especially designed for the Aero 7. Kit consists of 3 twice-matched units. Coils are wound on Bakelite skeleton forms, assuring a 95 per cent air dielectric. Tuning range from below 200 to above 500 meters. Adaptable to 201-A, 199, 112, and the new 240 and A. C. tubes.

Code No. U-12 (for .0005 Cond.)..... \$12.00
Code No. U-123 (for .00035 Cond.)..... 12.00



AERO Four Kit

An exceptionally efficient kit for use in the Aero 4 and other similar circuits. Consists of one Aero Universal Radio Frequency Transformer and one Aero Universal 3-Circuit Tuner. Uses 201-A, 112, 199, and new A. C. tubes.

Code No. U-95 (for .0005 Cond.)..... \$8.00
Code No. U-953 (for .00035 Cond.)..... 8.00

NOTE: All AERO Universal Kits for use in tuned radio frequency circuits have packed in each coil with a fixed primary a twice matched calibration slip showing reading of each fixed primary coil at 250 meters and at 500 meters; all having an accurate and similar calibration.

A NEW SERVICE

We have arranged to furnish the home set builder with complete Foundation Units for the above named Circuits and for the Chicago Daily News 4-Tube Receiver, drilled and engraved on Westinghouse Micarta. Detailed blueprints and wiring diagram for each circuit included in foundation units free. Write for information and prices.

You should be able to get any of the above Aero Coils and parts from your dealer. If he should be out of stock order direct from the factory.

AERO PRODUCTS, Inc.

Dept. 105

1772 Wilson Ave.

Chicago, Ill.

RESONANCE

(Continued from page 754)

PENDULUM EXPERIMENTS

Another interesting experiment is furnished by a piece of string, two small screw eyes and a few weights such as iron washers or nuts from small stove bolts. In a clear place in some room, stretch the string horizontally between two walls (see Fig. 5). The screw-eyes may be screwed into the garage or wood shed; in the house small tacks may be used.

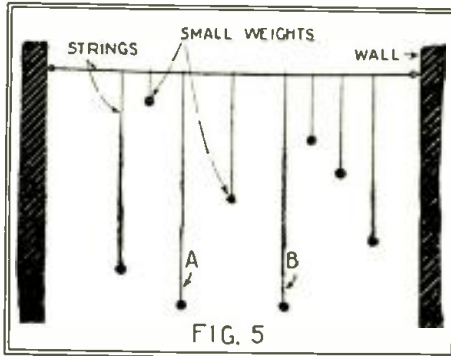

FIG. 5

Mechanical resonance effects can be studied by suspending small weights by strings from a string, stretched as shown above.

Prepare two equal lengths of string, which will clear the floor by about one foot, and fasten one of the washers or nuts to each string. Then suspend both strings from the horizontal cord. With both strings at rest (that is, not swinging), take hold of one washer or nut, pull the string out about two feet or so toward you and let it go. It will swing back and forth without apparent effect at first on the other string; but after a few swings the other string will pick up the motion and swing with almost the same amplitude as the first one. When the second string is swinging at its greatest amplitude, the first string will have slowed down to practically a standstill. Soon it will speed up again and the second string will slow down, etc. This is analogous to two simple radio circuits acting upon one another. The "kicks" (corresponding to the "coupling" between two radio circuits) are so timed that the vibrations are reinforced.

To show the effect of detuned circuits, that is, circuits not in resonance, choose a length of string about half the size of the first two and suspend this from the horizontal string also. When one of the long strings is in movement the other one of the same dimensions will readily pick up the motion, but the shorter string will not do so. A little study will show that the "kicks" traveling along the horizontal string are not timed right and these will sometimes reinforce or sometimes destroy the swinging of the shorter string.

Several interesting conclusions can be drawn from this resonance analogy. The two pendulums are tuned, since they are of the same physical dimensions. The shorter string is untuned and thus can pick up little of the energy.

The radio analogy is shown in Fig. 6. When a passing radio wave strikes the aerial, a small current surges up and down between aerial and ground, passing through coil 1, the primary. If coil 2, the secondary, has the same dimensions electrically, as the primary, maximum current will flow in the secondary and maximum response will be set up in the receiver. If the secondary is detuned (analogous to shortening the string) very little response will result and the signal

All Metal Chassis Shielded Ready to Wire

6 TUBE SUPERPHONIC

Only \$16.95

FREE! 6 TUBES LIKE 201-A TYPE Tested and Matched

Can be wired in a few minutes

An amazing value that can't be beat! Latest 6-tube tuned radio frequency circuit. Extremely selective, marvelous sensitivity. Three stages of radio frequency, detector, and two stages of low ratio audio frequency, for improved tone quality. Two-dial control. Straight-line frequency condensers. All metal chassis. Shielded. Clear and realistic reception guaranteed. Beautiful black front panel (7 in. x 18 in.); ornamental design, degree and kilocycle markings in gold. Metal panel and sub-panel. Complete chassis. No extra parts to buy. All parts mounted. Simply connect a few wires. No special tools needed. Kurz-Kasch indicator knobs. New type UX sockets. All hook-up wire and colored battery cable included. Value \$60.00; our price, \$16.95.

TESTED AND APPROVED
Severe laboratory tests have proved the remarkable efficiency of this set. Owners everywhere are sending us letters praising its wonderful receptive qualities.

SIMPLE WIRING DIRECTIONS
Very easy to wire this set with the instructions we furnish. Just connect a few wires. All you have to do is to follow numbers. That is all. (Can be wired in a few minutes by anyone. No radio knowledge needed. Make money by wiring these sets in your spare time and selling them to your friends.)

SEND NO MONEY

Just write your name and address on a post card and ask us to send you this great outfit together with six tubes. We will ship them right away. When they arrive, pay only \$16.95, plus a small delivery charge. (Foreign countries send \$19.50 with order. We pay shipping charges.)

RADIO EQUIPMENT CO.
Dept. NB 549-S. Wells St. CHICAGO, ILL.

Build Any Set but use ACE Hard Rubber PANELS

Their high insulating values insure the utmost protection against leaks and losses which often cause poor reception.

Made with Crackle or plain Polished Surface in all regular sizes:

7 x 10, 7 x 12, 7 x 14
7 x 18, 7 x 21, 7 x 24
7 x 26, 7 x 30 inches.

Low prices at all dealers or write to

AMERICAN HARD RUBBER CO.
11 MERCER STREET
NEW YORK, N. Y.
Makers of famous RADION PANELS

Insure your copy reaching you each month. Subscribe to RADIO NEWS—\$2.50 a year. Experimenter Publishing Co., 230 Fifth Ave., N. Y. C

From the Largest Radio Parts Plant in the World

There's no limit to the circuits you can build with Pilot Precision Parts—and you save more than half because they are produced in tremendous volume in World's Largest Parts Plant and merchandized only through responsible dealers.



TRADE MARK



Pilotohm Metal Resistances
A new Pilot development. All values for all resistance purposes

Listed below are only a few of the many Pilot Precision Parts—each piece of apparatus scientifically correct and electrically efficient, equal in every way to parts selling at four or five times Pilot's volume-production prices.

- No. 9—Pilot ABC Eliminator Kit
- No. 80—Pilot Micrograd Adjustable Condenser
- No. 374—ABC Power Transformer
- No. 301—Pilot Redi-Blox Detector Unit
- No. 302—Pilot Redi-Blox A. F. Unit
- No. 350—Pilot Resistograd
- No. 1278—Pilot Vernier Art-Dial
- No. 1281—Pilot Double Vernier Drum Dial (also Single No. 1280)
- No. 1517—Pilot S.L.F. Condenser
- No. 1617—Pilot Centraline Condenser
- No. 9000—Pilot Filter and Buffer Condensers (shown with Condenser Block Clamp)

"Radio Design"

To keep informed on Radio's Latest Developments, return the coupon below for "Radio Design," edited by M. B. Sleeper, Chief Research Engineer of this Company, showing new circuits, how to build S-P-5, amazing Socket-Power Receiver, the famous "X-11," and other popular circuits — at great savings.

Radio Manufacturers Since 1908

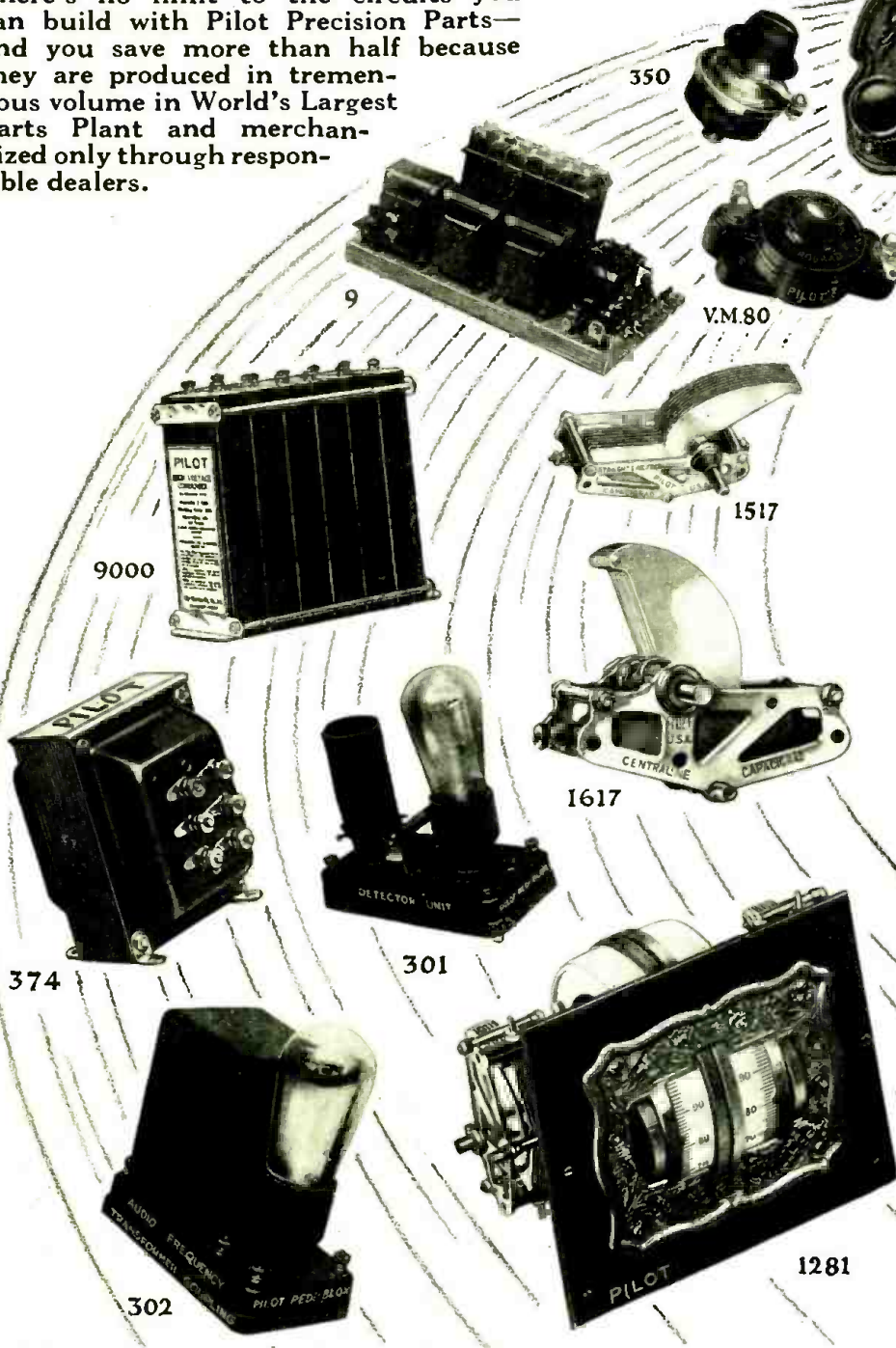

PILOT

ELECTRIC M'FG. CO., INC.
323 BERRY ST., BROOKLYN, N.Y.

CLIP and SLIP This COUPON
into envelope and mail to
PILOT ELECTRIC MFG. COMPANY, Inc.,
323 Berry Street, Brooklyn, N. Y.

Enclosed find 25c coin or stamps for four issues of "Radio Design" Quarterly.

Name

Address

City State

RN-1-28

- | | | | | |
|-----------|---------|---------|--------|--------------|
| ARGENTINE | CANADA | FINLAND | INDIA | NORWAY |
| AUSTRALIA | CUBA | FRANCE | ITALY | SOUTH AFRICA |
| BELGIUM | DENMARK | GERMANY | JAPAN | SPAIN |
| BRAZIL | ENGLAND | HOLLAND | MEXICO | SWEDEN |

Note: If you are unable to obtain complete parts at your dealer, write us and we will see that you are immediately supplied. Pilot Electric Mfg. Co., Inc., 323 Berry St., Brooklyn, N. Y.



Everywhere Under The Sun

Speed Radio Tubes

SUPER EMISSION

A Tube for Every Radio Need



CABLE SUPPLY CO. INC.
MANUFACTURERS
EXECUTIVE OFFICES
31 Union Square, New York

will not be heard or will be heard only very weakly.

You will notice that when one pendulum is nearly at a standstill the other will be swinging the farthest. Similarly, the current in the secondary will be greatest when the current in the primary is at a minimum. Also, one pendulum will be swinging in one direction (away from the supporting string) while the other is proceeding in the opposite direction. In the radio circuit, the current in the secondary is flowing in an opposite direction to that in the primary. One should remember, in using this analogy, that the motions are damped, due to friction between the strings. In the radio circuit, the motion is continuous as long as the station is broadcasting.

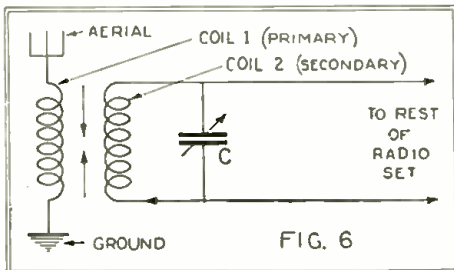

This circuit is analogous to the oscillating system diagramed in Fig. 5.

If a number of strings of different lengths (differing by one-inch lengths or so) are hung up, certain of the strings will swing more than others. That is, strings tuned to $\frac{1}{2}$ or $\frac{1}{3}$ of the frequency will have good amplitudes, too, these being the harmonics. They are much weaker than the main frequency. The strings will not be definite fractions of each other, however, for the frequency depends on the size of weights and the thickness of the strings.

These experiments are so simple and require so little equipment that the radio fan should not hesitate to try them; for they show, in a manner which he will be able to observe visually, how the more complicated electrical actions take place. With experiments of this nature, illustrating in an excellent manner the phenomenon of resonance, the listener really understands what is happening in a radio set when he "tunes" in. One is merely changing the "lengths" or electrical "dimensions" of his radio set, so that it will respond, in maximum fashion, to the frequencies at which the programs are broadcast. The circuits must be brought into resonance.

AMAZING STORIES

IN OUR JANUARY ISSUE: The **PSYCHOLOGICAL SOLUTION**, by A. Hyatt Verrill. Here our well-known author presents a scientific mystery story, in which pure reasoning and deduction are used to solve

the most baffling murder case of the decade.

ROBUR THE CONQUEROR, by Jules Verne. (A serial in 2 parts) Part II. In his attempt to convince the two officials of the advocates of the "lighter-than-air," Robur, his crew and prisoners meet with daring experiences, thrilling situations and breath-taking escapades. Still they are unconvinced, until the very end, when doubt is no longer possible.

THE COMET DOOM, by Edmond Hamilton. For sheer audacity of imagination and vivid presentation of good scientific fiction, we believe that Mr. Hamilton is hard to beat. There is so much that is novel and interesting in this story.

THE STOLEN BODY, by H. G. Wells. Now this versatile writer bases his story on psychic assumptions. It has many points of interest and solid scientific reasoning, particularly from a hypnotic viewpoint.

And others of scientific merit.



90-Day Guarantee

only \$1.00 Down C.O.D.
An absolutely unequalled value! We want you to test the World "A" Socket Power Unit and compare it with any other of two or three times the price. Try for ten days at our risk. Then if you are not convinced that it is unsurpassed as to quality and wonderful results, purchase price will be refunded in full. Operates on 50 or 60 cycles at 110 volts A. C. Highest quality Westinghouse electrical equipment. No hum or noise. Approved by Radio News Laboratories and other leading Authorities.

Send Order Today Just write your name and address on a slip of paper—pin a one dollar bill to it and mail today. We will ship same day order is received for \$12.75 C. O. D. 5% discount for cash with order. Remember you are the judge and are fully protected—so send order NOW.

WORLD BATTERY COMPANY

1219 South Wabash Avenue
Dept. 60 Chicago, Illinois

Station W. S. B. C., owned and operated by World Battery Company

Wirthmore Radio Cabinets

SAVE MONEY



Right in your own city are many people who have saved money by buying Wirthmore Cabinets direct.

You too can buy a Better Cabinet and save Money. A Complete Line of Consoles equipped with Newcombe-Hawley Speakers.

Get Your Catalog

THE WIRTHMORE COMPANY

910 Wirthmore Street

Rockford, Ill.

25 Cents Brings ALL THIS!

One Official Blueprint of the Five-Tube Diamond of the Air

One official booklet describing in detail how to build this famous set, wind coils, etc.

Act Now! Send That Quarter to

Guaranty Radio Goods Co.

141-J West 45th St.
New York, N. Y.

SPECIAL PRICES

Send for literature on the Scott's World's Record Ten and The Nine in Line. Dept. N.
NORTH SHORE RADIO LABORATORIES
ASSOCIATES I. R. E.
6902 North Clark Street Chicago, Ill.



Your Home Deserves Zenith Radio

GOOD music deserves good musical reproduction. Zenith radio will bring fine broadcast programs in the manner they should be brought—with tonal delicacy, with clear undistorted rendition of every voice or instrument. For the Zenith receiver is a high grade musical instrument, made with exacting care and scientific devotion to the highest standards of performance.

Zenith design ranges from the six-tube, battery or electrically operated set to the De Luxe, fully electrical ten-tube type. Every model embodies more than twenty-five Zenith improvements

that have led the way in radio development. The Zenith price begins at one hundred dollars because Zenith quality cannot be built into a receiver of lower price. Whichever one of the sixteen Zenith models you select will bring those fine qualities of tone, selectivity, volume and clarity that your home deserves.

Make it a point to hear a Zenith demonstration before you buy radio. You will then have a standard of judgment—the Zenith standard. Both as musical instrument and as exquisite cabinet furniture Zenith radio is worthy of a place in the truly modern home.

DE LUXE ENGLISH ELECTRIC MODEL

10 Tubes

The first 10-tube completely Electric Radio using power speaker.



World's largest manufacturers of high grade radio—16 models—3 different circuits—6, 8 and 10 tubes, battery or electric—antenna or loop—\$100 to \$2500

*Western United States prices slightly higher
Licensed only for Radio amateur, experimental and broadcast reception*

ZENITH
TRADE MARK REG.
→ **LONG DISTANCE** ← **RADIO**
TRADE MARK REG.
3620 IRON STREET, CHICAGO

BENJAMIN

Red Top Cle-Ra-Tone Sockets



Spring Supported Shock Absorbing

Makes the socket stand out from the dead black of the base and panel

Easier to establish correct position of tube and prongs
Improves the appearance of the set

Have all spring supported and shock absorbing features of the famous Cle-Ra-Tone Sockets. Non-microphonic. Unaffected by stiff bus wiring. Tube holding element "floats" on four finely tempered springs. Used in most of the leading circuits. Among the most recent for which Cle-Ra-Tone Sockets have been specified are:

- Strobodyne 8
- Magnaformer 9-8
- Camfield Super-Selective 9
- Lynch Suppressor Circuit
- H. F. L. Nine in Line
- World's Record Super 10
- Melo-Heald Fourteen
- St. James Super
- Karas Two-Dial Equamatic
- Knickerbocker 4
- Hilograd Receiver
- International One-Spot
- Thompson Super 7
- Hot Spot Fourteen

PRICES

Push Type, on Mounting Base

Benjamin Cle-Ra-Tone Sockets 75c each
Without Mounting Base 50c each

Green Top Sockets for A. C. Tubes

Specially designed, for use with 3-pronged A. C. Radio Detector Tubes:
For direct attachment to panel 90c each
For mounting on top of panel \$1.20 each

Insist on the socket used by those who know and want the best. ASK FOR BENJAMIN "RED TOP," or "GREEN TOP."

At all Radio Jobbers and Dealers

Made by

Benjamin Electric Mfg. Co.
120-128 So. Sangamon St., Chicago

247 W. 17th St. New York 448 Bryant St. San Francisco

Manufactured in Canada by the Benjamin Electric Mfg. Co., Canada, Ltd., Toronto, Ontario

Hook-Up Review

(Continued from page 788)

ALL-WAVE SUPERHETERODYNE

All apparatus is arranged in an orderly fashion, and when the shielding is in place only a few wires are visible above the chassis. The detector shielding compartment is on the front edge of the chassis at the left, and the oscillator shield is located in the same relative position on the right of the chassis. The intermediate-frequency amplifier is located at the rear of the detector stage, and the audio amplifying apparatus is at the rear of the chassis on the right.

An interesting feature of the receiver is that it may be wired for either battery or alternating-current operation. The circuit diagram shown above is used when a filament storage battery is employed; while an instruction booklet, which is available, explains the method which should be followed if the new A. C. tubes are employed. A diagram of the circuit appears on page 796 of this issue.

A complete list of the apparatus required for the construction of the Improved Laboratory Superheterodyne follows:

Two Silver-Marshall audio transformers, type 220; four S-M tube sockets, type UX; two S-M vernier drum dials; one S-M R.F. choke coil, type 275; one S-M condenser, type 342; one S-M time-signal amplifier; two S-M coils, type 111A; two S-M coil sockets; two S-M .00035-mf. variable condensers; two S-M stage shields; one Carter .00015-mf. fixed condenser with clips; one Carter potentiometer, type M-200; two Carter 0.5-mf. by-pass condensers; one Carter 3-ohm rheostat; one Carter battery switch; four Carter tip jacks; one Polymet 2-meg-ohm grid leak; one Van Doorn panel and chassis unit; nine XL binding posts.

"EIGHT-IN-LINE" SUPERHETERODYNE

(Continued from page 788)

the last stage. Two variable condensers tune the first detector and oscillator circuits, while a midget condenser is used as regeneration control and a rheostat is employed as volume control. The set operates on a loop antenna and uses standard 201A-type tubes in all circuits but the last audio stage.

From the mechanical viewpoint, however, there are many new and interesting features. An examination of the picture showing the inside appearance of the receiver will show that practically all of the apparatus is housed in one unit. This unit is a plywood box shaped much like the toy piano usually purchased for the little daughter at Christmas time. On the shelf in place of keys eight sockets for the various tubes of the set are mounted. On the front of the box there are eleven binding posts, and these are connected with the apparatus on the front panel and the loop antenna by twelve wires. Aside from this box, the only other parts are the three variable condensers and the rheostat, and these are mounted on the front panel.

The unit mentioned in the above paragraph contains all the apparatus, with the exception of the tuning controls, and is available in a completely wired form. The intermediate-frequency transformers of the receivers are matched and tuned to a frequency of 85,000 cycles at the factory, thus assuring a high degree of amplification.

For the construction of the receiver the following parts are required; one 'Eight-in-Line' unit; one Lignole panel 7x24 inches; one DeJur 10-ohm rheostat; two DeJur .0005-mf. variable condensers; one Marco .00045-mf. midget variable condenser; two Kurz-Kasch vernier dials; one Yaxley 1-ohm resistor; ten feet of Acme Celatsite wire.

30 Days FREE TRIAL



New Westgate One Dial RADIO

Here's our offer. Put any one of our 24 new 1928 models in your home on 30 DAYS' TRIAL. Use it for 30 days at our risk. Test it for distance, selectivity and real tone value. Compare it in quality and price with any Radio you ever saw or heard. Then if you are not convinced that the WESTGALE gives you the biggest value and the best price—YOU DON'T HAVE TO KEEP IT.

\$47 to \$72 Retail Prices

Big Discount to Agents. Now WESTGALE offers you the last word in Radio at lowest prices. Our new tone system gives amazing reproduction. One dial control, latest shielded construction puts Westgate sets years ahead in powerful reception and better tone quality. Our retail prices are low factory prices. Our Agent's Prices are even lower.

24 Styles to Choose From

5, 6 and 7 Tube Sets

Don't buy any radio until you send for our big FREE Catalog showing our complete line in 5 tube, 6 tube and 7 tube models and 24 styles. A beautiful array of table styles, consoles, and de luxe period type cabinets. Get our FREE Catalog and 30 Day Trial Offer at once. Write for it today.

WESTGALE ELECTRIC COMPANY
Dept. 209
1751 Belmont Ave., Chicago, Ill.



\$87
Retail Price Including Speaker

Why Not Be Our Agent?

Why not get your own Radio without cost? Get demonstrator set on 30 Days' Trial and make big money in full or spare time. Big discount to first Agent in each locality. Be first—write today for special agent's prices.

No "A" Batteries with These TELEVOCALLS

The new Televoecal A. C. 226 and 227 Tubes operate direct from A. C. current and require no "A" Battery. Televoecal T. C. 112A and 171A Power Tubes are made with oxide-coated filaments taking but half the current— $\frac{1}{2}$ amperes as against $\frac{1}{2}$ amperes heretofore. For best results insist on Televoecal Quality Tubes for all purposes. All standard types featured by the exclusive Televoecal Support—all fully guaranteed.



TELEVOECAL CORP'N
Televoecal Building
Dept. A-5, 588-12th Street
West New York, N. J.

TELEVOECAL QUALITY TUBES

RADIO

ACCESSORIES at WHOLESALE

Radio Sets, "B" Eliminators, Chargers, Tubes, etc. Parts—everything new in Radio at lowest wholesale prices. Thousands of nationally advertised bargains. All listed and illustrated in my Big New Catalog and FREE Call Book.
132 Pages of valuable Radio information—trouble finding, yet holding—Radio knowledge of all kinds. Write today. HARRY SCHWARTZBERG PRES.
AMERICAN AUTO & RADIO MFG. CO.
Dept. 104 American Radio Bldg. Kansas City, Missouri

BIG BARGAIN CATALOG

An Important and Decisive Verdict

The Radio Industry Says:

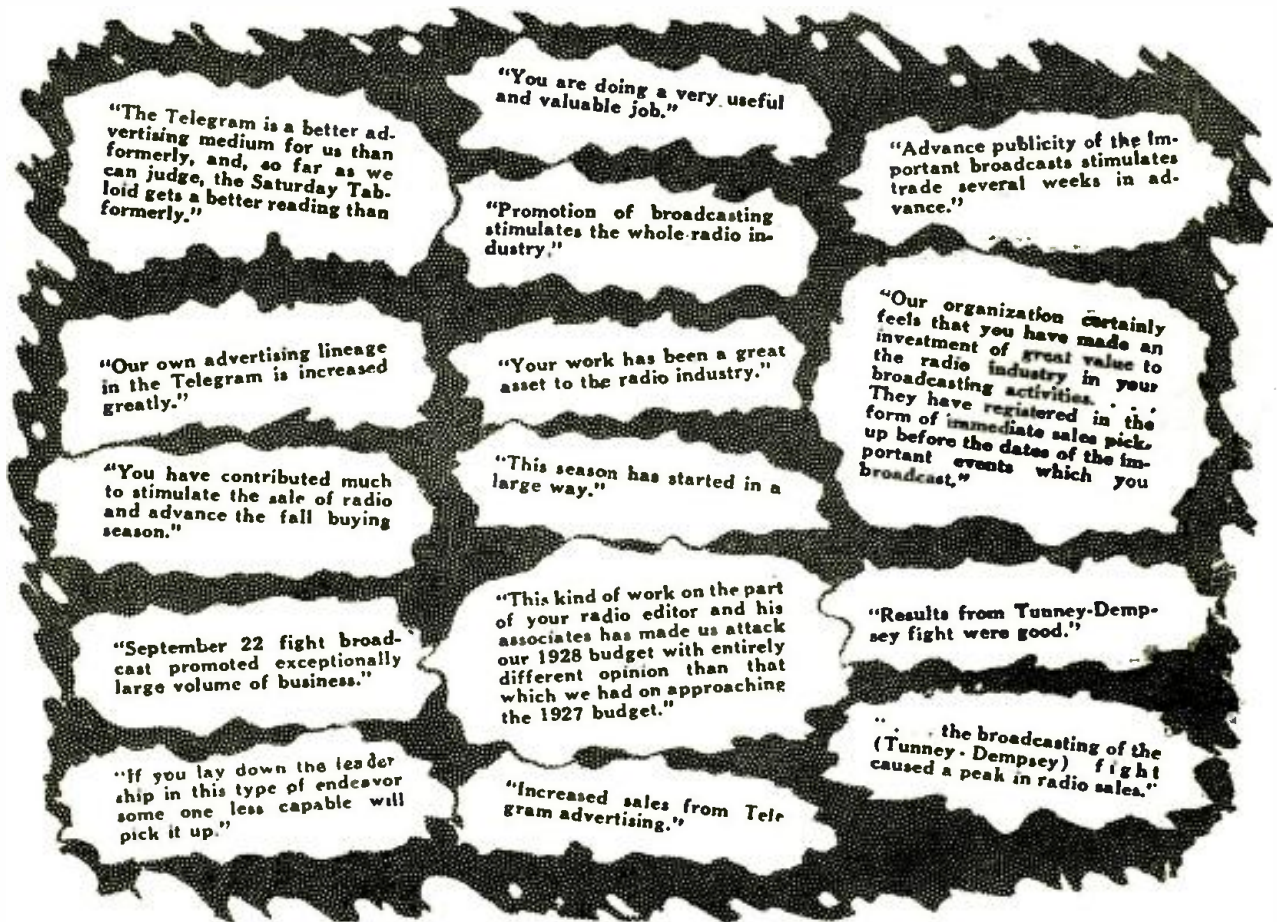

The foregoing are extracts from letters received from prominent radio manufacturers, dealers and advertising agencies, regarding The New York Telegram's radio activities.

They furnish conclusive evidence of the growing esteem in which The Telegram is held by the radio industry as an advertising medium.

The broadcasting of great events, sponsored by Scripps-Howard; The Telegram's publication of *complete* radio programs; The Telegram's improved Saturday Radio Magazine and other features, have furthered the interests of the radio industry and have won a radio readership which sellers of radio products recognize as essential to a complete sales campaign and maximum results in New York City.

The New York Telegram

A SCRIPPS-HOWARD NEWSPAPER

MEMBER AUDIT BUREAU OF CIRCULATIONS AND MEMBER OF THE UNITED PRESS

National Advertising Representative:

ALLIED NEWSPAPERS, INC.,
250 PARK AVE., NEW YORK CITY

SEATTLE · SAN FRANCISCO · CLEVELAND

DETROIT · LOS ANGELES · PORTLAND · ATLANTA



SCRIPPS-HOWARD

Advertising Department:

THE NEW YORK TELEGRAM,
73 DEY STREET, NEW YORK CITY

Phone: CORTLANDT-8000



While your neighbors are cussin' the static

Your set, with its Dubilier Light-Socket Aerial, is bringing the programs in smooth as silk. It's a fact! This little aerial, which you simply attach to the set and plug into the nearest light socket, reduces both static and interference to a marked degree. It uses no current whatever and absolutely eliminates the lightning hazard. Costs you nothing to prove it, for the Dubilier Aerial is sold by all good dealers on a 5-day, money-back basis. If your dealer can't supply you, write direct to us. Price, \$1.50.



Dubilier LIGHT SOCKET AERIAL

If you're replanning to build a power-unit make sure that the condenser blocks you intend to use are built to withstand long hours of heavy-duty service. Dubilier Blocks have an excessive high factor of safety and a "life" that makes them by far the most economical to buy. Full instructions enclosed with each block unit.

DUBILIER CONDENSER CORP.
4377 Bronx Blvd., New York, N.Y.

Dubilier CONDENSERS

The Search for the Perfect Detector

(Continued from page 783)

result. Hence a very efficient form of rectification is obtained, the curves obtained being sharper than usual, as shown by Fig. 4a.

The tuned input circuit is applied between plate and filament and the alternate positive and negative cycles applied to the plate provide a much more complete detecting action in the output grid circuit. Fig. 4b is the theoretical diagram of such a circuit.

Summing up the foregoing, it has been pointed out that:

1. Leaky-grid circuits, while very sensitive to weak inputs, cannot handle large input-voltage swings, and also suffer from an inevitable distortion produced by the grid current, and the varying impedance offered by the grid condenser to oscillatory currents.

2. Plate-bend rectification employing grid input is a comparatively insensitive device; since the bends of a normal tube employed in such circuits are not very sharp and nothing like perfect rectification can be obtained.

3. Plate-input circuits are a great advance towards perfection and, provided values are correctly chosen, curves can be produced, the bends of which are very much sharper than usual.

Both the second and third methods suffer from the great disadvantage that smooth regeneration cannot be introduced into the circuits with any measure of success, lowering efficiency to a great extent on distance work.

Now let us refer back to the circuits of Fig. 1 and 2 for a moment. It is probably well-known that all the electrons emitted from the filament do not reach the plate through the grid; some of them gather together just beyond the filament into a cloud and being negative in polarity tend to repel other electrons on their way to the plate. This cloud is known as the "space-charge."

In an effort to abolish, if possible, this space-charge Mr. Dowding of *Popular Wireless*, London, connected the electrode nearest to the filament (namely, the grid) to the source of high-positive potential; and, thinking it would be better to control the emitted electrons at their source, he connected the R.F. input to the filament. The plate was then connected via the "A" battery to the filament, to complete the circuit.

Large R.F. chokes of low D.C. resistance were then introduced to isolate the filament and prevent R.F. impulses from straying everywhere round the circuit; though they allow the steady D.C. to pass from the "A" battery to heat the filament. Finally regeneration was introduced, as shown in Fig. 5, and the circuit, when connected up and put on test, proved its inventor's theories to be correct beyond any shadow of doubt, for it gave results beyond all expectations.

Quality on local work was excellent and its DX capabilities were also very good. But—and here was the snag—the circuit as it then stood had a very limited range of suitable tubes; only one or two would give these results, others were poor, and some gave no signals at all. The chokes also were, of necessity, large and cumbersome, being wound with large gauge wire; their efficiency in isolating the filament was also none too good.

The above circuit was introduced some eighteen months ago; since then and up to the present time it has been developed and improved very greatly by one or two enthusiasts. The large chokes have been replaced by two parallel coils between which is placed the filament at one end, at the other

Build the

STROBODYNE

with the
New Improved
"Consrad"

BOOK PATTERN

THE sensational Strobodyne circuit, the greatest of Super-Heterodyne receivers that combines the best features of every circuit and has amazed Radio, is now ready for home and community set builders.

Consrad, the greatest radio book and Pattern publishers, has printed a brand new pattern for this amazing Strobodyne circuit. A sixteen-page, 9x12 book gives every last detail in the building up of reliable Strobodyne receivers.

In this booklet are drawings and photographs of various parts of the receivers. The few parts of the hook-up that require special attention are fully covered by special sample instructions.

FULL SIZE BLUEPRINTS

With this Strobodyne pattern come four full size blueprints. These blueprints are complete, accurate and highly simplified. Anyone can build a Strobodyne receiver, whether they have built a radio set before or not.

The Blueprints are as follows:

- No. 1. Panel layout Blueprint — Size 11x27 inches.
- No. 2. Sub-Panel Layout.
- No. 3. Wiring for Apparatus (Shown in perspective form) —
- No. 4. Underside view of Sub-Panel — Size 16x27 inches.

Size 23x27 inches.

Until you have studied the Strobodyne you are a back number in Radio—a man of the older school—the Strobodyne is not just a new circuit—it is an epoch in Radio.

50c THE COPY
USE THIS COUPON

CONSRAD COMPANY, Inc.,
230 Fifth Ave., New York.

Gentlemen: I enclose 50c for one copy of the New Official STROBODYNE PATTERN containing complete constructional information and all Blueprints.

Name

Address

City State

WHOLESALE PRICES

-- for Dealers, Community Set Builders, General Repairmen and Agents --

Be sure to get this great 100-page book with net prices to the radio trade.

Radio Specialty Company is radio's oldest radio parts mail order house in the country, and the new confidential prices on standard radio merchandise are the lowest of any radio house.

We are ready now to appoint additional agents in all parts of the country. If you care contemplating making big money in radio merchandise, be sure to get in touch with us at once.

WHEN WRITING
TO US,
USE YOUR
LETTERHEAD

1927
Edition

No. 17

500
Illustrations

NEW
Enlarged
Edition

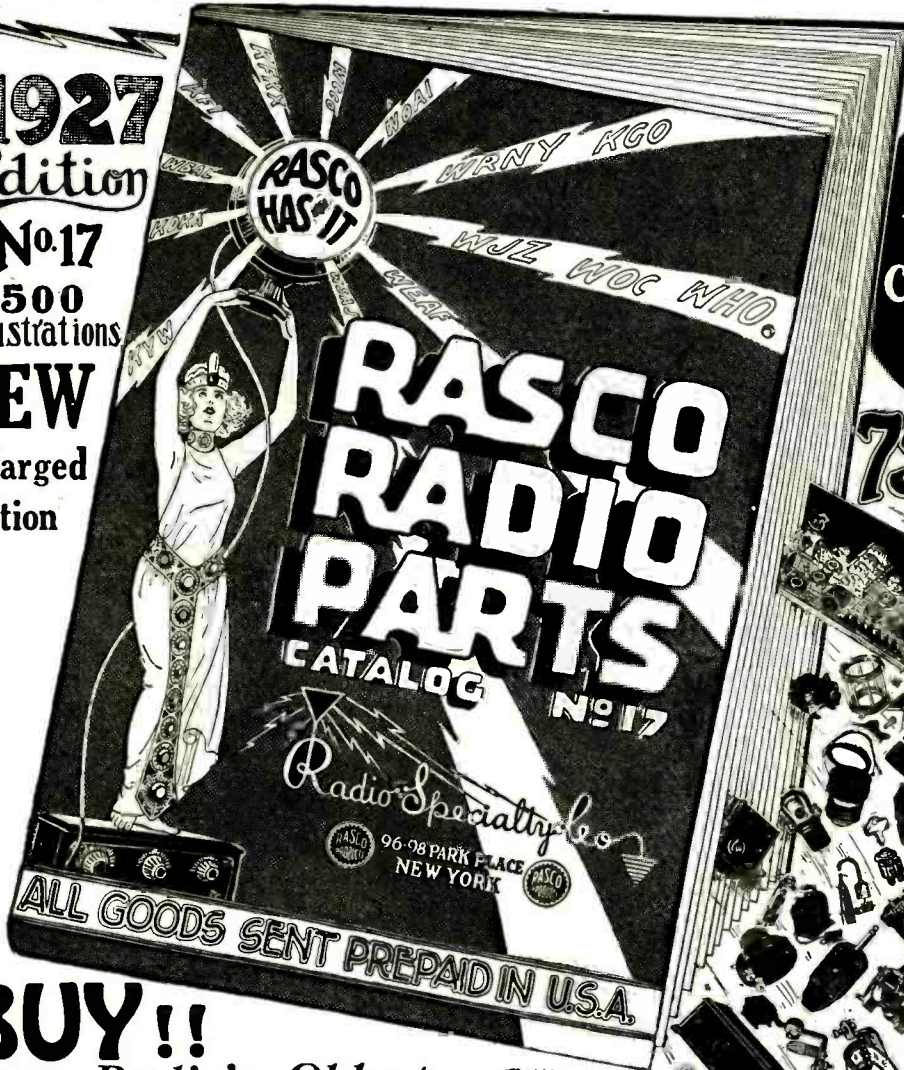

**THIS
100 PAGE
RADIO
CATALOGUE
FREE**

75 HOOKUPS



ALL GOODS SENT PREPAID IN U.S.A.

BUY!!
from Radio's Oldest
Mail Order House

WE are the oldest established, exclusive radio mail order house in the country. Our motto is "Quick Shipment." All orders are shipped within 24 hours. Quick, prompt, courteous service. We carry a larger variety of radio parts and findings than any other radio house in the country.

"RASCO HAS IT"

If you are in need of certain small radio parts that other radio and mail order houses do not bother to carry, get the Rasco parts catalog and you will find them there, anything from a screw to copper ribbon and telephone diaphragms, as well as thousands of other small radio findings. Just to mention a few:

Lugs, nuts, dials, vernier dials, jacks, plugs, every kind of knob, cords, panels, screws, sliders, washers, selenium, tinfoil, switches, crystals, cap nuts, Litz wire, cord tips, brass rods, resistances, name plates, spring binding posts, switch parts, metal ribbon, carbon balls, binding posts, all types, switch points, switch levers, lock washers, carbon grains, ground clamps, metal pointers, insulated tubing, low melting metal, antenna connectors, bus bar wire, as well as thousands of other articles.

We carry the Largest Variety of Small Radio Parts in the World. BUT We also carry ALL standard radio merchandise. **ANYTHING IN RADIO**

RADIO SPECIALTY CO. 98W PARK PLACE NEW YORK CITY, N. Y.

Finally—the Perfect “A” Eliminator For Your Present Set or the Set you eventually buy



Our 4-volt “A” Eliminator Fits Into All Radiola Consoles

Silver Beauty POWER

Replaces “A” storage battery and charger; has full wave “dry” rectification; maintains required voltage in uniform, constant flow; operates automatically by moving a switch; economical—uses minimum amount of current (about 1-10 cost of using electric iron); has rheostat control for additional refinement in voltage and reception; gives maximum power to radio tubes and lengthens their life; no acids to test or spill. Satisfactory results guaranteed.

Its principle is simple and correct!

The 110 volts Alternating Current is scientifically reduced with the famous “Silver Beauty” transformer coil to deliver the proper voltage to an especially developed dry, noiseless rectifier, which transforms the electricity to direct current. This current of exact voltage, is then transmitted through a patented special filter which clarifies the current, eliminating all foreign noises caused by rectifier or generator.

The Silver Beauty “A” Eliminator is endorsed by prominent radio engineers—adopted by leading distributors and dealers—approved by thousands of users. These are sufficient reasons for making Silver Beauty your choice.

\$39 ⁵⁰	\$43 ⁵⁰	\$39 ⁵⁰
6-volt; 2 amp.	6-volt; 3 amp.	4-volt; ½ amp.
\$2 Higher West of Rockies		

Silver Beauty “B-C” UNIT

Does away with “B” and “C” batteries

Embodies every up-to-date refinement and principle, insuring smooth, unflinching reception. As beautiful as it is efficient.

No. 450
180 Volts—40
Milliamperes
\$45

No. 460
135 Volts
\$35



Individual adjustment adapted to all sets.
Silver Beauty CHARGERS

Employing an entirely new method of rectification. Two models—with or without bulbs.
See Your Dealer or Jobber

Triple-A-Specialty Company
Manufacturers of the famous Silver Beauty Chargers
312-316 South Hamilton Ave., Chicago, Ill.



the “A” battery; these coils, of identical characteristics, tuned simultaneously by the usual condenser, provide an easier path for the “A” battery current and offer an infinite impedance to R.F. impulses of the frequency to which they are tuned. Thus was one difficulty effectively smoothed out.

The “one-and-only” tube question was solved by the application of “plate bias.” Rectification was found to be taking place on one of the bends of the plate-voltage-grid-current characteristic. Thus, by varying the plate-voltage bias, the working point may be moved up or down the excellently steep curve obtainable, shown in Fig. 6.

Hence in the first instance the “one and only tube” happened to be working just on its bend with zero plate volts.

With the bias adjusted correctly, most tubes of the 199 or 210A types will be found to yield excellent results. The completely-developed circuit is shown in Fig. 7. Further description is superfluous, except to state that feed-back between L2 and L3 is controlled by P, which controls also the positive bias to the plate.

Stages of R.F. and A.F. may be added in the usual manner, as desired. An important point to note with this circuit, and also with the plate-input detector, is that the normal connections to grid and plate are reversed; hence a tube of normal high impedance employed in either of these circuits automatically becomes of low impedance, and vice versa.

Tubes of a static impedance of 20,000 to 30,000 ohms are generally most suitable, and this impedance in these circuits decreases to about 8,000 to 17,000 ohms. Thus a high-ratio transformer may be used to couple the first A.F. stage, with no lack of quality and a step-up in amplification in addition.

The circuit has many points in common with the plate-input circuit referred to above and, while it gives the great purity of reproduction of that circuit, it combines with this an even greater sensitivity than that of an efficient grid-condenser-and-leak circuit.

Fig. 7 appears distinctly original on paper, and those readers who care to try it out will certainly find that originality is not secured at the expense of efficiency, when compared with the standard of to-day. With some experience of single-tube detector circuits, from straights to supers, the writer unhesitatingly ranks this circuit as second to none.

(Editor's note: The entire success of the novel detection arrangements described in this article depends on the proper values of the various “A,” “B” and “C” voltages. The radio fan who tries the hook-ups should experiment freely with his batteries, giving each adjustment a fair trial. Do not address the author in care of this office; the experiments described were made in England.)

A SIMPLE VOLUME CONTROL FOR ANY SET

OF the various methods recommended for controlling the volume of the usual radio receiver, none is simpler nor more effective than placing a variable high resistor in the antenna circuit. The main point about this method is that it can be applied to any existing set, without changing a single thing inside the set. Another point is that, with sufficient resistance, the volume can be reduced down to a whisper, without affecting the tone quality.

The resistor should have a range from virtually zero to several hundred thousand ohms, finally adjustable rather than in marked steps. Furthermore, it should be noiseless, since there is no more prolific source of “static” in a circuit than a faulty resistor.

A Famous Speaker

Benjamin Franklin once said
“My performance devotes itself entirely to thy service and will serve thee faithfully and if it has the good fortune to please its master, 'tis gratification enough for the labor of—”
Poor Richard

The New “99” Baldwin 99

is without comparison. To-day, as 15 years ago, Baldwin performance is the standard by which others are judged, comparable to the sensitive mechanism of a fine watch. At all good dealers, \$28.50. The new Baldwin “99” can be used on any set.

Ask your dealer to demonstrate it. Write for booklet.

BALDWIN UNITS—Loud-speaker units, Phono adapters, and head sets are standard the world over.

J. W. & W. L. WOOLF
Distributors & Exporters for
Nathaniel Baldwin, Inc.
227-229 Fulton St., N. Y.

THINGS DON'T JUST HAPPEN

That nothing to equal the patented *Chaslyn Balls* for accuracy, unbreakability and simplicity of reading has been discovered is why the big manufacturers of Batteries use them as *Charge Indicators* in Glass-Cased Batteries and Power Units.

**Easiest to Read
Nothing to Break**

*Swim a 1 three—charged fully
Sinks the white—charge still right
Sinks the green—charge is lean
Sinks the red—charge is dead*

Ask your dealer. If he can't supply, send 75c. to us. *Chaslyn* Corrosion Cure for Battery Terminals protects contacts. A large tube is 30c.

THE CHASLYN COMPANY
4617 Ravenswood Ave. CHICAGO, ILL.

6 TUBE RADIO

One Dial Latest advanced circuit. All steel chassis totally shielded. Balanced parts of best quality. Marvelous power and selectivity. Gets the long range stations as clear as a bell. One dial single control. An unsurpassed value—just one of our many mighty bargains.

FREE Log and Call Book and **Big New Catalog**—just off the press. Full of Radio Bargains. Send for your free copy now!

American Auto & Radio Mfg. Co.
Harry Schwartzberg, Pres.
Dept. 102, American Radio Bldg.,
Kansas City, Mo.

DEALERS & SET BUILDERS!

Complete stock of nationally known parts and accessories. Send for illustrated catalog and discount sheet.

Radio Exclusively Since 1921

CLARK & TILSON, Inc.
122 CHAMBERS ST. New York
The Nationally Known House

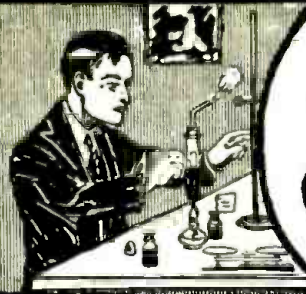

Dr. T. O'Conor Sloane will teach you CHEMISTRY Right in your own Home



Good Chemists Command High Salaries



T. O'CONOR SLOANE
A.B., A.M., LL.D., Ph.D.

Noted Instructor, Lecturer and Author. Formerly Treasurer American Chemical Society and a Practical chemist with many well known achievements to his credit. Not only has Dr. Sloane taught chemistry in the classroom, but he was for many years engaged in commercial chemical work.

Industrial firms of all kinds pay tempting salaries to get the right men. Salaries of \$10,000 to \$12,000 a year are not unusual for chemists of exceptional abilities. Chemistry offers those who are ambitious and willing to apply themselves conscientiously the greatest opportunities of any vocation. Why be satisfied with small pay and hard, thankless work—learn the profession of Chemistry and your salary will depend only upon your own efforts and your own abilities.

The work of the chemist is extremely interesting. If you are fond of experimenting, if you like exciting and fascinating work, take up Chemistry. To the man who is dissatisfied with his present job, to the young man just deciding on his life work, Chemistry holds alluring charms and countless opportunities. If you want to earn more money, the way is open through our course in Chemistry.

NOW IS THE TIME TO STUDY CHEMISTRY

Never before has the world seen such splendid opportunities for chemists as exist today. The war has awakened the United States to the need of trained chemists and chemical engineers. Everywhere the demand has sprung up. In factories, mills, laboratories, electrical shops, industrial plants of all kinds, chemistry plays a vital part in the continuation and expansion of the business. In every branch of human endeavor the need for chemists has arisen. No profession offers such alluring opportunities, and the next ten years are going to show the greatest development in this science that this country has ever seen. Those who have the foresight and ambition to learn chemistry now will have the added advantages and greater opportunities afforded while the chemical field is growing and expanding.

ten years are going to show the greatest development in this science that this country has ever seen. Those who have the foresight and ambition to learn chemistry now will have the added advantages and greater opportunities afforded while the chemical field is growing and expanding.

You Can Learn At Home

Ability to Understand Plain English the Only Requirement

Dr. Sloane will teach you Chemistry in a practical and intensely interesting way. Our home study course written by Dr. Sloane himself is practical, logical and remarkably simple. It is illustrated by so many experiments that are performed right from the start that anyone, no matter how little education he may have, can thoroughly understand every lesson. Dr. Sloane teaches you in your own home with the same individual and painstaking care with which he has already taught thousands in the classroom. He will, in addition, give you any individual help you may need in your studies. This personal training will be of inestimable value to you in your future career.

Experimental Equipment Given to Every Student



We give to every student, without additional charge, this chemical equipment, including fifty pieces of laboratory apparatus and supplies and thirty-nine different chemicals and reagents. The fitted heavy wooden box serves not only as a case for the outfit but also as a laboratory accessory for performing countless experiments. Full particulars about this special feature of our course are contained in our free book "Opportunities for Chemists."

What Well-Known Authorities Say About Our Course

From Hudson Maxlin:
"Dr. Sloane has done a much-needed work in a much better way than anything of the kind has, heretofore, been done."

"Dr. Sloane has a remarkable faculty of presenting Science for self-instruction of the student in such a clear and understandable way as to be most readily grasped and assimilated."

"I, therefore, unreservedly recommend and place my highest indorsement on his work."

From Dr. W. W. de Kerlor:
"I can not recommend your course too highly and I congratulate both you and Dr. Sloane on same."

From John A. Tennant:
"This is something which has long been needed. Your long experience in the teaching of chemistry... assurance that the course will be practical as well as plain to the untrained students."

What the Students Say:

"Your course has been worth \$50,000 to my concern."

"This is just like reading some fascinating fiction story."

"I have just been made Assistant Chemist of my concern."

"Your course is just what a person wants to start in the wonderful science of Chemistry."

"I find that your course is very interesting. I wait patiently for the next lesson."

"I find the study of chemistry more and more interesting at every lesson and you may be sure that I am getting into studying habit even more than I ever did even in my school days."

"I like the lessons so much that I honestly would not sell them for many times their price."

"I am taking this opportunity to express my satisfaction with your chemical lessons."

"I now have a fine position as chemist at the Du Pont Dye Works. It was thru your course alone that I have been so successful."

"I have written to different people about your course and they speak very highly of same."

"If I don't learn it isn't your fault for I find that your lessons contain a whole lot."

(Names and addresses on request.)

DIPLOMA AWARDED TO EACH GRADUATE

Upon graduation each student is awarded our Diploma in Chemistry, certifying that he has successfully completed his studies. Your name on this certificate will be a source of pride to you all your life, as well as an aid to obtaining a position in Chemistry.

Easy Monthly Payments

You do not have to have even the small price of the course to start. You can pay for it in small monthly amounts or earn it as many others are doing. The cost is very low, and includes even the Chemistry outfit—there are no extras to buy with our course. Write us and let us explain how you can qualify for a trained technical position without even giving up your present employment.

TUITION PRICE REDUCED

Besides furnishing the student with his Experimental Equipment, we have been able, through the big increase in our student body, to reduce the cost of the course. Write today for full information and free book, "Opportunities for Chemists." Send the coupon right now while it is fresh in your mind. Or just write your name and address on a postal and mail it to us.

CHEMICAL INSTITUTE OF NEW YORK Home Extension Division 1 16-18-R-East 30th St., New York, N. Y.

Please send me at once, without any obligation on my part, your free book, "Opportunities for Chemists," and full particulars about the Experimental Equipment given to every student. Also please tell me about your plan of payment and the reduction in the tuition price.

Don't Wait--Mail the Coupon NOW!

CHEMICAL INSTITUTE of NEW YORK, Inc.

16-18-R-EAST 30TH STREET Home Extension Division 1 NEW YORK, N. Y.

NAME.....

ADDRESS.....

CITY.....STATE.....



A Complete Aerial Kit that saves time and effort

It is much easier to buy a complete Belden Aerial Kit with Beldenamel Aerial Wire, Belden Lightning Arrester, etc., than to pick up the many odd items that are essential for a good aerial. Every item in the Belden Aerial Kit is matched for perfect performance.

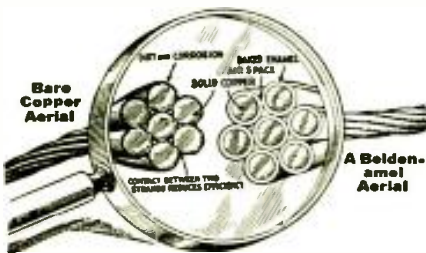

Insure yourself against aerial trouble. Ask your dealer for a Beldenamel Aerial Kit, today. A Beldenamel Aerial cannot corrode.

Belden Manufacturing Co.
2314-A Western Ave., Chicago



Specify
Belden
Aerial Kit

A Study in R. F. Amplification

(Continued from page 787)

article, we shall indicate this effect in terms of the *apparent inductance* of the tuned secondary coil; which, it is well known, is made up of the *pure inductance* of the coil plus the *distributed capacity*, the latter acting in parallel with the inductance.

COUPLING EFFECTS

Fig. 4 shows how the apparent inductance of the secondary (in this case a basket-weave R.F. transformer) of the second transformer changed as the distance separating the two was decreased; a decrease from 146 to 91 microhenries was noted. This value is for one particular type of transformer, but, nevertheless, shows the direction of the change. A decrease in apparent inductance is to be expected when the symmetrical ends of the secondary of the second transformer and the primary of the third transformer are connected to the grid and plate sides of the tube, *respectively*. If this condition is attained, by reversing the connections of either coil there will be an *increase* of the apparent inductance; the slope of the curve being approximately equal, but opposite, to that shown in Fig. 4.

Fig. 4 indicates that, if there be any coupling at all between the coils in question, a change of resonance-frequency may be expected.

Fig. 5 shows the change in resonance-frequency caused by bringing the second and third transformers (same transformers as were used for Fig. 4) together, parallel to each other. When the mutual inductance between the two coils was of the proper sign, there was an increase from 720,000 to 914,000 cycles per second, as shown by curve A; when they were reversed, there was a decrease from 720,000 to 616,000 cycles per second, as shown by curve B. In this case 720,000 cycles (or 416 meters) was the resonance-frequency of the amplifier when the two transformers were isolated.

Other types of transformers showed similar characteristics, the amount of change, however, depending upon their external field. The spider-web showed the greatest change, while the toroidal coil, with its enclosed field, showed the least.

CRITICAL ANGLES OF PLACEMENT

These curves show how very important the proper location of R.F. transformers really is. To prevent the fields of the transformers from interfering with each other, is one of the most important things in R.F. amplifier construction.

Fig. 6 illustrates how the keeping of transformers at right angles to each other minimizes the interference difficulty. The second and third transformers were placed 1½-inch apart, and perpendicular to each other. The amplifier was then tuned to a wavelength of 416 meters, or 720,000 cycles per second. The second transformer was then revolved through an angle of 360 degrees, noting, in steps of 22½ degrees, the frequency changes which occurred.

As the transformer was revolved there was, first, an increase of the resonance-frequency, continuing until the coils were parallel to each other. (Had the polarity of either coil been reversed there would first have been a decrease). The next 90 degrees showed a decline, coming back to the original 720,000 cycles when the coils were exactly perpendicular again. As we completed the revolution, with the polarity of the second coil then reversed, there appeared a decrease in frequency, which went through an opposite cycle and back to the original frequency

BRIDGE

AMERICA'S GREATEST
AND MOST POPULAR
CARD GAME

TAUGHT BY AMERICA'S
MASTER GENIUSES

Wilber C. Whitehead

The world's recognized authority—co-editor of "Auction Bridge Magazine," member and expert of Radio Broadcasting team—broadcasting through sixty-four stations, author of "Auction Bridge Standards," "Auction Bridge Summary," etc.

Whitehead's Complete Auction Bridge

Everything about Bridge by the man best qualified to write it. Clear, convincing, up-to-the-minute illumination of Auction Bridge in its every detail. Complete with 1926 authorized laws and 200 example hands illustrating modern bidding tactics and play. Flexible cloth binding. Special Price, \$2.00

Auction Bridge Standards

A complete explanation of proper bidding. New edition containing the new laws. Cloth, pocket size. Special Price, \$1.50.

Auction Bridge Summary

Briefly stating, for quick reference, the salient principles and conventions of Auction. Revised 1926 edition with a simple explanation of more important new laws. Cloth, pocket size. Special Price, \$1.00.

Milton C. Work

Another recognized Bridge authority. Also of the nation-wide Radio Bridge team.

Work's "Bridge Pointers and Tests"

Shower of terse, illumination Bridge ideas. Nothing like it ever attempted before. Here you simultaneously test your ability, stage your contest with your friends and gather a wealth of Bridge Knowledge.

192 Pages. Cloth bound. Special Price, \$1.00.

Milton C. Work's "Contract Bridge"

Every Bridge player is anxious to know what the difference is between bidding in Contract Bridge and bidding in Auction Bridge. Mr. Work explains it in a short and easy way which a child could understand.

160 Pages. Cloth bound. Special Price, \$1.50.

Auction Bridge Complete

AUCTION BRIDGE COMPLETE is not only the A B C, but also the X Y Z of Bridge. Whether you are a beginner, a player of moderate ability, or an expert, this book will improve your game. Let Mr. Work, the outstanding authority, help you to play winning Bridge.

500 Pages. Cloth bound. Special Price, \$2.00.

100 Bridge Lessons

100 LESSONS specially selected hands with an impressive lesson in every hand.....50c

Auction Bridge—(1927)

THE RED BOOK published annually with everything that is new in Bridge.....75c

Ferguson's "Contract Bridge"

With the Whist Club Laws and Rules. Tells you in plain language all about Contract Bridge.....75c

Practical Auction Bridge

PRACTICAL AUCTION BRIDGE. All about Bridge with full directions for teachers. How to teach, how to handle classes, how much to charge for teaching. Special Price\$2.00

Short Cut to Standard Auction Bridge

Introducing a quick and easy method of fixing in your mind the correct leads, rules and play of the recognized authorities of the modern game. Special Price\$1.50

Foster's "Contract Bridge"

The latest thing in Bridge is Contract. Society is playing it almost exclusively. Soon every Bridge player will be playing it. Why not be among the first to play Contract yourself?
Only \$1.00

"Bridge" is fast becoming the greatest American card game because of its unquestioned merit. "Bridge" has no equal.

Select your Books and Order Today
Direct from

CONSRAD COMPANY
230 Fifth Ave. New York, N. Y.

Read about This Amazing New Development! In Radio News

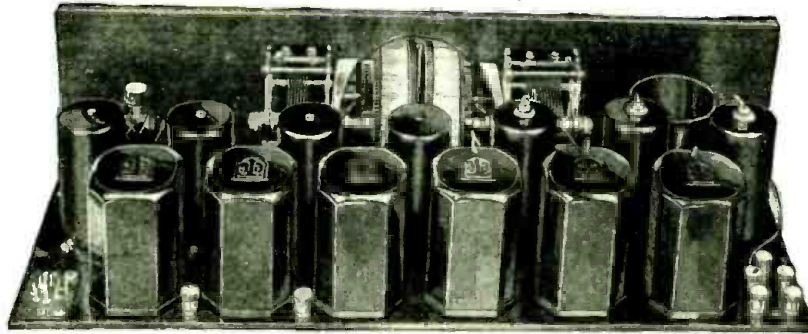

Tyrman Shielded Grid "7"

Shieldplate ^{Type S.P. 122 Shielded Grid} Tube

The Greatest Forward Step in Radio Since Its Invention

THIS startling new achievement guarantees the development of superior receiving sets. Leading radio engineers already have designed circuits incorporating the use of the new type SP-122 Shielded Grid Tube. Critics acclaim these receivers the most outstanding development in the radio industry.

SPECIFIED!

The Shieldplate Shielded Grid Tube, Type SP-122, is exclusively specified for use in the "Tyrman Shielded Grid 7," as described in Radio News. Other radio publications which specify this tube in new circuits are: Radio, Citizens Radio Call Book, Radio Review, Radio World, and many leading metropolitan newspapers.



MAIL COUPON for COMPLETE LITERATURE

SHIELDPLATE TUBE CORP.
208 S. LaSalle Street (Dept. N),
Chicago, Illinois.

Kindly send free booklet describing the Shielded Grid Tube, Type SP-122, and its many uses.

Signed.....
Address.....
City..... State.....

Specified for the
TYRMAN SEVEN



CAMFIELD
Equaltune Condensers

Camfield Condensers are again specified! Equalizing adjustment device makes them unequalled for accuracy, mechanical design, electrical efficiency, workmanship and general utility. They look the part, too—as handsome a job as you ever saw.

Camfield Condensers are officially specified for the Camfield Super-Selective-8, and 10, Tyrman Ten, Madison Moore, shielded Grid "7", Citizens Super-8, Duoformer-7 and 5, Thompson Super-7, and many other circuits.

NEWEST CAMFIELD SHIELDED GRID "7"
A new and remarkable receiver using the new shield grid tube. First receiver developed on this new revolutionary principle. Get the facts now! Mail coupon for free booklet, "Wherever You Require Quality," also details on new Shielded Grid "7" and newest radio developments.

CAMFIELD RADIO MFG. CO.
35 East Wacker Drive, Dept. R. N., Chicago, Ill.
Mail me your free booklet as advertised in R. N.

Name.....
Address.....

TYRMAN
SHIELDED
GRID SEVEN!

We offer complete parts for this newest circuit, as well as other well-known circuits, sets, parts, etc.
Lowest prices.

Dealers—Write for Catalog

WESTERN
RADIO MFG. CO.
126 W. Lake St., Dept. 11
CHICAGO

New! GENUINE BAKELITE
INSULATED X-L Push Post



At last a perfect binding Post. Convenient, simple, permanent connections. You don't have to remember to tighten X-L Push Posts. Just push down, insert wire, remove pressure. Connection is tight and will stay tight. No vibrations can loosen; releases instantly. All standard markings or boxed in complete sets for all popular circuits. Price, each 15c. If your dealer can't supply you, write direct.

FREE big, new, up-to-date book of wiring diagrams of all leading circuits. Write today!

X-L RADIO LABORATORIES
2426-B Lincoln Ave., Chicago, Ill.

LIGNOLE RADIO PANELS
Specified for TYRMAN and other world famous sets. Send for Circular 54-A. "Lignole Users are Lignole Boosters."
THE LIGNOLE CORP.
508 So. Dearborn Street
Chicago, Ill.

of 720,000 cycles, when the coils were again perpendicular.

The object in placing transformers, so that there is minimum interference of their fields, can plainly be seen from the given curves. Unless the transformers are absolutely symmetrical in their windings, and placed so that there is absolutely no interference of their fields, we cannot expect maximum efficiency from an amplifier. To be sure that you have no interstage coupling of the type mentioned, there is only one way out: properly shield your radio-frequency amplifier.

The Happiness Boys
(Continued from page 740)

heroine. The next member of the company to become disabled was the gentleman who impersonated a bear; so Mr. Hare came to his aid also and gave a most realistic and "growling" performance, with the aid of a picturesque bearskin. This tour must have been one of the high lights in Mr. Hare's theatrical career, since he played everything from beauty to the beast.

The broadcasting career of The Happiness Boys began in Newark, New Jersey, at WJZ, when it was an experimental station. They now hold the record for more consecutive weeks of commercial broadcasting than any other team on the air, and they were also the first to have a distinctive air salutation. There are very few of us who are not familiar with their cheery "How Do You Do, Everybody, How Do You Do?"

THEIR PROGRAMS

Fifty percent of their programs are "ad-lib," that is, extemporaneous. We were surprised to learn that they often prepare their Friday evening broadcast program no earlier than on the afternoon of that same day. Yet they feel that is the better way; since neither Ernie nor Billy is positive of what the other will say, and the result is delightful informality. During five years of broadcasting, they say, they have not repeated one "gag" or story.

Their personal appearances are many. During the past year they have given six request performances at the Strand Theatre, in New York City, and with a different act each time. Their oft-times smashing popularity is proven beyond doubt by the following incident. During the opening of a store in Plainfield, New Jersey, the personal appearance of the boys brought forth such a crowd of potential listeners that both front windows of the store were broken. To quell the enthusiastic mob, the police reserves had to be called out. This is what we most assuredly would call "breaking all records!"

In their office, we saw a motto tacked on the wall. It read: "If you can't get happiness out of your work, you don't know what happiness is." That has indeed been the secret of their success, for they love their work and they put their hearts and souls into it. To the question as to how they liked broadcasting, and as to whether they found the preparation of new programs hard work, they answered in chorus that it was never work, but seemed much more like play. They also confessed to a complete lack of nervousness before the usually terrifying mike; for their previous experience in phonograph recording had served as an excellent initiation.

Many of us have wondered as to the origin of their novel and captivating songs and ballads. The Happiness Boys do not do their own composing, but have these songs of every type and kind, literally thrust and showered upon them. Not only do music publishers send the boys first publications

QUALITONE LOOPS
(COLLAPSIBLE—ADJUSTABLE)

Exclusively Specified

with

"TYRMAN
Shielded Grid 7"

as described in Radio News

Also recommended for use with the Magnaformer, La Peer 9, Popular Mechanics Economy 9, World's Record Supers, Nine-in-Line, and many others.

Holds Two World Records for DX Reception

The De Luxe.....\$12.50
The Quali-Tone... 10.00

Ask Your Jobber

Duro Metal Products Co.
2651 North Kildare Ave.,
Chicago, Ill.



CARTER
Fixed Condensers

Selected again and again for dependable excellence in popular circuits

This Time It Is TYRMAN SHIELDED GRID SEVEN

Ask Any User
In Canada:
Carter Radio Co., Ltd., Toronto
Offices in principal cities of the world.

MEMBER RMA 

YAXLEY
APPROVED RADIO PRODUCTS
Specified for
TYRMAN SHIELDED 7

No. 669 Cable Connector Plug.....	\$3.25
No. 4-L Filament Resistance.....	15
No. 815 Fixed Resistance.....	15
No. 730 2-Circuit Jr. Jack Switch.....	.85
No. 915K Switching Rheostat.....	1.75

At Radio Dealers and Jobbers
YAXLEY MFG. CO.
Dept. N, 9 So. Clinton St.
Chicago, Ill.

BLUE PRINTS

Complete in every detail for
TYRMAN SHIELDED GRID SEVEN
Price \$1.25

Address: **RADIO NEWS**
230 Fifth Avenue New York, N. Y.

for them to exploit, but radio fans from all over the country compose sentimental songs for them, as well as to them. Their harmony in singing is unequalled. When Ernie starts to croon a southern song, Billy joins in with a rich, mellow tenor voice that seems to carry you "w-a-a-a-y down south." So it is not to be wondered at, that after hearing them sing, we too feel the creative urge, and want to do our bit toward helping the joyous cause of song along.

NO LACK OF APPLAUSE

Some man high in the public eye once said: "I would rather make the nation laugh than be president." According to that, Billy Jones and Ernest Hare can have almost anything they desire, since the two of them have done so much to bring joy into millions of homes. Their fame and good cheer have spread so far that they receive thousands of letters each week, thanking them for the bit of joy brought by their programs. Their work before the microphone is so genuine, so natural, and so "homey," that many of these fan letters show that the boys have been taken right into the hearts and homes of the listeners. They seem to feel that Ernie and Billy are "just one of the family," and they tell them of baby's whooping cough, how grandma sprained her ankle, and of sister's new beaux. And these "letters from home" are sincerely appreciated and enjoyed by the recipients.

Each Friday evening at seven-thirty, the Happiness Boys broadcast from a restaurant on Fifth Avenue, New York. The dining room has a normal capacity of about 300 people; but on this night of broadcasting, four hundred are packed into the room. People from all over the country, as well as from around New York, come to see their favorites in person. A great many of these visitors are little children and elderly people, who want to talk to the boys after the broadcasting and have some precious belonging autographed.

A clock on Mr. Hare's desk attracted our attention. It was noon, and we'd been interviewing for two hours—two hours which seemed like fifteen minutes. As we were leaving, with apologies for having taken up so much of their time, the boys asked if we'd like to stay and watch one of their rehearsals. Would we like to? Why, you couldn't have pried us out.

Two tiny slips of paper, with notes, carried the routine of the act. Dave Kaplan, the "maestro" of the Happiness Boys organization, came to the piano, and then the fun began. Such spontaneous humor, sparkling witticism, gay little songs, tender ballads—well as far as we were concerned—"they stopped the show," and we thanked them for the jolliest, happiest morning we've ever spent.

Any friends of the boys will tell you that Ernest Hare and Billy Jones are the most cheerful duo that they've ever met, and that they broadcast happiness in private life, as well as before the public. Their personalities "get over" because they are The Happiness Boys in every sense of the word. One of their invisible audience has suggested this slogan for them: "Happiness is like molasses; spread it on thick." And they do.

TOO MUCH COMPETITION

FLAPPER: "Daddy, I'd like to get a permanent wave."

DADDY (also a radio broadcaster): "Well, you'll have to take it out in liking; there ain't any left!"

—Wm. G. Mortimer.

ANOTHER PROSPECT FOR A BURNT-OUT TUBE CONTEST

CUSTOMER: "Will you allow me something on my old vacuum tubes?"

SALESMAN: "Well, we can allow you to take them home."

—Edw. R. Krych.



Improved Reception



Get it with the CARBORUNDUM GRID LEAK

ONE certain way of getting better and clearer reception is to slip a Carborundum Grid Leak into your set.

☞ Things will quiet down instantly. Carborundum Grid Leaks do not disintegrate—hence they are quiet. They are solid, fixed, dense rods of Carborundum. They assure an uninterrupted flow of current. They banish Grid Leak noises.

☞ Carborundum Grid Leaks are tested at 5 volts—the plate resistors at 90 volts.

From your dealer, or direct
Send for Hook-Up Booklet D-1

••

THE CARBORUNDUM COMPANY, NIAGARA FALLS, N. Y.
CANADIAN CARBORUNDUM CO., LTD., NIAGARA FALLS, ONT.
Sales Offices and Warehouses in New York, Chicago, Boston, Philadelphia, Cleveland, Detroit, Cincinnati, Pittsburgh, Grand Rapids, Milwaukee
The Carborundum Co., Ltd., Manchester, Eng.
Deutsche Carborundum Werke, Dusseldorf, Ger.

Carborundum is the Registered Trade Name used by The Carborundum Company for Silicon Carbide. This Trade Mark is the exclusive property of The Carborundum Company.

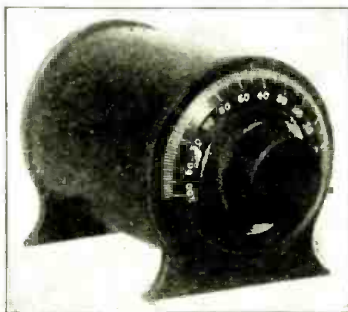

Pat. Pending
IMPROVED MODEL

\$ 4.75



REFERENCES:

First and Fargo National Banks

Reesonator

Equip your radio with this new instrument. A REESONATOR will boost your volume as high as twenty times on distant stations, making it possible to play with dance volume, stations that are barely or sometimes entirely inaudible without it. Model as illustrated is especially adaptable for Atwater Kent models 30, 32, and 35, and the Crosley Handbox machines. Attached externally to the machine, and can be attached by anyone in less than a minute. Increases A and B battery consumption, and increases the life of your tubes. We have testimonials from thousands of satisfied users. Try one for three days at our risk. If not entirely satisfied in every respect, your money will be cheerfully refunded. Sent complete with instructions, and postpaid on receipt of \$4.75 or sent C.O.D. Jobbers and Dealers write for territory.

F. & H. RADIO LABORATORIES
Fargo North Dakota

Dear Sirs: Your Reesonator received and sure does all if not more than you claim for it. Please ship me at once via C.O.D. parcel post, six more of the same kind.

Respectfully yours, VINCENT WALKER

Gentlemen: I have thoroughly tested out your REESONATOR, and believe it to be the best attachment made for a radio, regardless of price.

Yours truly, (Name on request).



**Taste Romance and Adventure
In the Far Lands of the Earth.**

How often you've longed to see for yourself the awe of Egypt's pyramids—the beauties of the gorgeous Mediterranean sunset—the squalor of China's ancient cities!

Spend a few years, or the rest of your life, tasting high adventure on the seven seas and in all the world's great ports—roving the earth's highways and byways! You can do it FREE—all your expenses paid—and earn a good salary besides!

Only one profession will carry you around the world at will, traveling like a gentleman, but that's the most interesting and pleasant work there is—Radio Operating! Easily and quickly learned, there's no other profession like it for the man who wants the experiences and pleasures of world-travel. Radio operators are needed—all sea-going ships like the one shown here must carry from one to half a dozen or more.



**Take a Look Beyond the Skyline
Without a Penny's Expense**

Radio operators aboard ocean liners live luxuriously—they rank as officers of the ship. Meals, a private cabin, all other living needs are furnished free, and besides the operator draws a good salary. You can learn quickly and easily at home in your spare time to be a Radio operator through our practical training methods. Take a look at the FREE BOOK which tells how—mail coupon below.

This U. S. Government-recognized school has been training successful operators since 1914. Our graduates are all over the world. We maintain an Employment Department to put you on your own ship. The world-famous NATROMETER, our own patented invention, obtainable only by students of this Institute, is recognized as the best and easiest way to learn the Radio code. A few short months, with the aid of the famous Natrometer and our quick home training, and you too can be a fully qualified Radio operator, sitting in your cabin like the one shown above, bound out for Liverpool or Nagasaki!

Read the Free Book that tells all about this fascinating profession and our practical Government-recognized methods of training you for it. Send coupon TODAY—no obligation. Special tuition offer now on, includes world-famous Natrometer free of extra cost with your course! Act at once.

**NATIONAL RADIO INSTITUTE
WASHINGTON, D. C.**

SPECIAL OFFER COUPON

National Radio Institute,
Dept. 155, Washington, D. C.

Gentlemen: Without obligating me in any way send me your free book and information about your offer of Natrometer with course.

**World-Famous
Natrometer**

Name.....
Address.....
City.....

**A High-Low-Tone
Loud Speaker**
(Continued from page 784)

THE SOUNDING ELEMENTS

While the frame is drying we can proceed with the cone and drum. One piece of cone paper is cut exactly 12 inches wide and 25½ inches long. As the distance between "A" top and "A" base is exactly 12 inches, the drum paper will fit snugly between these ends. The length, 25½ inches, will carry it around the circumference of "B" top and "B" base, with a little reserve for lapping. This is now called the drum form.

For the cone form draw on another piece of cone paper a circle 9½ inches in diameter; inside this circle describe another with a diameter of 8½ inches. With a pair of scissors cut around the outer circle and then notch as illustrated to a depth indicated by the inner circle. Cut out a wedge-shaped piece, 2 inches wide at the outer side; place a little glue along one edge of this sector and, drawing the paper into a cone, lap the sides ¼ inch and place a weight on the paper until the glue has set.

After the glue on the dowels has set, run the drum form inside the dowels and around "B" top and "B" base, and tack it in place at about one inch intervals. The ends of the drum paper will lap and this lap should be securely glued.

After the glue on the drum and the cone is dry, hold the cone, apex down, and bend up the notched sections. Make a hole in the apex with a large pin, so that it will be less difficult to run the unit's driving pin through. Now, by slightly squeezing the cone carefully, it may be inserted through the top of the speaker, apex down. Let it regain its natural form and work carefully down so that the driving pin will come through the small hole in the apex of the cone. Raise it until only about ¼-inch of the driving pin protrudes through the hole. After making sure that the cone's outer edge is at the same elevation all around, work glue between the turned-up notched sections and the drum and set back to dry.

After the glue is perfectly set, the tiny nut is screwed upon the threaded driving pin and may be adjusted to the proper position through the opening in the top of the speaker. In the event that it is impossible to have a driving pin threaded it may be necessary to resort to sealing wax. Simply let a drop or two of melted sealing wax fall on the opening where the pin protrudes through the cone and trust to luck that the tension on the cone is right for best tone.

Outside of staining and otherwise finishing the wood parts of the frame, the speaker is completed and ready for testing. It will be noted that we now have two different vibrating surfaces, one rather small and the other quite large. The unit's vibrator sets the cone in motion and in turn the drum is caused to vibrate. In this way the higher frequencies of the musical scale are taken care of by the cone while the low notes are handled by the drum.

If the work is carefully done throughout there is nothing to look forward to except wonderful reproduction, provided the radio set itself is "percolating" properly.

HE HAD SEEN IT DEMONSTRATED

SON: "Hey, dad, where can I see an example of "Remote Control?"
DAD: "Ride in the back seat with your mother."
—E. M. Grant.

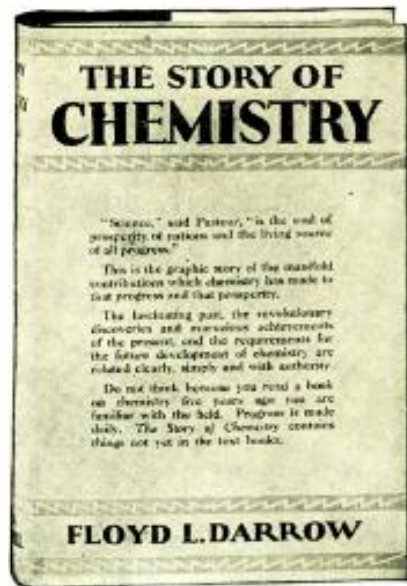

READ

The thrilling, intensely interesting story of the most marvelous science in the world.

"THE STORY OF CHEMISTRY" is what its name implies, the "story" of this strategic science. It is not a hit-and-miss collection of isolated phases of the subject, but a coherent development, leading logically from the days of the alchemist to the overshadowing importance of chemistry in the modern world.

It gives that broad and comprehensive grasp of the subject, both of past and present, essential to a liberal education. It is for everyone who wishes to be informed on the most practical of sciences, a science which touches modern life at every point.

It is written in simple, understandable English. It is almost entirely free from the chemical formulae, equations and mathematical expressions so forbidding to the non-technical reader. It entertains as well as instructs.

It is authoritative, for it is based on the statements of men who are leaders in chemical investigation and know where they speak.

It is the most nearly down-to-date book on chemistry for the general reader. Aside from the historic portions little of the story that it tells can be found in other books. It is written from the current literature of the most recent researches.

The illustrations are numerous, carefully selected, striking and instructive. They too tell a story.

It is a beautiful, stiff-covered book, 6 x 9 inches—a most valuable addition to anyone's library.

**SPECIAL PRICE
\$3.98**

CONRAD CO., Inc.,
230 Fifth Avenue, New York City.

Gentlemen: I enclose \$3.98—please send me one copy of 'The Story of Chemistry'

Name.....
Address.....
City.....State.....

Love in the Air

(Continued from page 743)

alone in this big city without a woman to take care of him."

She paused in her musings and smiled sofly. "The poor kid!"

* * * *

This was begun a strange romance; strange, because neither of the persons involved was acquainted with the other. Miss Johnson started it, of course, by writing a letter to Benjamin—and a spry, girlish sort of letter it was, bubbling with youth and appealing femininity. It began:

"My Dearest Big Buddy:—But I know you aren't so very much bigger than me, are you? I have listened to your voice each evening for weeks; but only since you mentioned your great loneliness have I been brave enough to write. I also am lonely—a lone girl making her way in a big city. Perhaps we might cheer each other up a bit by writing. don't you think?"

From there on, it was much the same as hundreds of other letters which Ben received daily—and yet not the same. He had started to throw it into the studio wastebasket when something wistful about the wording caught his eye. Quite abruptly he stuck the letter in his pocket, to be answered at his leisure. The answer he composed was, he flattered himself, a rather neat thing as letters go: modest, unoffending, and yet very personal and giving an impression of great confidence.

"My Dearest Ellen—" he wrote, and paused. He could imagine her as she read. Perhaps she was young, slender, divinely tall. Perhaps her hair was red or perhaps black, it mattered little. Here was a lonely girl in the city, and here—so to speak—was he, also in the city. The letter continued:

"—I received your adorable letter today and am answering it promptly. Yes, Ellen, I am a big, lonely boy in a big, lonesome city, and I should like very much to write to you and get your darling letters in return."

He smiled, as he wrote, imagining what the men on his paper would think if they knew that he, Burt, of the castiron heart, was corresponding with a young lady. He had no intention of telling them. Somehow, he felt that newspaper men would not understand this thing.

Into the bedtime hour Big Brother Ben began to insert a more cheerful and personal note. He did this slyly; but with the certainty that Ellen was listening he managed to convey over the radio a great many tender messages designed for her ears alone. Thus, when telling the story of Red Riding Hood, for no apparent reason, he called the heroine of the tale Ellen. "I know Red Riding Hood's name was Ellen," he explained to his audience, "because, lads and lassies, she was the very most beautiful girlie in the whole world! And I think Ellen is the most beautiful name anywhere. Don't you?"

Miss Johnson who, as usual, was listening, pulled the receivers from her slightly oversized ears. There was a gentle, knowing smile twitching at the corners of her good-humored mouth.

After this the letters between Miss Johnson and Benjamin increased in frequency, size, and intimacy. Ben, although fearing the line slightly overworked, made occasional hints concerning his great loneliness and lack of understanding friends. From that he gradually ventured out into fields of unexplored endearment. He wrote to Ellen as his "Little sister, little city playmate, little radio bird," and then, finally, he addressed a letter to his "Dearest Sweetheart." He had a weak feeling when he thought of what would happen to his status as a hard-boiled bachelor if that letter should, by any chance, find its way into the hands of any Telegram-News man. Sweetheart!



Heavy Duty
'B' Power Unit
with Long Life
Perfected 85
Mil. TUBE



\$18.50
Complete
Including
TUBE

No Liquids or Acids

Important New Features

Delivers up to 180 volts on any set, regardless of the number of tubes. Ample reserve power.

All voltages are fixed with permanent resistors. Output tapped at 22½, 45, 67½, 90, 135 and 180. This gives requisite voltage for any set. No variable resistors to change value and require re-tuning.

The input from the lighting circuit is controlled by a rheostat which can be set once for the proper amount of current and then forgotten.

A PERFECTED long-life rectifying tube (non-filament type) is used.

All connections are concealed under the lid as required by the Underwriters Laboratories. This also prevents tampering with connections after they are once made.

The Ferbend HEAVY DUTY "B" Unit is finished in handsome black crystalline and is furnished with a six foot flexible cord and switch.

NOISELESS—EFFICIENT

In this present day of high priced power units, Ferbend again pioneers with a Tube-Type Heavy Duty "B" Unit of unsurpassed quality at a price "Within reach of all."

Over 100,000 users prove the worth of Ferbend products. Now, in spite of rising competition, Ferbend sales are increasing. The truth of the matter is that as stabilization of the Radio Industry approaches, more people buy because of recognized MERIT. The new Ferbend "B" Unit will be popular with radio owners because it is everything that can be desired in this type socket power.

Try It! We want you to put the new Ferbend "B" unit side by side with any other make regardless of price. We INVITE comparison. We know you will instantly appreciate the fact that for workmanship or performance and in materials and appearance, there is no better "B" Power Unit made.

See Your Dealer—or Send Direct

Shipment will be made upon receipt of price, or C. O. D. If you wish. Use for thirty days to your own pleasure—then if not satisfied write us within that time and purchase price will be refunded. Send Coupon NOW!

FERBEND ELECTRIC CO.

425 West Superior Street Chicago, Illinois

**30 Days
Trial**

Purchase price will be refunded if not satisfactory in every way.

FERBEND ELECTRIC CO.,
425 W. Superior St., Chicago, Ill.
Send HEAVY DUTY B unit at once.
() I enclose \$18.50 () Send C. O. D.
() Send literature.

Name
Address
City State.....

**Radio
Since
1921**



**Tune Out With
SUPER TUNER
VARILOOP**
Directional Allocating

Complete and Positive Control

ELIMINATES All "The Undesireable"

Cuts out undesired stations without changing dial settings. Can be used either as loop or in connection with outside aerial, affording strong signal strength of long antenna with sharp tuning characteristics of loop. For ALL SETS — no changes whatever necessary. Antenna, Tuner and Eliminator combined. Unconditionally guaranteed, order today. \$15 prepaid.

Write for Circular

FROM YOUR DEALER OR DIRECT

PALMER & PALMER
404 WEST UTICA ST. BUFFALO, N. Y.

RADIO OPERATORS WANTED



Radio operators are officers aboard ships. Well paid, pleasant work, travel. You can qualify in a short time in our well equipped school under expert instructors.

Write now for free booklet on "Opportunities in Radio."

**West Side Y. M. C. A.
Radio Institute**

319 West 57th St., New York, N. Y.

What is a COOKOO NUT?

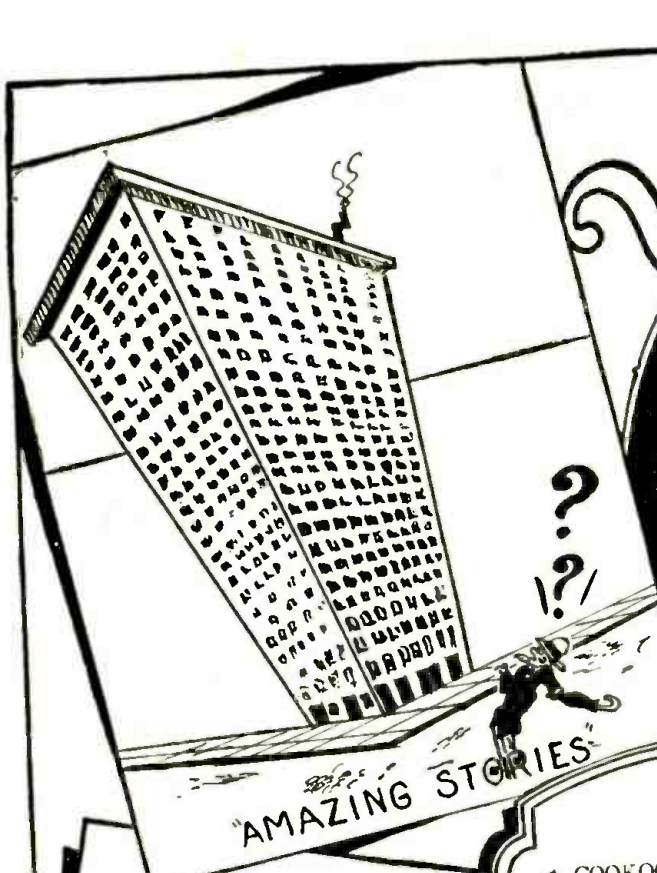

A COOKOO NUT is a new wrinkle to pass away your time. Far more interesting, more entertaining and more humorous than a cross-word puzzle. The COOKOO NUT illustrates an ordinary, well-known saying in a distinctly new manner. Study the examples on this page. The test of a COOKOO NUT is that there must be no question as to the correctness of the description. The quotation must absolutely fit the COOKOO NUT, otherwise it does not go. Cover up the captions of the COOKOO NUTS on this page, and make your friends guess what each COOKOO NUT stands for. An exciting new game is to play COOKOO NUTS at parties where everyone is asked to make up an original COOKOO NUT. The most mirth-provoking one gets the party prize. The best COOKOO NUT printed in FRENCH HUMOR gets a weekly prize of \$5.00. For every other one accepted FRENCH HUMOR pays \$1.00.

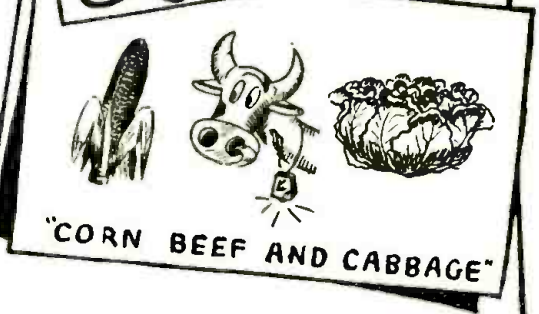
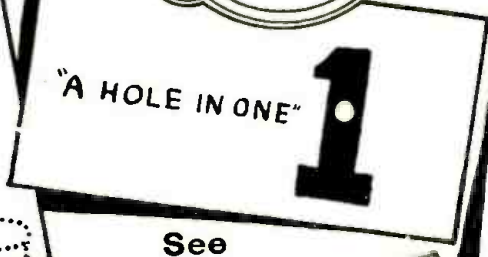
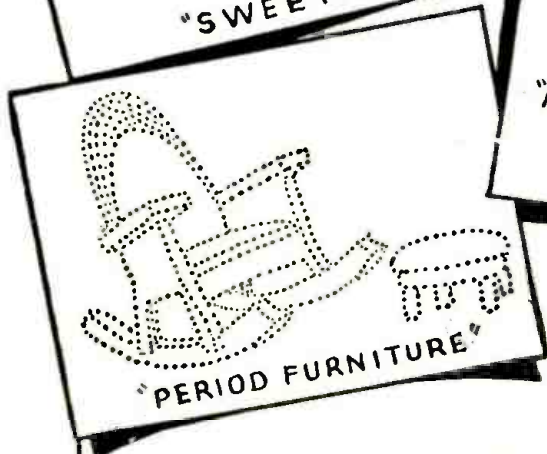
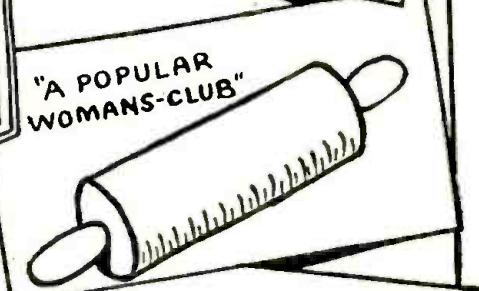
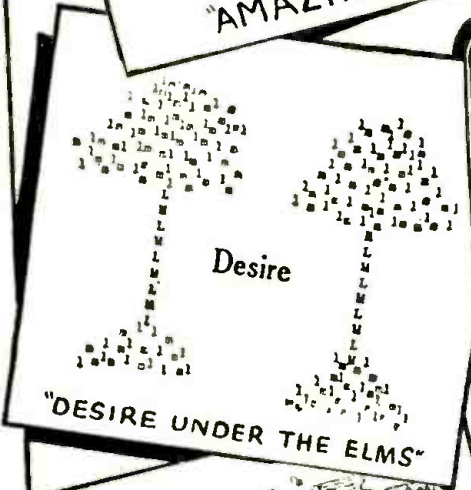

FRENCH HUMOR

France, that magic land of humor, wit, and keen, knife-edged "parlay," offers humor-loving Americans, its choicest, finest humor through the new weekly magazine, "FRENCH HUMOR." Your first copy of "FRENCH HUMOR" will prove what we

say—hundreds of choice jokes and original illustrations by French Artists, with all the illustrated jokes printed first in French and then in English. It's the funniest, wittiest and most entertaining magazine you have ever read.

10c WEEKLY ON ALL NEWSSTANDS

Ellen's replies were guarded in sentiment, but with enough of affection indicated to lead Benjamin on. He began to have a guilty feeling of complicity in crime and he slunk around the newspaper offices as though he were a man with a past—or a man, possibly, with a future! This guilty feeling increased with each exchange of letters. He lay awake nights worrying about it. So far, he had been writing purely for amusement; but he began to experience a new emotion tugging at what he presumed was his heart.

Increasingly he had the feeling that he owed some sort of explanation to Ellen. Not that there was anything deliberately deceptive about his letters. He had reported too many breach-of-promise suits to make a break like that. But there had undeniably been about his letters an air of playful youthfulness not supported by his bald head and forty-three years. He decided that he must end this thing one way or the other. The silly foolishness of it was plain to him; but when he tried to stop he found that the letter-writing habit had fastened on him more deeply than he had realized.

He began to have vague longings for the soft touch of a woman's hand on his brow. He dreamed absently of the joys which must belong to a man who has someone to darn his socks and sew buttons on his shirt. Benjamin's shirts had always shown a remarkable tendency toward button-moulting. Hitherto the absence of a button had not affected him; but now he found that he could not don a shirt with a button missing, without feeling almost naked. He fancied that this was what most people meant when they spoke of falling in love.

His companions noted his downcast appearance and joshed him openly about it. It was one Billings, police reporter, who started it.

"What's the matter with our Little Brother Ben?" he inquired playfully one noon, jabbing Ben in the region of his stomach.

Benjamin eyed the other man balefully. It occurred to him that it would be pleasant to smash a piece of pie over Billings' head. As he was fond of pie and had only one piece, he only glared.

"If you think it's any of your business," he growled, "say so. If not, shut your mouth!"

"Wouf! What's the matter with our little radio pet? Aha! I've seen those signs before in bachelors. What color is her hair, Burt?"

"It's none of your business!" roared Ben—and then stopped at his own betrayal. "That is," he said lamely, "she—she hasn't got any hair."

"Um," said Billings. "Bald, is she?"

"Course she isn't bald!"

"Um-hum. Wears a wig?"

"Wig—no!" yelled Benjamin. "There isn't any girl, I tell you."

"Tut-tut, old man," comforted Billings. "You can't fool an old hand. We all have to go through it. Don't give up till she's turned you down at least six times. After that, start flirting with another one. That'll fetch her around on her knees."

"There isn't any other one," brayed Ben, his face purple with rage. "That is—there isn't any one!"

"Tut-tut-tut!" Billings grinned equably. "Tell it to the marines, old turnip! Well, I'll toddle along and pass the good word to the staff. Don't forget the cigars are on you when the thing comes off."

Benjamin stared hopelessly at the back of the nonchalant Billings, and something near panic touched him. If the men on his paper should learn the truth, his life would be enlivened by various pungent remarks. He had always previously expanded his best oratorical efforts in defense of bachelorhood, and he could imagine the point his remarks would take on when reversed by his associates. He must abandon entirely this will-o-the-wisp affair. He realized, in the

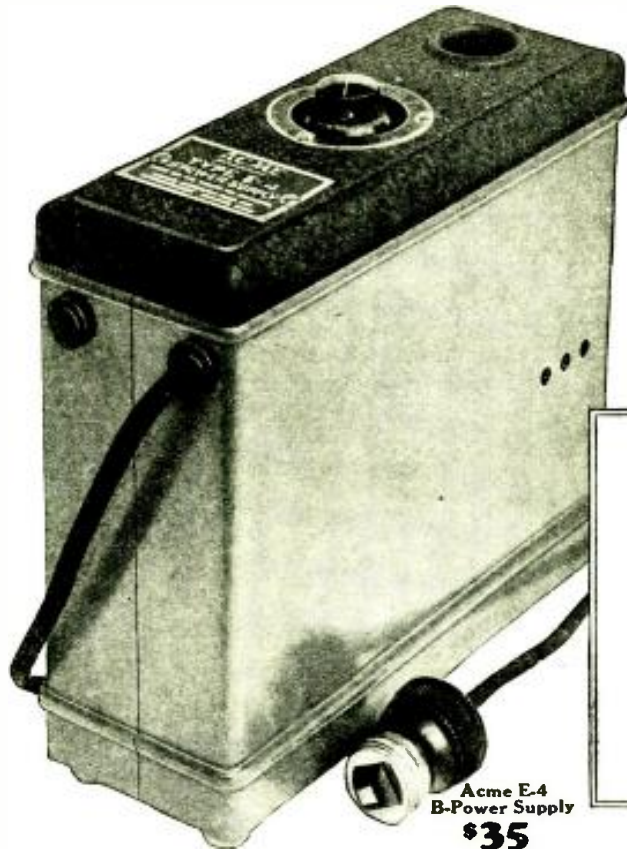

Acme K-1A \$25 Speaker



Acme E-4 B-Power Supply \$35

Don't condemn your present radio! Give it the equipment it deserves!

FIRST of all equip it with an Acme B-Power Supply. That will improve the quality and volume of your reception and keep

your power at constant maximum. Add an Acme K-1A Speaker! That improves any set; and gives beauty of tone quality you never dreamed your set could produce.

ACME - for amplification

-----TEAR OFF AND MAIL TODAY-----

ACME APPARATUS CORP., Dept. R.N.-4, Cambridge, Mass.

Gentlemen: Please send me a copy of the booklet entitled "Amplification without Distortion and Power Supply for Radio Sets," for which I enclose 10 cents.

Name.....

Street.....

City..... State.....



\$75 to \$125 Weekly

Charging Batteries Starts You

Let me show you how to make big money right from the start. I've prepared a FREE book explaining all details. First week's profit pays for all equipment. You can get all the battery charging business in your community with my Service Station Charger—it's years ahead of ordinary chargers—handles 50% to 70% more batteries. I explain everything—start you in a business of your own and put you on the way to big money. Write for FREE BOOK.

C. F. HOLMES, Chief Engineer, Dept. R.N.
Independent Electric Works
5116 Ravenswood Ave. Chicago, Ill.

FREE BOOK—Just Out



TRANSMITTING APPARATUS

A Complete Stock at "Chi-Rad"

In addition to our regular broadcast apparatus we carry a very good stock of transformers, chokes, grid leaks, high test condensers, etc., for transmitting purposes.

NEW SHORT-WAVE COILS

Specially built by "Chi-Rad." Write for descriptive bulletin and catalog. Dealers and set-builders please use business letterhead when writing for discounts.

Chicago Radio Apparatus Co.
415 S. Dearborn St., Dept. RN, Chicago

The Big Thrill of DX, and at very Small Cost to You

Everybody who owns a radio set likes to tune in far-distant stations now and then because not only is there a thrill in hearing a voice or instrument thousands of miles away but one verifies the fact that he has a powerful receiver and that it is in good condition. Now that the broadcasting stations are more suitably distributed as to wavelength or frequency, fans are in a better position to tune in distance. Besides, the weather is in their favor these days. But what kind of a set shall be used? You know very well that if the set can tune in distance once in a while, you can develop sufficient skill to make it tune in far-distant stations very often, virtually every night. Then when you have visitors you need not boast about the DX qualities of your set but simply tune the receiver and let them listen to stations thousands of miles away. You must be sure to have a receiver capable of responding to your distance-getting desires. You also want this set to have delightful tone quality, so that your own critical ears cannot detect even a single flaw in the reproduction. Indeed, even music lovers who may be guests at your home will comment admiringly upon the bewitching tone of your receiver. Then you know you have something real. The ability to get distance and to reproduce the original music without distortion depends largely on the circuit design, and you will find that the Diamond of the Air, either the 4-tube or the 5-tube model, will live up to your highest expectations. How are you going to know which to build? Carefully inspect the textual data as well as the blueprints that fully expound the theory, operation, characteristics and amplification of these two outstanding receivers that differ principally in the type of audio amplification.

The 5-Tube Diamond

can be constructed in a couple of hours. The authorized blueprints that make this speed and efficiency possible are just off the press and will be shipped at once, together with the new booklet of full textual exposition of construction, including the winding of coils, how to connect terminals, what values of condensers and resistors to use, etc. The receiver consists of a stage of tuned radio frequency amplification, a specially sensitized detector, first stage of transformer-audio and next two stages of resistance audio. It is easily adapted to playing phonograph records through the set and on your speaker. Get acquainted with this new delight.

The 4-Tube Diamond

represents the most that is obtainable from four tubes. A stage of tuned radio frequency amplification, a specially sensitized detector and two stages of transformer coupled audio. Follow the blueprint to amazing success. Build the set from parts you have. Full instructions cover utilization of such apparatus. Thousands are eager to build an economical set of surpassing performance and the amazing achievement and this one is the most economical, the most scientific, and the least expensive in cost of parts and upkeep. Works splendidly from batteries, either type 99 or type 1A tubes, and can be used with A and B eliminators, power packs, etc., with great success.

Look over both of these

blueprints and read the text in both cases before choosing your receiver.

SEND NO MONEY

Just fill out the coupon below and note what you get FREE.

Guaranty Radio Goods Co.

141-J West 45th Street, New York City

Please send me one newly-printed official blueprint of the 5-tube Diamond of the Air, one newly printed official blueprint of the 4-tube Diamond, and the textual data giving full directions for constructing these sets. I agree to pay the postman 75 cents on delivery, plus a few cents for postage. Also, you are to send me, without extra cost, one Auto Strop Safety Razor, one blade and one automatic razor strop.

Name

Address

City..... State.....

words of the poet, that he was out of luck. And so he decided to end it. As he saw the situation, there was no use of his prolonging the correspondence and playing with the girl's affections.

That night, after his bedtime story, he sent a kiss through the microphone to all his listeners. He specified quite plainly that it was for everyone—a sort of community kiss—but his heart was yearning toward one particular person whom he knew was listening.

Sadly he wended his way to his room, and there penned his last letter to Ellen. It was a carefully, tenderly-edited masterpiece. In it he delicately hinted that he might not come up to her expectations in the matter of age, looks, and abundance of hair. He ended by asking her to meet him for luncheon on a certain day at a fashionable restaurant. He explained for her the method of identification:

"I will be sitting at a corner table near the front; a rather large gentleman (he thought that rather cleverly done—"Large gentleman") in a blue serge suit and a white carnation in the left lapel."

The carnation bothered Ben. He hated carnations of any color because they always smelled so like a funeral. But he had read many stories, and when a meeting was arranged between two strangers, one of them invariably wore a white carnation as a means of positive identification. The white carnation, he felt, was indispensable.

* * * * *

On the eventful morning Benjamin rose early, bathed profusely, arrayed himself in his serge and fine linen, and sallied forth to the barber shop. By special arrangement, he had secured one of the staff to give his morning "housewife" talk from the studio, and so he had several hours in which to prepare for his meeting with Ellen. Most of that time he spent at the tonsorial parlor. He had a shave, a massage, a hair-cut (the barber spoke of it as such), and a manicure; the manicure was his first. He sat blushing profusely, all the time while the young woman was holding his horny paw in her soft palm and gently eroding his nails with a piece of scented sandpaper.

When that ordeal was concluded he slunk, by various alleys known to reporters, to the side door of the appointed restaurant. By means of a painfully-large tip he secured a front, corner table; and, fully a half hour before he might expect Ellen, he was stiffly sitting there, scowling furtively around the edges of his paper. He was nervous. His nervousness increased with the passing of time. He began to imagine queer things; that one sock was sliding down, that his suspenders had broken, that his shirt had lost another button. All these illusions were corrected by sly, guilty fumbings behind the shelter of his newspaper.

A steady stream of people was entering the place, passing by Ben's table on their noontime march to the feed-trough. Presently a sleek waiter was bowing beside him.

"Does Monsieur wish luncheon served?"

"Eh?" said Ben, jerking abruptly. "What's that?"

"Does Monsieur wish his luncheon now?"

"Aw, no. Waiting for someone," growled Benjamin. "Beat it, you! I'll sing out when I want to feed, see?"

"But, certainly, Monsieur."

The waiter faded discreetly into the background and Mr. Burt resumed his hawk-like scrutiny of the passersby. Of a sudden he perceived a buxom, full-hosomed woman who had detached herself from the rabble and was making directly for his table. She was not pretty, although she was comfortably good-looking in a middle-aged sort of way. Her face was round, her nose slightly pug, and her eyes were twinkling with a merry twinkle. Although powder had been applied with great lavishness and lesser skill, the ruddy health of her cheeks shone through in

Enriched



tone value...

by exact current regulation of this "B" Power Unit

THE secret of tone quality—richness and clarity—is found in proper current regulation. And, this feature is strikingly evident in the Sterling (R-81) "B" Power Unit. Its genuine Raytheon Tube and established record of reliability makes this the ideal "B" current supply for 4 to 8 tube sets including power tube.

A Sterling demonstration will be a revelation. Any Sterling dealer will be glad to prove it.

Sterling

"B" Socket Power

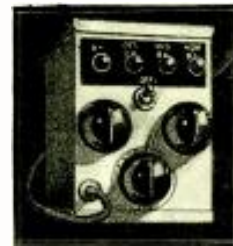

Model R-81
"B" Power
for sets from
4 to 8 tubes.

\$28.50

complete with
Raytheon
tube

THE STERLING MFG. COMPANY
2831 Prospect Avenue Cleveland, Ohio

"Kit was assembled with the result such as has not been our pleasure before, including both ease of construction and marvellous reproduction. Its performance cannot be fully described. It is hard to believe that it is possible for a speaker to be any better than yours."

JOHN F. WELCH Asst. Ed.
Bro. of Loco Engineers' Journal
Cleveland, Ohio.

G·R·P

3 FOOT
CONE SPEAKER
Build It Yourself



Finest Tone Quality

The speaker you build from a G. R. P. 3-ft. Cone Speaker Kit equals the finest factory-built speaker, both in tone quality and appearance. Yet it costs you but one-fourth to one-sixth as much.

Easily assembled by anyone; complete, simple, illustrated directions with each G. R. P. Kit.

Ask your dealer for genuine G. R. P. 3-ft. Cone Speaker Kit; or direct from us, f.o.b. New York City, if he hasn't them.

G. R. P. PRODUCTS CO., INC.
104 Fifth Ave. Suite 1999 New York City

No. 3 Kit, for 3-ft. DOUBLE Cone Speaker; absolutely complete with G. R. P. Unit and all other parts \$13.50

No. 4 Kit, for 3-ft. SINGLE Cone Speaker; Wall Type complete with Wall Frame & Unit \$10.50

Free Wholesale Radio Catalog Send today for it

1928 Catalog

Dealers, set builders—make this your biggest radio season. Shure's great wholesale catalog insures the best in quality at lowest prices.

This wonderful book is jammed full of the newest offerings of Nationally known radio parts, kits, sets, accessories, table and console cabinets, etc. Also contains short wave sections showing the finest electrical apparatus for short wave receiving and transmitting. Your request brings our book of a thousand bargains, price list and discount sheet. Write for a copy today.

2000 Items **Big Values**

Shure Radio Company
353C West Madison St., Chicago, Ill.

various spots. She came on, directly to Benjamin's corner, and she spoke.

"How do you do?"

"Uh?" said Ben, giving her a startled glance. "Oh, yes. It is a fine day, isn't it?"

The woman was evidently preparing to join him, for she pulled out the opposite chair with capable hands. Ben watched her with uncertain alarm.

"I—I beg your pardon, Madam," he stammered.

"You're Ben, aren't you?"

"My name, certainly, is Benjamin."

His eyes were straying nervously back to the stream of incoming diners. He was becoming distinctly nervous. This perfect stranger butting into things! A thought hit his perturbed mind with such force that he looked back quickly to his self-appointed companion. Perhaps Ellen wasn't coming. Perhaps she had sent someone as her representative—her mother—the woman opposite! At the thought of such an encounter his remaining courage oozed from him. He faced the woman, and the expression on his face was one of meekness. The woman explained, easily.

"Of course I knew it was you. The white carnation, you know."

Comfortably she settled herself in her chair, and then looked at him with sudden mild suspicion. "You are Ben, aren't you? My big Benny boy?"

"B-Benny boy? I'm sorry, Madam. Perhaps I have the wrong table. If you'll just excuse me—"

"Oh, no. Don't go yet. I'm Ellen."

Benjamin gulped several times, slowly. That perfectly obvious solution had not occurred to him. "You're Ellen!" he said.

"I am. Have you anything to say about it?"

Mr. Burt had several things to say about it, but strangely, for the moment, he seemed utterly incapable of saying any of them. There was, too, about that smile of Ellen's something decidedly fetching. Benjamin relaxed and sighed a weak sigh.

"Well, I'll be d-darned!" he murmured.

"I beg your pardon?"

"Nothing," said Ben.

So this, he told himself ruefully, was life! He had poured out the precious perfume of his affection upon this creature—this complacent person who must be nearly his own age, and who sat there so quietly with that gentle, kindly smile on her face. Benjamin Burt perceived that something was happening to him. He was beginning to like this Ellen person tremendously. To his growing amazement, his heart began to hop about within him. A queer feeling!

"And so," she said slowly, "you are Big Brother Ben."

"Well," he countered, feeling the need of some defense: "I never said how big, did I?"

"No, of course not."

"Well?"

"Aren't you going to say anything to your Ellen?"

"It strikes me," said Ben, "that I've already said too darn much in those letters."

"Um-hum. Of course, though, I knew you weren't the young fool you pretended to be in them."

"You—you did?" He looked at her foolishly. It aggravated him to look foolish, and so he tried to glare.

"Yes, I did."

"Oh, you did!" said Ben, and instantly felt that his response had lacked that virile force which he had intended to give it.

"Of course," said Ellen: "Your picture is at the head of the radio column in your paper every night."

"Oh—I see," mumbled Ben, and again felt that he had not put into the words all the strength and expression which they should have had.

He looked at Ellen and for the first time began to see her as herself and not as a substitute for his radiotic dream girl. After

A Sensational Success!

They are **Enthusiastic**

Being absolutely pleased with the Eliminator bought from you last June, it is really a pleasure for me to order two more for some of my relatives. Find enclosed money order.— Leopold O'Reilly, Montreal, Que.

Your Eliminator is certainly working fine. I have it hooked up to a 6-tube No. 20 Atwater Kent, and I get better reception than I have had since I owned the set.— John W. Jackson, Painesville, O.

The Eliminator I purchased from you six months ago has given perfect satisfaction. I have it connected to a six-tube Columbia and get better results than I ever had with B batteries.— Bernard V. Dugan, Lockport, N.Y.

I have one of your Eliminators purchased from you last winter. It has been in use constantly ever since and want to say it has been perfect in every respect and cannot be beat by any other.— Fred H. Kembel, Hastings, Neb.

You will be **enthusiastic, too**

Townsend "B" Socket Power

Approved and passed by the rigid laboratory tests of Popular Radio and Radio News

Over 25,000 sold the first 6 months

—Overwhelming evidence that VALUE is quick to be recognized and appreciated.

Unsurpassed quality is built into the Townsend "B" Socket Power Unit with money saved by unified production methods and lower merchandising costs.

You get more—you pay far less—for the most remarkable value in Radio today.

New thousands of Radio set owners are learning this daily by installing Townsend "B" Socket Power.

Sold on REAL GUARANTEE OF MONEY BACK IF NOT SATISFIED. Delivers up to 100 volts on any set, on DC or AC—any cycle. Full tone, clarity and volume.

SEND ORDER TODAY

Simply fill out the coupon and slip it into an envelope with only \$1.00 and mail at once. Your Townsend "B" Socket Power Unit will be sent promptly. Deposit only \$3.85 plus postage with the postman. Try out for 10 days—then if it does not do everything we say, return it to us and purchase price will be refunded.

TOWNSEND LABORATORIES Dept. 25 713 Townsend St., Chicago, Ill.

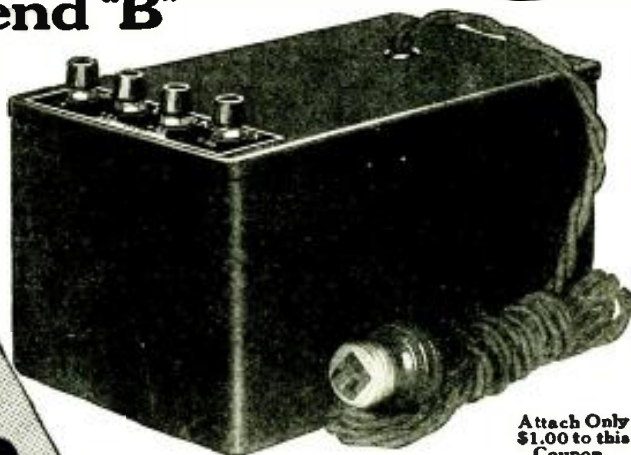

Attach Only \$1.00 to this Coupon

Complete \$6.85 \$1.00 Down Balance C.O.D.

TOWNSEND LABORATORIES 713 Townsend St., Dept. 25 Chicago, Ill. Gentlemen: Attached find \$1.00. Kindly send at once Townsend "B" Socket Power Unit. C.O.D. for \$5.85, plus postage, on guaranteed 10-day free trial.

Name _____ Address _____ City _____ State _____

Send for Literature

FLECHTHEIM Superior Condensers

Used Because They're Best BY-PASS — FILTER — BUFFER HIGH TENSION — TRANSMITTING Available In All Standard Sizes ACCURATE — CAPACITY RATING Dependable for Continuous Duty

Write for Catalogue Special Proposition for Manufacturers

A. M. FLECHTHEIM CO., Inc., Dept. R. N. 136 Liberty Street New York, N. Y.



Insure your copy reaching you each month. Subscribe to Radio News—\$2.50 a year. Experimenter Publishing Co., 230 Fifth Avenue, N. Y. C.

DEALERS Add to Your Profits!
 Use this Year-Round
FREE MERCHANDISING Service

You will want a year's subscription to this remarkable trade magazine and merchandising service. You cannot afford to do without it. Don't let your competitor put RADIO NEWS ideas into practise first. Double your business before the year is out. Mail coupon for sample copy today!



You are appointed editor, MR. DEALER, of the most unique radio trade magazine published—RADIO NEWS DEALERS' PERSONAL EDITION. This unusual publication is the stamping ground for the entire trade. Anything you may have to say about radio you can say in RADIO NEWS DEALERS' PERSONAL EDITION—just mail it in to us.

With every subscription to RADIO NEWS DEALERS' PERSONAL EDITION, every legitimate dealer is entitled to a complete DEALERS' PERSONAL SERVICE of merchandising and advertising assistance.

The magazine itself contains buying services, trade articles, and a host of sales-making ideas—once you've used it, you'll never again want to do without RADIO NEWS DEALERS' PERSONAL EDITION.

Merchandising Department

RADIO NEWS

230 FIFTH AVENUE
 NEW YORK CITY

Free

GOOD ONLY IF ATTACHED TO YOUR LETTERHEAD

RADIO NEWS,
 Merchandising Dept.,
 230 Fifth Avenue,
 New York City.

My name

My address

My firm

(Please make sure I receive my sample copy of the DEALERS' PERSONAL EDITION promptly.)

Three Men

whose earning power jumped

The same opportunity they grasped is open also to you

all, she was not bad-looking. And that gentle, slow smile of hers—Benjamin found it clutching more tightly at his heart. A shy young hope began to flutter about in his eye, but he could not bring himself to state the matter openly. He must approach it from a different angle.

"You said once in one of your—er—letters," he began, "that you could cook, didn't you?"

"Cook?" Ellen smiled benevolently: "My dear boy, I have made that my sole occupation for the past twelve years."

"Ugh-huh," growled Ben. "Know how to make apple turnovers? Because I couldn't marry a woman who couldn't make apple turnovers!"

"I make very good apple turnovers, Ben," said Ellen softly.

Benjamin F. Burt fumbled nervously with the corner of his napkin, and when he spoke there was a plaintive note in his voice. "I'm not really such an old crab as I seem, Ellen. Do—do you think you could learn to like me a little—"

Quite unashamedly she reached across the table and took his trembling hand in her own warm one. "My dear," she smiled, "I already know you much better than you think. I like you a lot already; and I think I'd like you a lot more—if you would give me the chance. I guess, Ben, I'm falling in love with you."

Ben's heart gave a sudden leap within his breast, and then ceased motion altogether for an interval. He looked the other way, blinked twice, and then turned back and spoke gruffly—although the quivering bit of moisture in his left eye belied the harshness of his voice.

"Love? Who said anything about love?" "I did, Ben," answered Ellen.

"Huh!" Ben remarked, and there was in his voice a peculiar lilt of triumph. He scooped up his hat and lurched to his feet. "I'll sure get heck from the boys for this, but I guess apple turnovers the rest of my life is worth something. Come along."

"Where are we going?" inquired Ellen. "Going to get married," said Benjamin very firmly. "And if you raise any fuss about it, I'll smash you flat!"

"Such a strong, masterful man," murmured she: "But we haven't had luncheon yet, Bennie boy."

"Luncheon!" he snorted: "No use throwing away money in this dude joint. We can drop in at some chop house and feed."

"Certainly, dear," Ellen agreed: "I hate fingerbowls, too."

"You're sure," asked Ben fearfully, "that you are willing to go through with this?"

She slipped her arm companionably through his, and that gentle, knowing smile was on her face again.

"I know we shall be very happy, dear," she said.

"Well, who the devil said we wouldn't be?" inquired her betrothed defiantly. He planted his hat fiercely over his bald spot and turned toward the door. There was on his broad face a particularly foolish and rather happy expression.

RADIO AMATEURS GROW FAST IN NUMBERS

THE latest report of the Department of Commerce shows the licensed transmitting "hams" of the United States increased from 14,902 to 16,926 during the year ending June 30, 1927. This growth of over two thousand amounts to 13.3%. Almost all are operating on 80 meters or lower, the 150-200 meter band being little used.

Official credit is given by Chief W. D. Terrell, of the radio division, to the amateurs for the invaluable public services which they rendered during the disasters of the past year in Florida and along the lower Mississippi. Had the report been written a little later, it would have included credit also for the striking work done by the hams in the late New England floods.

In the center of this page you will find the brief facts about three men who learned Accounting, just as these men wrote them in their own letters to the International Accountants Society

The I. A. S. does not deal in theories; It was founded on this hard practical fact—that a knowledge of Accounting enables a man to make more money—real money. The accountancy trained man is in a splendid position to discover the sources of profit.

The accountant is the trusted advisor of the biggest business men. He has a bird's-eye view of the whole business. Because he is at the throttle of profit control, he is always in the confidence of the owners.

That the International Accountants Society's training does help men advance quickly in position and income is proved by the three men whose stories are summarized here. Our files are full of the stories of

Success of thousands of self-confident Americans

You, who read this are interested in a successful business career. You are married, perhaps; you are earning a reasonably good salary, and each year brings a little increase.

Somewhere among the thousands of successful graduates who have proved the value of the International Accountants Society's training you would find a man exactly like yourself in age, in position, and in earning power.

That man might have continued to go on slowly, and he might have reached some day a responsible department position. Instead he decided to shorten the path to success by grasping the almost limitless opportunities which a knowledge of accounting offers.

If you could find that man, and hear his story, we know that it would mean more to you than all the letters in our files from leading business men. For you would know that what this training had done for him it would do for you also.

You can afford anything but wasted years

Business training costs a little investment in money and in time. But think of the price they pay who pass such training by.

An opportunity comes and is lost because they have not the knowledge and self-confidence to grasp it. They spend years in slow routine progress, when the progress might be rapid and sure.

You, too, are paying for this training, whether you take it or not, and paying wasted years, the only price which no man can afford.

Spend an evening with this book

The International Accountants Society does not argue with men; it wants no man who can be argued into a decision. It seeks only to lay the facts before you. The facts are contained in an 80-page book entitled "How to Learn Accounting." It is worth an evening of your time and it will be sent without any obligation. Mail this coupon for your copy today.

Here are the men-- Read what they say:

1. Hugh J. Davey, Jr., was a book-keeper and cost clerk before enrolling. Mr. Davey is now Auditor of the Robbins Body Corporation, Indianapolis, with a 300 per cent salary increase. He says: "I owe my all to the International Accountants Society."

2. Mr. A. T. Hull, A. T. Hull & Son, Certified Public Accountants and Auditors, Bristol, Va., was a postmaster at \$150 a month when he enrolled. Upon completion of the Course he increased his salary over \$100 a month. His two sons enrolled for the Course, also. "Before the State Board of Accountancy at Richmond, I was one of seven out of forty-eight applicants to successfully pass the examination for Certified Public Accountant."

3. L. D. Hipple of Dayton, Ohio, was doing routine work when he enrolled in March, 1921. Today, he is Auditor of the M. D. Larkin Company at Dayton. Mr. Hipple writes: "I have doubled my salary since 1922 and much credit is due your organization."



INTERNATIONAL ACCOUNTANTS SOCIETY, INC.

Since January 1, 1927, a Division of the ALEXANDER HAMILTON INSTITUTE

To the INTERNATIONAL ACCOUNTANTS SOCIETY, Inc.
3411 South Michigan Avenue, Chicago, Illinois

Send me, free, "HOW TO LEARN ACCOUNTING," and tell me how I can increase my income as your other students have done.

Name..... Position.....
Street..... City..... State.....



Amazingly Easy Way to Get Into ELECTRICITY

Don't spend your life waiting for \$5 raises in a dull, hopeless job. Now... and forever... say goodbye to 25 to 35 dollars a week. Let me show you how to qualify for jobs leading to salaries of \$50, \$60 and up, a week, in electricity — NOT by correspondence, but by an amazing way to teach, that makes you a practical expert in 90 days! Getting into Electricity is far easier than you imagine!

Learn Without Dry Books or Lessons in 90 Days

No dry books — no lessons. All real actual work building real batteries, winding real armatures, wiring real houses, operating real dynamos, switchboards, etc. Lack of experience — age, or advanced education bars no one. I don't care if you don't know an armature from an air brake — I don't expect you to! I don't care if you're 16 years old or 40 — it makes no difference! Don't let lack of money stop you. Most of the men at Coyne have no more money than you have.

Earn While Learning

Many of my students earn a good part of their expenses and should you need this assistance we will help you. Then, in 12 brief weeks, in the great roaring shops of Coyne, I train you as you never dreamed you could be trained... on the greatest outlay of electrical apparatus ever assembled, in the new \$2,000,000 school.

Jobs, Pay, Future

Don't worry about a job, Coyne training settles the question for life. Demand for Coyne men often exceeds the supply. Our Employment Bureau gives you lifetime service... Coyne men get positions which lead to salaries of \$50.00, \$60.00 and up a week. You can go into radio, battery or automotive electrical business for yourself and make from \$3000 a year up.

Send for Big Book FREE!

Send for my big 56-page book containing 150 photographs telling complete story — absolutely FREE.

Mr. H. C. Lewis, Pres. Dept. 10-77
COYNE ELECTRICAL SCHOOL
 500 So. Paulina St., Chicago, Ill.

Dear Mr. Lewis: Without obligation send me your big free catalog and all details of Free Employment Service, Radio, Aeroplane and Automotive Electrical Courses and how many "earn while learning." I understand I will not be bothered by any salesman.

Name.....
 Address.....
 City..... State.....

Radio Wrinkles

(Continued from page 791)

ected from the radio receiver. One side of the house-lighting circuit is grounded;

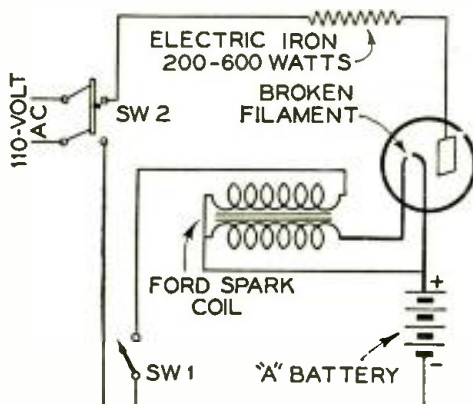

A rectifier tube with a burnt-out filament may often be used in a battery charger employing the circuit shown above, which may be assembled at a very low cost.

and, if the storage battery were grounded through the receiver, the 110-volt line might be short-circuited.

—Contributed by C. W. Mac Elroy

HOW TO DRILL HOLES EXACTLY AS LAID OUT ON THE PANEL

NO one knows better than the amateur radio constructor the difficulty of drilling a panel so that it comes out perfectly true. A panel may be laid out correctly and the center punch used for locating the start of the drill; and yet, due to the travel of the drill point, the drill holes will be off center.

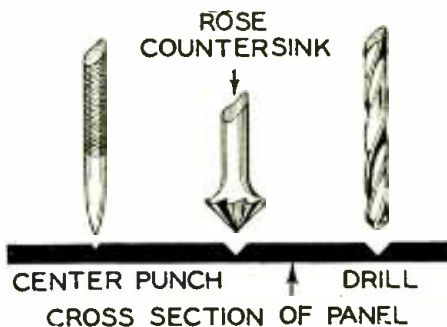

Radio panels may be drilled more accurately if a "bed" for the drill is drilled with a rose countersink, after the spot has been center-punched.

A simple method for overcoming this trouble follows: the panel is laid out in the usual way with the center punch. Then with a rose countersink drill out a "bed" which will just take the slope of the drill point, as shown in the illustration. This scheme is a sure way of starting the drill point on true center and never fails of getting a hole drilled where it is wanted.

—Contributed by Lester P. Young

IMPROVING A HORN SPEAKER

MOST speakers of the old horn type may be vastly improved by adding a large paper cone to the mouth of the speaker. The harsh resonance of some horns is almost completely removed, and both voice and music are made clear and distinct at a considerably greater distance from the horn. The design has to be varied somewhat to fit the individual speaker, but with a little experimenting, the speaker may be made to approach the efficiency of an exponential horn.

The large cone is made of stiff paper,

KARAS A-C-FORMER

FILAMENT SUPPLY—TYPE 12—List Price \$13.50



NO HUM!

At last you can step down your 110-volt A.C. house current to operate your set with standard A.C. tubes such as Cunningham, RCA and CoCo, without having to use separate device for center tap, and with absolutely no hum. Let the Karas A-C-Former Filament Supply, Type 12, replace your "A" battery and charger. Will operate 8 1 1/2-volt Type 226 or 326 Tubes, 2 2 1/2-volt Type 227 or 327 Tubes, and 2 5-volt Type 171 Tubes at one time. Compact, powerful, sturdy, and built the Karas Way—by precision methods. Write for complete information about the new Karas A-C-Former as specified in Radio News, and also data on the Knickerbocker 4 and Karas 2-Dial Equamatic.

KARAS ELECTRIC COMPANY
 4038-A North Rockwell Street Chicago, Ill.



Astonishing PERFORMANCE

With Long Satisfactory Service

ACME DRI-LINE RADIO POWER UNITS

Type AB-280 delivers 180 volts at 40 mills. New Dri Rectifier. Lists East of the Rockies... With 280 tube \$5.00 additional **\$54.50**

ACME "B" POWER UNIT

Type B-280 Delivers 180 volts at 40 mills. Lists East of Rockies **\$22.00** With 280 tube \$5.00 additional

Ask your dealer to show you these new sensational units. Write for our folder giving complete information.

THE ACME ELECTRIC & MFG. CO.
 1412 Hamilton Avenue Cleveland, Ohio
 Established in 1917

POWER UNIT

For large cones. Operates on "A" battery current. Gives enormous volume. Most amazing tone quality you have ever heard from any loud speaker unit. Sent C.O.D. PAY POSTMAN \$12. If not satisfactory, return in ten days and your money will be refunded.

FANSPEAKER RADIO CO., Dept. R
 199 Fulton Street, New York

such as ordinarily is used for cone speakers. In some cases it may be necessary to glue several thicknesses together to obtain the required stiffness.

Perhaps the easiest way to make a cone to fit a particular type of speaker is by the cut-and-try method. First, make as large a circle as possible (or at least a great deal larger than the diameter of the required cone) on the paper by means of a pencil and string. It is wise to provide the finished cone with a radius equal to the height of the center of the speaker. This will allow the edge of the cone to rest on the table and will prevent the speaker from overbalancing with the added weight of the cone.

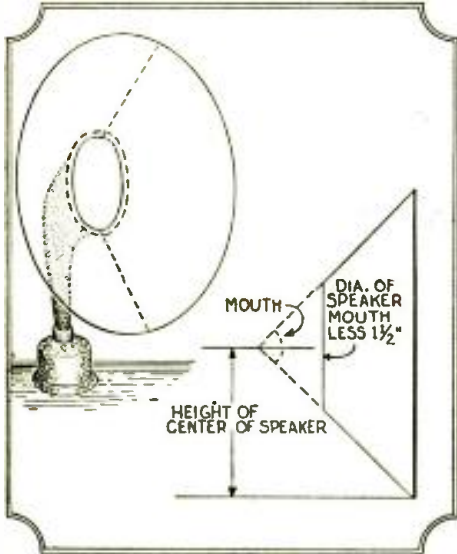

Frequently the reproduction from an old-type loud speaker may be greatly improved by mounting a large paper cone at the mouth of the horn as illustrated above.

After the large circle of paper has been cut the cone may be formed. Cut a line from the outside of the circle to the center and then, by experimenting, form a cone with an angle which fits the speaker's mouth. It is a wise plan to glue the cone at this point of construction; after the glue has thoroughly dried, the cone may be cut down to the proper size. Now cut an opening where the cone is to be fastened to the speaker and allow about $\frac{3}{4}$ inch all around this opening to overlap the mouth of the horn. The cone may be glued or bolted to the horn.

—Contributed by Meder Smith.

REPAIR VACUUM TUBES WITH LOOSENED BASES

WITH the UX types of receiving tubes it is frequently necessary to use force when placing them in and removing them from the sockets of a set. In the latter operation, if care is not exercised, the cement may break down. When this happens the bulb is no longer securely fastened to the base, and the terminals of the tube are apt to short-circuit.

A simple method for fixing tubes that



DRILL $\frac{1}{4}$ " HOLE AND FILL WITH SEALING WAX.

When a tube becomes loose in the base, it may be repaired by drilling a $\frac{1}{4}$ inch hole in the base and filling it with melted sealing wax. This is a good insulator, as well as a suitable cement.



New Formica Kit Panels

RECENT additions to the list of handsomely decorated panels for famous kits include the Madison Moore International One Spot (A.C.) and the new B^T Power Six Electric Kit. There are also front and sub panels for Karas (two dial), World's Record Super Ten; Camfield Nine; Tyrman; Magnaformer, H. F. L. Victoreen and many others.

These panels are sold by all leading jobbers

The FORMICA INSULATION COMPANY

4618 Spring Grove Avenue

CINCINNATI, OHIO

Any jobber or dealer can get Formica panels for you.



Formica has a Complete Insulating Service for Manufacturers.

LEARN THE CODE AT HOME

WITH THE OMNIGRAPH

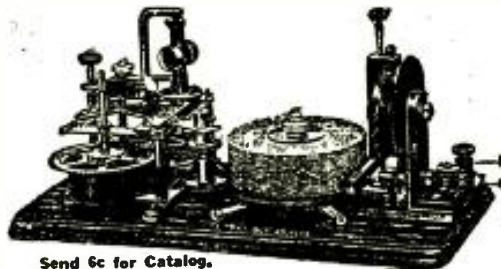

THE OMNIGRAPH Automatic Transmitter will teach you both the Wireless and Morse Codes—right in your own home—quickly, easily and inexpensively. Connected with Buzzer, Buzzer and Phone or to Sounder, it will send you unlimited messages at any speed, from 5 to 50 words a minute. THE OMNIGRAPH is not an experiment. For more than 15 years it has been sold all over the world with a money back guarantee. THE OMNIGRAPH is used by several departments of the U. S. Government—in fact, the Department of Commerce uses the OMNIGRAPH to test all applicants applying for a Radio license. The OMNIGRAPH has been successfully adopted by the leading Universities, Colleges, and Radio Schools.

Send 6c for Catalog. **THE OMNIGRAPH MFG. CO. 15 HUDSON STREET, NEW YORK CITY**
If you own a Radio Phone set and don't know the code—you are missing most of the fun

RADIO—SETS—PARTS
 Eliminators at amazingly low prices
 Write for latest money-saving literature
 S. R. S. CO., P-427 16th St., New York City

C. R. LEUTZ, Inc.
 6th and Washington Avenues
 LONG ISLAND CITY NEW YORK

Enjoy LOUD SPEAKER OPERATION from a CRYSTAL

NO "TUBES" - NO "B" BATTERIES - NO COSTLY "ELIMINATORS" WITH THE SKINDERVIKEN TRANSMITTER UNIT

Simple microphone unit provides a most effective and inexpensive way to satisfactory speaker operation. Easy to build and operate circuit.



Everybody can do this now with a Skinderviken Transmitter Unit. The unit is fastened to the diaphragm of the speaker unit. It will act as a "microphonic relay." Every time an incoming signal actuates the diaphragm, the electrical resistance of the microphone unit will be varied correspondingly and the current from the battery, in series with it and the loud-speaker, will fluctuate accordingly.

Thus the problem of securing sufficient power to actuate the Loud-Speaker is simply and adequately solved.

The results from this very novel and simple unit will astound you.

The expense of this hookup is trifling compared to elaborate tube circuits that give no greater actuation of the speaker.

Besides this there are many other valuable uses in Radio Circuits for this marvelous little unit. Every builder of Radio sets should have a few on hand.

LISTENING THROUGH WALLS

This Unit makes a highly sensitive detectaphone, the real thing—you listen through walls with ease. Plenty of fun and real detective work too.

CONDUCTING SOUND THROUGH WATER

Make yourself a miniature submarine signaling apparatus like those used during the war. Simple circuit with this microphone unit gives splendid results.

12-PAGE INSTRUCTION BOOKLET

containing suggestions and diagrams for innumerable uses mailed with each unit.

We Pay \$5.00 in Cash

for every new use developed for this unit and accepted and published by us.

SEND NO MONEY

Order as many as you want—use the coupon below. When the postman delivers your order you merely pay him 95c plus a few cents postage. If you order two units you pay him only \$1.75, plus postage.

PRESS GUILD, INC. R-1-28
16-18-R-East 30th St., New York, N. Y.

Please mail me at once.....Skinderviken Transmitter Units, for which I will pay the postman 95c. plus postage, or \$1.75 plus postage if I order two units.

Name.....
Address.....
City.....State.....

have become loose in the base is to drill a 1/4-inch hole in the center of the bottom of the tube base and pour hot sealing wax through this hole. After the wax has hardened, the tube will be found quite rugged.

When repairing tubes in the manner described above it is important to make sure that the wires in the base of the tube are not already short-circuited when the wax is applied.

—Contributed by Ira Flowers

The Shielded-Grid Tube

(Continued from page 763)

used for the wiring of ignition systems of automobiles, is excellent for the purpose.

When mounted in a vertical position (which is the best), the tube itself should be shielded by a metal jacket fitting closely over it but having an insulated hole at the top to allow the metal connecting cap to protrude. The shield or can should extend down at least to the base of the tube, and should be connected to either filament terminal of the socket.

OTHER ADAPTATIONS

Another use for the new shielded-grid tube will be found in circuits requiring a tube of high amplification factor and high mutual conductance, such as resistance, impedance- and transformer-coupled amplifier hook-ups. For this service the inner grid, G, is used as a space-charge



End view of the tube base, showing the arrangement of the contact pins. P, plate; FF, filament; SG, screen grid.

grid at a potential positive with respect to the filament. The operating conditions are as follows: plate voltage, 135 to 180, to be applied through a plate-coupling resistor of 100,000 to 250,000 ohms value; outer (screen) grid, 0 to 1.5 volts negative bias, furnished by rheostat or potentiometer; space-charge grid (inner), 22.5 volts positive bias, applied through metal cap; filament 3.3 volts. For this particular use the higher plate voltage is generally best.

In a subsequent issue, RADIO NEWS will present further data on these interesting new tubes, giving characteristic curves which the layman can understand and other information of value.

RADIO IN THE BIBLE

BESS: "What makes you think Salome was a radio fan?"

TESS: "Why she must have been. Didn't she ask for John the Baptist's head on a charger?"—Gleason Pease.

HI, HI!

ENGLISH VISITOR: "Nice outfit, what, old bean?"

YANKEE HAM: "A watt? The dickens! Fifty watts, OM." —Earl Nelson.

A PERMANENT JOB

FAN: "Something's wrong with this, can you fix it for me?"

REPAIR MAN: "Sorry, but that's a fixed condenser." —Fred T. Kohara.

IT MATCHED HER GOWN

HE: "Which would you rather listen to, the Red or the Blue network program?"

SHE: "Oh, the blue by all means. It's my favorite color." —Wm. G. Mortimer.

No Hum

Sovereign



STANDARD SOCKET

Tube

Put Sovereign A-C Tubes into your set. Throw away your "A" Batteries, "A" Eliminators and Chargers. Be free from all battery noises and hitches, and get clear, clean, true music with full over-tone and without hum or crackling. Sovereigns use standard sockets. Easy to install in a few minutes. Then simply throw your switch, for your power is unfailing and plenty. Have your set up-to-date. Write for treatise on A-C Tubes and Receivers with typical wiring diagrams included. If your dealer cannot supply you we will ship C.O.D.

SOVEREIGN ELECTRIC & MANUFACTURING CO.
125 N. Sangamon Street, Chicago, Illinois

Changes Your Set Into a Short Wave Receiver



Sent postpaid anywhere in U. S. upon receipt of \$15.00 M. O. or C. O. D. plus postage upon receipt of \$1.00 to guarantee carrying charges. When ordering state kind of set so that detailed directions for use may be given if necessary. Also state type of tubes, such as UX199, UV199, WD11 or 201A.

The SUBMARINER

Regardless of the kind of set you have, this device will permit you to listen to short wave stations between 30 and 75 meters. Operates with sets such as T. F. Neutrodyne, Super-Heterodyne, regenerative sets and all other types. No additional tubes or batteries required. No changes to the wiring of the set. A short aerial and ground is connected to the "Submariner," and a cable and plug attaches it to the set. Requires less than a minute to attach or detach. Operates as a wave changer with Super-Heterodynes, and as a detector unit with others.

SHORT WAVE RECEPTION

Is practical because they penetrate better, and there is less static. There are several powerful stations using the wave band covered by the "Submariner" for broadcasting programs. You may also learn code by listening to amateurs from all parts of the world. Get a thrill by tuning in a station your friends cannot get. You will have a highly efficient short wave receiver when the "Submariner" is attached to your set. Nothing else like it on the market. Take a trip in the low waves on board the "Submariner."

ORDER TODAY

We guarantee to refund if the "Submariner" fails to operate

ADDRESS
J-M-P MANUFACTURING CO.
Dept. 119 Milwaukee, Wis.



CAMERON ANTENNA

WORLD'S CHAMPION STATION GETTER

SENSATION of year. Makes every set selective. Positively gets more distance. 418 stations including England, Germany, Alaska and Mexico tuned with Cameron Antenna in national contest. Entirely new, patented principle. Nothing else like it. Comes in convenient knock-down form. Installed in few minutes.

Endorsed by Radio Engineers Everywhere. Thousands of enthusiastic users. You'll never know what your set can do till you hook it to a Cameron. Send no money. Pay postman \$5.00 plus few cents postage. Money back if not satisfied.

CAMERON MANUFACTURING CO., Dept. A1
517 Ellicott St.
Buffalo, N. Y.

If it's in the air the Cameron Antenna will get it

The Radio Beginner

(Continued from page 753)

hear only when sound waves are of certain frequencies. Sixteen vibrations per second produce the lowest-pitched sounds that most ears can hear, and few can hear vibrations of frequencies higher than ten thousand per second.

WHAT HAPPENS IN THE SET

Radio waves usually come in frequencies much higher than ten thousand per second, often up in the millions. To eliminate these high frequencies and leave only those of the broadcast music and speech a "detector" is used. This is a device, originally a "coherer" or a crystal, and now a vacuum tube, which will permit current to pass in one direction but not in the other. The vacuum tubes also *amplify* the energy by adding to it some of the power of the batteries or socket-operated units that light the filaments of the tubes and connect with their "plates."

The output current of the receiver is then passed through many turns of fine wire in the phones or loud speaker. While passing through this wire the energy, which is now in the form of "pulsating" direct current, produces motion of the diaphragm of the phone or loud speaker, just as does an ordinary conversation through a telephone. The wires are parts of an electromagnet which causes the diaphragm or cone to vibrate. The vibrations produce sound waves in the air; these strike the ear drums of the listener and he hears a reproduction of the sounds that the musicians or speakers are making at the broadcast station.

This brief description could be made more complete and accurate by the use of technical terms; but, while it is not accurate to the last degree, it may give the novice some idea of what is happening in a radio receiver.

The marvelous power under the control of even a novice who builds a radio receiver is revealed by the statement of a prominent radio engineer, who said recently: "Half a million voices, singing at the same time, would produce only about the same amount of energy as is used in the last tube of a radio receiver."

STRUCK IT RIGHT

TEACHER: "What would make a good ground connection for a radio set on a farm?"

PUPIL: "Well—I think—"

TEACHER: "Correct! You may take your seat."—*Ralph D. Campbell.*

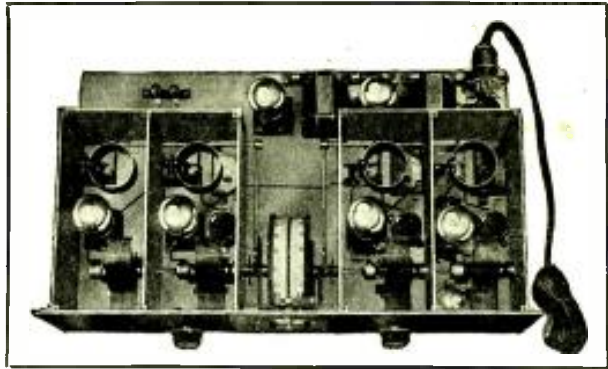

NO ordinary standards can be applied to the Hi-Q Six Receiver, for this CUSTOM-BUILT instrument is not only the greatest radio advance of recent years, but is equally remarkable both in its low cost and in its profit for the thousands of men who are now building and selling it.

First, its circuit is the final expression of three solid years of research and scientific development.

Second, it employs only the very finest parts available, all having been selected for perfect synchronization.

Third, its Automatic Variable Coupling effects even and maximum amplification over the entire tuning range and is one reason for faithful reproduction and *absolute absence of oscillation.*

Fourth, each of its four tuned stages is completely isolated by means of chokes,

by-pass condensers, and heavy aluminum shields. Each stage operates independently, without inter-stage coupling.

Fifth, symphonic audio amplification, plus a power tube, reproduces full, round, natural tones, which are nothing short of a revelation.

Sixth, due to the elimination of the

usual high costs of factory assembly, distribution and selling the Hi-Q Six can be built complete at a cost of only \$95.80 for all parts. The finished CUSTOM-BUILT instrument is unequalled by ready-made sets selling at least \$100 higher in price.

If you want to save at least \$100 on America's finest receiver, or if you want to make big, easy profits CUSTOM-BUILDING the Hi-Q Six, send 25c. now for the fully illustrated and diagrammed Construction Manual.



HAMMARLUND - ROBERTS, Inc., 1182 Broadway, Dept. C, New York City

Associate Manufacturers



Going Like Wildfire—FREE!

Due to the tremendous demand for these sets at our special limited offer and the interest created among radio fans throughout the country necessitates our extending until January 25th, 1928.

Think of it, an \$8.50 value, yours without cost. WHY? The one best way to acquaint you with VOGUE quality is to make our offer so interesting that you just can't resist. Then you'll tell your friends of their marvelous results and your friends will ask their dealer for VOGUE tubes and that's our reward. We only ask that you purchase the 3-201-A of our combination matched set at the regular price of \$1.75 each and the

power and superdetector selling for \$4.50 and \$4.00, respectively, are yours FREE. This beautifully packed set makes an ideal Xmas gift. FULLY GUARANTEED. Dealers write.



X112



X300



Allan Mfg. Co., 102 N. 5th Street, Harrison, N. J.
 Enclosed herewith is \$5.25 for which please send me prepaid one combination matched set.
 Name.....
 Street.....
 City.....

Over 20,000

SOLD TO DATE!

Let me send you a copy If you don't like it return it SEND NO MONEY

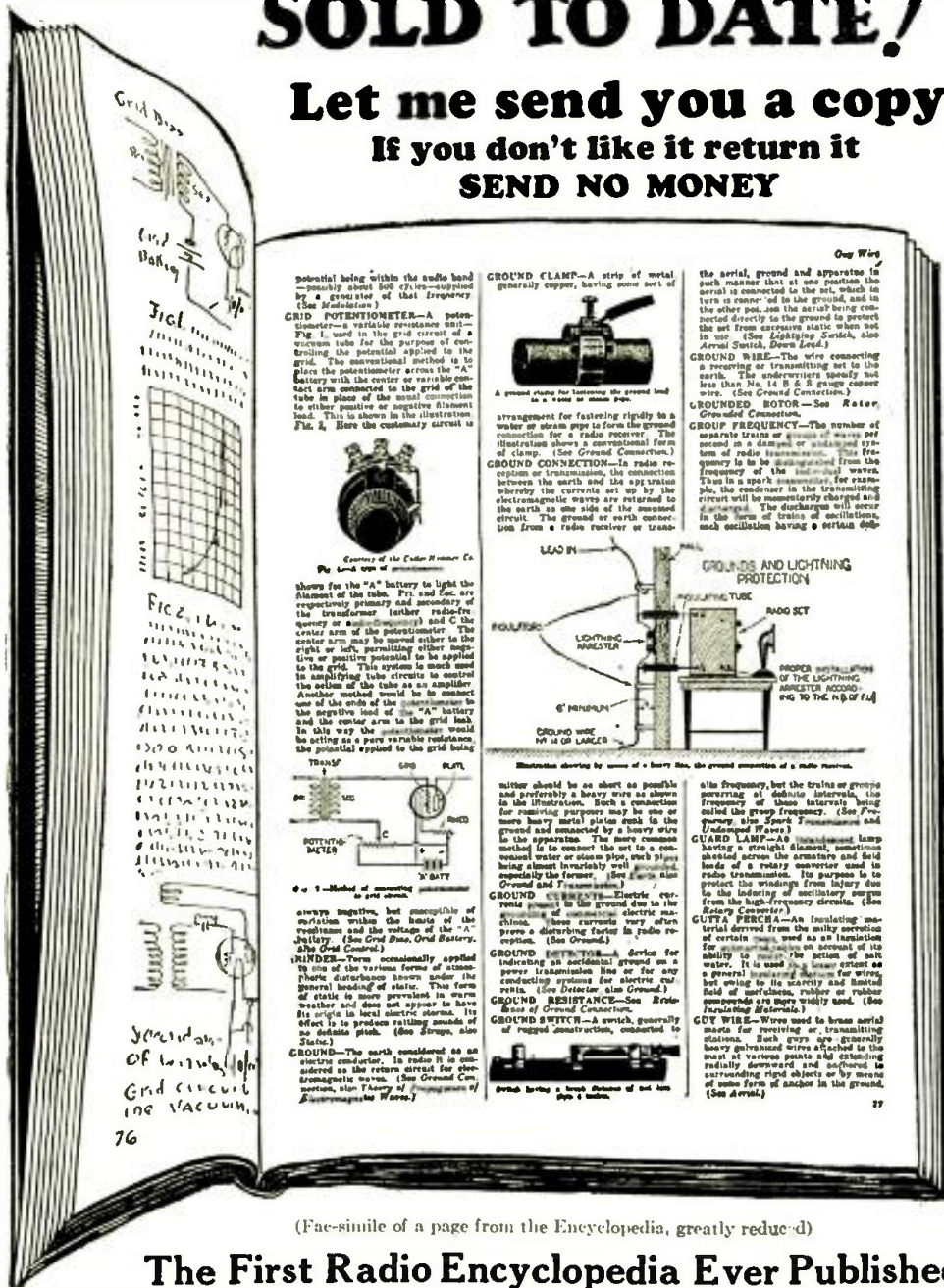

(Fac-simile of a page from the Encyclopedia, greatly reduced)

The First Radio Encyclopedia Ever Published

Edited by **SIDNEY GERNSBACK**, Editor of "Radio Listeners' Guide and Call Book (Radio Review)," Editor of "Money Making," Author of "Wireless Course in Twenty Lessons," "One Thousand and One Formulas," "Practical Electricity Course"—etc.

S. GERNSBACK'S RADIO ENCYCLOPEDIA is the only standard work ever published in America attempting to classify alphabetically the countless words used in the highly specialized science of RADIO. The ENCYCLOPEDIA is written in plain English so that everybody can understand the definitions and descriptions.

No expense has been spared, covering over two years in compilation, to make it worthy a place in your library.

It is published in one volume—168 pages—size 9 x 12 inches, nearly an inch thick and nicely accommodates the beautiful illustrations and the large, easy to read type.

Every page is replete with illustrations—to make the text easily understandable.

The book contains as a supplement a classified

cross-index designed to bring together radio references under one heading having relations in common.

All circuits new and old are described by word and picture and every part and apparatus used in Radio is explained and made understandable by means of photographs and drawings.

The work contains 1,330 definitions, 549 photographs, drawings and diagrams. The volume is printed upon fine paper—bound in full black Keratol, marbled paper fly leaves and end sheets, with the title stamped in gold.

This volume should find a place in every library, and will be a veritable boon to you who are interested in Radio, from any angle.

PRICE \$2.00

SIDNEY GERNSBACK, 230-5th Ave., New York.

Send me one copy of Sidney Gernsback's First Radio Encyclopedia in one volume as advertised. I will pay postman \$2.00 plus postage on delivery.

NAME.....

ADDRESS.....

TOWN.....

REMEMBER THIS IS A REAL ENCYCLOPEDIA—NOT A DICTIONARY—and very few of the things described and illustrated in this volume can be found in any dictionary, or any other encyclopedia.

S. GERNSBACK
230 Fifth Avenue New York, N. Y.

Housekeeping by Radio

(Continued from page 742)

A THOUSAND DAILY INQUIRIES

In these days, when there is so much talk about the falling off of fan mail, the daily bag tagged "Alfred W. McCann" at the WOR studios may be some indication of the response to the morning programs filled with household hints and home entertainment. Mr. McCann, who is a noted food authority, averages a thousand letters a day from women who want to augment the advice they receive on the air with the help they seek by individual letters.

There isn't a phase of woman's work that can't be lightened or systematized by just turning the set dials any day. The novice at the housekeeping game, the woman whose ideas have become old-fashioned through the introduction of new ways and methods, the wife who has lost interest because of the recurrent monotony of daily work that has run into years—all these women can get help beyond any financial remunerative value, simply by listening to what is being broadcast on many wavelengths from all the big broadcast centers of the country.

A wide expanse of vacant territory surrounding a dwelling is not the only condition that doesn't make for isolation. A woman in a crowded tenement district or even a moderately-populated area, who is held close to her rooms or house with the care of her children, the preparation of meals and the cleaning of her home, can be just as isolated from outside interests as her sister on some far-off Minnesota farm.

A few years ago, when Mrs. Julian Heath was organizing women's programs through station WJZ, she decided to hold a pie-making contest and chose one winter morning and the Waldorf-Astoria Hotel in New York as the time and the place. It was quite an experiment. The studio executives were dubious about the response, but Mrs. Heath knew her women listeners and prophesied that many cherry pies would find their way to the exhibition room at the hotel. She was right. From all over several states, by mail and by personal messenger, pie tins filled with successful examples or miserable failures at pie-baking were entered. Nearly a thousand pies lined up on tables gave the judges a stupendous task. Young bride offered their first efforts, while experienced older women proudly entered the confections they had been making for years. Elaborately-decorated pies, flaky pieces, sodden masses, overdone failures were there; but every entry represented the sincere effort of some woman who was interested enough to want to learn, or to show how well she had absorbed the help given her on the air.

That was one of the early gatherings. There have been many since and through other auspices. Ida Bailey Allen has enrolled thousands and thousands of women in her home classes via the microphones of several New York stations. In Chicago, Detroit, Cleveland, San Francisco and other cities, the results have been repeated many times.

Every kind of help needed in the home can be found somewhere in the ether. How to give baby a bath, how to cure Johnny's cold, how to bake a cake or boil corned beef, how to sew dresses or design hats, how to lighten the household burdens through newly-perfected contrivances, how to do the fall canning or the

spring cleaning, how to build up little Mary's failing strength by properly-balanced meals, how to hold down mother's rapidly-increasing weight through the elimination of some of those dreadful calories, how to improve father's disposition by the right home atmosphere, how to make the neighbors jealous of new draperies which can be made effectively if you only know how—these are just a few instances of what an hour a day with the loud speaker can do for the busiest homemaker.

FROM A BUSY HOME

Among the most interesting sample letters from the heavy WEAF files is one from a woman in New York State who wrote that, for fifteen years, she had never been to a large city; that often, for weeks at a time, she didn't get away from her home. This is her story of what radio did for her:

"I am married eighteen years and have six children. We have little money, so I couldn't afford to get help. My husband has a truck farm and he gets to market often, but I can never get away from the house. Sometimes I never see anyone but my own family for a long time. My oldest boy built a radio set; I don't think I can ever tell you how much it has been to me. I didn't pay much attention to it at first until he made one big enough to use a loud speaker with; and since then, no matter how busy I am, I always take time to get the morning programs. I have learned so much on the radio. It is just as good as though I could go down to New York myself, and learn all these things there. I take an interest in my cooking and like to try the recipes you broadcast. The family likes it too and, while they make fun of my listening-in all the time, I wouldn't be without it for the world."

This woman is just one of thousands and her letter differs only in detail from the reaction that most of the morning listeners get. Nor is the interest confined entirely to women. One man wrote to Miss Nagel, at WGBS, that his wife was dead, he had a night job and was taking care of his home and four children but that he had received many practical ideas by tuning in to the first programs of the day. He was wage-earner, cook, house cleaner and nurse to that family, and felt he needed housekeeping advice as much as the women do.

THE TRAGI-COMIC

Of course there are the amateurish blunders, which often bring a laugh in the station mailrooms. One wife tearfully wrote that she had followed a broadcast dinner menu; but that it had been a terrible failure and her husband was so angry with her that he was going to throw the radio out the window.

Then there is the case of four women in one neighborhood who tuned in on a dressmaking lesson on WGBS and all blossomed forth at once in identical gowns which followed in detail the teacher's directions, even to material and trimming!

There's a right and a wrong way of doing the most insignificant or trivial household duty. There's an easier method that can be substituted for nearly every form of household drudgery. Women often have little opportunity to learn of these modern ideas—unless they are brought directly to their kitchen doors—and that's what radio is doing for them.

The men and women who plan the programs for these housewives realize they must have an entertainment value as well as an instructive basis and, while part of each period is devoted to oral teaching of many subjects, there is included intermittent music or humor which helps to

The TEMPLE air column-speaker

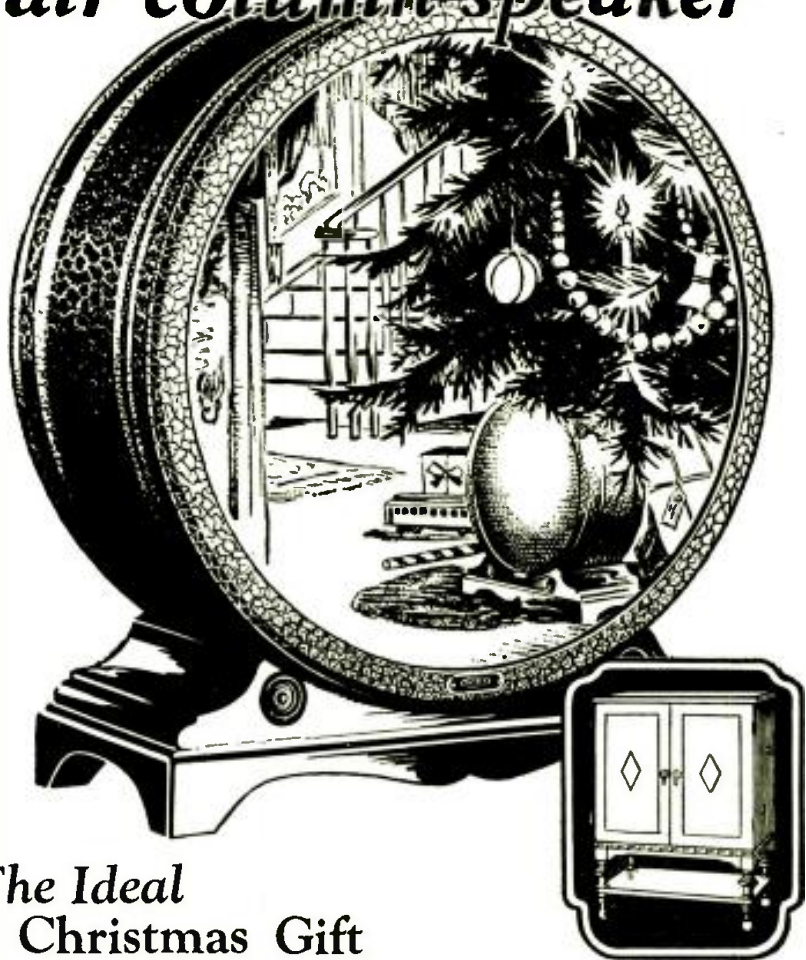

The Ideal Christmas Gift

Radio fans—here's your opportunity to be a real Sa ta Claus—to bring a gift home that the folks can enjoy Christmas Day and every day in the year—a TEMPLE SPEAKER, the ideal Christmas gift. Nothing will give greater pleasure in radio than a TEMPLE—the speaker that has been the sensation of every radio show, the joy of thousands of fans all over the country. Do your Christmas shopping early—buy a TEMPLE, Console or Drum Type Model. Either will bring you a richness and purity of tone reproduction that is far beyond what you ever thought was possible. Ask your dealer for a demonstration on the TEMPLE COMPARATOR.

Temple Models Priced at \$29.00—\$48.50—\$65.00—\$85.00

TEMPLE, INC., 213 S. Peoria St., Chicago

The Best Radio
Made

Is Only as Good
as Its Speaker

NOT A



CONE

WE ARE operating complete service laboratories. Repairing and reassembling all sets to bring them up to the 1928 model and guarantee your set to work equal to any new set. All sets are tested in sound-proof shielded room which enables us to make this guarantee and a low price for repairing. We custom build superheterodynes of the same parts specified by their designers. Free of charge to those buying kits from us.

New Remler 1928 Infradyne	\$180.00	Popular Mechanics Economy Nine.....	\$ 61.85
New Improved Nine-in-Line	127.00	Victoreen Circuit	110.00
Camfield Super Selective Nine	124.00	Tyrman Ten	142.00
Melo-Heald Hot-Spot	150.00	World Record Super Ten	137.00
Lincoln Super Receiver	110.00	Silver Marshall Eight-Tube Super	90.00
Thomson Super Seven	79.30	Aero Seven Receiver	59.55
Eight-in-Line Super	126.10	Stroboddyne Receiver	129.97
M-S Eight Portable Super	82.50	Hazeltine Neutrodyne	39.60

These or any other superheterodyne circuit will be built free of charge at the above prices. Set builders and dealers get our surprisingly low prices on all super kits and parts. Whatever you want we have. The above kits are complete.

DETROIT RADIO LABORATORIES, 2506 Park Street, Detroit, Mich.

PATENTS Protect your inventions and Trade-Marks today. Write for illustrated patent book and sketch sheet and forms free. BRYANT and LDWRY, 314 Victor Bldg., Washington, D. C.

EVERYTHING IN RADIO AT ATTRACTIVE PRICES. SETS OR PARTS. Orders shipped exactly as ordered. Prompt Service. Write for Prices. Mail Order Only. Send Your Address. ALL RADIO COMPANY, 417 North Clark St., Chicago

ARISTOCRAT

"The Speaker of the House"

BECAUSE the Aristocrat is a lamp of such rare beauty is no reason to believe that the mechanism of the unit is not equally perfect. On the contrary, there is an even match; a very judicious combination for every home.



Trade Mark Reg.
U. S. Pat. Off.

\$37.50

Prices slightly
higher west of the
Rockies.



Every Unit is
non-adjustable,
and **GUARAN-
TEED** if seal is
not broken.

U. S. and Foreign
Patents Pending

Add beauty and bring Christmas carols into your home with
ARISTOCRAT—"The Speaker of the House"

ARISTOCRAT CORP. OF AMERICA, One Fifteen West Twenty-third Street, New York, N. Y.

lighten the morning duties. Mrs. Jones turns on her set, hears a peppy pianologue or an inspiring vocal number, and is quite in the humor for her work. Then she gets her pencil and paper and take down notes on how that work can be made different and easier. These classes on the air bring the schoolroom to her and make learning such an entertaining activity that she takes a joy in absorbing new household knowledge.

One station, which was dubious about the reception its morning periods were getting and about the importance of these hours, made an air canvass of its listeners. As a result of the response, it not only retained the old features but added some new ones. There's no doubt in any metropolitan station about whether women listen in during the morning. They do, and how!

A Phonograph Amplifier

(Continued from page 779)

"antique" device in the system is the spring motor of the phonograph. Though the preferred arrangement, for an A.C. operated phonograph, includes the use of an induction motor to operate the turntable, such motors of the proper size are rather difficult to obtain. Most phonograph dealers, however, stock excellent motors of the universal type, which, as they are run only when the radio receiver is not in operation and will therefore cause no interference, are entirely satisfactory. Such motors cost from \$15.00 to \$30.00, depending upon the type. Generally an allowance is made for the old spring motor if it is turned in at the same time.

If the spring motor is retained in the phonograph, then the amplifier should be so placed that the rectifier and power tubes, which become quite warm in operation, are at one side and not directly under the motor; for such placement might result in the melting of the graphite in which the spring is packed.

If the spring motor is replaced by an electric drive, then, of course, no thought need be given to the location of the amplifier.

CONSTRUCTING THE AMPLIFIER

If the builder will carefully study the several accompanying pictures, diagrams and drawings of the complete amplifier little difficulty should be encountered in its construction.

The soft-steel base plate may be either prepared at home or constructed by a local machine shop. The name "steel" seems to scare many home constructors who think nothing of drilling their own bakelite and even brass panels. They have a surprise in store for them when they find out just how easy it is to drill, file, and saw a piece of soft steel.

The plate may be finished with enamel, crystal lacquer, or just polished and varnished. It should be given some kind of protective finish, however, to prevent it from rusting. After the finish has dried, the different holes should be retapped, so that the mounting screws will automatically ground the cases of the various component parts.

The wiring should be neatly done with a flexible tinned wire having a high-voltage insulation. When the wiring has been completed, it should be bound together with a waxed thread into cable form. Extreme care should be used, when passing wires through holes in the base plate.

THE GROUND CONNECTION

A ground connection to the negative side of the filter circuit is highly desirable. In most instances this may be obtained through

50c Everywhere

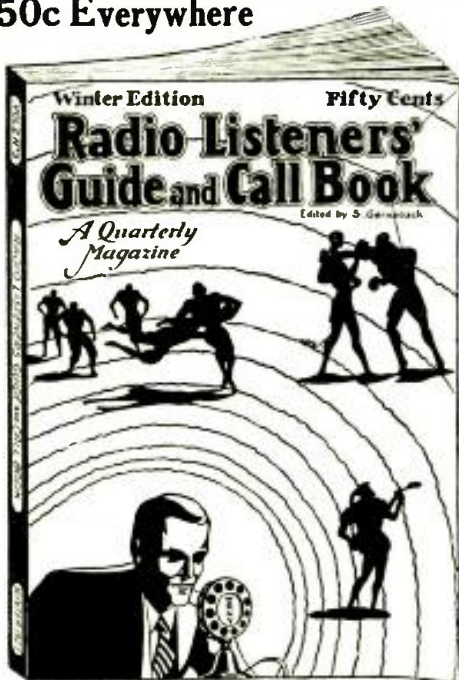

**The
Greatest
of All Popular
CALL BOOKS**

*No Other
Popular
Call Book*

compares
*in completeness
and convenience to*

Radio Listeners' Guide and Call Book

THERE is little difference in price, but a *big difference* in the quality and usefulness of Popular Call Books.

In presenting this most valuable of all books for every owner of a Radio Set, RADIO LISTENERS' GUIDE has emphasized its section devoted to the listing and information of Radio Stations.

This information is more complete and presented in a clearer and better arranged manner than in any other Popular Call Book.

If you wish to know the Letters, the Wave Length, the Power, the Location, the Ownership of any Broadcast Station in the United States, Canada or Foreign Countries, you will find them all in "RADIO LISTENERS' GUIDE and CALL BOOK," and so conveniently and completely that you will be amazed.

There is also a large portion of RADIO LISTENERS' GUIDE devoted to new circuits, apparatus and helpful hints for set owners.

116 pages in all, hundreds of illustrations, all Radio Information.
Beautiful Colored Cover. Size 9 x 12 inches.

50c.—Only—On All Newsstands

OR ORDER DIRECT

CONSRAD CO., INC., 230 Fifth Avenue, New York City

a 2-mf. condenser to one side of the 110-volt line. The 110-volt line connections may have to be reversed to see which way is best. This is readily accomplished by merely plugging into the lamp socket, or base outlet, first one way and then the other.

It is also desirable in some instances to ground the case and supporting arm of the pick-up; also to try reversing the leads from the pick-up to the amplifier.

Freedom of the Air

(Continued from page 746)

I believe in some mild form of private censorship. That seems necessary. The broadcaster, however, must, within due bounds, select what shall or shall not go over his microphone. But he must, like every newspaper man, edit, and not censor. He should permit the radical, the liberal, the orthodox, the modernist, the fundamentalist, the conservative—all to express their views. He could and should taboo speakers who are bores or bores. It must be remembered, though, that radio is not limited to parlor entertainment. It is bound to be used for the widest possible discussion of mooted topics. The radio fan is not compelled to listen. That's his remedy. He can tune off and hunt for something more to his liking; but "if a scientist speaks on evolution, it is better to let the radio users in Tennessee tune out than to muzzle the scientist;" otherwise free speech in radio is meaningless.

Congress carefully avoided censorship in the radio bill. It prescribed only that all candidates for political office have equal radio opportunities; so that if the radio facilities are offered, for example, to a Republican candidate for congress, the same facilities would have to be open to his Democratic or Socialist opponents. In the discussion on the bill private censorship was barely considered. Apparently, we of the congress did not anticipate some of the clumsy methods of private broadcast stations. Surely Government censorship is far better than some of the private censorship indulged in by a number of mealy-mouthed broadcast station managers. The cure seems worse than the disease. Let the broadcasters put their thinking caps on. Let them clean house; otherwise congress will at the next session.

I don't presume to be able to solve these vexatious problems, but there are several inescapable principles that should govern in the discussion of this matter. First, the broadcaster has received a franchise and the operations over his station are not unaffected by public interest. Second, consequently the public cannot be hornswoiggled out of its rights in that regard, and this includes the right to hear both sides of a question, as well as the right to hear the truth, no matter whom or how it hurts.

I have no ready made remedy that will be a cure-all for the difficulty. I desire, however, to make certain suggestions which might be helpful:

RECOMMENDATIONS

(1) Every station should keep a log or record of all matters of importance that happen at the station, including all protests; and, wherever possible, there should be deposited in the station copies of all speeches delivered. Section 4, subdivision 1, of the radio law gives the radio commission power to insist upon such a record being kept; but I do not believe as yet any orders have been made by the commission to compel stations to comply therewith.

(2) A radio station which contracts to broadcast a certain dinner, function or occasion, either free or for profit, should be

Hundreds of thousands of owners of General Electric Battery Chargers now have peppy radio batteries - always



5-Ampere
Tungar



G-E Trickle
Charger

\$10.24 \$14.

Keep your radio set ready—at all times—for all the good things that come over.

Just turn on Tungar (the name of the General Electric battery charger) at night, leave it as you would the light in the hall . . . in the morning your storage batteries are pepped up and ready for active duty.

More than 1,000,000 G-E Tungars are in use today. For the Tungar long ago established its reputation for dependable, trouble-free, economical service.

Your dealer can help you. Ask him to show you the popular 2-ampere Tungar that gives both trickle and boost charging rates. It charges "A" and "B" radio batteries and auto batteries, too.

Tungar causes no radio interference. It cannot blow out tubes.

An overnight charge costs a dime.

It is a G-E product developed in the Research Laboratories of General Electric.

The 2- or 5-ampere Tungars charge 2-, 4-, and 6-volt "A" batteries, 24- to 96-volt "B" batteries in series; and auto batteries, too. No extra attachments needed.



Tungar

REG. U.S. PAT. OFF.

BATTERY CHARGER

Tungar—a registered trademark—is found only on the genuine. Look for it on the name plate.

New Low Prices
(East of the Rockies)

2-ampere Tungar, now \$14
5-ampere Tungar, now \$24
G-E Trickle Charger, now \$10

Merchandise Department
General Electric Company
Bridgeport, Connecticut

GENERAL ELECTRIC

NEW SUPER MACK SPRING AERIAL



Dealers and
Jobbers Write
for Our
Proposition

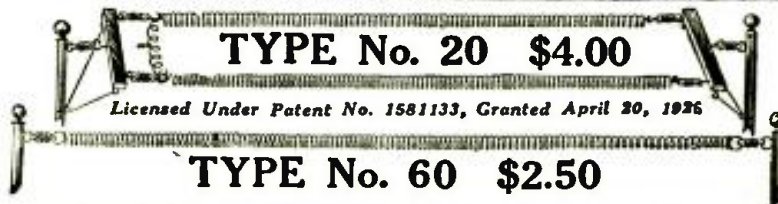

TYPE No. 20 \$4.00

Licensed Under Patent No. 1581133, Granted April 20, 1926

TYPE No. 60 \$2.50

GUARANTEED TO IMPROVE DISTANCE RECEPTION ON ANY SET IN ANY LOCALITY
EASY TO ERECT

No. 20 for 20 to 60 ft. stretch
No. 60 for 60 to 125 ft. stretch
Better looking and more efficient Antenna, built to fit your roof, having two to five times as much capacity, four to ten times as much induction, greater selectivity and omni-directional reception.
If your dealer cannot supply you, send check or money order direct. **MACK CO., Inc.** 44 North Fourth Street PHILADELPHIA, PENNA.

Insure your copy reaching you each month. Subscribe to Radio News—\$2.50 a year.
Experimenter Publishing Co., 230 Fifth Avenue, N. Y. C.

All About Electrification and "How to Build" Latest Apparatus Explained in New Book

What is Electrification? Why is it now being used on all modern Receivers? How can it be adapted to my set? How can I *build* a satisfactory unit to electrify my set?

All these questions and more are simply, fully and practically answered in the newest, latest and most complete book on Electrification "HOW TO ELECTRIFY YOUR RADIO RECEIVER."

The book is illustrated with drawings and photos of electrical units and parts. It is 6 x 9 inches in size and bound with a special hand-drawn 2-color cover.

Get your copy now and enjoy the benefits of steady, unvarying power at any voltage for your Radio.

ON
ALL
NEWS-
STANDS

25c THE COPY EVERYWHERE

If your dealer cannot supply you, write direct

THE CONSRAD CO., INC., 230 FIFTH AVENUE
NEW YORK

compelled to broadcast the entire program, even though the station objects to the views of one or more of the speakers; provided, of course, that the matter broadcast is not unlawful, obscene or slanderous. Having struck a bargain it must abide by it. It cannot summarily cut off a speaker either because he wears a red necktie or doesn't like baseball or has divorced three wives. WJZ, for example, had contracted to broadcast the thirtieth anniversary of the Jewish Daily Forward at the Century Theatre. The ex-premier of Great Britain, Ramsay MacDonald, who was scheduled to speak, became ill and Congressman Victor Berger, Socialist, was called upon instead. WJZ allotted fifty-five minutes; before the time was up the button was pressed and Berger was off the air, and a church vesper service was substituted. That method of private censorship and failure to abide by an arrangement is quite drastic and unfair, let alone unsportsmanlike. It is just the kind of censorship that has brought the radio stations into bad odor.

(3) In applications for renewal of licenses the radio commission and the department of commerce should take into consideration the liberal or illiberal attitude of the station anent broadcasting both sides of a controversy and the fairness with which programs are selected. For this purpose the log or record of that station shall always be open to the inspectors or accredited officers of the radio commission and department of commerce.

(4) Each station should permit two or three or even more hours per week for discussion of controversial, political and social issues. These hours could be designated either in the morning, afternoon or evening, at the option of the station. Mr. M. H. Aylesworth, president of the National Broadcasting Company, recognizing that his company, in operating WJZ and WEAJ as well as a chain of stations across the continent, has franchises that carry certain duties to the public, promises to permit his facilities to be used so that both sides of any perplexing problem may be heard. Bravo, Mr. Aylesworth, that is the right spirit! Let each radio station follow suit. We hope, however, that Mr. Aylesworth will suit the action to the word.

PROBLEMS OF LIBEL

(5) Our laws of libel and slander may have to be modified to suit peculiar radio conditions. In the case of a newspaper publishing a libel there is strict accountability. That arises from an uncontrolled right to reject or accept the matter to be put into the paper. If you give the broadcaster less control over his program, you must to that extent limit his liability for damages for slander. The publisher can see the written word before his paper prints it, and can thus adequately protect himself and omit libelous matter. The broadcaster, with reduced power of rejection, cannot anticipate what a speaker will say. He may not be able to prevent the slander.

Slander, in general, is verbal defamation of character, libel is written defamation. Libel is more serious, since written; the written word is permanent and may be indelible; it can be circulated more extensively than the spoken word, and requires more deliberation, and thus it does more damage. The spoken word dies as soon as it is uttered. But slander over the radio may be far more damaging than libel in a newspaper. The newspaper will reach less than half a million people, but the radio will reach millions of people. That danger, therefore, calls for extra vigilance on the part of the station owner; it must of necessity temper the demand to limit his control of his program and his speakers. These rather fine adjustments of responsibility for what is said over the radio will have to be made. Within the next few years the courts will be compelled

to render decisions and probably change the old ideas of slander and libel. I lay down no rule, but offer these observations for whatever they may be worth.

(6) There should be set up a sort of advisory council or committee in every broadcasting station. The membership thereof should be drawn from men of recognized ability and of standing in their respective communities. All sects, creeds and shades of political and civic opinion should have representation. This advisory board or council could advise with the station owner as to the nature of his programs. This is the method adopted in France. It does away with a bureaucratic control and censorship by the station owner. It recognizes that the public has an interest and, in a way, a sort of ownership in the station.

In conclusion, permit me to quote portions of the classic concurring opinion of Mr. Justice Brandeis, in the famous California Criminal syndicalism act, just recently held constitutional by the United States Supreme Court. It would be most helpful to have all the station managers read the following from that opinion:

"Those who won our independence believe that the final end of the State was to make men free to develop their faculties; and that in its government the deliberative forces should prevail over the arbitrary. They believed that discussion affords ordinarily adequate protection against the dissemination of noxious doctrine; that the greatest menace to freedom is an inert people; that public discussion is a political duty; and that this should be a fundamental principle of the American government."

Consider the Radio Public

(Continued from page 747)

interest. I do sincerely believe, and know, that there is not a station of the first class in the country that will not give every faction a chance to broadcast on any major issue.

Before election, for instance, practically every station throws its doors wide open to every political faction, whether Republican, Democratic or otherwise. In religious matters, it is the same way. For instance, this station—WRNY—has always encouraged all political parties to use its station on any important public questions, and they have always availed themselves of this opportunity to broadcast. WRNY has broadcast talks from practically every religious denomination, Catholic, Protestant, Jewish and even Mohammedan.

DECENCY IN SUBJECTS

But when it comes to the point of permitting a speaker belonging to one church to assail another church over this station, the manager would certainly be within his rights to censor such a talk; because, in the public opinion, it would be in bad taste. There have been stations which would not be so particular in such cases; but they could not be classed as first-class stations, and paralleled the yellow papers in that respect.

To carry this thought further, particularly referring to the public's rights, I might ask the question, "Do the public's rights include the broadcasting of speeches on subjects that are decidedly in bad taste?" I believe not. This station, WRNY, has censored a number of talks that were to be put on the air, and feels that a station is fully within its rights to do so; and I'll cite you an example. Not so long ago, a former manager of this station undertook to broadcast a series of talks by Mrs. Aimce Semple MacPherson. The owners of the station promptly refused to let her go on, not with the idea that the manner in which Mrs. MacPherson would present her talks might have been unfit to

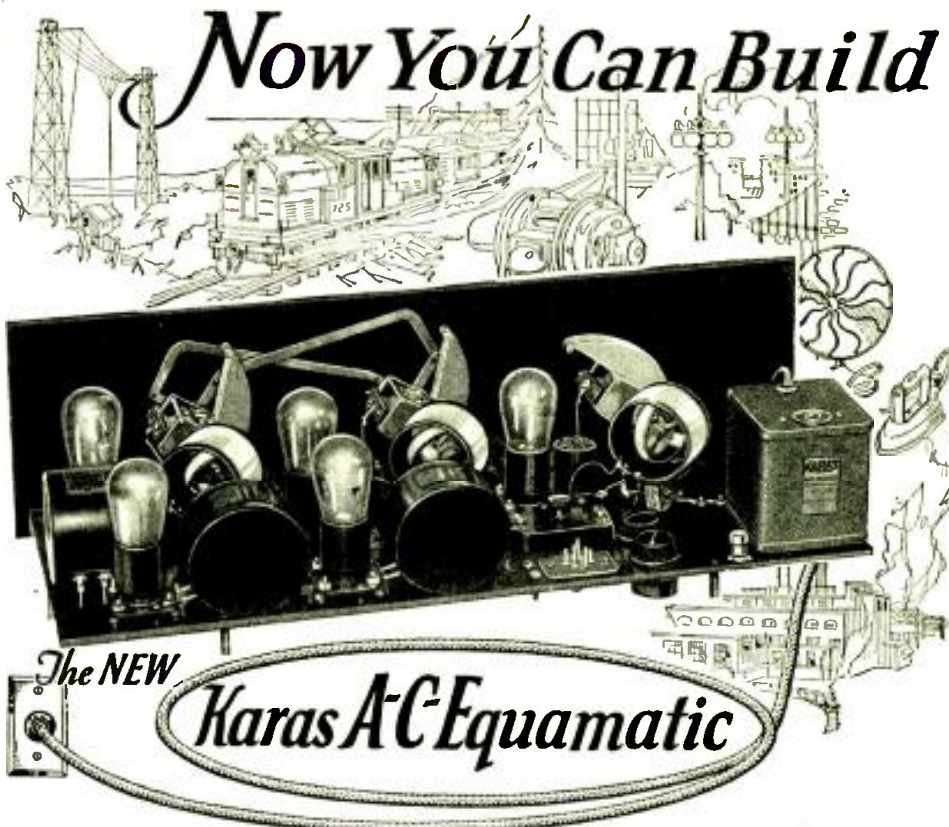

It operates from any 110-volt house lighting circuit!

THE NEW KARAS A-C-EQUAMATIC is the only completely balanced and perfectly neutralized 5-Tube A.C. Kit using standard Cunningham R.C.A. or CeCo 1½ volt, 2½ volt, and 5 volt A.C. tubes. All of the "A" filament supply for this marvelous new set is furnished by the new Karas A-C-Former Filament Supply, Type 12. Those who build this great receiver will have a set that is two years ahead of them all!

The Karas A-C-Equamatic does away with all need for "A" batteries and chargers, the Karas A-C-Former providing a constant, noiseless and unvarying filament supply of correct potential for each of the A-C Tubes used in the set. And this accomplished without the sacrifice of a particle of the matchless tone, remarkable selectivity, splendid distance-getting qualities and tremendous volume for which the Karas 2-Dial Equamatic has become famous.

The Karas A-C-Equamatic is the perfected product of the Karas Engineering laboratories, utilizing Karas parts in association with other standard parts of the Affiliated Manufacturers who have cooperated with Karas to make this great receiver what it is—the A-C-E of A-C operated sets. Because of this fact you will find this receiver extremely easy to build. It utilizes a Type 227 or 327 2½ volt A. C. detector tube, three Type 226 or 326 A-C 1½ volt amplifier tubes, and a Type 171 or 371 5-volt output amplifier tube, all receiving their current supply from the house lighting circuit through the Karas A-C-Former Filament Supply.

Build this great receiver! Enjoy its freedom from "A" Battery and charger troubles! Enjoy its tone, its volume, its selectivity and simplified control. Write us TODAY for full size wiring diagrams and complete instructions, which we mail FREE on request. Begin to build this matchless A-C-Equamatic right away.

Karas Electric Company
PRECISION ELECTRICAL APPARATUS
4038-A North Rockwell Street · Chicago

Six tubes - One Control
FRESHMAN MASTERPIECE
Sold by Authorized Freshman Dealers Only

INTERESTED IN —
Aviation, Biography, Economics, Education, Engineering, Fiction, History, Mathematics, Languages, Music, Radio or Science
We have hundreds of books covering these fields at actual price reduction ranging from 25% to 60%. Latest up-to-date editions. Regular bindings. All complete and identical to those sold at any bookstore.
Write for Big Book Bargain Bulletin No. 5
EXPERIMENTER PUBLISHING CO., Inc.
230 Fifth Avenue, New York, N. Y.

REL

YOU CAN GET QUICK SHIPMENT

ON ALL STANDARD PARTS AND KITS, INCLUDING THE LATEST

HI - Q6 - Strobodine - LR4

SEND FOR R. E. L. HANDBOOK AND DISCOUNT LIST

RADIO ELECTRIC LACAULT LABORATORIES
1931 BROADWAY NEW YORK CITY



Ida C. Bailey Allen

International
 Authority
 Presents
the Greatest
 Cook Book
*America Has Ever
 Seen!*

—in which is presented 2500 complete recipes usable by anyone that reads, including the plain and the fancy, the inexpensive and the expensive, the modern and the old fashioned.

ALSO

—extremely valuable time and money saving information on purchasing of foods, dieting, Feeding of children, Vegetarian Menus, Seasoning, table settings, using left overs, Feeding the sick, Foreign dishes, Church and Club Suppers, Outdoor Meals, Canning and Preserving, etc.

REGULAR PRICE \$2.25
 SPECIAL OFFER at \$1.98

2500 RECIPES 1001 PAGES

Use this Coupon

CONSRAD CO., Inc.,
 230 Fifth Ave., New York, N. Y.
 Gentlemen: I enclose \$1.98; please send me one copy of Ida Bailey Allen's COOK-BOOK.

NAME.....
 ADDRESS.....
 CITY.....STATE.....

broadcast, but rather in the belief that the speaker in question had already sufficient notoriety and publicity, and that most people would object to listening to her broadcasting. It was also known that nothing new was to be presented; so why broadcast it?

It is to the credit of every broadcaster in the city of New York that Mrs. MacPherson was not allowed to broadcast over any New York station. This is only one example. Many other similar cases could be cited.

I want to comment on one of Congressman Celler's helpful suggestions that every station should keep a log or record of all matters of importance that happen at the station. May I point out to him that every first-class station does so, as a matter of routine? A careful log is kept of all such matters; but, of course, not every talk is taken down stenographically. The expense of this to the station would be tremendous, and it is well known that there are few stations in existence today that are making money.

TIME WAITS FOR NO SPEAKER

Congressman Celler states that a radio station which contracts to broadcast a certain dinner, function or other occasion, either free or for profit, should be compelled to broadcast the entire program, even if the station objects to the views of one or more of the speakers. In answer to this, may I voice the opinion that, in 99% of the cases, the station does. But why should a station broadcast the entire banquet or dinner? Not even the sponsors of the banquet or dinner demand this.

As a rule, only the important speeches from important speakers are broadcast, if for no other reason than that it is most tiresome to listen in to a lot of speechmaking. As a rule, stations try to limit all speeches to fifteen minutes. Once in a great while, on a special occasion, an hour may be consumed in broadcasting a banquet or a dinner; but I think every one is agreed that this is the absolute effective limit, because listening in to talks from broadcast stations is at best difficult. The present state of the air due to interferences, tube noises and other imperfections, make it often impossible, even with the best of sets, to catch all the words distinctly.

Then, another important consideration arises, and that is, that stations nowadays must try to attract enough income to meet their expenses, if possible. They often have commercial features booked that simply must go on the air and, if a speaker runs beyond his allotted time, it may become necessary to cut him off before he gets through. No discourtesy is meant, and no broadcaster likes to do such a thing; but in the very nature of things, it cannot always be helped. Often, the broadcaster goes out of his way to accommodate a speaker and usually does so, unless another important function or feature must start at the advertised time.

For instance, at this station only a few weeks ago, Mrs. Franklin D. Roosevelt and Mrs. Charles H. Sabin were scheduled to broadcast a political debate. Mrs. Roosevelt was delayed for twenty minutes, during which time the station was forced to stand by with piano solos till Mrs. Roosevelt arrived; the program, in consequence, ran twenty minutes late. Although the station would have been within its rights to cut the discussion of both sides short, it sacrificed part of another important program in order to see the debate through; because it felt that the public was interested. These are some of the problems of broadcasting, which are not always understood by the outsider, but are vital to the broadcaster himself.

Congressman Celler states that each station should permit two or three or even more

RADIO DOCTORS
 Trade Mark
 WANTED—One representative to every 10,000 population in U. S. and Canada to service sick receivers. Technical and practical data furnished on all types. \$7 to \$10 spare time evenings. \$50 to \$150 weekly after short training period. Send for booklet No. 28.
 CO-OPERATIVE RADIO DOCTORS
 131 Essex St. Dept. M Salem, Mass.

Your Next "B"
 Power Supply
 had Better be
 The NATIONAL BETTER "B"
 NATIONAL CO., INC. MALDEN, MASS

MUTER AUDICHOKE ELIMINATES
 "MOTORBOATING"
 New Complete Audio Frequency Choke Unit prevents feed back through the common "B" supply—thus eliminating shrieking whistles, howling, "Motor-boating" and other troubles due to audio frequency regeneration. Eminent—inexpensive. Write today for full details and catalog of Muter Complete Quality Popular Priced Line.
 LESLIE F. MUTER COMPANY
 76th & Greenwood Avc., Dept. 827-A, Chicago, Ill.

JEWELL WRITE
 For Our 32 Page
 Radio Instrument Catalog
 No. 15-C
 JEWELL ELECTRICAL INSTRUMENT CO.
 1650 Walnut St. Chicago

Insure your copy reaching you each month. Subscribe to Radio News—\$2.50 a year. Experimenter Publishing Co., 230 Fifth Avenue, N. Y. C.

hours per day for the discussion of political and social issues. This is impossible at the present, because it would be economically suicidal as far as the stations are concerned. In the first place, no station is anxious to have too many talks, for they drive away the listening public. Second, practically all discussions and controversies, political and social issues, are broadcast gratis. Inasmuch as the stations are already losing a good deal of money, they would be in a sad plight, if they had to be burdened with a great quantity of such matter. And anyway, why should a broadcaster be asked to do this, when newspapers are not forced to publish each and every political speech, important or unimportant?

Congressman Celler admits that our laws of libel and slander may have to be modified to suit peculiar radio conditions. This seems a clear admission that there must be some form of censorship for radio. If everything that came along were to be broadcast, the usefulness of a broadcast station would be seriously endangered; because, first of all, the station would find itself with hundreds of lawsuits on its hands, and secondly, no one would listen to the station any further. It is fully admitted, by every thinking individual, that broadcasting is not perfect; but neither is the best newspaper in the country, nor for that matter is anything else. Present-day methods can be improved a good deal in all lines.

Give radio a chance to work out its own salvation and trust to the common sense of the broadcasters. Being human, they will never be perfect, even if there were the most rigid censorship, but they may be counted upon to do the right thing in the overwhelming majority of cases.

IMPROVING THE TONE QUALITY OF EXISTING SETS

GOOD tone quality is fundamentally a matter of good design. However, the tone quality of the old-style radio set, with its small and inefficient transformers, may often be remarkably improved by one or more simple and inexpensive changes.

First of all, substitute a power tube for the usual 201A tube in the last stage. This is essential, for tube overloading is a common source of distortion. A 171-type tube is preferable, but a 112-type may be used. Be sure to employ the proper "C" battery or grid bias, as specified for the tube.

The next step is to provide a speaker filter, comprising a 30-henry choke and a 4-mf. 400-volt filter condenser. This prevents the direct-current component from flowing through the loud-speaker windings, protects the magnet, and, sometimes, improves volume as well as quality. A .002- to .006-mf. fixed condenser should be placed across the loud speaker, to lower the apparent tone and to reduce static "background."

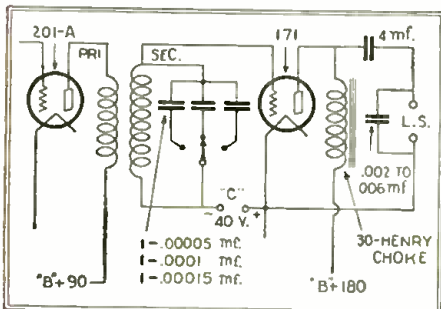

A simple tone control.

Lastly, a tone—not a volume—control may be made up of three condensers of .0005-.0001-, and .00015-mf. capacity, respectively, with a three-point switch as shown in diagram, shunted across the secondary of the second transformer. This will permit of sharpening or dulling the tone of the radio rendition, in a most pleasing manner.

Amazing NEW Ground Antenna

Gets Everything but Static!

Brings in Far Away Stations Loud and Clear Regardless of Static Conditions

Fans everywhere are replacing their troublesome and static gathering up-in-the-air aeriels with the marvelous new (GROUND) ANTENNA—Aer-O-Liminator. Radio engineers and hundreds of users testify that Aer-O-Liminator gets better long distance reception, almost unbelievable freedom from outside noises, far greater selectivity and marvelously true, clear sweet tone quality.

John E. Christenson, Radio Engineer, Chicago, writes: I have tested and thoroughly approve the Aer-O-Liminator. I find it increases selectivity and volume without distortion, practically eliminates static, gives good clear tones, both on local and distant stations. I would recommend the use of the Aer-O-Liminator to every radio owner to get the best reception from his set.

FREE TRIAL

Make this thrilling test at our risk!

Install an Aer-O-Liminator (Ground Antenna). Leave your old overhead aerial up. Try out on a night when static is bad. If you do not get a wonderful improvement in freedom from static, greater selectivity and clear sweet tone without interfering noises. If you can't get good reception on stations that are drowned out by static on your old aerial, you need not pay us a red cent for this test. Send coupon at once for scientific explanation of Aer-O-Liminator (Ground Antenna) proof of performance and our conclusive iron-bound guarantee and remarkable Free Trial Offer—Mail Coupon TODAY!

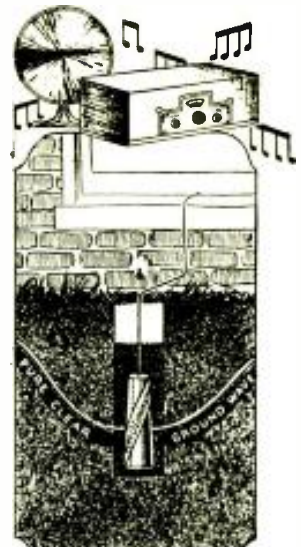

EASY TO INSTALL
Just dig a small hole about 6 inches in diameter and drop Aer-O-Liminator into it.

Aer-O-Liminator (Ground Antenna)

Endorsed by Foremost Engineers and Dealers

CURTAN MFG. CO.

154 East Erie Street
Dept. 827-A Chicago, Ill.

Rush This Important Coupon

CURTAN MFG. CO.,
154 E. Erie St., Dept. 827-A,
Chicago, Ill.

Please send me at once complete description of Aer-O-Liminator, with details of guarantee, Scientific Proof, and FREE TRIAL OFFER.

Name.....
Address.....
City.....
State.....

FREE WHOLESALE RADIO CATALOGUE
The Book they are all talking about

WHOLESALE RADIO CATALOG

Listing thousands of items in standard radio parts, Kits, Accessories, Complete Sets, Furniture, etc. Every Set Builder and dealer should have a copy. Real wholesale prices. Send for your copy today.

THE HARCO COMPANY
1257 So. Wabash Ave. Chicago, Ill.

The HARCO CO. 1257 So. Wabash Ave. Chicago

D-X RECORDS SHATTERED BY MAGNAFORMER 9-8

K. G. Ormiston's remarkable feat of getting Japan and Australia on the loud speaker—spanning 6,000 to 9,000 miles with a Magnaformer 9-8 home-made receiver—shatters all D-X records. Another fan logged 43 D-X stations in 2 hours. A Mexican got the States and Canada. A Mass. fan logged 5-NO, New Castle, England, and a Detroit fan picked up San Paulo, Brazil. Write Radiart Laboratories, 1010 Ass'n Bldg., Chicago, NOW for complete instructions FREE, and build this super-powerful set. It has marvelous tone quality.—Adv.

SPECIAL PRICES ON PARTS

Write for special prices on all parts. Orders shipped same day exactly as received. Send for literature, Dept. N.

NORTH SHORE RADIO LABORATORIES ASSOCIATES I. R. E.
6902 North Clark Street Chicago, Ill.

BOSCH RADIO Includes five A.C. tube models, five standard tube models—"A" and "B" Power Units, Cone-Type Reproducers, and Phonographic Pick-up device.

AMERICAN BOSCH MAGNETO CORP.
Springfield Massachusetts

1 ONLY FOR EIGHT

Brilliant Novels

in BOOK FORM

YOUR CHOICE of EIGHTEEN POPULAR TITLES

SENSATIONAL BOOK OFFER

EACH novel complete in a 144-page 5 1/2 x 8 book set in large, readable type and profusely illustrated with scenes from the film. Greatest book value ever offered. If you have seen the pictures, the fast moving, brilliantly written stories will thrill you. If you read the books first, you will find greater pleasure still in seeing the characters live for you with your favorite stars. This is the most sensational book offer this season. It may never again be repeated. We expect thousands of requests for these books. Place your order now to insure prompt delivery. Below are given 18 titles, of which you may choose any 8. Clip the coupon below and enclose \$1.00, mentioning the books you desire, and we will send them to you at once postpaid.

HERE ARE THE TITLES!

1. New York	7. The Dixie Flyer	13. The Road to Mandalay
2. Campus Flirt	8. The New Klondike	14. Tracked by the Police
3. Almost a Lady	9. Forbidden Waters	15. Tell It to the Marines
4. The Love Thief	10. Sensation Seekers	16. What Happened to Jones
5. Les Miserables	11. The Rambling Ranger	17. The King of the Jungle
6. That's My Baby	12. Don't Tell the Wife	18. The Cat and the Canary

Place Your Order While the Supply Lasts

What's New in Radio

(Continued from page 759)

of the speaker coils and magnets is greatly lengthened.

The output filter is provided with speaker cords attached to its input binding posts, and for this reason it may be connected outside the set without making any changes in the wiring. The two "input" binding posts are connected by the cords to the speaker binding posts of the set, and the loud speaker is connected to the two binding posts marked "output." On the other hand, if it is desired to build the output filter into the audio amplifier, the speaker cords may be removed.

The audichoke, which is also shown in the illustration, is designed especially for use in resistance- or choke-coil-coupled amplifiers. When properly used it will reduce the "motorboating" effect usually experienced when amplifiers of this type are operated from socket-power units. For best results, one unit must be connected in the plate circuit of each audio-frequency tube and of the detector tube.

The unit, when connected in the circuit, inserts a choke coil in the plate-supply lead and a by-pass condenser between the audio transformer and the negative "B" battery wire. This prevents coupling between the various stages of the receiver, which might otherwise take place through the plate power supply circuit.

DECORATIVE ILLUMINATION FEATURE OF SPEAKER

A NEW loud speaker, which may be described as a light transmitter as well as a sound reproducer, is one of the latest novelties to make its appearance in the radio field. A standard 110-volt lamp is mounted between the two paper cones of the speaker



The decorated cone of this "glow" speaker presents a very pleasing appearance, when lighted from the inside with an electric lamp.

Illustrations courtesy Aladdin Manufacturing Co.

and, when the current is turned on, the speaker emits a pleasing glow.

In construction the speaker is of the usual double fixed-edge-cone type. It is twelve inches in diameter and six inches deep. The base and the metal rim which supports the cone are of brass, and the paper cones are tinted in orange. Decorations have been painted on the front cone to improve the appearance of the instrument.

In the mechanical design of the unit there are several features which are different from those of the average speaker. In order to make the electric light bulb, which is located between the two paper cones, accessible for replacement a new method of mounting the front cone in place was found necessary. The illustration on this page shows the ar-

CONSRAD CO., INC., 230 Fifth Ave., New York, N. Y.
 Gentlemen: I enclose \$1 for books Number.....
 Name.....
 Address.....
 City..... State.....

MAIL YOUR ORDER NOW

CONSRAD CO., Inc.
 230 Fifth Avenue
 New York, N. Y.

C. L. PARKER

Ex-Examiner U. S. Patent Office
 Attorney-at-Law and Solicitor of Patents
 McGill Building, Washington, D. C.
 Patent, Trade Mark and Copyright Law

LIGHTING FIXTURES

Ready to Hang
 Direct from the manufacturer. Completely wired, including glassware. Send for new catalogue No. 29. Just Reduced Prices.
 Special Proposition to Dealers.
 Erie Fixture Supply Co., Inc., Station R, Erie, Pa.

Radio Table \$3.95

Most extraordinary value is offered radio fans for a limited time. Full size 13 x 27 in. with battery shelf. Table is knocked down for safe shipping. Sent upon receipt of check or money order for 3.95.
 Send for catalog of Consoles, Battery Cabinets and Radio Tables.
BERNARD FURNITURE CO. 38 So. 2nd Street, Philadelphia, Pa.

ELKAY EQUALIZORS

and Suppressors are made by The Langbein-Kaufman Radio Co. (Dept. N), 62 Franklin St., New Haven, Conn. Write for prices and tables of values.

Insure your copy reaching you each month. Subscribe to Radio News—\$2.50 a year. Experimenters Publishing Co., 230 Fifth Avenue, N. Y. C.



Inside view of "glow" speaker, showing method of mounting electric lamp (L) and loud speaker unit (U).

range-ment which is employed. The edges of the front cone are held in position against the metal frame of the speaker by the driving pin of the speaker unit, which is attached to the cone at the apex. Therefore, in order to remove the front cone it is necessary only to loosen the set screw in the apex unit. Another feature is the location of the adjustment screws of the loud-speaker unit in the rear of the speaker.

The two views of the speaker which are printed on these pages clearly illustrate the construction and show the arrangement of parts inside the cone. Also, it may be seen from the pictures, two outlet cords and a chain are located at the rear of the speaker. One cord connects with the radio receiver, the other connects with the light socket; while the chain is attached to the switch which turns the lamp on and off.

A PARLOR UTILITY WHICH ADDS CONVENIENCE TO SET OPERATION

ANY owner of an electrified receiver, who desires to operate it in a corner of the living room which is not adjacent to a lamp socket or outlet plug, will find the flat floor cord, which is illustrated on this page, a very useful accessory to the set. Also, the cord may be used when it is desired to place the loud speaker on the opposite side of the room from the receiving set; or it may be employed as an aerial lead-in wire to the set, in cases where it is necessary for this wire to cross the room.

Arranging the wiring for a radio installation has puzzled a large number of listeners. Wires crossing the room are unsightly and



This new flat lamp-cord makes it easy to run wires to a radio receiver under the rug without impairing the appearance of the living room.

Illustration courtesy Belden Manufacturing Co.

in most cases, cannot be tolerated; yet they are frequently necessary. On the other hand, ordinary wires placed under the rug are not satisfactory; as they cause added wear to the rug and there is a possibility of fraying the insulation with a short circuit as the result.

All of these difficulties have been overcome by the new flat floor cord, however, as this device has been designed so that it may

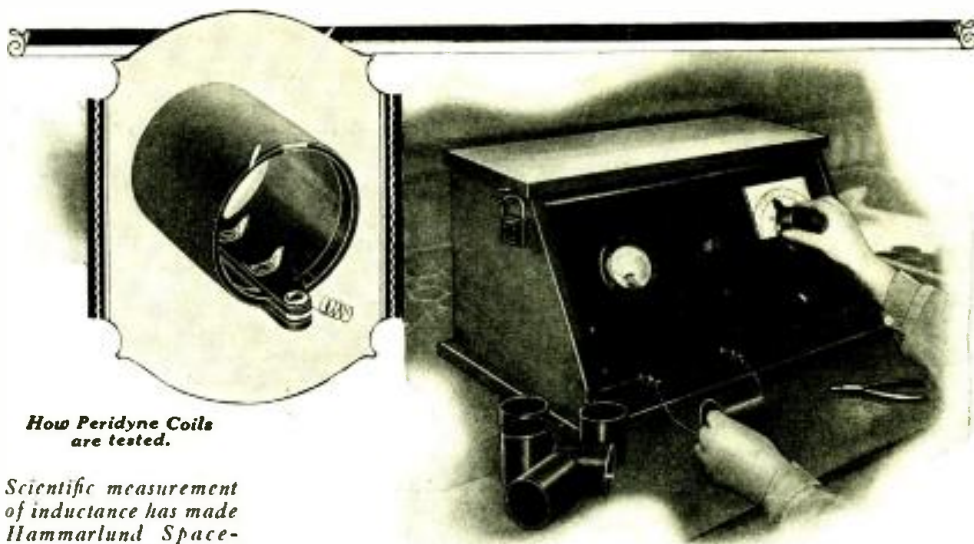

How Peridyne Coils are tested.

Scientific measurement of inductance has made Hammarlund Space-wound Coils the most efficient and dependable ever devised.

Hammarlund Coil Inductance Scientifically Measured.

NOT very long ago, so many turns of wire on such and such size core were considered accurate enough for inductance measurement.

But in this age of multi-tuned, single-control circuits, guess-work is out of the question. Coils must be matched to the finest degree. Not satisfied merely with producing the most efficient type of coil, Hammarlund devised the instrument, pictured above, to insure accurate measurements of inductance values.

You can depend on Hammarlund precision. It means standardized quality and assurance that you get what you pay for.

Your dealer sells Hammarlund Matched Coils for the latest popular circuits.

HAMMARLUND MANUFACTURING COMPANY
424-438 West 33rd Street, New York

Canadian Representative:

WHITE RADIO COMPANY, LTD.
41 West Ave. N, Hamilton, Ont.

More than a score of radio designers officially specify Hammarlund Precision Products for their newest circuits.

For Better Radio
Hammarlund
PRECISION PRODUCTS

Dealer inquiries invited concerning several new and appealing Hammarlund developments, having a wide sales demand.



Special Library of Information
on
RADIO PATENTS
and
TRADE MARKS

JOHN B. BRADY
Patent Lawyer

Ouray Building Washington, D. C.
Cable address: RADIOPAT Telephone: Main 4806

Thompson Neutrodyne
CUT TO \$67.50

5-Tube Quality Set with Built-in Cone Speaker. Sold at less than cost.

List price, \$150. Reorganization forces sacrifice. Direct from manufacturer to you. Fully guaranteed. Licensed under Hazeltine and Armstrong patents. Beautiful tone and distance. Handsome and unique design. Set and cone speaker in one unit. Endorsed by leading engineers. Circular free or send check for \$67.50 and will ship immediately.

THOMPSON RADIO CO.
66R York Street Jersey City, N. J.

Insure your copy reaching you each month. Subscribe to Radio News—\$2.50 a year. Experimenter Publishing Co., 230 Fifth Avenue, N. Y. C.

1001 RADIO QUESTIONS AND ANSWERS
 COMPILED BY THE STAFF OF
Edition **RADIO NEWS**

HERE'S THE ANSWER TO EVERYMAN'S RADIO QUESTIONS

50c on all Newsstands

PRICE 50c

1928 EDITION!
of Radio's Greatest Question & Answer Book

HAVE you a question to ask about Radio—about this circuit, that circuit, this method or that method of Amplification, Balancing, Regeneration, Transmission, Set construction, Operation, Speaker design, control, Electrification, Accessory installation, Antenna possibilities—anything and everything in Radio?

Your question is answered in the greatest and most complete Book of Radio problems in print, the new 1928 edition of "1001 RADIO QUESTIONS AND ANSWERS." Radio is Worldwide, its problems, its intricacies are Worldwide as well. The questions that hundreds of Radio men ask are the same questions you want answered.

These 1001 Questions and Answers are selected from those asked by readers of the greatest of all Radio Publications, "RADIO NEWS" magazine.

Every question is worth the price of this book—Real Radio problems of every conceivable nature are propounded and answered.

You may think you know something about Radio Circuits and the practical, useful side of Radio, but this book will double or triple your knowledge.

You can get a copy now—today, tonight. Just visit your newsdealer. 50c. the copy everywhere. Or you can write us direct if you choose—We pay postage.

50c ON ALL NEWSSTANDS

or direct from

EXPERIMENTER PUBLISHING COMPANY, INC.
 230 FIFTH AVENUE NEW YORK CITY, N. Y.

be placed under the rug with perfect safety. It consists of two parallel wires, imbedded in a strip of soft rubber one inch wide. The rubber strip is flat on the side which is nearest the floor and is convex on the other side. When placed under the rug, there is difficulty in detecting its presence; and, since the wires are so well separated, there is no danger of short-circuiting from ordinary handling.

The flat floor cord illustrated on page 837 is intended for use in cases where the wire is to pass under a 12-foot rug; the rubber-strip section of the cord is 12 feet 4 inches long. At one end of the cord there is an outlet receptacle into which any standard light-socket plug may be inserted, and at the other end a connecting cord and plug four feet in length. The cord is so arranged that it may be shortened if desired.

If the cord is to be used as a loud-speaker extension, it is necessary only to connect the phone tips of the speaker cord to a standard 110-volt plug before contact can be made to the unit.

The Karas A. C. Equamatic

(Continued from page 775)

the set screws on the coupling unit should be tightened.

This view also shows that the coils are mounted at an angle. This is necessary in order to prevent interstage coupling. The correct angle will be found indicated on the drilled sub-base, if one is used; and it is shown also in the sub-base drilling layout.

SPECIAL DETECTOR BIAS

For the operation of this receiver it will be noticed that a "D" potential is called for as well as the usual "A" and "B" potentials. This is made necessary by the use of the heated-cathode type of tube in the detector circuit; and if the correct voltage is used the sensitivity of the receiver is improved. In the circuit the detector cathode and grid return are at ground potential and the "D" potential is connected between the cathode and the heater of the detector tube. The value of this potential is not critical and may vary from 10 to 45 volts, with the positive connected to the heater. Also, strange as it may seem, the set sometimes works better if the potential is reversed, i.e., with the negative terminal connected to the heater; and in some cases it may be found that better results are obtained if the battery is omitted and the terminals connected together. When the "D" potential is used, the voltage from the plate-power-supply unit may be employed.

The Story of Resistors

(Continued from page 775)

ever-growing demands for accurate yet inexpensive units. First of all, the glass support is drawn to a filament of small diameter. This glass rod is later passed through the coating bath and then through a furnace, to form the metallized deposit which, virtually, becomes part of the glass as the result of the heat treatment. Even while the filament is being metallized in continuous lengths, the resistance value is being controlled: since the metallized filament passes over mercury contacts spaced the exact distance of the solder-to-solder mounting in the ultimate

resistor unit. The resistance is continually read in ohms or megohms, so that the intricate process can be corrected in order to insure the desired resistance value for the metallized filament being produced.

The metallized filament is cut automatically into two-foot lengths, and aged for a considerable period of time. Once more the filament, in these lengths, is passed through mercury contacts and tested for resistance and then sorted into piles. The filaments are then stored in steel cabinets, until this stock is drawn upon by the various licensees manufacturing metallized resistors. The two-foot lengths are cut into shorter lengths when ready to be mounted into complete units.

The mounting of the metallized filaments is an accurate operation. An ingenious centering device serves to hold the filament in position as the brass caps and glass tubing are assembled about it. A special solder insures a mechanical and electrical bond with the filament. Once assembled, the resistance is again tested and the resistors are sorted once more.

Practically the same type of filament is employed in the usual receiver resistor, or so-called grid-leak type, and in the power type, the latter being capable of handling 2.5 or 5 watts, depending on the size, because of the greater dissipation of heat secured by its design.

There are many uses for metallized resistors, aside from radio applications; they are widely employed in electrical work in general, and particularly in electrical laboratory practice. They are also finding a considerable use in X-ray and mercury-vapor-light apparatus, as well as in electrotherapeutic work, where high-frequency current is employed and non-inductive resistors are essential.

I Want to Know

(Continued from page 796)

to a certain extent the pick-up action of the leads. This sharpens the tuning and increases the selectivity of the receiver. The condensers should be connected at the receiver and not at the battery.

Another use of condensers of the by-pass type which is rapidly gaining favor is in series with the antenna circuit. The use of a by-pass-type condenser of about 1 mf., connected as shown in Fig. Q, 2263E, in the ground lead of the antenna circuit, will serve to prevent any possible short circuit of the lighting line, when a "B" power unit is used. Because of the large capacity of this condenser, it will have no effect on the tuning.

If you want to use such a condenser in the ground circuit, do not connect it externally (that is, between the ground post of your receiver and the ground), unless you have your lightning arrester connected directly between the aerial and ground. A glance at the diagram will show the proper connections of the condenser, the ground, secondary circuit, and the lightning arrester.

The use of condensers of large capacities in the ways outlined above, will result in more realistic reproduction and a better appreciation of the quality of music which it is possible to obtain with a properly-designed receiver.

LABORATORY SUPERHETERODYNE

(Q. 2264.) Mr. C. G. Moseley, Borger, Texas, asks:

Q. Kindly publish the schematic wiring diagram of the Improved Laboratory Superheterodyne using the time-signal amplifier, with the new heated-cathode type of raw-A.C. vacuum tube.

A. You will find the diagram you request on page 796. The intermediate-frequency amplifier is tuned to 112 kilocycles, which is equivalent to 2675 meters. This makes the intermediate-frequency amplifier suitable also for receiving time signals from station NAA, Arlington, Virginia. The components of the set are the same as those specified for D.C. operation, except for the filament supply. The filament connections to the time amplifier are left open and the A.C. filament wiring is put in separately. The tuning coils used in this receiver are of the plug-in type which adapt the set for receiving short, intermediate (broadcast) and long wavelengths. All of the radio-frequency stages are shielded and two attractive drum controls are used for tuning.

A HIGH-POWERED 10-TUBE MODEL FOR 1928



NORDEN-HAUCK IMPROVED SUPER-10

LICENSED UNDER HOGAN PATENT 1,014,002

"Highest Class Receiver in the World"

This new and advanced design brings to you all the luxury and performance you could possibly desire in a radio receiver. Absolutely nothing has been omitted to provide supreme reception—a new standard previously unknown.

The up-to-the-minute engineering principles found exclusively in the improved Super-10 are comparable to the high compression head and super charger in an automobile engine.

In the Norden-Hauck Improved Super-10 you have

- Wonderful Selectivity
- Faithful Reproduction with any Degree of Volume
- Signals received at only one point
- Two major tuning controls for all wave lengths
- Wave band 200/550 meters (adaptable down to low waves and as high as 6000 meters with removable coils)

Material and workmanship conform to U. S. Navy specifications.

The improved Super-10 is sold complete as a manufactured receiver, or we are glad to furnish blue prints and all engineering data for home construction.

Upon request, new attractive illustrated literature will be promptly mailed to you without cost or obligation on your part.

Tear off and mail today—

Your correspondence or inquiry for further information is cordially invited

Write direct to

NORDEN-HAUCK, INC.
ENGINEERS

"Builders of the Highest Class Radio Apparatus in the World"

MAPINE BLDG., PHILA., PA., U. S. A

Cable: Norhauck

NORDEN-HAUCK, INC.,
MARINE BLDG., PHILA., PA.

Gentlemen:

- Without obligation on my part send me complete literature on the new improved Super-10.
- I enclose \$2.00, for which send me, postpaid, complete Blue Prints and operating instructions for the new improved Super-10.
- I enclose \$1.00, for which send me Blue Prints of the Model 500 B. C. Power Unit.

Name

Address



YOU GET

FREE TECHNICAL ADVICE
By R. E. LACAULT, E. E.

ON PARTS AND KITS PURCHASED FROM US

Let Him Help You Select
THE BEST

SEND FOR R. E. L. HANDBOOK
AND DISCOUNT LIST

R. E. LACAULT
DIO ELECTRIC LABORATORIES

1931 BROADWAY

NEW YORK CITY

FROST-RADIO

FROST GEM RHEOSTATS — De Luxe Apparatus



FROST-RADIO

Now you can install a really good small rheostat or potentiometer and be absolutely sure of the result, because Frost Gems are built for service. They are accurate as to resistance, sturdy, correctly designed and beautifully finished. Have Bakelite pointer knob, hand-buffed nickel plated exposed metal parts. Windings are mounted on flexible Bakelite strip—non-burning, non-charring, non-warring. Plain Gem rheostats, 3 to 50 ohms, 75c. With filament switch, \$1.00. Potentiometers, \$1.00. Secure Gem Rheostats from your dealer today.

HERBERT H. FROST, INC.
Main Offices and Factory—Elkhart, Ind.

Have You Asked for YOUR Copy of This Unusual RADIO Catalog?



Mail This TODAY!

Hampton-Wright
128 Darmody Building
Indianapolis, Ind.

Dear Sirs: I want to see your catalog of unusual radio bargains. Mail one to:

Name _____
Address _____
City _____ State _____

Here's the "Book of a Thousand Radio Bargains!" All over the country, radio fans, dealers and set-builders are acclaiming it as the best "market place" for radio parts and accessories. So ask today for this new

HAMPTON-WRIGHT FREE CATALOG of RADIO PARTS and ACCESSORIES

In it you'll find the world's best merchandise at the lowest possible prices. And our fast, conscientious service will surprise you. If you're interested in radio, you have a treat in store if you

MAIL THIS
COUPON Today!

HAMPTON-WRIGHT
RADIO PARTS AND ACCESSORIES
DARMODY BUILDING + + + INDIANAPOLIS

SEND FOR FREE CATALOG
From Chicago's Oldest Radio Jobbers. The most valuable Radio Catalog. Write for your copy today—IT'S FREE!
TELEPHONE MAINTENANCE CO.
123-5 S. Wells St., Dept. 50, Chicago, Ill.

The SONOCHORDE
CONE \$25.
Brings the Studio Home

2 AMPERE CHARGERS, \$10.50
B-Eliminators, 22.5-45, 60, 90, 135-180 Volt taps, steel case, 60 milliamperes. Silent in operation, \$11.95; Trieklers, \$7.00. Guaranteed two years. They employ Dry Oxide rectification. 24-hour shipments—Catalog.
Electro-Chemical Company of America, Indianapolis, Ind.

Making the House Talk and Sing

(Continued from page 745)

temporary loud speaker of the same type can be made, as in Fig. B, using a door for the sounding surface; only in this case a permanent installation cannot be made without considerable care to present a good appearance.

In Fig. C is presented an idea for obtaining loud-speaker reception outside the house from a radio set. The unit is built on supports, as indicated, and the driving rod is pressed tightly against a window pane. If the glass is firm in the sash and if the latter is tight in the frame, excellent music will result. In some houses it may be possible to utilize for a diaphragm the baseboard or even an entire wall, if it has sufficient elasticity; see Fig. D.

THE TALKING TABLE

In Fig. E is shown how a table can be made to perform musically. A folding card table has, in most instances, a top made of strong light wood, which will act excellently as a diaphragm. However, any small table will do, or even a piano bench, as illustrated in Fig. F. A very good permanent installation can often be made in a book-case which has a back of fairly thin wood; this is held tightly in place by the heavier woodwork, thus making a good diaphragm. It is necessary that the shelf on which the unit is fastened be firmly attached to the sides of the case, in order that the unit may be stationary with respect to the body of the case. See Fig. G.

Another example of a permanent installation of an excellent type is shown in Fig. H, in which the frame of a picture is used as the diaphragm of the loud speaker. The unit can be fastened against the wall and it will be found that the frame will reproduce music in a first-rate manner.

In many of the installations described above, it will be found advantageous to insert the driving rod a short distance into the wood. However, good temporary operation may be had merely by pressing the rod firmly against the surface to be vibrated.

THE HEART OF THE NEW A. C. TUBES

NOT larger than the lead of the common pencil, yet with two holes running from end to end, the heart of the heated cathode type of A.C. tube represents a triumph in ceramic production.

The internal construction of this tube comprises the tiny insulating tube just mentioned, with parallel holes occupied by the heater wire. The outside of the insulating tube is covered with a metal sheathing, which in turn is coated with certain metallic oxides which emit the electrons required for the functioning of the tube. The grid and the plate surround the heated element, which serves in lieu of the usual filament.

The dimensions for the heater tube are so minute that serious problems were encountered in the development of this device. In fact, for a time it did seem as though the heavy-filament type of A.C. tube, even though it has an A.C. hum which prevents its use as a detector, would be a more practical solution. However, after numerous materials and particularly the usual ceramics such as porcelain had been tried, isolantite has been adopted by most manufacturers of heater-type A.C. tubes. This is a highly-refined ceramic, the base of which is finely pulverized mineral instead of clay. It can be moulded, extruded and machined into a wide variety of shapes and sizes. It is extensively employed in present-day radio apparatus and also for the internal details and bases of vacuum and gaseous tubes.



Listed by Underwriters Laboratories

Gone—Aerial Troubles!

NEW
ELECTRAD
Lamp Socket Antenna
\$1.00

You can have an aerial—a neat, efficient aerial—in 20 seconds by simply attaching the Electrad Lamp Socket Antenna. Screws in any outlet, uses no current. Positively SAFE. Tested at 2500 volts, A.C.

At your dealer's or write
Dept. 51B, 175 Varick Street
New York, N. Y.

ELECTRAD

INSIST



AMPERITE is the only automatic filament control that keeps the temperature or voltage of the tube filament constant despite variations in the "A" Battery voltage. It guarantees improved tube performance and increased tube life through always operating tubes at their proper filament temperature. Simplifies wiring, panel design, tube control, tuning. Eliminates hand rheostats. Do not confuse with fixed filament resistors which attempt to imitate AMPERITE but are entirely different in principle and operation. Insist upon AMPERITE. Price \$1.10 mounted (in U. S. A.) For sale by all dealers.

Write for FREE "Amperite Book" of season's best circuits and latest construction data.
Address Dept. R N-1

Radiall Company
60 FRANKLIN ST., NEW YORK

AMPERITE

REG. U.S. PAT. OFF.
The "SELF-ADJUSTING" Rheostat.

BE A JAZZ MUSIC MASTER

PLAY PIANO BY EAR

Play popular song hits perfectly. Hum tune, play it by ear. Self-instruction—no teacher required. No tedious ding-dong daily practices—just 20 brief, entertaining lessons which you master.

At Home in Your Spare Time
Send for FREE BOOK. Learn many styles of bass and syncopation-trick endings, 6c. in stamps brings interesting CHART also.

Niagara School of Music
Dept. 233 Niagara Falls, N.Y.

Send for this Free Book

Higher Voltage for Power Tube Easily Obtained

MANY radio fans whose receivers are now equipped with power units which provide potential sufficient for the operation of 171-type tubes in the last audio stage, would like to increase the reserve power, and thereby the quality of reproduction from the A.F. amplifier (as explained in RADIO NEWS for November—page 482) by making use of a 210-type power tube in the last stage; but, since the plate-power-supply ("B") unit does not usually provide a voltage high enough to permit efficient operation of the latter tube, the cost of building an entirely new power unit may make such a change out of the question.

By making use of the circuit illustrated on this page, it is possible to double the output voltage of some types of plate-power units. In some cases it is necessary only to provide an additional rectifier tube, add one or two extra parts and make a few slight changes in wiring. These changes usually necessitate slight expense; and, when they have been completed, the plate power unit will provide ample voltage for the efficient operation of a type-210 power tube.

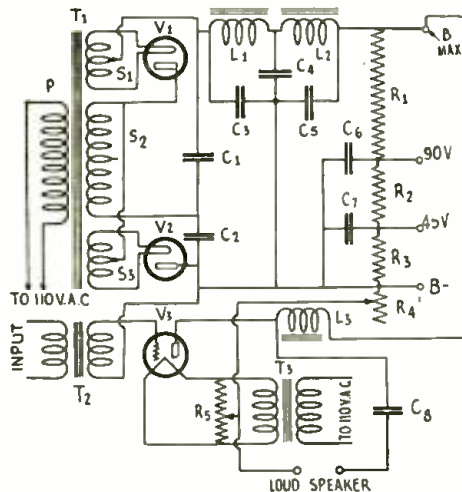

Schematic diagram of a "B" unit and last-stage audio-amplifier using a 210-type power tube; for which two half-wave rectifiers connected as shown provide ample voltage. Units already in use may be readily converted to this hook-up.

Examination of the schematic wiring diagram will show the arrangement of the rectifier circuit which makes it possible to double the voltage of a plate-power-supply unit. The circuit is not new, but hitherto it has not been generally applied to radio power units. It is no more complicated to build, adjust or operate than present circuits, and the results obtained are very satisfactory.

ELEMENTS OF THE CIRCUIT

In the rectifying circuit of the power unit are the two half-wave rectifiers, V1 and V2, and the method of connecting these tubes makes possible the voltage-doubling feature. The tubes may be of the standard 216B type, and their filaments must be heated from separate filament windings (S1 and S3) of the transformer T1. Other instrumental parts of the voltage-doubling circuit are the two high-voltage condensers C1 and C2, which have a capacity of 2 mf. each.

Following the rectifier circuit is a filter circuit of standard design. There are two standard filter choke coils, L1 and L2, and three filter condensers, C3, C4 and C5. However, any good filter may be used, provided the condensers are rated for continuous operation at a potential not less than 500 volts. The voltage-dividing resistors,



Selected for the Peridyne



The Peridyne shields, manufactured exactly to Mr. Gernsback's specifications, are available in kit form. The kit of three (S-M 639 Shield Kit) is priced at \$6.00.



The new S-M 240 audio transformer, specified for the Peridyne, is unquestionably the greatest transformer value ever offered. Its 3:1 ratio provides high amplification, and its generous design gives uniform amplification from 100 to 5,000 cycles, with the famous S-M 5,000 cycle cut-off that renders the Peridyne so free from



heterodyne squeals and static. S-M 240 transformers are worth twice the price, for they contain more silicon steel and more copper wire by far than any other transformer, excepting only the S-M 220—the finest transformer money can buy. Price, 240 audio transformer, \$6.00. Type 241 output transformer should also be used with the Peridyne to prevent loud-speaker overloading and distortion—price \$5.00.

For his newest invention the Peridyne receiver, Mr. Hugo Gernsback has chosen S-M 240 audio transformers to secure perfect and natural tone. Mr. Gernsback has also arranged to have the special Peridyne adjustable shields furnished by Silver-Marshall, Inc., and they are available in sets of three, designed exactly to his specifications, completely pierced.

The use of these genuine and approved parts in your Peridyne will insure your getting the truly remarkable results that this newly invented circuit will deliver.

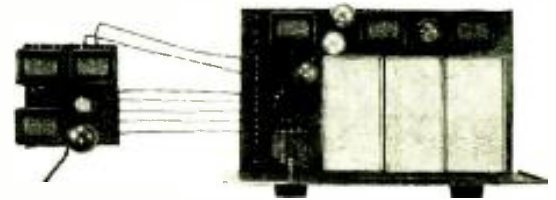

The Famous Shielded Six—With A.C. Operation

The Improved Light Socket Shielded Six was described in the last issue of RADIO NEWS. It is the finest receiver kit on the market, with tremendous DX ability, wonderful selectivity, and tone guaranteed finer than that of any other set. The light socket model uses new A.C. tubes, obtaining all ABC power from the small dry power unit at the left of the illustration. Price, 630 A.C. Kit, containing all parts for the light socket Shielded Six, \$99.00. Type 652A, ABC power kit, is \$36.50. The regular 630 Shielded Six kit for battery or eliminator operation, is \$95.00 complete.

We can't tell you here about all the new S-M developments, but if you'll send us 10c for postage we'll send you more information on light socket operation, super audio amplification, and other pertinent subjects than you can read in a week.

SILVER-MARSHALL, INC.

848 West Jackson Blvd. Chicago, U. S. A.

Silver-Marshall, Inc.
848 West Jackson Blvd., Chicago.

Please send me full information on the new S-M developments for which I enclose 10c.

Name.....
Address.....



NEWEST BLUEPRINTS

You can obtain a complete set of blueprints for these receivers direct from RADIO NEWS

- THE PERIDYNE FIVE—Radio News Blueprint Article No. 37..... \$1.50
- THE SUPER-HETERODYNE RECEIVER—Radio News Blueprint Article No. 38..... 1.50
- "B" SOCKET-POWER UNIT—Radio News Blueprint Article No. 39..... 1.00
- THE TYRMAN SHIELDED GRID SEVEN—Radio News Blueprint Article No. 40..... 1.25
- THE KARAS A. C. EQUAMATIC RECEIVER—Radio News Blueprint Article No. 41..... 1.25
- A PHONOGRAPH AMPLIFIER—Radio News Blueprint Article No. 42..... 1.00
- A STURDY "A" POWER UNIT—Radio News Blueprint Article No. 43..... 0.75

Order Direct from RADIO NEWS

230 FIFTH AVENUE, NEW YORK, N. Y.

MENTION NAME OF RECEIVER AND ARTICLE NUMBER

Acme ANTENNA



with Seven Strands of Enameled Copper Wire

Best outdoor antenna you can buy. Seven strands of enameled copper wire. Presents maximum surface for reception, resists corrosion, this greatly improves the signal. Outside diameters equal to sizes 14 and 16. (We also offer solid and stranded bare, and stranded tinned antenna.)

Battery Cable

A rayon-covered cable of 5, 6, 7, 8 or 9 vari-colored Flexible Celatsite wires for connecting batteries or eliminator to set. Plainly tabbed; easy to connect. Gives set an orderly appearance.



Acme Celatsite Wire

Tinned copper bus bar hook-up wire with non-inflammable Celatsite insulation, in 9 beautiful colors. Strips easily, solders readily, won't crack at bends. Sizes 14, 16, 18, 19; 30-inch lengths.

Flexible Celatsite for sub-panel wiring

A cable of fine, tinned copper wires with non-inflammable Celatsite insulation. Ideal for sub-panel or point-to-point wiring. Strips easily, solders readily. Nine beautiful colors; sold only in 25-ft. coils, in cartons colored to match contents.

Send for folder

THE ACME WIRE CO., Dept. D
New Haven, Conn.

ACME WIRE

MAKES BETTER RADIO

\$1.00 WILL SAVE YOUR SPEAKER



The Craftsman Dollar Speaker Filter is Guaranteed to relieve your speaker of the DC plate current (up to 250 volts). It gives speaker a chance to operate at its best. Attached in a second. Send dollar bill NOW!

CRAFTSMAN RADIO PRODUCTS
9 Orchard St. Newark, N. J.

You can be quickly cured, if you STAMMER

Send 10 cents for 288-page book on Stammering and Stuttering, "Its Cause and Cure." It tells how I cured myself after stammering 20 yrs. B. N. BOGUE, 675 Bogue Bldg., 1147 N. 111 St., Indianapolis.

R1, R2 and R3, are also standard and those used in a low-voltage power unit may be employed, if an additional resistor of suitable value is connected between the former high-voltage tap of the resistor unit and the positive wire in the output circuit of the power unit (that is, above R1).

It is also shown in the diagram how the power unit is connected with the last stage of the amplifier. It will be noted that the filament of the 210-type power tube (V3) is heated from a separate 7½-volt step-down transformer, and the potentiometer R5 is used in order to obtain the center tap. Also, the grid-bias potential is provided by variable resistor R4. In the loud-speaker circuit a tone filter, comprising the condenser C8 and the choke coil L3, is used to protect the windings of the loud-speaker unit.

As there are many designs of low-voltage plate-power-supply units, it is impossible to undertake printing detailed directions for making the required changes. However, with the data contained in this article, the schematic wiring diagram and the following list, which contains the electrical specifications for the parts required, it should be possible for the constructor to redesign his present power-supply unit to conform to this circuit.

PARTS REQUIRED

Two half-wave rectifiers, 216B type (V1, V2); one power tube, 210 type (V3); four 2-mf. condensers (C1, C2, C3, C4), 500-volt test; one 8-mf. condenser (C5), 500-volt test; two 1-mf. condensers (C6, C7), 200-volt test; one 4-mf. condenser (C8) 500-volt test; one power transformer (T1—see below); one audio transformer (T2); one 7½-volt filament transformer (T3); three filter choke coils; three fixed resistors (R1, R2, R3—see below); one 2,000-ohm variable resistor (R4); and one 20-ohm potentiometer (R5).

The transformer, T1, should have a 300-volt secondary winding, or a winding with at least 150 volts on either side of the center tap. Also, it should have two 7½ volt filament windings. If only one is available a separate filament transformer must be employed. This may be a standard bell-ringing transformer.

Unless the output voltage is known, it is impossible to give correct values for R1, R2, and R3. However, the total resistance of these three resistors should be approximately 25,000 ohms.

HIGH-POWER ENGLISH STATION
"DAVENTRY EXPERIMENTAL"—
 Its operators object to the popular term of "Junior"—is Great Britain's only super-power station with a wavelength in the (American) broadcast range. This is given as 491.8 meters in the British press; though one of our readers reports it on 460.2. The station, 5GB, has about a 30-kw. input and should often be heard in America this winter.

Station
WRNY
 NEW YORK

326 Meters — 920 Kilocycles

is owned and operated by the publishers of this magazine
Our Editors will talk to you several times every week—

See your Newspaper for details

TUNE IN ON WRNY



The 4th and Greatest
edition of RADIO NEWS
AMATEURS'
HANDBOOK

HERE is the greatest Radio Handibook ever published! Right up to date—a brand new edition of the very finest selected articles that have appeared in RADIO NEWS, Radio's Greatest Magazine, this year.

All new Radio—Plenty of latest model circuits with blueprint diagrams, ready for building. This is the most popular Radio Book ever printed. The past three editions were completely sold out.

—And now we offer the biggest and best edition of them all—116 pages of 1927 Radio complete with elaborate circuit diagrams and illustrations and parts. Size 9x12 inches.

Copies are going fast. Get your order in now—or see any news-dealer.

50c
ON ALL
NEWSSTANDS

If your newsdealer cannot supply you, use coupon below.

EXPERIMENTER PUBLISHING Co., Inc.
 230 Fifth Ave., New York

EXPERIMENTER PUB. CO., Inc.
 230 Fifth Ave., New York, N. Y.

Gentlemen: I enclose 50c. for one copy of the new 1927 AMATEURS' HANDBOOK.]

Name.....
 Address.....
 City, State.....

An Experimental Second Detector

(Continued from page 785)

shown. These are desirable so that the grid resistance of each tube can be varied at will to match operating conditions. The grid condensers are not particularly critical; a value between .00025 mf. and .0005 mf. may be used. The input transformer, IF3, should be a center-tapped intermediate transformer; but this is not always easy to obtain. A good way out of this difficulty is to use a band-pass filter coil, one type of which is made by a prominent manufacturer of helical-wound transformers. This coil is wound on a bakelite tube, solenoid-fashion, and its wavelength can be varied to match any intermediate frequency from 20 to 80 kilocycles. The center tap can easily be taken off, as the wiring is exposed to view and is easily accessible; this is not the case with regular intermediate-frequency transformers. The filter at the output end of the intermediate amplifier makes for greater selectivity, if anything; so no disadvantage is caused by its use at this point.

The by-pass condenser C1 is necessary, as it forms a path of low impedance for the unrectified R.F., which is always found in the output of any detector because of incomplete detection. The 125-millihenry radio-frequency choke coil RFC prevents this R.F. from getting into the audio circuit, where it would often be a cause of serious distortion. The alternate path is, of course, via the condenser C1 to the filament.

Special notice should be taken of this arrangement for the output of the push-pull detector, and of the method of feeding the detector plate current to the first audio transformer. This circuit should be followed carefully for best results. It is the result of much experimenting.

The action of the volume control R, in the first audio stage, is excellent in theory and practice. This method is free from distortion, the load on the secondary being practically constant for any setting of the volume control. This is as it should be, and is sound engineering practice.

AMPLIFIER CIRCUIT

The first audio transformer should be of the highest quality, and its turn ratio in the neighborhood of 3½:1. The 112-type tube is excellent here.

It will be noticed that the second stage of audio is push-pull. It is not necessary to go into the advantages of this type of audio amplification, as they are well known. Suffice it to say that the output is superior to that of most straight tube arrangements; because in this system many causes of distortion, such as core saturation, the formation of harmonics and distortion due to the dynamic characteristics of the tube itself, are practically eliminated.

The transformer AF2 is a regular input transformer designed for push-pull amplification. It has a center-tapped secondary which allows the connection of the grid return through either the proper "C" battery, or, if preferred, the proper bias resistor as supplied on many "B" power supply devices.

The tubes in this stage are of the 171-type; although larger tubes may be used, these will give ample power for ordinary home use. Where they are used with the regular run of "B" socket-power units supplying 200 volts or so, the tone will be superior to that obtained from larger tubes. This is because of the better regulation of the low-voltage units compared with the type employing only one rectifier tube, and supplying 400 volts for a 210-type tube.

If the experimenter cares to go to the

- HERE IT IS -

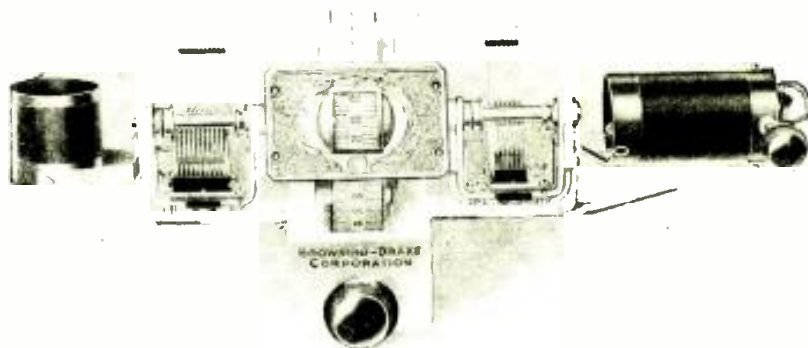

The New Official Browning-Drake Kit! MAKES IT EASIER TO BUILD

THE new Browning-Drake Two-Tube Tuner, which when combined with General Radio or other power amplifier apparatus, gives remarkable reception.

The new Browning-Drake five-tube Kit-Set, using the new kit, will give you an up-to-the-minute receiver.

Construction booklets covering the assembly of new units may be had either from your dealer, or direct, for 25c. Get yours TODAY!

BROWNING - DRAKE CORPORATION
CAMBRIDGE MASSACHUSETTS

BROWNING DRAKE

PARTS CABINETS KITS RECEIVERS

No More "A" Battery Worries!

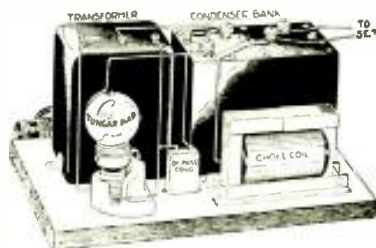

Licensed under Andrew-Hammund Patent Applications

\$24.50 Complete (less tube)

Discount to the Trade

Headquarters for the Improved Laboratory Super, Silver Shielded Six, Unipaacs, and all other standard merchandise.

SETBUILDERS SUPPLY CO.,
512 South Peoria St., Chicago.

- Please send me literature on the SETCO "A" Eliminator.
- Enclosed is \$24.50 for one SETCO "A" Eliminator kit.

Name.....
Address.....

Setco A Eliminator

—a true eliminator, not a battery combination

NOT a battery or battery and trickle charger combination, but a real "A" eliminator of tried and proven design—lower in price than any true "A" eliminator on the market. Will operate any receiver with eight or less regular 201A type tubes—no change in your set wiring. No battery troubles of any kind—it requires less attention than your floor lamp. Simply turn on the current and the power is there—instantaneous—dependable—unfailing. No need to change to expensive A.C. tubes for complete light socket operation.

The SETCO "A" Eliminator comes to you in kit form with every necessary part included. A 30-minute job with a screw driver and soldering iron will put it into immediate operation. Your "A" battery worries will then be over.

Nothing to wear out—the SETCO will last a lifetime! It costs less than a battery and charger combination—it will operate on any 110-120 volt A.C. current—its current consumption is less than that of an ordinary electric light.

The SETCO "A" Eliminator Kit can only be purchased from us. It is unqualifiedly guaranteed to perform exactly as stated. Send in the coupon for literature describing the SETCO—or order one today. Orders can only be filled in the order in which they are received.

SETBUILDERS SUPPLY CO.

512 South Peoria Street Chicago, U. S. A.

THE RADIO NEWS SUPERHETERODYNE BOOK

A complete history of this most popular circuit, including full details of all patents touching on Superheterodynes.

100 Pages, 9 x 20 inches, fully illustrated

50c on all newsstands or direct

WE PAY POSTAGE CHARGES

Experimenter Publishing Company, Inc.

230 FIFTH AVENUE

NEW YORK CITY, N. Y.

Better by Far

Then any fixed leak in the detector circuit is the

BRETWOOD VARIABLE GRID LEAK

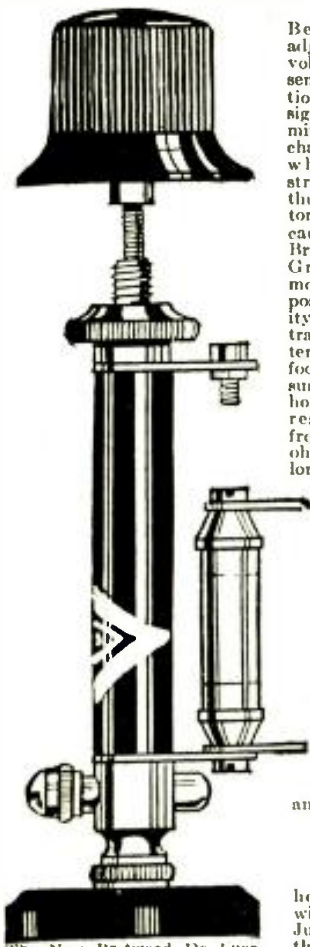

Because it allows adjustment of grid voltage to maximum sensitivity for reception of far-distant signals, while permitting faster discharge of electrons when receiving strong local stations, thus preventing distortion from this cause. Therefore a Bretwood Variable Grid Leak means more miles plus best possible tone quality, without any extra tubes. A patented plastic and foolproof plunger insure permanence in holding any desired resistance setting from .25 to 10 megohms, as well as very long life of the leak itself. As no grid leak can function any better than its grid condenser, be sure that you use a leak-proof Bretwood Bullet Condenser, of mica dielectric, and of .00025 mfd. capacity (another precision product, accurate to plus or minus one per cent). Get these two parts and also get our

FREE

hookups, supplied with each purchase. Just fill out and mail the attached coupon.

The New Bretwood De Luxe Variable Grid Leak with Condenser Attached

Don't Send a Solitary Cent!

The Bretwood Leak may be baseboard or panel mounted. Works the same in any position. No fluid used.

North American Bretwood Co.,
141 West 45th Street, N. Y. City.

Please mail me at once one New and Improved 1928 Model De Luxe Bretwood Variable Grid Leak (price, \$1.75) and attach one Bretwood Bullet Condenser (50 cents extra), for which I will pay the postman \$2.25 on receipt. Both must be the genuine Bretwood articles, imported from England.

NAME.....

STREET ADDRESS.....

CITY..... STATE.....

N-1

AMRAD

MERSON CONDENSERS

For full information address Department RN,

THE AMRAD CORPORATION

Medford Hillside

Massachusetts

HOME FURNISHINGS
ON CREDIT - Catalog **FREE**

Over 1,400 bargains in living room, dining room, and bedroom furniture, rugs, dishes, etc. A year to pay. 30 days trial. Write today for free catalog.

STRAUS & SCHRAM Dept. 3571 Chicago, Illinois

Insure your copy reaching you each month. Subscribe to RADIO NEWS—\$2.50 a year. Experimenter Publishing Co., 230 Fifth Ave., N. Y. C.

extra expense of an amplifier that will handle even more power, he can use 210-type tubes with a full-wave rectifier supplying 500 volts, such as the new power packs described by McMurdo Silver in Radio News for June, 1927. This offers an interesting field of exploration for radio constructors who believe that they now have the best obtainable with the regular type of straight audio amplification.

As a note of caution, include all the by-pass condensers and audio chokes shown in the hook-up. These are put in for a purpose and their use will more than repay their expense. Any heavy-duty "B" socket-power unit may be used to feed the "B" current to the amplifier. One of cheap or inferior quality will not have sufficient power nor satisfactory voltage regulation, which is essential to successful operation, especially where power tubes are used. Usually, less hum is present in the output of a push-pull system than in the regular arrangement; this is due to the inherent characteristic of "balancing out." The filaments of the 171-type tubes may be lighted by any 110-volt transformer having a secondary voltage of 5 volts underload. A bell-ringing transformer of heavy construction will do the work nicely. A rheostat placed in the filament circuit will provide the proper adjustment of filament voltage.

The writer will gladly answer any questions from experimenters trying this amplifier, and he also will be pleased to hear any comments on results. He can be addressed at 12 Netherton Ave., Beverly, Mass. (Letters requesting information should be accompanied by a self-addressed and stamped envelope.)

American Radio Is Difficult to Tame

(Continued from page 761)

ENGLISH RADIO MORE REGULAR

"There seems also to be greater variability in the signals in America during the summer months than in England, nor is there any very great increase here in variability as winter approaches, although there is a considerable general increase in strength of signal. The maximum variability in summer may amount to 40%, in contrast to the 10% variability of the English observations." For example, the average variability of the 10 o'clock morning signals from the New Brunswick, N. J., transmitting station ranges from 15.6% in September and 17.6% in June, to 19.4% in December.

Observations of scientists in this country and abroad are in general agreement as to the phenomenon of the so-called "skip effect" of signals. That is to say, short-wave signals, after being heard over a short distance—100 miles or less—from the transmitting station, depending on the wavelength, become inaudible over considerable distances, and then at greater distances are again heard with great intensity. This and similar discoveries in the realm of short waves, made by Dr. A. Hoyt Taylor, superintendent of radio at the Bellevue Naval Research Laboratory, were largely responsible for the award of the 1927 Liebermann prize to this government physicist.

EASY TO ANSWER

(Fifty-eight lines of business handle radio equipment on the side. — Government Bulletin.)

STRANGER: "Say, where can I get radio supplies in this town?"

BRIGHT BOY: "See that church, mister?"

STRANGER: "Sure, but you don't mean to tell me they sell them there?"

B. B.: "No, sir, but that's the only place where they don't."—Albert T. Jackson.

M&H

Radio's largest
kit supply house

ESTABLISHED 30 YEARS

WE HAVE COMPLETE KITS

For the following:

**Tyrman Super Heterodyne
National A.C. Phono Amplifier
Karas A.C. Equamatic**

AND FOR ALL CIRCUITS AS DESCRIBED
IN RADIO NEWS

SET BUILDERS

Send for Our Handy
CIRCUIT BOOKLET and CATALOG
just off the Press

M & H SPORTING GOODS COMPANY
512 MARKET ST. PHILADELPHIA, PA.

TELEVISION is Here!!!

Radio Fans! Mechanics! Scientific Men!—Everybody—Build a TELEVISION SET. The greatest and most amazing development of the 20th Century!

HERE, friends, is the first book to be published giving you the history of TELEVISION, from the first crude experiments at the beginning of the 20th Century—to the comparatively perfect machines just put into daily operation. From this book you can build your own workable television set that will serve as a fundamental apparatus for hundreds of tremendously interesting and amazing experiments.

Get in now on this new development. You may be fortunate enough to discover some improvement to Television that will be worth many thousands of dollars.

Start with a copy of this new book today, 116 Pages, 9 x 12 in., illustrated.

50c ON ALL NEWSSTANDS

If your Newsdealer cannot supply you, use this coupon

EXPERIMENTER PUBLISHING CO., Inc.
230 Fifth Avenue, New York, N. Y.

Gentlemen: I enclose 50c. for one copy of "ALL ABOUT TELEVISION."

Name.....

Address.....

City, State.....

A 10-Foot Curved Horn

(Continued from page 782)

to shape; and then some thin mixture of the plaster should be brushed on to fill up any rough spots. This mold should now be covered with at least a double layer of paper to prevent the plaster horn from adhering to it. The paper can be cut in narrow strips and wound around the mold, using some starch paste.

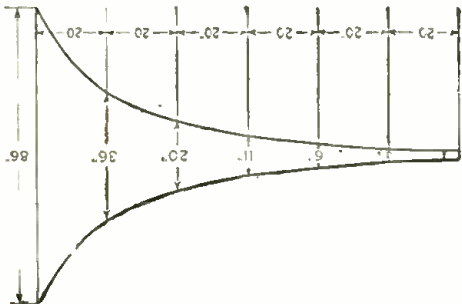

Dimensions (without lap) of the sackcloth used to form the pattern of the horn

Next, proceed to make the horn. The plaster should be mixed in small quantities at a time, as it sets quickly. After troweling it on, about 1/2-inch thick, it can be smoothed with a soft brush. A bag of plaster costing fifty cents will probably do the job. After the plaster has set for two or three days, cut around each side with a fine saw, and take off the upper half of the small part of the horn, in a section about three feet long. The lower half of the horn should be joined with plaster to the large part of the horn where it bends around the latter, as this will strengthen the whole horn.

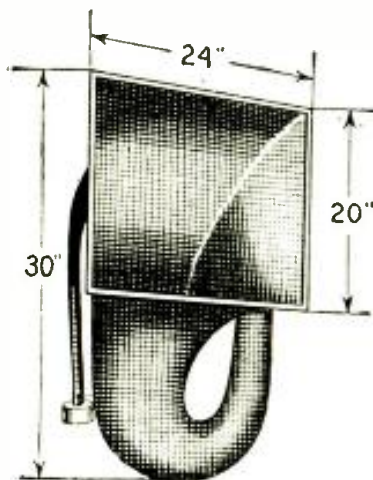

The shape of the horn, as seen from the front, is indicated here. The mouth is squared to fit the frame which holds it in place in the cabinet.

In taking out the mold or core, cut through the jute and remove the sawdust. The iron rod will have to be cut where required. The large part of the horn can be cleaned from its mouth. Before joining up the halves of the horn, it is a good plan to brush down the inside with a thin solution of the plaster. The joints can be made tight in the same way. Fly-screen wire should be wound around the end where the speaker unit enters to strengthen it and this should be coated with plaster. Now give the horn a coat of glue and then paste some layers of brown paper on the outside. When dry, the horn is given a coat of paint, and around it a cabinet is built, upon which the radio set is placed.

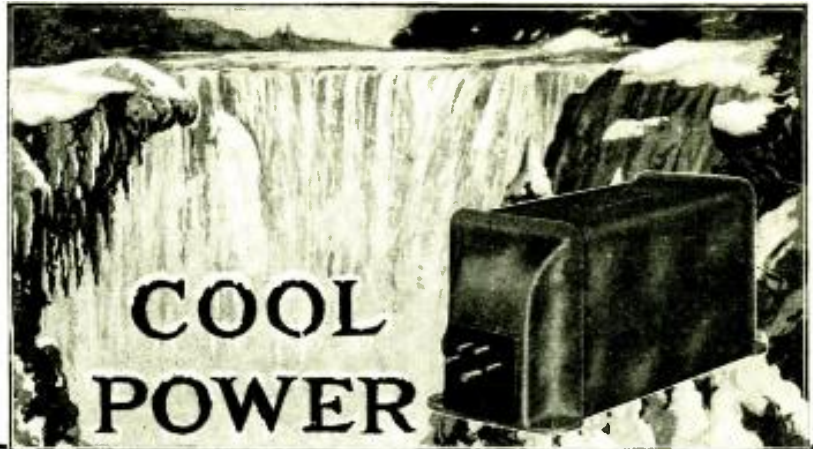

Samson Power Block No. 210—The only block which will supply 500 volts at 80 mils to two 210 tubes.

Powerize with Samson Units for Best Results

For new SAMSON Power Units insure the best there is in radio current supply by

1. Doing away with hum, motor boating and poor voltage regulation.
2. Remaining so cool after 24 hours continuous operation under full load that they will be well within the 20° rise of temperature specified by the A.I.E.E.
3. Being designed to more than meet the specifications adopted by the National Board of Fire Underwriters.
4. Insuring safety against shock because of protected input and output terminals.
5. Insuring for all tubes the correct filament voltages specified by their manufacturers.
6. Compensating for lighting circuit voltage variation by the use of a special input plug and terminal block to which is attached a 6 ft. flexible rubber-covered connecting cord and plug.

Our Power Units bulletin descriptive of these is free for the asking. In addition, our construction bulletin on many different "B" Eliminators and Power Amplifiers will be sent upon receipt of 10c. in stamps to cover the mailing cost.

SAMSON ELECTRIC COMPANY

Manufacturers Since 1882

Principal Office, CANTON, MASS.

Electrify your radio set with *Majestic*

NO ACIDS
NO LIQUIDS
NO HUM
—DRY

"A" and "B" Electric Power Units



Gives any radio set full strength, permanent Electrical "A" and "B" power all the time. Both "A" and "B" power and your radio set, all controlled by one switch. Only one light socket connection necessary.

See Your Dealer NOW!

GRIGSBY-GRUNOW-HINDS CO., 4540 ARMITAGE AVENUE CHICAGO



GEARS All kinds--Small

The most accurate made and prices reasonable. We carry a complete line of gears in stock for immediate shipment. Can also quote on special gears of all kinds. Send us your inquiries. Write for Catalog 40
Chicago Stock Gear Works
105 So. Jefferson St., Chicago

PARVOLT WOUND CONDENSERS

Stand The Surges

The ACME WIRE CO., New Haven, Conn.



UNIFORM! They Stand Up

No matter whether you buy a TOBE Condenser in California or New York, whether you buy it this year or next year, the quality will be the same. All TOBE Condensers are made of materials selected for their serviceable and lasting qualities, by methods perfected over years of experience. All TOBE Condensers are made to work continuously at their rated voltages—and do. The trademark "TOBE" takes all the doubt out of condenser performance. For sale wherever Good Radio is Sold.

TOBE DEUTSCHMANN CO.
Cambridge, Mass.

At \$6.00 this famous
Cabinet
has no equal!

The Blue Ridge
Mahogany or Walnut
Finish

Dimensions	Prices
7x18x10.....	\$6.00
7x21x10.....	6.50
7x24x10.....	6.75
7x26x10.....	7.25
7x28x10.....	7.75
7x30x10.....	8.25
7x18x12.....	7.50
7x21x12.....	8.00
7x24x12.....	8.25
7x26x12.....	8.75
7x28x12.....	9.25
7x30x12.....	9.75

The Blue Ridge Cabinet is made from best grade birch, noted for the quality and the beautiful finish it takes. Specializing for years in wood-working craftsmanship we are especially equipped to produce cabinets famous for quality of construction and lustrous finish. The Blue Ridge, finished either in gleaming Mahogany or rich Walnut has full length nickel-plated piano hinge and nickel-plated support, rubber anti-vibration feet and free non-warping baseboard. Send us your order today. It will be on its way within 12 hours of receipt.

C.O.D. half price with order

All Prices f.o.b. Hickory **2 hour service factory to you**

Southern Toy Co. Inc.
Manufacturers Hickory N.C.

Learn Code Quickly! **TELEPLEX** With New Portable

The ONLY instrument that REPRODUCES actual sending of expert operators. 5 to over 80 words per minute—five times as many on one tape as any other instrument—6 tapes furnished. Quickest way to learn any code. Used by U. S. Navy. Fully guaranteed. Write for booklet N. R.

TELEPLEX COMPANY
76 Cortlandt Street New York City

6-TUBE RADIO COMPLETE
\$34.75 to \$66.66

Licensed R.C.A. Circuits. Shielded. One Dial
Write for catalog. Big discounts to agents
Consumers Radio Co., Dept. N, 4721 Lincoln Ave., Chicago

A 6-Foot Duplex Straight Horn

(Continued from page 782)

was added to the dimensions shown and four pieces each were cut alike for inner and outer horn.

The inner horn was first shellacked on the inside and assembled by gluing and nailing

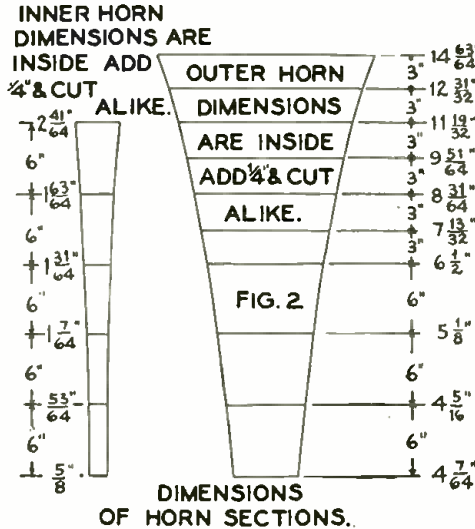

The dimensions for the sides of both sections of the duplex horn.

the sections together and then running a fillet of glue down each inside corner to insure tightness.

In assembling the sections of the outer horn some trouble was encountered in putting the sections together, because of the greater curvature of the sections; but this was over-

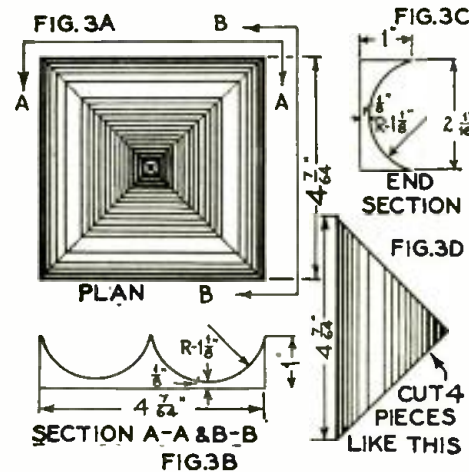

Details for the base section which connects the inner air column to the outer.

come by passing a wire over the center batten strip and through small holes drilled in each section across to the opposite section. After this the twisting of this wire easily drew the sections snugly together. The sections were then nailed and a fillet of glue run down the inside corners. When the glue was thoroughly dry, the inner horn was properly centered in the outer one and held in this position by wedges or other means, until the braces shown in the drawing could be fitted and glued into place. The bottom end of the inner horn was kept one inch above the bottom end of the outer horn to allow for the installation of the curved bottom piece (Fig. 3A and 3B). This bottom

Modern Air-Craft



THE AGE OF AVIATION —IS HERE—

Learn Design, Construction, Operation and Maintenance

Contents of each chapter—1. Aircraft Types. II. Lighter-than-Air Craft. III. Early Airplane Designs. General Design Considerations. IV. Design and Construction of Aerofoils. V. Arrangement, Fabrication and Bracing of Airplane Wings. VI. Airplane Fuselage and Landing Gear Construction. VII. Airplane Power Plant Types and Installation. VIII. Aviation Engine Design and Construction. Air-cooled Engines. IX. Aviation Engine Design and Construction. Water-Cooled Engines. X. Aviation Engine Auxiliaries. XI. Aircraft Propeller Construction and Action. XII. Airplane Equilibrium and Control Principles. XIII. Uncrating, Setting Up and Aligning Airplane. XIV. Inspection and Maintenance of Airplanes and Engines. XV. Details of Modern Airships and Airplanes. XVI. Seaplanes, Flying Boats, Amphibians and Other Aircraft. XVII. Some Aspects of Commercial Aviation. XVIII. Aircraft Instruments and Aerial Navigation. XIX. Standard Nomenclature for Aeronautics, Report No. 240, Part I.

This book is written in simple, understandable language.

**700 Pages : 500 Illustrations
Price, \$5.00**



AVIATION ENGINES

This book describes the basic principles of aviation, tells how a balloon, or dirigible is made and why it floats in the air. Describes how an airplane flies. It shows in detail the different parts of an airplane, what they are and what they do. Describes all types of airplanes and how they differ in construction; as well as detailing the advantages and disadvantages of different types of aircraft. It includes a complete dictionary of aviation terms and clear drawings of leading airplanes.

274 Pages. Price, \$1.25



A. B. C. OF AVIATION

This treatise, written by a recognized authority on all of the practical aspects of internal combustion engine construction, maintenance and repair, fills the need as no other book does. The matter is logically arranged; all descriptive matter is simply expressed and copiously illustrated, so that anyone can understand airplane engine operation and repair even if without previous mechanical training. This work is invaluable for anyone desiring to become an aviator or aviation mechanic.

Price, \$1.25

CONSRAD COMPANY, Inc.
230 Fifth Avenue New York

piece was then accurately fitted and glued into place, care being taken to prevent any air leakage.

The construction of this bottom piece may be difficult, but it can be made in either of two ways. If molding of the cross-section shown (Fig. 3C) can be obtained, it can be cut in a miter box to the shape in Fig. 3D, and glued together to form this bottom, or it can be cut from a piece of 1 inch white pine on a power band saw. A piece twelve inches long is sufficient.

The temporary base was then attached and both inside and outside of horn stained and given two coats of shellac. If any vibration develops in the outer horn with full volume, it can be eliminated by additional batten strips.

While the appearance of the completed horn will be good, if care has been used in its construction, it can, no doubt, be further improved by installation in a cabinet of a design to match the radio cabinet used. The design in Fig. 4 is one the writer has found suitable. If it is not desirable to install the horn in a cabinet, a molding of suitable size may be used in place of the plain 1/2x1/2 inch batten strips, greatly improving the outward appearance.

Producing Radio Power from Heat or Daylight

(Continued from page 755)

Out of twenty-seven samples of molybdenite tested at the Bureau of Standards—these specimens of crystals originating in Canada, Japan, and Australia—twelve had a positive thermoelectric power and fifteen had a negative. "On focusing the short-wave radiation from a Nernst glower," relates Dr. William W. Coblenz, chief of the radiometry section, in describing his experiments, "filtered through a water cell, it was found that, in some of these samples, there were spots giving high positive or minus electromotive forces, which were evidently caused by the action of thermal radiation of short wave length, as distinguished from thermal excitation resulting from a temperature rise due to conduction of heat from a body at a higher temperature.

"In some cases this actinoelectrical action was so strong that daylight falling upon the molybdenite was sufficient to throw the galvanometer deflection off the scale; whereas causing a temperature rise of 70 degrees Centigrade (158°F), thus melting a globule of Wood's alloy, produced a galvanometer deflection of only 3 millimeters."

The piece of molybdenite used in these experiments of transforming the heat of the sun or stars into electricity is not much larger than the head of a pin. The chip of mineral thus used is larger than a pin head, but only a small spot of each specimen manifests this inexplicable phenomenon of changing light into electric current. Oddly enough, this bit of mineral is enclosed in a discarded pill box, the tiny hole being opposite the magic spot of the mineral. And when it is exposed to the sun, sufficient electricity is generated from the light to force the deflection of the galvanometer, an extremely sensitive electrical measuring instrument, off the scale.

Thus, the daily inquiries addressed to the Bureau of Standards, contemplating the use of thermoelectric current or even electricity from the sun in operating radio receivers, are not as nonsensical as they appear on the surface. While impractical at present, radio experimenters of the future may not only discard "A" and "B" batteries, but instead of plugging into electric-light sockets they may draw upon the sun, moon, or stars



New!



"BRAIDITE"
Hook-Up Wire
"The Braid Slides Back"

BRAIDITE is the easiest working and most durable hook-up wire made. To make a soldered connection, it is not necessary with Braidite, to strip back the insulation. The braid is simply pushed back and after the connection is made, the braid slides right back, thus making the neatest possible connection and leaving no exposed sections of bare wire. Braidite is made from either solid or stranded tinned copper wire, covered first with a cotton wrap and then with a cotton braid. Braidite is impervious to moisture and possesses the highest insulation qualities. Made in red, green, yellow, brown and black.
25 ft. solid copper core 30c.; 25 ft. stranded copper core, 35c.

"Corwico" Radio Wires
"Best from the Ground Up"

- Antenna Wire (Solid, Stranded and Braided)
- Complete Aerial Kits
- Magnet Wire
- Battery Cable
- Bus Bar Wire
- Hook-up Wire
- Lead-In Wire
- Amplifier Wire
- Loop Aerial Wire
- Litz Wire
- Flexible Wire

"Corwico" Radio Wires are sold by all leading dealers. Order direct if your dealer can not supply you. Write for free booklet on radio wires and their uses.

CORNISH WIRE COMPANY
30 CHURCH ST., NEW YORK CITY

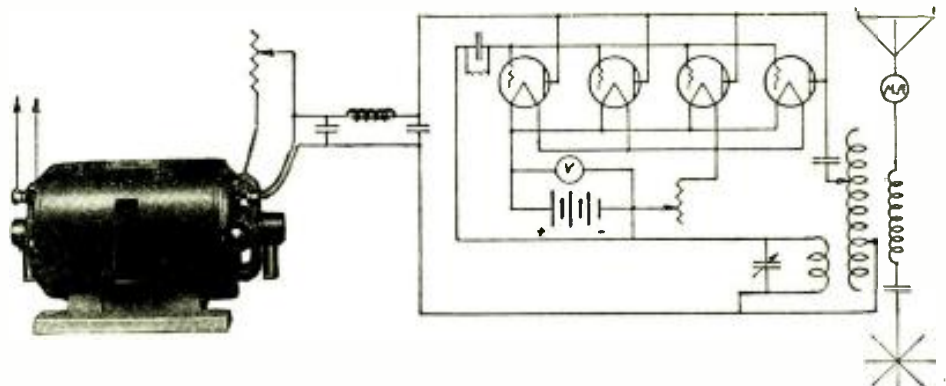

This is Item No. 8 furnishing Power Supply for 4/5 watters in the reversed feed back hook up.

Item 8 can be furnished with either AC or DC motors, or as a separate generator. The machine is two bearing, wick oil, and its output is conservatively rated at 500 volts, 150 watts. It's a real little maximum miles per watt DX getter.

ELECTRIC SPECIALTY COMPANY

TRADE "ESCO" MARK

211 South Street

Stamford, Conn., U. S. A.

Manufacturers of Motors, Generators, Motor-Generators
Dynamotors and Rotary Converters, for Radio and Other Purposes

SAVE 25% TO 60%

on every book you buy

Write for **BOOK BULLETIN No. 5**

CONSRAD COMPANY, 230 Fifth Avenue, New York

"Double R" PANEL METERS Rugged and Reliable Assets For Your Sets At a Price You're Glad To Pay



Tubes last longer when the voltages are right. The panel meter is just the thing you want for that. If you are discriminating you want the finest tone quality. A 0-50 milliammeter in the plate circuit of the last tube serves that object admirably. Mount the meter on the panel.

You will be delighted at the enjoyment that will be afforded by the use of a panel meter. The **DOUBLE R** meters are sturdily built and accurate, yet priced very modestly.

You send us nothing, yet we send the meters. All you have to do is to let them know what meters you want. Order by catalog number, which appears on the left in the list printed herewith. When the postman delivers the meter you pay him the price listed below, plus a few cents postage. Then you will put your meter into action and enjoy the fruits of your wise buy. Note AC meters for new AC tubes.

DC PANEL MILLIAMMETERS

No.	Price	No.	Price
No. 311—0-10 milliamperes	\$1.95	No. 390—0-100 milliamperes	\$1.65
No. 325—0-25 milliamperes	1.85	No. 395—0-300 milliamperes	1.65
No. 350—0-50 milliamperes	1.65	No. 394—0-400 milliamperes	1.65

DC PANEL VOLTMETERS

No.	Price	No.	Price
No. 326—0-6 volts	\$1.65	No. 342—0-150 volts	\$1.75
No. 335—0-8 volts	1.65	No. 348—0-8, 0-100 volts (doublerad- ing)	2.25
No. 319—0-10 volts	1.65		
No. 337—0-50 volts	1.55		
No. 339—0-100 volts	1.75		

DC PIN JACK VOLTMETERS

No.	Price
No. 306—0-6 volts, for Nos. 25, 28 Radiolas	\$2.50
No. 308—0-6 volts, for No. 20 Radiolas	2.50
No. 307—0-6 volts, desk type, with cord	2.50

AC PANEL VOLTMETERS

No.	Price
No. 351—0-15 volts	\$1.75
No. 352—0-10 volts	1.75

GUARANTY RADIO GOODS CO.
141 West 45th Street, New York City

Please send me Double R meters, catalogue numbers.....
for which I will pay the postman on receipt of meters, plus a few cents extra for postage. These meters are to be received by me on a 5-day money-back guaranty.

Name.....
Address.....
City.....State.....
N1

BIG NEW CATALOG FOR RADIO BUILDERS
FREE My big 1928 Radio Catalog, Call Book and Trouble Finder. 132 pages about Radio. Chock full of newest circuits—kits, transmitter parts, short wave outfits, eliminators and speakers. Thousands of bargains at lowest wholesale prices. A regular Radio Encyclopedia—Free. Write today.
American Auto & Radio Mfg. Co.
HARRY SCHWARTZBERG, PRES.
Dept. 105 American Radio Bldg., Kansas City, Mo.

LATEST RADIO CIRCUITS

RADIO PANELS
BAKELITE—HARD RUBBER
Cut, drilled, and engraved to order. Send rough sketch for estimate. Our Complete Catalog on Panels, Tubes and Rods—all of genuine Bakelite or Hard Rubber—mailed on request.
STARRETT MFG. CO.
520 S. GREEN STREET - - CHICAGO

as a never-diminishing source of power. "We have found substances that apparently transform light into electricity," declares Dr. Coblentz. "The importance of this can not be foretold," is his cautious afterword. "The next thing to be done," he continues, 'is to isolate the spots exhibiting high actino-electrical sensitivity and examine them separately. This will be a tedious, time-consuming undertaking. The material is of rare occurrence, and the risk of injury or loss is too great to attempt to attain the goal in one step."

While a student of the Case School of Applied Science of Cleveland, Ohio, 27 years ago, Dr. Coblentz became interested in radio. As a means of propagating messages from one building to another, he and a fellow senior in physics rigged up apparatus for wireless signaling, using an inductance coil and otherwise following the method of procedure outlined in the book of Heinrich Hertz. Crude but ingenious at that time was the method employed by these two seniors in signaling to each other their readiness in transmitting a wireless message, namely, the hoisting of a bicycle lamp to the window of the building. That was twenty-seven years ago, and the novelty of sending and receiving wireless messages prompted Cleveland newspapers to use bold headlines, "Two Case Seniors Send Wireless Messages Through Blinding Snowstorm."

Nearly twenty years later, during the World War, Dr. Coblentz invented a secret method of radio signaling, making use of infra-red rays. And, who knows but that this same physicist, in collaboration with fellow members at the Bureau of Standards, may eventually conceive a more economical and direct method of feeding our radio equipment with the necessary power?

Wanted--Radio Aerials for Airplanes

(Continued from page 755)

minimum weight. This outfit, now in experimental use in conjunction with the operation of the aircraft radio beacon at Hadley Field, New Jersey, is 10x12 3 inches in size, and weighs 8 pounds. It has been designed especially for installation on mail-

40 Non-Technical Radio Articles

every month for the beginner, the layman and those who like radio from the non-technical side.

SCIENCE AND INVENTION, which can be bought at any newsstand, contains the largest and most interesting section of radio articles of any non-radio magazine in existence.

Plenty of "How to Make It" radio articles and plenty of simplified hook-ups for the layman and experimenter. The radio section of **SCIENCE AND INVENTION** is so good that many **RADIO NEWS** readers buy it solely for this feature.

Radio Articles Appearing in January Science & Invention Magazine

- Telephotos Sent in Thirty Seconds by Radio
- Making an Oscillograph from a Baldwin Phone
- Newest German Radio Station
- World's Largest Loud Speaker
- Radio Reception Dependent on Solar Radiation
- The Hayden De Luxe Super (including power pack)
- Remote-Control Radio Tuning Device
- Making a Phonograph Pick-Up
- Radio Oracle—Questions and Answers
- Latest Patents and Patent Advice

Exclusively Licensed by Technidyne Corporation under U. S. Patent No. 1593658, July 27, 1926.

Startling!

"TONATROL"

A True Tone and Volume Control

This new and highly perfected Electrad device is amazing users with its smoothness and efficiency in controlling volume. It permits reception of soft music or the most powerful tones with remarkable clarity.

Sturdy Bakelite construction. Very simple to install in any receiver.

Tonatrol—Standard Volume Control.....\$1.50
Tonatrol—Type W.S. (with filament switch).....\$2.00

Write for installation booklet for the proper way to control volume.

Dept. 49C, 175 Varick Street, New York, N. Y.

ELECTRAD

LOOK !! IT'S FREE !!
DEALERS AND PROFESSIONAL SET BUILDERS!
Your **BIG NEW 1928 Catalog** is NOW READY!
Contains **Nationally Known Parts and Kits**

YAXLEY	AERO COIL
CARTER	WESTON
ACME	BENJAMIN
SAMSON	PRECISION COIL
TOBE	HAMMARLUND
	SILVER-MARSHALL, ETC.

Send for it Now ! It's FREE !
S. HAMMER RADIO CO.
307 Atkins Avenue Brooklyn, N. Y.

ELECTRICITY Easily Learned

IN A FEW WEEKS

Learn with real tools on real equipment. No books, no printed lessons, no dry lectures. McSweeney's shop plan system of training makes real electricians in shortest possible time. 90 days' training fits you for a big-day job at \$50 a week, and up. Write for big electrical book **FREE**—also remarkable tuition offer, which includes R. R. fare and board. I guarantee satisfaction or money back.

McSWEENEY ELECTRICAL SCHOOLS, Dept. 76-AA
Cincinnati, Ohio Cleveland, Ohio

DURHAM
RESISTORS

Print Your Own
Cards, Stationery, Circulars, Paper, etc. Save money. Print for others, big profit. Complete outfits \$8.85. Job press \$11.29. Rotary \$149. All easy, rules sent. Write for catalog presses type etc. **THE KELSEY CO., P-72, Meriden, Conn.**

carrying airplanes, and is being tested by the Lighthouse Service in cooperation with Colonial Air Transport, Inc., which operates on the New York-Boston airway, the air-mail service, the army and navy.

Oddly enough, this midget radio receiving set is the first suitable commercial receiver designed exclusively for use on airplanes; it is an experimental product and, at this time, no radio manufacturer is making a standard airplane radio receiving set—which fact offers a germ of opportunity to some forward-looking concern.

NEW RADIO BEACON

At least half a dozen aircraft radio beacons are now in operation or ready for service. The Lighthouse Service, in cooperation with the General Electric Company, has completed its first installation; this beacon being located at Hadley Field, about 7 miles from New Brunswick, New Jersey. This installation consists of a wooden mast 92 feet high, outfitted with Bellini-Tosi directional antennas. The radio "shack" is a wooden building 13 by 17 feet, situated at the base of the mast or tower. The transmitting set is a 1-kilowatt vacuum-tube unit similar to the apparatus used for the radio beacons of the Lighthouse Service, but modified by the installation of a goniometer (device for reading the angle of bearings) and automatic telegraph keys for sending the interlocking radio signal.

Operating tests with the new aircraft radio beacon at Hadley Field indicate that the width of the double-beam radio beacon may be controlled at will; thus overcoming what was once a serious obstacle. That is to say, in the pioneer experiments of several years ago, as the airplane traveled a considerable distance from the beacon station, the path of the double-beam signals became so wide as practically to nullify the safety effect of such a directive system.

Up to a distance of 100 miles, the Hadley Field beacon signals have been received satisfactorily on an unshielded airplane. "Ground tests have been made," reports the Aeronautic Branch of the Department of Commerce, "and the apparatus has been adjusted to produce a smooth signal pattern and an interlocking radio beam. This converges at Hadley Field, making it possible for airplanes equipped with radio receivers to determine their direction to the field, under conditions when bad visibility prevents flying with safety."

"Lopez Speaking"

(Continued from page 741)

think it silly of me to write you that letter?" As he didn't know her name and had no idea of the contents of the letter, he made some general remark about his appreciation of her interest. He never did find out what the admiring female had said in her note; but he got extra service for the remainder of the meal.

On another occasion Mr. Lopez was talking from a pay station in New York. He was calling a hotel that receives hundreds of calls daily, but when he asked the switchboard operator to hurry with his call, she answered, "All right, Mr. Lopez." He was surprised and asked, "How did you know who was calling?" and her reply was, "Oh I hear you on the radio and I knew your voice right away." And don't believe incidents like these don't please him.

But the letters were what interested us and although Mr. Lopez was loath to talk about them, we persuaded him to permit the reproduction of a few.



HIGH IN PUBLIC FAVOR

IN the air, where dependability is all important, and in the home, where quality is so vital, the Victoreen Super merits unquestioned leadership.

Listen to a Victoreen Super for just one moment, and you will easily recognize the tonal superiority over what has been called good reception! Build a Victoreen Super and learn, first hand, of its great simplicity and reliability. Learn why thousands and thousands of Victoreen enthusiasts eagerly watch for new developments which they consider authentic steps in the progress of Radio.

There is a new thrill for you in the new Victoreen A.C. Receiver. Send today for 1928 blue prints of the new hook-up.



**VICTOREEN
112 Audio Transformer Unit**

This unit is worthy of its place in the Victoreen Circuit and renders a marvelous offering in tonal quality—presenting all the intimate naturalness of the original program.

Designed to handle up to 475 volts of B Battery supply, this unit is especially adapted to the Western Electric cone speaker or similar types. The transformer consists of two stages of Audio amplification in one case and is designed for use with two 112 power tubes.

Retail Price—\$22.00 Each

THE GEORGE W. WALKER COMPANY

Merchandisers of Victoreen Radio Products

2825 CHESTER AVENUE - - - CLEVELAND, OHIO

Victoreen

POWER and QUALITY

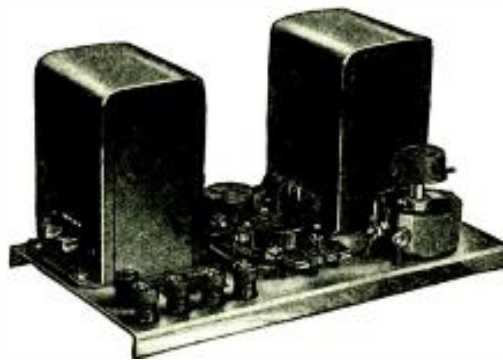

TYPE 441 AMPLIFIER

For use with UX 226, CX 326, UX 171, CX 371, UX 210, or CX 310 tubes.

Input inductance.....30 henries
Input turns ratio.....1:2.25
Output impedance ratio.....12:1
(Whole primary to secondary)

Price, completely wired.....\$20.00

Licensed by the Radio Corporation of America for radio amateur, experimental and broadcast reception only, and under the terms of the R. C. A. license the unit may be sold only with tubes.

A PUSH-PULL amplifier in the last stage provides the speaker with ample power to sustain a high volume level without tube overloading, transmitting the full effects of large swings in intensity common in orchestra music.

Other advantages of the push-pull system are, a reduction in hum when alternating current is used for filament supply, and for equal power outputs, a reduction in the plate voltage required.

The amplifier is supplied completely wired.

GENERAL RADIO Co
CAMBRIDGE MASSACHUSETTS

BOOK BARGAINS

You can save 25% to 60% on every book you buy through our wonderful bargain offer. Latest editions of Fiction, Scientific Books, Biographies, etc. More than 200 selected titles by the best authors.

Bulletin No. 25 lists all books.

FREE—BULLETIN NUMBER 25

The Consrad Company, 230 Fifth Avenue, New York

New!



Eby Sockets in Modern Receivers

The unqualified endorsement of EBY Sockets for the newest type receivers is another important step in the transition from cushion to rigid type sockets.

The new and improved tubes have rigid non-microphonic elements which make the cushion type socket unnecessary. The EBY Socket is the best rigid type socket on the market on at least three counts.

Look for the name EBY—it's your guarantee of a quality product. List price, 40c.

The H. H. EBY MFG. CO., INC.
4710 Stenton Ave., Philadelphia, Pa.

The New Morecroft Opens Wide Field to You

The great Morecroft has a new message for you. The second edition of his masterpiece, "Principles of Radio Communication," just off the press, is offered to you by Professor John H. Morecroft of the Electrical Engineering Department of Columbia University and past president of the Institute of Electrical Engineers.

The outstanding book on radio principles and practice is something that you must not be without. Every set builder, every designer, every engineer, every service man, simply must have this book. Ready reference to all intricate problems makes this volume invaluable. Distributors and dealers, salesmen and teachers, students and operators, all find Morecroft their standby, and now the new second edition awaits you. 1,001 pages and 831 illustrations in this cloth-bound volume.

SEND NO MONEY

Fill out and mail in the attached coupon

GUARANTY RADIO GOODS CO.,
141 West 45th St., New York City.

Gentlemen: Please send me at once and without cost to me full analytical exposition of brand-new edition of Professor Morecroft's famous "Principles of Radio Communication," consisting of 1,001 pages and 831 illustrations, constituting the second edition, which is brought right up to date, and constituting the most complete and authoritative book.

NAME

ADDRESS

CITYSTATE

N.Y.

FROM A HUGE MAILBAG

"What is the most interesting letter you ever received from an admirer among your listeners?" we asked him. After much delving into files and boxes this is what he produced from a girl somewhere in a Pennsylvania village:

"You don't know who I am and maybe you never will, but I have fallen in love with your voice and while I may seem silly to you I just can't help writing to you. Your music makes me so happy and your voice is so real to me, I feel that I have known you for years. I am living here in this town of 7,000 people. I had to come back here from Pittsburgh, where I was living with my aunt and going to high school. My mother died and I take care of our house and my sisters and brothers. In all my life I have never had a beau. Since I returned from school I have never gone to a party. Our relatives sent us a radio for Christmas and I have never failed to listen for you. There is something about the way you talk and tell us the names of the pieces your band plays, which has just made me feel you must be wonderful.

"Some of the other voices are so cold; but I can tell when you are happy and when things go wrong. I often dream that I am in New York seeing you in your club and not way out here. I have nothing real in my life, so I make believe and all my imagination is built around you. Every week you make me so happy. So please forgive a foolish girl and won't you send me your picture?"

There are hundreds of foolish missives which ask Mr. Lopez to write the senders. If he answered every letter he gets, it would take several secretaries and would give him little time to make further friends through his radio music.

Occasionally a writer takes it for granted that, because she expresses her interest, Lopez should immediately return the compliment and accept the proffered friendship. One woman (who was old enough to know better) wrote him every week until letters with her signature became well known at the studio. During a particularly busy night at his club, Mr. Lopez was handed a card, bearing the familiar name. The woman had come almost two hundred miles to see in reality the man whom she knew by his voice. He had never answered her letters, but that didn't lessen her enthusiasm and getting rid of her gracefully was a trifle difficult.

One young lady, who said she was a college girl, penned some fond words to the young maestro, telling him how she had grown to love his music and now felt that he and his music were one. Which seemed like a declaration of rather personal affection, further emphasized by the following paragraph:

"I really believe that you would love me if you ever got to know me, and I wonder if you would care to see me if I should go to New York?"

"I don't like any of the men I meet in my home town. They aren't interesting. But I have your picture on my dresser and when you say, "From the radio, we've got to go, we're signing off, good-night, everybody," I feel that you mean me especially and I could cry because I won't hear you again for another week. Do you feel that there is someone particularly thrilled by your words as you talk into the air? Well, it is I."

THE ARTIST'S THOUGHTS

The closing comment was our cue to ask Mr. Lopez, "Do you ever really feel that you are talking to one individual, such as this girl who writes you?" His reply was:

Faithful Service

The function of a power resistance is to control voltage and current—accurately—permanently—silently.

AEROVOX PYROHMS used with GOOD equipment make a BETTER power unit.

AEROVOX PYROHMS are built to last—are used by more than 20 leading power unit manufacturers.—This is conclusive evidence of their reliability—accuracy—worthiness.

Made in all values of resistance for continuous duty at 20, 40, 100 and 200 watts.

AEROVOX
"Built Better"
70 Washington St., Brooklyn, N. Y.

PRICES SLASHED

On Standard Radio Products

Now ready! Harry Alter's price list for January. Saves you money on every requirement—not merely on a few "bait" bargains. Check and prove my unheard-of values. Test Alter's "Minute-Man" shipping service. Send for this big catalog—free.

(NOTE: We Sell to Dealers Only)

The Harry Alter Co.

1798 Michigan Ave., Chicago, Ill.

1000 HOURS—of the Best Fun You Ever Had—Get Your Copy of SAM LOYD'S Tricks and Puzzles

The year's most unique book, contains 120 pages that are crammed full of all kinds of tricks, puzzles, games, conundrums, etc. Size, 9 x 12 inches—illustrations on every page. Fun for every member of the family.

50c On All Newsstands

EXPERIMENTER PUBLISHING CO., Inc.
230 Fifth Avenue, New York, N. Y.

Master-Craft
TUBE REJUVENATOR

POSITIVELY will rejuvenate any type tube on the batteries of your set in 45 seconds. Simple to operate. No other parts necessary. Good for any number of tubes. Made of genuine red Bakelite.

Tested and Approved by Popular Science Institute of Standards, Popular Radio Laboratory, Radio Engineering and twelve other leading radio laboratories.

We guarantee that it will equal the results obtained with any rejuvenator regardless of price. Get yours today. All old radio tubes can be made good as new in 45 seconds. Save the difference.

If your dealer cannot supply you we will send postpaid upon receipt of \$1.00.

Satisfaction Guaranteed
\$1.00 ONLY
POSTPAID

Master-Craft Products Co.
ENGINEERS - DESIGNERS - MANUFACTURERS
3803 N. CLARK ST. CHICAGO, ILLINOIS
BRANCH OFFICES IN ALL PRINCIPAL CITIES

Free! **THE RADIO MAN'S BUYER'S GUIDE** **Free!**
WALTER ROWAN BATTERY SUPPLY CO.

Professional Set Builders and Dealers

Write today for this big new Catalog. It's yours for the asking without obligation. Contains everything worth while in Radio, including all popular kits described in this and other leading publications. We carry in stock a complete line of parts, accessories, consoles and cabinets.

Buy Direct
from the largest jobbing house in the middle west and save money on all radio equipment. Try us for quick, accurate service. No delays, no substitutions.

Walter Rowan Battery Supply Co.
Dept. N, 227 N. Peoria St., Chicago, Ill.

IMPROVED TURN-IT
Variable Grid Leak (Non-Evaporating) .5 to 12.6 megohms. \$1.00
If your dealer can't supply you write direct
GARDINER & HEPBURN, INC.
611 Widener Building Philadelphia, Pa.

TOWER RADIO PRODUCTS
ON SALE EVERYWHERE

PATENTS
As one of the oldest patent firms in America we give inventors at lowest consistent charge, a service noted for results, evidenced by many well known Patents of extraordinary value. Book, Patent-Sense, free.
Lacey & Lacey, 631 F St., Washington, D. C. Estab. 1869

"Well, perhaps I should answer that 'Yes,' but the truth is that I am so concerned with giving my listeners the best music my boys can play, that I really don't think about my voice at all. In fact, I am always afraid that my voice is not interesting enough, that I do not get sufficient expression into what I say. That is why letters like these always amaze me. "But I do find that my voice reflects my feelings. When I am not particularly happy, I get sympathetic letters from some of my friends of the air. Then, if I sound buoyant, they detect that, too; and I can tell by the trend of my mail just what reaction my audience gets from my announcements.

"More letters, please," we urged; and, as Mr. Lopez went further into the files, the following written by "Myrtle" in Buffalo seemed worthy of attention. It read in part:

"I wrote you before and you never answered me. I used to think you were wonderful; but I guess you are just like a lot of celebrities who get puffed up because they receive a lot of attention. I suppose many girls write to you and you haven't time for poor little me; but you'd be sorry if you only knew how nice my friends think I am."

There's another side to this "mash" note business, too. Sometimes the men don't like to have so much attention showered on artists by their particular girl friends. One fellow, who seemed to have a real grievance, wrote Mr. Lopez:

"For the love of mike, can that sentimental stuff you recite. My girl goes goofy over it every time you start in. She won't let me tune you out and she sits there mooning while you talk and play. She says 'Isn't he wonderful?' and I try to tell her that you're no better than us fellows who can't talk slush over the air, but she just sits and eats it up. Do you have to recite, 'Where'd you get those eyes?' as though you meant every woman listening to you?"

But on and on he goes, every week with the familiar "Lopez speaking;" the same words but new music, new ideas of entertainment—and those who listen to him this winter will get the advantage of all the radio plans he has made during his absence from the air in the summer months.

The Tyrman Shielded-Grid Seven

(Continued from page 769)

which corresponds to that of the corresponding wire in the battery cable. When wiring the set the following system should be followed: connect the common "A—," "B—" and "C+45" lead with the terminal of the cable plug marked "Black"; connect "A+" with "Red"; connect "B+45" with "Blue"; connect "B+90" with "Brown"; connect "B+135" volts with "Grey"; connect "B+180" volts with "Green"; and connect "C—" 45 volts with "Yellow."

After the wiring on the sub-base has been completed, the parts on the front panel should be mounted; and then four screws are used to attach the front panel to the sub-base. When the set is in this state of completion only six wires remain to be connected.

CURRENT SUPPLY AND LOOP

Either batteries or a power unit may be used for the operation of the receiver. As the three shielded-grid tubes require a current of only .125 amperes each, the total current required by the filament cir-

This is a Raytheon-Approved Power Unit. 1 price INCLUDES the \$4.50 Gencine Raytheon BH 125 m. a. tube, made by Raytheon Mfg. Company, Cambridge, Mass.



We Challenge anyone to EQUAL our VALUE at our Price

IT can't be done. This is the lowest price ever made on a "B" supply of equal voltage and quality. Greatest saving ever offered on a high quality "B" approved by leading radio laboratories, authorities, experts, radio owners, engineers, and passed by Raytheon Mfg. Company as a Raytheon-Approved Power Unit.

GUARANTEED TO DELIVER AMPLE POWER FOR TEN TUBES, INCLUDING POWER TUBE

You can adjust the three variable controls, connected to the detector, intermediate, and amplifier taps, to suit any set. You get exactly the correct voltage with the necessary milliamperes to assure full "B" current at all times. Has a power tap for high power tubes as well as reserve capacity in the filter to carry smoothly the long sustaining notes. No liquids; no acids. Neat, compact—5½ x 6½ x 9½ inches. Finished in old gold bronze. 110-V., 60-cycle, A.C. All ready to plug into light socket.

Only \$21 COMPLETE WITH RAYTHEON BH 125 M. A. TUBE

Unsurpassed by "B" supplies costing up to three times as much. Nationally advertised; sold regularly at \$35.00 retail. Now, direct to you, at \$21.

GUARANTEED, OR MONEY BACK.—Subject to return any time within 30 days, money refunded, if not satisfactory. Immediate delivery. Don't pass up this guaranteed opportunity to make a big saving. Mail coupon, send money order TODAY!

WARREN ELECTRIC CO.
Dept RN Peoria, Illinois

WARREN ELECTRIC CO., Dept. R.N., Peoria, Ill. Gentlemen: Ship at once guaranteed Model T WARREN "B" SUPPLY at \$21 (822 West of Rockies), with the understanding that I can return it (any time within 30 days from date) and get my money back if not entirely satisfied.

Name.....
Address.....
Town.....
State.....
Shipped C.O.D. Or we pay express (in U. S.) if money order or bank draft accompanies order.



QUALITY RECEPTION!

Your receiver should give it to you. It will... if equipped with Ferranti audio frequency transformers. They amplify every note in rich, mellow tones with an abundance of volume. See that your set has them!



AUDIO FREQUENCY TRANSFORMERS

There is a Ferranti audio transformer for every requirement, and if your dealer has not the necessary information, write us direct.

Ferranti, Inc.

130 West 42nd Street
New York, N. Y.

Ferranti, Ltd. Ferranti, Electric, Ltd.
Hollinwood, Eng. Toronto, Ontario, Can.

Electricity!
a complete line of
AC TUBES
By **DAVEN**

"The King of Merit"
DAVEN RADIO CORPORATION
TRADE MARK "Resistor Specialists" REGISTERED
146 SUMMIT STREET NEWARK, N. J.

cuits of this receiver is only 1.625 amperes, which makes the set very economical to operate. Also, the plate current is not excessive, as it is usually less than 35 milliamperes. For the grid circuit two "C" batteries are required; one of 45 volts, and the other 3 volts.

For the operation of this receiver a loop antenna is employed as a pick-up. The sensitivity of the receiver is sufficient to allow distance reception without the necessity of an outside aerial, and the use of the loop provides the additional advantage of directional selectivity. Satisfactory loop antennas are available on the market; but if the amateur wishes to construct one he will not find it a difficult task. The loop is of the box type and wound on a rectangular frame: 23 inches high, 12 inches wide and 6 inches deep. It has 14 turns of wire and a center-tap connection is made to the seventh turn. Flexible silk-covered wire is used and the winding is in two sections of seven turns each, with the wires spaced 6 turns to the inch and one inch between each section. The loop revolves on a wooden rod, 3/4 inch in diameter, passing through the center of the frame.

Set Builders' Letters

(Continued from page 794)

hesitates to recommend any one to build such a set for use on the broadcast band, or to print such a circuit. In countries where reception is licensed, owners of such sets are often fined in court for interference with their neighbors; and it is a question whether, under the Radio Act of 1927, the operator of a "blooper" could not be dealt with similarly in a United States court.—EDITOR.)

ANOTHER ULTRADYNE FAN

Editor, RADIO NEWS:
I have just been looking over the November issue, and read two letters from Ultradyne fans. I am with them, and want to go farther by saying that, tube for tube, I doubt if it can be equalled. There is just one kick I have against Mr. Lacault, and that is, that there is no use for the second stage of audio.

Last winter this set did things that one would not believe if I had told them. I have never troubled to have reception verified, and I make no claims for the greatest number of stations received, or farthest distance pulled; but this set held 2BL (Sydney, Australia) for 22 minutes one night last winter.

Let's hear more about the Ultradyne and give Mr. Lacault credit for designing a real honest-to-goodness receiver that will give anybody pleasure to build and listen to.

L. J. CHARLAND,

129 West 72 Street, New York City.

CORRECTION

The R.F. transformers (types 4A and 4D) made by the Precision Coil Co., 209 Centre Street, New York City (Certificate of Merit No. 2139), are designed for use with a .00035-mf. variable condenser, in combination with which they cover the broadcast waveband; and not for a .0005-mf. condenser, as stated, through a typographical error, in the November issue of RADIO NEWS.

STANDARD-FREQUENCY TRANSMISSIONS

THE schedule of standard-frequency (by C. W. telegraphy) transmissions from the Bureau of Standards at Washington will vary slightly from frequencies previously used. The transmissions are given once a month, eight frequencies on each evening; and for those with suitable receiving apparatus, provide a means of calibrating wavemeters and other instruments. Details and instructions are obtainable from Letter Circular No. 151, sent out on application by the Bureau.

The programs for the next few months is as follows: Figures opposite hours are kilocycles of the respective signals (those under each, in parentheses, the nearest corresponding meters of wavelength):

Hour E.S.T.	P.M.	Dec. 20	Jan. 20	Feb. 20	Mar. 20	Apr. 20
10:00	3000 (100)	550 (545)	125 (2399)	300 (999)	3000 (100)	3000 (100)
10:12	3300 (91)	650 (461)	150 (1999)	325 (923)	3300 (91)	3300 (91)
10:24	3600 (83)	750 (400)	175 (1713)	350 (857)	3600 (83)	3600 (83)
10:36	4000 (75)	900 (331)	200 (1499)	375 (800)	4000 (75)	4000 (75)
10:48	4400 (68)	1050 (286)	225 (1332)	400 (750)	4400 (68)	4400 (68)
11:00	4900 (61)	1200 (250)	250 (1199)	450 (666)	4900 (61)	4900 (61)
11:12	5400 (56)	1350 (222)	275 (1099)	500 (600)	5400 (56)	5400 (56)
11:24	6000 (50)	1500 (200)	300 (999)	550 (545)	6000 (50)	6000 (50)

R.E. Lacault ^{*} Knows- SUPER-HETERODYNES

* Originator and designer of the nationally known 'ULTRADYNE,' Radio Engineer, and former Editor with many years practical experience on Super-Heterodynes.

He has written this book for you

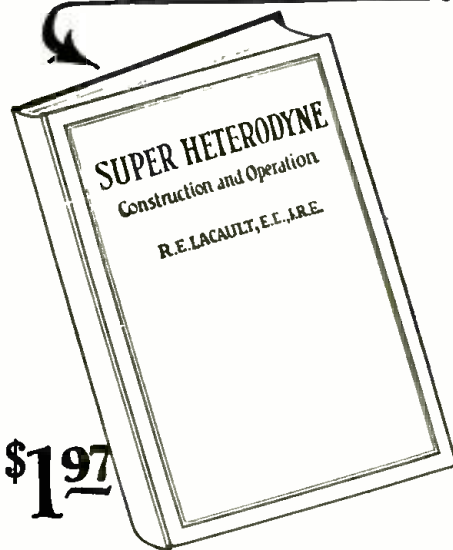

\$1.97

R. E. LACAULT has been an Editor of R. Radio magazines for many years. He has specialized in the greatest and most powerful of all Radio Circuits, "The Super-Heterodyne." He has studied, originated and developed to marvelous perfection the "ULTRADYNE" Super-Heterodyne. He has advised thousands of set owners and builders in Super-Heterodyne problems.

—and now he has used his immense experience, his clear mind and his editorial ability to write, by far the most lucid, interesting, instructive and plainly written book on the theory and construction of Super-Heterodynes that has ever been published.

You who already own Super-Heterodynes will find this book especially helpful in locating and correcting troubles. A special trouble chart is printed for detecting and correcting common faults.

SEND NO MONEY

Just send us a card mentioning the book with your name and address. We will mail you the book. You pay the postman \$1.97 plus a few cents postage on delivery.

Distributed by

THE CONSRAD CO., Inc.
230 Fifth Ave., New York, N. Y.

Improved, positive voltage control for "B" eliminator

The new Centralab Heavy Duty Potentiometer is all wire wound and will carry the entire output of any "B" power device with an unusually high margin of safety. Resistance remains constant at any knob setting so that panel or knob can be marked in volts. A single turn of the knob will give full variation.



Has sufficient current carrying capacity to permit shunting a low resistance value across the "B" power unit to obtain constant voltage regulation. A sufficient current load is maintained throughout the resistances to reduce the rectifier voltage to workable pressure, even though set is not connected—an insurance against filter condenser break down.

Write for folder giving details of this circuit

Resistances 2,000, 3,000, 5,000, 8,000, 10,000, 15,000, 20,000, 50,000, price \$2.00, at your dealer's or C. O. D.

CENTRAL RADIO LABORATORIES
19 Kiefe Avenue, Milwaukee, Wis.



90 Volt Power Unit :: \$12.75



Hums, line noises, etc., positively impossible with this new advanced unit. Plug in and forget. Non-noise and noiseless. All detector and intermediate voltages plainly marked. Simpler to hook up than dry cells. Operates any type set 1 to 12 tubes. Greater volume and clearness guaranteed. If not thoroughly satisfied return after using 30 days for complete refund. Guaranteed further 2 years. For 110-120 volts A.C., 25 to 60 cycle current, 90 volts, \$12.75; 112½, \$15.25; 135, \$17.50; 157½, \$19.50; 180, \$24.00; 202½, \$26.00. Also built for D. C. current 110 and 32 volts at only \$3.00 additional, any size above. Ample stocks—same day shipments. Simply say—ship C.O.D. or write for my interesting literature, testimonials, etc.

B. HAWLEY SMITH

334 Washington Ave. Danbury, Conn., U. S. A.

5 TUBE RADIO
At Low Factory Prices

It's a wonder for power and selectivity. Famous AIRL circuit. Coast to coast reception! Finely built of selected, tested parts. Thousands now in use.

FREE Log and Call Book and New 132-p. Catalog with thousands of nationally advertised bargains. Latest in radio at big savings. Write for Free copy.

AMERICAN AUTO & RADIO MFG. CO.
HARRY SCHWARTZBERG, PRES.
Dept. 101, American Radio Bldg., Kansas City, Mo.

RADIO "BUGS"

MARK TWAIN'S Connecticut Yankee had many ingenious ideas regarding the combination of chivalry and modern inventions, but even he never saw the noble Sir Kutt riding forth in full caparison. This vision was reserved for our contributor, Harrison Wilson of Greenville, Ohio, who entrusted it to paper and entitled it "The Radio Knight-Mare."

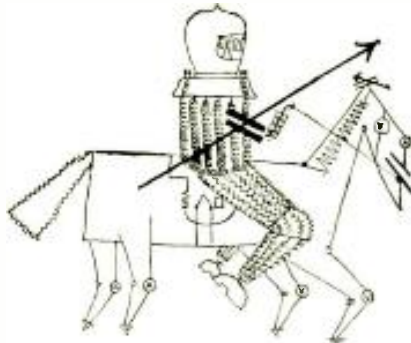

Blessed are the peacemakers, even though their efforts are not always rewarded as they should be. In this affecting little sketch we have "A Neutralizing Condenser" endeavoring to restore harmony between two of his fellow-capacities who are, perhaps, slightly out of phase. Brinton Sullivan of Macomb, Illinois, sketched this on the field of hostilities.



Strange things happen in the canyons of the West, if there be truth in the bright-colored magazines obtainable in such large quantities from our corner newsstand. Here is a scene which Joseph W. Sine, of Salt Lake City, has drawn, we suppose, from nature. The circuit, he explains, is like most of our conventional hook-ups; i.e., it works best at night. "In closing," he adds, "great care should be taken with the output of this device, as the filtering factors are positively low."

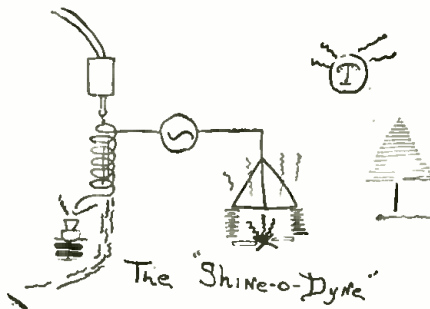

One of the famous characters in prose and poetry is Old King Cole; a descendant of his, perhaps, is Good King Coil. The artist, Mrs. J. B. Stewart of Willoughby, Ohio, explains that while "he owns a nice set of long waves, it is not a switch; it is permanent."

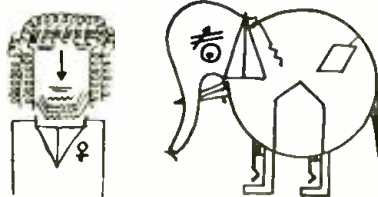

To the right of his majesty is one of the ornaments of a royal menagerie; the keeper,

"Ionized Helium"

The Secret of an EFFICIENT RECTIFYING TUBE



THOUSANDS of radio users know the satisfactory service given by Raytheon Long Life Rectifying Tubes, but few know the reason.

The filament in the ordinary tube deteriorates while it is emitting electrons. In Raytheon, ionized helium gas, eighty times more conductive than copper, is used in place of a filament. This ionized helium supplies, over and over again, millions of electrons per second, with no deterioration to the helium. Thus, in Raytheon, each helium ion veritably becomes an endless chain of power.

As a result, a Raytheon tube has a far longer life and affords sustained voltage throughout.

RAYTHEON MANUFACTURING CO.
Cambridge, Mass.

When purchasing a battery eliminator, look for the green seal which marks it as being Raytheon - equipped.



The Heavy Duty Rectifier for B power service. Maintains a constant flow of smooth, silent power, at full voltage throughout its life. Type BH is standard in those units designed to supply the type 171 Amplifying tube. Rating: 125 m. a. at 300 V. Price \$4.50.

TYPE BH

The tube that has made practical the elimination of A, B and C batteries. The Raytheon-equipped eliminator provides a noiseless constant flow of power. 350 m. a., 250 volts, \$7.50.

TYPE BA



OPPORTUNITY AD-LETS

Follow these advertisements every month. Reliable advertisers from all over the country offer their most attractive specials in these columns.

Classified advertising rate twenty-two cents a word for each insertion. Ten per cent discount for 6 issues, 20 per cent discount for 12 issues. Names and addresses must be included at the above rate. Cash should accompany all classified advertisements unless placed by an accredited advertising agency. No advertisements for less than 10 words accepted.

Objectionable or misleading advertisements not accepted. Advertisements for the March issue must reach us not later than January 1st.

CIRCULATION LARGER THAN THAT OF ANY OTHER RADIO PUBLICATION

EXPERIMENTER PUBLISHING CO., INC., 230 Fifth Avenue, New York, N. Y.

Agents Wanted

Big Money and fast sales. Every owner buys gold initials for his auto. You charge \$1.50; make \$1.35. Ten orders daily easy. Write for particulars and free samples. American Monogram Co., Dept. 133, East Orange, N. J.

Guaranteed Genuine Gold Leaf Letters anyone can put on store windows. Large profits, enormous demand. Free samples. Metallic Letter Co., 422 N. Clark, Chicago.

Sell subscriptions to magazines known the world over. Steady monthly income with absolutely no investment required. Hundreds of selling arguments every month. Start now. Full information sent free, no obligation. Agency Division, Experimenter Publishing Co., 230 Fifth Avenue, New York.

"Superkeen! Amazing New Patented Magnetic Blade Sharpener!" Sharpens all razor blades instantly, magically, by powerful magnetic force! New! Absolutely different! Sensational Demonstration! Whirlwind seller! Write for "Pocket Sample" Superkeen, Dept. B-14, Salisbury, N. C.

Radio Agents—make big money—easy! Selling marvelous new sets and accessories. Buy from factory at lowest prices. Get new catalog with thousands of nationally advertised bargains. Free call book. Write today. American Auto and Radio Co., Dept. 108, American Radio Bldg., Kansas City, Mo.

Send name, address on postcard. Free introductory copy Salesology Magazine; contains 1000 money making opportunities offered by big reliable firms; no obligation. Salesology Magazine, Desk B280, 500 No. Dearborn, Chicago.

Antenna

Make your receiver do all the manufacturer claims it can! The answer is a practical, proven fact—Scott's Single Pole Tuned Radio Antenna—no trick—description FREE. Scott, 719 First St., New Orleans, La.

Business Opportunities

Inventions Commercialized. Patented or Unpatented. Write Adam Fisher Mfg. Co., 278 Enright, St. Louis, Mo.

67 Ways to Increase Income. 96-page book "Spare-time Money Handbook" contains 67 practical and complete plans to operate sparetime business. For everyone who wants more money. Price only 50c. Conrad Company, Inc., 230 Fifth Avenue, New York.

Amateur Cartoonists: Make money in spare time with new cartoon selling plan. Write Smith's Service, Watachee, Wash.

Average Intelligence plus our home training places you in a big paying radio job. Information upon request. McKay Instrument Corp., 631 Railway Exchange Bldg., Portland, Oregon.

Tired of working for other people? Without experience, training or capital I'll show you how you can become financially independent. Easy, pleasant work. \$100 profit every week. Free automobile. Write today for particulars. Albert Mills, Mgr., 1500 Monmouth, Cincinnati, Ohio.

Free Book. Start little Mail Order business. Hadwii, 5A-74 Cortlandt Street, N. Y.

Chemistry

Learn Chemistry at Home. Dr. T. O'Connor Sloane, noted educator and scientific authority, will teach you. Our home study correspondence course fits you to take a position as chemist. See our full page ad on page 811 of this issue. (Chemical Institute of New York, 16 E. 30th Street, New York City).

Correspondence Courses

Used correspondence school courses sold on repurchase basis. Also rented and exchanged. Money-back guarantee. Catalog free. (Courses bought). Lee Mountain, Pisgah, Alabama.

Detectives

Detectives Needed Everywhere. Travel. Experience unnecessary. Particulars free. Write, American Detective System, 2190 Broadway, N. Y.

Electricity

Electric Fun! Seventy stunts, 110 volts, \$1. Cooperco, Campbell, Calif.

Esperanto

Complete Text-book, and 1800 Word Esperanto Dictionary \$1.00 prepaid. Buho Print Shop, 1435 Race Street, Denver, Colorado.

For Inventors

Inventions Commercialized. Patented or Unpatented. Write Adam Fisher Mfg. Co., 278 Enright, St. Louis, Mo.

I am in touch with hundreds of money men and manufacturers who wish to buy good inventions. Hartley, 38 Court St., Bangor, Maine.

Help Wanted, Instructions

Earn \$25 Weekly Share Time, writing for Newspapers and Magazines. Experience unnecessary. Copyright book. "How to write for Pay" Free. Press Reporting Inst., 973, St. Louis, Mo.

Help Wanted

Become a Landscape Architect. Uncrowded profession; wonderful opportunity for money-making. Easily mastered by mail. Earn while you learn. Est. 1916. Write for details. American Landscape School, 11 Newark, N. Y.

Government Forest Rangers, Chauffeur-Carriers, Patrol Guards, Mail Clerks, Special Agents (Investigators) needed often. \$125-\$250 month. "How to Qualify" mailed Free. Write, tizmet, 251, St. Louis, Mo.

National Publisher, needs agents, boys and shops to help sell great national magazines. No investment required. Big profits, sparetime work very successful. Write Agency Division, Experimenter Pub. Co., 230 Fifth Avenue, New York.

Men, get Forest Ranger Job: \$125-\$200 month and home furnished; permanent, hunt, fish, trap. For details, write Norton, 249 Temple Court, Denver, Colo.

Instruction

Learn Chemistry at Home. Dr. T. O'Connor Sloane, noted educator and scientific authority, will teach you. Our home study correspondence course fits you to take a position as chemist. See our full page ad on page 811 of this issue. (Chemical Institute of New York, 16 E. 30th Street, New York City).

Miscellaneous

Inventions Commercialized. Patented or Unpatented. Write Adam Fisher Mfg. Co., 278 Enright, St. Louis, Mo.

Save Money at Home. You can build many home necessities yourself, such as furniture, kitchen utensils, decorative material, etc., thus saving many dollars. All construction information on thousands of things given in 116-page book "How to Make It." Price 50c. Experimenter Publishing Co., Inc., 230 Fifth Avenue, New York.

Musical Instruments

Learn to play! Famous "Likenu" rebuilt instruments. Saxophones, trumpets, trombones, clarinets, sousaphones, etc. All leading makes. Lowest prices. Beautiful folder, bargain list, free. Waltersdorf, Instrument Builders, Creston, Iowa.

Old Money Wanted

\$2 to \$500 each paid for hundreds of Old or Odd Coins. Keep all old money. It may be very valuable. Send 10c for New Illustrated Coin Value Book, 46c. Guaranteed prices. Get posted. We pay Cash. Clarke Coin Company, 14 Street, LeRoy, N. Y.

Patent Attorneys

Patents—Send for form "Evidence of Conception" to be signed and witnessed. Form, fee schedule, information free. Lancaster and Allwine, Registered Patent Attorneys in United States and Canada, 269 Ouray Bldg., Washington, D. C.

Patents—Send drawing or model of your invention for examination and instructions. Advice and booklet free. Highest references. Best results. Promptness assured. Watson E. Coleman, Patent Lawyer, 724 9th Street, N.W., Washington, D. C.

Inventors—Should write for our Guide Book. "How to Obtain a Patent" and Record of Invention Blank, sent free. Send model or sketch of inventions for our inspection and instructions free. Radio, Electrical, Chemical, Mechanical and Trademark Experts. Terms Reasonable. Victor J. Evans & Co., 922 Ninth, Washington, D. C.

Patent Sense—Valuable book free. See Lacey's ad, page 851. Lacey & Lacey, 631 F. St., Washington, D. C. Established 1869.

Patents secured. Easy terms. Inventors Service Bureau, Box 1648, Washington.

Patents

Inventions Commercialized. Patented or Unpatented. Write Adam Fisher Mfg. Co., 278 Enright, St. Louis, Mo.

Postage Stamps

Stamp Collectors—Phillips Monthly Bulletin (illustrated) offers over 2,000 special bargains, sets, packets, single stamps, etc., each issue. Free. Phillips, Box 1012, Hartford, Conn.

Printing Outfits and Supplies

Print your own cards, stationery, circulars, paper, etc. Complete outfit \$8.95; Job Presses \$11. \$29; Rotary \$149. Print for others, big profit. All easy, rules sent. Write for catalog presses, type, paper, etc. Kelsey Company, F-13, Meriden, Conn.

200 Noteheads and 100 Envelopes, \$1.15, postpaid. ORERMAN COMPANY, Box 1268, Chicago.

Multigraph typewritten letters sell anything. Two dollars thousand. Miscellaneous printing. Meyer Rey Corporation, Monmouth, Illinois.

Radio

Kit bargain. 10 essential radio tools \$2 postpaid. Winga Tool Co., Box 626, Madison, Wis.

Press and public concede it to be the best ever produced. "Radio Theory and Operating," by Mary Texanna Loomis, member Institute of Radio Engineers, Lecturer on radio, Loomis Radio College. Thorough text and reference book; 886 pages, 700 illustrations. Price \$3.50, postage paid. Used by Radio Schools, Technical Colleges, Universities, Dept. of Commerce, Gov't Schools and Engineers. At bookdealers, or sent on receipt check or money order. Loomis Publishing Company, Dept. B, 465-9th St., Washington, D. C.

Interested in getting Radio catalogs from U. S. firms. Parker, 268 Sydney Road, Coburg, Australia.

Edison Nickel-Steel Storage "A" Batteries. 6-volt—112½-ampere. Guaranteed, \$16.00. Also 225 and 450-ampere cells. 5-tube Gang Sockets, all Bakelite, 70c. Zied, 834 N. Randolph St., Phila., Pa.

Panel Lamp. Rests on top cabinet. Lights dial. \$1.50 prepaid. Robert Stevenson, Lancaster, Ohio.

Transformers—650—7½ volts, \$7.25. 550 volta, \$3.50. Chokes, 30 H 150, M.A., \$5.75. 50 H, 100 M.A., \$2.50. Write for lists. Radio Parts Sales Co., Orange, N. J.

2 Ampere Chargers, \$10.50, B Eliminators, Bulb type, steel cabinet, SILENT, 60 Mills, C. O. D. Guaranteed. Catalog, Electro-Chemical Company of America, Indianapolis.

Log-Chart Ur Radio. By the newest and simplest way. Absolutely no writing of call letters, wavelengths or dial numbers—A MERE DOT locates that station as received on ur RADIO. Stations all over the WORLD and outline map of the United States. Price 25c. Dea Rie Radio Laboratories, 505 Madison Square Bldg., Chicago, Ill.—229 Whittemore, Pontiac, Michigan.

Edison "A" Batteries. 3-cell, 20-ampere hour, in neat metal cases. Price \$3.50 each, ten or more \$3.00 each. Cash with order. Department II, 25 East South Street, Indianapolis, Indiana.

Radio Equipment

Direct Factory Sale. Wholesale prices. Tremendous savings. Selling direct to you. Here are some of our many items: 30 Henry Choke, 100 M.A., \$2.19; 10 Henry Choke, 400 M.A., \$5.48. Power Transformers for all kinds of eliminators and for all types of A.C. tubes at special low prices. EVERY ITEM FULLY GUARANTEED. Promptly shipped, upon receipt of order. Send for free illustrated catalog today. Todd Electric Co., Inc., (Manufacturers) 36 West 20th Street, Dept. G, New York City.

Salesmen Wanted

Large Manufacturer of popular priced Radio Cabinets wants representatives selling radio dealers. Models listing at \$13 and up. Well made in large modern plant. Quantity sellers. Straight commission basis. For full details, address Drawer E 10, Ironville, N. Y.

Photo Medallion Men and Women, make \$75 to \$125 a week with the largest line of Photo Novelties in the world—Photo Medallions, Photo Medallion Clocks, Photo Fountain Pens, Photo Mirrors, Photo Powder Compacts, Photo Jewelry, Photo Buttons. Send for Catalogue. Gibson Photo Jewelry Co., Box G-608-614 Gravesend Ave., Brooklyn, N. Y.

Make old phonographs rival finest modern machines. Salesmen understanding Radio sell Crescendophone Electric Reproducer in every other home. Write Crescendophone Co., Dept. N, Shrinig Arcade Bldg., Los Angeles.

Scenery to Rent

World's Most Beautiful settings for operas, plays, minstrels. Amella Grain, Philadelphia.

Song Writers

Song-Poem writers. Address Monarch, 236 W. 55th St., Dept. 122, New York.

Song Poems

Song Poem Writers—Address Hibbler, DIX, 2164 N. Keystone Ave., Chicago.

Telegraphy

Telegraphy—Both Morse and Wireless taught thoroughly. Big salaries. Wonderful opportunities. Expenses low, chance to earn part. School established fifty years. Catalog free. Dodge's Institute, Our St., Valparaiso, Ind.

Wanted to Buy

Full Value Paid for Old Gold, Jewelry, Watches, Diamonds, crown, bridges, dental gold, silver, platinum, gold or silver ore; magnetite points, old false teeth. Packages returned if our offer is not satisfactory. United States Smelting Works (The Old Reliable), 39 So. State St., Dept. 16, Chicago, Ill.



**Cure
Lead-In
Ills**

ELECTRAD Certified Lead-In

You can eliminate all lead-in troubles with this improved Electrad Lead-In. No holes to bore, no losses, no work to install.

Bends or twists any shape to fit neatly under window or doors. You lock them tight upon it. One piece heavily tinned copper strip covered with triple-ply insulation 10 inches long.

Waterproof, all connections riveted and soldered. Fahnestock clips. Get the genuine "Electrad." 40c. at dealers or write.

*Free Descriptive Circulars
on Request*

Dept. 50B, 175 Varick St., New York, N. Y.

ELECTRAD

XL Products



Pep up Your Set!

Quick, easy tuning—more volume, clearness, stability, with an X-L VARIO DENSER in your circuit.

MODEL "N" VARIO DENSER Micrometer adjustment easily made, assures exact grid bias control in all tuned radio frequency circuits. Neutrodyne, Roberts 2-tube, Ironwing-Drake, McMurdo Silver's Knockout, etc. Capacity range 1.8 to 20 micro-micro farads. Price, \$1.00.

MODEL "G" Obtains the proper grid capacity on Cockaday circuits, filter and intermediate frequency tuning in super-heterodyne and positive grid bias in all sets. Capacity range: Model G-1, .00002 to .0001 Mfd. Model G-5, .0001 to .0005 Mfd. Model G-10, .0002 to .001 Mfd. Price complete with grid ellipse \$1.50.

Investigate the Goodwin Aberleide Detector Circuit. This is applicable to any set and adds a stage without added tuning controls.

FREE Here is a new 16-page book of wiring diagrams of popular circuits including the LOFTIN-WHITE constant coupled radio frequency circuit, Stroboddyne, etc., sent free on request.

X-L RADIO LABORATORIES
2426 Lincoln Avenue Chicago, Ill.

AT RADIO WHOLESALE

Write for my Big 1928 Radio Catalog
—just off the press. Thousands
of marvelous bargains in nationally
advertised goods. All the
LATEST IN RADIOS and
equipment. Lowest wholesale
prices.

It's a
regular
FREE
encyclope-
dia on Radio.
All about trouble finding.

**FREE Log and
Call Book and Cat-
alog.** Get your copy to-
day. Send postcard now!

American Auto & Radio Mfg. Co.
HARRY SCHWARTZBERG, PRES.
Dept. 103 American Radio Bldg., Kansas City, Mo. 3

**DEALERS
NEW
1928
CATALOG**

Quality Fixed Electrical Condensers

Fast III-Test extra-capacity Condensers for all purposes meet all tests. High insulation resistance. One-piece die-press, steel housing. Impervious to climatic changes. Laboratory treatment—moisture resistant, assures dependable service. Millions in use since 1919. Fit all units. Write for the attractive booklet. 3982 Barry Ave., Dept. RN, Chicago, U.S.A.

JOHN E. FAST & CO.

William O. Strosahl of Brooklyn, N. Y., who appeared previously as Mr. Anonymous, comments that the Sacred Elephanthus "will remind one of the peanuts, while listening to the game."

William G. Mortimer, of London, Canada, is well known to our readers; at least, his cartoons are. So, Mr. Mortimer must, perhaps, receive less credit than some of our non-professional entomologists. His first illustration is full of action: the explanation is "Not enough resistance in the receiver."



The football season inspired Mr. Mortimer to this view (below) of a college warrior, "all set for the 'grid' battle;" and as his companion we have an "Old Spark." The veteran is bearing himself cheerfully, in spite of age and evident infirmities which may result in his quenching.

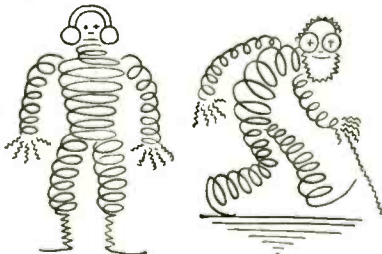

The international nature of radio is brought home to the editorial staff of Radio News at every mail. Several excellent bugs have been received from overseas; the best and most full of character comes from Herman Puusep of Valga (Walk) in Esthonia. This picture shows a sudden storm along the Baltic, and bears a piece of good advice to the set owner who depends upon a switch to keep his aerial grounded while he is not enjoying reception.



Other "bugs" remain on hand for publication; preference has been given, in the order of using them, to those which were drawn in firm ink lines, suitable for fac-simile reproduction. A great deal of wit and ingenuity has been put into these quaint creations, and we trust that our readers have enjoyed them as much as our contributors evidently have their production.

RUSSIAN RADIO ACTIVITY

THE number of licensed listeners in the Soviet Union, says an official announcement, has increased from 30,000 to 200,000 in the past two years. There are now 47 broadcast stations in this area.

RADIO PARTS for Discriminating Set Builders

Bradleyunit-A



This fixed resistor is scientifically treated to resist moisture. It is not affected by temperature, moisture or age. Provides the ideal resistance for B-eliminator hookups requiring fixed resistors of quality.

Bradleyohm-E

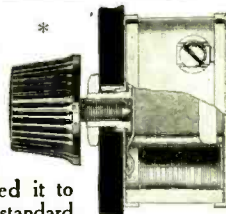

The remarkable accuracy of the Bradleyohm-E has caused it to become standard equipment for accurate plate voltage control on many leading B-eliminators. Use it on your power-unit hookups.

Bradleyleak

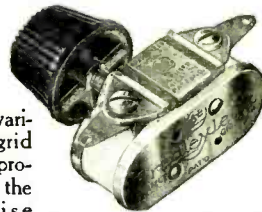

This variable grid leak provides the precise grid leak value for best results with every tube. Try it on your set and notice the greatly improved reception.

Bradleystat

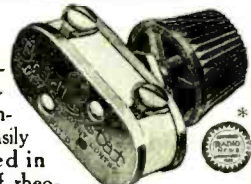

The perfect filament control. Easily installed in place of rheostats now in service. Gives noiseless, stepless filament control for all tubes. Use Bradleystats on your next set.

Allen-Bradley Co.
Electric Controlling Apparatus
MILWAUKEE, WISCONSIN

You won't
have to do
THIS-



DISTANT stations come in PLAINLY over a SUBANTENNA

There are three prime factors in the equation of radio reception. The broadcasting station—the medium from which the broadcast wave is received—and the receiving set. Practically speaking, two of these factors are always constant. The broadcasting station sends out a uniformly strong wave night after night throughout the year. And your set is just as capable on Wednesday night as it is on Tuesday night. But, the air—the medium out of which you pick the broadcast wave—changes. It changes hourly. It is never the same. How then, can you expect, so long as you take your radio music and song out of the air—to be able to receive distant stations enjoyably? How then, can you avoid having to get right up close to the speaker in a vain effort to hear the fading, mushy call letters of the far-off broadcaster?

Take Your Reception Out of the Ground

The same radio wave that you have always picked out of the air with an "aerial," also travels thru the

ground. But the condition of the ground does not change hourly as does the air. Hence, the ground is almost static-free regardless of what is happening in the air; and, practically speaking, the wave broadcast from some distant point reaches you equally as strong one night as it does the next—and clearly. Therefore, when you receive from the ground, your radio equation has all its three prime factors equal and constant. And you can sit back in your easy chair, away from your speaker, and hear the call letters of distant stations plainly enunciated! Leading research engineers have long recognized the advantages of receiving from the ground. But, until the advent of SUBANTENNA, no device was available by which the broadcast wave could be taken out of the ground. Now, however, it is here—endorsed by Radio News, Popular Radio, Radio Age, Radio Digest and other testing laboratories—tried and proved by thousands of fans—and available at a price that every

set owner can afford to pay. Easily and quickly installed. Never needs attention.

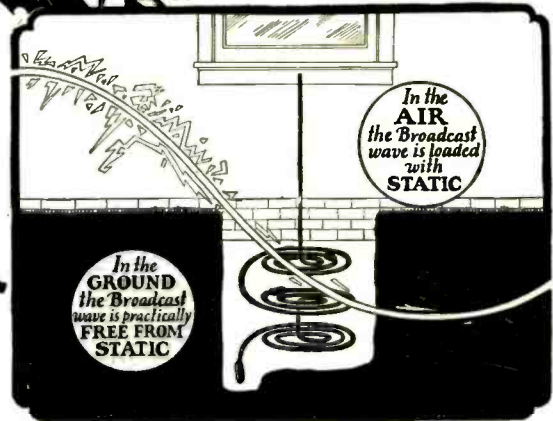

CLOVERLEAF Lifetime "B" Eliminator 180 Volts

A new, better, advanced type "B" unit at a new lower price than any other unit of equal capability. 180-volt output. Supplies fixed voltages of 22—45—90—135 and 180 volts for power tube from permanent, non-adjustable taps. Absolutely no hum. No "motor boating." Will run any standard set. The true "lifetime" eliminator, because built of the finest quality materials that money can buy. Neatly enclosed in maroon crackle



**2
Year
Guarantee**

finished steel case. Guaranteed for 2 years. Test it FREE. Prove its superiority. Mail coupon for full details, and for particulars of FREE TRIAL GUARANTEE OFFER.

Cloverleaf AUTOMATIC "A" and "B" Control

Localizes the control of "A" battery, trickle charger and "B" Eliminator in the switch on your set. Installed in a minute. Never needs attention. Cannot get out of order. When you turn your set "on," the Cloverleaf Control automatically turns the tubes off, and the trickle charger on. When the set switch is turned "on," the Cloverleaf Control automatically turns the trickle charger off, lights your tubes, and turns the "B" Eliminator "on." Try it at our risk. Check coupon and mail at once for full details.



*For Christmas
Cloverleaf
products greatly
increase the joy
of Radio — they
make long-re-
membered gifts*

FREE TRIAL Prove Any Cloverleaf Product Before You Buy It

What we claim for SUBANTENNA, this new device actually does. And we let you prove it before you buy. Make this test. Install a SUBANTENNA. Leave your old up-in-the-air aerial up. Tune in a distant station on the old aerial. Then switch to SUBANTENNA.

If SUBANTENNA doesn't give you real, enjoyable clarity on stations that are just a jumble of static and noise with the old aerial, and if SUBANTENNA doesn't give you greater usable distance and bigger volume on far-away stations, this test won't cost you a single cent. You are to be the sole judge. SUBANTENNA must make good—on your set. Mail the coupon now for full particulars of this liberal free trial guarantee offer. Also use coupon to obtain further information about the Cloverleaf Lifetime "B" Eliminator and the Cloverleaf Automatic "A" and "B" Control. Mail the coupon NOW—today.

**Cloverleaf
Mfg. Company
2713-O Canal St.
Chicago, Illinois**

Send me full particulars of FREE TRIAL Guarantee Offer on

- SUBANTENNA
- CLOVERLEAF Lifetime "B"
- CLOVERLEAF "A" and "B" CONTROL

(Write Your Name and Address in the Margin Below)

CLOVERLEAF MFG. CO.
2713-O Canal Street - - CHICAGO, ILLINOIS

CLIP AND MAIL NOW



FACTORY PRICES—SAVE 50%
Choice of beautiful cabinets offered

**3 Year
 Guarantee**

**TRY IT 30
 DAYS FREE**

BEFORE YOU BUY

**ALL
 METAL
 SHIELDED
 CHASSIS**

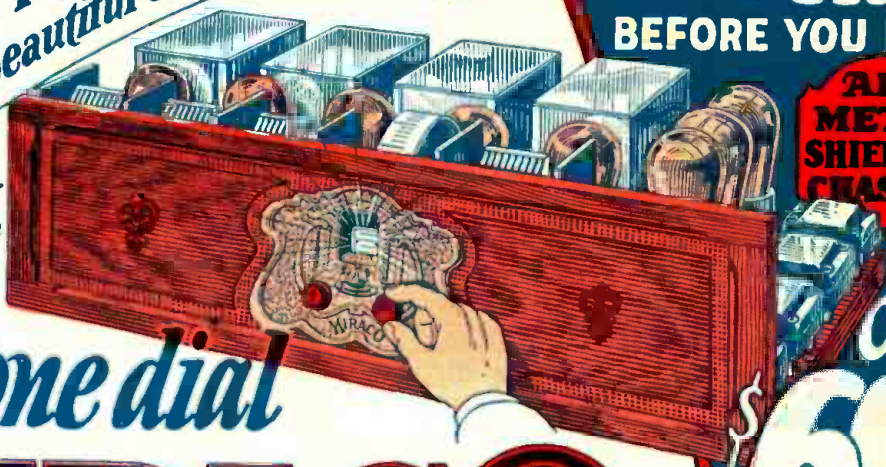

Only
\$69⁷⁵
 Retail List
 Completely
 Assembled

8 tube—*one dial*
MIRACO
 TRADE MARK REGISTERED

MAGNIFICENT TONE—SUPER SELECTIVE—POWERFUL DISTANCE GETTER

All Electric or Battery Set!

*Big Discounts to
 User-Agents*

MIRACO Users Say:

Reports from users everywhere leave little for us to add. These are only a few of the many in our files and which we receive daily. Send coupon for plenty of additional proof and testimony of nearby users.

TRIED MANY SETS—MIRACO BEST
 Miraco is best set I've ever heard. It's just the set I've always wanted and I've had so many sets I got just a little hard-boiled about believing there were any sets perfect. I sure got my wish. I've had just 104 stations. There's about a station to each number on dial. I get KFI (Cal.) every night. Had PWX last night and got 6KW tonight good and loud.—FRANCIS ARM-BRUSTER, Cleveland, Ohio.

P.S. You pack your sets wonderful.

HE KNOWS SETS—READ THIS
 I have built radios since they first made their appearance and it has been my pleasure to build, repair and sell them. For quality, selectivity and sensitivity it is my firm belief that the Miraco cannot be excelled. I have proven beyond any shadow of doubt that it will outperform any other radios. I bring in the farthest distance with little or no effort. The Miraco also gives me tone quality.—URBAIN BARIL, Jr., Fall River, Mass.

MIRACO EXCELS EXPENSIVE RADIOS
 The Miraco set and loud speaker beat anything around here, regardless of price. Have tried them out against a \$200 outfit. Have logged 140 stations, coast to coast.—E. J. CARRIERE, Bathgate, N. D.

HEARS CUBA, CANADA, MEXICO
 A friend visited here that has close to \$300 in a radio—but no better tone and no plainer than the Miraco. Have gotten 118 stations. We get Mexico City, Winnipeg, Canada and Havana, Cuba—all of these so plain.—MRS. CLEM CORRELL, Morristown, Ind.

CUTS THRU NEW YORK LOCALS
 I can get distance thru the locals when they are all on early in the evening.—J. F. LOGAN, Rockaway Beach, New York.

America's big, old, reliable Radio Corporation* (8th successful year) **guarantees** in its big, powerful, latest 6, 7 and 8 tube Miraco sets "the finest, most enjoyable performance obtainable in high grade radios." Unless 30 days' use in your home fully satisfies you a Miraco is unbeatable at any price for beautiful, clear cathedral tone, razor-edge selectivity, powerful distance reception, easy operation, etc.—**don't buy it! Your verdict final.** Save or make lots of money on sets and equipment—write for testimony of nearby users and **Amazing Special Factory Offer.**

Miraco's work equally fine on "AC" electric house current or with batteries. Take your choice. Many thousands of Miraco users—who bought after thorough comparisons—enjoy programs Coast

to Coast, Canada to Mexico, loud and clear—with the magnificent cathedral tone quality of costliest sets. Don't confuse Miraco's with cheap, "squawky" radios, Miraco's have finest parts, latest approved shielding, metal chassis, etc.—as used in many \$200 sets.

Deal Direct with Big Factory
 Your Miraco reaches you completely assembled, rigidly tested, fully guaranteed. Easy to connect and operate. **30 days' trial free.** 3 year guarantee if you buy. You take no risk, you insure satisfaction, you enjoy rock-bottom money-saving prices by dealing direct with one of radio's oldest, most successful builders of fine sets. 8th successful year in the radio manufacturing business.

7 tube one dial METAL SHIELDED CHASSIS \$49⁷⁵ RETAIL LIST

MIRACO "Powerplus" sets—both 8 and 7 tube models—have magnificently beautiful, clear cathedral tone quality. Turn one dial for stations everywhere. Ultra-selective. Miraco multi-stage distance amplification gives "power-plus" on far-off stations. Latest all-metal shielded chassis. Illuminated dial. Fully guaranteed. Try one free for 30 days! Choice of beautiful cabinets.



Dealers Write!
Free!
BEAUTIFULLY ILLUSTRATED CATALOG AND AMAZING SPECIAL OFFER
SEND NO MONEY—30 DAYS' TRIAL, Special Wholesale Price Offer to User-Agents, Bank References, testimony of nearby Miraco users—all the proof you want—sent with catalog.
mail coupon right now!

Electrify Any Radio with MIDWEST NO-BATTERY "AC" Light Socket Power Units

BIG DISCOUNT TO User-Agent

"A", "B" and "C" power, direct from light socket, without batteries! Write for Midwest prices and discounts. Midwest Units are highest grade—lasting, dependable, quiet in operation, fully guaranteed.



6 tube Super \$36⁷⁵ RETAIL LIST

Another Big Bargain! Famous powerful big Miraco Super 6, 1928 model—ultra selective! Thousands find it outperforms sets of much higher price. 30 Days' Trial Free. Fully Guaranteed.

MIDWEST RADIO CORPORATION
 Pioneer Builders of Sets
 404-K Miraco Building, Cincinnati, Ohio.

THIS COUPON IS NOT AN ORDER

Without obligation, send free catalog, **AMAZING SPECIAL OFFER**, testimony of nearby Miraco users. User Agent Dealer

NAME
ADDRESS

No Falling Off

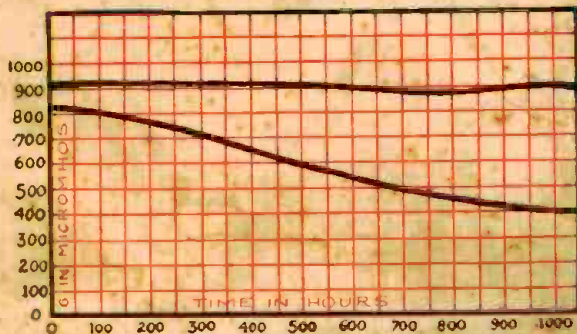
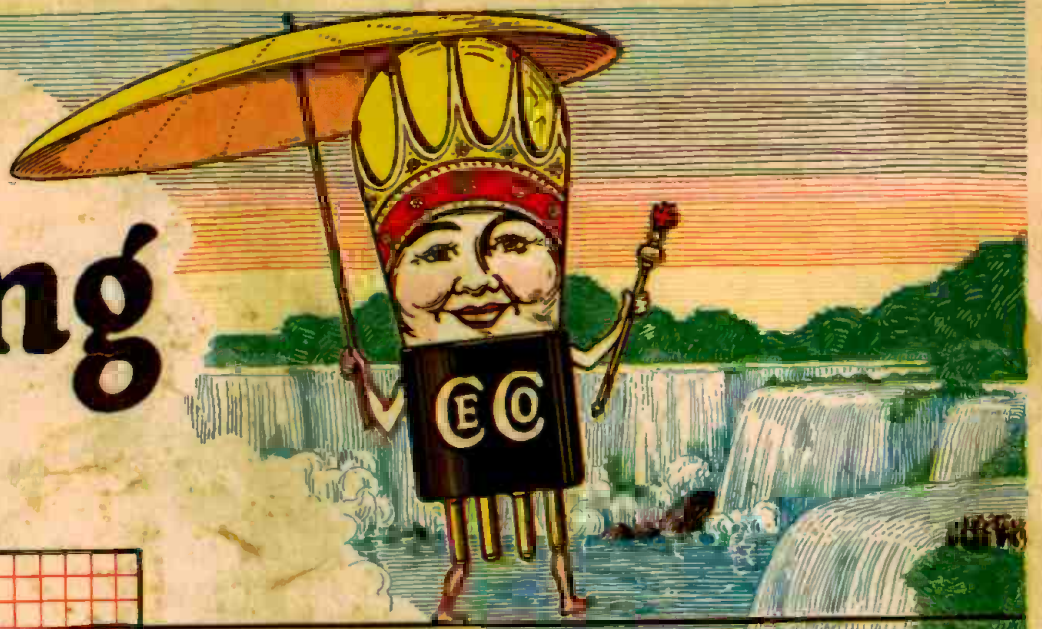

CeCo Tubes
Avg. of 27
Other Makes

THE above chart graphically illustrates the longer life and steadier performance of CeCo Tubes as shown by an unbiased test of CeCo Tubes in comparison with twenty-seven other makes.

The test was conducted by a nationally known set manufacturer (Name on request).

CeCo Tubes prove to be as efficient after 1,000 hours of use as when new. In fact, hundreds of instances have been called to our attention by users where CeCo Tubes have performed for over 2,000 hours without apparent deterioration.

Experiences like these, together with a noticeable improvement of tone, clarity and volume resulting from the use of CeCo Tubes, have secured the recommendations of well-known radio authorities such as

- | | | |
|----------------------|------------------|----------------|
| ARTHUR H. LYNCH | GERALD M. BEST | HERMAN BERNARD |
| GLENN H. BROWNING | KENNETH HARKNESS | KEITH HENNEY |
| LAWRENCE M. COCKADAY | VOLNEY HURD | JAMES MILLEN |

There's a CeCo Tube for Every Radio Need

- | | |
|-----------------------|-------------|
| GENERAL PURPOSE TUBES | POWER TUBES |
| SPECIAL PURPOSE TUBES | RECTIFIERS |
| A. C. TUBES | |

Ask your dealer to help you select the types best suited to your set.

C. E. MFG. CO., INC., Providence, R. I.

Largest plant in the world devoted exclusively to making of Radio Tubes

