

1927

AUGUST
25 Cents

Over 200
Illustrations



RADIO NEWS

REG. U.S. PAT. OFF.

Edited by HUGO GERNSBACK

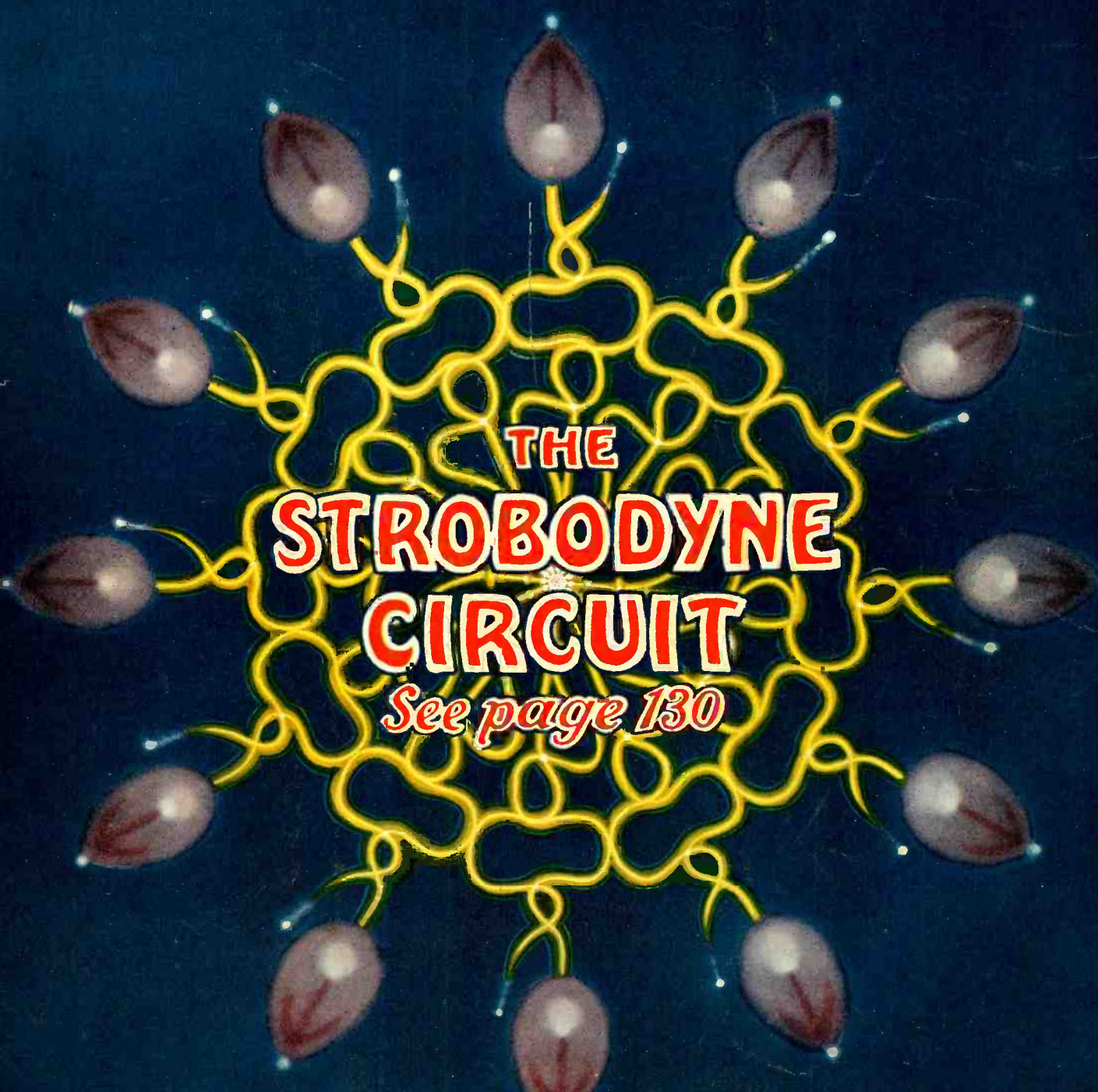

THE
STROBODYNE
CIRCUIT

See page 130

RADIO'S GREATEST MAGAZINE

EXPERIMENTER PUBLISHING COMPANY, NEW YORK, PUBLISHERS OF
RADIO NEWS • SCIENCE & INVENTION • RADIO LISTENERS' GUIDE • AMAZING STORIES • SPARE-TIME MONEY MAKING • RADIO PROGRAM WEEKLY

Cunningham

RADIO TUBES

Round out the circle
of vacation joys ---

For real summer enjoyment you cannot do without Radio. To increase that pleasure, Cunningham Radio Tubes are most essential to your set.

No matter where you plan to be—the mountains, the seashore or the back country—you can depend upon Cunningham Radio Tubes to bring you the world's best music with song, dance and laughter.

Your nearest Radio dealer will tell you the best combination of Cunningham Tubes for your particular set.

E. T. CUNNINGHAM, Inc.

New York

Chicago

San Francisco

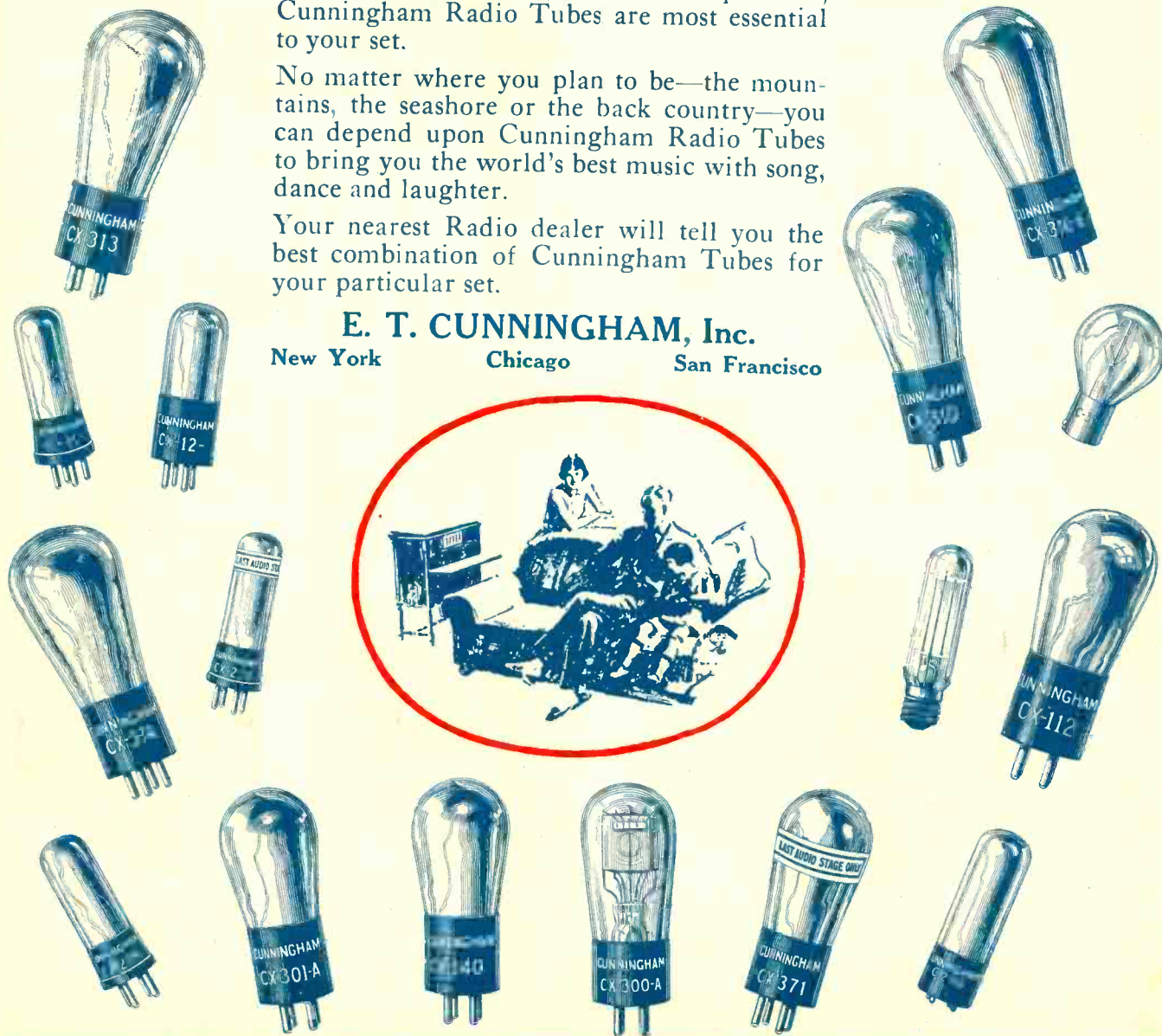

It's Here!

for the first time

Dependable FULL POWER Electric Light-socket Operation at LOW COST



OUTSTANDING TOWER FEATURES NOT CLAIMS—FACTS

- FULL POWER *under all loads.*
- ABSOLUTELY NOISELESS.
- NO DISTORTION. No loss in volume.
- SET SWITCH controls everything.
- WORKS AUTOMATICALLY
- OPERATES any standard receiver without re-wiring.
- NO TUBES to replace.
- COSTS LESS to operate than average light bulb.
- OPERATES all sets using from 3 to 10 (6 volt) tubes, including power tube.
- AMAZINGLY low price.
- MADE BY a manufacturer of recognized standing—over 2,000,000 Tower Radio Products now in use.

WRITE FOR ILLUSTRATED
FOLDER

Tower

"A" and "B"

SOCKET POWER UNITS

The phenomenal advance of the radio art is nowhere better exemplified than in the new Tower Socket Power Units. Now—for the first time—you can obtain from your house lighting current that steady, uniform flow of radio energy—long sought but never before accomplished in a wholly satisfactory manner.

No more recharging storage batteries—no more "B" batteries to replace—no more apologies necessary for poor tone quality or volume.

Here—at last—is radio socket power that is FOOL-PROOF—as easy to operate as an electric fan, supplying adequate power for any multi-tube receiver without change in wiring on 100—125v., 60 cycle, A.C.

Again Tower achieves the unusual—Radio Socket Power is now available for all. Write for Descriptive Folder.

TOWER MFG. CORP.
Boston

124 Brookline Ave.
Mass.

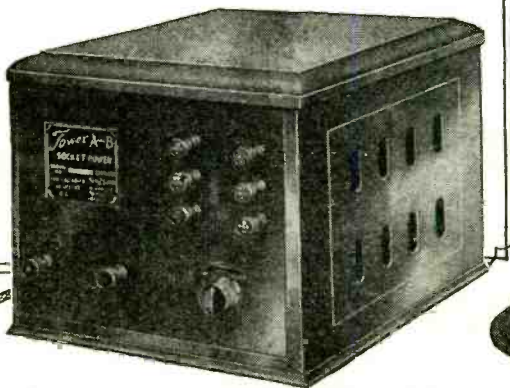

\$57⁵⁰

"A" and "B"
Combination



"A" Power \$30⁰⁰

Dependable, economical "A" Supply. Delivers FULL Power under all loads. Absolutely no hum! Automatically controlled by set switch.

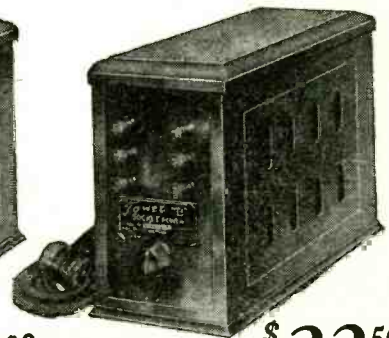

"B" Power \$32⁵⁰

Most powerful "B" Supply Unit on the market. Furnishes voltages indicated on terminals. No guesswork. Automatic control.

RADIO NEWS

Published by EXPERIMENTER PUBLISHING COMPANY, Inc., Publishers of "Radio News," "Science and Invention," "Radio Program Weekly," "Radio Listeners' Guide," "Spare-Time Money Making" and "Amazing Stories."

H. GERNSBACK, President. S. GERNSBACK, Treasurer. R. W. DEMOTT, Secretary.
Member: Audit Bureau of Circulations Radio Magazine Publishers Association

Editorial and General Offices: - - 230 Fifth Avenue, New York City

VOLUME 9

AUGUST, 1927

NUMBER 2

Contents of This Issue:

Radio On the Upswing, By Hugo Gernsback	109	Design of a Simple Stroboscope, By Hugo Gernsback	131
Correlation of Static With Weather Changes, By Lieut. E. H. Kincaid	110	Constructing The 8-Tube Stroboddyne Receiver, By Lucien Chrétien	132
"Why Kilocycles?"—A Short Explanation	112	A Six-Foot Horn of Exponential Design, By R. E. Baumgarner	140
Making the Most of Summer Reception, By Charles M. Adams	113	A New Double-Impedance A.F. Amplifier, By G. C. B. Rowe	142
A Loud Speaker With a Three-Quarter Mile Range, By Clinton R. Hanna	114	Hearing Short Waves With a Broadcast Set, By H. E. Overacker	146
The Why of Power Tubes,	115	"Motorboating," What It Is, and Why, By O. D. Westcott	149
Radio News of the Month Illustrated, By George Wall	116	"How's Your Wavelength?" By John L. Reinartz	150
Super-Power Broadcasting in Germany, By A. W. Herbert	117	A Simple Tube-Testing Device, By A. W. Bothwell	152
What's New in Radio,	118	A Trickle Charger for a Storage "B" Battery, By E. C. Nichols	153
List of Broadcast Stations in the United States,	122	Letters From Home Radio Set Builders	154
Radio News of the Month,	123	Progress in Radio,	156
The Case for the Headphones as Aids to Reception, By Charles M. Adams	124	Radiotics,	157
Radio Revenge, By Armstrong Perry	125	RADIO NEWS LABORATORIES	158
Some Aspects of High-Quality Repro- duction (Part II) By Paul Traugott	126	Getting the Most From Resistance Coup- ling, By A. C. Lescarbours	159
WRNY's New 31-Meter Transmitter	127	Radio Wrinkles,	160
The Raytheon "A" Rectifier, By James Millen,	128	I Want to Know, By Joseph Goldstein	161
The Stroboscope and Its Operation. By R. E. Lacault	130	Radio Jingles—Radio "Bugs" Radio Book Review—Current Radio Articles	168 186

In Forthcoming Issues:

A LOOP-OPERATED STROBODDYNE RECEIVER
By R. E. LACAULT

How the year's greatest circuit can be adapted for loop operation, with some hints for the constructors.

THE COMMUNITY SET BUILDERS
By ARMSTRONG PERRY

An article on the activities of those who build sets to sell them, and some of the factors in this phase of the radio business.

RADIO'S WILL-O'-THE-WISP
By S. R. WINTERS

A resume of the efforts to curb that bane of radio—Static—and the ingenious inventions of distinguished radio engineers.

RADIO NEWS is published on the 10th of each preceding month. There are 12 numbers per year. Subscription price is \$2.50 a year in U. S. and possessions. Canada and foreign countries, \$3.00 per year. U. S. Coin as well as U. S. Stamps accepted (no foreign coins or stamps). Single copies, 25 cents each. Checks and money orders should be drawn to order of EXPERIMENTER PUBLISHING CO., INC.

All communications and contributions to this journal should be addressed to Editor, RADIO NEWS, 230 Fifth Ave., New York, N. Y. Unaccepted contributions cannot be returned unless full postage has been included. All accepted contributions are paid for on publication. A special rate is paid for novel experiments; good photographs accompanying them are highly desirable.

RADIO NEWS, Monthly. Entered as second class matter, July 12, 1924, at the Post Office at New York, N. Y., under the Act of March 3, 1879. Additional entry at Long Island City, N. Y., and San Francisco, Calif. Title registered U. S. Patent Office. Copyright, 1927, by The Experimenter Publishing Co., Inc., 230 Fifth Ave., New York. The contents of this magazine are copyrighted and must not be reproduced in the United States without giving full credit to the publication. Translation into foreign languages must not be made unless permission is obtained from the publishers. Copyrighted in Germany. Reproduction of articles in Germany is reserved for Radio, Berlin 42.

RADIO NEWS is for sale at all newsstands in the United States and Canada, and at Breniano's, Ave. de L'Opera, Paris, France. European agents: S. J. Wise Et. Cie, 40 Place Verte, Anvers, Belgium.

HOW TO SUBSCRIBE FOR RADIO NEWS. Send your name, address and mittance to Experimenter Publishing Co., 230 Fifth Ave., New York. Mention the name of the magazine you are ordering. We also publish SCIENCE AND INVENTION, RADIO PROGRAM WEEKLY, RADIO LISTENERS' GUIDE, SPARE TIME MONEY MAKING and AMAZING STORIES. Write clearly.

RATES AND TERMS. The subscription rate for RADIO NEWS is \$2.50 per year. (12 numbers). When remitting do so by check, money order, or registered letter if cash is enclosed. Avoid sending cash through the mail if possible. Subscriptions for less than one year are not accepted. Subscription may be made in combination with SCIENCE & INVENTION, RADIO PROGRAM WEEKLY, RADIO LISTENERS' GUIDE, SPARE TIME MONEY MAKING and AMAZING STORIES.

POSTAGE. We prepay postage in all parts of the United States, Mexico and island possessions. For foreign or Canadian subscriptions we require 50 cents in addition to the subscription price for additional postage charge. CHANGE OF ADDRESS. Notify us as far in advance as possible. It requires several weeks to make an address change on our records. Always write clearly.

General Advertising Dept., 230 Fifth Avenue, New York City

ADVERTISING REPRESENTATIVES

L. F. McCLURE, 720 Cass Street, Chicago, Ill.
DAVIES, DILLON & KELLY, 15 West 10th St., Kansas City, Mo.
T. F. MAGRANE, Park Square Bldg., Boston, Mass.

HARRY E. HYDE, 548 Drexel Building, Philadelphia, Pa.
A. J. NORRIS HILL CO., 5 Third St., San Francisco, Calif.
412 West 6th St., Los Angeles, Calif.
Leary Building, Seattle, Wash.

LEUTZ

UNIVERSAL TRANSOCEANIC

9 TUBES

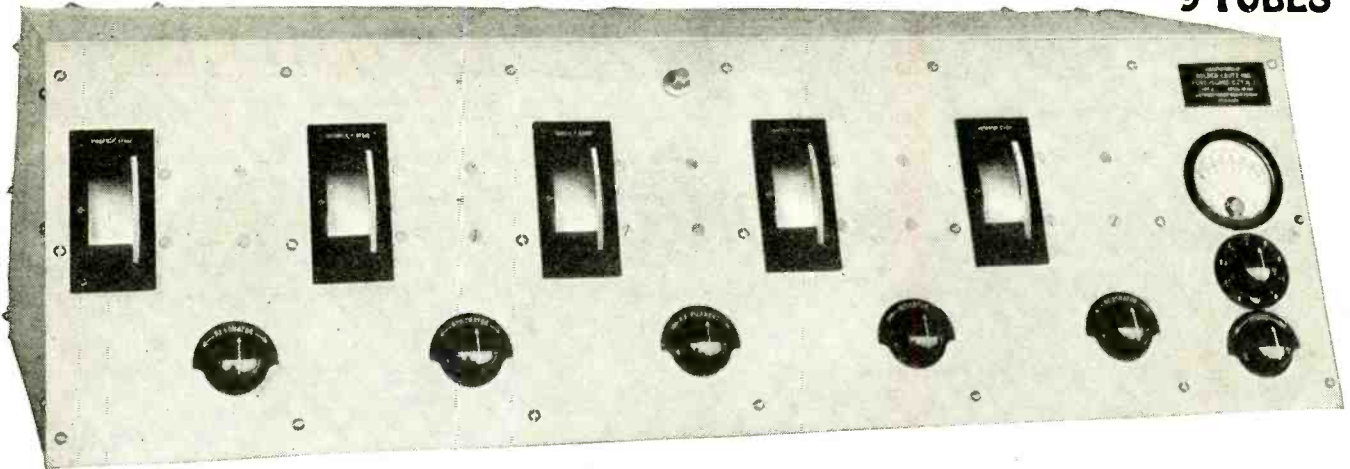

TRUE SELECTIVE POWERFUL

NEVER before has any radio ever provided at so low a price, so many **QUALITIES** and exclusive features. Modern to the minute in design, offering True distinction in appearance, built of fine materials, master workmanship,—the “**UNIVERSAL TRANSOCEANIC**” is the outstanding triumph of the most favorably known builders of powerful radio receivers.

Write For Our New Literature Today.

C. R. LEUTZ, Inc.

Sixth and Washington Aves., Long Island City, N. Y.

NOW

\$150

DIRECT

FROM OUR FACTORY

TO YOU

QUALITY AT LOW COST

The STROBODYNE

Combines the best features of every circuit

STROBODYNE

These are the official list of Parts
to make it a record

Dubilier

Carter Radio Co.

Cardwell
"BALANCET"

ELECTRAD

BUILD THE
STROBODYNE

NATIONAL

Belden

INTERSTATE SALES COMPANY

X-L RADIO LABORATORIES

- Hammarlund Mfg. Co.
3 Variable midline condensers .00035 mf.
1 Set Strobodyne coils
3 Shields
2 Equalizing condensers
1 Brass Shaft 10 1/4 inches long
- Samson Electric Mfg. Co.
2 Symphonic Transformers
1 No. 85 Choke
- Radio Electric Laboratories
4 R.F. Units Type F
5 Fixed Matched Condensers
- Micarta Fabricators, Inc.
1 Panel 8"x24"x3/16"
1 Sub Panel 12"x25 1/4"x3/4"
Interstate Sales Company
1 Output Filter
- Carter Radio Company
3 No. M-20 Midget Rheostats 20 ohm.
1 No. M-400 Midget Potentiometer 400 ohm.
1 No. 1 Short Jack Open Circuit
1 No. 2A Short Jack Closed Circuit
1 Imp. Battery Switch.

- Allen D. Cardwell Mfg. Co.
1 Balancet Type 618A
Dubilier Condenser & Radio Corp.
4 By-Pass Condensers .5 mf. Type 907
1 Fixed Condenser .0035 mf. Type 601
- Benjamin Electric Mfg. Co.
8 Sockets UX Type 9040
- X-L Radio Laboratories
12 Binding Posts
National Company
2 Dials
Radiall Company
4 Amperites Type 1A
1 Amperite Type 112
Electrad, Inc.
1 Royalty Variable Resistance Type B
- Belden Manufacturing Co.
2 Rolls of Beldenamel
- C. E. Manufacturing Co.
7 Vacuum Tubes Type 201A
1 Vacuum Tube Type 112
- D. H. Fritts & Co.
1 Cabinet for Panel 8"x24"x12 1/2".

The STROBODYNE

Will amaze you in performance

STROBODYNE

used by the designer of the Stroboddyne breaking Achievement

Hammarlund

AMPERITE
The "SELF-ADJUSTING" Rheostat

Samson Electric Co.

MICARTA
Fabricators Inc.

ECO

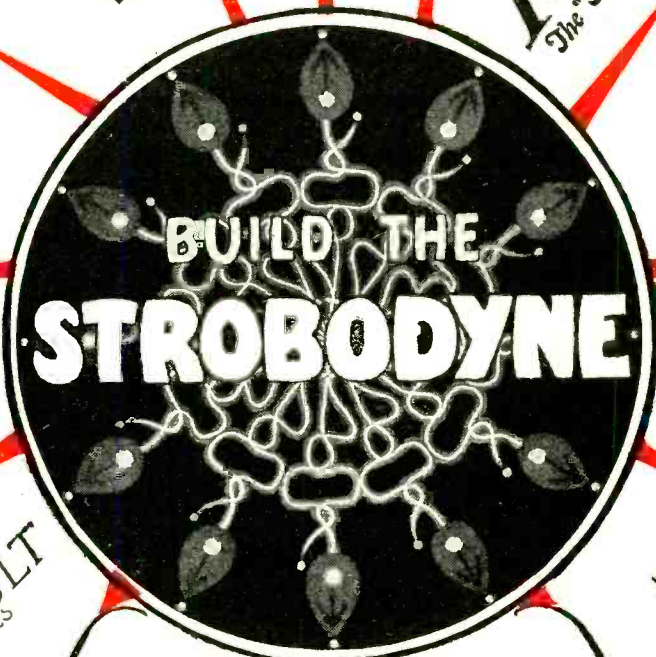

BENJAMIN

R. F. LACAULT
Radio ELECTRIC LABORATORIES

FRITTS CABINET

Hammarlund Manufacturing Co., Inc.
424 W. 33rd. Street
New York City

R. E. Lacault
1931 Broadway
New York City

Samson Electric Co.
Canton, Mass.

Interstate Sales Co.
1140 Broadway
New York City

Allen D. Cardwell Mfg. Corp.
81 Prospect Street
Brooklyn, N. Y.

Carter Radio Co.
309 So. Racine Avenue
Chicago, Illinois

Dubilier Condenser & Radio Corp.
4377 Bronx Blvd.
New York City

Benjamin Electric Manufacturing Co.
128 Sangamon Street
Chicago, Ill.

Electrad, Inc.
175 Varick Street
New York City

Micarta Fabricators
Canal & Mercer Streets
New York City

Belden Manufacturing Co.
2300 So. Western Avenue
Chicago, Ill.

D. H. Fritts & Co.
604 Hearst Square
Chicago, Ill.

C. E. Manufacturing Co.
Providence, R. I.

X-L Radio Laboratories
2426 Lincoln Avenue
Chicago, Ill.

National Company, Inc.
Malden, Mass.

Radiall Co.
50-52 Franklin Street
New York City

Address all inquiries to STROBODYNE, 230 Fifth Ave., New York City.

INDEX TO ADVERTISERS

EX
D
ER-
RS

A	D	K	Page
Acme Apparatus Co.185	Deutschmann Co., Tobe... 186	Karas Electric Co..... 169	
Acme Electric & Mfg. Co. 183-187	Dexter & Sons, Inc., C. H. 191	Kellogg Switchboard & Supply Co..... 184	
Acme Wire Co..... 164	Dubilier Cond. & Radio Corp.100-101-170	Kodel Radio Corp..... 186	
Acme Wire Co..... 169		Kokomo Electric Co..... 181	
Aero Products, Inc..... 173	E		
Aerovox Wireless Corp....169	Electrad, Inc.100-101-187	L	
Alden Mfg. Co., The.... 174	Electric Specialty Co..... 177	Lacault Radio Elec. Labs., R. E.100-101-176	
All Radio Co..... 176	Electro-Motive Engineer- ing Corp..... 189	Lacey & Lacey..... 186	
Alter Co., The Harry.... 174	Emerson Radval Corp.... 173	Langbein-Kaufman Radio Co. 177	
American Bosch Magneto Corp.169	Engineers' Service Co.... 182	Leutz, Inc., C. R. 99	
American Hard Rubber Co. 191	Erie Fixture Supply Co... 169		
Amplion Corp. of America 191		M	
B	F	M & H Sporting Goods Co. 183	
Balsa Labs..... 191	Fansteel Products Co., Inc. 169	Martin-Copeland Co..... 191	
Belden Mfg. Co.100-101	Ferbend Electric Co..... 184	Massachusetts Radio School 177	
Benjamin Elec Co.100-101	Ferranti, Inc..... 174	Metro Electric Co..... 184	
Blancke Auto Devices Co...189	Formica Insulation Co., The 171	Micarta Fabricators ...100-101	
Bogue, B. N.172	Freshman Co., Inc., Chas. 189	Midwest Radio Corp..... 182	
Boudette Mfg. Co..... 186	Fritts Co., H. D.....100-101		
Brady, John B..... 187	Frost, Inc., Herbert H.... 183	N	
Bremer-Tully Mfg. Co. Back Cover		National Carbon Co. 179	
C	G	National Co., Inc. 100-101-185	
C. E. Mfg. Co., Inc. 100-101-183	Gearhart-Schlueter 179	National Radio Institute.. 103	
Carborundum Co., The.... 174	General Radio Co..... 187	Norden-Hauck, Inc. 175	
Cardwell Mfg. Corp., A. D. 100-101	Gray & Danielson Mfg. Co. 191	North American Bretwood Co. 105	
Carter Radio Co. 100-101-185-187	Grigsby-Grunow-Hinds Co. 175		
Central Radio Labs..... 182	Guaranty Radio Goods Co. 105	O	
Chemical Institute of New York, Inc. 165	H	Omnigraph Mfg. Co..... 171	
Chicago Radio Apparatus Co. 172	Hammarlund Mfg. Co. 100-101		
Chicago Salvage Stock Stores 191	High Frequency Labs.... 175	P	
Cloverleaf Mfg. Co., Inside Back Cover	Hydro United Tire Corp. 184	Parker, C. L..... 185	
Columbia Radio Corp.... 177	I	Press Guild, Inc., The.... 170	
Consrad Co., Inc., 172-176-182-184-188-192	International Resistance Co. 189		
Cooper Corp., The..... 185	Interstate Sales Co....100-101	R	
Cornish Wire Co..... 175		Radiall Co.100-101-179	
Coyne Electrical School... 169	J	Radio Association of Amer- ica 175	
Cresradio Corp..... 186	Jewell Electrical Instru- ment Co. 177		
Crosley Radio Corp... 106-107		S	
Cunningham, Inc., E. T., Inside Front Cover		Radio Institute of Amer- ica 191	
		Radio Specialty Co..... 163	
		Raytheon Mfg. Co..... 167	
		T	
		Samson Elec. Co.....100-101	
		Sangamo Electric Co.... 175	
		Shure Radio Co..... 185	
		Silver-Marshall, Inc..... 166	
		Smith, B. Hawley..... 185	
		Southern Toy Co., Inc.... 187	
		Starrett Mfg. Co..... 174	
		Steinite Labs..... 181	
		Sterling Mfg. Co., The... 173	
		Stewart Battery Co..... 174	
		Straus & Schram..... 186	
		V	
		Thordarson Electric Mfg. Co. 173	
		Tower Mfg. Corp..... 97	
		Townsend Labs..... 168	
		W	
		Walker & Co., The Geo. W. 173	
		Warren Electric Co..... 179	
		Weber, Henry..... 186	
		Webster Co., The..... 176	
		Western Radio Mfg. Co... 179	
		Windsor Furniture Co... 189	
		World Battery Co. ...172-189	
		X-Y	
		X-L Radio Labs. ...100-101-189	
		Yaxley Mfg. Co..... 176	

Now! ⁹great Radio Training made greater!

If you want to get into the Radio Profession, or if you're in it and want to get ahead—READ THIS ANNOUNCEMENT!



J. E. SMITH,
President

Here's a message of importance to every man who hopes to better himself along the lines of Radio. Never before has there been a Radio training course that could be made to fit the needs of all—both experienced men who wish to better themselves and inexperienced men who wish to start from the beginning. There is one now. I am prepared to help the beginner start in Radio from the very beginning. And I am prepared to help the Radio dealer, the experienced Radio operator, the Radio service man, the college engineering student, the graduate engineer, the Radio fan, the "ham," the factory or broadcast man who wants to get a more responsible job.

An old, established system of Radio home-study training has now been so *developed, improved and enlarged in scope* that not only will it help *anyone* who wants to get into the Radio profession, but more, *can be adapted to help* almost any man now engaged in Radio (Radio engineers of experience and standing excepted.)

If you want to get into Radio, or if you're already in it and want to add to your knowledge and get ahead, let me send you my free 64-page book of information about this new and greater Radio training system.

The Good Jobs Pay \$50, \$75, Up to \$200 a Week---Some Pay More

If you're earning a penny less than \$50 a week, you're not earning what you should be able to get out of Radio. Thoroughly-trained Radio men—men whose knowledge of Radio is practical and completely rounded out on every point—earn up to \$200 and \$250 a week. Radio is a new industry with plenty of fine positions unfilled. There are countless opportunities in Radio for a man to earn a splendid salary. But these are not opportunities as far as you are concerned, unless you are fully qualified for them. The only way to qualify is through knowledge—training—*practical, complete* training that fits you to get and to hold a better position in the Radio field.

For the beginner, I have a complete training that will take him from beginning to end. I will round out and bring up-to-date the experienced Radio operator's knowledge. I can take a Radio service man who has a pretty good idea of the "how" but very little idea of the "why," and give him the practical and theoretical knowledge he must have before he can hope to climb higher on the Radio ladder. Regardless of how much you know already (or if you don't know the first thing about Radio technically), I'll fit my methods to suit your needs.

What other line offers such an opportunity as Radio? From \$2,000,000 a year in 1920 to \$500,000,000 a year in 1926; from 1,000 persons engaged in Radio in 1920 to 300,000 in 1926. That's its record. The accomplishment of television and the many other inventions constantly being made promise the same sort of boom for the future.

If you're already in the Radio business, stay in it. But prepare yourself for advancement and more money. If you're not in Radio yet, get in. Men always do their best at work that interests them.

Send Coupon for Free 64-Page Book

My free 64-page book is filled with facts and photos relative to Radio and its opportunities, and tells all about my new and greater system of Radio training. Under my practical methods, you can study at home in your spare minutes and get a thorough, clear, practical and expert knowledge of Radio in from 4 to 12 months. The time required depends on your previous knowledge, your ability, and the time you can spare for study. You keep right on with the job you have—no necessity for your leaving home or living on expense.

This proposition is open to anybody who is not satisfied with his job, his prospects, or his Radio knowledge. No particular amount of general education is needed to start—many men I've trained didn't even finish the grade schools.

If you want to enter into any correspondence about your own situation, anything you write will come directly to me and will be held strictly confidential. Send the coupon at the right, or write me a letter today.

Address: J. E. SMITH, President,

NATIONAL RADIO INSTITUTE

"Oldest and Largest Radio Home-Study School in the World"
WASHINGTON, D. C.

Employment Service to all Graduates
Originators of Radio Home Study Training

The Beginning of Radio, 1898-1902

Below is the historical Marconi apparatus. These "jiggers" are transmitters and receivers, used by Marconi in his first Radio experiments.

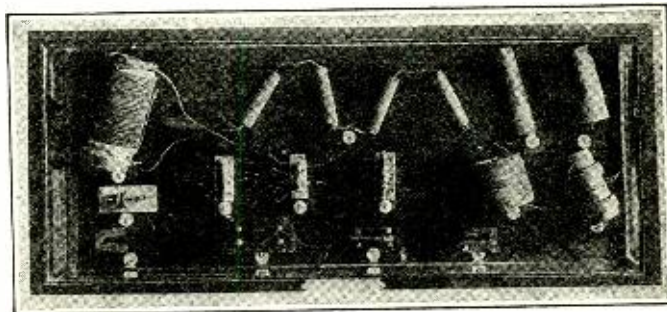

Radio Television—First Demonstration, 1927

Below, television apparatus in operation—perhaps the best indication of the enormous progress made by Radio during the past 25 years. Now we not only can transmit any sound by Radio, we have learned to SEE by Radio as well.

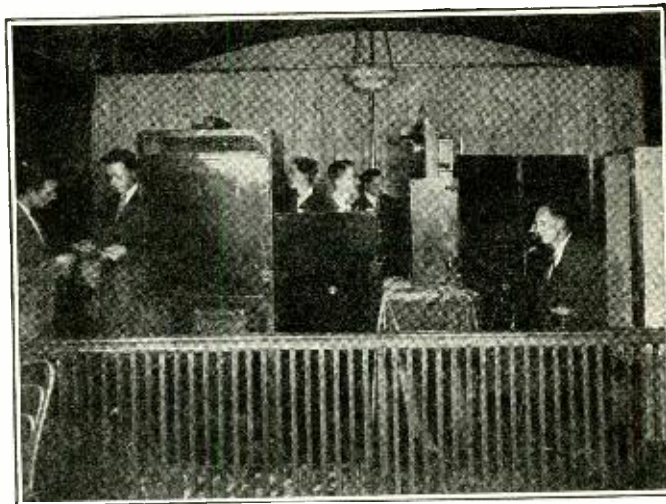

Mail this Coupon for free information

J. E. SMITH, President,
National Radio Institute,
Dept. HB-9, Washington, D. C.

Dear Mr. Smith: Kindly send me your free 64-page book about your new and greater Radio training system. I understand this request places me under no obligation, and that no salesman will call on me.

Name

Address

Town State.....

FREE

This Perfect Writing Instrument

THE NEW IMPROVED INKOGRAPH

Never before has any manufacturer of a standard writing instrument which is guaranteed to give perfect satisfaction, offered you so great a value. Remember, the Inkograph answers the purpose of both pen and pencil combined. Its point is shaped like a fine lead pencil point and writes with ink free and easy without a miss, skip or blur. The steady uniform flow of ink actually improves your handwriting. Won't blot, scratch, leak or soil hands.

You who already possess a standard fountain pen will find the Inkograph a most valuable addition to your writing equipment, for it will do everything any fountain pen can do and many very important things which it is impossible to accomplish with any fountain pen at any price.

HERE is your chance to get at no cost the new improved INKOGRAPH—a perfect writing instrument that operates like a fountain pen. The INKOGRAPH is guaranteed to give perfect satisfaction. It is a beautiful, finely shaped pen of exceptionally high standard of manufacture, strong, durable and handsome materials are used throughout. It is a pen that will stand "heavy duty service." It is a pen that anyone would be proud to own. Same size and shape as regulation \$7 and \$8 fountain pens.

We offer you one of these standard regulation INKOGRAPH pens as illustrated on this page ABSOLUTELY FREE merely for getting two of your friends or acquaintances to subscribe to either RADIO NEWS, SCIENCE and INVENTION, AMAZING STORIES, or SPARETIME MONEY MAKING. All four of these magazines are more fully advertised in another part of this magazine.

Easy to Get Subscriptions

It is the easiest thing in the world to get your friends to subscribe to these magazines. Every one of them who owns a radio set will be glad to have RADIO NEWS around; SCIENCE and INVENTION tells how to save money on building things for the home, and tells all about the marvelous inventions of the day; AMAZING STORIES is the biggest, finest, and cleanest fiction story magazine now being published; and SPARETIME MONEY MAKING will help those who want to make an extra income on the side.

So you see, you have many selling arguments. Convince two of your friends, take their subscriptions and we will send you one of these beautiful pens FREE.

Save Money

Your friends can save money by subscribing. That's one of your strongest talking points. The subscription price of SCIENCE and INVENTION is \$2.50 a year. Single copies sell for 25c each, or \$3.00 a year. They save 50c. The same saving is offered to subscribers for RADIO NEWS and AMAZING STORIES. The subscription price of SPARETIME MONEY MAKING is \$1.50 per year. The price on a single-copy basis would be \$1.80 per year. And these subscription copies are delivered by mail, whereas other readers must go out and purchase their issues at the stands. Furthermore a subscriber is always sure of receiving his copy, but the single-issue buyer, unless he gets to the stand on the day the magazine is received, may find all copies sold—and additional issues as scarce as hen's teeth.

The coupon below will be accepted by us as a regular subscription order. Clip it out, check the magazines you desire, enclose the correct amount and we will enter the subscriptions at once and send you a pen immediately.

The subscription prices are as follows: Radio News, \$2.50; Science & Invention, \$2.50; Amazing Stories, \$2.50; Sparetime Money Making, \$1.50.

Combines Features

of both pen and pencil, minus the weak points of both, plus improvements not found in either. The lead pencil smudges, the point breaks and its writing soon is obliterated. Most fountain pens skip, scratch, flood, clog, leak, blot, soil hands and clothing. The old stylographic ink pencil dries up, balks, blots, writes heavy, flows unevenly and is never reliable. The Inkograph feeds as fast and uniform on the 20th page as it did on the first.

Cannot Leak

Not the tiniest drop of ink will spill, although one filling is sufficient to write thousands of words. Will write on any quality of paper.

Makes 3 to 4 Carbon Copies

at one time with original in ink. Bear down as hard as you like without fear of bending, spreading, injuring or distorting its 14 Kt. solid gold point. Are you a salesman?—use an Inkograph, make out your orders in ink and retain a duplicate for your records. Do you wish to keep a copy of your private correspondence?—use an Inkograph. Do you do office work which requires clear carbon copies?—use an Inkograph. Do you make out bills or sales slips?—use an Inkograph and make a permanent original in ink with carbon copies. You can permit any one to write with your Inkograph, for no style of writing can affect the Inkograph point as it will a fountain pen.

What Users Say Counts Most

My Inkograph is the smoothest writing instrument with which I have ever written. That is saying a lot. I am a teacher by profession. I have a \$7.00 pen and another that cost more than the Inkograph, but Inkograph is better than either. It is the greatest improvement in writing instruments since the Babylonians recorded their thoughts on clay tablets with a triangular pointed reed. John R. Atwell, Chadwick, N. C.

I wouldn't take \$5.00 for the pen I am writing this letter with. I have a good fountain pen but don't write any more with it. I am proud of the Inkograph and that I can say this to you and mean every word of it. R. H. Wilson, Beckley, W. Va.

In making out local requisitions, it is necessary to make an original and two carbon copies on very heavy paper, and the Inkograph does this twice as well as the hardest indelible pencil, and is much neater and the original is much more legible. Wm. L. Fortney, Placerville, Ia.

It sure has improved my hand writing—I never took home any medals for penmanship but I can almost read my own writing since I got this pen. M. F. Johnson, Medina, Wis.

I want to thank you for the return of my Inkograph pen, which you repaired for me. I feel rather lost without this pen in my pocket. I prefer it to any pen I ever carried principally because of the ease with which one can write with it, not having to be careful whether you slide the pen to the North, East, South or West, it flows freely in all directions. Win. B. Brown, New York, N. Y.

Delighted: It writes bully—you have invented a pen that is perfection. It is so much more rapid than my \$9.00 fountain pen. I wish you abundant success. S. L. Carlton, Aurora, Ill.

MAIL the COUPON NOW

EXPERIMENTER PUBLISHING CO., Inc., 230 5th Ave., New York, N. Y.

Gentlemen: I enclose \$..... for 1 year (12 months) subscription to RADIO NEWS, SCIENCE AND INVENTION, AMAZING STORIES, SPARETIME MONEY MAKING. Send one "Inkograph" to me FREE.

My name is	Send	Send
My address is	(Mention name of magazine) to	(Mention name of magazine) to
City, State	Name	Name
.....	Address	Address
.....	City, State	City, State

NOTE:—You must inclose full price for TWO subscriptions. Be sure to mention magazine or magazines desired and write plainly.

B. S. T. DE LUXE

A NEW AND IMPROVED RECEIVER MODEL

Simply Beautiful—Beautifully Simple



The Set that All Admire

The B. S. T. De Luxe is one of the most beautiful sets made. Beautiful to eye and ear alike. Thrilling fidelity of tone and fine volume assured. Uses any type tubes. May be used with B eliminators without "motorboating." Awarded Certificate of Special Merit after exhaustive tests.

A Switch, a Volume Control and a Tuning Unit—These are the Only Parts on the Bakelite Front Panel. Simplicity and Beauty in the Extreme.

Only First-Class Parts Used

The B. S. T. De Luxe is made from the same type of high-class parts that a most discriminating fan would select for a receiver if he had unlimited choice—Bruno drum tuning control and straight line frequency condensers, Benjamin push type sockets, Carter Imp switch, Electrad Tonatrol, Electrad stopping condensers and grid condensers, Lynch metallized plate and grid resistors throughout, Lynch Bakelite mountings, Bakelite front panel, Bruno adjustable brackets, Corbett genuine walnut sloping cabinet, Frost filament resistors, Yaxley pup jacks, and parts of equivalent merit.

The B. S. T. De Luxe, a 5-Tube Receiver, with Concentrated, Simplified Tuning, and Using Resistance Coupled Audio. Price of set, in genuine walnut cabinet, and including built-in eliminators of all "C" batteries

\$ 60⁰⁰

GUARANTY RADIO GOODS CO.,
141 West 45th Street, New York City.

Gentlemen:—Enclosed please find check (or money order) for \$60.00. for which kindly ship by express at once one B. S. T. De Luxe 5-Tube Set. in genuine walnut cabinet, less accessories, but with built-in eliminator of all "C" batteries, on five-day money-back guarantee.

NAME

STREET ADDRESS

CITY STATE.....R.N.

BRETWOOD VARIABLE GRID LEAK

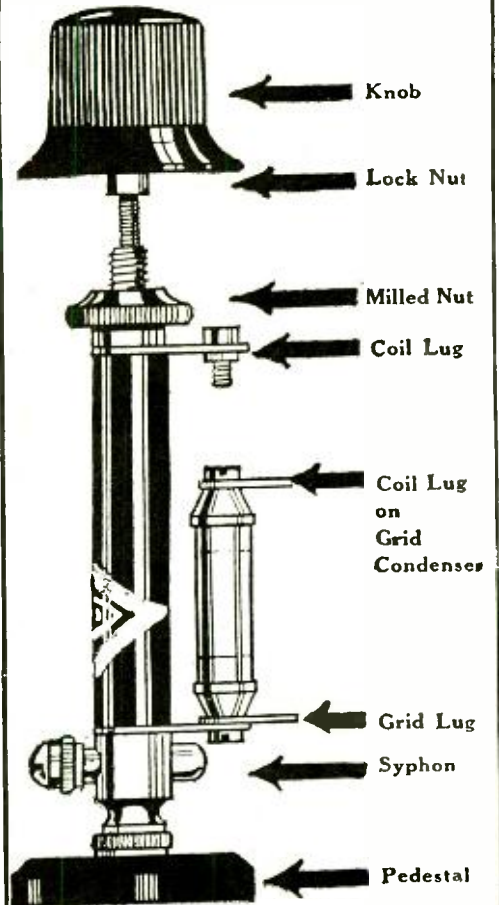

The De Luxe Model Bretwood Variable Grid Leak is shown in actual size. The knob is secured by the hex nut to the threaded shaft. The milled nut secures the leak to the front panel, if such mounting is desired. The coil lug goes to the outside of the secondary and to the corresponding lug on bullet grid condenser. The grid lug is connected to the grid post of the detector tube socket. The syphon contains the secret resistance element. The pedestal is for baseboard mounting.

You should use a BRETWOOD VARIABLE GRID LEAK in a set you are about to build, or should put one in your present receiver, because it will enable you to get highest operating efficiency from the detector tube. As nearly all tubes used as detectors draw grid current, the resistance value of the leak is important for biasing and discharge purposes. Not only can exactly the right degree of flow be established to discard excess electrons, but the grid-to-filament impedance is so affected as to afford best selectivity under the circumstances. Only a variable leak gives this precision choice.

You prevent overloading of the detector tube by correct leak setting. This improves tone quality considerably. Often if your set sounds distorted, this is immediately and permanently remedied. Hence you reap greater volume, better selectivity and purer tone quality—all by the simple insertion of a BRETWOOD DE LUXE MODEL VARIABLE GRID LEAK.

North American Bretwood Co.,
141 West 45th St., New York City, N. Y.

Gentlemen: Enclosed find \$1.75. Send me at once one De Luxe Model Bretwood Variable Grid Leak on 5-day money-back guarantee. (Or \$2.25 for leak with grid condenser attached.)

Name

Address

City State.....

Inquiries Solicited from the Trade

Dealers: If your jobber can't supply you, write us.

Announcing



-When the gong rings for the big fight.....



When the famous director lifts his baton....

When Babe Ruth steps to the plate and the score is tied.....



NEW PRICE
SUPER MUSICONE
\$12.75

"The BANDBOX"
6tube receiver
BATTERY TYPE

\$55.

A.C. Type
\$65

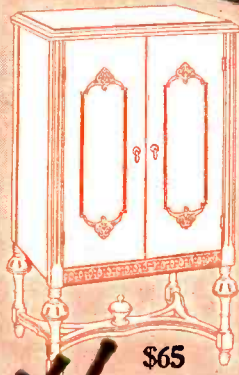

\$65

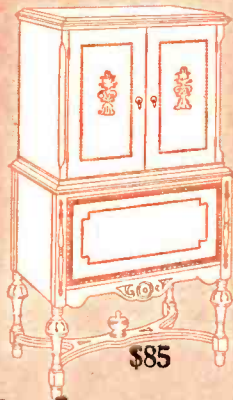

\$85



\$35

"You're there with a Crosley"

APPROVED CROSLY CONSOLES

These three handsome cabinets, especially designed to receive the shielded chassis of the "Bandbox" and other Crosley receivers, have been approved by Powel Crosley, Jr. as mechanically and acoustically ideal for the installation of Crosley Radios.

H. T. RABERTS CO.
914 S. Michigan Ave., Chicago, Ill.
Sales Agent for Approved Console Factories
SHOWER BROTHERS COMPANY
THE WOLF MANUFACTURING INDUSTRIES
THE CROSLY RADIO CORP.
Cincinnati, Ohio
POWEL CROSLY, JR., President

the CROSLEY "Bandbox"

and other new radio reception equipment for the complete enjoyment of the 1927-28 radio season



Recent court decisions now greatly clarify radio patent situation.

Ever since Crosley entered the radio field their methods and developments have created a leading place for Crosley radio receivers.

And now—completely available to Crosley—and amplifying Crosley supremacy in fullest measure, are the enormous resources, discoveries and ideas, embodied in patents of the Radio Corporation of America, The Westinghouse Co., The General Electric Co., and The American Telephone and Telegraph Co.—under which Crosley is now licensed to manufacture.

No wonder the new Crosley receivers are in the forefront, their amazing efficiency acknowledged and demanded by that section of the radio trade which insists on the latest and best at all times.

THE BANDBOX

It is a new 6 tube set of astonishing sensitiveness. Many exceptional features commend the Bandbox. The metal outside case, 'tho keeping out strong local signals effectually enough, did not fully satisfy Crosley ideals of fine radio reception. Signals must be kept in order inside the set.



Coils and condensers are like families living in a row of houses with no fences between. The children run around the yards; they meet, mix it up, quarrel and squabble. No harmony. Magnetic and electric fields are the offspring of coils and condensers. With no fence between, they, too, run around the house, mix it up, quarrel and squabble. Howls and squeals result.



So, to keep each "family" or field of individual coils and condensers separated, metal fences are erected (copper fences for the coils), the individual parts of the Bandbox are shielded as only found in the highest priced sets.



For fans who love to go cruising for faint, far-away signals the "Acuminators" intensify weak signals like powerful lens revealing distant scenes. The "Bandbox" employs completely balanced or neutralized radio frequency stages, instead of the common form of lesser method of preventing oscillation. In presenting this important feature Crosley is exclusive in the field of moderate price radio.

Volume control is another big "Bandbox" feature. Signals from powerful local stations can be cut from room filling volume to a whisper.



Volume for dancing.

Each "Bandbox" is fitted with a brown cable containing colored rubber covered leads for power and other connections.

The frosted brown crystalline finish harmonizes with the finest furniture and matches the frames of Musicones and the casing of the power unit. The bronze escutcheon creates an artistic control panel.



Withal, in the beautiful appearance and modest size of the "Bandbox" is the utmost in adaptability to requirements of interior arrangement or decoration. The outside case is easily and quickly removed for installation in console cabinets.



Soft and low thru volume control.

AC AND BATTERY OPERATION

The "Bandbox" is built both for battery and AC operation. The new R.C.A.—AC tubes make the operation of the set directly from house current both practical and efficient.

In the AC set the radio stages and the first audio stage use the new R.C.A.—AC—UX-226 tubes. Filaments in these tubes are heated with raw AC current at proper voltage.

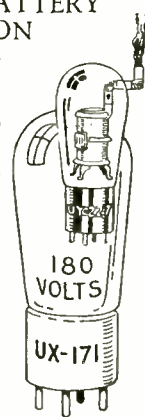

A Master Station Selector, with illuminated dial for shadowy corners, enables tuning for ordinary reception with a single tuning knob.

The UY-227, with indirectly heated emitter, is used with the detector. Power tube UX-171 at 180 volts plate.



There is no AC hum. The new R.C.A. Radiotrons do the work.

The power convertor is a marvel of radio engineering ingenuity. Half the size of an ordinary "A" storage battery, it supplies A, B and C current direct from lampsocket to tubes.

Price of Power Convertor \$60.00

Models for 25 and 60 cycles. Snap switch shuts down set and power convertor completely.

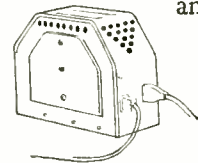

Write Dept. 22 for Descriptive Literature.

CROSLEY RADIO

Crosley Radio is licensed only for Radio Amateur, Experimental and Broadcast Reception. RCA Radiotrons are supplied at standard prices with each Crosley Receiver. Prices slightly higher west of Rocky Mountains.

THE CROSLEY RADIO CORPORATION

Cincinnati, Ohio



Powel Crosley, Jr., Pres.



TILT-TABLE MUSICONE
\$27.50

Although Musicones improve the reception of any radio set they are perfect affinities in finish, beauty and reproductive effectiveness for Crosley Radios. A new model built in the form of a Colonial Tilt-table and finished in brown mahogany stands 3 ft. high.

12-inch Ultra Musicone \$9.75	16-inch Super Musicone \$12.75
----------------------------------	-----------------------------------

Home Entertainers!

Fool 'em! Tease 'em! Trick 'em!

1000 HOURS!

-of the best fun you ever had



NEW—

SAM LOYD'S Tricks & Puzzles

SAM LOYD is the Puzzle King. The best of them all. We're willing to wager he can "stick" you.

Here's a new book of one hundred and sixteen pages crowded to the full with hundreds of the very *choicest* of Sam Loyd's own puzzles; tricks and conundrums.

There are easy puzzles, hard puzzles, full page puzzles, illustrated puzzles, riddles, conundrums, charades, rebuses, and a 26-page special section of scientific puzzlers for mechanics, engineers and scientific minds.

It beats most puzzle books by many miles. Get your copy as soon as possible—Why not today?

50c — AT ALL NEWSSTANDS
or order direct

EXPERIMENTER PUB. CO., Inc.
230 Fifth Ave., New York

SECRETS OF YOUR HANDS

(Palmistry)

A Revelation of Character, Fortune and Natural Span of Life

FINGERPRINTS are used throughout the world as a means of apprehending criminals—but fingerprints are but a small portion of the secrets of your character that your fingers, your palm, even your handshake reveals.

Every inch of your hand has been charted by the experts of this highly developed science, and so simply and accurately that anyone can learn the telltale signs by heart.

Here is a brand new book with all the latest information—written in such a way that you can quickly master "Palmistry."

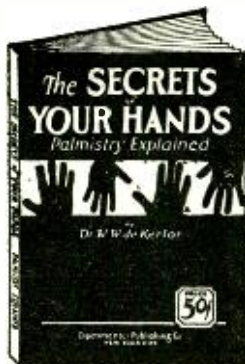

Price 50c
— —
96 pages
— —
9x12 inches
— —

SOLD EVERYWHERE
or direct from

EXPERIMENTER PUB. CO., Inc.
230 Fifth Ave., New York

116 - pages of MODERN MAGIC
by *Dunninger*

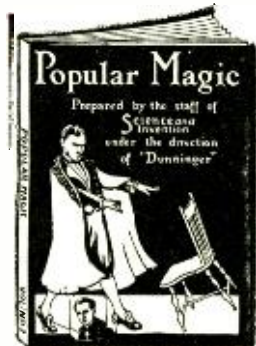

The Greatest Living Magician of the Day discloses his choicest tricks—hundreds of them

POPULAR MAGIC Second Edition

EVERYBODY'S buying this book. The first time "Dunninger" has revealed his tremendous store of marvelous parlor and professional tricks and magic in one volume. Second big edition of 100 pages, crammed full of mystery. Illustrated—large size 9 x 12 inches. They are going faster and faster. Orders are pouring in. We believe there never was a magic book like this. It may never be reprinted—so order now. Delivery within 24 hours.

THERE'S NOVELTIES—FUN—MYSTERY IN "POPULAR MAGIC"

Only 50c

If your dealer cannot supply you, order direct

EXPERIMENTER PUB. CO., Inc.
230 Fifth Ave., New York



RADIO NEWS

HUGO GERNSBACK,
Editor and Publisher

Editorial and General Offices, 230 Fifth Avenue, New York

Vol. 9

AUGUST, 1927

No. 2

RADIO ON THE UPSWING

By HUGO GERNSBACK

FOR a period of about two years radio development has been devoted principally to the work of refinement. Apparatus and circuits which were previously well known have been improved, refined, standardized, and otherwise whipped into shape; but, during the past two years, no revolutionary and few outstanding radio achievements are to be recorded.

During the past few months, however, the picture has changed, and we are about to witness in radio something in the nature of a renaissance, which bids fair to gather momentum as time goes on. For one thing, we now have actually with us, Television. The experiments made recently by the American Telephone and Telegraph Company show conclusively that Television, after all, is not a will-o'-the-wisp, but an actuality.

To be sure, the final product has not as yet been evolved. Television of the future will require no huge motors at the sending and receiving sides; for we shall have simpler means, most probably vibrating systems, at the transmitter and receiver. These should occupy very little room; and, when they have been evolved, universal television will be with us. In the meanwhile, our inventors are not standing still, and many new apparatus for practical television are being perfected.

We have an indication of this in RADIO NEWS LABORATORIES, into which new television appliances are now beginning to come. Various light-sensitive cells are being produced already, both in this country and abroad. Of course a light-sensitive cell is one of the essential factors of a television system, and it may be said that we are making satisfactory progress in this direction. By next winter it should be possible for the radio enthusiast to build himself a home-made television apparatus; and it will not be long, now, before our broadcasters will begin, perhaps experimentally at first, to send out television impulses at certain stated periods.

Returning, for a moment, to the field of present activity, it may be said that the house-current-operated radio set is becoming more and more universal. Last year there were for sale hardly any current-operated receivers which could be termed satisfactory. This year a number of good sets are already on the market, and satisfactory progress seems to have been made in this direction.

In radio tubes, many novelties are being produced right now. We already have tubes that can be operated, practically direct, from the 110-volt circuit. During the last six months, rectifier tubes with very large current output have also been produced, so that one of them will replace both "A" and "B" batteries supplying the receiver with current derived from the 110-volt line.

Of late we have seen the development of a new cartridge type of rectifier, which is not dependent upon a heated filament, and can, nevertheless, give an output of about 2½ amperes. The whole device is not larger than a man's thumb. Other dry rectifiers, which do away with messy liquids, are now on the market; these are exceedingly efficient and really excellent, either to recharge your battery or, in connection with other devices, to replace the battery itself.

Of course, these are steps in the right direction and mean a silent revolution in radio. These few remarks allude, to be sure, to alternating-current devices; but so far only very few appliances to operate on house-lighting direct current are available. This need not worry us greatly, because the total of direct current produced for general distribution in this country is only about 10 per cent

of the entire power; and this is why the "A" and "B" batteries will presumably hold their own for some time to come.

As to the broadcasting end, it may be said that, thanks to the Federal Radio Commission, the situation has now been cleared up to such a degree that we all may enjoy satisfactory and really excellent broadcasts, without being greeted with whistles and cat-calls every time we tune in a station. This condition alone should help to stabilize the radio trade. It certainly will be the direct incentive to the purchase of radio sets by many people who have not done so before.

Recently one of our great radio manufacturing corporations made the announcement that it is now possible, by means of a new method called "frequency modulation," to make the transmission of a radio station so sharp that it will be possible to have many more broadcast stations operating, in the vicinity of each other, than hitherto; and thus to do away with practically all station interference. This seems a step in the right direction and, if sets can be built that will tune sharply enough, the radio millenium, so long expected, may after all, come about in a not-too-distant future.

In set-building, the stagnation that seemed to prevail during the last two years appears to have suddenly lifted. For the coming fall, we are promised many new circuits that will give us greater distance, better quality, and many other points of excellence of which we were aware only dimly during the past.

The Strobodyne Circuit, described in RADIO NEWS exclusively, is one of these new circuits, and may be called an evolution in radio. Super-regeneration, which may be the final word in radio, is coming back with a whoop. The recent super-regeneration contest staged by RADIO NEWS has produced a number of really excellent sets. We have in our Laboratories

several two-tube sets that give a very fine amount of volume, and will bring in stations over a radius of several hundred miles satisfactorily on a small loop. The old bug-a-boos of hand-capacity and whistles have been eliminated in these sets and really, they may be said to work as well as any ordinary set. Nor do these newer sets radiate and annoy your neighbors.

Super-regeneration, in my opinion, is a step in the right direction, and it is quite possible that, in the future, we shall use only one or two tubes, yet obtain the same results that we do now with five- and eight-tube sets. These new super-regenerative sets will be described in coming issues of RADIO NEWS.

While Europe has been generally conceded to be behind American radio progress, it is, nevertheless, a rather singular fact that one vast improvement in radio, the double grid tube, is not only not produced in this country, but is hardly known here. There is no denying the fact that the double grid tube is a great improvement over the American single grid tube. This tube is in great demand and is very popular in Europe, yet in America the only few samples that are in existence are all imported. Why there should be such a situation has always been a cause of wonderment and we hope it will be rectified speedily.

All in all, it may be said that radio is on the upswing. We may expect this to continue, as it usually does in one of these major cycles, for a considerable length of time. It is also a hopeful sign that the number of radio patents now in the Patent Office is greater than it has been for many years. All of this tends to progress and advancement in radio.

IN which the Editor notes the progress of Radio, after a period of steady, but not sensational work—the probability that Television will bring a new interest to the set builder's work within the year—development of new material for current-supply devices—how intelligent broadcast regulation will stimulate business—and technical improvement result in better broadcasting and reception—new circuits, such as the Strobodyne, and the possibilities of the perfected Super-Regenerat—The Golden Age of Radio is not in the past—but in the future.

Mr. Hugo Gernsback speaks every Monday night at 9 P. M. from station WRNY on various radio and scientific subjects.

Correlating Static and Weather Changes

How Static Measurements Show the Movement of Storms

AT sea, on board the *U.S.S. Kittery*, the writer has had opportunity to study static with relation to the condition of the atmosphere since the spring of 1924. During 1926, these observations were made with the assistance of the radio compass. The research, originally started on board the *Kittery*, is now being continued by the Hydrographic Office of the Navy Department.

The purpose of this article is primarily to show that static has a relationship to the distribution of the atmosphere, as plotted on the daily weather map, sufficiently definite to enable one, by proper observations, to make use of static in weather forecasting; and, *vice versa*, to make use of our present knowledge of atmospheric distribution and movement in static forecasting.

VALUE OF STATIC OBSERVATIONS

This problem must be considered from two different viewpoints. The first is that of making use of instantaneous static intensities without reference to any directional properties that static may have. This might be called plotting the "high" and "low" of static, just as we now plot "high" and "low" of barometric pressure. The first experiment conducted by the *Kittery* for the Navy Department, before the introduction of the direction finder, was on this principle.

Considering that a definite relationship is established between atmospheric conditions, or change of conditions, and static, facts ascertainable concerning static from one or more points of observation will be of value in forecasting weather; and our knowledge concerning the development and movement of atmospheric conditions will assist in making static forecasts. Add, to this knowledge, that of whatever directional properties static is found to have, and we begin to realize the possibility of the importance of the relationship of a static observation to a condition remote from the station making the observation. It is this latter feature that will prove of greatest advantage to the mariner.

RADIO COMMUNICATION IN STORMS

Two examples are given herewith of well-known meteorological conditions with contrasting types of pressure distribution. One is a well-formed homogeneous "high" (area

By **LIEUT. E. H. KINCAID***

of high barometer readings) which covers the West Indies, the South Atlantic and East Gulf States, and the ocean area adjacent thereto.

Fig. 1 illustrates the static-free and excellent communication conditions attending this "high." The ship at the time was off Cape Haitien, Haiti, on March 16, 1927, and with a two-kilowatt transmitting set had no diffi-

The other example, Fig. 2, is of the same geographical area but during a hurricane, the most intense type of "low" (region of low barometric pressure, such as accompanies tornadoes) occupying a part of the same area. (The "low" in this case is the historical Miami hurricane shortly after it had passed over and devastated Turk's Island.) The position of the observer was the same during the observance of both states of weather and attendant radio reception conditions; that is, off Cape Haitien, Haiti, in this case on the evening of September 16, 1926. In the former case, in the "high" static was practically zero and reception excellent in all directions over long ranges within the "high."

In the latter case, in the "low," reception was impossible; although attempts were made to communicate in all directions indicated by arrows in Fig. 2; with Arlington, San Juan, Guantanamo, Port au Prince and even Cape Haitien, which was only 40 miles distant.

Here we deal not with theory but with facts, namely (1) that on one occasion static was terrific and the observer was within the 29.60 isobar, southeast quadrant of a hurricane; and, (2), on the other occasion the observer was within a homogeneous "high" and static was practically nil.

BAROMETER LOW, STATIC HIGH

The writer wishes to ask what this and similar phenomena would seem to indicate. To the observer in this case the same relative situations have recurred so often that he is of the opinion that "high" are relatively static-free and "lows" are attended with static somewhat proportional to the intensity of the disturbance. This would seem to hold good from troughs or areas of moderate "low" pressure to those of the highest intensity, associated with hurricanes, and from poorly-defined "high" with mild static to great homogeneous "high" with practically no static.

Assuming that this is true, and that "high" and "lows," in the light of our knowledge concerning their development, disintegration, and motion across the area mapped, are to be the basis for our static forecasting, we need next to study the structure of "high"

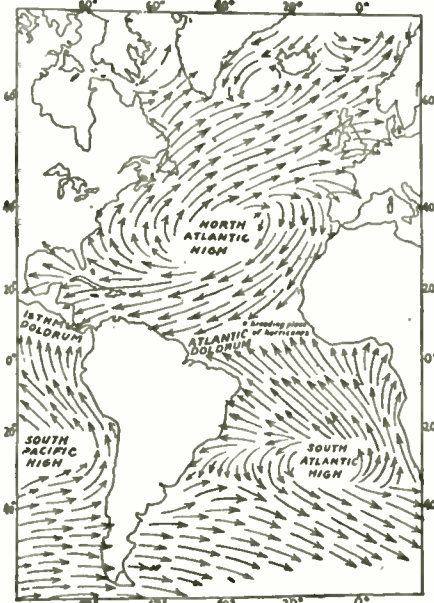

FIG. 3

The origin of tropical hurricanes is shown above. As "low" pressure areas, they originate between the "high" of fair, calm, weather, and sweep the shores of the continents. They are accompanied by static which radio compasses will locate; and thus give warning of their approach.

culty in communicating with Port au Prince, Guantanamo, San Juan, Arlington and New York.

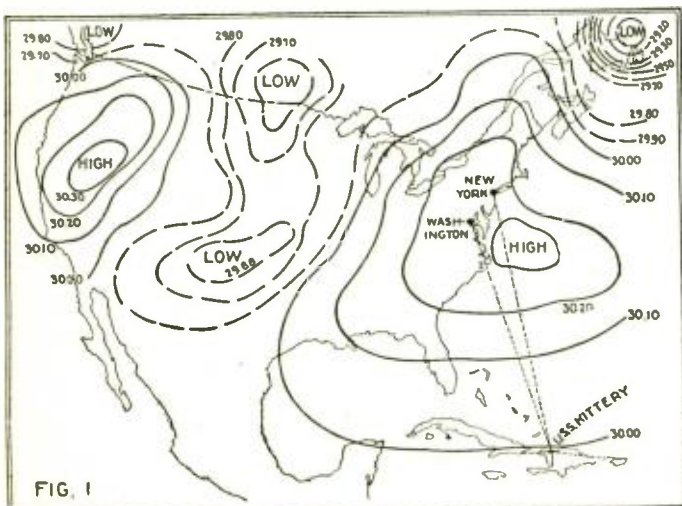

FIG. 1

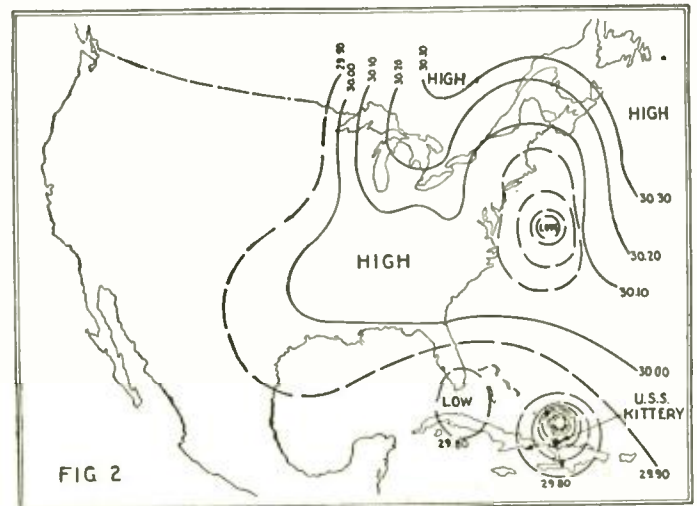

FIG. 2

The circles in the lower right, closely grouped, show a great difference in the air pressure, and consequently a wind of hurricane proportions. The "Kittery," almost in the center of the Miami hurricane, which is seen sweeping toward the Florida peninsula, is unable to communicate with Cape Haitien, only forty miles away, with her radio apparatus, because of the enormous intensity of the static disturbance.

Illustrations courtesy Hydrographic Office, U. S. Navy.

* Hydrographic Office, U. S. Navy.

and "lows" with a view to locating that part of each which may, under the most general conditions, be expected to give the greater amount of static. We also want to know where within the "high" or "low" to expect the minimum amount of static for that particular structure.

In the Miami hurricane, static was stronger in the southeast quadrant than in the northwest or southwest quadrants. In general, the eastern half of "lows" will be heavier in static than the western; the southeast, in general, than the northeast and the southwest, than the northwest.

On March 21 last when the "high" shown in Fig. 1 had moved from the position shown to the eastward until the *Kittery's* position was in its southwest quadrant, static increased steadily. The above facts can be reconciled with results obtained by many who are studying static with the view of correlating it with the atmosphere. In "highs," it has been my observation that the center has the mildest static, the southeast quadrant less than the southwest, and northeast less than the northwest; especially is this true near the edge of the area.

"Highs" have different static conditions associated with them: A Pacific "high," deep but of limited area, will have a different static association from an Alberta "high," which is shallow but of great magnitude. And similarly, "lows" of different origin will have correspondingly different static attendant upon them.

Fig. 5 shows the same Miami hurricane as it was passing over Florida. I have listed the above facts in this particular manner in order to show how much can be forecast concerning static, once its relationship to "high" and "low" areas is well established. In our knowledge of the development and motion of translation of "highs" and "lows" we have the basis of a static forecast which will be enhanced by the use of an instrument which will make use of the directional properties of static.

TRACKING THE MIAMI HURRICANE

Here it will be seen that from Guantanamo, where the *Kittery* was then moored, the heaviest static was in the general direc-

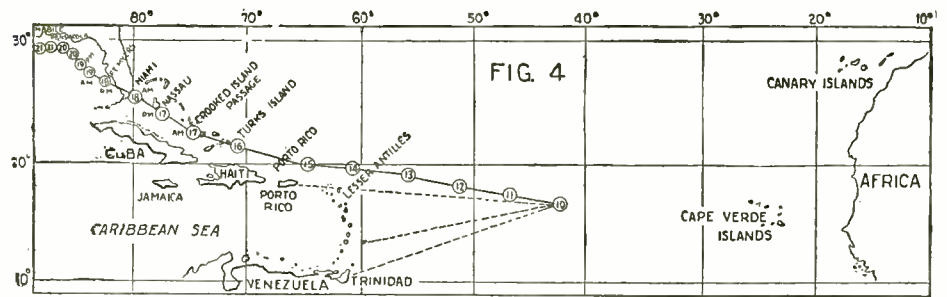

The map above, illustrating the movement of the Miami hurricane of 1926, indicates the positions of the "low" shown on larger-scale maps, on successive days. The dotted lines indicate the proposed use of radio compasses to locate the center of the approaching storm and its movements over the ocean; thus making possible much more accurate forecasting at an earlier date.

tion of the hurricane's southeast quadrant. Its center was 600 miles distant. Fig. 4 shows the path of the center of the Miami

hurricane from the time it was first observed, to the eastward of the Lesser Antilles, to the time it filled up and dissipated over Mobile, Alabama. This static belt drifted along with the hurricane. The dotted lines show how a radio-compass system may enable us to reach out in the region to the eastward of the Lesser Antilles, where barometer readings are scarce, and triangulate a static center from St. Thomas, Barbadoes, and Trinidad.

"THE DOLDRUMS"

Fig. 3 shows the ideal atmospheric distribution for summer, from which the hurricane belt, "the doldrums," may be studied. In addition to these hurricanes, which form to the eastward of the Lesser Antilles, we see the breeding place for the early spring and late fall type that forms around the Isthmus of Panama, between the North Atlantic or States "high" and the South Pacific "high." The selection of compass stations here, as elsewhere, will depend upon the proved range of accuracy of the radio compass for this kind of work.

Anyone working in a field as new and undeveloped as this naturally finds comfort in having another and independent source, wherein his conclusions have been verified. H. T. Friis, of the Bell Telephone Research

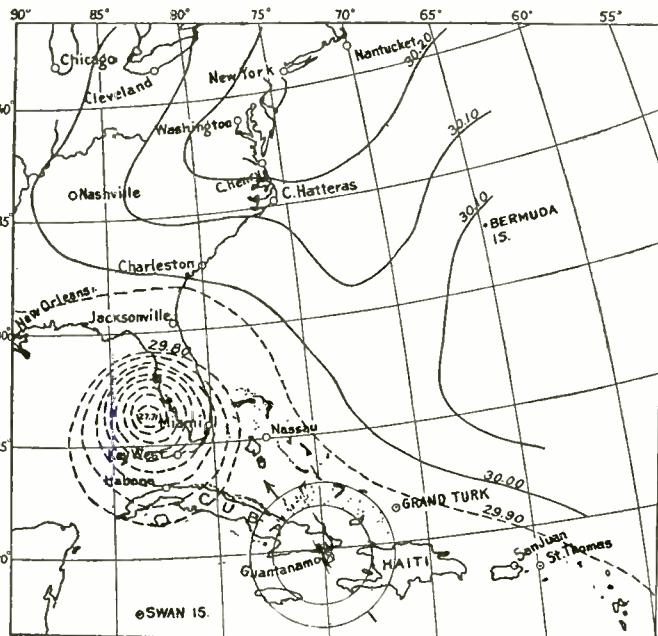

FIG. 5

Above is a magnified view of the hurricane "low" at Miami on Sept. 18, showing the static readings in different directions, as taken by the loop apparatus of the "Kittery" at Guantanamo. The field is quite clear of static to the south of the observation point.

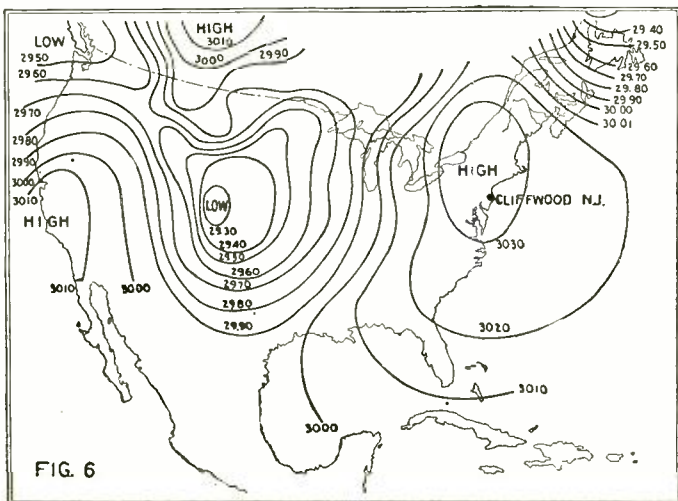

FIG. 6

The weather map of Nov. 25, 1926, showing a "high" and fair weather around the observation point at the Bell Laboratories at Cliffwood, N. J. Static was practically zero when the center of the "high" area was at the observation point, as shown, and conditions were unusually favorable.

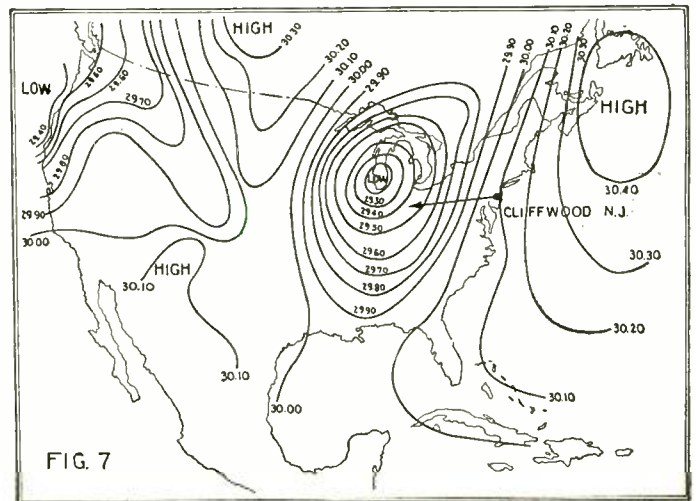

FIG. 7

The following day, with the approach of the "low" storm center across the Mississippi Valley, static increased in intensity four hundred times. The direction of its center changed from west, as shown, through south and east, and finally east of north, as the storm passed up the Atlantic coast.

Laboratories, has taken observations over a period extending from last August up to the present date. They very generously cooperated with the Hydrographic Office in this work and I show you here the results of a part of their observations which substantiate work previously done by me.

Fig. 6 shows a "high," central over New Jersey on November 25, 1926. Static was zero during the passage of this homogeneous "high." Following its passage, the "low," shown in Fig. 7, in its motion of translation to the eastward passed over the same station. Static rose in intensity from 1 to over 400 microvolts per meter during its passage. The graph of direction and intensity of static shown in Fig. 9 was received by the Bell Laboratories' instrument. The direction shifted consistently from the west, as shown, to north of east.

At the right we have the record made by an automatic recorder of static, on the same principle as the mechanism shown below. The upper half of the record shows the intensity of the static; below, the relation of the direction of its impulses to the points of the compass, as determined by the revolving loop, during a period of five days: covering the rise, passage and disappearance of the "low" storm center show in Figs. 6 and 7.

Fig. 8 (below)—The directional loop of the "Kittery's" static recorder, and the hook-up used. The crashes of static are recorded by strokes of the recording pen in the lower right corner.

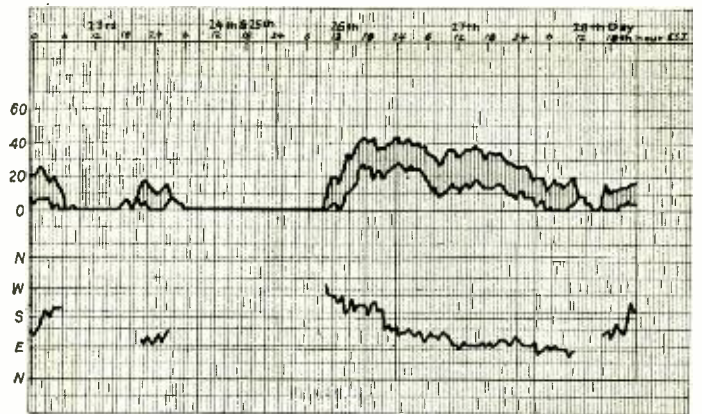
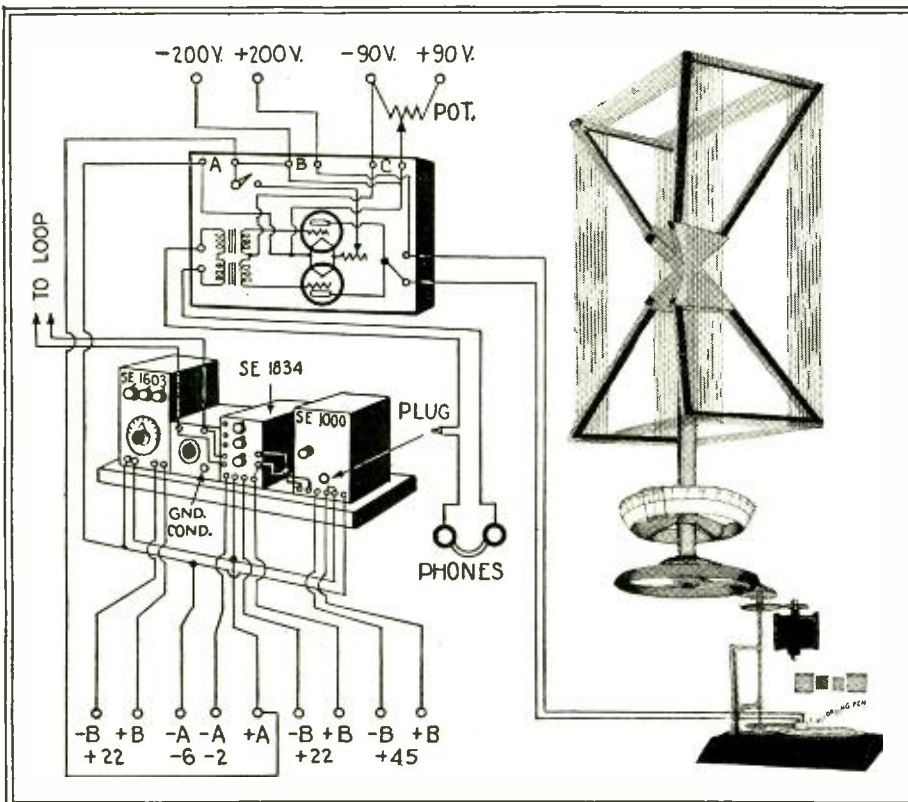

FIG. 9



AUTOMATIC RECORDERS

The Hydrographic Office is pleased to see its desire of a year ago so quickly fulfilled

by commercial enterprise. We said then that an instrument which can record both the direction and the intensity of static would be

necessary to the successful accomplishment of this work. Dr. L. W. Austin, at the Bureau of Standards, has developed another such device and there are still others. The recorder we used on the *Kittery* is shown in Fig. 8. The motor was so geared as to make one revolution in six to ten minutes.

Mr. Friis, in describing his static recorder, says, "The reason for the small advance which has been made to date in the automatic recording of static is probably due largely to the lack of suitable apparatus. Certainly there has never been any doubt that automatic records would be very valuable. It is just as important to know the static level as it is to know the strength of a radio signal, because it is the static-to-signal ratio that determines the intelligibility of the signal. A static recorder connected to a rotating directional-antenna system would tell us where static comes from and, therefore, enable the radio engineer to determine whether it is worth while to construct a directive antenna system. Also, the connection between thunderstorm areas and static would make static recording valuable to the meteorological service. There is perhaps no reason why a suitable static recorder should not make it possible in a few years to obtain a daily static forecast, just as we get our weather forecast now."

I believe another year will see it possible to have static forecasts as Mr. Friis predicts, and, with such forecasts, will come a more exact knowledge of the relation of storms to static. The result of this will be the identification and tracking of many storms, which is at present difficult, especially over ocean areas where barometer readings are scarce.

"Why Kilocycles?"—A Short Explanation

IN rearranging the licenses of stations lately, the Federal Radio Commission, like all technical men, has laid special emphasis on *kilocycles*, rather than on *wavelengths*. Yet the public has previously failed to respond to efforts to impose upon it this more scientific method of reckoning. There seems to be a popular feeling that a wavelength is something tangible, while a kilocycle is an abstract idea.

Yet the matter should be simple enough. A *cycle* is a reversal from positive to negative, and back again from negative to positive, in the electricity in an alternating-current circuit, or in the impulses creating the field of a radio wave. "Cycles," used as a measure of the rapidity of these changes, implies always *per second*; and "kilocycle" is simply a short expression for thousands of cycles (per second). A thousand kilocycles, therefore, means a million (double changes per second in the *polarity* of the wave, as measured at any point in its progress; and, as the wave advances 300,000,000 meters (more accurately, 299,820,-

000, more or less) per second, the "peaks" will be highest at points 300 meters apart, along the path of a 1000-kc. wave. We have here the idea of a simple wave, corresponding to a wave in water, with approximately equal spaces between its highest crests. However, the water does not move steadily forward—it rises and falls—and the radio wave is *not a flow of current*; it is a *rise and fall of voltage*.

The frequency of currents, alternating from thousands to millions of times a second, has been very accurately measured, by means described in *RADIO NEWS* for December, 1926; the wavelength, with a lesser degree of accuracy, by other complicated devices. From the standpoint of classifying stations in a broadcast list, we might use either kilocycles or meters readily enough. We may also describe a distance as 66 feet, or as 1/80 of a mile, with equal accuracy; it is merely a question of convenience in reckoning.

But, in the technical problem of arranging stations so that they will not interfere

with each other, it is necessary to calculate in cycles; because what is impressed on a radio carrier-wave is *not a wavelength*. It is a *frequency*.

A musical note is a vibration at the rate, for instance, of 300 cycles a second, causing air waves about four feet long. In an electric speech amplifier this would correspond to electric waves about six hundred miles long, because of the greater speed of electricity. But we do not add a six-hundred-mile wave to a thousand-foot wave; we impress a frequency of 300 cycles (per second) upon one of a million (per second). The result is a "modulated wave." The function of a radio detector is to iron out, so to speak, the million-per-second wave and leave the 300-per-second wave, which enters the loud speaker and reproduces a 300-cycle note, of sound in air.

Now, at the upper end of the broadcast band, a 300-cycle change affects the wavelength (measured in meters) about ten times as much as it does at the lower end of the
(Continued on page 182)



Making the Most of Summer Reception



Why Keep Your Radio In Moth Balls from May Till September?

By CHARLES M. ADAMS

NO. We don't use our radio much in the summer. You know. The static is so bad." You have no doubt heard such an explanation offered many times for parking radio among the moth balls from May till September every year—probably you have offered it yourself. And there is of course some truth behind it.

Summer reception is admittedly not as satisfactory as that in winter. Signal strength is lessened, atmospheric interference is increased, and distance range is limited. But granting all this, there is still no reason to relegate your radio to the same disuse as sleigh bells during the hot months—at least not under present-day conditions.

If you give it a fair chance, it will go right on giving you information and entertainment in spite of static and the thermometer. The broadcasters continue to put good programs on the air, you notice; many of them features not possible during the winter, such as sporting events. All you have to do is give your radio a chance—first by getting rid of the notion that summer static makes it practically useless.

WATCH YOUR ACCESSORIES

You have probably noticed nights during the winter when the static was just as bad as on the worst during the summer, and summer nights when the air was as clear and the signals as sharp as during the winter. Further, you can easily overcome even bad static, as will be explained in a moment. But first you must be sure that your receiver is in proper condition.

Because they have the notion radio is only for the winter, many people let their sets struggle through the summer with worn-out tubes and run-down batteries. The result

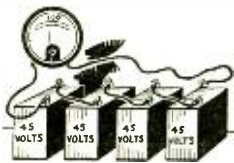

How are your batteries? Check them with a good meter.

is noise they charge to static, and weak signals they lay at the door of the hot weather; when the fault is solely that of defective accessories. So be careful to see that your tubes are live and your batteries as fully charged in the summer as during the winter.

Now as to static:—As you know, modern receivers are designed to overcome this much more successfully than older types; and you can assist them by some simple means.

OPERATING SUGGESTIONS

For example, even very bad interference of this kind can be materially reduced by merely turning down your rheostats (the filament-current controls). This, of course, also reduces the volume; but, since you will probably be listening to a nearby station, the volume will still be found ample for all practical purposes, at the same time making the program much more enjoyable.

If your set is so equipped, you can get the same result by plugging in your loud speaker on the first audio stage instead of the second, as usual. The jacks will be found plainly marked, or your dealer will give you full directions.

A better way of combating "old man static," however, is by using a small indoor



Cutting out the last audio stage may help on locals.

aerial. This can be made by running a piece of insulated wire from ten to thirty feet long around the baseboard or picture molding. Simply disconnect your usual outdoor aerial and connect the indoor wire in its place. You will find that this reduces the amount of static and other interfering noises picked up to a considerable degree, and at the same time gives ample volume and surprising distance.

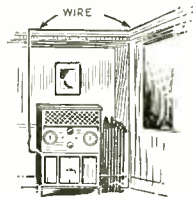

The city dweller will find possible advantage in an indoor aerial.

UNDERGROUND RECEPTION

If you live out in the country or, even though you live in the city, if you have access to a back yard, you can do away with practically all static, not only in the summer, but in the winter as well.

Professor James H. Rogers, of underground radio fame, was the first to show that excellent reception could be had by the *ground method*, using no aerial. All you need to do is to bury your aerial in your back yard or any open plot.



If you are fortunate enough to have your own yard, try "underground" reception.

Such underground radio "aerials" require a hole about three feet in diameter. The hole is sunk about four feet into the ground; while a lead-covered connection cable runs to your set. With such a device it is possible to listen, even during a thunderstorm, and you will not be troubled with an excessive amount of static. During normal periods, the underground system picks up practically no static at all. Long-distance stations can be picked up with the "underground aerial" method just as with the outdoor open aerial.

If your receiver is of a type two or three years old, and unshielded, you will even find that you can get much the same result by disconnecting the aerial entirely.

But the principal reason why you use your radio less in summer than in winter is that you want to be out of doors. Likewise, you do less reading, less theater-going, less card-playing, less dancing in hotels and halls, because it is too hot indoors. Instead, you seek porches, yards, parks, roads, camps—anything that promises relief from the heat. However, instead of putting radio on the shelf till cooler weather, you can take it out of doors with you easily and conveniently.



You need not sit in a hot room to listen to your radio.

For example, there are few houses in which several alternative locations for a set are not offered; and one making it possible for the set (if with a built-in speaker) to be placed near a window so that those on the porch or in the yard may hear the program, should be chosen at the time of installation. If this has not been done, you may find it possible to have the set moved to such a location without difficulty.

EXTENSIONS EASY

Should your receiver be provided with a separate speaker, the solution is still more simple. All you need do is equip the speaker with an extension cord and place it in a window or on the porch. These exten-



Why not take the speaker out on a cool porch?

sion cords are now available in lengths up to fifty feet. Their cost is small. They can be connected easily, and make it possible to place the speaker in any of several locations that command the out of doors, and offer as well considerable convenience when it is desired to move the speaker about the interior of the house during the winter.

In fact, if your receiver is already equipped with a built-in speaker, you will find it of material advantage, as many have done, to purchase in addition a separate speaker, which can be moved about with the convenience just suggested, both in summer and winter.

In any event you should have little difficulty in finding ways and means of adapting your receiver for full summer usefulness. The principal thing is to remember that your radio can give you just as much pleasure in summer as in winter, if you give it a fair chance.

A Loud Speaker with a Three-Quarter Mile Range

An Explanation of the Theory and Operation of a Large Exponential Horn

By CLINTON R. HANNA

AN important development in the science of acoustics—a huge exponential horn for reproducing notes of all pitches with great volume—was demonstrated in Pittsburgh recently before an audience of newspapermen, music critics, and electrical engineers. The horn was operated from the research laboratory of the Westinghouse Electric and Manufacturing Company, and with the auditors assembled on a hill three-quarters of a mile away from the horn, its radiating capacity was put to the acid test.

Phonograph records were used for the demonstration, and afforded a wide range of frequencies. The piccolos and bass horns of Sousa's Band; the treble and contra-bass notes of the pipe organ, and the 2,500 voices of the Associated Glee Clubs of America singing to full-organ accompaniment, bridged the wide gap between auditors and horn without blurring or faltering.

The inventors are Dr. Joseph Slepian and Clinton R. Hanna, of the Westinghouse research staff, to whom a patent has been recently granted.

The basic principles underlying the exponential method of sound radiation are explained by Mr. Hanna in this article. The popular theory, that the function of a horn is to amplify sound, is exploded by the writer, who is recognized as one of the leading authorities on the science of acoustics.

—EDITOR.

THE exponential horn is a sound-radiating device whose usefulness is appreciated more and more as time goes on. Over three years ago methods of designing such horns for loud speakers or other reproducing instruments were published by the writer and Dr. Slepian. At that time the principal advantage of a reproducer using the properly-designed exponential horn, over those using the conventional short horn of random shape, was that the bass notes were given more nearly their correct prominence, and that the resonances of the diaphragm were minimized to prevent undue prominence of notes

in the middle- and upper-frequency ranges.

Today the correctly-designed horn is useful also in making it possible for relatively simple and small vibrating mechanisms to radiate the very great amounts of sound required for large auditoriums, ballrooms, out-of-door concerts, etc. With apparatus recently developed, it is possible to reproduce Sousa's Band at full volume, or 2,500 voices singing to full-organ accompaniment, without the slightest rattle or overloading.

Applications for such reproducers are at once apparent. Within a short space of time it will be unnecessary to travel to the big cities to hear a famed symphony orchestra, or an acclaimed musician playing the organ scores of a picture. Such music can be reproduced in local auditoriums or theatres.

FUNCTION OF HORN

In view of the importance of the horn in the new development, it is advisable to review some of the characteristics of horns and methods of designing them. Contrary to the popular conception, a horn on either a talking machine or loud speaker is *not* an amplifier. Nor is it necessary that it shall resonate in order to perform its function; in fact the best horns for reproducers do not resonate strongly at any frequency.

The real function of a horn is to be a sound radiator; much the same as that of an antenna is to be an electromagnetic wave radiator. The horn enables the relatively small diaphragm to get a "grip" on the air, so to speak; just as the antenna enables the radio transmitter to get a "grip" on the medium through which radio impulses travel. Of course, it is possible to radiate sound directly from the vibrating member to the air, but much larger surfaces are required when this is done. The horn enables a small diaphragm to radiate large amounts of sound to the atmosphere.

How does the horn accomplish this? The student of physics knows that, in a mechanical system, power is measured by the product of force and velocity. Thus, if two vibrating diaphragms of greatly different size are radiating equal amounts of sound-power when moving with the same velocity, the total force must be the same for each; and the pressure per square inch on the smaller diaphragm must be much greater than it is on the larger. The horn is the device which brings this about. It

causes the *pressure per square inch* over the surface of the diaphragm, for a given velocity, to be many times greater than if the diaphragm were to vibrate in free space. The horn, therefore, *makes the diaphragm work harder*; and this is the reason more sound is radiated from a given diaphragm with a horn than without.

A horn does not amplify. It increases the amount of sound radiation by causing a greater load to be placed on the diaphragm.

"EXPONENTIAL" DEFINED

The best horn is one which radiates most uniformly over the required range of pitches. It can be shown that, of all horns having a given size (*i.e.*, same length and terminal areas), the *exponentially-shaped horn is the most uniform sound radiator*. The mathematical equation of such a horn could be given; but it is much more easily understood if described as a horn whose cross-section doubles at equal intervals along its length.

For example, if a horn has an orifice with an area of half a square inch and, at one, two and three feet, etc., from the orifice the sections are one square inch, two square inches and four square inches respectively, we have an exponential horn in which the area doubles every foot. A horn whose area doubles at smaller intervals would be said to expand more rapidly, and one whose area doubles at longer intervals would expand at a lower rate.

This rate of expansion is an important factor in horn design, for it determines the lowest frequency down to which the horn is a uniform radiator. This limiting frequency is called the "cut-off" frequency; for below it the radiation is very small. A horn whose area doubles every foot cuts off at 64 cycles. One expanding half as rapidly would cut off at 32 cycles, and one expanding twice as rapidly at 128 cycles. Thus the contour of the horn is determined, if we know at how low a frequency we wish to reproduce.

MOUTH OF HORN

The next question that arises is, "How far should the horn be extended before being terminated at the mouth?" It was stated at the beginning that a properly-designed horn should be free from noticeable air-column resonance. To prevent resonance, the large end, or mouth of the horn, should be large enough to transmit the pressures emanating from the horn to the atmosphere without any reflection. Of course this is impossible, because of the sudden relief of pressure as the wave passes outside the confining walls of the horn. But, if the mouth is made comparable to one-quarter of the wavelength corresponding to the cut-off frequency of the horn, (as determined by its rate of expansion) the resonance of the horn will be very small.

The wavelength in feet is determined by dividing 1120 (the velocity of sound in air in feet per second) by the frequency. So the horn should be extended until the mouth has a diameter about one-quarter this wavelength. If the horn section is approximately square, the area of the mouth should be as large as that of a circle having this diameter.

As an example, the horn whose cut-off frequency is 64 cycles, corresponding to a wavelength of 1120 divided by 64, or 17½ feet, should have a mouth about 4½ feet in diameter, if circular, or four feet square.



The author in his laboratory. The unit in the foreground is the one used in the exponential horn shown on the opposite page.

THROAT OF HORN

Now we come to the small end of the horn. What cross section should we choose for this end? Just as the large end was determined to secure the proper coupling to the atmosphere, so the small end must be chosen to give the best coupling to the vibrating mechanism. This area is fixed by three things: (1) the mass of the diaphragm, (2) the area of the diaphragm, and (3) the highest frequency to which the reproducer is to respond with uniformity.

To understand this part of the problem we must get a clear picture of how the horn loads the diaphragm. Imagine a diaphragm vibrating back and forth as a piston (i.e., every part moving together through the same amplitude), pumping air in and out of the throat of a horn. If the air cavity just above the diaphragm is small, nearly all of the air displaced by the diaphragm will move into the horn, and only a small part of the motion will be lost in compressing the air in the cavity.

Suppose the diaphragm in vibrating back and forth moves 100 cubic inches of air per second into the horn. If the horn has a throat area of half a square inch, the velocity of air in the throat will be 100 divided by 0.5 or 200 inches, per second. If the area of the throat were only one-quarter of a square inch, the velocity would be twice as great or 400 inches per second.

Now the characteristic of the horn is such that, when air is moving back and forth at its throat with a frequency greater than the cut-off frequency, a pressure, known as radiation pressure, is created. This pressure is directly proportional to the velocity of the air particles at the throat, and makes itself felt back into the air cavity and all over the surface of the diaphragm. Since the air velocity in the horn is greater for the horn having the smaller throat, the pressure will be greater; and the total force exerted on the diaphragm, which is the pressure multiplied by the diaphragm area, will be greater.

Part of the force used in moving the diaphragm will be spent in overcoming this radiation pressure, and part will be spent in overcoming the inertia and stiffness of the diaphragm. Now it is desirable that the greater part of the driving force shall be spent in overcoming the radiation pressure, at least over a good part of the range of pitches required. To bring this about, the radiation pressure must be high, and

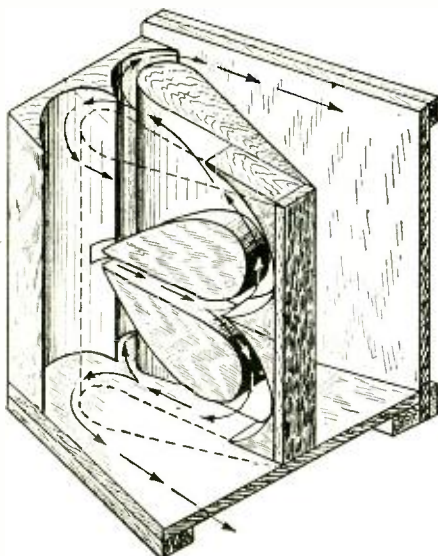

The peculiar method of folding the Westinghouse exponential horn (shown above) was developed by engineers of the Bell Telephone Laboratories. This design makes possible a long horn within a reasonable space. The folding in no wise affects the performance of the horn.

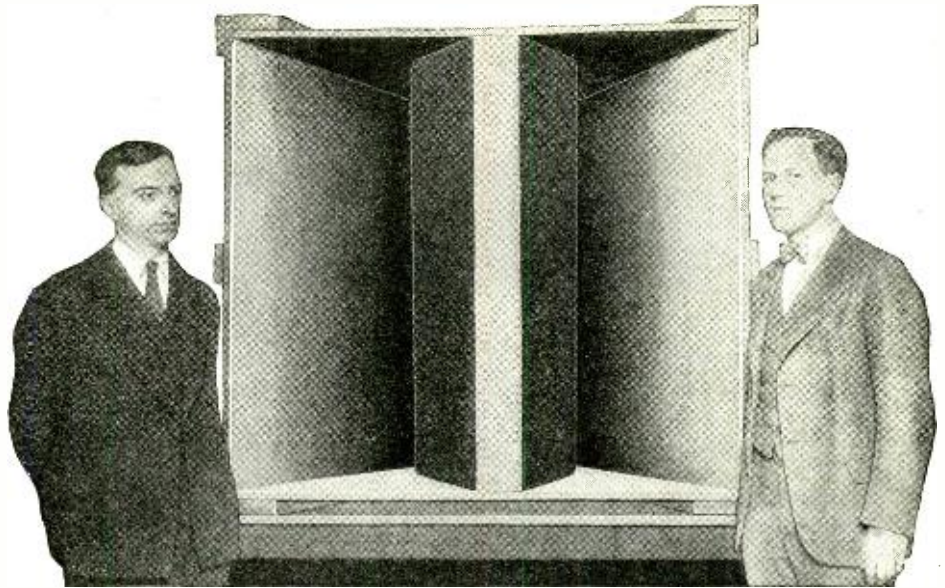

The exponential horn mounted on a pedestal, preparatory to the demonstration during which the voice of the horn was clearly heard, three-quarters of a mile away. The inventors—Dr. Slepian at the left, Mr. Hanna at the right, are shown beside it.

thus the throat of the horn must be relatively small.

We have then the requirements of a good horn. First, it must be approximately exponential in shape and of slowly increasing section, in order to transmit the lower pitches. Second, it must be large at its mouth in order to prevent noticeable horn resonance. And third, it must be small at its throat in order to cause sufficient radiation pressure to be exerted on the diaphragm as it moves. It will be noted that all three of these requirements make for a long horn. Length, however, is merely incidental and not fundamental in determining the performance of a horn. It should be stated that while good horns are long, the exponential horn is shorter than any other covering the same range of pitches. It has the added advantage of having greater freedom from horn resonance.

APPLICATION TO POWER LOUD SPEAKERS

It has been hinted that horns are advantageous because small vibrating systems may be used instead of large ones. This advantage is greater for loud speakers which are to radiate very great amounts of sound.

To illustrate this, consider a horn having a throat area of half a square inch and a mouth area of 2,304 square inches (corresponding to 4 feet square). Let the rate of expansion be low enough to include 64 cycles. If a diaphragm pumps air in and out of this size throat at the rate of 50 cubic inches per second, approximately one watt of sound will be radiated, provided the frequency is above the cut-off of the horn.

Now let us see what is taking place at the large end or mouth. The rate of flow of air in cubic inches per second is not the same along the horn but is greater for the larger sections in proportion to the square root of the area. Thus, at the mouth of the horn the area is 4,608 times as great as at the small end, and the air current, instead of being 50 cubic inches per second, will be 50 times the square root of 4,608, or 3,400 cubic inches per second. This increase does not signify *amplification* but rather *multiplication*; for what is gained in air flow is lost in pressure, so that the power remains the same. But the significant thing is that a small diaphragm, perhaps two or three inches in diameter, displacing only 50 cubic inches per second when attached to a horn, is capable of moving, in this case, 3,400 cubic inches of

air per second at the mouth of the horn.

The horn and small diaphragm can of course be replaced by a large diaphragm, of size equivalent to the mouth of the horn, moving in free air so as to displace 3,400 cubic inches of air per second. The mechanical difficulties of arranging such a large diaphragm are at once apparent, however. Also the force required to move such a diaphragm is very much greater, due to its greater inertia; and this makes for much lower efficiency. When large amounts of sound are needed, relatively large amounts of driving power from amplifiers are required. Naturally the device having lower efficiency will require the largest amplifier to drive it.

Summing up the advantages of the horn in its new high-power development, we may say that: (1) it allows the use of relatively small and easily-constructed vibrating systems; and (2) it makes for high efficiency, thereby reducing the size and cost of amplifiers for operating the loud speaker.

The Why of Power Tubes

WHY are large audio amplifier tubes of the 112, 171 and 210 types essential for quality reproduction? This question can be answered, briefly, as follows:

Older types of radio receivers reproduced with full intensity only the medium-pitched notes, to which both the loud speaker and the human ear are sensitive. The lower bass notes were not reproduced and the high frequencies were slighted. Under such conditions, tubes of the 201A type were capable of giving satisfactory service.

Present day requirements call for full reproduction of a much wider range of frequencies with uniform intensity. The high frequencies do not carry much energy, and hence impose no additional load on the tube supplying the speaker. The low frequencies, on the other hand, contain most of the energy present in musical selections or speech and, therefore, have a tendency to greatly overload the tubes. At the same time, the reproduction of these notes does not give the impression of loudness, because the ear is less sensitive to them.

It will be evident, therefore, that quality reproduction requires tubes capable of furnishing greater power output than can be obtained from 201A type and similar tubes. Emphasis should be placed on this feature of tone quality in reproduction, and not on the volume obtainable from power tubes.

Radio News of the Month Illustrated

By GEORGE WALL

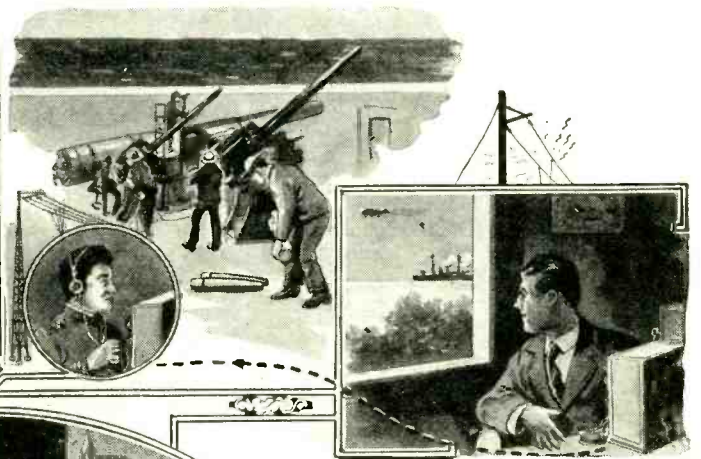
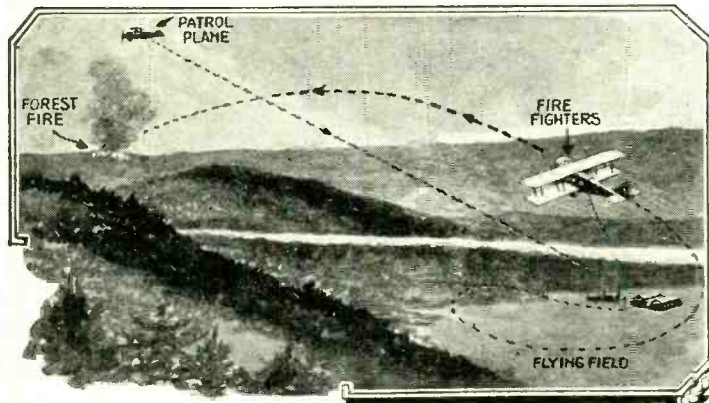

The forests of Manitoba, Canada, are patrolled by the Royal Canadian Air Forces in co-operation with the province's forest service. Lately the airplanes used in this work have been equipped with transmitting sets, whereby they can at once report fires, obviating delay of flying to their base or a telegraph station. At once reserve planes with fire fighters and equipment are dispatched to the spot, without the loss of a precious minute. This may prevent the spread of many small fires into conflagrations.

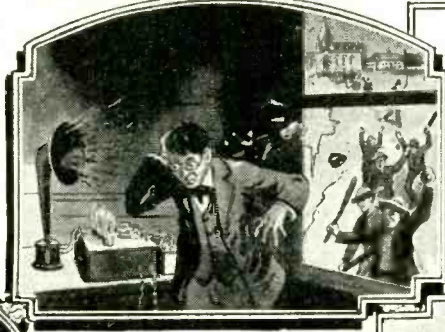

Radio amateurs co-operated with the "defending" "Blue" forces during the recent grand military and naval maneuvers off the southern coast of New England. Over 150 of them joined in this net, and kept close watch for the "invading" "Black" forces—thus adding somewhat to the difficulties of the latter. This intelligence system reported the appearance of any warships or aircraft within its range to the headquarters of the defence, just as in actual warfare, when its members would be invaluable in active service.



There are still regions where the fear of witchcraft is not extinct, and the radio comes under strong suspicion. A country schoolteacher in Central Europe was recently the victim of the superstitious peasantry, who associated the mysterious box with recent unfavorable weather. After breaking his windows, they fell upon the radio set and its unlucky owner, both of whom suffered considerable violence.

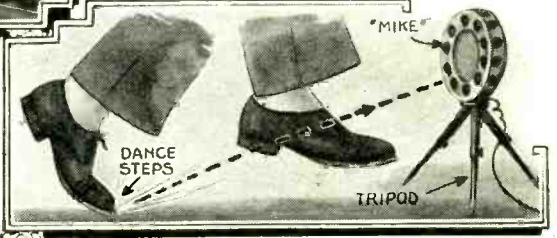

To broadcast dance steps, as well as music, a New York station uses a special microphone of the type shown. It is but six inches above the floor, and thus catches the "lowest" terpsichorean notes.

Have you often felt that you would like to join in a DX radio concert? One of the staff of WAAM did this very thing, when a Tulsa orchestra was picked up on a receiver. The singer joined in, and the combined harmony was broadcast, giving listeners the impression that vocalist and musicians were in the same room.

Every seat in the new parlor cars of the Canadian National Railways is equipped with radio headphones, plugged into outlets in the walls, while the car has a cone speaker. This was a special part of the structural design: each car has its own built-in receiver and special aerials are provided.

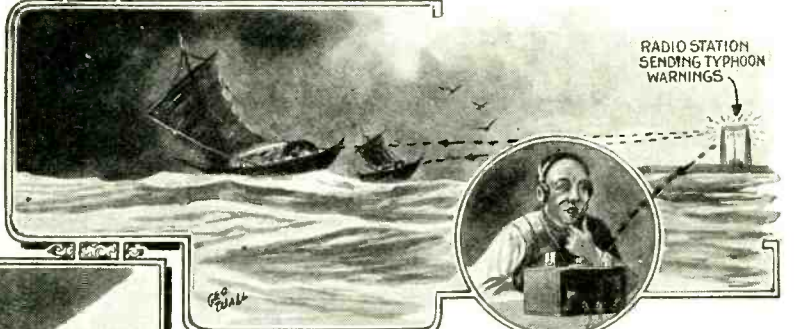

The China seas are subject to violent hurricanes, or "typhoons," with much destruction of shipping occasioned thereby. To minimize this loss, the British government has erected at its concession of Kowloon, on the mainland opposite Hongkong, a 1½-kw. station devoted to the purpose of sending out storm signals. It operates with the call VPS3. Typhoon warnings will be sent out in code on 600 meters (spark), on 800 meters I. C. W., and finally on 300 meters by telephone, in many languages—English, French, German, Japanese and Chinese. While most native coasting craft have no radio equipment, it is hoped that many of them will install crystal receivers for the purpose of listening in for these warnings, and thus be able to seek timely shelter.

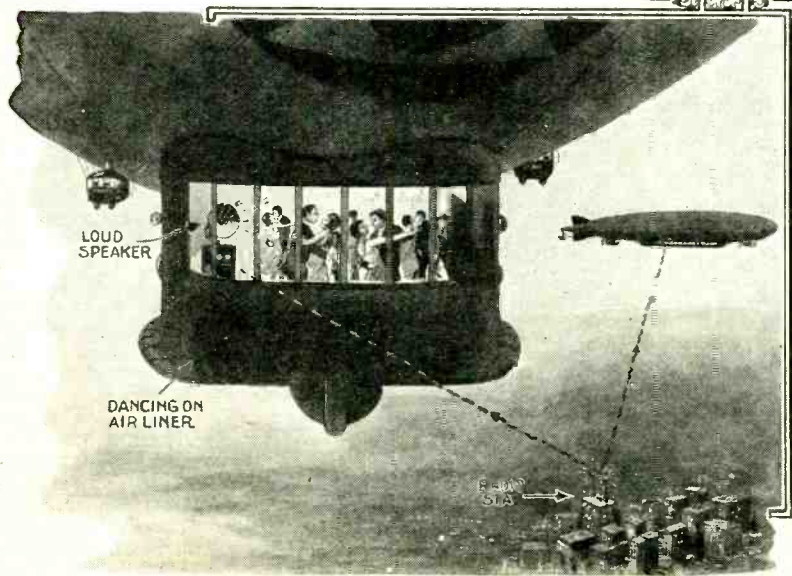

Plans for the installation of transatlantic air service by dirigibles next year have been made. It is proposed to operate between Seville, Spain, and Buenos Aires, Argentina, a super-Zeppelin 675 feet long and 96 feet in diameter, with the conveniences of an ocean liner; and thereby cut the time of the voyage from seventeen days to three. Radio communication, of course, will be maintained continuously during the voyages. The capacity of the aerial vessel will be twenty-five passengers; and their quarters will have even a dance floor. Music will be provided internationally, from New York, Paris or Berlin, as desired, and the trip will be a round of pleasure. Later the establishment of similar service to cover a route between New York and the Continent will be attempted.

Super-Power Broadcasting in Germany

Views of Europe's Largest Transmitter. The New 24-Kilowatt Langenberg Station, 5XX

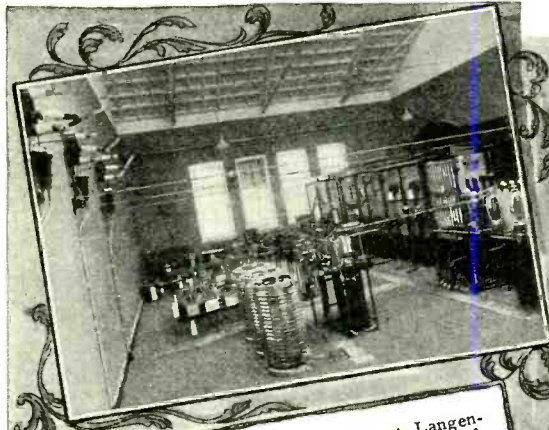

Interior of the transmitting room at Langenberg, showing the large inductances used, and the operating panel, wires from which operate the switches on the wall at the left.

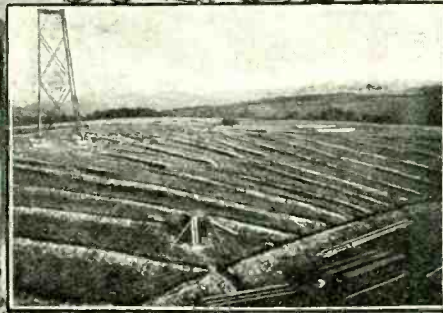

The excavations for the construction of the elaborate ground system, showing the trenches for the heavy ground wires. They cover radially a huge ellipse.

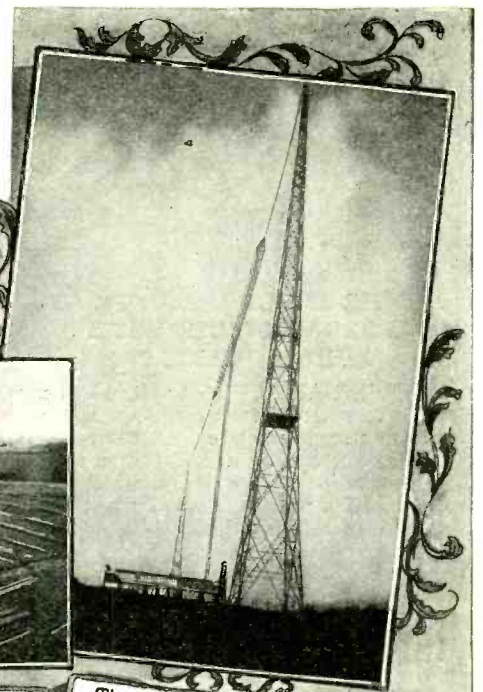

The building and aerial system at Langenberg. The towers are braced only by their own structure, and designed for minimum wind resistance. The cooling tower may be seen beside the lead-in.

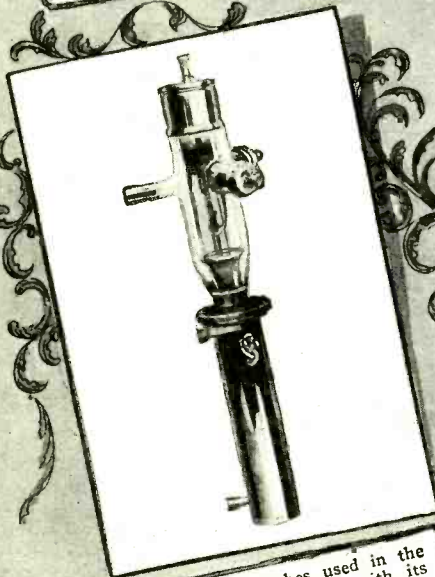

One of the 20-kw. tubes used in the final stage of amplification, with its filament jacket for cooling the plate below. Its filament uses 48 amperes at 35 volts.

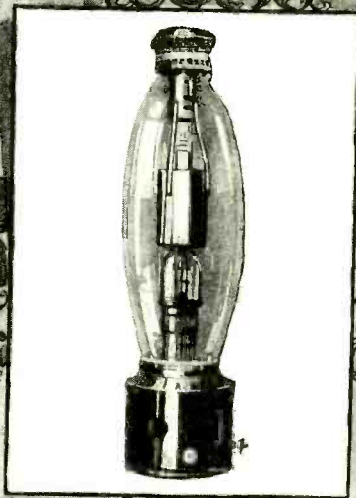

A 1 1/2-kw. tube, used in the intermediate stage of the transmitter. The filament requires 24 amperes, at 22 volts. Its efficiency is estimated at 75 to 80%.



A 400-watt tube, used to supply the constant-carrier wave in the first stage of the transmitter. It uses 12 amperes at 22 volts "A" current, and 2,000 volts "B."

By A. W. HERBERT (Berlin)

THIS giant station is located on a wooded height between the rivers Wupper and Ruhr, in Germany's greatest industrial district, the Rhineland, six miles north of Elberfeld, and a little more south of Essen. Its studios are at Elberfeld, Düsseldorf, Köln (Cologne), Dortmund and Münster; though it may be connected by land-line with any other German broadcast station. Its input is 60 kw.; output, 24 kw.; wavelength, 468.8 meters (640 kc.).

The transmitter operates in three stages; the first a 400-watt tube with two 50-watt modulators; the second has two 1 1/2-kw. tubes; and the third employs three 20-kw. tubes, the various types used being illustrated above. On the plates of the inter-

mediate tubes, 4,000 volts is used, and on the final amplifiers, 10,000.

Six huge rectifier tubes are used to convert the 5,000-volt A. C. received over long-distance power lines; this current supplies the tubes, except for the filaments of the smaller ones, for which a D. C. generator is used.

The apparatus is housed in a single building, 75x140 feet. The transmitter room, 32x45 feet, is divided by a 14-panel iron switchboard. All the operating levers are grounded for the protection of the staff.

A special refrigeration plant is included to cool the plates of the tubes; it consumes hourly about 1,300 gallons of water, which is first put through a softening process, in order that scale may not be deposited in the jackets around the tube plates.

A T-aerial, of five 70-meter (230-foot) wires, is suspended between two 328-foot steel towers, 820 feet apart. These are not guyed in any way, but set in concrete foundations, with porcelain insulation about their lowest members. Condensers shunted by variometers are used to tune this aerial, which was the subject of much experiment.

The ground is a radial net of copper wire, buried about three feet deep, and joined by an outer circuit. Eight miles of wire are thus used; and excellent reception of this station (830 miles on a crystal set) is attributed to this elaborate system.

Powerful as Langenberg is, a "dead" area for its reception has been found south of Cologne; and a relay station is proposed for the benefit of the residents of this district.

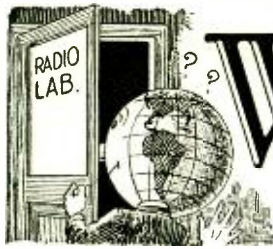

What's New in Radio



POWER-AMPLIFIER UNIT AFFORDS VOLUME WITH HIGH QUALITY

A POWER-AMPLIFIER unit, which can be connected to any complete radio receiver to strengthen its output, has recently been brought out by a Mid-Western firm. The installation of the device, which takes the form of a neat little wooden box about seven inches long, six inches high and four wide, necessitates no changes in the wiring of the radio set, and can be accomplished in a few minutes.

Electrically, the amplifier comprises a single stage of resistance-capacity-coupled amplification, feeding the loud speaker through a conventional filter consisting of a 30-henry choke coil and a 2-mf. fixed condenser. The choke coil carries the D.C. of

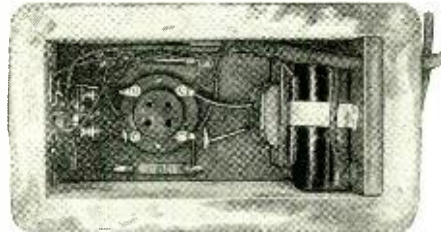

Inside view of the amplifier. At the left is the potentiometer, mounted against the side of the case; in the center, the tube socket, fixed filament resistor, and coupling resistors; and at the right, the choke coil and the fixed condensers.

receiver, is a fixed one of 125,000 ohms value. The grid resistor is a 500,000-ohm potentiometer, wired as indicated in the schematic diagram. It acts as a volume control, and allows a fine graduation of tone. This instrument is fitted with an independent switch, connected in the filament circuit of the amplifier tube, which is opened when the knob is turned to the "off" position.

The components of this amplifier unit are encased in a walnut-finished box, on one side of which are mounted the potentiometer and two output tipjacks to take the loud-speaker cord. The amplifier tube is inserted through the bottom, and hangs nose down. Convenient lengths of battery cords are furnished for easy connection of the unit.

The amplifier is made in two models, one to accommodate a power tube of the 171 type, operating on a storage "A" battery, and the other for a tube of the 120 type, working on dry cells. Plate voltages up to 180 may be used, with the corresponding "C" voltages for the respective types of tubes.

As might be expected with an amplifier of this type, the operation of this unit leaves little to be desired. The reproduction afforded by it is faultless, the quality of the tones actually recreated by the loud speaker being limited only by the quality of the preceding audio amplifier.



The wooden case of the amplifier is finished in walnut, and presents a pleasing appearance. The knob, actuating the shaft of the 500,000-ohm potentiometer, acts as a combined volume control and filament switch. The two small jacks at the bottom accommodate the loud-speaker tips.

Illustrations courtesy Central Radio Laboratories.

the "B" supply to the plate, at the same time forcing the A.F. component of the plate current through the condenser into the speaker, which responds audibly. The condenser, while passing the A.F., blocks the passage of the direct current and keeps it out of the delicate windings of the speaker.

The input resistor, which connects to the output from the last audio stage in the re-

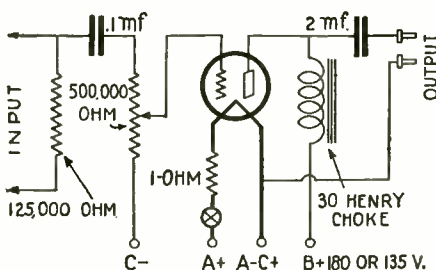

CONDENSER CAN BE MOUNTED IN TWO POSITIONS

The three-gang variable condenser shown in the two accompanying illustrations is one of the most interesting instruments of its kind which has appeared for some time. It is so made that it can be mounted on a receiver panel in two positions; in one, with the shaft protruding directly through the panel in the usual manner; and in the other, with its frame parallel to the back of the panel, in which case the rotation of the shaft is controlled by a geared dial of the drum type. The scale S of the latter (see illustration) is illuminated by a flashlight bulb mounted behind the panel and viewed by the operator through a little decorative bronze window, SC. The actual manual adjustment of the condenser is made on the knob K, working against the metal gear MG, which in turn is fastened to the shaft of the condenser.

Both sets of plates, in each unit of this condenser, are square in shape, and both move when the shaft is turned. They mesh into each other; the maximum capacity being

produced when they are fully interleaved and the minimum when they are completely separated. At the front end of each triple-unit assembly there is a pair of gears, only the left one, G, being visible in the illustration. These two gears, of the same size, mesh with each other; one of them being turned by a comparatively smaller gear attached directly to the end of the condenser shaft. Thus, when the latter is rotated, the two sets of plates (consisting of three sections apiece) move in opposite directions, and the capacity changes accordingly.

As the ratio of the shaft gear to the bakelite gears which it turns is fairly high, the shaft acts as its own "vernier," and allows fine adjustment of the condenser capacity.

On a small insulated sub-panel resting on the frame of the condenser (beneath the plates) are three compensating "vernier" condensers V, each connected across the

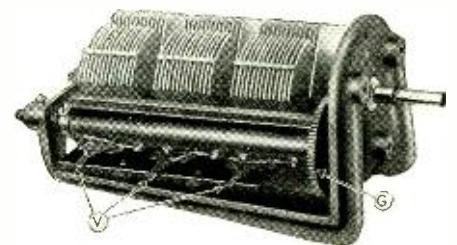

General view of the three-gang variable condenser. The small compensating or "vernier" condensers V are of the flat-leaf type, their capacities being adjusted by means of short machine-screws bearing down on the top plates. Illustrations courtesy Gray & Danielson Mfg. Co. (Remier Division).

variable condenser unit above it. These allow perfect matching of all the stages of any R.F. circuit in which the triple condenser is used for simultaneous tuning. To enable the set owner to make the proper adjustments while the circuit is in actual operation, a wooden screwdriver is furnished with the instrument; an ordinary metal screwdriver being useless for the purpose.

The substantial frame of this condenser is made of aluminum, finished in a dull black color. This forms a fine background for the brass plates. The instrument, over all, is about 7½ inches long, 4 wide and 4 high, and is in general rather unusual in appearance.

The drum-control may be obtained separately from the condenser, and used with other multiple-condenser assemblies.

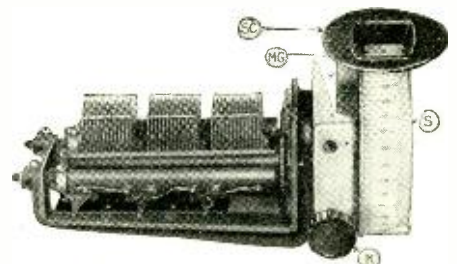

The triple condenser with the drum-control parts mounted temporarily in place to show their approximate positions. On a completed set, only the knob K and the scale window SC, with the section of the scale behind it, would be visible.

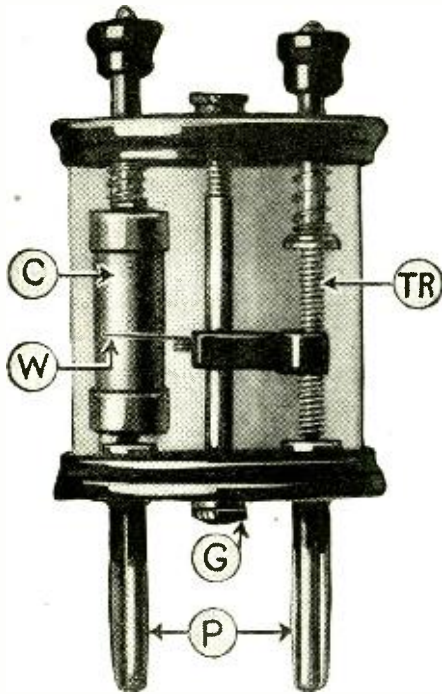

The small cylinder C at the left is the crystal part of this ingenious crystal detector. The two knobs at the top turn the crystal and adjust the position of the catwhisker W. Connection is made to the instrument by means of the plugs P.

Illustration courtesy Dr. Hugo Graf.

INGENIOUS CONSTRUCTION IN GERMAN CRYSTAL DETECTOR

THE characteristic ingenuity of German instrument makers is evident in a new crystal detector which was sent recently to RADIO NEWS LABORATORIES. The device, as can be seen from the accompanying illustration, is entirely different from anything ever used in the United States, even the crystal taking a different form.

The main elements of the detector are the three upright members: TR, a threaded rod which is turned by means of the small knob at its upper end; a fixed guide-rod, G; and the crystal itself, C, which takes the form of a small cylinder and which likewise can be rotated by a small knob fastened to the cap over its upper end. These members are fastened between two discs of insulating material, 1 3/8 inches in diameter, and are protected against dust, dirt, moisture and the operator's fingers by a glass barrel encircling them. The bottom disc is equipped with two split plugs, P, which are intended to fit in small jacks on the top of the cabinet of a set or on its front panel.

The catwhisker wire, W, is soldered to a small forked member which slides up and down the center guide-rod G when the threaded rod TR is turned. As the crystal is rotatable, its entire surface can thus be probed by the catwhisker as the latter travels across it.

The crystal itself is a surpassing novelty. It is galena (lead sulphide) lead and mercury, formed into a smooth solid cylinder about 1/4-inch in diameter and 7/8-inch long.

The complete detector, over all, is 2 3/4 inches high and 1 3/8 inches in diameter.

OUTPUT UNIT AND POWER-TUBE ADAPTER COMBINED

OWNERS of two- or three-year-old broadcast receivers, who want to install such up-to-date expedients as a power tube and an output unit for the protection of the loud speaker, will find a new connector device very convenient for their purpose. It can be installed in a few minutes, and requires no changes in the wiring of the receiver circuit itself.

The three parts of the connector are a plug P, which is exactly like the base of a vacuum tube, an output unit OC, consisting of a choke coil and a fixed condenser, and a tube socket S. The two latter units are mounted on a square wooden base; which holds, in addition, two tip jacks, TJ, for the loud speaker.

The application of the apparatus is obvious. The plug P is simply pushed into the last audio socket in the set, and the audio power tube then inserted in the external socket S. The proper "A" and "B" batteries (or socket-power units) are connected by the cables provided for the purpose. The loud speaker, instead of being wired to the usual jack or binding posts on the receiver, is plugged into the tip jacks, which connect to the tube through the protective output unit.

If there is room for it inside the receiver cabinet, the connector board can be placed therein; otherwise, it may be kept behind the set, where it will not be seen.

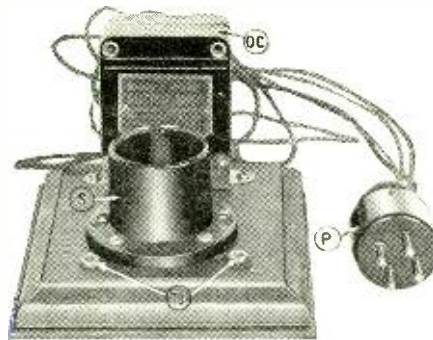

The parts of the connector device: P, plug which fits in amplifier socket in set; OC, output unit consisting of choke coil and fixed condenser; S, socket for power tube; TJ, tip jacks for loud-speaker cord.

Illustration courtesy Alden Mfg. Co.

"KUPROX," NEW COMPOUND, ACTS AS RECTIFIER OF A.C.

ONE of the outstanding radio developments of the past few months has been the discovery and perfection of a new compound known as "kuprox," which possesses the ability to rectify alternating current. A number of discs of this material, clamped together in suitable mechanical form, comprise a rectifier unit which can be adapted to practically all styles of existing battery chargers now using rectifiers of the bulb, chemical or mechanical type.

These discs of kuprox, which are reddish in appearance, are of about the size of a twenty-five cent piece. Varying numbers of discs are built up, to suit the needs of battery charges of different current output. In operation, this new rectifier element is absolutely noiseless, and being perfectly dry, involves no trouble in either care or upkeep. The efficiency is very high.

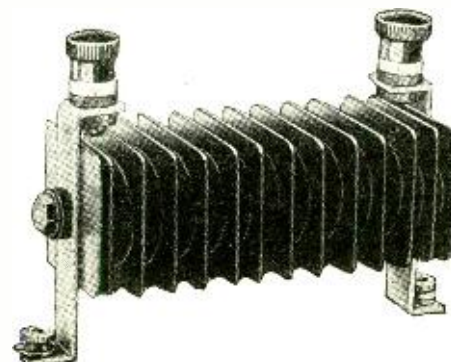

A typical assembly of "kuprox" discs, designed for use in battery chargers and "A"-socket-power units.



Appearance of a rectifier unit made up of "kuprox" discs, for use with trickle chargers. It employs two piles of six discs each, and will pass a current of one ampere. The device is only 3 1/4 inches long, 2 1/2 high and 2 1/2 deep, and is made entirely of durable metal.

Illustrations courtesy Kodak Radio Corp.

Kuprox does not deteriorate with age or use, and therefore will last almost indefinitely, according to the claims of the manufacturers. The metal discs are bolted solidly together and cannot break or develop other mechanical trouble unless deliberately tampered with.

In an accompanying illustration is shown a typical rectifier, made up of these kuprox discs, for use as a replacement unit in chargers. The device is easily installed; two wires lead to the terminals of the step-down transformer regularly used in the charger, while two other terminals connect to the battery to be charged.

NEW RECTIFIER TUBES HAVE HEAVY CURRENT OUTPUTS

TWO new heavy-duty gas-filled rectifier tubes, intended for use in various forms of "A," "B" and "C" socket-power units, have recently been perfected by one of the pioneer radio firms in this country.

The larger of the two is rated to deliver an output of 300 milliamperes, at 500 volts, in a full-wave rectification circuit. This means it is capable of supplying one-quarter of an ampere, or 250 milliamperes, to the filaments of 201A-type tubes wired in series; the remaining 50 milliamperes being sufficient for the plate and grid supply of the same receiver. One of the striking features claimed for this rectifier is its long useful life, rated by the manufacturers at 2,500 hours. This, according to the general theory that the average set is run approximately 1,000 hours a year, is equivalent to about two and a half years of actual service.

The tube is of sturdy construction, being about seven inches high over all and three inches in diameter at the bulge in the glass. It is equipped with a four-prong base which will fit in any standard socket. As with other full-wave rectifiers, only three of these prongs are used.

The smaller tube, also a full-wave rectifier, will deliver 90 milliamperes at 470 volts, an output sufficient to meet the "B" and "C" requirements of practically any ordinary receiver. Its life is also stated as 2,500 hours at the rated output, and will be considerably lengthened if it is subjected to smaller loads.

This 90-milliamper tube is not limited to "B" and "C" service, but will also supply enough "A" power for the filament operation of a receiver employing 199-type tube connected in series.

It can be seen from the foregoing that, with the aid of these tubes in a circuit of the proper design, a broadcast receiver can be constructed to operate directly from any A.C. lamp socket.

In the accompanying illustration, the 300-milliamper rectifier is the large tube in the

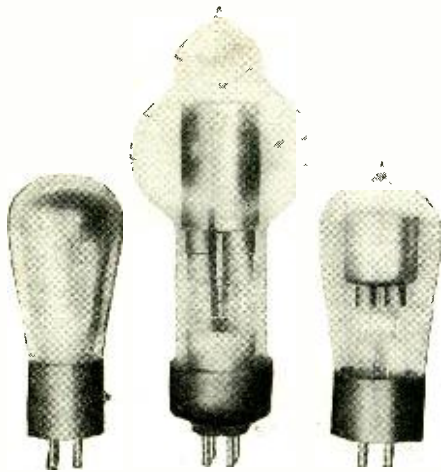

The 300-milliamperere tube is in the center, and the 90-milliamperere one at the right; while a 210 tube at the left shows the comparative sizes of these rectifiers.

Illustrations courtesy Manhattan Electrical Supply Co.

center, while the 90-milliamperere one is at the right. By way of comparison, a 210-type tube is shown at the left.

The cross-sectional drawing shows the details of the internal construction.

The principle employed in the operation of this type of rectifier is by no means simple, being concerned with the respective mass of electrons and positive ions, as well as the relative sizes of the two electrodes. In this tube, the electrodes are included in a bulb filled with an inert gas at a fixed pressure. When a potential difference is applied to the electrodes, the gas is ionized and the electrons, due to their smaller mass, will travel much more rapidly in the one direction than the positive ions travel in the other. Therefore, due to the more sluggish action of the positive particles, there will be a preponderance of positive ions in the space between the electrodes. On the application between the electrodes of a voltage which is alternating in character, current will flow each half of the cycle in opposite directions, and the plate and point will alternately become anode and cathode. On account, however, of the much greater area of the plate, the greater current will flow when it is the positive terminal of the external circuit; hence a rectifying effect will be obtained. Absolutely perfect rectification is not possible, but by careful design practically perfect results may be obtained.

The rectification ratio, as the ratio of the mean current in one direction to that in the other may be termed, is thus approximately the ratio of the respective electrode areas at any given pressure.

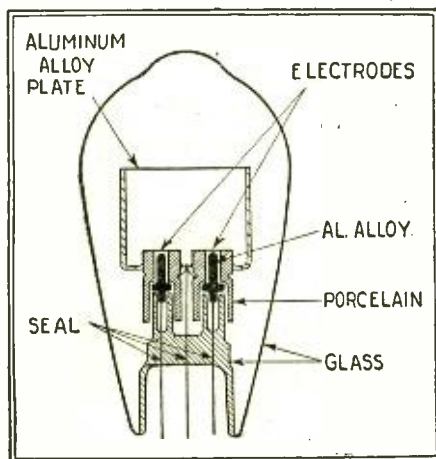

Cross-sectional view of the rectifier tube, showing the arrangement of the elements.

In the foregoing explanation, the term "electrodes" is used to indicate the large cylindrical plate and one of the small elements set in the protective porcelain tubes. Each of these small elements, working in conjunction with the plate, produces an individual rectifying action, independently of the other, so that the tube is in reality double, and can pass both halves of the alternating-current cycle.

NEW RESISTORS WILL CARRY HEAVY LOADS

A SERIES of fixed resistors, ranging in resistance value from 50 to 10,000,000 ohms, in two sizes, and capable of handling loads of 6 and 12 watts, respectively, has made its appearance on the market. The design and construction of these devices is of the most advanced type, and is responsible for a product of high quality. The resistors are fitted with lugs, and may be soldered without suffering disintegration because of the heat of the iron.

In the making of these resistors, a conductive, metallic deposit of a special material is fused, at a high temperature, into the outer surface of a vitreous tube. The ends of the latter are silver-plated, so that a perfect joint between the deposit and the end caps may be established. The unit is then "spiralled," or cut as if it were a bar being threaded on a lathe. The actual resistance

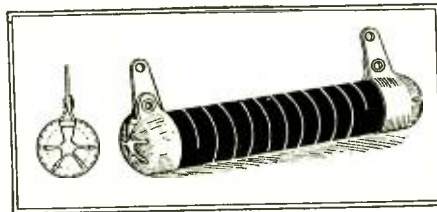

The end caps of this resistor make firm contact with the highly resistant coating on the vitreous tube. They may be soldered with safety.

Illustration courtesy Electro-Motive Eng. Corp.

value depends on the pitch of this cut; the greater the number of spirals per inch, the higher the resistance, and vice versa. Tinned terminal caps are eyeletted upon the silver-plated ends; and the unit is then treated with a special paint which renders it moisture-proof.

The small resistors, used as grid leaks, etc., are of the usual size, about 1 3/4 inches long and 3/4-inch in diameter, and will safely dissipate 6 watts, which is a considerable amount of power when applied to small fixed resistors of this type. A larger size, 3 1/2 inches long and 3/4-inch in diameter, is rated at 12 watts, but will handle 25 if the air circulation is favorable, according to the manufacturers, and will operate without deterioration even at a dull-red heat.

DEVICE COUPLES PHONOGRAPH TO RADIO RECEIVER

A SIMPLE and inexpensive phono-graph attachment, by means of which any radio set can be used to reproduce the music of

The electrical pick-up device, PU, is placed near the turntable of the phonograph, and replaces the regular tone arm. The plug P fits in the detector-tube socket of the radio receiver.

Illustrations courtesy Magnaphon-Electric Mfg. Co.

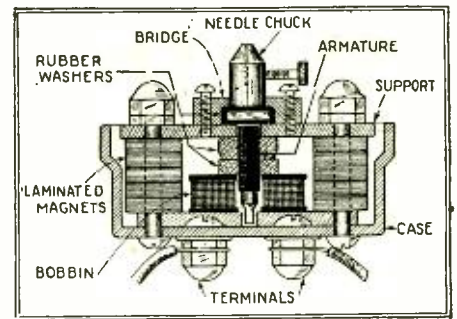

Cross-section view of the electrical "tone arm" or pick-up. The needle chuck and the armature are one piece of soft iron, which is free to wobble because the rubber washers hold it in place with moderate tension.

phonograph records, has been placed on the market by a New York manufacturer. The instrument takes the form of a pick-up device which replaces the regular tone arm on the phonograph. It is simply placed next to the turn-table of the talking machine and handled in the same manner as the regular arm.

A 20-foot length of flexible cable connects the instrument to a four-prong plug made exactly like the base of a standard vacuum tube. This plug is inserted in the detector-socket of the radio set. The pick-up unit converts the sound waves from a phonograph record into electrical impulses, which are amplified by the audio amplifier of the radio set and reproduced by the loud speaker.

The reproduction afforded by this system is of high quality, being very much superior to that of an old-style phonograph equipped with a horn. The volume can be controlled at will by a filament rheostat or other suitable means on the audio amplifier.

The accompanying cross-sectional picture shows the internal construction of the electrical pick-up unit, which converts the sound waves of the phonograph record into electrical waves. A small chuck, which holds a regular phonograph needle, is part of a single small iron bar which extends through the center of a bobbin of wire and terminates

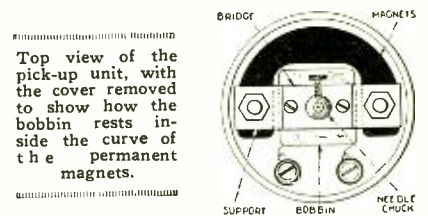

Top view of the pick-up unit, with the cover removed to show how the bobbin rests inside the curve of the permanent magnets.

between the two pole pieces of a strong permanent magnet. This bar is clamped at the top of the case by small rubber washers, which are loose enough to allow it to wobble slightly. Therefore, when the pick-up unit is placed on a record, the needle, in following the grooves in the latter, will cause the arm to vibrate in exact accordance with the sound impressions registered on the record. The movement of the small iron bar, or

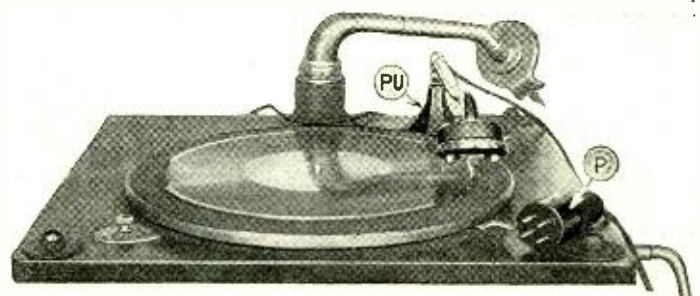

"armature," disturbs the magnetic field of the permanent magnet and causes a fluctuating current to be set up in the bobbin. This is the common phenomenon of induction. The varying current in the bobbin carries the characteristics of the voice or music impressed on the phonograph record, so that when it is fed to the audio amplifier, this portion of the radio set will amplify it and reproduce it just as if it were a detected radio signal.

NEW RECTIFIER TUBE

A WELL-KNOWN tube manufacturer has recently developed a rectifier, for use in "B"-socket-power units, which is of the gas-filled type and gives full-wave rectification when used in the proper circuits.

The output capacity of the tube is rated at 85 milliamperes at 300 volts. The tube can, therefore, be used to supply the plate current for practically any standard radio set.

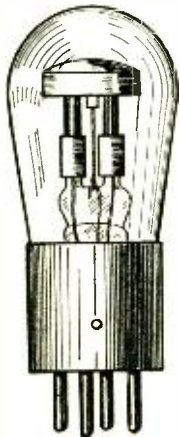

This full-wave rectifier is of about the same size as a tube of the 201A type, and is equipped with a standard four-prong base. It will supply "B" voltages for almost any receiver, of the usual types.

Illustration courtesy C. E. Mfg. Co.

This rectifier is equipped with a standard four-prong base which will fit into standard vacuum-tube receptacles.

SIX-TUBE SET OPERATES ON ALTERNATING CURRENT

A SIX-TUBE receiver, operating direct from the 110-volt, 60-cycle house lighting lines, is the latest product of an Ohio radio firm. It employs no battery, or combination of battery and charger; the A.C. being applied in unrectified form to the filaments of the special tubes used and, in rectified and filtered form, to their plates. To place it in operation, one need only connect the aerial and ground wires, screw an attachment plug into the nearest lamp socket, plug in the loud speaker and snap on the switch.

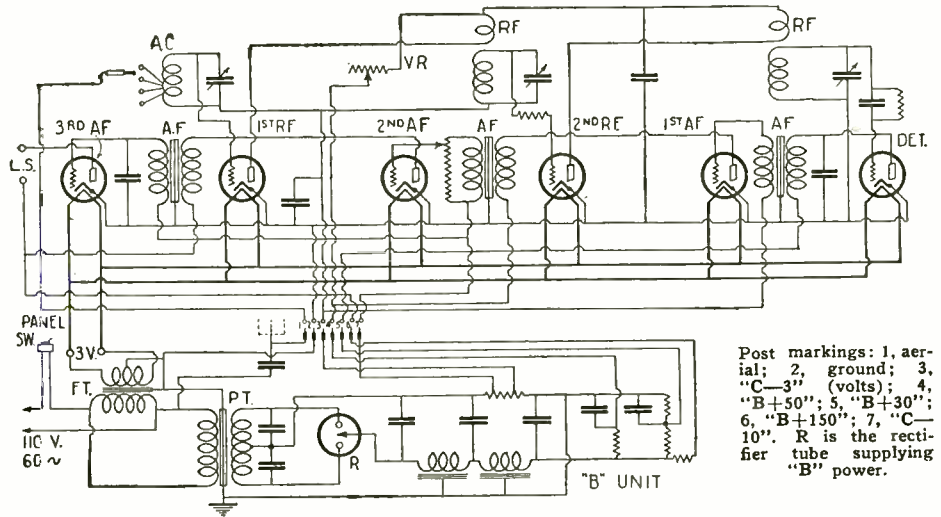

Post markings: 1, aerial; 2, ground; 3, "C-3" (volts); 4, "B+50"; 5, "B+30"; 6, "B+150"; 7, "C-10". R is the rectifier tube supplying "B" power.

The set is of the single-control type, the one principal tuning knob operating three separate variable condensers, connected by a pulley-and-string arrangement. The circuit comprises two stages of tuned radio-frequency amplification, a non-regenerative detector, and three stages of straight transformer-coupled audio amplification. The antenna coil, AC, is an auto-transformer, the primary section being adjustable by means of a simple plug-and-jack scheme. Four taps are provided.

A high-value variable resistor, VR, connected in series with the primaries of the R.F. transformers, acts as a volume and oscillation control. Additional control of the volume is made possible by another resistor, connected across the secondary of the second A.F. transformer.

The six tubes are arranged in a straight line along the rear edge of the receiver's sub-panel, but their circuit positions do not follow in the usual R.F.-detector-A.F. order. Instead, the first tube on the left is the last audio, the second the first R.F.; and the others are as indicated in the schematic diagram shown herewith.

Combined with the variable resistor VR is a small snap-switch, which is automatically turned on when the resistor knob is disturbed from its "off" position. This switch, it will be noted, is connected in one side of the 110-volt power circuit, and controls the current to the filament-heating transformer, FT, and the "B" supply transformer, PT.

TWOFOLD FILAMENT STRUCTURE

The tubes used in this receiver are of a special type, known as the McCullough. The electron-emitting element of these bulbs, which corresponds in function to the filament of a tube of the 201A and similar types, is a thimble-like member surrounded by a regu-

lar grid and plate. It is heated by an independent filament inside of it and, under the influence of the heat generated by the latter, its chemical coating throws off the electrons essential to vacuum-tube operation. As this active cathode has no direct connection with the filament which heats it the raw A.C. supplied to the latter produces no disturbance in the R.F. and A.F. circuits. In actual operation the receiver is entirely free of hum.

Plate and grid voltages are furnished by a "B"-supply unit of standard design, using a



Panel view of the socket-power operated receiver.

Illustrations courtesy Simplex Radio Co.

full-wave rectifier, R. The instruments comprising this unit, along with the special 3-volt step-down transformer for the heater-filaments of the tubes, are enclosed in a single case, which occupies the compartment at the left of the receiver unit itself. A single length of flexible lamp cord connects the set to the lamp socket, from which it derives its entire operating power.

The front instrument panel of the receiver is made of brass, and is neatly engraved. It holds the main tuning knob (the pointer of which travels over an 180-degree scale), and the knobs for the two variable resistors. It is 17x8½ inches and fits in the center of the cabinet, which is 33 inches long, 14 inches deep and 10½ inches high.

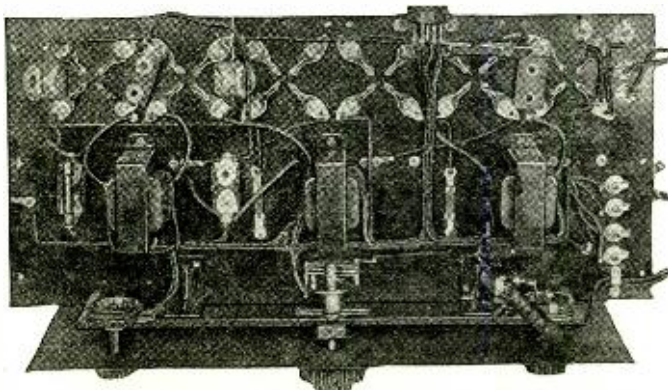

Bottom view of the alternating-current receiver chassis, showing the A.F. transformers, sockets, variable resistors (at the bottom, left and right) and a "vernier" condenser for tuning (center).

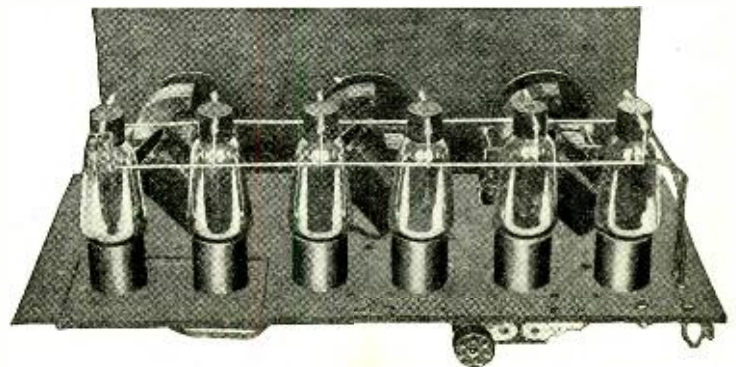

Rear view of the chassis. The wiring which appears at the tops of the tubes carries the 3-volt A.C. to the heater-filaments. These connections are independent of the rest of the set.



Radio News of the Month



ENCOURAGE DAYLIGHT RADIO

IN the current list of broadcast stations, it will be noticed that several are licensed for only the daylight hours, and that others are authorized to use higher power before 7:00 p. m. The Radio Commission has announced that it is desirous of encouraging higher-power work in the daylight hours, though curtailing power during the night hours, when the interference range is much greater.

HIGH POWER IN HUNGARY

BUDAPEST, Hungary, is to have a new high-power station, 25-kw., which will be erected about nine miles outside the city. It will operate on the same wavelength as the small transmitter now used—555.6 meters.

"HAMS" BRIDGE THE GAP

QUENSLAND, Australia's northeasternmost state, suffered recent cyclones and floods, practically cutting off telegraph service. In this emergency, the authorities fell back on the assistance of amateur radio. Leighton Gibson, 4AN, of Brisbane, opened communication with Andrew Couper, 4BW, of Mareeba, who had the only "ham shack" in the northern end of the state. The latter's aerial had been blown down by the storm; but with an emergency antenna he reopened communications; and the two "hams" worked night and day in the public service until the land lines had been repaired. The *Queensland Radio News*, of Brisbane, recording these events, urges "that all principal postoffices should be equipped with a small power transmitter. Bush fires, cyclones and floods would then give no cause for isolation."

RADIO AIR DISPATCHING

BELGIUM, which is encouraging aviators to make its air lanes their pathway, lighting them at night with projectors, is also inaugurating a radio dispatching service, which will be completed within eighteen months on the Brussels-London route. Radio installations are being erected at Ghent, Strombeek and Evere. By this means constant communication will be maintained with all planes suitably radio-equipped; schedules will be expedited, the risk of collisions minimized, and help sent at once in case of accident.—*L. Reid.*

ESPERANTO ANNOUNCEMENTS

ON the suggestion of the Swiss station, Radio-Geneve, the Union Internationale de Radiophonie, meeting recently in Lausanne, Switzerland, unanimously voted to ask all its members to arrange regular weekly numbers in Esperanto, and to announce their station calls once daily in that tongue.

PARIS PHONES NEW YORK

NOT only is Charles A. Lindbergh the first flyer from the American continent to the European, but the first radiophone speaker over the route. From Paris he talked with his mother in Detroit, the connection being made by sound—not electrical—connection of telephones in London and over the transatlantic radiophone. A similar conversation was later arranged for Clarence Chamberlin from Berlin to New York.

FRENCH INTERCONTINENTAL LINK

PARIS is the latest European capital to be connected directly with all its colonies, by the completion of a station at Brazzaville, in equatorial Africa. Other stations are at Bamako and Djibouti in Africa, Tananarivo in Madagascar and Saigon in Indo-China.

RADIO ADDRESS SYSTEM

THE speech-amplifiers generally used to make addresses audible to a large gathering are usually wired systems; but a new method was tried out at the commencement of the Georgia School of Technology, Atlanta. The speeches of the day were actually broadcast by radio, through WGST, and reproduced by the loud speakers of powerful receiving sets distributed among the audience.—*Archie Richardson.*

RADIO MEMORIES

RADIO has the power to make the past, as well as the present, live. In a Memorial Day program of KOA, Denver, were included addresses by Theodore Roosevelt and Woodrow Wilson, which had been stored up on phonograph records, and were thus given again to the air.

"BLOOPERS" MAY LIVE

THE regard of the British for the sanctity of life has often seemed a trifle exaggerated, perhaps, to many Americans. In a court at Bradford, England, some days ago, an aggrieved broadcast listener who had threatened to knife his next-door neighbor for maintaining an oscillating set was bound over to keep the peace for six months.

IT PAYS TO ADVERTISE

THE service which the radio amateur can perform is seldom fully appreciated by the average broadcast listener. Radio Commissioner Caldwell has lately addressed a letter to the "ham" organization, the A. R. R. L., suggesting that local groups use the newspapers to announce their willingness to aid in finding and eliminating sources of interference. "Hams" have done much work of this kind.

GREETING OUR HERO

THE largest chain broadcast, a hook-up of fifty stations, was among the unprecedented honors received by Colonel Lindbergh on his arrival at Washington. Among other novelties, the progress of the triumphal procession at New York was reported by radio from an airplane; though this was discontinued, not because of difficulty in transmission, but because of the number of stations working on the simultaneous program from the ground.

A CHAMELEON TRANSFORMER

A NEW transformer exhibited at the radio exposition in Brussels is screened in perforated metal, which, it is claimed, prevents its magnetic field from affecting a radio set. In addition to this, it carries a patented safety device which indicates by a distinct change of color whenever high voltage is causing its windings to become too hot. The operator and the set are thus protected.—*L. Reid.*

THROW AWAY YOUR OLD RADIO LOG

THE reallocation of the broadcast stations of the United States, just completed by the Radio Commission, leaves few of them on their old frequencies, and the official announcement is that the arrangement is only tentative. There are too many stations in the waveband, in the present state of the radio art. The power of most of the larger stations has been notably reduced; the average for the whole seven hundred stations is now about 645 watts; but twenty-seven stations have half the power and the three largest have about as much as the three hundred smallest, combined. The majority range between 500 and 100 watts. There are now but two high-power stations on each of four frequencies; but as high as seventeen on one of the longer wavelengths, 223.7 meters. NAA, the government station, is alone on a wave otherwise reserved for Canadian use. To make even this arrangement tolerable, over two hundred sta-

(Continued on page 184)

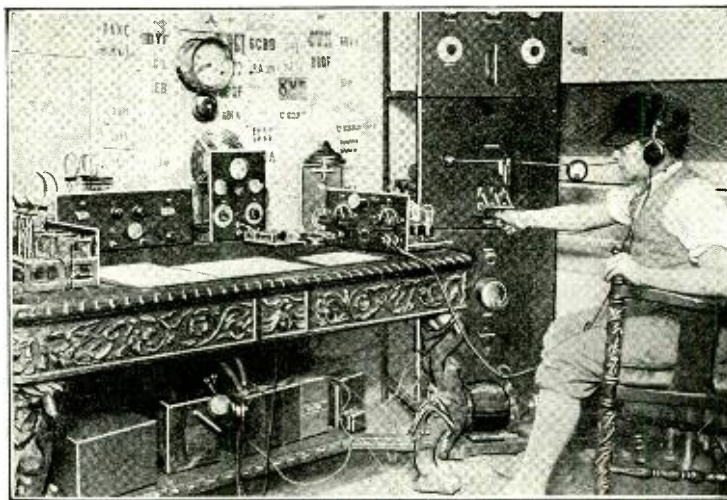

Many "Hams" would be in danger of committing an infraction of the Tenth Commandment if they should see the elaborate outfit of which Robert J. Marx, 2AZK, of New York, is the possessor. He is said to be the youngest licensed operator in the United States (he is but 12); and is here seen operating his 1-kw. transmitter on 40 meters.



The Case for The Headphones as Aids to Reception



Why These Old Friends Should Be Given Another Chance to Show Their Usefulness

TO the suggestion that headphones be brought down from the radio attic, dusted off, and put back into use, the natural reaction of the present-day broadcast listener would be, in nine cases out of ten, about the same sort of amused incredulity as that precipitated by

By CHARLES M. ADAMS

with the phones; and for easily understood reasons.

Theoretically, a speaker is designed for both maximum sensitivity and maximum volume; but in practice such an ideal is an obvious impossibility. The designer of the average speaker must necessarily incline toward good volume characteristics rather than sensitivity. Besides, the incoming distant signal is often so feeble that, even after being built up in the amplification system, it emerges from the last stage still so weak that it has little effect on the speaker.

Phones, on the other hand, are designed for maximum sensitivity. On them signals which get little if any response from the speaker register clearly. The volume is small, of course. But all the sound is focused where it is most wanted, in the listener's ear, rather than scattered thinly over an entire room. Last, but not least, the wearing of phones automatically excludes many local noises which sometimes interfere with distance reception.

The importance of this one fact is generally overlooked. As an illustration, a few nights ago I had tuned in a distant station, and was getting tolerable speaker volume.

But just as the announcer began speaking, the clock struck the hour, causing me to lose the call letters; irretrievably, as it happened, since an interfering station came on the air a moment later.

From all this it should not be difficult to see why fans who achieve the best distance records use phones.

USE ON DETECTOR

Next, there is the matter of bad atmospheric conditions. Every listener has encountered nights when, though stations roll in with excellent volume, "static" is so severe that satisfactory reception, even over moderate distances, is practically out of the question. The usual recourse is to turn down the rheostats, which reduces not only the static, but also the signal, generally to a degree which prevents enjoyable speaker volume. But if phones are plugged in on the detector or first audio stages, it will be found that the signal strength is materially increased as compared with static, and that the programs can be received with real pleasure.

The explanation is that, in most receivers, the audio-frequency end amplifies static and other extraneous noises more, in proportion to the signal, than does the radio-frequency

(Continued on page 172)

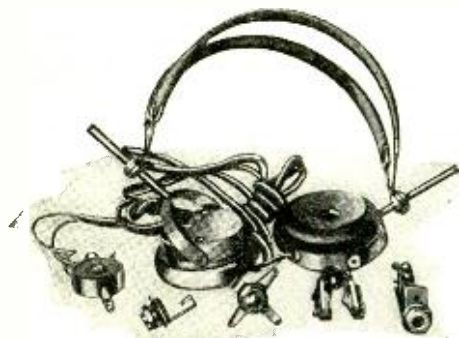

Above is shown a typical pair of headphones, with a headband of the split type. In the foreground are four different phone jacks, which may be used as shown in Figs. 1, 2 and 3.

the suggested return of the bustle or the high-wheeled bicycle.

He has heard, of course, from certain old timers, who operated quaint little one- and two-tube sets as far back as five years ago, that phones were once indispensable for enticing programs out of the ether. But his modern receiver, with its five or more tubes, one probably of a power type, is designed expressly for loud-speaker operation. It may not even be provided with a jack for phones; and, if it is, it has not occurred to him that a pair of "earphones," (his corruption of the correct term) is a necessary part of his accessories.

Even the old-timer admits too that the development this demonstrates is eminently sound, and in the right direction. The advent of the loud speaker, making possible reception by a much wider circle of listeners, with increased comfort, has in itself been responsible for much of the growing popularity of radio. But the old-timer has considerably the better of the argument when he points out that, granting all this, there is still a real place for headphone reception in present-day radio; advantages to be gained, not only for himself, clinging to the headset with sentimental tenacity, but also for the newcomer.

GOING OUT AFTER 'EM

It holds out certain definite advantages, he says, though they have been generally overlooked. For example, there is the matter of DX.

Everyone, of course, knows by this time that just as good programs can be heard from stations 50 or 500 miles away as from those 2,000 or 3,000 miles away. But now and again every fan has the urge to see what his set will do in the way of bringing them in from the great open spaces; and it is then that those discarded relics of radio antiquity, headphones, come again fully into their own.

Not that good DX cannot be had on the loud speaker; it can, to be sure. But just as surely, the extreme distance range of which a set is capable can be secured only

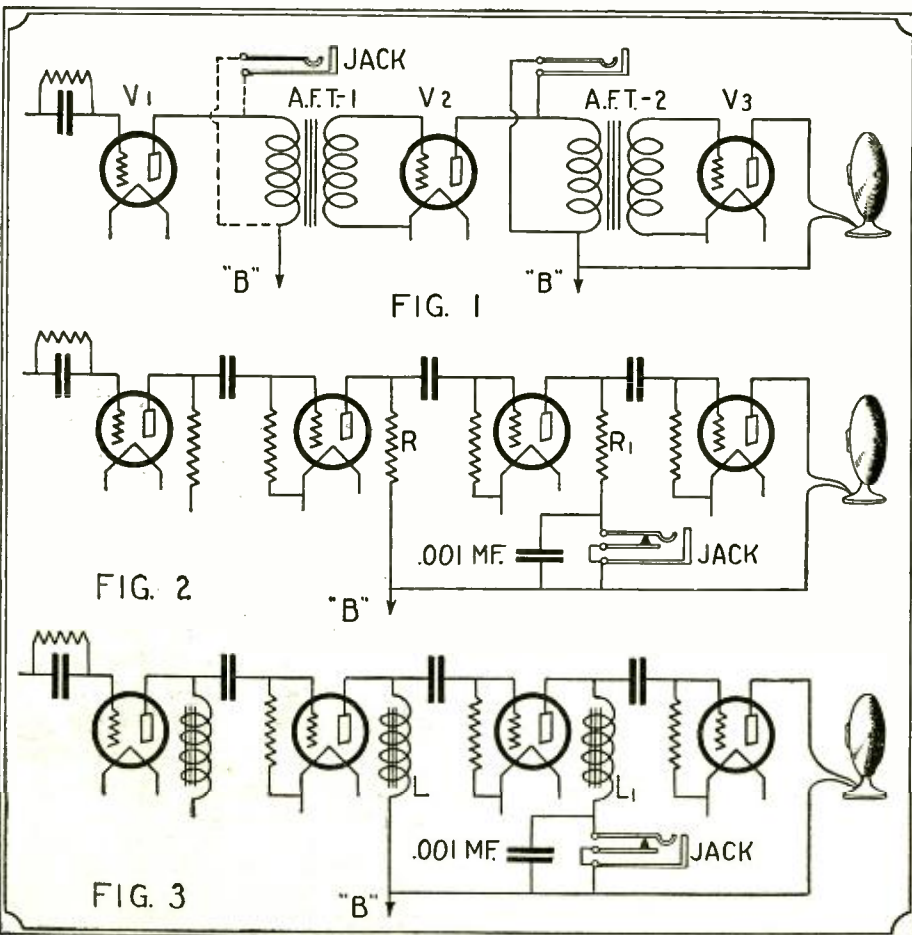

Fig. 1. How a jack may be connected to either the detector or the first A.F. stage of a transformer-coupled amplifier. The dotted lines indicate the detector position. In either case, no wires in the set are disturbed. Figs. 2 and 3. In resistance- and impedance-coupled amplifiers respectively, closed-circuit jacks are connected as shown. The use of a by-pass condenser is advisable.



Radio Revenge

By ARMSTRONG PERRY



3CGX stared angrily at his wrecked aerial. The halyard had been cut—there was no doubt of that!

He stamped into his cabin, threw off his haversack, sat on the edge of his bunk and thought: "Here I come all the way up into the mountains, hunt up a good location, build a cabin, set up a station, get good DX within a week, and now I am stopped by some vandal, who probably don't know an aerial from a clothes line."

He shook his fist at Shingleton, the lumber camp down the valley from which he had just come. "I'll get even!" he muttered. "I'll have my revenge!"

The uncouth gang that was loafing on the front steps of the general store would have been delighted to hear the threat. It would have added to the satisfaction the lawless tribe felt at having made trouble for a stuck-up guy. It knew nothing about him except that he invaded their wilderness, went ahead with his own business without asking their advice and looked important, but wasn't that enough? He had a radio—why didn't he invite them up to hear the concerts? They'd show him that a stuck-up city guy couldn't ignore them and get away with it.

The weather was in sympathy with 3CGX's mood. The thunder muttered in the distance when he went to his bunk; and he was awakened before midnight by a terrific storm. In the morning Elk Run was on a rampage. The south branch was tearing away the banks of its gully and majestic trees that had stood for a century on its sloping sides were going down, undermined by the rushing water. The north branch was washing out the roots of the great pine that had held his aerial. What if the two branches, which joined a hundred feet below the cabin, should eat away the triangle of land on which it stood?

3CGX forgot this unpleasant possibility when he looked down the narrow valley and saw what was happening to Shingleton. The big lumber mill was an island; if the water rose much higher it soon might be a floating island. The workmen's houses, which were high above the water the day before, were close to it now. They seemed to have been located with a view to making it easy for their occupants to throw tin cans, ashes and all manner of refuse into the stream; and the Run threatened to take its revenge by carrying down the houses along with the rest of the dump.

Already the houses were cut off from the mill and store. The bridge still spanned the channel, but both approaches were under water. A man came out of a cottage and tried to reach the bridge. The water soon came to the top of his hip boots. He felt ahead with one toe, slipped and went under. Another man rushed out, grabbed a pole, thrust one end toward him and pulled him out. It was a narrow escape.

3CGX looked again at the two branches of the Run that hemmed in his little domain. Maybe it would be better to get out while the getting was good. His trail over the ridge was cut by several tributaries of Elk Run; they might rise high enough to cut off his escape. Above the top of the mountain to the westward the skies let loose their heaviest artillery. A rush of wind filled the cabin with the damp fragrance of the forest. He decided to wait for one more shower to pass.

The roar of the Run grew louder. He looked down the valley again. It seemed as though a giant hand were passing across the scene, obliterating landmarks as a child

might erase a picture from a slate. There was water on both sides of the row of houses now. A dry channel cut by some flood of long ago was filling. A perpendicular ledge of rocks prevented escape to higher ground, except by crossing one stream or the other; and it looked as though the population of Shingleton would have to remain on its island until the waters receded.

Suddenly the mill began to tremble, sagged and cast ten thousand floating fragments upon the flood. A few minutes later the bridge slipped from sight beneath the muddy current, its foundations cut away. Then a pile of logs, lifted by the rising water, charged upon the store. It shivered, toppled and went down with all the food supplies that Shingleton was likely to have for days or weeks to come.

3CGX rubbed his eyes. It must be a dream, a nightmare. No, real men, women and children were rushing from the houses. They gesticulated wildly and ran about in the rain. The skin tightened on his scalp and he felt a sinking within him as he sensed the fact that some unfortunates must have been engulfed in the disaster.

His cabin shuddered. He ran to the window, filled again with alarm at his own danger. The great pine was swaying. Down by its roots a wide crevice had appeared.

For a moment he stood gripping the window sill. Everything that had seemed permanent, immovable in his surroundings was slipping away. Life itself suddenly seemed strangely uncertain. The lightning blinded him, the thunder deafened him, the water menaced him. Hurriedly he prepared for flight.

He turned first to his radio set; it was the work of his own hands and therefore was his most precious possession. He started to remove the tubes, but there flashed into his consciousness, as clearly as a picture on a motion-picture screen, the fact that here was the only means of communication that had survived the attack of the elements.

"That is none of my business—safety first!" he tried to tell himself. "These folks down the valley care nothing for me. They

do not know that I have sent messages thousands of miles from their mountains. They even cut down my aerial, just for meanness."

He cast another glance down the valley. All the people from the houses were out in the rain now. Some of the men were piling things at the up-stream end of the island to turn the water aside. The Run was still rising.

The cabin trembled again. He thought of the radio operators who had gone down at sea, sticking to their keys to the last. Should he run away just because nobody knew? How did he know he could call help anyhow? How did he know anyone would hear, even if he did risk his life to put his set into operation again? How could anyone help if they did hear?

But the great tradition of radio gripped him. He could not tear himself away. It was the radio man's job to stick as long as there was any chance. Young fellows of his age had climbed icy masts, drenched with freezing salt spray, to repair aeriels. Amateurs as well as professional operators had maintained the honor of their craft, even at the cost of their lives.

Suddenly his hesitation vanished and the decision came. Better to lose his life, if need be, than to live knowing that he had been a coward, disgraced his kind. He went out into the storm. Coiling the end of the severed halyard and taking advantage of the wind, he heaved the line over a limb of the tottering pine. He adjusted the insulators and the wire and ran up the aerial.

Another tremor shook the cabin as he reentered. He threw a switch, pressed his key, watched the nervous finger of the meter as it indicated the input amperage.

"SOS SOS SOS de 3CGX 3CGX 3CGX." Would anybody hear? He dare not stop to listen—there was no time to explain. He must trust to some brother "ham" out there beyond the mountains to hear and understand and act.

"SOS SOS SOS—"

With a deafening crash the pine fell across the cabin.

(Continued on page 173)



"SOS SOS SOS—" With a deafening crash the pine fell across the cabin." * * * *

Some Aspects of High-Quality Reproduction

Part II--A Discussion of the Elements Affecting It on the A.F. End

By PAUL TRAUGOTT

IN Part I of this article, which appeared in the July issue of RADIO NEWS, Mr. Traugott defined high-quality reproduction as that most faithful to the original sounds at the transmitter; and discussed the factors in the R.F. end and detector of the receiver which favorably or unfavorably affect attempts to obtain this result. In the second part, which follows, he analyzes the A.F. and loud-speaker elements of the receiver from this standpoint. The experimenter will almost surely find helpful suggestions here.—EDITOR.

IT is doubtless obvious, from this discussion and those by other writers, that, in conventional R.F. and detector circuits, the higher audio frequencies tend to be depreciated. The lower audio frequencies get through in good shape. In the audio amplifying channel the opposite of this is likely to be the case.

Consider the transformer-coupled amplifier shown in Fig. 4. It works out of the detector tube in the usual manner. In order to transmit a very low tone through to the first audio-amplifying tube, the transformer primary must have an extremely high inductance. Talk about matching impedances at this point is, from the standpoint of high-quality reproduction, mostly hokum. The higher the primary inductance of this transformer, the better—for high-quality reproduction. Similarly, the lower the output impedance of the detector tube, the better.

For effective amplification through this first transformer, the primary impedance must be at least twice the output impedance of the tube at the lowest frequency wanted. Considering fifty cycles as the required low limit, and considering the output impedance of the detector tube to be about 25,000 ohms (as it may easily be), the inductance of this first transformer primary must be equal to approximately 160 henrys. This is rather high, and usually requires special core material, if the effectiveness of the transformer is not to be otherwise reduced. Fortunately, considerably lower primary inductances still give good low-note transmission.

BY-PASS CAPACITIES

Across the primary of this first transformer is usually a by-pass condenser, serving to shunt the R.F. current in the detector-plate circuit to ground and out of the audio system. If the capacity of this condenser be too large, it will also by-pass some of the higher audio frequencies, and may introduce

undesirable resonance effects. But there exist in transformer-coupled amplifiers, where the plate load is inductive, certain phase relations which permit this by-pass capacity to be of rather large value without materially reducing the high audio frequencies reaching the grid of the next tube. A capacity of .001-mf. as a detector-plate-circuit by-pass has an entirely negligible effect upon audio frequencies as high as five thousand cycles. Even much larger values can be used without serious frequency distortion resulting. However, in a resistance-capacity coupled amplifier the story is somewhat different. In this case even a comparatively small by-pass condenser results in a loss of high audio frequencies.

HIGHER-FREQUENCY SUPPRESSION

The requirement for low-note transmission through a transformer is then, high primary inductance (principally). In order that the same transformer shall transmit high frequencies equally well, a number of other conditions must exist. Perhaps the most important single factor is the *effective capacity* existing across the secondary windings. Very small values of capacity across the secondary seriously reduce the voltage of the higher frequencies. Condensers shunted across audio transformer secondaries are almost always fatal to high-quality reproduction; though they often cause the production of unnatural musical effects which are quite pleasing to many listeners. Even a resistance shunted across a transformer secondary reduces the high-frequency component on the grid of the tube. Advantage is often taken of this fact, in efforts to reduce the extraneous noises in radio sets. Most of this noise being in the upper register, a resistance across the transformer secondaries will reduce it considerably. The naturalness of reproduction is simultaneously reduced if the shunted resistance is too low.

With modern design, audio transformers can be built to handle equally frequencies from 100 to 6,000 cycles. This range can be extended when special core materials and other special constructions are used.

IMPEDANCE COUPLING

In an impedance-capacity coupled amplifier, the same desideratum of high inductance holds, if good low-note amplification is wanted. Impedance couplings are sometimes used between high- μ tubes. Such tubes have high output impedances and so require coupling impedances having very high inductances. One standard high- μ tube has, under operating conditions, an output impedance close to fifty thousand ohms; to

amplify a fifty-cycle note out of this tube requires a coupling impedance having about 300 henrys inductance—that is, if high-voltage amplification is wanted at the fifty-cycle point. Coupling devices can be built so that they have resonance points at very low frequencies, in which case they permit very low note amplification.

In impedance-coupled amplifiers and circuits of similar types, it is essential to have sufficient capacity in the stopping condensers in the grid circuit of each tube. The resistance of the grid leak also must be sufficiently great. These points have been well covered by other writers, and much light has been shed on the subject.

It should be noted that, in these audio amplifiers, whatever frequency-distortion takes place is usually in the form of a reduction in the low frequencies. It would seem that this point in itself would help to compensate for the reverse condition holding in the radio-frequency system. To a certain degree it does; but the difficulty is that the low-frequency reduction is too sudden; it cuts off sharply. If it were a gradual reduction of all frequencies from about 3,000 cycles down, it would compensate very nicely. Fig. 5A shows what the actual frequency-against-amplification curve looks like; Fig. 5B shows how it should look in order to compensate properly.

CORRECTING FOR R.F. CHARACTERISTICS

However, it is feasible to compensate the audio system to correct for the distortion of the R.F. system preceding it. Fig. 6 shows a circuit for such a compensating arrangement. An extra tube is used. The inductance L1, for standard 201A-type tubes, may be about 1 henry; the series resistor should have a maximum value around 25,000 ohms and be variable. The value of the resistance determines the amount of the equalization. The remainder of the amplifying system must not have any marked peaks in its transmission range; and the loud speaker used must be capable of reproducing high tones. The understandability of speech in the output of a set using this arrangement is usually markedly improved; the female voice is more natural and, of course, music is more brilliant and true.

RESISTANCE-CAPACITY CONSIDERATIONS

To return to audio amplifying channels: the resistance-capacity-coupled amplifier is to be considered. This type of amplifier is probably likely to be freer of frequency distortion than any of the others. Depreciation of the higher frequencies (up to 7,000 cycles, anyway) seldom occurs; and if the capacities of the stopping condensers and the resistances of the grid leaks are properly chosen, very low notes will be amplified well. Blocking of the grids under high input voltages may give trouble, but in actual operating conditions it very seldom does. Whatever high-frequency depression does occur in a resistance-coupled amplifier is usually attributable to a by-pass condenser, of capacity too high, in the detector-plate circuit. Its effect in this type of amplifier is greater than in others, and its value should be reduced to a small figure. If a radio-frequency choke also is used between the detector and the first audio tube, the by-pass condenser can be made very small.

Common impedance in the power-supply circuits of any form of audio channel will

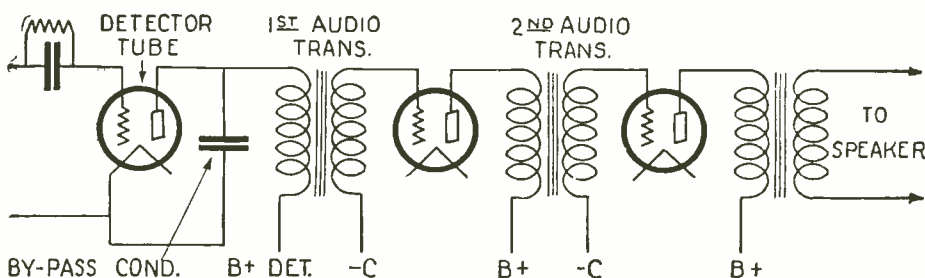
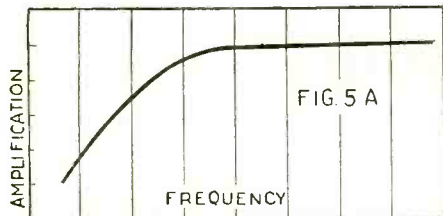

FIG. 4

An typical transformer-coupled audio-frequency amplifier, which, if certain details are observed, is capable of giving excellent reproduction.



An actual frequency-amplification curve, showing the drop in amplification at the lower frequencies.

cause various kinds of frequency distortions. New "B" batteries keep this trouble down; and in "B"-power-supply units ample by-pass capacity must be used. Special arrangements are sometimes necessary to reduce these effects, for in a high-quality amplifier they may become serious.

USE OF POWER TUBES

There exists in audio channels forms of distortion other than frequency distortion. Wave-form distortion will occur if the operating voltages on the grids of the tubes are not properly adjusted. This subject has been already well covered and explained. The last tube in the audio system is required to handle large voltage-swings, and it must have a high grid bias in order to prevent non-linear operation. The various standard power tubes are designed for high grid-bias operation, and meet the requirements very well.

Tube overloads usually produce wave-form distortion, with its resultant generation of harmonic currents. This condition may easily exist in a high-quality amplifier where low notes are being transmitted. For a given amount of energy, the amplitudes of a low-frequency current are considerably higher than the amplitudes in an equivalent high-frequency current; and on low notes even a large power tube may overload, if too much is required of it.

A contributing factor in low-frequency overloading is the low impedance of the output load at low frequencies, which tends to accentuate the curvature of the tube characteristic. At very low frequencies and moderate output volume, even comparatively large power tubes will generate some harmonic currents; but if they are small with respect to the normal currents no serious distortion results.

The push-pull amplifier arrangement helps to keep down distorting harmonics, but its use is not often warranted in ordinary home radio work. Where power supply limitations necessitate the use of low plate voltages, the push-pull amplifier can be used with excellent results—results not obtainable, with low plate voltages, without its use. The push-pull system has, for power work, the advantage that the output-transformer core is never saturated by direct current flowing to the plate of the tubes. Core saturation in the power end of an audio system can cause serious distortion, but is not

often present except in very large amplifiers.

The loud-speaker coupling devices now available prevent a great deal of D.C. saturation distortion in home radio receivers. In large power amplifiers, even the A.C. flux of the audio currents may cause core saturation and distortion.

THE SOUND REPRODUCER

The final link in the high-quality reproducing chain is the loud speaker. It is improving rapidly, and many good speakers are commercially available. Loud speakers are apt to be deficient in high frequencies as well as low; that is, their output, measured in sound pressures is materially less for both low notes and high notes than for notes in the middle of the register.

Horn-type speakers, to be good, must have the right kind of unit, or driving motor, and must as well, for low note reproduction, have very long properly-tapered horns, with a mouth of large area. Twenty feet is not too long for a high-quality horn. High-note transmission from a horn-type speaker is largely dependent upon the unit behind the horn; its diaphragm must have the proper mass, stiffness, and area; and the electromagnetic or electrodynamic machinery which actuates it must be right.

Many cone speakers are relatively efficient on low notes, but discriminate badly against high tones. One of the most successful

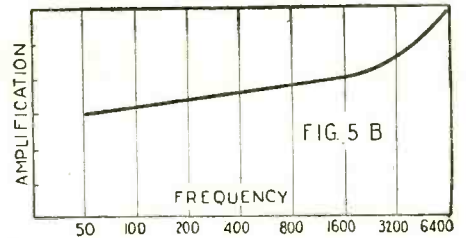

If the amplification curve would assume this shape, better reproduction would result.

Cone speakers, for the lower frequencies in any event, are roughly non-directional in their sound radiation. For small places and moderate volume-outputs, they will probably always be best. The horn-type speaker is distinctly directional and, because of this property, will project a given quantity of sound into a large place with rather more efficiency than the non-directional speakers. Horn-type speakers will probably always be used in theatres, halls, etc., where sound is desired only on one side of the loud speaker.

DON'T BLAME THE SOPRANOS

In summing up, it becomes apparent that the principal difficulty in high-quality work in radio reception is in getting good high-note transmission. For true high-quality

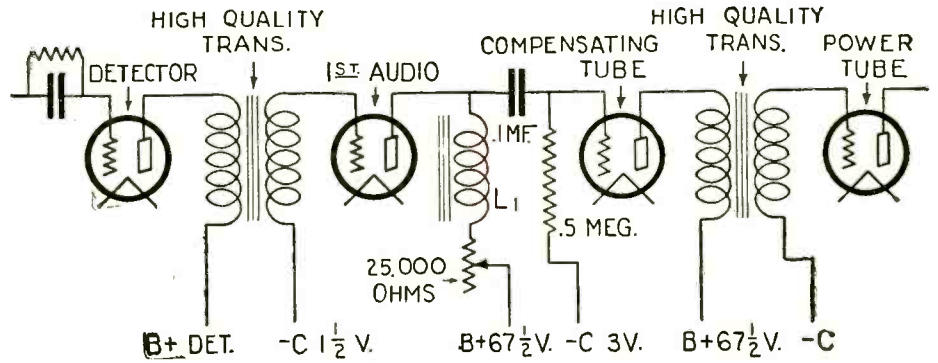

FIG. 6

An A.F. amplifier, which may be compensated for any distortion that occurs in the R.F. circuit.

cones functions somewhat in the fashion of an electromechanical band-pass filter; its action occurs as a series of resonances. But as these resonances cover a very wide range of frequencies, the over-all output from this cone is rather good. Another excellent cone speaker has an electrodynamic drive unit and a small stiff conical diaphragm which acts substantially as a plunger at all the more important sound frequencies. This type of cone speaker requires a baffle board to give good low note radiation; the larger the baffle the better. A baffle, in this case, is merely a vertical surface interposed between the front and back of the vibrating diaphragm or cone.

reproduction, equal transmission of the high notes is essential. Real and natural musical brilliance requires high frequencies. For high intelligibility and naturalness in voice (more especially in the female voice) reproduction, the higher frequencies are necessary; and frequencies even up to 7,000 cycles should be present for best results. It is possible that the common objection to women as radio artists is really due to the fact that many radio sets drop the high tones somewhere in the system; and, as the overtones of the female voice are rather well up on the scale, low intelligibility as well as drummy unnaturalness results.

(Continued on page 179)

WRNY's New 31-Meter Transmitter

THE RADIO NEWS broadcast station, WRNY, New York, has just been licensed by the Federal Radio Commission to use on 30.91 meters (which is equivalent to 9700 kilocycles) a new 500-watt short-wave transmitter, which will be operated jointly with WRNY's regular transmitter, which works on 309.1 meters. The short-wave set will be on the air at all times when WRNY's longer-wave transmitter is broadcasting. It will be noted that the short wavelength, 30.91 meters is a harmonic (the tenth) of the higher wavelength of 309.1 meters; this is necessary inasmuch as the two transmitters are housed in the

same building. The low wavelength was selected by WRNY's engineers because the station desires to reach distant points, as well as the nearby ones, which are reached perfectly with the regular wavelength of 309.1 meters. It is estimated that an average radius of between 2,000 and 3,000 miles will be reached regularly with the new transmitter, with greater distances occasionally.

John L. Reinartz, one of the world's foremost experts on short-wave work, has been retained as consulting engineer. The transmitter itself was assembled by WRNY's engineers under the supervision of James

V. Maresca, chief engineer of the station, and went into operation during the latter part of June.

Readers of RADIO NEWS who are short-wave listeners-in are asked to send in reports as to their reception of WRNY's programs. The call letters of the short-wave set, 2XAL, are used only when the short-wave transmitter is used for code work. With a power of only 50 watts and using code, 2XAL in the first few days of its operation was frequently in touch with the Pacific coast, as well as with steamers 2,000 miles out of New York.



The Raytheon "A" Rectifier

A New Development in High-Current Rectification

By JAMES MILLEN

THE rectifier described in this article is a genuinely new development which promises to have wide application in the radio field. It is different, in both appearance and operation, from anything previously in use for battery charging and "A"-socket-power service; so the following complete description of its characteristics will be of interest to all of our readers.

—EDITOR.

TO many people a rectifier may mean anything from a chemical cell to a Tungar bulb. Actually, it is any device that offers to the flow of an electric current more opposition, or resistance, in one direction than it does in the opposite direction.

Thus, by the aid of a suitable rectifier, we are able to obtain a uni-directional current flow from our house-lighting circuit, should it be (as is most generally the case) what is commonly known as alternating current. This uni-directional current is essential for battery charging and many other radio uses. A good rectifier is, therefore, quite an important device to the radio set owner.

Rectifiers are of many different types and of many different degrees of reliability and efficiency. Some are of the mechanical variety, such as sets of contacts that reverse the connections of the power line every time the direction of the current changes. Chemical cells form another class; and the so-called bulbs of both the gaseous-conduction and the incandescent-cathode types form still other classes.

An ideal rectifier might consist of a short length of wire or rod which would offer almost infinite resistance to the passage of an electric current in one direction, and practically zero resistance to the passage of current in the opposite direction. Such a rectifier would be highly efficient, compact, durable, silent in operation, long-lived and perhaps low in first cost.

A METALLIC-CONTACT RECTIFIER

Working in his small laboratory near Paris, M. Henri André, the well-known French physicist, had devoted many years



Fig. 8. A typical "A"-power-supply unit, using the new rectifier, along with a small storage battery.

Illustration courtesy Sterling Mfg. Co.

of his life to the development of a rectifying device which operated on an entirely new and different principle from any previous form. Due, however, to his limited facilities, he was encountering great difficulty in bringing his invention to a final satisfactory commercial form. About this time Laurence K. Marshall, of the Raytheon Company, was traveling in France and met Prof. André. Just as years before Mr. Marshall had seen the possibilities of the present-day Raytheon tube in the crude hand-made experimental gaseous-conduction rectifiers of the American physicist, C. G. Smith, so did he realize the importance of Prof. André's new type of battery-charging rectifier.

As a result, Prof André came to America and spent a year in Cambridge, Mass., working with C. G. Smith, Dr. V. Bush, director of electrical engineering graduate research work of the Massachusetts Institute of Technology and many other engineers and scientists in one of the most completely equipped research laboratories in the country.

Here his work progressed rapidly, until a final commercial product, of even greater electrical merit than had been at first possible, was finally evolved.

INSIDE THE "A" TUBE

The new device is a small, rugged steel tube hardly larger than one's thumb.

What is inside of this small copper-plated steel tube? Let us look at Figs. 1 and 2.

First there is the outside steel shell, B, in the bottom of which is fastened a silver rivet contact A. The purpose of this silver rivet is to insure the best of electrical contact between the steel tube and the granular silver anode S, which is closely packed around the alloy cathode, (C). Concentrated C.P. sulphuric acid paste is mixed in with the porous silver anode and is thoroughly dehydrated in order to prevent undesirable chemical reactions. The remainder of the structure consists of suitable washers or discs of different materials (E) for confining the parts in the proper place, a spring D to keep the anode and cathode together under the correct pressure, the cathode lead wire, and the bakelite cap G, with cathode terminal, F.

As just described, there are two metals; a porous anode of pure silver, connected to the casing, and an alloy cathode connected to the central projection are brought into contact on the inside. The porous anode contains in its interstices the non-conducting agent (sulphuric acid) which has free access to the junction between the metals. The presence of this agent preserves the junction in an "oriented" condition, but the actual conduction is through the metals themselves.

The presence of the non-conducting agent not only creates the oriented condition, but preserves this function; and the unit will continue to operate properly even after abuse in the form of excess momentary potential or current.

There is much yet to be learned in regard to metallic conduction, and the behaviour of electrons in solids is not at all clearly understood. Hence a clear explanation of the exact nature of this oriented condition is indeed difficult. Still, there are some theories on electron behaviour which

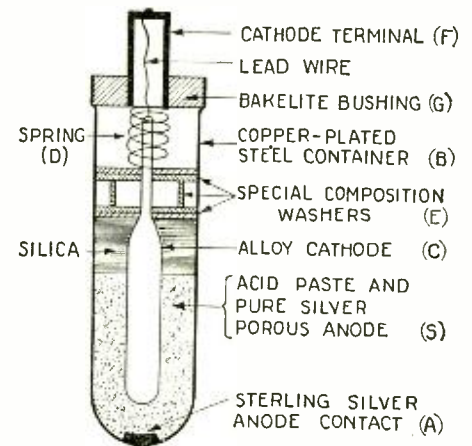

FIG. 1

This cross-section drawing of the rectifier cartridge shows the arrangement of the parts clearly.

are taking shape; and the explanation which follows appears to be reasonable.

To quote from a report by Dr. Bush: "All materials contain electrons, distributed in orbits about the nuclei of atoms. When conditions are such that electrons may with ease pass from an orbit about one nucleus to an orbit about an adjacent nucleus, a motion of electrons through the material is readily produced and we have an electrical conductor.

"Metals have this property in large degree and are hence good conductors. When two metals are in contact, a similar interchange of electrons ordinarily takes place between the adjacent atoms of the two metals, and conduction readily occurs in the two directions. A proper choice of metals, however, in the presence of a suitable agent, may set up a condition in which this property is oriented or unilateral.

"Briefly, this may possibly occur because electron excursions of one metal are much extended in the presence of the agent, while the excursions of the other are inhibited. In this condition the far-extending electrons readily pass to the opposed metal and conduction occurs, while for a potential in the other direction there is no overlap of orbits and the device insulates."

Undoubtedly the complete story of the action is more complicated than this, and no one at present pretends to understand

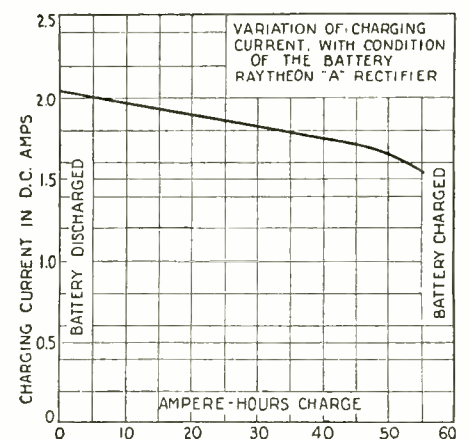

Fig. 7. How the charging rate automatically tapers off, as the battery approaches a fully-charged condition.

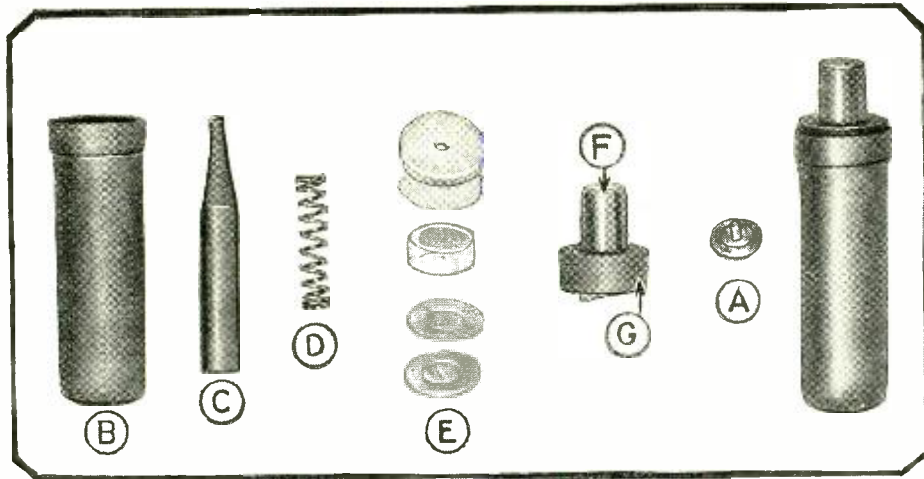

Fig. 2: The component parts of the rectifier. B, steel container; C, alloy cathode; D, spring; E, washers; F, cathode terminal; G, bakelite bushing; A, anode contact. At the right is shown a completely assembled unit.

In some types of chargers, where the secondary voltage is from 20 to 30 volts, the rise in back-voltage as the battery reaches its fully charged condition is but a small percentage of the total impressed voltage.

Still other advantages than a pronounced taper-charge rate and a high electrical efficiency of chargers employing the "A" tube as a rectifier are low first cost, compactness, low operating temperature and silence in operation.

DESIGN OF CHARGERS

With so many prominent manufacturers making complete chargers for use with the new rectifier, the main features of their design will, no doubt, prove of interest.

By reference to Fig. 3, it will be seen that the only parts required are a transformer, a rectifier cartridge, mounting clips, fuse, leads, and case. The transformer may be any well-made unit of about 25 watts capacity with a low-resistance secondary having an open-circuit voltage of between 8 and 9. In the case of the double-wave charger the transformer should be rated at about 50 watts and have two 8-9-volt low-resistance secondaries connected in series, or one 17-18-volt secondary with mid-tap.

Although the rectifier will function when mounted in any position, its life is sometimes increased if operated with the small end up.

One of the fuse clips which support the rectifier should make contact with the body of the tube and the other with the small cylinder projecting from the top. The small cylinder (cathode) should be connected to the positive output circuit and the body of the rectifier (anode) connected through the transformer to the negative.

In the half-wave charger, a fuse of not over 10 amperes capacity must be connected in the charging circuit, to prevent damage should the output of the charger become short circuited or the battery be connected in the reverse manner. A 20-ampere fuse should be used with the full-wave charger. The small automobile cartridge fuses are excellent for this purpose.

Perhaps it may occur to some readers that a charger with variable rate may be readily constructed from a transformer with a higher secondary voltage than that described by inserting a rheostat in series with the tube. Such is not the case. The maximum back-voltage that the tube will withstand continuously without injury is 22 volts. As there is no current flowing during the half-cycle in which the battery is not charging, the IR drop becomes zero and the back voltage becomes equal to the peak A.C. secondary voltage plus the battery voltage. Thus, for long tube life,

(Continued on page 176)

all that goes on at an electrical contact surface.

USES FOR THE NEW RECTIFIER

At this time the new tube has two important uses in battery chargers and in "A" socket-power units. In fact several well-known manufacturers have already placed chargers and "A" power-supply devices employing the new rectifier on the market.

Due to the fact that the conduction is metallic, the internal electrical resistance of the rectifier and the power, or I²R losses in the rectifier, are exceedingly low and thus its efficiency is quite high. The efficiency of a charger employing the new rectifier is in the neighborhood of 60%. This, as charger efficiencies go, is unusually high. Aside from the saving in power consumed, which may amount to as much as from \$6.00 to \$10.00 a year, the higher efficiency of a charger of this type permits it to be constructed with exceedingly compact, and thus less expensive, parts.

Only a tube, a fuse and a transformer, as indicated in Fig. 3 are required. As no energy worth mentioning is wasted in the rectifier, it may be made quite small and, as the transformer does not have to supply a great deal of useless energy, its core need not be any larger than those of some high-quality audio amplifying transformers.

Such a charger will have a maximum charging rate of 2½ amperes. By utilizing two tubes in a full-wave rectification circuit, as shown in Fig. 4, the maximum charging rate is increased to five amperes.

BEST CHARGING METHODS

Storage battery manufacturers tell us that as far as the life of the battery itself is concerned, the ideal charging system would consist of a high-rate initial charge (to remove any sulphate formation on the plates and to reduce greatly the time required for the complete charge), followed by a gradually-decreasing rate of charge in order to prevent excessive gassing and thus slow disintegration of the positive plates as the charge nears completion.

In the better service stations this feat of high initial charging, gradually tapering off, is accomplished by manually regulating the charging rate, as the state of charge of the battery changes, by means of field rheostats on the motor-generators employed for charging.

Because of the high efficiency of chargers utilizing the new rectifier, which permits of low secondary voltage, the variation in battery back-voltage, as it approaches its fully charged condition, is a large percentage of the total effective voltage of the circuit.

Thus the current flow, which is governed by the difference in the impressed voltage and the back-voltage, will be appreciably lessened as the battery voltage rises. (Fig. 7).

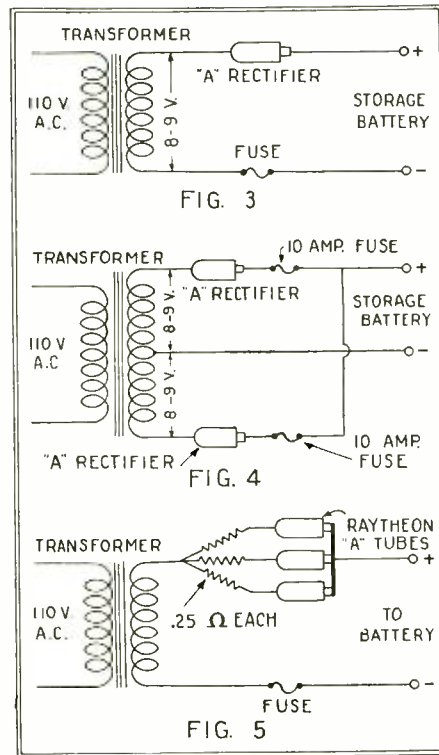

Above: How the rectifier is used in half- and full-wave rectifier circuits for battery charging.



Fig. 6. Left: a commercial model of full-wave battery charger. The circuit is that of Fig. 4.

Illustration courtesy the National Co.



The Stroboscope and Its Operation

A Popular Introduction to Stroboscopy and Its Connection with Radio and the Strobodyne



WHAT IS STROBOSCOPY?

IN his article in July RADIO NEWS, M. Chrétien explained how the Strobodyne system operates; the name being derived from the effect, taking place in the oscillating circuit, which may be compared to the optical stroboscopic effect. We shall now try to make this a little clearer for the readers who are not familiar with this optical phenomenon. Everyone understands the motion pictures which permit reproduction of action. This is accomplished by taking rapidly a great number of photographs of moving objects on a film of sufficient length. Each one of these pictures is a "still," similar to those taken with any camera; but when they are projected, exactly as fast as they were taken, they reproduce the action photographed with the movie camera.

We can receive the impression of continuous action from motion pictures, because our eyes retain for an instant a picture at which we look quickly. This is called *persistence of vision* and permits the eyes to see each one of the *still* photographs, taken on the motion-picture film, for a fraction of a second after it is projected. During this time another picture has been substituted by the mechanism of the motion-picture projector, and the new picture blends with the previous one so that no interruption is visible on the screen. Motion pictures are really a succession of ordinary photographs taken at the rate of sixteen a second and projected at the same interval.

A very simple experiment shows the persistence of vision. If, in a dark room, you look at a lighted cigar or cigarette you will see only a red spot; if you now rapidly revolve the hand holding it you will see a red circle. This circle is formed in your eyes, which combine into one picture impressions of the successive positions of the red spot.

A MECHANICAL EXPLANATION

To explain the functioning of the Strobodyne we shall describe a simple apparatus which may be built to observe the phenomenon. Since we cannot see it work, we shall explain how it operates.

It is made of two discs, from each of which a triangle is cut out, as shown in Fig. 1, and a lamp placed at the back; so that, when the triangular openings in the

discs are in front of each other, one may see the light through them. When the front disc is in the position shown, the lamp is lit, because a contact is made at the switch shown at the right; thus the lamp is flashed at each revolution of this disc. It is necessary to flash the lamp, in order to show

only one position of the triangle; otherwise, if the lamp were lit all the time, light would be seen irregularly in front of the opening in the box containing the lamp.

Now, if the discs are arranged to revolve on their axes at the rate of 16 and 16½ revolutions per second, respectively, we may observe the following optical illusion; If one looks in front of the discs the triangle will appear to increase in size and shrink during one second. This is accomplished in the following manner:

After disc No. 1 has revolved one turn, disc No. 2 will have revolved one turn plus 1/32 of a turn which brings the corner of the triangle in disc No. 2 in line with the other. (See Fig. 2). During the next revolution disc No. 2 will travel another 1/32 of a turn farther, exposing a little more of the triangle in front of the other. After the next revolution of the two discs the triangle in disc No. 2 will be exposed a little more, and so forth, at every revolution (as shown in Fig. 2) until at the eighth revolution of disc No. 1 the two triangles will be just behind each other, when they can be seen full size. Then since, disc No. 2 travels faster, the triangle cut out in this disc will advance a little more at each turn and the size of the triangle of light decreases in size until the two triangles are no longer behind each other.

Since, as explained above, the eyes retain a picture for 1/16 of a second, the triangle of light will appear to increase and decrease in size; because all these successive changes take place during one second. The eyes do not detect the successive changes; exactly as, when looking at a motion-picture screen, one does not see the substitution of the still pictures. If, instead of looking at the discs, we placed a motion picture camera there with the lens facing them and turned the crank, the film when developed would show the size of the triangle increasing and decreasing in regular progression on each one of the successive pictures (as shown in Fig. 3). This effect at the same time illustrates how frequencies in the vacuum tube of the Strobodyne interact to form a lower frequency.

THE STROBODYNE ACTION

In the case of the optical effect the two discs turn at the speed of 16 and 16½ cycles or revolutions a second, respectively;

(Continued on page 167)

ONCE more RADIO NEWS leads in presenting the Strobodyne Circuit, which has been termed "an evolution in radio". Attention is called to the fact that in the past RADIO NEWS has brought out the following important circuits, all of which were new, and all of which made history in radio. Among the few circuits that became internationally well known are the following:

The Ultradyne,

by R. E. Lacaull

The Tropadyne,

by Clyde Fitch

The Interflex Circuits,

by Hugo Gernsback

The Solodyne,

by G. V. Dowding and K. D. Rogers

The Crystodyne,

(oscillating crystal)

by O. V. Lossev

The Autoplex,

by M. L. Muhleman

The Autoregenerator

by Sylvan Harris

The DX-2 Multivalve Receiver,

by A. J. Haynes

The Interbalanced Regenerative Receiver,

by A. Barbieri

The Hi-Q Hammarlund-Roberts Receiver

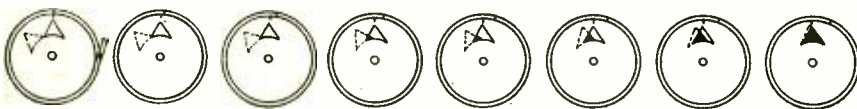

FIG. 2

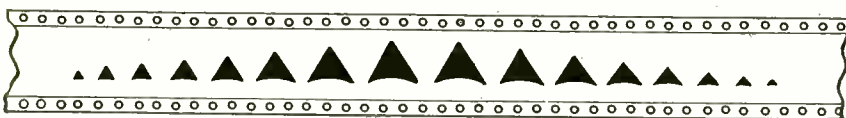

FIG. 3



FIG. 4

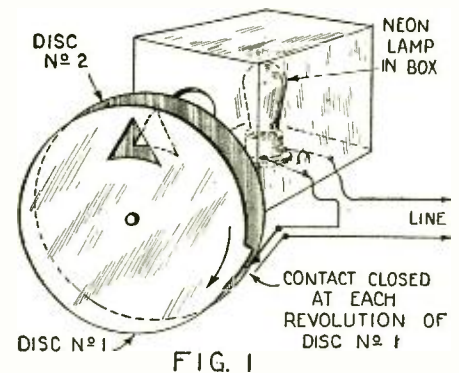

FIG. 1

Above we have the simple elements of the Stroboscopic apparatus, presenting the effects pictured at the left. Fig. 2 gives the positions of the two triangles (disc No. 2 shown in phantom) at successive flashes of the lamp; Fig. 3 the resulting effect on a motion-picture negative; while Fig. 4 shows how the wave-forms in the Strobodyne frequency-changer produce an electrical effect which is highly analogous.

Design of a Simple Stroboscope

A Striking Experiment Changing the Apparent Speed of Moving Objects

By HUGO GERNSBACK

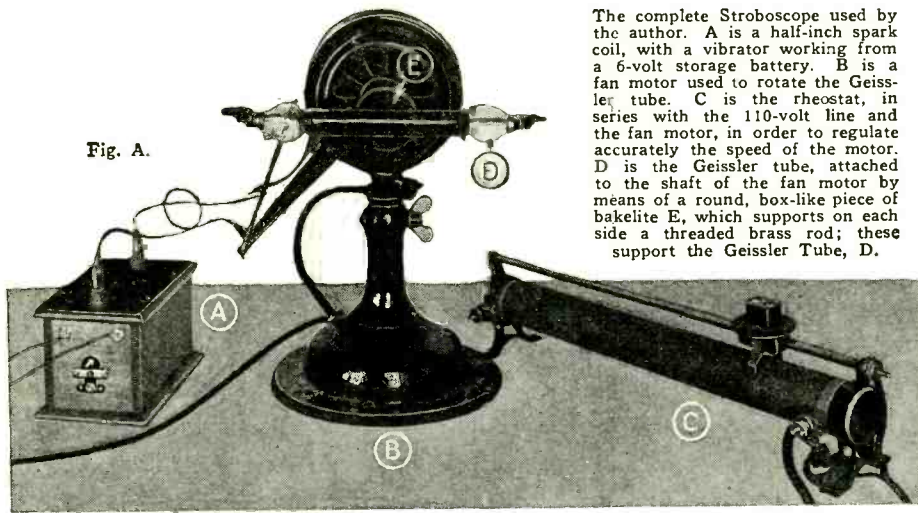

Fig. A.

The complete Stroboscope used by the author. A is a half-inch spark coil, with a vibrator working from a 6-volt storage battery. B is a fan motor used to rotate the Geissler tube. C is the rheostat, in series with the 110-volt line and the fan motor, in order to regulate accurately the speed of the motor. D is the Geissler tube, attached to the shaft of the fan motor by means of a round, box-like piece of bakelite E, which supports on each side a threaded brass rod; these support the Geissler Tube, D.

vibrator, then the tube seems to rotate in a clockwise direction. If this relation of the relative speeds is reversed, the tube seems to rotate backwards.

This illustrates in its simplest form the Stroboscopic principle—"Stroboscope" coming from the Greek, and signifying "twisted vision."

MULTIPLE TUBE PATTERNS

By carefully adjusting the speed of the motor and the speed of the vibrator, particularly when the vibrator moves very slowly, effects of a harmonic nature are produced. First, if the adjustments have been carefully made, we get a pattern of a single tube that seems to stand still, as we have said. If the vibrator-frequency is doubled, there will appear to be two tubes crossed at right angles; and so on.

By continuing to increase the frequency at which the vibrator interrupts the circuit, until it is four times the speed of revolution, we can form a pattern of four tubes; thus obtaining the effect shown in Fig. B. It is necessary that this frequency shall be an exact multiple of the speed of the motor. We can thus obtain the appearance of as many separate tubes as we desire.

The faster the speed of the vibrator, the more tube patterns will appear; until there are so many—with the increase in the speed of the vibrator—that the separate tubes can no longer be distinguished in the Stroboscope.

(Continued on page 181)

FREE To Strobodyne Builders

WE have issued a beautiful decalcomania nameplate to be affixed on the panel of every Strobodyne, as illustrated here. This is a neat design, measuring about one inch in diameter, and executed in gold and colors.



All set builders constructing the Strobodyne are entitled to this decalcomania. When it is affixed to the panel it appears as if the latter had been engraved with this design.

Do not fail to send for it. A postal with your name and address will bring it to you.

brator of the spark coil, and likewise carefully regulate the speed of the motor, we will find an adjustment whereby, instead of the tube's appearing to spin, it will seem to stand still.

If the frequency of the vibrator exactly coincides with the speed of the motor (as for instance, 1,000 revolutions per minute of the motor and 1,000 interruptions by the vibrator) the tube will appear to remain in a fixed position. If the speed of the motor is slightly greater than the frequency of the

WHEN the first demonstration of the Strobodyne was recently made in RADIO NEWS LABORATORIES, New York, before a number of radio engineers and radio editors, I had constructed a simple Stroboscope to show the operation of this instrument; in order to explain the Stroboscopic action and its analogy to the electrical Strobodyne action.

As shown in Fig. A, I used an ordinary spark coil, with a vibrator, capable of giving a half-inch spark between two pointed metal electrodes. The coil is operated on 6 volts. An old electric fan was secured and a suitable piece of bakelite in the form of a cap, about two inches in diameter, was secured to the shaft of the motor. From the secondary of the spark coil one lead went to the frame of the motor, while the other high-voltage lead went to a brush made of a flat copper leaf-spring, which made contact with a ring running around the bakelite piece.

When the motor was put in operation, the high-voltage current was thus fed to a Geissler tube, which was attached with two brass rods to the bakelite cap, where it was held secure. (Most students of physics know the Geissler tube, and the beautiful colors that it gives off.)

A BEAUTIFUL EFFECT

If the room be now darkened, and the motor started with the tube illuminated, we will see a number of luminous circles, made by the rapidly-rotating Geissler tube. By increasing or decreasing the speed of the motor (using a rheostat in series with the supply line) the speed and consequently the appearance of the rapidly-revolving tube is varied. If we then carefully adjust the vi-

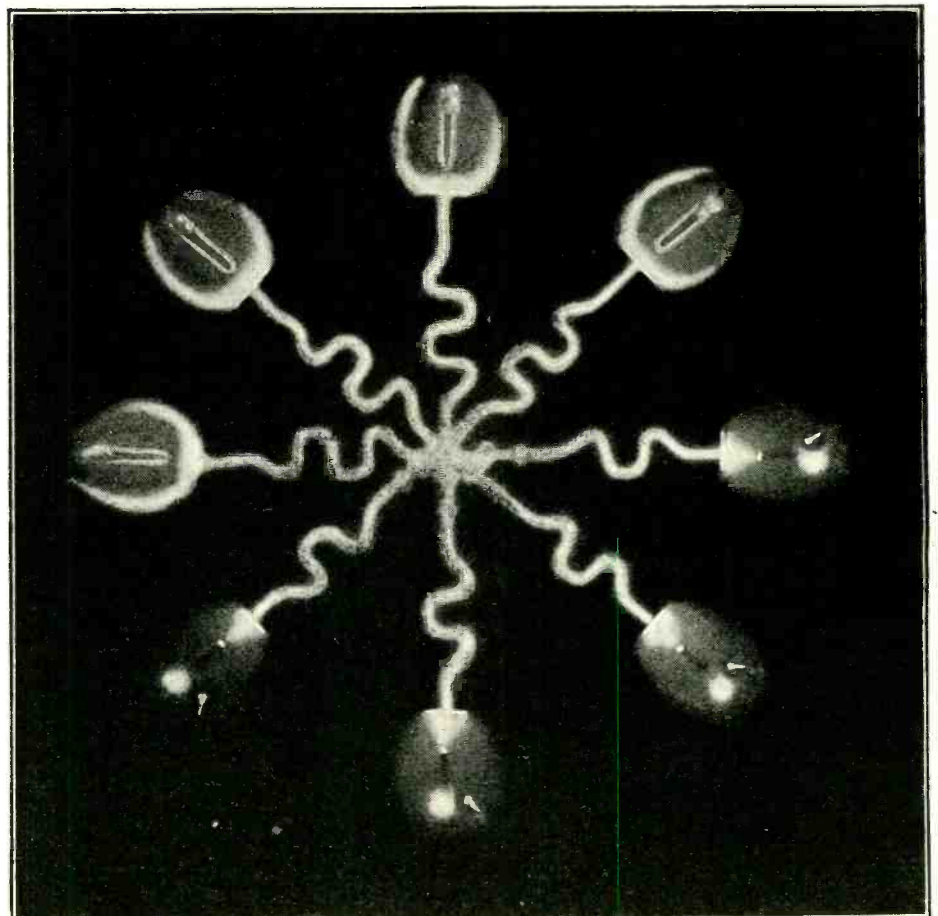
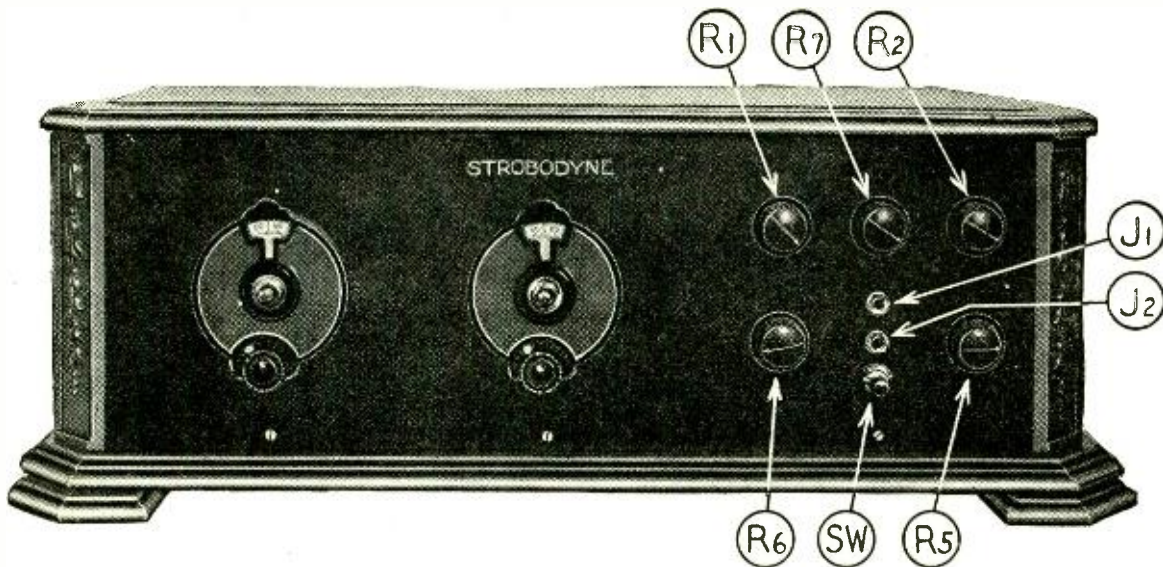

Fig. B. This (from a photograph) shows how the Geissler tube in the electric Strobodyne appears to the eye. Although revolving at about 1,000 revolutions per minute, the Geissler tube assumes various fixed patterns, in multi-tube designs. By adjusting the vibrator, the image of a single tube (or upwards to several dozen tubes) will be seen; these appear to stand still, though the tube is revolving rapidly.



The front view of the Strobodyne Eight-Tube receiver, R1, R2, R5, R6, and R7 are rheostat controls; J1 and J2, jacks; and SW is the filament switch.

Construction of the 8-Tube Strobodyne Receiver*

Complete Details for Building the Year's Greatest Circuit

By LUCIEN CHRÉTIEN

Translation and American Adaptation by R. E. Lacault

WHEN I designed the Strobodyne circuit, I might have announced it as a revolution in radio. I am aware of the fact, however, that this has been done so many times before that I might better desist.

I would much rather leave any extravagant claims to my American radio confrères, who no doubt will find enough adjectives themselves after they have built the Strobodyne for their own use.

There is only one point on which I admit that I am puzzled. What claims can be made for the Strobodyne? How can I make myself understood and prove to you that this new circuit is not merely a new adaptation of an old system? This, as we are all aware, has been done many times, too, and the radio builder has become pretty much discouraged for that reason.

I should, therefore, much rather say that the Strobodyne is not a revolution, but, to

be more exact, an evolution. Perhaps I may be pardoned for saying that the Strobodyne will prove to be a *révelation*.

However, better to permit the readers to judge for themselves. The constructional data of the Strobodyne are given in the following article, and radio enthusiasts will be able to form their own opinions; even though I do not call it "The King of the Ether," or the "Emperor of the Waves."

DISTANCE WITH SELECTIVITY

It may be well to mention the results obtained with this receiver, which any reader should be able to duplicate. Thus, for instance, the short-wave transmission of WGY at Schenectady was picked up (in Paris) on the loud speaker in the middle of the evening, and I mean by this that the reception was such that we heard it over a room of average size. Other stations in all parts of Europe were received with much better volume. (With the American-built set described in this article, stations over a radius of fifteen hundred miles were picked up *in the heart of New York City* with excellent volume and no trouble at all from interference.) Stations come in at but one point of the dials, if the dials are turned together. However, if the tuner dial is left fixed and the oscillator condenser varied, then the other beat note will be heard. Also, if the stations produce harmonics, these can not be eliminated.

We have tried, and succeeded, in incorporating in this Strobodyne the following characteristics:

AN AMBITIOUS PROGRAM

(1) The set has been designed to use the smallest possible energy-collecting device, *i. e.*, the loop antenna; and with the set used in Paris a loop one foot square was employed. (However, the set described in this issue of RADIO NEWS has been designed for use with an outdoor antenna, and the results

"THE GREATEST CIRCUIT OF THE YEAR"

IN presenting the constructional data on the year's greatest circuit, we wish to enumerate, here, the outstanding points of superiority of the Strobodyne. We hesitate to use laudatory adjectives, as they have been used so many times before, in connection with mediocre circuits—and with disappointing results.

Here are the FACTS about the Strobodyne:

- (1) An entirely new frequency-changer, operating on a new and original principle.
- (2) A circuit unexcelled for distance, with great selectivity, out-performing the best superheterodynes in use today.
- (3) Remarkable sensitivity.
- (4) Stations come in at but one point of the dials.
- (5) Tremendous volume, with no distortion.

The set built with American parts, here illustrated, has been used for over a month in New York City with astonishing results.

In order to give our readers the best, RADIO NEWS commissioned Mr. R. E. Lacault to build the Strobodyne. Mr. Lacault is the inventor of the well-known Ultradyne and an acknowledged expert on superheterodynes. He, too, unhesitatingly pronounces it the greatest circuit of the year.

—EDITOR.

* RADIO NEWS Blueprint Article 27.

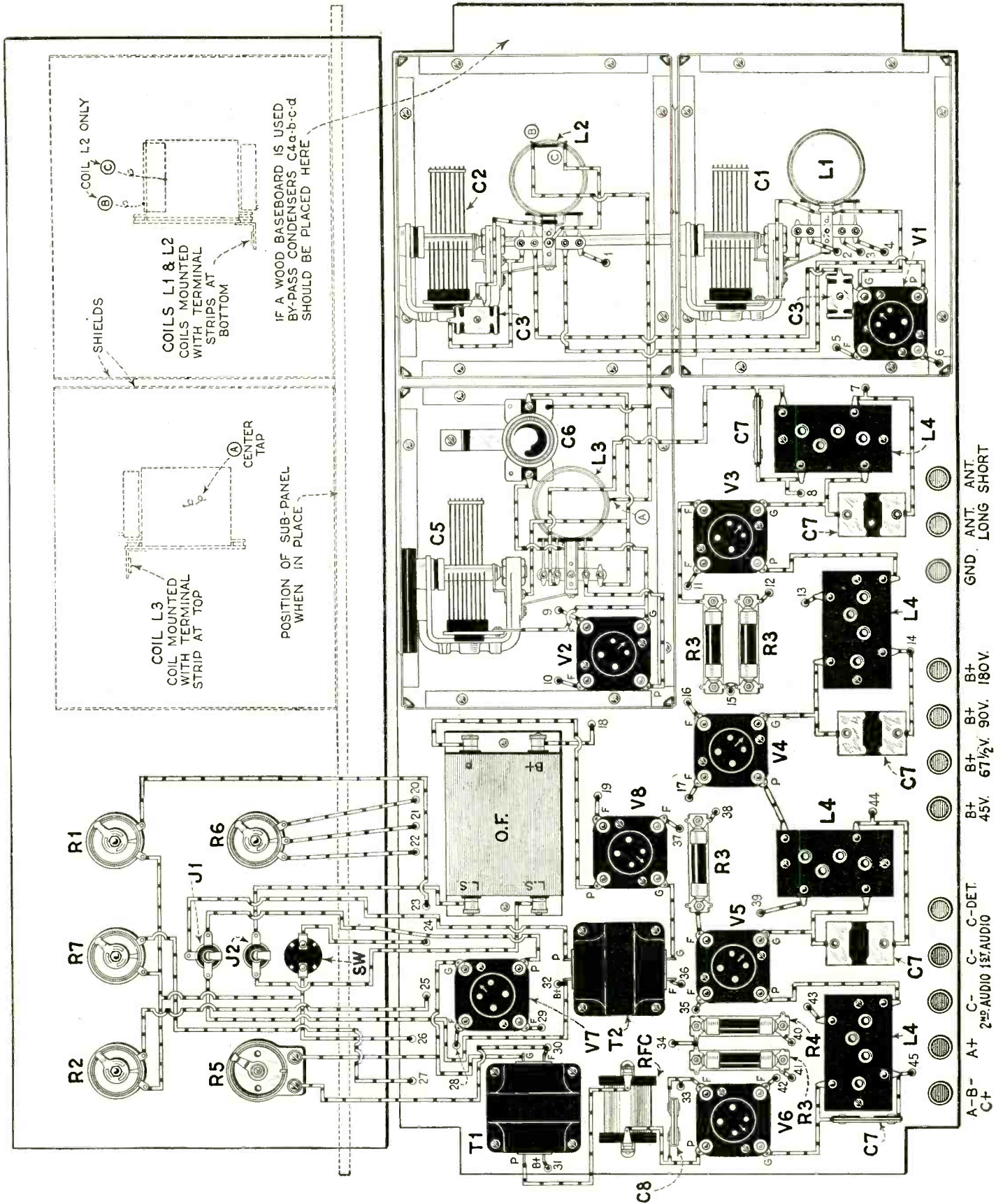

The wiring diagram of the panel and the upper side of the sub-panel of the 8-Tube Strobodine Receiver. On page 138 will be found that for the under side of the sub-panel. The holes which are numbered correspond with

identical holes shown in the other drawing, and the connecting wires are run through these holes. Notice the change in layout if a wooden baseboard is used.

mentioned above were obtained while using this type of collector. A further article will deal with loop reception.)

(2) I have tried to obtain the greatest possible selectivity in order to receive, in districts where there are a number of broadcast stations, the maximum number of dis-

tant broadcasters with a minimum of interference.

(3) I have endeavored to obtain the best quality of reproduction which is possible with the available apparatus on the market.

(4) The receiver has been designed to have as much "reserve power" as possible, in order to overcome partially the fading of

distant stations. This, of course, is of great advantage.

It is easy to describe these conditions, but it is an entirely different matter to obtain them. It should be noted that some of these conditions are antagonistic. For instance, a very sensitive receiver is generally not selective and a very selective receiver generally

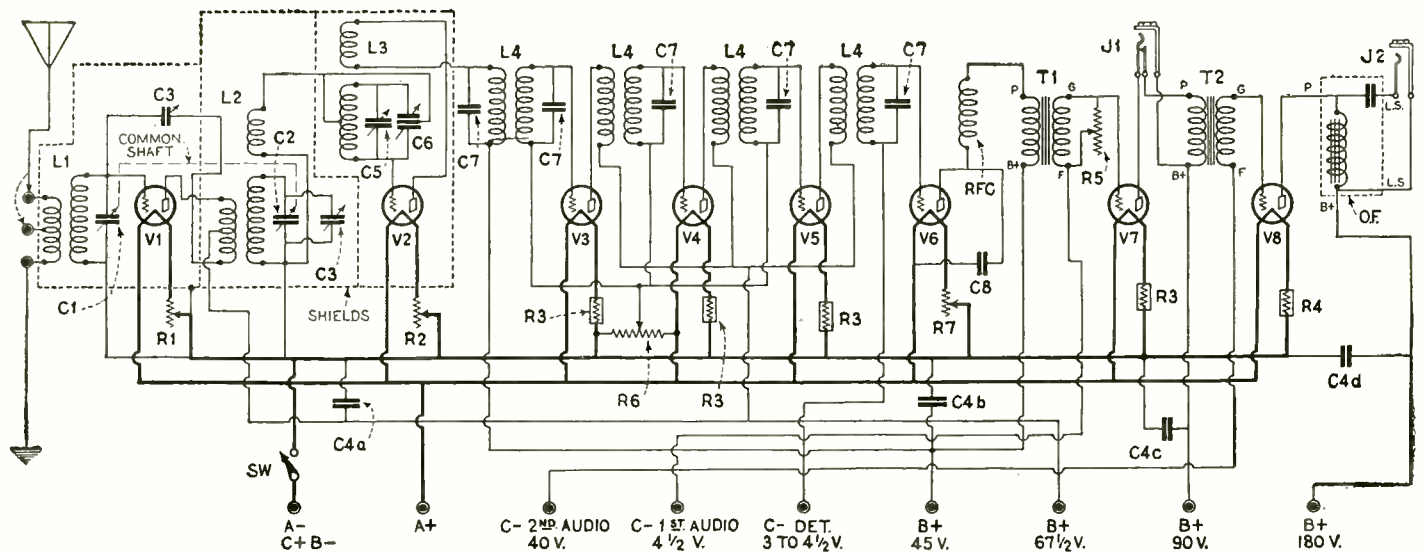

The circuit diagram of the 8-Tube Stroboddyne Receiver is shown above. The symbols indicating the different pieces of apparatus are the same as those which appear on the other illustrations in this article and in the list of parts on page 139.

causes distortion. Since we are not limited in the number of tubes to be used, we can overcome these apparent contradictions in the results. It is entirely possible to obtain sensitivity together with selectivity, if enough stages of radio-frequency amplification are used.

USE OF AN R.F. STAGE

When designing the set the question arose, whether radio-frequency amplification should be used ahead of the frequency-changer. In previous experiments with a standard superheterodyne receiver it had been found that amplification of this type aided reception to

a very great extent. For example, while I was listening to Berne (Switzerland) on a small loop, the fading was very pronounced and the local (Paris) station PTT was heard in the background. When a stage of radio-frequency amplification was placed ahead of the superheterodyne, the fading was not so noticeable and the interfering station was

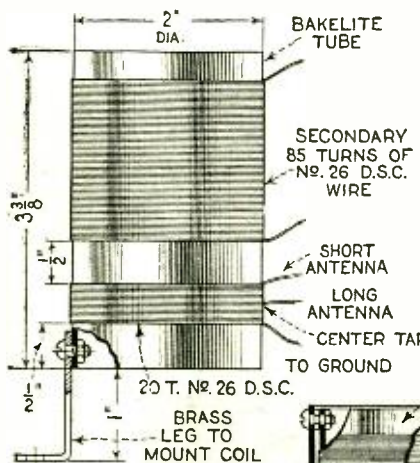

~ RADIO FREQUENCY AND INPUT COILS ~

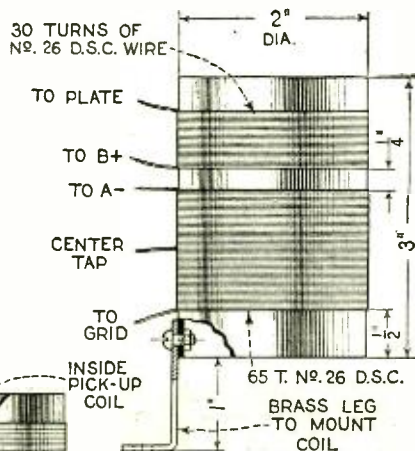

~ TAPPED COIL ~

IN THE INPUT COIL A SMALLER COIL WOUND WITH 30 TURNS OF NO. 30 D.S.C. WIRE SHOULD BE MOUNTED AT THE TOP, SO THAT THE UPPER TURN OF EACH IS ON THE SAME LEVEL.

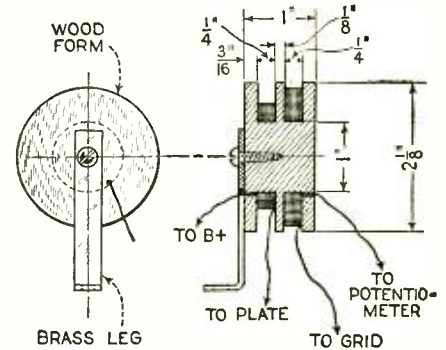

PRIMARY - 200 TURNS OF NO. 28 D.S.C. WIRE
SECONDARY - 400 TURNS OF NO. 28 D.S.C. WIRE
BOTH WINDINGS IN SAME DIRECTION AND WOUND IN LAYERS

~ LONG WAVE TRANSFORMER ~

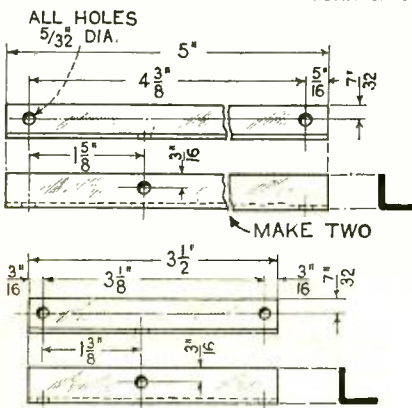

~ SUB-PANEL MOUNTING BRACKETS ~
1/2 x 1/2 x 1/16 ANGLE BRASS

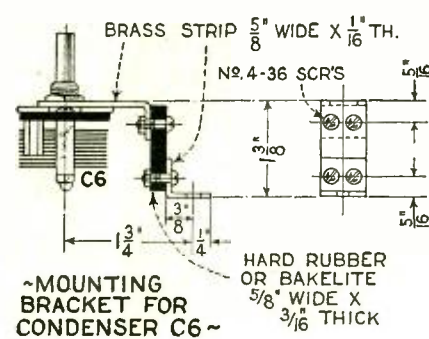

~ MOUNTING BRACKET FOR CONDENSER C6 ~
HARD RUBBER OR BAKELITE 5/8" WIDE X 3/16" THICK

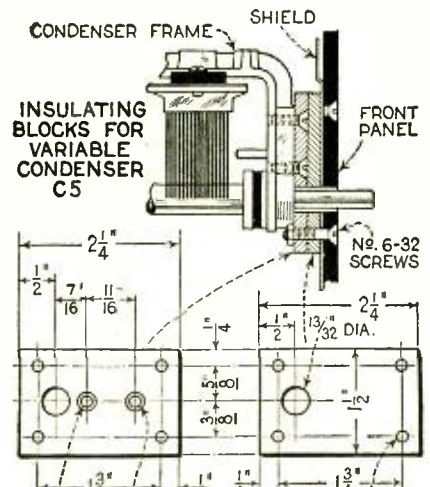

INSULATING BLOCKS FOR VARIABLE CONDENSER C5
~ MAKE ONE OF EACH ~ BAKELITE OR HARD RUBBER, 3/16" THICK. ~

FIG. 3
Above are given the specifications for constructing some of the apparatus for the Stroboddyne receiver. Directions should be carefully followed, in order that the apparatus may fit perfectly in the allotted space.

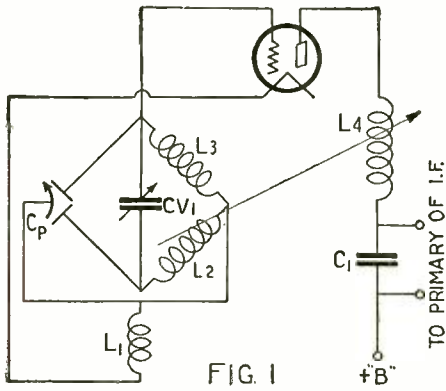

FIG. 1

The "bridge circuit" of the frequency-changer, which is the heart of the Stroboddyne circuit. The letters in this circuit do not correspond with those in the other diagrams and illustrations.

entirely cut out, which seems to indicate a gain in both amplification and selectivity. Of course, this requires one more tube and another control to adjust. However, since the input circuit and radio-frequency unit are tuned to the same wavelength, they can be controlled by a tandem variable condenser, as in the set here described.

It is of advantage to use three stages of intermediate-frequency (long-wave) amplification. Although the third stage does not produce much amplification, it provides the reserve of power mentioned before. In practice a third stage may be eliminated if one wishes to eliminate a tube; but it will be found very advantageous to use three stages in order to secure the best results. If it is desirable to reduce the number of tubes, it is better to cut out one of the stages of the intermediate-frequency amplifier, rather than the R.F. before the frequency-changer.

GRID-BIAS CONTROL

The intermediate-frequency stages are controlled by a potentiometer, the value of the later being in the neighborhood of four or five hundred ohms. This value is not critical and affects only the amount of "A" battery current flowing through the potentiometer

winding. This instrument is used to vary the grid potential of the tubes and to bring them near the point of oscillation, where they are most sensitive.

Before adopting transformer-coupling in the A.F. system, I hesitated between resistance and transformer coupling. The former has the advantage that, if all the proper precautions are taken, an approximately straight-line amplification curve can be obtained. However, in resistance coupling three tubes are required to give the same volume that can be obtained with two tubes when transformers are used. Transformer coupling was therefore decided upon, as excellent quality may be had with a good make of transformer; besides we can eliminate a tube.

THE FUNDAMENTAL CIRCUIT

Fig. 1 shows the circuit of the frequency changer. The coil L1 is used to apply the signal through the tube; coils L2 and L3 form the oscillating circuit to which is coupled the feed-back coil L4, which is inserted in the plate circuit of the tube. Also, in the plate circuit, there is inserted the primary of the first intermediate-frequency transformer; this primary being shunted by a by-pass condenser C1.

In the previous article (which appeared in the July issue of RADIO NEWS) it was explained that the frequency-changing system should be so adjusted that the oscillations produced are of the proper amplitude. This amplitude may be adjusted in several ways, viz.:

- (a) By varying the size of the feed-back coil, L4.
- (b) By varying the coupling between L2, L3 and L4.
- (c) By adjusting the voltage on the plate of the tube.

It should be noticed however, that if any of these methods are employed, the adjustment is good for only one wavelength and has to be varied for every signal that is tuned in. However, the necessity of readjusting the controls has been eliminated by using a large inductance in L2 and L3 and a small tuning condenser, together with a low plate voltage. The compensating condenser, C_p, should have as small a capacity

"FULLY JUSTIFIED"

Editor, RADIO NEWS:

When I received the July issue of RADIO NEWS and read the very clear description of the new STROBODDYNE circuit, I simply had to try it, because it appeared to be a REAL improvement on the superheterodyne.

The results I obtained fully justified my labor, and I will briefly outline the apparatus I used. Of course, as the first article did not name the constants, I used what I had at hand.

Referring to Fig. 4 (Page 29, July RADIO NEWS), I used for C1 and C2 two General Radio variable condensers; C3 and C4, two Silver-Marshall No. 340 variable condensers, connecting the rotors together; for L1 and L2, I used a Silver-Marshall No. 101-B coupling unit, using the rotor winding for the coil P. The coil marked R, I used as the signal collector; and I made a Mathieson loop work here, tapping it as shown in Fig. 5 (page 28) at about the third turn from the filament end. For the intermediate amplifier, I am using the No. 170 Victoreen R.F. transformers, two stages of R.F. Tubes used were 201A throughout, except the last audio stage, a 210; the audio amplifier is transformer-coupled.

Today (Sunday, June 12) I received WBZ at 2:00 p. m., Eastern Daylight time; it could be heard very well, and this is fine compared with other supers I have. I am also getting WMCA, WBBR, WRNY, WPG, WJZ and WEAF; all very good on a Western Electric cone.

I am now going to try and make the coil P-S-T, as in Fig. 6; but I wanted to let you know the results I have had so far. I would be glad to do some test work with you; because if a set works well in New Haven, it should work better elsewhere.

THOMAS I. BURWELL,
565 Quinipiac Ave., New Haven, Conn.

as possible, as it is in parallel with the variable condenser, CV1 which has a capacity of .00035-mf. The capacity of the compensating condenser should be small and the instrument should have one rotor and two stators, as indicated in Fig. 1.

DESIGN FOR AMERICAN SET BUILDERS

The first article of this series (in the July issue of RADIO NEWS) has described in detail the principle used in the frequency-changer of the Stroboddyne and the experiments which led to its practical development; and the optical principle which suggested it. We shall

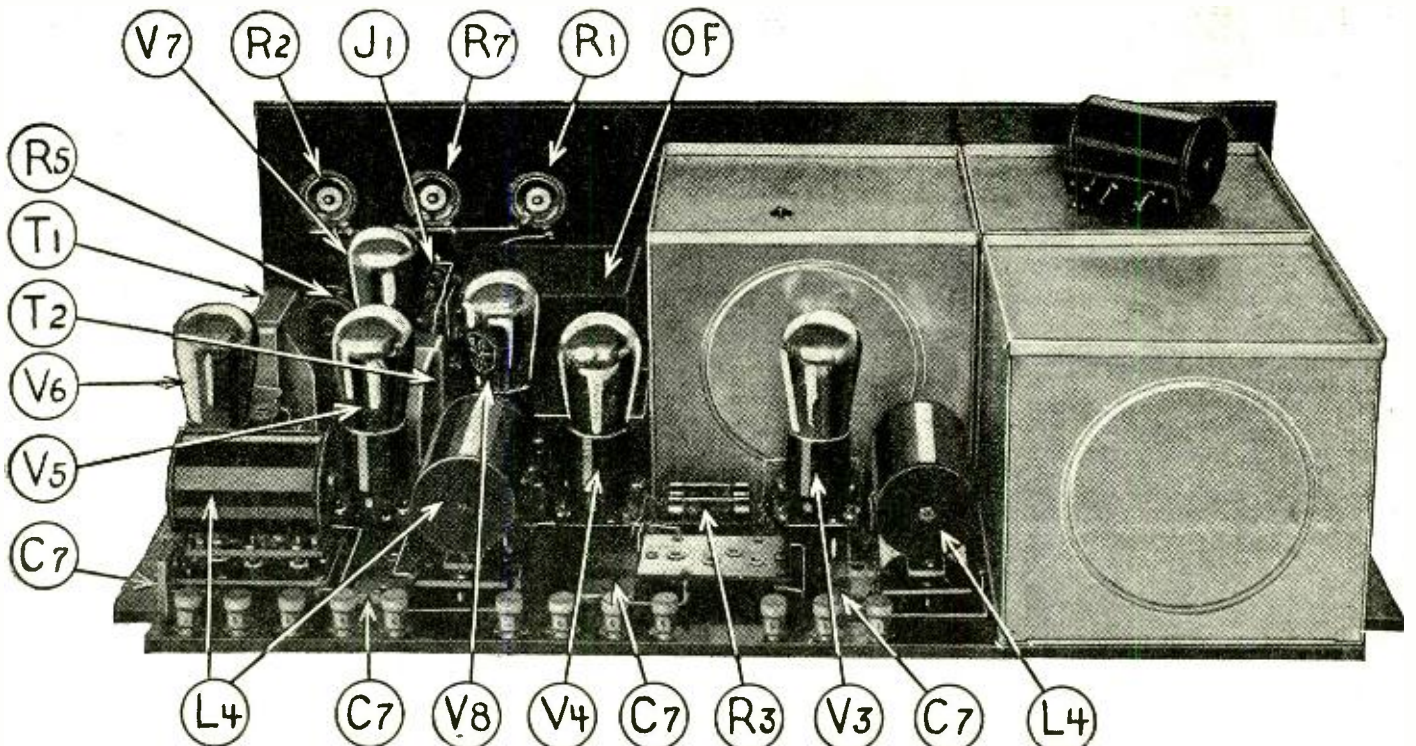

Rear view of the 8-Tube Stroboddyne receiver, with one of the long-wave R.F. units on top of one of the shields (right) to show the base into which it is plugged. C7, fixed condensers, which tune the coils, L4; V3, V4, and V5,

long-wave amplifier tubes; V6, detector; V7 and V8, A.F. amplifiers; T1 and T2, A.F. transformers; R1, R.F. rheostat; R2, frequency-changer rheostat; R7, detector rheostat.

now explain how to build the receiver with standard parts obtainable on the American market, and how it should be adjusted for best results.

This receiver is designed to amplify the received signals after their frequency has been lowered through the Strobodyne oscillator. Therefore, the usual precautions taken in circuits using a frequency-changer must be observed in this case also. In the American adaptation, shielding has been used to prevent interaction or feed-back between the various radio-frequency units; and provisions have been made in the binding-post arrangement for the use of a power tube in the second audio stage, and to insure a suitable choice in the voltages, depending upon the tube used, etc.

The Strobodyne may be equipped with either batteries or any good socket-power unit supplying enough current. If desired 199-type tubes may be used with dry cells; but the ¼-ampere tubes are to be preferred. The present model is designed for operation with an aerial, either outdoor or indoor; and any length up to about 120 feet is suitable. In the next article we shall explain how to adapt the receiver to loop operation.

CONSTRUCTING THE SET

The first thing to do, after all the parts required are on hand, is to drill the panel and sub-panel, as shown in Figs. 2 and 2A. The panel should then be fastened to the sub-panel by means of pieces of angle-brass, cut and drilled as shown in Fig. 3. Machine screws, No. 6/32 about 1-inch long, are used for this and the mounting of the parts on the sub-base. The same screws used for fastening the sub-base to the angle-brass also hold the shield in place, and these may be mounted at the same time. The No. 1 shield is the left forward one. The back and right shields are No. 2 and are different, in that the back partition is not drilled. The back of the sub-base is raised, by means of

either a piece of brass strip bent to form a letter "U," or pieces of wood of the proper thickness. The space under the sub-base is used to wire the set with soft rubber-covered, or other flexible insulated wire, and to provide space for the by-pass condensers used across the "B" circuit. These condensers

which is pushed through both condensers to line them up. The rotor set-screws are then tightened when the two rotors are completely meshed in the stators, and the two shield partitions are screwed down on the sub-base so that the rotors turn freely without binding at any point.

COIL MOUNTING

Next mount the auto-couple coil on the back variable-condenser frame, by means of the bracket and screws furnished with the coil, and remove the long machine screw which limits the motion of the primary on the coil. This is not used; because the primary is made to move up and down inside of the secondary by means of the cam which must be fastened on the end of the shaft.

The three-circuit auto-couple coil is mounted in the same way on the frame of the forward variable condenser and the cam slipped over the shaft so as to move the primary out of the secondary when the plates are all unmeshed. Note that these two coils are mounted with the movable coil at the bottom.

THE STROBODYNE UNIT

As the oscillator uses a bridge circuit, it is necessary to insulate the variable condenser from the shield. This is done by mounting the condenser on a piece of bakelite, which is covered with another in order to insulate the heads of the mounting screws; both of these strips being fastened on the panel as shown in Fig. 3. When mounting this condenser be sure that the shaft is not touching the shield. With some types of dials, some hand-capacity may be noticed and it may be necessary to replace the condenser shaft by a piece of ¼-inch bakelite rod; which has been done in the receiver here described. The tapped autocouple coil is mounted on the frame of the condenser with the movable coil on top. In this case

THE STROBODYNE CIRCUIT

BY arrangement with Lucien Chrétien, the inventor, all articles on this circuit for this country have been copyright by RADIO NEWS in the United States, and must not be republished without permission of the publishers.—EDITOR.

are fastened on pieces of angle brass if their legs are at the ends of the condenser; but, if the legs are in the plane of the back of the condenser, no angle brass is required.

MOUNTING THE CONDENSERS

After the bottoms of the shields have been placed on the sub-base, the forward left condenser should be mounted on the panel. This holds the front of the forward shield in place.

Next mount the R.F.-stage variable condenser on the front of the back shield and the back of the front shield, placed back to back. The mounting screws hold these in place.

Note that the small shields furnished with each condenser are not used; the large threaded bushing provided on each condenser for single-hole mounting is not required, either, and should be taken out. The short shafts of each condenser should be taken out by loosening the two set screws on each rotor, and replaced by the 10¼-inch shaft,

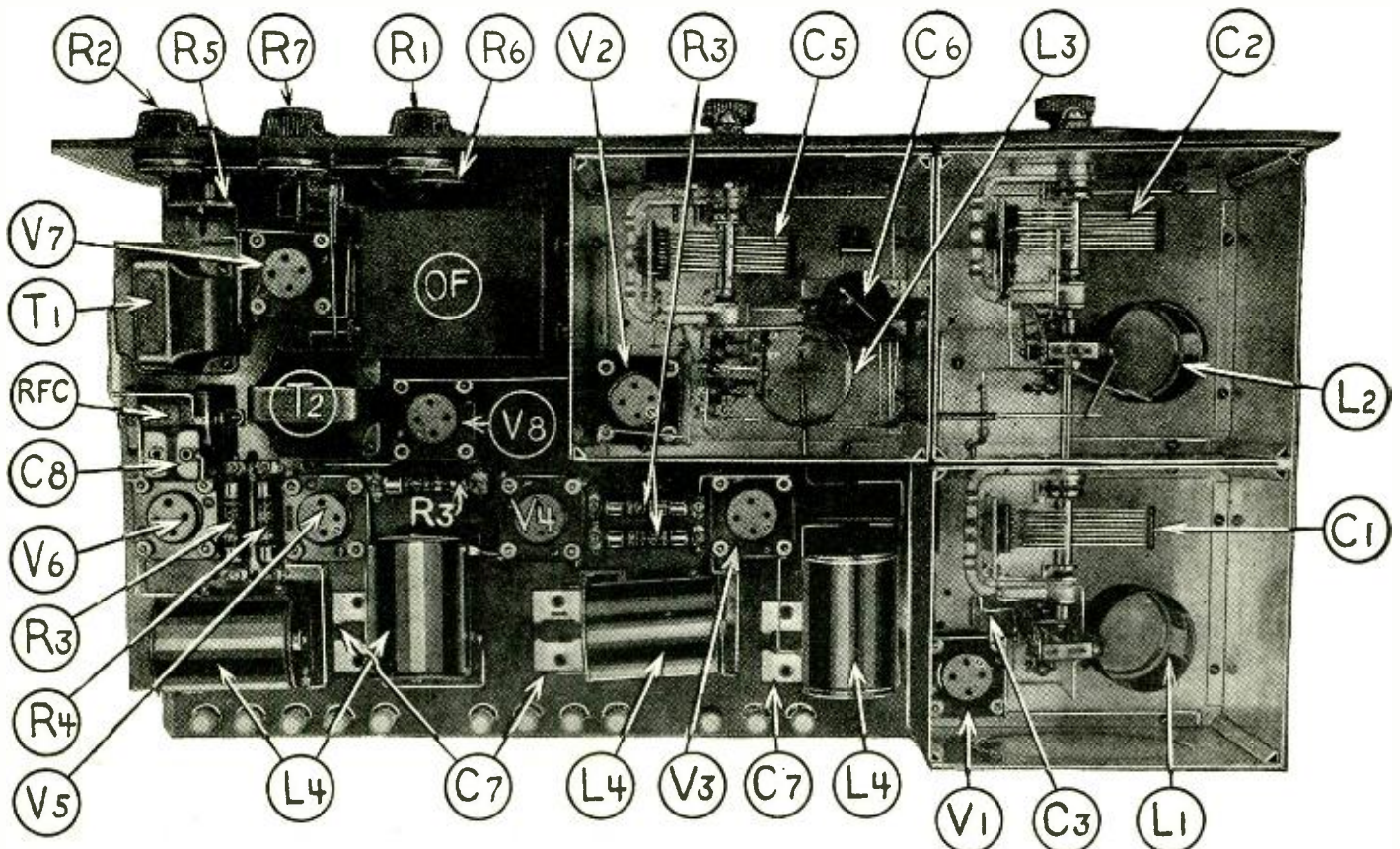

The interior of the 8-Tube Strobodyne Receiver, with the tops of the shields removed. C1, C2 and C5, variable condensers; L1, L2 and L3, R.F. coils mounted on the rear of the variable condensers; C6, compensating condenser;

R3 and R4, filament ballasts; RFC, R.F. choke coil; V1, R.F. amplifier; V2, frequency changer; C8, by-pass condenser; OF, output filter; R5, 100,000 ohm variable resistor; R6, potentiometer.

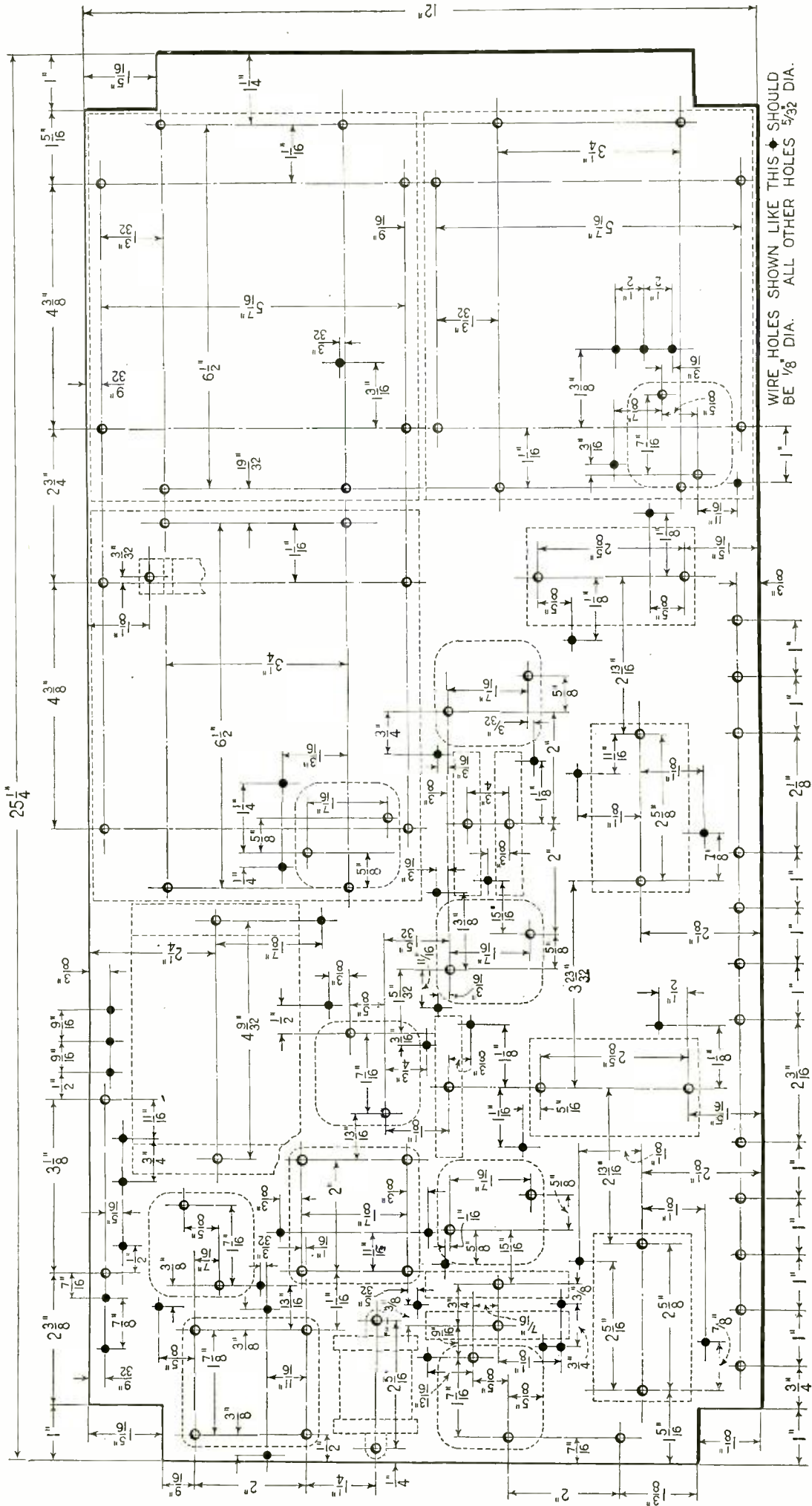

the long machine-screw is used to adjust the coupling and the cam is not necessary.

The small balancing condenser is mounted as shown in Fig. 3, to insulate it from the bottom of the shield upon which it is mounted.

The wiring shows clearly the location of the other parts on the sub-base diagram (page 133) how the various rheostats, jacks, etc., are mounted on the panel.

LOUD-SPEAKER COUPLING

Ever since the advent of the power tubes of the 112 and 171 type for use in the last stage of audio-frequency amplifiers, there is an attendant danger that some damage may be done to the windings of the loud speaker, unless some protective device be inserted in the output circuit of the power tube. The plate voltage required by these tubes is anywhere from 135 to 180 and, in the majority of cases, such a voltage flowing through the loud-speaker windings will burn them out or cause some other damage.

The protective device mentioned above generally takes the form of either a 1:1-ratio transformer or an audio-frequency choke coil with a large fixed condenser placed in the plate lead of the power tube. By either of these means the high voltage is supplied to the plate of the tube without passing through the loud-speaker coils. In the Stroboddyne receiver the choke coil and condenser combination is used, as is indicated in the illustrations at O.F. In this system of protection the condenser prevents any of the high voltage from passing to the loud speaker, without impeding its progress to the plate; and the choke successfully stops any of the audio-frequency currents from getting into the "B" circuit, at the same time allowing free passage for the "B" voltage.

WIRING

The wiring on this set should be done by starting

FIG. 2A

The drilling specifications for the sub-panel of the 8-Tube Stroboddyne Receiver. To make it easier for the constructor the outlines of the different apparatus are drawn in dotted lines about the holes for mounting them on the sub-panel. The solid black holes are those through which the connections are run, from the upper to the lower side of the sub-panel, as shown in the wiring diagrams.

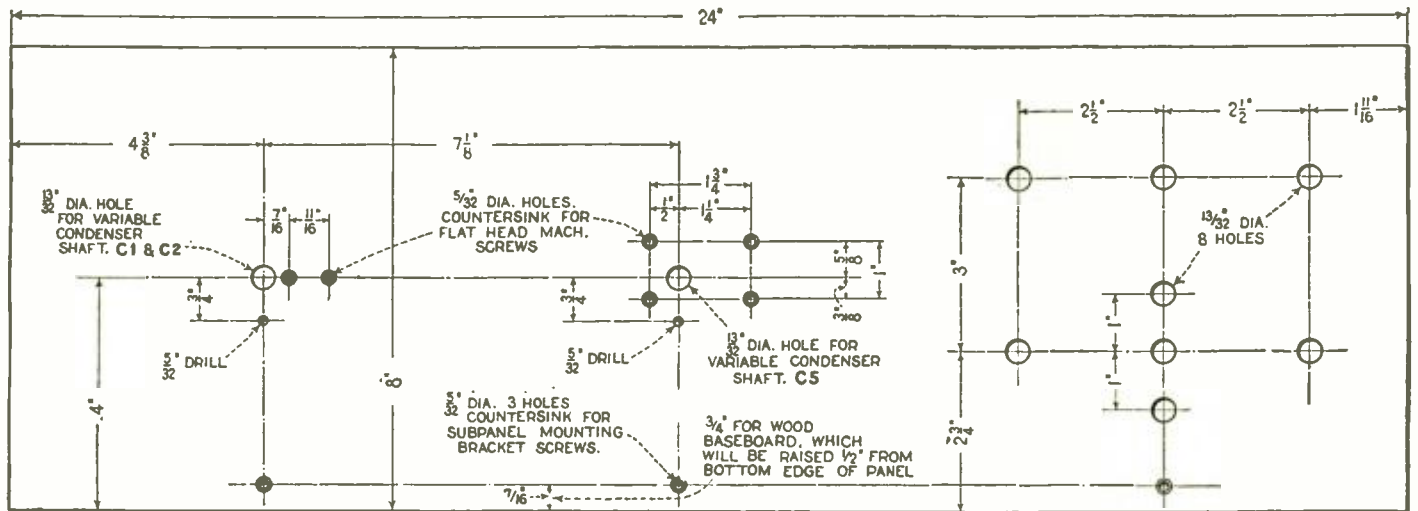

Fig. 2. The drilling specifications for the front panel of the 8-Tube Stroboddyne Receiver. Notice that, if a wooden baseboard is used, the dimensions of the mounting screws are changed.

from each binding post and running the wire to the various instruments in the circuit. The wire is looped, passed through the hole in the sub-base and after being cut, connected to the terminals of the various apparatus. (See diagram below.)

The wiring above the sub-base, which includes the grid, plate and other high-frequency leads, is made with bus bar covered with spaghetti where it passes through the shields. The rigid wiring is preferable because, once it is in place, the receiver may be balanced and the extra capacities caused by the proximity of the wiring to the shield may be compensated.

After the wiring is completed, check it carefully to make sure no lead has been left out or connected wrong. Then connect the "A" battery only and plug all the tubes into the sockets. Turn the rheostats up and the switch on, and see if all the tubes light. If they do, leave the "A—" lead connected, touch the "A+" lead to the various "B+" terminals, and notice if any of the tubes light. If some of them do there is a wrong connection or a short circuit, which

would burn out the tubes if the "B" voltage were applied. If none of the tubes lights during this test, everything is O. K., and the set may be completely hooked up for operation.

ADJUSTING THE RECEIVER

Before attempting to tune in signals one should adjust the equalizer mounted on the grid terminal of the R.F.-tube socket. This may be set so that there is a gap of about 1/16 to 1/8 of an inch between the copper plate and the mica sheet. It may have to be readjusted later if a whistle is noticed when turning the tuning condenser, but for most tubes this adjustment is about correct.

Next, the balancing condenser connected across the tapped auto-couple coil should be set so that the rotor is equally meshed with each of the two stators; and the long screw on top of the same coil should be turned so that the primary is just out of the secondary. Since the screw protrudes beyond the level of the shield cover, it is necessary to drill or cut a hole in the cover; this hole should be large enough so

that the screw does not touch the shield.

Set the equalizer mounted on the forward left condenser to leave a gap of about 1/8-inch between the copper plate and the mica. After these adjustments are made, turn the three rheostats on almost full and set the potentiometer so that the sliding arm is about in the center. Do not forget to turn the volume control up also. Then turn the two dials simultaneously to about the same readings. If the set is working properly, some signals should be heard; especially if the set is installed within a reasonable range of some broadcast stations.

To adjust everything to the point of greatest efficiency tune in a weak signal or use only a few feet of wire as an aerial and listen in with a pair of phones plugged in the first-stage jack. Then readjust the equalizer on the forward condenser with a small wooden-handled screwdriver until the signal is loudest. (Do not touch the metal of the screw driver, as this would produce an increase in capacity.) The weaker the signal, the easier it is to notice the point of best adjustment.

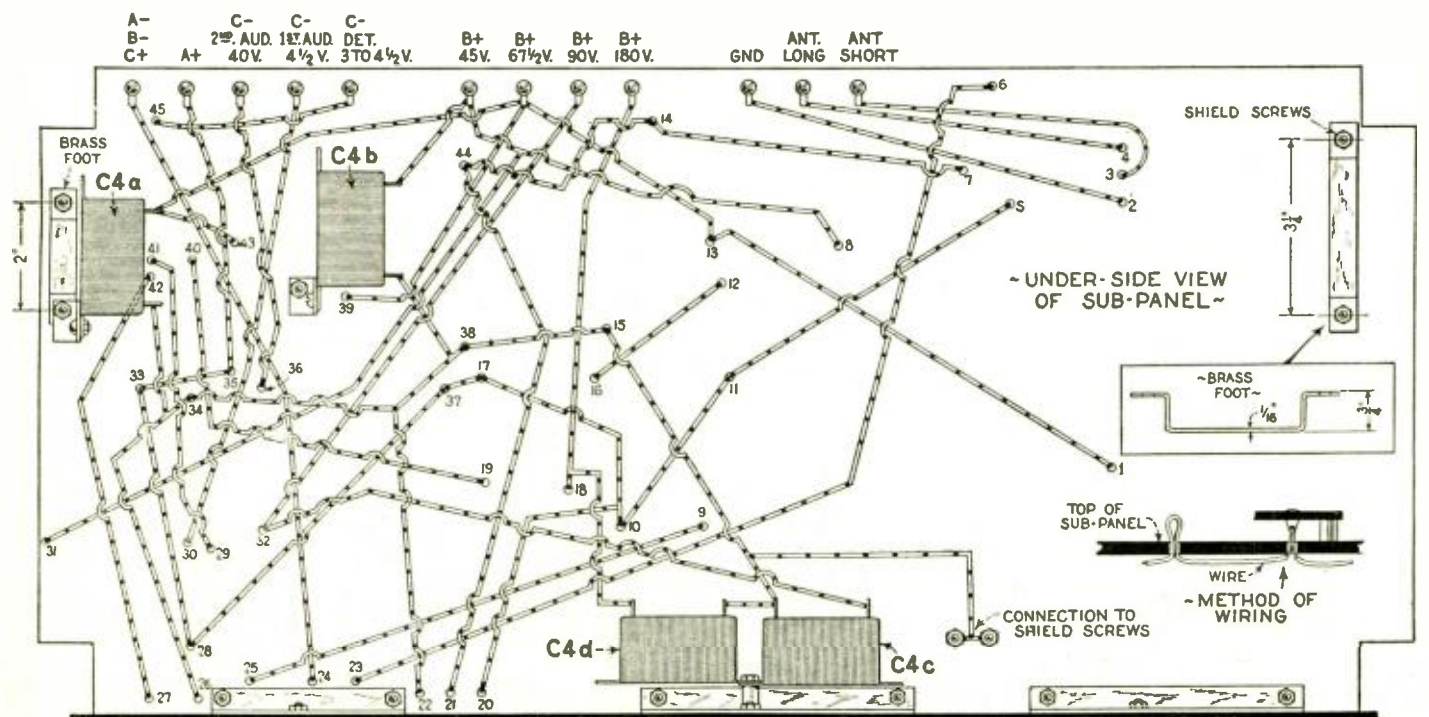

The wiring diagram for the under side of the sub-panel of the 8-Tube Stroboddyne. The four condensers C4a, C4b, C4c and C4d are by-pass condensers.

Notice, in the lower right-hand corner, the method which is used for running the connections between the different instruments.

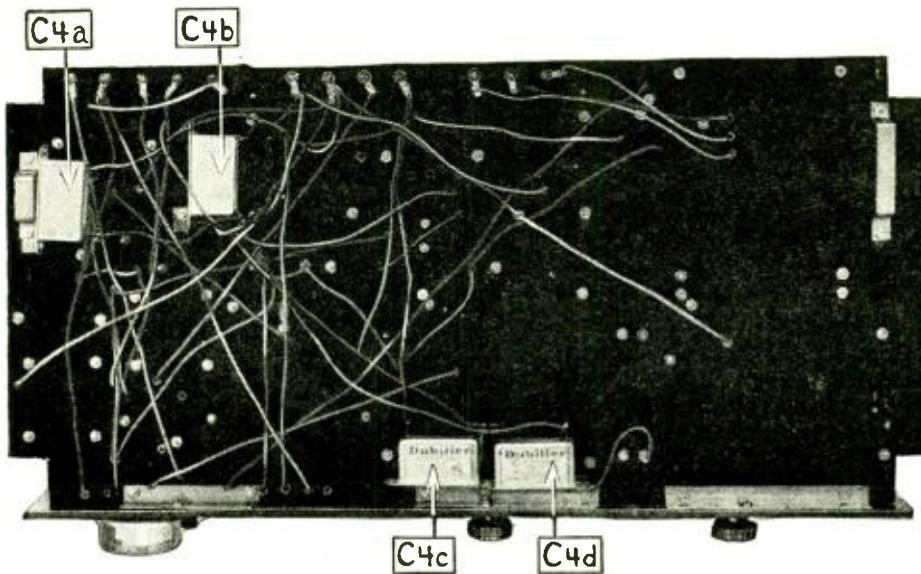

The view of the under side of the 8-tube Stroboddyne Receiver. This view shows the "golf" system of wiring employed in its construction. This facilitates the connecting of the apparatus.

NEXT MONTH

Further data on the Stroboddyne Receiver will be published in the September issue of RADIO NEWS.

Instructions will be given for the adaptation, with very slight changes, of the receiver described in this article for operation on a loop.

How to use the Stroboddyne Receiver with an A. C. power unit, including the use of a 171-type power tube, with A. C. on the filament, in the last stage, will be explained.

In addition to this, practical advice to the operator on the tuning and adjustment of the Stroboddyne will be given by Mr. R. E. Lacault.

—EDITOR.

Next readjust the three rheostats for best reception and leave them at this point. Adjust also the balancing condenser and the coupling of the tapped coil, until the weak signal comes in best. These adjustments, once made, need not be varied.

The readings on the two condensers are not exactly alike over the entire scale, but they are sufficiently close to make the tuning easy especially since, after a few stations are logged, it is easy to note the difference between the low and high figures on the scale.

BUILDING THE VARIOUS PARTS

For the more ambitious constructor, who wants to build everything himself, the complete constructional details are given for the coils. In order to have the set work right these should be very carefully made; otherwise the results will not come up to expectation.

Since the R.F. and input stages are tuned with a double condenser, the two coils must be exactly alike; otherwise the tuning will be broad. For the same reason the four tuned stages should tune on exactly the same frequency. This requires coils having the same inductance, and it may be necessary to adjust them individually with an oscillator and peak-voltmeter after they are wound. The method is described in an article by Professor Mitchell entitled "Matching Intermediate Wave Transformers for Superheterodynes," published on page 37 of the *Radio News Superheterodyne Book*.

Fig. 3 gives the data for the three coils. However, the coupling in these coils is fixed; because it is beyond the means of the average constructor to build the elaborate mechanism employed in factory-made coils to vary the coupling automatically.

It shows also the constructional details of transformers which may be used in the tuned amplifier.

ALL data on the Stroboddyne Circuit are published in conjunction with RADIO NEWS' sister publication, TSF MODERNE, of Paris. Sole rights to the publication of the Stroboddyne in the United States are held by RADIO NEWS.

LIST OF PARTS REQUIRED FOR THE EIGHT-TUBE STROBODDYNE RECEIVER

SYMBOL	Quantity	NAME OF PART	REMARKS	MANUFACTURER *
C1, C2, C5	3	Variable Condensers	.00035 mf.	1 54
L1	1	Auto Couple Coil	Special tapped	
L2	1	Auto Couple Coil	Special	1
L3	1	Auto Couple Coil	Regular	1
L4	4	R.F. Units (tuned)	Plug-in type	2
C7	5	Fixed Condensers	Match-1	2
	3	Shields		1
T1, T2	2	A.F. Transformers		3 17, 19, 20, 22, 23, 24, 25, 28
OP	1	Output Filter		4 18, 20, 25, 46
PFC	1	R.F. Choke		3 19, 22, 24, 25, 26, 27, 28, 29, 30
C6	1	Compensator Cond.	2 stator - 1 rotor	5 10, 31
R1, R2, R7	3	Rheostats	20 ohms	6 11, 21, 24, 25, 32, 33, 45
RA	1	Potentiometer	400 Ohms	6 10, 11, 21, 24, 25, 32, 33, 45
C4	4	By-pass Condensers	.5 mf.	7 6, 11, 24, 25, 28, 35, 37, 38, 55
C8	1	Fixed Condenser	.002 mf.	7 6, 11, 24, 25, 28, 35, 36, 38
	8	Sockete	UX type	8 19, 20, 22, 29, 30, 39, 40, 41, 45, 46
SW	1	Filament Switch		6 8, 10, 11, 21, 25, 32, 41, 42, 43, 45
J1, J2	2	Short Jacks	1-2 circuit and 1-1 circuit	6 11, 21, 43, 45
	12	Binding Posts		9 12, 21, 24, 39, 44
	2	Dials		18 10, 22, 19, 24, 26, 29, 30, 39, 44, 46
R3	4	Filament Ballasts	5 volts, 1/4 ampere	15 6, 21, 31, 47, 48
R4	1	Filament Ballast	5 volts, 1/2 ampere	15 6, 21, 31, 47, 48
C3	2	Balancing Condensers		1 9, 25, 31
R5	1	Variable Resistor	100,000 ohm	11 6, 25, 32, 33, 34, 45
	1	Panel	8" X 24" X 3/16"	12 49
	1	Subpanel	12" X 25 1/2" X 1/4"	12 49
	6 ds.	Machine Screws	6/32 - 1" long with nuts	
	1/ft.	Angle Brass	1/2" X 1/2"	
	2	Rolls of Wire	Rubber Covered	13
		Spaghetti		
	1	Cabinet	For panel 8" X 24" X 12 1/8"	16
	1	Brass Shaft	1/4" diameter 10 1/4" long	1
	7	Vacuum Tubes	20L-A type	14 50, 51, 52, 53
	1	Vacuum Tube	112 type	14 50, 51, 52, 53

NUMBERS IN LAST COLUMN REFER TO CODE NUMBERS BELOW.

1 Hammarlund Mfg. Co.	2 Radio Elec. Laboratories	3 Sanson Elec. Co.
4 Interstate Sales Co.	5 Cordwell Mfg. Co.	6 Carter Radio Co.
7 Dubilier Condenser & Radio Corp.	8 Benjamin Electric Mfg. Co.	9 X-L Radio Lab.
10 Martin Copeland Co. (Marco)	11 Electrad, Inc.	12 Miarta Fabricators, Inc.
13 Belden Mfg. Co. (Colorubber)	14 C. R. Mfg. Co.	15 Bestall Co. (Auraria)
16 D. H. Fritze & Co.	17 Premier Electric Co.	18 National Co. Inc.
19 Brewer Tully Mfg. Co.	20 General Radio Co.	21 Tuxley Mfg. Co.
22 All-American Radio Corps.	21 Thordarson Electric Mfg. Co.	24 Electrical Research Labs. (Eria)
23 Leslie P. Water Co.	26 Karas Electric Company	27 Radio Engineering Labs. (REL)
26 Radio Receptor Co.	28 Silver-Marshall, Inc.	30 Gray & Hamilton Mfg. Co. (Sawler)
31 Davon Radio Corp.	32 Allen Bradley Co. (Bradlevat)	33 Central Radio Labs.
34 American Mechanical Lab. (Clarostat)	33 Sengco Electric Co.	36 Aerovox Wireless Corp.
37 Ingrad Condenser & Mfg. Co.	34 Sprague Specialties Co.	38 H. H. Eby Mfg. Co.
40 Airgas Products Co.	41 Cutler Hammer Mfg. Co.	42 Bruno Radio Corp.
43 Bryn M. Electric Co.	42 Hart & Hegeman Mfg. Co.	43 Herbert H. Frost, Inc.
46 Alden Mfg. Co.	43 Langbein Kaufman Radio Co. (Flkey)	44 L. S. Braoh Mfg. Co.
49 American Hard Rubber Co. (Radion)	50 F. T. Cunningham, Inc.	51 Radio Corporation of America
52 Zetka Laboratories	51 Supertron Mfg. Co.	52 Oakfield Radio Mfg. Co.
55 Acme Wire Co.	52	57

* THE FIGURES IN THE FIRST COLUMN OF MANUFACTURERS INDICATE THE MAKERS OF THE PARTS USED IN THE ORIGINAL EQUIPMENT DESCRIBED HERE.

If you use alternate parts instead of those listed in the first column of manufacturers, be careful to allow for any possible difference in size from those originally used in laying out and drilling the panel and sub-base.

Copyright 1927. E. Pub. Co.

A Six-Foot Horn of Exponential Design

Instructions for Building an Efficient Speaker of Heavy Paper

By R. E. BAUMGARNER

IN recent issues of RADIO NEWS directions have been given for the construction of cone speakers. The increasing interest in the exponential horn, stimulated by its application to high-quality phonograph and radio reproduction, has brought many requests from readers for the details of its construction. Mr. Baumgarner describes the easy method by which he has built, at trifling cost, a very efficient speaker of this type. —EDITOR.

AN exponential horn of correct design will, in conjunction with a nearly-perfect amplifying system, reproduce notes as low as 35 cycles and higher than 4,000 cycles. It can be seen that all voice frequencies and nearly all ordinarily audible frequencies are included in its range.

The exponential horn differs from the ordinary conical horn in two distinct respects: first, it is radically different in design. The conical horn increases its diameter by adding a constant figure to the preceding diameter at the end of each unit of length. For example, at the end of the first foot we add an inch to the preceding diameter, the first being the diameter at the bottom. At the end of the second foot we add another inch, and so on to the end of the horn; adding a constant figure to the preceding diameter, until the end is reached. The exponential horn increases its diameter with a constant multiple for each unit of length; each unit must expand in

an equal ratio. The two principles are shown graphically in Fig. 1.

The second difference is in their respective lengths. Heretofore the longest loud speaker in common use measured about two and a half feet. As a result, its average range was limited from about 200 to 1,500 cycles. This greatly-limited range cut off most of the harmonics and delicate overtones which are necessary to good music.

SIMPLE MATERIALS REQUIRED

Two methods of making an exponential horn are here cited, and each serves its purpose faithfully. Before constructing a new horn for the parlor or living-room, the average constructor wishes to experiment

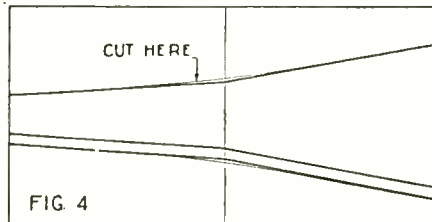

How the cutting of the paper is rounded out from that in Fig. 3.

and practice a little. In order to do this, material found in almost any home is utilized.

Ordinary wrapping paper is used in the first attempt. When we have mastered the peculiarities of the construction of an exponential horn we may use stiff paper of the kind used for cone speakers.

First, we shall need several sheets of heavy brown paper, such as used in wrapping laundry, a small box of rivets of the split-shank variety, preferably of brass, and a number of thin fibre or heavy paper washers, having holes to fit the rivet shank (Fig. 2). The remaining factor is a quarter of a pound of glue, commonly known as "horse glue." This may be obtained at any hardware store, at about 40 cents the pound. The flake variety is the best, but that which comes in flattened bar form will suffice.

The paper must consist of four thick-

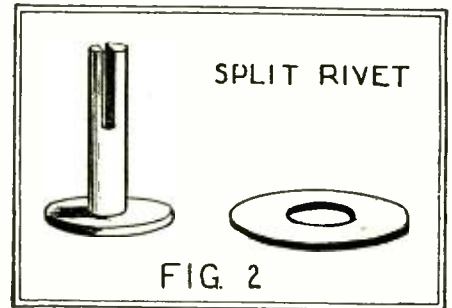

A split rivet and washer of the kind used for fastening the two sections of the horn.

nesses, cemented together by cooked starch paste. All the wrinkles must be smoothed out. This sort of paste is so strong that, when the paper cemented with it is dry, the paper will tear before the two sheets will separate.

We shall need five pieces 18x38 inches, each consisting of four layers of paper.

METHOD OF CONSTRUCTION

For convenience in marking and handling, the horn is divided into two sections; the lower having one segment, and the upper having four segments. The lower segment is identical with the four upper ones, except that it is two inches shorter.

When the five sections have been made up of their respective four sheets each and are thoroughly dry, we may begin to mark off the lines to guide in cutting. To aid in doing this, a yardstick and soft lead pencil are necessary. Each of the five sheets is marked with a line running through its center, from end to end. Now we start marking the first sheet, for the lower section. A two-inch strip is cut from its length, so that it now measures 18x36 inches. At the bottom of the paper, measure one and a half inches on each side of the center line and place dots accordingly; and place another dot an inch to right of the dot already on that side. This extra inch is to allow a lap for gluing. Eighteen inches from the bottom these dots are again placed, but this time three inches on each side of the center line. Be sure to place the extra dot an inch to the right as before. At the top of the paper we measure six inches on each side of the center line, and again add the inch for lap. This inch lap is marked on every piece. Its importance cannot be emphasized too much. With the yardstick connect the dot at the bottom with the dot on the same side near the center with a straight line. The end of this line which terminates near the center is connected with the dot at the top on the same side. The remaining dots are connected in the same manner. The finished piece will resemble the sketch in Fig. 3-A.

All the other pieces are done in a similar manner, but for one exception: the two inches which we cut off the first sheet is merely indicated by a ruled line on the other four sheets. Instead of starting at the bottom of these when marking, we start on this line two inches from the bottom (See Fig. 3-B). When the lines are drawn to connect the dots on these four sheets, the first line is extended down across the two-inch piece which was marked off from the segments to begin with.

It will be seen that the three dots are not in a straight line. The exponential principle explains this eccentricity.

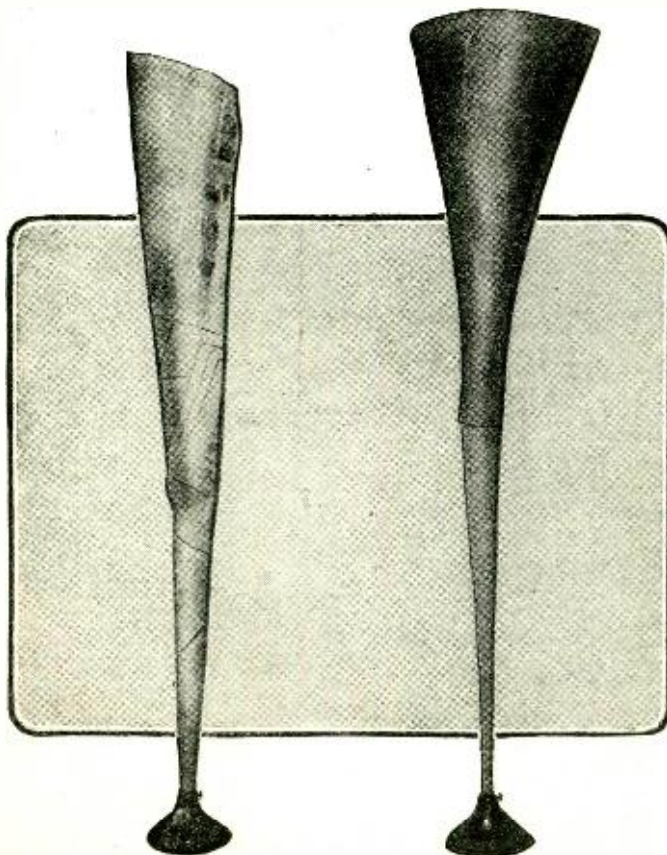

The horn at the left is an experimental one of the conical type; it is made of newspaper. The one on the right is of the exponential design, and was made according to the directions in the accompanying article.

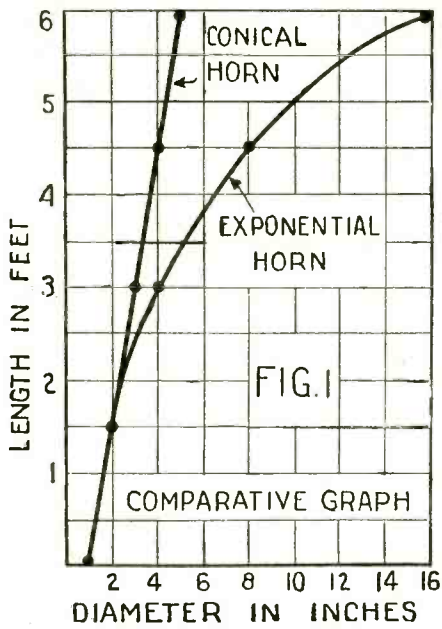

This curve shows the difference, in the rate of expansion, between an exponential and a conical horn.

Now that all the segments are marked off, we may begin to cut them out. Starting at the bottom on the line at the left, cut close along it until a point about four inches from the bend of the line, or rather the intersection of the two lines, is reached. Here we begin to leave the line and gradually round out just enough to keep the turn from being angular. This is clearly shown in Fig. 4. The heavy line is the one we first marked, and the light one is the one showing the direction in which we cut. On the right side of the segment we cut the *outside* line, marking the edge of the lap. If the inside one is cut, our whole segment will be ruined. An ounce of prevention is worth a pound of cure, you know. This outside edge is rounded out as was the first. All the segments undergo the same treatment.

ASSEMBLING THE SEGMENTS

The next operation is perhaps the most difficult. It is on this that the efficiency of the whole horn rests. If a good job of gluing is done, decided efficiency results.

The lower section is rolled on a long, round wooden rod about an inch in diameter. A broomstick will serve the purpose very nicely. The upper segments are rolled likewise over a larger rod, about four or five inches in diameter. This little kink helps the horn to form more naturally when glued. The resultant curl is also a great advantage when glueing.

The rivets and their washers play an important role. Holes for the rivets are punched at intervals of four inches along the laps by means of a small nail or punch. Care should be taken to see that the holes are just a half inch from each edge of the paper. This situates them in the center of the lap. Now we are ready to glue the parts of the horn.

The "horse glue" has first been soaked in a small amount of water overnight, and cooked in a double boiler afterward. Before application it should be quite warm and of the consistency of syrup.

The lower half is glued first. The warm "horse glue" is spread thinly, but thoroughly over the inch lap. The marked side should be on the outside. The rivets and washers are inserted and the two edges are pulled together by them. The rivets are then split to hold them in place. If some of the inside of the lap is left unglued, the horn will rattle and clatter when it is used.

Following this, the other sections are

glued, in pairs. The first two are glued together with glue and rivets, and the second two are done in the same manner. Care must be exercised here. The laps must be on opposite sides of the sheets. The edges of each section must run along the lap lines, or the proper curve of the horn will not be obtained. When these are dry, all are glued together, forming the "bell" (See Fig. 5).

When this is dry all the rivets used previously should be removed. The two halves of the horn must now be joined. To do this, the small part is inserted in the larger one and is pulled down into it until the upper end of the small part fits firmly around the lower end of the large part. Do not pull it down too far, or the upper end of the small part will buckle. When

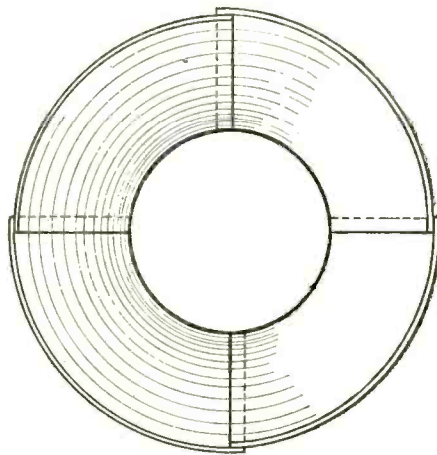

FIG. 5

The appearance of the "bell" of the exponential horn after assembling.

the two parts fit satisfactorily, rivet holes are punched. Only a few will be needed, due to the small diameter of the horn at

this part. The small section is then removed and glue is applied outside around its top, extending down about two inches, not more. This small section is replaced in the larger one, the rivets set, and it is left to dry.

The remainder of the work is only finishing. When all the rivets are removed, the holes are covered with brown paper. To improve its appearance and tone quality, the horn should be given several coats of a good grade of black paint.

USE OF SPECIAL PAPER

A neater and more efficient horn can be constructed of the new cone paper, which has no fundamental frequency of its own. This paper can be obtained in sheets 38x38 inches. Three such sheets are required, but only five halves are used. The sheets must be cut in halves, cutting with the "grain" of the paper. This is absolutely necessary, because if they are cut the other way, considerable wrinkling will be the result. A special cement is needed. This may be procured from the manufacturers of the cone paper.

All the foregoing specifications are adhered to, as this horn is identical in construction with the first.

Owing to the parchment-like texture of the cone paper, it is easily decorated. It may be hand painted in design, or shellac may be applied to its surface.

AMPLIFIER AND SPEAKER UNIT

It is grossly unfair to expect startling results if a reproducing unit or amplifier of poor quality or workmanship is employed. With a good transformer-, impedance-, or resistance-coupled amplifier, and a power or semi-power tube in the last stage, this horn produces excellent results. And by all means, *don't* try to use this horn without an output unit between the last tube and the speaker unit. It simply can't be done satisfactorily. The writer prefers a good output transformer to a condenser-choke arrangement. The output
(Continued on page 181)

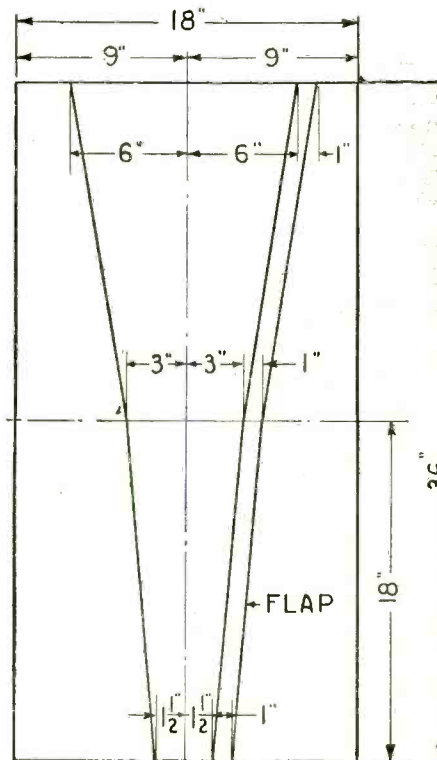

FIG. 3 A ONE REQUIRED

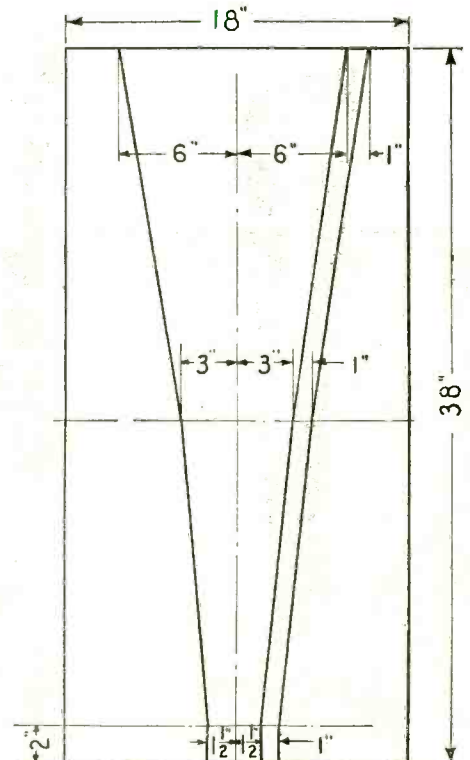

FIG. 3 B FOUR REQUIRED

The sizes of the parts required to build up the two sections of the experimental-horn loud speaker are given in the sketches above. The method of laying out and assembling them is fully described in the text.

A New Double-Impedance A.F. Amplifier*

Details of a Unit Which Can be Matched to the Loud Speaker

By G. C. B. ROWE

DURING the last two years radio enthusiasts have been becoming more particular about the quality of reproduction afforded by their receivers. It matters not how selective or sensitive your set may be; if the reproduction of the signals picked up is not of the best, what is the use of listening to something that pains the aesthetic sense?

The double-impedance audio-frequency amplifier which is described in this article will, when properly constructed and adjusted, assure the builder of reproduction of the highest quality. It can be so adjusted that it will compensate for some of the discrepancies in the loud speaker; and utilizes successfully the much abused audio-frequency regeneration. The experiments which can be performed with it are manifold.

—EDITOR.

IT must be admitted that great steps have been made in the improvement of audio-frequency amplifiers, within the last year or two; and at the present time almost any type of amplifier, whether transformer, impedance- or resistance-coupled, will give very satisfactory results. However, little has been accomplished in the line of regulating audio-frequency amplifiers to meet the shortcomings of some types of loud speaker. Most loud speakers are somewhat deficient on the lower frequencies, so that, if a uniform sound output is to be had, it is necessary to slightly over-amplify the low-frequency notes in the audio-frequency-amplifier circuit. Until the introduction of the tuned double-impedance A.F. amplifier, described in this article, it has been difficult to obtain a sufficient amount of amplification at low frequencies to make up for this deficiency of the loud speaker. Now, however, it is not only possible and practical to do this, but the amount and degree of low-frequency amplification can be adjusted to suit the tastes and the hearing of the listener.

WELL-DESIGNED AMPLIFIER

The tuned double-impedance A.F. ampli-

fier, invented by Mr. E. E. Hiler, looks very much like any other form of double-impedance amplifier and, so far as the circuit is concerned, there is very little difference. It is an interesting fact that the operation of the amplifier was predetermined solely through the means of mathematics.

This amplifier is tuned much in the same way as a radio-frequency amplifier, except that each of the stages is adjusted permanently to some predetermined frequency. As a matter of fact, if sufficient coupling is introduced into the circuit, each individual stage can be made to oscillate at the frequency to which it is tuned.

The amplifier can actually be made to regenerate. Each stage provides tremendous

An interesting fact about this amplifier is that, if a 201A tube is used in the last stage with about 135 volts on the plate and an appropriate grid bias, the output will be practically distortionless and the tube will not be overloaded. In the amplifier constructed in the RADIO NEWS LABORATORIES, which is shown in the accompanying illustrations, a 112-type power tube is used for the sake of greater volume, and clarity and is so specified in the list of parts. However, for the man who wishes to experiment with this amplifier, the fact that a 201A tube can be used is mentioned.

COMPENSATING ADJUSTMENTS

The tuned double-impedance amplifier here described can be so adjusted that the frequency characteristics of the three stages and the output of the last tube are made to conform with the frequency characteristics of

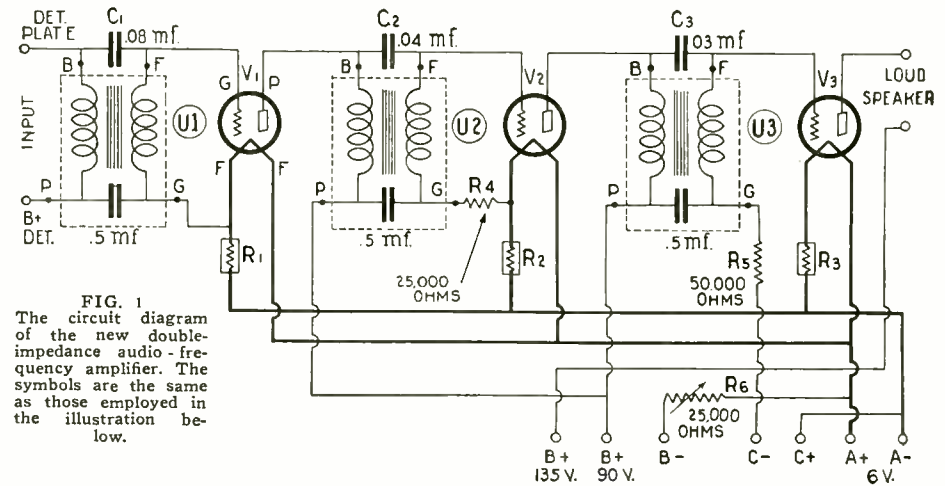

FIG. 1
The circuit diagram of the new double-impedance audio-frequency amplifier. The symbols are the same as those employed in the illustration below.

amplification in the low-frequency scale. Furthermore, the amount of over-all audio-frequency regeneration can be controlled by the variable resistor and the extent of regeneration in each of the three stages can be controlled by a separate resistor. This means that greater volume can be had at, say 50 cycles, than at 80 cycles, or *vice versa*, merely by adjusting the individual stages. The result is quite remarkable.

the loud speaker in use; that is to say, if the loud speaker fails to reproduce low-frequency notes to the same degree as high-frequency notes (which is usually the case), the tuned double-impedance amplifier can be adjusted to amplify low-frequency notes to a much greater degree than would otherwise be necessary. The result is a uniform frequency-response output.

Incidentally, this method of proportioning amplification to the energy requirements of the loud speaker brings about several other important effects. In the first place, a steady average grid potential is maintained. Next, it eliminates motor-boating without any other apparatus, such as large condensers or inductances. Also it provides complete magnetic shielding, which, aside from other considerations, tends to absorb any radio-frequency currents that may enter the audio-frequency circuits.

DOUBLE-IMPEDANCE UNIT AND CIRCUIT

The double-impedance unit consists of a laminated figure-8 core, carrying one coil on each outer leg. By placing the windings in this manner, it is possible to practically isolate the windings magnetically. Figs. 2 and 3 give the details and elements of the circuit. L1 and L2 are the windings, and C is a condenser put across the plate and grid connections. A variable resistor, with a maximum value in the neighborhood of 50,000 ohms, is put in series with the impedance in the grid circuit (as shown at X, Fig. 3), and used to adjust the resonance peak, as will be

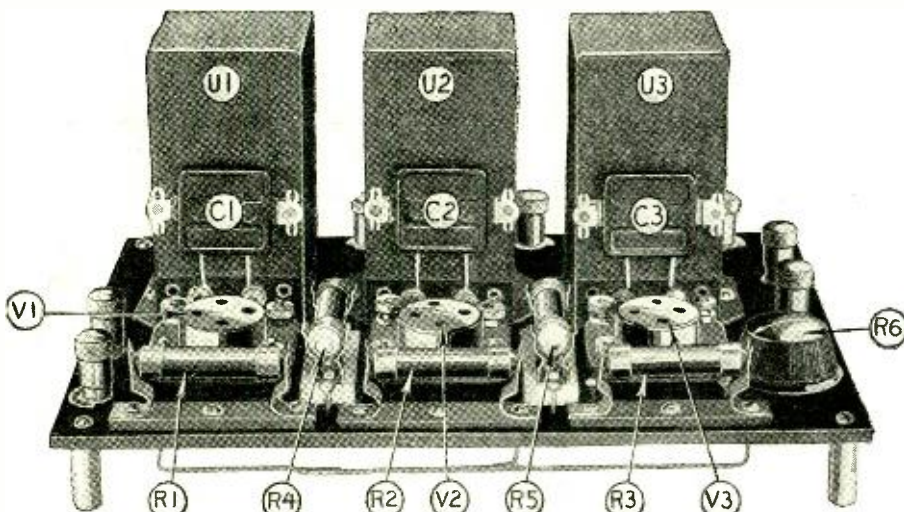

U1, U2 and U3 are the impedance units; C1, C2 and C3, the coupling condensers, which are supported by their bus-bar connections; R1, R2 and R3, filament ballasts; and R4 and R5 resistors.

* RADIO NEWS Blueprint Article No. 28.

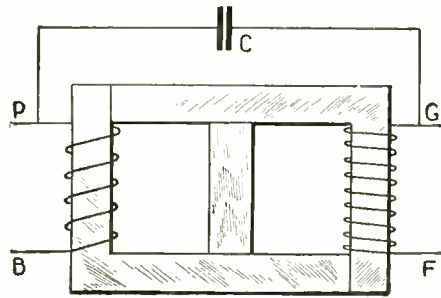

FIG. 2

Above is shown the manner in which the windings are placed on the "figure-8" core.

explained later on. This is used in the second and third stages only.

For the most perfect results that can be obtained from tuned audio-frequency amplification, the three stages of double impedance should be so designed that they will compensate the response curve of the particular type of loud speaker that is to be used. While this system lends itself to mathematical calculations, the values can be also determined with ease experimentally.

In most cases, as in the coils used in the amplifier here described, standard windings and a standard coil are used in all three stages. The units are, therefore, matched to the loud speaker by the proper selection of coupling condensers, and by the introduction of resistances, if they are needed, in one or two stages in series with the grid coil.

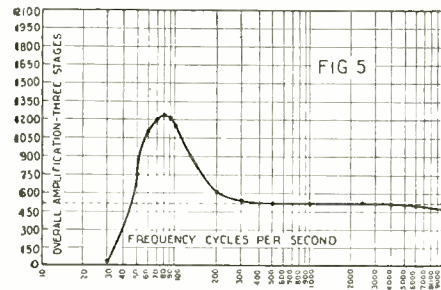

FIG. 5

The frequency-characteristic curve of a three-stage tuned double-impedance amplifier.

COMPENSATING SPEAKER CHARACTERISTICS

The response curves of the highest-type cone speakers start to drop off quite steeply at about 200 cycles. Therefore, the problem of producing reproduction as nearly perfect as possible is in building up this response curve from 40 to 200 cycles; and this without changing the curve above the latter figure. This change would occur if a large by-pass condenser were connected across the plate and filament of the detector tube. In the double-impedance amplifier this effect is attained through staggering the resonance peaks of the three stages by using different values of coupling condensers.

Let us take a practical example. Using standard coils, if coupling condensers of .08 mf., .04 mf., and .03 mf. capacity, are used in the first, second and third stages respectively, the resonance peaks are at 50, 70.7, and 81.6 cycles respectively. This is clearly shown in Figs. 4 and 5. Fig. 5 shows the over-all frequency characteristic of a three-stage amplifier of the double-impedance type.

Transformers capable of amplifying frequencies as low as 30 cycles, or the ordinary resistance-coupled amplifiers, cause trouble known as "motor-boating," because the amplification does not cut off sharply just about 30 cycles. Motor-boating occurs between

zero and a value just above 30 cycles, usually because the filter systems used in socket-power units are resonant within that band. Therefore, to eliminate this motor-boating without external apparatus, the over-all amplification must not exceed approximately twenty. A well-designed resistance amplifier with three stages has an amplification factor somewhere around forty or fifty at 30 cycles. This frequently causes motor-boating. In contrast to this the tuned double-impedance amplifier of three stages gives only a factor of 11.8 at 30 cycles.

In Fig. 4, the heights of the resonance peaks in the second and third stages have been adjusted by resistances in series with the grid coils in the second and third stages. This is done in order to produce a uniformly-rising over-all amplification curve from 200 cycles to the cut-off frequencies.

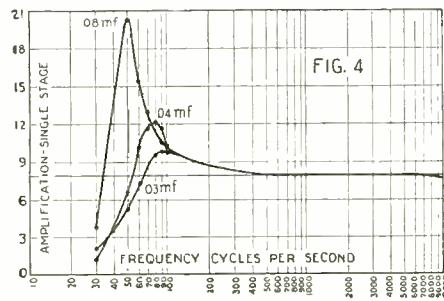

FIG. 4

The plotted curves of three stages of tuned double-impedance amplification, each using a coupling condenser of different value.

A.F. REGENERATION

Audio-frequency regeneration can play a very important part in the tuned double-impedance amplifier system, and it can be used to great advantage, because the resonance peaks are at low frequencies.

While the idea of audio-frequency regeneration dates back to the time when the regenerative circuit for detectors first came out, it was never considered practical to make use of this principle. Instead, it has been the aim of engineers to design audio amplifiers to avoid regeneration as much as possible. The fact that no precautions against feed-back have been taken in most audio circuits of radio sets accounts for the fact that the over-all characteristic curve of

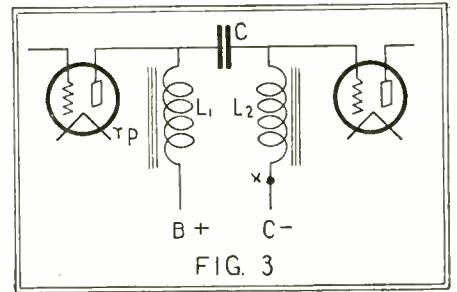

FIG. 3

The fundamental circuit of the amplifier. By adding resistance at X, the resonance peak can be adjusted.

the amplifier looks very different from the curves of the individual transformers.

CONSTRUCTION

As may be seen from the illustrations, the three impedance units are lined up at the rear of the panel, which should be 1/4-inch thick; because of the weight of the apparatus would tend to bend a panel any thinner. Immediately in front of each impedance unit is the vacuum-tube socket with its filament-ballast resistor; two of these being for 201A tubes and the third one for a power tube. The coupling condensers C1, C2, and C3 are mounted with leads as short as possible from the plates and grid connections of the impedances. As mentioned before, it is very important to have the values of these condensers as near as possible to the specified capacities.

In the amplifier here described there have been used, instead of variable resistors, fixed resistors, the values of which have been found to peak the characteristic curves of the different stages at the most efficient values for compensating the low-frequency drop of the loud speaker. The condenser values, of course, also fix this peak. The variable resistor, R6, with the value of 25,000 ohms, is in the "B—" lead. This controls the audio-frequency regeneration.

The input binding posts are at the left side of the panel, the loud-speaker output being at the right, while along the rear of the panel are seven binding posts for the "A," "B" and "C" battery connections. If it is so desired, the constructor may use a battery cable instead; but, for clarity and ease of connections and testing, the amplifier built in RADIO NEWS LABORATORIES uses binding posts.

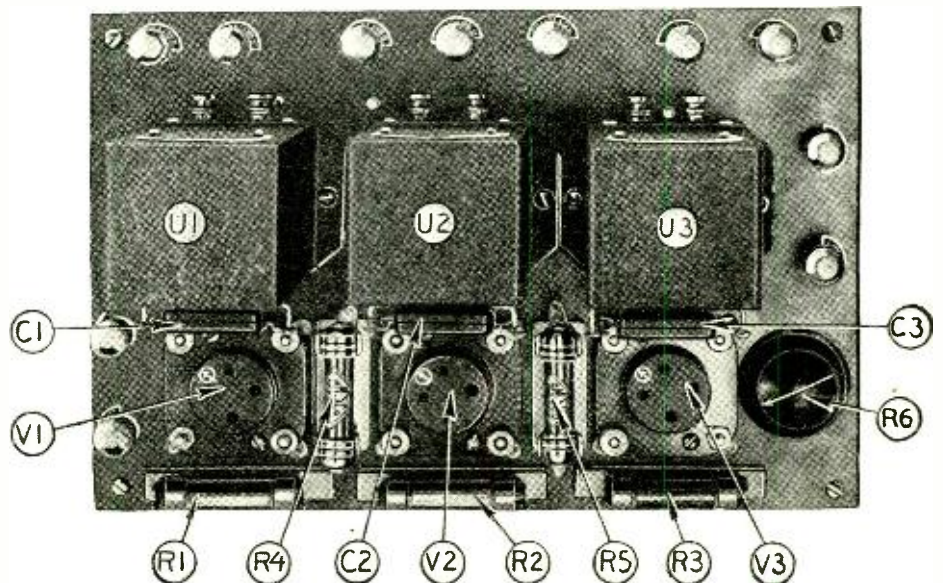

R6 is a 25,000-ohm variable resistor, controlling the A.F. regeneration. The two binding posts at the left side are the input, and the two at the right are the output. Those along the rear of the panel are indicated on accompanying illustrations.

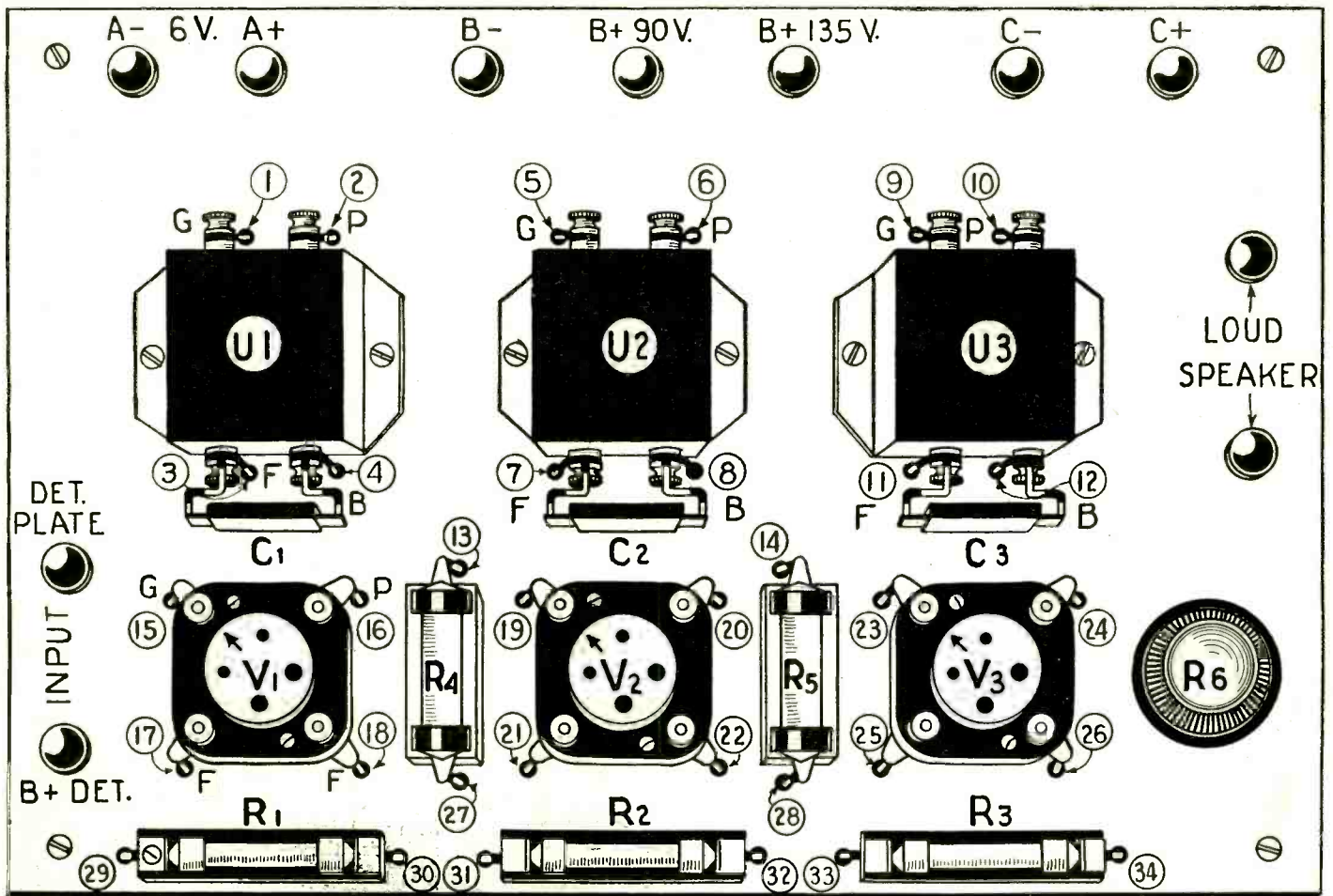

How the apparatus is laid out on the panel. The symbols are identical with those on the other illustrations.

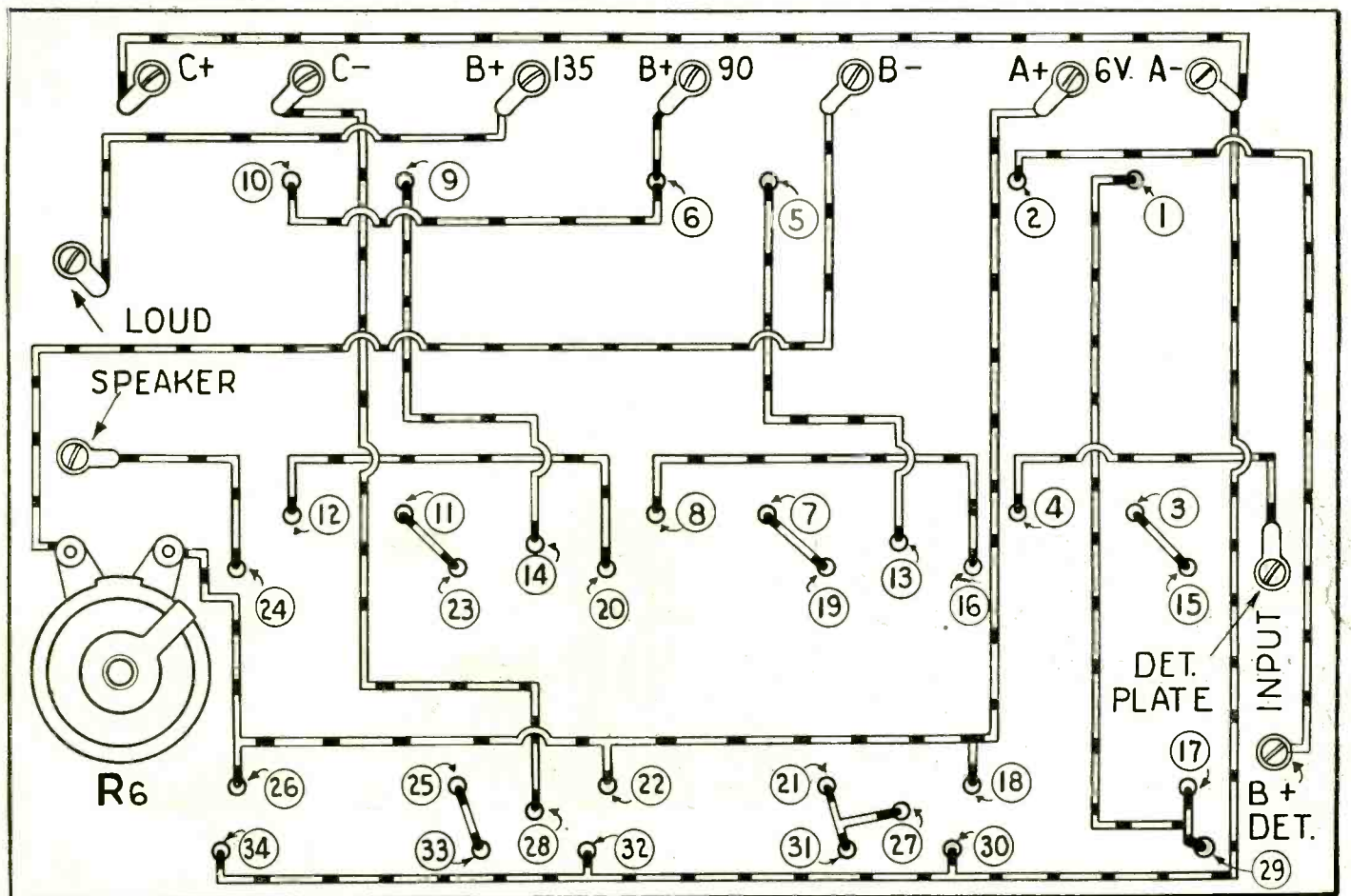

Wiring diagrams of the A.F. Amplifier. Most of the connections are beneath the panel. The holes are numbered alike in the top view (above) and bottom view.

THESE HOLES $\frac{3}{32}$ " DIAMETER
ALL OTHER HOLES $\frac{5}{32}$ "

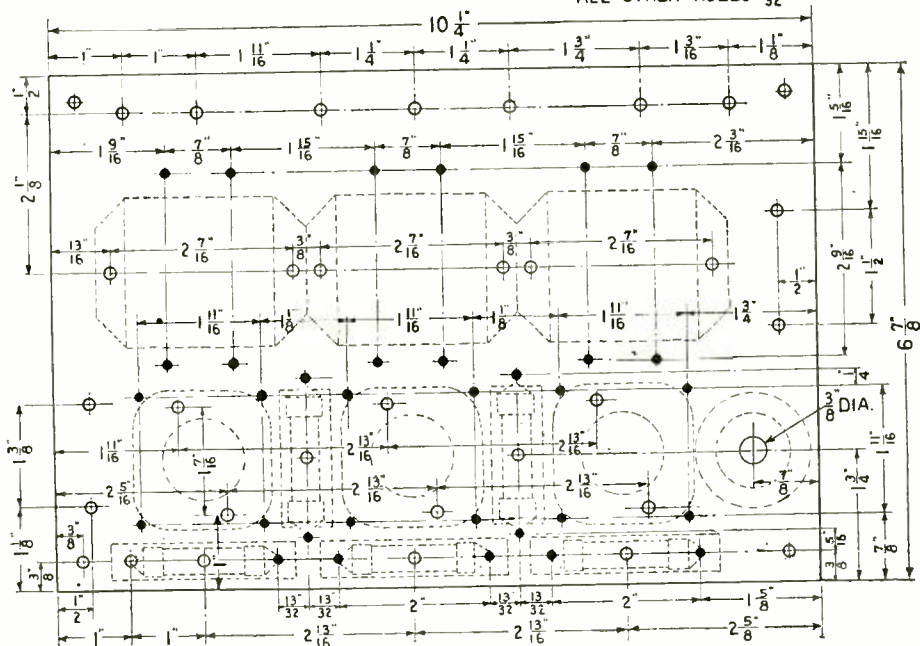

As may be seen from the illustrations, the majority of the wiring is done beneath the panel, which is raised one inch above table level by means of brass rods. The unit can be installed in a set, instead of the amplifier now used, merely by connecting the output of the detector tube to the input of the amplifier and making corresponding changes in the leads to the binding posts of the amplifier.

If he desires to experiment with this amplifier, the constructor will find a large field open to him. Instead of using fixed resistors at R4 and R5, variable resistors of approximately the same values can be inserted and the A.F. regeneration varied to provide different peaks for the last two units; thus matching the entire amplifier to the loud speaker which is to be used.

AMPLITUDE AND FREQUENCY

"A frequency characteristic curve is made with a constant amplitude or "volume"; but it is also important to know what happens when the frequency is kept constant and the volume varied," says Mr. Hiler in an explanation of the technical considerations required by his work on the design of the amplifier. "This is called an 'amplitude characteristic' and shows the amount of amplification obtained with different degrees of amplitude.

"Since the amplitude of the fundamentals and harmonics is not the same in any two instruments or any two tones on the same instrument, and sometimes *even varies as the same tone is sustained*, it is very important that waves of different amplitudes of the various tones and overtones be amplified to the same degree in order to reproduce the relative amplitudes of these tones and overtones in their original relationship. Tone quality is therefore dependent on two variables, frequency and amplitude.

"For instance, we are listening to a musical tone and we increase the volume until a point is reached where that quality which we had virtually "goes to pieces." The ability of a receiver or reproducer to produce an amount of volume without harmonic distortion is usually called its "undistorted power output." It is measured in a receiver by the square of the allowable maximum grid-voltage swing.

"An experience common to all is recalled when we have had a "rattle" in our loud speaker and were unable to tell by the ear alone whether or not the rattle was in the speaker or in the set. A rattle in a set is by

In the illustration shown above are given the instructions for drilling the panel on which the apparatus is mounted. The apparatus can be located by the dotted outlines. The holes shown in solid black are those through which the connecting wires are run to the apparatus above. The reason for making the panel $\frac{1}{4}$ inch thick is the weight of the different parts, which would cause a thinner panel to sag in the middle. On the right is an illustration of the wiring beneath the panel, with the variable resistor in position. The legs of the amplifier are of $\frac{1}{2}$ -inch brass rod. Below is the list of necessary parts, designated by the same letters as in the illustration.

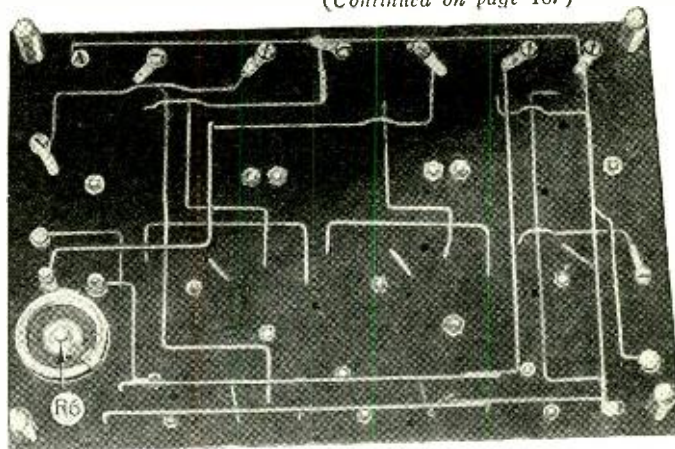

(Continued on page 167)

SYMBOL	Quantity	NAME OF PART	REMARKS	MANUFACTURER *
U1,U2,U3	3	Double Imped. Units		1 33,34,35,36
C1	1	Fixed condenser	.08 mf. capacity	2 16,17
C2	1	Fixed condenser	.04 mf.	2 16,17
C3	1	Fixed condenser	.03 mf.	2 16,17
R1,R2	2	Filament ballasts	5 volts, 1/4 ampere type	23 3,5,13,17,22,24
R3	1	Filament ballast	5 volts, 1/2 ampere type	5 3,13,17,22,23,24,27
R4	1	Fixed resistor	25,000 ohms	6 2,14,15,17,18,19,21,22,25,27
R5	1	Fixed resistor	50,000 ohms	6 2,14,15,17,18,19,21,22,25,27
R6	1	Variable Resistor	25,000 ohms maximum	3 6,14,15,19,21
	11	Binding posts		7 6,12,13,14,15
	1	Baseboard	10 1/2" X 7" X 1/4"	8 29
V1,V2	2	Vacuum tubes	20L A type	9 10,11,28,30,31,32
V3	1	Vacuum tube	112 type	9 10,11,28,30,31,32
	4	Brass rods	1" X 1/2"; feet for baseboard	
	27	6-32 Machine screws	For fastening parts	

NUMBERS IN LAST COLUMN REFER TO CODE NUMBERS BELOW.

- | | | |
|-----------------------------------|---------------------------------------|------------------------------------|
| 1 Ford Radio & Nica Company | 2 Aerovox Wireless Corp. | 3 Carter Radio Co. |
| 4 Benjamin Electric Mfg. Co. | 5 Radiall Co. (Amprite) | 6 Amaco Products, Inc. |
| 7 K-L Radio Labs. | 8 Micarta Fabricators, Inc. | 9 E. T. Cunningham, Inc. |
| 10 C. F. Mfg. Co. (Ceco) | 11 Radio Corp. of America | 12 H. H. Eby Mfg. Co. |
| 13 Yaxley Mfg. Co. | 14 Herbert H. Frost, Inc. | 15 Pilot Electric Mfg. Co. |
| 16 Tobo-Deutschmann Co., Inc. | 17 Polymat Mfg. Co. | 18 International Res. Co. (Durham) |
| 19 Allen-Bradley Co. | 20 Dalur Products Co. | 21 Electrad, Inc. |
| 22 Arthur H. Lynch, Inc. | 23 Langbein Kaufman Radio Co. (Elkey) | 24 L. S. Brach Mfg. Co. |
| 25 Ampex Instrument Lab. | 26 Airgap Products, Inc. | 27 Deven Radio Corp. |
| 28 Supertron Mfg. Co. | 29 American Hard Rubber Co. (Radion) | 30 Schickerling Products Corp. |
| 31 Conneway Electric Lab. | 32 Gem Tube Co. | 33 Leslie F. Muter |
| 34 W. H. Radio Laboratories, Inc. | 35 American Specialty Co. | 36 Paragon Elec. Corp. |
| 37 | 38 | 39 |

* THE FIGURES IN THE FIRST COLUMN OF MANUFACTURERS INDICATE THE MAKERS OF THE PARTS USED IN THE ORIGINAL EQUIPMENT DESCRIBED HERE.

If you use alternate parts instead of those listed in the first column of manufacturers, be careful to allow for any possible difference in size from those originally used in laying out and drilling the panel and sub-base.

From copyright, 1927, E. P. Pub. Co.

Hearing Short Waves with a Broadcast Set*

A Simple Attachment to Your Receiver Makes High-Frequency Work Possible

By H. E. OVERACKER

MORE and more work is being performed on radio waves under 100 meters; and more and more people are becoming interested in the subject of short waves. Many letters have been recently received by RADIO NEWS, asking for details for a receiver that will pick up these short waves, and several circuits have been already published. However, there are many of our readers asking for a unit of some sort, which can be attached to a broadcast set and will enable the operator to receive stations operating under 100 meters. Such a unit is described in this article. It consists of but two tubes; and when operated with a standard five-tube tuned-R.F. set in RADIO NEWS LABORATORIES, in the heart of New York City, readily picked up KDKA'S short-wave transmitter operating on 63.6 meters.

—EDITOR.

antenna, and you have an all-wave receiver without disturbing the wiring of the broadcast receiver.

DESCRIPTION OF SHORT-WAVE UNIT

The general appearance of the short-wave converter unit is made evident in the illustrations. It is shown in use with a factory-made six-tube set, and will work with any receiver having a fair amount of radio-fre-

done by using the proper number of coupling turns on the oscillator coil L2, and by varying an external filament rheostat until best results are obtained. A fixed resistor can then be made and placed inside the set. Adjustments on additional coils should be made with the coupling only.

CONSTRUCTIONAL DATA

The construction of the unit is very simple. A ¼-inch bakelite panel, 6½x10 inches, is fastened at its lower edge to a piece of ½-inch board 10x7½ inches. The back of the

WITH the rapidly increasing use of short wavelengths for radio broadcasting and communication, the need of extending the range of broadcast receivers is becoming apparent.

At present there are two good systems for receiving short waves, the regenerative receiver and the superheterodyne. The first method gives good results on code reception, but the receiver is not sensitive unless it is oscillating. It, therefore, distorts telephony almost beyond recognition. A good superheterodyne is very satisfactory for all kinds of receiving, but as ordinarily made, is very expensive.

In experimenting along this line, the writer has overcome these difficulties by using a good broadcast receiver as the intermediate-frequency amplifier unit. In this way it is necessary only to make an oscillator and high-frequency detector, couple their output to the receiver in place of the

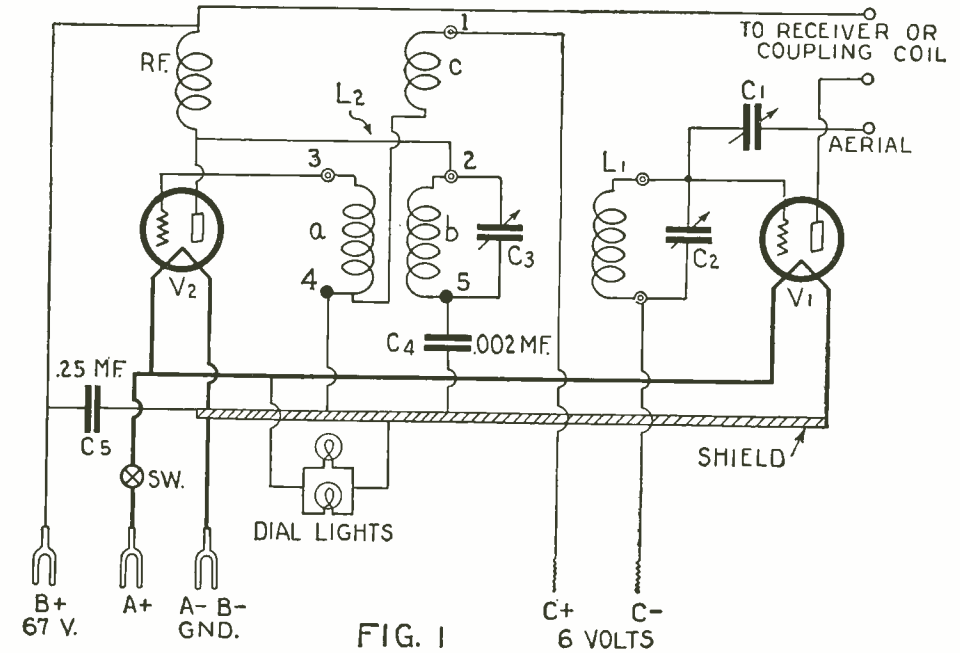

FIG. 1
Circuit diagram of the short-wave unit. The symbols on this diagram correspond to those in the other illustrations.

quency amplification. The wiring diagram is given in Fig. 1.

The most important point in making this unit is to insure the correct amount of local-oscillator voltage impressed on the grid of the high-frequency detector, V1. This is

panel and the top of the board are covered with thin copper sheeting; a vertical piece of this is soldered in, near the center of the set, for shielding. The latter is set about ½-inch to one side of the center, to allow the filament switch to be placed in the middle of the panel. The shielding is necessary to prevent capacity coupling between the oscillator and detector, as this would make the required inductive coupling uncertain in amount.

Two .00035-mf. condensers are mounted on the panel and are controlled by the vernier dials, C2 and C3; they tune the grid circuits of the detector (V1) and oscillator (V2) tubes, respectively.

The tube sockets are mounted just behind the condensers. The coil receptacles, mounted two inches above the bottom board, so that the terminals on the under sides will be accessible, are just behind the tube sockets. Plug-in coils are used, so that any wavelength can be received.

COIL SPECIFICATIONS

The coils are wound on 1½-inch bakelite tubing. Bakelite discs are fastened in the bottoms of the forms, to hold the small plugs and jacks used as terminals.

The oscillator coil L2 is wound "Figure 8"-fashion, by slotting the tubing part way down the center, and passing alternately around one half, then the other, with each turn of wire. This type of coil prevents an unduly large magnetic field, which might affect the detector.

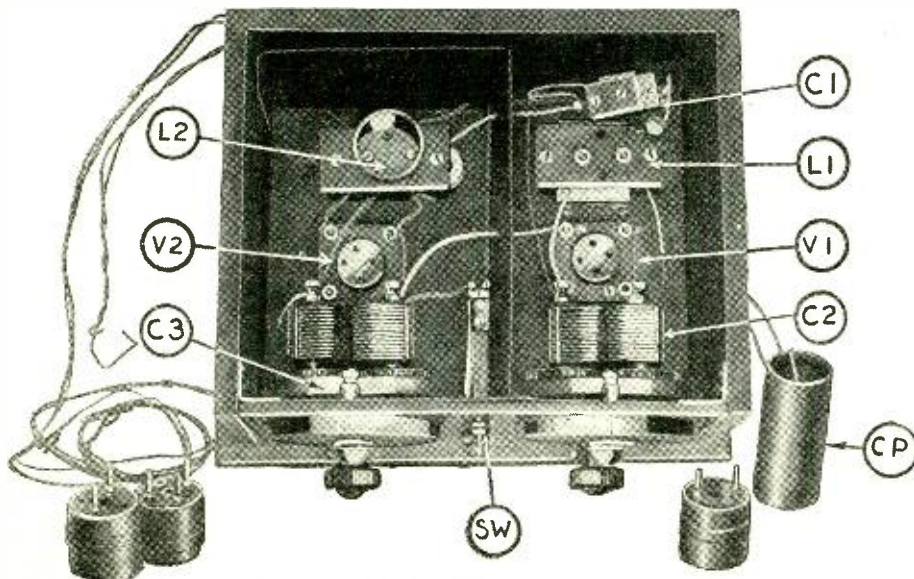

The interior of the short-wave unit. The extra plug-in coils are shown at the left of the set and at the right is shown the coupling coil, C P.

* RADIO NEWS Blueprint Article No. 29.

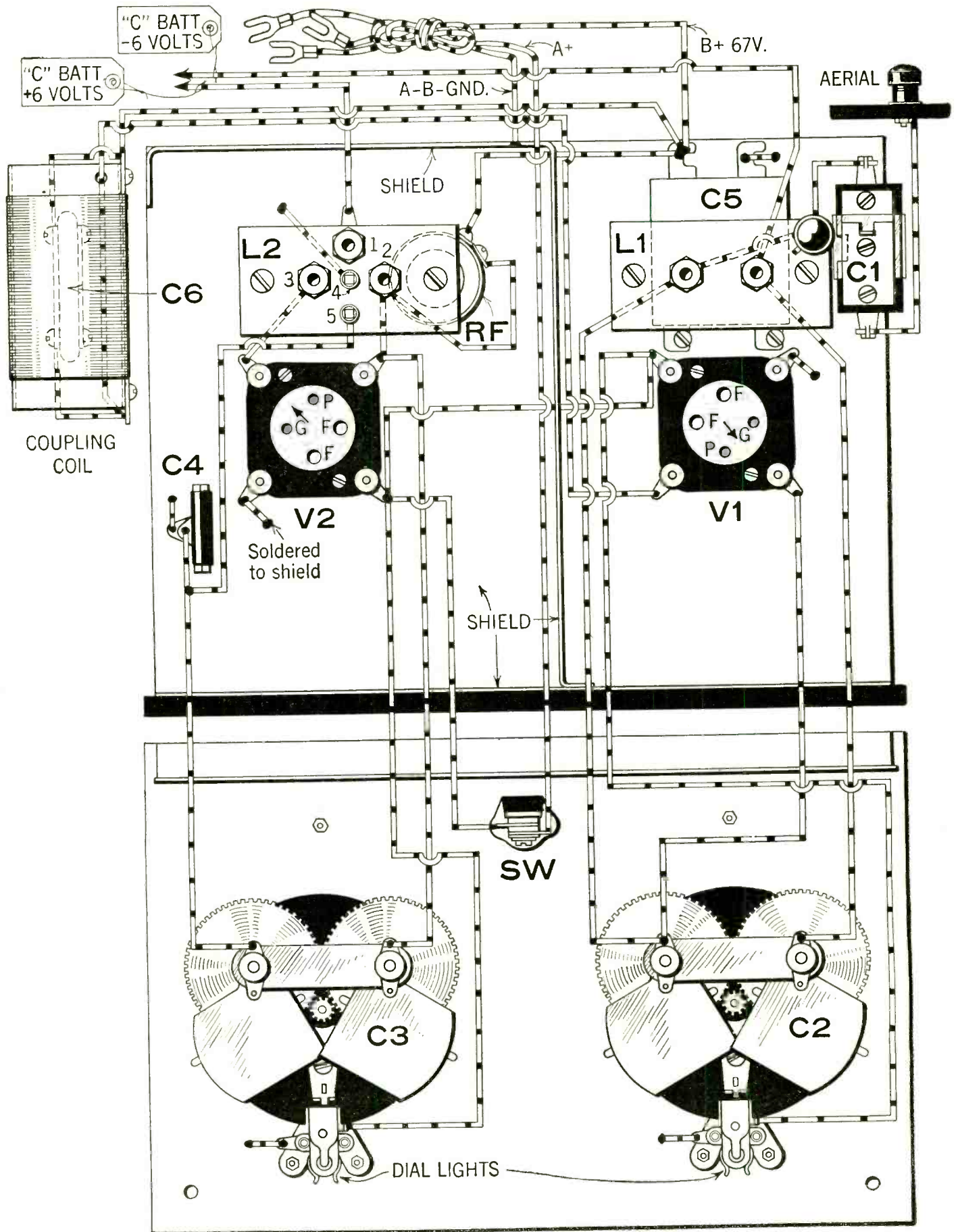

The wiring diagram of the short-wave unit. C1 is the midget condenser; C2 and C3, are .00035-mf. variable condensers; C4, fixed condenser; C5, by-pass condenser; C6, .0003-mf. fixed condenser; L1 and L2, grid and oscillator coils respectively; V1 and V2, vacuum-tube sockets; R.F., special R.F. choke coil, and SW, filament switch. The coupling coil is used only when the broadcast receiver is a loop set. In other sets the leads shown here as to the coupling coil are connected directly to the aerial and ground posts of the set.

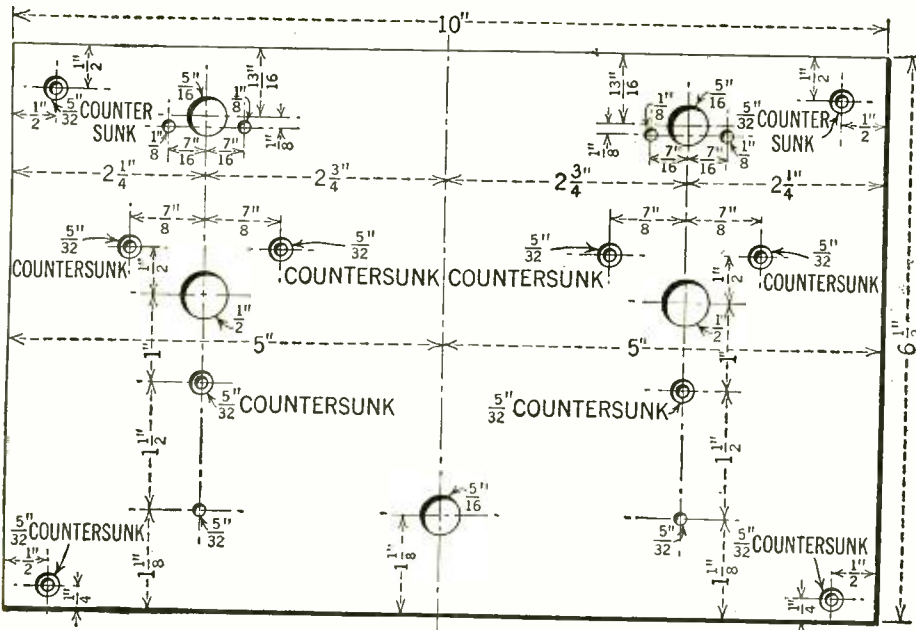

Drilling specifications for the front panel of the short-wave unit.

At the right is shown the short-wave unit connected to a broadcast receiver of the tuned R.F. type. In this case the coupling coil is not used; the leads to this coil shown in the diagram are connected instead to the aerial and ground posts of the set.

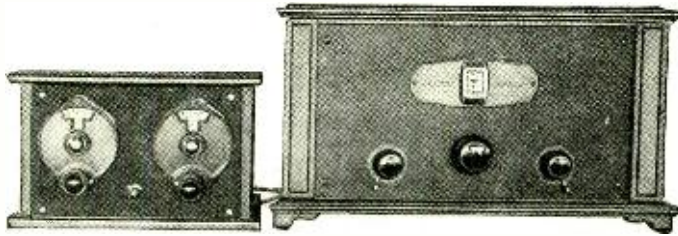

The detector tuning coil L1 is simply wound on a piece of 1 1/2-inch bakelite tubing. At present the writer is using two sets of coils, one covering the wavelength range between 21 meters and 47 meters, and the other between 45 meters and 105 meters.

The oscillator coil for the 21-47-meter range consists of 4 grid turns (A) wound on first, the top end going to the grid. The plate coil (B) of 3 turns is wound on next, the bottom end going to the plate. The pick-up coil (C) consists of 1 1/2 turns wound on 3/8-inch above the plate winding. About No. 26 double-silk-covered wire may be used for all windings. The detector tuning coil (L1) consists of 5 turns wound on a short length of the tubing.

The 45-105-meter coils are wound in the same manner, except that more turns are required. The oscillator grid coil has 12 turns; the plate coil 7 turns; and the pick-up coil 1 1/2 turns, spaced 1/8-inch from the plate coil. The detector tuning coil consists of 8 turns. Other sets of coils may be made to cover any wavelength range desired.

A disc fitting into one end of the coil L1 is equipped with two small spring plugs, which snap into two jacks mounted on the receptacle block behind the tube socket V1. An identical disc fitting in the bottom of the form of L2 (the oscillator) holds three such plugs and two jacks, arranged as shown. The start of the first winding, which is the grid coil (a) goes to the center jack, marked 4, while the other (top) end goes to plug 3. The start of the plate winding (b), immediately next to the end of the grid coil, goes to plug 2, the finish to jack 5. The start of the pick-up coil (c) connects inside the tube to the center jack 4, while the finish goes to the remaining plug, 1. All these connections should of course, be soldered.

The plugs and jacks on the receptacle board for L2, (just behind the tube socket V2) correspond in marking to the respective jacks and plugs which fit into and over them.

That is, plugs 1, 2 and 3 on the oscillator inductor slide into jacks 1, 2 and 3 on the little board; while jacks 4 and 5 fit over plugs 4 and 5. This may sound complicated but, if the reader will study the illustrations for a few moments, he will realize how simple it all is.

CONNECTIONS

Good results are obtained by using an ordinary receiving antenna connected to the grid of the high-frequency detector, through a small fixed condenser (C1) of about 30-mm.f. capacity. The negative filament lead is connected to ground.

The plate of the detector tube is connected to the "B+" battery through some coupling device, the nature of which depends on the type of broadcast receiver used. If a loop is used on the broadcast receiver, the coupling is best secured by setting a tuned coil in the loop. This coil must be tuned to the same wavelength as the receiver.

Be sure to pick a wavelength where broadcast stations will not interfere. The writer has obtained excellent reception by using a superheterodyne as the receiver. In this case the frequency is converted twice before it is amplified.

With the ordinary tuned-radio-frequency set, simply connect the plate of the high-frequency detector V1 to the receiver in place of the aerial and connect the "B+" battery lead in place of the ground wire. With this type of coupling separate batteries must be used for the short-wave unit. With loop coupling, the receiver batteries can be used for the unit.

COUPLING TO A LOOP

If you have a loop receiver, make up the (Continued on page 166)

SYMBOL	Quantity	NAME OF PART	REMARKS	MANUFACTURER *
C1	1	Widgit Condenser	30 mf. screw adjustment	1 12, 22
C2, C3	2	Variable Condensers	.00035 mf.	2 1, 12, 14, 15, 16, 17, 18, 20, 28
C4	1	Fixed Condenser	.002 mf.	3 14, 15, 19, 21, 22, 23, 24, 25
C5	1	By-pass Condenser	.25 mf.	3 15, 19, 21, 22, 23, 24, 25, 26
L1	1	Grid Coil	Special	
L2	1	Oscillator Coil	Special	
V1, V2	2	Tube Sockets		4 2, 7, 8, 11, 15, 16, 17, 27, 28, 29, 30
	2	Dials	For condensers C2 and C3	5 2, 15, 17, 29, 30, 31, 32, 33
RF	1	R.F. Choke	Special	
	1	Front Panel	6 1/2" X 10" X 1/4"	6 31, 34, 35, 36
	2	Coil Mounts	2 1/2" X 1 3/8" X 1/4"	6 31, 34, 35, 36
	1	Wood Baseboard	9 1/2" X 7 1/2" X 1/2"	
	1	Binding Post	For aerial wire	7 9, 12, 14, 15, 34, 37
	12	Spring Contact Plugs	For plug-in coils and mounts	8
	9	Jacks	For above	8
SW	1	Filament Switch		9 4, 15, 21, 22, 23, 29, 30, 37, 38, 48
	3	Copper Sheets	9 1/2" X 6"; 9 1/2" X 7 1/2"; 13 1/2" X 6 1/2"	
	4	Lengths of Tubing	Each: 1 1/2" X 1 1/2" dia., 1/16" wall; for L1 & L2	6 15, 31, 34, 35, 36
	4	Discs	To fit inside tubing	6 15, 31, 34, 35, 36
	4	Brass Rods	2 1/2" X 3/8"	
	2	Tubes	20L-A type	11 39, 40, 41, 42, 43, 44, 45
C6	1	Fixed Condenser	.0003 mf.	3 14, 15, 19, 21, 22, 23, 24, 25
L3	1	Length of Tubing	3 1/2" X 1 1/2" diameter spec. coupling coil	6 15, 31, 31, 35
		Flexible Wire	For connections	46 10, 37, 47

NUMBERS IN LAST COLUMN REFER TO CODE NUMBERS BELOW.

1 Hammerlund Mfg. Co.	2 Gray & Danielson Mfg. Co. (Reiner)	3 Dubilier Condenser & Pella Corp.
4 Benjamin Electric Mfg. Co.	5 National Company	6 National Vulcanized Fibre Co.
7 H. H. Eby Mfg. Co.	8 General Radio Co.	9 Tally Mfg. Co.
10 Rome Wire Co.	11 Radio Corp. of America	12 L. Radio Laboratories
13 Ambassador Sales Co.	14 Ameco Products, Inc.	15 Pilot Electric Mfg. Co.
16 Patent Electric Co.	17 Silver-Marschall, Inc.	18 Wirt Company
19 Aerovox Wireless Corp.	20 United Scientific Laboratory (USL)	21 Electrad, Inc.
22 Leslie F. Muter Co.	23 Carter Radio Company	24 Tobe Deutchmann Company
25 Inrad Condenser & Mfg. Co.	26 Wicamold Radio Corp.	27 Air-Gen Products, Inc.
28 Bremer-Tully Mfg. Co.	29 Herbert H. Frost, Inc.	30 Martin-Copeland Co. (Herc)
31 American Hari Rubber Co. (Radion)	32 Karas Electric Company	33 Workrite Mfg. Co.
34 Wicarta Fabricators, Inc.	35 Fibrac Insulating Co.	36 Century Radio Panel Co.
37 Frank W. Morse Co.	38 Bryant Electric Co.	39 C. E. Mfg. Co. (CoCo)
40 Magnavox Co.	41 Sonatron Tube Co.	42 E. T. Cunningham, Inc.
43 Ken-Red Corp.	44 Van Horns Company	45 United Radio & Electric Corp. (Ureco)
46 Belden Mfg. Co. (Colorubber)	47 Cornish Wire Co.	48 Allen-Bradley Mfg. Co.
49	50	51

* THE FIGURES IN THE FIRST COLUMN OF MANUFACTURERS INDICATE THE MAKERS OF THE PARTS USED IN THE ORIGINAL EQUIPMENT DESCRIBED HERE.

If you use alternate parts instead of those listed in the first column of manufacturers, be careful to allow for any possible difference in size from those originally used in laying out and drilling the panel and sub-base.

© Copyright, 1927, E. P. M. Co.



"Motorboating," What It Is, and Why



The Sporting Proclivity of Resistance-Coupled Amplifiers

By O. D. WESTCOTT

"MOTORBOATING," as applied to radio, is a term used to express the action taking place in an audio-frequency amplifier, when pulsations of the current in the output circuit, if passed through the coil windings of a loud speaker, cause the latter to emit the familiar "put-put-put" sounds which are somewhat analogous to the sound of the exhaust of a distant motorboat; hence the name.

There is a distinct difference between "motorboating" and "howling"; they are not inherently the same, as some writers have claimed. One man, for instance, states that "motorboating" is a term applied to low-frequency oscillations between the limits of half a cycle per second and 50 cycles per second. He then goes on to say that, when the frequency of these oscillations goes above 50 cycles per second, "we no longer call the action 'motorboating'; we call it 'howling'."

"Howling" is "howling," and "motorboating" is "motorboating"—two inherently different actions. When an amplifier "howls" it is oscillating at an audio frequency. "Motorboating" is not an oscillatory action; it is a "limiting" or "blocking" action. "Howling" is oscillatory; "motorboating" is non-oscillatory. Our ears can distinguish oscillations as low as 30 or 40 cycles per second, but not much lower; hence, if "motorboating" were an oscillating action, how could we hear these low frequency oscillations, when they are changed from electrical oscillations to sound waves, if their frequency were lower than 30 cycles per second? The answer is; we couldn't. We do hear the "put-put-put" sounds emanating from the loud speaker at frequencies below 30 cycles when an amplifier "motorboats"; hence it is a non-oscillatory condition.

SOURCES OF TROUBLE

"Motorboating" is experienced chiefly in resistance-coupled amplifiers. Under certain conditions the tendency to "motorboat" is more pronounced than under others, more favorable. For instance, when a resistance-coupled amplifier is supplied with plate voltage from a set of new "B" batteries, the tendency to "motorboat" is not pronounced. If "motorboating" should occur, it might very possibly be due to interaction between the radio-frequency and audio-frequency circuits. To overcome this, be sure to keep all radio frequency out of the audio amplifier circuit. Keep the radio frequency isolated. This may be done as follows:

If you consider the schematic wiring diagram in Fig. 1 you will see that there is a .002-mf. condenser C4 connected from the plate of the detector tube T1 to the negative filament terminal of the detector tube socket. The function of this condenser is to by-pass radio-frequency energy around the plate coupling resistor R1, the latter being a part of the audio-frequency coupling unit, in the input circuit of the audio amplifier.

Now, the by-pass condenser C4 may not be adequate. Part of the radio-frequency energy at this point in the circuit may pass through the by-pass condenser in question, but some radio frequency may also get into the input circuit of the first audio amplifier tube T2. To obviate this possibility, a radio-frequency choke coil RFC1 having an inductance of 85 millihenrys, is connected between the plate of the detector tube and the plate resistor R1.

Even though a resistance-coupled amplifier be supplied with plate current from a new

set of "B"-batteries, "motorboating" may take place; due to no other reason than the fact that the interstage coupling condensers store up electrons on the grid side faster than the grid leak can carry them off to the negative side of the filament. When this occurs in any one coupling unit, electrons collect on the grid side of the coupling condenser faster than they leak off through the grid resistor; and the grid of the succeeding tube gradually assumes a more negative bias until it finally becomes so negative that no plate current flows in the output circuit of the tube in question. The tube is then said to be "blocked."

Now, when the plate current ceases, no more electrons are passing from filament to plate within the tube, and no more electrons are passing from filament to grid within the tube. Then the grid leak carries off the electrons accumulated on the grid side of the coupling condenser, the grid returns to normal potential, plate current flows again; and the circuit returns to normal operation, until the grid of the tube in question goes far enough negative again to "block." The frequency of this "blocking" or "motorboating" depends, among other things, upon the value of the interstage coupling condenser and the value of the grid resistance.

This effect is most apt to occur in the last audio-frequency stage, where the potential swings of the grid are greatest. One way to eliminate "motorboating" due to this cause is to decrease the resistance of the leakage path for electrons accumulating on the plate of the coupling condenser. This can be done by decreasing the value of the grid leak at this point in the circuit; but, when this is done, stability is effected at the expense of volume, for the volume is thus decreased.

AN INDUCTIVE LEAK

The best method is to use an impedance leak in the grid circuit of the last tube as shown in Fig. 1; the inductance value of this leak should be between 100 and 200 henrys. Since it is used in the grid circuit, where the current-carrying requirements are so small as to be considered negligible as far as determining the size of the wire is concerned, very small wire may be used

and the actual space taken up by a choke having this amount of inductance is no greater than that required by some of our large audio-frequency transformers.

With the impedance leak, the resistance to the flow of direct current is so small that the electrons which flow to the grid side of the coupling condenser will be leaked off to negative filament as fast as they arrive, and the average potential of the grid will remain constant. The volume will not be impaired in this case, as it was when we decreased the value of the grid leak resistor, because even at audio frequencies the impedance of this choke is very high. Thus, most of the audio-frequency potential that is apparent across the plate resistor R5 will appear also across the impedance leak, since it and C3 are connected in series across R5. If this impedance is large compared to that of C3, most of the voltage across the combination will be apparent across the impedance.

RESISTANCE-COUPLING PROBLEMS

In passing, the thought might be mentioned that one of the reasons for distortion in connection with resistance-coupled amplifiers is the very thing that we have just been discussing. When electrons collect on the grid side of the coupling condenser, faster than they leak off, the average potential of the grid goes further and further negative. In the extreme condition of this sort we get "motorboating" but, even before this occurs, we get distortion, due to the fact that the average potential of the grid goes below that point on the straight part of the characteristic curve which will allow for linear amplification, and we get non-linear amplification with subsequent distortion. Hence, the impedance leak is an aid to obtaining good quality amplification with a resistance-coupled amplifier.

The resistance-coupled amplifier we have been discussing has been operating on a set of new "B"-batteries. Now, as these batteries grow old, the tendency to "motorboat" is more pronounced, due to the fact that their internal resistance increases, with subsequent increase in the interstage feedback coupling. This permits voltage-ripples or surges at one point in the circuit to be fed back in just the proper phase relation to build up in another part of the circuit, and

(Continued on page 175)

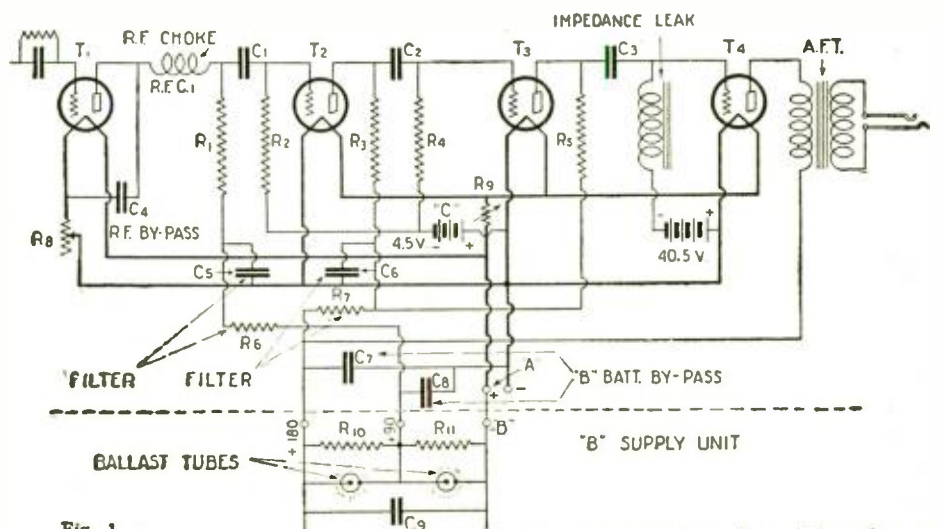

Fig. 1 By the use of an audio-frequency amplifier of a design such as that shown above, it is made practically impossible for "motorboating" to occur.

"How's Your Wavelength?"

The Importance of Wavemeters and Oscillators and Data for Their Construction



By JOHN L. REINARTZ

THIS is the third of a series of articles written exclusively for RADIO NEWS by one of the best-known radio amateurs in America. In this article, Mr. Reinartz takes up the very important subject of wavemeters, their use and construction. This subject is not only of the greatest value to the amateur, but of interest as well to the broadcast listener; for by the means of a wavemeter it is possible for him to set his receiver at a given wavelength when he is looking for a distant station and tune it in much easier than if he had to use a hit-and-miss method.

Next month Mr. Reinartz will give the readers of RADIO NEWS some data on other uses besides transmitting for transmitting equipment. —EDITOR.

circuit itself is the height of simplicity, being merely a capacity and an inductance of known values in series. One of the two must be variable, and because of the nicety of variation possible with the condenser, the capacity is generally the variable factor. A hot-wire ammeter, or some other suitable device for measuring radio-frequency currents, is either inserted in the circuit directly or coupled to it.

If the frequency of the current flowing in a circuit is to be measured, the coil of the wavemeter is brought near some inductive part of the circuit, and the condenser of the wavemeter is varied until the indicating device shows a maximum reading. When making final adjustments, it should be remembered, the wavemeter should be as far away from the circuit as may be compatible with

a range from a very few meters up to thousands, yet having but one inductance and an ordinary variable condenser. With every wavemeter there comes a set of coils, each of which is calibrated with the condenser; and different condenser scales are used to get the proper reading.

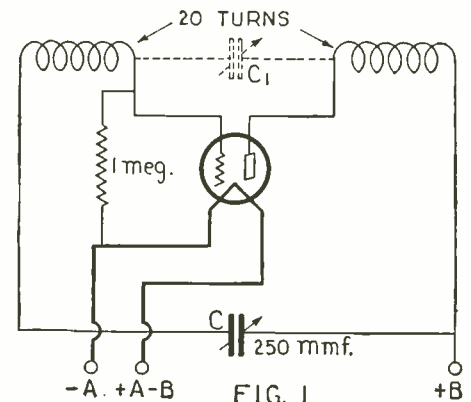
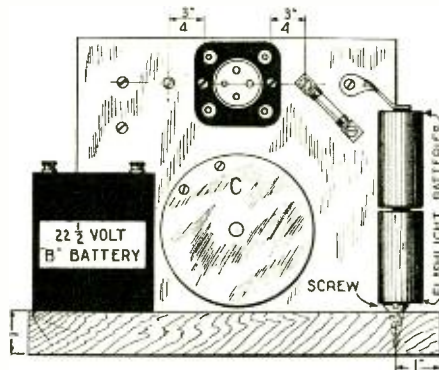

FIG. 1
The circuit diagram of the short-wave oscillator. C1 is used only when waves over 200 meters are wanted.

ONE of the most essential articles in a "ham shack" is a wavemeter. This point cannot be stressed too strongly for those who are just starting in the transmitting game, and the old-timers will certainly agree. Of course, there are wavemeters of many types, but in this article we shall describe one which will serve hams well, being at the same time simple of construction and cheap to build.

Let us consider for a moment the theory of the wavemeter and how it operates. It is possible, through the phenomenon of resonance, to generate relatively large currents in a circuit to which only a small electromotive force is applied, the only provision being that the circuit is properly tuned. A wavemeter is used either to determine when resonance is realized with a given frequency, or to measure the frequency at which a certain circuit is in resonance. The wavemeter



The rear of the oscillator. Any desired arrangement for the batteries may be used, other than that suggested above.

obtaining a good maximum reading of the current-indicating device.

It is impossible to have a wavemeter with

CALIBRATING A WAVEMETER

Now the question that will perhaps arise in the mind of the reader is, "How will I know when a wavemeter that I construct is correct?" This is not as difficult as might be imagined. It is necessary to start with something which we know to be correct, and in this case it is a coil. For example the writer has a coil which he knows will resonate at 34.25 meters; its physical dimensions being 2½ inches in diameter and 2¾ inches long, wound full (55 turns) of No. 26 D.C.C. wire. The method then for obtaining a certain known point on the wavemeter is as follows:

Hold this standard-inductance coil just described on a glass rod near the coils of the receiver until a "click" is heard in the phones. At first two clicks will be heard as the condensers of the set are varied, due to the coil being held too near the inductances of the receiver. The coil is moved to such a distance that only a single click is heard. The wavelength of the oscillator (of which more later) is then adjusted to zero-beat note and allowed to remain at that point. This means that we have the oscillator operating at the same wavelength as the set, which is tuned to 34.25 meters. The wavemeter is brought near the receiver and the condenser varied until the indicating device denotes resonance.

Now we have one point on the scale, this being 34.25 meters. The receiver's tuning is then varied, going to higher wavelengths. The next zero beat-note that will be heard in the phones will be 68.5 meters, this being observed also as a reading on the wavemeter scale. The wavelength of the receiver is again varied, this time to the lower side. The first beat note on the way down will be the 34.25 wavelength and the second will be 17.125 meters; which is also observed as a point on the wavemeter's condenser scale. These three points may then be marked off on a sheet of cross-section paper, on which wavelengths are plotted against condenser readings, and a curve drawn through them. In order to avoid error in drawing this curve, which holds good, of course, for only one coil of the wavemeter, it is well to use

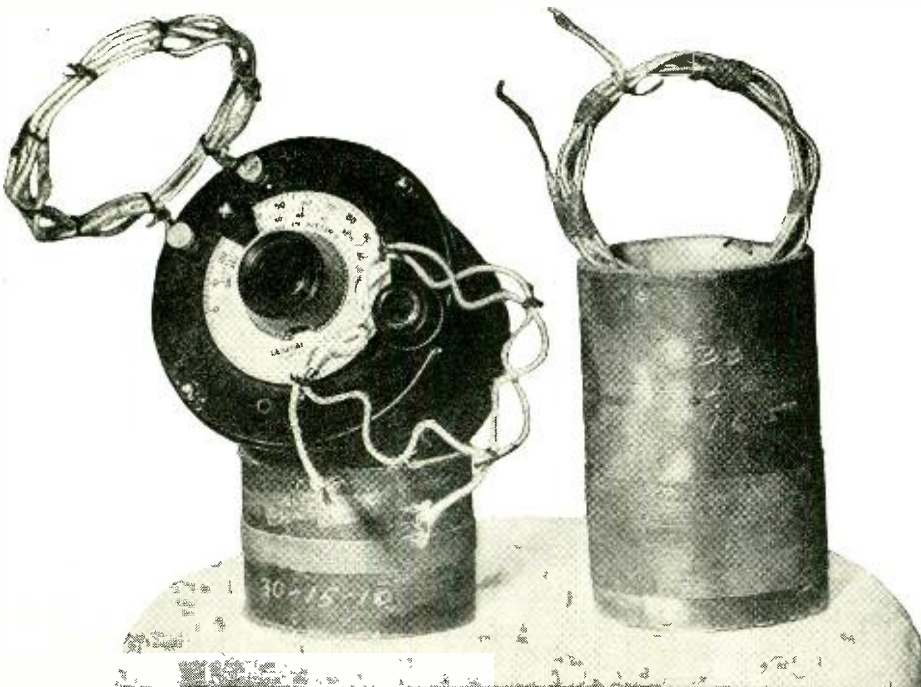

The wavemeter described in the accompanying text. The three wavemeter coils are for low waves. The coils on the tubes are standard inductances.

logarithmic paper. Here the curve will be a straight line.

WAVEMETER CONSTRUCTION

The wavemeter itself is extremely simple to build. It is necessary to procure a high-grade variable condenser having a maximum capacity of .0005-mf. This condenser should be of the type enclosed in a metal case, for more than one reason. In the first place, it

On the left is the 34.25-meter standard inductance coil and on the right the 5-meter wavemeter. The constructional details of both of these instruments are given in the accompanying text.

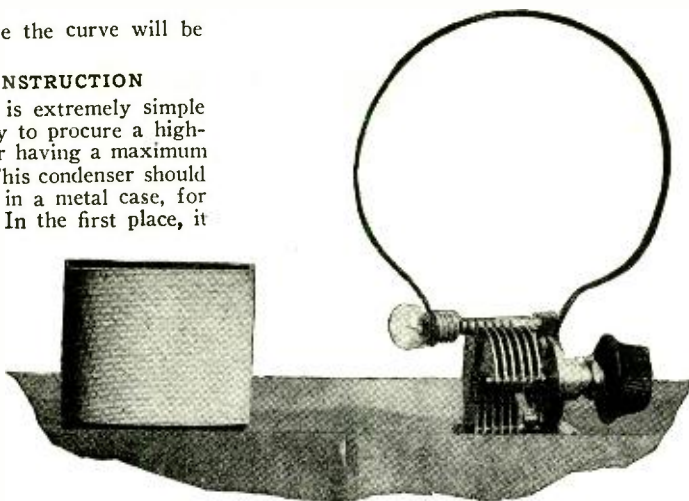

can be moved around and handled without any damage to the plates; secondly, there are no bad effects from body capacity; and lastly, the indicating device mentioned above (being, in the writer's case, a small neon lamp) is enclosed inside the case and a greater contrast can be seen through the peephole in the top of the case than if the lamp were in the open.

The coils for the wavemeter are wound with No. 12 D.C.C. wire in a 3½-inch loop. The wire is stiff enough to support itself without any form. As may be seen from the illustration, it is covered with tape, except in one place where a couple of the turns are bent inward. This is done to get a fine adjustment of the inductance when the scale of the wavemeter's condenser is calibrated in meters instead of from 0 to 100. In the latter case, of course, bending the coils is unnecessary. The number of turns necessary for a coil covering the 20-meter band is 2; for the 40-meter band, 4; and for the 80-meter band, 8. The neon lamp, which can be obtained for about fifty cents, is connected across the terminals of the condenser in parallel with the coil. The lamp is secured beneath the top of the condenser's case and a peep-hole about ⅜-inch in diameter is drilled directly above the center of the lamp.

THE OSCILLATOR

A very efficient oscillator can be built at a very small cost from parts perhaps lying unused in the junk box. A panel 7 inches square is fastened to a 1-inch wooden baseboard, 9 by 7 inches. A vacuum-tube socket for a 199-type tube and a .00025-mf. variable condenser C are fastened to the panel in the middle, and eight binding posts are placed as shown in the illustrations. The two middle binding posts are used to secure the socket to the panel.

The coils for the oscillator are wound on the same 3-inch tube and are spaced ¼-inch apart. Each coil has 20 turns of No. 28 D.C.C. wire, the ends leading to the four middle binding posts on the panel. If it is desired to use this oscillator for the broadcast wave-band, merely connect a .00025-mf. condenser C1 between the plate and the grid of the tube, as shown in the circuit diagram of the oscillator, Fig. 1. A "B" battery of 22½ volts is at the left of the baseboard, and at the right are piled two flashlight batteries to supply the filament current. This type of filament battery is not necessary, but it facilitates moving the oscillator about. A piece of spring brass is bent into the form shown in the sketch, for clamping the upper end of the batteries into position; and at the baseboard they rest upon a large wood-screw driven into the wood.

SOME SUGGESTIONS

It has been mentioned previously that, when the standard inductance coil is brought

near the coils of the receiver when the wavemeter is being calibrated, it is necessary to hold it in position by means of a glass rod. This is to eliminate completely all body capacity effects. The rod should be at least a foot in length. If no rod is at hand tie a piece of string to the inductance and hold it near the receiver's coil with that.

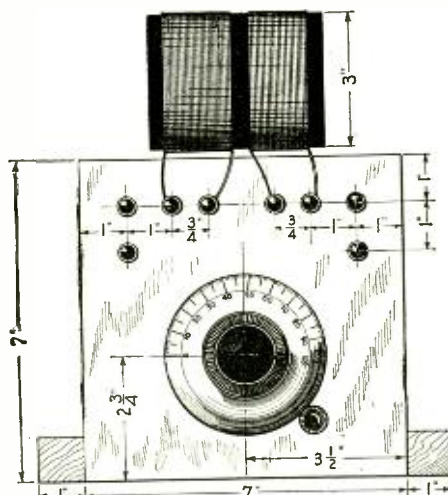

The front view of the oscillator. The coil needs no other support than the wires as shown.

It is not necessary that the "ham" who wishes to make himself a standard inductance, such as described above, should limit

himself to one having the wavelength mentioned. The Bureau of Standards regularly broadcasts standard-frequency signals, such schedules being printed in RADIO NEWS. The constructor can avail himself of these transmissions in the following manner: We will assume that he wishes to wind a standard inductance for 40 meters. He will tune his receiver to the standard 40-meter wavelength signal as broadcast and allow his set to remain tuned to that frequency. Now we have, approximately, from the data given above, that 1½ turns on the 2½-inch coil equal 1 meter, so the constructor will have wound one of about 60 turns.

This coil is held at the proper distance from the receiver's coils and the "click" is listened for. If none is heard, part of a turn is removed and the click is listened for again. Continue taking off part of a turn at a time, until the single click is heard. Then the coil is resonant at exactly 40 meters.

After the coil ends have been secured, the coil should be dipped in liquid paraffin or painted with collodion. The coil should then be re-checked, to see that the coating has had no effect on its electrical properties.

To avoid inaccuracies, the fundamental wavelength only of the coil should be used for exact work; as the harmonics (½, ⅓ and ¼ wavelength) are slightly out; but they may be used for approximations.

OTHER INDICATING DEVICES

A neon lamp is not the only indicating device for the wavemeter that one can use, nor is it the most accurate; but it is the least expensive and, if installed as we have mentioned, is as nearly correct as the average "ham" wishes. A plate milliammeter or a plate voltmeter will give excellent results and, for really fine work, the former is recommended. The instrument is connected in series with the plate supply of the receiver. Resonance is indicated on a meter by the needle's swinging sharply up and down; the wavemeter condenser can be so adjusted that the needle will remain at the peak.

A 5-METER WAVEMETER

It is difficult, because of the high frequencies involved, to get a wavemeter of the type described above that will operate satisfactorily on 5 meters. Therefore the one shown in the accompanying illustration was developed. It consists of a 4-inch loop of No. 16 bare copper wire; one end is connected to the rotor of a midget condenser and the other to one side of a flashlight lamp, the other side of which is connected to the stator side of the condenser.

(Continued on page 177)

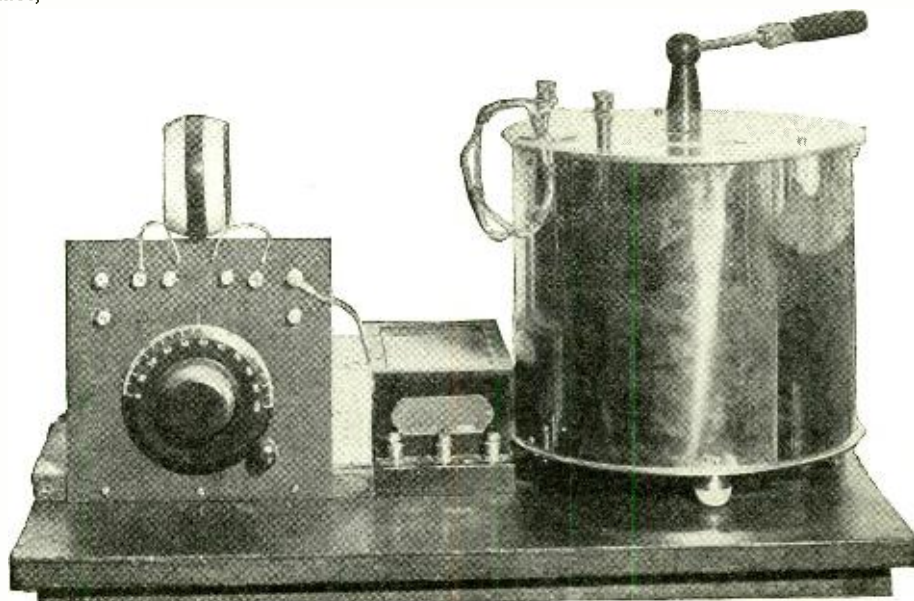

The author's oscillator, repeating relay and standard condenser, the latter being for accurate wavelength measurements.



A Simple Tube-Testing Device



How the Different Characteristics of Vacuum Tubes Can Be Determined Easily

By A. W. BOTHWELL

MANY well-constructed devices for the testing of tubes are now manufactured; they fall, as a rule, into one of two classes. The first consists of the simplest kind of vacuum-tube circuit with an indicating device, such as a milliammeter, in the plate circuit.

This is illustrated in Fig. 1. When a tube is operating such a testing circuit, if the filament emission is high or low, a corresponding reading will be shown on the meter.

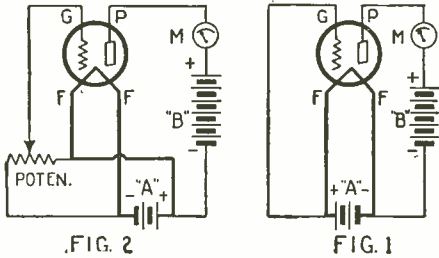

Two typical tube testing circuits which, however, do not give all the characteristics of a tube.

Should the filament be broken, or the tube shorted internally, either a zero or an extremely high reading will be obtained, showing a defective tube.

The second class usually takes the form of the circuit shown in Fig. 2. This has all the advantages of the first type but goes further; in that the factor of amplification may be obtained by varying the potential applied to the grid of the tube from positive to negative. These and other similar tests are based, however, on "static curves," and do not truly indicate the worth of the tube; as there are many other factors to be taken into consideration which cannot be measured in this type of circuit. The direct-current resistance reading shown by the meter in Fig. 1 may be correct. The variations of plate current obtained by varying the grid potential, as in Fig. 2, may show the tube under observation to be first-class; yet the tube may not be able to oscillate or otherwise perform successfully, in which case it would be worthless as a radio-frequency amplifier or detector.

A USEFUL COMBINATION

A correct and complete valuation of the

tube under consideration may be obtained only by a study, involving the use of a laboratory bridge circuit, which would take into full consideration such qualities as plate impedance, mutual conductance, ratio of grid-to-plate-current changes, and other operating characteristics. This operation can be completed only by one well versed in such studies.

However, in Fig. 3 a circuit is shown which, when carefully worked out, will quickly provide most of the tests of the above mentioned circuits; and it will in addition take into consideration the potential oscillating ability of the tube being tested. Therefore, the reading shown will be a fairly true indication of the real worth of the tube. A poor or defective tube is immediately evident to any person capable of reading the figures on the meter.

No computing is required, it being necessary merely to press a button opening the

At the right is shown the under side of the panel of the tube-testing device. L1 and L2 are the grid and plate coils, wound on the same tube; M is the milliammeter; C, a .002-mf. fixed condenser shunting the meter; S, the vacuum-tube socket; and A and B, the leads.

Below is shown the upper panel view of the tube tester with a vacuum tube in place for test. At the left of the tube is the push-button.

special plate circuit and to notice the amount of increase in plate current caused by coil L2 being included in the circuit.

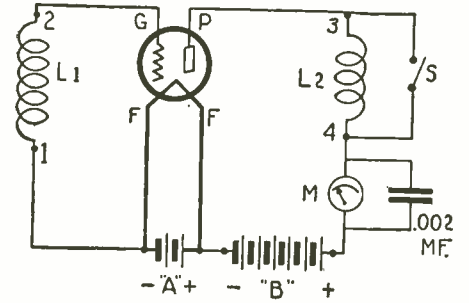

The diagram of connections for the tube tester.

By reference to Fig. 3, it may be seen that, on short-circuiting coil L2 with the switch S, we have a tube tester of the simple

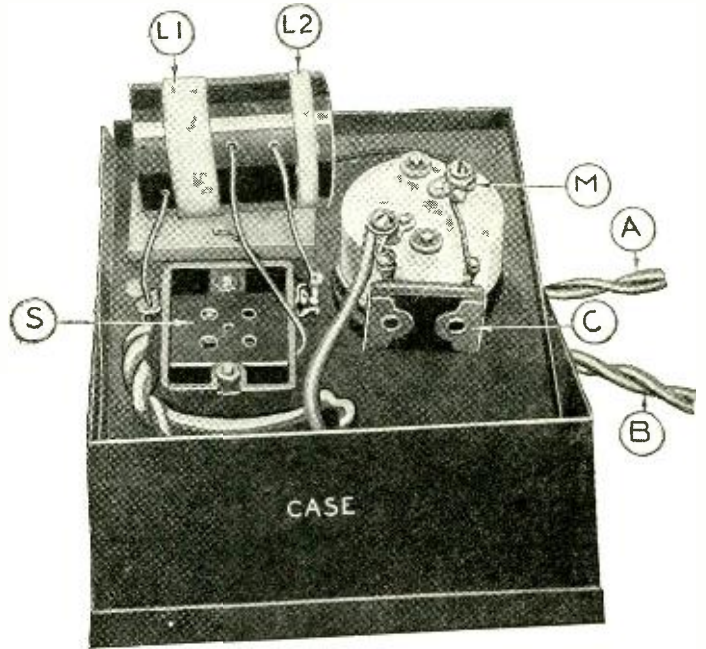

filament-emission measurement type; but, on cutting L2 back in the circuit we find an entirely different action and result. With six volts applied to the filament, 45 volts of plate battery and L2 shorted out by the switch, a good tube will show a plate current flow of about two or three milliamperes; but, when L2 is placed in the circuit by opening the switch, the plate flow will suddenly increase to about 10 or 12 milliamperes, because the tube is now oscillating and draws more current. If the tube should be for any reason unable to oscillate, no increase will be obtained; so it may be considered worn out, shorted, or otherwise unfit for service.

SPECIFICATIONS

When constructing the instrument, great care must be used in winding coils L1 and L2. Both coils are wound on a single form of 1½-inch diameter, and they must be separated about an inch. (See Fig. 4). L1 consists of twenty-two turns of No. 26 S.C.C. wire, and L2 of ten turns of the same wire, wound in the same direction. Starting at one end of the tube form, the

(Continued on page 171)

A Trickle Charger for a Storage "B" Battery

Convenient for the Set Owner with Plate-Current Supply of this Type

By E. C. NICHOLS

FOR those who would prefer, as well as for those who already have storage "B" batteries for plate supply in their radio receiving set equipment, it is possible, at a small expense, to obtain all the advantages of the "B" socket-power unit,

charger and one for a "B" unit. When the receiving set is turned on, the "A" trickle charger is off, while the "B" socket device is turned on.

In this trickle-charge arrangement only that connection on the automatic-relay switch which is meant for the "A"-battery trickle charger is used; a double socket being inserted here. The "A"-battery trickle charger is inserted into one side of this socket and the primary of the A.C. power transformer into the other side. The specifications for this transformer depend upon the total voltage of the "B" batteries to be charged and the type of rectifying tube used. The transformer should have a high-voltage output, approximately one hundred volts more than the voltage of the "B" batteries which are being charged, in order to take care of the drop in voltage through the rectifying tube. If a rectifying tube having a filament is used, a 7½-volt tap for heating the filament will be necessary. If a raytheon tube is used, the filament winding will not be required.

CHOICE OF TUBES

Probably the best type of rectifying tube is the large size raytheon, which gives a full-wave rectification. In some cases, no doubt, the constructor will have on hand some of the older type tubes, such as VT-2, 216A or some of the old five-watters. If the latter tubes are used, filament taps on the power transformer will be required, as mentioned above.

In the raytheon-tube combination, as shown in Fig. 1, the charging rate is controlled by placing an adjustable resistor in the negative lead between the storage "B" battery and the A.C. power transformer. The charging rate is read on a milliammeter placed in the same negative lead between the A.C. power transformer and the battery. The resistance is adjusted until the charging rate is approximately fifteen milliamperes, or fifteen one-thousandths of an ampere. This will be ample for any receiver requirements. It is not necessary, unless it is so desired, to keep the milliammeter in the circuit after the adjustment is made.

In the case of the VT-2, or similar tube, combination, which gives a half-wave rectification, the adjustment of the filament rheostat controls the charging rate, as shown in Fig. 2. It is important in this case that the charging rate of fifteen milliamps be not exceeded, as a short-lived tube will result from failure of the filament.

(Continued on page 164)

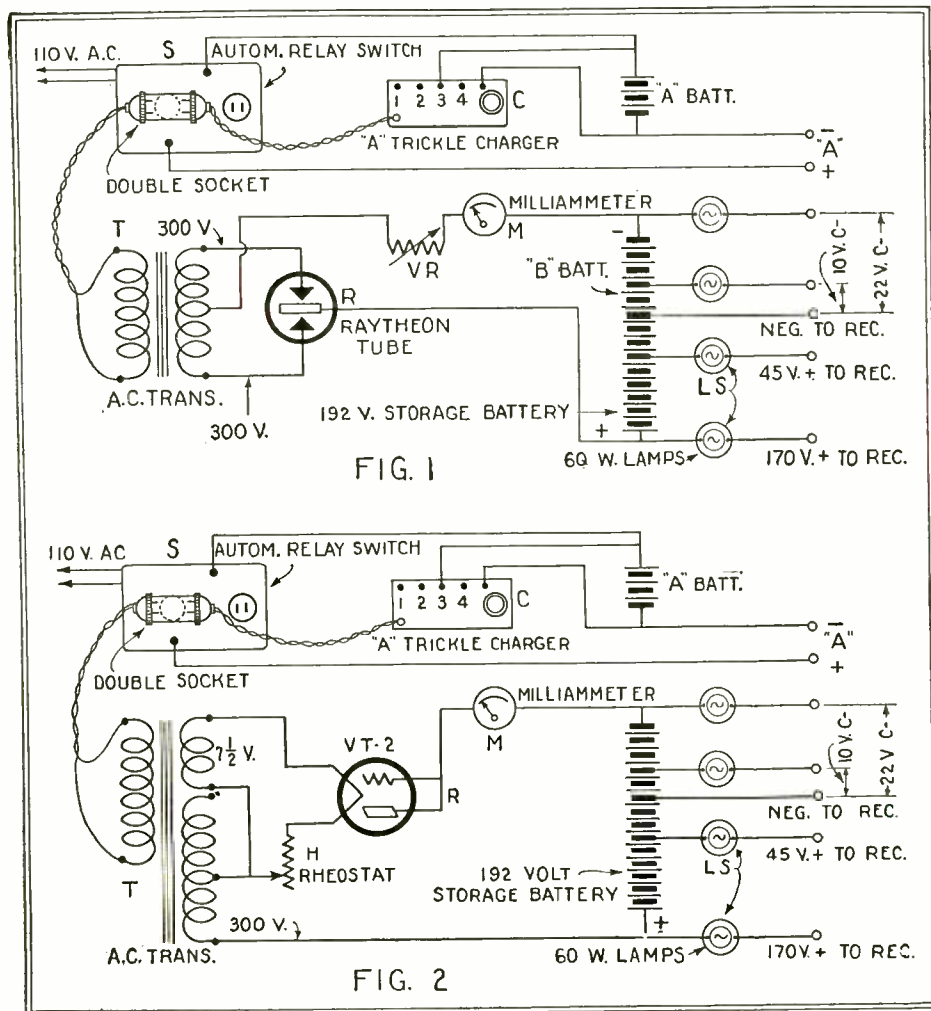
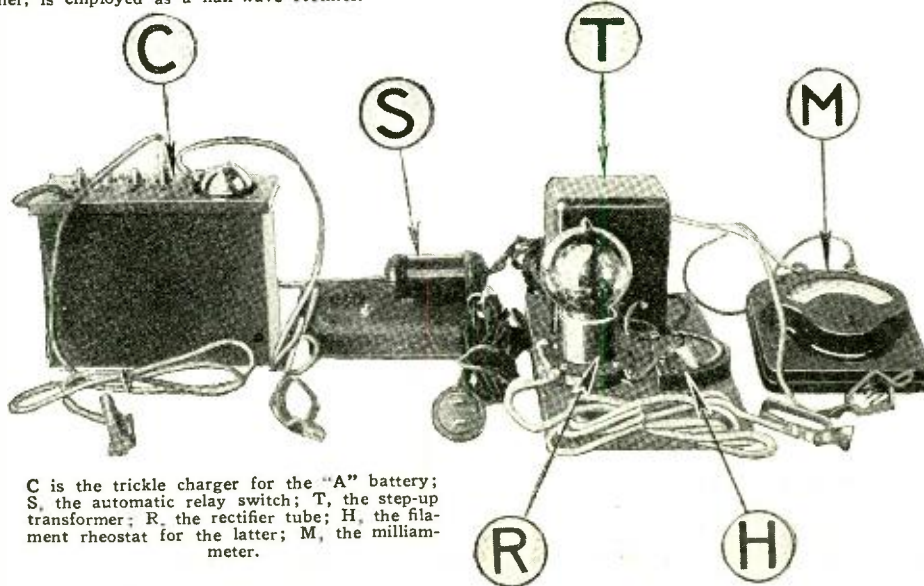

Fig. 1: In this arrangement the charging current for the storage "B" battery is furnished by a Raytheon or similar tube. Fig. 2: In this hook-up an ordinary amplifier tube of the power type, with the grid and plate connected together, is employed as a half-wave rectifier.

while still retaining the splendid quality of storage-battery plate supply.

Most "A" and "B" power-units require some attention, at least twice a year. By developing a combination, which is made possible by using an A.C. power transformer, such as employed in "B" power devices, and an automatic-relay switch, it is possible to construct an automatic "A" and "B" trickle-charge arrangement which will keep the batteries fully charged with no more attention than is required by the so-called "eliminators." This device has adjustments which make it possible to govern the charging rate of both "A" and "B" batteries so that dangers of over-charge are eliminated. In fact the charging rates are so small in each case that the likelihood of damage is negligible.

This arrangement is one wherein the usual automatic-relay switch, inserted in the "A" battery circuit, controls a standard-type "A"-battery trickle charger, of which there are many on the market. These automatic switches usually have two locations for plugging in, one for an "A"-battery trickle



C is the trickle charger for the "A" battery; S, the automatic relay switch; T, the step-up transformer; R, the rectifier tube; H, the filament rheostat for the latter; M, the milliammeter.



Letters from Home Radio Set Constructors



A FINE PIECE OF MECHANISM

Editor, RADIO NEWS:

The writer has read that the ultimate simplicity in a radio set should be one knob for stations and one for volume. Verily, it must be so; after one has used 17 one-ampere tubes in a line, with a piano bench to slide on to tune the monstrosity; an "N" tube miniature; a two-tube super-regenerator, which probably made listeners within ten miles use every cuss word in the language—he feels that four tubes and one control is the answer.

Mr. Hugo Gernsback brought out in one of his "Flex" circuits the lossier method of keeping oscillations out, by turning the ticklers to the best point of regeneration and leaving them fixed. Since then the manufacturers have grabbed this arrangement and I do not believe he has been given the proper credit. At that time the writer was working along that line with the Foucault idea; but it didn't work out very satisfactorily. It was then noticed that Mr. Gernsback shunted his ticklers with large fixed condensers. That was the missing link.

It was found that the theory of the tickler moving through an arc of even movement of the secondary condenser did not work out in practise. On the higher frequencies, one of the condensers required less ticklers; therefore the first tickler remains in a stationary position until a wavelength of 250 meters is reached, then moves by

Mr. Thompson's circuit, showing the connections of the specially-coupled coils; an eccentric gear varies the rotor at varying angles as the capacity in the circuit is altered. The result is a set which is very easy to control—though far from easy to build, as may be conjectured. (No blueprints available!)

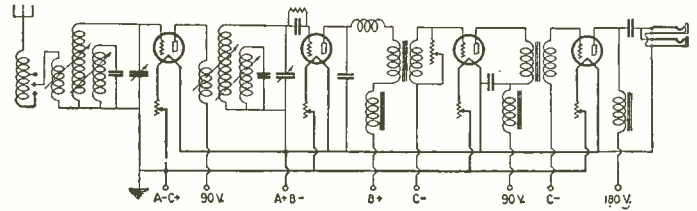

A CORRECTION

Editor, RADIO NEWS:

There is an error in the drawing of my hook-up (on page 1464, June Radio News) which, though small, is sufficient to make it unworkable. (The "B + 90" connection to the plate of the first A.F. tube was omitted in the drawing.) I am pleased that you considered this stunt of enough interest to publish. With the crystal or with a grid leak, either one, I was able to get some forty stations on my loud speaker; the greatest distance with very good volume was WDAF, Kansas City, which, from Boston, didn't seem bad for a "junk set." The extra tube in the last stage did not prove to be of any advantage. The secondary of the crystal circuit acted as a wave-trap when open. The sliding primary worked best near the grid of the de-

4-tube Receiver by Joseph Bernsley in RADIO NEWS Amateurs' Handbook of this year and found just what I was looking for—a receiver of the three-circuit type employing regeneration in the radio-frequency stage.

I assembled and built the set with the best parts and made my own coils according to specifications; and I'll tell the world that right now there is no superior set made, considering selectivity, sensitivity and tone quality, also ease of tuning. For local stations I use a small loop (it is too loud with an antenna) and that makes the set needle-sharp, with beautiful tone quality. I cut through Chicago any night, using a twenty-foot bell wire under the carpet for an antenna and, on Sunday and Monday nights, I get California with plenty of volume on the loud speaker with that short antenna. Of course on silent night I use also a seventy-foot outside aerial and I surely get volume from coast to coast.

With an added two steps of impedance-coupled R.F. (untuned) and my twenty-foot antenna I have been able to get Oklahoma, Des Moines and Davonport through Chicago in the daytime; but my best work is with the 4 tubes as it is.

VICTOR L. SALLE,
3702 Pine Grove Avenue, Chicago, Illinois.

WANTED—CONDENSER COUPLINGS

Editor, RADIO NEWS:

Many of the experimenters who build their own sets find the type of apparatus best suited to their particular needs by consulting the text and advertising in your magazine. With the present tendency to reduce the number of controls, many of us are turning to the tandem or gang condensers.

Most gang condensers are made with rotor plates on the same shaft and therefore electrically connected. Many methods of balancing preclude the use of this arrangement; and we have returned to the use of single condensers, belted together or connected in tandem by a piece of insulation. Such arrangements require condensers with shaft extensions on both ends.

The writer uses an arrangement of two condensers by removing the vernier drives from both, the balance weight from the first, and connecting with fiber tubing. The first, or front condenser is attached to the panel in the usual way. The extended shaft (front and rear of second condenser) is supported by bearings or brackets attached to the sub-panel. This leaves the stator of the second condenser free to rotate through a small arc around the rotor shaft. A small vernier dial rotates this second stator through a small arc, to sharpen tuning or match up, without disturbing the setting of the front condenser. This permits direct reading of the dial for logging. Perhaps some manufacturer might be interested in making up a suitable coupling to be used between such condensers.

Other items for the elimination of controls might be included; such as a rheostat with hollow shaft, through which another shaft is passed for verniers to condensers of balancing controls. This would put one knob over another, thus making them appear but one, so far as looks are concerned.

H. R. KOHLER,
1132 Kingshighway Park, St. Louis, Mo.

A DOUBLE REGENERATIVE INTERFLEX

Editor, RADIO NEWS:

As a constant reader of your magazine, I wish to register my appreciation of RADIO NEWS, and the pleasure I've had building some of the circuits therein described.

And mark up another score for the *Regenerative Interflex*. I've built several variations of this cir-

WORK ON THE DYADYNE

Editor, RADIO NEWS:

I experimented with all sorts of radio frequency with no apparent improvement. The little I gained was sacrificed in tone. Finally I came across the description and constructional data of the Dyadyne

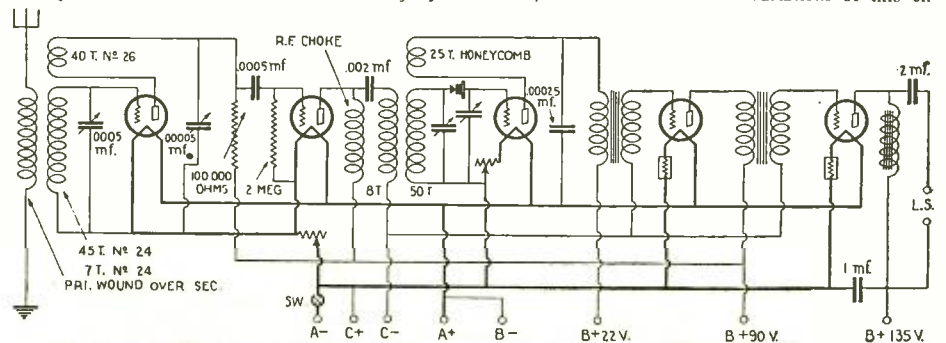

Mr. Battocletti has greatly increased the range and power of the Regenerative Interflex by a preceding regenerative stage. It is a real DX set, and brings in a considerable range outside the broadcast band, at both ends.

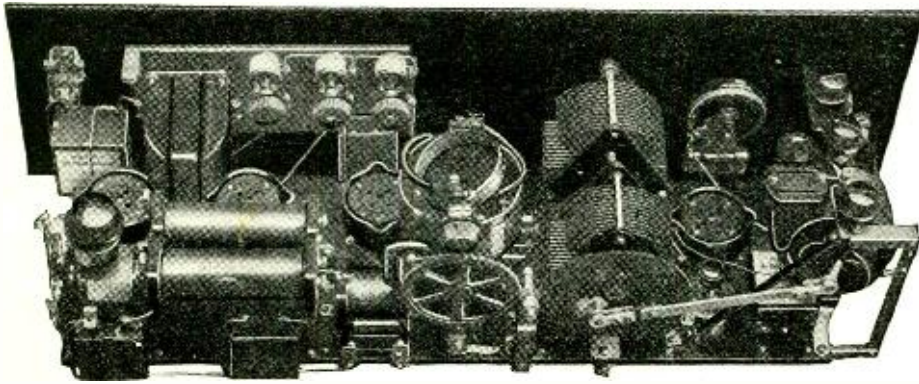

A rear view of Mr. Thompson's single-control set, which contrasts with the simple appearance of its panel. The variable coupling gear, shown at the right, has cost an enormous amount of experiment.

means of an eccentric, ball-and-socket joints, and lever to a point of 500.

The coils are litz; the leading coil has 15 turns, tapped at 7; first primary 15, second primary 19 turns; secondaries 49 turns, ticklers 28. The variable condensers are .0005-mf., those across ticklers .006-mf. The writer does not recommend litz to anyone with little patience; also it has little advantage over No. 24, silk-over-cotton.

No neutralizing condenser or choke coils are used; the R.F. rheostat controls both oscillation and volume. The first condenser is in "A—" while the second is in "A+"; old-style are used, after trying out the various straight-lines. The sockets are floating. Across the filaments are 0.5 condensers. Since the picture was taken a two-arm parallel switch has been added across the 30-henry chokes. Note the scarcity of wiring.

The writer uses a 42-inch cone, a 36-inch cone, a Thorola horn, one of his own, and a Manhattan; while the pet of the collection is a sea shell with a Utah unit. A two-and-a-half foot seashell is now contemplated.

I gold-leafed the panel myself; with a sharp-pointed small file tang dig out the lines. Use 40-minute gold size; lay in the leaf; wipe off the thinner.

As the writer holds no brief from any manufacturer, he recommends the Ceco "H" tube and the new "K" R.F. tubes.

The eccentric on the gear is the whole idea; by loosening the screw the eccentric can be changed to any angle. It is weird to see that rotor remain stationary while the gear keeps turning; then all of a sudden the rotor starts to move.

In a sense, the "tickler" is not a tickler; nor is it a lossier. It looks to me like a half-baked variometer. I can't tell what it does; and when I pin the engineers to facts, they "think."

Last night checked the stations and pulled in 54 from WAAT—235—to WFAF 491—and some one up in the 500s. Four Canadians.

J. H. THOMPSON,
48 Laura Street, Providence, R. I.

(In response to further queries about the gearing of the variable coils—the tuned "tickler" circuits appear to be "rejectors"—Mr. Thompson says: "I'm fearful on that eccentric. Anyone who has ever worked on eccentrics knows to his sorrow the failures." He is, therefore, unable to supply to inquiring fellow-constructors the necessary constructional details of this delicate apparatus.—EDITOR.)

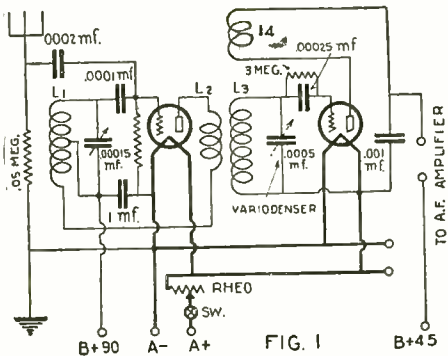

Mr. Nichols has applied the ultradyne principle to the construction of a four-tube set, with an intermediate frequency of 450 kc., which is a very high figure. The simple method by which this is done is shown here; the audio stages are omitted, for the sake of space.

cut, one a double regenerator that was remarkable. It consisted of a simple regenerator in the first stage; this was resistance-coupled to the next tube, and that coupled to the Interflex, making a five-tube set.

With this set I could tune in WGN, WEAO, WPG, WMSG without any interference from the others. Using .0005-mf. Pilot condensers, I could tune over part of the amateur band; thus I could listen to "hams" calling each other all over the states. At the same time, it would tune over the present broadcast range of 545 meters, this range being confined between 10 and 90 on the condenser dials. Commercial code stations could be tuned in above 545 meters and, withal, it was as selective as one could wish.

Its DX ability caused members of my family to spend the best part of many nights at the dials, reaching out after the elusive distance. Its best DX was KFJ, KGRS, KFQB, PWX, the Canadian and southern stations coming in regularly. All this was loud-speaker reception. I have an average L-type antenna surrounded by houses and trees.

The latest circuit I built is a single-control Interflexed Dyadyne. I built the Dyadyne according to specifications in Radio News Amateurs' Handbook, except that I put a crystal in the grid circuit of the detector and a 25-turn duo-lateral as the tickler in the detector inductance, thus eliminating a regeneration control. I find it as quiet and reliable as the Interflex.

LAWRENCE J. BATTOCLETTI, Bridgeport, Ohio.

HIGH INTERMEDIATE-FREQUENCY WORK

Editor, RADIO NEWS: I enclose circuit diagrams of two receivers I have built along the lines of the Ultra-5 in March RADIO NEWS. It appealed to me as a good way to make the most of the sensitivity of a regenerative detector or three-circuit tuner set. The obvious disadvantages of poor selectivity and varying feedback are of course overcome by Mr. Lacault's method.

It seemed possible to make these improvements in a three-circuit set by adding only one tube. Theoretically, an autodyne first detector would do it; but that still requires two major controls where the three-circuit set has one. Continuing the comparison, I reasoned that, as the aerial circuit of the latter is more or less untuned, the baby super might be operated the same way by feeding all broadcast frequencies from an untuned aerial into the oscillator, whose tuning control would be the only one in the set.

A set using standard parts is working very well, using the hook-up of Fig. 1. The three-circuit tuner L2-L3-L4, functioning as the intermediate amplifier, operates at about 450 kc. (666 meters);

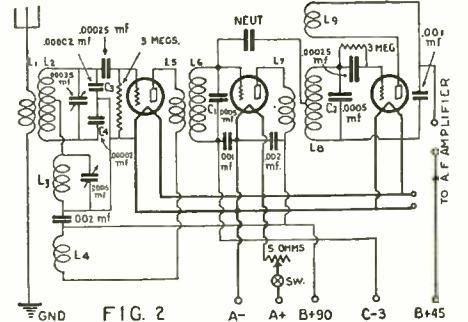

Here is another application of the same idea for the production of a set using the Brown-ing-Drake units; the experiment has given excellent results. As the I. F. operates on only 666 meters, it is wise to shield this set wherever there are strong code stations nearby.

it is a "baby"-type coil, designed to tune with a .00035-mf. condenser, and adjusted to the higher wavelength by means of a .0005-mf. variocoupler. Using this intermediate frequency requires the oscillator to have a range of 150 to 300 meters; so that there will be no interference between it and any given signal frequency being heterodyned—at least compared with what there would be when using a lower I.F.

The oscillator inductances are combined in the secondary winding of a baby-type aerial or R.F. coil, matching the three-circuit coil. The secondary is tapped, at two-thirds of its length from the grid end, and this section is tuned with a .00015-mf. condenser; the remaining third of the winding is the plate coil. The primary winding is not used.

(Continued on page 181)

LIST OF BROADCAST STATIONS IN THE UNITED STATES

(Continued from page 122)

Table with columns: Radio Call Letter, BROADCAST STA. Location, Wave (Meters), Power (Watts). Lists stations across the United States, including WJBI, WJBL, WJBO, etc., and continues from page 122.

LIST OF CANADIAN BROADCAST STATION CALLS

Table with columns: Call Letter, Location, Wave (Meters), Power (Watts). Lists Canadian broadcast stations such as CFAC, CFCA, CFCE, etc., and continues from page 122.

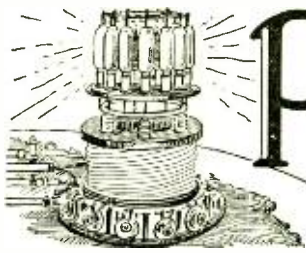

Progress in Radio



A DIRECT RADIO-CONTROL RELAY

THE Ruben vacuum-tube direct-radio-controlled relay was developed to fill the need for a simple and direct means of radiodynamic control for various commercial uses and practical applications. It is the first and, so far as known, the only relay which *directly* controls an associated circuit by an applied potential from a radio receiver or other electrically receptive circuit.

The inventor, Samuel Ruben of New York, is a physicist of note, with many accomplishments in the field of electro-physics to his credit. An earlier type of the relay was described in a paper presented at the annual convention of the American Institute of Electrical Engineers at Chicago in June, 1924, this paper being reprinted in the November, 1924, Journal. The present device is much simpler and more efficient.

The underlying principles of operation are readily understandable by comparison with the usual present-day vacuum tube. The ordinary vacuum tube has three elements, filament, grid and plate; the filament discharging the electron stream which makes the otherwise non-conductive vacuum gap between the filament and plate conductive, to a degree which is controlled by the grid element.

This relay employs the effect of the bombardment of the electron stream from the filament upon a special plate element which *moves* under the influence of the bombardment, to which it is sensitive and responsive. The grid serves to vary the intensity of bombardment of the electron stream from the filament, thereby controlling the movement of the sensitive plate. This plate, or anode element, controls a local circuit by means of contacts, one of which is mounted upon it or moved by it, thereby making or breaking the local circuit. The vacuum protects the contacts, allowing the use of high voltages and current in the local circuits.

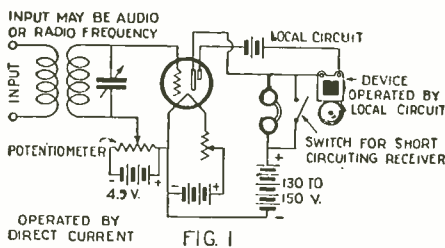

This diagram shows how the relay is connected in a D.C.-operated circuit.

STRUCTURE OF THE TUBE

Specifically, the relay consists of a high-vacuum tube having a filament, grid, plate element and stationary contact located close to the plate element. This plate element, however, functions in an additional capacity to that in ordinary vacuum tubes; namely, it is movably responsive to the electron bombardment. It is constructed of a special high-temperature resisting bimetallic element and has a contact mounted at one end. In its normal connection, the electron bom-

bardment is so controlled that the density is insufficient to cause the plate-element contact to move over and touch the stationary contact. However, when a potential is impressed upon the grid, the incremental flow of electrons due to the applied grid voltage, especially when the grid is normally negatively biased, causes the anode to move to the stationary contact and close the local circuit. The metal-base shell serves as a connection terminal for the stationary contact.

A directly-controlled radiodynamic relay is thus created, of high sensitivity which makes practical radio or other sensitive electrical control of circuits or devices. It will be seen that the outstanding feature of the relay is its simplicity, no special or delicate or complicated devices or circuits being required.

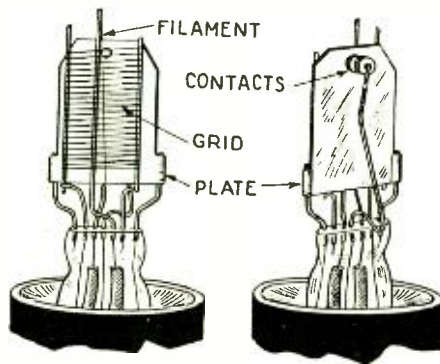

The construction of the elements of the direct radio-control relay, which can be built into a radio receiver, to operate a local calling or recording device.

USE IN RADIO SETS

The connection for radio control is similar to that of any ordinary vacuum tube, except that two plate leads are utilized, these including the movable and stationary contacts for the local circuit control. The base and the electrical characteristics of the relay are such as to allow of its use in standard radio receiving sets. Thus, if placed in the usual tube socket in a standard set, as in the radio-frequency amplifier stage, with the necessary contact-circuit attachment, at a predetermined wavelength, it will operate any call signal, such as a bell, a lamp, etc. Another important advantage lies in the fact that it can be utilized as an ordinary vacuum tube simultaneously with or independent of a call-signal device.

The type described is considered a universal one. Because of its direct local-control characteristics, which eliminate the necessity of employing any auxiliary means (as an electromagnet relay connected in a plate circuit, such as has been necessary heretofore in other devices) it is ideally adapted for call-signal work, radio call systems and similar uses, where high speed is not required. This type will open and close a circuit approximately twenty-five times a minute, but this speed may be increased by the substitution of another plate operating at higher temperatures. The current capacity is one ampere at 110 volts; plate voltage 130 to 150; filament voltage 5.5 to

6; filament current 0.5 ampere; negative grid potential 4 to 4.5 volts.

ELIMINATION OF MOVING PARTS

In order to satisfy the requirements, where speed is an essential factor and continuous variation of an amplified current is desired, a contactless relay of resistance-type plate has been developed. This has a speed in the order of 25 cycles. The plate element or anode in this type is a wound, grid-like iron wire of small diameter, having a high resistance, which varies with the density of the electron discharge. The plate element is connected in series with the local circuit, to control the current flow in the amplified circuit. The grid, of course, controls the density of the electron discharge bombarding the plate or anode element.

The current normally flowing through the wire-plate element is of such an order as not to increase the resistance of the wire materially; but the effect of the electronic bombardment is to raise its temperature to such an extent as to increase the resistance of the wire plate more than tenfold (from 40 to 400 ohms); so that a relay of the ordinary armature type can easily be operated by the current flowing through the anode wire by use of the control obtained by variations in the applied grid potential.

This high-speed type relay has been developed for such applications as cable work requiring a bridge type of circuit, also where extreme vibration makes it difficult to use the contact type. The plate impedance of a sample tube of this sort is 10,000 ohms. The filament draws 1/2-ampere at 5 volts, and the amplification constant is 9.

Both types of the relay can be operated on either alternating or direct current for their filament and plate. Of course, batteries may be used if desired.

APPLICATIONS

Generally, it may be stated that the Ruben relay can be used where it is desired to obtain a relay controllable by minute ener-

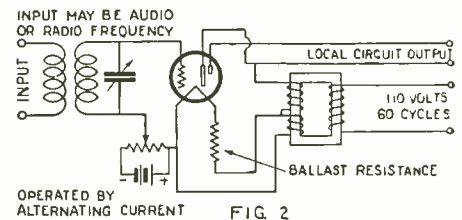

When the relay is used in an A.C.-operated circuit, the connections are made as shown above.

gies in the form of current of any frequency, either radio or otherwise, and capable of controlling circuits of considerable current and potential; it offers an opportunity for development in the field of radiodynamics because of the simplification of the local circuit control obtained by its use.

Some of its most important specific uses are for radio call systems; radio recording systems; simultaneous call signal and radio or audio-frequency amplification; controlling devices at a distance; wired-wireless signalling or switching systems; telegraph
(Continued on page 182)



LUMBERMEN, TAKE NOTICE

Item of interest to the lumber trade, found in the Rochester Democrat and Chronicle for April 13: "The high resistance of the antenna is introduced into the tuned circuit feeding the first tube and BOARD tuning is likely to be the result." Perhaps this type of tuning is made for these so-called stable receivers, well set in adjustment all the time.

Contributed by James B. Cummings.



WATTA CONDENSER!



This description of a condenser is found in the American Auto and Radio Mfg. Co.'s catalogue: "No loss type 56-D, Capacity MIN. 10 MFD." We would like to know just what kind of a condenser this is that has a minimum capacity of 10 mf. We sent Mike of the Investigation Department over to find out what the maximum capacity was, and he said he couldn't count that high.

Contributed by Toliff R. Hance.

GET ONE OF THESE



New type of radio accessory advertised in the Columbus, Ohio, Dispatch of April 21: "\$1.25 SNEAKER plugs while they last—59c." We suppose that these plugs are put into a set, if there is anything wrong with it; and they sneak around till they detect the trouble, which they then tell the operator.

Contributed by Robt. G. Ferbrache.

LATEST HOME ENTERTAINMENT

In the Pittsburgh Press of April 18, we find this announcement, doubtless for radio movies: "The switch for FILMED control and jack for loud speaker connections are the only other parts that show on the front of the panel." The set here described is doubtless a forerunner of the television apparatus promised us by the far-seeing engineers.



Contributed by Joseph Werl.

SEE "BOOK OF ETIQUETTE"

New use for a hydrometer explained in the New York Evening Journal of April 12, in the questions and answers department: "Get a voltmeter and hydrometer to test your CALLS each week." We are going to arm Mike of the Investigating Department with a hydrometer and let him make a call on our storage battery; it ain't been acting right lately.

Contributed by James E. Cosgrove.



HOW THE MONEY ROLLS IN!

Effect of the naval mobilization clearly shown in advertisement, in June RADIO NEWS, for "SPARTIME Money Making." The profits of a life on the ocean wave have never been appreciated hitherto to their fullest extent; but a noteworthy increase in recruitment will be noticed by the U. S. navy as soon as this advertisement starts 'em coming.

Contributed by A. Lawson.



HOW DO THEY DO IT?



The following tube advertisement appeared in the Quincy, Ill., Herald-Whig on April 1: "Sixteen types ALL IN THE ORANGE AND BLUE CARTON." Perhaps this company is putting out some sort of rubber vacuum tubes, that they can pack in like this.

Contributed by William Francis.

WANT ONE OF THESE?

Advertisement from the New York Sun Radio Section of April 9: "A THREE SET CONE SPEAKER ready to use, guaranteed." We'll say it must be some speaker to need three sets to make it perk. We wonder what would happen if the sets were tuned to three different wavelengths.

Contributed by John P. Barrington.



SIX OUNCES OF INDUCTANCE, PLEASE

From an advertisement in the May issue of Popular Mechanics magazine: "Catalogue and OVER TWO POUNDS CIRCUITS." We did not know that circuits can be weighed; and we would like to find out if someone can tell us the difference in weight between the R.F. and the A.F. circuits.

Contributed by Richard H. Ward.



INVITING RADIO CENSORSHIP

Rather peculiar heading on some circuit diagrams in a folder published by the Paragon Electric Corporation. "SUGGESTIVE Wiring Diagrams." We do not see how Mr. Summer ever let a thing like this get by. We thought he was on the job to keep everything broadcast sweet and pure.

Contributed by Hy Bayer.



FROM A CRUEL CRITIC

Uncomplimentary reference to Al Jolson's singing in the Springfield, Mass., Union of April 28; it reads, in part: "plans are being made whereby POISON will be heard simultaneously over every important station in the country." We always enjoyed Jolson's singing and we can't see why it should be referred to as poisonous.

Contributed by H. A. Pooley.



SAY IT AIN'T SO, JOE!

Progress in radio engineering is revealed by an advertisement in the April 22 issue of the Easton, Pa., Express, of a receiver with "THREE STATES OF RADIO FREQUENCY BATTERY CABLE." Hard on the choke-coil makers; but we hope the last state of this R.F. cable will be better than the first.

Contributed by Irwin Uhler.



POWER PLUS

Extraordinary type of station tie-up as mentioned in the Rochester Times-Union of April 14 listing programs: "WEAK hookup 8:30 P. M." We generally considered the tie-up of stations to have more power and to reach further than just one single station. Will someone please tell us what is the advantage of the tie-up in this case?

Contributed by John C. Heberger.



WELL! WELL! WELL!

New source of electricity, as related in the Seattle Daily Times of April 24: "A grid biasing voltage of 1 1/2 volts obtained from a single small dry WELL will just suffice." We suppose that out in that neck of the woods they have all sorts of things like tube trees, rheostat bushes, etc. if they have wells from which you can get volts.

Contributed by Edw. Everett.



THEN WE LOOKED AT THE DATE

Contribution toward remedial measures by the United States Daily, of Washington, D. C., on April 1, regarding wavelength changes of national broadcast stations: "Their interference (BEST-NOTE)-producing zone would cover the country." Mr. Lawrence must be one of these fans who enjoy hearing several programs at once.

Contributed by F. B. Thorne.



ATTENTION, THE RADIO COMMISSION

Explanation of tuning difficulties in "What Radio Set Shall I Buy?" is that: "The waveband is CROWDED into 100 divisions on the ordinary receiver." Mike of the Investigation Dept. reports that it will be necessary only to muzzle the roosters; and in future no one will have any difficulty in separating stations.

Contributed by H. M. Matz.



Contributed by Frank F. Wessell.

A NEW SPEAKER

Latest type of loud speaker, advertised in the Hamilton (Ohio) Daily News of April 25: "Latest COHEN type speaker." Now let someone invent a Murphy speaker too, and the broadcasting of "Abie's Irish Rose" will be a very simple matter.





Radio News Laboratories



RADIO manufacturers are invited to send to RADIO NEWS LABORATORIES samples of their products for test. It does not matter whether or not they advertise in RADIO NEWS, the RADIO NEWS LABORATORIES being an independent organization, with the improvement of radio apparatus as its aim. If, after being tested, the instruments submitted prove to be built according to modern radio engineering practice, they will each be awarded a certificate of merit; and a "write-up", such as those given below, will appear in this department of RADIO NEWS. If the apparatus does not pass the Laboratory tests, it will be returned to the manufacturer with suggestions for improvements. No "write-ups" sent by manufacturers are pub-

lished in these pages, and only apparatus which has been tested by the Laboratories and found of good mechanical and electrical construction is described. As the service of the RADIO NEWS LABORATORIES is free to all manufacturers, whether they are advertisers or not, it is necessary that all goods to be tested be forwarded prepaid, otherwise they cannot be accepted. Apparatus ready for, or already on, the market will be tested for manufacturers free of charge. Apparatus in process of development will be tested at a charge of \$2.00 per hour required to do the work. Address all communications and all parcels to RADIO NEWS LABORATORIES, 230 Fifth Avenue, New York City.

POWER UNIT

The "B" Power-Unit shown, submitted by the Cornell Electric & Mfg. Corp., 135 East 58th Street, New York City, N. Y., operates on 110-volt, 50-60 cycle house-lighting current, and uses a Raytheon-type



hull as rectifier. Two "Clarostat" variable resistors and a three-position switch allow a wide regulation of the supplied voltages. The operation of this power unit is very satisfactory and quiet; so that it does not interfere with the reproduction of the radio set in conjunction with which it is operated.

AWARDED THE RADIO NEWS LABORATORIES CERTIFICATE OF MERIT NO. 1994.

POTENTIOMETER

The Potentiometer (Rheostat) shown, submitted by the Central Radio Laboratories, 16 Keefe Ave., Milwaukee, Wis., is of the air-cooled one-hole-mounting type and is constructed almost entirely of metal.



The resistance wire is wound on a metal strip covered with asbestos. The cooling is perfect and the contact is smooth and efficient. Available in different resistance values.

AWARDED THE RADIO NEWS LABORATORIES CERTIFICATE OF MERIT NO. 2023.

CONDENSER

The "Polymet Block Condenser"



(type F-1000 shown) submitted by the Polymet Mfg. Co., 599-601 Broadway, New York, N. Y., is intended for use in filter system of

"B"-power-supply units using a Raytheon tube as a rectifier; it contains all the necessary capacities. The total capacity of the block is 14 mf., and it is tapped at 1, 1.2, 2, 8 mf. AWARDED THE RADIO NEWS LABORATORIES CERTIFICATE OF MERIT NO. 2024.

RHEOSTATS

The "E-Z Stat Noiseless Rheostat" (metal case) shown, submitted by the same company, is of the one-



hole-mounting type. The metal housing insures good cooling and is provided with holes for screw-and-nut attachment to the panel. The contact arm runs smoothly and makes good contact in all positions. Available in different standard resistance values.



The "E-Z Stat Noiseless Rheostat" (with switch) shown is constructed on the same principles; in addition it is provided with two springs forming a switch and operated by an extra arm on the shaft.

AWARDED THE RADIO NEWS LABORATORIES CERTIFICATE OF MERIT NOS. 2025, 2026.

POLYTROL

The "Polytrol" shown, submitted by the Polymet Mfg. Corp., 599-601



Broadway, New York, N. Y., is an automatic filament control which, when used in series with the filament of a radio tube, eliminates the usual rheostats. Polytrols are manufactured in various values, to control different types of standard radio tubes.

AWARDED THE RADIO NEWS LABORATORIES CERTIFICATE OF MERIT NO. 2027.

RESISTOR

The "Wire Wound Resistor" shown, submitted by the same company, has very fine resistance wire, wound on a porcelain tube, and protected against mechanical injury and

corrosion by an enamel coating. This resistance unit, made in different



values, is designed to carry a relatively heavy load and can be used very conveniently in "B" power units.

AWARDED THE RADIO NEWS LABORATORIES CERTIFICATE OF MERIT NO. 2028.

OUTPUT FILTER

The "Erla Output Filter" shown, submitted by the Electrical Research Laboratories, Inc., 2500 Cottage Grove Ave., Chicago, Ill., embodies in one metallic container a fixed condenser of approximately 1-mf. capacity and a choke coil of approximately 275 ohms resistance. The low D.C. resistance of the choke coil



causes only a small drop of the plate voltage; thus allowing the last tube, especially when it is of the power type, to work under the best conditions for amplification and reproduction. On the other hand, the filter prevents the direct current of the plate from flowing through the loud-speaker windings, thus eliminating the continuous pull on the diaphragm and protecting the windings from burning out.

AWARDED THE RADIO NEWS LABORATORIES CERTIFICATE OF MERIT NO. 2029.

JACK SWITCH

The jack switch shown, submitted



by the Yaxley Manufacturing Co., 1103 West Monroe St., Chicago, Ill., is of the three-pole, double-throw type and is very well constructed. It is very easy to install, and the contact between the springs is perfect.

AWARDED THE RADIO NEWS LABORATORIES CERTIFICATE OF MERIT NO. 2030.

ADJUSTABLE RESISTOR

The resistor shown, submitted by the same company, is equipped with

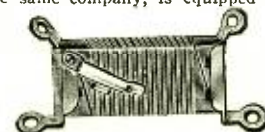

a movable arm which allows the regulation of the total resistance by short-circuiting part of the winding. AWARDED THE RADIO NEWS LABORATORIES CERTIFICATE OF MERIT NO. 2031.

SMALL JACK

The "Junior" jack shown, submitted by the same company, is designed to be used in sets where little space is available. The jack is neat-

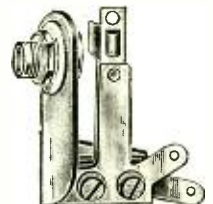

ly built. Its springs are provided with silver contacts and will take any standard radio plug.

AWARDED THE RADIO NEWS LABORATORIES CERTIFICATE OF MERIT NO. 2032.

REPRODUCER

The "Simplex" Loud Speaker shown, submitted by the Simplex Radio Co., Sandusky, Ohio, is of the conventional cone-type construction. It has been found to give very good reproduction of speech and music, with regard to both volume and quality.



AWARDED THE RADIO NEWS LABORATORIES CERTIFICATE OF MERIT NO. 2033.

RESISTOR STRIP

The Resistor Strip (No. 2313 shown), submitted by the Carter Radio Co., 300 So. Racine Ave., Chicago, Ill., is designed to be used in "B" power-supply units as a voltage-control element. It consists of a bakelite strip 8x3/4x1/8 inches, covered with one layer of a very fine resistance wire, having a total resistance of 7,500 ohms and equipped with



sliders to permit accurate adjustment of the various voltages. Once adjusted for the desired voltage values, the sliders are kept in their position by tightening the thumb screws. This adjustment is permanent and is not affected by temperature or climatic changes.

AWARDED THE RADIO NEWS

LABORATORIES CERTIFICATE OF MERIT NO. 2034.

RESISTOR

The resistor (type PA-400 shown), submitted by the same company, is similar in construction to the strip



described above, except that it is provided with only one slider and has a total resistance of 400 ohms.

AWARDED THE RADIO NEWS LABORATORIES CERTIFICATE OF MERIT NO. 2035.

FIXED CONDENSER

The "Aerovox Gold Bond" fixed condenser shown, submitted by the Aerovox Wireless Corp., 70 Washington St., Brooklyn, N. Y., is of the paper-dielectric type and is designed especially to be used in the filter systems of "B" power-supply units. It is rated at 600 volts (working



voltage) and is available in all the different capacity values necessary for the conventional "B" filter systems. The condenser is almost entirely enclosed in a metal container, the bottom of which is provided with two extensions having holes for screw-and-nut mountings.

AWARDED THE RADIO NEWS LABORATORIES CERTIFICATE OF MERIT NO. 2036.

FIXED CONDENSERS

The fixed condenser (types 902 and 903 shown), submitted by the Dubilier Condenser and Radio Corp., 4377 Bronx Blvd., New York, N. Y., is of the paper-dielectric type and may be used efficiently as a blocking



condenser. In addition to a choke coil, it forms an output filter, connecting the last tube of an audio amplifier to the loud speaker, thus protecting the windings of the unit from the heavy plate current. This

condenser is available in different capacity values, and is rated at 400 and 600 D.C. working voltages.

AWARDED THE RADIO NEWS LABORATORIES CERTIFICATE OF MERIT NO. 2037.

The fixed condenser (type 907 and 908 shown), submitted by the same company, is also of the paper type, and designed to be used as a bypass. It is enclosed in an aluminum shell and equipped with soldering lugs and mounting feet, which make it very convenient for base-board mounting. Available in different ca-



capacity values, and rated at 160 and 400 D.C. working voltages.

AWARDED THE RADIO NEWS LABORATORIES CERTIFICATE OF MERIT NO. 2038.

The fixed condenser (type PL-91 shown), submitted by the same company, is of the paper type, and is intended to be used in connection with "B" socket-power units as a buffer condenser across the secondary of the step-up transformer. It is provided with soldering lugs and mounting feet, and is rated at a continuous working voltage of 400, D.C.



AWARDED THE RADIO NEWS LABORATORIES CERTIFICATE OF MERIT NO. 2039.

AUDIO TRANSFORMER

The "Pilotran" audio transformer



shown, submitted by the Pilot Electric Mfg. Co., Inc., 323 Berry St., Brooklyn, N. Y., is enclosed in a neat molded bakelite housing. It is built very well electrically and affords fine reproduction, with regard to both music and speech, when used in an audio-frequency amplifier.

AWARDED THE RADIO NEWS LABORATORIES CERTIFICATE OF MERIT NO. 2040.

REPRODUCER

The "Lata Balsa Wood Reproducer" shown, submitted by the Balsa Wood Co., Inc., 331 Madison Ave., New York City, N. Y., uses a rectangular diaphragm made of thin

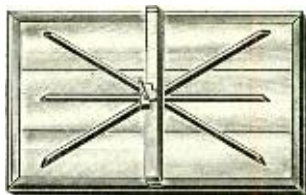

wide strips of balsa wood. These strips are glued to a heavy wood frame and kept flat by several radially-placed thin ribs of the same balsa wood. The frame is provided with one or two cross pieces of hard wood for mounting the electric driving unit. Tested in the Laboratories, in conjunction with a good loud-speaker unit, the reproduction was very good.

AWARDED THE RADIO NEWS LABORATORIES CERTIFICATE OF MERIT NO. 2041.

CABLE PLUG

The cable connector plug (No. 660, shown), submitted by the Yaxley Mfg. Co., 1103 West Monroe St.,



Chicago, Ill., permits easy connecting and disconnecting of the radio set to and from the "A" and "B" batteries. This cable is provided with seven stranded insulated wires of different colors all braided into one cable. The different wires are provided with cable markers.

AWARDED THE RADIO NEWS LABORATORIES CERTIFICATE OF MERIT NO. 2042.

VACUUM TUBE

The "Kleer-Tone Model H-L" tube shown, submitted by the Globe Electric Co., 341 Halsey St., New-



ark, N. J., is of the UX type and its characteristics are similar to the standard 201A-type tube. The interesting feature of its construction is that the upper ends of the metallic rods carrying the elements of the tube pass through a special insulat-

ing plate, thus insuring a constancy of the spacing between the elements and to a great extent preventing microphonic noises.

AWARDED THE RADIO NEWS LABORATORIES CERTIFICATE OF MERIT NO. 2043.

RADIO GROUND

The "DX Radio Ground" shown, submitted by Ungar and Watson, Inc., 1366 So. Figueroa St., Los Angeles, Calif., consists of a container made of copper sheet 12 inches long and 4 inches in diameter. This can contains a compound of copper salts and is sealed except for two small holes near the bottom. The top of the can is provided with a clip for the wire connecting to the



set. This ground has been found to be effective when buried two or three feet in damp ground.

AWARDED THE RADIO NEWS LABORATORIES CERTIFICATE OF MERIT NO. 2044.

A.F. COUPLING UNIT

The "Galmard" audio-frequency coupling unit shown, submitted by L. Galmard, 3 Rue de l'Oasis, Thiais (Seine) France, is of the auto-transformer type. On top of



the last layer, which is spaced by several layers of thin impregnated paper from the rest of the coil, is wound one layer of insulated thin wire. One end of this layer is connected to the binding post marked "grid," while the other is open. This layer and the layer of the coil directly underneath it form the coupling capacity which prevents a direct metallic connection between the plate of one tube and the grid of the tube in the next stage. A two-stage audio-frequency amplifier, built with the corresponding units, gave very good results with regard to volume and fine reproduction.

AWARDED THE RADIO NEWS LABORATORIES CERTIFICATE OF MERIT NO. 2047.

Getting the Most from Resistance Coupling

By A. C. LESCARBOURA

SINCE the amplification in resistance-coupled A.F. circuits is due entirely to the amplification constant of the tube itself, the advent of the UX-240 or CX-340 type, of exceptionally high amplification factor, is of prime interest to advocates of this method. Furthermore, the correct application of the new tube is of equal importance, because the voltage amplification actually realized is based on the correct values of the associated components.

The new tube, properly applied, has an over-all amplification about equal to that of average transformer coupling with the 201A tube. In fact, using the new tube as the detector and also as the first stage, the power tube of the second stage will deliver a satisfactory volume. It appears that three stages of resistance coupling are no longer essen-

tial. Under the conditions of actual voltage amplification, the new tube will average between 15 and 20; representing better than 50 per cent. utilization of the inherent amplification factor of 30.

HIGH PLATE VOLTAGES

Either the UX-240 or the CX-340 has the same filament characteristics as the standard 201A-type tube, namely, 5 volts and .25 ampere. The plate voltage, on the other hand, should be 135 to 180 volts, preferably the latter for best results. The plate resistance is stated as 150,000 ohms.

The coupling condensers should be small, ranging from .006- to .05-mf.; as there does not appear to be a noticeable gain in quality

in going beyond .05-mf.; while possibilities of blocking and distortion rapidly increase.

As for resistors, the values vary materially from those employed with former high-mu tubes. Thus, the plate-coupling resistor should be 250,000 ohms instead of the usual 100,000 ohms; while the grid leak should be 2 megohms. These values apply only to those stages using the high-mu tube, and not to the last or power tube of the amplifier. The usual values for the UX-112 type of power tube work out at 250,000 ohms for the plate coupling resistor, and 250,000 ohms for the grid leak. The 171 type, on the other hand, will have the same plate-coupling resistor and a 100,000-ohm grid leak. Grid biasing by means of a "C" battery for the best tonal quality is strongly advocated with

(Continued on page 180)

Radio Wrinkles

SIMPLE COIL-WINDING FORM

WHEN winding low-loss coils supported by celluloid strips, the most usual practice is to make a form by cutting a cardboard tube lengthwise into three or more segments, and pasting these segments together again with gummed paper from the inside.

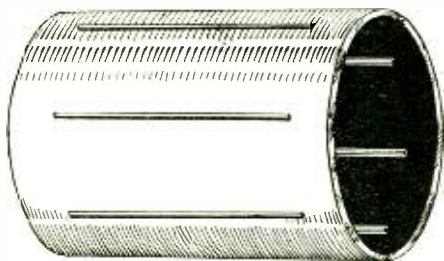

Above is shown a form prepared for winding low-loss coils by partially cutting the tube lengthwise.

A better way is to cut the tube only part way across (as shown in the figure), making the cuts slightly longer than the coil is to be. After the coil is finished, the cuts are extended to the ends of the tube, and the latter is removed.

—Contributed by Sherwood O'Bryan.

SHIELDING AGAINST HUM

A MOST simple way to eliminate A.C. hum from receivers, when it is caused by nearby socket-power and other electrical devices, is to shield the troublesome wire with sheet tinfoil or leadfoil, such as comes



By preparing the A.C. leads to a set as shown, a great deal of the hum is stopped.

with a roll of friction tape. Cut the foil into lengths, 2 inches wide, and wrap the wire with it; then wind over the foil a length of No. 18 bare wire, which is connected to the ground. All trace of hum will be eliminated.

—Contributed by Joseph S. Grant.

"FLOATING" DRY CELLS

THE circuit shown has been used with excellent results to float dry cells used with a trickle charger. Using a receiver with four 201A tubes, 215 hours of use was obtained from one especially good dry cell; the average, out of ten, was 123.5 hours. Without recharging, dry cells last about 25 hours on this receiver. The writer

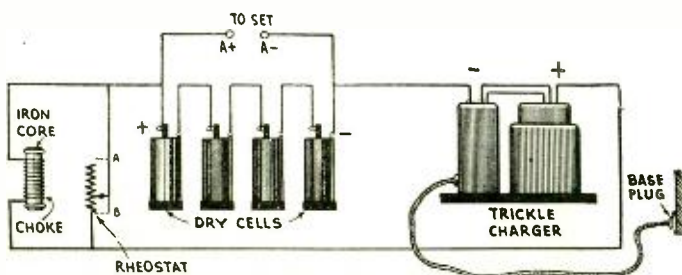

At the left is a diagram showing how dry cells can be "floated" on the filament-supply line. This will prolong the life of the batteries; as they act with the choke as a filter for the A.C. hum.

estimates that the cost is about the same as that of recharging a storage battery at a service station, and that greater convenience is obtained. The dry cells do not seem to require as much charging as a storage battery.

At first it was found that there was a decided A.C. hum, which became worse as the cells were older. This was corrected by the use of a simple choke, made with 25 feet of wire from the secondary of a Ford coil, wound on an iron core (a common wire nail) and shunted by a rheostat. Experiment may be necessary to suit this to a set; beginning with ten feet of wire and gradually increasing the amount.

—Contributed by Robert Bradford.

RECLAIMING SOLDER SCRAPS

SCRAP solder, drippings from the soldering jobs, butt ends of soldering wire or bars, rapidly accumulates in the radio worker's workshop. These bits can be easily melted and cast into new bars of solder.

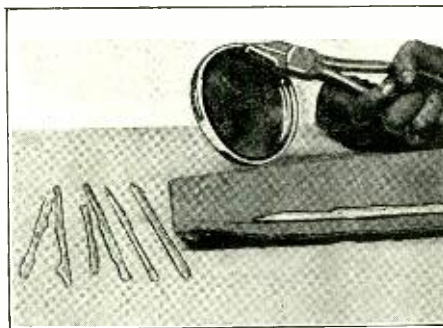

By melting bits of solder in a can's lid, they can be molded into sticks and used again.

For melting the scraps and butts, the "tin" lid of a coffee can can be used very well, over the kitchen gas stove, a Bunsen burner, or even an alcohol or gasoline flame.

For a casting mold, nothing could be simpler than a heavy piece of cardboard, such as used for packing boxes. A bend down the center of the cardboard, forming a V, will make a good casting trough. The molten solder will not burn the cardboard in the least when poured in the V trough.

Contributed by Raymond B. Wailes.

SMALL R.F. TRANSFORMER

A VERY small but efficient plug-in R.F. transformer can be made as shown, using the base of an old tube as both plug and primary coil form. UX-199 bases were used, the slightly tapered sides "A"

being made parallel for easy winding. The secondary was wound on 1¼ inch (outside diameter) tubing, which was a tight fit at the bottom end of the tube base. The

Details for making a small plug-in R.F. transformer.

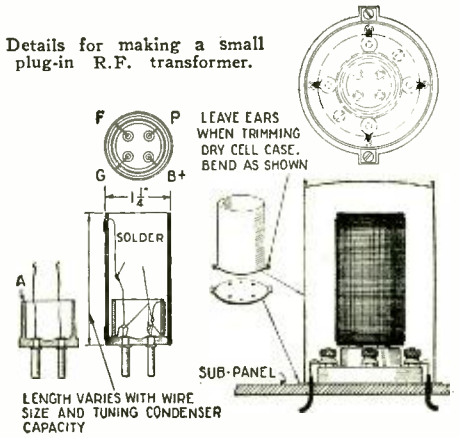

filament and grid ends of secondary were soldered to the filament wires of the base and the "B+" and plate of the primary to the plate and grid of the base.

With such small coils, having a closely confined field, it was found that a very compact 5-tube portable set could be made when the coils were shielded as shown. The shields were made from the zinc cases of old No. 6 dry cells, which have a diameter of about 2½ inches. UX-199 tubes were used in the set, the antenna coil being tuned by one variable condenser, and the two R.F. stages by a two-gang condenser.

—Contributed by H. W. Holdsworth.

HEADBAND LEAD-IN

THE writer recently found that he could not buy a lead-in strip in his home town, so made one from the band of a discarded headset. The insulation was allowed to remain, and a Fahnestock clip

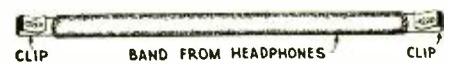

Construction of a simple lead-in from an old headband.

soldered on each end. The band was just flexible enough to go under the window, and gave very good results. Two lead-ins can be made from each headband.

—Contributed by Leslie Carpenter.

NEUTRALIZING MADE EASY

IN the old home-built neotrodynes, it was easy for the fan to neutralize the set, by a simple method, which was to cover one of the socket contacts with paper and adjust the neutralizing condenser until the station disappeared.

However, with the new sockets and tubes, the fan has another problem to worry over. Of course, he can remove one of the filament leads, but that isn't so easy when he has built a shielded set.

A simple solution is found when a quill toothpick is cut the right length for the

(Continued on page 171)



I Want to Know

Conducted by Joseph Goldstein

THIS Department is conducted for the benefit of our Radio Experimenters. We shall be glad to answer here questions for the benefit of all, but we can publish only such matter as is of sufficient interest to all.

1. This Department cannot answer more than three questions for each correspondent. Please make these questions brief.
2. Only one side of the sheet should be written upon; all matter should be typewritten or else written in ink. No attention paid to penciled matter.
3. Sketches, diagrams, etc., must be on separate sheets. This Department does not answer questions by mail free of charge.
4. Our Editors will be glad to answer any letter, at the rate of 25c. for each question. If, however, questions entail considerable research work, intricate calculations, patent research, etc., a special charge will be made. Before we answer such questions, correspondents will be informed as to the price charge.

CROSLY POWER-SUPPLY UNIT

(Q. 2226) Mr. R. Delaney, Mt. Morris, Pa. asks: Q. I have recently purchased the Crosley A.C. supply unit for use with my model AC-7 receiver. I would like to know more about its operation; if possible, please publish a circuit diagram of this apparatus.

A. The Crosley A.C. supply unit was designed primarily for operation of Crosley models AC-7, and AC-7C receivers. It delivers rectified "A" current for five 199-type tubes connected in series, alternating current for the filament of a power tube, and "B" current for all tubes. Because the "A" voltage delivered by the unit is of the proper value to operate five 199-type tubes, the filaments of which are connected in series, the unit cannot be used with ordinary radio sets, which have the tube filaments wired in parallel, unless these sets are rewired.

Electrolytic Condenser

The Mershon type of filter condenser used in this power unit has many advantages, not the least important of which is that it is self-healing. That is, if a high-voltage surge punctures the insulating film, a new film is immediately built up. The principle used in its construction makes it possible to build a high-capacity condenser, which will stand high voltage, in a minimum of space. Another important feature is the smoothing action of the condenser on the pulsating direct current furnished by the rectifier, which it converts into a steady flow of direct current.

These condensers are so constructed that it is practically impossible for them to go wrong unless handled roughly. The electrolyte cannot leak out, and as said before, they are self-healing. If the unit is allowed to get colder than a few degrees below zero, there is danger that the electrolyte will freeze. Freezing and breakage of the glass jar are practically the only causes which will make the condenser cease functioning. If either of these troubles is encountered, the condenser should be replaced by a new one obtained from the factory; for the electrolyte is of such character that it cannot be replaced conveniently in the field.

When the supply unit is first put into operation it usually requires from five minutes to a half-hour for the condenser to become conditioned so that it will function normally. This condenser depends for its action upon a thin film of insulating material that is built upon the plates in a manner somewhat analogous to the process of electrotyping. When the units are assembled at the factory, a film is built up on the plates so that the condensers operate normally when tested. If the unit stands around for some time, however, as in shipment or in stock, the film gradually wears away and a new film must be built up.

To condition the condenser, it is merely necessary to connect the set to the unit in the usual way and operate the set until normal reception is obtained. If the unit delivers the necessary "A" current, immediately upon being placed in operation, it probably requires no conditioning. If the set stands idle for a number of weeks, conditioning, as outlined above, is sometimes necessary.

Circuit Diagram

The circuit of the supply unit is shown in the accompanying diagram. The A.C. supply line connects to the primary of a transformer through switch (1), and fuse (2). By changing the fuse from one position to another in the clips, the transformer may be adapted for a high or low voltage A.C. supply line within limits, roughly, from 100 up to 130 volts. In the positions shown in the circuit diagram, only part of the transformer primary turns are being used. This is the proper position for use with a low-voltage supply line, and corresponds to the left-hand position of the fuse in the clips as viewed from the control-knob end of the unit.

The middle tap of the transformer secondary is the "A-B" lead to the set. A rheostat (3) is

connected in this circuit for use as a control of "A" and "B" voltage.

The two ends of the transformer secondary are connected to the terminals of the Raytheon rectifier tube (4). The central electrode of the tube connects to the "A+" and "B+" leads; the lower voltage required for the "A" supply being obtained by connecting the high resistance (5) in series with the "A+" lead. The choke coils (6) and (7) and the condensers (8) and (9) help to smooth out the current so that the hum will be eliminated. The leads (10) are from a special secondary which supplies A.C. current for lighting the filament of the power tube in the last audio stage of the set.

Eliminating Hum

A loud A.C. hum may occur if any of the connections to the Mershon condenser are making bad contacts. If the set hums persistently, examine these connections first.

A defective Raytheon tube may also cause A.C. hum. To determine if this is the seat of trouble, try another tube in the unit. In some instances, defective tubes have been known to operate satisfactorily at first, the unit later failing to deliver proper "A" current. The "A" current will fall off to as little as 20 to 35 milliamperes, despite all adjustments, and the set will operate with considerable hum. These symptoms indicate a defective tube in which the elements are too close to each other; so that arcing, and eventually short-circuiting takes place within the tube. Such tubes should be replaced.

If the unit fails to deliver current, the entire circuit should be tested with a circuit tester to be sure that there are no open circuits in the transformers or short circuits in the wiring.

UNDERGROUND ANTENNAS

(Q. 2227) Col. L. L. Rice, Mayland, Tenn., asks:

Q. I have been doing some extensive experimenting with various types of underground aerials to determine whether static can be positively eliminated by underground means without excessive sacrifice of signal strength. I am in a position to make a very thorough test; but, before I attempt any further work, I would like to know whether the following methods would be of any advantage?

First, four coils of rubber-covered wire, each about 60 feet in length, are to be wound about a cylinder of wood some four inches in diameter; the four separate wires at the top of each cylinder being soldered to the lead-in wire. This lead-in wire is to be shielded from a point one foot under

ground to receiving set by a lead tube in order to be relatively impervious to atmospheric. The four cylinders are to be buried from three to five feet under porous soil and about two feet apart. As I am not a mathematical expert, I am not certain as to the capacitative effect of these four buried coils. Please do not hesitate to check me up if I am running into a scientific absurdity.

Second, a rubber-covered wire is to be dropped into a well about seventy-five feet deep, the lower end of wire being sealed to be impervious to water; said wire continuing to a point about four feet from surface, where it will be led sidewise under ground to a point beneath my receiving set—on the first floor—and before it leaves the ground to be lead-sheathed, to be relatively free from picking up atmospheric static. That the receiver itself may have no pick-up static effect, I propose to shield it by placing it on a metal sheet and then to cover it by a box-like metal container. Is there anything else you can suggest that may help me prove whether static is eliminable? If so, I shall be greatly obliged.

From Dr. Rogers

A. We are indebted to Dr. J. H. Rogers for the following reply to the above inquiry:

"I do not see that the four coils you suggest would be as efficient as one of a larger size.

"By the use of underground and underwater antennas, static is reduced, and this is the most effective means yet found. I believe it only a question of time before someone, possibly yourself, will devise some form of earth antenna that will further reduce or eliminate atmospheric disturbances.

"Best results with any form of these collectors are only attained when buried deep, at least to 'depth of water earth.'

"As to your proposed tests in a fifty-foot well, I would suggest that as it is well known that intensity of signals remains almost constant even when antennas are located far beneath the surface of the earth, and conversely, 'atmospheric static' decreases rapidly; if you could devise some form of antenna which would take advantage of these characteristics, static would be greatly reduced. Shielding the receiver as you suggest, and certain portions of the leads, might solve the problem."

HIGH-VOLTAGE POWER SUPPLY

(Q. 2228) Mr. Edward Mattis, Glen Cove, L. I., asks:

Q. I intend to construct a power unit to deliver about 400 volts D.C., but I desire to employ two

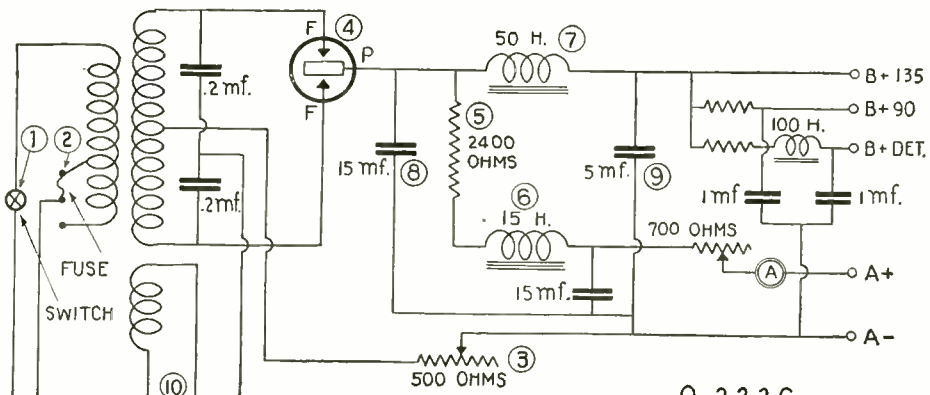

Q. 2226
Schematic diagram of the Crosley A.C. Power Unit, which operates on houselighting current and supplies both "A" and "B" current. It can be used with any receiver which utilizes 199-type tubes with the filaments wired in series.

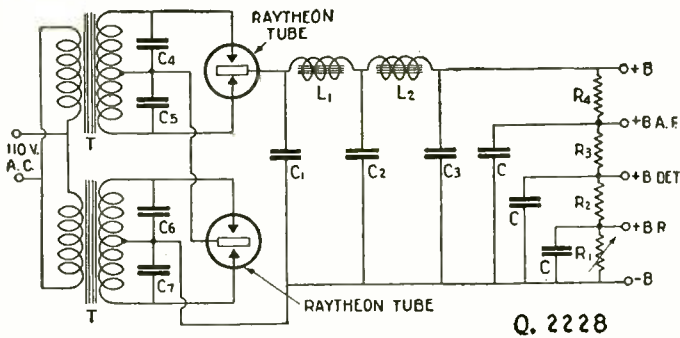

Circuit diagram of a high-voltage "B" power supply unit, employing two transformers and the two Raytheon tubes in series, thus giving an output of up to 425 volts. Constants for parts employed are given in the accompanying text.

Q. 2228

"C" Voltage Supply

While the "C" or grid-bias voltage can be obtained for the power tube by means of a suitable resistance drop, it is advisable to employ a tapped "B" battery with from 28 to 35 volts in the grid circuit. This is a simpler arrangement and, since there is virtually no drain on the battery, it should last for a year or more.

Various voltage taps may be obtained by the use of suitable resistance units and by-pass condensers. Thus the full voltage is delivered to the power tube, or approximately 425 volts. If the "B" or plate supply is to be furnished to the usual four or five-tube receiver, employing 201A-type tubes, a variable resistor should be used for R1, allowing a range of from 0 to about 20,000 ohms; and fixed resistors of 10,000 ohms each for R2 and R3, and 18,000 ohms for R4, with by-pass condensers of 1-mf. in each case, as indicated.

Remarkable volume, together with extreme depth and utmost realism, may be obtained through the use of the UX-210 tube, operating with this double Raytheon arrangement. Furthermore, there will be a complete absence of hum. There is ample voltage available for operating a high-power resistance-coupled amplifier at its maximum efficiency, with the UX-210 power tube in the final stage.

NEW A.C. TUBES

(Q. 2229) Mr. L. Jackman, Little Falls, Minn., asks:

Q. Please publish information on the new UX-226 and UY-227 tubes; also on the rectifier tubes, UX-280 and UX-281.

A. UX-226 is a 1½-volt A.C. filament type, drawing a current of 1.05 amperes and intended for radio-frequency and audio-frequency amplification in circuits especially designed for its use. The filament is energized from an A.C. lighting source through a suitable step-down transformer. The operating characteristics of the UX-226, other than the method of energizing the filament, are generally similar to those of the standard 201A. UX-226 is not recommended as a detector.

UY-227 is an A.C. heater type, in which the electron-emitting element (cathode) is made active through an independent internal-heating element requiring 1.75 amperes at 2½ volts, A.C. It is primarily intended as a detector tube in receiving sets where the radio-frequency and audio-frequency stages employ the UX-226 tube; although it may be employed for radio-frequency and audio-frequency amplification as well. It employs a special five-prong base.

These new tubes will be welcomed by experiment-

rectifier tubes of the gaseous or Raytheon type, since a single tube of this type will not furnish more than 250 volts. Kindly publish a circuit diagram and any other information which will enable me to construct this unit.

A. With the trend decidedly toward higher operating voltages, especially in connection with the UX-210 or CX-310 type of super-power amplifier tube, there is often a desire for doubling the voltage of the usual Raytheon power unit. Requiring no filament current, highly economical in operation, and most rugged in everyday practice, the gaseous rectifier has proved a favorite in "B" power units, even though it has been limited to use with power tubes of the 171 type or smaller. Hence the following suggestion, which enables the radio enthusiast to employ the Raytheon type of tube for the highest operating voltage found in present day reception.

Two standard Raytheons may be connected in series to furnish plate voltages up to 435 volts D.C. at 20 milliamperes, when using the type B, and at 35 milliamperes, when using the type BH.

Standard transformers and choke coils are employed, the same as found in the usual "B" power unit employing a single tube. When different makes of transformers and choke coils are used in this arrangement, there will be variations in the output voltages and in the milliampere loads for each type of tube.

High-Voltage Condensers

The condensers are of the same values as in the standard Raytheon circuit, namely, C1 and C2, 2-mf.; C3, 8-mf.; C4, C6 and C7, 0.1-mf. However, the condensers should be designed for a working voltage of 750. The necessity of having condensers designed and built for this working voltage is to take care of the high voltage which would be delivered if there were no load on the radio power unit; i. e., when the filament of the UX-210 power tube is not lighted. In fact, care should be exercised that the filament of the power tube is always turned on while the "B" power is turned on. If the "B"-power and filament circuits are under one control, this is automatically arranged for; otherwise, peak voltages, even as high as 800 volts, may be encountered, severely straining the filter condensers, when the radio power unit is working on no load.

The filament of the UX-210 may be operated either from a storage battery or from raw alternating current supplied by a separate transformer capable of delivering a current of at least 1.25 amperes at 7.5 volts.

ers, and it is likely that newly designed sets will employ UX-226 in all RF. sockets and in the first A.F. stage, UY-227 in the detector stage and a power tube in the last audio stage—i. e., UX-112, UX-171 or UX-210. The requisite low-voltage supply for the filament may be obtained from an independent step-down transformer or from additional low-voltage windings on the usual "B" or plate-supply transformer.

New Rectifying Tubes

UX-280 is a full-wave rectifier designed for rectifying apparatus and circuits requiring a greater D.C. output than that afforded by the standard half-wave rectifier. It will deliver up to 300 volts at 125 milliamperes. The increased output of this tube will, however, be secured only in circuits especially designed for it.

UX-281 is a half-wave rectifier similar to the present 216-B tube, although of increased physical dimensions. It will furnish an output of up to 500 volts at a current of 110 milliamperes.

Both of the new rectifiers are of the hot-cathode type, equipped with a new ribbon, oxide-coated filament which insures great ruggedness. The combination of these new tubes in a radio receiver especially designed to accommodate them, provides complete A.C. socket operation, eliminating batteries or liquid-containing devices. The requisite voltage for operation of the filament circuits of the various tubes can be secured by equipping the power transformer, which usually provides the "B" current, with special low-voltage windings and suitable taps.

IMPROVED AMBASSADOR FOUR-TUBE SET

(Q. 2230) Mr. D. Nelson, Paterson, N. J., asks: Q. Kindly furnish me with a schematic diagram and constructional data on the revised Ambassador 4-tube set. This set employs one stage of radio frequency, detector, and two stages of audio frequency with an output filter.

A. We give here the schematic diagram of this popular circuit, which is simple and economical of construction, besides possessing a great deal of selectivity and good receiving range. This receiver was recently described in the *New York Telegram* by Jack Grand. This compact set can be easily assembled on a 7x21-inch panel, and features a double-primary antenna coil, a double-primary 3-circuit tuner, and a new method of neutralization. By means of a single-pole double-throw switch, the primaries of the antenna coil can be changed to vary the degree of selectivity.

The 3-circuit tuner also employs the double primary in a similar manner by locating the exact electrical center of the primary to be used in neutralizing. Both the antenna and the 3-circuit-tuner secondaries may be tuned by .0005-mf. condensers of standard make. There is no need of a neutralizing condenser in this circuit, as the center tap on the primary inductance makes the latter act as two arms of a Wheatstone Bridge, while the two other arms are the grid-plate capacity and the grid filament capacity. The .01-mf. fixed condenser is used to keep the "B" battery voltage off the grid of the tube. This method is preferable to a variable neutralizing condenser, as it eliminates an additional control, simplifying the operation of the set.

This receiver employs only four tubes, but the results obtained compare very favorably with any number of six-tube sets now on the market. It is built for power, the circuit consisting of a stage of balanced tuned radio frequency, a regenerative detector and two stages of transformer-coupled au-

(Continued on page 179)

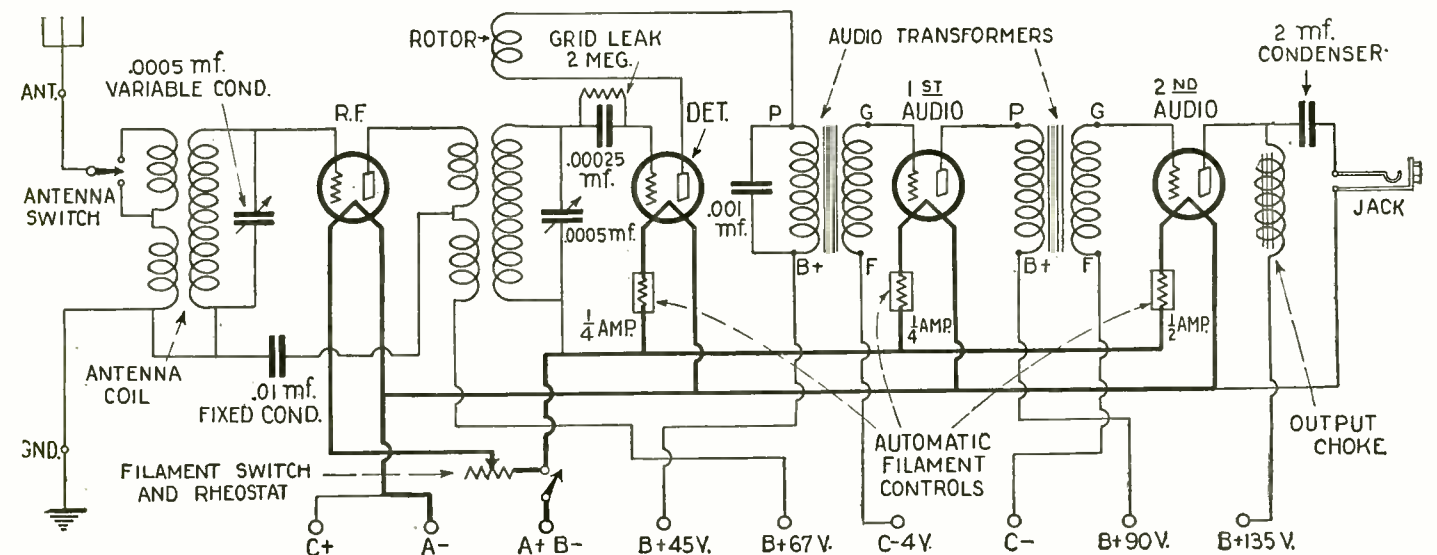

Q. 2230

Above is the circuit diagram of the Ambassador four-tube set, a very efficient and sensitive receiver, employing one stage of tuned radio-frequency with a

regenerative detector, and two stages of transformer-coupled audio-frequency. An output filter is used to protect the loud speaker.

WHOLESALE PRICES

--- for Dealers, Community Set Builders, General Repairmen and Agents ---

WE have just issued a new catalog with net prices to the radio trade. This company is Radio's oldest radio parts mail order house, and the new conditional discounts on standard Radio Merchandise are given only for resale

purposes. We are ready now to appoint several thousand additional radio dealers and radio agents all over the country, so if you are contemplating going into the radio business, be sure to get in touch with us at once.

IN SENDING IN YOUR COMMUNICATION TO US, BE SURE TO USE YOUR LETTERHEAD.

In case you are not entitled to wholesale prices, address your request for our No. 17 Catalog to our Retail Department, and note that our retail prices are considerably less than current radio prices and less than those of most radio mail order supply houses.

—and don't forget, on practically all retail orders — we pay all transportation!

1927
Edition
No. 17
500
Illustrations
NEW
Enlarged
Edition



THIS
100 PAGE
RADIO
CATALOGUE
FREE
75 HOOKUPS



BUY!!
from Radio's Oldest
Mail Order House

WE are the oldest established, exclusive radio mail order house in the country. Our motto is "Quick Shipment." All orders are shipped within 24 hours. Quick, prompt, courteous service. We carry a larger variety of radio parts and findings than any other radio house in the country.

"RASCO HAS IT"

If you are in need of certain small radio parts that other radio and mail order houses do not bother to carry, get the Rasco parts catalog, and you will find them there, anything from a screw to copper ribbon and telephone diaphragms, as well as thousands of other small radio findings. Just to mention a few:

Lugs, nuts, dials, vernier dials, jacks, plugs, every kind of knob, cords, panels, screws, sliders, washers, selenium, tin-foil, switches, crystals, cap nuts, Litz wire, cord tips, brass rods, resistances, name plates, siring binding posts, switch parts, metal ribbon, carbon balls, binding posts, all types, switch points, switch levers, lock washers, carbon grains, ground clamps, metal pointers, insulated tubing, low melting metal, antenna connectors, bus bar wire, as well as thousands of other articles.

We carry the Largest Variety of Small Radio Parts in the World. BUT We also carry ALL standard radio merchandise.

ANYTHING IN RADIO

RADIO SPECIALTY CO.

**98W PARK PLACE . . .
NEW YORK CITY, N. Y.**

Acme ANTENNA

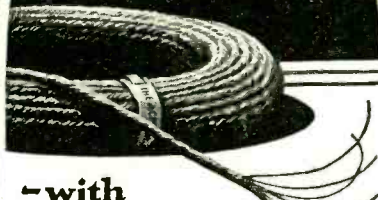

-with Seven Strands of enameled Copper Wire

Best outdoor antenna you can buy. Seven strands of enameled copper wire. Presents maximum surface for reception, resists corrosion; this greatly improves the signal. Outside diameters equal to sizes 14 and 16. (We also offer solid and stranded bare, and stranded tinned antenna.)

Loop Antenna Wire

Sixty strands of No. 38 bare copper wire for flexibility. 5 strands of No. 36 phosphor bronze to prevent stretching. Green or brown silk covering; best loop wire possible to make.

Battery Cable

A rayon-covered cable of 5, 6, 7, 8 or 9 vari-colored Flexible Celatsite wires for connecting batteries or eliminator to set. Plainly tabbed; easy to connect. Gives set an orderly appearance.



Acme Celatsite Wire

Tinned copper bus bar hook-up wire with non-inflammable Celatsite insulation, in 9 beautiful colors. Strips easily, solders readily, won't crack at bends. Sizes 14, 16, 18, 19; 30 inch lengths.

Flexible Celatsite for sub-panel wiring

A cable of fine, tinned copper wires with non-inflammable Celatsite insulation. Ideal for sub-panel or point-to-point wiring. Strips easily, solders readily. Nine beautiful colors; sold only in 25 ft. coils, in cartons colored to match contents.



Spaghetto Tubing

Oil, moisture, acid proof; highly dielectric — used by leading engineers. Nine colors, for wire sizes 12 to 18; 30 inch lengths. (We also make tinned bus bar, round and square, in 2 and 2½ ft. lengths.)

Send for folder
THE ACME WIRE CO., Dept. D
New Haven, Conn.



Storage-"B"-Battery Trickle Charger

(Continued from page 153)

The diagrams include both the "A" and the "B" trickle-charger arrangements. When one has not a milliammeter, the charging rate is controlled by adjusting the filament so that there is very little, if any, purplish glow about the plate of the tube. Also, care should be taken that the polarities of charger and battery are properly observed. The plate and grid of the rectifying tube are connected to the negative lead of the storage "B" battery.

GRID-BIAS CONNECTIONS

Sixty-watt lamps are shown in series with the "B+" and "C—" leads connecting to the receiver, to avoid disastrous short circuits. The lamp regulates the maximum amount of current flow possible.

In Fig. 2 is incorporated a wiring arrangement which provides for "C" battery connections, in the event that they should be desired. As many "C" battery taps may be arranged as desired; the arrangement being made by adjusting the "B—" connection to the receiver for the largest "C" battery re-

quirement; any other "C" battery requirements, smaller than this, are measured from the "B" connection to the receiver, as indicated in the diagram. This does not in any way complicate the wiring for the charger.

A fixed condenser of standard make, of at least 1-mf. capacity, should be shunted across the entire "B" battery, either at the battery or, preferably, at the receiver.

When the receiving set is in operation, neither the "A" nor "B" trickle charger is in operation, leaving no opportunity for introduction of the undesirable A.C. hum. It is possible, however, if desired, to leave the "B" battery charger going while the receiving set is operating; a very slight hum, however, is evident when no signal is coming through.

To sidetrack possible disappointments, the use of spring clips for the permanent connections to the batteries is to be avoided; as they cause noisy reception, due to corrosion. All connections should be made by soldering directly to the "B" battery or other apparatus, whatever it may be; excepting, of course, the A.C. supply, where standard plugs are used. Stranded flexible rubber-covered wire is preferable for making the connections.

When the charging rates have been adjusted to the requirements of the receiver, the only attention necessary will be the addition of water to the batteries.

SYMBOL	Quantity	NAME OF PART	REMARKS	MANUFACTURER ★
C	1	Trickle Charger		1 3, 11, 12, 13, 14, 15
T	1	Power Transformer	As used with "B" socket units; with filament winding if rectifier with filament is used.	2 16, 17, 18, 19, 20
S	1	Relay Switch	Automatic type	3 21, 22, 23, 24
R	1	Rectifier Tube	either 1/2-wave filament type	4 1, 25, 26, 28
R	1	Rectifier Tube	OR Full-wave filamentless type	5 1, 27
H	1	Rheostat	10 ohms, used only with filament rectifier tube	10 9, 20, 22, 23, 30, 34, 36
	1	Socket	Double unit for standard lamp plugs	6 31
M	1	Milliammeter	0-100 milliamperes range	7 16, 23, 32, 33
VR	1	Variable Resistor	Universal "B" type (or 25,000-ohm max.)	8 31, 35, 36
	1	Tube Socket		9 2, 6, 20, 29, 30, 37
	4	Lamp Sockets		6 31
	4	Lamps	60 watts, 110-volt	

NUMBERS IN LAST COLUMN REFER TO CODE NUMBERS BELOW.

1 General Electric Co. (Tungar)	2 Silver-Marshall, Inc.	3 Acme Electric & Mfg. Co.
4 Western Electric Co.	5 Raytheon Mfg. Co.	6 Be Marlin Electric Co.
7 Weston Electrical Instrument Corp.	8 American Mechanical Lab. (Clarostat)	9 General Radio Co.
10 Gray & Danielson Co. (Remler)	11 Westinghouse Elec. & Mfg. Co. (Rectox)	12 Fansteel Products Co. (Ealkite)
13 Kodel Radio Corp.	14 Charles Freshman Co.	15 Valley Electric Co.
16 Dongan Electric Mfg. Co.	17 American Trans. Co. (Amertran)	18 Thordarson Electric Mfg. Co.
19 Jefferson Electric Mfg. Co.	20 Pacent Electric Co.	21 L. S. Brach Mfg. Co.
22 Yaxley Mfg. Co.	23 Sterling Mfg. Co.	24 Mayellian Radio Corp.
25 E. T. Cunningham, Inc.	26 Radio Corporation of America	27 Q. R. S. Tube Co.
28 Amrad Corporation	29 Air Gap Products, Inc.	30 Klossner Radio Corp.
31 Bryant Electric Co.	32 Jewell Electric Instrument Co.	33 Burton & Rogers Co. (Hoyt)
34 Allen Bradley Co.	35 Central Radio Lab.	36 Carter Radio Co.
37 Alden Mfg. Co.		38
40		42

★ THE FIGURES IN THE FIRST COLUMN OF MANUFACTURERS INDICATE THE MAKERS OF THE PARTS USED IN THE ORIGINAL EQUIPMENT DESCRIBED HERE.

If you use alternate parts instead of those listed in the first column of manufacturers, be careful to allow for any possible difference in size from those originally used in laying out and drilling the panel and sub-base.

Form copyright, 1927, E. Pub. Co.

A SUBSTITUTE FOR THE VOLTAGE-REGULATOR TUBE

THE necessity of some form of line-voltage control is now fully appreciated in radio power units. Especially is this need apparent with the better types of radio receivers, in which the various tubes may be carefully adjusted and biased for certain plate voltages which are in turn dependent on a definite line voltage. The voltage regulator or glow tube, with its automatic regulation of voltage within narrow limits, presents one solution. This device is being applied to factory-built, home-made, and existing radio power units for controlling the plate voltages of the receiver and first amplifier tube, but not the higher voltage for the power tube.

A simpler solution, and one which is rapidly gaining in popularity, is the use of a

suitable variable resistance inserted in the primary or input circuit of the transformer, as a means of compensating for line-voltage increase or decrease. Indeed, this method, while it is not automatic as in the case of the glow tube, has a decided advantage in that, by controlling the input or line voltage, it also adjusts the various voltage taps, including the power amplifier, to the desired degree, in a single operation.

A heavy-duty variable high resistor, with a 25-watt rating and a resistance range of from 25 to 500 ohms, is required for this service. In the case of "A-B-C" radio power units, requiring a still greater input, larger variable resistors of the same compression type are available.

The adjustment of the line voltage may be determined by a high-resistance voltmeter across any voltage tap, or by loud-speaker results.

SUCCESS

from

CHEMICAL INSTITUTE OF NEW YORK
16 East 30th Street, New York City.

Mountoursville, Pa.

Gentlemen: I must tell you the success I have had since taking your chemistry course. My salary has been increased several times, and different industrial plants are coming to me for a little advice on different things, netting me a fair side income.

I am only sorry that I did not make My whole life study of the wonderful science.

(signed) *M. E. Van Sickle.*

CHEMISTRY

NOW
is the Time to Study
Chemistry

Not only are there boundless opportunities for amassing wealth in Chemistry, but the profession affords congenial employment at good salaries to hundreds of thousands who merely follow out its present applications. These applications are innumerable, touching intimately every business and every product in the world. The work of the chemist can hardly be called work at all. It is the keenest and most enjoyable kind of pleasure. The days in chemical laboratory are filled with thrilling and delightful experimentation, with the alluring prospect of a discovery that may spell for time always at hand to spur your enthusiasm.

Easy Monthly Payments

You don't have to have even the small price of the course to start. You can pay for it in small monthly amounts—so small that you won't feel them. The cost of our course is very low, and includes everything, even the chemistry outfit—there are no extras to buy with our course. Our plan of monthly payments places a chemical education within the reach of everyone. Write us and let us explain our plan in full—give us the opportunity of showing you how you can qualify for a highly trained technical position without even giving up your present employment.

CHEMISTRY has no equal as a profession in the modern world. There is mystery, romance and fortune awaiting the man in the laboratory.

Millions have been made by the discoverers of the chemical formula of dynamite, bakelite and many other world known chemical products.

Opportunities in the chemical profession abound on every hand—and as modern business and competition progresses the chemist will play an important part.

Profit by the experience of Mr. Van Sickle and many others, resolve to study chemistry NOW.

YOU CAN LEARN AT HOME

To qualify for this remarkable calling requires elaborate specialized training. Formerly it was necessary to attend a university for several years to acquire that training, but thanks to our highly perfected and thorough system of instruction, you can now stay at home, keep your position, and let us educate you in Chemistry during your spare time. Even with only common schooling you can take our course and equip yourself for immediate practical work in a chemical laboratory. Dr. Sloane gives every one of his students the same careful, personal supervision that made him celebrated throughout his long

career as a college professor. Your instruction from the very beginning is made interesting and practical, and we supply you with apparatus and chemicals for performing the fascinating analyses and experimental work that plays such a large part in our method of teaching, and you are awarded the Institute's official diploma after you have satisfactorily completed the course.



T. O'CONOR SLOANE,
A.B., A.M., LL.D., Ph.D.

Noted Instructor, Lecturer and Author. Formerly Treasurer American Chemical Society and a practical chemist with many well known achievements to his credit. Not only has Dr. Sloane taught chemistry for years but he was for many years engaged in commercial chemistry work.

Special 30 Day Offer

Besides furnishing the student with his Experimental Equipment, we are making an additional special offer for a short while only. You owe it to yourself to find out about it. Write today for full information and free book "Opportunities for Chemists." Send the coupon right now while it is fresh in your mind. Or just write your name and address on a postal and mail it to us. But whatever you do, act today before this offer is withdrawn.

DON'T WAIT—MAIL COUPDN NOW!



EXPERIMENTAL EQUIPMENT FURNISHED TO EVERY STUDENT

We give to every student without additional charge this chemical equipment, including forty-nine pieces of laboratory apparatus and supplies, and forty different chemicals and reagents. These comprise the apparatus and chemicals used for the experimental work of the course. The fitted heavy wooden box serves not only as a case for the outfit but also as a useful laboratory accessory for performing countless experiments.

Chemical Institute of New York

Home Extension
Division 8
16-R- East 30th St.
New York, N. Y.

CHEMICAL INSTITUTE OF NEW YORK
Home Extension, Division 8
16-R—East 30th Street, New York City.

Please send me at once, without any obligation on my part, your free Book "Opportunities for Chemists," and full particulars about the Experimental Equipment given to every student. Also please tell me about your plan of payment and your special 30 day offer.

NAME

ADDRESS

CITY STATE

R.N. Aug., '27.

SM

UNIPAC for Power

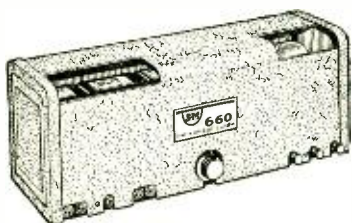

The Silver-Marshall laboratories now offer a series of power packs absolutely without comparison. Type 660-W Unipac, a push-pull amplifier using two UX-210 tubes, will deliver from 100 to 300 times more power than a 201-A tube, or from 4 to 17 times more power than average 210 power packs. Type 660 Unipac, with two 171 tubes will deliver equal or greater power than average 210 packs at far lower cost!

There is a Unipac for every need, from the most powerful receiving amplifier ever developed down to a low power 171 power pack. There are models for phonograph amplification, turning any old phonograph in a new electric type actually superior to commercial models costing from five hundred to several thousand dollars. And every Unipac, operating entirely from the light socket, supplies receiver "B" voltage as well.



112 K. C. LONG WAVE TIME AMPLIFIER

Type 440 Jewelers Time Amplifier, accurately tuned and measured to exactly 112 K. C., 2,677 meters (NAA's exact time signal wave) makes available a three-stage R.F. amplifier and detector that is a laboratory product. It simplifies receiver construction, and eliminates all guess work in transformer matching. Price, completely shielded, \$35.00.

A. C. TUBE TRANSFORMER

S-M offers a new filament transformer No. 325 for operation of new UX-226, UY-227, CX-326, CX-327 and all other A.C. tubes. Type 330 power transformer, with 600-volt secondary, is ideal for new UX-281 or CX-381 rectifiers, while type 329 transformer is suited to new UX-280 or CX-380 rectifiers.

SILVER-MARSHALL, Inc.
848 West Jackson Blvd., Chicago, Ill.

Send all data on

New Unipacs, Long Wave Time Amplifier, New A.C. Tube Transformers.

Name

Address

City

Hearing Short Waves with a Broadcast Set

(Continued from page 148)

coupling coil as shown in the accompanying drawing, and connect it to the output wires of the converter unit. This coil, with the condenser across it, tunes to about 500 meters; so adjust the receiver to this wavelength. If there is a broadcast station operating on this wave, add a few turns of wire to the coil and tune the set a little higher. Then simply hang the coupling coil in the loop and turn on the apparatus.

liammeter in one of the leads between the short-wave unit and the coupling coil. With the oscillator tube V2 out, the meter should read about 0.2 milliamperes; when it is inserted in its socket the reading should increase to about 0.5 milliamperes.

I have obtained the best results by using 201A-type tubes; as the smaller tubes do not oscillate so readily at short-wave lengths.

Wiring will be found very easy. Wires

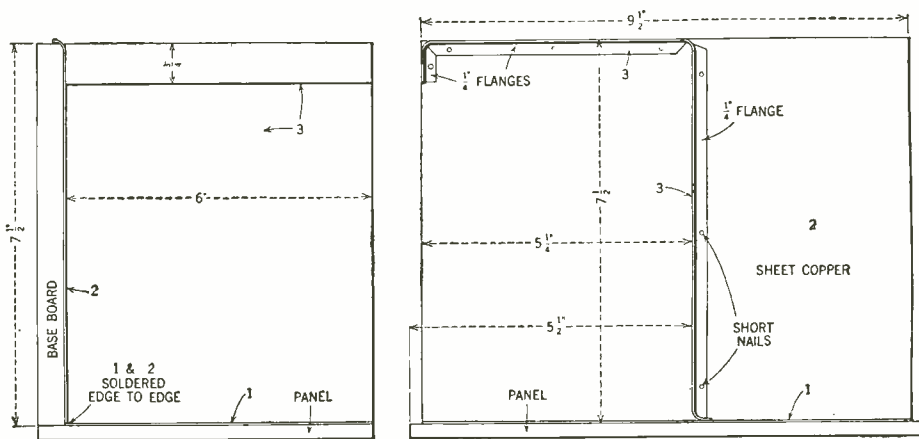

Specifications for the shield which is used in the short-wave unit. Additional information may be had from the illustration on page 146.

If no response whatever can be obtained from the combination, the trouble is, most likely, in the adjustment of the broadcast receiver; the latter must be tuned to exactly the natural frequency of the circuit comprising the coupling coil and its associated fixed condenser. The correct setting can be found with a little experimenting, and should be noted carefully for future use.

It is of great help to connect a D.C. mil-

which must go through the center shield are insulated with varnished cambric and passed through small holes in the copper. The "F—" terminals of the tube sockets are soldered to the shielding, which is used as the "A" battery connection.

If C.W. telegraph signals are to be received, either make the broadcast receiver oscillate or introduce a little voltage from an oscillator, tuned to nearly the same fre-

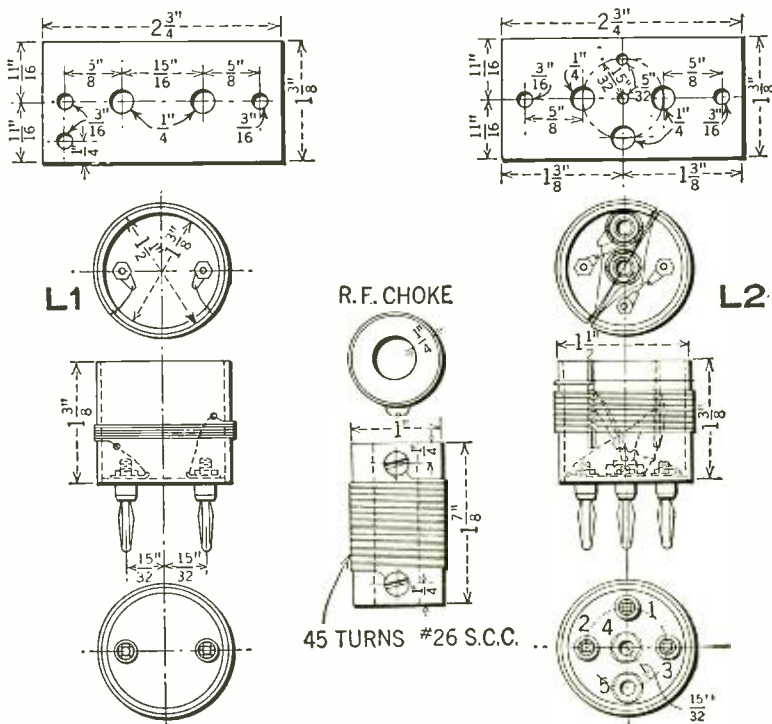

Specifications for the grid, oscillator and R.F. choke coils, with their respective sockets.

quency as the receiver, to form a beat note.

When finished the unit should be protected with a neat wooden or metal cabinet.

Several of the large broadcasting stations, such as WGY, KDKA, WLW and WRNY, send out almost their entire programs on short wavelengths. The above stations, when transmitting, can be received on the Pacific Coast every afternoon and evening.

The Stroboscope

(Continued from page 130)

and produce a complete cycle of increase and decrease of the triangles' dimensions, in one second. This may be compared to the "beat note" produced in the Strobodyne by the incoming and local frequencies. In the instrument just described the amount of light seen through the triangles varies according to the position of the discs. In the Strobodyne circuit the same thing happens, as shown by Fig. 4. The two frequencies are not in step and, at each cycle one gains a little over the other, until they become in step; then, since one is a little faster than the other, they gradually become out of step again. The shaded spaces show the intervals when the energy of one is added to the other and the areas shaded show the resulting energy obtained during one beat note. As may be seen, it is similar to the picture registered on the motion-picture film. The lower parts of the cycles, shown in dotted lines, do not add to each other, because, during each half-cycle of the oscillator tube when the grid is positive, it does not amplify the incoming signal; thus producing a one-sided amplification equivalent to a complete detecting action. This is similar to what happens in the optical instrument described above, during the time when the two triangles in the revolving discs are not in front of the light at the same time.

A New Double-Impedance Amplifier

(Continued from page 145)

"Harmonic distortion is a two-dimensional proposition; i.e., the frequency characteristic affects it and also the amplitude characteristic affects it. We can see from the theoretical discussion that the problem is a complicated and elusive one but there are certain laboratory means available which are a great help in determining the amplitude characteristic, and detecting the production of harmonics not present in the wave applied to the apparatus. Microammeters in the grid circuits of the tubes show how much grid current can be drawn before the harmonics develop; you can actually hear them commence in a loud speaker if a nearly pure wave is introduced and its amplitude gradually increased. It is based on all of these considerations, both practical and theoretical, that the claim of about four times the power output is made for double impedance, this being equivalent to double the grid swing on the last tube.

"We might add that grid currents are no longer a thing to be watched and eliminated; but they can be put to use, the same as we put audio-frequency regeneration to work on the phase angles to help the rising characteristic. The way that grid currents are useful is in automatically and "smoothly" reducing the phase-angle of the grid inductance circuit; so that extra large swings of the grid, which are at or near the resonant frequency, will not carry the amplitude beyond the "straight" portion of the grid-potential-plate-current curve."



When You Offer Your Opinion on Light-Socket Power-Units

Amateurs are often called upon to act as "purchasing directors" for neighbors whose knowledge of radio goes no deeper than their tuning dials. And now with light-socket power growing more popular every day you can well expect a request for intelligent advice on what and what not to invest in.

There are many good radio power-units on the market, but, since the performance of all of them depends upon the rectifying element, isn't it showing good judgment to advise a Raytheon-equipped unit? No liquids, no chemicals, no fragile filaments to handicap reliable, noiseless radio power.

Your opinion is backed by a staff of engineers who make it their business to see that every Raytheon-equipped power-unit will prove satisfactory to the final purchaser.



Raytheon B is the original gaseous Rectifying Tube and is standard for most types of B-power service, guaranteed for 1000 hours of service over the period of one year.

Rating: 60 m. a. output at 150 volts.

Raytheon BH is designed for heavy duty applications of light-socket power, supplying complete A.C. power for series-connected tubes and power amplifiers. Guaranteed for 1000 hours over one year.

Rating: 85 m. a. output at 200 volts.



RAYTHEON MANUFACTURING CO., Kendall Square Bldg., Cambridge, Mass.

Raytheon

THE HEART OF RELIABLE RADIO POWER

Townsend "B" Socket Power "Best in World!"

Says A. W. GALE
of Gloversville, N. Y.



Only
\$6.85
1⁰⁰/₁₀₀ Down
Balance
C.O.D.

Below is a re-
production of
Mr. Gale's let-
ter of May 8th,
1927.

48 W. Fulton St.,
Gloversville, N. Y.

"Received the Townsend all O. K. It is the best in the World and that is saying some. I have a Radiola 4 tube. Get more stations than ever before. Some of them are CFCF, CKNC, WGY, KDKA, WGZ, WIP, WWJ, KTHS, KOP, KOA, WHAS, WTAM and KSD—besides 4 in Chicago, all in the East and then some."

A. W. Gale.

Replaces "B" Batteries

The letter above speaks for itself—proves beyond doubt that the Townsend "B" Socket Power is the most remarkable value in Radio today. Sam E. Fry of 1415 Holmes St., Kansas City, Mo., writes: "Eliminator works fine. Showed it to a friend and he wants one also. I will say it sure beats batteries. I get stations I never got before on a 6 tube set." Charles Ellis, 88 Jones Ave., Columbus, Ohio, says, "Your Eliminator is working fine. Have had station WJAX and others over 1,000 miles distant. Picked up 22 different stations one evening and around 30 another time. My neighbor has a \$27.50 Eliminator and I don't see that it works any better than yours."

Delivers up to 100 volts on any set, on D. C. or A. C.—any cycle. Full tone, clarity and volume.

Tested and approved by America's leading Radio authorities—Radio News and Popular Radio Laboratories

ORDER TODAY!

Simply fill out the coupon and slip it into an envelope with only \$1.00 and mail at once. Your Townsend "B" Socket Power Unit will be sent promptly. Deposit only \$5.85 plus postage with the postman. Try out for 10 days—then if not delighted with improvement in reception, return it to us and purchase price will be refunded.

TOWNSEND LABORATORIES
713 Townsend St., Dept 25 Chicago, Ill.

Attach Only \$1.00
to this Coupon!
SEND TODAY

10 Days FREE TRIAL
You are the Judge!

TOWNSEND LABORATORIES
713 Townsend St.
Dept. 25 Chicago, Ill.

Gentlemen: Attached find \$1.00. Kindly send at once Townsend "B" Socket Power Unit, C. O. D., for \$5.85, plus postage, on guaranteed 10-day free trial.

Name _____
Address _____
City _____ State _____

RADIO JINGLES

CHARGING RATE, THREE AMPS.

There was a young fellow named Jones
Whose set "pulled" only the
He altered its wiring;
And now he is hiring
An expert—per hour, three "bones."
—R. B. Martin.



APOLOGIES TO LONGFELLOW—

I sang a song into the air—
It fell to earth most everywhere,
For I sang it, quite modern like,
Right in front of a radio
—Al Klein.



—AND TO EDWARD LEAR

There was an old man of Madrid;
Far too much did he tickle the
Result, oscillation and sharp condemnation
For that blooping old fan of Madrid.
—O. Walker.



WOULDN'T IT MAKE YOU OSCILLATE?

Tom went to a liquor dispenser
Who gave him a quart and said "Ten, sir."
Tom then made a still
With the help of friend Bill
And used copper pipe to
—Carl Vollick.



He now has his ten dollars back
And rides in a new Cadillac,
But he won't touch a drop—
This bootlegging fop,
Although he is rolling in
—Carl Vollick.



ELEVATING THE PROFESSION

The system worked like a dear;
The distillate was clear;
But the got choked, and house and all
Soared over a nearby
—Stanley C. Amidon.



VARIOUS POLARITIES

Broadcasting will first be unscrambled,
Then ruled by the D. of C.—
Of course I can't B+
But that's how it seems to me.

I wrote to dear Mary McGee
To ask if she'd marry me,
And if her reply is A—
I'll go and jump into the sea.
—Helen Peters.

THE NEW YOUNG IDEA

THE lad who could recite Honus Wagner's averages over a stretch of twelve years has a small son now who knows the wavelengths of Fort Worth, Clearwater and Omaha.—Detroit News.

AN ENGLISH JOKE

THIS week's libel is the story of the Scotsman who bought a tube, used it for three years and then took it back to the shop and said he had just learned that it contained a vacuum and he would like either a gas-filled tube in exchange, or his money back.—Popular Wireless, London.

RADIO BUGS

THERE is personality in radio diagrams that appeals at once to the skilled constructor; but the "circuits" presented here will be a novelty to the most blasé veteran of the radio mystery.

Observe the bland smile of Ohmic Kitty, all of whose whiskers were sacrificed to the development of the DX-getting properties of the magic crystal. Perhaps it is she who takes a midnight revenge in adding her howls to the troubles of those who toil with tricky circuits.

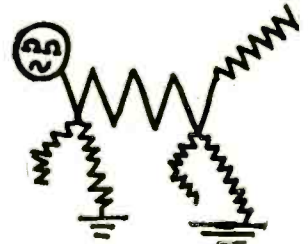

OHMIC KITTY

Inductus Ostrichus is truly inductance personified; he probably answers to the pet name of Henry. And Ampa Bugae says loudly—"Don't touch me; I'm an insect with an innate capacity for shocking."

These drawings were sent in to RADIO NEWS by William S. Klein, of Seattle, Wash. Perhaps some of our other readers can create equally convincing characters out of the conventional symbols of radio. For

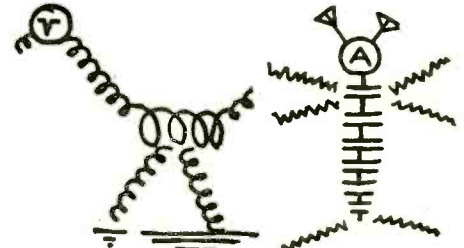

INDUCTUS OSTRICHUS AMPAE BUGAE

each such suitable sketch printed—and there will be strong competition, in which the most meritorious will win—RADIO NEWS will pay \$1.00. Draw your entry in ink, on a card or a good quality of paper, and send it in. Address the Jingle Editor, RADIO NEWS, 230 Fifth Ave., New York.

A WISE PRECAUTION



When the B-Power Unit Fails to Deliver

By CHARLES GOLENPAUL*

"TROUBLE-SHOOTING" in the "B"-socket-power unit should be a systematic process of elimination—but with nothing eliminated until it has been checked up. In other words, take nothing for granted; because things taken for granted are often the very things causing the trouble. We all recall the chap who took the automobile half apart, looking for the trouble, when someone reminded him that his gas tank was empty. Radio trouble-shooting can be very much the same.

The first step in trouble-shooting the B-device is to make sure that the 110-volt current is turned on, and that it is reaching the transformer primary of the device. The next step is to be sure that the fault lies with the B-unit, and not with the associated radio receiver.

With the trouble narrowed down to the B-device, the logical procedure is to start with the resistance bank and then work backward through the filter, rectifier tube, and finally the transformer.

DEFECTIVE RESISTORS

A common trouble, when trouble does occur, is the absence of voltage at a given tap. This is generally traceable to an open-circuited or burnt-out resistor. Thus if the 10,000-ohm fixed resistor of the usual B-unit becomes open, the detector voltage will immediately increase; so that, in the tuned radio-frequency receiver, the signal strength will be greatly diminished, while in the regenerative receiver there will be constant oscillation.

A defective resistor may be located by means of a high-resistance voltmeter connected to each tap in turn. The reading obtained at each tap should be approximately that called for by the designation on the tap. In the absence of a high-resistance voltmeter, a 15-watt, 220-volt incandescent lamp may be employed. It should glow a dull red on the full output and on the intermediate tap of the B-power unit. If it lights to equal brightness on the detector tap, it is an indication of an open or defective 10,000-ohm fixed resistor.

A satisfactory temporary repair can generally be made by means of a variable resistor connected between the plus binding post and the terminal which gives no voltage. The resistance is adjusted until the proper voltage is obtained, and this saves the trouble of seeking the correct value for a fixed resistor, while at the same time providing ample current-handling capacity.

If the voltage taps are found satisfactory, yet the receiver still fails to operate properly, the trouble may be due to an open by-pass condenser. A short-circuited by-pass condenser will act in the same manner as a short-circuited resistor.

TRACING CIRCUITS

If there is no voltage at any of the terminals, the trouble may be traced to an open circuit in the wiring, or in the transformer or choke-coil windings, or again to a broken-down condenser. The wiring should be checked over for broken wires or bad connections.

The transformer secondary and choke-coil windings can be tested by means of a telephone receiver and a dry cell, for continuity. Filter condensers can be tested by the same means, with a loud click at the time of making contact, and a weaker click upon successive tapping of the terminals, to indicate

The LIFE of the FILTER CONDENSERS you use depends upon POWER FACTOR AND RESISTANCE

PAGE

BAKELITE CORPORATION RESEARCH
REPORT NO.

DIVISION
LABORATORY
CHEMIST
REPORT WEEK ENDING

COPIES TO
3/4/27

AEROVOX WIRELESS CORPORATION CONDENSERS

No.	1000 Cycles				Power Factor	60 Cycles	
	Capacity	Series Resistance	Leakage 500 VDC	Resistance 1000 VDC		Capacity	Power Factor
1	1.105 mf	0.7 ohms	1000+ Megs	5000 Megs	0.44%	1.1 mf.	0.505%
2	1.015 "	1.1 "	1000+ "	5000 "	0.69%	1.07 "	0.426%
3	1.105 "	1.0 "	1000+ "	5000 "	0.63%	1.102 "	0.418%
4	1.085 "	0.9 "	1000+ "	4000 "	0.57%	1.086 "	0.392%
5	1.10 "	1.1 "	1000+ "	5000 "	0.69%	1.101 "	0.410%
6	1.045 "	0.8 "	1000+ "	3000 "	0.50%	1.040 "	0.392%

Notes:

(a) #1, 2, 3, and 4 were dipped in an asphalt-wax compound and #5 and 6 were not dipped in any moisture resisting composition.

(b) The 1000 cycle tests were made with a #1202 Leeds & Northrup Farad Bridge.

(c) Resistance measurements were made with 500 and 1000 Volt D.C. Megger Instruments. The maximum reading on the 500 Volt Megger was 1000 Megohms.

E. B. Hanson
E. B. Hanson

ERR:FM

NOTE- Aerovox Condensers are Impregnated With Halowax.

AEROVOX

70 Washington Street
Brooklyn, N. Y.

LIGHTING FIXTURES
Ready to Hang

Direct from the manufacturer. Completely wired, including glassware. Send for new catalogue No. 28. Just Reduced Prices. Special Proposition To Dealers. Erie Fixture Supply Co., Inc., Station R. Erie, Pa.



KARAS EQUAMATIC MANUAL 10c

MAIL 10c today for complete Manual of Karas Equamatic 5-Tube Sensation. Contains simple instructions and complete wiring diagrams for building this great receiver—the most powerful and most selective 5-tube radio frequency receiver ever designed. Address

KARAS ELECTRIC CO.,
4038-H North Rockwell St. Chicago

Balkite
Radio Power Units

FANSTEEL PRODUCTS CO., INC.
North Chicago, Illinois



PARVOLT
WOUND CONDENSERS

Stand The Surges
The ACME WIRE CO., New Haven, Conn.

BOSCH RADIO 5-6-7 tube receivers wired for battery or socket power. Cone type reproducers—"A" and "B" power units. Beautiful cabinets. AMERICAN BOSCH MAGNETO CORP., Springfield, Mass. Write for Booklet.

ELECTRICITY—EASY AT LAST!
Learn By Doing in 90 Days

NO BOOKS—NO LESSONS. Big jobs waiting to pay \$50 to \$200 a Week. Come to COYNE for 90 days then get one. Learn by doing. COYNE gives you training and experience. Write for big FREE book and FREE R. R. Fare offer. COYNE ELECTRICAL SCHOOL, 1300 W. Harrison St., Dept. C7-77 Chicago, Ill.

* American Mechanical Laboratories.

Dubilier Light Socket Aerial

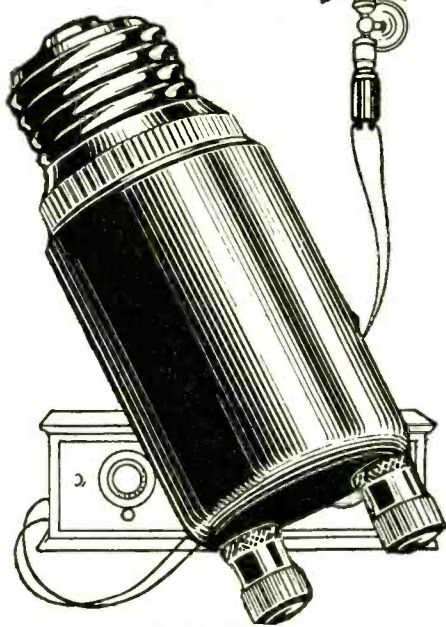

**All You
Need Today—**

Five years ago we needed all the aerial we could swing to bring in uncertain broadcasting on our little tube sets—but today it's different! Screw a Dubilier Light Socket Aerial into the nearest 110 D.C. or A.C. outlet. Connect it to your receiver and listen! The static is about gone, interference is reduced, and you've done away entirely with sooty aerials, lead-in wires, ground switches and lightning arresters. The device consumes absolutely no current and needs no attention whatever.

Price \$1.50

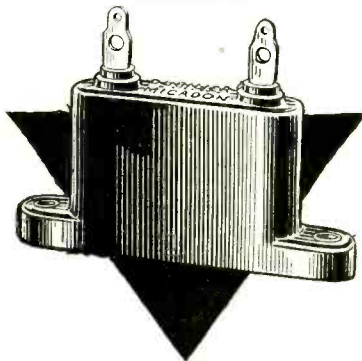

The New Dubilier Micadon

The famous "Standard Fixed Condenser of Radio" in a more modern shape, and more efficiently insulated by its new case of molded Bakelite. Terminals are adaptable to either screwed or soldered connections.

Lowest dielectric loss
Lowest variation in capacity
In all capacities .. Prices \$.45 to \$.85
Dubilier Condenser Corp.
4377 Bronx Blvd. New York

Dubilier

a good condenser. If the successive clicks are equally loud, the condenser is short-circuited.

After this, the rectifier tube should be considered. The best method is to try a new tube or a tube known to be good, in place of the existing tube. This is especially true with the gaseous type of tube, which gives no other indication of its operation than a slight warmth.

TAKING RADIO SETS ABROAD

NOW that our thoughts are turning towards holidays, it is interesting to know that some of the continental countries have made arrangements to grant permits for the temporary importation of receiving apparatus with tourists, says *Amateur Wireless*. In Austria for instance, formalities are but few; it is only necessary that the owner should declare his "portable" at the Customs on arrival at the frontier. A small amount of money must be deposited with the authorities and is returnable on leaving the country. For the use of the apparatus whilst in Austrian territory a monthly license of one Austrian shilling (about 14 cents), must be taken out at the nearest post office.

As regards Switzerland, a traveller in possession of wireless apparatus must, in advance, obtain a permit from the central post office at Berne. A letter should be written to the authorities giving full name, address, date of birth, date of arrival in Switzerland, length of stay, name of districts which it is proposed to visit, and reason for the use of the receiving instruments. The cost of the license is 5 Swiss francs (97 cents) in addition to the usual tax of one franc monthly. Should authority not be obtained in advance, an import tax of twenty-francs will be levied at the frontier to be refunded on leaving the country. For a "rover's" license where no particular district is specified, a deposit of 50 francs (\$9.65) is required.

In France, conditions are somewhat more stringent, inasmuch as an application to the General Secretary of the Posts and Telegraphs at Paris must be made at least three months in advance. Should this have been obtained, a deposit of twenty francs (80 cents) is required at the frontier.

In Italy also permits are granted to foreigners, but a listener's license for a full year must be taken out.

(The above information naturally suggested inquiry as to the regulations governing temporary importations of their own radio sets into the United Kingdom by travelers; but inquiries directed to the British consular and customhouse authorities have up to the present failed to elicit authoritative statements for publication.—EDITOR.)

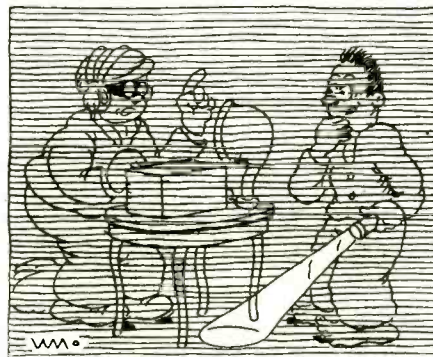

BURGLAR: "Just a moment, Boss! I think I got Los Angeles!"
HOUSEHOLDER: "Gosh! How'd you do it? The farthest I ever got is Denver!"

Thousands Use These Ingenious TRANSMITTER UNITS

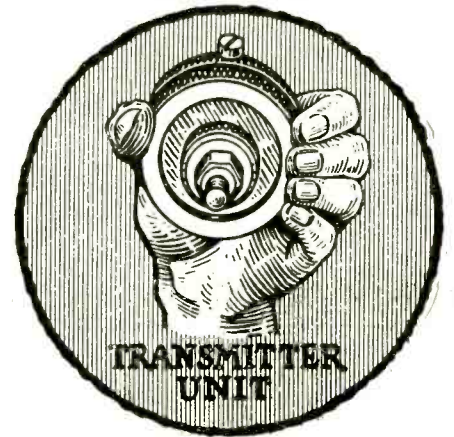

Here's a marvel of engineering design—a practical miniature transmitter, used by thousands of radio fans and experimenters for amplification purposes. It is a most novel unit, having hundreds of uses. Every amateur should have two or three of these amplifiers in his laboratory.

A FEW USES FOR THESE UNITS

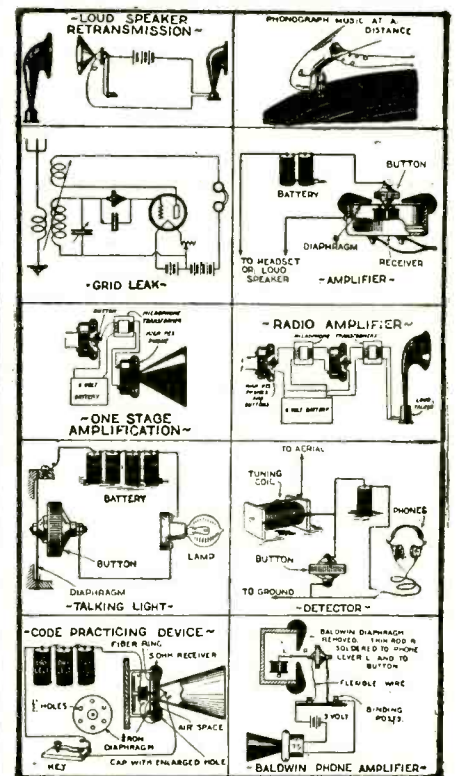

With each unit is mailed an eight-page instruction pamphlet containing suggestions for innumerable uses. Our supply is limited; avoid disappointment by ordering today. The coupon below is for your special convenience.

**SPECIALLY PRICED
AT . . . 95c
(or Two for \$1.75) per unit**

THE PRESS GUILD,
16-R East 30th St., New York, N. Y.
Enclosed find 95c/\$1.75 for which send me postpaid one/two amplifier units as advertised.
Name
Address
City, State

Radio Wrinkles

(Continued from page 160)

tube prong and pushed over it. Of course, it will be necessary to get one that will fit snug; or if it is a trifle small, it can be split and then put over one of the tube prongs in such a way that the open space will not make contact with the socket, as most of the new sockets are the side-wiping type.

—Contributed by D. P. Bryan.

A Simple Tube-Testing Device

(Continued from page 152)

outer end of L1 should go to the negative filament and the inner end to the grid post of the tube socket. Then, leaving a one-inch space, the inner end of L2 leads to the plate, while the outer end goes through the milliammeter to the "B+45." An .002-mf. fixed condenser is used as an R.F. by-pass at the meter. The rest of the constructional detail is apparent from the diagram and the illustrations. The coils, when mounted, should not touch any metal parts.

MOUNTING

In constructing the tester shown in the accompanying illustrations, the writer used as a case a metal box five inches square and three inches deep, of the kind employed by electricians in joining a number of lengths of conduit. Of course, the constructor can easily make his own box out of cigar-box wood, for instance, or he may pick up an odd candy tin of about the right dimensions.

The mounting of the switch, socket, meter, fixed condenser and coil is a simple task, involving little work. For the socket, any standard receptacle is suitable. For the short-circuiting switch S an ordinary push-button, costing ten cents, is ideal, although a regular filament switch may be used if the constructor has an idle one on hand. If a push button is used, a high plate-current reading should be obtained from a good tube the instant it is inserted in the socket. When the button is pressed, short-circuiting the plate coil L2 (which tunes the plate and thereby causes oscillation), the meter reading should drop, as explained above.

The leads to the "A" and "B" batteries may be regular double-twisted lamp cord, one length each for the "A" and "B". If a metal case is employed these wires should

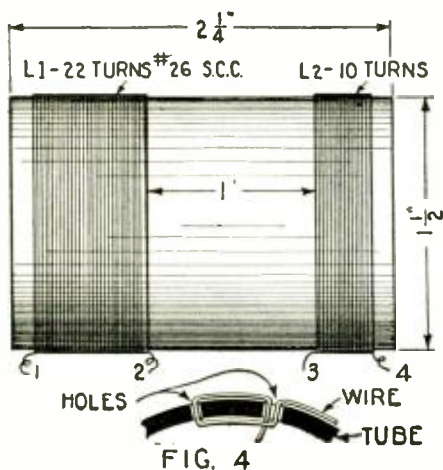

FIG. 4

The winding details and coil dimensions for L1 and L2 are given in the above sketch.



Veri Chrome Decorated Formica Panels

These handsome panels decorated in Gold on Black and Wood finished Formica will be found on many eliminators, instruments and radio receiving sets this year.

Formica kits are sold by leading dealers and jobbers for a long list of popular sets: Madison-Moore One Spot; Melo-Heald Superheterodyne; World's Record Super Nine; B.T. Power Six; Karas Equamatic; Aerodyne; St. James; Browning-Drake and many others.

Panels cut to any size or tubing are also available for amateurs

The Formica Insulation Company
4618 Spring Grove Avenue Cincinnati, Ohio

Hear the FORMICA
Orchestra Tuesday
9 to 10
over WLW

FORMICA
Made from Anhydrous Bakelite Resins
SHEETS TUBES RODS

Formica has a
Complete Service on
Insulating Material for
Radio Manufacturers

LEARN THE CODE AT HOME

WITH THE OMNIGRAPH

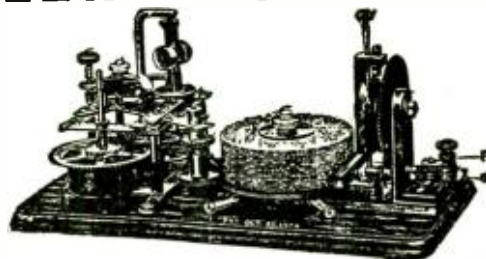

THE OMNIGRAPH Automatic Transmitter will teach you both the Wireless and Morse Codes—right in your own home—quickly, easily and inexpensively. Connected with Buzzer, Buzzer and Phone or to Sounder, it will send you unlimited messages at any speed, from 5 to 50 words a minute.

THE OMNIGRAPH is not an experiment. For more than 15 years, it has been sold all over the world with a money back guarantee. The OMNIGRAPH is used by several Depts. of the U.S. Govt.—in fact, the Dept. of Commerce uses the OMNIGRAPH to test all applicants applying for a Radio license. The OMNIGRAPH has been successfully adopted by the leading Universities, Colleges and Radio Schools.

Send 6c for Catalog
THE OMNIGRAPH MFG. CO.,

DO IT TODAY.
15 HUDSON STREET, NEW YORK CITY

If you own a Radio Phone set and don't know the code—you are missing most of the fun

Insure your copy reaching you each month. Subscribe to Radio News—\$2.50 a year
Experimenter Publishing Co., 230 Fifth Ave., N. Y. C.

WORLD Radio Units Save You 50%

"A" Current From Your Light Socket World



"A" POWER UNIT

Automatically provides even, unvarying "A" current from the moment you throw on your set switch. A marvelous improvement—at less than half the cost of any similar equipment. Finer reception, uninterrupted by "fadouts" and "screches." Absolutely noiseless. Assures full tone quality from your set and wider D X range. Shipped complete, subject to inspection, on receipt of price—or C. O. D. if you wish.

25 Amp. Unit for sets of 4 tubes or less —\$12.75
60 Amp. Unit for sets of 5 tubes or more—\$15.75

Clearest Truest "B" Power with World Radio Storage

"B" Batteries 12 Cell 24 Volt

Sturdy construction. Solid Rubber Case protection. Recharged for almost nothing. Endorsed and listed as standard by Radio News Lab., Pop. Radio Lab., Pop. Sci. Inst. Standards, Lefax, Inc. and other famous Radio Authorities.

Send No Money Just state number wanted, and we will ship same day order is received by Express, C. O. D., subject to examination. 5% discount for cash with order.

Extra Offer: 4 Batteries in series (96 volts) \$10.50.

Radio Storage "A" Battery—6 Volt

Unequaled battery value! 25 ampere capacity. Ideal for Trickle Charger. Solid Rubber Case. Shipped C. O. D. subject to inspection, for only \$5.00. Send to-day. 6% discount for cash with order on any World Unit.

WORLD BATTERY COMPANY
1219 So. Wabash Avenue
Dept. 75 Chicago, Illinois

Set your radio dials at 288.3 meters for the World Storage Battery Station W S B C. Variety—New Talent—Always Interesting.

TRANSMITTING APPARATUS

A Complete Stock at "Chi-Rad"

In addition to our regular broadcast apparatus we carry a very good stock of transformers, chokes, grid leaks, high test condensers, etc., for transmitting purposes.

NEW SHORT-WAVE COILS
Specially built by "Chi-Rad". Write for descriptive bulletin and catalog. Dealers and set-builders please use business letterhead when writing for discounts.

CHICAGO RADIO APPARATUS CO.
415 S. Dearborn St., Dept. RN., Chicago

You can be quickly cured if you

STAMMER

Send 10 cents for 288-page book on Stammering and Stuttering "Its Cause and Cure." It tells how I cured myself after stammering 20 yrs. B. W. BOGUE, 6970, Bogue Bldg., 1147 N. 111 St., Indianapolis.

be run through small rubber or porcelain insulating plugs set in the side of the case. The milliammeter should have a range from 0 to 15, or 0 to 50 milliamperes. It need not be an especially accurate or expensive instrument, as its readings are purely relative.

With the simple apparatus outlined above a novice can successfully apply to his tubes tests which will quickly and accurately determine the real worth of any tube; and this can be built at a very small total cost.

Headphone Reception

(Continued from page 124)

end. This, through a filter action, tends to hold it to a minimum. Accordingly, cutting out the audio stages by using phones permits the program to be received with the least possible interference.

LONE-EAR LISTENING

Still another case, in which headphones demonstrate that they deserve something better than consignment to the scrap-heap, is when only one listener is using the receiver.

Often this individual is a DX hunter, and if he is a true member of the sleep-defying fraternity, his quest for mileage will likely hold him at the dials long after the other members of the family have succumbed to Morpheus. Under these conditions, if a speaker only is provided, the usual procedure dictated by *entente cordiale* is to reduce volume to a degree such that the sound will not disturb the sleepers. But, as most DX fans know to their sorrow, this makes it impossible for the set to deliver anything like its best. If phones are used, however, the distance hound can cruise the clock around with the set at the top of its form, and have no fear of an unpleasant aftermath to hamper his acquisition of faraway call letters.

It often happens too, that some member of the family is ill and cannot be disturbed by the sound of the speaker, thus making the set useless to other members of the household. Here again headphones will permit at least one person to enjoy good reception without disturbing anyone else.

Irrespective of both these conditions, many old-timers, inseparably wedded to phones, feel that, wherever only one person is listening, the headset offers inherent advantages over a speaker. As a friend of mine, one of the veterans, puts it, "They seem to bring the program closer"; and fair trial will prove that there is something in this contention more than mere sentiment.

HOW TO USE PHONES

For those listeners whose radio experience has been limited to loud speakers, but who wish to add phones to their receivers, a few words of explanation regarding the proper use of headsets may not be out of place.

Never plug in phones on the last stage of audio, if you are using a power tube. The delicate windings of headsets are not designed to withstand the high plate voltage and current employed with these tubes; and subjecting phones to such a strain will burn them out or at best cause speedy demagnetization.

Do not make a practice of plugging in phones on the last audio stage, even though you are using standard tubes and only 90 volts of "B." Unless the signals are extraordinarily weak, the volume thus secured will be much too great for comfort with phones; and, still worse, the noise background which is built up by the audio amplifier will prove decidedly unpleasant. The proper place to connect headphones is in the detector or first audio stage.

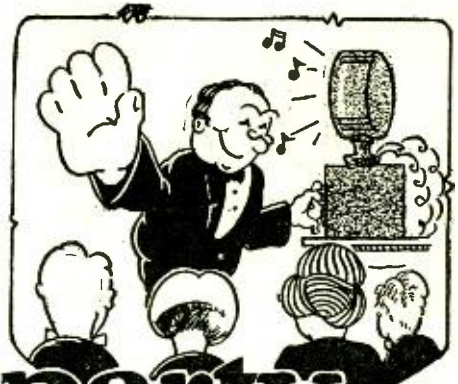

party manners

RADIO Receivers know no rules of etiquette—they cannot be taught to act on best behavior when company and friends are judging them—but they can be made to act properly if the operator understands the few simple factors that effect tuning or the proper adjustment of the Receiver's controls.

Be one of those on the safe side. Don't be afraid to invite friends and show them that good tuning means good reception and enjoyable programs.

The 64 page, illustrated book on How to Tune Your Radio Set (Conrad—25c) is a carefully prepared, yet simplified, instruction book on tuning alone.

Receivers, of different types, individual characteristics are handled separately. All there is to know, all that must be known before one can really say to understand the tuning of a set—is given in this book.

It will surprise you—Buy a copy today—at the nearest Radio Shop. Only 25c. You'll get three times that value out of it.



25c
SOLD EVERYWHERE

If Your Dealer Has None in Stock Write Us Direct

The Conrad Company, Inc.
230 Fifth Ave. New York, N. Y.

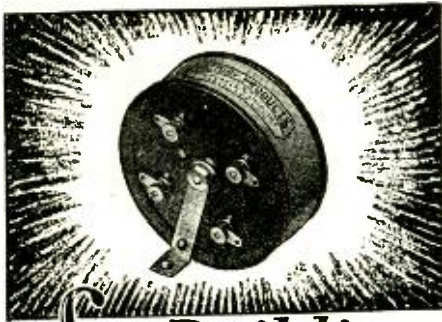

Set Building made Easy~

SIMPLIFIED wiring of the Victoreen Universal Circuit, according to precise plans and definite instructions, assures the success of your Victoreen-Super, even for the most amateur of amateurs.

Victoreen Transformers Are Precision Instruments

These wonderful transformers—the heart of the circuit—are actually tuned to a precision within 1/3 of 1%! Other Victoreen products are built with the same care and accuracy. They guarantee fine quality, selectivity, range and volume of your Victoreen.

Ask your dealer or write for folder.
THE GEO. W. WALKER CO.
 6528 Carnegie Ave. • Cleveland, Ohio

VICTOREEN

THESE COILS IMPROVE ANY RADIO RECEIVER!



T.R.F. KIT List \$12.00

This set of supersensitive Aero Tuned Radio Frequency Coils has never failed to improve the performance of any radio receiver. Tremendously increased power, extreme selectivity, and improved tone quality are sure to result from their use. This kit of Aero Coils has a much lower high frequency resistance than other types of inductances. You should use them in any circuit, if you want the best possible results.

FREE Big 8-page 4-colored layout system (actual size blue prints) and complete instructions for building the 5-tube Aero-Dyne Receiver free with each kit. Also insert showing how to wire for a power tube if desired. Extra copies, 75c each.

Get these Aero coils from your dealer. If he is out of stock, order direct from the factory.

AERO PRODUCTS, INC.

Dept. 105, 1772 Wilson Ave. Chicago, Ill.

M-EMERSON-MULTIVALVE

Seven-element tube with 201A filament, three plates and three grids. Uses any battery. Operates on 5 volts. Draws only 1/4 ampere. Fits any standard socket. Can be used with many circuits. Write for information.

List Price \$6.50
 Exclusive Licensees and Manufacturers

Emerson Radval Corp.

25 West 43rd St. N.Y.C.

Radio Transformers

For All Purposes

Thordarson Electric Mfg. Co.
 500 W. Huron Street
 Chicago, Ill. (3511)

As was suggested previously, some present-day receivers are not provided with a jack for this purpose; but even if yours is of this type you can install one at small cost. Use a jack of the filament-control type if you are capable of installing it. This will automatically extinguish all tubes not in use while you are listening with phones, resulting in a worth-while saving of "A" and "B" power.

EDUCATING THE EARS

It is only fair to say that your first experience with headphone reception, particularly over extreme distance, will prove somewhat disappointing. You will find it difficult to catch the weak signals; but this is simply because the sensitivity of your hearing has not been developed. As veteran fans know, amplification has spoiled many a good radio ear.

In other words, the modern emphasis on volume has made less and less the demand on keenness of hearing, till the average ear is far less efficient than it can be. But if you persevere, you will be amazed at the speed with which the sensitivity of your hearing develops; and in a short time you will be able to read any signal strong enough to actuate your receiver.

One of the chief objections to the use of phones has been their pinching of the ears. So, while buying, it is well to choose a pair which is comfortable as well as efficient. The unpleasant pinching can be reduced materially by loosening the tension of the springs which form the bow section of the headband. But at the same time the ear pieces should fit snugly. For greatest comfort, as well as to exclude local noises, a pair of soft rubber cushions slipped over the ear pieces will be found an added refinement well worth while.

The first and principal thing, however, is to rid yourself of the notion that the loud speaker has doomed headphone reception to the limbo of things outgrown in radio. Each has a place the other cannot usurp. Each makes its own contribution to the pleasure and usefulness of broadcasting; and, as I have tried to show, phone reception is still very much worth while, for not only the old-timer, but the lately-arrived fan as well, particularly in view of the small outlay involved.

Radio Revenge

(Continued from page 125)

The radio waves shot skyward, struck the Heaviside layer of ionized atmosphere and were reflected back to earth. Flashing thus across the continent with giant strides they swept a million aeriels. The listeners at most of the receivers were interested only in broadcast programs; they would not have understood the dots and dashes even if they had heard them.

The waves traversed 3,000 miles of ether before they reached an amateur, who was listening for code signals. 6XM, out on the Pacific coast, was sitting beside an open window where the sunlight streamed in and the fragrance of orange blossoms filled the air. Storms and trouble were farthest from his mind when he caught the signal of distress.

He turned a dial slowly, deftly, and made a hasty entry in his log. He checked it letter by letter as the call was repeated.

The signals halted abruptly. He turned his dial again, to see if some variation of the wave were keeping the dots and dashes from reaching him.

Silence!

He threw a switch, pressed his key and glanced at the meter on his transmitting panel—



this perfected Sterling 'A' Power Unit!

STERLING'S new "A" Power Unit is the headliner of the light-socket field. Thoroughly tested for mechanical excellence, it has been proved out for power and tone quality in use.

Compact for the console, attractive to the eye, this Sterling Power Unit combines everything that you look for in an "A" Power Unit. Meter equipped to insure adjustment to exactly the power needed—economical—permanent.

Its Raytheon "A" Rectifier, the metal-enclosed, tubeless rectifier that never heats up and cannot break, requires no attention at all. In short, this is the light socket power unit that all Radiodom has been waiting for.

\$47⁰⁰
 complete

Sterling

"A" POWER UNIT

THE STERLING MFG. CO.
 2831 Prospect Avenue • Cleveland, Ohio

Announcing!

the first

Amazing Stories "Annual"

132 pages, 9 x 12 in., of the choicest, carefully selected stories from the most amazing and most popular fiction magazine of today—"AMAZING STORIES"

featuring

The Master Mind of Mars

--- BY ---

EDGAR RICE BURROUGHS

A complete edition of this world famous author's new story—*This will be the first time this story appears in print.*

All stories will be complete. It will be a perpetual source of pleasure and exciting reading for years to come.

ORDER YOUR COPY NOW!

50c—EVERYWHERE—Or use this coupon.

EXPERIMENTER PUBLISHING CO., Inc.,
230 Fifth Avenue, New York, N. Y.

Gentlemen—I enclose 50c for a copy of the AMAZING STORIES ANNUAL as advertised above.

Name

Address

City

State

RADIO PANELS OF GENUINE BAKELITE

Cut, drilled and engraved to order. Send rough sketch for estimate. Our Complete Catalog on Panels, Tubes and Rods—all of genuine Bakelite—mailed on request.

STARRETT MFG. CO.
520 S. GREEN ST. CHICAGO

SOCKET POWER UNITS

Ask your dealer, or write us for complete information on our complete line of socket power units, chargers, Radio "A" and auto storage batteries.

STEWART BATTERY COMPANY
125 N. Peoria St. Chicago, Ill.

Everything in Radio

at lowest prices for nationally known merchandise. We sell to dealers only. Send for monthly catalog.

THE HARRY ALTER CO., 18th & Michigan, Chicago

NA-ALD



UX POWER TUBES installed in any set without rewiring by Na-Ald Adapters and Connectoralds. For full information write Alden Manufacturing Co., Dept. K-31, Springfield, Mass.

For Perfect Amplification— FERRANTI



Audio Frequency Transformers Amplify faithfully every note in the scale—each transformer tested ten times—your set needs one for perfect reproduction. Model A.F. 3—\$12.00. Model A.F. 4—\$8.50.
FERRANTI, INC.
130 West 42nd St., New York, N. Y.

IMPROVE ANY SET
CARBORUNDUM STABILIZING DETECTOR
UNIT. CARBORUNDUM GRID LEAKS
AND RESISTORS

SEND FOR HOOK-UP BOOK.
THE CARBORUNDUM COMPANY, Niagara Falls, N. Y.

"3CGX 3CGX 3CGX de 6XM 6XM 6XM"—he called, then cut in his receiver and listened.

No response.

He reached for his call book, thumbed the leaves rapidly, found the station, looked at a map. "In the Pennsylvania mountains," his lips said. He cut in his transmitter again.

"CQ 3s CQ 3s CQ 3s for SOS SOS SOS."

He repeated this general call for all amateurs in the third radio district until, listening for a few moments between calls, he caught a faint reply.

6XM told all he knew. He recommended the use of the telephone for reaching the proper authorities, because the skip-distance characteristic of the short waves, which had brought him the message that could not be heard by amateurs ten times nearer 3CGX, might prevent a broadcast from reaching anyone who was near enough to help.

The eastern amateur, a hundred miles from the scene of the disaster, hurried to the phone. He snatched the receiver from the hook—and found it as dead as a fossil dinosaur.

* * * * *

Several hours later, 3CGX became dimly conscious of heavy weights that crushed his body and oppressed his spirit. He tried to move. A million red-hot irons seemed to pierce his lacerated flesh; everything went black again.

In troubled dreams he heard gigantic dragon flies droning overhead, felt rivers of water flowing around and over him, smelled pine needles that seemed to be thrusting their sharp points into his eyes and nostrils and throat. The ring of axes mingled with the murmur of distant voices. After what seemed like aeons of time he opened his eyes.

A tall man in a leather helmet and coat was on his knees beside him. The weights that had pinned him down were lifted. Other men in khaki were clearing up the wreckage of the cabin.

"Look out for the tubes!" said 3CGX faintly. "Don't break them!"

The man in the helmet smiled understandingly and 3CGX knew that he, too, had been an amateur, sometime.

"Don't excite yourself, Old Man," the stranger said, soothingly, as he began to feel for broken bones with the considerate thoroughness of a skilled surgeon. "Everything's OK—and we hope you will be. That was some DX—your signals were QSA way out on the coast. 6XM relayed your SOS to an eastern ham who couldn't get out for some reason, but we happened to pick it up at the Army post."

"Ouch!" cried 3CGX as the doctor touched a sore spot.

"Grin and bear it, Old Man!" said the surgeon. "The farther I go the better I feel about you. As I was saying, we picked up the SOS, sent out a plane to investigate and report the situation, then sent a detachment with equipment and supplies to take care of the folks down the valley. And, by the way, there is a gang of young fellows down there who say they are going to build you a new cabin and put up for your aerial the tallest pole that grows in these mountains!"

FORMIDABLE TERMS

THE devotees of an ancient game will note with interest in a Dutch radio magazine, "Officiele Korte-Golf-Zenders" in connection with radio; but only short-wave transmitters are meant thereby. The striking expression "Dubbelroosterlamp" refers to nothing more startling—in Europe—than a double-grid tube.

"Motorboating"—What It Is and Why

(Continued from page 149)

effect this limiting or blocking action that is termed "motorboating."

The way to overcome this is to reduce the interstage feed-back coupling by connecting condensers across the "B"-battery terminals; and, if condensers are already connected across these terminals, you might increase the value of the capacity used. In the schematic diagram, Fig. 1, the by-pass condensers C7 and C8 are shown connected from the "B+180" and "B+90" terminals, respectively, to the "A—" terminal. The value of these condensers should be in the order of 1-mf. each; this should be sufficient. This is one of the most important places to operate on the circuit to eliminate "motorboating."

SOCKET-POWER OPERATION

When we use our resistance-coupled amplifier in connection with a "B" socket-power unit, the tendency to "motorboat" is increased; because the impedance between the different voltage taps on an "eliminator" unit is of high value and, unless properly by-passed, offers considerable interstage coupling. Here again, the way to eliminate this undesirable coupling, which is so apt to cause "motorboating," is to connect 1-mf. by-pass condensers from the "B"-supply terminals for the plates of the audio-frequency amplifier tubes to the negative filament terminal *right inside the amplifier unit*. Don't think that by-pass condensers across the voltage taps in your "B" unit are going to be adequate, when you run long leads from your eliminator to your amplifier.

In the case of the "B" power unit and its relation to "motorboating," we find another reason why it is apt to be the prime reason for this undesirable condition; namely, the fluctuation in the output potential of the unit. There are many reasons why the voltage output of a "B" device is apt to fluctuate. One reason is that, the greater the current drain, the lower the voltage available at the different output taps. Because of the high impedance of the rectifier tube and filter circuit, a small increase in current drain causes a large decrease in potential at the voltage-output taps. The current drain to the audio-frequency amplifier tubes is not constant. More current is drawn on the lower frequencies in the audio-frequency band than when the higher frequencies are passing through the circuit. This means that the voltage output from the eliminator is changing, since it is so susceptible to relatively large changes in voltage output with relatively small changes in current drain.

USE OF VOLTAGE REGULATORS

One way to overcome the fluctuation in output voltage from the "B" socket-power unit is to connect a UX-874 "voltage-regulator" tube from the "B+90" output tap to the negative terminal, and, if you have an 180-volt tap, connect another one of these tubes from the "B+180" terminal to the "B+90" one. The output resistors in your "B" unit should be so chosen that the voltage at the 90- and 180-volt taps is slightly over those respective values and does not fall below them as a result of the action of the "voltage-regulator" tube.

The UX-874 is a two-electrode gas-filled tube. When the potential difference across its terminals rises above 90 volts, ionization of the gas within the tube takes place, the internal impedance of the tube decreases, and enough current flows through the tube to decrease the value of the potential across its terminals to 90 volts again. It is highly desirable to have a device of this sort to regulate the voltage available at the output taps of a "B" socket-supply unit.

\$75.00 A WEEK BUILDING RADIO SETS —in your spare time

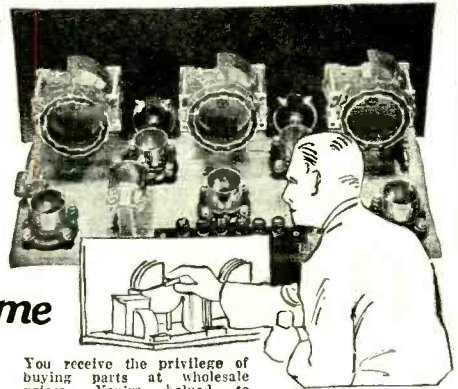

Join the Radio Association of America. Learn how to build and repair radio sets. The Association will train you—start you out in business if you wish. Be the radio "doctor" of your community. \$3 an hour upwards easily made. Radio offers you a big money-making opportunity right now.

You receive the privilege of buying parts at wholesale prices. You're helped to make money.

JOIN THE ASSOCIATION NOW

If you're interested in Radio for either pleasure or profit, join the Association without delay, because we have a plan whereby your membership may not—need not—cost you a cent. Only a limited number of these memberships are acceptable. Write now for details. Write before it's too late.

This Association has prepared a beautiful book that gives figure-facts regarding the profit possibilities of the Radio Industry, the purpose of the Association, and the details of the Special Membership Plan.

MAIL THIS COUPON

RADIO ASSOCIATION OF AMERICA
Dept. RN-8—4513 Ravenswood Ave., Chicago.

Send me your book and details of your Special Membership Plan.

Name
Address
City State

EARN \$500 IN SPARE HOURS

"I have at last found myself," writes Lyle Follick, Lansing, Michigan, "I have already made over \$500 building radio sets after working hours." Werner Eichler, Rochester, N. Y., writes, "I have made over \$50 a week in my spare time."

Our members are starting radio stores, increasing their salaries, securing better positions, earning big money for the most enjoyable kind of spare-time work.

WHAT A MEMBERSHIP MEANS

A membership in the Radio Association of America enables you to get into Radio and make money from the start.

You're taught how to build and repair all kinds of sets.

Majestic
100% Electric "B"
Gives your radio Full Strength Permanent "B" Power from the light socket. It does improve reception!

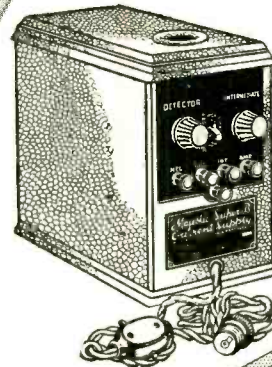

No acids or liquids—No hum. Ask your dealer to demonstrate

Majestic Standard-B
Capacity Nine 201-A tubes or equivalent. 45 milliamperes at 135 volts.
\$26.50 Raytheon Tube \$4.50 extra

Majestic Super-B
Capacity 1 to 12 tubes, including the use of power tubes. 45 mils. at 150 volts.
\$29.00
(as illustrated)
Raytheon Tube \$4.50 extra

Majestic Master-B
Positive control of all output voltage taps. For sets having high current draw or heavy biasing batteries, 60 mils. at 150 volts.
\$31.50
Raytheon Tube \$4.50 extra

FULLY GUARANTEED — SOLD ON EASY TERMS
GRIGSBY-GRUNOW-HINDS CO., 4572 Armitage Ave., Chicago.



TRANSFORMERS

The ultimate choice of America's leading radio engineers. Unconditionally guaranteed. Jobbers—Dealers — Write for facts.

HIGH FREQUENCY LABORATORIES
129 N. Wells St., Chicago, Ill.



RADIO'S BEST WIRE
From the Ground Up
At All Dealers

SANGAMO

ACCURATE - PERMANENT
MICA CONDENSERS

ADMIRALTY SUPER-10
HIGHEST CLASS RECEIVER IN THE WORLD
Write for Information
NORDEN-HAUCK, Inc.
Engineers
Marine Building, Philadelphia, Pa.

Insure your copy reaching you each month. Subscribe to Radio News—\$2.50 a year
Experimenter Publishing Co., 230 Fifth Ave., N. Y. C.

YAXLEY
APPROVED RADIO PRODUCTS

**Automatic
Power Control**



Here is undeniably the greatest radio convenience ever made. It will without fail, automatically take care of all the switching on your set.

When you turn the switch on your set, the Automatic Power Control switches on the "B" eliminator and cuts out the trickle charger or both. When you turn the set off, the Power Control is working automatically, surely and without fail turning off the "B" eliminator and the trickle charger on. Easily attached.

No. 444—Series Type Automatic Power Control—Now furnished in the new construction, exclusively Yaxley, to take care of sets having a current draw from four 199 type of tubes up to eleven 201 type of tubes, keeping the voltage drop below 2/10 volts \$5.00
No. 445—Multiple Type Automatic Power Control—for all tube sets \$6.00

At your dealer's. If he cannot supply you, send his name with your order to

YAXLEY MFG. CO.
Dept. N, 9 So. Clinton Street
CHICAGO, ILL.

**NEW!
UNITS**

As Illustrated
Complete with base.
\$4.50



of the plug-in type designed to receive all waves.

R.E.L. units may be used in any circuit. Accurately matched capacities for tuning amplifiers designed to operate at one frequency only. 35c each.

R. E. L. UNITS
are specified for the
STROBODYNE

Let us send you new Radio hand book. It's Free.

R. E. LAECAULT
RADIO ELECTRIC LABORATORIES

116 West 65th St., New York City
Only firm having exclusive services of
Mr. R. E. Laecault, F.F.

WEBSTER

**"Bone-Dri" A Socket Power
and Battery Chargers**

Equal to Webster "B's"—Raytheon equipped. Enough said!

Before you miss an important program from run down batteries, equip your set with Webster "A", "B" and "C" socket power. Operate from electric light socket.

Send for free booklet "How to eliminate your batteries"

THE WEBSTER CO.
866 Blackhawk, Chicago



EVERYTHING IN RADIO

AT ATTRACTIVE PRICES. SETS OR PARTS.
Orders shipped exactly as ordered. Prompt Service.
Write for Prices. Mail Order Only. Send Your Address.
ALL RADIO COMPANY. 417 North Clark St., Chicago

FILTER COMBINATIONS

Filter circuits can be used to smooth out any fluctuations in the voltage applied to the "B+" side of the plate-coupling resistors in a resistance-coupled amplifier. For instance, looking at Fig. 1, let us assume that the voltage applied to the "B+" side of the plate-coupling resistor R1 undergoes periodical ripples and surges, conducive to making the circuit "motorboat." A filter circuit, consisting of a 10,000-ohm resistor R6 and a 0.1-mf. by-pass condenser C5, can be connected as shown, to smooth out the ripples and the surges in the supply voltage. The condenser C5 acts as a reservoir, to collect energy when the D.C. supply potential surges above normal, and to dispense energy when there is a deficiency in the value of the supply voltage. This little filter circuit thus tends to equalize the D.C. potential at the "B" side of the plate-coupling resistor.

Another filter circuit, consisting of a 10,000-ohm resistor R7 and the 0.1-mf. by-pass condenser C6, can be connected in the plate-voltage supply lead for the two audio amplifier tubes T2 and T3, as also shown in Fig. 1.

Another type of filter circuit, which will primarily prevent any feed-back of audio-frequency energy from one circuit to a preceding one, with the possibility of effecting enough instability to produce "motorboating," can be arranged by substituting audio-frequency choke coils in the two small filter circuits just described, in place of the two resistors R6 and R7.

RESISTANCE VALUES

If you are experiencing trouble from "motorboating," one easy thing to try in the course of getting rid of this undesirable action is to "stagger" the values of the resistors in the coupling units in the amplifier circuit. If the values of the coupling resistors throughout the different stages of amplification are the same, the R-C (resistance-capacity) constants will be the same throughout. This means that a "limiting" effect established in one stage would find better response in the succeeding circuit, if this succeeding circuit had the same "time-constant"; and the possibility of the limiting action being sustained in succeeding circuits would be greater.

However, if the R-C constants of the several coupling units are different, there is less chance of a periodic disturbance (established in one stage and passed on to the next) being amplified in this latter stage to a degree sufficient to cause "motorboating." With this thought in mind, you might use 50,000-ohm resistors at R1 and R2; 100,000-ohm resistors at R3 and R4; and a 200,000- or 250,000-ohm resistor at R5.

(Editor's Note—Readers desiring a complete list of parts for the non-motorboating resistance-coupled amplifier shown in Fig. 1 may obtain same by writing to the "I Want to Know" Department, RADIO NEWS, 230 Fifth Avenue, New York, N. Y. A stamped and self-addressed envelope should accompany each request for this information.)

The Raytheon "A" Rectifier

(Continued from page 129)

transformer voltages must be limited to 8 or 9 volts at no load. (Peak A.C. voltage = $RMS \times \sqrt{2}$).

HIGHER CHARGING RATES

When a single "A" tube is used to rectify currents in excess of 2½ amperes, its life is reduced. For currents up to five amperes, the full-wave rectification circuit, utilizing two "A" cartridges, is recommended.

Still higher currents may be handled by operating a sufficient number of the recti-

**PUBLIC
SPEAKING
SIMPLIFIED**



This book is for the busy man or woman and all those who wish to overcome self-consciousness and cultivate the art of speaking with ease and confidence. 100 pages. 12mo. cloth.

Postpaid \$1.00

**The Vest Pocket
Bookkeeper**

and Short Cuts in Figures

A simple and concise method of Practical Bookkeeping with instructions for the correct keeping of books of account. How to take off a trial balance sheet and finally close and balance accounts.

The perfect self-teacher. 160 pages.

Postpaid \$1.00

**The Real Estate
Educator**

The Encyclopedia of Real Estate which insures success in the real estate business. It contains valuable information on selling, buying, advertising, appraising, investigating, leasing, insuring, and mortgages. Just what you want to know, need to know, and ought to know in simple, practical usable form. Cloth binding. 208 pages.



Postpaid \$2.00

The Vest Pocket Lawyer

Here at last in a single volume—a complete law course—clearly analyzed in understandable English. A daily guide for the business man—the law student—the justice of the peace—the notary public—the farmer—the clergyman—the merchant—the banker—the doctor. Just as the lawyer advises. The only book of its kind. 360 pages, cloth.

Postpaid \$1.50

The Vest Pocket Cushing

Just out. An A. B. C. Guide to Parliamentary Law based on the highest authorities and adapted to general use—containing model speeches and toasts for all occasions. 128 pages, leatherette.

Postpaid \$1.00

THE CONSRAD CO., Inc.
230 Fifth Ave., New York, N. Y.

I enclose \$..... in payment of the books checked below:

- The Real Estate Educator \$2.00
- The Vest Pocket Bookkeeper \$1.00
- The Vest Pocket Lawyer \$1.50
- Public Speaking Simplified \$1.00
- The Vest Pocket Cushing \$1.00

Name

Street

City State

fiers in parallel so that none is overloaded. In order to distribute the load evenly among the various tubes in such a circuit, a 1/4-ohm ballast resistor (which may be a three-inch length of No. 18 nichrome resistance wire) should be connected in series with each tube as shown in Fig. 5.

COMMERCIAL FORMS OF CHARGERS

The charger shown in Fig. 6 is so designed as to be used either as a half- or full-wave charger. As a half-wave charger, only one rectifier unit is plugged in, while as a full-wave outfit two are employed. The charging rate with one rectifier is approximately 2 1/2 amperes and with both tubes 5 amperes.

THE "A" SOCKET-POWER UNIT

Just what the final solution of the "A" power problem will be remains to be seen. Some new sets will be built to use the several new types of A.C. tubes. Many other new sets will be built to utilize the highly-perfected and yet inexpensive -01A tubes with their filaments series-connected for operation from a high-voltage, high-current rectifier of the gaseous-conduction type (such as the Raytheon BA, described by Arthur H. Lynch and the writer in the June issue of RADIO NEWS.)

But what of the hundred of thousands of sets now in use? Many will continue to use battery power, and with a good battery and a silent and efficient charger, such as those just described, will give excellent results. Some few of these sets may be rewired for series-filament power-unit supply. Some few may also be converted for A.C. tube operation.

The great majority, though, will either continue to operate from batteries, as they were originally designed to, or else from a power unit so designed as directly to replace the "A" battery without any changes whatsoever to the receiver itself.

With this in mind, several manufacturers have developed a new form of "A" socket-power unit, the heart of which is the new rectifier used in the new chargers.

There are many tricks in the successful design of such devices, however, and the development of suitable filter circuits has been exceedingly difficult. The present commercial units employ several chokes with quite low inductance and exceedingly low D.C. resistance. Instead of ordinary condensers, special dry-paste cells offering a very high D.C., and at the same time extremely low A.C. path, are employed.

"How's Your Wavelength?"

(Continued from page 151)

When this wavemeter is being used, it is imperative that the condenser be supported by the operator's hand on the rotor side, so that this group of plates will be at ground potential. It is more difficult to calibrate a wavemeter of this type than one of the other. However, it may be done by the use of Lecher wires, which are two parallel wires stretched across a room. These wires are connected to an oscillator or transmitter capable of generating frequencies of ultra-high values. Thus waves can be "set up" on the two wires and their length determined by exploring along the wires with a neon lamp connected to a loop of wire. The lamp will glow brightest at the points of maximum voltage (the crests of the waves) and will grow dimmer as it is brought nearer the place where the wave nears a nodal point. The spots of maximum brightness can be marked and measured with a rule and the wavemeter calibrated for this frequency and two others, using the method mentioned earlier in the article.

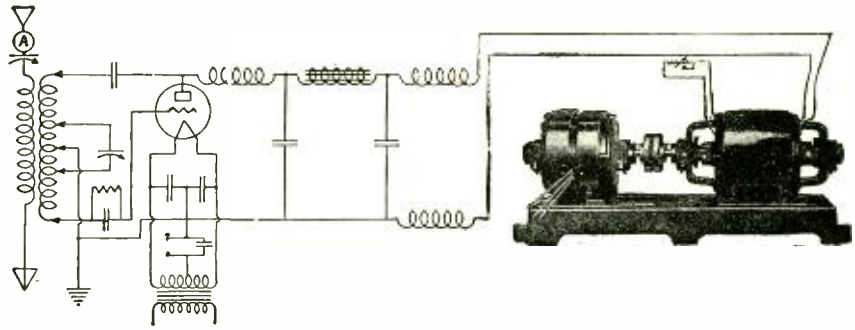

This is Item #26 used as a Plate Power Supply for a 204-A Tube.

Bulletin 237 lists over 300 other Generators, Motor-Generators and Dynamotors for Radio purpose. If you haven't your copy, write for it today!

ELECTRIC SPECIALTY COMPANY

Mark "ESCO" Trade

211 South Street

Stamford, Conn., U. S. A.

Manufacturers of Motors, Generators, Motor-Generators
Dynamotors and Rotary Converters, for Radio and Other Purposes



On the New Set - - use an Instrument →



Pattern No. 135-B Double Scale
Voltmeter 0-7.5-150 Volts.

A Jewell Pattern No. 135-B double scale voltmeter mounted on the panel of your radio set gives you the best available and convenient means of quickly checking the filament and plate voltages, and also gives you a means of determining the condition of the "A" and "B" batteries.

Besides its usefulness, the Pattern No. 135-B makes an attractive addition to any set. It has a two-inch diameter, black enameled case, and the movement is of the D'Arsonval moving coil type. Movement parts are all silver plated and the scale is silver etched with black characters. The movement is provided with a zero adjuster, as are all Jewell instruments.

Write for a copy of our radio instrument catalog No. 15-C, which describes this instrument in detail.

Jewell Electrical Instrument Co.

1650 Walnut Street, Chicago, Ill.

"27 Years Making Good Instruments"

Valley "B" Power Unit

Manufactured by
VALLEY ELECTRIC CO.
ST. LOUIS, MO.



ELKAY EQUALIZERS

specified as "ballast" for the Hiler Amplifier are made by The Langheim-Kaufman Radio Co. (Dept. N), 62 Franklin St., New Haven, Conn. Write for prices and tables of values.

RADIO SCHOOL

Send for Catalogue

MASSACHUSETTS RADIO and TELEGRAPH SCHOOL

NEW TERM SEPT. 12

18 Boylston St. Boston, Mass.

RADIO DEALERS' CATALOG---FREE!

A most complete catalog of everything in Radio. All the latest hook-ups, Sets, Parts and Kits of every description. Live Dealers need this book. Write on your business stationery.

COLUMBIA RADIO CORP.,
711 W. Lake St., Dept. 245, Chicago, Ill.

Insure your copy reaching you each month. Subscribe to Radio News—\$2.50 a year.
Experimenter Publishing Co., 230 Fifth Avenue, N. Y. C.

NEW YORK TO PARIS

WE Made it -

Says LINDBERGH

New York to Paris flyer gives much credit to plane. Read about the marvelous instruments that helped to achieve this victory for aviation

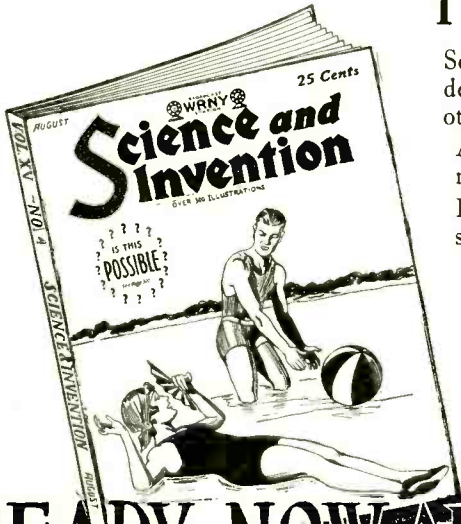

THE "Earth Inductor Compass", Lindbergh's faithful guide to Paris is probably the most remarkable instrument on his plane.

So accurate was it in Lindbergh's case that it brought him within 3 miles of a predetermined point on the Irish coast after traversing some 3,000 miles with no other guide.

Another instrument of great value and of extreme sensitivity was the "Altimeter."

Everyone interested in this great flight should know about these and other instruments that made such a flight possible.

See the August issue of SCIENCE AND INVENTION.

Also in this issue

Traceless Poisons.

A De Luxe Super-Heterodyne.
Berlin Landing Field at Night.

An Electric Fly Killer.

New Radio Picture Transmitter Enlarges Image.
What Chance Has Your Baby to Live?

25c ON ALL NEWSSTANDS—\$2.50 THE YEAR.

EXPERIMENTER PUBLISHING CO.

230 FIFTH AVENUE, NEW YORK, N. Y.

READY NOW AUGUST ISSUE - 25¢ EVERYWHERE

The WAR of the WORLDS

by H. G. WELLS

THE Martians descend upon the earth, not many miles from London, clad in gigantic steel armor 100 or more feet high and equipped with a terrific, terrifying heat ray.—They annihilate regiments, destroy power, ammunition, everything that man has invented to stop them.

Will they conquer the earth? Will men be swept into oblivion? Will these inhabitants of Mars—forced to develop unheard of inventions—coerce men into slavery?

Read the most thrilling, most amazing, most realistic story of the War of the Worlds in the August Issue of AMAZING STORIES.

Also, in this issue

The Retreat to Mars By Cecil B. White	The Ultra-Elixir of Youth By A. Hyatt Verrill
The Tissue-Culture King By Julian Huxley	Hicks' Inventions With a Kick Hicks' Automatic Apartment By Henry Hugh Simmonds
The Chemical Magnet By Victor Thaddeus	The Shadow on the Spark By Edward S. Sears
Electric-Episodes in A. D. 2025 By E. D. Skinner	

EXPERIMENTER PUB. CO., Inc., 230 5th Ave., New York
SUBSCRIPTIONS \$2.50 THE YEAR

JUST OUT AUGUST ISSUE - 25¢ EVERYWHERE

**Now
You can build the
kind of a radio you
have always wanted**

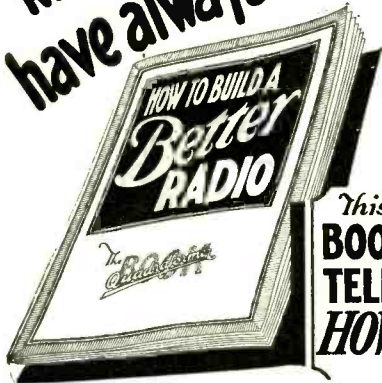

**This
BOOK
TELLS
HOW**

No matter whether you want to improve a set you now have or build a new one - *get this book first.* Tells how to build the latest one, two and three dial receivers - 5 to 7 tubes.

10¢ PREPAID
GEARHART-SCHLUETER, Fresno, Cal.

**The
WATCH DOG
of Your Tubes**

Permits just the right amount of filament current - no more, no less, while sufficient current is there - for each tube's best individual performance. Insist on Amperite. Nothing else will do. Eliminates hand rheostats. Simplifies wiring.

Send for FREE Radiall Book
Fully explains Amperite operation. Gives seasons most popular Hook-Ups and valuable Construction Data. Address Dept. R.N.-8.

RADIALL CO.,
50 Franklin St., N.Y.

Price \$1.10
complete (in U.S.A.)
Sold Everywhere



AMPERITE
REG. U.S. PAT. OFF.
The "SELF-ADJUSTING" Rheostat

RADIO CATALOG

DEALERS
Send for our new 1927 catalog.
COMPLETE PARTS
Improved Nine-In-Line Super;
Melo-Heald Super-Eleven;
Camfield Super-Selective Nino;
Citizens Super-Eight; Victoren Super; and many other popular circuits.

Western Radio Co.
134-136 W. Lake St. Chicago, Ill.

EVEREADY
Radio Batteries
— they last longer

**High-Quality
Reproduction**
(Continued from page 127)

It is quite possible, also, that a large number of persons do not like brilliant and natural musical reproduction; a preponderance of low tones gives a mellow, soft sound that often pleases. Truly high-quality systems are therefore not always to be recommended. In radio reception another limiting factor exists: the higher the quality of the over-all amplification, the greater will be the noise admitted; and in a high-quality reproducer the noises will sound very much like distinct noises rather than like vague, shadowy sounds mingled with the voice and music.

So that, perhaps, a quality of reproduction not so extremely faithful would, all things considered, be the best for plain, worthy listeners. For those with highly-cultivated musical sensibilities the high-quality system is available. And for public-address systems and similar work, the high-quality machinery is of course, an economic necessity.

At any rate, great credit is due to those scientists and engineers who, laboring in high, still places, twisting about mathematical symbols and wires, have made possible the utilization of some of the great forces of nature in the further interests of humanity.

I Want to Know
(Continued from page 162)

dio amplification, with an output filter between the last tube and the loud speaker. This system allows the use of a power tube which employs high plate voltage without danger of burning out the loud speaker. The antenna coil and the 3-circuit tuner can be constructed by the average set builder, although they are easily obtained from any reliable dealer.

For the benefit of the home constructor the following data will be of some assistance:

Specifications

The primary of the radio-frequency coil has 6 turns for each of the two primaries, and the secondary has 52 turns of No. 26 D.S.C. wire on a 2 3/8-inch form. The 3-circuit tuner has the same constants as the antenna coil, but in addition has a 14-turn tickler of No. 30 D.C.C. on a 1 1/2-inch form. The space between the primaries and secondaries is 5/16-inch. In the construction of this coil it is suggested that six binding posts be used; two for each primary and two for the secondaries. The same is recommended for the three-circuit tuner, with two additional binding posts for the tickler, making a total of eight. It will be found that, by having each primary on a separate binding post, one can do quite a bit of individual experimenting for his own particular location. It is also suggested that various-colored wires be used on these coils; such as white for one primary and blue for the other.

The audio transformers should be chosen with care, since here lies the secret of tone quality. Transformers recommended are those which would match best with parts used. The filter system between the last tube and loud speaker consists of a 30-henry choke and a 2-mf. condenser, although there are other combinations that can be used.

The choice of tubes is of the greatest importance in any set. For the radio-frequency stage any one of the special tubes made by a reliable manufacturer is recommended, such as Ceco type K, or tubes of the 201A type. A 201A or a Ceco type H will be satisfactory, the latter tube operating best with a plate voltage of 67 to 90. The first audio tube is not very critical; a 201A or Ceco type A tube may be used. In the power stage, the choice of the proper tube requires a great deal of consideration. In the event that 135 volts is used, a tube of the 112 type, or Ceco type F, can be used with a 9-volt negative grid bias. If a 171-type tube is employed, 27 volts of "C" bias is required. At 180 volts, these tubes require 40 1/2 volts of "C" battery.

Automatic filament controls are used for all tubes, with the exception of the radio-frequency tube, which employs a combination rheostat and filament switch. This also adds to the simplicity by putting two units under one control. The rheostat for the radio-frequency tube acts as a volume



**Tune in Stations
Loud and Clear**

**200 VOLT
WARREN
"B" SUPPLY**

has the power to do it. 200 volts at 20 mls; 180 volts at 30 mls; 150 volts at 50 mls **GUARANTEED.** VARIABLE VOLTAGE CONTROLS give your set any voltage you need for your detector, intermediate and amplifier, plus an extra tap for power tubes.

Delivers unsurpassed tone quality without objectionable hum. No tubes to burn out. No acids to buy or bother with. Exceedingly simple, efficient; costs little to use. Well made, neat, compact. Measures only 5 1/4 x 7 x 9. Finished in old gold.

"WARREN" works just as good as higher priced ones selling at from \$35 to \$45 each. Radio Supply House, Moline, Ill. "Only eliminator I ever found that will operate an 8-tube Kolster." William Gushard Co., Decatur, Ill. "Don't even get a ripple while receiving on my Superhet." J. F. Finnerty, Fall River, Mass.

If dealer does not stock
ORDER DIRECT

Have your dealer test the "WARREN" - see for yourself that it delivers up to 200 volts without "motor boating." Shipped complete, ready to plug into light socket and turn on. 110 V.; 60 cycle; A.C. Approved by Radio News The "WARREN" will outlast your present set and fit your big future set. If your dealer can't supply you, send only \$29.75; we will ship prepaid. West of Rockies \$31.25. Fully guaranteed or money back.

WARREN ELECTRIC CO.
Dept. R. N. Peoria, Ill.

Warren Electric Co., Dept. R.N.
Peoria, Illinois.

Ship at once, express paid \$29.75 (check enclosed).

Ship at once, C.O.D. for \$29.75, plus slight express charges.

Send free literature.

Name

Address

City

State

DEALERS -
"WARREN" sells fast
and stays sold. Write for
proposition.

The whole COUNTRY

is praising

America's First Radio Encyclopedia

\$2

A place in every home, every library, every laboratory

S. GERNSBACK'S RADIO ENCYCLOPEDIA is the only standard work ever published in America attempting to classify alphabetically the countless words used in the highly specialized science of RADIO. The **ENCYCLOPEDIA** is written in plain English so that everybody can understand the definitions and descriptions.

No expense has been spared, covering over two years in compilation, to make it worthy a place in your library.

It is published in one volume—168 pages—size 9x12 inches, nearly an inch thick and nicely accommodates the beautiful illustrations and the large, easy to read type.

Every page is replete with illustrations—to make the text easily understandable.

REMEMBER THIS IS A REAL ENCYCLOPEDIA—NOT A DICTIONARY—and very few of the things described and illustrated in this volume can be found in any dictionary, or any other encyclopedia.

The book contains as a supplement a classified cross-index designed to bring together radio references under one heading having relations in common.

All circuits new and old are described by word and picture and every part and apparatus used in Radio is explained and made understandable by means of photographs and drawings.

The work contains 1,930 definitions, 549 photographs, drawings and diagrams.

Order Direct from
S. GERNSBACK
230 Fifth Ave., New York

NEW YORK, N. Y. . . . It is the best work of the kind we have ever seen and shows considerable painstaking and laborious effort.—*Telegram*.

NEW YORK, N. Y. . . . The volume amounts to practically a compact review of all that has been done in radio up to this date.—*Radio*.

WASHINGTON, D. C. . . . It presents a complete classification of the latest authoritative data in radio.—*Evening Star*.

SAN FRANCISCO, CAL. . . . A book that will be of value to all that are interested in practical radio work.—*Examiner*.

PITTSBURGH, PA. . . . Many radio fans will be interested in the new Radio Encyclopedia by Sidney Gernsback.—*Sunday Post*.

PITTSBURGH, PA. . . . It is the latest and most complete classification of radio information.—*Day Tribune*.

NEW YORK, N. Y. . . . Mr. Gernsback is author of other volumes on radio and his encyclopedia may be recommended as authoritative.—*Daily Press*.

CHICAGO, ILL. . . . S. Gernsback has aimed to provide not merely a dictionary of radio terms but an actual ready reference. Encyclopedia.—*Herald and Examiner*.

ST. LOUIS, MO. . . . S. Gernsback's new radio encyclopedia holds all needed facts.—*St. Louis Star*.

ST. LOUIS, MO. . . . A book of radio information is S. Gernsback's radio encyclopedia.—*Globe Democrat*.

MACON, GA. . . . Gernsback's radio encyclopedia fills a demand that has been made by every radio fan as well as technical expert since the industry has started.—*Telegraph*.

DALLAS, TEXAS. . . . This encyclopedia is readily understandable to anyone who reads English and is thorough and readable.—*Sunday News*.

LOS ANGELES, CAL. . . . Its references cover every item of importance relative to the radio industry.—*Sunday Times*.

OTTAWA, CANADA. . . . It is an encyclopedia in the true sense of the meaning and not a mere dictionary.—*Journal*.



BUFFALO, N. Y. . . . Here is the world of radio, all in one volume and it is one of the most comprehensive, enlightening and illuminating publications that has yet been issued.—*Courier-Express*.

BRIDGEPORT, CONN. . . . All radio terms are fully described in layman's style, and the explanation of the whys and wherefores of various circuits are also given.—*Herald*.

BOSTON, MASS. . . . A practical handbook with references covering every item of importance relating to radio.—*Globe*.

PHILADELPHIA, PA. . . . In his Encyclopedia Mr. Gernsback has succeeded in reducing high sounding electrical and technical terms to every day speech.—*Daily News*.

S. GERNSBACK 230 FIFTH AVE., N. Y.
I enclose \$2.00 for one copy of your encyclopedia.
Name.....
Address.....
City.....
State.....

control in conjunction with the tickler. In this way, the volume may be varied before the detector, resulting in a minimum of distortion; as only the signal intensity is varied.

Parts Required

The following is the list of parts used in the construction of this set:

Two vernier dials; one pointer knob; one 7x21 panel; one 5 1/4 x 20 sub-panel; one pair sub-panel brackets.

Two .0005-mf. variable condensers; one double-primary tuning coil; one double-primary antenna coil; one single-circuit jack; one combination switch and rheostat; four UX sockets; two audio transformers; one output filter; eleven binding posts.

Two 1/4-amp. and one 1/2-amp. filament ballasts; one 2-mf., one .01-mf., one .001-mf., and one .00025-mf. fixed condensers; one 2-meg. leak, and one aerial switch.

Construction

The following information will be of assistance when wiring the receiver:

First, study the schematic diagram and have a mental picture of the layout impressed upon your mind. It is not advised that metal brackets be employed in this particular circuit. For socket holes it is recommended that a good circle cutter be used and, after holes are cut for the size of socket, bring the socket up from under side of sub-panel and fasten securely. The screws used in fastening the sockets to the sub-panel are used also as connecting terminals.

After a wire has been traced from one point to another and the connection made, that line should be crossed off the diagram. This is a good method for checking wiring, as the wire that is not crossed off is not connected. After the set is completely wired, it is ready to be tuned. The following method may be followed:

Adjustment

Set the tickler at a slight angle and tune your condenser dials until you hear a slight squeal (if no squeal is heard, reverse the tickler connections). This is a signal that you have a station. Swing the dials slowly until you bring the station in as loud as possible. You can then manipulate the tickler to increase or decrease the volume. If all instructions are followed carefully, and if you have a good antenna and ground connection, a good loud speaker and batteries, excellent results should be obtained from this set.

The arrangement of parts and wiring should be carefully considered. Poor placement may result in feed-backs and oscillations which are hard to locate and eliminate. All apparatus should be inspected for possible loose contacts, open or short circuits.

This receiver should appeal to all who want one that is easily tuned and delivers sufficient volume combined with excellent tone quality. There is no danger of any oscillations being radiated, since the neutralization of the first radio-frequency tube prevents any feed-back from the oscillating detector into the first stage and thence to the antenna. We are thereby enabled to take advantage of the extra sensitivity afforded by a regenerative detector, which in itself is equivalent to an extra stage of radio-frequency amplification.

Getting the Most from Resistance Coupling

(Continued from page 159)

the new tube. At 180 volts on the plate, the tube should be biased with —3 volts, and at 135 volts it should be biased with —1.5 volts.

SUGGESTED CONSTANTS

For those seeking a simple, inexpensive yet remarkably good tone quality with ample volume, the following combination is suggested:

Use a UX-240- or CX-340-type tube as the detector, with a .00025-mf. grid condenser and a 2-megohm grid leak. The detector output is turned over to a coupler comprising a 250,000-ohm plate coupling resistor and a 2-megohm grid leak, with a .01-mf. coupling condenser. The first amplifier is a UX-240- or CX-340-type tube.

The output of this stage is delivered to a second coupler, consisting of a 250,000-ohm plate-coupling resistor and a 100,000-ohm grid leak, with a .01-mf. condenser. The second tube should be a 171-type if possible; although the 112-type may be employed with a 250,000-ohm grid leak. The detector should be operated on 90 volts, and the amplifier tubes on 135 or 180, with proper grid bias.

A Six-Foot Exponential Horn

(Continued from page 141)

transformer will, to a certain extent, overcome some deficiencies of amplifier design. At any rate, it matches the speaker to the tubes and protects the speaker's windings from the direct current in the plate circuit.

A reproducing unit of the balanced-armature type should be used because the other type cannot produce great volume without chattering. The writer uses a balanced-armature unit, in conjunction with a transformer-coupled amplifier with a 210-type tube in the last stage.

It is truly a revelation to hear the low notes come booming in, as clear and pure as the treble.

Design of a Simple Stroboscope

(Continued from page 131)

scopic pattern. The appearance then will be that of hundreds of tubes all revolving at great speed. It is easy to make a Stroboscope of this kind. It is highly instructive and intensely fascinating in studying this beautiful phenomenon.

Letters from Home Set Constructors

(Continued from page 155)

To avoid breaking the coil, the "B" battery is connected at the taps, and by-passed with a 1-mf. condenser to filament. The antenna is connected through a .0002-mf. condenser directly to the grid of this same tube (the oscillator). Between aerial and ground is a 50,000-ohm resistor; this prevents the fundamental wavelength of the aerial from affecting the frequency of the oscillator. It also eliminates a slight A.C. hum and certain types of static which give trouble when the leak is not used.

The plate of the oscillator feeds first to the three-circuit primary, then to the oscillator plate coil (which is the lower half only of the winding L1). The three-circuit primary is rewound with 20 turns of No. 30 D. S. C. wire close beside the filament end of the secondary. The detector is connected to an ordinary audio amplifier, with a .001-mf. by-pass from the low end of the tickler to filament.

The set, with four tubes, seems to have about the same sensitivity as a three-tube, three circuit set. One tube is sacrificed for the sake of selectivity and fixed feed-back; but the results are well worth it, for the signals snap in and out just as with a true superheterodyne. In other words, the set brings in, through interference, everything a plain three-circuit set would get with all local stations off the air. The tickler is mounted on the panel and used as a volume control; but the oscillation point does not vary, from one end of the broadcast scale to the other.

Additions to the Browning-Drake

The Browning-Drake is so similar, and at the same time, so superior to the three-circuit set, that I applied the same idea to the former. Laid out on the table, it proved very successful; using three-circuit tuners with fixed primaries and the hook-up of Fig. 2. As this was to be a more elaborate receiver, it seemed worthwhile to use two controls, oscillator, and tuner. The same intermediate frequency is used; making an autodyne first detector very simple to operate, with the oscillator and tuner, respectively, at one end of the scale on 150 and 200 meters, at the other end on 300 and 550 meters.

The intermediate amplifier consists of the neutralized R.F. tube and the regenerative detector. Their input circuits are tuned to about 450 kc. by means of .0005-mf. variocouplers. The exact setting can be at whatever point brings the oscillator condenser to the same reading as the tuner.

The R.F. and detector circuits are tuned to resonance just as with the usual Browning-Drake, by picking up a carrier wave on the oscillating detector; only that in this case the carrier is the heterodyned wave from the first tube instead of



For Good Reception!

Guaranteed to remove the battery nuisance and deliver clearer tone and increased volume. Provides three different voltages at the same time. Each tap adjustable over a wide range, making possible any desired voltage from 5 to 150, absolutely harmonizing "B" current supply to your set. Raytheon tube used as rectifier. No noise or vibration. Contains no acid or solution and will not get out of order. Operating cost negligible.

At Your Dealer's

Price, Complete with Raytheon Tube - - \$35.00
Kokomo Electric Company
 Kokomo, Indiana

Kingston "B" Current Supply Unit



FRED W. STEIN
 Designer of Famous Steinite Circuit.

Steinite

LIGHT SOCKET NO-BATTERY RADIO

Don't confuse the Steinite with Power Units that operate independently and merely attach to light socket to eliminate batteries. Steinite uses no batteries—is one complete synchronized unit. Think of regular battery expense before you buy a radio.



In One Complete Synchronized Unit

1c An Hour To Operate THE HIGHBOY

With Built-in Speaker

Faithfully reproduces all voices and every musical instrument with fidelity of tone. Not merely designed to eliminate battery annoyance and expense—these Steinite Models are built to use power that batteries can not supply. Hear the Tone Test and you will be convinced. Their clear reception will surprise you. Any Steinite Dealer will gladly answer every question asked about these new Steinite Models.

\$150

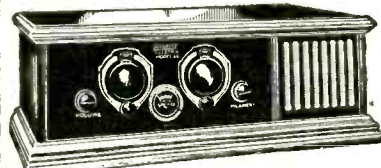

\$125 Built-in Speaker

Highly selective; coast to coast reception. All cabinets solid Philippine Mahogany, beautifully finished in dark brown shaded lacquer. Attach to any lighting circuit (60 cycle a.c. 95 to 125 v.) Use new Q.R.S. Rectifier Tube. Guaranteed against all electrical or mechanical defects. 2-dial control. Prices do not include tubes.

STEINITE LABORATORIES

Gen'l Sales Office:
 506 So. Wabash, Chicago, Ill.
 Largest Exclusive Radio Factory in the West.

Jobbers!
 Write for Terms and Territory on these popular Steinite Models
Dealers
 Write your Jobbers

Factory at Atchison, Kans.

\$100 TABLE MODEL

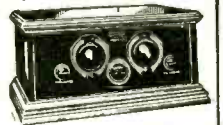

Use any speaker

RADIO NEWS

AUGUST BLUEPRINTS

You can obtain a complete set of

Blueprints for these receivers direct from RADIO NEWS

- THE STROBODYNE RECEIVER
- Radio News Blueprint Article No. 27 \$1.75
- A DOUBLE IMPEDANCE A.F. AMPLIFIER
- Radio News Blueprint Article No. 28 \$1.00
- A SHORT-WAVE UNIT
- Radio News Blueprint Article No. 29 \$1.25

Order Direct from RADIO NEWS

230 FIFTH AVENUE, NEW YORK, N. Y.

MENTION NAME OF RECEIVER AND ARTICLE NUMBER

The Genuine 3-ft. Cone \$10

ENSCO Kit \$11



Endorsed by all leading magazines and news papers. Kit No. 10 includes Ensko Unit; decorated, marked material (FONOTEX) for cone, apexes, extension and book of instructions, 5 types of cone or roll speaker. Price \$10. Kit No. 11 includes hardwood wall frame. Price \$11. Assemble your own in less than 1 hour. Sold under Money Back Guarantee. Ask your dealer or send order to nearest office.

ENGINEERS' SERVICE CO.
25 Church St., New York,
911 Steger Bldg., Chicago
73 Cornhill, Boston

Send check or money order—or we will ship C. O. D., you pay the postman, we pay shipping.

Name
Address
City, State

the signal on its original wavelength. Neutralization is accomplished in the same way, making the R.F. tuning completely independent of the detector at the most critical point. The primary, L7, of the three-circuit tuner is rewound with 30 turns of No. 30 D. S. C. wire; primary L5 is 20 turns of the same wire.

The two circuits of the first tube are connected by a bridge; that is, the oscillator circuit is bridged across the tuner, but the balance is not very critical. It is adjusted by the midget condensers C3, C4, which are about .00002-mf. The tuner and antenna input are a standard R.F. coil with a .00035-mf. condenser. A coil of the same size is used for the oscillator circuit, the secondary being broken into two sections, two-thirds for the grid and one-third for the plate circuit. Tuning is done with a .00015-mf. condenser across the grid coil.

The writer believes this circuit considerably better all around than the ordinary Browning-Drake; the best point is the constancy of the regenerative amplification regardless of wavelength, neutralization or antenna constants. I am getting parts together for a permanent model of this. Now and then there is considerable code interference from ship-to-shore stations. Probably the 450-kc. circuits should be shielded.

I hope that these circuits are of sufficient interest for publication. I am much indebted to you and to Mr. Lacault for the basis of a great deal of pleasant experimentation.

STACY W. NICHOLS,
63 Oakland Ave., Eden Park, Providence, R. I.

Progress in Radio

(Continued from page 156)

repeaters and recorders, line and cable systems; railway signal radio-frequency systems and train control systems; remote control of lighting and other circuits; industrial furnace and other sensitive temperature control; storm detection; educational purposes, etc.

"Why Kilocycles?"

(Continued from page 112)

band. At 5,200 meters, the wavelength used for transatlantic radiophone work, one kilocycle added to the frequency makes a difference of about 100 meters in the wavelength. At 5.2 meters, down near the very short wavelengths at which amateurs are now working, a kilocycle makes a difference of only about one ten-thousandth part of a meter in the wavelength. As a mathematician might put it, the difference in the length of a wave represented by a kilocycle varies inversely as the square of the frequency (approximately).

40 Non-Technical Radio Articles

every month for the beginner, the layman and those who like radio from the non-technical side.

SCIENCE & INVENTION, which can be bought at any newsstand, contains the largest and most interesting section of radio articles of any non-radio magazine in existence.

Plenty of "How To Make It" radio articles and plenty of simplified hook-ups for the layman and experimenter. The radio section of SCIENCE & INVENTION is so good that many RADIO NEWS readers buy it solely for this feature.

Radio Articles Appearing in August Science & Invention

- Radio Picture Machine Enlarges Image Received
- Why Trans-Atlantic Planes Should Carry Radio
- Latest Radio News Snapped by the Camera
- A De Luxe Super-Heterodyne
- Making an Amplifier Switch
- Radio Directs Auto Traffic
- Combination Radio Set and Telephone



LAUGH
an hour a day
for the rest of
your life!

1001 LAUGHS

The newest and funniest
joke book in the
world

Did you ever pick up a French, German or Spanish joke magazine and wonder what their specially good cartoons said?—Here's a brand new laugh book with hundreds of the best Foreign jokes and illustrated cartoons translated into English for you, together with plenty of good American humor and cartoons.

Altogether this is the greatest, funniest, most uproarious book of jokes and cartoons ever presented to Americans. Each leaf of this book is one merry round of pleasure. Every joke is a winner.

Relax from your daily grind, spend an hour a day in good old-fashioned laughter. It's a healthy recreation.

"1001 Laughs" is an extra-large size book, 9 x 12 inches, with over 300 illustrations.

50c ONLY

116 PAGES OF
UPROARIOUS JOKES
and

HUNDREDS OF SELECTED
ILLUSTRATED CARTOONS.

From All Nations—Especially Translated

ASK YOUR NEWSDEALER
OR ORDER DIRECT

EXPERIMENTER PUB. CO., Inc.,
230 Fifth Avenue, New York City

Centralab
Modu plug



GIVES old receivers the improved tone volume control of latest, best sets. Replaces present speaker plug. Tune in with dials. Then modulate to any degree on Modu Plug alone (between speaker and set). Reduces interfering noises. Attaches without tools. Nothing else like it. Cord or Jack Type, \$2.50 at dealers, or mailed C. O. D. Parts manufacturers for 69 makers of leading standard sets.

Central Radio Laboratories
19 Keefe Ave. Milwaukee, Wis.

Centralab

Turn Dial-get programs everywhere **30 Days FREE!**



MIRACO literature \$

Users report Miraco Radios set Coast to Coast, Canada to Mexico, loud and clear on speaker; outperform \$100 to \$200 sets. Some hear Europe. Marvelous bargain! Don't buy unless 30 Days Trial proves it Most Selective, Clearest and Most Powerful Distance-Getter among big fine 6-tube radios. Solid walnut cabinet. Write for **Factory Prices—SAVE UP TO 1/2**. Every set completely assembled, rigidly tested, fully guaranteed. Ultra-5, \$49.75 list. Speakers, batteries, tubes, etc. at big savings. Free literature, users' testimony and BIG SPECIAL OFFER. **MIDWEST RADIO CORPORATION** Pioneer Builders of Sets **USER-AGENTS WANTED** Write for discounts

404 - E Miraco Bldg., Cincinnati, O.

HOME FURNISHINGS ON CREDIT . Catalog FREE

Over 1400 bargains in living room, dining room and bedroom furniture, rugs, dishes, etc. A year to pay. 30 days trial. Write today for free catalog.

STRAUS & SCHRAM Dept. C357 Chicago, Illinois

For that reason, the stations at the upper end of the broadcast band must be placed about ten meters apart; at the lower end of the band (other things being equal) they need be placed only about a meter apart. The reason is that the separation between them is measured in tens of kilocycles, corresponding to the range of the audible sounds which are to be transmitted and reproduced by the modulation and the detection of the carrier-wave.

OTHER TERMS

The amateur, working with very high frequencies, uses the *megacycle* (million cycles) as a convenient measure. It has been suggested that the *myriacycle* (ten kilocycles) be used as the unit of broadcast frequencies—but it is hard enough to put the “kilocycle” over without adding to the public’s perplexities.

This explanation will seem unnecessary to most of our readers; but it is surprising to note the confusion, as to the relation between kilocycles and wavelengths, existing in the minds of many who should be better informed.

The table of broadcast stations published on another page adheres to the popular method of listing them by the nearest even meter of wavelength. This is far from accurate, however, on the lower end of the broadcast band. The following table, to the nearest tenths of meters, is therefore published for the information of our readers, who may desire to convert kilocycles into meters, or *vice versa*.

CONVERSION TABLE

Meters	K. C.	Meters	K. C.	Meters	K. C.
545.1	550	344.6	870	252.0	1190
535.4	560	340.7	880	249.9	1200
526.0	570	336.9	890	247.8	1210
516.9	580	333.1	900	245.8	1220
508.2	590	329.5	*910	243.8	1230
499.7	600	325.9	920	241.8	1240
491.5	610	322.4	930	239.9	1250
483.6	620	319.0	940	238.0	1260
475.9	630	315.6	950	236.1	1270
468.5	640	312.3	*960	234.2	1280
461.3	650	309.1	970	232.4	1290
454.3	660	305.9	980	230.6	1300
447.5	670	302.8	990	228.9	1310
440.9	680	299.8	1000	227.1	1320
434.5	*690	296.9	1010	225.4	1330
428.3	700	293.9	1020	223.7	1340
422.3	710	291.1	*1030	222.1	1350
416.4	720	288.3	1040	220.4	1360
410.7	*730	285.5	1050	218.8	1370
405.2	740	282.8	1060	217.3	1380
399.8	750	280.2	1070	215.7	1390
394.5	760	277.6	1080	214.2	1400
389.4	770	275.1	1090	212.6	1410
384.4	780	272.6	1100	211.1	1420
379.5	790	270.1	1110	209.7	1430
374.8	800	267.7	1120	208.2	1440
370.2	810	265.3	1130	206.8	1450
365.6	820	263.0	1140	205.4	1460
361.2	830	260.7	1150	204.0	1470
356.9	*840	258.5	1160	202.6	1480
352.7	850	256.3	1170	201.2	1490
348.6	860	254.1	1180	199.9	1500

*Canadian only.



Announcing

the New

E C

Gas Filled Rectifier

“The Tube that is Radically Different”

RATING—Maximum volts 300
Maximum current 85 M. A.

Assuring long life without decrease in output.
Easy filtration—less strain on filter condensers and smoother output with less hum or ripple.

C. E. MFG. CO., Inc., Providence, R. I., U. S. A.



For Matchless Service and Satisfaction

Use the ACME

“A & B”

Socket Power Unit

A turn of the switch and your radio set is always ready with a strong flow of constant, dependable A & B Power

It has many exclusive advantages. One switch controls everything. It's compact. It's neat. It's quiet. It's always ready for action!

Comes ready to operate at **Only \$6750** East of the Rockies

Acme Radio Products are sold through the leading jobbers everywhere. They include Trickle Chargers, Automatic Control Switches, Power Units, etc. Send for folder.



COUPON

Send me your latest literature on Acme Radio Products.

Name

Address

THE ACME ELECTRIC and MANUFACTURING CO.

1412 Hamilton Avenue Cleveland, Ohio

Station

WRNY

NEW YORK

309 Meters—970 Kilocycles

is owned and operated by the publishers of this magazine

Our Editors will talk to you several times every week—

See your Newspaper for details

TUNE IN ON WRNY

M & H

Radio's largest kit supply house

ESTABLISHED 30 YEARS

We Have Complete Kits for All Constructional Articles Appearing in This Magazine

OUR CIRCULAR

Is Now Ready—It Will Pay Set Builders to Send for This

M & H SPORTING GOODS CO.

512 Market St., Philadelphia, Pa.

FROST-RADIO

BAKELITE and METAL FRAME RHEOSTATS

These rheostats are the neatest, most compact long-service rheostats on the market. Windings are genuine nichrome wire of highest quality and cannot burn out under load for which they are designed.

Bakelite Type, 2½ to 75 ohms, 75c.

Bakelite Potentiometer, 200 and 400 ohms, \$1.00.

Metal Frame Rheostats, 2½ to 75 ohms, 50c.

Metal Frame Potentiometers, 200 and 400 ohms, 75c.

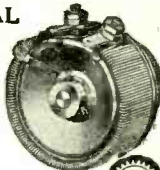

HERBERT H. FROST, Inc.,

Main Office and Factory

Elkhart, Ind.

Chicago

New York

Boston

Pittsburgh

Philadelphia

Washington, D. C.

New Orleans

St. Paul

Los Angeles

Buenos Aires, Argentina

10 Days Trial



Forget "B" Battery Nuisance

FERBEND "B" Socket Power Unit

Within Reach of All

Original cost less than half of any equipment of similar quality; lowest maintenance cost. Equal to any, not only in operation, but in workmanship, quality, durability and appearance. Sooner or later you will change to "B" Socket Power. Why pay more?

Model III, for all sets using 90 volts, . . . **\$12.50**

Model IV, for extremely large sets and sets using power tubes; delivers up to 180 volts, \$17.60.

ORDER NOW

Shipment made direct upon receipt of price or C. O. D., if preferred. Use for 10 days; if not satisfied, write us within that time and purchase price will be refunded. Send today.

FERBEND ELECTRIC CO.
425 W. Superior St., Chicago

ENDORSEMENT
Hartford, Conn.
"Enclosed find \$17.50 for which please ship me one of your high voltage Eliminators as advertised. At the present time I am using your 90 volt model I bought from you some time ago, but having built a new set which requires more "B" voltage, the larger Eliminator is necessary. I am having no trouble disposing of the smaller Eliminator to one of my friends. It certainly does all you claim for it, and I will gladly recommend your products to anyone."
Herbert G. Bissell

Tested and Approved by the Rigid Laboratory Tests of Radio News and Popular Radio

Radio News of the Month

(Continued from page 123)

tions have been required to share hours with others nearby; in New York five are "sleeping in one bed." The trouble is, of course, as one distinguished radio authority puts it, that a station's interference range is enormously larger than its service area. While there has been general acceptance of the commission's decisions, because of the realization that its measures are intended for the general good, there has been much protesting by smaller stations assigned to the lower wavelengths in the crowded New York area; and WMSG has commenced legal proceedings, with a view to testing the constitutionality of the radio act.

UNIVERSAL RADIO TAX

IN European countries, owners of radio sets are taxed to pay for the broadcasting; but most northern Europeans voluntarily subscribe. According to *Wireless World*, the Italian government, now planning a very elaborate broadcast system, proposes to lay a small radio tax on householders, whether or not they now have sets.

A RADIO PIRATE

LISTENERS in New York have been victimized by the owner of a transmitter of unknown location, who has been roaming over the waveband. One of his favorite tricks appears to be announcing that he is a French station making a transatlantic test, and thus "kidding" the searchers for DX. A penalty of \$5,000 fine is provided by the law for such acts, and the would-be joker may be out of luck if he is located.

RADIO IN TURKEY

TURKEY'S energetic president, Kemal Pasha, who has established a high-power radio station at Angora, purposes to make radio his traveling companion. A new special train, built to his order, has a built-in radio set, with batteries, replenished by the train's electrical system; and an aerial running lengthwise on the car roof, and protected by a lightning arrester. The president's study, the dining and smoking cars are equipped with loud speakers, and fourteen headsets are wired into the cars. The receiver used is a 5-tube German neotrodyne.—*Frank A. Gibson.*

SIBERIAN SHORT-WAVE BROADCASTER

KHABOROVSK, Siberia, has now a 20-kw. short-wave transmitter of American make, designed for not only telegraph work between 20 and 100 meters, but also for broadcasts on short waves. Owing to the enormous distances in Asia, these broadcasts should be more effective than those on longer waves; and a station of this power

R.E. Lacault

Knows-

SUPER-HETERODYNES

★ Originator and designer of the nationally known 'ULTRADYNE,' Radio Engineer, and former Editor with many years practical experience on Super-Heterodynes.

He has written this book for you

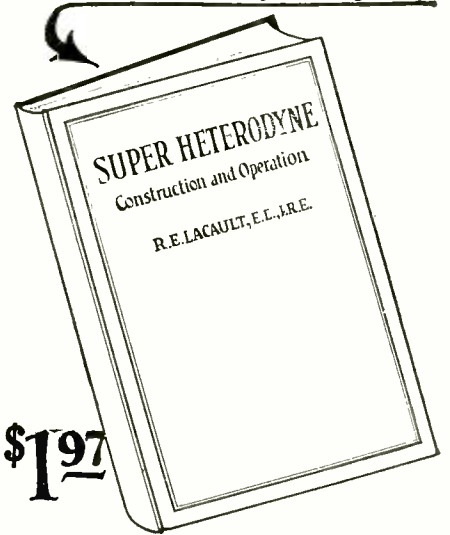

\$1.97

R. E. LACAULT has been an Editor of Radio magazines for many years. He has specialized in the greatest and most powerful of all Radio Circuits, "The Super-Heterodyne." He has studied, originated and developed to marvelous perfection the "ULTRADYNE" Super-Heterodyne. He has advised thousands of set owners and builders in Super-Heterodyne problems.

—and now he has used his immense experience, his clear mind and his editorial ability to write, by far the most lucid, interesting, instructive and plainly written book on the theory and construction of Super-Heterodynes that has ever been published.

You who already own Super-Heterodynes will find this book especially helpful in locating and correcting troubles. A special trouble chart is printed for detecting and correcting common faults.

SEND NO MONEY

Just send us a card mentioning the book with your name and address. We will mail you the book. You pay the postman \$1.97 plus a few cents postage on delivery.

Distributed by

THE CONSRAD CO., Inc.
230 Fifth Ave., New York, N. Y.

30 Days Free Trial

7 Tube-Single Dial RADIO SET



Write for This Wonderful offer direct from factory

World's greatest radio. Perfect working, single dial control, 7-tube receiver, shipped to your home for 30 days free trial. Test it for distance, volume and tonal quality—and if you are not convinced that it is the best single dial set you ever heard return it to factory.

METRODYNE SUPER-SEVEN

Only one dial tunes in all stations. Get 1,000 to 3,000 miles on loud speaker. Easiest set to operate. Highest grade parts used. Magnificent Two-tone Walnut Cabinet.

Big Profits to Agents and Dealers

selling Metrodyne radios. All or part time. Great money making opportunity. Demonstrating set on 30 days free trial. **WRITE FOR OUR OFFER.**

METRO ELECTRIC CO.
2161 N. California Ave., Dept. 10B, Chicago, Ill.

Retail Price \$75 Completely Assembled

Auto Owners Wanted

to sell **HYDRO** Insured TIRES—the only tires in America Insured for One Year against all road hazards regardless of mileage. Insurance Policy with every tire. Made by the only tire factory in America selling its product through authorized Salesmen-Agents. We offer opportunity of life-time to establish profitable tire business of your own. No capital required. Sales Kit and advertising helps furnished. Exclusive territory granted. Write today for catalog and complete information about the Hydro Agency Plan.

HYDRO Insured TIRES
The Most Beautiful Tire in America

ADDRESS NEAREST BRANCH. Dept. 35 HYDRO-UNITED TIRE CORPORATION
POTTSTOWN, PA. CHICAGO, ILL.

KELLOGG Radio
Flawless Reproduction



should be readily receivable in America when it is in operation.

INTERNATIONAL CONFERENCE

MANY of the problems occasioned by the rapid growth of the radio art will be dealt with by the International Radiotelegraph Conference, which will meet in Washington Oct. 4 next. Secretary Hoover will head the group of American delegates appointed by President Coolidge; Congress, the various government departments, science and commerce will be well represented.

BROADCASTING IN SALVADOR

SAN SALVADOR, Central America, has a broadcast station, AQM, operating on 482 meters. To encourage listening, the government has reduced the tax on receivers, and made more favorable regulations.

HUGE RADIO PICTURES

THE first radio "newspaper" was produced at a dinner of the Massachusetts Institute of Technology Alumni at New York, as an addition to the features of last year's demonstration, "the phantom radio dinner" described in RADIO NEWS for April, 1926. This year's novelty was a radio picture receiver which turned out pictures three feet square; a hot-air blast instead of the usual pen is employed. These radiographs, with similarly-transmitted messages, were posted on the walls of the banquet hall as fast as they were received.

RADIO CHARTS FOR BALLOONS

RECENT German experiments, in receiving radio weather maps aboard balloons, were quite successful. A low-power transmitter at Hamburg maintained satisfactory connections with the aerial craft during a five-hour journey. The reception was best at an elevation above 2,000 feet.

RADIO STARTS THE WHEELS

IT is no longer necessary to press a button to start a 170,000-horsepower electric plant; radio does it by a wave of the hand. This was demonstrated when Chairman Gary of the U. S. Steel Corporation put the Homestead (Pennsylvania) steel plant of the company in motion by a motion of his hand over a grid-glow relay tube in New



IN OUR AUGUST ISSUE:

THE MOON POOL. by A. Merritt. Fantastic incidents and unusual science permeate the succeeding chapters of this absorbing scientific classic.

THE TISSUE-CULTURE KING. by Julian Huxley, grandson of the famous English scientist, and himself Professor of Zoology in Kings College, London. A remarkable story of unusual interest—an assortment of science and adventure in Africa.

THE ULTRA-ELIXIR OF YOUTH. by A. Hyatt Verrill, in which a scientist in search of the Elixir of Youth, far exceeds his wildest expectations. The startling results which follow and the unprecedented end, only make the story more complicated and absorbing. It is a picturesque tale of the biological possibilities in the field of modern science.

THE FOUR-DIMENSIONAL ROLLER-PRESS. by Bob Olsen. A well-told, plausible story, makes excellent reading.

THE SHADOW ON THE SPARK. by Edward S. Sears. Our new author weaves his science through this unusual murder story in a thoroughly ingenious manner.

SOLANDER'S RADIO TOMB. by Ellis Parker Butler. In his inimitable style.

RELIABLE—EFFICIENT — TAPERING — CHARGING



A silent, dry, bulbless Battery Charger employing the new Raytheon "A" Rectifier. Works at either half wave, 2½ or full-wave, 5 amperes, and is so efficient that it automatically tapers the charge, saving your battery and reducing your electric bill. Sup-

plied with cord and plug, and long rubber covered battery leads with clips attached.

Price \$10.00 without rectifier cartridges. Raytheon "A" cartridges. \$4.50 each (two required).

NATIONAL

DUO-RANGE CHARGER

NATIONAL COMPANY, Inc., W. A. READY, Pres., Malden, Mass.

CARTER

New Complete line of Molded Mica By-Pass Filter Buffer

CONDENSERS

(Half Size)

A complete line of fixed condensers that are not only made accurately but are unaffected by climatic conditions and stay accurate.

Carter reputation for quality parts is your strongest guarantee. You will find these condensers fulfill every expectation.

See them at your dealers.

In Canada: Carter Radio Co., Ltd., Toronto



90 Volt Power Unit :: \$12.75

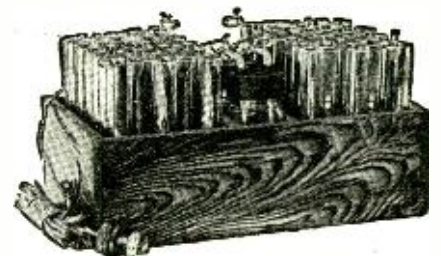

Hums, line noises, etc., positively impossible with this new advanced unit. Plug in and forget Non-acid and noiseless. All detector and intermediate voltages plainly marked. Simpler to hook up than dry cells. Operates any type set 1 to 12 tubes.

Greater volume and clearness guaranteed. If not thoroughly satisfied return after using 30 days for complete refund. Guaranteed further 2 years. For 110-120 volts A.C. 25 to 60 cycle current. 90 volts, \$12.75; 112½, \$15.25; 135, \$17.50; 157½, \$19.50; 180, \$24.00; 202½, \$26.00.

Also built for D.C. current 110 and 32 volts at only \$3.00 additional, any size above. Ample stocks—same day shipments. Simply say—ship C.O.D. or write for my interesting literature, testimonials, etc.

B. HAWLEY SMITH

334 Washington Ave., Danbury, Conn., U.S.A.

FREE New 1927 Catalog FREE

Wholesale Headquarters Shows photographs and hook-ups of all latest kits, complete line of cabinets and consoles, accessories and parts. We are headquarters for all nationally advertised lines. Dealers and professional set builders write on your letterhead to-day for your copy of this big FREE CATALOG. SHURE RADIO CO., 333J-335 W. Madison St., Chicago

HEAR the wonderful New Acme Speaker at your dealer's.

ACME for amplification



C. L. PARKER

Ex-Examiner U. S. Patent Office Attorney-at-Law and Solicitor of Patents McGill Building, Washington, D. C. Patent, Trade Mark and Copyright Law

Cooper

RADIO BATTERIES THE COOPER CORP., Cincinnati, O.

TELEVISION -is here!!!

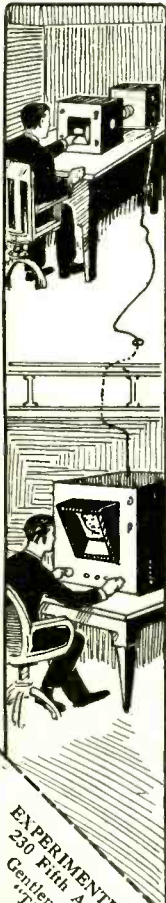

Radio Fans! Mechanics! Scientific men! Everybody! Build a TELEVISION SET--The greatest and most amazing development of the 20th Century

The first and only complete book on TELEVISION.

50 CENTS

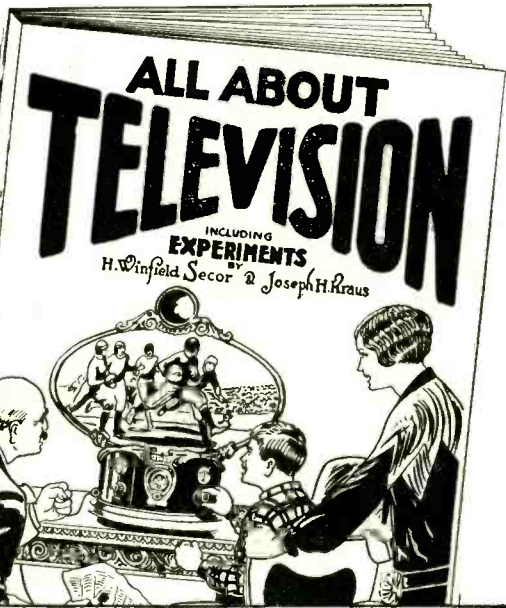

HERE, friends, is the first book to be published giving you the history of TELEVISION, from the first crude experiments at the beginning of the 20th Century—to the comparatively perfect machines just put into daily operation.

From this book you can build your own, workable television set that will serve as a fundamental apparatus for hundreds of tremendously interesting and amazing experiments.

Get in now on this new development. You may be fortunate enough to discover some improvement to Television that will be worth many thousands of dollars.

Start with a copy of this new book today. 116 Pages—Size 9x12 inches, Illustrated.

50 CENTS THE COPY—EVERYWHERE or clip this coupon and send it to EXPERIMENTER PUB. CO., Inc. 230 Fifth Ave., New York, N. Y.

EXPERIMENTER PUBLISHING CO., Inc.
230 Fifth Avenue, New York, N. Y.
Gentlemen—I enclose 50c for one copy of the new book.

Name
Address
City
State

York. The hand-capacity effect set off a telegraphic relay which transmitted an impulse to a short-wave set in Newark. Its wave, on 42.95 meters, actuated a receiver at Pittsburgh, whose relay in turn closed a switch at the mills and started the 6,000-kw. motor of a rolling mill.

Book Review

USING RADIO IN SALES PROMOTION, by Edgar H. Felix. Published by McGraw-Hill Book Co., Inc., New York, N. Y. 5 3/4 x 9 inches, 386 pages, cloth covers. Price, \$5.00.

Using Radio In Sales Promotion is presented by its author primarily as a trade manual, or we should say primer, for advertisers, station managers, broadcast artists and others interested in commercial radio broadcasting; but it is such an accurate and exhaustive discussion of the uses of radio as a publicity and good-will-advertising medium that even the casual radio listener will find it an extremely interesting book. It is the very first work of its kind; but it is so thoroughly complete in its considerations of the numerous ramifications of modern broadcasting that it is likely to stand as a standard manual of radio procedure for many years to come. There is no question about any phase of commercial broadcasting that it does not answer in precise and clearly-defined language; such factors as the potential audiences of broadcasting stations, estimating a feature's audience, qualities of successful good-will programs, selecting a feature, what the public wants, formulating the program policy, preparing the script, directing the effort, announcements, the relation of broadcasting to other advertising and publicity, the future of commercial radio broadcasting, etc., are fully treated in a serious style, albeit easily read.

There certainly are few people so well qualified to prepare such an important book as Edgar H. Felix, who is one of the most versatile men in the radio field. He was the first publicity director of station WEAJ, and in that capacity has been able to observe the development of the sponsored radio program at the very closest range. His work at WEAJ led him into the offices of the largest advertising agency in the United States, an organization responsible for the most important sponsored features on the air; so, when he describes the methods of handling these features and of the thousand and one details surrounding them, he knows whereof he speaks. As a member of the Institute of Radio Engineers he is an accomplished technician, a fact which accounts for the absolute technical accuracy of his book; as a broadcasting and merchandising consultant, he possesses a proper appreciation of sales and promotion ideas; and as contributing editor of Radio Broadcast and writer of the widely-respected March of Radio department in that magazine, he retains the ability to consider things from the standpoint of the listener-in. His almost unrivalled experience in the radio field explains the very gratifying completeness and evident authenticity of his book.—Robert Hertzberg.

Current Radio Articles

RADIO BROADCAST, July, 1927.

The leading article in this issue, "The Aurora and Fading" by A. C. Cooley, continues a series. It is an excellent resume of the findings of the last MacMillan expedition, to Greenland and Labrador, in respect to the relation between radio signals and the aurora borealis. The theory of the reflection and refraction of radio waves is gone into thoroughly and the results are most interesting.

Under the head "A Low-Cost Battery Charger" James Millen gives some of the facts about the new 2 1/2-ampere Raytheon tube. In the article are included instructions for a home-made charger. Another excellent article is by W. T. Mithoff, who writes on the construction of a 36-inch cone loud speaker; the details for cutting the paper, mounting the cone and installing the loud-speaker unit are very clear.

Other interesting articles are "Something about Single Control" by Edgar H. Felix; "A Lamp Socket 'A, B, C' Device" by Gilbert Edgar; "Receiver Design for A. C. Operation" by H. E. Rhodes. Among the constructional articles are "A Combined Push-Pull Power Amplifier and Socket 'B' Device"; "A Portable Long-Wave Receiver"; and a description of a short-wave station, which contains the details of a 500-watt crystal-controlled transmitter and a four-tube receiver.

QST, June, 1927.

The editorial in this issue urges the amateurs to do more work on the 20-meter band and a

The Kodol Radio Corp.

The World's Largest Manufacturers of Battery Chargers and Eliminators

Cincinnati, Ohio

Watch for our 1927-28 Announcement



SET BUILDERS — DEALERS
Get this Bargain Sheet
It enables you to buy high grade, nationally advertised kits, transformers, condensers, and parts at less than factory cost. Most prices are equal to 60% and 75% discounts. We sell you C. O. D. direct by mail ONLY—no references required.

HENRY WEBER
6742 N. Maplewood Ave., Chicago, Ill.

A Laboratory Product



CRESCENT LAVITE RESISTANCES

Used in 50 big broadcasting stations 12,000, 48,000, 50,000 and 100,000 ohms. For distortionless amplification. Order 2 Crescent today at \$1.50. Special sizes made to order. Discounts to dealers.
Cresradio Corp., 166-32 Jamaica Ave., Jamaica, N. Y.



The SONOCHORDE CONE \$25.

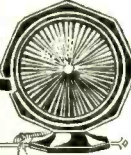

Brings the Studio Home

INVENTORS

who derive largest profits know and heed certain simple but vital facts before applying for Patents. Our book Patent Sense gives these facts; sent free. Write LACEY & LACEY, 631 F St., Washington, D. C. Established 1869.



CONDENSERS and VERITAS RESISTORS

Stand up on their Jobs

Tobe Deutschmann Co., Cambridge, Mass.



Licensed by Technidyne Corporation under U.S. Patent No. 1,393,653, July 27, 1926.

New TONATROL

A True Tone and Volume Control

Now you can regulate volume smoothly and evenly—from a whisper to full power with this new Electrad device!

"Tonatrol" is a smart addition to any receiver. Very neat in appearance and constructed of genuine Bakelite. Quickly and easily installed.

"Tonatrol" Standard Type \$1.50
 "Tonatrol" Type W.S. (with filament switch attached) \$2.00

Write for free installation booklet explaining the correct way to control volume.

At your dealer's
 Dept. 49, 175 Varick Street,
 New York, N. Y.

ELECTRAD

CARTER

New
 All Metal Self-Cooling
"Midget" Rheostat



At the Cross Roads. Every man by his decision either makes or mars his life—and the same with his radio set. The majority in most cases are right: they buy Carter—why take a chance?—follow the lead of the leaders.

All Resistances
50c Any dealer can supply

In Canada: Carter Radio Co., Ltd., Toronto

CARTER RADIO CO.

CHICAGO

Special Library of Information
 on
RADIO PATENTS
 and
TRADE MARKS

JOHN B. BRADY
 Patent Lawyer

Ouray Building Washington, D. C.

Cable address: RADIOPAT Telephone: Main 4806

Insure your copy reaching you each month. Subscriber to RADIO NEWS—\$2.50 a year. Experimenter Publishing Co., 230 Fifth Ave., N. Y. C.

little more experimenting around 5 meters. With the Radio Commission doing the things it has already done, it is important that the amateurs utilize as many of the wave bands as possible, in order that they may be better able to keep what rightfully belongs to them.

In the first few pages are described several short-wave receivers, operating on 20 and 5 meters. Under the title of "A Flexible Crystal Transmitter" Edward M. Glasser, 2BRB, gives excellent advice and constructional details of an 80-meter transmitter. Everything from the antenna down is considered and the layout has an interesting appearance.

Several articles are devoted to work on 5 meters, among these being "5-Meter Work at 2XM with Crystal Control" by A. H. Turner; "Landmarks in the 1/2 to 5-Meter Region" by Robt. S. Kruse; and "A 5-Meter Transmitter" by W. H. Hoffman. It is interesting to note that at these ultra-high frequencies, meters seem a more definite measurement than megacycles.

RADIO, June, 1927.

"Direction Finders for Mail Planes" tells in non-technical language about the latest safety devices in flying circles. The direction finders take the form of three loops installed on the fuselage of the airplane, and are tuned to wavelengths about 50 meters apart. These loops are mounted at slight angles to one another and by a system of colored lights the pilot can tell very exactly whether he is on his course.

Seeing by radio is also touched upon in an article entitled, "Progress in Television". The receiving end of radio is taken care of in an article on a new "ABC" socket-power unit; a description of the Loewe Triplex vacuum tube, which has three sets of tube elements under one glass bulb; and instructions for installing a radio receiver in a phonograph cabinet. For the experimenter there is a description of a laboratory transmitter for short waves; A. C. measurements with a wattmeter and a few handy hints.

RADIO ENGINEERING, June, 1927.

This magazine, intended primarily for the radio manufacturer and radio engineer, can be well considered as an up-to-date text book on radio for the experimenter and the man who is interested in the subject from a scientific viewpoint. Although there are various items of interest to the manufacturer alone, yet there are numerous articles in the magazine which the class of readers already mentioned will appreciate.

In the third of a series of articles on the double-impedance amplifier which he has designed, F. E. Miller gives an excellent exposition of harmonic distortion and the means for its elimination. The first two of Mr. Miller's articles have explained the special points of his amplifier by means of mathematics and the present one is as well done. V. T. Baird gives an article entitled "Charts for Determining Inductance and Capacity Values," a series of very valuable graphs from which can be determined the inductance of a coil, having given the turns per inch, its length and diameter. There are also charts which will give the inductance required if the wavelength and shunted capacity are known.

Of interest to everybody is an article on how houses may be wired for radio reception. Different phases of the work are well illustrated, such as how to run the wires in the walls, the necessary outlets, etc. One of the high points in this issue is a special-duty vacuum-tube characteristic chart, in which are given all the necessary characteristics of various makes of vacuum tubes. It is invaluable to the experimenter.

Among the regular departments of the magazine are constructional developments, news of the industry, and new developments of the month.

MODERN WIRELESS, London, May, 1927.

The call of the outdoors is apparent in the title of a portable 7-tube superhet featured in this issue. "The Summerdyne," "Radio on Road Tours," "Choosing Your Portable Set," and three pages of illustrations of British apparatus of this type (practically all with the formidable panel arrays) bear witness to the same urge.

"The 'Hex. Presto' Four," recommended for special DX qualities, employs a Hartley-Reinartz circuit. "The KLI Two" uses two A. C. tubes, with a rectifier tube for plate supply included in the small cabinet. "The 'Wee' Three" is of semi-portable type, in a plain case with a small panel at one side; it utilizes plug-in coils. Details for a convenient laboratory instrument, a high-frequency "resistometer," are given by Percy W. Harris.

Other articles include "The Existence of the Ether," by Sir Oliver Lodge, who pleads for continued faith in this subject of modern scepticism; a review of the Loftin-White circuit, which is arousing much interest throughout Europe; "Experimental Aerials," by J. F. Corrigan (one novelty is found in the use of the strings of a piano for this purpose); "Exit the Bright Emitter," a tube discussion; "Davenport Junior," a description of the new 20-kw. station being erected to operate on "short-waves"—300 to 400 meters;—alongside the 1600-meter giant; "In Search of Those Bass Notes"; the application of a loud speaker unit to a piano; and "The Search for Quality," by Capt. P. P. Eckersley of the B. B. C.



New Radio Products

now include these famous service rendering units:

Acme "A & B" Socket Power Unit
 the most efficient and compact outfit ever offered the radio owner. Exceptional value.
 Type AB-2—R, capacity 60 mills at 180 volts. Recommended for any number of tubes. Three controls, one external and two internal.
 List price complete, ready to operate, \$72.50, east of the Rockies.

Acme "A" Power Unit
 Furnished complete with six volt "A" battery, rectifying tube. Very efficient, and attractive.
 List price, complete, \$35.00 east of the Rockies.

Acme Universal "B" Supply Units
 BE-40 for six and eight tube sets with power tubes. Capacity 40 m.a. at 150 volts. Complete with QRS, 85 mill tube at only \$35.00 east of the Rockies.
 BE-60 for any number of tubes including power tubes. Cap. 60 m.a. at 180 volts. Complete with QRS, 85 mill tube at only \$39.50 East of the Rockies.

Other Acme products include Automatic Control Switch, Two Rate Trickle Charger, Trickle Charger with Automatic Relay, and Universal Charger.

Acme Radio Products are sold through the leading Jobbers everywhere. They give matchless service and satisfaction.

THE ACME ELECTRIC & MANUFACTURING Co.
 1412 Hamilton Avenue
 Cleveland, Ohio

CLIP and MAIL

Send me your latest literature on Acme Radio Products.

Name

Address

Wonderful Bargain

at \$2.90



Here's a beautiful cabinet at a remarkable price made possible only by our tremendous production. It is quality you can't match at twice the price.

The Cabinet is made of selected hardwood with three coats of lacquer, all rubbed down to a rich, lustrous piano finish. Two nickel plated hinges.

No increased price even for larger sizes. A real bargain for the amateur set builder.

Dimension
 7" x 18" x 10" Deep
 7" x 21" x 10" Deep
 7" x 21" x 10" Deep
 7" x 26" x 10" Deep

12 hour service factory to you.

Southern Toy Co. Inc.
 Manufacturers Hickory N.C.

GENERAL RADIO
 Parts and Accessories. Write for Catalog No. 926-N.
 General Radio Co. Cambridge, Mass.



Men who have pointed the way to success in sparetime business!

"Sparetime Money Making" has shown these six men the way to achieve instant profits in 6 different lines of endeavor

Anthony Azzopardi
New York, N. Y.

SAFETY RAIN PAD
Some time ago I noticed a copy of your magazine on a newsstand at 6th Avenue and 18th Street. I grabbed it in the hope of finding a side line to pay some bills and return some borrowed money.

It contained a formula for a Safety Rain Pad. Being an auto mechanic by trade I seized this opportunity.

My first sale was a tremendous success. The first day in active selling I made \$4.50 from the pads.

I am enclosing a subscription to **MONEY MAKING** as I may forget to buy it at the newsstand.

Alex Kulik
Detroit, Michigan

COMPILING NAMES
This letter is written in honor of the possibilities of your magazine. Some time ago I bought your November issue in which I read the article "Money in Names." Having access to a number of names in my business I started to work in my spare time.

During the month of November I made \$508.10 total profits selling names to shop keepers.

Besides this I have a steady monthly income from this source.

May your magazine have prosperity forever.

Jack Young
Rapid City, S. D.

BEAUTY FORMULA
I was broke, forlorn, disgusted with life. While passing a store I noticed "SPARETIME MONEY MAKING."

Hoping against hope I studied the copy from cover to cover.

I decided to sell a beauty cream formula by Mail Order.

My local town paper allowed me a small ad on credit. The second day brought 1 sale, the third 4, and so on until today I made \$31.00. From the wonderful success I am making I expect to make this my life occupation.

Thanks to "SPARE-TIME MONEY MAKING."

A. W. Hill
Germantown, Pa.

TOWN PAPER
I was in need of some ready funds quickly. I had no capital with which to experiment.

In searching the pages of "SPARETIME MONEY MAKING" I came across an article on co-operative advertising.

I secured a plain sheet of paper (his sole initial investment) and made a 4-page folder called the Town Booster, ruled off with certain spaces for ads. Then I proceeded to sell the ad spaces to merchants on a guaranteed mailing list.

In just one week after reading the article in "SPARETIME MONEY MAKING" my "Boosters" were in the mail and my net gain for the week's sparetime work was \$117.00.

K. W. Hickey
Wichita, Kan.

MEDICAL SERVICE
I have been a steady reader of SPARETIME MONEY MAKING and each month I find many valuable suggestions which I keep to try them out when the weather effects my regular Roofing Business.

It occurred to me that there was a wonderful opportunity in the article "Operate A Medical Service Bureau."

Working along the lines suggested I make many profitable connections with town papers, doctors, etc.

I went into this as a side-line, but since it is proving such a splendid money making proposition. I have decided to spend all my time at it.

My newsdealer saves me a copy of SPARETIME MONEY MAKING each month. I would not be without it, as every article is worth many times the price of the magazine.

E. L. Steve
Fordson, Mich.

DOUGHNUT BAKING
I have been a reader of your magazine for three months. While reading through your magazine I noticed the ad of the Food Display Machine Corp.—to make "Brown B o b y" Greaseless Doughnuts.

Having a very small capital I decided to try their "Junior sized machine."

I took my first batches to the factory where I worked and passed them around.

Now I am selling 12 dozen daily in the factory and many dozen for private parties.

My net profit was \$64.68 for 1 month requiring 2 hours of my Sparetime each evening.

SPARETIME MONEY MAKING—15c ON ALL NEWSSTANDS

Subscriptions only \$1.50 for 12 months

THE CONSRAD CO., Inc., 230 Fifth Avenue, New York City

The new Summer- EDITION



SUMMER is here—with the big outdoor features on your radio—baseball, fights, stadium and band concerts. You'll want all you can get of course. But to get them all you'll need a brand new up-to-date call book.

The new "Summer Edition" of Radio Listeners Guide and Call Book is as new as the season. Bright and fresh from the press. It gives the very latest revised list of all broadcast stations of the United States, Canada and foreign stations. Arranged with spaces for writing in your dial readings.

And don't forget—there are a dozen or more brand new circuits written up for home construction. See the list of contents on this page.

It's one great edition for each and every radio set user. Contains 176 pages, 100 illustrations on the large magazine size, 9 x 12 inches—and with a beautiful two-color cover.

**Buy your copy today
On Sale Everywhere**

50c THE COPY

If your dealer cannot supply you, order direct

The Consrad Co., Inc., 230 Fifth Avenue, New York

50¢
the Copy

XL Products

Used in the new Sensational STROBODYNE

circuit featured in Radio News. This confirms the endorsement of all the foremost radio authorities who have consistently selected X-L Vario Densers and X-L Binding Posts in their designs of all the out standing circuits of recent years.

MODEL "N" VARIO DENSER Micrometer adjustment easily made assures exact oscillation control in all tuned radio frequency circuits: Neutrodyne, Roberts 2-tube, Browning-Drake, McMurdo Silver's Knockout, etc. Capacity range 1.8 to 20 micro-micro farads. Price \$1.00.

MODEL "G" Obtains the proper grid capacity on Cockaday circuits, filter and intermediate frequency tuning in super-heterodyne and positive grid bias in all sets. Capacity range: Model G-1 .00002 to .0001 Mfd. Model G-5 .0001 to .0005 Mfd. Model G-10 .0003 to .01 Mfd. Price complete with grid clips \$1.50.



X-L Push Post

X-L PUSH POST—Push it down with your thumb, insert wire, remove pressure and wire is firmly held. Vibrations will not loosen, releases instantly. Price each 15c.

X-L PUSH POST PANEL permanently marked in white on black insulating panel. Price complete with soldering lugs, raising bushing and screws, etc., each \$1.50.



FREE wiring diagrams of popular circuits including the new LOFTIN-VIITE constant coupled radio frequency circuit, sent free on request. Write for yours today.

X-L Radio Laboratories

2426 Lincoln Avenue Chicago, Illinois



WINDSOR HORN and CONE Loudspeakers and Loudspeaker Consoles
WINDSOR FURNITURE COMPANY
 1410 Carroll Avenue, Chicago, Illinois
 Los Angeles Branch, 917 Maple Ave.

Money from LIMERICKS!

EARN big cash-prize money writing interesting, fascinating Limericks. Anyone can learn. New book, written by noted Limerick authority tells you in detail how to compose winning lines, also gives valuable rhyming dictionary of words especially suitable for Limericks.

Hundreds of dollars being offered monthly by many magazines and newspapers. An easy, pleasant way for you to increase your income in Sparetime.

Get your copy of this Book NOW!
 "Limerick Writing For Profit"

50c the Copy

CONSRAD COMPANY, INC.
 230 Fifth Ave. New York, N. Y.

WIRELESS MAGAZINE, London, June, 1927.

"More Summer Wireless" is the slogan of this issue; and £25 in prizes is offered for the best sets constructed from plans given for the "Countryside Four." This receiver, with a switch for changing over from the short to the long European wavelengths, is a neat portable. A two-tube D. C. socket power amplifier is also featured as this type of house-lighting supply is common in England. The "Fonotrol" crystal set is designed to be hung upon the wall, and is put in operation by taking its headphones, like a telephone receiver, from their hook.

"A New Method in Reception," by J. F. Johnston, couples the plates of tubes directly to the grids of the following stages, without condensers or resistances. In order to maintain the correct grid bias—or should we say filament bias?—each tube has its own "A" battery, and the negative sides of these are connected to different taps along the "B" battery. An application of the same principle to a D. C. operated set is shown; and excellent results are claimed, as fluctuations in the voltage supplied affect the three elements of the tube simultaneously, and therefore practically cancel out.

WIRELESS CONSTRUCTOR, London, June, 1927.

The first feature is a two-tube short-wave receiver—really short waves this time, down to 20 meters; a Reinartz circuit is employed in this, the "Radio." A novelty in the article is the use of full-size illustrations of the exact lengths of all leads used; the longest is twelve inches. A short-wave five-tube superhet is also described; it embodies a sixth tube for use in C. W. reception. Other articles deal with revisions of previous sets, or additional data on "The Special Five;" "The Signal Box," a three-tuber; "The Resistance Three;" etc.; and much in the way of excellent constructional hints and "wrinkles" is supplied.

QST FRANCAIS, Paris, May 1927.

The phenomena of wave propagation are dealt with in several very solid articles in this issue, continuing several series which began in former numbers. Gen. Cartier considers the Heaviside layer theory; Leon de la Forge gives a resume of the results obtained from 164,000 observations with radio compasses of the apparent direction of signals from long-wave stations, in which deviations amounting to as much as 90° have been noted under exceptional circumstances; "A. S." treats mathematically the effect of the ionized particles of different gases in the upper atmosphere upon the waves. An unusual departure (for American readers) is a setting aside of mathematics for metaphysics in a discussion of relativity, "Is the Soul Independent of the Body?" by S. Lwoff. There is a study of high-frequency measuring methods by Jean Vivie and an elaborate mathematical consideration of the characteristics of transmitting antennas by M. A. Crémail.

One constructional article, "The Cryptasupradyn," by Adj. Bernard, deals with a seven-tube superheterodyne, whose oscillator and first detector are double-grid tubes, of the type so popular on the Continent. Dr. Titus Konteschweller, a distinguished authority on his subject, gives most involved calculations on the difficult subject of the super-regenerator.

L'ONDE ELECTRIQUE, Paris, May, 1927.

This purely technical magazine, the organ of the *Societe des Amis de la T. S. F.*, though small is of the highest order; it contains copious illustrated reviews of articles showing the progress of radio science; a study of beam transmission, by Prof. Mesnay; an analysis of vacuum-tube characteristics, by R. Jouaust; and a report by F. Dacas on researches into the variation of dielectric hysteresis in phosphorescent substances (calcium sulphide) in which the greatest field losses were found as the luminosity became more pronounced.

LA RADIO, Paris, May, 1927.

Far more popular in its contents than either of the preceding, this magazine is for the ordinary "amateur"—a word far more sweeping in its scope in Europe than in America. Its leading article gives details for the construction of a four-tube set, with a regenerative detector, described as of extreme sensitivity. A coil tuned by an adjustable iron core is used as a regeneration control. Other articles cover the subjects of condensers, alternating-current tubes, and endeavors to supply filament current by the use of the thermoelectric principle. This magazine incorporates a section of a radio encyclopedia, which may be saved for reference.

LA T. S. F. POUR TOUS, Paris, May, 1927.

This magazine, a companion publication of the above, contains the identical encyclopedia section. It is devoted almost wholly to construction, with very elaborate diagrams and illustrations for the set builder. Its leading feature is the "Simpladyne"—a word, which, it is explained, needs no translating into any European language—and others include a single-tube hook-up using a



EL Menco HY-WATT

HEAVY DUTY RESISTORS

For best results with Raytheon and other power circuits you must have permanently accurate resistors capable of carrying heavy loads without change or deterioration. "HY-WATT" Heavy Duty Resistors dissipate up to 12 watts.
 100—500—1000—2000—5000 ohms \$1.25
 10,000—25,000—50,000 ohms \$1.50
 100,000 ohms \$2.00

Write for full details and literature on El Menco Gridleaks and Resistors
Electro-Motive Engineering Corp.
 127 West 17th St. New York, N. Y.

Guaranteed Performance

at a **50% Saving!**
World Storage "A" Battery
 2-Year Guarantee
 Bond in Writing



ACKNOWLEDGED as the most reliable and economical "A" power known to radio, the "A" Storage Battery has yet to find an equal. Guaranteed performance proves it. No other method can give the same lasting satisfaction. For this reason, the World Radio Storage "A" Battery is the constant choice of thousands of set owners. *Solid Rubber Case.* APPROVED and listed as standard by Radio News Lab., Pop. Sci. Inst. Standards, Pop. Radio Lab., LoFax, Inc., and other famous radio authorities. SEND NO MONEY—We ship same day order is received by Express, C. O. D. Batteries subject to examination on arrival, 5% discount for cash in full with order. Send today.

- Low Prices
- SOLID RUBBER CASE RADIO BATTERIES
 - 6-Volt, 100-Amperes \$10.00
 - 6-Volt, 120-Amperes \$12.00
 - 6-Volt, 140-Amperes \$13.00
 - SOLID RUBBER CASE AUTO BATTERIES
 - 6-Volt, 11-Plate \$10.00
 - 6-Volt, 13-Plate \$12.00
 - 12-Volt, 7-Plate \$14.50

WORLD BATTERY CO., 1219 So. Wabash Ave. Chicago, Ill., Dept. 10

Set your radio dials at 288.3 meters for World Storage Battery Station WSEC. Variety—new talent—always interesting.

Six tubes ~ One Control FRESHMAN MASTERPIECE

Sold by Authorized Freshman Dealers Only

68 MILES ON 1 GAL. OF GAS
 Thermostatic Carburetor Control big success. Ford gets 68 miles on 1 gal. gas. Starts coldest motor instantly. ONE FREE TO INTRODUCE. Sales guaranteed. \$15.00 a day guaranteed to distributors. Write BLANCHE AUTO DEVICES CO., Dept. 827-L 154 E. Erie St., Chicago, Ill.

OPPORTUNITY AD-LETS

Follow these advertisements every month. Reliable advertisers from all over the country offer their most attractive specials in these columns.

Classified advertising rate twenty-two cents a word for each insertion. Ten per cent discount for 6 issues, 20 per cent discount for 12 issues. Name and address must be included at the above rate. Cash should accompany all classified advertisements unless placed by an accredited advertising agency. No advertisement for less than 10 words accepted.

Objectional or misleading advertisements not accepted. Advertisements for the October issue must reach us not later than August 1st.

CIRCULATION LARGER THAN THAT OF ANY OTHER RADIO PUBLICATION

EXPERIMENTER PUBLISHING CO., INC., 230 Fifth Avenue, New York, N. Y.

Agents Wanted

Big Money and fast sales. Every owner buys gold linings for his auto. You charge \$1.50; make \$1.35. Ten orders daily easy. Write for particulars and free samples. American Monogram Co., Dept. 133, East Orange, N. J.

Guaranteed Genuine Gold Leaf Letters anyone can put on store windows. Large profits, enormous demand. Free samples. Metallic Letter Co., 422 N. Clark, Chicago.

Earn \$10 daily silvering mirrors, plating, refinishing metalware, chandeliers, headlights, bedsteads. Outfits furnished. Bolanger Decie Laboratories, 152 E. 23rd St., New York.

Business Opportunities

Free Book. Start little Mail Order Business. Pier Company, 72AF Cortland Street, N. Y.

Earn \$120 to \$250 Monthly; expenses paid as railway traffic inspector; we secure position for you after completion of 3 months' home study course or money refunded. Excellent opportunities. Write for free booklet. G-30, Standard Business Training Inst., Buffalo, N. Y.

Co-operative membership in EIA RADIO is establishing one honest, industrious man of each locality in his own successful radio industry. Young married men preferred. Write, naming your county. Equitable Industries Association, Radio Division, 350-R Broadway, New York.

For complimentary copy of the Promoters' Hand Book, a leaflet on financing, write to Amster Leonard, 617 Central Ave., East Orange, N. J.

Chemistry

Learn Chemistry at Home. Dr. T. O'Connor Sloane, noted educator and scientific authority, will teach you. Our home study correspondence course fits you to take a position as chemist. See our full page ad on page 165 of this issue. Chemical Institute of New York, 66R-W, Broadway, New York City.

Correspondence Courses

Used correspondence school courses sold on repurchase basis. Also rented and exchanged. Money-back guarantee. Catalog free. (Courses bought). Leo Mountain, Pisgah, Alabama.

For Inventors

I am in touch with hundreds of moneyed men and manufacturers who wish to buy good inventions. Hartley, 38 Court St., Bangor, Maine.

Patent applications filed for inventors. New financial plan. Inventors' Service Bureau, Box 1648, Washington, D. C.

Help Wanted

Earn \$25 weekly, spare time, writing for newspapers, magazines. Experience unnecessary. Details FREE. Press Syndicate, 973, St. Louis, Mo.

Detectives Needed Everywhere. Travel. Experience unnecessary. Particulars free. Write, American Detective System, 2190 Broadway, N. Y.

Y. M. C. A. Radio Institute, 154 East 86th Street, New York. Hundreds of successful graduates. Home Study and School courses. Radio operating or mechanics. Send for Free Booklet.

Instruction

Learn Chemistry at Home. Dr. T. O'Connor Sloane, noted educator and scientific authority, will teach you. Our home study correspondence course fits you to take a position as chemist. See our full page ad on page 165 of this issue. Chemical Institute of New York, 66R-W, Broadway, New York City.

Double Entry Bookkeeping mastered in 60 hours with 8 Keys; guaranteed; diplomas. International Bookkeeping Institute, Dept. 28, Springfield, Mo.

Lists

Radio Mailing Lists, 40,000 Radio Dealers, 2,785 Manufacturers, 3,265 Jobbers, 1,072 Set Manufacturers, 2,930 Phono. & Music Radio Dealers. Ask for price list showing every kind of Radio mailing lists. Guaranteed. Trade Circular Co., 166 W. Adams, Chicago.

Miscellaneous

Inventors: Use our special service for presenting your invention or patent to manufacturers. Adam Fisher Mfg. Co., 278-A Enright, St. Louis, Mo.

Miscellaneous (continued)

Be the licensed Radio Doctor of your community. \$7-\$10 spare time evenings. Our co-operative plan procures all the work you want. Secure franchised territory now. Write for booklet. Co-operative Radio Doctors, 131 Essex St., Salem, Mass.

Multigraph typewritten letters sell anything. Two dollars thousand. Mayer Rey Corporation, Monmouth, Illinois.

Old Money Wanted

\$2 to \$500 each paid for hundreds of Old or Odd Coins. Keep all old money, it may be very valuable. Send 10c for New Illustrated Coin Value Book, 436. Guaranteed prices. Get posted. We pay Cash. Clarke Coin Company, 14 Street, LeRoy, N. Y.

Patents

Inventions Commercialized. Patented or unpatented. Write Adam Fisher Mfg. Co., 278 Enright, St. Louis, Mo.

Patent Sense—Valuable book free. See Lacey's ad page 186—Lacey & Lacey, 631 F. St., N.W., Washington, D. C. Established 1869.

Patent Attorneys

Patents—Send for form "Evidence of Conception" to be signed and witnessed. Form, fee schedule, information free. Highest references. Best results. Promptness assured. Lancaster and Allwine, Registered Patent Attorneys in United States and Canada, 269 Ouray Bldg., Washington, D. C.

Patents. Send drawing or model of your invention for examination and instructions. Advice and booklet free. Highest references. Best results. Promptness assured. Watson E. Coleman, Patent Lawyer, 721 9th Street, N.W., Washington, D. C.

Inventors—Should write for our Guide Book. "How to Obtain a Patent" and Record of Invention Blank, sent free. Send model or sketch of inventions for our Inspection and Instructions Free. Radio, Electrical, Chemical, Mechanical and Trademark Experts. Terms Reasonable. Victor J. Evans & Co., 922 Ninth, Washington, D. C.

Postage Stamps

Stamp Collectors—Phillips Monthly Bulletin (illustrated) offers over 2,000 special bargains, sets, packets, single stamps, etc., each issue. Free. Phillips, Box 1012, Hartford, Conn.

Printing Outfits and Supplies

Print your own cards, stationery, circulars, paper, etc. Complete outfits \$3.85; Job Presses \$11, \$29; Rotary \$149. Print for others, big profit. All easy, rules sent. Write for catalog presses, type paper, etc. Kelsey Company, F-13, Meriden, Conn.

\$3.00 Delivered. 500 Watermarked Bond Letterheads, 8 1/2 x 11 and 250 envelopes. Cash. Catalogue Free. Printing bargains. National Printing, Goshen, Indiana.

Radio

Boys! Don't Overlook This. The "Rasco" Baby Detector. Greatest detector ever brought out with moulded base. Fully adjustable. See former advertisements in this publication, or our catalog. Detector with Galena Crystal, complete 50c, the same detector with Radiolite Crystal, 75c prepaid. Send for yours today. Radio Specialty Company, 96-98 Park Place, New York City.

Attention!—50 vacuum tube hook-ups. The greatest collection of vacuum tube circuits ever brought under two covers at such insignificant cost. These diagrams will be found in the great "Rasco" catalog, which contains raw materials and parts in a greater profusion than any other catalog. Send for free catalog. Radio Specialty Co., 96-98 Park Place, New York.

Transmitting Sets. All sizes constructed. Bargain prices. Write S. & S. Radio Company, 31 N. Warren St., Trenton, N. J.

Manufacturer Wanted. Radio Panel Lamp. Parts furnished. Easily assembled. Sample \$1.25. Robert Stevenson, Lancaster, Ohio.

Chokes 20H, \$1.00; 30H, \$2.25; 50H, \$2.75. Write for material lists. Radio Parts Sales Co., Orange, N. J.

Our Free Radio Bulletins Give Advanced Information on latest radio developments for fans who build their own or wish to improve their present sets. Free on request. Radio Research Bureau, Waukegan, Ill.

Salesmen Wanted

66 Miles on 1 Gallon—Amazing new moisture gas saver. All autos. 1 Free. Critchlow, E-88, Wheaton, Ill.

Scenery for Rent

World's Most Beautiful Settings for operas, plays, minirels. Amelia Grain, Philadelphia.

Song Poems

Song Poem Writers—Address Hibbler, DTX, 2104 N. Keystone Ave., Chicago.

Song Writers

Song-Poem writers. Address Monarch, 236 W. 55th St., New York.

Telegraphy

Telegraphy—Both Morse and Wireless taught thoroughly. Big salaries. Wonderful opportunities. Expenses low, chance to earn part. School established fifty years. Catalog free. Dodge's Institute, Cour St., Valparaiso, Ind.

Wanted to Buy

Full Value Paid for Old Gold, Jewelry, Watches, Diamonds, crowns, bridges, dental gold, silver, platinum, gold or silver ore; magneto points, old false teeth. Packages returned if our offer is not satisfactory. United States Smelting Works (The Old Reliable) 39 So. State St., Dept. 16, Chicago, Ill.

"I believe you have taught the average citizen something about Juries."
—Charles Evans Hughes.

The Inside Story ABOUT JURIES

How they work and what may be expected of them.

What we have always wanted to know.

A fascinating book written by a Juror who has served 23 years on everything, from petty cases to first degree murder.

Worth its weight in gold to the citizen, the student, the witness, the juror, the lawyer, the general reader.

Widely indorsed by the Press, the Bench and the Bar.

From the New York Evening Telegram: "Mr. Sutcliffe's descriptions of an average juror's actions, of how he is influenced by the bearing and arguments of counsel, as well as by the attitude and manner of witnesses, are vivid, unassuming and *** of great value to lawyers."

The Brooklyn Citizen says: "We recommend it for universal reading. . . . It should indeed be read by every adult citizen and seems worthy of being used in schools and colleges."

Mr. E. W. Osborn, of the New York World, writes: "Within the 'Impressions of an Average Juror' are gathered perhaps more practical facts pertinent to the subject of jury duty and responsibility than were ever before assembled between the binding of a book."

An Ex-Judge of the New York Supreme Court writes: "Impressions of an Average Juror is the best thing that I have ever seen on New York or other juries."

We are offering the second printing of this valuable book at one-half its former price.

Send \$1.10 for a copy by mail of

IMPRESSIONS OF AN AVERAGE JURYMEN

By ROBERT STEWART SUTCLIFFE
120 Pages Full Cloth Bound

THE CONSRAD CO., Inc.
230 Fifth Avenue New York City

No matter what panel the specifications call for, a **RADION PANEL** will give your set the greatest protection against leaks and losses.

Order from your dealer or write to

AMERICAN HARD RUBBER CO.
11 Mercer Street
New York, N. Y.

SET BUILDERS

Before you build get our special prices on the parts you are planning to use. We'll save you money. Largest and most complete stock in U. S. A.

Chicago Salvage Stock Store
Dept. RN. 509 S. State St., Chicago, Ill.

BUILD A GENUINE TRU-TONE BALSALWOOD SPEAKER

Marvelous new discovery, **Balsa Wood**. Gives sweetness of tone never before heard—and remarkable clearness. Light as a feather—can be painted or draped to harmonize with room—easily made up into handsome speaker that you will be proud to own.

COMPLETE KIT \$6.50 LESS UNIT
Size 36 x 20 inches Any cone unit with full instructions can be adapted to the Balsa Speaker.

Clip this coupon, postage paid.

NAME _____ SPECIAL OFFER TO DEALERS
ADDRESS _____
Please send—Kit
Booklet
Balsa Laboratories, 205 Greenwich St., N. Y. City

AMPLION

triple-grid tube for which an amplification factor three times that of the ordinary tube is claimed, and a "five-in-two" arrangement with the Loewe tubes.

An amusing article, very pleasantly illustrated, rebukes the credulity of the radio fan who is taken in by the most impossible claims. But, after all, only incurable optimism has been able to develop radio to its present advanced stage, in spite of difficulties too numerous to mention.

RADIO, Stockholm, May 16, 1927.

RADIO UGE-REVUE, Copenhagen, May 27, 1927.

NORSK RADIO, Oslo, May, 1927.

With smaller populations to draw upon for their circulation, the Scandinavian radio magazines must combine the features in which magazines of more populous countries specialize. Sweden and Denmark, especially, are making elaborate installations for broadcast purposes.

"How shall I adapt my receiver to Motala's wavelength?" is a subject of a series in Sweden's *Radio*. This new station, not far from Stockholm, operating on 1304.5 meters, with an output of 30 kw., is, next to Moscow, the most powerful in Europe. Yet, with all this technical improvement, the leading editorial in this issue demands, "Why Are Radio Programs Getting Worse?" The technical matter includes discussions of new apparatus, in which American goods are conspicuously present; an analysis of tube characteristics; reviews of the Loftin-White system, the Cockaday receiver, high-quality loud speakers, including the 3-foot roll type described by Clyde J. Fitch in February *RADIO NEWS*; and a large number of circuits for the popular double-grid tubes.

Radio Uge-Revue combines the usual program section with a well-rounded list of contents. Its editorial, however, inquires, "Is Radio at a Standstill?" and answers with a confident negative, except that there is "stagnation" in the state of Denmark. It features a portable employing two double-grid tubes, with full constructional details; there is a study of R.F. coils, based on American data, and another of the efficient use of coupling in A.F. and output stages. Russian radio is given a page, showing some novel applications of art—one a set whose variable coupling coils represent a butterfly perched on a field of flowers, the cabinet top!

Norsk Radio is lacking in editorial jeremiads; it is devoted more strictly to the technical and constructional side of radio. Its first article deals with the Solodyne; the Browning-Drake, with phasatrol control, is reviewed; there are a page of popular data, discussions of condenser construction, of double-grid tubes, etc. A regular feature is a page of a Norse-Esperanto-English radio dictionary. American apparatus is noticeably less featured in this than in the other Scandinavian radio publications.

STATEMENT OF THE OWNERSHIP, MANAGEMENT, ETC., REQUIRED BY THE ACT OF CONGRESS OF AUGUST 24, 1912.

Of *Radio News*, published monthly at New York, N. Y., for April 1, 1927.

State of New York, County of New York, ss.

Before me, a notary public in and for the State and county aforesaid, personally appeared Hugo Gernsback who, having been duly sworn according to law, deposes and says that he is the Editor of *Radio News*, and that the following is, to the best of his knowledge and belief, a true statement of the ownership, management, etc., of the aforesaid publication for the date shown in the above caption, required by the Act of August 24, 1912, to wit:

1. That the names and addresses of the publisher, editor, managing editor, and business managers are:

Publisher, The Experimenter Publishing Co., Inc., 230 Fifth Avenue, New York, N. Y.

Editor, Hugo Gernsback, 230 Fifth Avenue, New York, N. Y.

Managing Editor, none.

Business Manager, R. W. DeMott, 230 Fifth Avenue, New York, N. Y.

2. That the owners are:

The Experimenter Publishing Co., Inc., 230 Fifth Ave., N. Y.; Hugo Gernsback, 230 Fifth Avenue, New York, N. Y.; Sidney Gernsback, 230 Fifth Avenue, New York, N. Y.; R. W. DeMott, 230 Fifth Avenue, New York, N. Y.; H. W. Secor, 230 Fifth Avenue, New York, N. Y.; I. S. Manheimer, 230 Fifth Avenue, New York, N. Y.; Dr. T. O'Connor Sicane, 230 Fifth Avenue, New York, N. Y.; Mrs. Catherine Major, 230 Fifth Avenue, New York, N. Y.; M. M. Finucan, 720 Cass St., Chicago, Illinois; L. E. McClure, 720 Cass St., Chicago, Illinois.

3. That the known bondholders, mortgagees, and other security holders owning or holding 1 per cent. or more of total amount of bonds, mortgages, or other securities are: None.

4. That the two paragraphs next above, giving the names of the owners, stockholders, and security holders, if any, contain not only the list of stock holders and security holders as they appear on the books of the company but also, in cases where the stockholder or security holder appears upon the books of the company as trustee or in any fiduciary relation, the name of the person or corporation for whom such trustee is acting, is given; also that the said two paragraphs contain statements embracing affiant's full knowledge and belief as to the circumstances and conditions under which stockholders and security holders who do not appear upon the books of the company as trustee, hold stock and securities in a capacity other than that of a bona fide owner; and this affiant has no reason to believe that any other person, association, or corporation has any interest direct or indirect in the said stock, bonds, or other securities than as so stated by him.

HUGO GERNSBACK,

Sworn to and subscribed before me this 28th day of March, 1927.

JOSEPH H. KRAUS, Notary Public.

(My commission expires March 30, 1929)

(SEAL)

Opportunity abounds in Radio

Advancement in salary and rank is rapid in this fascinating work. Trained men are always in high demand—as ship operators sailing to foreign lands, and as mechanics, assemblers, salesmen and installers on shore.

Study at home

Radio Institute of America offers the finest instruction obtainable. The low cost of the course makes it a real investment that pays dividends in higher wages. Study at home! Write now for full information.

---SEND THIS IN---

Radio Institute of America H.
324 Broadway, New York City

Please send me full information about both your Home Study Courses of radio instruction—with code and without.

Name.....

Address.....

RADIO INSTITUTE OF AMERICA
(Formerly Marconi Institute)
Established in 1909
324 Broadway New York City



Condenser Tissues

? IS your Radio set giving trouble? Do the condensers have to be replaced frequently? Are you aware that this annoyance can usually be traced to the use of imperfect condenser tissue paper?

Condensers built with DEXSTAR Condenser Tissue, will give longest service and highest efficiency. ASK your dealer to ask the manufacturers, to use DEXSTAR Tissues only, as insurance against condenser break downs.

C. H. DEXTER & SONS, Inc.,
Specialists on High-Grade Condenser Tissues
Windsor Locks, Conn.

Improve reception in any circuit!



Write for New 1927 Catalog
Remler Division of
Gray & Danielson Mfg. Co.
260 First Street - San Francisco

Mar-Co Dials

The three essentials for the fullest enjoyment of Summer Radio features!



SUMMER
A PORTABLE RECEIVER

fun with this powerful portable set!

MAKE THIS A RADIO SUMMER

Touring, camping, or at home, a portable Radio Receiver is a real summer enjoyment. It's convenient to carry, in your car, with your baggage, or if at home from room to room or out on the lawn.

You can build your own "portable" at a small cost—from a "Conrad" pattern which gives 4-page instruction booklet of parts needed, together with full size blueprints 16 inches wide by 20 inches high, of panel and wiring diagram.

The Conrad method is the simplest ever devised—you do not have to know anything about radio to follow it.

THIS CONSRAD PATTERN
50c—EVERYWHERE
Or send direct on receipt of 50c.

THE CONSRAD CO., Inc.
230 Fifth Ave., New York, N. Y.

WHEN stations crowd the air
spoil your programs



use a wave trap!

Improve your Reception—build a wave-trap with a Conrad Pattern

NO matter how large or small, how expensive or inexpensive a Radio Set may be, it can be decidedly improved with a good WAVE-TRAP.

The new Conrad pattern contains a gigantic blueprint, 27 1/4 inches by 20 1/2 inches, containing simplified Panel layout, Front View, Top View, Side View and Picture Wiring diagram. All measurements are shown actual size. A complete Illustrated Pamphlet is enclosed that shows exactly how to proceed throughout the entire construction; these are enclosed in a heavy folder envelope size 9 1/4 x 9 1/2 inches.

ONLY 25c—EVERYWHERE

If your dealer cannot supply you, write direct
The Conrad Co., Inc., 230 5th Ave., N.Y.



12 P.M. Gives up in disgust!

The man who forgot to buy

THE RADIO TROUBLE FINDER

FROM 8 o'clock to 12 he was frantically trying to tune in on the big anniversary program, but his radio set positively would not work.

He had a dozen books on the care of his car but not one for his Radio.

Radio Sets rarely need an expert's attention, if you have a copy of "The Radio Trouble Finder" handy.

It's a 68-page, simplified manual for trouble correcting—written expressly for home users.

Common Radio faults are charted and remedies are given in language as devoid of technical expressions as is possible.

ORDER YOUR COPY TODAY

25c Every Where

If your dealer cannot supply you write—

The Conrad Co., Inc., 230 Fifth Ave. New York



The 5 essentials of a complete Radio Education

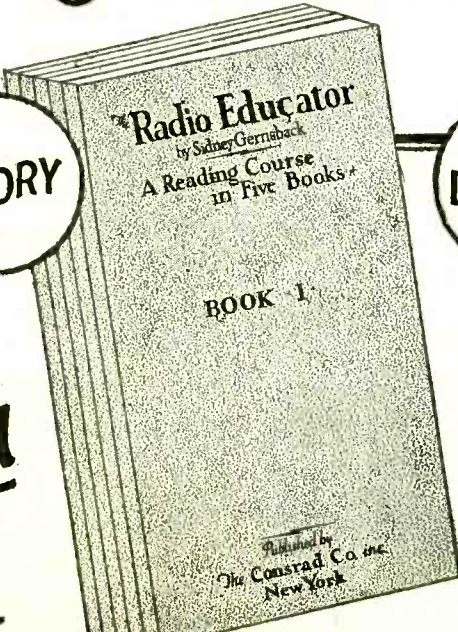

THEORY

DESIGN

CONSTRUCTION

OPERATION

MAINTENANCE

Radio Educator
by Sidney Gernsback
A Reading Course in Five Books
BOOK 1

\$1.97

Published by
The Conrad Co. Inc.
New York

RADIO can be learned—from beginning to end—from raw, practical theory to maintenance and operation of large installations—all from this compact, finished set of 5 volumes. They contain the five component parts of an entire Radio Instruction course and not only the essentials but all that any modern, up-to-date textbook on any subject would cover. They teach every possible portion of Radio Science.

Size of each book is 6 x 9 inches, handsomely bound and illustrated with charts, diagrams, drawings and tables. Each book contains 52 pages.

SEND NO MONEY

Send us no money for these books—just your name and full address—On receipt of same you pay the postman \$1.97 plus postage (a few cents) and then they are yours. Note: This is the second new reprint of these books—Order early and be sure of quick delivery.

THE CONSRAD COMPANY, Inc.
230 Fifth Avenue
New York, N. Y.

SUBANTENNA

UNDERGROUND ANTENNA SYSTEM

**Be Sure to Tune In
KYW**
(536 Meters)
every Wednesday Evening
7:30 to 8:00 P. M. Central
Daylight Saving Time. The
SUBANTENNA CRU-
SADERS and their accom-
panists will entertain you.

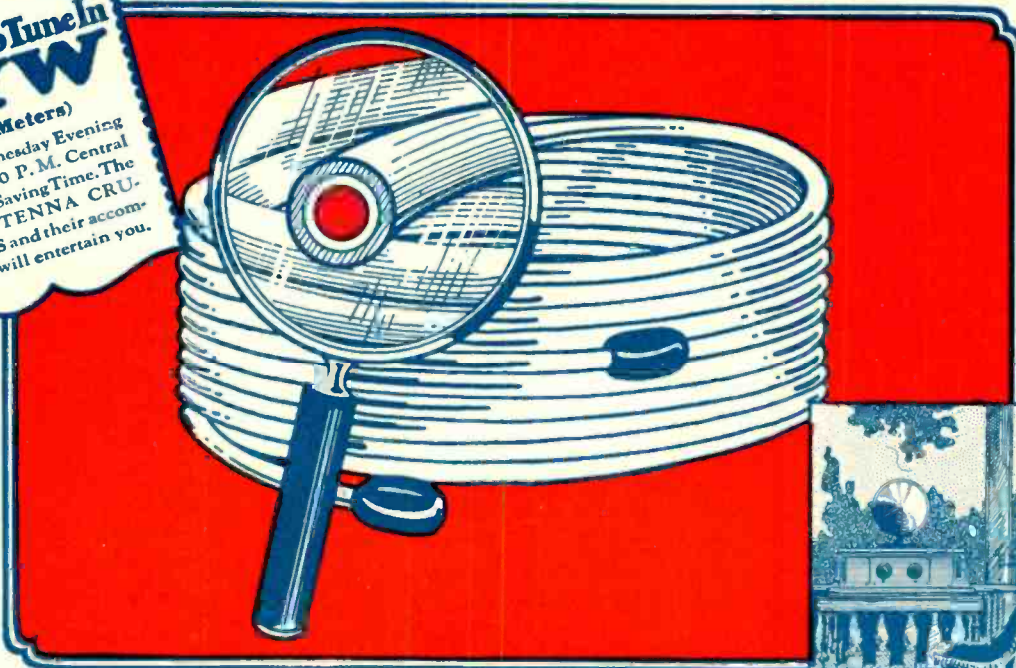

Gets Distant Stations Clear and Loud— Summer and Winter—Right thru Static



NOW—you can get "distance" in summertime. Loud, clean, clear distance, sweet and true in tone—almost like local. The marvelous new device illustrated above makes this possible. **STATIC** is no longer a nuisance. Engineers have long known that the ratio of static strength to signal strength **IN THE AIR**, favored Static, but that in the **GROUND**, the ratio of static strength to signal strength favored the music you wish to hear. They knew that if some device could be perfected whereby broadcast waves could be taken out of the **GROUND** instead of from the air, that all-year-round distant reception would become a reality. **SUBANTENNA** is the answer. It completely does away with the old style up-in-the-air aerial; it picks up clear, filtered waves from the ground—it delivers a strong signal; waves so powerful that the tiny amount of weak ground static they may contain is drowned out. The performance of **SUBANTENNA** is nothing short of marvelous. It will amaze you—just as it has amazed laboratories and thousands of critical fans.

User Says "Static Is No More"
"I have received the Subantenna. My grandson installed it. **STATIC IS NO MORE.** Am well satisfied. I can tune in stations I never could coax out of the air even though I had a long aerial."—A. E. F., Kans.

User Says "Greater Distance"

"To show you that I received a program from Station PWX in Havana, Cuba, I enclose herewith a verification card from that station. On January 28th, I received a program on my set broadcasted from Buenos Aires, South America at 10:15 in the evening. Many other long-distance stations have been heard on my set after installing the Subantenna. I never could receive such distance on my outside antenna."—W. C. F., Chicago, Ill.

User Says "Gets More Stations"

"I get plenty of stations with my Subantenna, on the loud speaker that I have never been able to reach with my outside aerial. It absolutely cuts down interference to the minimum, cuts static out too—not just partly out—but *all out*."—H. S. M., N. Car.

User Says "Cuts Out Interference"

"Have had Subantenna some months and it beats any antenna I have ever had by forty miles. Have a five tube set and get New York City, Atlantic City, Atlanta, New Orleans, Fort Worth, Denver perfectly clear, and next to an elevated train with much interference. Cuts it all out."—C. H. Y., Chicago.

User Says "More Volume"

"We have been receiving stations that formerly did not register on the outside antenna. A marked increase in volume on Stations over 800 Kilocycles has been noted."—Capt. F. W. F., Md.

Eliminates Lightning Risk

Not only does **SUBANTENNA** make possible loud, clear DX in summer—not only does this remarkable invention better the selectivity of any set—but it also completely eliminates the Lightning hazard. With **SUBANTENNA** one can go right on listening-in dur-

ing the most severe electrical storm without noise, fear of attracting lightning or damaging the set.

FREE TRIAL

Make This Convincing Test

Install **SUBANTENNA**. Leave your old aerial up. Select a bad night when DX is almost impossible with the ordinary aerial. Make a comparison station for station, connecting first your aerial, then **SUBANTENNA**. If, from stations that are just a mess of jumbled noise with the old aerial, you don't get reception that rivals local in sweetness and clarity the instant you switch to **SUBANTENNA**, this test won't cost you even a single penny. Obtain a **SUBANTENNA** from your dealer or send coupon at once for scientific explanation of **SUBANTENNA** and for particulars of **GUARANTEE** and **FREE TRIAL OFFER**. Send **COUPON NOW!**

CLIP AND MAIL AT ONCE

CLOVERLEAF MFG. CO.,
2717-C Canal Street, Chicago, Illinois
Tell me all about **SUBANTENNA**, your unqualified, unconditional guarantee and your **FREE TRIAL OFFER**.

Name _____

Address _____

CLOVERLEAF MANUFACTURING CO.

2717-C CANAL STREET

CHICAGO, ILLINOIS

Model 135

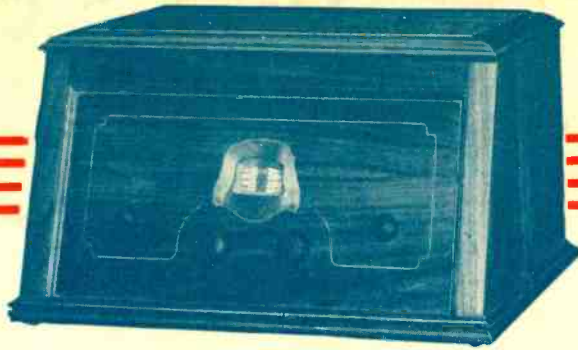

Price \$110.00

A New Counterphase Six ... at a Lower Price

B-T quality is now available at a price that puts it within the reach of all.

Here in compact form the Counterphase Circuit again proves its eminently successful efficiency.

Match the performance of this new Six with any other receiver in its price class—you will then realize why B-T holds a record for having produced only outstanding successes.

To maintain that record is the B-T aim in further new developments now under way.

Announcements will be made from time to time—watch for them.

There are other Counterphase Models—two of them illustrated on this page.

Further information is given in the new B-T catalogue—write for it.



Counterphase 8 Model 12



Counterphase 6 Model 22

Bremer-Tully Mfg. Company

Dept. N ... 520 S. Canal St. ... Chicago, Ill.

