

CIRCULATION LARGER THAN THAT OF ANY OTHER RADIO PUBLICATION

RADIO PHONE  
**WRNY**  
STATION

# RADIO NEWS

REG. U. S. PAT. OFF.

25 Cents

JUNE

Over 200  
Illustrations

Edited by HUGO GERNSBACK

## WIRELESS PHONE LINKS TRAIN AND HOME

SEE PAGE 1636

TRAIN RADIOPHONE



IN THIS ISSUE  
THE FENWAY SU...

RADIO'S GREATEST MAGAZINE

EXPERIMENTER PUBLISHING COMPANY, NEW YORK, PUBLISHERS OF

SCIENCE and INVENTION RADIO REVIEW AMAZING STORIES RADIO INTERNACIONAL



# Cunningham

## RADIO TUBES



# Leadership

The radio store that sells Cunningham Radio Tubes is a leader in its community—Its dominant policy is to serve and protect its customers, to give them utmost value, and the ultimate degree of radio satisfaction.

Of course—a store of this sort is quick to appreciate the Invisible Integrity, the In-built Value, of Cunningham Radio Tubes. Its management knows that for eleven years these tubes have never failed; that no compromise or short-cut has ever endangered their reputation or their superlative service to the public.

No wonder that progressive dealers prefer to sell a product of such outstanding merit.

*In the Orange and Blue Carton*

*E. J. Cunningham Inc.*

New York

Chicago

San Francisco

Manufactured and sold under rights, patents and inventions owned and/or controlled by Radio Corporation of America.



# The new Tower CONE

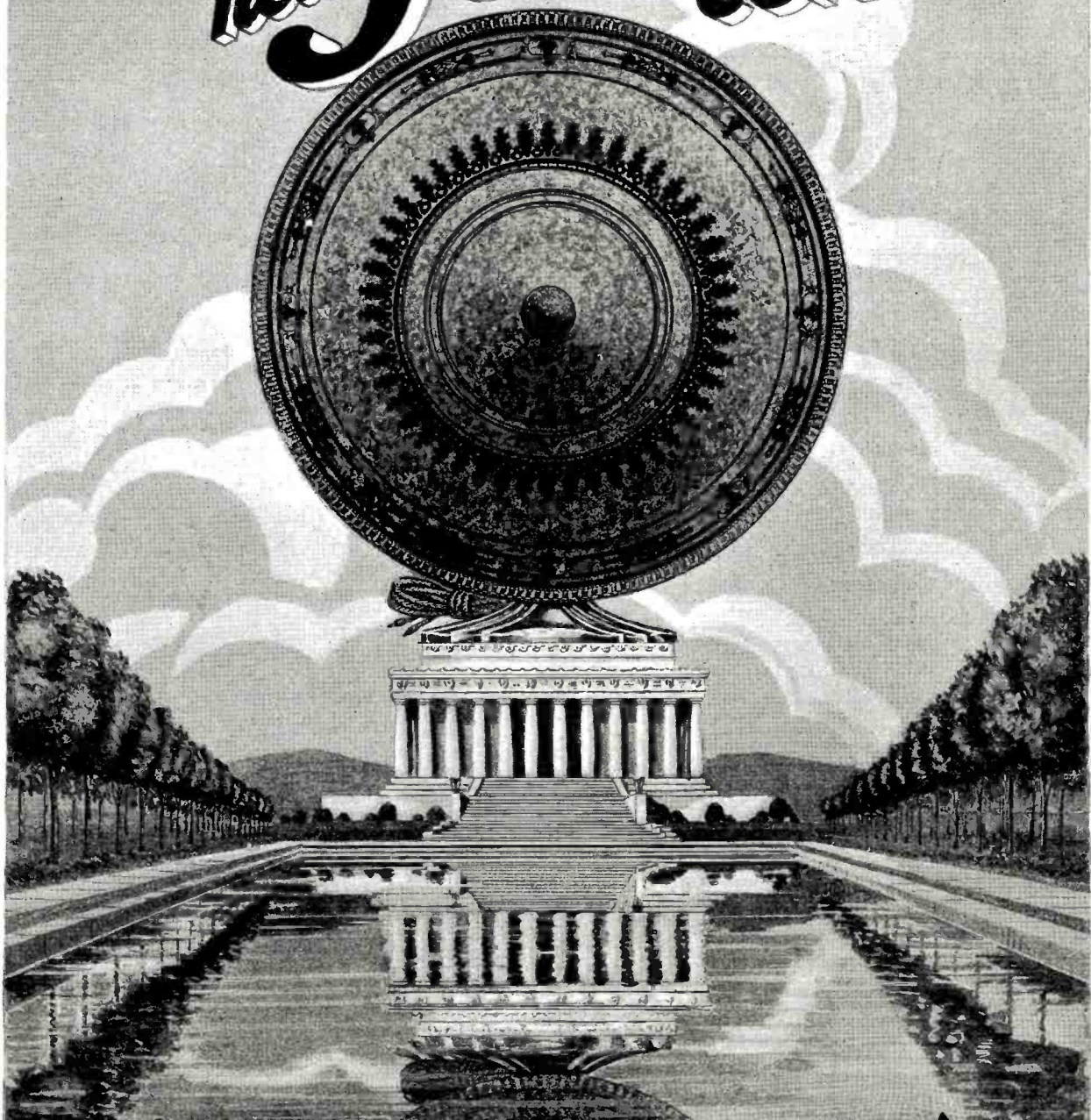

## America's Most Beautiful Speaker

Surpassing all previous cone speaker conceptions, this brilliant achievement enables you to experience anew the magic thrill of modern Radio. Its performing capabilities are amazing.

**\$9.50**

Revolutionary in principle, this acoustically perfect cone employs a direct-drive unit with eight connections (instead of one) from unit to cone—*exclusive Tower features.*

On sale by all good dealers.

**TOWER MFG. CORP. - BOSTON, MASS.**



# RADIO NEWS

Published by EXPERIMENTER PUBLISHING COMPANY, INC.  
 Publishers of "Radio News," "Science and Invention,"  
 "Radio Internacional," "Radio Review" and "Amazing Stories,"  
 Editorial and General Offices: 53 Park Pl., New York City  
 H. GERNSBACK, President. S. GERNSBACK, Treasurer  
 R. W. DEMOTT, Secretary.  
 MEMBER: AUDIT BUREAU OF CIRCULATIONS  
 RADIO MAGAZINE PUBLISHERS ASSOCIATION

VOLUME 7

## CONTENTS JUNE, 1926

NUMBER 12

### In Our Next Issue

#### The Latest Step Toward Radio Television

By Lucien Fournier

An account of the most recent experiments of Prof. Edouard Belin, pioneer in television work, who has found that the eye will retain an image of 1/250,000th of a second's duration. This principle will make seeing by radio soon practicable.

\* \* \*

#### Newly-Discovered Cosmic Rays

By Dr. Charles B. Bazzoni

Another of this series of simple explanations of the latest scientific researches, which will tell us about the recent remarkable experiments of Prof. R. A. Millikan, discoverer of the electron, on electro-magnetic rays of almost unimaginable shortness.

\* \* \*

#### Audio-Frequency-Amplifier Transformers

By Sylvan Harris

Continuing this series, devoted to practical study of the apparatus most affecting the quality of music and speech reproduced by radio receivers.

### In This Issue

Summer Radio Reception By Hugo Gernsback	1623	Static Forecasts Forest Fires By S. R. Winters	1644
Radio Reception by Ground Alone By S. R. Winters	1624	New Developments in Radio Apparatus By G. C. B. Rowe	1646
Pity the Poor Announcer By Muriel Brewster	1626	What's Wrong With My Super-Het? By Edmund T. Flewelling	1649
The Noise Hounds—They Chase That Buzz! By Helen F. Price	1627	A New Method of Amplifier Coupling By H. P. Donle	1650
The Course of Waves Through Space By William Fenwick	1628	The Jewell Audio Amplifier By Fred A. Jewell	1651
Radio News of the Month Illustrated By George Wall	1629	A Music Lover's Set By the Staff of RADIO NEWS Laboratories	1652
Crystal Detector Receiving Sets By A. P. Peck	1630	Everyman's Receiver, the Fenway. By Leo Fenway	1656
"Degenerative Sets" By Cecil de Lenoir	1632	A Knockout Portable	1658
"S. O. S.—Searchin' Out Sadie" By Marius Logan	1633	A Bell-Wire Receiver By John Wallace Gillies	1660
Recent Radio Exhibits	1634	Audio-Frequency-Amplifier Transformers By Sylvan Harris	1662
Radio Under The Sea	1635	Radio Set Directory	1664
Radiophone Links Train and Home By John N. Rentzos	1636	How Transformer Constants are Measured By Sylvan Harris	1665
Electric Train Operation by Radiophone	1637	Radio Wrinkles	1666
Radio Set Owner's Information	1638	Radiotics	1668
Symbols for the Set Owner	1639	Standard Hook-Ups	1669
The Manufacture of Mica Condensers By Samuel Siegel	1640	With the Amateurs—"Why Stop?" By Henry Lamonte	1671
A Typical Month at WRNY By Charles D. Isaacson	1641	RADIO NEWS LABORATORIES	1672
List of Broadcast Stations in the United States	1642	I Want to Know By Joseph Bernsley	1674
A Remarkable Loud Speaker By Dr. Eugen Nesper	1643	Sharpening the Tuning of Crystal Sets By E. B. Judson	1706

RADIO NEWS is published on the 10th of each preceding month. There are 12 numbers per year. Subscription price is \$2.50 a year in U. S. and possessions, Canada and foreign countries, \$3.00 a year. U. S. Coin as well as U. S. Stamps accepted (no foreign coins or stamps). Single copies, 25 cents each. Checks and money orders should be drawn to order of EXPERIMENTER PUBLISHING CO., INC.

All communications and contributions to this journal should be addressed to Editor, RADIO NEWS, 53 Park Place, New York, N. Y. Unaccepted contributions cannot be returned unless full postage has been included. All accepted contributions are paid for on publication. A special rate is paid for novel experiments; good photographs accompanying them are highly desirable.

RADIO NEWS, Monthly. Entered as second class matter, July 12, 1924, at the Post Office at New York, N. Y., under the Act of March 3, 1879. Additional entry at Long Island City, N. Y., and San Francisco, Calif. Title registered U. S. Patent Office. Copyright, 1926, by The Experimenter Publishing Co., Inc., 53 Park Place, New York. The contents of this magazine are copyrighted and must not be reproduced without giving full credit to the publication. Copyrighted in Germany. Reproduction of articles in Germany is reserved for Radio, Berlin 42. RADIO NEWS is for sale at all newsstands in the United States and Canada.

New York City  
 General Advertising Dept.  
 53 Park Place

Western Advertising Representatives  
 Finucan & McClure  
 720 Cass St., Chicago, Ill.

New England Advertising Representative  
 T. F. Magrane, Park Square Building, Boston, Mass.

and at Brentano's, Ave de L'Opera, Paris, France. European agents: S. J. Wise Et Cie, 40 Place Verte, Antwerp, Belgium.

HOW TO SUBSCRIBE FOR RADIO NEWS. Send your name, address and remittance to Experimenter Publishing Co., 53 Park Place, New York. Mention name of the magazine you are ordering. We also publish SCIENCE AND INVENTION, RADIO INTERNACIONAL, RADIO REVIEW and AMAZING STORIES. Write clearly.

RATES AND TERMS. The subscription rate for RADIO NEWS is \$2.50 per year. (12 numbers). When remitting do so by check, money order, or registered letter if cash is enclosed. Avoid sending cash through the mail if possible. Subscription for less than one year are not accepted. Subscription may be made in combination with SCIENCE AND INVENTION, RADIO INTERNACIONAL, RADIO REVIEW and AMAZING STORIES.

POSTAGE. We prepay postage in all parts of the United States, Mexico and island possessions. For foreign or Canadian subscriptions we require 50 cents in addition to the subscription price for additional postage charges.

CHANGE OF ADDRESS. Notify us as far in advance as possible. It requires several weeks to make an address change on our records. Always write clearly. ON EXPIRATION of your subscription we enclose a renewal blank in our last number to you; we stop our delivery to you on expiration.

Pacific Coast Advertising Representatives  
 A. J. Norris Hill Co.  
 Hearst Bldg., San Francisco, Calif.  
 Detwiler Bldg., Los Angeles, Calif.

Kansas City Advertising Representatives  
 Davies and Dillon  
 15 W. Tenth St., Kansas City, Mo.

Detroit Advertising Representative  
 Roy Buell, Donovan Bldg., Detroit, Mich.



**Excerpts  
from Telegrams:**

"Tested your RFL-60 within two blocks of local 500-watt broadcasting station, using twenty-five foot wire on floor for aerial. We picked up stations all over the country and when local station came in tuned it out and picked up WSAI at 319 meters. The local station is 270 meters. This is the only set ever tested under these conditions that would tune this station out at any point on dials."—Decatur, Ill.

"We tested one of your new RFL-60 sets here in our building using an antenna about 75 feet long and directly under and parallel with our transmitting aerial. The exceptional selectivity of the Crosley receiver permitted us to tune out our station WTAX, just as easily as we would tune out a Chicago station."—Streator, Illinois.

"An RFL-60 tested in competition with other receivers of much higher price proved its unquestioned superiority. The new Crosley models offer the greatest values on the radio market."—Kansas City, Mo.

"The Model 4-29 is classed with the Trirdyn. Model 5-38 bringing in Pacific points with ample volume, using a Musicone. RFL-60 and 75 are very selective. Have separated distant stations on less than one degree on the dial. Have logged Mexico City and Pacific Coast Stations with plenty of volume."—Miami Fla.

"The RFL sets outstripped much higher priced outfits. These sets bring in Canadian, Cuban and Mexican stations as easily as those on nearby states."—Glasgow, Ky.

What's the idea of keeping a fellow up all night foolin' around with that darned little 4-29?

I've been in the radio game for seven years and was beginning to believe that there wasn't a set in the world that would keep me up late but when that little 4-29 started to pull in Houston, Texas and with such extreme volume I sat up and took notice.

I got California stations with unbelievable volume last night. KFI came in so loud that it could be heard over a block on a Musicone speaker. I've gotten over one hundred and twenty-five stations in only three nights.—Spring Valley, Ill.

**The Crosley 5-tube—5-38**  
All the volume, selectivity and purity of tone available in the best 5-tube set—plus the Crescendon **\$38**



**The Crosley 5-tube—RFL-60**  
A set of marvelous performance and beautified by the artistic decorative panel . . . . . **\$60**



**The Crosley 5-tube—RFL-75**  
Simplicity and speed in tuning, fidelity of tone and decorative beauty, enhanced by the art panel . . . . . **\$75**



**The Crosley 4-tube—4-29**  
in which the Crescendon is equal to one or more additional tubes of tuned radio frequency amplification . . . **\$29**

Prices slightly higher west of the Rockies

# By Expressed Opinion of Fans The Greatest Radio Values Ever Offered!

Real performance! Amazing sensitivity and selectivity! Marvelous tonal qualities—inspiring volume. And surpassing beauty!

Read, in the column at the left, the enthusiastic comments of a few of the many radio fans who have voluntarily written or wired us their praise.

True radio values—at astonishingly low prices. Hear a Crosley Concert at your nearby Crosley dealer's.

For descriptive catalog write Dept. 22

THE CROSLEY RADIO CORPORATION, CINCINNATI, OHIO  
Powel Crosley, Jr., President

Owning and Operating WLW, first remote control super-power broadcasting station in America

# CROSLEY

BETTER · COSTS LESS

# RADIO

for the Entertainment Corner

Manufactured under Armstrong U. S. Patent No. 1,113,149, or under patent applications of Radio Frequency Laboratories, Inc.







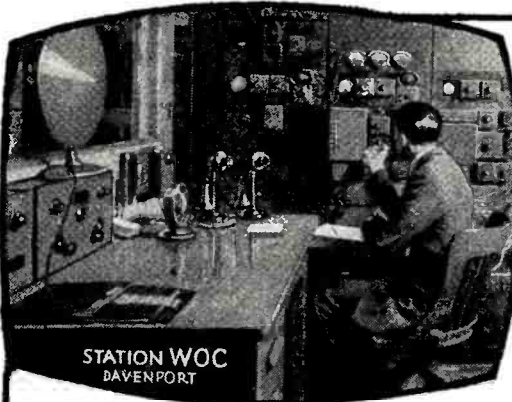

STATION WOC  
DAVENPORT

HERE'S WORK THAT IS  
ALMOST ROMANCE!



These  
Instruments  
Given FREE of  
Extra Cost

All instruments shown here and others sent to all my students free of extra cost under short time special offer. Clip coupon now—find out all about this big unequalled offer while you still have time to take advantage of it. This training is intensely practical—these instruments help you do the practical work.

**My Radio Training is the "Famous Course That Pays for Itself"**

Make more money quick when you take up this practical course.



I show you how to increase your earnings almost from the start of your course through practical pointers I give you.

**Howard B. Luce** of Friedens, Pa., made \$320 in 7 weeks during his spare time. D. H. Suitt of Newport, Ark., writes "While taking the course I earned in spare time work approximately \$900." Earl Wright of Omaha reports making \$400 in a short time while taking his course—working at radio in his spare time only! Sylvester Senso, 207 Elm St., Kaukana, Wis., made \$500. These records not unusual—these men are a few of hundreds.

And when you graduate, my big Free Employment Department helps you get the job. You get just the same preparation and assistance toward success we gave C. C. Gielow, Chief Operator of the Great Lakes Radio Telegraph Co., E. W. Novy, Chief Operator of Station WRNY, Erle Chambers, Radio Engineer for Stewart-Warner, J. E. Fetzer, Chief Engineer of Station WEMC. The National Radio Institute, established 1914, today offers you the same opportunity these men had under a bond that guarantees you full satisfaction or money refunded. It's your big chance to get into the great Radio field—mail coupon TODAY for my big Free Book and proof!

**\$70 in one Day for T. M. Wilcox**

"I am in business for myself and recently made \$70 in one day. I was an electrician of rich experience and was occupying a splendid position as telephone superintendent when I enrolled with your course believing it would open up greater opportunities—have not been disappointed. Estimate that Radio will be worth tens of thousands of dollars to me in the next few years." T. M. Wilcox, Belle Island, Newfoundland.



**Kimball With WMAQ Chicago**

"Accepted a position with the Chicago Daily News Station WMAQ. My income practically doubled, thanks to your fine course. I handle all consultation also do operating." Keith Kimball, Station WMAQ, Chicago, Ill.



**Promoted to Big Job**

"Just been made Sales Manager of this Radio firm—received a very good increase in pay. Up to present have been getting salary which in 3 months enabled me to purchase a new car." R. Jones Bay City Mich.

**Now Owns a Radio Store**

"The Radio business is rushing just now. Building many Super Heterodynes, also doing installation and repairing. To your course I owe all my success in the Radio profession." A. J. Ommott, Bowman, N. Dak.



**Controls First Car by Radio**

"I operate the portable broadcasting station in rear car, driving front car by Radio control. Will operate this car from New York to Frisco—13 months trip. Then we take the car around the world—a three years' tour. I owe it all to you." Leo Paul, New York City.



# You Can Do What These Men Did!

## I Will Train You at Home to Fill a Big Pay Radio Job

Get into the great new Big-pay Industry—Radio. If you're earning a penny less than \$50 a week, clip coupon now. Send for AMAZING FREE BOOK, "Rich Rewards in Radio." Why go along at \$25 or \$35 or \$45 a week, when you could earn \$50 to \$250 in the same six days, as a Radio Expert? Hundreds of N. R. I. trained men are doing it—why can't you? I'll train you just as I trained them—just as I trained the men whose letters you see on this page. I'll teach you quickly at home in your spare time to be a Radio Expert, and draw down big money for the easiest and most fascinating work in the world.

### \$50 to \$250 a Week as a RADIO EXPERT

It's the trained man, the Radio Expert, who gets the big jobs of this profession—paying \$75, \$100, \$200 a week and up. Free book gives all the facts. Every day N.R.I. trained men are taking good places in the Radio field—men like you—men like those whose stories I show you here. You can prepare just as they did by new practical methods, learn right at home in your spare time. Lack of experience no drawback—common schooling all you need. Our tested clear methods make it easy for you. We guarantee to train you successfully. Big Free Book contains all the proof.

**Clip Coupon Now for FREE BOOK**

Most amazing book on Radio ever written—full of facts and pictures—tells all about the great Radio field, how we prepare you and help you start. You can do what others have done—GET THIS BOOK. Send coupon today—no obligation.

**J. E. Smith, Pres. NATIONAL RADIO INSTITUTE Dept. FW-1 Washington, D. C.**

**RADIO NEEDS TRAINED MEN!**

**Originators of Radio Home Study Training**



**MAIL THIS NOW!**

**J. E. Smith, President NATIONAL RADIO INSTITUTE Dept. FW-1 Washington, D. C.**

Dear Mr. Smith: Without obligating me in anyway, send me your free book "Rich Rewards in Radio" and all information about your practical, home-study Radio course.

Name..... Age.....

Street Address.....

Town..... State.....

Read the true stories printed in this border of men who got out of the rut



**Chief Operator at Station WGR**

"Am sending a photograph of station WGR where I am now Chief Operator. I am proud to say that your course is the reason for my success." Edward Stanko, Hotel Statler, Buffalo, N. Y.



Photo shows Graduate E. F. Spadoni in his own Radio store at Chicago, Ill. "Your course gets the credit," says Spadoni.



## Contents of ACME B-Eliminator Kit

Wiring Diagrams with  
complete instructions  
Baseboard.

- 1 Acme B-4-Transformer
- 2 Acme B-2-30 Henry Chokes
- 1 Acme Condenser Block
- 1 Bradleyohm
- 1 Raytheon Tube and Socket  
Wire

**PRICE \$39.50**

*Photo at right—Acme B-Eliminator,  
assembled from kit.*

Photo below of factory-made  
Acme B-Eliminator Type  
E-1—110 Volts, 60 cycle.  
Type E-2—110 Volts, DC, \$20.

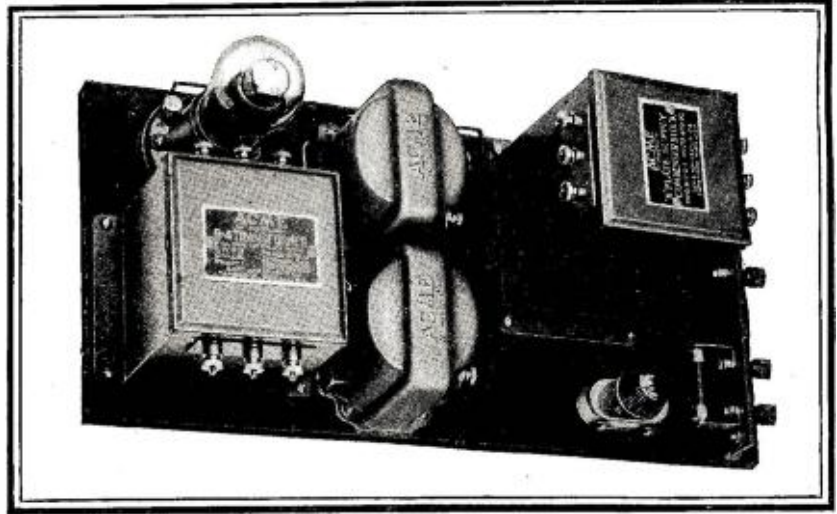

PRICE  
**\$50.00**

# You can easily make this Acme B-Eliminator yourself

*The New Acme B-Eliminator Kit con-  
tains complete instructions and all parts*

**G**ET one of the new Acme B-Eliminator Kits—take it home and lay out the full size diagrams on the table in front of you. It only takes a few minutes to fasten the parts to the baseboard and connect them up. All the parts are there and the baseboard too, and easily-followed instructions that explain each step. It's as easy as rolling off a log. You fellows who have tinkered with radio will do it in less time than it would take to tell about it.

Then you'll have an Acme B-Eliminator and save the difference between the cost of the Kit and a factory-built Acme B-Eliminator.

### *Advantages of the Acme B-Eliminator*

You get better quality and more distance, more volume, and no hum and no distortion. You can be sure of that. Also the Acme B-Eliminator maintains its voltage at all times

and you get voltages up to 180 volts which prevents any chance of over-loading. It will supply sets using up to 10 tubes.

### *A permanent B-Supply*

When you invest in an Acme B-Eliminator you get a permanent B-Supply. No more running out to get new B Batteries. There's nothing to wear out—the Raytheon Tube used has no filament to burn out and will last for thousands of hours—the current cost is practically nothing.

### *Send coupon for both booklet and circular*

Send 10c for our booklet, "Amplification without Distortion," which will tell you some things about improving the quality of your radio reception, together with special free circular on the B-Eliminator Kit, or ask us to mail the free circular. Check the coupon.

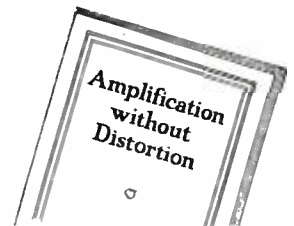

# ACME

*~ for amplification*

ACME APPARATUS COMPANY,  
Dept. K16, Cambridge, Mass.

( ) I enclose 10c for copy of your booklet, "Amplification without Distortion" and circular on the B-Eliminator Kit.

( ) Please send only free circular on B-Eliminator Kit.

Name .....

Street .....

City ..... State .....





H. GERNSBACK, Editor and Publisher  
SYLVAN HARRIS, Managing Editor

EDITORIAL AND GENERAL OFFICES, 53 PARK PLACE, NEW YORK

Vol. 7

JUNE, 1926

No. 12

## Summer Radio Reception

By HUGO GERNSBACK, F. R. S.

AS summer after summer rolls around, the broadcast listeners, as well as the professionals, are becoming more and more accustomed to the idea that summer reception, after all, is in no wise different from reception in the winter.

In the statements which I shall make in the following discussion, it must be understood that when I refer to "summer reception" I really mean reception in the north temperate zone. Below the Tropic of Cancer, receiving conditions are, of course, vastly different from those in northern countries. Thus, for instance, reception in the tropics is notoriously poor, due to the frequent heavy thunderstorms that abound, many days in succession, during the so-called "rainy season". But in the temperate zone this is not at all the case.

I have pointed out many times before that reception in the summer-time is really better in many cases than during the winter. Did you, for instance, try for DX (long-distance stations) this past winter? DX reception was so notoriously poor that even stations 100 miles away could hardly be received consistently. Even with an excellent set it was almost impossible, for days and weeks at a time, to log the usual DX stations that were easy to reach, right along, during the summer of 1925.

As a matter of fact, I make bold to assert that the radio fraternity at large logged 50 per cent. more DX stations last summer than they did during the winter just past. For instance, the International Tests in February were notoriously unsuccessful, and that at a time when radio reception is supposedly at its best. The reason for this lies, not in static, as the term is commonly understood, but, rather, in disturbances that have their origin in the sun.

The sun, as we well know, goes through certain sun-spot cycles; and such a cycle reached the maximum of solar activity last winter. I, for one, am of the firm opinion that the sun was directly responsible for cutting down DX reception. The explanation is probably that increased solar activity caused an increased ionization of the earth's atmosphere, as well as of the earth (soil) itself; and the two, coupled together, probably have much to do with the greatly-reduced reception.

The objection might be advanced that the sun is not shining at night, when most reception is had; but to this argument I will say that the ionization, which is nothing but an electrical charge, is not dissipated at once, but persists for quite some time. It is the same with thunderstorms, which make themselves felt for hours, and sometimes days, before they register their effect on a radio set.

As to the so-called "static" during the summer, I make bold to assert that there is less static during the summer than during the winter, as a whole. This may seem to be a very extravagant statement, but a little reflection will show that it is not. Every one, located either in the city or in the country, will have noticed that in the winter time, particularly when snow is falling, long sparks can be drawn from the antenna, showing that the aerial is collecting a tremendous charge. This is an almost unheard-of thing during the summer, except when a thunderstorm is actually under way, with the thunder clouds in sight.

Time and again, last winter, right in New York City, I have drawn sparks from a quarter to a half an inch long from my antenna, which is only sixty feet long, but I do not remember such an occurrence during all last summer, with the single exception of one time when a thunder cloud was overhead.

All radio listeners will hear me out in my statement that static was more violent during the past winter than it has ever been before;

certainly very much more than during most of our summers. In our temperate latitudes, during summer, heavy static charges occur, practically, only when there is a thunderstorm in the offing, or right upon us. Otherwise, reception is usually good; moreover, it is often extraordinarily good, immediately after a heavy rain or thunderstorm.

On the other hand, how many thunderstorms are there during the summer? Certainly not more than the number of snowfalls or rainstorms during the winter. Possibly a good many less, if we except some storm belts in certain parts of the world.

When it comes to static, however, there are two classes, natural static and man-made static, with the latter very much in the lead. Every time some one in your neighborhood rings a bell, starts an electric vibrator, or a heating pad, or an electric fan, or rings a telephone, operates a vacuum cleaner, or an X-ray machine; every time that an automobile, electric train, or trolley car passes, small electric charges are let loose, all of which produce a static level usually far in excess of that produced by nature. And this static is *always* with us, winter as well as summer.

Naturally, this man-made static is very much more severe in congested centers, such as our big cities, than in suburbs or sparsely-settled districts.

Next in our discussion we have the good old-fashioned fable of the danger of lightning. Why so many people should be afraid of lightning hitting their aerials is a great and unsolved mystery.

The lightning danger during the summer is, in the vernacular, pure and undiluted "Bunk", with a capital B. Last year I announced a prize contest in RADIO NEWS, in which this magazine offered prizes of \$300 for authentic proof of lightning doing material damage to dwellings. Although the contest was advertised not only in the United States, but throughout the world, having

been given a tremendous amount of publicity through the daily newspapers and the press in general, there were only sixty entries received. A mighty poor showing.

Now, if all these entries had actually been able to show material damage, each one of them would have been entitled to \$300. But this was not the case. There was only one case, the prize winner, where the building had actually been kindled into flames and the roof destroyed; but even in this case it should be noted that lightning did not strike the antenna directly, but struck a flagpole first.

All the other cases submitted were ones in which lightning, or, rather, a secondary charge, did some damage to the radio outfits; but in no case wrecking the sets beyond repair.

The chances of your aerial being hit by lightning are about one in eighty-four thousand—practically nil.

Long before this prize contest started, I usually operated my set with an outdoor antenna—plus a good lightning arrester,—during a thunderstorm; and while I admit that reception during the height of the storm has been almost impossible at times, in no case was I ever forced to discontinue operation entirely. Of course I don't wear headphones, but with the loud speaker going I do not feel that I am taking much risk. While I do not recommend this procedure to the everyday broadcast listener, who will usually find it best to turn off his set, still I have merely tried to show here that radio reception during the summer need not worry us at all.

As for danger from lightning, everyone knows that broadcast stations with their big aerials and steel masts—a wonderful target for lightning—never think of shutting down, just because there is a thunderstorm raging overhead.

*... in which the Editor makes the assertion that Summer reception is better than Winter reception,—why sun spots affect radio reception,—why man-made static is worse than natural static,—why lightning danger is the "grand Bunk",—and why he operates his radio throughout a thunderstorm. . . .*

Mr. Hugo Gernsback speaks every Monday night at 9 P. M. from Station WRNY on various radio and scientific subjects.



# Radio Reception by Ground Alone

By S. R. WINTERS



*This article, which tells of the experiments of Dr. J. Harris Rogers with buried ground connections instead of antennae, should prove of great interest to experimenters. The apparatus is extremely simple to make, and we recommend it to amateurs and B.C.L.s who want static-free reception.*



My dear Mr. Gernsback:

I am forwarding to you herewith a description of the very recent results of Dr. J. Harris Rogers in picking up signals without the use of loop, coil, or other form of antenna. In other words, he merely used a rod with copper disks submerged in a small pit of water.

His experiments were inspired and prompted by your editorial in the April issue of RADIO NEWS. Furthermore, he has personally requested of me that I convey to you his sincere appreciation for your sustained interest in his underground tests, as repeatedly reflected in your editorial column.

Sincerely yours,  
S. R. WINTERS.

**M**ORE as a prediction of doubtful realization than as a challenge for immediate action, Hugo Gernsback, in an editorial in the April issue of RADIO NEWS, inquired:

"Who knows, therefore, but that the coming radio receiver will be operated by the ground method entirely, without relying upon loops or aeriels? This would certainly be an improvement, because the aerial and loop pick up not only nature's static, but man-made static, which escapes from electrical insulators, power houses, all sorts of electrical appliances, etc."

Accepting this as a challenge to activity rather than dismissing it as an editor's visionary dream, Dr. J. Harris Rogers, renowned exponent of the theory of underground propagation of radio waves, made so bold as to test the validity of the idea. He commissioned Brent Daniel, formerly identified with the Radio Laboratory of the Bureau of Standards, to construct for him a special type of super-heterodyne radio receiving set, operative at high frequencies or low wave-lengths—on the order of 35 to 100 meters. Then, the fire poker was taken from its accustomed corner beside the old-fashioned fireplace and planted three feet into the ground, then attached to the super-heterodyne radio receiver.

A competent radio operator—G. W. Cook, a member of that fraternity of 20,000 amateurs—put on the head phones and initiated the tests, a radical departure from previous undertakings at the Rogers Radio Research Laboratory. Without a vestige of antenna or aerial other than the metal contained in the fire poker, radiotelegraph signals from a few scattering amateur stations, located a thousand miles distant, were intercepted. This result was more of an incentive to renewed and extensive efforts than a satisfying achievement. Consequently, Doctor Rogers, whose previous experiments with underground radio transmission and reception had thoroughly acquainted him with the soil, decided that the red clay surrounding the laboratory was not conducive to the best results in underground wireless tests. The soil was devoid of that moisture so essential in the proper functioning of ground antennae—or, in this instance, the fire poker.

## SEEKING A BETTER GROUND

About three-fourths of a mile from the home of Doctor Rogers is a miniature valley,

a marshy spot where water gushes from the soil when tapped two feet below the surface of the earth. Thither, under the ideal radio ground environment of perennial moisture, the equipment, incident to the continuation of experiments looking to the abandonment of loops and aeriels in the strictest sense of the definition, was transported for installation. A copper rod three feet long was prepared, with 25 copper disks or plates ten inches in diameter and spaced about one inch apart, as illustrated. The super-heterodyne radio receiver, previously referred to, was connected to this rod. Other than this, no antenna, counterpoise or capacity of any kind was employed; and only one lead wire extended from the submerged copper disks to the radio receiving set.

This small valley, abounding in wet soil, at once demonstrated its fitness for such tests—a vast improvement over the moisture-robbled red clay around the laboratory. There was a marked increase in the strength of incoming signals and the amateur stations heard, if represented on a map, would show an outline of the United States, including the far-away Hawaiian Islands. The log book kept of these experiments—from March 18 to April 3—would do credit to the efforts of a DX hunter for months. Virtually, all of the amateur stations in California were heard and signals were picked up from widely separated sections of the country, including the following States: Texas, Kansas, Missouri, Oklahoma, Illinois, Minnesota, Nebraska, Colorado, Indiana, Arizona, Oregon, Montana, Washington, Ohio, New York, Georgia, Alabama, Florida, North Carolina, Pennsylvania, New Jersey, Michi-

gan, Wisconsin, Arkansas, Iowa, West Virginia, and Maryland. In addition, signals were picked up from stations located in San Juan, Porto Rico, the Hawaiian Islands and Philippine Islands. All told, about 250 stations were heard during the brief period devoted to these tests—short intervals each day or night, from one to two hours.

## INVESTIGATING STATIC PROBLEMS

Of greater significance than the mere listing of the "calls heard," are the notations in this log book giving assurance of the virtual freedom from static when radio waves are picked up from under the crust of the earth.



Above is shown Dr. Rogers, holding the household poker, by which satisfactory reception was obtained from amateur short-wave stations up to a thousand miles.

On the left is Dr. Rogers and the receiving outfit, with which he obtained excellent results, as described. The copper rod and the discs which were used as a ground are shown next the super-heterodyne receiver.





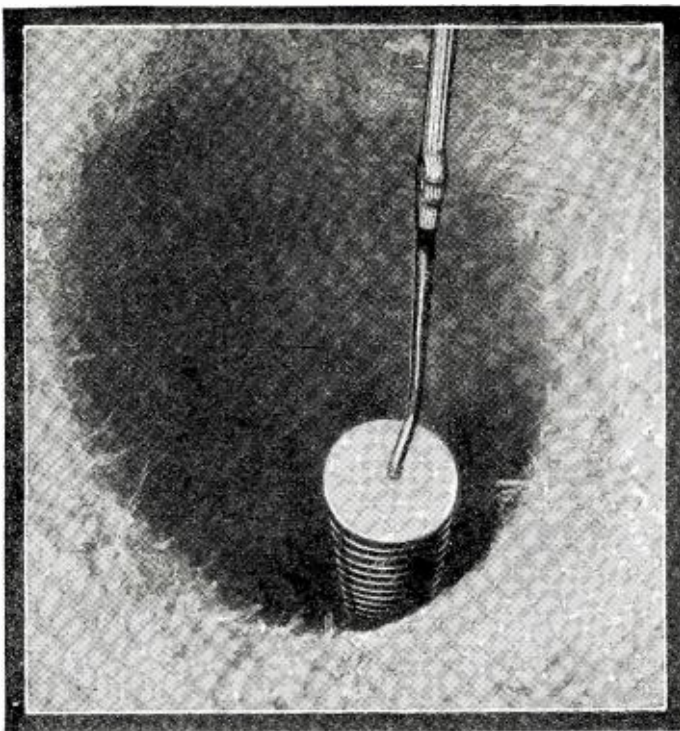

There are twenty-five copper discs on this copper rod. These are lowered into a hole in the earth, which is filled with water, as it seeps into the hole as the latter is dug in the marshy land.

Glancing over this log book, which Doctor Rogers had instructed the radio operator to keep with great fidelity in observing and noting true conditions, we find such phrases as the following: "No static, some fading in signals, set very sharp, that is, sharply tuned;" "signals good and strong, no static;" "signals fading considerably, seem to get interference constantly, believe from power leak;" "signals excellent, distant stations drowned out by nearby stations;" "amplifier seems to have decreased signal fading and body capacity effect;" "static increasing at 2:30 a. m., very few stations working account QRN;" "static heavy, raining out, 2-step amplifier squeals badly, unable to locate the trouble, necessary to open and repair, using straight set;" "signals strong, no static, comparatively few stations working;" "signals fading badly, replaced bad tube, little better;" "signals good and strong but fade considerably—believe due to fluctuating current of batteries;" "static increasing at 8:30 p. m., discovered one bad tube in set and low batteries, cause of set being noisy," "QRN light, QRM heavy, weather warm and raining."

The static which was in a few instance reported could as logically be attributed to other causes producing noises; for instance, faulty vacuum tubes or loose connections in the receiver. In fact, the elimination of static, a reduction in fading, and uniform signal strength day and night, are among the manifold advantages justifying a continuation of the experiments which would ultimately place a utility value on the propagation of radio waves underground. Therefore, it is very significant to note that C. J. Young, of the radio engineering department of the General Electric Company, is negotiating with Dr. Rogers toward conducting co-operative tests to determine the practical advantages of underground transmission and reception of radio waves. He writes the distinguished inventor as follows: "This letter is simply to express our interest in your investigations and to suggest that we will be ready to make accurate reception measurements if you wish to arrange a regular transmission schedule."

**EARTH OR AERIAL PROPAGATION?**

While Dr. Rogers entertains the highest regard for radio scientists, and appreciation for their earnest endeavors, he, nevertheless, made so bold as to say, "The upper elements

have been exploited since the birth of radio, and it is most surprising that more attention has not been paid to Mother Earth. If the distinguished scientists could only divest themselves of early training and devote some time to this globe as a conducting medium, most of the difficulties of radio would be solved. Static would be reduced, fading eliminated, uniform signal strength would be effected day and night, and the ever-changing and shifting conditions of the upper elements would not be encountered.

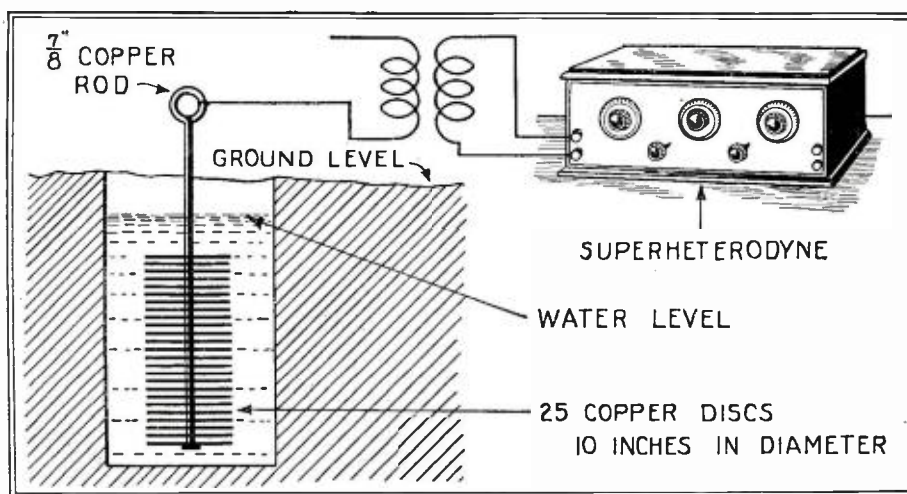

The arrangement used by Dr. Rogers is shown in this sketch. A super-heterodyne is connected inductively to the rod and discs which are lowered into the water hole until they are submerged.

"Tests made of late with horizontal antennae, notably those conducted by \*Dr. Greenleaf Pickard, further confirm the theory of earth propagation of radio waves. The signal intensities were much greater when the antenna was in an horizontal position than when in a perpendicular position. If energized by space waves the perpendicular position should be best, according to my theory—the electric forces being parallel to the earth's surface and the magnetic component perpendicular thereto. Therefore, any horizontal antenna will be cut by the magnetic flux or flow of the waves. Once again practical tests have demonstrated the validity of my theory that electromagnetic waves are propagated through the earth as well as through the air. I have never claimed that radio

waves do not travel through the air, but I do insist that they are readily propagated under ground and under water."

Doctor Rogers has held steadfastly to the theory for many years that radio reception at great distances is due to the raising and lowering of the potential of the grounded plate and not to space waves energizing an aerial. Results of tests outlined in this article seem to him further to support the validity of this theory; and additional substantiation is offered by observations that when using an elevated antenna with the present arrangement, the signal intensity is only slightly increased. "Such an increase," contends Dr. Rogers, "is not due to any appreciable energy imparted to the elevated wire, but to additional surges from the earth, there then being a greater difference of potential between the ground and the top of the antenna."

"The many theories advanced in accounting for the propagation of radio waves around the earth's curvature by refraction, earth's magnetism, and more recently the corkscrew action, have no practical proof. The beautiful idea visualized by Hertz is being discontinued. Accepted theories maintain the existence of an upward wave, a so-called gliding wave sliding around the curvature of the earth, and a corkscrew wave—with antennae of all descriptions being tried above the earth—and investigators seem loath to give any attention to earth propagation of radio waves."

**REFLECTION FROM THE EARTH'S CORE?**

"Of the imaginative mind," stated Dr. Rogers, "wedded to the reflected rays from the Kennelly-Heaviside mirror, may it not be asked: is it not more rational to consider the metallic center of the globe as a medium of reflection? A great deal more could be said upon this interesting subject, but suffice to add that from day to day we read of old theories being discontinued and what was deemed an impossibility only yesterday becomes a reality to-day."

It is recalled that some years ago, Dr. Lee de Forest, in speaking of the underground system of propagation, said in effect, that he had always declined to accept contracts to build radio stations surrounded by mountains, for the reason that space waves would shoot over the antenna. More recently a crew of explorers of the Geological Survey, when hemmed in by a thousand feet of rock wall in the Grand Canyon of the Colorado, picked up signals nightly from a broadcasting station located a thousand miles away.

As to the possibilities of shooting electric energy under the crust of the earth, Doctor Rogers demonstrated the efficiency of underground transmission last year. He has shown this writer cards from practically all sections

(Continued on page 1702)

\*See RADIO NEWS for May, 1926, Page 1540.



# Pity the Poor Announcer

By MURIEL BREWSTER

*The personality of a radio broadcast station is expressed to its great public by the voice of its announcer: and fortunate indeed are those whose ethereal introductions make friends at first hearing. What an admirable Crichton is needed at the "mike", and what are a few of his daily and nightly problems, is here pleasantly told.*



**I**F you are thinking of applying for a job as a radio announcer, think again. For the traditional stony road to Jordan is a state speedway compared to the path of the gentlemen who stand before a microphone and confide to its cold and unappreciative countenance, hour after hour, night after night, the tale of the radio program. Think again!

For, to be a reasonably good announcer, you must possess the patience of Job and the adaptability of a chameleon. You must be like that impossible person in Kipling's "If," and be able to keep your head while all about you, in studio, reception room and office, people are losing theirs and blaming it on you. You must have a nervous system as steady as the Rock of Gibraltar.

Added to these little matters of temperament, you must be not only bi-lingual, but poly-lingual. For, as you set at your desk, some one thrusts a bit of paper under your nose, bearing an inscription something like this: "Légende, by Weiniawski. Zigeunerweisen, by Heuffner. Artist. Signor Bertucci Casaglia, violinist. Concertmeister of the Philharmonic Orchestra at Prague." Four languages besides your own! Is it any wonder that your announcement comes out something like this: "You will now hear a violin number, consisting of Ledge-end, by Winny-Wusky, and Sy-goonaer-wissen, by Hoof-near, which will be played for you by Signor Bertucky Cassa-glea, Concert-mister of the Philharmonic Orchestra at Praygue?" No, none at all. The real wonder is the frequency with which these puzzling announcements come over the air in meticulously perfect pronunciation of half-a-dozen languages. Because it cannot be made compulsory that every announcer shall have an honor degree in moderns; and even if he did, be it whispered, he might still say "Winny-wusky!"

### IN HOURS OF JAZZ

A sense of humor is indispensable, but you must not have a sense of the ludicrous. For, after your "classical hour," come the Zoo-

zoo Orchestra, or the Wheng Boys. And you have got to go right on sitting at your microphone and keeping your voice steady, clear, and apparently interested through batches of information like this: "The next number will be given by the Zippy-Zop Zoo-Zoo Boys, and will begin with 'I'm Sitting on the Tail of the Moon,' and Dearie, Kiss Me, I Love You.' This will be followed by 'You're My Sweetie.' Then two request numbers, 'I'm your Great Big Chimpanzee,' and 'Wully Woo.'"

In order to keep your voice straight, you must keep your face straight. It is therefore highly essential that you possess a sense of humor, but altogether fatal if you have a sense of the ludicrous; for in that case you will end up, some night, by flinging the microphone suddenly into the middle of the saxophones and banjos, and somebody will call for the police-wagon.

Yes, this new profession of "announcing" is a strange business. The men who get the jobs are necessarily recruited from all ranks of life and many varieties of training. A census would be most interesting; but as radio announcers are busy people, letters asking "What did you do before?" would, in all probability, remain scornfully unanswered. The loud speaker gives forth a wide range of tones and accents; all the way, seemingly, from the instructional voice of the erstwhile professor to the cheery accents of the former insurance agent. There are some announcers who sound as if they might have been almost anything, but it's awfully hard to tell. Anyway, now they are announcers. They have found their place in the world. They will go down to their last resting-place murmuring "At least we have lived!" For to date, no radio announcer has been heard to say that he doesn't like his work.

### PECULIARITIES OF THE RADIO EAR

Elocution before the microphone is in itself an art, newly born, and promising to be highly interesting in its developments. The

radio receiving outfit has become a universal household pet so much more rapidly than anything else in history that the art has necessarily lagged behind the installations; for art is long, and the public is impatient. It is highly probable that the next move will be a course of radio speaking, at some university (it has been started—EDITOR) but in the meantime interesting discoveries can be made by means of sitting before a receiving set, through many evenings, with a notebook, and then experimenting through the microphone, while other people sit with note-books and record the results of the tests.

The overtones of the speaking voice are less dependable than those of musical sounds, as the average speaking voice is not rhythmic in its vibrations. And the air has a little trick of multiplying these and turning them into a horrible racket. Consequently, the art of the pause has been cultivated by those few radio speakers who have made any study of this point; but in many cases they have neglected to watch out for the human equation, and their pauses are too long and too frequent.

Every public speaker knows that the pause is the thing; but if you over-estimate its weight, the audience becomes bored and loses attention. When you are safely ensconced on a platform, with the audience under your eye and hand, you know instantly, by means of that sympathetic connection established between you and your listeners, that something is wrong, and you can instantly change your tactics or your tempo. But if you are sitting, all alone, in a sound-proof room, with a silly little round thing standing on the table gaping at you, and all your waves going out and none coming in—how are you going to know? You can't, that's all.

The biggest joke on the radio speaker is that he dare not emphasize anything. Put one extra bit of tone-volume into your voice and it degenerates into a roar like a crash of static. If you want to emphasize a word,

*(Continued on page 1686)*



How many and diverse are the elements that must be united to make up a successful radio announcer. A few of them are indicated in our artist's fantasy of the creation of the perfect one.



# The Noise Hounds—They Chase That Buzz!

By HELEN F. PRICE

Here is an interesting little story that may be the means of helping out some fans who are wondering where "that buzz" originates.

FOR three months a group of about twenty "noise hounds," including the electric service company, the radio corporation, the steel mill representatives, the telephone company and the private radio owners, had hunted a noise that put our radio reception out of commission, every night at about nine o'clock. After about a dozen or more false leads, when each time we were sure we had located the trouble, we finally discovered it to our complete satisfaction—only to have our theories exploded before our very eyes, or rather ears, though we still "knew" that we were right.

For three days more we tried to solve the mystery, for by this time it really amounted to one; and ultimately succeeded in clearing it up. The explanation was so simple, and the disturbance one which can be so universal, that the incident is worth while passing along as a possible "hint" to others.

This noise was like nothing we had heard before. In the houses within a radius of two blocks it sounded as loud as a steel riveter, and of course was heard to a lesser degree in the whole neighborhood. In our home it was so loud that we could not hear over the telephone in the same room until we had shut off the radio; and of course we could get no station over it, not even the local ones.

## SHOTGUN PRESCRIPTIONS FOR TROUBLE

The first thought was that it might be a violet-ray machine or an electric vibrator; but upon investigation we found that no one in the vicinity was using such a machine. Then we traced down electric refrigerators, radio chargers and all the known disturbers; but these were all false leads, and the noise continued to come on, as regularly as clockwork, at about ten minutes after nine and to last for the rest of the night.

This fact implied two possibilities—that it was being done maliciously, or that it was an appliance used at a certain hour every night. Working on this idea, one

HERE is a story that actually occurred recently, and we recommend it warmly, not only for this reason, but also because it makes most excellent reading.

If at any time our readers run across such occurrences, the editor would be glad to hear from them, for the benefit of the entire radio are.

—EDITOR.

of the "noise hounds" informed us excitedly one day: "I'm sure I've discovered the trouble! I just learned today that the steel company's mines start their night shift at nine o'clock. Their mines run directly under the hill where we live and they do all the cutting at night." Of course that was it! We all agreed with him. We rushed to the phone, called up the superintendent of the mines and let him hear the noise over the telephone. Then his answer came back, "Sorry, but we couldn't possibly be responsible for that. This is Sunday evening and our mines are closed down every Sunday night."

Gone was our perfect explanation!

Next we discovered that on rainy nights there was no noise. That implied some outside trouble and confused us more than ever. For five weeks we conjectured and experimented in vain. The radio men watched suspicious houses for spark sets; they persuaded the steel company to test their high-power lines, and the telephone company and electric light folks to test their lines, too. They even cut down branches of trees that might be causing trouble. During this time there were occasional reports of a similar noise from other parts of our city.

## SYSTEMATIC DETECTIVE WORK

At the end of two and a half months we became desperate and the electric light company and the radio wholesalers went on a regular campaign. One evening they

cut off the lights from this whole hill-top section, and the noise stopped. That proved that it was someone who was using electric current. Next they cut off the lights, street by street, till they narrowed it down to our block; then they started, house by house. The first night they tested five houses unsuccessfully. That left a possibility of eight houses. We were hopeful, for we knew that the next night would solve our riddle.

The next afternoon however a group of radio fans were talking as usual about our "curse" when one woman looked up and said:

"Mr. Williams has rheumatism." The remark was simple enough but all caught the significance. "You've got it!" someone shouted and rushed to the phone; and all gathered around excitedly, while she fired rapid questions at the bewildered Mrs. Williams.

"Does your husband use an electric pad for his rheumatism?"

"Why, yes," she answered.

"What time does he usually turn it on?"

"At about half past eight."

I remembered that two nights before we had had no noise. I prompted the phoner: "Did you use the pad last Thursday evening, the night it rained?" she asked.

"No, it was too warm that night."

"When did you get your pad?"

"About two weeks before Christmas." We all looked triumphantly at each other—that was just two and a half months ago!

"But who is this talking?" Mrs. Williams in her turn questioned.

We explained. Dear little Mrs. Williams was so distressed: "Why, we've been reading all about the noise in the paper, but we never dreamed we had anything to do with it!"

"Neither did we," we assured her. "And now will you please turn on the pad, so we can prove our theory?"

She did; and in about twenty minutes, on came the noise as beautifully loud as ever. Beautifully, is right—we were so delighted to hear it this time!

## THE MYSTERY THICKENS!

Well, it didn't take us long to donate a brand-new electric pad to Mrs. Williams, concluding that of course the old one was defective; and that evening the whole neighborhood settled down to enjoy their radios for the first time in nearly three months. So you can imagine our consternation, our disgust and our exasperation when at exactly nine-fifteen on came the noise as usual!

Once more phones hummed. "What does this mean?" we demanded of the radio experts.

But the answer they thought, was simply—"The trouble is not in the pad, it's in the wiring."

The next afternoon three carloads of men arrived to "fix things up." Mrs. Williams turned on the pad and they waited expectantly. That's all they did do—just wait! They sat there for two and a half hours with not one sound out of that electric pad!

Stumped? We were all dumbfounded. We knew that the noise came from that pad—and yet—?

Well the only thing to do was to prove that we were right, in spite of this proof that we were wrong. That night one of the electric company's linemen crawled to the top of the pole in our alley and sat

(Continued on page 1680)

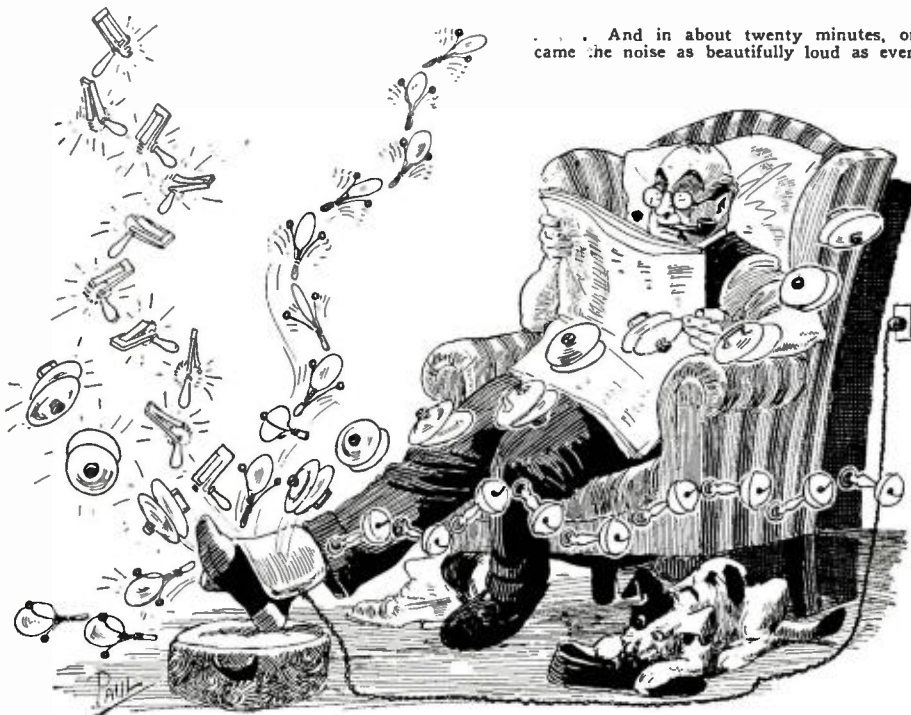

And in about twenty minutes, on came the noise as beautifully loud as ever.



# The Course of Waves Through Space

By WILLIAM FENWICK

*Every radio fan glibly talks about radio waves and their behavior. Relatively little of this subject is understood by Mr. Average Fan, however, and this article will clear up many points of doubt in his mind.*

**R**ECENT months have brought about in the radio world the evolution of what appears to be a brand-new series of conceptions as to what really occurs in the ethereal regions between radio transmitters and receivers, when they are in communication. The theories of the functioning of the apparatus are extremely plausible and agree with the observed facts; but the hypotheses concerning the path of the emanated waves are still vague.

The recent development in the theories of wave propagation has resulted from the effort to explain phenomena which had received scant attention, or were unknown, in what may be called the pioneer day. This was because the earlier investigations were

ception of wave propagation became necessary.

### RESULTS OF SHORT-WAVE WORK

As experimentation proceeded down the scale of wave-lengths, existing theories were either modified or discarded to be replaced by others, in order to explain the startling phenomena discovered daily by the amateurs. The extraordinary antics which the waves seemed to go through were enough to make seasoned old scientists wonder; as the peculiar effects noted were mostly in contradiction to the previously-received theories of wave-propagation.

It is true, the theories which have been most lately propounded tend to clear our vocabulary of ambiguous phrases to a considerable extent, though to the beginner it seems to be but another opportunity for the trained minds to add a few more perplexing terms to his vocabulary of dimly-comprehended technical expressions.

However, when an explanation devoid of baffling phrases, so far as possible, is set before the neophyte, he will readily come to the same conclusion that his fellow-experimenters of more experience, as well as the experts, have reached: that the utilization of the waves shorter than 50 meters (frequencies higher than 6 megacycles—6,000,000 wave impulses per second) will usher in an epoch as important, perhaps, as did the introduction of the electron vacuum tube (valve).

### THE ACROBATICS OF A WAVE

For the purpose of showing the path through space followed by radio waves, according to the theories accepted at the present time, the writer will make use of the illustration which accompanies this article, and which should render the explanation quite clear to the lay mind.

It might be argued by some that the direct representation of the curve of a wave would

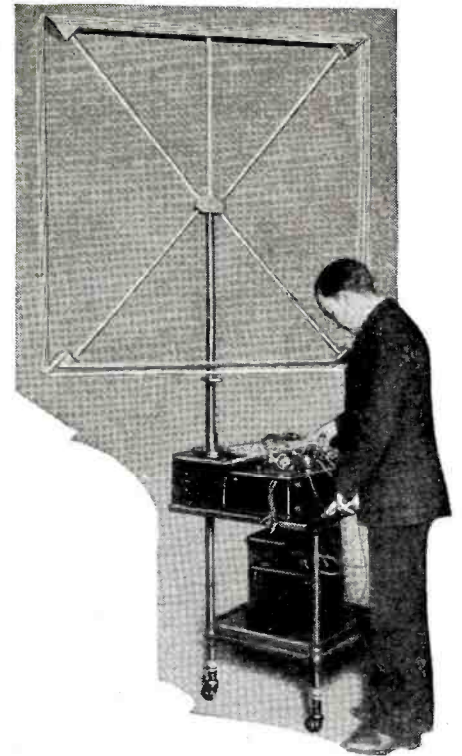

Dr. Dellinger of the Bureau of Standards with the apparatus by means of which a study is being made of the behavior of radio waves. © P. and A. Photos.

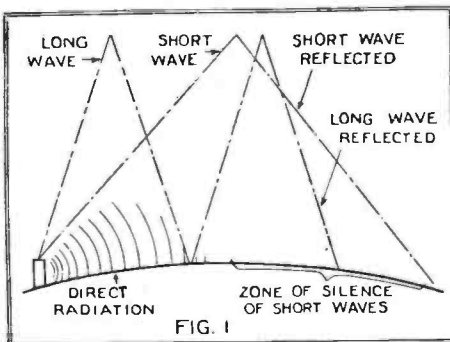

The lines illustrate the reason for "silent zones" about some broadcast stations. It is sometimes due to this reflection, especially in the case of short waves.

conducted on long waves, seldom as short as 200 meters. When a few investigators thought a source of new thrills might lurk lower on the wave-length scale, and tried their luck below 50 meters, with truly revolutionary results, a great change in the con-

be readily understood, as well as the human figure indicated below. But to follow the diagram of a wave-motion through any medium is difficult for a beginner, and will inevitably confuse him as to its direction; especially when it is represented as going through a state of rotation and refraction simultaneously. The reader will more easily comprehend the entire discussion when a familiar object is used in lieu of the wave—and what figure can be more familiar to him than his own?

First, the reader may imagine that he has been transformed into an electromagnetic wave (a more scientific name for a radio wave) with a frequency of say 500 kilocycles, which corresponds to the 600-meter wave-length. Now suppose yourself to be emitted from a transmitting antenna at an

(Continued on page 1678)

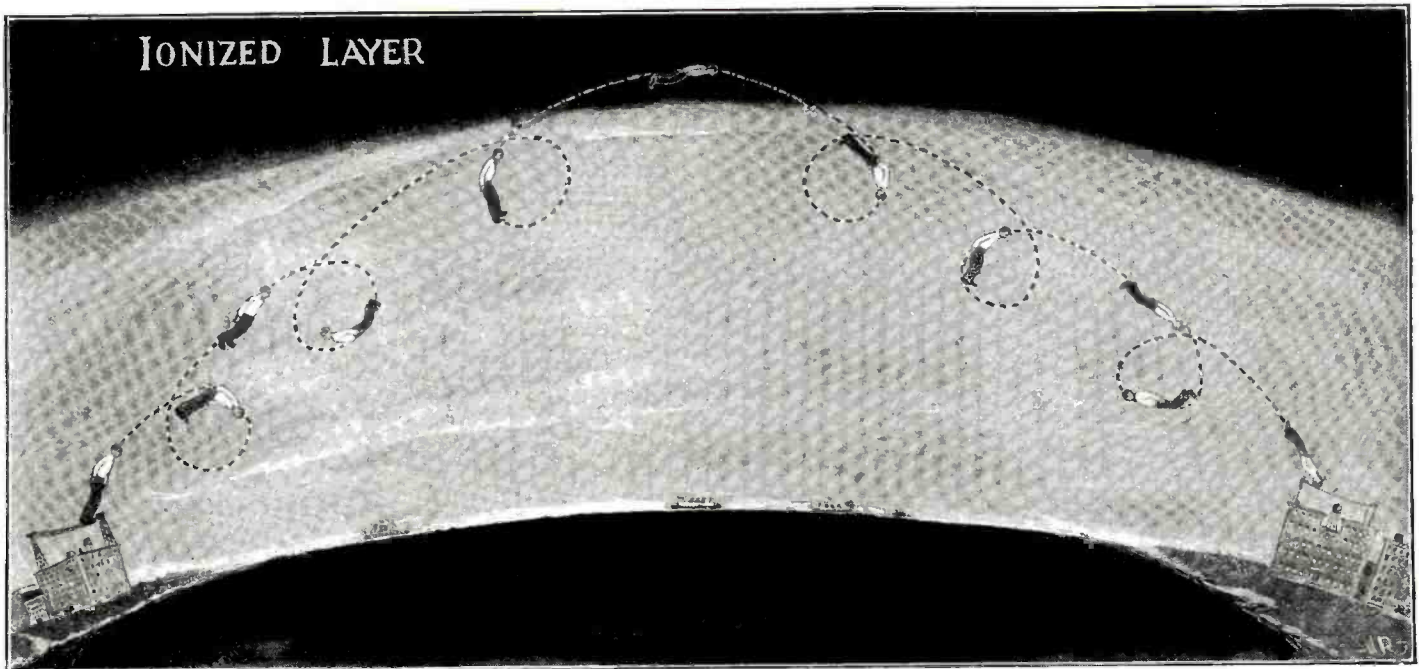

How would you like to be a radio wave? Our artist has suggested a few only of the ethereal somersaults such as you would turn in your progress from one antenna to another via the "Heavyside layer."



# Radio News of the Month Illustrated

By GEORGE WALL

Novelties and Oddities from Far and Near that have Appeared in Press Dispatches



Commander Byrd, who is at the head of the U. S. Navy's polar expedition, expects to use Marconi's original type of antenna for long-distance radio transmission. It consists of a kite, to which is attached the wire that is used as an antenna.



A new form of community singing has been instituted by station WGN, Chicago, with great success. A performer at the studio sings familiar songs and in thousands of homes he is joined by folks gathered around the loud speaker.

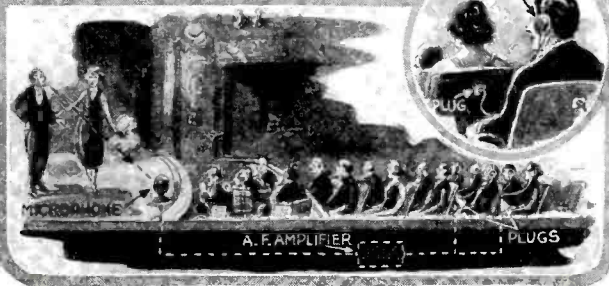

The Guild Theatre, in New York City, has installed microphones on the stage, which lead to amplifiers and thence to a row of seats where outlet boxes are located. Headsets are supplied, and partially deaf people are enabled to hear with ease all that is said on the stage.

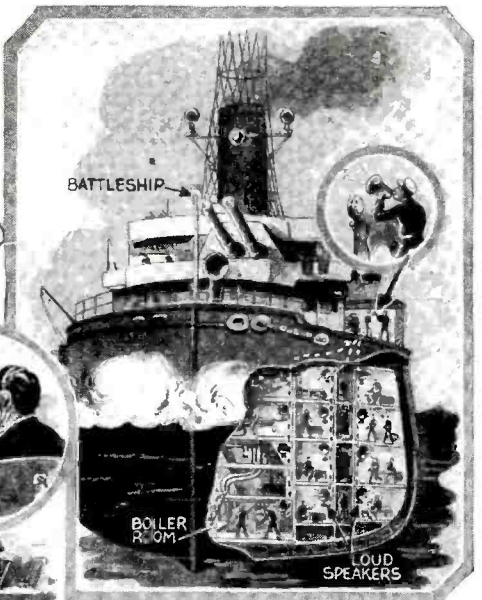

In order to give orders simultaneously over the whole of the new naval airplane carriers, 265 loud speakers have been installed on each. Orders are given by bugle as usual and much waste of time is prevented by this method.

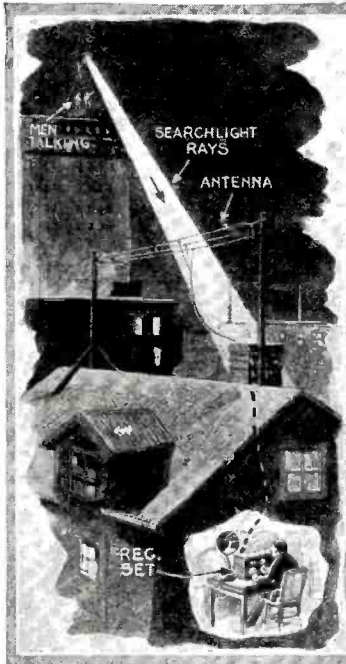

During experiments with a powerful searchlight in Birmingham, Ala., a man with a receiving set heard men talking when the light shone on his antenna. The men heard were on the roof operating the light.

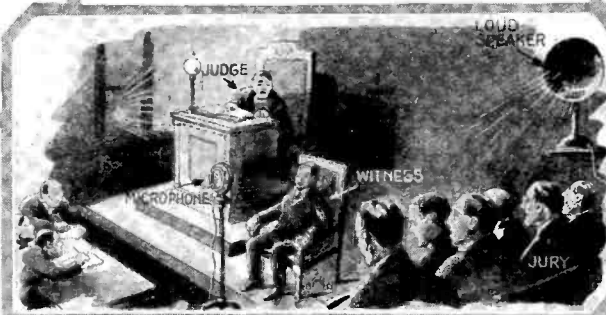

Because of the noise made by passing trolley cars and elevated trains great inconvenience was experienced by the lawyers, jurors, and attendants of a court in Brooklyn, N. Y. The judge ordered installed a microphone before the witness chair, with a loud speaker behind the jury box, thus relieving the strain on all.

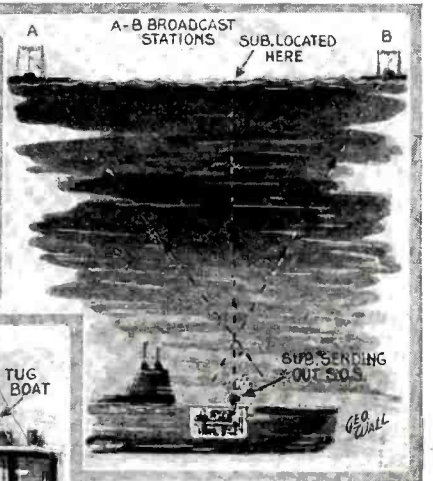

A method of locating submerged submarines is shown above. Two stations receive the sound signals transmitted by the submarine and by triangulation can easily calculate the exact position of the craft.



The Mayor of East Chicago, Ind., after delivering a speech to a boosters' club by means of radio, discovered that the microphone was disconnected from the transmitter. He caused the man who made the arrangements for the dinner to be arrested.

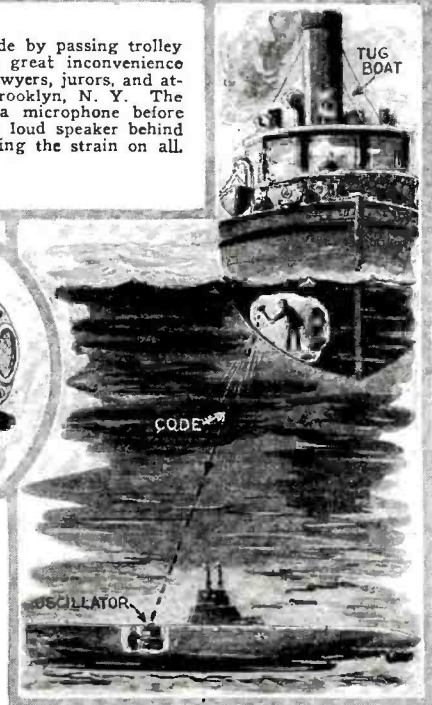

During the trial of a new big submarine, a means of communication between it and a tug which stood by was desired. By pounding out code with a hammer on the hull of the tug the radio operator in the submarine was able to receive orders, which he replied to by sounding his oscillator, as shown at the left.





# Crystal Detector Receiving Sets

By A. P. PECK\*

**A**LTHOUGH there have been many articles written regarding crystal sets and many different types of receivers of this nature have been described, still there are often some small details lacking which, while seemingly unimportant to the better-informed reader, are of the utmost moment to those who are seeking information about crystal sets. They are the ones who are exceedingly interested in radio in a small way, but for financial or other reasons do not care to invest a great amount of money in the purchase or construction of a complicated set. Therefore in this article we will deal with crystal detectors in general; and, in detail, with the construction of a very simple yet highly efficient receiver, designed for use with a crystal detector.

While the receiving range of a set of the type to be described is conservatively placed at twenty-five miles, still in this day of comparatively high-powered broadcast stations, reception over distances of two or even three hundred miles is often noted. In fact the writer, using a set very similar to the one to be described, has consistently received signals from WSB, Atlanta, Ga., and from KYW, Chicago, Ill., when the receiver was located in New Jersey.

### THE ANTENNA

One of the most important things to be considered in the use of a crystal set, for any kind of reception, is the antenna to be employed. This particular part of the average set is too often neglected. In the first place, the antenna for use with a crystal receiver should be comparatively long. This, of course, will tend to reduce the selectivity, or the ability of the tuning control of the receiver to separate stations operating on closely-related wave-lengths; but, on the other hand, a long antenna will give louder results and, when the local stations are quiet, it will enable the operator to receive greater "DX" (distance) under good weather conditions. As a general rule, we advise that the antenna for use with a crystal receiver should be at least 100 feet long. This does not include the lead-in, or wire which connects the antenna proper with the receiver, which will add to the effective length of the aerial and probably make it about 135 to 150 feet over all. Of course, all the joints on

the antenna and lead-in should be soldered, as repeatedly urged in the pages of this magazine.

The ground connection should also be given attention. If the ground wire is fastened to a water pipe, it should be clamped firmly in position so that it cannot be moved. A good contact here is imperative, because a poor contact will reduce the amount of current in the set and, therefore, the volume of output from the phones. Inasmuch as the input volume is comparatively small to start with, we do not want to lose any more of it than is absolutely necessary.

### THE DETECTOR

In Fig. 1 is shown a manufactured type of crystal detector which is completely enclosed. This feature is an advantage, because exposure to the air of a crystal, of

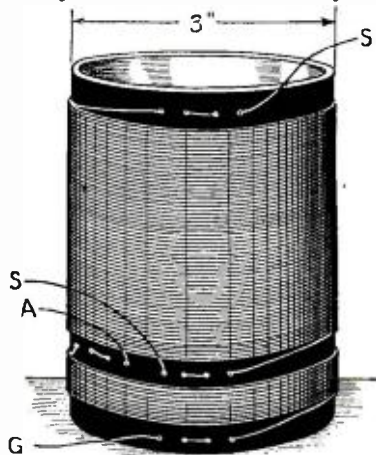

FIG. 5

The relative positions of the two windings of the tuning coil are shown above, and the method of fastening the ends is depicted.

the kind used for radio reception purposes, causes that crystal to deteriorate quite rapidly. Enclosing it prevents dust and moisture from accumulating on the surface and rendering it comparatively insensitive. In the particular type of detector shown, a series of contacts are used on the surface by rotating the wheel shown at the right. In this way, it is claimed, greater sensitivity is

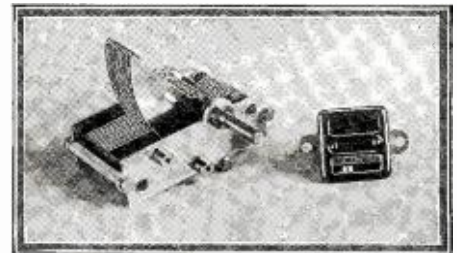

Fig. 8. A standard type of straight-line-frequency variable condenser. Right: A fixed condenser, such as is indicated at C1 in Fig. 9.

Courtesy of Amisco Products, Inc., and Micasold Radio Corp.

obtained and the detector is far more stable in operation. It cannot easily be knocked out of adjustment by vibration and, therefore, it will give reception over long periods of time without the necessity of readjustment.

Another enclosed type is shown in Fig. 2. This detector, unlike the first, is not adjustable but is merely connected into the circuit in the conventional manner and will be found to give excellent operation. However, the average user of a crystal receiving set likes to try continually for a better point in order to obtain louder signals, and also to test crystals until the very best one is obtained. For this latter-mentioned individual, some sort of open-crystal detector stand, which allows changing of the crystal and continual adjustment, should be employed.

Figs. 3 and 4 show what might be termed extremes in crystal detector construction. Fig. 4 is an exceptional piece of apparatus which was constructed by one of the readers of RADIO NEWS. As will be seen, it is very critically adjusted, particularly as to the pressure of the contact point on the surface of the crystal, which is controlled by turning the knob at the right. Furthermore, the entire detector stand is so constructed that the contact point can be moved to any position on the surface of the crystal and, therefore, the detector can be constantly readjusted until the very best of results are obtained.

The paramount idea in making an adjustable crystal detector is to have flexibility. This is obtained in the detector shown in Fig. 4. It is quite important that the contact point, or "cat whisker," can be placed on the surface of the crystal with just the right amount of pressure. Varying this pressure on the same point on the crystal may cause a great change in signal strength and in reception range.

### SIMPLICITY IN CONSTRUCTION

The simplest possible type of crystal detector is shown in Fig. 3. All that is needed for making this detector is a block of wood or other insulating material for the base, a wood-screw, a safety pin, a metal cup and a piece of crystal, which are assembled as shown in the drawing. The metal cup can very easily be obtained by breaking up an old dry cell, removing the carbon rod from the center and taking the brass cap from the end

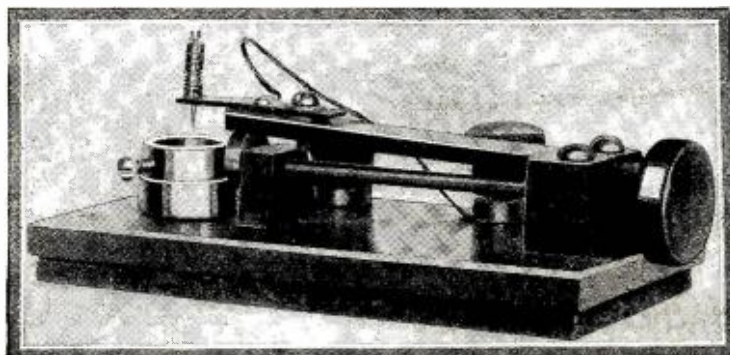
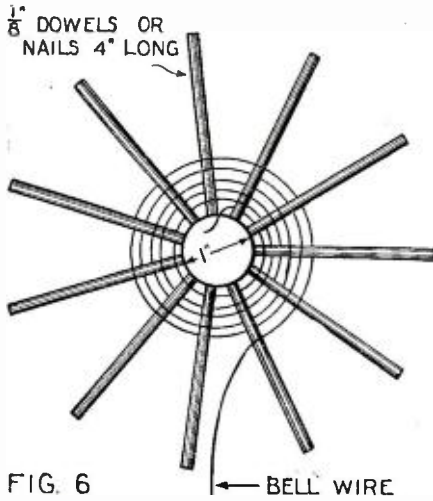

Fig. 4: A home-made type of crystal detector which is extremely flexible. A great deal of skill and ingenuity has been exercised in the design and construction of this interesting piece of apparatus.

\*Radio Editor, Science and Invention.



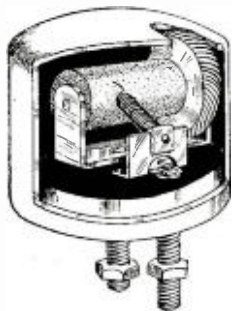

**FIG. 6**  
Note the method of winding the wire over two and under two spokes, alternately, to make "spiderweb" coils.

of that rod. This, when inverted, will be found to make quite a suitable crystal cup; and is already provided with a mounting screw by which it can be fastened to the insulating base. The safety pin is then cut off as shown, leaving only the loop and the pointed end. The loop is screwed to the base, a connecting wire being placed under the screw-head to make a connection with the metallic pin. The pin is then bent into a curved shape, as shown, so that the pointed end makes a contact with the crystal placed in the metal cup.

In any crystal detector, the crystal itself can be fastened into the containing cup in many ways. The cup can be equipped with a set screw as in the type of crystal detector shown in Fig. 4; or the crystal may be fastened in the cup with some metal having a low melting point; or placed in the cup and tinfoil then packed tightly around it, giving a fairly good contact.

A low-melting alloy can be made by dissolving as much tinfoil as possible in a small quantity of mercury. Knead the mass together and keep adding tinfoil until no more is taken up by the mixture. Heat this mixture until it melts, set the crystal in the cup with it, and allow it to cool. It will solidify, and will be found quite satisfactory as a mounting for crystals. Never heat it to a very great temperature when using it for this purpose, inasmuch as the heat so applied is very liable to spoil the sensitivity of the crystal.



**Fig. 1:** A sectional view of an enclosed type of crystal detector, which presents many advantages and that is easily mounted and operated. Turning the knurled wheel adjusts this detector which is of English make.

**THE TUNING COIL**

The next part to consider is the tuning coil, or "inductance" as it is technically termed. Two general types are suitable for winding by the embryo radio fan, and their construction is shown in Figs. 5, 6 and 7. One is of the so-called spider-web type, and the other is a single-layer coil (or "solenoid") wound on a cylindrical tube. Either will be found quite satisfactory, and the choice lies with yourself. In the case of either type of coil, you will find very excellent results can be obtained by using what is known as No. 18 bell wire. This has heavy insulation, but a coil wound with this wire will be highly efficient.

Let us deal first with the construction of a spider-web coil. It is necessary to have some sort of a form, which can be either purchased or made. If you make this winding form yourself, obtain a disk of wood one inch in diameter, and half an inch thick; around the edge of it, drill 11 holes just large enough to allow the insertion of a 1/8-inch dowel, or nail, in each hole. The wooden dowels, or nails, are then placed in position as shown in Fig. 6 and the winding is started. To accomplish this, the wire is fastened to the center core and then wound back, underneath two of the pins, over the next two, under the next two, and so on until 45 turns of wire have been wound on this form, when the wire is cut off and the end wrapped once around one of the dowels. Collodion, such as can be obtained at any drug store, is then applied in small quantities to the intersections of the wire along each dowel; being careful not to apply so much that it will soak through the winding and glue the wire to the dowel. After this collodion has hardened the pins are removed from the form and the center pushed out. This coil of wire, which should contain 45 turns, is what is known as the secondary coil and has two terminals, which are plainly shown in Fig. 7A and indicated by S and S1.

Still another coil has to be wound, and this can be done on the same form and in

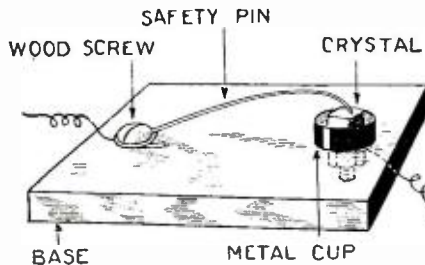

**FIG. 3**  
A crystal detector can be made from a very few simple parts, as the above drawing suggests. The pin point makes an excellent "catwhisker" or crystal contact.

the same manner as the secondary coil. However, only 10 turns are to be placed on this coil, which is known as the primary; and whose two ends are lettered A and G in Fig. 7A. Follow the same procedure for fastening the coil with collodion and remove the form. Place this last-made coil against the larger secondary coil, as shown in Fig. 7B, and cement it in place with a few drops of collodion. This completes the inductances for your receiver; and they can now be fastened to a baseboard or panel by means of an insulating strip and a wood or machine screw, as shown in Fig. 7A and 7B.

Some experimenters using coils of this nature do not like to apply collodion in very great quantities and, therefore, in order to make the coil rigid and self-supporting, they lace it with thin, yet strong cord, which is passed through the coil from the inside, over one of the cross-overs and then down through the coil. The first loop is tied tightly and the lacing carried through, as shown in Fig. 7C. After the cross-overs on one side of the coil have been carefully laced, proceed in the same manner with the other side.

**THE "SOLENOID" TUNER AND CONDENSERS**

In case you do not care to go to this trouble, the tuning coil for your receiver can be wound on a tube of special cardboard or other insulating material, 3 inches in diameter. Here again No. 18 bell wire is employed and the secondary consists of 50 turns, the primary as before, has 10 turns. As shown in Fig. 5, each end of the wire is fastened by drilling four holes in the cardboard or insulating tube and threading the wire through the holes as indicated. This coil also has four terminals; S and S1 de-

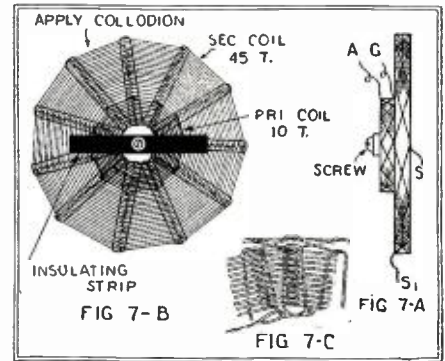

The method of mounting the primary and secondary coils of the "spiderweb" tuner whose construction is explained; 7C shows how they are tied.

note the ends of the secondary coil, while A and G are the ends of the primary coil.

Besides the crystal detector and the inductance coils, there are three other parts that you must have for your receiver. One is what is known as a variable condenser, having a capacity of .0005 microfarads ( $\mu f.$ ). A very good type to employ is that called the straight-line frequency type, and this is illustrated in Fig. 8, and diagramed at C in Fig. 9. Be sure that the box in which it comes specifies the exact maximum capacity, which should be as mentioned, .0005  $\mu f.$  Besides this variable condenser you will also need what is known as a fixed condenser, which is diagramed at C1 in Fig. 9. This is a little instrument, usually about an inch square, also shown in Fig. 8. The connections to this condenser are made to the two metallic ends. It should be of a capacity of .001  $\mu f.$

You will also need a pair of phones. Get a good pair, because they will give you longer service and will be found most satisfactory. If your phones are not sensitive, you will not get good results, regardless of how well the rest of your set is made. A very good pair can be purchased for not more than \$4.00 or \$5.00, and such an investment will be very much worth while. They can always

(Continued on page 1695)

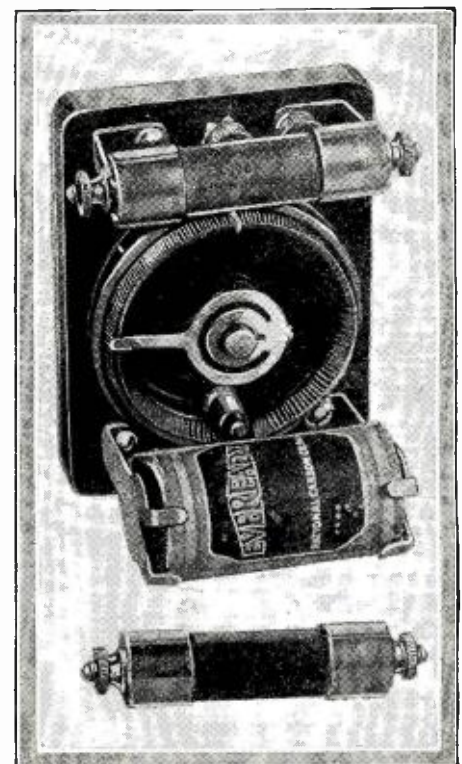

**Fig. 2:** A crystal detector in a sealed case; above, a similar one is mounted in a unit with an electric cell, which gives it extreme sensitivity, regulated by a small potentiometer.

Courtesy of the Carborundum Company.



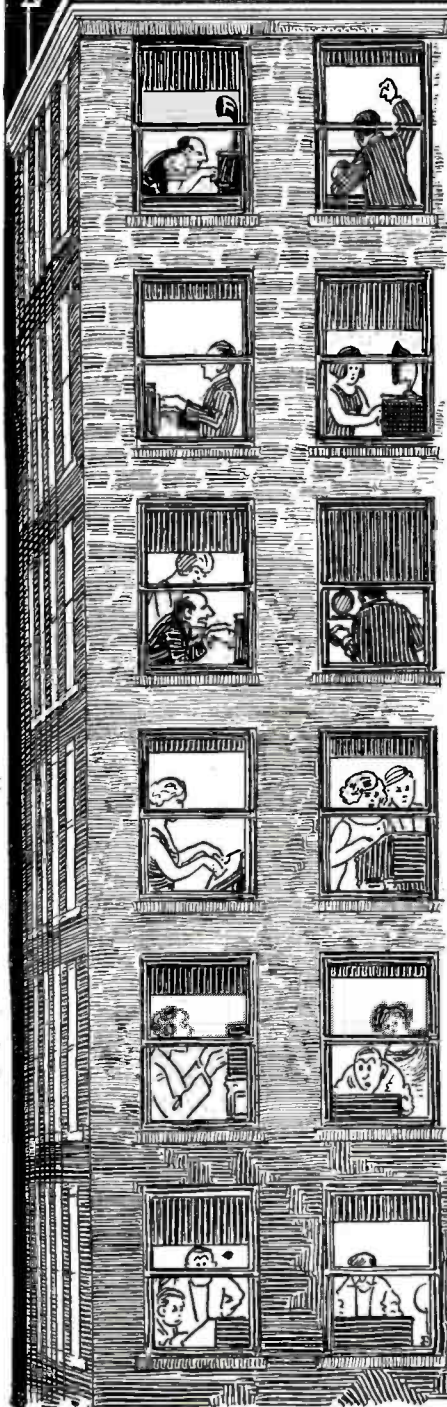
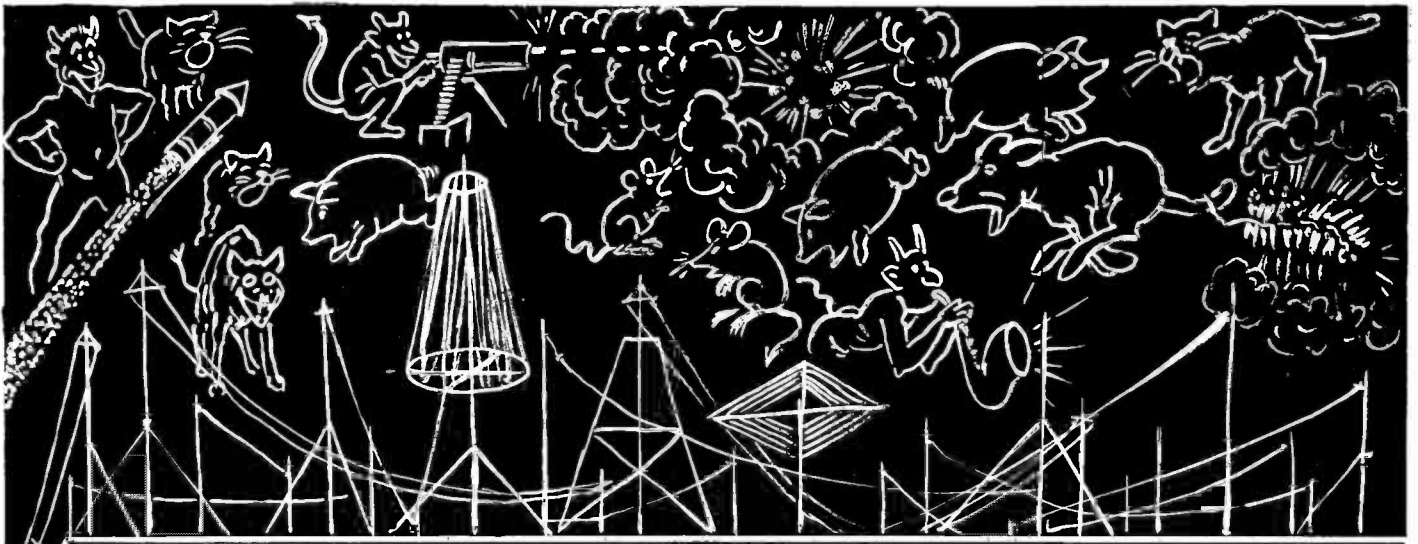

## "Degenerative Sets"

By CECIL de LENOIR

*It is my custom every night to set my seven dials,  
And when my tubes are burning bright, I listen  
wreathed in smiles,  
I harken to the timbals as I sit with twiddled  
thumbs,  
To the clashing of the cymbals and the banging of  
the drums,  
To the scraping of the fiddles and the piping of  
the flutes,  
To the syncopated riddles that my favorite sta-  
tion shoots;  
And as the music percolates, I sip my glass of  
stum,  
I shuffle both my number eights and murmur  
"Rum-ti-tum."  
I soon forget my daily strife, I love the village  
bore,  
I love my lawful wedded wife, my neighbors by  
the score;  
This tune from my antenna drives away the pass-  
ing care,  
And I wit not of Gehenna when there's music in  
the air.  
But I do not wax romantic when my soul is  
fiercely wroth;  
There are nights when I am frantic and my mouth  
is full of froth.  
Then instead of harps and lyres and the tooting  
of bassoons,  
There are many bursting tires and the bang of  
musketoons.  
There's a tintinnabulation . . . and a host of  
squealing rats,  
With a canine altercation and the wails of dying  
cats;  
Then a groan, a ghastly rattle, in a fearsome  
howling pitch,  
And my neighbors win the battle, and I operate  
the switch.*

*It is good to sit and twiddle when there's music  
on the line,  
And to listen to the fiddle with the dials at fifty-  
nine,  
But it isn't good to grumble when your neighbors  
oscillate,  
Nor to hark to squeal and rumble as they try to  
navigate.  
When they tear their dials asunder, when they  
spin them to and fro,  
Then I suffer grief and thunder and my soul is full  
of woe;  
And my ultra-patent speaker has to quarrel with  
my set,  
Just because some earnest seeker tries for miles  
he'll never get.  
I am hoping that these critters, as they jam the  
air with woe,  
Will be sipping cups of bitters when they tune in  
down below.  
May they get their fill of static seven nights in  
every week;  
May their tubes be muriatic, may their speakers  
never speak;  
May they wail their lamentations when their  
rheostats are jammed,  
And I hope a thousand stations in their dials are  
ever crammed.  
I am hoping that these blighters with their inter-  
ference tricks,  
Will be met by impish smiters when they cross the  
River Styx.*

\* \* \* \*

*There are forty Towers of Babel in my repro-  
ducer cone,  
When my sticky-fingered neighbors will not leave  
their dials alone.*

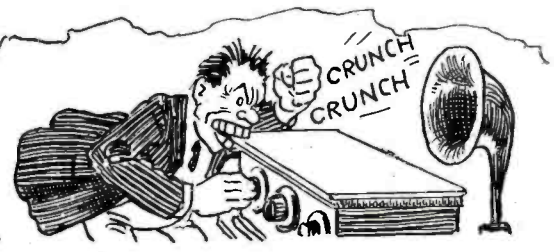



# "S.O.S.!"—Searchin' Out Sadie

By MARIUS LOGAN

"HEY, yuh funny-lookin' bozo, fill 'em up again!"  
"Hooray fer Solly! T'ree cheers fer de Egg! Wasamatta wid Solly? 'Ray!!"

This outburst was my greeting as I passed through the swinging door of Red Mike's "soft drink" emporium, on Ninth Avenue in New York.

"Great Calvin's hobby horse!" I thought, "the place must be packed. And didn't Pat McRosen tell me a story about someone called Solly, the Egg?"

When I opened the door of the back room, the dozen or so men, seated at several tables drawn close together, turned as one man and looked me over carefully.

"Why, hello there, guy, come on in and have one on Solly."

I recognized Pat McRosen, who was so little he was hidden behind the giant form of the young fellow he introduced as Solly, the Egg. I met the rest of the group, who, I learned later, comprised the far-famed Frog Alley gang.

When Pat had told them how we had first met in France during the recent set-to with Wilhelm & Gott. (G.m.b.H.) and that I was all right, the crowd resumed their talk, and I gathered that this was the start of a celebration.

"What's the party all about, Pat?" I asked, when I was seated beside him.

"Gosh, guy, where do you live anyhow? Didn't you hear about the scrap we had with the Gas House gang?"

"Not a word, Pat."

"You're a swell reporter, you are. Wait till this bunch mosey along and I'll spill you an earful. And there's radio in it, too," he finished up.

About midnight the members of the Frog Alley gang decided to move on to conquer new fields. Pat and I refused their invitation to accompany them, saying we would see them later.

"Now, Pat," I said, "Spill that earful you promised."

"Sure, but what do you say to hoisting one while we chin?"

Upon my affirmative answer he yelled to

Mike to "Make it two of the same," and then after lighting a cigarette, he started.

"Well, the whole mess started at a dance the Pretzel and Suds Club gave about three weeks ago. You remember about Mat Frankel, Solly and his girl Sadie, and me running the spiritualist dive, don't you? Well, we was all at the dance and having a great old party. There was good-looking broads there, the beer was there—not near—and the music the best in New York, for they had a super-lic with a gang of loud speakers to give us the jazz.

"Along towards one o'clock or so, the three of us was out in the hall gathering in some suds for our lady friends. We comes back with our hands full, walking real careful like. Solly was walking ahead of me and Mat and he stops, all at once, sudden. I near drops my glasses of suds and I says to him, real peevish, 'Why don't you stick out your mit, if you're going to block the traffic that way?'"

"He don't answer and I looks at him and then I looks where he was staring. And then I saw the reason for the block in traffic. Sadie was getting a lot of unwelcome attention from a bird named Hank the Hook. This guy Hank is one of the Gas House gang and he's as hard as a pavement after you've fallen out the second story window. In some ruckus Hank had lost his right lunch-grabber and in place of it he had a nice hook. He was sure one mean hombre in a scrap, because he could do a mess of damage with that hook of his.

"Well, he was trying to get Sadie to dance with him and she was objecting strenuous. Solly drops his drink on the floor and grabs an empty bottle that was setting on the floor by a chair, on his way to Hank.

"'Hey, you bozo, lay off that lady,' he whispered to Hank, as though they were a mile or so apart.

"'Who says so?' inquires Hank, and then sees Solly heading for him.

"Now, if there's one thing on this earth I like to see, it's a good mill and in about three seconds this one was a beaut. Solly crowned Hank with the bottle when his tongue started to get messy, and then they mixed it up lively. Some of the Gas House gang seen that Hank was getting the worst of it and they heaved a bottle that caught Solly alongside the ear. I saw who did the dirty trick and I soaked him with one to make everything nice and even.

"And, boy, you can bet your last jit that

the fun started then and there! There were more fists flying around than bottles, but there was enough of both. It was just like the old days over there in France.

"Well, as there was more of our gang—and we was better scrappers too—than there was of theirs, pretty soon they had enough. After we threw the last of them out of the hall, they hung around yelling in to us that they'd get us. We told them there was very, very few tracks outside away from the hall, and to go and make some; which they does, when we threatens to come out and chase them.

"Well, things was sort of quiet around the neighborhood for a few days, but what's that old saying about the calm before the storm? Well, you know it as well as I do. Anyhow, one night Mat and I was in here about eight bells, and in blows Solly, looking like he was going to get mad but had changed his mind.

"'Hey, you guys,' he says, and sits down with us at that very table in that corner. 'she's gone!'"

"'Aw, so's your old WD-11' cracks Mat. 'Me, I'm saying nothing and lots of that, because I knows Solly; and when he gets that funny look in his eyes, boy, I just knows when not to speak out of turn. I sits and waits for Solly to get through bawling out Mat, which he does pretty, 'cause he was in the Marines, and then I asks real soothing.

"'When did you hear that Sadie had got lost?'"

"'Boy, I admit I'm there with the brains, 'cause I draws Solly's mind off bawling out Mat, and I knows that there's just one *she* in this world for Solly—leastwise right now.

"'Well,' he says, 'it's like this. You see, she was coming home from work at that flossy dressmaking dive and left Mary Flinn at Twenty-Third Street. Her mother is waiting supper for her yet. I'm sort of worried for it looks as if she just naturally stepped off the map.'

"'Mat and I both said, 'Is zat so?' and then says nothing.

"'You couple of simps, and a fine lot of help you two are. Why don't you say something? She never done nothing like this before, you know that. Come on, get the electrons floating around in those vacuums of yours. Light your filaments. Light your filaments!'"

"We sat over there in that corner for near an hour trying to figure out what and where and when and why, but nothing doing. Then who should come busting in that door but young Chick, Solly's kid brother.

"'Hey, Solly, did you know that Sadie ain't come home from work yet?'"

"Solly lets out a yelp and grabs at the kid to whale him, but Mat and me, we holds him back.

"The kid says, 'Aw, lay off me, Solly, and listen. I was coming over Twenty-Second Street, when I sees two of the Gas Housers coming. I ducks in a dark door to get out of their way. As they goes by me, one of them says something about getting square with you, and then something about Sadie that I couldn't get.'

"Then you should have heard the fireworks that were let loose. Honest, I'll bet the walls bulged. That gang of Gas Housers are hard-boiled babies—there ain't no tenors in that bunch—and they're capable of anything from manslaughter down—and up.

"Solly sends his kid brother to round up as many of our gang as he can find and slip them the old SOS. In about fifteen minutes they starts blowing in and we has a council of war. Some of them wanted to go over

(Continued on page 1683)

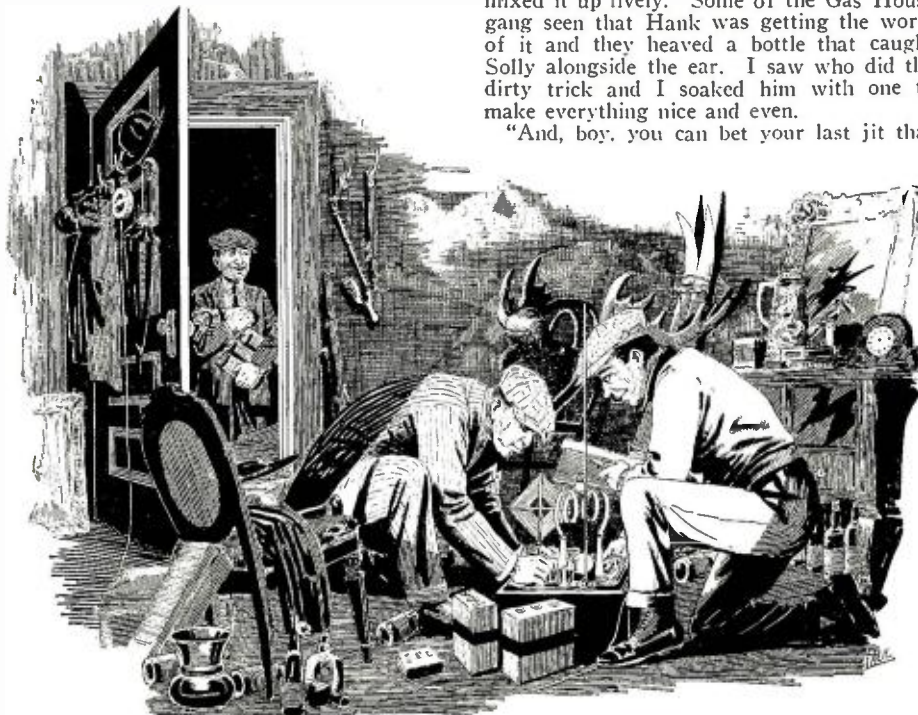

"We moved enough of it real careful like and set up WEAJ Jr., in a back corner."



# Recent Radio Exhibits

## THE LAST WORD IN RADIO RECEIVERS—A UNIQUE TABLE-LAMP SET

The radio receiver—would you guess it?—at the right was made by Irving P. Wolfe, of the Bronx, New York City, who is shown with his handicraft. The shade of the lamp forms the loud speaker of this novel set, which is among the many ingenious devices shown at the Sixth Annual Radio show in New York City.—© P. & A. PHOTOS.

Below is shown Frank Gow Smith, explorer and ethnologist, who is now on his way to the primitive regions of Brazil to study the ways of the South American Indian. The short-wave receiving set, which he is exhibiting to the Scottish Chief (Clan Fergus) beside him, will serve not only to study radio reception and keep in touch with civilization, but also to astonish the natives; whose awe of the supernatural it will undoubtedly serve to excite.—© KADEL & HERBERT.



## MODEL RADIO STATION

At the radio show held recently under the auspices of the American Radio Relay League there were a great many distinctly different exhibits made by New York "hams," who built them with much skill. One complete model "ham" station is shown at the left. © KADEL & HERBERT.

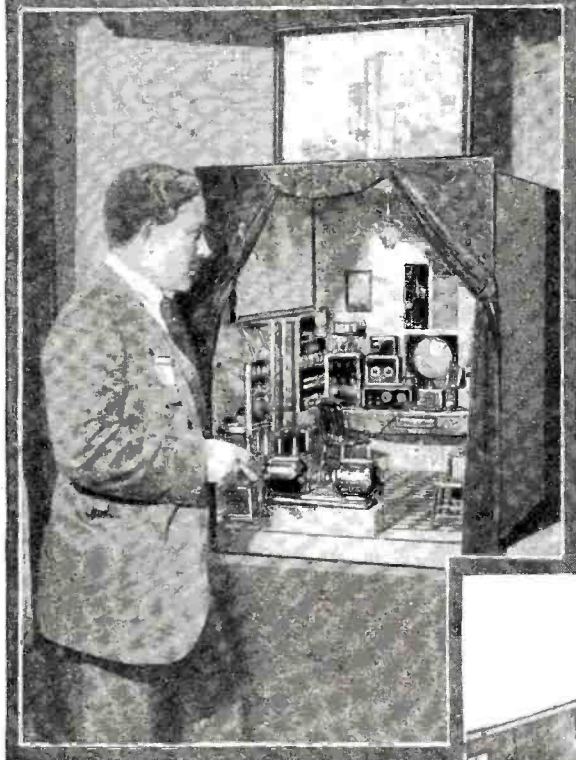

## THE HOUSE THAT RADIO JACK BUILT

Above is Miss Pauline Kopple, holding a radio receiving set which is built in a small house instead of the more conventional type of cabinet. Miniature though it is, this set, which was another of the Radio Show exhibits, is said to function as well as those of larger size. It is evidently simple of control and quite portable.—© P. & A. PHOTOS.



## "UP-TO-DATE RADIO SHACK"

Miss Elizabeth Pearson is examining this ingenious miniature station, the exhibit of the Bronx Radio Club, which was constructed to show the improvement which has been made in amateur transmitting stations.—© FOTO TOPICS.



# Radio Under the Sea

## SUPERSONIC SUBMARINE TRANSMITTER

Left, the transmitter is the flanged device being lowered through an opening in the floor of a naval barge into the Potomac River, where these experiments are being carried on. It is electrically connected to the apparatus shown at the right, the barge carrying laboratory equipment for these tests

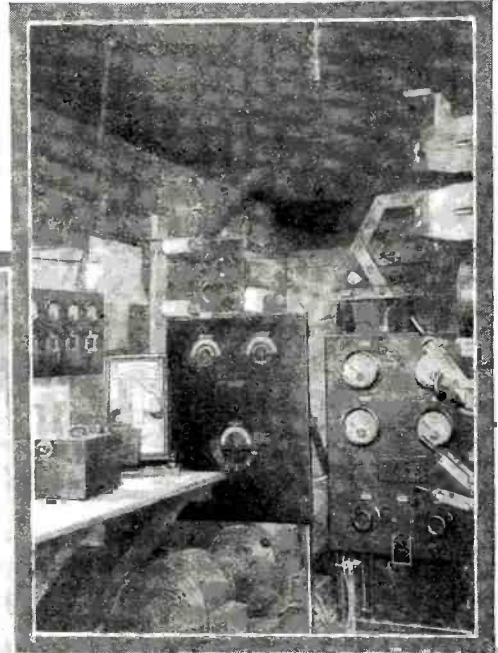
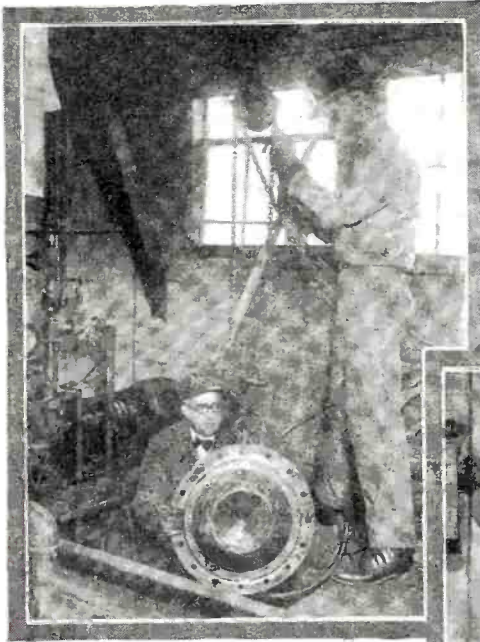

## CONTROL ROOM OF THE TRANSMITTER

Above, the generators and control switch boards for actuating the sound transmitter shown at the upper left.

## TELEPHONING TO A SUBMARINE

Dr. E. B. Stephenson, of the Naval Experimental Research Laboratory, is shown at the right in conversation with a submarine by means of the new device. This telephone booth is sound-proof, as may be judged from the care with which it is fastened; and is thoroughly shielded. It contains apparatus for both reception and transmission by telephone.

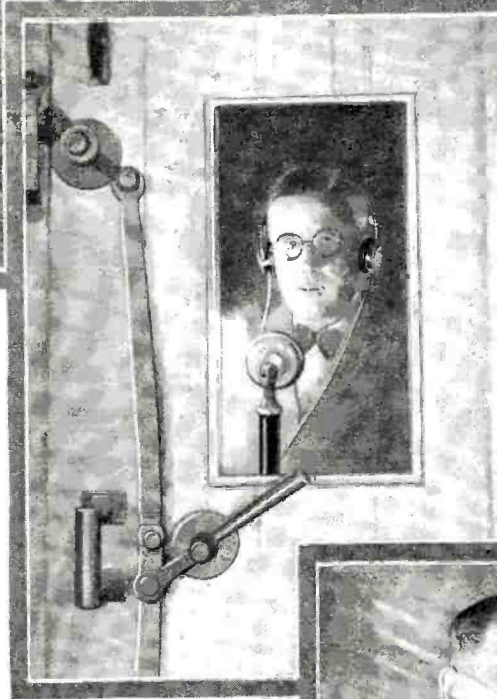

## THE NAVY'S FLOATING LABORATORIES ON THE POTOMAC RIVER

Below is a picture of the laboratory-equipped barges used by the navy in carrying on these experiments in under-water conversation. Their aerial antennas will be seen in the picture; and part of their submarine telephonic equipment is shown in the views above and at right. Submarine signalling, as well as detective work by the use of under-water receivers, was extensively utilized during the war, but these new devices utilize the conductivity of water to a greater extent than any previously developed apparatus.

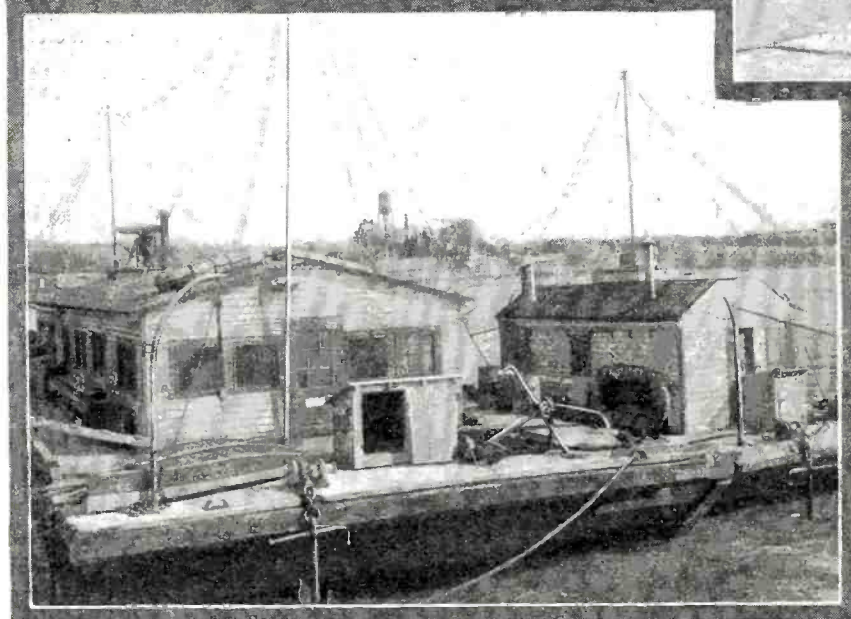

## INVENTOR OF THE SUBMARINE TELEPHONE.

Above, Dr. Harvey C. Hayes of the Naval Experimental Research Laboratory, inventor of the supersonic method of submarine telephony, is seen using the apparatus devised by him. This new method of under-water signaling combines the merits of directional control and secrecy in communication. It has been perfected to the point where telephoning under water at a distance of two miles is as satisfactory and distinct as ordinary land-telephone communication. The transmitting device shown in the upper left-hand view is connected to the set shown at the upper right, which transmits to it electrical impulses; either in form of regular dot-and-dash code, or as a continuous wave which is modified by speech-frequency from the telephone transmitter, in like manner to the operation of broadcast stations on land, making speech transmission and reception possible.



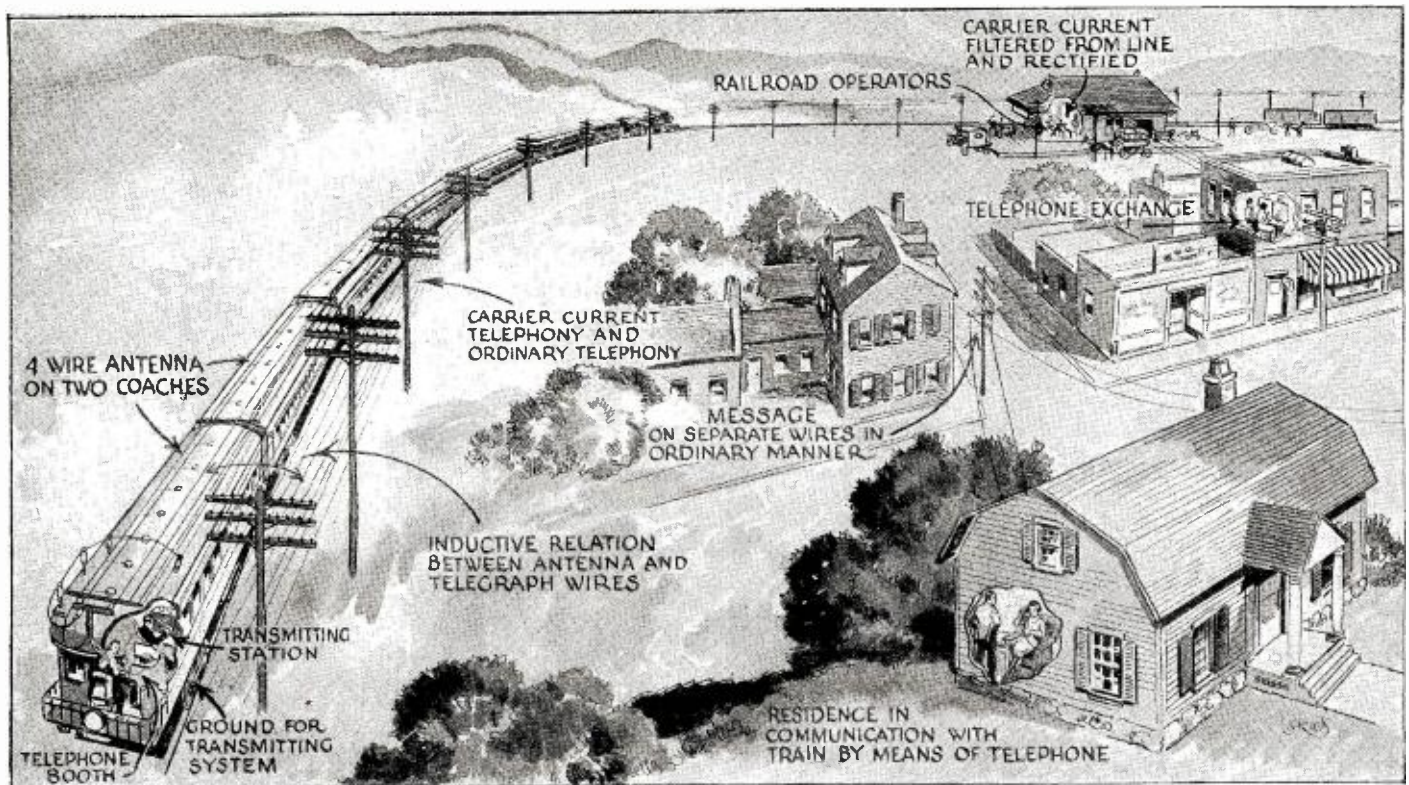

The telephone messages from the train are sent out by a long-wave radio transmitter, and find an easy path through the telegraph wires. At the nearest radiophone switchboard in a railroad station, they are converted into sound-frequency and switched over to the ordinary telephone lines. The voice from the other end is similarly transferred to the railroad wires, but at a different wave-length, and picked up by a receiver on the train.

## Radio Links Train and Home

By JOHN N. RENTZOS

*After fifty years experiment, the difficulties of successful telephone communication with trains in motion have been overcome by using radio-frequency current carried by telegraph wires. The system is now in commercial operation.*

THE problem of assuring successful telephone communication to and from railway trains in motion, upon which inventors have been working for nearly half a century, has been solved at last, to such a degree that service of this kind has been placed on a commercial basis, through the use of radio to supplement land-line systems. By this means passengers on the trains running between Berlin and Hamburg, Germany, are now able to carry on conversations with any telephone stations reached by the national long-distance lines, as well as to send and receive telegrams while the trains are in motion.

The possibilities of sending a radio message from trains were appreciated at a very early period in the development of the art; but it was a very different matter to avoid the prohibitive costs of operating high-power apparatus on every train. The present ingenious system, worked out by eight years of experiment, uses radio-frequency currents which are picked up and carried by the telegraph wires which parallel every track; so that the air gap to be crossed is reduced from miles to inches, and losses are minimized. The cost of installation is comparatively small, because no additional trunk lines need be built, the currents used being of frequencies too high to interfere with the simultaneous use of the same wires for ordinary telegraphy and telephony.

### OPERATION OF THIS SYSTEM

As will be seen from the accompanying illustrations, the railway telephone booth is located at one end of a coach, and reached from the vestibule. It contains a comfortable seat and a desk telephone; and is upholstered and cushioned to minimize train noises. In an adjoining small room, with a connecting window, is located the sending

and receiving apparatus, together with its operator.

The voice-frequency currents from the telephone are impressed on a carrier-wave by a method similar to the Heising system of modulation, well known to our readers. Each train has a special wave-length assigned to it, just as with a broadcast station. The modulated wave is emitted through the four-wire antenna, strung along the roofs of two coaches, to the nearby telegraph wires, which pick it up and carry it to the receiving sets, located in stations along the line. The ground for the transmitting system on the cars is obtained, as shown, through the axles and wheels of the railway coach to the rails. Where the telegraph wires are gathered into a cable, or are located at a considerable distance from the main track, a special pick-up wire is provided to take the current from the train transmitter, and carry it across the interval. In reverse order, the voice-frequencies of messages from the telephone at the other end are used to modulate a carrier wave (using a different frequency) at the nearest train-telephone switchboard; and then transmitted over the wires and inductively to the train. A trap arrangement is used to prevent interference between the sending and receiving sets, which operate on long wave-lengths.

At the train-telephone exchanges, located at each end of the train's run and at convenient points along the line, apparatus is installed, capable of communicating with every train on its own wave-length, and receiving from it. This has been reduced to the utmost simplicity of control, so that an operator without technical training may take charge of it. On the station panel are tuning boards, so constructed that by the turn of a button, the receiver and sender are tuned to the wave-lengths of the train tele-

phones with which communication is desired. A four-tube receiver is used, whose amplification may be regulated by turning on or off one, two, or three tubes, in addition to a volume control.

### COMMERCIAL OPERATION BEGUN

At the present time, there is an exchange at Berlin and another at Bergedorf, at the Hamburg end of the line, a central station at Spandau and another at Wittenberg, where the Hamburg-Leipzig line branches off. The latter will have double equipment, to serve two lines. While two stations would be sufficient for operation on a single line, the use of the intermediate stations reduces the length of long-distance calls and is therefore more economical.

At each station and on each train, two sets of batteries are used for each set, transmitting and receiving, in order that one may be charging all the time. The train batteries are charged from the electric lighting current; and operate a motor generator which supplies the carrier wave.

By this system, as has been said, telegrams are transmitted to and received from trains in motion. Special attendants are employed to deliver these, as well as to summon passengers to the telephone. A train charge of two marks (50 cents) is made for a telegram; for calling a passenger to the phone, 30 pfennigs (7½ cents), and 60 pfennigs (15 cents) for a messenger service; while the train charge for a telephone conversation is three marks (75 cents), in addition to the regular long-distance phone toll. Messages may also be sent with answers prepaid. The commercial value of this service and its possibilities for expansion can readily be seen. The same system, of course, offers also opportunity for greatly improved reception of radio-broadcasting by passengers on trains.



**MANY SPECIAL DEVICES INVENTED**

This installation marks the adaptation to business purposes of a principle which has been the subject of constant experiment for over eight years; beginning with the experiments of Swedish engineers on inductive telephony to and from trains. This original method failed of success, but in 1920 the radio-frequency land-line principle was tried experimentally on a line of private railroad near Berlin, and within another year had reached a stage at which it was possible to hold communication with any telephone in the metropolitan district. After this, the ministry of government railways offered more extensive facilities, including the use of a telegraph line; and in 1924 a franchise was given for the operation of telephone, telegraph and broadcast receivers on the national railways. Under this the Train Tele-

phony Joint-Stock Co., of Berlin, has been organized as the operator of this system. The Berlin-Hamburg installation was completed early in the present year, and this is the first railway line in the world on which a commercially-practicable telephone service is in operation. At the date of writing, work is still in progress on the line between Berlin and Munich.

The fundamental patent, covering the simultaneous use of the air and of land lines as media for radio-frequency current, for communication with trains, is the German No. 297,116 issued to the Dr. Eric F. Huth G. m. b. H. of Berlin, which has developed all the apparatus and methods used in the above-described system, having been granted for the purpose also the use of all the patents of the Telefunken Co. Transmission is effected

by means of the Huth-Kulm system, which employs a tube with two tuned oscillatory circuits, one between filament and plate, and the other between filament and grid; making it easy to regulate the carrier-wave, the exactness of whose frequency is essential to satisfactory operation. Other patents deal with the features by which the transmitted and received waves are simultaneously modulated and demodulated by this apparatus, without interruption of service or interference. A great many other inventions are involved of various devices produced in the successful working-out of this system. All of these were originated by the Huth Co., from whose publication "Antenne," as well as from personal examination of the system, the writer has derived the facts related above.

## Electric Train Operation by Radiophone

**F**OR some time the Westinghouse Electric & Manufacturing Co. has been continuing experiments with a carrier-current set, for the purpose of maintaining communication between two ends of a long train, which may be used also for communicating between two trains at some distance. As with the system described in the article above, on this page, the radio set is inductively coupled to a wire which follows the track, in this case the wire supplying power for operation, and along which the radio-frequency impulses are carried.

The antenna used with this outfit consists of 20 feet of copper or brass pipe mounted

rigidly along the running board and spaced 8 or 10 inches above it on insulators, as shown in the illustration on this page.

A suitable protective device using three high-voltage condensers and an air-core choke furnishes ample safety against high voltage in case of contact between the "pantagraph" and the antenna. This unit is mounted directly under the roof and is connected in series with the antenna lead to the set.

A test of the described apparatus was made on the Westinghouse Interworks Railroad and proved very practical over the length of the electrified section, about three miles. One complete set was placed in an experimental

electric passenger car while the other was mounted in a small sheet metal shed parallel to the tracks. Good strong code signals were exchanged while running; and voice of excellent quality was transmitted while stationary.

A more practical test has been made on the electrified section of the Norfolk and Western Railroad. The sets were mounted in two locomotives, which were used as head and pusher engine. The average length of the trains used was about one half mile. Starts and stops were made with carrier-current signals serving as a means of communication

(Continued on page 1707)

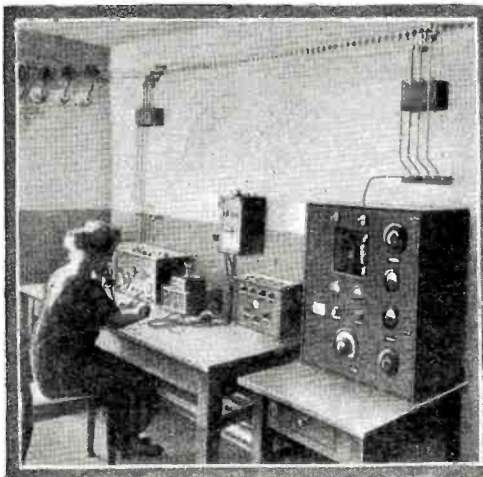

At the left, the interior of one of the railroad-telephone exchanges, showing the apparatus used to transmit and receive messages from trains, as well as to make connection with the ordinary long distance telephone lines. Simplicity of control is essential, in order that an ordinary telephone operator may take charge of the station. This is the exchange at Wittenberg, Germany.

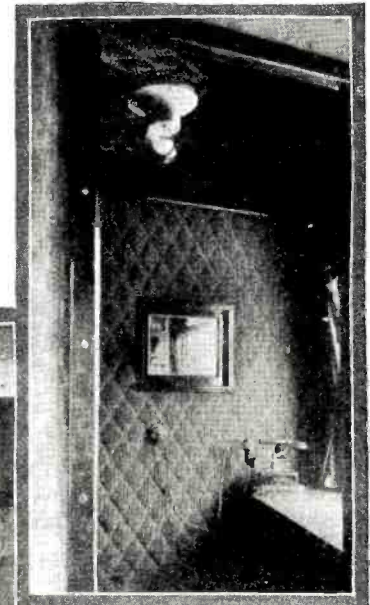

At the right, the interior of the train telephone booth, which is upholstered for the sake of silence as well as comfort. The telephone instrument, of the continental type, which combines mouthpiece and receiver, is seen on the window shelf. The small window opens into the compartment which contains the transmitting and receiving apparatus, together with its operator.

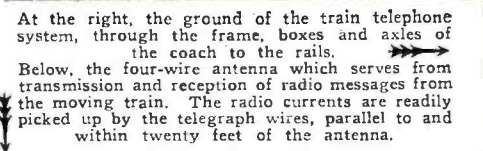

At the right, the ground of the train telephone system, through the frame, boxes and axes of the coach to the rails. Below, the four-wire antenna which serves from transmission and reception of radio messages from the moving train. The radio currents are readily picked up by the telegraph wires, parallel to and within twenty feet of the antenna.

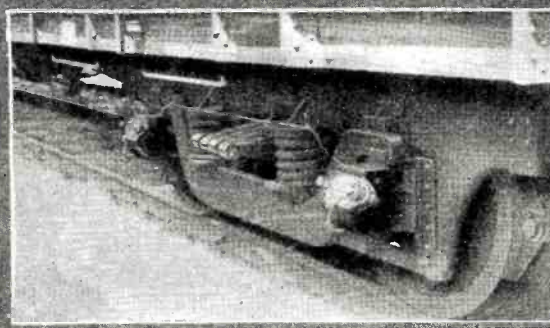

At the lower right is shown an illustration of the train telephone in operation. The comfort and convenience to the passenger are evident.

Below, the experimental antenna used in American electric train experiments by the Westinghouse Electric Mfg. Co.

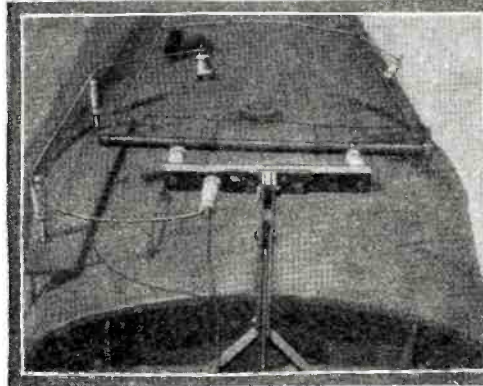

At the right, the antenna used on an electric train. The "pantagraph" transmits power to the train from the overhead wires, which are now utilized also to carry the radio current.

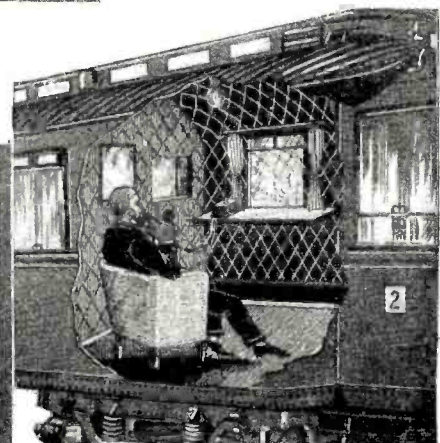
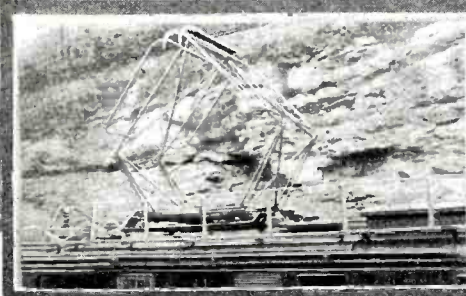



# Radio Set Owners' Information

## TUNING AND VOLUME CONTROLS

15. Jason M. Tilley of Amherst, Mass., writes:

Q. My one-tube set has two controls, one marked *Tuning* and one marked *Volume*. The only station that I get is WBZ, perhaps because I have a short indoor aerial and no place to put an outdoor one on the dormitory where I live. When this station is coming in I can make it louder by turning up the *volume* dial, until it gets harsh and crackly, and sometimes whistles. But when I turn up the dial marked *tuning*, the station gets louder for a while and then gets softer again. All this occurs very low down on the dial reading. It comes in loudest at the point marked 20 and then gets softer again, and after 30 I can get nothing but faint whistles. Why is it that the station doesn't get louder the farther I turn the *tuning* dial? I should think that it would. Does it mean that something is wrong with the set?

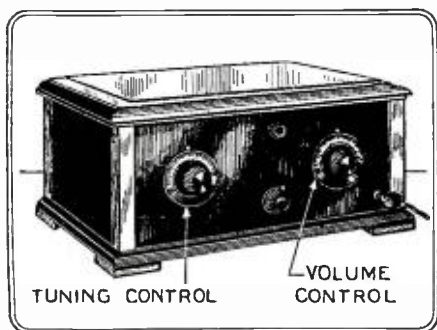

Do not mistake the function of the various dials on your receiving set. Ascertain which do the tuning, which control the volume, and which control the tubes. You will get better results.

A. From the description there seems to be nothing seriously wrong with your set. You do not understand, however, the function of the tuning dial. The fact that there is a change of volume when this dial is varied does not mean that the volume should continue to increase indefinitely the more you turn it. The function of the tuning dial is to select one station from the broadcast range. You have evidently missed this point because you receive only one station. Each station has its own point on the dial of your set. You say that WBZ comes in loudest at 20. If you put up an outdoor antenna WJZ would come in, probably, at about 45, and so on. The fault with your set seems to be, primarily, that it tunes too broadly. The stations should become inaudible within two or three degrees of the point at which they come in full strength. But the tuning dial is merely a station selector. Turn it until the best volume is obtained. Leave it in this position, and control any further variation of the volume, whether to increase or to decrease it, with the other dial labeled "Volume."

## INTERFERENCE FROM OTHER RADIO SETS

16. James V. Foelrichs, of Lincoln, Neb., asks:

Q. I have been having trouble of what seems to be an incurable nature. Every few minutes or so, while I am listening in, a loud howl issues from the loud speaker, and not only ruins the music or speech, but often scares everyone. Then again, the music fades out and entirely disappears, only to come back with terrific volume. I am at a loss to account for this, as I have had my set, which is a standard neodyne, carefully tested. Can you suggest a solution of the problem?

A. From your description, it would seem that you are probably in the neighborhood

THIS page constitutes what is to be known as the SET OWNERS' INFORMATION department, and is to be conducted regularly each month in RADIO NEWS. The purpose of the department is to furnish assistance to those readers who have not yet acquired any extensive knowledge of radio, but who are the possessors of radio receivers and wish to know how to handle them.

There is always new blood coming into the fraternity of radio enthusiasts; and it is obviously unreasonable to expect that they can intelligently read the articles which are written for the more experienced fans. Consequently this new department has been started for their benefit; and we invite anyone who desires to do so, to write an account of his troubles to the editor of this department. No letters will be answered by mail. The editor will select from the letters which he receives those queries that seem to be of most practical interest to all, and will answer them fully and in detail each month. There will be no charge for this service. Simply write to SET OWNERS' INFORMATION DEPARTMENT, RADIO NEWS, 53 Park Place, New York City.

of a powerful receiver whose radiating qualities must far surpass its other features, and make it practically a local broadcast station so far as you are concerned. The powerful oscillations from its antenna are im-

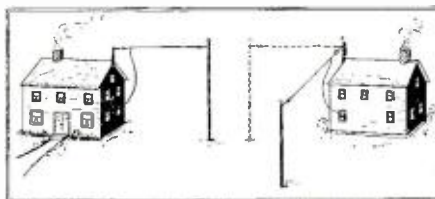

If you are experiencing interference from your neighbor's receiving set, put your antenna at right angles to your neighbor's, and your troubles may be partly or wholly remedied.

pressed on your own, and as a result your reception suffers. In the fading, you experience the result of interference by this set with your own, which is receiving the same program. To remedy this situation, to some extent, shorten your antenna and place it at right angles to the offending one, as shown. It would also be a good point to see your neighbor; and if he is inclined to be reasonable, he might be persuaded to add a stage of neutralized radio frequency to his set, as well as incorporate a loop in it.

## PROPER POSITION OF "B" BATTERIES

17. Arthur H. Quinn, of New Orleans, La., asks:

Q. Is there any truth in the statement that "B" batteries should not be placed upon their sides, since their solutions are apt to leak out and spoil the whole battery in a short time?

A. Inasmuch as there are two distinct styles of "B" batteries available, the vertical and the horizontal, it is possible that your question is directed toward one particular type. In short, it is inadvisable to place the batteries, of either kind, on their sides; but they should be kept in the position for which

they are designed, so that the cells remain in an upright position. Otherwise, there is a tendency for the semi-liquid contents (the "electrolyte") to leak out and thus shorten the life of the battery to a marked degree. An actual test showed that when two batteries were connected to a set, one in the proper position and the other turned on its side, the

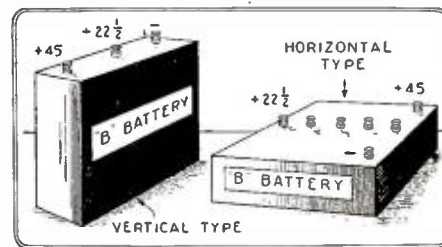

Do not place "B" batteries in any position other than the one for which they are intended. Placing them on their sides may result in shortened life.

latter showed a drop of 14 volts as compared to a drop of 6 in the former, after two weeks. To prove that the position of the batteries in the circuit was not responsible for this, two new batteries were connected in, with the positions reversed. After a lapse of two weeks, voltmeter readings again showed beyond doubt that the deterioration caused by placing a battery on its side is very marked.

## IMPROVING REPRODUCTION FROM HORN

18. Roger Burt, of Atlanta, Ga., asks:

Q. I have a good make of horn-type loud speaker which gives fairly satisfactory results: but I would like to alter it to duplicate the better reproduction of the low notes that is obtained from cone speakers I have heard. Can it be done readily, and if so, how?

A. It all depends upon the construction of your loud speaker; that is, upon the coils in its sound-producing unit. However, a device of the kind described below may serve your purpose and greatly improve the quality of your speaker.

The two winding forms shown in the illustration are made of wood or fiber, or some other insulating material, and then about 5000 turns of No. 34, enamelled copper wire are wound into each. Two fixed condensers of .01 microfarad and one of .02 microfarad size are connected to these and to the loud speaker, as indicated. This material can be (Continued on page 1693)

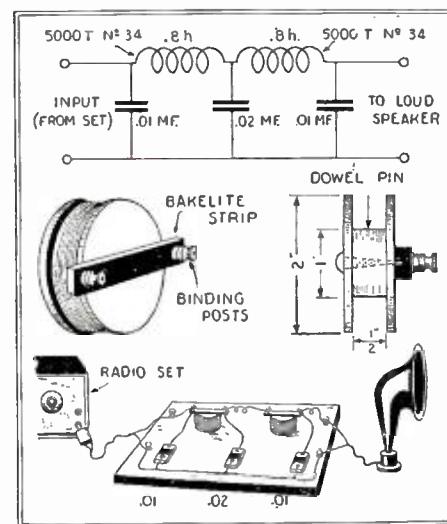

A filter design to pass more of the lower notes and suppress the higher ones. This arrangement may improve the tone quality of your present horn speaker.



# Symbols for the Set Owner















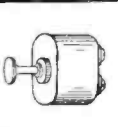

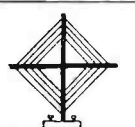
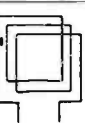
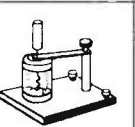

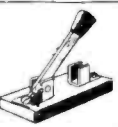

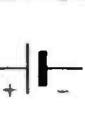
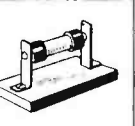

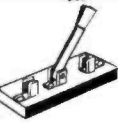





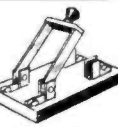

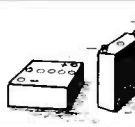

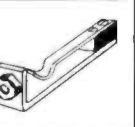
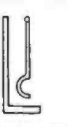
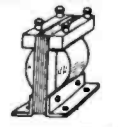
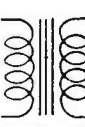
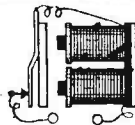
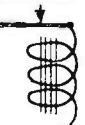
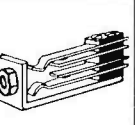

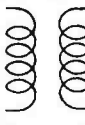
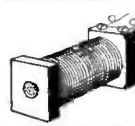
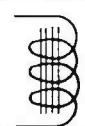
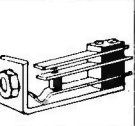

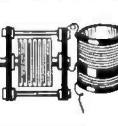
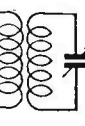

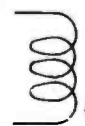

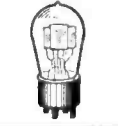

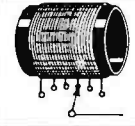
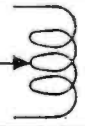



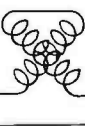





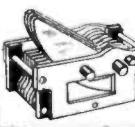

**T**HE radio set owner always wants to know and learn more about his receiver—how it operates, what the various parts do and in what manner they function. Invariably, he seeks recourse to well-written and popular articles, describing these things in detail. In many cases, though the reader really understands the line of thought, he fails to comprehend the wiring diagram, and looks on it as a meaningless maze. To alleviate or remedy

this condition, RADIO NEWS presents to its readers the very latest compilation of up-to-date radio symbols, covering the entire field of instruments and apparatus used in receiving circuits.

This page with its invaluable contents will be found most instructive and enlightening, and should be kept for reference. Study carefully the diagram or sketch of the apparatus and then each corresponding symbol. With a little practice, one can

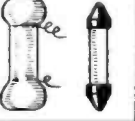
soon become adept at memorizing the symbols; so that, after a while, he is able by a mere glance at a receiver or circuit to tell, not only what type of circuit it employs but whether it is a good one or not.

Standardization in radio equipment and symbols has always been stressed by RADIO NEWS and the editors are happy to publish this complete up-to-the-minute page of symbols, believing that it will help not only the beginner, but everybody interested in radio.

	ANTENNA			VOLT-METER			SWITCH FILAMENT	
	LOOP ANTENNA			CRYSTAL DETECTOR			SWITCH S.P.S.T.	
	"A" BATTERY DRY CELL			GRID LEAK FIXED			SWITCH S.P.D.T.	
	"A" BATTERY STORAGE			GRID LEAK VARIABLE			SWITCH D.P.S.T.	
	"B" BATTERY			JACK SINGLE CIRCUIT			TRANSFORMER AUDIO FREQ.	
	BUZZER			JACK DOUBLE CIRCUIT			TRANSFORMER RADIO FREQ.	
	CHOKE COIL AUDIO FREQ.			JACK FILAMENT CONTROL			TRANSFORMER TUNED RADIO FREQ.	
	INDUCTANCE COIL FIXED			NO CONNECTION			VACUUM TUBE	
	INDUCTANCE COIL TAPPED			POTENTIOMETER			VARIOMETER	
	CONDENSER FIXED			RECEIVERS TELEPHONE			VARIO-COUPLER	
	CONDENSER VARIABLE			RHEOSTAT			LIGHTNING ARRESTER	
	CONNECTION			RESISTANCES			GROUND	



# The Manufacture of Mica Condensers

By SAMUEL SIEGEL

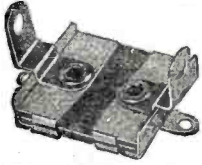

*One of the most necessary of all the instruments in a radio receiver is the fixed condenser. Mr. Siegel tells about their construction in an article that radio fans will want to read.*

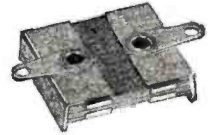

**T**OO much emphasis cannot be placed upon the quality of individual units which go into the manufacture of a radio receiver. If any part is overlooked, even though it may appear at first thought to be insignificant, maximum results cannot be obtained. In fact, in ninety per cent. of all cases, the failure of radio receivers to function properly may be traced to one faulty unit.

The present day radio receivers show a remarkable advance over those of three years ago. It is the writer's opinion that this can be compared to ten years in the development of the automobile. The reason for this rapid development is found in the untiring work of the engineering departments of the set manufacturers, refining and improving radio circuits; supplemented by the development work of parts specialists, increasing the electrical efficiency of the units which enter into the receiving set. In this article are outlined some improvements in the manufacture of fixed condensers,—instituted by one manufacturer, in order to make a more efficient and more accurate product.

The two most important requirements which a fixed condenser must meet are accuracy and electrical efficiency. Neither of these is attained as easily as might be expected after a superficial examination of these small parts.

It is well known that the fixed condensers used in receiving sets are built up of alternate layers of dielectric and conductor; the capacity depending upon the number of layers, the thickness of the dielectric, and the material used as a dielectric. Mica is the most desirable material for electrical efficiency, compactness and ability to withstand high voltages, but not all mica can be used for condensers. The presence of foreign matter, even in minute quantities (which is not uncommon), is sufficient to cause leaks which show up in the receiver by broad tun-

ing, noisy or distorted reception. The manufacturer must also be on his guard for small cracks and pinholes in the mica, one bad sheet being sufficient to spoil an entire condenser. The only safe way is to test every piece which goes into the manufacture of radio condensers.

Another of the chief defects of fixed condensers which gives considerable trouble and

condensers. The illustration shows by-pass condensers being removed from the vacuum tank after impregnation.

Faulty adjustment of the conducting plates and mica will also cause leaks and this must be guarded against by assembling these units in accurate fixtures which locate the plates and prevent shifting. This work is very delicate and requires skilled operators.



The capacity of the up-to-date condenser is determined before the final assembly, shown above, so that errors may be easily rectified.

is hard to locate is the presence of moisture. To protect a condenser from moisture, it should be thoroughly impregnated with a special compound, in a vacuum. This method of impregnating is also very essential in the manufacture of condensers with paper dielectric, such as by-pass condensers and filter

To obtain accurate capacities has always been the most difficult problem for the manufacturer of fixed condensers. Theoretically, we should get accurate condensers by using a predetermined number of plates of the same thickness. In practice, even though every precaution is taken in sorting the mica to a fraction of a thousandth of an inch, the resulting capacity will vary more than twenty-five per cent. for the same number of layers of foil and mica; due to the fact that different parts of the mica plate of film will vary in thickness, even over the small area used in fixed condensers. For this reason the accepted method used in manufacturing fixed condensers has been to assemble them, test them for capacity and stamp them to the nearest standard capacity. At best this method is not satisfactory; and as a result many condensers are thirty and even fifty per cent. above or below their stamped capacity.

After several years of condenser manufacturing a new method of condenser assembling has been developed and perfected. Instead of assembling the condenser first and determining the capacity later, the capacity is determined and fixed before the final assembling of the condenser in its bakelite housing. To accomplish this it is necessary to make the condenser element a distinct and separate unit, capable of being handled and tested without the housing. This method has been perfected so that condenser elements, having as many as sixty layers of foil and mica, are assembled into a unit which has the appearance of a solid block and can be handled and tested without danger of injury.

In this form the condenser element is subjected to a test for leakage. If it passes this test it is treated by a patented process to

(Continued on page 1707)

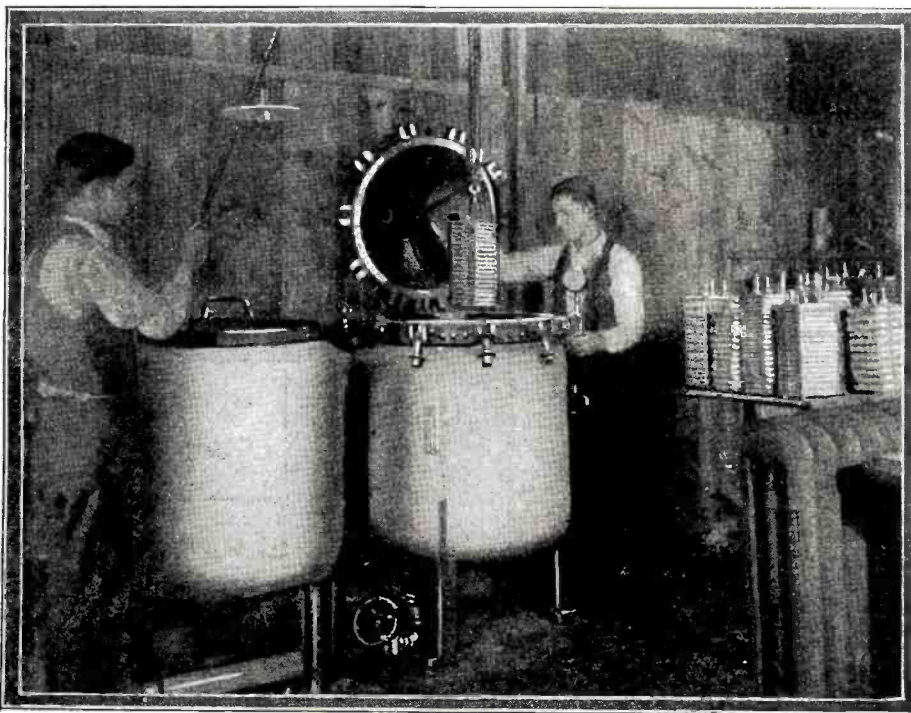

The workmen in the above illustration are removing by-pass condensers from the vacuum impregnating tanks.

Photos on this page courtesy of Aerovox Wireless Corp.



# A Typical Month at WRNY

By CHARLES D. ISAACSON, Program Director



**ALBERTO TERRASI**  
Baritone, well known throughout the world, as Figaro. He sings operatic selections at WRNY.



**Estelle Winwood**  
Famous actress, now with "Taming of the Shrew," who appears frequently at WRNY.

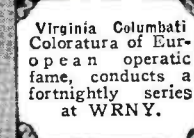

**Virginia Columbat**  
Coloratura of European fame, conducts a fortnightly series at WRNY.



**ROCK FERRIS**  
WRNY's official organist, gives Wednesday night recitals from Temple Emanuel's organ.

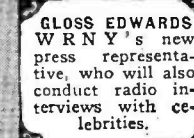

**GLOSS EDWARDS**  
WRNY's new press representative, who will also conduct radio interviews with celebrities.



**THOMAS FRANCO**  
Directs violin ensembles of his pupils at WRNY, sometimes to the number of twenty-five.

*EACH number on a WRNY program is part of a carefully-balanced whole of cultural and educational values; the continuity being kept up through the year's courses in music, science, sports, body building, the arts, literature, religion, and many other subjects, all dealt with in a comprehensive and systematized manner. Should you leave your receiver tuned in to WRNY, you would find a complete and interesting series of broadcast programs; both entertaining and instructive, in such regular order that your calendar and clock would inform you what to expect. The same artists and lecturers of whom you are told in this article reappear on corresponding evenings each month, or are replaced by others who give later numbers of the same series; for this reason the review of a month at WRNY tells you what is in store for you during the current and coming month.—EDITOR.*

**I**N this article I am going to review the activities of a recent month and tell you some of the outstanding events. The first Sunday included, of course, Dr. Christian F. Reischer, in his "Hour of Religion," who brought with him the Girls' Chorus from the Chelsea Methodist Church, of which he is the pastor; Frederick Hulsmann in one of his "Body Fit" talks; and vocal and instrumental music by the Hulsmann Trio, continuing thereby the ambitions of a program that seeks to supply not only the needs of the soul, but the body as well.

In the evening came one of the greatest of concerts which New York has heard in many a day—the Charles D. Isaacson concert which was given free to the public at De Witt Clinton Hall, and which was broadcast over WRNY. At this concert the master pianist of South America, Juan Reyes was heard, as well as Alberto Terrasi, the opera-

*(Continued on page 1693)*

**ALEXIS KUDISCH QUARTETTE**  
Mr. Kudisch, Edward Goorno, Joachim Chassman and Rudolph Simonwitch, who give weekly morning recitals at WRNY. (Left).

**GEORGETTE NYRIELLE**  
WRNY'S ambassador to France, who broadcast songs and an address, from the Eiffel Tower.



**RUTH CONNE**  
Authority on fashions and decorations, who speaks in WRNY's Women's Hour.



**OSCAR SAENGER**  
One of the foremost of the world's music masters, has a series at WRNY.



**EMMA BURKHARDT**  
Contralto, broadcast from the Charles D. Isaacson concert over WRNY



**SARA BAIR**  
Fine young American soprano who appears frequently on WRNY's programmes.



**YANG MAO YANG**  
Flutist, who gave us the spirit of a Chinese wedding ritual at WRNY.



**Lucille Collette**  
French violinist, who has returned to WRNY after a tour of America.



**Magdeleine Brard**  
Pianiste, now en route to France, who broadcast exclusively through WRNY here.









# A Remarkable Loud Speaker

By Dr. EUGEN NESPER

The loud speaker explained in this article employs an entirely new principle in the actuating of its diaphragm, which is made of India rubber, covered with electrified carbon grains.

**A**N extraordinary improvement in German broadcasting has been recently brought about by means of the inventions of Eugen Reisz, the marble-block microphone [an illustration of which appeared in RADIO NEWS for August, 1925, page 169] and filter apparatus. Clear reproduction is obtained of soprano voices, which often had been distorted insufferably before the introduction of these devices; and unpleasant harmonics introduced in fortissimo orchestral passages are now almost entirely eliminated by this new apparatus. The broadcast transmitters now send out acoustically-refined notes, agreeable and artistic, from both vocal and instrumental program numbers.

Since then Mr. Reisz has produced two new and important inventions, whose development reached such a stage in January that a number of interested radio workers were given the opportunity to try out the improved new receiving set and loud speaker.

A great deficiency hitherto has been experienced hitherto in reproduction, for the broadcast listener, of speech and music. The first-mentioned inventions have practically eliminated distortion in the transmitting apparatus; and a further improvement will be effected by a new type of microphone, to be produced by Mr. Reisz at an early date. The technique of broadcasting and the development of its amplifiers have been carried to such perfection that a broadcast program can be received practically free from distortion; that is, only if good parts are used for building the receiver, and if it is connected with proper care and suitable batteries are used.

### SHORTCOMINGS OF EUROPEAN SETS

Unfortunately, this is not always the case with the phones and loud speakers which are on sale. For reasons which need not be detailed here, many of the sets which have been purchased by the Central European broadcast listener are to be recommended rather for the loudness of the reproduction than for its quality. Of course, there are a great many sets built on a quality basis; but even these are often too complicated for the layman, or the hook-up is incorrectly made. The speech and music reproduced by such is very unsatisfactory to a sensitive ear. These defects, so far as the phones and loud speaker are concerned, are overcome by the new Reisz invention.

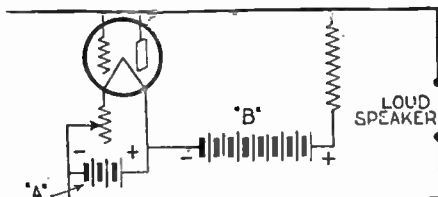

FIG. 5

A diagram of the last tube in a receiver, showing how the loud speaker is connected.

It will be seen that this device, as described below, does not use the principle of the magnetic telephone, thus avoiding many of the fundamental defects in reproduction which are caused by the use of an iron diaphragm. Moreover, its adjustment is automatic, and it is not possible for the broadcast listener to tinker with it.

The arrangement of the Reisz diaphragm is ridiculously simple: its operation is based

on the electro-static (condenser) principle. It is diagramed in Fig. 1, in which A is a thin metallic plate, perforated with small holes, D-D; B is the india-rubber diaphragm, stretched close behind the plate; and C-C are very small round carbon granules, attached to the rubber and very nearly touching the plate A.

These granules are very carefully attached to the diaphragm in such a way that the contact between them is sufficient to make a conducting surface, which acts as one plate of a condenser. The charge and discharge takes place between the perforated plate A on one side, and the layer of carbon granules C-C on the other. At the same time, because of the manner in which they are attached to the elastic rubber sheet, each of the granules is capable of a small amount of independent movement.

The operation of this device is similar to the action of the Hollundermark granules beneath a plate of ground glass. As soon as the carbon granules acquire potential, they begin to move under the influence of the electric field which is built up between the two surfaces of the condenser; and in moving, they draw with them the sheet of rubber, B, to which they are attached. This action

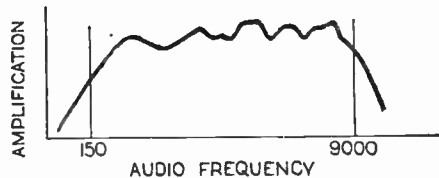

FIG. 4

This curve shows the amplification range obtained with the Reisz loud speaker.

is diagramed, in exaggerated shape, for a single granule in Fig. 2.

### FREEDOM OF THE COMPOUND DIAPHRAGM

While, in general, it may be said that the diaphragm B is limited in its movement by the perforated plate A, there is a sort of piston-action possible in the areas of the perforations, D-D. This action brings about a transformation of the electric impulses impressed on the granules into acoustic vibrations. Each individual granule, moreover, is in a condition to respond to the electric waves; and for this reason the diaphragm can produce tone-true aerial vibrations. The practical freedom from distortion of the telephone or loud speaker employing this diaphragm is so great that, for a range of audio-frequency of from 300 to 9,000 vibrations per second, no especial emphasis on a note of any particular pitch can be detected.

The difference in charge (potential) which is used between the metal plate A and the carbon granules, C-C, amounts in practice (in the apparatus which has been constructed up to the present) to between 100 and 150 volts; and can therefore be supplied directly by a "B" battery, especially when the choke coil connection shown in Fig. 5 is used. The capacity of this diaphragm condenser, as used in a loud speaker, amounts to as much as .0145  $\mu$ f.

When this new diaphragm is employed in a headset, its diameter is small, and suited to the shells of the ordinary phones; and it is light in weight, compared with the coils of the magnetic phones. For a loud speaker the inventor uses a plate and rubber dia-

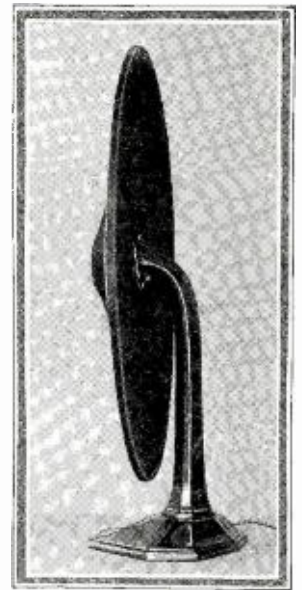

Fig. 3. This view of the new Reisz loud speaker, taken from a photograph, explains its very powerful reproduction, as the sound unit, about twelve inches in diameter, is very much larger than any type used previously and gives proportionate volume to the output.

phragm, about 12 inches in diameter and slightly conical. The general appearance of this loud speaker is shown in Fig. 3. Sound waves are emitted from both front and rear; and a good acoustic effect is obtained by placing the loud speaker, say 12 to 20 inches from, and at an oblique angle to the wall.

### POWER OF THE REISZ LOUD SPEAKER

A loud speaker of this type possesses another new characteristic, which is of importance for broadcast reproduction. Most of those hitherto in use send out sound waves from a small focus, because of the proximity of the magnet poles in their sound box. In the new Reisz loud speaker, however, the large membrane "breathes" all over its surface; and the suction-and-pressure action described is attained with a cylinder of relatively large diameter.

This brings about, not only a great amplitude of sound waves, but the consequent effect that it is almost immaterial where the listener is placed, even in a large room. This is of especial value when a considerable number of people are listening at the same time to broadcast reception, and makes it easy to obtain a natural effect.

The amplification curve of the new loud speaker is shown in Fig. 4. Full amplification is reached at a frequency of a few hundred vibrations per second. On account of this, the deep tones which are completely suppressed in most loud speakers, are

(Continued on page 1682).

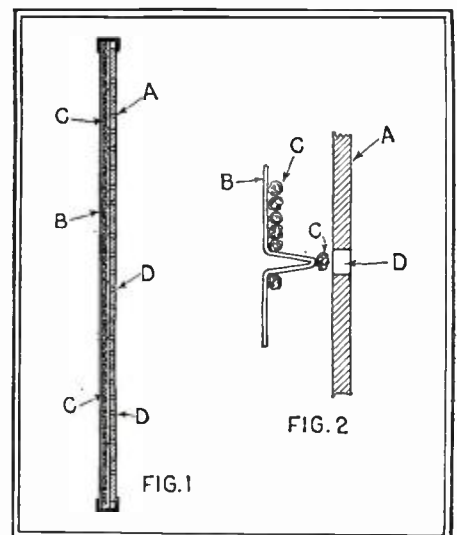

Cross section of the speaker. A is a metal plate; D, perforations in A; B, India rubber diaphragm; C, round carbon granules attached to B. Fig. 2 shows the movement of a granule.



# Static Forecasts Forest Fires

By S. R. WINTERS

*At last radio experts have found some use for static, the bugbear of all radio listeners. This article tells how the weather is forecast by measurements of static, and its relation to forest fires.*

**S**TATIC as a benediction instead of a malediction is exemplified by its strange application in forewarning of impending forest fires. As a disturbing factor in radio reception, static is a bugbear to millions of radio fans; and, when the United States Forest Service characterizes it "as an indicator of fire weather," this electrical phenomenon assumes the dual role of a Dr. Jekyll and Mr. Hyde.

The relation between weather conditions and forest fires—those originating from natural causes—has been established. This relationship is so definite that the Weather Bureau issues forecasts of forest-fire dangers based on the "complement of the hu-

acing flames in their ravaging and onward sweep. Therefore, if static can be coaxed to reveal the amount of moisture in the atmosphere and other conditions conducive to so-called fire weather, it will compensate for some of the evils for which it stands indicted by approximately 25,000,000 broadcast listeners.

To the fire-fighting crew, it would give proof of the efficacy of the adage "forewarned is forearmed." Faith in the theory that static may play benefactor as well as malefactor has prompted the Forest Service to equip and establish a radio station that is unique. Since it is devoted exclusively to a study of that electrical phenomenon known to radio fans by a variety of designations—"static," "strays," "noise," "atmospherics," "atmospheric disturbances," etc—it may be described as a "static station." Here is an exception to the general rule, since static, if it must come, finds a welcome reception instead of being ostracized as the greatest of all natural maledictions. Instead of devising ingenious instruments for eliminating atmospheric disturbances they are given accommodation and their traits or pranks analyzed under the searching eye of the scientist.

### THE STATIC STATION

Novel experiments require unusual equipment. And, out at the Pacific Northwest Forest Experiment Station, near Portland, Oregon, even surface indications suggest the oddity of the apparatus that is being employed in harnessing static as a useful servant. Towering above the group of buildings, planted in the midst of a wilderness as it were, are two masts which support the four-wire inverted L antenna. On the roof of one of the frame structures is a loop or coil antenna, around which is wound sixteen turns of No. 16 enameled copper wire. It would be logical to assume that the towering antenna is for radio transmission and the loop for reception; but this assumption would be an error, as we shall see presently. The buildings are nestled among shrubbery and undergrowth, with a mountain in the background—all of which indicates that the behavior of static is being studied in a wilderness—far, far from what we of the city call civilization. This surmise becomes more than a figment of the imagination when we are told that it is a forest ranger station and that, somewhere thereabouts, is a stream of water, lazily pursuing its devious course, taking the designation of Wind River.

### A RADIO HYGROSCOPE

The barrage radio receiving system (so-called by its inventor, Dr. L. W. Austin, head of the special Radio Transmission Research Laboratory of the Bureau of Standards) is

being employed in this pioneer effort to forecast the amount of moisture in the air, at least twenty-four hours in advance. It consists of two collectors of electric energy—a coil of 16 turns of wire wound around a box-like frame 10 by 10 feet in dimensions, and a 100-foot 4-wire antenna supported on two 115-foot masts or towers. The loop antenna is stationed on the roof of the laboratory or frame building, and so installed that it may be rotated by the operator when seated at the table in the radio receiving room. The receiving instruments proper comprise a two-stage audio frequency amplifier, operating over a frequency range of 1,500 to 15 kilocycles (about 200 to 20,000

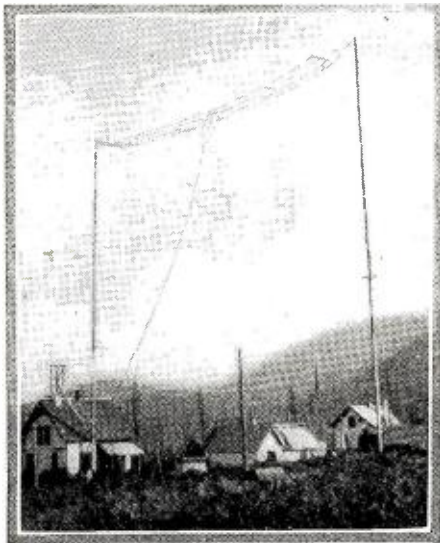

The unique static station at Wind River Forest Experiment Station, Oregon.

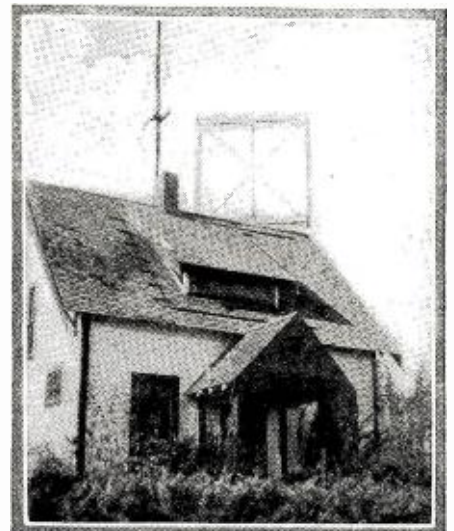

The laboratory at Wind River. Note the loop antenna on the roof and one of the antenna masts.

midity." Also, there is an apparent relationship between static and relative humidity; and on this hypothesis the major obstacle to radio reception is being harnessed in order to determine the amount of moisture in the atmosphere.

Forest fires take a toll of approximately \$20,000,000 worth of timber and other property annually, frequently ravaging thousands of acres of valuable timberlands of the West. The Forest Service, the guardian of 156,000,000 acres of national forests, maintains an extensive fire-fighting crew; but the latter is often unable to cope with such conflagrations because of the headway which they have gained at their inception. Lack of moisture in the atmosphere, a fast-traveling wind, dryness of the timber, and similar conditions help rather than hinder the men-

eters). A stage of push-pull amplification and a Wheatstone post office relay are also included in the equipment. When the experiments were first introduced, the ear or aural method of studying the kind and intensity of atmospheric disturbances was employed, using a pair of head telephones for this purpose. Recently, however, an automatic recording device has been designed by A. Gael Simson, forest ranger; this instrument, resembling a telegraph ticker, has a capacity for automatically recording code at a speed of ninety words a minute.

The method of procedure in studying the relation of static to relative humidity is outlined in detail in an official report from Mr. Simson, who is scientific assistant to E. N. Munns, Chief of Forest Experiment Stations, with headquarters in Washington. The

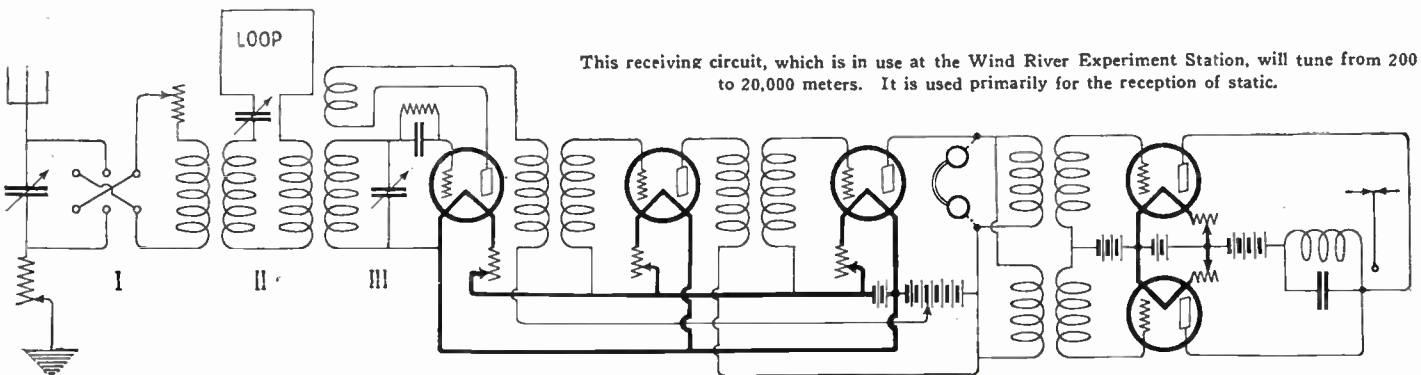

This receiving circuit, which is in use at the Wind River Experiment Station, will tune from 200 to 20,000 meters. It is used primarily for the reception of static.



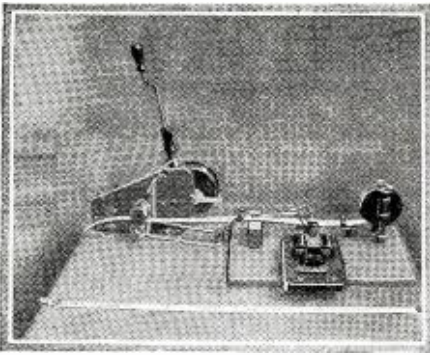

The home-made tape recorder, used in making graphic records of signals and static.

twenty-thousand-odd bona fide radio amateurs and thousands of other radio fans will be more interested in the method of analyzing static as an indicator of fire weather than in the results obtained or the objective of these novel tests. The method of making observations follows:

By means of a small double-pole double-throw switch (not shown in the circuit diagram in order to simplify the drawing), the antenna and ground are switched to the primary, of coil III, and all the circuit to the left of this winding is eliminated. This leaves a regenerative radio receiving set, connected to an inverted L antenna. "Now," indicates Mr. Simson, "where the length of the flat top of an antenna does not greatly exceed the height, for all practical purposes, the field is equivalent to that of a vertical cylindrical wire; or, in other words, the direction from which the signal is received with respect to the plane of the antenna will have no appreciable effect on the signal intensity. Therefore, with the receiver placed in operation in the ordinary manner and tuned to 109 kilocycles (about 2730 meters), the static noise received will be a component of the atmospheric disturbances from all directions. With the receiver as previously indicated, directly connected to aerial and ground, the operator listens to the static noise and notes the one or two predominating kinds and intensity. The aforementioned double-pole double-throw switch is then thrown in the reverse position and the receiver circuit is now exactly as shown in the circuit diagram."

#### USE OF THE TWO ANTENNAE

The Austin barrage radio receiving system, which is employed at the Bureau of Standards as well as by the Forest Service in making observations relating to static, may be explained, briefly, as follows. Broadcast listeners are aware of the fact that an outdoor or towering antenna will ordinarily receive signals as well from one direction as another; whereas, the indoor or loop antenna demonstrates marked directional effects. That is to say, radio signals are heard with maximum intensity when the plane of the loop or coil of wire is pointing in the direction of the particular broadcasting station from which the signals are coming; and minimum signal intensity is obtained when the plane of the loop is at right angles to the broadcasting station or other source of radio signals. Thus, there are two points of maximum intensity 180 degrees apart and two points of minimum intensity 180 degrees apart. Advantage is taken of this condition in confirming the belief that static is an indication of fire weather.

For instance, if the electromotive force of the towering antenna is impressed on the electromotive force of the loop antenna so that the two electromotive forces are equal, then with the loop pointing in one direction the two electromotive forces will be in phase and the signal strength will be enhanced or multiplied; but as the loop is rotated around its axis the two electromotive forces will

be shifted more and more out of phase. This results in a consequent decrease of signal strength until such time as the loop has been rotated 180 degrees from the position of maximum signal strength and then the two electromotive forces will oppose each other and the signal strength is cancelled or reduced to zero. Then, there is only one point of maximum and one point of minimum signal strength. As the minimum is much sharper than the maximum, the minimum plus 180 degrees is used as indicating the direction of static.

The advantage of the so-called Austin barrage receiving system over the conventional loop receiving unit is two-fold—sharper bearings, and there is no chance for an 180 degree error in the azimuth, since there is only one minimum compared with the two minima, 180 degrees apart, of the single-loop receiving system.

The loop coupler (II)—referring to the lettered circuit diagram—and the primary circuit (I) are tuned to the secondary circuit (III), which is already tuned to 109 kilocycles (about 2,730 meters) from the first operation, referred to in a preceding paragraph. Now, the complete receiving equipment is in resonance with a single frequency, 109 kilocycles or a wave-length of 2,730 meters. The loop antenna is slowly rotated through 360 degrees and the point, or points, of minimum static intensity is noted. The direction pointer and the loop is so set that with the coil of wire oriented for minimum static sound, the direction of maximum intensity is indicated. The static azimuths are plotted on the daily weather maps for correlation with the daily weather conditions.

#### WEATHER AND STATIC

The *Monthly Weather Review*, official publication of the United States Weather Bureau, attaches a certain amount of credence to the relation between static and weather conditions, in publishing the following report: "Studies made during the summer of 1921 at the Geophysical Institute of Strasbourg on radiogoniometry (radio direction finding), have led to the interesting meteorological relations between the direction of maximum intensity of 'strays' or static and the movement and shape of depressions.

"(1). In the case of a well-defined circular depression, the maximum intensity of 'strays' is observed in the direction of the southern or southeastern part of the depression; the change of this direction of maximum intensity serves to follow the movement of the depression.

"(2). In the case of an elliptical depression, less well marked, the maximum intensity, as in the first case, is observed to come from the southern or southeastern parts. This case is less satisfactory than the first.

"(3). In the case of secondary depressions, or the barometric fluctuations along squall fronts, the maximum is difficult to determine.

"(4). A squall close at hand gives violent 'strays.'"

"These observations have permitted following the movements of known depressions, and also forecasting the arrival of those as yet unseen on the weather map. A striking relation is also found between observations of maxima in 1920 and the corresponding barometric distribution. This seems to point the way to a new viewpoint in the forecasting of weather."

#### HUMIDITY INCREASES STATIC

"It would appear," reports Mr. Simson in noting the relation of static to the amount of moisture in the atmosphere, "that diurnally the static is directly proportional to the relative humidity. However, in any attempt to judge the direct relation between static and relative humidity, the so-called 'night-effect' influence on signal and noise strength must be taken into consideration. That this effect is not inconsiderable is evident from one chart or graph plotted. From this chart, it is apparent that a signal of given strength transmitted at 4 a. m. will set up approximately ten times as much current in the receiving antenna as the same signal transmitted at 4 p. m.

"A better perception of the diurnal relation between static intensity and relative humidity may be obtained by plotting a static intensity observation taken at a fixed hour of the morning (late enough so that the value of observation is not distorted by the 'night-effect,' and early enough to avoid distortion from distant thunderstorms or ex-

(Continued on page 1682)

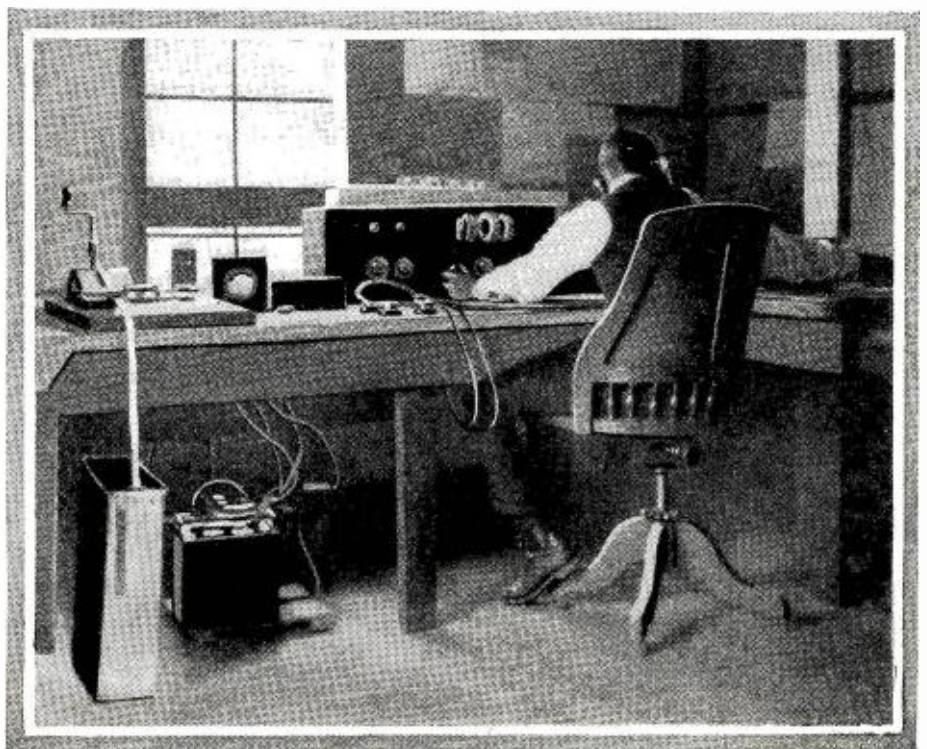

A corner of the static-recording instrument room, showing radio receiver and amplifier.



# New Developments In Radio Apparatus

By G. C. B. ROWE



*Fine craftsmanship has been bestowed upon the vital parts of these radio receivers and accessories, no less than upon their housings. To the eye of the radio engineer, as well as that of the lay purchaser, they are good to look upon and satisfying.*



THE fashions to which we have become more or less accustomed are always subject to change with a minimum of notice. Consider an automobile of last year's model (any one will do) and compare it with the same maker's 1926 product. There may be drastic changes (according to the manufacturer's announcement) which tend to improve the car to a standard above every other on the market; such radical modifications, perhaps, as changing the position of the lamp brackets or adopting a new shade for the upholstery of the rear seat. Then, too, there are the ever-changing fashions in the gowns of the fair sex, which are obvious to all. The length of Milady's skirt is added to, or shortened a trifle—which, matters but little—and *voilà*, the newest mode.

Radio too has its changes in styles each season; but in this industry, as in any which is yet in its formative period, the new styles represent decided advancement in the art of set and part building. A few years ago, while radio broadcasting was a still undeveloped and untrained infant, little attention was paid by manufacturers or purchasers to the external appearance of a receiver, and the apparatus within was equally crude in many respects, from the standpoint of today. The changes which have taken place since that comparatively recent time are very well illustrated by the receiving sets of this year's model, three of which are reviewed in this article.

For example, on this page are reproduced photographs of a receiver whose details and ensemble may justly be termed works of mechanical art. In the opinion of the old-timers, no less than of the novices, a receiver which operates satisfactorily with but one control is "a consummation devoutly to be wished": and when such a receiver embodies craftsmanship of such high order that every line of its appearance is pleasing, it deserves more than momentary attention.

## INSURING UNIFORM CONTROL

In the receiver shown there is a new idea, that of building the three straight-line frequency condensers upon a substantial frame, on which are assembled also the gears for rotating the condenser plates and a circular dial for logging stations. On the rear of this frame are mounted the radio-frequency transformers which are tuned by the condensers; as well as the audio-frequency

able condensers to tune all the stages of radio-frequency amplification in synchronism. There is likely to be more or less wear on the gears as time goes on and consequently there should be some means of compensating for this. In the receiver here illustrated, the worm gear that drives the main shaft of the condensers is designed on a floating-bearing principle, one end of the bearing being pivoted on a flat spring and

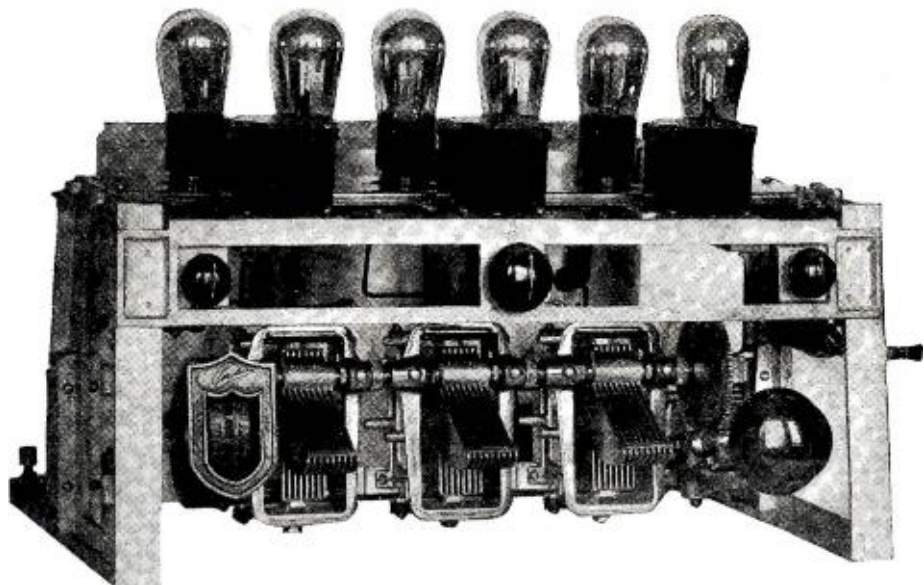

This illustration shows very well the rigid construction of the framework carrying the condensers. The shielded coils of the set are in the rear.

transformers, the filament rheostats and other apparatus, in a manner giving the highest mechanical stability.

One of the greatest drawbacks generally encountered in receivers that have but one control is the difficulty of getting the vari-

the other being supported by an adjustable spiral spring. Therefore if there is any wear on the worm and gear, it is taken up automatically by the spiral spring.

The majority of listeners, when they log a receiver's setting for broadcast stations, are apt to read the scale of the condenser dial a fraction of a degree one way or the other. This is due sometimes to parallax, and sometimes to carelessness in taking the readings. Then when someone who is unfamiliar with the set endeavors to tune in the same station great surprise is expressed that it does not come in as it should. With the type of scale shown in these pictures, there is very little likelihood of anything like this occurring, for the circular drum on which is engraved the scale is quite close to the indicators on each side of it. It seems needless to say that this scale is attached to the shaft which also operates the three variable condensers.

## SUBSTANTIAL CONSTRUCTION

Another great advantage, with apparatus of this nature, is the ease with which it may be assembled in a receiving set. Ordinarily there are at least three holes—and sometimes four—that must be drilled in the panel for each condenser, and also three holes to be drilled for each rheostat. However, in the apparatus shown here there are but four large holes needed for the controls of the set and the large opening for the revolving scale. This is a great saving of time, and

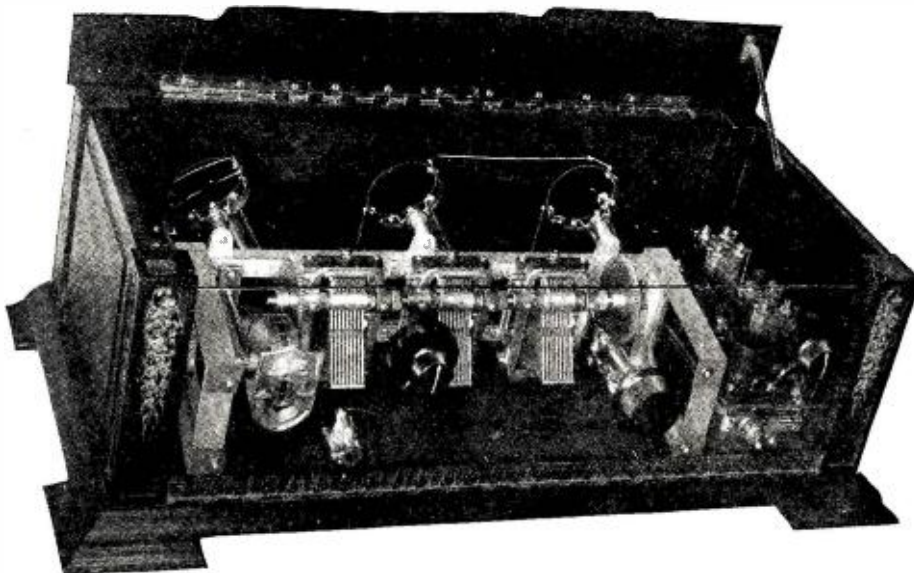

Here is another variation of the construction of the gang condensers with their single control, the gears of which can be seen at the right.

Photos on this page by courtesy of Perless Radio Corp.



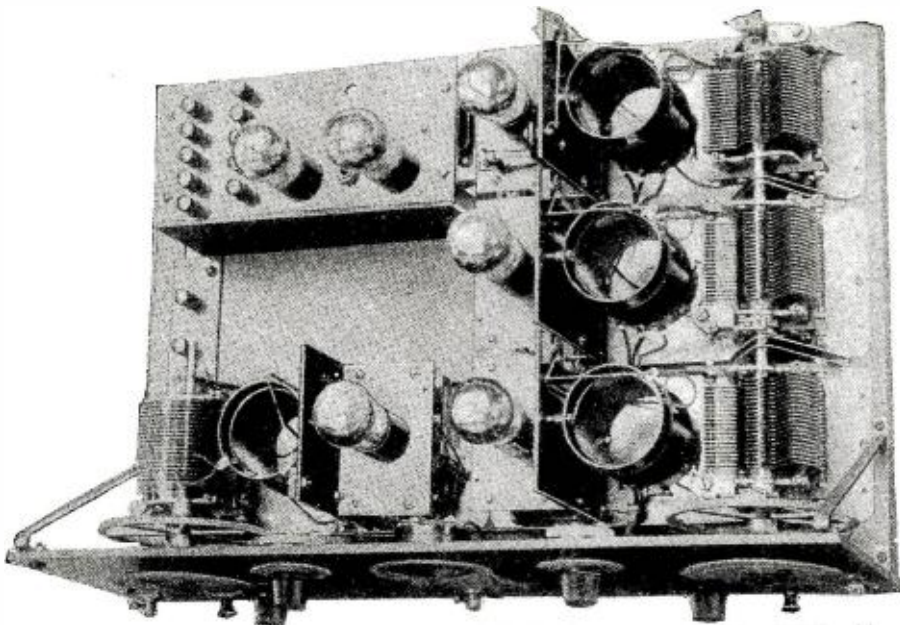

The solution of one of the greatest problems of tuning more than two stages of tuned R.F. with a single control is shown above. The condensers have hollow shafts which are fastened to a main shaft extending from the dial.

also there are fewer holes to drill, and therefore less chance for an error to be made.

These receivers employ a circuit having tuned-frequency amplification, and are built for six, seven and eight tubes. In the last two cases there are three stages of tuned radio frequency before the detector tube, this number being made possible only by the precision tuning of the system used.

The construction of the condensers is sure to command the attention of enthusiastic radio fans. The rotor and stator of each condenser are die cast, each in a single solid piece, thus insuring that they are uniform in every respect, and the air gap absolutely constant. The condensers have a straight-line-frequency characteristic up to 400 meters, and from there up to about 600 meters a straight-line wave-length characteristic. The advantage of this type of condenser will recommend itself at once to the fan who has experienced difficulty in tuning in stations under 250 meters and who wishes his receiver to have a range sufficiently wide that the higher wave-length stations also can be received. Another excellent feature of these condensers is a small compensating device in the rear of each, by which the fine balance can be adjusted after the condensers have been wired into the circuit. It is here that multiple condensers sometimes fail to function, as the wiring of a set invariably throws the capacity slightly off.

**COMPLETE RADIO-FREQUENCY SHIELDING**

Another phase of radio receiver construction which has been getting more attention

recently than heretofore is that of shielding. The receiver shown in the accompanying illustrations is one that primarily owes its being to this system; as without it, it would be impossible to use the three stages of radio-frequency amplification.

The main reason why it is possible to have three stages of tuned R.F. amplification in this receiver is the excellent shielding. The illustration above shows the same receiver before the shields are installed. The A.F. amplifier is shown at the left rear of the set.

Photos on this page by courtesy of Stromberg-Carlson Telephone Mfg. Co.

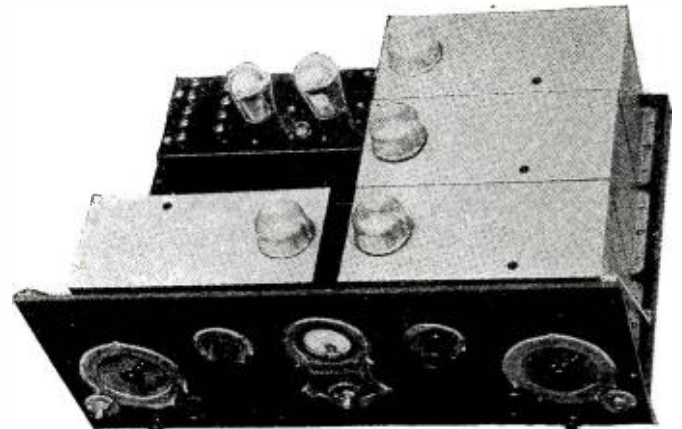

Let us consider this problem that confronts the engineer when he wishes to use more than two stages of tuned radio frequency. In addition to tube capacity, there is coupling between adjacent radio-frequency coils and also between non-adjacent coils, as well as capacity effects between the several coils and the antenna. All these capacities must be neutralized if efficient and stable operation is to be obtained. In a two-stage receiver,

interstage coupling may be eliminated by tilting the coils at an angle; and capacity effects between antenna and coils are so slight as to be practically negligible. In a three-stage receiver, however, all these must be neutralized. There are four tuned circuits and in order to neutralize all capacity effects, six neutralizations would be necessary. This would be unwieldy, and we are led to the conclusion that if three or more stages of radio-frequency amplification are employed, complete metallic shielding must be used. In addition to these major couplings, there are other incidental ones that must be eliminated in order to produce a successful receiver and which are also prevented by the shielding.

Now, although the problem of neutralization seems to be solved if three stages of tuned radio-frequency amplification is used, there is that of the number of controls, which have increased accordingly. In the receiver shown the four controls necessary (i.e., one for the antenna system and one each for the three stages of the radio frequency amplifiers) have been reduced to two. It was deemed wisest to have the condenser which tunes the antenna circuit by itself; and in order to reduce the number of controls to a minimum, the three condensers that tune the radio frequency stages have been placed on the same shaft.

This reduction in the number of controls introduces some mechanical problems that required special treatment. It is obvious that all three of the coils in the second, third and fourth tuning circuits must be alike in in-

ductance and that the three associated condensers must be alike also, for each setting of the dial throughout its complete scale. The requirement that each of the condensers be inclosed in individual shields also complicates the problem.

**SINGLE-SHAFT CONTROL**

The three tuning condensers for the radio-frequency stages have been placed on the

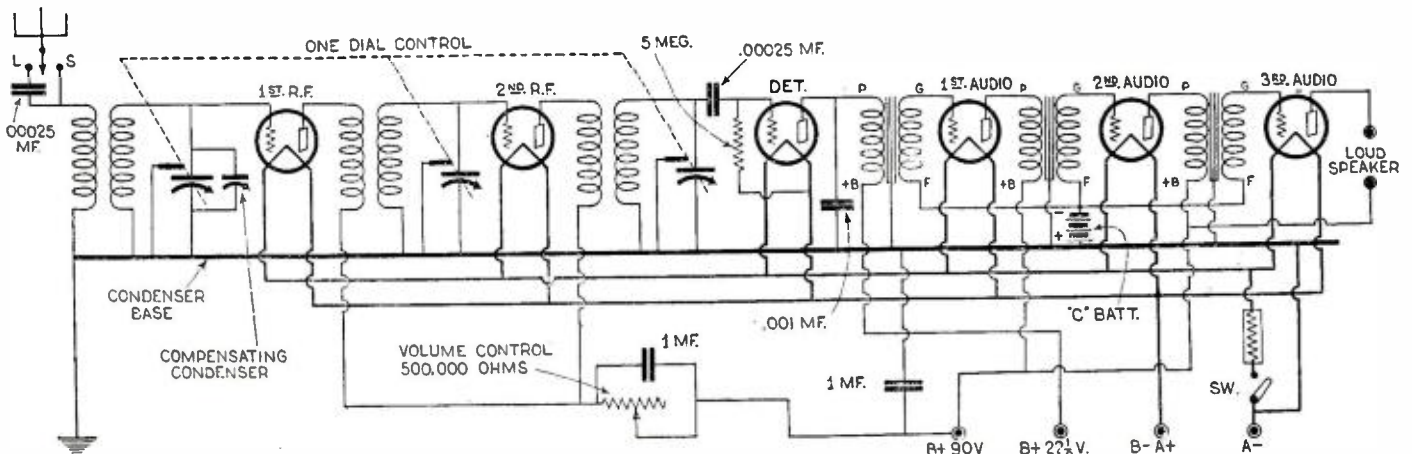

This is the circuit diagram of the receiver shown on the opposite page. The three stages of R.-F. amplification are tuned by the three variable condensers, operated by the one control





The outward appearance of the shielded receiver described on page 1647 is as attractive as the inward craftsmanship.  
Courtesy of Stromberg-Carlson Telephone Mfg. Co.

same shaft, in order that the tuning adjustments may be reduced to two. These condensers are driven by a solid one-piece 5/16-inch shaft, which extends from the dial through the hollow-sleeve shafts of the separate condensers and three main-shaft supporting bearings. An adjustable flexible-spring type bearing is employed to provide against shaft looseness due to wear. Each rotor is securely attached to the main shaft by means of a set screw, which also permits these rotors to be adjusted to any desired angle.

Thus it is that shielding solves the problems of power and selectivity; the first through the use of a third stage of radio-frequency amplification which increases both power and distance, the second by making the signal from the antenna pass through four tuned circuits in series before reaching the detector tube.

The audio-frequency transformers employed in this receiver are designed to give a flat voltage-amplification curve over the range of audio frequencies that are considered essential to good quality reproduction. Then usual "second peak" in the amplification curve is removed by the use of a short-circuiting band of copper, applied around the outside of the secondary winding. As

shown in the circuit diagram, both stages of the audio amplifier are connected to the loud speaker output binding posts and output phone jacks at all times; thereby including sufficient amplification to insure ample volume of loud speaker output without the common tendency to overload the detector tube.

**A RECEIVER OF POWER AND STABILITY**

Another receiver in the circuit of which are more than two stages of radio-frequency amplification is shown in the accompanying illustrations. The primary idea back of this set is that it shall bring in the distant stations and at the same time have good quality of reproduction. In order to get away from too many controls the designer of this receiver combined tuned and untuned radio frequency, the result being an eight-tube receiver, having five stages of radio frequency amplification, detector and two stages of audio frequency amplification.

This receiver is operated on a loop antenna, the advantages of which it is not necessary to set forth here. One of the greatest of these advantages is, however, that the set may be tested at the factory under approximately the same operating conditions as the purchaser's.

It is claimed that the incoming signal is amplified 3000 times before it is led to the detector tube, which is greatly in excess of the amplification of most other receivers. The circuits in this set are so balanced that leads from the batteries to the set have been

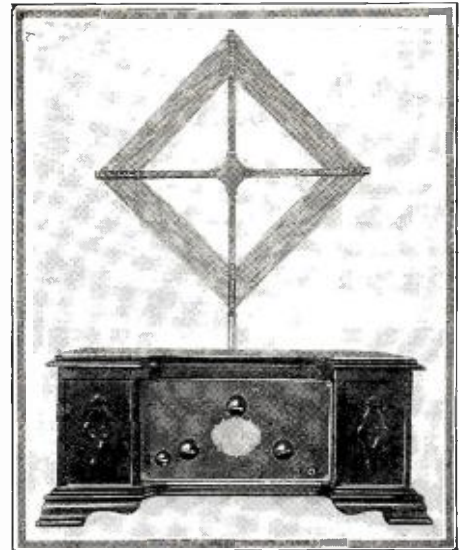

As the batteries for this receiver fit inside the cabinet and the circuit is designed for a loop the set is truly self-contained.

Courtesy of Priess Radio Corp.

set is a single-wave-length-control instrument, this being the only actual tuning adjustment. There are also a sensitivity control as an aid to nursing along the feeble signal into loud speaker volume, a volume

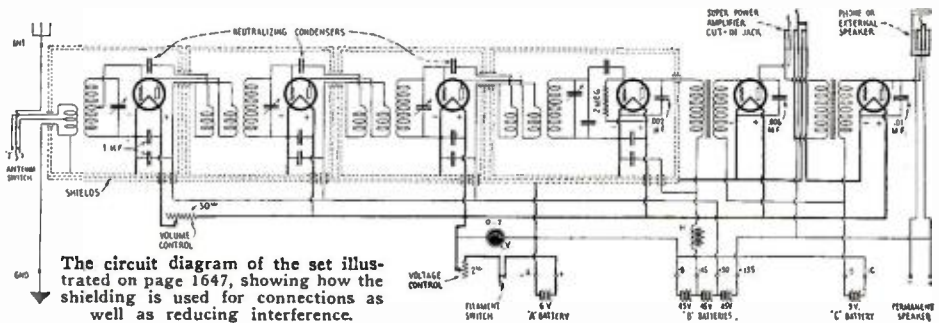

The circuit diagram of the set illustrated on page 1647, showing how the shielding is used for connections as well as reducing interference.

made as long as ten or twelve feet, without disturbing the balancing of the circuit, or causing a noticeable change in the operating characteristics of the set. The capacities throughout the set are proportioned to such a small margin as to be almost incomparable with any previous standard. This means that it is possible to shift tubes having similar plate-grid characteristics anywhere in the set without causing a difference in the quality or intensity of the signal.

The two condensers that tune the radio frequency stages are connected to a single shaft, therefore with the loop antenna, the

control and a vernier balancer. In order to provide means for an instantaneous change from one to two stages of audio amplification, there is a T.P.D.T. anti-capacity switch directly over the output jack.

**A CONVENIENT VOLUME CONTROL PLUG**

There are doubtless many times when the volume controls on a radio receiver are not all that the fan would like them to be, and the adjustable plug shown in the accompanying illustrations will prove most acceptable,

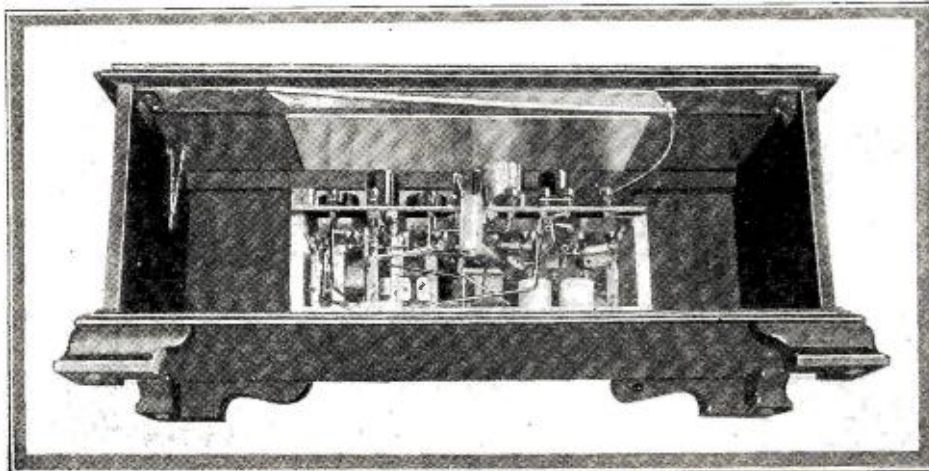

The interior of the receiver illustrated at the top right of this page, showing the ample room for batteries.  
Courtesy of Priess Radio Corp.



By turning the knob adjusting the rheostat on this phone plug, the volume can be varied.  
Courtesy of Central Radio Laboratories

especially in cases where the loud speaker is at some distance from the receiving set. When it is desired to change the volume, the small instrument can be used, as there is generally a jack outlet at remote points.

As may be seen from the illustration showing the plug opened, there is a small center  
(Continued on page 1698)



# What's Wrong With My Super-Het?

By EDMUND T. FLEWELLING

The ambitious constructor of a Super-Heterodyne has usually run up against a lot of questions, which, like the celebrated riddle of the Sphinx, must be answered correctly or undesirable consequences will result. Mr. Flewelling gives some practical hints and advice that may make it easier for the Super-Het owner.

“WHAT’S wrong with my super-het?” must be a question that an exceedingly large number of radio experimenters have asked themselves, if the writer can judge at all by the great number of times the question has been put to him personally. About a year ago it was decided to “go to the mat” with this question; and accordingly a plan of action was mapped out, whereby we were to try for a suitable answer to the question and, if possible, also carry on with our idea that radio sets should be built and not tied together with wire. Due to the complexity of circuits and actions in the super-heterodyne, this circuit presented unusual difficulties in the working out of this “wireless” idea; and it was felt that if it could be applied to the super, the other types of circuits would be taken care of easily. More on this subject will be given in an early article.

A large share of the questioners about the super-het were using, or at least expressed a desire to use, the 201A or 301A type tube; more volume, clarity and punch, they said. Very well, nothing but 201A type tubes were to be used; and as we set about to gather in all available types of intermediate-frequency transformers, it was always carefully specified that they were to be used with such tubes. A super-het layout was built up, to be as flexible as possible (See illustration). It will be noted this consists of three units; second detector and audio amplifier, the intermediate train, and on the left the oscillator. Terminals were arranged on the intermediate for ready interchange of the various transformers, and the potentiometer was so arranged that various grid voltages could be obtained by it or a “C” battery. The oscillator was built with plug-in coils for interchange, to cover

the intermediate peak of the various transformers to be used. With each unit self-contained as shown, it was possible to tie them together with clips, as in the illustration, or with wire, so that they could be placed in a metal box for shielding or completely removed from the room if necessary. With each unit separately tested and proven, the work was much easier when they were operated together.

### FITTING TRANSFORMERS TO TUBES

Knowing the operating characteristics of the W.E. 83-A intermediate transformers

vice based on the tests: If you buy intermediate transformers without absolute knowledge of their characteristics, then, by all means, plan to use type 199 or WD11 or 12 tubes. They work very well indeed with the majority of intermediate transformers on the market. Build your audio amplifier for 201A tubes if you must, but stick to the low  $\mu$  tubes for the super-het part of your outfit. This because, although we specifically called for parts suited to use with 201A tubes, it was perfectly obvious after test in more than one instance that the transformer was a real blood relation to the 83-A. If you are in a position to know how and where, then it is possible to purchase suitable transformers for use with 201A tubes; but before doing so it might be of advantage if you spent a few minutes with the chapter on high-frequency amplifiers in J. H. Morecroft’s “Principles of Radio Communication.”

### SHORT DIRECT CONNECTIONS

After you get your super operating even “fair to middlin’”, run your loop directly to your first detector without using the coupling to the oscillator. Almost every “expert” super that I have seen would “supe” just as well or maybe better without using the coupling coil to the oscillator at all. If it does that, how do we know just what the coupling coil is doing? We don’t. is the answer. Short direct connections, and a direct control over the functions of the four parts (oscillator, detectors, intermediate and audio) are the first requisites for the successful super-het.

There is no need, nor is it possible to go into the action of various transformers that we tested in this outfit. Much more may be gained if we refer to those things that we

(Continued on page 1689)

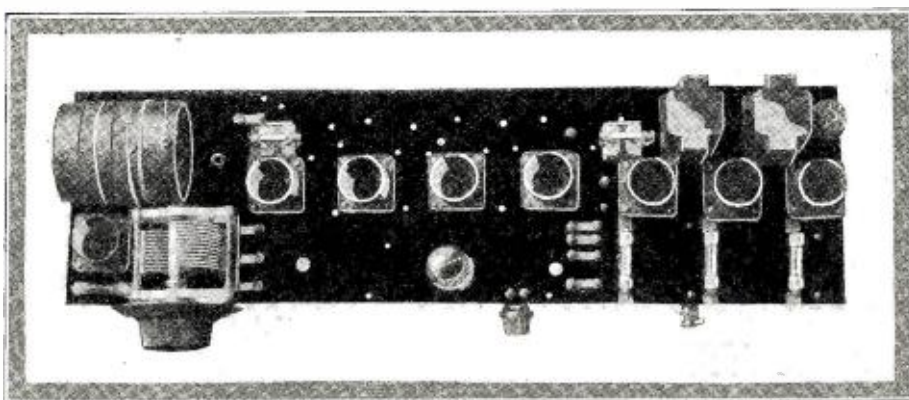

This baseboard layout shows how to make a good start. As illustrated, it was used for experimental purposes, to test out different parts and determine their suitability.

they were chosen as the first transformers to try out with the 201A layout. The 83-A transformer, and this should be emphasized, was never designed for use with the “high  $\mu$ ” 201A tube, and will not operate, under ordinary conditions, at all satisfactorily with tubes of this type. Taken altogether the 83-A is about as good as any transformer available, when used as it is intended to be used (i.e. with low  $\mu$  tubes) and it was therefore used as a standard of comparison in our tests.

The above paragraph should be emphasized, because it was surprising how many intermediate transformers were found in our test that were related in some manner to the 83-A coils. So here is the first bit of ad-

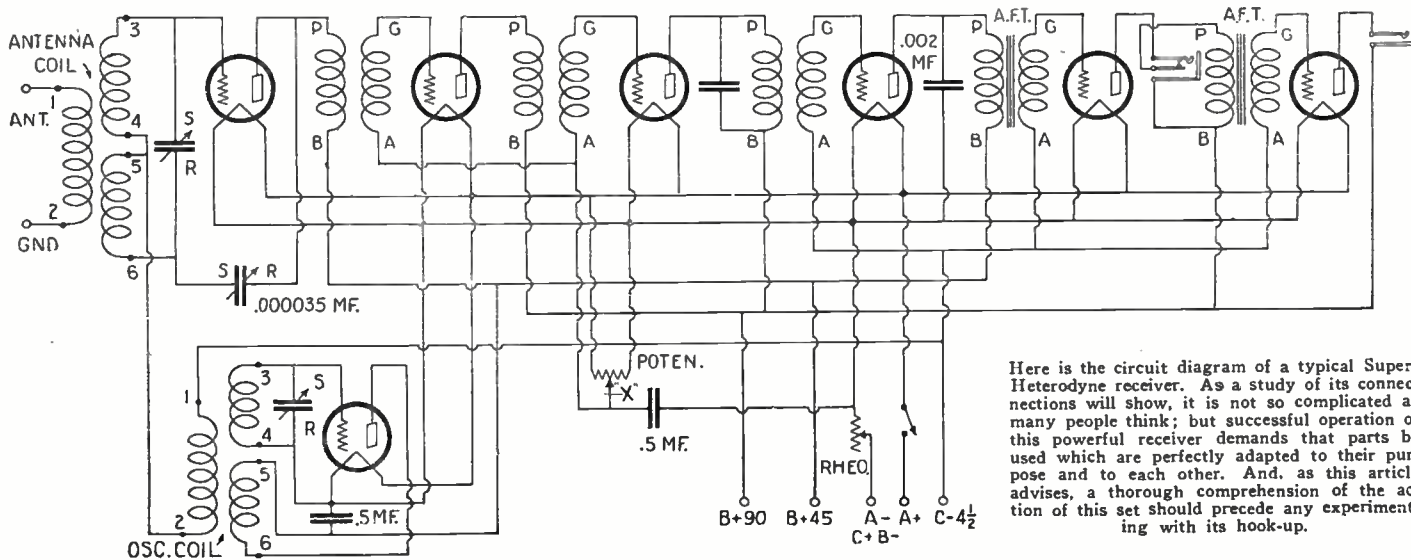

Here is the circuit diagram of a typical Super-Heterodyne receiver. As a study of its connections will show, it is not so complicated as many people think; but successful operation of this powerful receiver demands that parts be used which are perfectly adapted to their purpose and to each other. And, as this article advises, a thorough comprehension of the action of this set should precede any experimenting with its hook-up.



# A New Method of Amplifier Coupling

By H. P. DONLE\*

*This article is a description of a new type of audio-frequency amplification, developed by the author. It should prove of great interest to those fans, who are concerned with the quality of reproduction.*



**M**R. DONLE, the inventor of the Sodian tube and the B-6 detector, describes for our readers in this article an improved method of coupling, which combines the best features of several previous systems, as a distinguished publisher was wont to say, and another one in the bargain.

This is the latest, but not the last invention Mr. Donle is to give radio enthusiasts this year. He has afforded us a peep up his sleeve at a couple more ideas which have interested us, and will interest you when they appear, before long, in the pages of RADIO NEWS.

—EDITOR.

**I**N the early days of radio broadcasting the transformer system of coupling audio amplifiers was almost universal, because the efficiency of this system is very high and it does not require many tubes. Furthermore, the standards of quality at that time were much lower than those of today. Transformer coupling is remarkably efficient on weak signals; but its performance differs considerably from that of other systems of coupling, in the fact that this high efficiency decreases very rapidly as the signal intensity is increased. This is a transformer characteristic which is not often considered but which, without doubt, gives rise to considerable distortion on account of the fact that the weak signals are amplified more than the stronger ones. It is, furthermore, difficult to use more than two stages of transformer coupling because there is a marked tendency for audio-frequency regeneration to take place, which not only increases distortion but produces a howl or squeal in the loud speaker. And while this howl may be lessened, and more stages introduced by various methods of stopping regeneration, these methods themselves always introduce losses into the circuit; and thus decreases the volume of reproduction and neutralize to a large extent the expected gain from addition stages.

### RESISTANCE COUPLING

Resistance coupling consists essentially of connecting the plate of an audio amplifier tube to the grid of another by means of a small condenser; supplying the plate cur-

rent to the first tube through a resistance which is usually of the order of one-tenth of a megohm; and connecting the grid of the second tube to the negative filament terminal through a resistance of from one-tenth to one megohm. This system, although very inefficient, has one advantage; it is capable of giving excellent quality of reproduction, only so long as the signal intensity is not too great. And since there is no tendency for regeneration to take place between stages, it is possible to use several stages, which allows a sufficient amount of amplification to be secured even though the individual stages are inefficient. Aside from the inefficiency of this system, it has the considerable disadvantage of inability to handle large signals, because the grids of the amplifier tubes accumulate charges too rapidly to be properly taken care of by the grid leaks. Furthermore, this effect is noticeable on signals of medium intensity, as manifested in a certain amount of blurring and distortion which increases as the signal intensity increases.

The so-called impedance system of amplifier coupling differs from resistance coupling only in that the resistance, through which the plate circuit of the amplifier tube is supplied, is with this system replaced by a choke coil. The rest of the circuit is the same. This system, while it has an efficiency per stage somewhat higher than resistance coupling, has the disadvantages of resistance coupling in the tendency for the grids of the amplifier tubes to load up and introduce distortion as the volume of signal increases. Unless a grid leak of very low resistance is employed, which reduces the efficiency of the system, this arrangement is not capable of giving much volume.

### THE NEW DONLE COUPLING

A system of audio-frequency amplifier coupling has been developed by the writer, which overcomes most of the disadvantages of previously known systems. It permits a quality of reproduction which is equal to the very best which can be secured with resistance coupling under the most favorable conditions of weak signals. It is a much more efficient method of coupling tubes than resistance or impedance and thus affords a considerably greater amount of amplification per stage. It does not share the disagreeable

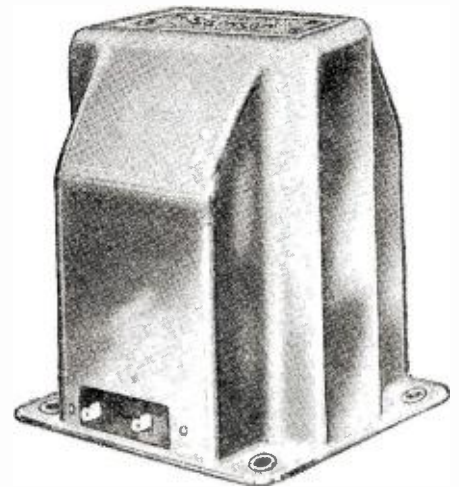

Fig. 3. One of the coupling devices now on the market utilizing Mr. Donle's principle. Photo courtesy of Samson Electric Co.

characteristic of transformer coupling, amplifying weak signals to an excessive degree. It may be readily used in three stages without the slightest tendency towards audio-frequency regeneration or howling; and when so used, will give a signal intensity for any input far greater than can be secured with any other known system of coupling an equal number of stages.

The system used is diagramed in Fig. 4, by which it will be seen that an impedance leak is used instead of a resistance leak. By this method high impedance is presented to the alternating signal, but the resistance to the grid charge is unusually low. How well this system performs is shown by the accompanying curves (Figs. 1 and 2) in comparison to two well-recognized systems, that is, transformer and resistance coupling.

Fig. 1 shows the operation of the Donle system, in comparison with the others. On this curve the input and output are given in arbitrary units; it shows very clearly most of the characteristics mentioned above. For example, with transformer coupling the efficiency falls off very rapidly as the input increases. The curve for the Donle system crosses the transformer curve at a relatively low input and rises to a considerably higher value.

(Continued on page 1701)

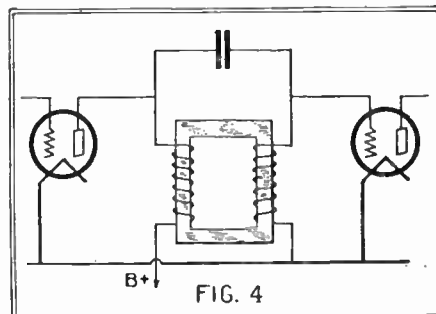
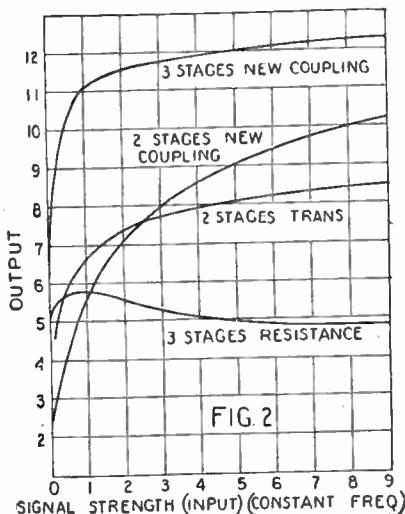
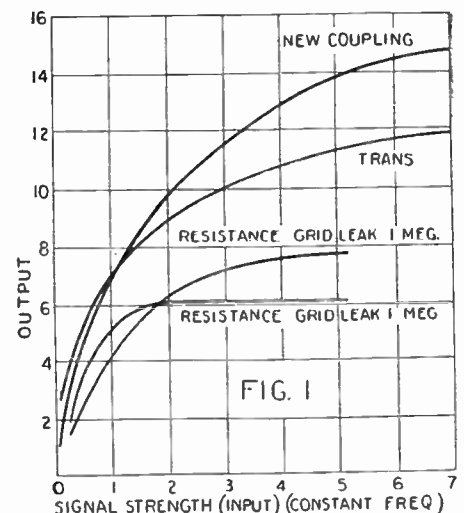

Fig. 4 (above). Circuit diagram of the Donle coupling system. The two windings are on a single core; the grid charges leak off through the winding on the right.

Fig. 1 (right). Curves illustrating capability of various types of coupling devices to respond to signals of varying strength.

Fig. 2 (left). Comparison of efficiencies of various types of amplifiers taken under the same conditions as the curves of Fig. 2, excepting that the latter curves are for one stage only.



\*Donle Electrical Products Co.



# The Jewell Audio Amplifier

By FRED A. JEWELL

Here is a new development in audio frequency amplifiers that will doubtless be of the greatest interest to fans who are after quality of reproduction.

**D**URING the last year there has been great agitation among radio engineers for an audio-frequency amplifier that will give as nearly perfect reproduction as possible. Recently there have appeared on the market many different types of amplifiers, for each of which is claimed by its designer that it is the ultimate and that reception from this amplifier cannot be improved upon.

No matter how many claims the manufacturer may put before the public, discriminating engineers can generally find some weak spot in the armor. For example, although the designer of a certain transformer may say that his instrument, and his only, gives an absolutely flat amplification-characteristic curve, the chances are pretty good that there are a couple of humps somewhere which will cause more or less distortion. Yet transformers are still being sold, and will continue to be sold and used; because for a certain class of work, it is almost impossible to find anything that is any better.

should be large compared with the reactance of the blocking condenser. Now, as he is concerned chiefly with alternating currents, he is at liberty to employ an impedance. This combination has been found to solve the problem successfully, and has been used in the amplifier shown in the accompanying diagram. The reactance is made sufficiently high so that that of the condenser is negligible, even at low frequencies, and at the same time there is never any danger of allowing the grid to become excessively charged.

### BUILDING THE JEWELL AMPLIFIER

The diagram shows the circuit which is used in this amplifier, as well as five stages of radio-frequency amplification. It will be noticed that the detector tube has a special plate construction; in fact there are two plates but no grid. The construction of this type of tube is interesting, as there are two cylindrical plates whose vertical axes are parallel in the tube. Through the centers of these two plates is run the filament of the tube.



The author explaining a receiver in which is incorporated the amplifier explained in this article.

© International Newsreel.

and it is claimed that this much-desired goal is very closely approached by using this double-plate tube.

A careful study of this system of amplification will reveal the fact that advantages have been taken from the systems of resistance and impedance amplifiers and combined to make this type of amplifier as nearly perfect as practically possible. It is claimed that an almost constant ratio of output to input voltages is obtained at all frequencies, with an amplification which is in excess of that obtained in resistance- or impedance-coupled amplifiers of the ordinary type. At the same time, since high impedance can easily be obtained for the plate circuits, low "B" voltages may be used.

### BUILDING THE JEWELL AMPLIFIER

If the reader is desirous of constructing one of these amplifiers, he can easily do so without the outlay of a very great sum of money. For the inductances that are connected in the grid circuits of the tubes, he may use the primary and secondary of an ordinary audio-frequency transformer connected in series aiding. Caution should be observed that the windings are connected so that their fields have the same polarity; otherwise the fields of the coils will buck and tend to annul each other. In the plate circuit there may be used the regulation impedance coils sold for such purposes. The capacity used between these two coils and

(Continued on page 1707)

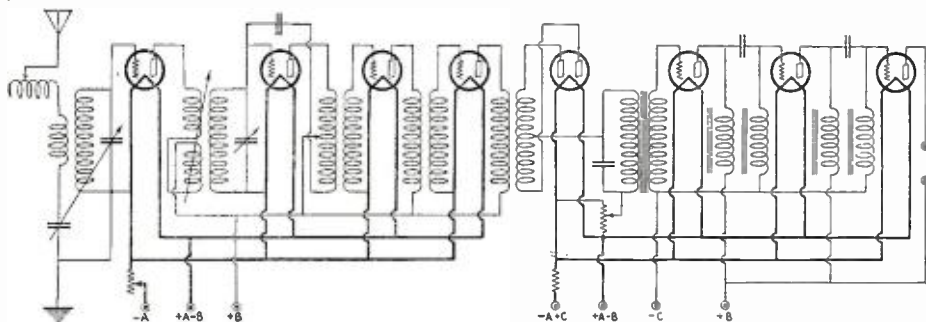

This eight-tube receiver compares most favorably with other circuits of more complicated nature, using the same number of tubes.

However, when quality of reproduction is taken into consideration, the set constructor turns to either resistance-coupled or impedance-coupled amplification. One great disadvantage of both these types of amplifiers is that it is necessary to use at least three vacuum tubes in order that the volume shall not be less than that of the two-tube transformer-coupled amplifier. There is also the added disadvantage of a greater plate voltage which must be employed with resistance- or impedance-coupled amplifiers. Yet these disadvantages are greatly outweighed by the advantage of the vastly improved quality of reproduction obtained.

### SPECIAL COUPLING SYSTEM

In the system used in the amplifier explained here, there is a close similarity to impedance coupling. There is, however, a fundamental difference that, instead of a high-resistance leak in the grid circuit of the second and succeeding tubes of the amplifier, there is used an impedance coil. This is done because, if too high a resistance is used, it will block the tube and not allow the charge to leak off. The impedance coil has a relatively low resistance, when compared to a leak, which has often as much as one or two million ohms. This D.C. resistance is in the neighborhood of only a thousand ohms.

The problem which the designer of an amplifier meets is that of the grid leak to use. Theoretically he should use a resistance which will be high enough to furnish sufficient amplification; but as has been mentioned above, there is the additional danger that he will block the tube. This resistance

The reason for using this special detector tube is to obtain full-wave rectification. Ordinarily the plate current is proportional to the square of the input voltage, i.e. the voltage across the grid of the detector. When using the ordinary type of detector tube the resulting graph, if plate current is plotted against input voltage, is a curve. Now, in order to have distortionless rectification, this plate-current-input-voltage curve should be as near a straight line as possible;

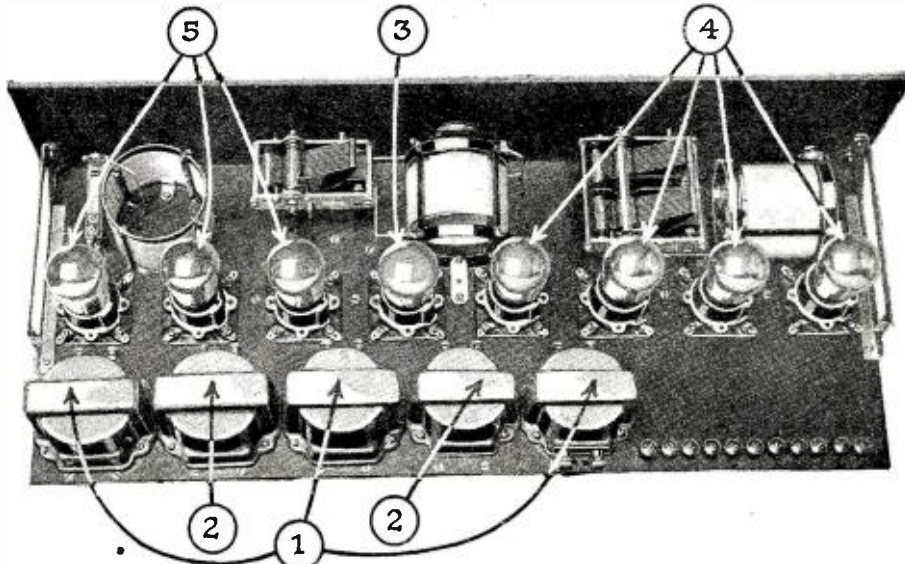

No. 1 shows the grid impedances; 2, the plate impedances; 3, the detector tube; 4, the R.F. amplifiers, and 5, the A.F. amplifiers.



# A Remarkable Quality Receiver

By the Staff of Radio News Laboratories



*In this article is a description of a six-tube receiver which is remarkable for the quality of its reproduction. There are but two controls for this excellent set, and we can recommend it to the lover of good music, for it will surely give him the best reproduction.*

*Editor's Note:—The wonderful reception which marks the operation of this receiver, which has been constructed and fully tested in the RADIO NEWS LABORATORIES, at once places it foremost in the attention of the editors. To any one who loves true musical quality without distortion or lost overtones and harmonics, we are proud to recommend this receiver. It should be remembered that the set is designed only for quality reproduction and not for exceptional distance. Hence, the local stations will come to be more appreciated when listening-in with this receiver. You will be surprised at the distinctive difference.*

and resistance-coupled. The circuit finally decided upon is different only in a careful selection and assembly of standard parts; but the results which have been obtained with this set place it in a class by itself, so far as concerns the purpose for which it was designed—Quality.

It is difficult to describe musical reproduction in words that will give an adequate idea of performance; but it may be said for this set that it is, beyond a doubt, the best for the quality of its reproduction with which the editors have met. This article will point out the reasons why different types of receivers are best adapted to different purposes, such as selectivity, distance-getting, volume, or (as in the case of the receiver here described), fidelity of reproduction; and why the circuit diagrammed on page 1655 was selected for the latter function especially.

non-regenerative receiver; yet, because of its inherent limitations, it is undesirable to employ this. It is neither selective nor sensitive, and it does not afford the volume

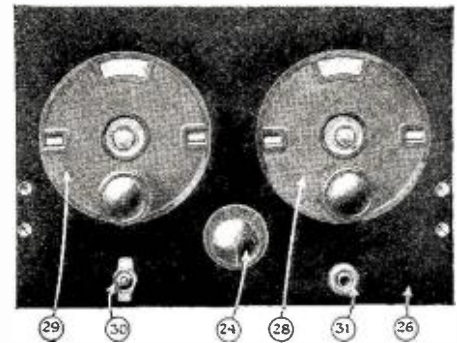

The front panel, 28 is the tuning dial; 29, regeneration dial; 30, filament switch; 31, output jack; 24, rheostat knob.

THE purpose of this article is to give our readers the benefit of an idea upon which the editors of RADIO NEWS have been working for a long time—one which has to do especially with *Quality of Reproduction*. Many circuits have been considered and carefully tested—non-regenerative, reflex and regenerative; super-heterodyne, super-regenerative and radio-frequency; transformer-, impedance-

### COMPARISON OF RECEIVERS

For broadcast reception, the set builder has the choice of constructing anything from a one-tube circuit to a 10- or 12-tube super-heterodyne. In this wide range are all the types of sets referred to above, with their variety of outstanding characteristics, a brief summary of which is given.

Pure reproduction may be obtained with a

which is necessary for loud speaker reproduction. Of course, three or more stages of audio amplification may be added to such a set; but the results, at best, will be far from satisfactory. We therefore dismiss this type from consideration.

The simple regenerative set, without doubt one of the most selective and sensitive available, has countervailing disadvantages. It has not the ease of tuning which is desirable, nor the distance-getting ability of the radio-frequency circuits; though excellent results may be obtained with such, and great numbers are in use today. The quality of reproduction from the regenerative receiver depends upon the type of A.-F. amplification used; usually two stages of transformer-coupled audio, which seem, to the musically-trained ear, to cut off a great part of the harmonics essential in pleasing reproduction. The use of resistance coupling, however, removes this objection.

In the radio-frequency classification, hundreds of different combinations are possible. Two stages of tuned R.-F.—sometimes neutralized, sometimes stabilized, or reflexed or made regenerative—with the various types of audio amplification make up numerous different combinations, some really good and others far from it. In the main, the tuning arrangement is the controlling factor in the performance of receivers of this type. Usually it affects only too noticeably the wave-form of the radio currents, resulting in many of the "side-bands" of the carrier wave being completely cut off. Of course, when this condition obtains, it is impossible to obtain faithful reproduction, regardless of the excellence of the A.-F. amplifiers.

### AVOIDING COMPLICATIONS

This is especially true of reflexed circuits using tube detectors. A careful analysis of the output will show that it is not at all similar in quality to the original. When a crystal detector is used, improvement is at once manifested; but it cannot be maintained that reflexing will add to the quality. Distance and volume, it is true, are materially increased, but not quality—our desideratum in this receiver.

The super-regenerative receiver has shown but little success on the broadcast wavelengths, so we pass it by with little fear

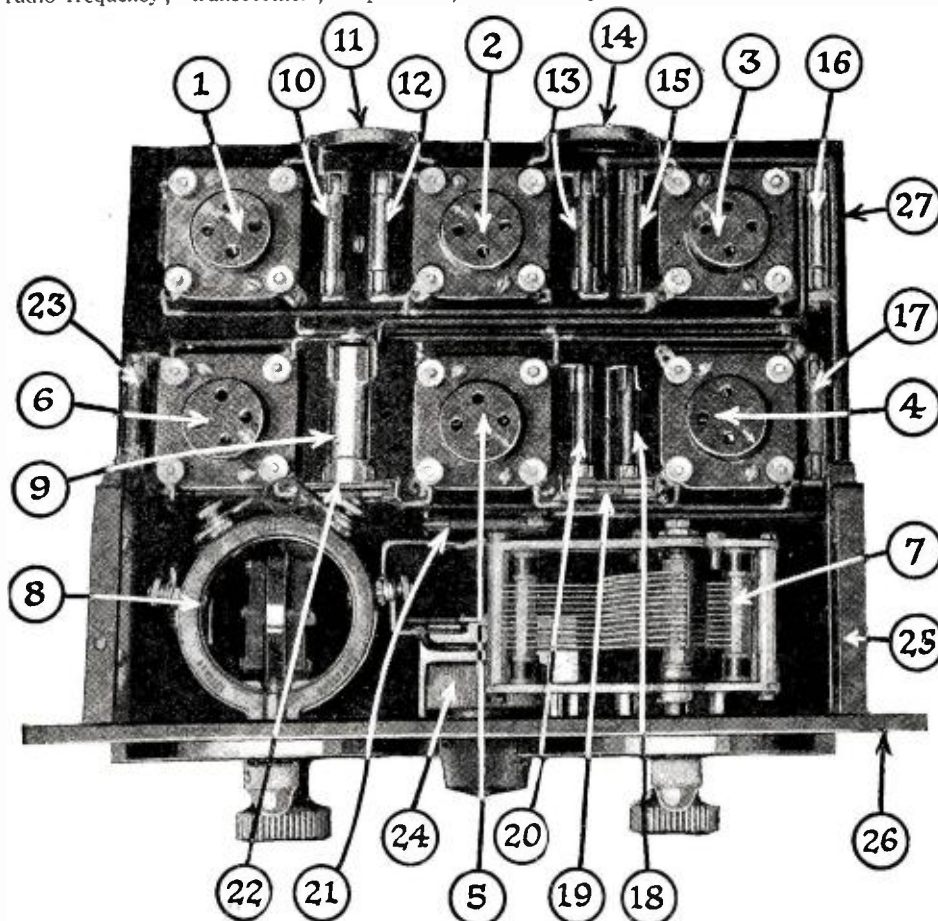

Looking down on the receiver, 1 is the first R.F. socket; 2 and 3, the second and third R.F. sockets respectively; 4, 5 and 6, the first, second and third audio frequency amplifier sockets; 7, tuning condenser; 8, three-circuit tuner; 9, fixed crystal detector; 10, plate resistor for first R.F. tube; 11, coupling condenser for first and second R.F. tubes; 12, grid leak for second tube; 13, 14, 15, 16, same, respectively for second and third R.F. tubes; 17, grid leak for first A.F. tube; 18, plate resistor for second A.F. tube; 19, coupling condenser for first and 2nd A.F. tubes; 20, grid leak for second A.F. tube; 21, 22 and 23, same, respectively for second and third A.F. tubes; 24, 6-ohm rheostat; 25, brackets; 26, panel; 27, sub-panel.



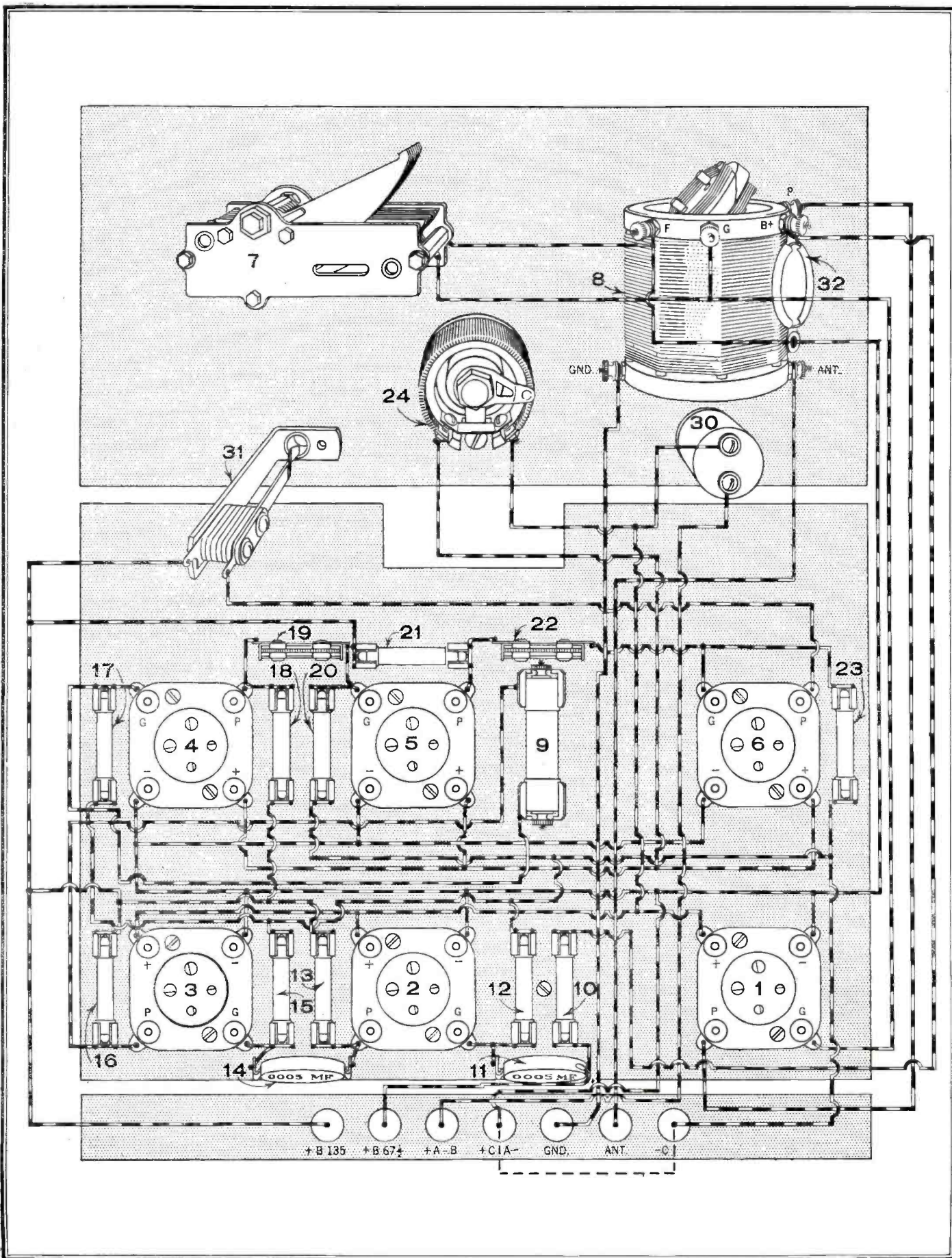

The above picture diagram of the Music Lovers' Receiver will make its simple wiring and construction easily understood by the constructor. The panel, sub-panel and binding-post rack have been drawn on one surface, to make the arrangement easier to follow. The numbers on the parts correspond to those on the conventional diagram and illustrations on other pages. 1, 2 and 3 are the first, second and third R.F. sockets, respectively, and 4, 5, and 6, the A.F. sockets, also in this order; 7, the tuning condenser; 8, the three-circuit tuner; 9, fixed crystal detector; 10, 13 and 16 are the plate resistors for the R.F. tubes, and 18 and 21 those for the first two audio tubes, in the same order; 12 and 15, grid leaks for the 2nd and 3rd R.F. tubes; 17, 20, and 23, grid leaks for the three audio tubes, in that order; 11, coupling condenser between 1st and 2nd R.F. tubes; 14, same for 2nd and 3rd R.F.; 19, same for 1st and 2nd A.F.; 22, same for 2nd and 3rd A.F.; 24, six-ohm rheostat; 30, filament switch; 31, single-circuit jack; 32, .002-by-pass condenser. The "C" battery, for which a connection is shown, is optional.



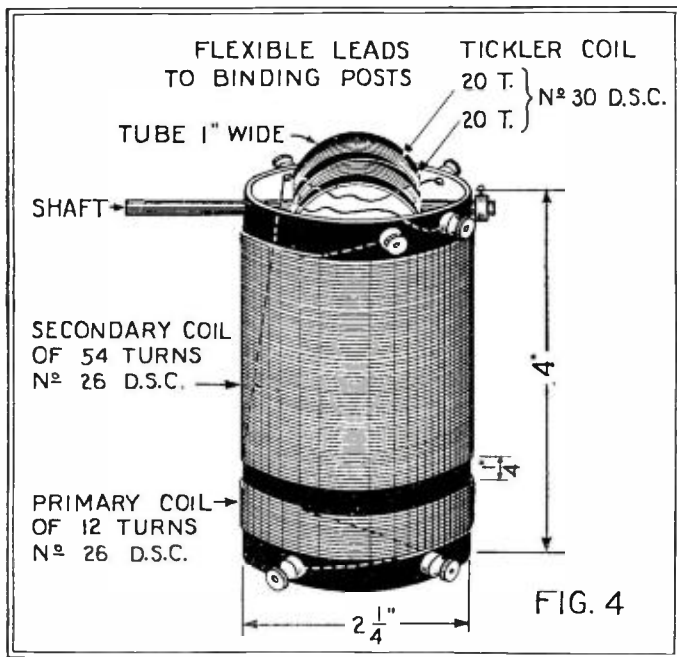

Showing the details of the construction of the three-circuit coupler or tuner as employed in the receiver of quality. If, when the set is completed, there is a decided lack of volume, try reversing the connections to the tickler coil. It is necessary to ascertain the correct connections.



of overlooking possibilities. Its outstanding characteristics, it will be remembered by those familiar with it, are great volume and a high-pitched whistle, the latter immediately disqualifying it in this elimination research.

As for the super-heterodyne, it must be admitted at once that it is a splendid receiver; but it is generally too complex for the average set builder. We are looking

quality, and increases volume and distance reception. Through the use of resistance coupling throughout, and of a crystal detector, true wave-form amplification is obtained, and full advantage is taken of the undistorted rectification thus made possible. In every instance, problems have been foreseen and provisions made to answer them.

Primarily built for reception of local stations with highest quality, this receiver has done some good distance work. Its outstanding physical features are neatness and symmetry, compactness and low cost. The already enthusiastic builder will find the following constructional information sufficient to build a duplicate of the laboratory model illustrated here, with the minimum of trouble or perplexity.

After the materials and parts have been collected, the first step is to lay out the panel. See Fig. 1, wherein all dimensions are given. The sub-panel, as shown in Fig. 2, is next drilled, care being taken to align the two panels so that the brackets can be properly fastened to them. The complete chassis is seen in Fig. 3. Note the way in which the binding post rack has been underslung. Such construction is sturdy and substantial.

The variable condenser and three-circuit tuner are mounted first. The latter instrument can either be purchased or made. Details of its construction can be obtained from Fig. 4. The tickler tube is 1/4" in diameter.

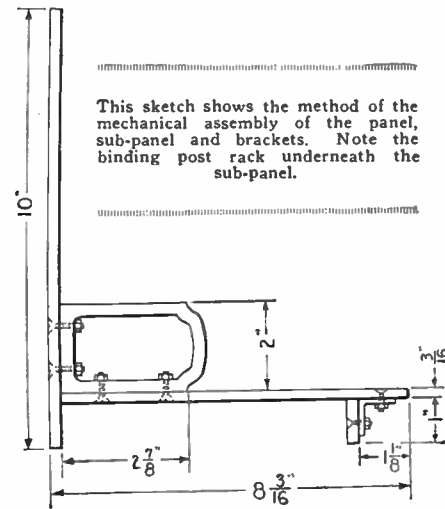

FIG. 3

also for simplicity, not only of operation, but of construction, and for the minimum of cost and labor.

**RESISTANCE COUPLING THROUGHOUT**

Our problem now presents the second question, what shall we place next in importance to our first choice of quality? We have chosen one outstanding feature; yet the receiver must serve our purpose without sacrificing other features desirable in a set. We must have a fair degree of selectivity, ease of control, and volume. These requisites, in the order named, have been successfully provided in the receiver described in this article.

Its small size and the compact arrangement obtained will at once strike the eye. It is individual in appearance, and the circuit employed is unusual; yet nothing has been overlooked, in spite of the appearance of ultra-simplicity.

There is, however, nothing radically unique about it. Resistance coupling is used, in both the radio and audio stages. The regeneration which is effected in the first tube obtains selectivity without the slightest sacrifice of

The dimensions and layout of the sub-panel are clearly depicted in the sketch to the right. The sub-panel is notched in order to allow the panel mounting of the rheostat.

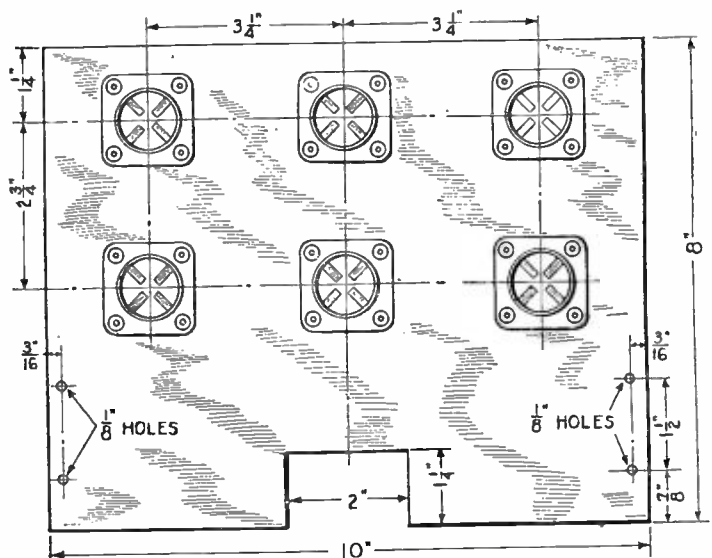

FIG. 2

**LIST OF PARTS**

- 1 3-Circuit Tuner;
  - 1 Variable Condenser .0005  $\mu$ f.;
  - 6 Standard Sockets;
  - 1 Panel, 7x10 inches;
  - 1 Sub-Panel, 10x8 inches;
  - 1 Binding-Post Rack, 10x1 inch;
  - 2 Vernier Dials;
  - 1 Rheostat, 6-ohm;
  - 1 Filament Toggle Switch;
  - 1 Single-Circuit Jack;
  - 2 Fixed Condensers .0005- $\mu$ f.;
  - 1 Crystal Detector (fixed type);
  - 2 Fixed Condensers .05- $\mu$ f.;
  - 5 Fixed Resistors, .1 meg.;
  - 5 Grid Leaks, .5 meg.
  - 1 Fixed Condenser, .002- $\mu$ f.;
  - 6 Binding Posts;
  - 5 Resistor Holders;
  - 5 Grid Leak Holders;
  - 2 Brackets;
  - 2 Small Brass Angles;
  - Miscellaneous Screws and Nuts.
- Approximate cost of parts \$30.00.

Fastening the filament switch, jack and rheostat to the panel completes the list of the parts which go on the panel proper. Attention is then directed to the sub-panel on which the spring-suspended sockets, resistors, crystal detector, grid leaks and grid condensers are mounted. Note particularly the manner of mounting the sockets. The filament terminals of the sockets in the first row face those of the sockets in the second.

This is for ease in wiring. In fact, by the judicious disposition of the parts, the wiring job has been made an easy task. The filament circuit should be wired first. Be careful to include the rheostat in the audio amplifier circuit. This instrument controls the volume of the set and in no way does it affect the quality of reproduction. It is amply large enough to take care of the standard type 201A tubes and also the so-called "high  $\mu$ " tubes. Either type can be used, the latter tubes giving somewhat better amplification. The filaments of the radio-frequency amplifiers are operated directly from the 6-volt storage "A" battery, without a rheostat.

With the filament circuit completed, the allied circuits can be wired; care being exercised to ascertain that no defective equipment such as a short-circuited condenser or a broken resistor or grid leak is used. The wiring may be run both on top of the sub-panel and underneath it.

As the result of a series of tests with the circuit, no "C" battery was found absolutely essential for its optimum operation. One may be used however, inserted in the



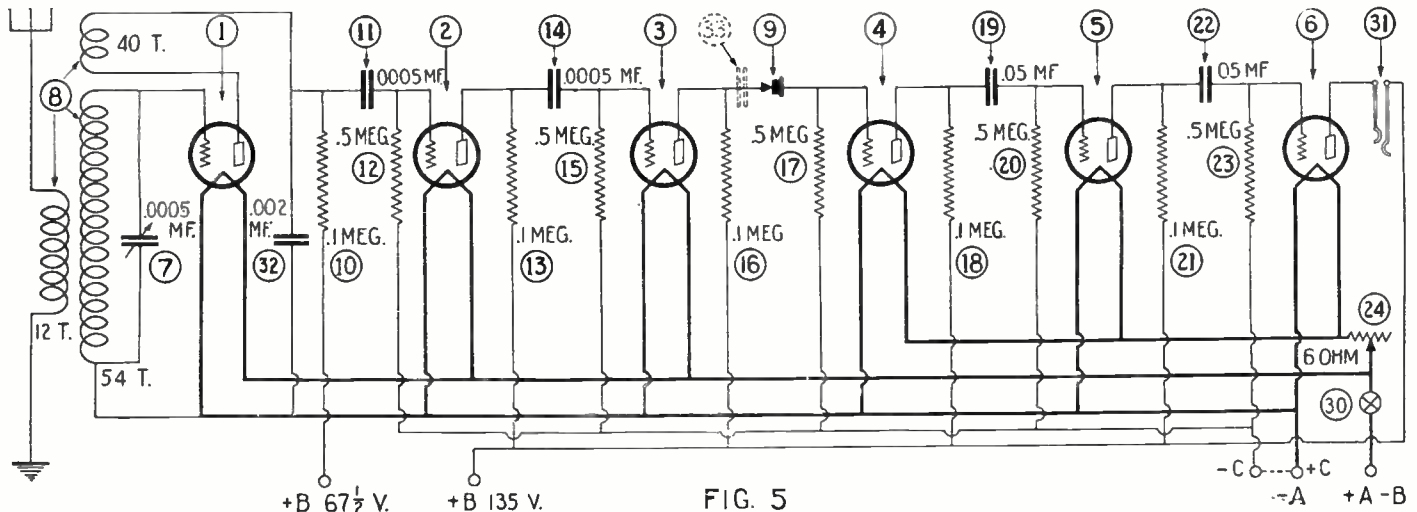

FIG. 5  
The numbers correspond with those on the illustrations. The three stages of R-F. and three stages of A-F. resistance-coupled amplification, together with the crystal detector, make the quality of this receiver above criticism.

regular position between the grid leak and the return to the negative side of the filament circuit. About 4½ volts negative potential can be successfully applied on all the tubes except the first radio-frequency tube, which will require no grid bias.

**TESTING AND TUNING**

With the completion of the wiring, the filament circuit should be tested. If the tubes light properly, the negative lead of the battery should be left connected and the positive one connected in turn to the term-

oscillation and will distort the music. Turning the tickler coil too far, will cause squealing and howling in the circuit. Avoid this.

**RESUME OF THE RESULTS**

In going over the merits and outstanding features of this receiver, it must be borne in mind that the primary object has been obtained only after due and careful consideration of all existing limitations and governing factors. With quality reproduction as the goal, it was necessary to duly weigh all the items entering into the problem. Thus, the selection of the circuit, being of major importance, contained much of the answer to the problem. Then again, the choice of materials, the use of the best values of inductance, of resistance and of capacity, constants which in themselves held the key to the solution—all had to be determined by careful test and close observation. Finally, the arrangement of the apparatus in compact and portable form to conform with maximum practicability—good results, simplicity, reasonable cost and fine appearance was given careful attention. All these distinctive traits have been incorporated in this receiver. Nothing has been left to the imagination of the reader. In its perfected form, the finished product is well worth serious consideration as being the acme of satisfaction in its own realm of true quality reproduction.

There is no doubt in our minds that this set will prove very popular among the readers of RADIO NEWS. There is a great tendency for the designers of radio receivers to attempt to design receivers that will work under all sorts of conditions, and will do all kinds of work. In other words, it amounts

to the same things as making a Ford touring car do the work of a 10-ton Mack truck.

This receiver was designed for quality reproduction. It must not be expected that it will do any more than reproduce with fine quality the concerts broadcast by the local stations. If one should try to bring in the distant stations, the regeneration required to do this might spoil the quality. As a matter of fact, the only reason why the first stage of R-F. was made regenerative was to make the set selective. With only one tuned circuit, it is evident that this was the only way out.

The set will, however, bring in stations located afar, just as any regenerative receiver will, but the reader must remember that if the quality resulting does not suit him, the reason is that he is using the set to do something that it was not intended to do.

IT is against the policy of RADIO NEWS to publish the names of manufacturers or of makes of instruments in connection with the apparatus described in these pages, but this information will be gladly given privately. If you are interested in any special instruments described here, address a letter to the I WANT TO KNOW DEPARTMENT, enclosing stamped return envelope. The names and addresses of the manufacturers will be given free of charge. —EDITOR.

inals marked 67½ and 135. The tubes should not light when the battery is so connected. If they do, there is a mistake in the wiring or a short circuit. The fault should be remedied before an attempt is made to connect the "B" batteries. If the circuit tests all right, the batteries should be connected; in the event that 135 volts of "B" battery is not procurable, 90 will serve, the difference being a slight diminution in volume. Lower potentials than 67½ volts on the plate of the first radio-frequency tube may mean rectification rather than straight radio-frequency amplification, so be careful not to tolerate this condition. However, if such is the case, there will be no immediate bad effects other than too much volume and lack of sharpness of tuning.

When receiving broadcast stations, no difficulty should be experienced with uncontrollable oscillations. The receiver is capable of howling; but inasmuch as there are but two controls, one for tuning and the other for regeneration or increased volume and selectivity, the howling can be perfectly controlled after a few moments of practice. It will be noticed when operating the receiver, that the variation of the tickler coil, for a complete revolution of the tuning dial, is but 10 or 15 degrees on the regeneration dial. In other words, but a slight change of the regeneration dial is necessary to afford maximum regeneration over the entire wavelength range. The regeneration dial should never be turned to the point at which a decidedly noticeable rushing noise is heard in the loud speaker. This is radio-frequency

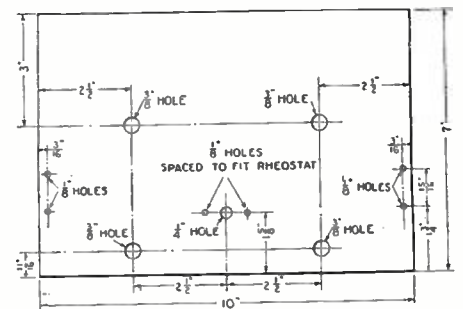
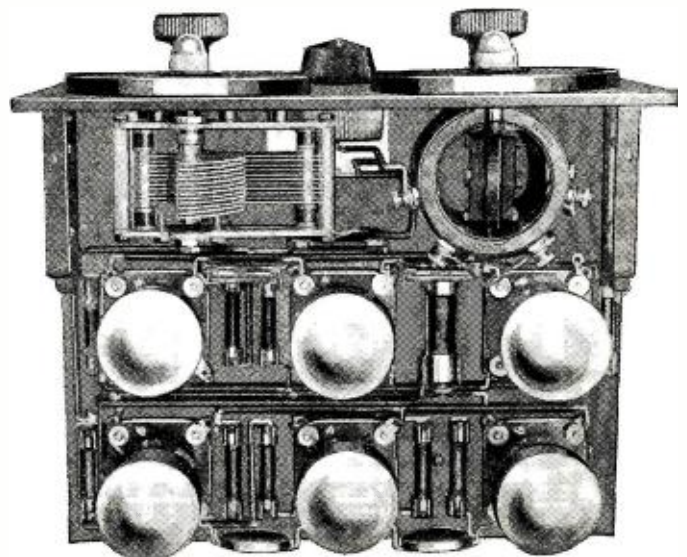

FIG. 1  
The dimensions of the front panel and the location of all the necessary holes is shown above.

The receiver is one of the very neatest in appearance that we have seen for some time. Our readers are urged to duplicate the good work, and if possible improve upon it. The illustration shows the receiver with the tubes in the sockets.





# Everyman's Receiver—The Fenway

By LEO FENWAY

The following article is the first installment of a complete description of this popular super-heterodyne receiver. Here are the instructions for constructing and testing a most important part of the circuit—the oscillator and first detector.



IN the greatest city in the world—New York—as in a myriad of towns and hamlets the comparatively new drama, "How to Build Your Own Radio Set," is being staged by the enthusiasts among radio listeners-in. In all radio dramas the principal characters—the coils, condensers, transformers, tubes—have practically the same rôles; but the plot of the production—the circuit—is in a state of continual modification.

The dramatist sets his stage, introduces his characters, and the action goes on in the form of a beginning, a body, and an ending. The radio constructor-dramatist is under the same necessity of visualizing his receiver in successive scenes. If he keeps in mind that these scenes are the basis of his composition, he may feel that he has mastered the most difficult problem of assembly.

The beginning of the properly - constructed radio set-building drama has for its function the presentation of the conditions confronting the builder. What is that condition in the version entitled "Everyman's Receiver—The Fenway." We pause for a moment as the curtain rises on Fig. 1.

A glance shows us that the first act will have the "business" of making the first three tubes function. And immediately the problem confronts us: "How well can we make these three tubes perform—well enough to operate a loud speaker on locals?" We already know that the first tube is a stage of tuned radio frequency with regeneration; the second tube a modulator or first detector; the third tube is the oscillator. We realize that if we try the set on all three tubes the oscillator is likely to—in fact, should—"mush" the signals of the other two tubes. Therefore we will build the first two tubes with the oscillator but when the set is tested we will keep the oscillator tube out of the socket.

The characters—or translating, the parts—appearing in our first act are:

### CONSTRUCTIONAL WORK

The first act of the drama is now under way: after the panel is bored for the arrangement shown in the illustrations (making sure that the center shafts of all instruments turn smoothly) it can be mounted upon the baseboard with nickel-headed wood screws. Two of the cans may now be put in place. The first and third will be held in position by the condensers, but the center can must be attached to the panel with short machine screws, as its condenser (that is the plates) must not touch the can, since the rotor plates are not grounded until after the current has passed through the pickup coil, L3. This must be watched.

The rest of the characters—or parts—seem to fall naturally into their proper places. It is now perfectly obvious that the main character in Act I is the two-circuit coupler.

When the coupler is all wound, test it for continuity of circuit. It should now be ready for mounting upon the panel. The copper can, four inches square, is placed around this coupler, and the little insulating square (2½ x 2½ inches) should be attached to the back of this can. Upon this insulator are mounted the tap switch and the three taps. Place the knob of the coupler upon the shaft and the coupler is ready for wiring into the circuit.

The sub-panel, at the back of the set, should not be screwed to the baseboard. Upon this mount the 6-ohm rheostat and the binding posts. (Only one rheostat is to be mounted at this time; the other will come later.) Next mount the double-circuit jack in the top hole on the panel. Now come the three dials. With the three condensers all in mesh—the plates all in—set the dials to read 100, then tighten the set screws to the shaft.

Remove the nuts from the binding posts and put a soldering lug on every post. Put the nuts back and tighten firmly. Put all the binding posts on the sub-panel and then mount the fuse holder behind the first can. Now mount the A battery switch. The four copper cans must be connected together and grounded on the minus A. The minus of the voltmeter, and the plus of the milliammeter, should be connected to the cans as these two connections are grounded.



The panel of this super-heterodyne is symmetrical and the meters show the conditions which should be known.

connected to the cans as these two connections are grounded.

### WIRE CAREFULLY

The first step of the assembly being completed, the parts are ready for wiring. If you use colored wiring you can easily trace the circuits if trouble comes. Solder all connections well; and if you use resin core solder watch out for "resin joints," where the wire is held by resin but no connection is actually made with solder. You really need a good hot electric iron for soldering. Make haste slowly and with all the care and patience at your command, as your wiring will

This should now be prepared, following the specifications given in Fig. 4. Be sure, in winding this coupler, to wind the first twenty-six turns spaced, and all on one side.

The purpose of spacing the first twenty-six turns is to cut down the distributed capacity. Ordinarily, spacing the turns means spacing the metal wire itself; this is usually accomplished by covering the wire with silk or cotton. But such spacing is not enough; as the distance between turns should be about equal to the diameter of wire used.

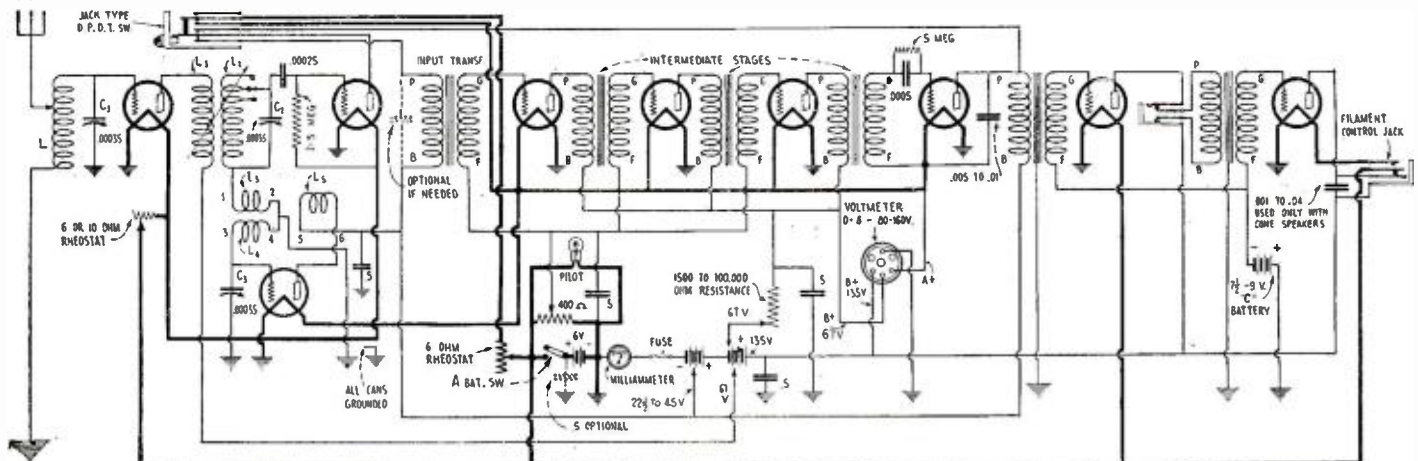

By the introduction of the jack switch, shown at the upper left side of the diagram, the receiver can be made to operate on either four or nine tubes.



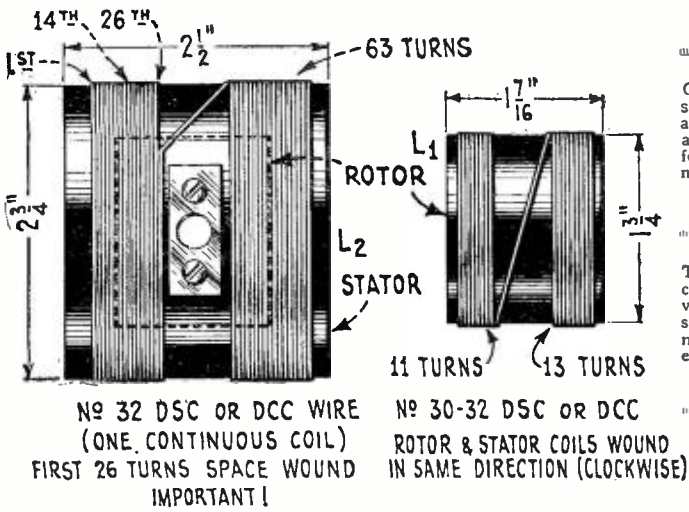

On the left are shown the constructional details for inductances, L1 and L2. This variable radio-frequency transformer is the means of connecting the radio-frequency tube to the first detector.

The sketch on the right indicates the manner in which the various coils of the Fenway super-heterodyne receiver are made interchangeable, in order that different wave-bands may be received.

BUSHINGS TO RAISE COIL FROM BASE

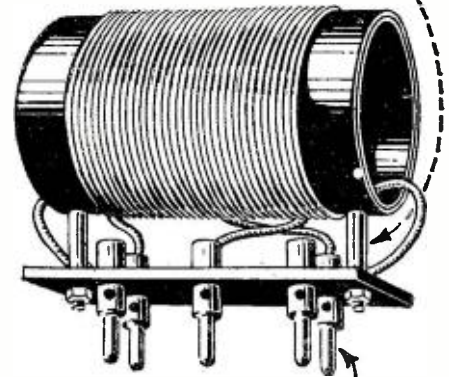

CONTACT PLUGS

reflect credit or discredit upon you in the form of results.

When the wiring is all completed put the first two tubes in the set, temporarily connect the plate of the first detector to one prong of the double-circuit jack, the B plus 45

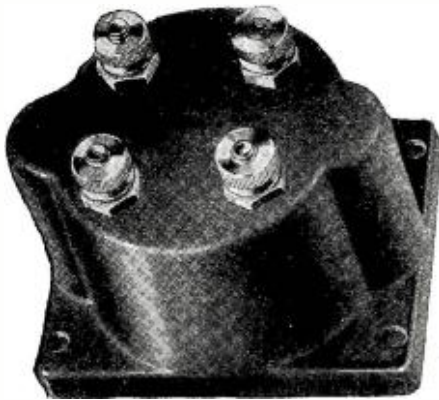

This long-wave transformer is excellently adapted for use in the Fenway.  
 Photo, courtesy Silver-Marshall.

volts to the other prong (meaning outside prongs, of course) and the set thus far is ready to be tested.

We are now very close to the end of the first act. The problem which confronted the builder at the beginning is about to be answered. It was, if you remember: "How well can we make the first three tubes perform? Will they operate a speaker with fair volume on locals?" The problem is solved by connecting the batteries, antenna, ground and the speaker to the set. The filament switch is then closed, and the first act is completed—the set works!

WHYS AND WHEREFORES

The curtain falls on Act I. We pass out of the foreground and into the lobby—what we actually do is, leave the whole "mess" on the kitchen table and go to the movies—but that thought introduces the apple of short-circuits and hinders the drama in the construction of "Everyman's Receiver—the Fenway."

So we pass into the lobby and listen to the comments on the first part of the show. "Building the first three tubes," we hear someone saying, "is certainly a novel way of constructing a radio receiver. But it sounds like a sensible way. Instead of mounting all the apparatus for the nine tubes, and then trying to make the whole set work, it seems plausible that building it tube for tube is the better method. And that reminds me," he continues, "that when I built my first set it was a one-tube affair. I operated that set on one tube for over a year, then, when I added two more tubes—an audio amplifier—the whole set functioned beautifully. But later, when I attempted to build a three-tube

set for a friend of mine, I ran into lots of trouble, simply because I didn't get the set working on one tube first."

"What I don't understand," another remarked "is why copper cans are used to shield the important circuits."

"That's just the point," said still another. "The important circuits are shielded in order to keep out interference, make the set more selective and improve the quality of reception. And shielding of that nature—where the condenser, coil and tube are completely isolated—is coming more and more into general practice. Did you notice that the wires coming out of those cans are at the very bottom, through a hole only large enough to accommodate the wire itself, and possibly a piece of spaghetti that is acting as a protection for the wire? And no attempt was made to pull two or three wires through one hole."

"What I was wondering," said the first speaker, "is what could be done if the thing failed to work?"

HOW TO CHECK UP

"Well," said someone, "you saw how the set was constructed—tube for tube—then the easiest method of locating any trouble is to go back over the set, beginning with the first tube. If you were to call in a professional trouble shooter—assuming that there is such an animal—he would doubtless locate your trouble through the process of elimination. He would know that only through the systematic elimination of probable defects in the set can the real cause or seat of the trouble be found. Hasty here-and-there quick-search methods generally result in

failure. There is always a "certain something" that one can put his finger on, which explains beyond any further speculating why a Fenway will not "percolate"—fails to bring home the bacon.

"Say you find the first condenser has no tuning effect; you turn it this way and that way, but nothing happens. What's wrong? Well, look inside the first copper can. You see there a coil, a condenser and a tube socket—perhaps a tube. Which one of those three or four things isn't functioning? Test the coil for shorts and continuity of circuit;

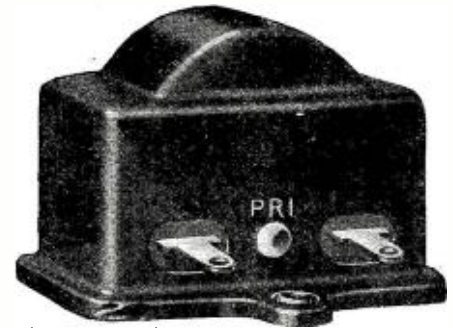

Another type of long-wave transformer that may be used in the Fenway.  
 Photo, courtesy of General Radio Co.

test the condenser for a short circuit; test the tube socket—is it grounded, anywhere, to the can? How about the tube? Are the condenser, coil and socket properly connected into the electrical circuit? Have you  
 (Continued on page 1698)

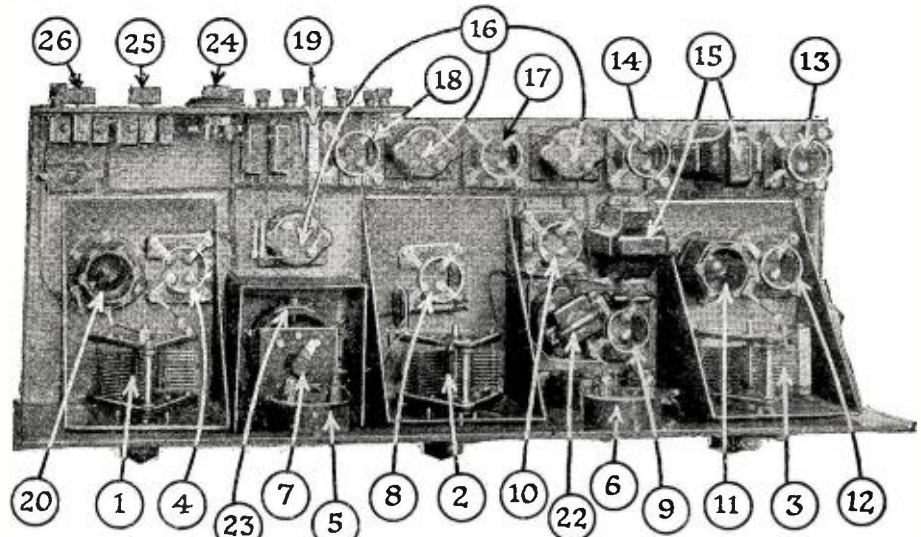

1 and 2 show tuning condensers; 3, oscillator condenser; 4, R.F. socket; 5 and 6, meters; 7, wave-change switch; 8, first detector; 9, second detector; 10, 17, 18, I.F. sockets; 11, oscillator coupler; 12, oscillator socket; 13 and 14, A.F. sockets; 15, A.F. transformers; 16, long-wave transformers; 19, jack switch; 20, antenna inductance; 22, grid leak and condenser; 23, R.F. transformer; 24, potentiometer; 25 and 26, rheostats.



# A Knockout Portable

*This unusual set is not only extremely light and compact, but easy to operate, remarkably sensitive, and gives an excellent volume and quality of reproduction. Many of our readers will feel the urge to build a similar one for use this summer.*

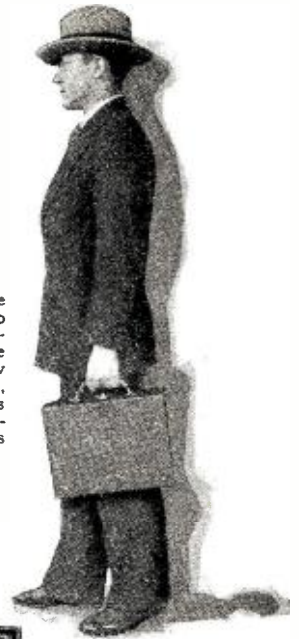

This set is quite as convenient to carry as the typewriter in whose case it fits. How the interior looks, when the panel is raised for renewals or adjustments is shown below.

THE other day a man walked into our editorial sanctum and placed upon our desk a black leatherette box, which we at first took to be a portable typewriter. He opened up the cover of the box and took out a pair of receivers, which he handed to us, and laconically said "Listen."

He turned one dial and made a further adjustment, and some ten local stations came rolling in, one after the other, although this portable radio set, for such it was, rested on top of our steel desk, and notwithstanding the fact that we are located in a 12-story steel building, where loop reception is always notoriously poor.

Here, then, is a real 2-tube portable receiver, with enclosed loop, that can be taken anywhere and which weighs only ten pounds. It can be constructed by anyone, and will well prove worth the little trouble expended in building it.

It is the first really light and portable radio set that is not fussy and that actually works. —EDITOR.

loop to the tuning inductance caused a variation in regeneration. If the loop was near, and in inductive relation, the signals were noticeably increased and the circuit would even begin to oscillate violently.

The potentiometer was used extensively in controlling oscillations, and although it was and is admitted that it gives the finest control of regeneration, yet better results could be obtained by employing a more efficient circuit. At any rate, the use of the potentiometer involved an additional control and

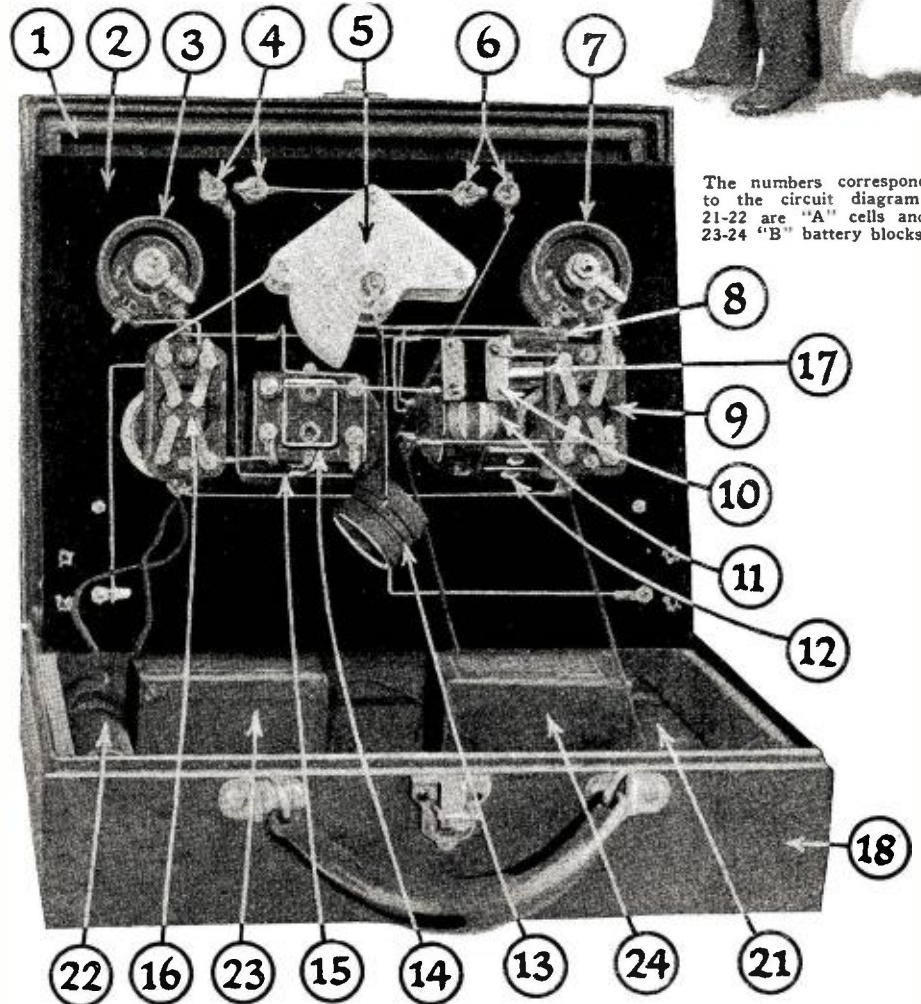

The numbers correspond to the circuit diagram; 21-22 are "A" cells and 23-24 "B" battery blocks.

A PORTABLE receiver for vacation time! That is what every real wide-awake and live radio enthusiast wants. And in this day of radio progressiveness, there are many articles appearing in print which seem to the uninitiated to give just what they are looking for. Here is one of the very best of really portable sets.

The first portable receivers made were cumbersome affairs employing highly inefficient circuits and it was considered a great feat to be able to receive over distances of more than 25 miles. As time went on, the untuned radio frequency transformer was replaced by the better tuned units, and the number of tubes decreased from six to three and even two. Reflex circuits sprang into popularity and a waning faith in the potentiality of the crystal detector was offset by the introduction of the fixed crystal. The loop antenna was experimented with, but it was found that there resulted very little difference between various types. One thing observed was that the proximity of the

what was wanted was a simplified tuning arrangement capable of being operated by even a child.

Regarding the battery supply, for both the filaments and plate circuits of the tubes, battery manufacturers were quick to foresee this condition, and readily made available small but powerful units having exceptionally fine characteristics, especially longevity. Thus the set builder had co-operation from all.

But it was felt that the primary requirement of a portable set was sadly overlooked. What was wanted, seemingly, was not to be had; for what purported to be a portable set was in reality a heavy, unwieldy thing, ugly in appearance, poor in reproduction and utterly failing in its purpose of being trouble-proof. Hence, it was decided to get something better and this was achieved after some careful planning and experimenting.

### THE PORTABLE SET

A regenerative reflex circuit using two 199 tubes was constructed. No potentiometer, no crystal, no multiplicity of tuning controls, no veritable "piano weighing a ton," no unnecessary embellishments; but almost "profound" simplicity, portability in every sense of the word, good quality reproduction and trouble-proof are the earmarks of this set.

The total weight of the set is about ten pounds and it is fitted into a small typewriter case. Everything is self-contained. The batteries, the loop and all other accessories fit snugly inside the case.

The set has proved its worthiness by receiving more than a dozen of the New York stations, when placed in offices throughout the city and when taken along on the train. Provision is provided for two headsets and if the owner cares, he can allow his neighbor on his seat to share the program and enjoy

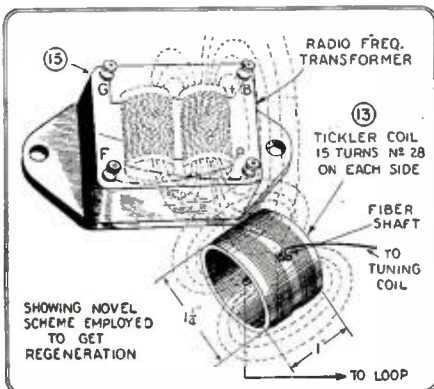

This diagram shows the manner in which the tickler coil is variably coupled to the plate (primary) coil of the R.F. transformer.



what may be otherwise a trying, tiring and tedious trip.

**CONSTRUCTION**

The panel and carrying case are the first considerations. These may vary in size according to the discretion of the builder and the availability of the material. In this specific case, the size of the panel is 10x12 and the case 4 inches deep, from cover to bottom. The cover itself is 1 1/4 inches deep. Its sides contain the fixed loop which has ten turns of No. 16 flexible lamp cord, the ends of which are led to terminal binding posts on the panel.

The loop is tuned by means of a .00035- $\mu$ f. variable condenser; but, as will be noted in the diagram, this tuned circuit includes a grid coil so arranged that it is coupled to the plate circuit of the first tube. This coil contains 30 turns of No. 28 D.S.C. wire, wound on a form 1 1/4 inches in diameter and 1 inch wide.

**A MOST NOVEL SCHEME**

It is placed in inductive relation to the primary of the radio frequency transformer and is made variable by means of a shaft and attached dial. Turning this dial causes the coupling between grid and plate circuits to vary, and offers a practical solution for getting the utmost regeneration over the entire range of the broadcast wave-lengths.

The detector is coupled to the radio frequency amplifier and reflexed audio tube by means of an untuned radio frequency transformer. A small R.F. transformer is used to prevent stray fields with resultant erratic operation, due to self-oscillation.

A variable grid leak is used for better results and the plate circuit of the detector is coupled back with the first tube, through

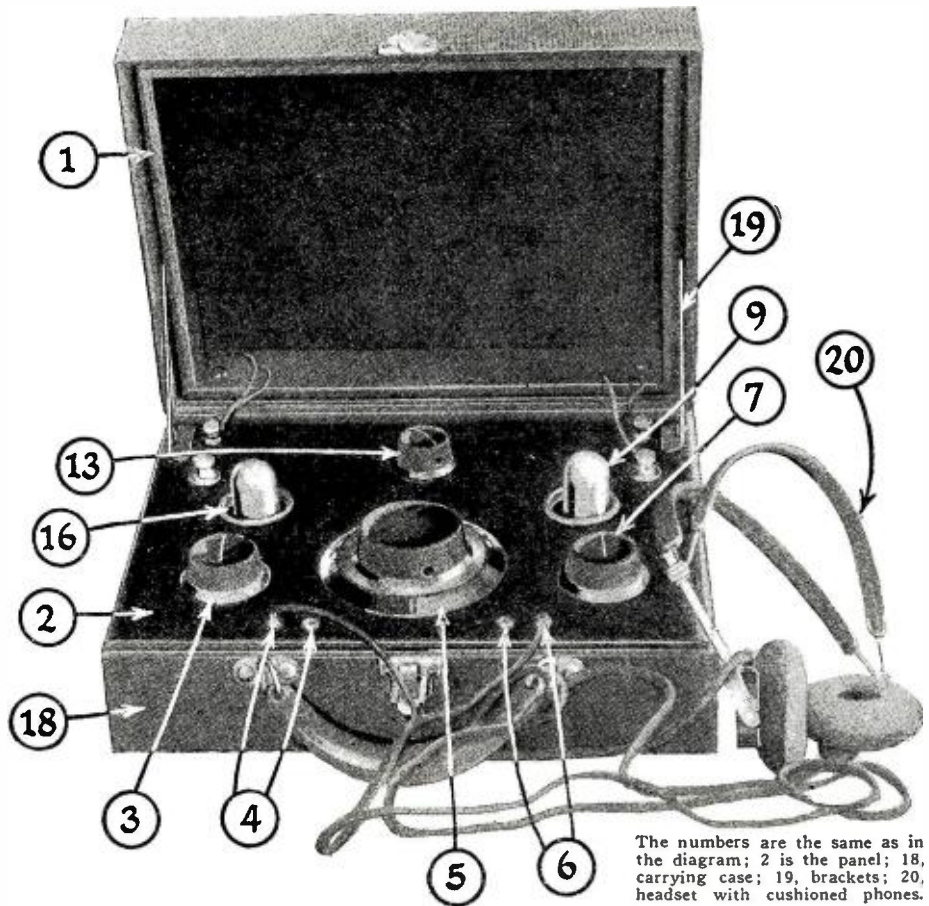

The numbers are the same as in the diagram; 2 is the panel; 18, carrying case; 19, brackets; 20, headset with cushioned phones.

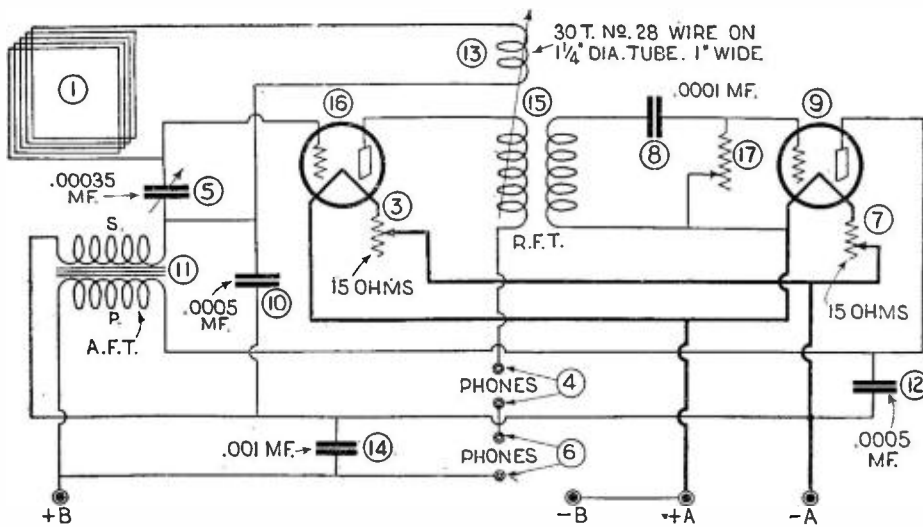

The miscellaneous equipment will include some binding posts, several feet of flexible wire, a couple of brackets and an assortment of machine screws. Two brackets are used to attach the panel to the case, and flexible leads connect the loop to binding posts on the panel.

**OPERATION**

By orienting the plane of the loop, stations can be brought in with the usual direction-finding characteristics. Under certain conditions, the case may be closed, and the set carried around tuned to a station with music being reproduced. However, this practice is not to be advised, for trouble may be experienced with self-oscillation.

When only one pair of headphones is used, the phone tips are placed in the two

the use of an audio frequency transformer. By-pass condensers are clearly shown in the circuit diagram, and aid materially in the operation of the set.

**LIST OF PARTS**

The necessary parts for the construction of this receiver include, besides the panel and carrying case:

- 1 Variable Condenser, .00035- $\mu$ f.,
  - 1 Radio-Frequency Transformer,
  - 1 Variable Grid Leak,
  - 1 Audio Transformer,
  - 1 Grid Condenser, .0001- $\mu$ f.,
  - 1 By-pass Condenser, .001- $\mu$ f.,
  - 2 By-pass Condensers, .0005- $\mu$ f.,
  - 2 Sockets, type-99,
  - 2 Rheostats, 15-ohm.
  - 4 Phone Tip Jacks,
- Approximate cost of parts under \$10.00

The diagram above, numbered like the pictures, shows the loop, 1; rheostats, 3 and 7; phone jacks, 4 and 6; grid condenser, 8; detector, 9; by-pass condensers, 10, 12, 14; A.F. transformer, 11; tickler, 13; R.F. transformer, 15; R.F. and reflexed A.F. tube, 16; grid leak, 17.

Below: details of the construction of the loop.

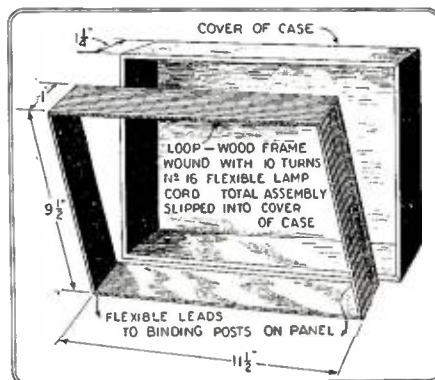

It is against the policy of RADIO NEWS to publish the names of manufacturers or makes of instruments in connection with the apparatus described in these pages, but this information will be gladly given privately. If you are interested in any special instruments described here, address a letter to the I WANT TO KNOW DEPARTMENT, enclosing stamped return envelope. The names and addresses of the manufacturers will be given free of charge. —EDITOR.

outside terminals, as clearly shown in the illustration above. This method of connection allows of a series connection for headsets—the best manner of employing them.

In case the batteries run down after long usage, the panel is merely slipped upwards and new ones readily snapped into place. Two 3-cell flashlight batteries in parallel supply the filament current. The "B" battery voltage is furnished by the smallest blocks obtainable, two 2 1/2-volt units being used.

Anyone who is contemplating the construction of a real portable set will make no mistake in duplicating the receiver here outlined, for it fulfills all the requirements of such a set and gives very good results.



# A Bell-Wire Receiver

## By JOHN WALLACE GILLIES

*The use of larger size wire for the winding of inductance coils is becoming more and more common. Mr. Gillies has utilized coils wound with bell wire in the receiver here described, and receives programs with great volume. This set is recommended especially to experimenters.*

**A**N article by Sylvan Harris appeared in the January, 1926, issue of RADIO NEWS, in which the bold assertion was made that a radio frequency coil made of bell wire would have something on any other coil; and with such seeming authority that the reader could not fail to grasp the fact that Mr. Harris was in a position to make some measurements, so the assertion was accepted as gospel. Surely this bell wire set would outperk all others.

To get a pound of bell wire was the first step; it had a nice, bright red color which was quite fascinating, and a nice waxy feeling which seemed to add to its inherent mystery. It seemed to say that better sets were just ahead of us. Recent issues of radio papers had had much to say about four-tube sets, with a stage of R.F. in front of a regenerative detector, and which would not chuck whistles into the air. It seemed to be the best thing to do, if this bell wire idea was so good, to build such a set and see what it would do when compared with others of a similar hook-up. The writer had built nearly everything in four tubes, including Roberts, Browning-Drake, various concoctions of his own, and the TC, which last seemed to have something on the field. Against this we would compare the bell wire receiver, knowing it would have to step some to make an equal showing.

An old 7x30 panel which had been used for something else was available, and large enough to contain the elephantine coils; also a baseboard 9½x29, which was large enough to skate around on easily. A stage of straight audio and a stage of push-pull were designed, for if this rig had the volume expected, those two tubes would be needed at the end.

### ELEPHANTINE COILS

Bell wire runs 12 turns to the inch, and these coils are very large, so plenty of space would be needed. A glance into our bible showed that a coil of No. 18 D.C.C. wire, which would tune over the broadcast range with an .0005- $\mu$ f. condenser, requires 41 turns on a 4-inch form. Since it is evident that the bell wire coil would have less distributed capacity, a start was made with 49 turns. This tuned too high on the dial, and it would be better to use 51 or 52 turns. The condensers used were straight-line wave type.

With some difficulty, 4-inch hard rubber tubes were obtained, about 5 inches long. Leaving a little space for the brackets, it

was possible to wind 49 turns of the bell wire on these forms; but they should have been at least 5¼ inches long to accommodate the needed turns. When completed, these coils looked more like an elephant's foot than any radio coil the writer had ever seen. As they were so big, it was necessary to place the primary and tickler tubes inside the secondary, or they would have been too long. These were made of a smaller diameter, 3 inches, to reduce primary-secondary capacity and minimize tendency to feed back. They were suspended inside the secondaries by means of brass machine screws, set in at three points; the inner tubes being drilled and tapped 6-32, and the larger tubes being drilled to pass the screw freely. Thus, when suspending the inner forms, they could be centered by taking up on one screw and loosening the others.

The primary winding was next; that of the antenna coil was arbitrarily set at 12 turns of No. 24 D.C.C. wire, and remains such. That of the second R.F. coil was tried with 16 turns of the same wire, the result being severe oscillation at all wave-

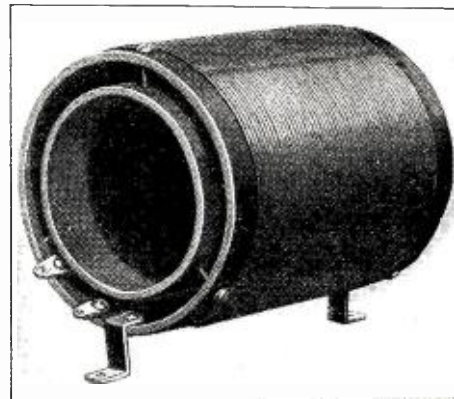

The R-F transformer, wound with No. 18 bell wire; showing the method of attaching the inner form which carries the primary and tickler windings.

lengths were found to be all right except on the very low waves; and a further reduction to nine turns worked well.

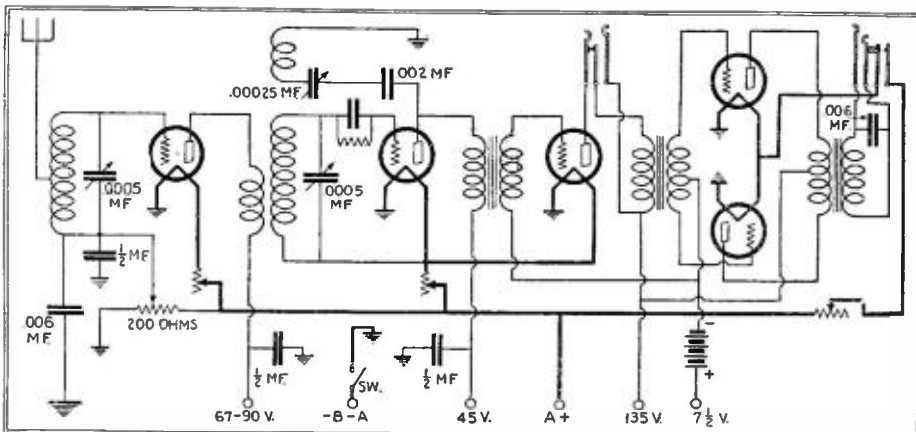

This is the circuit diagram of the bell-wire receiver, as rearranged to suit reception conditions in the average locality. The changes from the first hook-up will be seen by comparison with the partial diagram on the opposite page. Except for the regular ground in the antenna circuit, the ground connections indicated are made on the brass-covered baseboard as well as A-B—.

lengths. A primary of 20 turns of No. 30 wire wound in a slot was then tried and though the oscillation was less, the result was not satisfactory. Then 12 turns with the No. 24 wire were tried, which resulted in oscillation when the set was tuned at 300 meters, but none above that point. Then ten

All this was done at Sixth Avenue and Fortieth Street, New York City, perhaps the worst location in the country for radio reception; and the set was to be taken out into the country for final tests.

### CONNECTING THE SET

Capacity feed-back was adopted, because of the difficulty in making a rotating tickler, and also because a compact .00025- $\mu$ f. variable condenser was at hand. Twelve turns of No. 24 D.C.C. wire were wound on the inner form and placed inside the grid end of the coil; and this worked very well, oscillation taking place, on the high waves, at a condenser setting of 45° and at less than that on the low waves. Since there are 45 volts across this condenser, and a "B" battery short is possible through contact of plates, a .002- $\mu$ f. condenser in series was added as a precaution.

The "A—" "B—" leads were placed together and connected to the baseboard, which is of wood, covered with 36-gauge brass sheeting, fastened down with copper tacks. All rheostats were set in the positive leads; thus eliminating negative leads, as all minus connections are made directly to the baseboard. This simplifies wiring. The metal baseboard is connected to the batteries through the filament switch, and when the

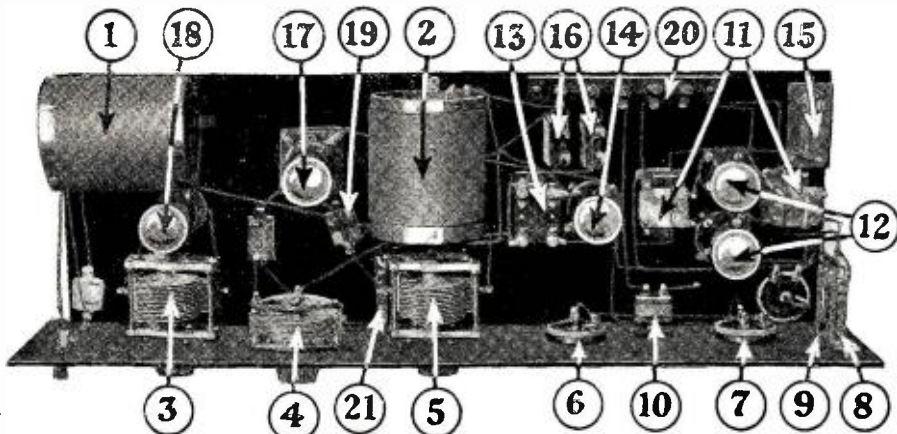

No. 1, the antenna coil and 2, the R-F. coil, wound of No. 18 bell wire; 3 and 5, tuning condensers; 4, small variable condenser, protected against shorting by fixed condenser; 6, 7, rheostats; 8, 9, jacks; 10, filament switch; 11, 12, push-pull transformers and their tubes (2nd A.-F.); 14, 15, first A.-F. transformer and tube; 17, detector; 18, R.-F. tube; 19, grid condenser and leak; 20, terminal board.



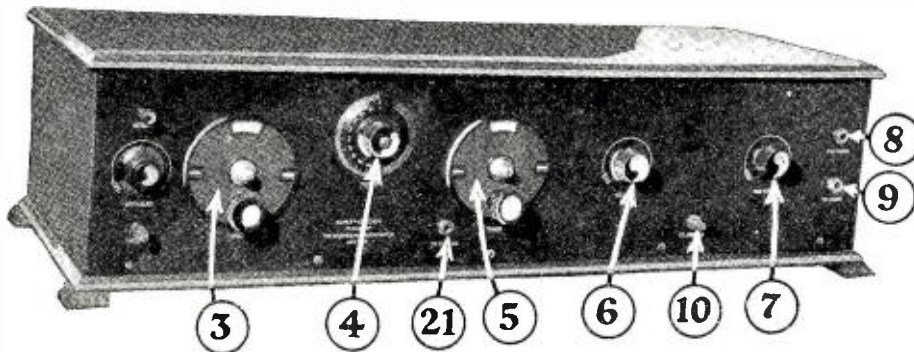

The factory-made appearance of this receiver is something which is commended to every set constructor. The numbers correspond to those on the opposite page.

set is turned off, this part is dead. All condenser cans and transformer cores are grounded to the baseboard; the latter being merely screwed down after scraping the paint off the bottom. The baseboard is connected to ground through an .006- $\mu$ f. condenser; so that a charger may be left connected to the "A" battery and operated when desired by merely plugging into the circuit, without disconnecting the ground lead. (This is true only for a tube-type of charger, where the current operates to the plate and is off when the filament is not burning.) The quality of the set, which is very fine, testifies to the success of these precautions.

The first audio is one of the new heavy-core transformers, 3-to-1 ratio; the second stage is push-pull, and it has seldom been necessary to use it. On the audio end 135 volts of "B" and 7½ volts of "C" battery were used; and the milliammeter shows that the tubes operate properly. The .006 condenser across the output of the second audio does a great deal of work, and "takes the curse out of it," so this should not be omitted. A single filament-control jack was used on the second audio tubes, with a rheostat fixed inside the set, adjusted to deliver 4 to 4½ volts to the tubes. Volume control is best obtained with the rheostat which controls the R.F. tube.

A R.F. choke may be inserted in the detector plate circuit, just ahead of the first A.F. transformer, although the set as built is remarkable for its quality without it. This choke may be made by winding in jumbled manner 300 turns of No. 30 wire on a one-inch spool. Nearly every kind of feed-back has been tried, except rotor-tickler; and capacity feed-back finally found most satisfactory.

**DIFFERENT RECEPTION CONDITIONS**

Now comes an interesting part of the story. All this work was done, as said before, in the heart of New York City, and the set showed up well. No DX was tried, as the location is buried among huge steel buildings. So the set was taken out to Jamaica (Long Island) and exhibited altogether different characteristics. It tuned far sharper out there; and while it brought in all the locals, and reached out a little, it was unsatisfactory. It also showed a greater tendency to oscillate, which might be expected. On distant stations it tuned so sharply that distortion undoubtedly occurred, and it showed a marked loss in volume, too much so. So it was ripped apart, and rebuilt this way.

The antenna coil primary was thrown out and the antenna connected to the grid coil, about a quarter of the way from the minus filament end. The primary of the second R. F. coil was taken out and rewound with No. 30 D.C.C. wire, twelve turns being all it would stand. It will probably come down to ten turns in the end, and be quite stable that way, whereas it was not with ten turns of No. 24. The tickler was rewound with 18 turns of No. 30, and then cut down to twelve, with which it seems to work all

right. A potentiometer was put into control the grid return of the R.F. tube; but while this can be operated at full negative most of the time, it is not possible to do so on the extreme low wave-lengths. However, this winding improved the volume tremendously and broadened the set out a little, as desired. It still tuned sharp enough; but if there is a station within a mile, it will be necessary to shield the coils, since they are so large as to pick up energy from nearby stations. However, this will probably be unnecessary if the station is five miles away, unless it uses super-power.

**POSSIBILITIES OF IMPROVEMENT**

This set has now the most terrific volume of any the writer has ever heard, and will

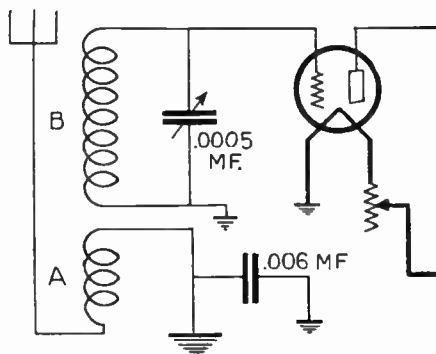

This shows the original hook-up of the bell-wire receiver (up to the R.F. tube) with which it worked best in the heart of the business district of New York.

pick up good DX. The final design, of course, has not been reached; but the end is visible, and the set is in ideal condition to present to the man who likes to experiment. It would seem that there is a great deal of fun ahead with bell-wire outfits; and that different experimenters might be asked to send in their findings, as they are reached. In the end it is possible that we

might get the best four-tube set yet built, judging from the performance of this one in its experimental stages. The writer is now muddling with another set of coils, which approximate these in characteristics, and when they are working as they should, will send in the information. This set seems to be one which will stand a year's work from all hands. The main thing to do with it is to keep it on a large baseboard, so that there will be no trouble in making changes; the last alterations described were effected in two hours' work at home on the good old kitchen table.

As might be gathered from the illustration, the writer is not connected with any manufacturers. (The name on the panel was adopted to make it look well, and take away that "home-made" look.) Once he made a super-hot for his maternal parent; and when the insurance appraiser came around to list the household goods, he set it down as "one home-made radio set." Since then all panels for the writer's use have been made with more care for appearances, and he has had them engraved in the best professional manner.

The illustrations show the set as it appeared before the primary was ripped out of the antenna coil; since then the coil has been remounted and now stands up vertically. Very little wiring appeared, as telephone switchboard wire, which is very thin, was used.

**LIST OF PARTS**

- 1 Panel, 7x30 inches,
- 1 Baseboard, 9½x29 inches, covered with 34-gauge sheet brass.
- 2 Condensers, .0005- $\mu$ f., S.L.W. or S.L.F.,
- 2 Vernier Dials,
- 1 Rheostat, 20-30-ohm,
- 1 Rheostat, 10-ohm,
- 1 Filament Switch,
- 1 Potentiometer (optional),
- 1 Dial, 3-inch, for feed-back condenser,
- 1 Variable Condenser, .00025- $\mu$ f.,
- 1 Double Jack,
- 1 Single Jack,
- 5 Sockets,
- 1 Grid Condenser, .00025- $\mu$ f., and 2-megohm Leak,
- 2 Fixed Condensers, .006- $\mu$ f.,
- 1 Fixed Condenser, .002- $\mu$ f.,
- 2 Fixed Condensers, 0.5- $\mu$ f.,
- 1 Audio Transformer, 3-1 ratio,
- 1 Pair A. F. Transformers, push-pull, Binding Posts, etc.
- A 4½ to 7½ "C" battery is used.
- Approximate cost of parts, \$35.00.

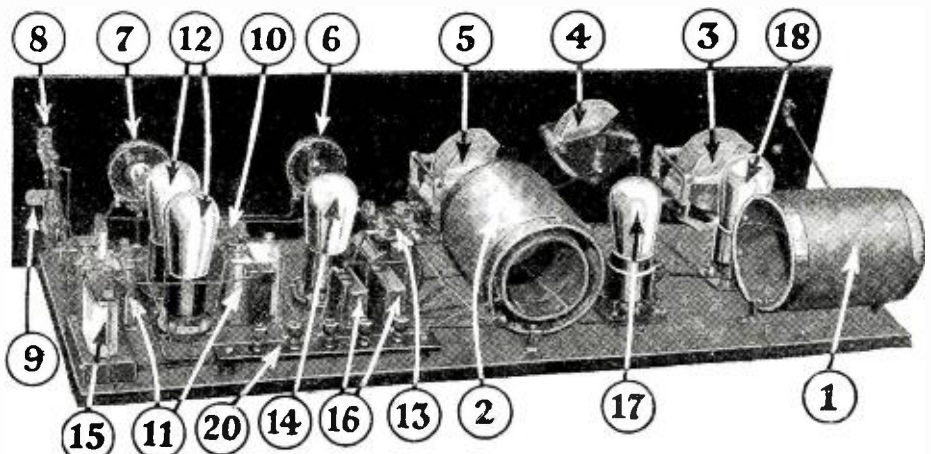

A rear view of the bell-wire receiver. The numbers shown correspond to those at the bottom of the opposite page.



# Audio-Frequency-Amplifier Transformers

By SYLVAN HARRIS



*After the problem of making a radio receiver powerful and selective enough to amplify any signal which reaches it has been solved, there comes that of perfecting the output of the reproducer. In solving this, the audio-frequency transformer plays a most important part. The reader who is trying for quality, as well as distance, will find these articles of the greatest value.*



**A**UDIO-FREQUENCY transformers have been the subject of extensive articles in radio periodicals in the past; much has been said about them, and the recent improvement in their design has been considerable. Unfortunately, much of the matter which has appeared in radio publications, at least in those of the popular type, has been written over and over again and become hackneyed. There is much more, however, that can be said about audio-frequency transformers and which is not so generally known. In the series of articles to appear in RADIO NEWS, of which this is the first, I shall endeavor

**T**HIS is the first of a series of articles which will deal with audio-frequency transformers, and the reproduction of voice and music which is obtained through their use in radio receivers. The first two articles will deal with this subject in general; and the later ones will give information as to the standards by which the quality of transformers should be judged, and the methods of correcting the undesirable effects which result from the use of those which distort reproduction.

For some time past extensive tests of the better-grade transformers, including nearly all on the market, have been carried on in the RADIO NEWS laboratories; and from the measurements thus obtained, we will be in a position to present to our readers information that will be of the greatest value to them.

These articles, like the present one, will be written in non-technical language, so that they can readily be understood by all our readers, and will be worthy of careful reading by every listener who is interested in the quality and clearness of the programs which issue from his receiver.

—EDITOR.

This means that the voltage ratio (the secondary voltage divided by the primary voltage, at any instant) should be a constant number, unaltered by the frequency. When this requirement is fulfilled, the transformer will reproduce with the utmost fidelity whatever is put into it. The different speech (audio) frequency voltages transmitted through the transformer will be magnified equally in all their components, their amplitudes will not be altered, and no additional frequencies will be introduced.

To make more clear the idea of what is required from a transformer, let us consider some properties of sound waves. In Fig. 1 we have represented one cycle of a fundamental voice-sound, shown at A. The hori-

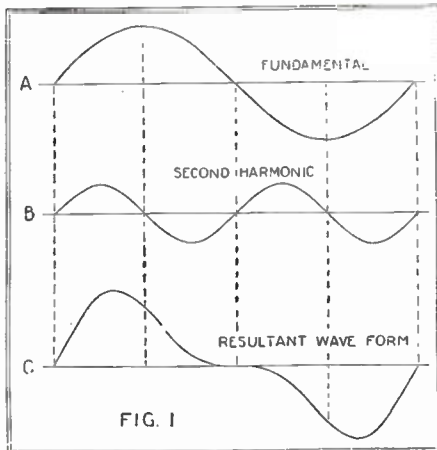

The wave A of the fundamental tone and the wave B of its second harmonic combine to produce the wave C. This, like all those produced by even-numbered harmonics, is not symmetrical.

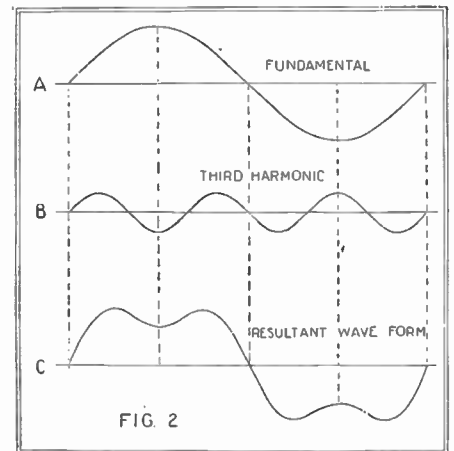

A symmetrical wave form results from the combination with the fundamental A of an odd harmonic wave, such as the third, shown at B.

to incorporate some of these facts. There will be only such repetition of elementary details as may be required to present the story in continuous and fairly complete form.

The purpose of incorporating audio-frequency transformers in amplifier circuits is well enough known. Where there are two circuits, the output of one tube and the input of another, to be coupled together, the purpose may be accomplished by the use of either resistances and condensers, or transformers; the latter may be either auto-transformers, or transformers with two separate windings. In the greater number of cases, coupling is accomplished by means of transformers of the latter type; the principal reason for this being that, besides furnishing a means of coupling the circuits, they have increased amplification by reason

of the stepping-up of the voltages in the transformer. There are other reasons for the great popularity of the two-winding transformer for amplifying audio frequencies, but we will not discuss them here. This article will be confined to the properties of coupling of this type.

### REQUISITES FOR GOOD TRANSFORMERS

In any system of coupling, there are certain requirements which must be fulfilled. Since the electron-tube with which the coupling devices are used is an apparatus operated essentially by differences of potential, we are interested primarily in the voltages in such a system. The requirements to be met by amplifier transformers, therefore, may be summed up in the statement that the output voltages of the transformer must in every way correspond to the input voltages. In other words the amplitude of the secondary-voltage wave must be a true and exact multiple of the primary-voltage wave at every instant.

zontal axes in this figure represent time, the vertical axes represent the air pressure, and the distance of the curve from the horizontal therefore indicates the relative loudness of the sound, as reproduced at various frequencies ("itches"). It is well known that the waves created by musical or vocal sounds are very complex, having components of many different frequencies. For an illustration, let us suppose that the sound represented by the wave A is emitted simultaneously with its second harmonic B. These two sound waves do not exist separately in the air, but combine to form a resultant wave C. For a further illustration, in Fig. 2 we have again pictured the wave of the fundamental note A, but with its third harmonic B, and the resultant curve at C, more symmetrical than in Fig. 1.

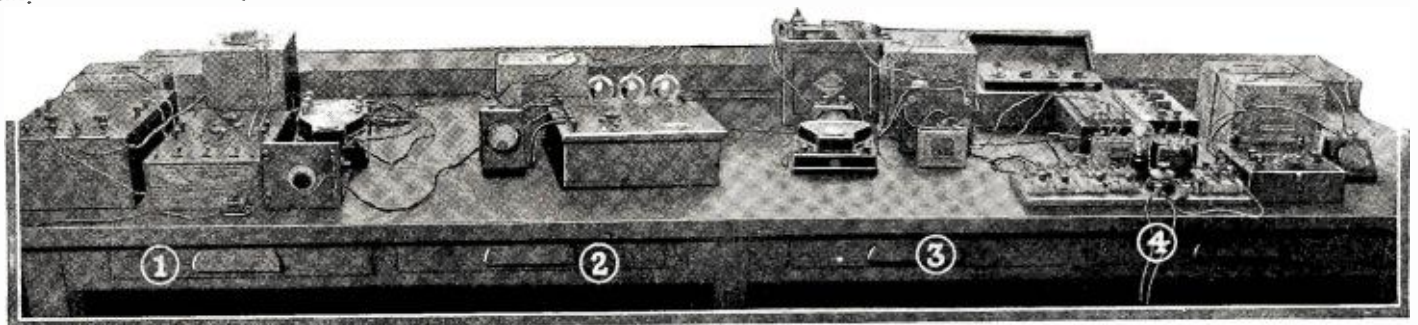

This illustration, reproduced from a photograph taken in the RADIO NEWS LABORATORIES, shows apparatus used in these studies of audio amplifiers. The calibrated audio-frequency oscillator is indicated by 1; the audio-frequency amplifier by 2; the tube and transformer undergoing test are behind the small panel above 3; and the measuring instruments are at 4. The circuit used is diagramed on page 1665.



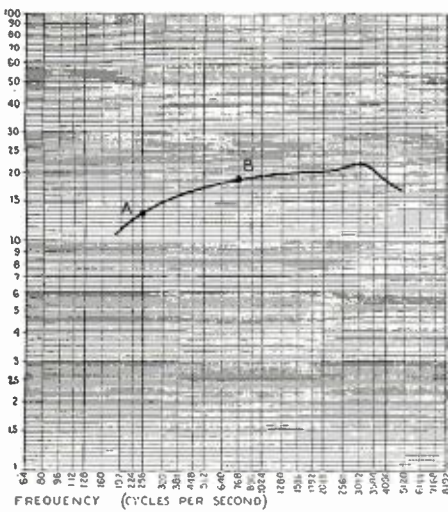

FIG. 3

Here is the characteristic curve of a typical transformer, showing the amount of amplification at different frequencies. The co-ordinates used in these charts will be fully explained later.

There is nothing new in any of this, but it must be kept in mind when considering the problems of obtaining high-quality reproduction from amplifiers. The harmonics of a note or sound are important in determining its overtones; and the latter determine the quality or timbre of the sound. The reader must be careful to differentiate between octaves and overtones; all overtones are harmonics, but all harmonics are not octaves. Let us see how this happens.

**THE MUSICAL SCALE OF FREQUENCIES**

Octaves of a frequency are exact multiples of it by powers of 2. The fundamental tone has a frequency of 128 cycles per second, the second octave has a frequency of 256, the third octave of 512, the fourth octave a frequency of 1024, and so on. These are exact octaves, which the ear perceives by very similar physiological sensations; and when these notes are sounded *simultaneously*, the ear does not distinguish between them, as it does in case of overtones.

To understand the nature of overtones, we must know something about the musical scale and chords. When several musical tones are sounded simultaneously we have what is known in musical parlance as a chord. If the combination of tones is pleasing to the ear, it is called a harmonious chord, or consonance; if not, it is an inharmonious chord (discord or dissonance). There are many degrees between consonances and discords, since an infinite number of tone shades are possible.

It has been found by experience that when the frequencies of the tones which are sounded simultaneously are in the ratio of 4:5:6, the chord produced by the combination is very pleasing, to the Occidental ear at least. Take, for instance, the fundamental tone which has a frequency of 256 cycles per second; this is "middle C" on the musical scale. The frequencies are then

256 320 384

and the combination is the "major chord," also known as the "major triad," corresponding to C,E,G on the scale.

Again, we start with G on the scale (384 cycles) and build up another major chord in the same ratio (4:5:6), giving the chord G,B,D (384,480,576). In this manner the musical scale is developed, thus:

C D E F G A B C<sup>1</sup> D<sup>1</sup>  
 4 : 5 : 6  
 4 : 5 : 6  
 4 : 5 : 6

If these ratios be reduced to common denominators, we arrive at the series:

C D E F G A B C<sup>1</sup> D<sup>1</sup>  
 1 9 5 4 3 5 15 2 9  
 1 8 4 3 2 3 8 1 4

In other words, D has a frequency per second nine-eighths times that of C, E's frequency is five-fourths that of C, etc. From C to C<sup>1</sup> is one octave of the scale, each octave repeating the notes of that below it, at twice the frequencies. The values of C, for instance, are 16, 32, 64, 128, 256, 512, 1024, 2048, 4096, etc., etc.

Now we are ready to consider what the overtones have to do with audio transformers. In Figs. 1 and 2 it has been shown how the presence of one or more harmonics of a tone changes the form of the wave resulting from that tone; it has also been pointed out that the overtones of a note determine the quality or timbre of the resultant sound.

Suppose we have a complex note or chord consisting of a fundamental and the third harmonic, as for instance, 256 and 768 cycles per second. (Note that 768 is three times 256.) Now 256 is middle C; what is 768? We see, on going over the list of the values of C, that 768 lies between 512 and 1024; therefore 768 is more than an octave and less than two octaves higher than middle C. The C immediately below it is 512, and 768 is to 512 as 3 is to 2. It is evident, therefore, that the third harmonic of middle C is not a C, and on comparison with the table of proportions, we find it to be a G.

**IRREGULAR AMPLIFICATION**

To apply this information to transformers, suppose we have a transformer, which does not amplify equally at all frequencies, such as the one whose characteristic is shown in Fig. 3. Note that the amplification is much less at 256 cycles per second than it is at 768. If a fundamental of 256 and a weak third harmonic of that tone are passed into this transformer, the third harmonic is likely to become unduly strong. In a violin, for instance, the third harmonic is generally strong, while that in a 'cello is weaker. Emphasizing the third harmonic in the reproduction of a 'cello, therefore, will give it more of the quality of a violin. On the other hand, if the conditions indicated in Fig. 3 were reversed—that is, if the amplification at 768 cycles per second were less than that at 256, the violin might take on more of the quality of the 'cello.

Since it is difficult to distinguish octaves sounded simultaneously, it is evident that the quality or timbre of a sound depends more particularly upon the overtones or harmonics which are not octaves. In sixteen harmonics there are only four octaves, the intermediate overtones forming other tones of the scale.

- First harmonic ..... Fundamental Tone
- Second harmonic ..... First Octave
- Third harmonic ..... Overtone
- Fourth harmonic ..... Second Octave
- Fifth harmonic ..... Overtone
- Sixth harmonic ..... Overtone
- Seventh harmonic ..... Overtone
- Eighth harmonic ..... Third Octave

Each successive harmonic down to the sixteenth is an overtone, the sixteenth being the fourth octave.

The accentuation of the harmonics which are true octaves of the fundamental tone will also change the timbre, by making it seem a little more shrill; but this is not generally noticed, for, as said before, it is difficult to distinguish octaves when they are sounded simultaneously.

**CHARACTERISTICS OF INSTRUMENTS**

This matter of overtones is illustrated very forcibly in the cornet, which, as with almost all brass instruments, is very rich in harmonics. The overtones give to them what is often called the "voice;" that is, the instrument seems almost to be alive, with the sound jumping out of its brazen throat. On the other hand some instruments, such as the flute, have few overtones. This has, for this reason, the plaintive, restful tone, which is characteristic of most wood-wind instruments.

The suppression of overtones lends to musical sounds a certain mellowness which many listeners find pleasing. This, however, is a matter of which each individual must judge for himself; but certainly such incomplete reproduction is not faithful. It is characteristic of many loud speakers, especially of the cone type, to suppress the overtones; with the result that, as explained before, a violin will sound like a 'cello and

(Continued on page 1682)

It is interesting to note how high the pitch of a low frequency seems to the ear. We speak quite easily and familiarly of a 1000-cycle tone; but, as the diagram shows, it is at nearly the highest pitch a soprano can reach. The pipe organ, not indicated here, has perhaps the greatest range of sound frequencies possessed by any instrument; it produces beat frequencies of 16 cycles per second in the diapason, and harmonics several octaves above the upper limit of our chart. These extremely high overtones are weak, however, and can rarely be detected. Note the possibly unfamiliar ("logarithmic") scale employed in drawing these frequency charts: it will be explained in the second article of this series.

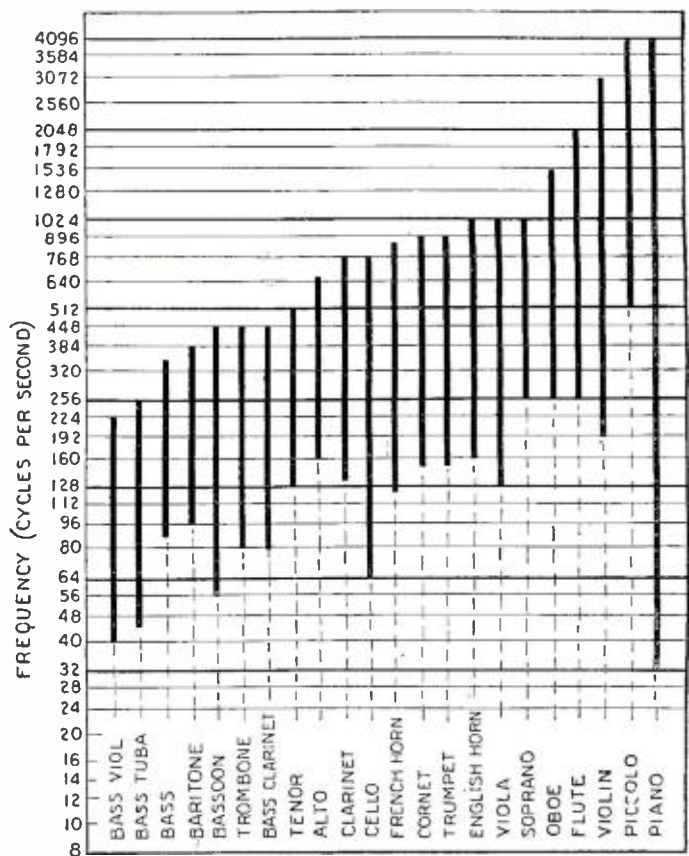



# RADIO SET DIRECTORY

IN presenting various sets in a directory of this kind, it is naturally possible to touch only the high points. We have therefore listed all outfits under a simple classification that will, we hope, be of great service to the public, as well as to the trade. We have attempted in this directory to list every set manufactured in this country, but although we have written a number of letters to all manufac-

turers, not all have replied. In order to make the directory complete, all sets manufactured by any one manufacturer listed have been included.

The Directory will be kept up to date, month by month. All manufacturers are invited to send monthly corrections as to the various features of the sets which they produce.

**BRONX RADIO EQUIP. CO.**  
687 Courtlandt Ave.,  
New York City  
Trade Name: Breco B. S-3  
Circuit: Straight  
Batteries: Storage  
Antenna: Outdoor  
Loud Speaker: Separate  
Controls: Three  
List Price: \$80

Trade Name: Breco B. R. 5  
Circuit: Radio frequency, detector and audio frequency  
Batteries: Storage  
Antenna: Outdoor or loop  
Loud Speaker: Separate  
Controls: Three  
List Price: \$100

**BROWN RADIO MFG. CO.**  
675 Wyoming Ave.,  
Kingston, Pa.  
Trade Name: Thoroughbred Console B-66  
Circuit: Tuned radio frequency  
Batteries: Storage or dry cell  
Antenna: Outdoor  
Loud Speaker: Built-in  
Controls: Three  
List Price: \$225

Trade Name: Thoroughbred Model B-88  
Circuit: Tuned radio frequency  
Batteries: Storage or dry cell  
Antenna: Outdoor  
Loud Speaker: Separate  
Controls: Three  
List Price: \$130

Trade Name: Thoroughbred Model B-77  
Circuit: Tuned radio frequency  
Batteries: Dry cell or storage  
Antenna: Outdoor  
Loud Speaker: Separate  
Controls: Three  
List Price: \$115

**MANUFACTURER: GOLDEN-LEUTZ INC.**  
6th & Washington Aves.  
Long Island City, N. Y.  
Trade Name: Super-Plio 9  
Circuit: Tuned radio frequency  
Batteries: Storage  
Antenna: Outdoor  
Loud Speaker: Separate  
Controls: Two  
List Price: \$295

Trade Name: Plio 6  
Circuit: Tuned radio frequency  
Batteries: Storage  
Antenna: Outdoor  
Loud Speaker: Separate  
Controls: Two  
List Price: \$60-\$75

Trade Name: Universal Plio 6, 35 to 3600 meters  
Circuit: Tuned radio frequency  
Batteries: Storage  
Antenna: Outdoor  
Loud Speaker: Separate  
Controls: Two  
List Price: \$125

Trade Name: Universal Super 8

Circuit: Tuned radio frequency  
Batteries: Storage  
Antenna: Outdoor  
Loud Speaker: Separate  
Controls: Two  
List Price: \$460

**MANUFACTURER: GORMAC ELECTRIC CO.**  
311 W. 59th St.,  
New York City  
Trade Name: Gormac  
Circuit: Batteries: Storage  
Antenna: Both  
Loud Speaker: Separate  
Controls: Three  
List Price: \$40

**MANUFACTURER: A. H. GREBE & CO., INC.**  
113 West 57th St.,  
New York, N. Y.  
Trade Name: Synchrophase Type MU-1  
Circuit: Tuned balanced radio frequency  
Batteries: Storage  
Antenna: Outdoor or indoor  
Loud Speaker: Separate  
Controls: Three, with unit control  
List Price: \$155 less accessories

Trade Name: Synchrophase Type MU-2  
Circuit: Tuned balanced radio frequency  
Batteries: Dry cell  
Antenna: Both  
Loud Speaker: Separate  
Controls: Three with unit control  
List Price: \$155 less accessories

**MANUFACTURER: GUNDLACH MANHATTAN OPTICAL CO.**  
Rochester, N. Y.  
Trade Name: Korona Radio Crystal Receiver  
Type of Set: Crystal

**MANUFACTURER: THE HALLDORSON CO.**  
4745 No. Western Ave.,  
Chicago, Ill.  
Trade Name: Halldorsen Receiver R. F. 500  
Circuit: Tuned radio frequency  
Batteries: Storage  
Antenna: Outdoor  
Loud Speaker: Separate  
Controls: Three  
List Price: \$75

**MANUFACTURER: W. B. HALLER**  
2100 Sarah St., S. S.,  
Pittsburgh, Pa.  
Trade Name: Hallerio 3  
Circuit: Crystal  
Antenna: Outdoor  
Controls: Two  
List Price: \$3

Trade Name: Hallerio 4  
Circuit: Crystal  
Antenna: Outdoor  
Controls: Two  
List Price: \$4

Trade Name: Hallerio 5  
Circuit: Crystal  
Controls: Two  
List Price: Complete aerial equipment and phones \$6

**MANUFACTURER: HAL-LOCK & WATSON RADIO CORP.,**

190-192 Park St.,  
Portland, Ore.  
Trade Name: Halowat TR-5  
Circuit: Tuned radio frequency  
Batteries: Both  
Antenna: Outdoor  
Loud Speaker: Separate  
Controls: Three  
List Price: \$90

Trade Name: Halowat AW-5  
Circuit: Tuned radio frequency  
Batteries: Both  
Antenna: Outdoor  
Loud Speaker: Separate  
Controls: Two  
List Price: \$160

**MANUFACTURER: H. W. HARMON & SONS CO.**  
418 Poplar St.,  
Grove City, Pa.  
Trade Name: Harmonson IV-A  
Circuit: One stage tuned and regenerative radio frequency  
Batteries: Dry cell or storage  
Antenna: Outdoor

Loud Speaker: Separate  
Controls: Two  
List Price: \$75 and \$80.20

Trade Name: Harmonson Grand V-C  
Circuit: Tuned Antenna and one regenerative radio frequency stage  
Batteries: Dry cell or storage  
Antenna: Outdoor  
Loud Speaker: Built-In  
Controls: Three or two  
List Price: \$135

**MANUFACTURER: KENNETH HARKNESS RADIO CORP.**  
727 Frelinghuysen Ave.,  
Newark, N. J.  
Trade Name: (Kenneth Harkness) 2-Tube Reflex  
Circuit: Harkness Reflex  
Batteries: Storage preferred  
Antenna: Outdoor  
Loud Speaker: Separate  
Controls: Two  
List Price: \$33.50

Trade Name: (Kenneth Harkness) 3-Tube Counterflex  
Circuit: Harkness Counterflex  
Batteries: Storage preferred  
Antenna: Outdoor  
Loud Speaker: Separate  
Controls: Two  
List Price: \$52.50; kit \$36

Trade Name: Five-Tube Counterflex  
Circuit: Harkness counterflex  
Batteries: Storage preferred  
Antenna: Outdoor  
Loud Speaker: Separate

Controls: One  
List Price: \$62.50; kit \$47.50

**HEARWELL ELECTRIC CO.,**  
53 Devonshire St.,  
Boston, Mass.  
Trade Name: Forbes Short-Wave Receiver  
Batteries: Dry cell  
Antenna: 2-foot loop, 3 strands  
Loud Speaker: Separate  
Control: One  
List Price: \$10

Trade Name: Forbes One-Tube Portable  
Circuit: Single-circuit regenerative  
Batteries: Dry cell, 199 tube, 2 1/2 "B"  
Antenna: Locals, without aerial but with ground  
Loud Speaker: Separate  
Controls: Two  
List Price: \$10

Trade Name: Forbes Selective Crystal Receiver  
Circuit: Crystal  
Antenna: Outdoor  
List Price: \$3.50

List Price: \$180  
Trade Name: Case Radio Apparatus No. 702  
Circuit: Tuned radio frequency  
Batteries: Both (storage recommended)  
Antenna: Outdoor  
Loud Speaker: Built-In  
Controls: Three dials  
List Price: \$160

Trade Name: Case Radio Apparatus No. 703  
Circuit: Tuned radio frequency  
Batteries: Both (storage recommended)  
Antenna: Outdoor  
Loud Speaker: Built-In  
Controls: Three Vernier  
List Price: \$170

**MANUFACTURER: INTERNATIONAL RADIO CORP.,**  
145 Pacific Electric Bldg.,  
Los Angeles, Calif.  
Trade Name: Rotolor Ten  
Circuit: Tuned radio frequency  
Batteries: Both  
Antenna: Outdoor or indoor  
Loud Speaker: Separate  
Controls: One  
List Price: \$97

Trade Name: Rotolor Twenty  
Circuit: Tuned radio frequency  
Batteries: Both  
Antenna: Outdoor or indoor  
Loud Speaker: Separate  
Controls: One  
List Price: \$128

Trade Name: Rotolor Thirty  
Circuit: Tuned radio frequency  
Batteries: Both  
Antenna: Outdoor or indoor  
Loud Speaker: Separate  
Controls: One  
List Price: \$150

Trade Name: Rotolor Forty  
Circuit: Tuned radio frequency  
Batteries: Both  
Antenna: Outdoor or indoor  
Loud Speaker: Built-In  
Controls: One  
List Price: \$235

Trade Name: Rotolor Fifty  
Circuit: Tuned radio frequency  
Batteries: Storage or dry cell  
Antenna: Outdoor or indoor  
Loud Speaker: Built-In  
Controls: One  
List Price: \$290.00

**MANUFACTURER: IRVING RADIO CORP.,**  
Columbus, Ohio  
Trade Name: Irving Model No. 42  
Circuit: Tuned radio frequency  
Batteries: Storage  
Antenna: Indoor or outdoor  
Loud Speaker: Separate  
Controls: Three  
List Price: \$49.50

Trade Name: Irving Model No. 44

Circuit: Tuned radio frequency  
Batteries: Storage  
Antenna: Indoor or outdoor  
Loud Speaker: Separate  
Controls: Three  
List Price: \$65.00

Trade Name: Irving Model No. 46  
Circuit: Tuned radio frequency  
Batteries: Storage  
Antenna: Indoor or outdoor  
Loud Speaker: Built-in  
Controls: Three  
List Price: \$80

**MANUFACTURER: THE JEWETT RADIO & PHONOGRAPH CO.**  
Pontiac, Mich.  
Trade Name: Jewett Receiver  
Circuit: Tuned radio frequency  
Batteries: Either  
Antenna: Indoor or outdoor  
Loud Speaker: Separate  
Controls: Two  
List Price: \$155

**MANUFACTURER: JOSEPH W. JONES RADIO MFG. CO.**  
40-46 W. 45th St.,  
New York City  
Trade Name: J 621  
Circuit: Tuned radio frequency resistance coupled  
Batteries: Wet or dry  
Antenna: Outdoor  
Loud Speaker: Separate  
Controls: Three  
List Price: \$65 less equipment

Trade Name J 700  
Circuit: Tuned radio frequency resistance coupled  
Batteries: Wet or dry  
Antenna: Outdoor  
Loud Speaker: Separate  
Controls: Three  
List Price: \$125

Trade Name: J 675  
Circuit: Tuned radio frequency resistance coupled  
Batteries: Both  
Antenna: Outdoor or indoor  
Loud Speaker: Separate  
Controls: Three  
List Price: \$85

Trade Name J 655  
Circuit: Tuned radio frequency resistance coupled  
Batteries: Both  
Antenna: Outdoor or indoor  
Loud Speaker: Separate  
Controls: Three  
List Price: \$75

Trade Name: J 175  
Circuit: Tuned radio frequency resistance coupled  
Batteries: Both  
Antenna: Indoor or outdoor  
Loud Speaker: Separate  
Controls: Three  
List Price: \$175

Trade Name: J 195B  
Circuit: Tuned radio frequency  
Batteries: Both  
Antenna: Indoor or outdoor  
Loud Speaker: Built-In  
Controls: Three  
List Price: \$150

(To be continued in the July issue.)

## Notice to Readers

Detailed information respecting the following sets, or any other receiving sets, may be had on inquiry by addressing a letter to the Editor of the Set Directory, RADIO NEWS.

Loud Speaker: Separate  
Controls: Two  
List Price: \$75 and \$80.20

Trade Name: Harmonson Grand V-C  
Circuit: Tuned Antenna and one regenerative radio frequency stage  
Batteries: Dry cell or storage  
Antenna: Outdoor  
Loud Speaker: Built-In  
Controls: Three or two  
List Price: \$135

**MANUFACTURER: KENNETH HARKNESS RADIO CORP.**  
727 Frelinghuysen Ave.,  
Newark, N. J.  
Trade Name: (Kenneth Harkness) 2-Tube Reflex  
Circuit: Harkness Reflex  
Batteries: Storage preferred  
Antenna: Outdoor  
Loud Speaker: Separate  
Controls: Two  
List Price: \$33.50

Trade Name: (Kenneth Harkness) 3-Tube Counterflex  
Circuit: Harkness Counterflex  
Batteries: Storage preferred  
Antenna: Outdoor  
Loud Speaker: Separate  
Controls: Two  
List Price: \$52.50; kit \$36

Trade Name: Five-Tube Counterflex  
Circuit: Harkness counterflex  
Batteries: Storage preferred  
Antenna: Outdoor  
Loud Speaker: Separate

**MANUFACTURER: INDIANA MFG. & ELECTRIC CO.**  
600 Case Block  
Marion, Indiana  
Trade Name: Case Radio Apparatus No. 500  
Circuit: Tuned radio frequency  
Batteries: Both (storage recommended)  
Antenna: Outdoor  
Loud Speaker: Separate  
Controls: Three dials  
List Price: \$65

Trade Name: Case Radio Apparatus No. 503  
Circuit: Tuned radio frequency  
Batteries: Both (storage recommended)  
Antenna: Outdoor or indoor  
Loud Speaker: Separate  
Controls: Three Vernier  
List Price: \$85

Trade Name: Case Radio Apparatus No. 506  
Circuit: Tuned radio frequency  
Batteries: Both (Storage recommended)  
Antenna: Outdoor  
Loud Speaker: Separate  
Controls: Three Vernier  
List Price: \$75

Trade Name: Case Radio Apparatus No. 701  
Circuit: Tuned radio frequency  
Batteries: Both (Storage recommended)  
Antenna: Outdoor or indoor  
Loud Speaker: Built-in  
Controls: Three vernier



# How Transformer Constants Are Measured

By SYLVAN HARRIS

This article gives a simple method for determining various characteristics of audio-frequency transformers, which was devised especially for use in the researches which RADIO NEWS Laboratories are making upon the different types of these instruments now on the market.

THE series of articles, commencing in this issue and dealing with transformers and other coupling devices used in A.-F. amplifiers, is made possible by reason of measurements that are being made in RADIO NEWS laboratories on a large number of transformers of different makes, now on the market.

This article explains in brief the methods used in these measurements. The method used to measure voltage ratio is not new; but its application to the measurement of other constants of the transformer, such as impedance, power-factor, resistance, primary inductance, mutual inductance, etc., is new, as far as the writer is aware.

The apparatus used is shown in the illustration in the article entitled "Audio-Frequency-Amplifier Transformers," on page 1662 of this issue of RADIO NEWS. At the left end of this picture appears an audio-frequency oscillator, which has been accurately calibrated by a method described by the writer in the April, 1926, issue of the I. R. E. Proceedings.

The manufacture and design of A.-F. amplifier transformers has been widely undertaken during the past few years; but although simple and inexpensive methods for measuring voltage ratio are available, the determination of such constants as the primary inductance, resistance and power-factor generally requires somewhat expensive apparatus, or standards which have been previously calibrated by other methods and under other conditions.

The present method employs no apparatus other than that customarily found in laboratories; and depends upon no previous calibrations other than those of resistance boxes, a thermocouple and milliammeters. It involves a slight modification of a well-known method

of measuring voltage ratio. An audio-frequency generator, so arranged that the power taken from it does not influence the frequency, feeds into a resistance  $R_1$  (Fig. 1), the voltage drop in which is impressed on the

switch B to the left, and R is adjusted until the plate current of T has the same value as before. The voltage impressed on the input of the tube is then the same as the voltage which was impressed from the transformer secondary, and is found by a second calculation from the values of R and the current through T.C. From the input and output voltage thus measured, the voltage ratio is determined.

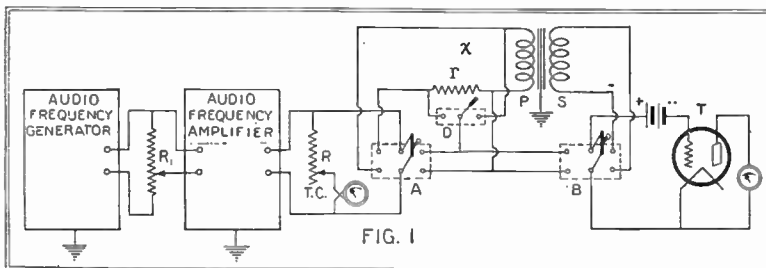

Fig. 1. This is the complete schematic diagram of the apparatus illustrated on page 1662, used to measure the constants of A.-F. transformers, as there described. If it is desired to measure the combined amplification of tube and transformer, the amplifier tube may be connected in at X.

input of an audio-frequency distortionless amplifier. The output of the amplifier feeds into a resistance R in series with a thermocouple T.C.

With switch A to the left and switch B to the right, the secondary voltage of the transformer being measured is impressed on

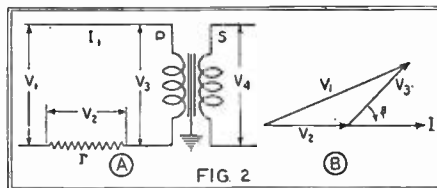

Fig. 2A shows the simple arrangement used to measure the power-factor, impedance, resistance, etc., of transformers. Fig. 2B is the vector diagram for the voltages in this circuit.

the input of the electron tube T. The plate current of this tube is noted, and the input voltage calculated from the resistance in R and the current through the thermocouple. Switch A is then thrown to the right and

## USUAL METHODS OF MEASUREMENT

This method is in general use and requires little more than usual care in making such measurements, the main requisites being that the frequency of the generator be not influenced by the load taken from it, and that the resistance R be non-inductive. The resistance r is connected in series with the primary of the transformer to simulate the plate-filament resistance of an electron tube, to which the transformer is generally connected in radio receivers. By introducing a biasing battery at T, and by regulating the filament temperature of T, the space current may be so adjusted that a very sensitive current-indicating instrument may be used to indicate the plate current. If preferred a bridge\* or zero-shunt arrangement may be used.

Rectification is obtained either by operating T at the bend of its characteristic curve or by using the grid-condenser and leak method.

The current passing through the current indicator in the plate circuit of T is the sum of a constant and an alternating component. We are interested only in the latter and this may often represent but a small proportion of the total current flowing through the current indicator. The sensitivity of the arrangement is therefore subject to considerable variation unless precautions are taken to

(Continued on page 1703)

## LIST OF BROADCAST STATIONS IN THE UNITED STATES

(Continued from page 1642)

Radio Call Letter	BROADCAST STA. Location	Wave (Meters)	Power (Watts)	Radio Call Letter	BROADCAST STA. Location	Wave (Meters)	Power (Watts)	Radio Call Letter	BROADCAST STA. Location	Wave (Meters)	Power (Watts)	Radio Call Letter	BROADCAST STA. Location	Wave (Meters)	Power (Watts)
WLTS	Chicago, Ill.	258	100	WOC	Davenport, Iowa	432.6	5000	WRAV	Yellow Springs, Ohio	265	100	WSM	Nashville, Tenn.	282.8	1007
WLW	Harrison, Ohio	422.3	500-5000	WOCL	Jamestown, N. J.	375.2	15	WRAW	Reading, Pa.	238	10	WSMB	New Orleans, La.	319	507
WLWL	New York, N. Y.	288.3	3500	WODA	Paterson, N. J.	224	250	WRAX	Gloucester City, N. J.	268	500	WSMH	Owosso, Mich.	240	20
WMAC	Cazenovia, N. Y.	275	100	WOI	Ames, Iowa	270	750	WRBC	Valparaiso, Ind.	278	50	WSMK	Dayton, Ohio	275	500
WMAF	Dartmouth, Mass.	440.9	1000	WOK	Homewood, Ill.	217.3	5000	WRCC	Washington, D. C.	468.5	1000	WSOE	Milwaukee, Wis.	246	507
WMAK	Lockport, N. Y.	266	500	WOO	New York, N. Y.	233	50	WRCD	Raleigh, N. C.	252	100	WSRO	Hamilton, Ohio	252	100
WMAL	Washington, D. C.	212.6	100	WOD	Philadelphia, Pa.	508.2	500	WRCE	Coldwater, Miss.	254	10	WSSH	Boston, Mass.	261	100
WMAN	Columbus, Ohio	278	50	WOG	Grand Rapids, Mich.	212	500	WRED	Lansing, Mich.	285.5	500	WSUI	Iowa City, Iowa	483.6	500
WMAG	Chicago, Ill.	447.5	1000	WOQ	Kansas City, Mo.	278	1000	WRHF	Washington, D. C.	256	50	WSVS	Ruffalo, N. Y.	218.8	50
WMAY	St. Louis, Mo.	243	100	WOR	Newark, N. J.	403.2	500	WRHM	Minneapolis, Minn.	252	50	WSWS	Wooddale, Ill.	275	100
WMAZ	Macon, Ga.	261	500	WORD	Batavia, Ill.	275	5000	WRK	Hamilton, Ohio	270	100	WTAB	Fall River, Mass.	266	100
WMBB	Chicago, Ill.	250	500	WOS	Jefferson City, Mo.	440.9	500	WRM	Urbana, Ill.	273	500	WTAD	Carthage, Ill.	236	50
WMBG	Detroit, Mich.	256.4	100	WOWL	New Orleans, La.	270	10	WRMU	Richmond Hill, N. Y.	236	100	WTAG	Worcester, Mass.	268	500
WMBF	Miami Beach, Fla.	394.4	500	WOWO	Port Wayne, Ind.	227	500	WRNY	New York, N. Y.	258.5	500	WTAL	Toledo, Ohio	252	10
WMC	Memphis, Tenn.	499.7	500	WPAK	Agricultural Col., N. Dak.	275	50	WRR	Dallas, Tex.	246	500	WTAM	Cleveland, Ohio	389.4	3500
WMCA	Hoboken, N. J.	340.7	500	WPCC	Chicago, Ill.	258	500	WRST	Bay Shore, N. Y.	215.7	250	WTAP	Cambridge, Ill.	242	50
WNAB	Boston, Mass.	250	100	WPDR	Buffalo, N. Y.	263.4	50	WRVA	Richmond, Va.	256	1000	WTAQ	Eau Claire, Wis.	254	100
WNAC	Boston, Mass.	280.2	500	WPG	Atlantic City, N. J.	299.3	500	WRW	Tarrytown, N. Y.	273	500	WTAR	Norfolk, Va.	261	100
WNAD	Norman, Okla.	254	500	WPRC	Harrisburg, Pa.	215.7	100	WSAI	Mason, Ohio	325.9	5000	WTAW	College Station, Texas	270	500
WNAL	Omaha, Nebr.	258	50	WPSC	State College, Penna.	261	500	WSAJ	Grove City, Pa.	229	250	WTAX	Streator, Ill.	231	50
WNAT	Philadelphia, Pa.	250	100	WQAA	Parkesburg, Pa.	220	500	WSAN	Allentown, Pa.	229	100	WTAZ	Lambertville, N. J.	261	15
WNAX	Yankton, S. Dak.	244	100	WQAC	Amarillo, Tex.	234.2	100	WSAR	Fall River, Mass.	254	100	WTIC	Hartford, Conn.	475.9	500
WNBH	New Bedford, Mass.	248	100	WQAE	Springfield, Vt.	246	50	WSAX	Chicago, Ill.	268	100	WWAD	Philadelphia, Pa.	250	250
WNJ	Newark, N. J.	252	150	WQAM	Miami, Fla.	263	100	WSAZ	Pomeroy, Ohio	244	50	WWAE	Plainfield, Ill.	242	507
WNOK	Knoxville, Tenn.	268	100	WQAN	Scranton, Pa.	250	100	WSB	Atlanta, Ga.	428.3	1000	WWAO	Houghton, Mich.	263	250
WNYC	New York, N. Y.	526	1000	WQAO	New York, N. Y.	360	100	WSBC	Chicago, Ill.	209.7	1000	WWGL	Richmond Hill, N. Y.	212.6	500
WOAI	San Antonio, Tex.	394.5	2000	WQJ	Chicago, Ill.	447.5	500	WSBF	St. Louis, Mo.	273	250	WWI	Dearborn, Mich.	266	500
WDAN	Lawrenceburg, Tenn.	282.8	500	WRAF	Laporte, Ind.	224	100	WSBT	South Bend, Ind.	275	250	WWJ	Detroit, Mich.	352.7	1009
WDWA	Omaha, Nebr.	526	1000	WRAC	Escanaba, Mich.	256.3	100	WSDA	New York, N. Y.	263	250	WWL	New Orleans, La.	275	100
WOAX	Trenton, N. J.	240	500	WRAM	Galesburg, Ill.	244	100	WSKC	Bay City, Mich.	261	100				





# Radio Wrinkles

## A NEAT RADIO-FREQUENCY TRANSFORMER

The following material will be needed for its construction: a spool of No. 30 enameled wire; a burnt-out UV-201A tube; an insulating rod an inch long and 1/4-inch in diameter; three fiber washers; sealing wax (from the top of an old battery); a piece of cardboard and soldering equipment.

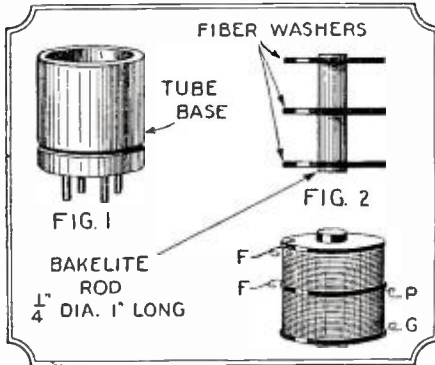

An efficient and readily interchangeable radio-frequency transformer can be mounted in the base of a discarded vacuum tube. This makes just the thing for a portable set.

First file the solder from the prongs of the burnt-out tube and heat the base until the tube is freed from it. Clean all the cement from the base and make sure that the holes in the prongs are clear. (Fig. 1).

Slip the washers on the insulating rod, as shown in Fig. 2. Drill two holes in the end washers for lead-out connections. Wind about 160 turns of wire in each space and bring the connections out through the holes in the washers.

Place the resulting transformer in the tube base and bring the connections of one coil through the filament prongs of the base; and those of the other coil through the plate and grid prongs. Solder the connections in the prongs. Place a circular piece of cardboard in the base and over the transformer, fitting the sides snugly. Melt the wax and fill the base to the top with it. This will result in a neat appearing radio-frequency transformer, which is of course, to be mounted in a tube socket. The builder may experiment with different numbers of turns, and make several transformers which are immediately interchangeable. —Contributed by D. M. Clayton.

## REMOVING INSULATION

Every experimenter knows the difficulty experienced in removing insulation from a wire, especially if it is small, with a knife. A simple device is here illustrated, which will readily remove silk, cotton or enamel insulation without damage to the wire.

The parts needed are two blocks of wood, 3x2x1/2 inches; a small hinge; a small knob from a coffee pot, say; and a piece of

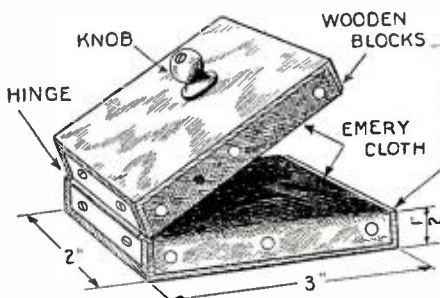

Wire can easily be freed of its insulation by this handy device, which is especially effective when handling the smallest sizes.

emery cloth 3x6 inches. The method of assembly is obvious from the illustration. Draw the wire between the two blocks while keeping pressure on the knob, in proportion to the thickness of the wire. It may be necessary to draw it several times through the jaws of the device before the insulation is entirely removed.

—Contributed by William Sikola.

## AN INEXPENSIVE COIL-WINDER

This wrinkle is a small and inexpensive coil-winder, which clamps on a sewing machine, such as almost every home possesses, and which has a large range of speed. The clamp is made of medium weight galvanized iron, and shaped as shown.

A form for the coil, of the desired dimensions, is then made from fiber or cardboard, a piece of which is cut as wide as the length of the coil and a little more than four times as long as the coil's diameter. This is then marked off crosswise into four equal parts and bent into the shape of a square form; ends for the form are made of suitable size, with square holes large enough so that they may be slipped over it, and glued on.

A square piece of wood, a little longer than and fitting snug inside the form, is made

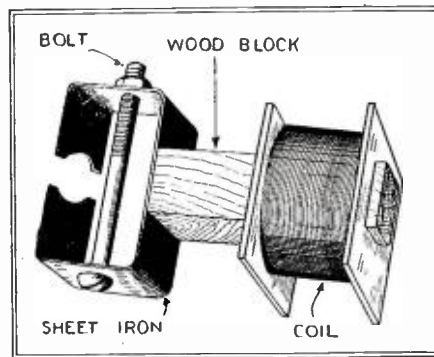

By making a coil-winding form like that shown above, the sewing machine can be utilized to do the work neatly and quickly. A square core form is used.

and attached by two screws to the clamp. The latter is fastened to the sewing machine by tightening the bolt, as shown, until the connection is rigid. The coil form is slid upon the wooden core; and the coil may be wound quickly to any desired size.

—Contributed by Harold Weiner.

## AN EXPERIMENTAL "B" BATTERY

A very economical method of supplying plate current to a radio set, after one has exhausted several blocks of 22.5-volt dry "B" batteries, is here shown. Usually the zinc containers of the individual cells are still in fair condition and will furnish sufficient zinc for the experiment. Also, each carbon rod is like new; so it is only necessary to "wreck" an exhausted "B" battery with chisel and hammer, using a hacksaw lengthwise on each zinc cell until the zinc can be unrolled. The zinc should be cleaned by scraping and washing, and then cut into six strips 3/8 inches wide, running around the cell. This, in the large size, has a diameter of 1 1/4 inches, making the strips about four inches long.

Fifteen small test tubes, about 2 1/2 x 3/8 inches, may be placed in any suitable wooden rack, and spaced as closely as convenient. The strips of zinc are cut just long enough, as shown, to extend from the carbon electrode of one cell over to, and down to the bottom of, the adjacent cell. They are soldered to the brass caps at the top of the carbons, making a series connection. Each carbon rod should be dusted with manganese dioxide, wrapped with cheesecloth and tied with common string. The manganese dioxide can be obtained from an old dry cell, if it is wrecked and the carbon removed. Sufficient will be found in one such to supply enough for this battery; its purpose is to prevent polarization of the battery.

After assembly, a strong solution of sal ammoniac in water is poured into each cell and the battery is ready for use. After four blocks of 22.5-volt dry batteries have been exhausted, a full 90-volt wet battery can be made in this way.

—Contributed by Karl L. Martin.

## A SIMPLE CHECK FOR SMALL CONDENSERS

Many radio fans, who doubt the accuracy of the capacity ratings of their small fixed condensers, may obtain a fair check through the agency of their receiver.

It will be necessary to have a curve, of capacity plotted against dial reading, for the tuning condenser. This is furnished by some makers or may be obtained from others on request. In this connection see the article "Activities of the RADIO NEWS Laboratories" in the November, 1925, issue of RADIO NEWS.

A substantial "B" battery of the wet-cell type, the active elements of which can be obtained from old dry cells. Fifteen test tubes are necessary and a solution of sal ammoniac is used for the electrolyte. Each block of dry battery cells will supply material for a home-made battery of equal voltage.

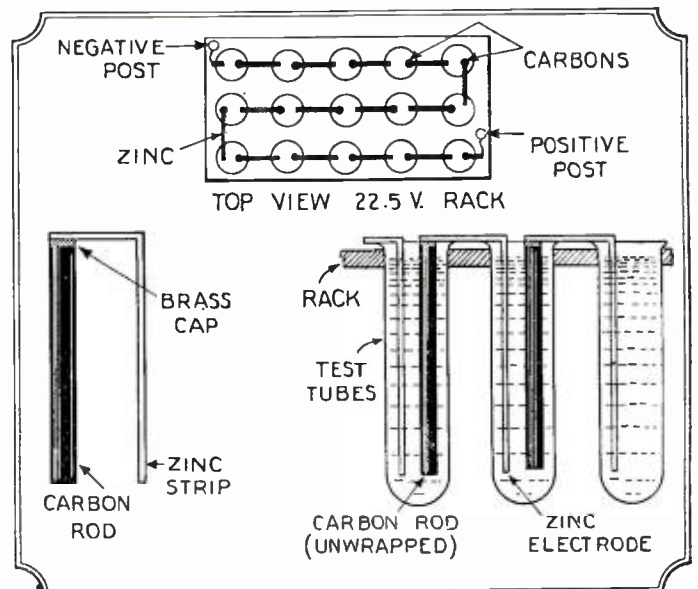



If the fixed capacity is small, as for instance the 150  $\mu\text{mf.}$  grid condenser for peanut tubes, proceed as follows: Tune in a station and note the dial reading. Connect the fixed condenser in parallel with the

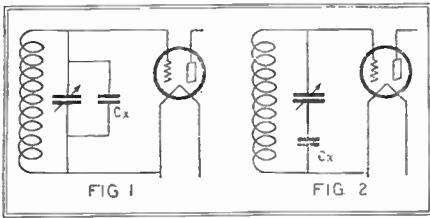

Two methods of connecting a small fixed condenser, in series or parallel, to find out whether it approximates the capacity rated. The experiment is simple, instructive and interesting.

tuning condenser as in Fig. 1, and tune in the same station. Note the new dial reading which will be smaller, due to the added capacity in parallel. Take from the curve of the tuning condenser the capacities corresponding to the two dial readings. The difference between them is the capacity of the fixed condenser. In employing this method it will be necessary to select a station such that both readings will come on the dial.

For larger sizes, connect the fixed condenser in series with the tuner as in Fig. 2, and proceed as before. Then, if  $C_1$  is the capacity necessary to bring in a station with the tuner alone;  $C_2$  the capacity of the tuner to bring in the same station when the fixed condenser is in series;  $C_x$  the capacity of the fixed condenser,

$$\frac{1}{C_x} = \frac{1}{C_1} - \frac{1}{C_2} = \frac{(C_2 - C_1)}{C_1 C_2}$$

or  $C_x$  equals the product of the two capacities obtained from the dial readings divided by their difference. Example:—

Using a 300  $\mu\text{mf.}$  S.L.F. tuning condenser. WBBM comes in at 16 on the dial. From the curve which came with the condenser we find the corresponding capacity is 68  $\mu\text{mf.}$  With a fixed grid condenser in series as in Fig. 2, WBBM comes in at 61 on the dial, and the corresponding capacity is 93.5  $\mu\text{mf.}$

$$C_x = (93.5 \times 68) \div (93.5 - 68) = 249$$

In using the second method it will be necessary to break one connection in the set. It is not probable that this will present any difficulty to anyone who knows enough of radio to be interested in his condensers.

—Contributed by H. L. Leadman.

### A SAFE AERIAL SELECTOR

The accompanying drawing shows an interesting method of changing from one antenna to another. This is often advisable, either for directional effects, or because two aerials of differing length are used under different conditions.

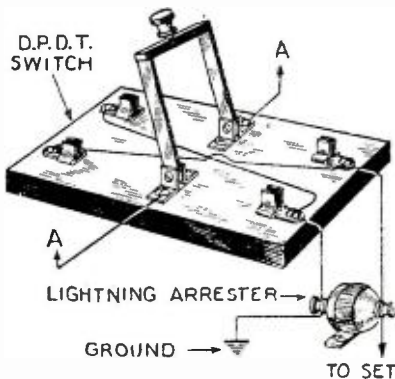

A clever manner in which a change from one antenna to another can instantly be made by means of a double-pole double-throw switch.

By using the method shown, the antenna which is not connected to the set is grounded automatically, while the other is protected

by a lightning arrester. Thus both antennae at all times conform to the rules of the underwriters, with a minimum of trouble in changing from one to another.

The diagram indicates clearly the method of connecting the terminals of the double-pole double-throw switch.

Contributed by W. H. Inge.

### QUICK, EFFECTIVE CONTACT FOR INTERCHANGEABLE COILS

In view of the popularity of the plug-in type of coil, used extensively now in short-wave reception, the wrinkle described below will be found to aid materially in solving the problem of low cost. Procure a discarded single-pole double-throw knife switch and mount it on the baseboard of the set. The coil is then equipped with knife-blade contacts, cut from the switch lever, to which the coil ends are connected. This makes a very effective arrangement and is cheap to construct. The Reinartz or Hartley circuits can be employed, using the tapped-coil method of tuning.

—Contributed by James Maresca.

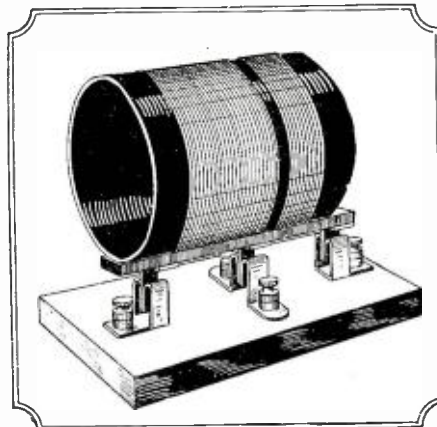

Inductances are much better, if they are equipped with plug-in terminals. This allows a change from one wave-length range to another. A discarded S.-P. D.-T. switch is used.

### A HIGH-SPEED KEY

A vibroplex key is a highly desirable piece of apparatus, and would be found in more ham stations if it were less expensive. One of the standard type requires much mechanical skill and patience to duplicate, principally because of the difficulty in making bearings for the moving elements.

The key shown in this illustration cannot compete with a standard vibroplex, but very accurate signals may be made, if it is carefully constructed with material of proper springiness and the weight is suitably balanced. As it has no bearings, it can be constructed easily by anyone who can handle a soldering iron and tin shears.

The dimensions are given as it was originally constructed, but will probably be varied to suit individual preferences. The main key lever was cut out of stiff spring brass, 3 x 1/2 x 1/16 inches. This may be found a bit too stiff if wide spacing of the dash contact is desired, but proved satisfactory to the constructor.

The vibrating armature was made of .005 shim brass, cut 4 x 1/2 inches; the dot-contact arm was cut and bent as shown, then hammered lightly with a ball-pein to make it a bit stiffer. It was turned slightly on the edge opposite the dot contactor to make up for a slight weakening caused by the slot. The supports were cut out of brass, 1/2-inch wide by 1/10-inch thick, bent, drilled and tapped as shown. Note how the adjustment screws are held tight, by springing back the curved portions slightly in order to put tension on them.

The contacts were made of coin silver, by punching or cutting, and then soldered in place; the screw contacts may be filed to

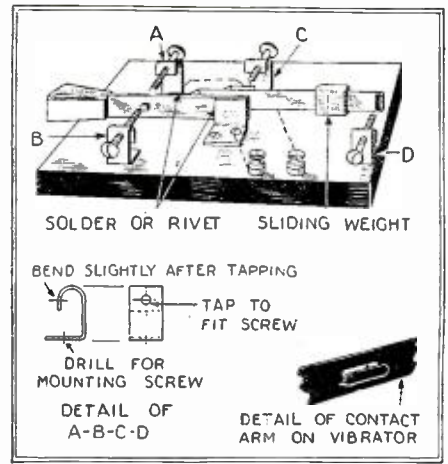

A high-speed key which can be made at home from odds and ends. This is a makeshift for a real vibroplex which works very well.

shape after soldering. A better way would be to drill holes about 1/16- or 3/32-inch, and melt scraps of a dime in an arc until they assume a globular shape, then let them cool. They should be of the same diameter as the holes, and when slipped in and hammered tight, may be filed flush on the face. Tungsten spark-coil contacts may also be used.

To melt silver for contacts, take a piece of carbon from a dry cell and hollow one end slightly. A piece of heavy pencil-lead or flashlight battery carbon may be used for the other pole of the arc. Because silver melts easily, as soon as the fusion point is reached withdraw the arc, or the metal will oxidize and become worthless. A couple of amperes, through a lamp bank or resistance such as a large electric soldering iron or flatiron, may be used, on D.C. preferably; or a 6-volt storage battery may be used with two or three ohms of resistance wire in series with the arc.

The rest of the construction is indicated in the diagram; the weight to be used on the vibrator must be determined by experiment. The speed of the key can be changed in two ways; by changing position of the weight on the armature, which affects it in the same way as altering the length of a clock pendulum; or by setting the weight near the end and changing the adjustment of the dot-contact screw. The latter method makes longer or "heavier" dots, which are easier to read.

The constructor has built a later model, using a stiff rod instead of light spring metal for the armature, which has given even better results and is not affected by the rolling of a ship, as the former was.

—Contributed by Robert Hale.

### A SIMPLE JACK

This very simple and inexpensive type of jack, as shown in the sketch, consists merely of a round wooden pill box about two inches in diameter, drilled for two phone tip jacks and a mounting screw. A hole for the wire is also drilled in one side.

—Contributed by Eldred M. Cartmer.

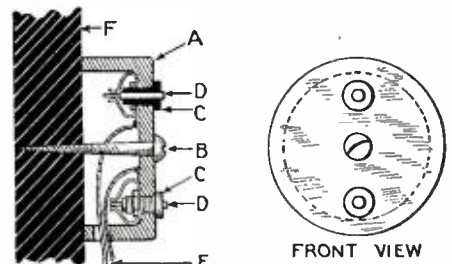

An excellent little wall jack which will find use when you are wiring the rooms in the house for connections to loud speakers. A pill box and phone tip jacks complete the assembly.



# RADIOTICS

## SOOTCH A DOLLINK BABY!



Miltgrossian gesture from the *Pittsburgh Press* of Feb. 21: "Hammarlund - Roberts KIDS—\$5.95". Nize baby, ett oop all de battery currents und Momma let you listen by de radio witt bettime stories how liddle Goldylocks got ett oop witt bears. Hlow wuz? Yi yi yi, don't esk!

Contributed by K. S. Hood

## BOY, PAGE MR. BUCKNER

Dark and dismal prophecy from the *Barawik Company's* catalog (Chicago, Ill.) to the effect that a filament ballast "cannot become open - CIRCULATED". Ye gods, isn't there enough prohibitive measures running around the country right now without putting the kibosh on filament controls?



Contributed by H. H. Yeager

## WHO'S THIS GUY WATTS?



Speaking of superstations and the giant tubes they use, the *Grand Rapids, Mich. Press* of Jan. 5 tells us, in a sub-head, that they "are cooled by WATTS". This fellow Watts is our idea of a busy man if he keeps a bunch of man-sized tubes cool either by fanning or by the old bucket-of-water system.

Contributed by P. L. Mann

## THE VANISHING MALE

Fundamentalist item from the *Topeka, Kansas, Capital* of Feb. 17: "There will be musical numbers broadcast by the male QUARTER of the *Wichita Post*." Now, Your Honor and Gentlemen of the Jury, half the humans in the world are men and women; the rest are evidently morons, as shown by these records.



Contributed by H. H. Yeager

## HONESTY IS THE BEST POLICY



In the *Boston Traveller* of March 5, in an advertisement for tubes, the dealer announces that with every tube is given a "BURNOUT GUARANTEE". That is certainly one way for the trade to increase sales, but we poor radio fans sure would suffer under this arrangement. Whaddya say?

Contributed by W. S. Knight

## QUITE A BOY

Historical note from *Radio Review Magazine* for March, 1926: "Marconi was born in 1874," and later on in the story, "Merconi came to England in 1876, where he took out the first patent for wireless telegraphy." We always thought he was a brainy hoy, but never any such prodigy as that.

Contributed by Peter Cullen

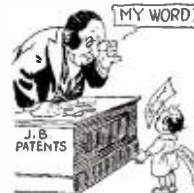

## HELPING OUT THE POLICE



Attempt by Congress to dissipate some of the crime waves as reported by the *Tampa, Fla. Daily Times* of March 12: "Allocation of broadcasting licenses and WAVE BANDITS is vested in the Secretary of Commerce." Anyhow this will relieve some of the crimes in large cities, we trust: if Mr. Hoover will locate the majority of the bandits in Alaska.

Contributed by C. R. Isaac

## HIS PEDIGREE IS TRACED



Revelation in the *Cleveland, Ohio, Press* of Feb. 12th about the Ford of radio, "Crosley PUG Sets." We have wondered for a long time just what breed these young sets were, and here they are, brothers to the favorite breed of yesterday.

Contributed by Sam Murtin

## FURNITURE FOR SALE!

In a dealer's advertisement in the *Hamburg, Pa. Item* of March 4, is the following question: "Ever see or HEAR a Pooley radio cabinet?" Evidently this scientific age is progressing more rapidly than usual, as now there is apparently no need for anything but a cabinet to hear broadcast concerts.

Contributed by Amnon Rentschler



## HOW TO BUY SETS CHEAP



Aid for the B.C.L. who is broke as announced by the *Radio Broadcast* for March, 1926, in an advertisement: "One burnt-out tube WILL PAY for many Belden Radio battery cords." We just can't quite follow the reasoning behind all this. Does the dead tube pay for the cords or—for the love Pete help us out?

Contributed by C. H. Lind

If you happen to see any humorous misprints in the press we shall be glad to have you clip them out and send to us. No RADIOTIC will be accepted unless the printed original giving the name of the newspaper or magazine is submitted with date and page on which it appeared. We will pay \$1.00 for each RADIOTIC accepted and printed here. A few humorous lines from each correspondent should accompany each RADIOTIC. The most humorous ones will be printed. Address all RADIOTICS to

Editor RADIOTIC DEPARTMENT, c/o Radio News.

## LIVERS VS. MONKEY GLANDS?



Surgical note from the *Sharon, Pa., Herald*, of March 4, states that "Radio LIVERS of England favor high-grade American equipment." Now, Grandpop, just because you've been to Europe and collected yourself some monkey glands, don't rush off to ask John Bull for one of these new-fangled livers.

Contributed by D. L. Geer

## HERE'S ANOTHER NEW ONE

Innovation in radio tubes as told in the classified pages of the *Milwaukee, Wis., Journal* of March 7: "RADIO TUBES—15 x 30, WALNUT FINISH, manufacturer's outlet—\$11." Well, well, now we can get tubes to match our cabinets; and next we suppose that we'll be flooded with wooden condenser plates.

Contributed by Emil E. Soldner



## A HOT ONE



Candid criticism by the *Minneapolis, Minn., Journal* of March 4 in its list of broadcast programs: "7:30 BOOB TALK." We don't think that is very complimentary to the speaker; do you? If we were the speaker and the publicity man did a thing like that, t. us, we'd go after him with a gat.

Contributed by Dwight H. Mahan

## A GREAT ACCESSORY



Help for the helpless B. C. L. as advertised in the *Toronto Daily Star*, of Feb. 25: ".0015 FIXER Condenser—.15." Now, you DX hounds, if the old receiver is not behaving as it should, install one of these condensers and it will fix anything that happens to be out of kilter.

Contributed by W. G. Mortimer

## ANYTHING TO AVOID MONOTONY

Transformers we don't want are told about in *Everybody's Radio Weekly* of Feb. 27, in an advertisement. It says that the Meloformer is used "—because it is NON-DISTORTION-LESS and gives volume." We suppose the sale of these transformers is limited to the places where only tomtom music is broadcast.

Contributed by E. C. Dymond.



## THE POWER OF FICTION



In the February issue of the *Radio Bug*, Winnipeg, Canada, there appears this safety-first item, "The Power Company have forbidden the attaching of any radio SERIAL to its poles." This shows us that these radio fiction yarns that run in some publications are useful to the fans besides passing the time of day.

Contributed by K. M. Healey

## PUSH 'EM UP, BIG BOY!

New type of receiving antenna as described by discouraged owner in the *Mar. 17th issue* of the *Portland, Me., Press Herald*, "Antenna 80 INCHES long and 35 INCHES high." Maybe the builder of this young wavecatcher has hopes that it will grow up some day into a man's sized version; he won't hear much until then.

Contributed by Anonymous



## AW, BE REASONABLE!



Extraordinary condition imposed upon entrants in a non-blooming set builders' contest as announced in the *March 16th issue* of the *Columbus, O., Dispatch*, "2. Every set must contain PARTS." Now we ask you as man to man, did you ever hear of the likes of that? We admit we never have.

Contributed by S. E. Clark

## A ROSE BY ANY OTHER NAME

Advertisement of big department store in the *St. Louis Post-Dispatch* of Mar. 14 tells about a set which has "...2 stages of tuned Radio frequency AMPLIFICATIONS, DETACHER, and 2 stages of audio frequency." This is a new name for the tube that untangles the music from the carrier wave. They tried to disguise it, but we fooled 'em. Now you know too.

Contributed by R. W. Williams



## CALL FOR THE S. P. C. T.



Sporting offer from the *New York Graphic* of Mar. 22: "ON-TUBE Journal 1. knob set without accessories; will take anything in exchange." If the owner would give the unfortunate tube a chance, he might offer to trade for "anything useful," like an advertiser in the next column who isn't knocking radio a bit.

Contributed by L. M. Brush



# STANDARD HOOK-UPS

EVERY month RADIO NEWS presents in this convenient form a selection of circuit diagrams, with constructional and other data, on standard hook-ups, which the editors have tried and found to give excellent results. Every radio experimenter should preserve these for their reference value, as they are selected to cover the complete range of radio apparatus, from the simplest to the largest and most complicated. Requests for special or additional advice and information should be addressed to the I WANT TO KNOW Department of RADIO NEWS. (A charge of 25 cents is made for answering each question which requires a reply by letter.)

## Handy Reference Data for the Experimenter

### A PRACTICAL SHORT-WAVE TRANSMITTER

Circuit No. 165. This short-wave transmitting circuit is the adaptation used by a successful British amateur station, and very efficient results have been obtained with it. It is a 40-meter transmitter, with shunt-feed grid modulation. The following apparatus is necessary for its construction:

Three coils (L1, L2, L3), of the specifications given below;

Two power rheostats (R1, R2), for transmitting tubes of either 5- or 50-watt type, depending on which is used;

One transmitting grid leak (R-3), 5,000-ohm;

One transmitting fixed condenser, .00025- $\mu$ f.;

Two transmitting variable condensers, .00025- $\mu$ f.;

One by-pass condenser, mica type, 1- $\mu$ f.;

One milliammeter, 0-100 scale;

One radiation ammeter;

One modulation transformer (a Ford coil may be used for this purpose if the vibrator is closed down tightly);

One microphone, switches, keys, sockets, etc.

For 40-meter work, L1 has 2 to 5 turns, L2 has 8, L3 has 3 to 5. For 20 meters, L1 has but one turn, L2 has 3 to 4, L3 1 or 2. No. 14 D.C.C. wire is used, spaced-wound to a diameter of about 3½ inches.

The key for CW. work may be placed in either the grid or the counterpoise circuit. If both are installed, one must be kept closed while the other is in use. Both must be closed for radiophone transmission.

### SHORT-WAVE RECEIVER

Circuit No. 166. Practically every radio constructor is at the present time interested in short-wave reception. The numerous radiophone tests made by stations such as KDKA and WGY on the short waves, as well as the increasing popularity of this wave band with ama-

teurs for phone transmission, give good reason for this interest.

The circuit shown in this diagram is extremely simple in both construction and operation, which makes this receiver a desirable one for the listener-in on this band. The necessary parts for its construction are:

One insulating panel, 7x18 inches;

One wooden baseboard, 7x17x½ inches;

Two variable condensers, .00025- $\mu$ f.;

One A-F. transformer, 6:1 ratio;

One grid condenser, .00025- $\mu$ f., with 2-megohm grid leak and mounting.

The antenna inductance, L1, must have various dimensions for various wave-length ranges; to cover the band from 15 to 100 meters, 12 turns of No. 22 D.C.C. wire wound on a three-inch tube of insulating material will suffice. For the band from 75 to 200 meters, 18 turns of the same size wire will be required.

L2 is an ordinary radio-frequency choke coil, which may consist of either a

300-turn honeycomb coil, or 200 turns of No. 28 S.C.C. wire on a tube 6 inches long by one in diameter.

In adjusting this receiver, the antenna tap should be varied carefully, as this adjustment will be found to have a considerable effect on the receiver's ability to oscillate efficiently from 0 to 100 degrees on the condenser. For this reason, it will be best to tap the windings of L1 at every turn. By varying the amount of inductance between the points indicated at X and Y, the wave-length range of the receiver may be varied. The less the amount of inductance used, the lower will be the wave-length reached.

### "B" AND "C" ELIMINATOR

Circuit No. 167. There can be no doubt that battery eliminators are the "coming thing"; in fact, radio set users are rapidly adopting devices of this nature, as it means to them a considerable saving of time and annoyance, besides being more economical in the long run than the use of the ordinary batteries. This diagram shows the circuit of a very efficient "B" and "C" batteries eliminator, which may easily be constructed from standard parts, everywhere purchasable.

The apparatus required is as follows: One step-up transformer (T), of a type suitable for "B"-elimination purposes, such as the Thordarson, Amertran, General Radio, Acme, Jefferson, etc.;

One rectifier tube;

Two choke coils (B1, B2), 30-henry;

Three fixed condensers (C1, C2, C3), 4- $\mu$ f.;

One fixed condenser (C4), .002- to .006- $\mu$ f.;

One rheostat (R1), for primary;

One rheostat (R2), 10,000-ohm;

One rheostat (R3), 400-ohm.

The amount of detector voltage obtained may be varied by simply changing the value of R2. Varying the amount of "C" voltage is taken care of by R3.

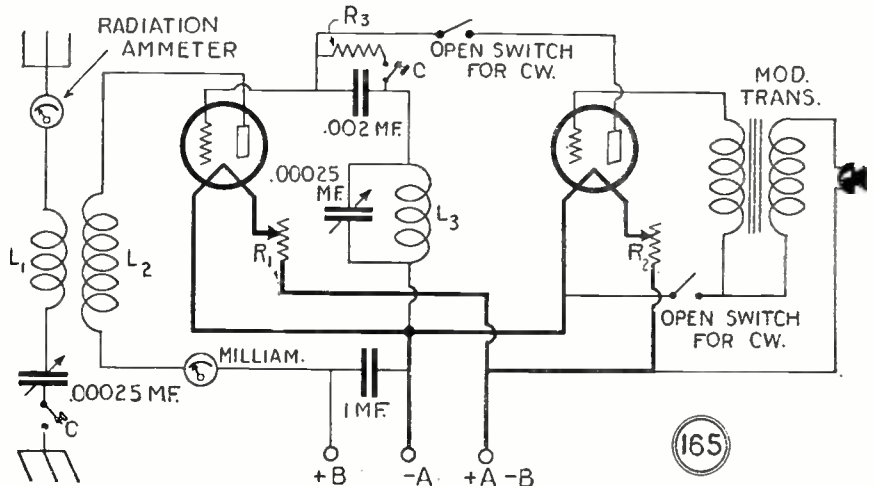

A very efficient and practical short-wave transmitter which may be used for both radiophone transmission and CW. The transmitter shown conforms with present legal requirements, being of the inductively-coupled type.

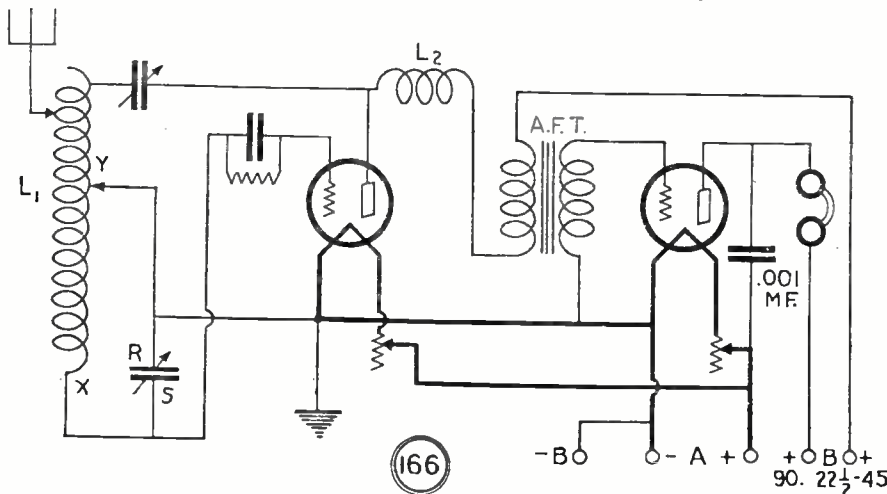

There can be no better receiver, for simplicity and ease of tuning for short-wave reception, than that shown above. With the constants mentioned in the description of this circuit, it is adapted to a wave-length band of from 15 to 200 meters.



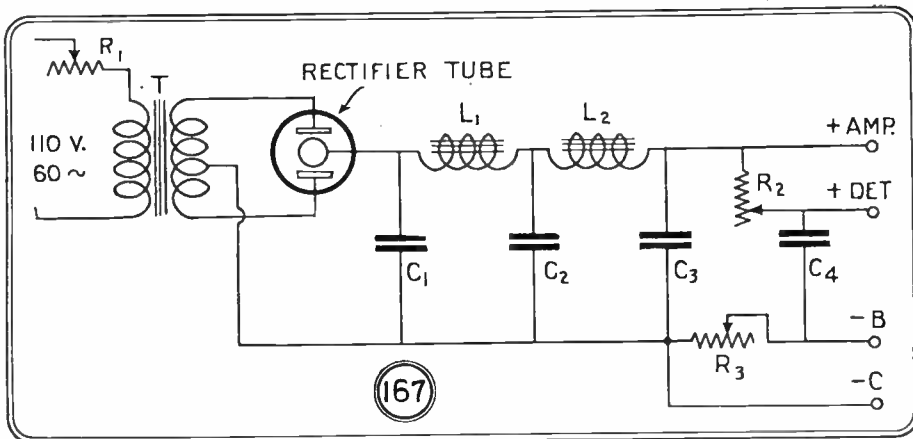

Circuit diagram of a "B" eliminator of conventional design. It is capable of producing a fairly pure direct current output to the receiver, thus eliminating "B" as well as "C" batteries.

When connecting this eliminator to the receiving set, it will be best to connect the B— of the set to the A+ instead of A+; unless the set is already wired, as some are, in this manner.

### FIVE-TUBE BROADCAST RECEIVER

Circuit No. 168. The publication of this circuit is an innovation, in that it was furnished to us by one of our readers, Mr. G. B. Ashe, of Annapolis, Md., who writes very enthusiastically concerning its efficiency. The set diagramed seems to be unique and interesting, and capable of producing as good results as any five-tube set known. We quote Mr. Ashe as to the development and success of the receiver:

"The diagram, I think, is self-explanatory, and it only remains to say that it was gradually developed from the "Six-Tube Set of Advanced Design," which you published in the September, 1924, issue of RADIO NEWS. I still have the additional push-pull stage of audio, although I very rarely have occasion to use it and have omitted it from the diagram.

"I believe the results obtained to be all the more interesting, when the kind of aerial I use is known. The set is situated on the second floor of the house. My aerial is led up to the third floor and attached to a steam radiator. The ground wire from the set is attached to a cold-water pipe on the second floor. The actual length of wire used in the aerial is about 60 feet, and the ground wire is about 15 feet long. The results obtained when the aerial is disconnected from the radiator cannot compare with those ob-

tained when it is connected as described above."

The apparatus required for the construction of this receiver is as follows:

- One three-circuit tuner (L1), with neutralizing winding, preferably designed to operate with .00035- $\mu$ f. variable condenser;
- One three-circuit tuner (L2), designed to operate with .0005- $\mu$ f. condenser;
- Two R.-F. choke coils;
- One A.-F. transformer, 5:1 ratio;

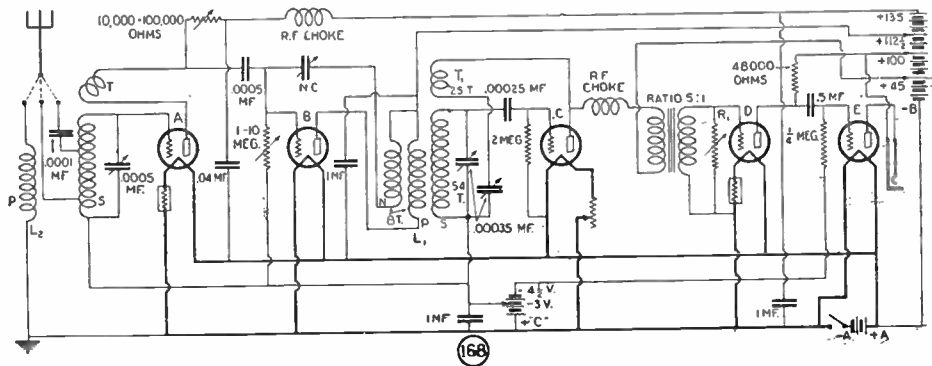

A five-tube receiver which has given excellent results. The originator uses 201A tubes at A, C and D; a "high  $\mu$ " tube, with amplification factor of 20, at B; and a power tube at E. The adjustment of the latter tubes is not critical.

- Two variable condensers, .00035- $\mu$ f., S.L.F.;
- One variable condenser, .0005- $\mu$ f., S.L.F.;
- One Midget balancing condenser (N.C.);
- Five by-pass condensers, three 1-, and one each 0.5- and .04- $\mu$ f.;
- One grid condenser, .00025- $\mu$ f. and 2-megohm grid leak;
- One grid leak, 1/4-megohm;

three-tube resistance-coupled audio amplifier, which results in a remarkable receiver, easy to tune and with excellent tonal efficiency.

The apparatus required to construct this includes:

- Three toroidal coils (C, T1, T2), designed to operate with .0005- $\mu$ f. S.L.F. condensers;
- Three condensers of the above size, and dials;
- One grid condenser, .00025- $\mu$ f., and 2-megohm grid leak, with mounting;
- Three rheostats, one 15-, two 10-ohm;
- One audio-amplifier unit, 3-tube resistance-coupled;
- One insulating panel, 7x24 inches, with sub-panel, and brackets;
- One filament switch;
- One antenna switch and points (A1, A2);
- One jack, open-circuit;
- Sockets, binding posts, etc.

In mounting the coils on the sub-panel, though it is not material in what position they are placed, a more symmetrical effect will be obtained by placing them at right angles to each other; or at similar angles, somewhat like the coils in a neodyne receiver.

"High  $\mu$ " tubes, or tubes with a high amplification factor, should be used in the first two sockets of the audio-amplifier unit; and an ordinary 201A or 301A tube in the last socket of this amplifier.

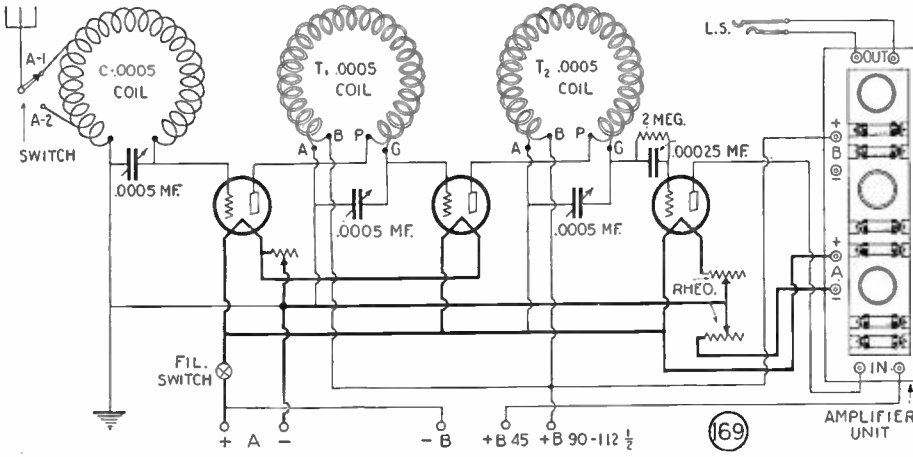

In the design of this receiver for maximum efficiency, clarity was considered one of the very important requisites. The use of toroidal coils and resistance-coupled audio amplification proves this statement.





## Why Stop? By HENRY LAMONTE

**H**ITHERTO, when the robins have started in hopping around under the trees that have a suggestion of green along some of their branches, and when the millionaires have made their exodus from Florida and begun to think about opening their camps at Newport and up in Maine, the hams also have started to think of things other than radio, whether they be baseball, golf, canoeing, swimming, or what a young man's fancy generally turns to—love.

Now, exactly why this sort of condition exists is "over the head" of the writer. Of course, the cry will boom forth from the lusty throats of hundreds of hams, "There is too much static!" That very slogan has been the cause of more good time being wasted than any other that we are aware of. Not only do the hams put their sets away in moth balls for the summer months, but the BCL's, being newcomers at the game, think that the old timers know what they are talking about and follow suit.

To our way of thinking, this is the well-known bunk, and it is a crime that this static stuff is so generally swallowed by gullible hams, who are otherwise pretty wise lads. We will freely admit that, back a few years ago before the vacuum tube came into general use for ham transmission, the note thrown on the summer breezes by the spark transmitters sounded more like static than old Man Static himself. Then were the times when the hams had a good excuse to relegate the set to the closet and spend the evenings in a canoe or hammock or what you will.

But let us consider the saying, "Them days are gone forever." In these enlightened days when vacuum tubes are in more or less

general use, so far as we can see there is no good excuse for hams to stop working. Surely the note put on the air by a tube transmitter is no more like the old-time spark crash than pinochle is like tennis. The writer has asked several ham friends about this very thing and the answer has been, in ninety per cent. of the cases, that they have no trouble whatsoever in distinguishing a good note through fairly heavy static.

Again we will admit something and that is that static is annoying and that we have let loose more than one bundle of vivid curses, when in the old days we found it impossible to work some other fellow. Yet when we gathered together enough of the filthy lucre to change over from the old spark set and got ourselves some tubes we found that times had indeed changed. We discovered that we could be heard a good distance off, and we were proud of the fact that our station was instrumental in doing some important rescue work in the middle of the summer.

### IT'S DECEMBER WAY DOWN SOUTH

Here is another angle from which to view the subject. While we are fighting mosquitos, flies, and other summer pests up here in the United States, below the Equator the hams are settling back in their chairs, rubbing their hands in glee that now is the time when they are going after a flock of DX. In other words, the winter time in South America, Australia and Africa is our summer. Think that fact over a moment and you will see that it is true, if you remember enough of your school days' geography lessons.

What does this fact mean? Just this. Although up here in the States we may have some static to bother us, down there where it is perfect radio weather they are more anxious to work than any other time; and there is always the chance that

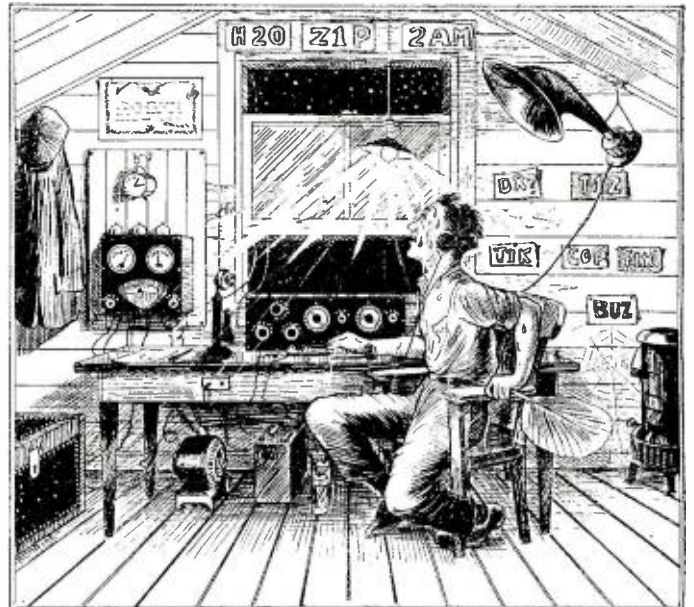

No longer is it necessary to sit in an attic that is hotter than the proverbial hinges, when —

some mighty fine DX records will be missed if we sign off for the summer. It must be understood that we do not mean to infer that we will get their signals better; but on the other hand there is a better chance that they will receive us. Do not forget that the South American and Australian ham is every bit as enthusiastic as we are in our winter; and if we all were to stop transmitting for the summer, what chance would he have? About as much as a chicken at a coon picnic.

Every good ham and true here in the United States would think it a crime if the hams below the line stopped working just because their weather was not exactly the kind they liked. The cry would rend the heavens, from hundreds of hams. "Why don't they give us a chance?" and the cry would be justified too. Now is it right and just that we treat them in a way we would get sore about, if they treated us in the same manner? We think that every right-minded ham will think this over carefully and call to mind the Golden Rule. Let us give them a chance.

### PRACTICAL DEVELOPMENT WORK

It is a well-known fact that many of the great developments in the art of radio transmission and reception have originated in the back of some ham's brain. If the ham will take the trouble to look over the advertisements in some radio publications he will find that there are many static eliminators and static reducers on the market. These pieces of apparatus are far from being perfect in many ways, and here is a field in which the ham can show his inventive genius.

Why not try your hand at doping out some sort of a gadget that will relieve this so-

(Continued on page 1691)



—it is possible to enjoy the coolness of the cellar, for instance, and work the set by remote control.





**APPROVED  
RADIO NEWS  
LABORATORIES  
1922**

# RADIO NEWS LABORATORIES



**R**ADIO manufacturers are invited to send to RADIO NEWS LABORATORIES, samples of their products for test. It does not matter whether or not they advertise in RADIO NEWS, the RADIO NEWS LABORATORIES being an independent organization, with the improvement of radio apparatus as its aim. If, after being tested, the instruments submitted prove to be built according to modern radio engineering practice, they will each be awarded a certificate of merit, and a "write-up" such as those given below will appear in this department of RADIO NEWS. If the apparatus does not pass the Laboratory tests, it will be returned to the manufacturer with suggestions for improvements. No "write-ups" sent by manufacturers are published on these pages, and only apparatus which has been tested by the Laboratories and found to be of good mechanical and electrical construction is described. Inasmuch as the service of the RADIO NEWS LABORATORIES is free to all manufacturers whether they are advertisers or not, it is necessary that all goods to be tested be forwarded prepaid, otherwise they cannot be accepted by the Laboratories. Apparatus ready for the market or already on the market will be tested for manufacturers, as heretofore, free of charge. Apparatus in process of development will be tested at a charge of \$2.00 per hour required to do the work. Address all communications and all parcels to RADIO NEWS LABORATORIES, 53 Park Place, New York City.

**LOUD SPEAKER**

The loud speaker shown was submitted to the RADIO NEWS LABORATORIES for test, by The Magnavox Company, 2725 E. 14th St., Oakland,



Calif. It gives faithful reproduction over the musical scale.

AWARDED THE RADIO NEWS LABORATORIES CERTIFICATE OF MERIT NO. 1342.

**VARIABLE RESISTOR**

This resistor was submitted to the RADIO NEWS LABORATORIES for test, by R. P. Cunningham Electric Co., 319 No. Whipple St., Chicago, Ill.



The device was found useful in various circuits where a variable high resistance is necessary.

AWARDED THE RADIO NEWS LABORATORIES CERTIFICATE OF MERIT NO. 1282.

**RADIO-FREQUENCY COIL**

This radio-frequency coil was submitted to the RADIO NEWS LABORATORIES for test, by the Davenport Radio Laboratories, Davenport,

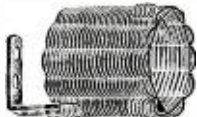

Iowa. It was found to cover the entire broadcast range of wave-lengths satisfactorily.

AWARDED THE RADIO NEWS LABORATORIES CERTIFICATE OF MERIT NO. 1293.

**CRYSTAL SET**

The "Monarch" Crystal Set was submitted to the RADIO NEWS LABORATORIES for test, by Rippper Bros. Mfg. Co., 2125 Superior Ave., Cleve-



land, Ohio. It is a complete set, giving good results for local stations.

AWARDED THE RADIO NEWS LABORATORIES CERTIFICATE OF MERIT NO. 1292.

**FIXED RESISTANCE UNIT**

This unit was submitted to the RADIO NEWS LABORATORIES for test, by Amsco Products, Inc., Broome



and Lafayette Sts., New York City. Measurements showed values which agreed favorably with rated values.

AWARDED THE RADIO NEWS LABORATORIES CERTIFICATE OF MERIT NO. 1402.

**ANTENNA LEAD-IN**

This flat, insulated strip, antenna lead-in was submitted to the Radio NEWS LABORATORIES for test, by



Windsor & Whitford, Wolcott, N. Y. It is specially suitable for use where windows must be tightly closed.

AWARDED THE RADIO NEWS LABORATORIES CERTIFICATE OF MERIT NO. 1380.

**VERNIER DIAL**

The variable-ratio vernier dial illustrated was submitted for test to the RADIO NEWS LABORATORIES by the



National Co., Inc., 110 Brookline St., Cambridge, Mass. The pin at the base is used to determine the ratio of reduction, which has a wide range, permitting fine tuning adjustments over the entire capacity scope of a variable condenser, of whatever type.

AWARDED THE RADIO NEWS LABORATORIES CERTIFICATE OF MERIT NO. 1420.

**CORD CONNECTOR**

The Extension Cord Connector was submitted to the Radio NEWS LABORATORIES for test, by The Saturn Mfg. & Sales Co., Inc., 48



Beekman St., New York. It is handy for making various connections.

AWARDED THE RADIO NEWS LABORATORIES CERTIFICATE OF MERIT NO. 1347.

**R.F. TRANSFORMER**

This compensated inductance was submitted to the RADIO NEWS LABORATORIES for test, by the Curkoid Corp., 100 Charles St., New York. When tuned by a suitable condenser, the transformer was found to cover



the entire range of the broadcast wave-lengths.

AWARDED THE RADIO NEWS LABORATORIES CERTIFICATE OF MERIT NO. 1300.

**JACK**

The "Perfect" Radio Jack was submitted to the Radio NEWS LABORATORIES for test, by The Saturn Mfg. & Sales Co., Inc., 48 Beekman



St., New York. It employs heavy springs and positive contacts.

AWARDED THE RADIO NEWS LABORATORIES CERTIFICATE OF MERIT NO. 1345.

**CONDENSER**

This nidget condenser was submitted to the RADIO NEWS LABORATORIES for test, by Silver-Marshall, Inc., 848 W. Jackson Blvd., Chicago,



Ill. It is an excellent little compensating condenser for balancing circuits.

AWARDED THE RADIO NEWS LABORATORIES CERTIFICATE OF MERIT NO. 1244.

**PHONE PLUG**

The Automatic Radio Plug was submitted to the RADIO NEWS LAB-



ORATORIES for test, by The Saturn Mfg. & Sales Co., Inc., 48 Beekman St., New York. It is a handy phone plug, having positive-contact grips.

AWARDED THE RADIO NEWS LABORATORIES CERTIFICATE OF MERIT NO. 1346.

**BUS-BAR AND SLEEVE**

The "Gosilco" Sleeve Connection and "Gosilco" Bus-Wire were submitted to the RADIO NEWS LABORATORIES for test, by the American Luminous Products Co., 320 Mar-

brisa Ave., Huntington Park, Calif. The bus-bar is a round, gilt-finished wire of great tensile strength and



low resistivity. The sleeve is a handy connector which can be used for all antenna work or wherever tight connections are necessary.

AWARDED THE RADIO NEWS LABORATORIES CERTIFICATE OF MERIT NO. 1371.

**SOCKET**

This socket was submitted to the RADIO NEWS LABORATORIES for test, by the Pacent Electric Co., 91 Seventh Avenue, New York City. It

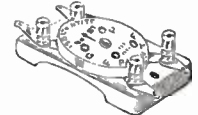

is for use with the type UX, UV and CX tubes.

AWARDED THE RADIO NEWS LABORATORIES CERTIFICATE OF MERIT NO. 1273.

**ADAPTER**

This adapter was submitted to the RADIO NEWS LABORATORIES for test, by the Pacent Electric Co., 91 Seventh Avenue, New York City. It



is an efficient and well-made adapter, to fit any standard socket.

AWARDED THE RADIO NEWS LABORATORIES CERTIFICATE OF MERIT NO. 1275.

**"B" ELIMINATOR**

This eliminator was submitted to the RADIO NEWS LABORATORIES for test, by the Epom Corporation, 114 East 47th Street, New York City. It has been tested and found to be



very satisfactory when used in conjunction with an ordinary radio receiver. It has fairly pure output and practically no distortion or hum is heard when it is used. This eliminator works on alternating current.

AWARDED THE RADIO NEWS LABORATORIES CERTIFICATE OF MERIT NO. 1143.



**INDUCTANCE BASE**

This instrument was submitted to the RADIO NEWS LABORATORIES for test, by Silver-Marshall, Inc., 848 W. Jackson Blvd., Chicago, Ill. The unit covers the broadcast range sub-



stantially well. The inductance base is a ring device into which the inductance can be very readily plugged.

AWARDED THE RADIO NEWS LABORATORIES CERTIFICATE OF MERIT NO. 1317.

**RADIO FREQUENCY KIT**

This radio frequency kit, consisting of three sets of coils and condensers, was submitted to the RADIO NEWS LABORATORIES for test, by the Martin-Copeland Company, Providence, R. I. It may be used in

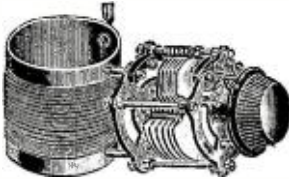

a radio receiving circuit where tuned radio frequency amplification is desired, and may also be used in special circuits.

AWARDED THE RADIO NEWS LABORATORIES CERTIFICATE OF MERIT NO. 1137.

**SOCKET**

The "Cle-Ra-Tone" Socket was submitted to the RADIO NEWS LABORATORIES for test, by Benjamin Electrical Mfg. Co., 847 W. Jackson



Blvd., Chicago, Ill. It is fine in appearance and adaptable for UV and UX tubes.

AWARDED THE RADIO NEWS LABORATORIES CERTIFICATE OF MERIT NO. 1296.

**CRYSTAL DETECTOR**

The "Crystal Pyradite" was submitted to the RADIO NEWS LABORATORIES for test, by the Pyradite Laboratories, 224 Second Ave., Ot-



tawa, Canada. It is an easily-adjustable detector, having a sensitive crystal.

AWARDED THE RADIO NEWS LABORATORIES CERTIFICATE OF MERIT NO. 1295.

**"PHENOLITE" LAMINATED BAKELITE**

This bakelite was submitted to the RADIO NEWS LABORATORIES for test by the National Vulcanized Fibre Company, P. O. Drawer 920, Wilmington, Delaware, and ap-



proved, having been found to have an exceedingly low absorption factor and to be well suited for radio use.

AWARDED THE RADIO NEWS LABORATORIES CERTIFICATE OF MERIT NO. 1138.

**CHOKE COIL**

This fixed radio-frequency choke coil was submitted to the RADIO NEWS LABORATORIES for test, by Bremer-Tully Mfg. Co., 532 S.

Canal St., Chicago, Ill. It proved effective, when connected in series with a grid leak, to prevent parasitic frequencies from being set up when the tube was in oscillation.



AWARDED THE RADIO NEWS LABORATORIES CERTIFICATE OF MERIT NO. 1404.

**NEUTRALIZING CONDENSER**

The "Mikro-Mike" condenser was submitted to the RADIO NEWS



LABORATORIES for test, by Bremer-Tully Mfg. Co., 532 S. Canal St., Chicago, Ill. It is a small and easily-adjusted unit, found effective in neutralizing circuits.

AWARDED THE RADIO NEWS LABORATORIES CERTIFICATE OF MERIT NO. 1334.

**CRYSTAL DETECTOR**

This detector was submitted to the RADIO NEWS LABORATORIES for test, by the S. A. M. Radio Co., 619 Securities Bldg., Omaha, Neb.



It was found to be sensitive and easy of adjustment.

AWARDED THE RADIO NEWS LABORATORIES CERTIFICATE OF MERIT NO. 1297.

**AUDIO TRANSFORMER**

This audio transformer was submitted to the RADIO NEWS LABORA-



TORIES for test, by the Samson Electric Co., Canton, Mass. It is a well-made and powerful instrument for audio amplification.

AWARDED THE RADIO NEWS LABORATORIES CERTIFICATE OF MERIT NO. 1289.

**CRYSTAL**

The "Rival" Radio Crystal was submitted to the RADIO NEWS LAB-



ORATORIES for test, by Mrs. P. F. Passera, Amsterdam, N. Y. Tests showed sensitivity and very clear rectification.

AWARDED THE RADIO NEWS LABORATORIES CERTIFICATE OF MERIT NO. 1350.

**BAKELITE BASEBOARD**

The bakelite baseboard shown was submitted to the RADIO NEWS LAB-



ORATORIES for test, by the Amsco Products Company, Broome and Lafayette Streets, New York City, and

was found to be of unique construction, being moulded of pure bakelite and containing five sockets, including binding posts, terminals, etc. It may be used in the construction of any 5-tube receiving set. The baseboard is of solid construction and able to withstand fairly heavy strain.

AWARDED THE RADIO NEWS LABORATORIES CERTIFICATE OF MERIT NO. 1134.

**NEUTRALIZING CONDENSER**

This neutralizing condenser was submitted to the RADIO NEWS LAB-



ORATORIES for test, by the Samson Electric Co., Canton, Mass. The instrument is easy of adjustment.

AWARDED THE RADIO NEWS LABORATORIES CERTIFICATE OF MERIT NO. 1291.

**RHEOSTAT**

This rheostat was submitted to the RADIO NEWS LABORATORIES for



test, by Pilot Electric Mfg. Co., 323 Berry St., Brooklyn, N. Y. It was found to have an even and unbroken range.

AWARDED THE RADIO NEWS LABORATORIES CERTIFICATE OF MERIT NO. 1376.

**TESTER**

The Tri-Tube tester was submitted to the RADIO NEWS LABORATORIES for test, by the Morrison Radio



Co., 1772 Wilson Ave., Chicago, Ill. It is a device employing a miniature lamp (in an oscillatory circuit) which lights up when the tube is capable of oscillation.

AWARDED THE RADIO NEWS LABORATORIES CERTIFICATE OF MERIT NO. 1339.

**TRANSFORMER**

This transformer was submitted



to the RADIO NEWS LABORATORIES for test, by the Dongan Electric Mfg. Co., 2987 Franklin St., Detroit, Mich. It is a finely-designed instrument for use with a B-battery supply unit.

AWARDED THE RADIO NEWS LABORATORIES CERTIFICATE OF MERIT NO. 1286.

**CONDENSER AND LEAK**

The Micamold Condenser Resistor Unit was submitted to the RADIO



NEWS LABORATORIES for test, by the Micamold Radio Corp., 1087 Flushing Ave., Brooklyn, N. Y. It is a combination which was found ef-

fective in biasing the grid of a detector tube.

AWARDED THE RADIO NEWS LABORATORIES CERTIFICATE OF MERIT NO. 1336.

**FIXED CONDENSER**

The Micamold Fixed Condenser was submitted to the RADIO NEWS



LABORATORIES for test, by the Micamold Radio Corp., 1087 Flushing Ave., Brooklyn, N. Y. It is a fixed condenser of quality, impervious to moisture.

AWARDED THE RADIO NEWS LABORATORIES CERTIFICATE OF MERIT NO. 1335.

**TUNING UNIT**

This R.F. unit was submitted to the RADIO NEWS LABORATORIES for

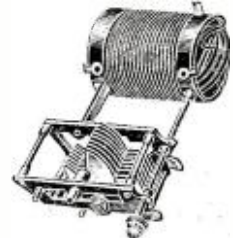

test, by the National Co., Inc., 110 Brookline St., Cambridge, Mass. The instrument comprises a unit having characteristics suitable for high efficiency.

AWARDED THE RADIO NEWS LABORATORIES CERTIFICATE OF MERIT NO. 1261, 1262.

**RESISTANCE-AMPLIFIER KIT**

This resistance-amplifier kit was submitted to the RADIO NEWS LAB-



ORATORIES for test, by the Micamold Radio Corp., Flushing & Porter Ave., Brooklyn, N. Y. This unit is suitable for an audio-frequency amplifier, consisting of coupling resistor, coupling condenser and grid leak.

AWARDED THE RADIO NEWS LABORATORIES CERTIFICATE OF MERIT NO. 1242.

**RADIO-FREQUENCY COIL**

This radio-frequency coil, "Cir-



coil," was submitted to the RADIO NEWS LABORATORIES for test by Nolte Mfg. Co., 193 Plainfield Ave., Jersey City, N. J. It is an inductance of meritorious design, and found to cover the entire wave-length range.

AWARDED THE RADIO NEWS LABORATORIES CERTIFICATE OF MERIT NO. 1268.

**GRID LEAK**

The "Nonoise" variable grid leak was submitted to the RADIO NEWS



LABORATORIES for test, by Radio Foundation, Inc., 25 West Broadway, New York City. It was found to approximate closely the rated value, and is well made.

AWARDED THE RADIO NEWS LABORATORIES CERTIFICATE OF MERIT NO. 1269.



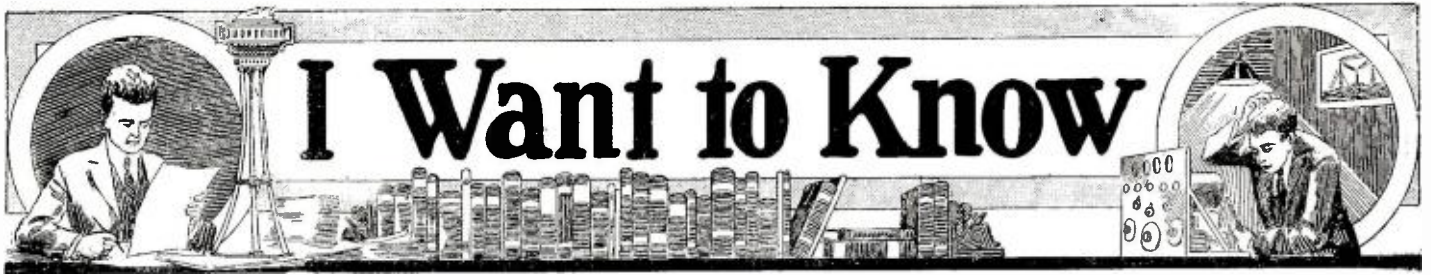

Conducted by Joseph Bernsley

**T**HIS Department is conducted for the benefit of our Radio Experimenters. We shall be glad to answer here questions for the benefit of all, but we can publish only such matter as is of sufficient interest to all.

1. This Department cannot answer more than three questions for each correspondent. Please make these questions brief.
2. Only one side of the sheet should be written upon; all matter should be typewritten or else written in ink. No attention paid to penciled matter.
3. Sketches, diagrams, etc., must be on separate sheets. This Department does not answer questions by mail free of charge.
4. Our Editors will be glad to answer any letter, at the rate of 25c for each question. If, however, questions entail considerable research work, intricate calculations, patent research, etc., a special charge will be made. Before we answer such questions, correspondents will be informed as to the price charge.

Mr. Bernsley answers radio questions from WRNY every Thursday at 8:15 P. M.

**JOURNAL'S ONE-KNOB ONE-TUBE SET**

(Q. 2172-C.) Because of limitations of space, the description and diagrams of this set were postponed to this month; the descriptions of the New York Journal's One-Knob (five-tube) circuit and its Selective Filter Tuner appeared in this department of RADIO NEWS for May. We quote the description and constructional information on the One-Knob One-Tube set; illustrated by a schematic diagram of this simple receiver.

"This set has proven itself to be one of the most remarkable developments of radio, and for ease of operation, maximum strength of broadcast music as well as the reception of long distance stations, it is hard to beat. The cost of a set of this kind is relatively small and it will give results equal, if not superior, to many sets selling for several hundred dollars. Its chief feature lies in the fact that it has only one control, which is for wave-length only, the regeneration being fixed at the best point.

"The two coils of wire, shown at the left of the Fig. Q-2172C, are both wound on the same cardboard tube, which is three inches in diameter. The upper coil is called the primary and consists of 20 turns of No. 22 S.C.C. wire; and the secondary, on the same cardboard tube, one-quarter of an inch away, consists of 50 turns of the same size wire. Make absolutely certain that both coils run in the same direction. Otherwise the set will not work. The only thing that is at all critical about this set is the wiring from the secondary coil to the rest of the circuit. If the set does not seem to work right at first, simply remove the wires where they are connected to this secondary coil and reverse them. It is also highly advisable not to use too much "B" battery, because it will make the tube oscillate too easily. Separate "B" batteries should be used if audio frequency amplifiers are added. Radio frequency amplification will not work with a set of this kind.

"No taps of any kind should be used with this set, the .0005- $\mu$ f vernier condenser across the secondary coil giving sufficient tuning; and it will be found that the set tunes extremely sharp, no trouble being experienced in bringing

in long-distance stations while the locals are sending. Of course, if you are located close to a broadcasting station, you may not be able to tune him out; but generally speaking, the other stations may be brought in through the locals without the least trouble.

"In order to make this, or any other set, work properly it is essential that the plans and specifications be followed just as closely as possible. Do not try to use a larger condenser in place of the one shown, because the set will probably be a failure if this is done.

"In order to overcome any hand-capacity effect that may be present, it is advisable to glue a piece of tinfoil on the inside of the panel in

Q. 2173-B. View of the interior of the Ultradyne L2 receiver. The layout, with its fine balance helps to make this set highly efficient.

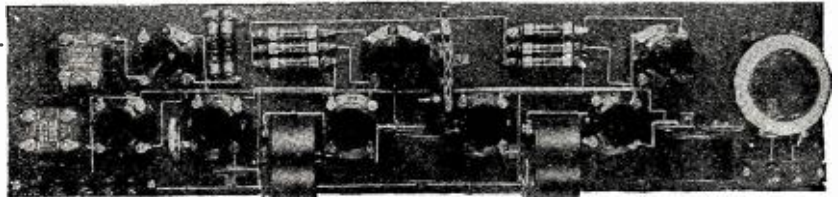

the place where the condenser is put. Make absolutely certain that none of this tinfoil touches the metal of the condenser at any place. One side of this is connected to the ground binding post. This will act as a shield and will positively eliminate all capacity effects. A vernier rheostat may also be of assistance with a critical detector tube. Never place the variable condenser inside of the inductance coil. This is extremely bad practice."

**PRIZE WINNING SET**

2173) Mr. M. L. Newmann, Brooklyn, N. Y., asks as follows:

Q. 1. Dr. C. H. Hullinger of Clinton, Iowa, won the International Broadcast Test cup for 1926, for receiving most European and other foreign sta-

tions during the recent International Broadcast Test Week. Have you any information available relative to the circuit or type of receiver employed by Dr. Hullinger? Any helpful information that you might be able to give me would be greatly appreciated.

A. 1. The circuit employed by Dr. C. H. Hullinger of Clinton, Iowa, with which he won the International Broadcast Test Cup for 1926, is none other than R. E. Lacault's famous L-2 Ultradyne, in which is included his well known Modulation System. The same circuit brought in European stations consistently in 1925.

Because of the system employed, the tuning is

extremely sharp and any station within range may be received without interference from locals. The tuning is extremely simple on account of the small number of controls required; only the variable condensers have to be adjusted for tuning. These features combined make the Ultradyne the ideal receiver for experimenters who want to receive distant stations.

To give an idea of the sensitiveness of the Ultradyne we may mention the fact that in New York City, using only a coil three inches in diameter, wound with 60 turns of No. 20 wire, instead of a loop, broadcast stations in Chicago, Detroit, Cleveland, Cincinnati, Atlanta and even Cuba are heard with good audibility practically every night. The reception is accomplished on the detector alone, or with one stage of audio-frequency amplification. With two stages, a loud speaker may be operated with good volume.

In order to help all others interested to assemble this efficient type of Super-Heterodyne receiver, embodying the Ultradyne circuit, the following data are given. No. 2173-A is the diagram of connections of the complete receiver with two stages of audio-frequency amplification. Jacks are shown, which allow the use of the detector alone, or with one or two stages of audio-frequency amplification to operate a loud speaker or to receive extremely weak signals. By means of a double-circuit jack a loop aerial may be substituted for the tuning circuit; this is an interesting feature which allows instantaneous comparison of efficiency between an aerial and a loop, when receiving from a certain station; for when the loop is plugged in all the connections are changed automatically.

**List of Ultradyne Parts**

- The following is a complete list of parts required for experimenters to construct a Model L-2 Ultradyne Receiver:
- One Cabinet, 7x30 inches, with Base Board and Panel;
  - Two Variable Condensers, .0005- $\mu$ f.;
  - Two Vernier Dials;
  - One Tuning Coil;
  - One Oscillator Coil;
  - One Ultraformer, Type "A";
  - Three Ultraformers, Type "B";
  - One Low-Loss 180° Coupler, with Shield;
  - One Dial for coupler;
  - Eight Vacuum Tube Sockets;
  - One Potentiometer;
  - Eight Automatic Filament Adjusters;
  - Two Double-Circuit Jacks;
  - One Double-Circuit and One Single-Circuit Filament Control Jacks;
  - One Filament Switch;
  - Two Audio-Frequency Transformers;

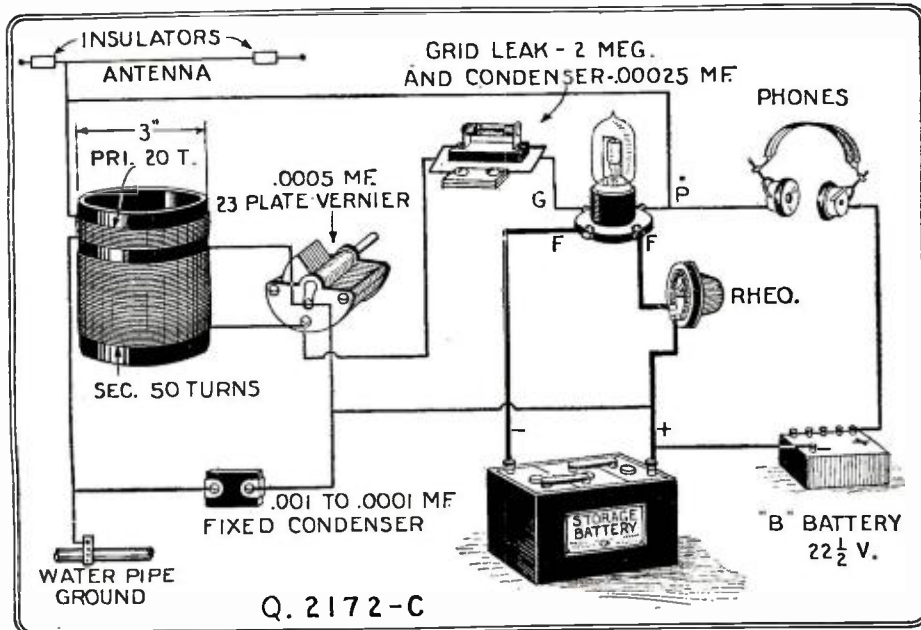

The Journal One-Knob One-Tube set. An unusually efficient receiver employing regeneration, with only one dial to tune. Extraordinary results have been reported from this set.



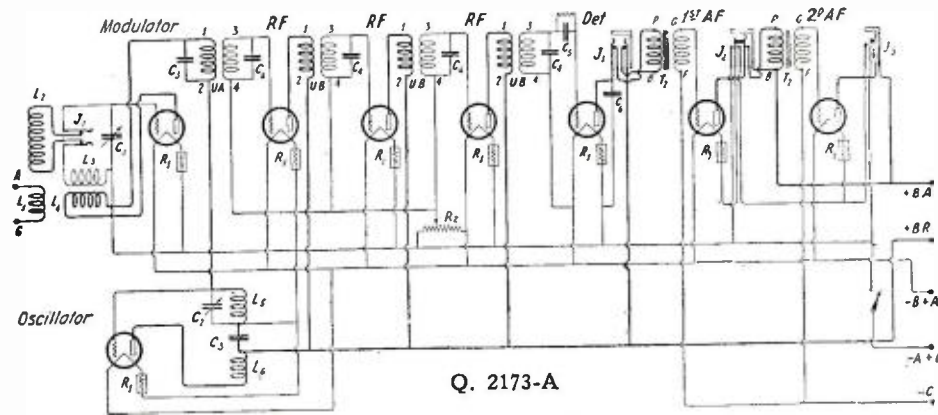

Wiring diagram of the Ultradyne L-2 receiver. L-1 has 7 turns, L-2 36 turns, L-3 20 turns, L-4 26 turns, L-5 36 turns, L-6 22 turns. See text for other specifications.

- One Grid Leak;
- Seven Binding Posts;
- Two Bakelite Binding-Post Mounting Strips;
- One Grid Condenser, .0005- $\mu$ f., with grid-leak Mounting;
- Five Fixed Condensers, .00025  $\mu$ f.;
- Two Fixed Condensers, .001 and .005  $\mu$ f.;
- Bus Bar Wire, No. 14 copper tinned, with assortment of screws and nuts.

**ULTRAFORMERS**

The radio-frequency transformers used in the Ultradyne receiver, are of a different design from those generally employed in such receivers. They are so constructed that they amplify at one wavelength only. The band of frequencies amplified by these Ultraformers is just wide enough to avoid distortion of radio telephone signals; but these are, nevertheless, sharp enough in tuning to provide the necessary selectivity. The first Ultraformer, connected between the plate of the modulator tube and the grid of the oscillator tube, is of a slightly different construction, the primary being shunted by a small fixed condenser to tune it to exactly the proper frequency. It is important that the capacity of this fixed condenser be exactly .00025- $\mu$ f., as otherwise the frequency of the input circuit will be different and the amplifier will not operate as efficiently as it should.

The basket-weave coils can be replaced by tubular coils, using tubes 3/4 inches in diameter. The primary of the antenna coupler consists of 7 turns of No. 22 D.C.C. wire, and the secondary of 36 turns of the same size wire. The oscillator coupler has a grid coil of 36 turns of No. 22 D.C.C. wire and plate coil has 22 turns.

The sensitizer coupler has a rotor coil of 20 turns and a stator coil of 26 turns, both No. 26 S.S.C. wire.

For exact constructional data of the transformers and coils, see the "I Want to Know" columns of the May, 1926, issue of RADIO NEWS in which all the necessary details were published. The ultraformers may be of the same type as are employed in the L1 model, described in that article.

**ASSEMBLING AND WIRING**

The construction of a Super-Heterodyne receiver is no more complicated than that of any other radio receiver, and such sets as the Ultradyne are in fact easy to construct. Any experimenter, even though he has but little experience with tools, may build an Ultradyne with good chances of success if the instructions given hereafter are carefully followed, and if apparatus of suitable quality is employed.

After procuring all the apparatus necessary for the construction of the receiver, it should be carefully examined to see if all is in proper condition to be used. It is a good precaution, before fixing the sockets, to make sure that the screws acting as terminals are tight. The potentiometer should also be looked over before mounting. The coils, sockets, and the Ultraformers are mounted on the base board and should be arranged as shown in the illustration and diagrams.

When connecting the variable condensers, care should be taken to connect the movable plates to the negative filament lead, as shown in the wiring diagram. This is important if capacity effect from the body of the operator is to be avoided when tuning.

In order to facilitate the work it is advisable to wire the panel and the base separately, and then connect the various circuits after the panel is fixed against the edge of the base. It is easy to wire both the panel and base by following carefully the wiring diagram.

The wiring of the receiver should be done very carefully and slowly, as results depend greatly upon the position of the wires in the set. Each connection fastened under a screw or nut should be made by bending the end of the wire or bus bar with a pair of round-nosed pliers, or soldering it to lugs fastened under the screws on the instrument. The wire or bus bar should be bent at right angles.

Note that the shield between the panel and feed-back coupler is connected to the negative lead of the "A" battery.

When wiring the eight-tube receiver, which is

equipped with two stages of audio-frequency amplification, one should be careful not to run the wires, connecting the audio-frequency transformers to the jacks, too close together, as this might cause a feed-back, and make the amplifier howl. It is also important, when wiring the audio- and radio-frequency amplifiers, to keep the connections from the secondary windings to the grid terminals on the sockets reasonably short, in order to insure higher efficiency.

**ANTENNAE**

Almost any type of antenna may be employed with an Ultradyne receiver and if the special coupler shown in the illustration is used, no extra control is necessary for the tuning of the antenna circuit. The antenna may be of the outdoor or indoor type, and consist of a single wire about 100 feet long, well insulated, and supported as far away as possible from walls, trees or structures. A good indoor antenna may consist of a single wire stretched around the room about 6 to 12 inches away from the walls and ceiling and supported in the corners of the room by means of small insulators. The end of the wire is connected to the receiver and constitutes the lead-in.

Very good results may also be obtained by using a loop or coil antenna wound on a frame. If the frame is constructed so that the loop is three feet square, eight turns of No. 18 wire or lamp cord spaced one-half inch apart and supported by strips of insulating material, are suitable to cover the broadcast wave-lengths. If the frame is only two feet square, ten turns will be required, also spaced one-half inch apart. Smaller sized loops may be employed with Ultradyne receivers, and some very suitable loops of this type are now obtainable on the market. A folding loop is quite practical when used with an Ultradyne receiver, as the complete outfit becomes portable and may be installed in an automobile or be carried to camp during the summer.

**Tuning**

Turn the oscillator dial one degree at a time, and for each setting of this dial turn the tuning dial over the whole range slowly. If nothing is heard at any setting, move the oscillator dial one more degree and repeat the process with the tuning dial. At some point one should hear a station, and it will be noticed that a slight hissing noise is heard when the station is transmitting but no one speak-

ing or singing in the microphone. This indicates the presence of a carrier wave, and will help in tuning other stations when the same slight noise is heard. All this tuning should be done with the potentiometer turned so that no whistles are heard. If whistles are present, the potentiometer should be turned toward the positive side until the whistles stop, at which point the amplifier operates at its maximum sensitiveness.

When tuning in distant stations, it may be necessary to readjust the potentiometer slightly. This should be done only after the station is heard faintly but clearly enough to increase the amplification. When tuning in very weak signals from distant stations, the feed-back coupler should be turned slowly until a whistle is heard, and moved back just below this point. A slight readjustment of the two condensers will then bring the signal to the maximum audibility. When tuning in another station, turn the feed-back coupler to zero (coils at right angles) and tune first with the two condensers as explained above, then adjust the coupler as soon as the station is tuned in.

When operating the loud speaker with two stages of audio-frequency amplification, a certain amount of the extra noises which may be present on account of static or other disturbances, can be reduced by slightly turning down the potentiometer. When using the telephone receivers, it is only necessary to use the detector or one stage of audio-frequency amplification.

**VACUUM TUBES**

Almost any kind of vacuum tube may be used in the Ultradyne receiver; however, we would advise the UV201-A or C301-A throughout.

If desired the low-consumption tubes, such as the UV199 or C299, may be employed throughout in the Ultradyne, WD11 or WD12 tubes are also suitable. Although it is not absolutely necessary, it is advisable to use two separate "B" batteries, one set exclusively for the two stages of audio-frequency amplification. This will reduce noises considerably, and also the tendency to feed-back which is often present in such amplifiers. The same "A" battery may be used for all the tubes, however, without experiencing any trouble. The small UV199 or C299 tubes may be used with adapters in the standard sockets or in special sockets.

If the special sockets are used, care should be taken when wiring the receiver to connect the sockets correctly, as the position of the binding posts is not the same as on standard ones.

**BATTERIES**

If standard six-volt tubes are employed in the Ultradyne receiver, a six-volt "A" storage battery should be employed as a filament current supply. The connection of this battery to the receiver is shown in the wiring diagram in which one may notice that the same binding posts are used to connect two batteries. This is to simplify the construction and avoid the use of too many binding posts. Whenever possible, it is advisable to use about 45 volts of "B" battery on the radio-frequency tubes, and 90 volts on the audio-frequency tubes. No tap is taken for the detector as this is only necessary when a "soft tube" or gas-content detector is employed. The use of such a tube is not advisable in super-heterodyne receivers, as it requires critical adjustment of the filament and plate current and does not improve the results in such sensitive receiving sets. If greater volume is wanted, the "B" battery voltage on the audio-frequency amplifier may be increased to 100 or 120 volts, provided the "C" battery is increased from 4 1/2 to about 9 volts. The "C" battery need only be a small flashlight battery, of a type now obtainable on the market for use in audio-frequency amplifiers. It is advisable

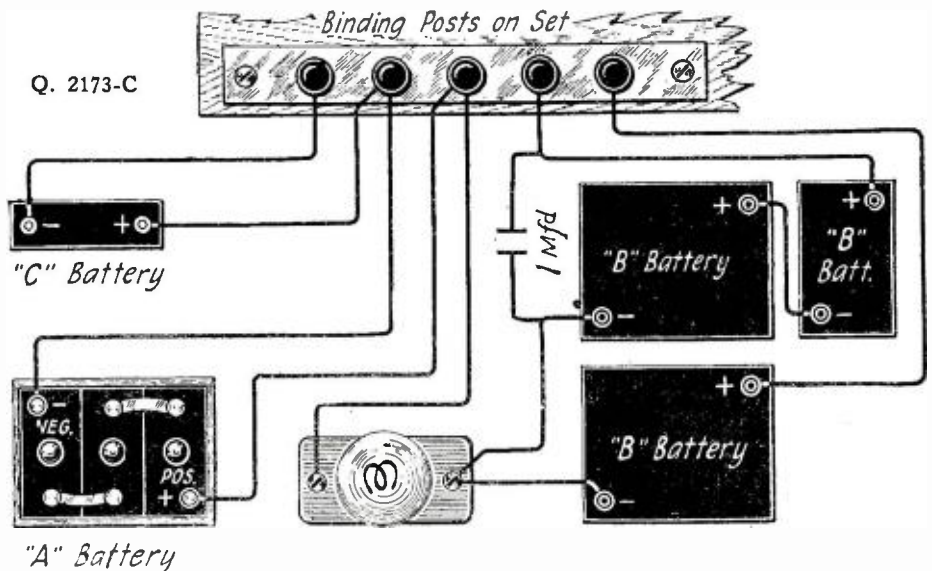

Method of connecting batteries to the Ultradyne L-2 receiver. A special test lamp is used to detect a possible short circuit in the receiver, and prevent burning out tubes.



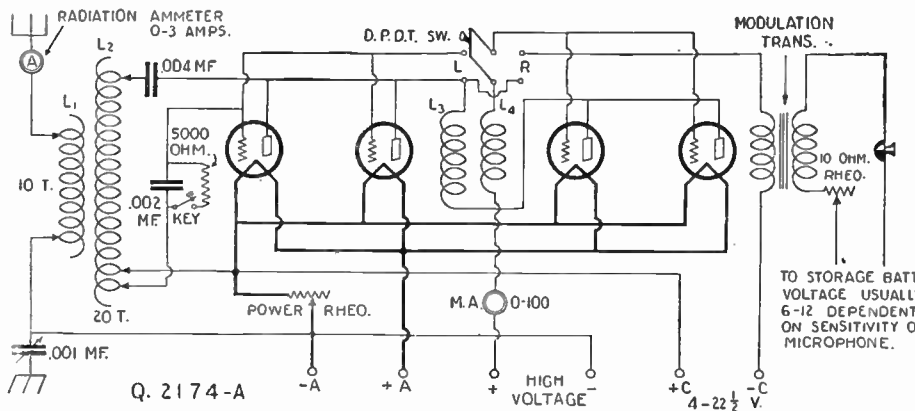

A low power transmitter, which changes from phone to continuous wave transmission, by a throw switch. The very efficient Heising system of modulation is employed.

to connect a 1.0- $\mu$ f. fixed condenser across each "B" battery.

If low-voltage tubes, such as UV199 or C299, are used, the set may easily be carried to camp or in a car; for it is then possible to use dry cells as a filament battery. To supply eight of these tubes, six No. 6 dry cells are necessary, connected in series parallel.

If UV199 or WD11 tubes are used, the proper type of automatic filament resistance should be selected, depending upon the voltage of the "A" battery.

Full information, with profuse illustrations, and layout patterns for the construction of this receiver, is contained in a descriptive booklet titled "How to Build and Operate the Ultradyne Receiver." This is somewhat hard to get (discontinued), although it may be obtained from some distributors who may have a few copies left.

**A 20-WATT RADIO PHONE TRANSMITTER**  
(2174) Mr. J. S. Anderson, Salt Lake City, Utah, asks:

Q. 1. I would like constructional details and circuit diagram of an efficient low-power (about 20-watt) phone and CW transmitter, which incorporates the Heising system of modulation, and employs some convenient means of quickly changing from phone transmission to CW, or vice versa.

A. 1. The Circuit diagram you request is shown in these columns, and incorporates the Heising system of modulation. A double-pole double-throw switch is used for quickly changing from CW transmission to radio phone, simply by throwing the switch from the left to the right position for radio phone work. When the switch is on the left side, all four tubes are in parallel and used as oscillators; when on the right side, two tubes are in parallel and functioning as oscillators, the other two in parallel and functioning as modulators.

The parts necessary for the construction of this transmitter are as follows:

Two specially constructed inductances, L-2 being wound on a 4-inch tube, and consisting of 20 turns of No. 12 or 14 D.C.C. wire, space wound. L-1 is wound on a tube 3 3/4 inches in diameter, or slightly smaller, and wound with the same size wire to the number of 10 turns. L-1 fits within L-2,

but the tubing must have a 1/2-inch slot cut through it so that the amount of inductance desired may be varied at will by means of a small clip.

One Variable Condenser, .001- $\mu$ f., preferably large-spaced transmitting type;

One Radiation Ammeter, preferably Thermocoupled type, and having a scale reading from 0 to 3 amperes;

Two Fixed Condensers, .004- and .002- $\mu$ f., transmitting type;

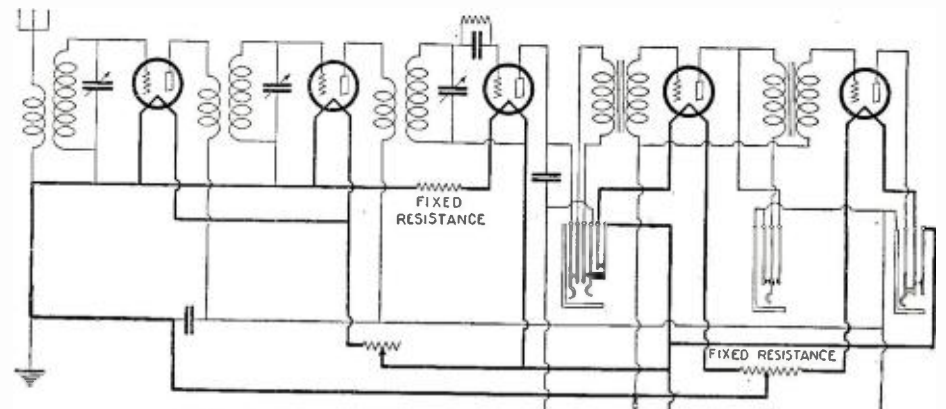

A receiver designed especially for quality reproduction, giving true values to the harmonics. Coils especially designed for this circuit may be purchased.

One Transmitting Grid Leak, 5000 ohms, with center tap at 2500 ohms (10,000 ohms with center tap at 5,000 ohms if larger tubes than the 5-watt type are to be employed);

One Double-pole Double-throw Switch;

One Power Rheostat;

One Modulation Transformer;

One Rheostat, 10-ohm;

One Milliammeter (0-100 scale for 5-watt tubes, 0-300 if larger tubes are to be employed, such as the DeForest "H" tubes, Telefunken 20-watt, or American 50-watt type);

Two Honeycomb Coils, 300-turn, which comprise the inductances L-3 and L-4; or 250 turns of No. 26 or 28 D.C.C. wire wound on a one-inch tube, approximately 6 inches long;

One Microphone and one Transmitting Key;

Four Tubes, 5-watt or the new 7 1/2-watt type.

**ADVICE ON OPERATION**

For best results it is advisable that either a motor generator be used to supply the plate voltages for the tubes, or "B" batteries if expense is not considered. It is entirely possible to use either chemical or "Kenotron" rectified A.C., but then an elaborate filter system is required; and the results obtained either on phone or C.W. would be inconsistent and tedious experimenting would be required to obtain perfect modulation.

The antenna system may be either of the inverted "L" or "cage aerial" type, not exceeding 75 feet in length and a lead-in of 50 feet. Either counterpoise or ground may be used. Best results on phone transmission will be obtained when the transmitter is operated on a wave-length of approximately 195 meters, although the transmitter may be adjusted to operate to as low as 40 meters for CW transmission, as the circuit shown is very flexible. The wave-length of the transmitter may be changed by means of the .001- $\mu$ f. variable condenser shown connected in series with the ground, or by changing the grid and filament taps. (the greater the amount of inductance between these two the higher the wave-length attained), or by both methods. It is suggested for finer adjustment

that a .0005- or .00035- $\mu$ f. variable condenser of the transmitting type be shunted across the grid and filament taps.

The 10-ohm rheostat shown in the microphone circuit should be of the heavy-resistance wire-wound type, and capable of withstanding approximately 1/4 ampere. This rheostat is employed to obtain various voltages on the microphone, because some "mikes" work best on 6 volts, and some on 12.

In adjusting the transmitter, do not allow the plates of the tubes to overheat, or glow to "incandescence," as this shows that a good deal of the energy is being dissipated. A slight red glow would be normal.

**FEDERAL TYPE 61 RECEIVER**

Q. 2. I have a Federal type 61 receiver which I am desirous of overhauling. Can you furnish me with a schematic wiring diagram of this receiver so that I may check the various connections, many of which are broken and need replacing.

A. 2. The circuit diagram you desire is shown in Fig. 2174.B. We regret that we cannot furnish any other additional data, such as coil specifications, etc. The number of turns for the antenna coil and the respective taps are indicated on the diagram. No other information on this receiver is available.

**PFANSTIEHL OVERTONE RECEIVER**

(2175) Mr. L. N. Brannon, Montreal, Canada, asks:

Q. 1. Some time ago I purchased a Pfanstiehl Overtone Receiver, but lately something has happened to it as it does not function properly. It is approximately two years old, and I think that a little overhauling and some minor adjustments made will put it in proper shape again. Can you furnish me with any data and with the circuit diagram of this receiver?

A. 1. The circuit diagram of the Pfanstiehl Overtone Receiver is shown in Fig. 2175.A. Much of the efficiency of this receiver is due to its scientific construction, i.e., lay-out, design of parts, etc. We therefore doubt if anything has radically gone wrong with your receiver. Perhaps there are some loose connections or some instrument has become defective. Compare the wiring of your receiver with the diagram shown, and

(Continued on page 1697)

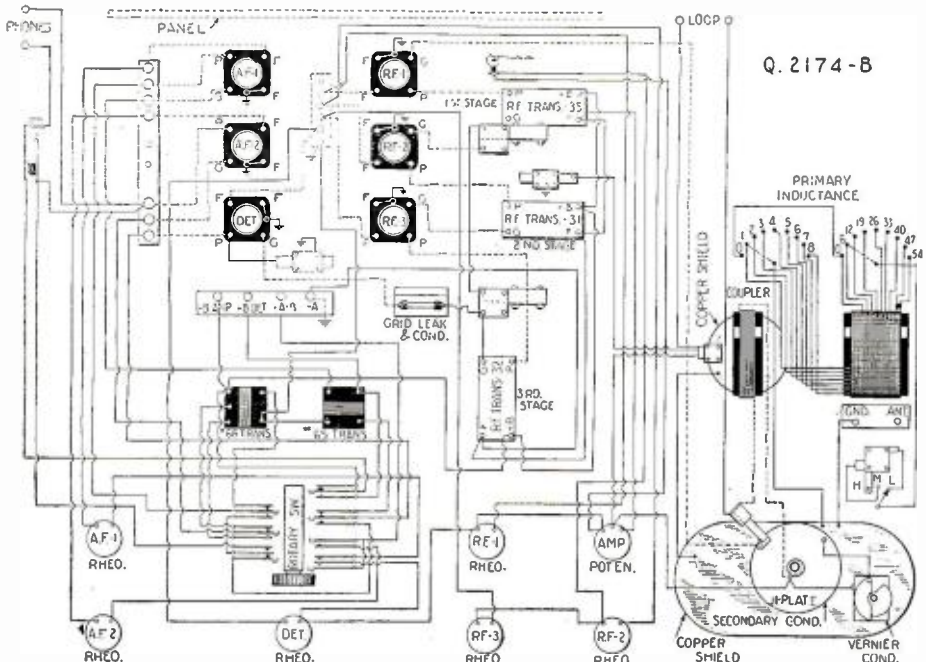

Complete wiring diagram of the Federal 61 receiver. The number of turns on the antenna coil are indicated on the diagram.





⚡
 “I’ve just had a lesson in radio economy, and, believe me, it’s illuminating”
 ⚡

“I WENT into my radio dealer’s this noon for a couple of Eveready ‘B’ Batteries and said, ‘Tom, give me a pair of Eveready 45-volt “B” Batteries No. 772’s.’

“‘How many tubes in your set, Jim?’ he asked.

“‘Five,’ I answered.

“‘Then what you want is a pair of Eveready Layerbilt No. 486’s.’

“‘Why?’ I asked.

“‘Because the Eveready 772’s are meant for sets having one to three tubes. With average use of the set, and used with a “C” battery\*, they should last a year or longer. But on a five-tube set, with average use and with a “C” battery, they will only last about four months. Anyone with a four or five tube set should buy a pair of Eveready Layerbilts No. 486. Used with a “C” battery they should last eight months or longer.’

“‘Yes, but the 772’s cost only \$3.75 each,’ I said, ‘and the Layerbilt \$5.50. There’s some difference.’

“‘Well, figure it out for yourself,’ said Tom. ‘Two sets of 772’s should last you about eight months, and will cost you \$15. One set of Eveready Layerbilts should last about eight months, and will cost you only \$11.’”

The simple rules for this satisfaction and economy are:

On 1 to 3 tubes—Use Eveready No. 772.

On 4 or more tubes—Use the Heavy Duty “B” Batteries, either No. 770, or the even longer-lived Eveready Layerbilt No. 486.

On all but single tube sets—Use a “C” battery.

When following these rules, the No. 772, on 1 to 3 tube sets, will last for a year or more; and the Heavy Duties, on sets of 4 or more tubes, for eight months or longer.

We have prepared a new booklet, “Choosing and Using the Right Radio Batteries,” which we will be glad to send you upon request. This booklet also tells about the proper battery equipment for use with the new power tubes.

\*NOTE: A “C” battery greatly increases the life of your “B” batteries and gives a quality of reception unobtainable without it. Radio sets may easily be changed by any competent radio service man to permit the use of a “C” Battery.

Manufactured and guaranteed by  
**NATIONAL CARBON COMPANY, Inc.**  
 New York San Francisco  
 Canadian National Carbon Co., Limited  
 Toronto, Ontario



LEFT—No. 486,  
for 4, 5 or more  
tubes. \$5.50.



RIGHT—Eveready Dry Cell Radio “A” Battery, 1½ volts.

# EVEREADY

## Radio Batteries

—they last longer

Tuesday night means Eveready Hour  
 —8 P. M., Eastern Standard Time,  
 through the following stations:

- |                  |                    |
|------------------|--------------------|
| WEAF—New York    | WSAI—Cincinnati    |
| WJAR—Providence  | WEAR—Cleveland     |
| WEEI—Boston      | WWJ—Detroit        |
| WTAG—Worcester   | WGN—Chicago        |
| WFI—Philadelphia | WOC—Davenport      |
| WGR—Buffalo      | WCCO { Minneapolis |
| WCAE—Pittsburgh  | { St. Paul         |
|                  | KSD—St. Louis      |



# Why THE METALLIZED RESISTOR



METAL long has been recognized as the best of electrical conductors. The metallized resistor gives conductive resistance and absolutely silent operation.

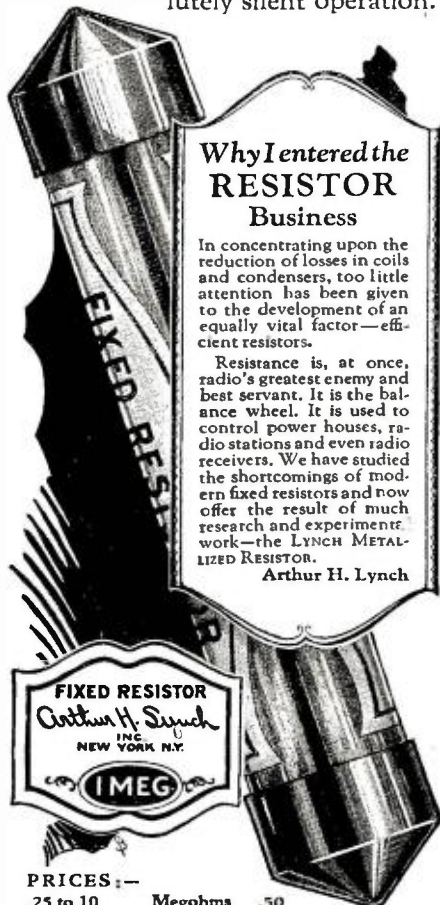

## Why I entered the RESISTOR Business

In concentrating upon the reduction of losses in coils and condensers, too little attention has been given to the development of an equally vital factor—efficient resistors.

Resistance is, at once, radio's greatest enemy and best servant. It is the balance wheel. It is used to control power houses, radio stations and even radio receivers. We have studied the shortcomings of modern fixed resistors and now offer the result of much research and experiment—work—the LYNCH METALLIZED RESISTOR.

Arthur H. Lynch

FIXED RESISTOR  
Arthur H. Lynch  
INC.  
NEW YORK, N.Y.

IMEG

PRICES:—

.25 to 10	Megohms	.50
above .01 to .24	"	.75
.001 to .01	"	\$1.00

The LYNCH METALLIZED FIXED RESISTOR comprises a concentrated coating of metal one-thousandth of an inch thick upon a glass core and sealed within a glass tube. Each Resistor is warranted noiseless, impervious to moisture, and of permanent resistance value.

The LYNCH label is your guarantee of accuracy, dependability and satisfaction. If your dealer cannot supply you, order direct and we will ship postpaid.

**ARTHUR H. LYNCH, Inc.**  
Manufacturers of Radio Devices  
Fisk Bldg., Broadway & 57th Street  
New York, N.Y.

DEALERS—write us!

## The Course of Waves Through Space

(Continued from page 1628)

angle of say 30 degrees from the vertical, in a backward-slanting plane. Then (with the assumption that you can pass through anything, whether earth, water, air or vacuum) you dart in a forward direction, your body still preserving the same inclination.

### THE SWARM OF "IONS"

Technically, you would be called a "vertically-polarized wave," as your polarization is presumed to be from head to foot. In other words, when your head is positive, your feet will be negative, and vice versa. This change in the polarity will take place in accordance with your frequency, which is 500 kilocycles; in other words, your polarity will have 500,000 complete reversals from positive to negative, at each end, and back again, in each second.

Then, while you are steadily travelling upward, you will turn slightly, if not considerably, in your plane of flight, according to the conditions which you encounter. You will not change your direction of movement, but instead of appearing to move up a steep incline with your body at right angles to your course, your body will acquire a tilt to one side. (This phenomenon is being investigated by Alexanderson and Pickard. Its cause has been attributed by Nichols and Schelleng to the magnetism of the earth.)

Presuming that you started on your flight during the daylight hours, you will encounter an "ionized layer," surrounding the earth at a height of about two hundred miles. In the daytime (according to Taylor and Hulbert) ionization is present at approximately this distance above the surface of the earth: while at night it lifts to a height of something like five hundred miles. This is due to the "de-ionization," or recombination of the components of the atoms in the rarefied upper atmosphere after the sun has ceased to send its rays upon them. This ionized stratum, whose existence in the upper air is a highly probable theory, must not be thought of as having a sharply-defined boundary. Rather, it begins gradually and its ionization constantly increases.

### BACK TO EARTH AGAIN

As you arrive at this region of appreciable and increasing ionization, the topmost part of you (which may or may not be your head, because of your rotation, due to the magnetism of the earth), will constantly gain in speed over your lowest portion, because of the diminishing density of the air, and the constant increase in the number of ions (electrical particles) which are less resistant to progress.

When the top or side of anything moves faster than the opposite side, it must swerve from its course. (The best known example, perhaps, is a base ball "curve"). This is exactly what happens when the reader in his imaginary course, or the wave-front which he represents, reaches the ionized layer. Due to this gradual deviation he will eventually return to earth, and while doing so, will continue the rotation caused by terrestrial magnetism. (This refractive property of an ionized layer was first suggested by Eccles, and later mathematically calculated by Larmor, both distinguished English scientists.)

So far we have considered only the case of a pure polarized wave, that is, one oscillating, or changing its polarity, in a single plane. A common radio wave oscillates in every conceivable direction; being analogous to a compound person, if such could exist, having bodies crossed and protruding like

## BRING IN EUROPE on a Victoreen "Super"

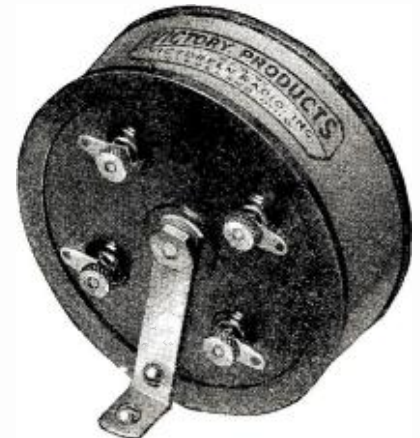

The Heart of the Circuit

4, No. 170 R.F. Transformers @ .....\$7.00  
1, No. 150 Coupling Unit @ ..... 5.50

You can secure these and all other parts necessary from your dealer.

Victoreen Air Core Transformers are more than matched—they are actually tuned to guaranteed precision of 1/3 of 1%.

Ask your dealer for a free folder on hook-up of Victoreen "Super" or write directly to us. This folder answers all questions about the Victoreen.

**THE GEORGE W. WALKER CO.,**  
6512 Carnegie Ave., Cleveland, Ohio.  
Branches in principal cities.

**WRITTEN 2-YEAR GUARANTEE**

**ARROW BATTERY**

### Battery Prices SMASHED!

**To Consumers Only**

Here is a real battery quality, guaranteed to you at prices that will astound the entire battery-buying public. Order Direct From Factory. Put the Dealer's Profit in your own pocket. You actually save much more than half, and so that you can be convinced of true quality and performance, we give a *Written 2-Year Guarantee*. Here is your protection! No need to take a chance. Our battery is right—and the price is lowest ever made. Convince yourself. Read the prices!

<b>Auto Batteries</b>	<b>Radio Batteries</b>
6 Volt, 11 Plate, \$8.50	6 Volt, 100 Amp, \$8.50
6 Volt, 13 Plate, \$10.25	6 Volt, 120 Amp, \$10.25
12 Volt, 7 Plate, \$11.75	6 Volt, 140 Amp, \$11.75

**Buy Direct—Send No Money**

We ask no deposit. Simply send name and address and style wanted. Battery will be shipped same day we receive your order Express C.O.D. subject to your examination on arrival. Our guarantee accompanies each battery. We allow 5% discount for cash in full with order. You cannot lose! Send your order today—NOW!

**ARROW BATTERY CO.**  
Dept. 6 1215 So. Wabash Ave., Chicago

## 1926 FREE RADIO GUIDE

NEWEST 1926 EDITION

Shows the latest circuits, the newest developments in radio at startlingly low prices. Get the parts you want here and save money. The best in parts, kits, sets and supplies. Orders filled same day received. Write for free copy NOW; also please send names of one or more radio fans.

**BARAWIK CO., 102-145 So. Canal St., Chicago, U. S. A.**

Insure your copy reaching you each month. Subscribe to **RADIO NEWS**—\$2.50 a year. Experimenter Publishing Co., 53 Park Place, New York City.







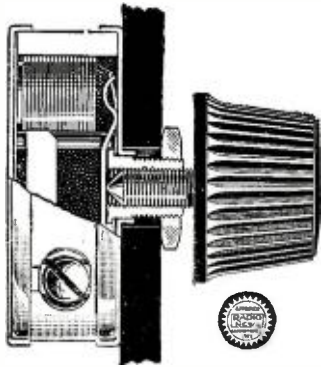

Use the  
**Bradleyohm**  
PERFECT VARIABLE RESISTOR  
for B-Eliminators

WHEN you build your B-battery eliminator follow the recommendations of leading radio engineers by using the Bradleyohm for your variable voltage control. Several Bradleyohms can be used to advantage in every B-eliminator, whether factory-built or homemade, to obtain several steps of voltage for detector, radio frequency and audio-frequency circuits.

The Bradleyohm with its scientifically-treated discs provides a marvelous range of control without steps or jumps. The turning of the small bakelite knob gives you instant control over a wide range.

Be sure to investigate the advantages of the Bradleyohm and other Allen-Bradley radio devices for your B-eliminator.



Allen-Bradley Co.,  
287 Greenfield Ave., Milwaukee, Wis.

Please send me your latest literature on the Bradleyohm and other Allen-Bradley radio devices.

Name.....

Address.....

the points of a star, only of infinite number. With the aid of your imagination, put this in turn through the path outlined above. No mention has been made of a horizontal polarized wave: but, to make brief the analogy for this, imagine that instead of standing almost erect, you are lying on one side and going through a similar trajectory.

WHY SHORT WAVES "SKIP" ZONES OF SILENCE

It is also the belief of Taylor and Hurlburt that, after a wave has returned to earth, it can be and is refracted by the earth back to the ionized layer: from this again to the earth, and the process is repeated until the wave has been entirely absorbed. Furthermore, that the shorter waves, of 50 meters and less, are emitted at a much lower angle from the ground than the longer waves; which explains why zones of zero reception are absent, when using the broadcast band of wave-lengths, while they are so apparent with the shorter waves. This is because the wave leaving the transmitter and following the ground, either partially or completely, fills in the distance between the transmitter and the point where the wave reflected from the sky again touches earth. This is supposed to be the case with waves of 100 meters and longer: but below this wave-length, due to the lesser angle of radiation by the transmitter, the waves may only return hundreds of miles from where they were originally emanated (Fig. 1.) Consequently, as the greater portion of the wave is absorbed within a hundred miles, or less, from its source, it is quite evident how certain areas may receive from it not the least amount of energy, if the Taylor-Hurlburt hypothesis is true.

The Noise Hounds  
(Continued from page 1627)

there until the noise started. Then he disconnected the Williams lights, and the noise stopped. He did this at intervals of two minutes, for a half hour. The proof was conclusive. But why had the pad remained inarticulate the day before? And why did it take the pad half an hour after being turned on, to commence to oscillate?

The next day the radio men made a round of all the districts where a similar noise had been heard. In every case they located an electric pad in the neighborhood. This proved that the trouble was not in the Williams wiring, but in all electric pads of this type.

THE ALIBI DISPROVED

That night the electricians experimented in the shop with the old electric pad, and here is the final answer to all our questions. The pad oscillated *only* when used in medium or low heat—not in high. You see: for the first half hour the pad was used, it was "on full," then as it got warmed up it had been turned to "medium" for the night; and the noise began! The day we had done our "watchful waiting," of course the pad had remained in high!

But now that we had found the trouble—what was the remedy? You can't ask a sick man to stop using his electric pad! Well, it was up to the "noise hounds" who were electricians to invent a "silencer"—and they did!

It was attached to the Williams pad, and now, *thank heavens*, we can enjoy our radios in peace—or at least as much peace as the regenerative sets will allow us!

AUTHOR'S NOTE: A 2- $\mu$ f. condenser, when placed across the 110-volt A.C. line, was found to be most effective in eliminating the disturbance caused by the thermostats used in most electric pads.

Unfailing "B" Power  
**GUARANTEED TWO YEARS**  
Stops all worry about "B" Battery supply. Makes your set work better and more powerful—100 Volts and more. Clean, compact unit.  
WRITE TODAY FOR OUR BIG CIRCULAR "R"  
**BRANT BATTERY CO.**  
1622 W. 16th St., Los Angeles, Cal.

For the  
**Season 1926-27**

At a price  
for the home  
of moderate means

**GOLD-MEDAL**  
RECEIVERS  
CONSOLES  
"B" ELIMINATORS

Distributors, Agents and Dealers

Write for Territory.

**GOLD MEDAL RADIO CORPORATION**  
1038 1/2 Longwood Ave., New York, N. Y.

**YAXLEY**  
APPROVED RADIO PRODUCTS  
WALL  
SOCKET JACK

For Radio House Wiring

More homes, apartments and hotels are being wired with Yaxley Wall Socket Jacks—a decided improvement in radio convenience outlets. Easily wired, in series or parallel, and substantially constructed. Mounts in smallest size outlet box.

Send for Illustrated Literature On Hookup

PRICE EACH, \$1.00

At all good radio dealers

**YAXLEY MANUFACTURING CO.**

Dept. N.

217 N. Desplains St. : : Chicago, Ill.

You can be quickly cured if you  
**STAMMER**  
Send 10 cents for 288-page book on Stammering and Stuttering, "Its Cause and Cure." It tells how I cured myself after stammering 20 yrs. B. N. Bogue, 6956 Bogue Bldg., 1147 N. Ill. St., Indianapolis.



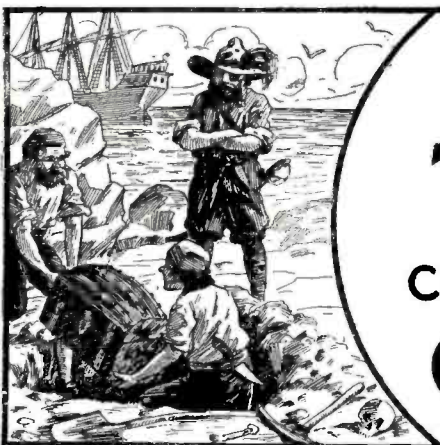

# BURIED TREASURE

can still be found in

# CHEMISTRY



## Good Chemists Command High Salaries

and you can make yourself independent for life by unearthing one of chemistry's yet undiscovered secrets.



**T. O'CONOR SLOANE.**  
A.B., A.M., LL.D., Ph.D.

Noted Instructor, Lecturer and Author. Formerly Treasurer American Chemical Society and a practical chemist with many well known achievements to his credit. Not only has Dr. Sloane taught chemistry for years but he was for many years engaged in commercial chemistry work.

Do you remember how the tales of pirate gold used to fire your imagination and make you want to sail the uncharted seas in search of treasure and adventure? And then you would regret that such things were no longer done. But that is a mistake. They *are* done—today and everyday—not on desert islands, but in the chemical laboratories throughout your own country. Quietly, systematically, the chemist works. His work is difficult, but more adventurous than the blood-curdling deeds of the Spanish Main. Instead of meeting an early and violent death on some forgotten shore, he gathers wealth and honor through his invaluable contributions to humanity. Alfred Nobel, the Swedish chemist who invented dynamite, made so many millions that the income alone from his bequests provides five \$40,000 prizes every year for the advancement of science and peace. C. M. Hall, the chemist who discovered how to manufacture aluminum made millions through this discovery. F. G. Cottrell, who devised a valuable process for recovering the waste from flue gases, James Gayley, who showed how to save enormous losses in steel manufacture, L. H. Baekeland, who invented Bakelite—these are only a few of the men to whom fortunes have come through their chemical achievements.

### What Some of Our Students Say of This Course:

I have not written since I received the big set. I can still say that it far exceeded my anticipations. Since I have been studying with your school I have been appointed chemist for the Scranton Coal Co. testing all the coal and ash by proximate analysis. The lessons are helping me wonderfully, and the interesting way in which they are written makes me wait patiently for each lesson.—**MORLAIS COUZENS.**

I wish to express my appreciation of your prompt reply to my letter and to the recommendation to the General Electric Co. I intend to start the student engineering course at the works. This is somewhat along electrical lines, but the fact that I had a recommendation from a reliable school no doubt had considerable influence in helping me to secure the job.—**H. VAN BENTHUYSEN.**

So far I've been more than pleased with your course and am still doing nicely. I hope to be your honor graduate this year.—**J. M. NORRIS, JR.**

I find your course excellent and your instruction, truly, the clearest and best assembled I have ever taken, and yours is the fifth one I've studied.—**JAMES J. KELLY.**

From the time I was having Chemistry it has never been thus explained to me as it is now. I am recommending you highly to my friends, and urging them to become members of such an organization.—**CHARLES BENJAMIN.**

I shall always recommend your school to my friends and let them know how simple your lessons are.—**C. J. AMDAHL.**

I am more than pleased. You dig right in from the start. I am going to get somewhere with this course. I am so glad that I found you.—**A. A. CAMERON.**

I use your lessons constantly as I find it more thorough than most text books I can secure.—**WM. H. TIBBS.**

Thanking you for your lessons, which I find not only clear and concise, but wonderfully interesting. I am—**ROBT. H. TRAYLOR.**

I received employment in the Consolidated Gas. Co. I appreciate very much the good service of the school when a recommendation was asked for.—**JOS. DECKER.**

## Now Is the Time to Study Chemistry



### Experimental Equipment Furnished to Every Student

We give to every student without additional charge this chemical equipment, including forty-nine pieces of laboratory apparatus and supplies, and forty different chemicals and reagents. These comprise the apparatus and chemicals used for the experimental work of the course. The fitted heavy wooden box serves not only as a case for the outfit but also as a useful laboratory accessory for performing countless experiments.

Not only are there boundless opportunities for amassing wealth in Chemistry, but the profession affords congenial employment at good salaries to hundreds of thousands who merely follow out its present applications. These applications are innumerable, touching intimately every business and every product in the world. The work of the chemist can hardly be called work at all. It is the keenest and most enjoyable kind of pleasure. The days in a chemical laboratory are filled with thrilling and delightful experimentation, with the alluring prospect of a discovery that may spell Fortune always at hand to spur your enthusiasm.

### You Can Learn at Home

To qualify for this remarkable calling requires elaborate specialized training. Formerly it was necessary to attend a university for several years to acquire that training, but thanks to our highly perfected and thorough system of instruction, you can now stay at home, keep your position, and let us educate you in Chemistry during your spare time. Even with only common schooling you can take our course and equip yourself for immediate practical work in a chemical laboratory. Dr. Sloane gives every one of his students the same careful, personal supervision that made him celebrated throughout his long career as a college professor. Your instruction from the very beginning is interesting and practical, and we supply you with apparatus and chemicals for performing the fascinating analyses and experimental work that plays such a large part in our method of teaching, and you are awarded the Institute's official diploma after you have satisfactorily completed the course.

### Easy Monthly Payments

You don't have to have even the small price of the course to start. You can pay for it in small monthly amounts—so small that you won't feel them. The cost of our course is very low, and includes everything, even the chemistry outfit—there are no extras to buy with our course. Our plan of monthly payments places a chemical education within the reach of everyone. Write us and let us explain our plan in full—give us the opportunity of showing you how you can qualify for a highly trained technical position without even giving up your present employment.

### Special 30 Day Offer

Besides furnishing the student with his Experimental Equipment, we are making an additional special offer for a short while only. You owe it to yourself to find out about it. Write today for full information and free book "Opportunities for Chemists." Send the coupon right now while it is fresh in your mind. Or just write your name and address on a postal and mail it to us. But whatever you do, act today before this offer is withdrawn. **DON'T WAIT—MAIL COUPON NOW!**

**CHEMICAL INSTITUTE OF NEW YORK**  
Home Extension Division 5  
66-R—West Broadway  
New York City

Please send me at once, without any obligation on my part, your free Book "Opportunities for Chemists," and full particulars about the Experimental Equipment given to every student. Also please tell me about your plan of payment and your special 30 day offer.

## CHEMICAL INSTITUTE OF NEW YORK, Inc.

HOME EXTENSION DIVISION 5

66-R—WEST BROADWAY

NEW YORK CITY

NAME .....

ADDRESS .....

CITY..... STATE.....

R. N. June, '26



# Goodrich Silvertown Radio Panels



For greatest range and selectivity

- 1 Easier to drill and machine.
- 2 Better color, lasting lustre.
- 3 Lower free sulphur—no discoloration.
- 4 Higher softening point—no warping.

Goodrich V. T. Sockets                      Spaghetti Tubing  
 Radiophone Ear Cushions                  Battery Mats  
 Hard Rubber Tubes for Coils

The B. F. Goodrich Rubber Company  
 Established 1870                                  Akron, Ohio

## Audio Frequency-Amplifier Transformers

(Continued from page 1663)

a baritone like a basso. The effect is often the same as would be obtained by putting one's head into a large empty wooden barrel and singing.

It will be seen, on glancing at such a characteristic curve as that shown in Fig. 3, that the amplification of the tones of lower frequency is often very small, compared with that of the higher tones. Without considering the change in timbre produced by the over-accenuation of the harmonics and overtones of these low notes, there is another effect which will be found of considerable importance. This may be illustrated by the example of a piano being played by an artist who has a strong right hand and a very weak left one. This effect, perhaps, is not quite as important as the other; but when these various modifications have been made by a transformer of unequal amplification, the reproduction is likely to sound like almost anything but the original sounds which went into the microphone at the transmitter of the broadcast station.

## A Remarkable Loud Speaker

(Continued from page 1643)

brought out admirably in this one; and the amplitude remains almost constant for the frequency range employed in broadcasting, up to about 9,000 vibrations per second.

Fig. 5 diagrams the method of connecting the phones or loud speaker, as preferred, with a receiving set. A special battery for operating the loud speaker, as stated before, is not necessary, as the "B" battery supplies sufficient current.

We are convinced that this new and important invention of Mr. Reisz will win many new friends for radio broadcasting, because, independently of its other advantages for the listener, it makes possible reproduction of the artistic qualities of music and speech much superior in technique to what has been commonly obtainable before.

## Static Forecasts Forest Fires

(Continued from page 1645)

cessive convection), against the minimum relative humidity for the day. Evidently we are correct in assuming that for the normal summer day the static intensity is proportional to the relative humidity, which is not in apparent accord with the annual relation." This apparent anomaly is then explained in the light of the theory of the physics of the air.

"The study of static as an indicator of fire weather," declares Mr. Simson by way of summary, "is too much in its infancy to draw any definite conclusions, other than that a relation appears to exist between static and relative humidity. Also, the area of territory which may be covered by a single forecast station is not known. It is believed that further investigation is warranted and sufficient instruments should be obtained to record graphically static intensity and atmospheric current density in order to correlate them properly with other meteorological factors."

It is a far cry from the primitive method of Egyptian weather forecasting of 2,000

# Steinite

**Low Loss Interference Eliminator**

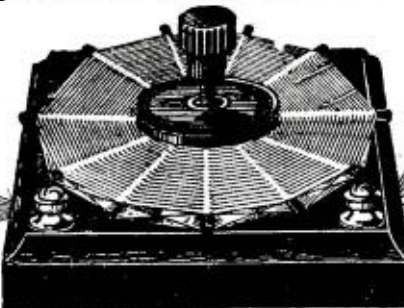

**Give Your Receiver a Chance**

Day by day radio reception is becoming more involved—few sets are built for wide distribution of stations—crowding results. This amazing eliminator attached to your aerial wire, gives your set a chance, it enables you to select stations at will. You get one station at a time, the one you want and tuned in loud and clear. Helps in all sets. Requires no extra tubes or batteries. Put this eliminator on your set today and note the amazing improvement. Installed in a moments time.

**Steinite 5-Tube Set \$29.75**

Free Descriptive Literature on Request.

**\$1 POSTPAID**

**Separates crowded wave lengths**

**Cuts out bothersome interference**

**Connects from aerial wire to set**

**\$1 POSTPAID**

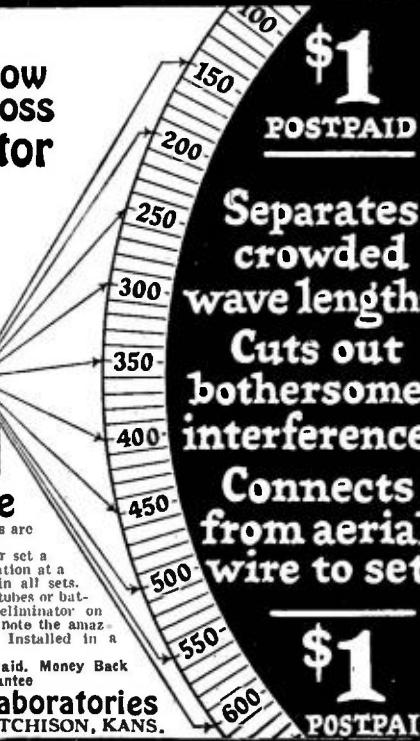

**Steinite Laboratories**  
127 Radio Bldg. ATCHISON, KANS.

**"IMP" Pilot Switch \$1.50**



Half Size  
Complete with 6 Volt Lamp

Any dealer can supply

# CARTER

**"FLAT" Plug**

Quarter turn battery switch indicating by red light when "OFF" or "ON." Current consumption negligible.

Fits snug against panel—tips concealed. Matches knobs on panel. Cord tips instantly connected or disconnected.

Half Size  
**75c**



Half Size

**75c**

In Canada: Carter Radio Co., Limited, Toronto



Write us for Catalog



years ago, in the Nile Valley, (the Egyptian was the forefather of today's weather man) to 1927, when the amount of moisture in the atmosphere may be forecast to fire fighters, aviators, agriculturists, nurserymen, and irrigation companies, twenty-four hours in advance. This may be a remote, but not impossible, achievement; since it is one of the major projects of the United States Forest Service at its experiment stations and the investigation is expected to be completed in 1927. If this objective is attained, the consuming interest in radio will have been responsible for initiating the project. Such are the peculiar twists in natural phenomena—static being described as nature's most powerful broadcasting station.

If static is developed into a basis for weather forecasting, with special reference to relative humidity, the 25,000,000 radio fans in the United States may eventually expect that the Weather Bureau will issue radio weather forecasts. Supplementary to the general forecast, "Fair and Colder Tomorrow night," will be the special forecast, "Good Radio Weather—Cold, Crisp and Clear—'DX Hounds' Should Have Their Batteries in Good Condition and Tune in on the Pacific Coast."

**S. O. S.—Searchin' Out Sadie**

(Continued from page 1633)

and raid the Gas Housers' hangout; others wanted to—aw, why waste the time telling you what that gang of near-brains proposed. The only catch was that Solly puts the thumbs-down sign on each and every brain-wave that was broadcasted.

"Then Solly pulls the idea that the best way to get any inside dope is to get somebody in the Gas Housers' hangout, that can get talking to them and sort of ease it out of them. That sounded like the goods to us and then we starts to figure out who's going to be the hero. I'll say this for the gang, they're game birds in a bout, but none of them don't like to wander in casual like to sudden death—or worse, as the movies say—and so there ain't no wild scramble and yells of 'I'm it!' Well, that idea went along the same way that a lot of other good ones go and finally we decides to mosey along.

"Solly says to me as we're slipping along towards home, 'Pat, let's you and me float down by the Gas Housers' and see what's who.'

"So down we goes, and there is lots of light and noise streaming out the windows of their hangout. Solly suggests that we look around a little and so we hikes around to the back of the building. It was dark and then some, but we could see the faint outline of a fire-escape that looked awful inviting.

"'What do you say, we plays firemen and see what we can gather?' suggests Solly.

"'Holy suffering mike, why don't you write 'em a letter and tell 'em you're going to try and get an earful?' I says.

"'Huh?'

"'Don't you know when you get on that swinging end of the fire-escape, it's going to act like a young burglar alarm by its squeaking?'

"Solly has to award me first prize for that bit of skull work and so we wanders on down the Avenue. We was walking slow and believe me, boy, we was working the old think-tanks overtime. Sudden like Solly grabs me by the arm and yelps:

"'I got it!'

"'Where?' says I, thinking just then of the pain in my arm which Solly was squeezing plenty.

"'Come on, Pat, we got to find Mat.'



**A New and Advanced Model—  
Norden-Hauck Super-10**

**Highest Class Receiver in the World**

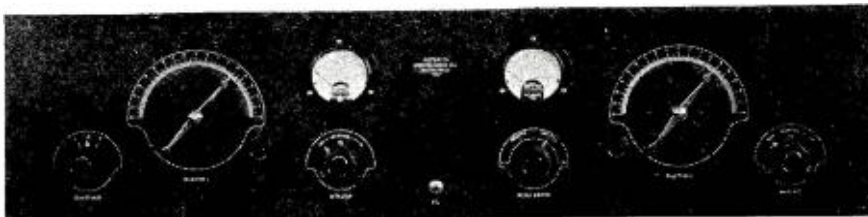

Panel Size: 36"x9"x1-4"

Weight: 55 lbs.

**T**HE NORDEN-HAUCK SUPER-10 is an entirely new and advanced design of Receiver, representing what we believe to be the finest expression of Modern Radio Research Engineering. It is the product of years of experience devoted exclusively to the attainment of an ideal Broadcast Receiver—regardless of cost.

Results obtained in every respect will upset all your previous ideas of good radio reception.

Here are only a few of the host of features that place the NORDEN-HAUCK SUPER-10 far in advance of competition:

- 10 tubes employed to give perfect reproduction with unlimited range and volume power.
- Super selectivity on all wave lengths.
- Built to Navy Standards.
- Wide wave length range without change of coils, etc. (Adaptable 35 meters to 3600 meters if desired.)
- Use Loop or Antenna.
- Simple to operate, having only two major tuning controls.
- No Harmonics. Signals are received only at one point.
- Special Power Audio Amplifier, operating any loudspeaker and eliminates necessity of external amplifier.
- Can be operated directly from house current if used with NORDEN-HAUCK POWER UNIT AB-2.

*The NORDEN-HAUCK SUPER-10 is available completely constructed and laboratory tested, or we shall be glad to supply the complete engineering data, construction blue prints, etc., for those desiring to build their own receiver.*

TEAR OFF AND MAIL TODAY

**NORDEN-HAUCK, Inc.**  
Philadelphia, U. S. A.

Gentlemen:—

Please send me without cost or obligation on my part, attractive illustrated literature describing the new Norden-Hauck Super-10.

I enclose \$2.00 for which please send me, postpaid, complete full size constructional drawings and all data for building the Super-10.

Name \_\_\_\_\_

Address \_\_\_\_\_

**Upon Request** A complete catalog, attractively illustrated, will be gladly mailed without charge, or full size constructional blue prints, showing all electrical and mechanical data, will be promptly mailed postpaid upon receipt of \$2.00

Write, Telegraph or Cable Direct to

**NORDEN-HAUCK**  
Incorporated  
**ENGINEERS**  
MARINE BUILDING  
Philadelphia, U. S. A.



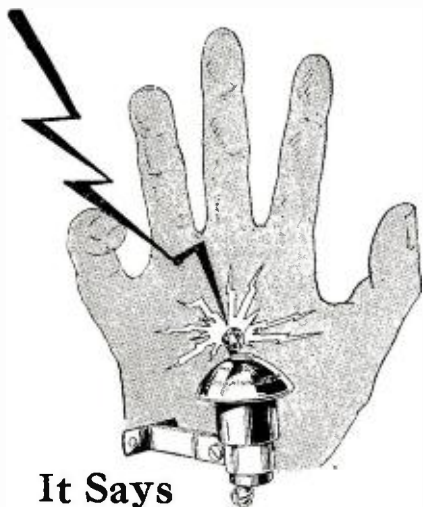

**It Says  
"STOP"  
and Lightning Won't  
Harm Your Set**

The National Board of Fire Underwriters specify that an approved Radio Lightning Arrester *must* be used with all out-door aerial installations. Protection is easy. Insure your insurance and save your set with a WIRT LIGHTNING ARRESTER (listed as standard by the Underwriters Laboratories). The cost is a trifle.

The WIRT LIGHTNING ARRESTER is an approved air gap type, made of bakelite giving ample insulation, with brass terminals moulded in bakelite, far enough apart so that there is no leakage. A "petticoat" of bakelite shields the arrester from water and dust. Handsome and rigid. Lasts a lifetime. Easy to install. Full directions on box.

THE WIRT LIGHTNING ARRESTER IS LISTED AS STANDARD BY THE UNDERWRITERS' LABORATORIES

Wirt Lightning Arrester...\$1.00  
Wirt Insulator ..... .35

When you install your WIRT LIGHTNING ARRESTER for a WIRT INSULATOR and prevent leakage along your lead-in wires. It keeps the wire at the proper distance, provides perfect insulation, and prevents wear and tear on the wire by preventing sagging and swaying.

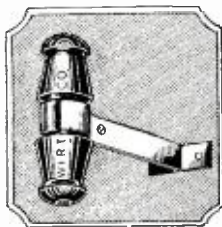

Sold by Leading Radio Dealers

**WIRT COMPANY**  
PHILADELPHIA, PENNSYLVANIA  
Makers of Dim-A-Lite

LATEST "COAST TO COAST" FULLY GUARANTEED

**RADIO'S-10 DAYS FREE TRIAL**  
SAVE 1/3 TO 1/2

Users everywhere report Miraco Radios get program coast to coast on loud speaker; outperform sets three times as costly. Many hear foreign countries. Radio's most amazing values in unconditionally guaranteed, factory-built long distance sets—let testimony of users convince you.

**MIRACO RADIO GETS 'EM COAST TO COAST**

Powerful New Multi-tube Miraco gets long distance on loud speaker. Set, ONLY \$27.35 retail

FREE! Literature on latest improved 1 to 5 tube models, new low prices, testimony of users and SPECIAL OFFER. Write: **MIDWEST RADIO CORP.** Pioneer Builders of Sets 404W E. 8th St. Cincinnati, O.

AGENT USERS WANTED Write for discounts.

**G-S SILK CORE CRYSTAL DETECTOR**

PRICE \$2.00

Write for new descriptive folder.

Man'd by G-S Radio Res. Lab., 1269 Cochran Ave., Los Angeles  
Distributors: Scott Sales Co., 439 S. San Pedro St., Los Angeles

"Sure, he's pounding his west ear at home by now. That's easy, but wise me up."

"Solly says nothing, and being sort of curious I lets him tow me to where Mat hangs out. Well, we finally drags Mat out of the hay, which don't make him none too cheerful, but he chirps up when Solly tells him about his brain storm.

"Now Solly and Mat had been fooling around with a nice little transmitter like the one I told you about we used in the spiritualist's dive. Remember it worked on a real low wave-length and was the real goods? Well they had been playing with some sort of a trick system of starting and stopping the thing by relays, that could be worked real classy by radio waves."

"But, Pat, I don't get you, I interrupted. "Well, now it's this way. When they wants to light the filaments of the tubes in the set number one, say, they sends out dashes from another set. These dashes bump into a nice little loop antenna on the number one set and act on a relay that closes the filament switch. That's done on one wave-length, and this little number one transmitter starts in broadcasting. See, it don't waste the batteries that way for you only have to keep one tube lit to work the relays. Gather it now?"

I nodded. "Well then Solly suggests that we smuggle this young WEAF into the Gas Housers' hangout along with a mike that will pick up the noise made by a fly winking his right eye. Solly says that he's been in the Gasers' place and there's an old closet off their big room that's never used except to put junk in, that will be slick to park the set in. As the mike is real small it can go behind the closet door, which don't close so very well.

"When do we slip that bunch the set?" Mat asks.

"Right now if they've cleared out," says Solly.

"So we packs the thing together and beats it for the Gas Housers' again. It was about three o'clock when we gets there and there ain't a light in the dump. We slides around to our friend the fire-escape and with a little luck and a lot of acrobatic stuff, they boosts me up so I can get a hold of the end of the swinging ladder. It comes down with a noise like a blooper with a bad tummy ache. We waits awhile and seeing as how nothing happens, we climbs up with the set.

"Their dump was on the second floor and of course the windows was shut and locked plenty. Solly did his stuff and soon we was walking cautious in the Gas Housers' office that was private plus. We gets into their big room and there was the closet that Solly had told us about and he was sure right about the junk, for it looked like a ham's workbench. We moved enough of it real careful-like and set up WEAF Jr. in a back corner, fixed up the mike and then piled back all the junk to look real natural.

"Well then, we locks the window again, walks down the front stairs just to show them we didn't give a damn about them and lights out for the hay, for we was sure in need of it.

"The next day one of the three of us was parked by our set all the time and we switched WEAF Jr. on and off again every ten minutes. We kept this up until about two o'clock the next morning and all we heard was two scraps and a stud poker game, neither of which was edifying. This kept up for four days and we was getting more and more worried about Solly's little playmate Sadie. The Gas Housers went around the neighborhood as though they had all been elected President and we was sort of careful how we treated them for fear that they might take it out on Sadie.

"On the morning of the fifth day Solly sees a Gas Houser that just got back to town from a little trip up the river. He tears

**ELECTRAD**

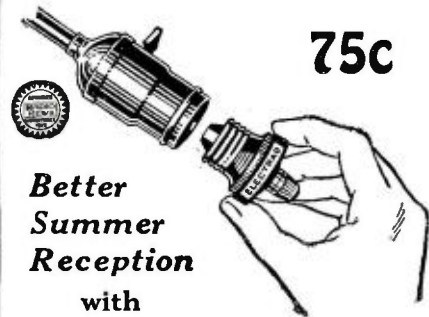

Better  
Summer  
Reception

with

**ELECTRAD  
Lamp Socket Antenna**

JUST screw this simple, electrically certified device into any lamp socket in the house, and you will minimize annoyance from squeals, howls and "canary birds." Brings in what you want—volume, distance, clarity. Ends lightning worries.

Consumes no current. Absolutely safe. Tested and certified electrically. At most good radio stores, price, 75c, in Canada, \$1.10.

**ELECTRAD Inc.  
New York City**

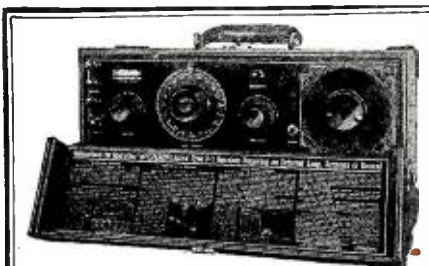

The Famous Truly Portable  
**TELMACO P-1 Receiver**  
Four Tubes Do the Work of Seven

The peer of portables in size, weight, ease of tuning, selectivity, distance, volume, workmanship and price. Aerial, loud speaker and batteries self contained. Complete with tubes and batteries, \$125.00 \$141.50. Receiver only

**P-1 Kit Saves You Money!**  
Our offer of the Telmaco P-1 Receiver in kit form has met with enthusiastic reception. This contains all parts, as built by us, including case, drilled and engraved panel, and illustrated instructions. \$80.00 Complete kit. Ask your dealer or write us. Descriptive folder free.

Radio Division:  
**Telephone Maintenance Co.**  
20 So. Wells St. Dept. B Chicago, Ill.

**TELMACO**  
Quality Radio Exclusively Established 1918

**PATENTS** WRITE for our Four Guide Books and "RECORD OF INVENTION BLANK" before disclosing inventions. Send model or sketch and description of your invention for our INSPECTION and INSTRUCTIONS FREE. TERMS REASONABLE. Electrical and Radio Cases a specialty.

**VICTOR J. EVANS & CO.**  
919 NINTH ST., WASHINGTON, D. C.



into where I was working the set every ten minutes regular and says:

"Keep them cans plastered to your skull, Pat. I just saw Micky Mahan and he was heading for the Gasers' place. They're liable to tell him all about this and us at the same time."

"I switched on the set and in a few minutes I heard the gang telling Micky how glad they were to see him after his two-year trip and vacation on the State. And then Solly's dope comes true; they start to tell Micky about how they had waylaid Sadie that night on her way home from work and how they were keeping her hid safe away from the peeping eyes of us Frog Alleyers.

"I was scared stiff that Micky wouldn't get inquisitive and ask where she was, but he runs true to form and blats out the very questions that we had been asking ourselves for the last six centuries, as it seemed.

"There was a roar of laughs went up when he asked that and someone answers real sarcastic like:

"I'll bet that's what the Frog Alley gang has been saying, all right?"

"When the laugh dies out someone answers this bird's question and tells him that Sadie is being kept careful in a cellar of an old stable on Twenty-Fifth Street. They was careful, I thought, not to mention the exact address, but Micky helps us out nice.

"Let's go 'round there and give her the once-over. I never liked that dame much and this is a good chance to tell her what I think of her."

"I'd heard enough right then and I dives for the telephone and calls up Solly and slips him the glad tidings. He spreads the word around quick and before you knew it there was about eight of our gang just r'aring to get at the Gas Housers. Solly says we'll wait around the corner from their hangout and follow them when they go to pay Sadie a visit.

"It was a lead-pipe cinch. Five of them came out of their dump and headed up the Avenue and we're right behind them just out of sight. Well they turns left on Twenty-Fifth Street and then Solly runs like the devil to the corner to see where they head in. The stable is only a couple of doors from the corner, and no sooner had their gang gone in the door than we was right after them, before they could lock any doors or anything like that.

"Then there was another pretty scrap. We were just as sore as a bunch of actors that has been given a cut in salary and we went to it with lots of pep. It was a shame to take the money! They were so surprised that they could hardly wiggle a fist and soon we had 'em backed into a corner with me holding 'em there with a gat that I had slipped into my pocket in case there was too much trouble.

"Solly and a couple of others busted in the door that kept Sadie from her 'pursuit of happiness' and we troops past the Gasers with the well known jeers and sneers. We also told them if they pulled any more rough stuff like that, they would get all that was coming to them and more too.

"And that's the inside dope on why Solly and the gang was having a little celebration tonight, over the way us Frog Alleyers and Old Man Radio's youngest hopeful had the last cheerful ha-ha on the Gas House outfit."

"Well, Pat, things sure have been lively, haven't they?" I said as he wound up his tale.

He yawned and pretended to be bored with life.

"Oh, I suppose so, but things ain't what they used to be. There ain't no good real serious scraps no more. Come on, let's have another and go hunt some trouble with the bunch. Waddy say?"

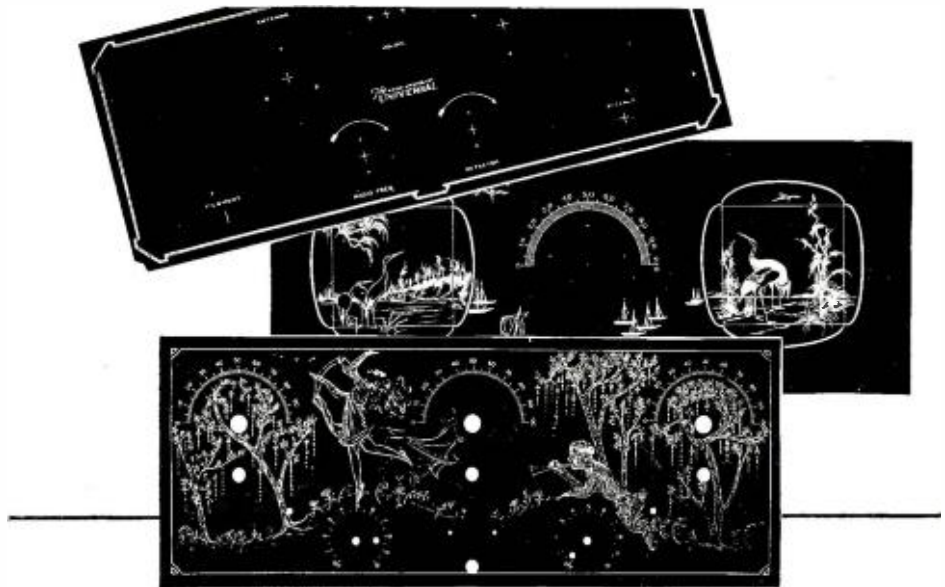

## New Ideas In Veri Chrome For The New Season

FORMICA'S experimental work in panel decoration has produced some new ideas that will be seen in many of the new models for next year. A new dull finish of great richness and beauty has been developed for Veri Chromed panels on both Black and Wood finished material and new decorative ideas of many types are available.

This year punched base panels and front panels of Formica will be largely used. The new designs require more holes in base panels than formerly and the advantages of punching become more apparent. More efficient methods of handling Formica make it a more economical material than many that cost much less per pound.

### Formica Panels For Kits

Fully decorated panels of Formica, gold or silver on black are available for the following well known kits: Bremer Tully Counter-phase; Nameless, No. 1; Browning Drake National; General Radio Broadcast Receiver; Cockaday L. C. 26; Victoreen Superheterodyne; two sizes of Best's Superheterodyne for Remler parts 7"x20" and 7"x26".

*Ask your dealer for these kit panels or write us direct.*

**THE FORMICA INSULATION COMPANY**  
4618 Spring Grove Avenue  
Cincinnati, Ohio



**FORMICA**  
Made from Anhydrous Bakelite Resins  
**SHEETS TUBES RODS**



**The S-C SILVER COCKADAY**  
"All Wave Receiver"

Send for this  
New Hookup

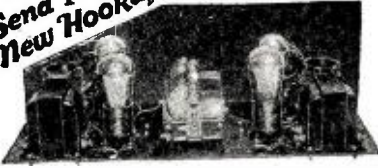

**Universally Approved**

This remarkable 4-tube, single-control receiver, designed by Silver and Cockaday and sponsored by Popular Radio Magazine has been described by Radio News and approved and endorsed by Radio Age—Radio Engineering—Radio Magazine—On the Air—Popular Science Monthly—Christian Science Monitor and Newspapers throughout the country... an overwhelming introduction and guarantee. The following comments by Set Builders are equally noteworthy: "Our S-C certainly is a wonder for volume and clarity"—"It's impossible to hook the S-C up wrong"—"My S-C. develops volume equal to 6 and 7 tube sets"—"Bring Chicago into Newark, N. J. easily with plenty of volume."—"Battery Cord is really remarkable piece of work"—"Never saw such simplicity and compactness." Anyone can assemble the S-C easily.

**Mail the Coupon Today**

The parts manufactured by the following reputable concerns have been recommended for the S-C by the designers, and can be obtained in a complete Kit from any Radio Dealer.

- Belden Mfg. Co.—S-C Wiring Harness
- Central Radio Laboratories—Centralab Resistance
- Polymet Mfg. Corporation—Fixed Condensers, Leak and Leak Clips
- Silver-Marshall, Inc.—Variable Condensers, Coil Sockets, Coils, Tube Sockets, Vernier Dial, Mounting Brackets
- Thordarson Elec. Mfg. Co.—R200 Power Transformers
- Poster & Co.—Drilled and Processed Front Panel and Drilled Sub-Panel
- Yaxley Mfg. Co.—Rheostat, Jacks, Switch

Get the hand-book at your radio dealer's, or clip the coupon and send with 25c to

**S-C MERCHANDISING CO.**

283 S. Peoria St., Chicago

**S-C MERCHANDISING COMPANY**

283 S. Peoria St., Chicago  
Herewith please find 25 cents for which send me the hand-book of the new S-C Four-Tube Receiver.

Name .....

Address .....

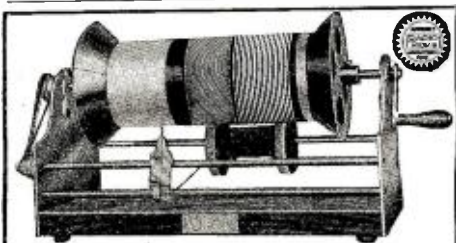

**STOP WASTING TIME.**

Patience, and money in winding your coils. The automatic WIZARD will wind the largest coil 4 1/2" diam. 10" long in thirty seconds. Cotton, silk, or enamel wire from 18 to 40 gauge can be used. SPACES WIRE uniformly. A machine well built, nickel plated throughout, ready for instant use. ONLY \$7.50, we pay postage in the U. S. If not at your dealer we will send you WIZARD C.O.D. or enclose \$7.50 with your order. **SOLD ON MONEY BACK GUARANTEE.** ORDER NOW. DEALERS INVESTIGATE. **WIZARD WIRE WINDER CO.,** 3812A Central Ave., Los Angeles, California

**Pity the Poor Announcer**

(Continued from page 1626)

a title, a name, you have no weapons but the pause, and the extra clarity that can be put into the word by the clipping of your syllables which is accomplished by the sharpening of your consonants. Then again, you dare not continue indefinitely to clip your syllables, as then your announcement begins to sound like machine-gun fire, and your audience gets annoyed. It does not cough or rustle—it dials you out. You do not know this, but that doesn't help.

**THE SOUNDS THAT VANISH**

There are several things that happen to speech over the air. The little word "of" disappears entirely. Most Americans—this includes Canadians—slur over this indispensable syllable at the best of times; but the effect over the air is an impression of sloppiness which produces a bad psychological effect. Try to articulate a sentence like this: "The President of the Board of Trade of the city of Hicksville will give a short talk on the value of the spreading of knowledge of good methods of advertising." Eliminate all the propositions, turn them into a faint sound of "uh," and listen to the effect. It's dreadful. You can log twenty radio announcers, one after another, in a single evening, and you will never hear the word "of."

Another air-speech difficulty is the double vowel-sound. Listeners wonder why it sounds so curious; but the reason is that no one speaker in a thousand realizes that the syllable "I" is not a single sound but a double one. It is a compound, of course, of "ah" and "ee." When the betraying ether picks up this sound, it magnifies it; so that nearly all the "I" sounds come over the galloping waves in Irish fashion—that is, of the musical-comedy style. "O! have to report a foire on Main Street," says the announcer gravely—and the listener is not sure whether he has one of the radio plays or a news report. "O" is another annoying combination, as it comes through like "ah—oo" with the accent on the "ah." The trick of getting over these difficulties, so far as I have been able to discover by experiment, is to appreciate the existence of the double sound and move over it as rapidly as possible, with great care to clip off the second vowel. It can be done.

**THOSE KINKY LETTERS!**

Then there are the sibilants. Oh, those hisses, snake-like in their tricky coils, that over the air, do one of two things—either disappear altogether, or hiss like a whole jungle-full of rattlers. This latter tragedy, however, only takes place when the speaker, from an excess of zeal, over-pronounces in his effort to make his words of wisdom clear to his so-called "invisible audience."

Diverging for a moment from syllabic discussions—when will these gentlemen, over-pronouncing or not, discover that they are misusing the word "invisible?" The fact that they can't see a thing doesn't make it invisible.

Returning to the reptiles, the sibilants can only be handled by means of fasting and prayer. Just enough, and not too much, is the rule to be applied. If you are suddenly faced with a sentence like this—"Senator Samuel Smith sends his congratulations to the studio singers for the sympathetic singing of the salvation songs—" well, as already said, fasting and prayer are necessary. It is a case of seeking the happy medium.

**THE MISUNDERSTOOD ANNOUNCER**

Added to the difficulty of these details is the matter of the tone of voice. There is the announcer who is pointedly and consistently joyful. He gets on the listener's nerves. There is the one who is solemn, as at a



**Holds 4 World Records**  
**ALL FULLY VERIFIED**

This amazing receiver has achieved in actual performance reception records that no other set can hope to duplicate. Mr. Scott's story of the development of his master receiver and the history of its records sent on receipt of stamped and addressed envelope.

**ALL THE PARTS**

Send for data on all the parts necessary to make an exact duplicate of this marvelous receiver.

**MATCHED!**

Special facilities for calibrating and matching intermediate frequency transformers and filters to match them. Write for full particulars.

**SCOTT RADIO LABORATORIES**  
**CRILLY BLDG. CHICAGO, ILL.**

**22 1/2 VOLT**  
unacid  
everlasting  
rechargeable  
"B"  
STORAGE  
BATTERY  
**\$2.95**  
Includes  
chemical



45 volts, \$5.25; 90 volts, \$10.00; 112 1/2 volts, \$12.50; 135 volts, \$14.75; 157 1/2 volts, \$18.80. Truly the biggest buy today. Easily charged on any current including 52 volt systems. Any special detector plate voltage had. Tested and approved by leading authorities such as Popular Radio Laboratories. Over 3 years sold on a non-red tape 30-day trial offer with complete refund if not thoroughly satisfied. Further guaranteed 2 years. Knock-down kits at greater savings. Complete "Hawley" "B" Battery Charger \$2.75. Sample cell 35c. Order direct—send no money—simply pay the expressman rest on delivery. Or write for my free literature, testimonials and guarantee. Same day shipments.

**B. HAWLEY SMITH**

314 Washington Ave.

Danbury, Conn.

**A NEW RADIO PLUG**

Simple to use, gives perfect electrical contact with any style tip.  
Simply push cord tip through plug, loop cord and push tip back into plug. Sent postpaid on receipt of 50c

**CULVER-STEARN'S MFG. CO.**  
Worcester, Mass.

**9 Circuits-1 Tuning Dial!**

A Separate Circuit for each 40 Meter Wavelength Band. A single tuning dial, yet greater selectivity. Let our nearest dealer show you the great Kellogg.

**WAVE MASTER**  
SWITCHBOARD & SUPPLY CO.

Or write for complete descriptive folder No. 1-F today. **KELLOGG SWITCHBOARD & SUPPLY COMPANY** 1041 W. Adams Street :: Chicago, Ill.

**RANGER DELIVERED FREE**  
on approval and 30 days' trial, express prepaid. Many styles. Bicycles \$21.50 up. Easy payments. Write today for our big catalog and Factory-to-Rider prices.

**MEAD Cycle Co., Dept. A-118 CHICAGO**



funeral—there are, fortunately, very few of him. You, as listener, find yourself gazing at the loud speaker and wishing you could offer him a cup of strong coffee or a glass of champagne. You wonder if he has just lost his wife and family, or if he has indigestion, and you wish that you could suggest Wiseman's yeast. But if you insinuate yourself into his studio, and lure him into conversation, you find to your astonishment that he is a fat, happy soul—away from the microphone.

Then there is the announcer who, with the idea of being brisk and efficient, snaps out the letters of his station so that nobody can hear them until about the third repetition. He has not studied the art of the pause. There is the delightful soul who keeps on repeating the letters of his station over and over again until you are ready to kick him. "W P T N," he says gaily. "W P T N. W—P T N!" He plays tunes on those four letters as if he loved them. But in the matter of station identifications, congratulations to the few announcers who have discovered that "This is station so-and-so" contains not less than three close-together sibilant sounds; and have rung variations on their introductory announcement, or else have fallen back on the dramatic letter W or K for opening. Sometimes the master of ceremonies has the help of a locomotive bell or a set of chimes, but more often it all depends on him. Pity the poor announcer!

**THAT MYSTERIOUS PERSONALITY**

He is such an unbelievably important person, as he is responsible for the popularity of the station to a degree that is not yet sufficiently recognized. If a number has not turned out quite as well as expected, the announcer can, by judicious conversation, soften the blow and distract the minds of his listeners. In signing off, he can make the listener feel that he has been a specially-honored guest at a good party—or exactly the reverse. And these miracles must be performed by the tones of the voice. The announcer may be as handsome as Valentino, beautifully tailored, with a marcel wave, but it will avail him nothing so far as his audience is concerned. He may be as ugly as sin, wearing muddy boots and a suit that has been sat on for a year without a pause for pressing; but if he has a personality behind his voice, all will be well with his programs.

The other day, I happened to be listening to an afternoon concert from an eastern station, in company with three other listeners of the feminine sex. The announcer was one of those reasonably cheerful ones who always make a good impression. Suddenly the oldest woman of the group said: "What do you think he looks like?"

The married flapper promptly suggested—with a dreamy look in her eyes—dark hair, medium height, slim figure, brown eyes, and a rather large mouth, a dimple in the chin and a grey suit. "Oh, no," said the youngest one: "He will have a little black moustache, and be almost fat, and I just know he wears spats!"

**UNTIL TELEVISION ARRIVES**

The party degenerated into a riot. When this backward continent catches up to Europe, and installs velvet-voiced, lovely ladies at the microphones, what fun such an experiment will be at a stag party! There are feminine announcers at Madrid and San Sebastian. The latter lady is famous for her clear enunciation, and for her careful translations into both French and English. Still another lovely lady officiates at Rome. Of course, they tell us that soon we will have photographs thrown on little screens from every station, but in the meantime, it is a pleasant indoor sport to imagine what a radio announcer looks like. Not what he thinks about, because he doesn't get much time to think. One moment, please!

Pity the poor announcer!

# Unfailing "A" Power direct from the light socket

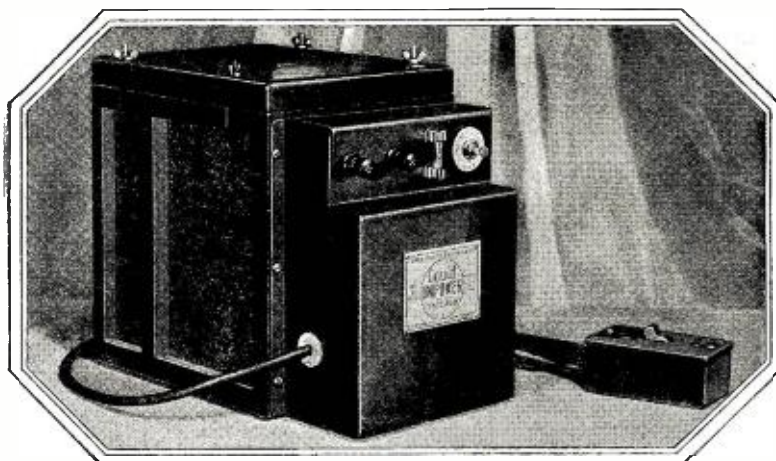

**E**LMINATE the inconvenience and cost of renewing "A" dry cells—of charging a storage battery! The new Gould Unipower automatically furnishes a continuous, unfailing "A" power of highest quality—always at highest voltage.

Unipower will last for years—there are no tubes, bulbs, lamps or working parts that require replacement. And it's easy to install. Simply connect two wires to your set and plug in on your light current.

The first cost of Unipower is moderate—and the first cost is practically the last. It costs only a few cents a month to operate. Write for booklet, "Unipower—a triumph in radio power."

**The Gould Storage Battery Co., Inc.**  
250 Park Avenue New York

Unipower contains a Balkite charging unit of special design.  
6 volt model, \$40—60 cycles, 110-125 volt A. C. Designed for radio sets using 201-A tubes or equivalent.

4 volt model, \$35—60 cycles, 110-125 volt A. C. Designed for radio sets using 199 tubes or equivalent.  
Prices west of the Rockies slightly higher. Special models 25-50 cycles, are available.

# Unipower

*Off when it's on—On when it's off*



## GEM TUBE

A Guaranteed Radio Tube Within Reach of All

A tube for a dollar of \$3 value. A trial order will convince you as it has thousands of others. (Blue or Silver with Rakelite Base). Send your orders at once. Orders sent C.O.D. parcel post

Types \$1  
401A  
400  
499  
499A Each

With Standard Base All Tubes with UV or UX Bases

## GEM TUBE CO.

(Dept. N.) 200 B'way N. Y. City  
220 So. State St., Chicago, Ill.  
Lafayette Bldg., Detroit, Mich.

## AMPLION

FOR BETTER RADIO REPRODUCTION

## MORE PROFITS for the Professional SET BUILDER

We have an unusually interesting proposition to make to the man who is now building (or has the ability to build) radio receiving sets for resale.

This is a real opportunity. Write today for full information.

**Gearhart Schlueter Radio Corp.**  
715 Voorman Ave., Fresno, California

**FREE RADIO BOOK**

Science has invented a new kind of coil. Now have it on your present set. Gives 4 great advantages otherwise impossible. Write for new book just published showing many new ideas. Also 8 new circuit diagrams. Address Electrical Research Laboratories, Dept. 176, 2500 Cottage Grove Ave., Chicago, Ill.



# HERE'S A BRAND NEW BOOK!

To delight every Hookup Fan.

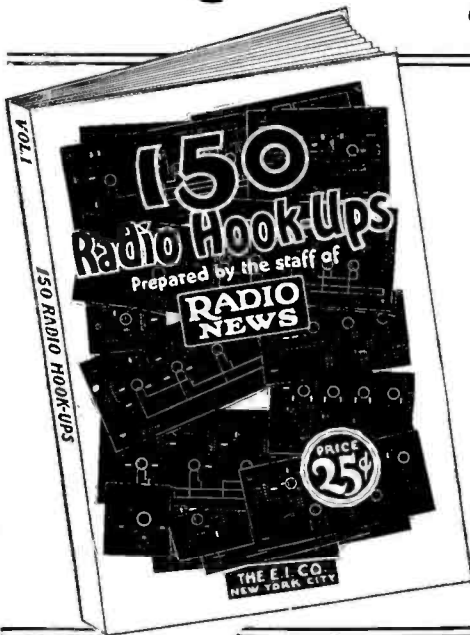

## 150 HOOKUPS

WHAT more could you ask?—150 of the very finest, selected hookups most popular today. Each one completely explained and fully illustrated so that a complete receiver can be constructed from the information. No out-of-date Hookups—all the finest and best in common use today.

Don't miss this opportunity—All Radio and News dealers have fresh copies *Now*. If there is no dealer near write us direct enclosing 25 cents.



64 PAGES  
—  
Illustrated  
—  
Large Size  
6 x 9 Inches

SOLD AT ALL NEWSSTANDS and RADIO STORES

Published by

**THE E. I. COMPANY**

Distributed by

THE CONSRAD CO., Inc., 64 Church St., New York, N. Y.

# The Radio Trouble Finder

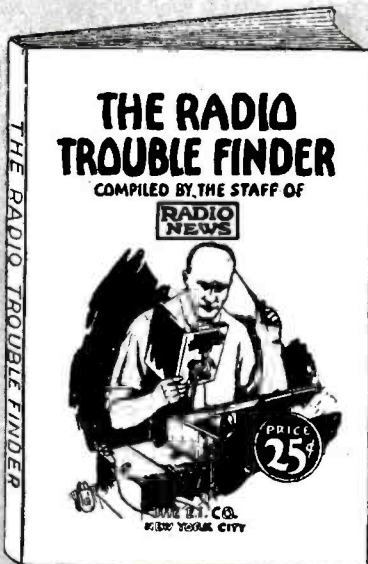
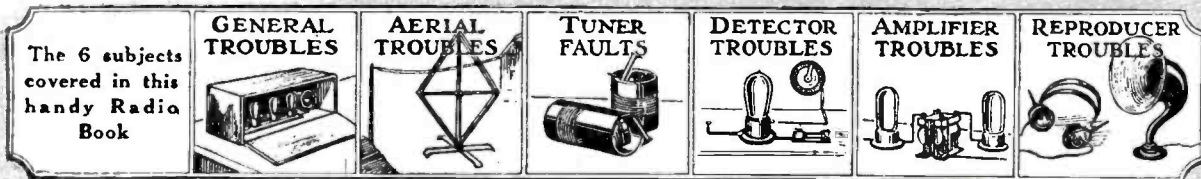

## TROUBLE FINDING AND CORRECTING SIMPLIFIED FOR EVERYONE

Every radio receiver owner should have this valuable book. All troubles and their remedies are arranged in simplified charts with numbered tests to locate and rectify disturbances. This handy book covers all common radio set troubles.

SIZE 6 x 9 — ILLUSTRATED

Price 25c—Sold Everywhere

Distributed by

The CONSRAD CO., Inc., 64 Church Street, New York, N. Y.



## Whats' Wrong With My Super-Het?

(Continued from page 1649)

learned, to our sorrow and otherwise, from its use. Shielding is first; and inasmuch as we are learning more and more about it every day, we will pass over it in this article by saying that for best results, so far as lack of interference by long-wave code, etc., is concerned, shielding is very necessary but it must be complete and properly designed. (See Proceedings I. R. E., Morecroft and Turner on "Shielding", August, 1925).

### BADLY-MATCHED INTERMEDIATES

Next in order come problems of silence, or squeals and howls from an unruly super. If one is sure of the other sections of his super (and they should be tested individually first), then we can come directly to the first detector and the intermediate train, for here is where the major part of the super-het difficulties resides. If you purchase your intermediates, you will also probably purchase the oscillator coils to go with them. The beat between the incoming signal and the oscillator may be at the correct frequency to go flying through the intermediate train, which we will suppose is designed to operate at a peak of 60 kc. But, supposing that one transformer has a maximum operating point of 60 kc., the second 50 kc., and the third 40 kc., to say nothing of the filter peak, what then? Here is the finest possible answer that I can give to the question of "Why don't I get volume from my super?"

Commercial intermediates often show a sad leaning to carelessness about matching peaks. Given a set of such intermediates and you will also be given enough silence, squeals and howls, or mighty little volume to suit anyone. If the plate circuit of the first detector tube is improperly designed the tube will oscillate; maybe followed by the intermediate train and maybe not. If not, you can immediately check the trouble by removal of the oscillator tube. The oscillating detector will beat with the incoming signal, produce an autodyne beat, and give you reception. If you can receive signals without the oscillator then, when the two oscillations, that is the detector and the oscillator, are doing their collective best to welcome the incoming signal, you are sure to feel like retiring for the evening. If all the kinds of signals, birdies, etc., occur in your super, check the condition by tuning after removal of the oscillator tube. Reception of broadcast or modulated signals without the oscillator means that the first detector is oscillating but that the intermediate amplifier is stable. Less filament, less plate voltage or re-design of the plate circuit constant for the detector is the cure.

When you buy your intermediate transformers, find out if each is guaranteed to have a peak within 1 per cent. of its mates. Be sure that the binding posts are properly spaced for direct leads to the tube sockets. In some makes they are not.

### THE BIGGEST TROUBLE MAKER

We now come to the intermediate amplifier because after all is said and done here is where 99 per cent. of the trouble is in the super-het. Some provision for changing the grid biasing should be made on your set, at least until you are sure of its action. Changing the biasing of the intermediate grids from positive to negative, according to our experience with so many different types of intermediates, will be sure to bring about oscillation of the train, at some point before full negative with respect to the filament is reached. It is recognized by a dull plop followed by the steady rushing sound, by the

# Thordarson Equipped!

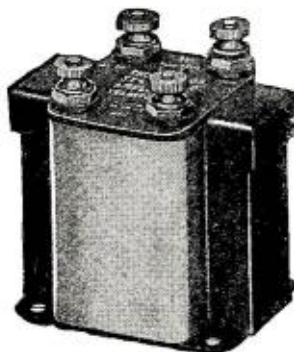

2 : 1 ratio \$5.00  
 3½ : 1 ratio \$4.00  
 6 : 1 ratio \$4.50

**M**ONTH after month, season after season, these leading receiving set makers continue to specify Thordarson Amplifying Transformers.

They have learned that Thordarsons will "stand the gaff"—that in tone quality they satisfy even the most fastidious—that even in hardest service they will not break down—that they are designed right, built right, and sound right.

Build or replace with Thordarsons.



### WRITE FOR DESCRIPTIVE CIRCULARS



**AUTOFORMER**  
 All frequency amplifier. Best bass note reproducer made.  
 Price, each, \$5.00

**R-200 AMPLIFYING TRANSFORMER**  
 Super sized. Gives good musical reproduction.  
 Price, each, \$8.00

**B-ELIMINATOR TRANSFORMERS**  
 For Raytheon Eliminators. Large capacity.  
 Price, each, \$7.00

**B-ELIMINATOR**  
 30 henries. Completely shielded. Capacity 60 milli-amperes.  
 Price, each, \$5.00

# THORDARSON ELECTRIC MFG. CO.

Transformer Specialists Since 1895

World's Oldest and Largest Exclusive Transformer Makers.

CHICAGO, U. S. A.

## Rubber Covered Insulators



Actual Size

Neat and efficient. For antenna, ground and for lead in wires. Small screw starts readily and makes finished job. Great improvement over ordinary large, unsightly insulators. They keep the wires in place and out of the way. Packed 10 in a box, 25c at your dealers or direct from us.

**CULVER-STEARN'S MFG. CO.**  
 Worcester, Mass., U. S. A.

**Learn Watchwork, Jewelrywork and Engraving** A fine trade commanding a good salary, and your services always in demand. Address Horological, Dept. 5, Bradley Institute, PEORIA, ILLINOIS, for our latest catalog.

## SILVER the KING OF RADIO CONDUCTORS GOSILCO

Super Aerials and Bus-Wire are Heavily Silver Plated No. 14 Soft Copper Wire Protected with a Plate of 24-K. Gold

Solders readily.

Endorsed by America's Foremost Radio Engineers.

Aerials 4½c per ft. Round Bus Wire, 12c per 2-ft. length. Quick Action on Mail Orders—C.O.D. Anywhere.

In writing us, furnish the name and address of your dealer.



American Luminous Products Co.  
 Patent Applied For 316 Marbrisa Ave.  
 Huntington Park, Calif.

## EVERYTHING IN RADIO AT ATTRACTIVE PRICES SETS OR PARTS

Mail order only  
**ALL RADIO COMPANY, 417 North Clark St., Chicago**



## Control Volume with this Modulator Plug

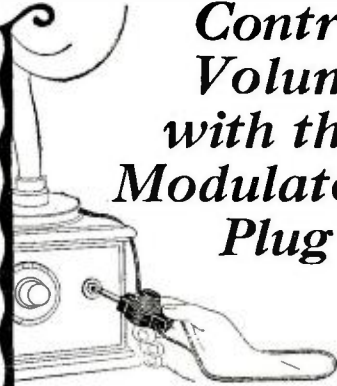

With your radio set operating under full power, you can now regulate tone and volume to suit your mood, by simply turning the knob on this *Centralab Modulator Plug!* Replaces ordinary loud-speaker plug. Provides perfect control of volume from a whisper to maximum, without touching the tuning dials or rheostat. *Cuts down static interference, smooths out powerful local stations, and brings through programs sweet and clear* — improves spring and summer reception wonderfully!

\$2.50 at your radio dealer's — or sent direct if he cannot supply you. Write for literature describing this and other Centralab controls.

**CENTRAL RADIO LABORATORIES**  
19 Keefe Ave., Milwaukee, Wis.

# Centralab

**CRESCENT LAMPE RESISTANCES**  
for Distortionless Amplification  
Used by chief radio experimenters and amateurs in America. All capacities 12,000 ohms and up. Special sizes made to order. Write today for full information. Liberal discounts to dealers. CRESCENT RADIO SUPPLY COMPANY  
1-5 Liberty Street, Jamaica, N. Y.

**MARVELOUS NEW AUDIO TRANSFORMER** adds a musical quality to any set far beyond anything you ever heard before. **KARAS HARMONIK** Amplifies low, middle and high tones—all to the same big volume, thus eliminating distortion. Brings out the vital harmonics and overtones of music. Price \$7.00. Write Karas Elec. Co., Dept. 1020, 4042 North Reckwell St., Chicago

Alden Processed  
**NA-ALD**  
Sockets and Dials  
**ALDEN MANUFACTURING COMPANY**  
Springfield, Mass.

continuous roar or squeal that we are all familiar with, and by all sorts of "birdies" when the oscillator dial is rotated. The remedy is less negative biasing, with the consequent lack of volume, distance, and heavy "B" battery consumption that such practice brings; or change of transformers.

This automatically brings us to the subject of selectivity which, in the super, is a subject to which this entire issue of RADIO NEWS might be devoted and still slight it a bit. Here are a few high spots that may help, if called to your mind. The more positive the bias on the intermediate grids, the more the train will be damped; this is to stop the oscillating of the train, of course, but it also broadens out the amplifier, because of the damping, and the selectivity of the receiver suffers proportionately. Intermediate grids for this reason also should be run as negative as possible. This, to my mind, is the most common reason for poor super selectivity. The less damping in a circuit, the sharper it will tune. Proper transformers in the intermediate will take care of the damping there, but there is also the loop or first detector circuit to be considered. This circuit will tune broadly unless low-loss parts are used and properly connected. It will even then be more or less damped, therefore more or less broad in its tuning, unless regeneration is used with the detector.

### EXPERIMENTING WITH THE CIRCUIT

Next helpful hint; under no circumstances attempt the use of regeneration in the first detector until after you are able to call your super-het by its first name. After such a happy condition of familiarity with what your receiver is doing, the use of regeneration is decidedly recommended. Greater distance, volume and selectivity always run hand in hand with properly controlled regeneration.

We next come to the autodyne super, wherein the first tube acts both as the oscillator and the detector.

Reflexing a super-het is to my mind for the average person, and for even most radio experts, like trying to paint the lily or trying to sell electric fans at the North Pole. Both things are perfectly possible but you'll admit that it would take some artist to do the job. Well, in a way, both of those things might be better than reflexing a super. Oh, certainly, I have heard reflexed supers that were absolute knockouts; but I also have heard plain every-day supers that would run gleeful circles all around them. The very theory of the thing is against it. A plain eight-tube super, if it has a real audio amplifier in it, will break the windows out with most anything that is above the noise level. In fact, if the intermediate is good, two stages instead of the usual three will give the neighbors cause for calling the police—and this on DX signals. Work for the results that you should obtain from a correctly-built super of the common or garden variety, i.e., separate oscillator, first detector with regeneration into loop, three stages of intermediate (two will do if they are right) second detector and two of audio.

There is nothing at all mysterious or tricky with the super-heterodyne. Master the intermediate amplifier and the rest of the circuit will be easy. Selectivity, distance and volume all belong to the super-heterodyne by right of conquest.

### SO WOULD WE

Bill: "I got a new kick out of my radio last night."

Phill: "How come?"

Bill: "The wind blew my aerial onto the high-tension power line."

—Frank N. Hoopingarner.

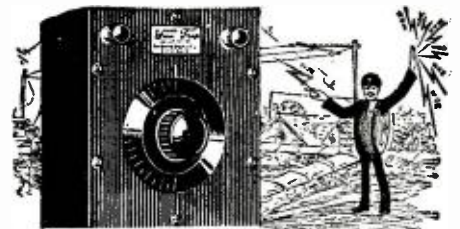

## The Traffic Cop of the Air

Add a Ferbend Wave Trap to your Radio Set and "Police" your reception. Regulate traffic! Guaranteed to tune out interfering station. Widely imitated but never equalled. Not a "toy"—quality, material, workmanship equal to that of the finest receiving sets.

The original and only successful WAVE TRAP. Now in its fourth year. Sent postpaid upon receipt of \$8.50 or C.O.D. plus postage. Send for Free Booklet.

**Ferbend Electric Co.**  
425 W. Superior St., Chicago  
See the new Ferbend "B" Eliminator announcement on page 1697

U. S. Post Office,  
Billings, Mont.

"Ferbend Electric Co. Gentlemen:  
With my Fada Neutrodyne and Ferbend Wave Trap I received the address of Fred Coolidge from W.O.A.W. Omaha, on a special wave length. Many fans tried to get it but failed. Also the base-ball World Series from W.O.A.W. and K.M.A. Shenandoah, Iowa. Had W.E.A.F. New York, loud enough to carry across the street. Will put my Set and Wave Trap up against any in the city regardless of price.  
(Signed)  
J. A. Thompson,  
Supt. of Mails."



**SEE THAT SCREW**

A Screw-Driver adjusts an X-L in crowded places

**X-L VARIO CONDENSER**

Results in easier tuning, more distance, volume and clarity—greater stability. Indorsed by leading radio authorities.

**MODEL "N"**—A slight turn obtains correct tube oscillation on all tuned radio frequency circuits. Neutrodyne, Roberts two tube, Browning-Drake, McMurdo Silver's Knockout, etc. Capacity range 1.8 to 20 micro-micro farads. **PRICE \$1.00**

**MODEL "G"**—with grid clips obtains the proper grid capacity on Cockaday circuits, filter and intermediate frequency tuning in heterodyne and positive grid bias in all sets. Capacity range .00018 to .00055 and .0003 to .001 micro farads. **PRICE \$1.50**

**X-L PUSH POST**—Push it down with your thumb, insert wire, remove pressure and wire is firmly held. Releases instantly. **PRICE 15c**

**X-L RADIO LABORATORIES**  
2426 Lincoln Ave. N. Chicago, Ill.

**Three "E" Straight Line Rheostat**

Perfect Control of Filament Temperature

Perfect reception depends on a fine, smooth, dependable variation of filament temperature in the detector tube. For there is only one temperature at which efficient reception is obtained and this point is very critical. The **THREE "E" STRAIGHT LINE RHEOSTAT** finds this critical point as no other can. It gives straight line variation, runs smoothly, is absolutely NOISE-LESS and once set "stays put!"

By all means secure this precision instrument at once Ask your Dealer or order direct, giving us his name. Price \$2.50—Postpaid

**ELECTRICAL ENGINEERS EQUIPMENT CO.**  
Radio Division, 708 W. Madison St., Dept. 6,  
CHICAGO, ILL. Circulars on Request

**HOMMEL DEALERS BENEFIT FROM OUR SERVICE AND REPAIR DEPARTMENT WHY NOT YOU?**

**LUDWIG HOMMEL & CO.**  
929 PENN AVENUE PITTSBURGH, PA.

Catalog 466-S is free to dealers.

Insure your copy reaching you each month. Subscribe to RADIO NEWS — \$2.50 a year. Experimenter Publishing Co., 53 Park Pl., N.Y.C.



## Why Stop?

(Continued from page 1671)

called static curse? There are certainly many paths that the inventive ham can follow, which have already been blazed through the wilderness of this extremely interesting field; and who knows if you may not be the one to announce next fall that you have perfected a device that has forever removed this bugbear of summer radio?

Then, along the same lines, there is the subject of underground antennae. There has been a great amount of fine work done on this phase, but much is still unknown. One of the great advantages of this type of antenna is that reception is remarkably free from static or like interference. There has been quite a large amount of information published on this interesting subject, and the summer is an ideal time in which to pursue investigations.

This type of antenna recommends itself particularly to hams who live outside of the large cities, for as the name of the antenna suggests, it is buried beneath the surface of the ground. The construction of such an antenna system need not deter the ham from experimentation, either by reason of the work involved or the cost of the necessary equipment. We would be willing to bet that the majority of hams have in the house or barn or garage all that is needed to make and install such an antenna system, without buying a single item. Some of these antennae are run under the ground in tile conduits; but there is no reason at all why the insulating conduit can not be an ordinary rubber garden hose, properly insulated at the ends. That does not sound very difficult to throw together, does it? Of course there is the problem of burying the antenna after it is made, but the trench needed does not have to be made as though you were running a twelve-inch pipe line. And then, too, the ground is a lot softer in the summer than it is in the winter.

### WHY NOT BE COMFORTABLE?

The other evening, as we were talking over the subject of summer transmission and reception with a brother ham, he brought up the fact that as he had his outfit up in the attic he found it too hot to work there in the summer time. We agreed with him and then suggested that he move his key, a couple of the necessary meters and his receiving set to a cooler part of the house. He looked at us with wide-open mouth, registering surprise, and then said, "Why the devil didn't I think of that before?"

There are doubtless many other hams in just the same boat as our friend, who have never happened to think of this very simple solution of this problem. It is only necessary to run a comparatively few wires from the set down to the part of the house where it is coolest, and install there the few instruments that are necessary for the remote control of the transmitter. No longer is it necessary to sit in an attic which has been giving an excellent imitation of an oven all day and retains an unbelievable amount of heat when the sun finally sets. That is another tradition of the days that have gone forever. It is now quite possible to enjoy the gentle pastime of brass-pounding and gathering in DX at one's ease in a cool part of the house. Surely this will make summer radio much more attractive to many hams.

These few suggestions that have been made should appeal to the deep-dyed-in-the-wool fan. When the matter is sifted right down to the bottom the only reason or ex-

## in 1925

the Ultradyne L-2 won honors as the first receiver to listen in on London in the International broadcast tests. Thousands of experimenters built this set because of its marvelous results recorded in the radio press.

## in 1926

again. Dr. J. D. Hullinger of Clinton, Ia., won first prize in the Radio Digest contest for best verified foreign reception during International Broadcast Week. He employed the Ultradyne L-2 of course.



A Home Built Ultradyne

THE Ultradyne L-2 is a consistent distance getter. From 7.30 P.M. Friday, February 26 to 5.10 A.M. Saturday, February 27th, Aaron Whitener of La Grange, Texas, logged 72 stations, totaling 69,000 miles of reception. The most distant station was Sydney, Australia, 9600 miles away.

Like Mr. Whitener, thousands have successfully built the Model L-2 Ultradyne, and claim it the most wonderful receiver they have known for great distance on the loud speaker.

In no other receiver is found the "Modulation System" of radio reception—the most sensitive form of detection.

With the application of regeneration to the "Modulation System" the Ultradyne is capable of detecting the faintest broadcast signal, regenerating and making it audible on the loud speaker.

In addition, the Ultradyne is the most selective receiver known. Regardless of close similarity in wave length, it selects any station within range—brings in broadcasting clearly, distinctively, faithfully.

Write for descriptive circular and free Radio Encyclopedia

# ULTRADYNE

## MODEL L-2

In addition to Ultradyne Kits, we carry a stock of Kits for other standard Nationally Advertised circuits.

**MADISON RADIO CORPORATION**  
114-116 E. 28th STREET NEW YORK CITY

### The Ultradyne Kit

Consists of 1 Low Loss Tuning Coil, 1 Special Low Loss Coupler, 1 Type "A" Ultraformer, 3 Type "B" Ultraformers, 4 Matched Fixed Condensers.

**\$30.00**



### How to Build and Operate the Ultradyne

32 page illustrated book giving the latest authentic information on drilling, wiring, assembling and tuning the Model L-2 Ultradyne Receiver **50c**

## FREE! — Radio Catalogue

### Radio Parts of the Best Quality

1. Right Prices
2. Quick Delivery
3. Dealer Cooperation
4. Complete Stock
5. National Advertising

### CHICAGO RADIO APPARATUS

415 South Dearborn Street, Chicago  
Dept. RN



## B-Eliminator Mfgs.

Get complete information on Dongan special transformers and chokes—mounted or unmounted types.

### Dongan Electric Manufacturing Co.

2977 Franklin Street Detroit, Mich.

TRANSFORMERS OF MERIT for FIFTEEN YEARS



# Three Best Sellers!

Price  
50c

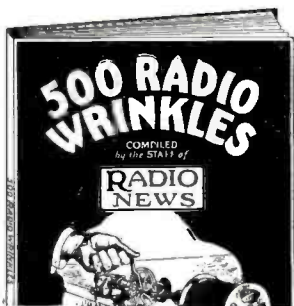

A big book full of short cuts, hints and practical ideas

The 500 RADIO WRINKLES BOOK is a very comprehensive compilation of the best time and money saving hints that can be effected. Under fifteen separate and distinct headings, the entire field of radio apparatus and instruments has been covered in simple, understandable language. There are no ifs nor buts to complicate directions. The Beginner as well as the more advanced radio man will soon find that this book contains a veritable storehouse of practical, inexpensive hints toward improving his radio apparatus.

PRICE 50c THE COPY—  
SOLD EVERYWHERE

If your dealer cannot supply you write direct to us using special coupon on this page.

Price  
50c

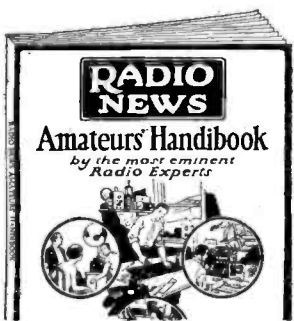

Radio's finest data book—  
The best Radio articles  
of the year

The "RADIO NEWS" Amateurs Handbook is a large 116 page magazine size book containing a wide, varied and carefully selected array of the finest and most helpful radio articles that have appeared in the pages of Radio's Greatest Magazine, RADIO NEWS.

The cream of practical, up-to-the-minute, circuits and miscellaneous information and data is culled from RADIO NEWS and presented in compact form in this book. It embraces every phase of radio, but particularly the new and more practical receivers and circuits developed for modern reception. Size of this book is 9x12 inches. It is sold everywhere. PRICE 50c THE COPY.

If your dealer cannot supply you use special coupon on this page.

## Here's the Latest Radio Book Published

116  
PAGES

300  
ILLUS-  
TRATIONS

Price  
50c

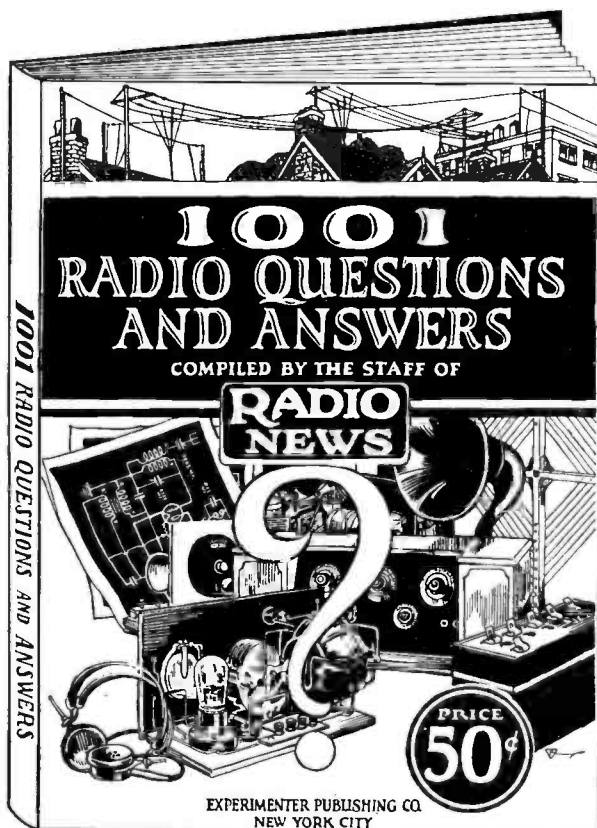

A brand new book filled to the brim with a priceless array of selected Questions and Answers that are necessary to everyone in the construction, care and maintenance of modern sets, including information on hundreds of simple and complex circuits in common use today.

In presenting this most valuable assortment of questions and in answering them in the best and most understandable way, the staff of Radio News feels that it has created a book in which appears the cream of every radio man's problems and the best method of coping with them. There is contained invaluable information on every phase of radio. Information on hundreds of simple and complex hookups is given in clear and concise language. Information on practically every type of receiving set, manufactured receivers, vacuum tubes, miscellaneous circuits, and in short just what the radio enthusiast needs as an unerring guide and aid. This book abounds in priceless data that is worth far more than the nominal price at which it sells.

### SOLD AT ALL NEWSSTANDS

If your dealer cannot supply you write direct—use coupon below if desired.

**EXPERIMENTER PUBLISHING CO., Inc.**

53 Park Place, New York, N. Y.

EXPERIMENTER PUB. CO., Inc.,  
53 Park Place, New York City

Enclosed find \$..... for one copy of  1001 RADIO QUESTIONS AND ANSWERS;  500 RADIO WRINKLES;  AMATEURS HANDBOOK. Check Magazine desired.

NAME .....  
ADDRESS .....  
CITY - STATE .....



cuse that the ham can possibly give for not working in summer is the static; and surely we have shown, in a more or less lucid manner, that static is no real excuse or reason.

We can easily realize that it is rather an easy matter to find an excuse for not lighting up the filaments, some evening when the moon is shining and the canoe or car is waiting to be taken for a trip; but even these things become boring after a while. There surely are some nights when there is no date on the book that holds engagements, and when Old Man Static is not doing his best to ruin every thing in sight, on which the ham will be able to do some good work with his set along the lines that have been mentioned above.

### Radio Set Owner's Information

(Continued from page 1638)

purchased for a small amount from your radio dealer, who can also install the attachment, if you lack either time or confidence in your ability, to make the simple connections needed.

A test will show the good results obtained from a "filter" of this type. It tends to suppress the high notes in your horn and to afford a freer passage to the low ones, which give the most pleasing tones to the reproduction. A horn speaker, equipped with a device of this kind, can hardly be distinguished from a cone speaker by the ear.

### A Typical Month At WRNY

(Continued from page 1641)

tic baritone who had just returned from a triumphant tour in South American cities.

On Monday morning, Ruth Conne, adviser of wealthy women in many cities, talked on the trend in fashions; and H. O. Osgood, of *Musical Courier*, about concerts in the forthcoming weeks; and Walter Gruening, of *Harper's Magazine*, about the best books. WRNY, broadcasting about the only noon-hour program, poured forth its entertainment to hundreds of homes, restaurants and radio shops with jazz piano work, singing.

### 40 Non-Technical Radio Articles

every month for the beginner, the layman and those who like radio from the non-technical side.

SCIENCE & INVENTION, which can be bought at any newsstand, contains the largest and most interesting section of radio articles of any non-radio magazine in existence.

Plenty of "How To Make It" radio articles and plenty of simplified hook-ups for the layman and experimenter. The radio section of SCIENCE & INVENTION is so good that many RADIO NEWS readers buy it solely for this feature.

### Radio Articles Appearing in the June Issue of "Science and Invention" Magazine.

- The Future of Radio Broadcasting. By A. P. Peck, Assoc. I.R.E.
- The Radio Constructor—Browning-Drake Receiver With Two Stages of Tuned Radio-Frequency Amplification. By William A. Vorhees
- New Device Prevents Radiation. Simple Pickle-Bottle Coils. By Herbert E. Hayden
- More Data on "B" Eliminators.
- Radio Oracle—Radio Questions Answered.
- Radio Wrinkles.

"MOST POWERFUL IN THE WORLD"

Navy Model

UNIVERSAL TRANSOCEANIC

Design by CHAS. R. LEUTZ

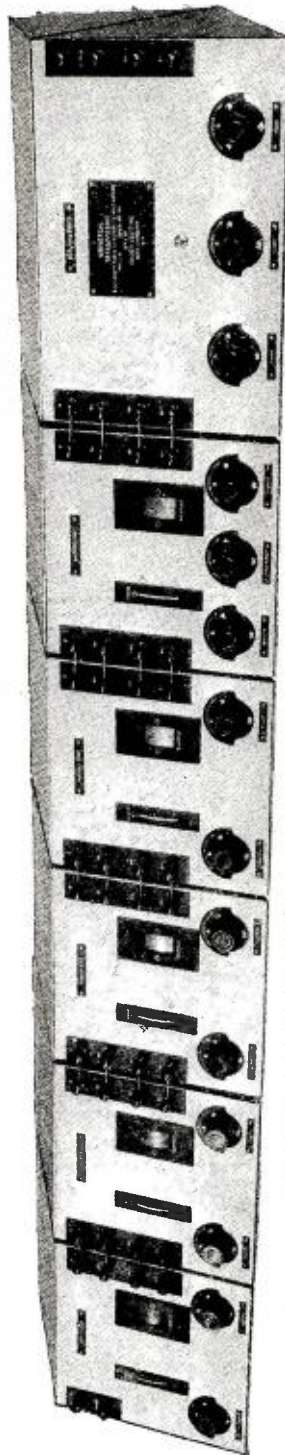

LICENSED UNDER HOGAN PATENT 1,014,002

Wavelength Range 35 Meters to 3600 Meters

Full details are given in our 88 Page Catalog Free. Wire or write for your copy today.

MANUFACTURED BY

GOLDEN-LEUTZ, Inc., Sixth & Washington Aves., Long Island City, N. Y.

CABLE "EXPERINFO"

## 100 Volt Storage "B" Battery \$10

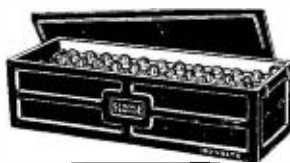

Everybody can now enjoy the benefits of Storage "B" Batteries—more power, quieter reception, greater economy. Rubber case prevents leakage or shorting. Easy to recharge. Will last for years with ordinary care.

**SERVICE Rechargeable "B" Batteries**  
 in all-rubber cases

50 VOLT	\$5.50
100 VOLT \$10 <sup>00</sup>	
125 VOLT	\$12.50

**Prices in Canada**

50 VOLT	\$7.75
100 VOLT \$14. <sup>50</sup>	
125 VOLT	\$17. <sup>00</sup>

**Service "A" Batteries**  
 Indestructible rubber case. Two year guarantee.  
 6 volt. 100 amp. hr. .... \$14.00  
 6 volt. 120 amp. hr. .... \$16.00

### SERVICE Double-Duty CHARGER

Charges 6-volt "A" or Auto Batteries or up to 125 volts of "B" Battery IN SERIES. Noiseless in operation. Extremely economical. The height of convenience.



SERVICE BATTERY CO. of Canada, 137 Roncesvalles Ave. Toronto, Ontario

**SERVICE BATTERY CO.**

704 East 102nd Street

Cleveland, Ohio

Complete with Bulb \$14.<sup>50</sup>



# Radio Manufacturers

**T**HE most perfect Radio set that can be devised falls short of its purpose unless it reproduces tone with extreme fidelity.

During our long experience in manufacturing amplifying horns, we have produced many models and have continually improved the different types as various sets developed and a more faithful reproduction became so necessary.

## Miller horns to fit your requirements

The trend in horn development has ever been toward the use of the long air column, as the best results are obtainable only by using horns of this character, carefully designed to attain the correct exponential curve.

Such horns, scientifically designed, reproduce both high and low frequencies with an extreme evenness of amplitude, giving a color definition and volume not otherwise obtained.

Our engineers have developed air columns which secure remarkable results and the material we use is particularly adaptable, as the horns are light in weight, unusually durable, can be molded to any practicable shape and are so inert that they meet the requirements of amplifying horns most admirably.

Send us your data, Mr. Manufacturer and let us submit specifications.

The Miller Rubber Co. of N. Y.  
Akron, Ohio, U. S. A.

etc. With the evening, the Poetry Post brought Baroness Posse, famous writer of Sweden, who told of the literary activities of her own country, and shortly afterwards, Kathryn Behnke, the original "Lullaby Lady" sang many thousands of children to sleep with her lullabies.

You should have been with us shortly thereafter when the beautiful reception room and halls of WRNY were crowded with young debutantes and their families. There was the tiny Joseph Gangeline with his accordion, larger than himself, and with him his guardian, Blind Alonzo. Then there was a competition among fine singers, out of whom two were selected for regular appearances on the WRNY roster. Hugo Gernsback, editor of this magazine, delivered his weekly scientific address; Ferrucci's Orchestra played dance music; and the Radio Theatre Players gave an interesting presentation of "At the Pearly Gates."

On Tuesday the women's clubs of New York broadcast, through their presidents, to thousands of club members throughout the country, as well as to the other women listeners.

In the evening, Joan Lowell sang ditties of the sea. She was born on the sea; her mother died while she was a baby, and for fifteen years Miss Lowell never saw a white woman. Her father was captain of a ship which ranged the South Seas. When she came back to America, the stage drew her, and today she is one of the most interesting figures amongst the younger actresses.

Back in the studio, Lazar Samoiloff stood facing his young artists, drawing out of them like a Svengali, although a pleasant one, their best singing. Then came Henry W. Jessup, one of the greatest lawyers in America today, and spoke on the Constitution. His grandfather drew up the platform upon which Abraham Lincoln was nominated for president. June Lee, the Singing Vagabond was heard, and after their performance, the whole cast of "The Bunk of 1926" came to the studio. While one member of the cast was broadcasting in the studio, the others were in the program director's office listening through the loud speaker and enjoying the broadcasting just as you did.

You remember the man who offered to put a wrist watch on the Statue of Liberty? He was here and told us all about it.

We jumped from this to Dr. Siegfried Block's talk on "Mental Hygiene," Mac and Lennie singing original songs, and Alfred McCann's "Food" talk. Richard Hageman, former conductor of the Metropolitan Opera House, appeared with his artists. J. Armour Galloway conducted the Tuxedo Musical Club; thirty beautiful young women singing a program of lovely songs, consisting of oratorio, light opera and grand opera.

The Czecho-Slovak Novelty Orchestra played exactly as they might in Prague. They even came in costume.

Monday evening Catherine Cronin read poetry; and then The Royal Aces Orchestra, Ferrucci's Orchestra, Florence Geringer and Judith Roth all brought popular music. J. Van Cleft Cooper gave another of his musical travelogues; and the Irvine Players presented the second RADIO NEWS prize play, "The Fugitive." Tuesday, again, and Charles A. Vilas spoke on "Law"; Wolfe Kaufman played his musical saw; Katherine McMillan sang and then we enjoyed more of Orlando's Roosevelt Concert Orchestra. Emilio Roxas, Italian musical conductor, with his artists gave a fine program, while Julian Huarte, one of the greatest living Spanish composers, played his own musical compositions and introduced the Mexican Nightingale, Anita Calberone, and Giovanni Gurreri.

Another theatre company comes after the show—"Not Herbert"—and the leading

# FREE

## Radio Catalog



Just off the press. Our second catalog for 1926. 100 pages of parts, accessories, kits and sets—all the best and the latest. A copy is yours for the asking. Just drop us a line—do it today!

CHICAGO SALVAGE STOCK STORE  
Dept. R. N. 509 S. State St., Chicago, U.S.A.

# RADIO INVENTIONS

Protected by U. S. and Foreign Patents,  
MASON, FENWICK & LAWRENCE  
Patent and Trade Mark Lawyers,  
Washington, D. C., New York, Chicago

Established Over Sixty Years  
References: Life Savers, Inc., Port Chester, N. Y.; Stephen P. Whitman & Son, Philadelphia; Pacific Coast Biscuit Co., Seattle, Wash.; Left, Inc., New York City; Sprague Warner & Co., Chicago; The Warren Co., Atlanta, Ga.; K. Baldwin Co., New Orleans, La.; Joseph Burnett Co., Boston.  
Send Description and Sketch.

# Be Popular Play Jazz

It sets them going. Young folks are enamored by those tantalizing tunes. Be the Jazz King with your



## SAXOPHONE

Teach yourself, 3 free lessons give you quick easy start. Try any instrument in your own home 6 days free. See what you can do. Easy terms if you decide to buy. Send now for beautiful free literature. A postal brings details.

Buescher Band Instrument Co. (8)  
1528 Buescher Block Elkhart, Indiana



## Wade Square Law Condenser and Dial

All sizes, complete with 4-inch vernier dial, for:  
Capacity .000125 mfd. .... \$6.00  
Capacity .00025 mfd. .... 6.25  
Capacity .00035 mfd. .... 6.35  
Capacity .0005 mfd. .... 6.50

At your dealers, otherwise send purchase price and you will be supplied postpaid.  
THE VIKING TOOL AND MACHINE CO., Inc.  
747 65th Street, Brooklyn, N. Y.

Immediate Shipment from Stock  
HAVE MERCHANDISE WHEN YOU NEED IT  
Catalog 466'S is free to dealers

WHOLESALE (EXCLUSIVELY)  
LUDWIG HOMMEL & CO  
629 PENN AVENUE PITTSBURGH, PA.

# AMAZING STORIES

## The New Magazine of Scientific Fiction

JUST OUT

(See full page ad, this issue)

**Marvelous Radio Invention Increases Summer Reception 100%**

**Effarsee**  
ANTENNAE  
REG. U. S. TRADE MARK  
PATENT PENDING

Summer no longer means putting your radio away. This new antennae gives you "winter clearness" during hot weather. Increases selectivity, cuts down static. Owners say it's worth \$10. Price only \$4. Write today for testimonials and full information.

Hang it anywhere!  
Greater Selectivity!  
Better Tone!  
Less Static!  
Use Indoors or Outdoors!

FISHWICK RADIO CO.,  
131 Central Parkway West Cincinnati, Ohio



members of the show put on a program that is unforgettable.

The Allied Theatre Interests hurriedly summoned their leaders to a dinner at The Roosevelt to present to Captain George Fried, of the President Roosevelt, the proceeds of the Hippodrome fund benefit. Over \$15,000 was given over to the crew, who, to the last stoker, came to the dinner. Augustus Thomas was toastmaster; Frank Keenan of the Players spoke there, and Thomas Meighan, who is president of the Lambs Club. There was much music. All of this went over WRNY.

Nick Cambourakis, a splendid young violinist, was heard. On this Friday night came an all-Irish program. Think of this—exclusively, through WRNY—William Cosgrave, the President of Ireland, sent his greetings to America. Vice-President Kevin O'Higgins cabled his greetings, as did Lord Glenavy, chairman of the Irish Senate, and the former Lord Mayor O'Neill of Dublin. Cardinal O'Donnell, Archbishop of Armagh and Primate of Ireland, John McCormack and many others were in the group. In person came Howard Harrington of Dunlow Castle, Killarney, and Lindsay Crawford, Irish representative to America.

Saturday night brought a group of little girls and boys under twelve associated with the National Stage Children's Association, many of whom have appeared in the White House before the President. There were tiny tots who had to stand on a chair to reach the microphone.

As a special novelty, we introduced Viola Gentry, daring aviatrix, who flew under the East River bridges.

The Women Lawyers' Association met at the Astor. Hon. James W. Gerard spoke, as did many distinguished lawyers, senators and other prominent men.

One of the most interesting events broadcast was a debate at the Manhattan Opera House. Professor Scott Nearing argued that the United States should recognize Soviet Russia. J. Robert O'Brien took the opposing side. The chairman began a harangue which the WRNY representative decided ought not to go on the air. The microphone was closed and the house was in an uproar. Why did WRNY refuse to broadcast? Congratulations poured in from those who praised the move.

Then there was the night that Gregory Kelly, the Duncan sisters and the cast of "The Butter and Egg Man" came over, and so on all through the thirty days.

I will see you again next month.

### Crystal Detector Receiving Sets

(Continued from page 1631)

be used in connection with any radio receiving set, regardless of its type; and therefore it is most advantageous to have a pair of them at hand at all times.

#### HOOKING UP THE SET

The connections are very simple. Each and every one of them is shown in Fig. 9. The letters A and G and S and S1, on the two coils L and L1, correspond to the letters on Figs. 5 and 7A, and show where the connections should be made. Coil L in Fig. 9 indicates the primary or 10-turn coil, whereas L1 indicates the secondary. After the set is all hooked up (and this is a very simple matter and should only take a few moments) you can connect your aerial and ground and start to listen in.

Turn the variable condenser slowly through its entire range. If no signals are heard, move the contact point over the crystal surface to another position and try again. You will soon find a sensitive point on the surface of your crystal and receive

## Samson Audio Frequency Units

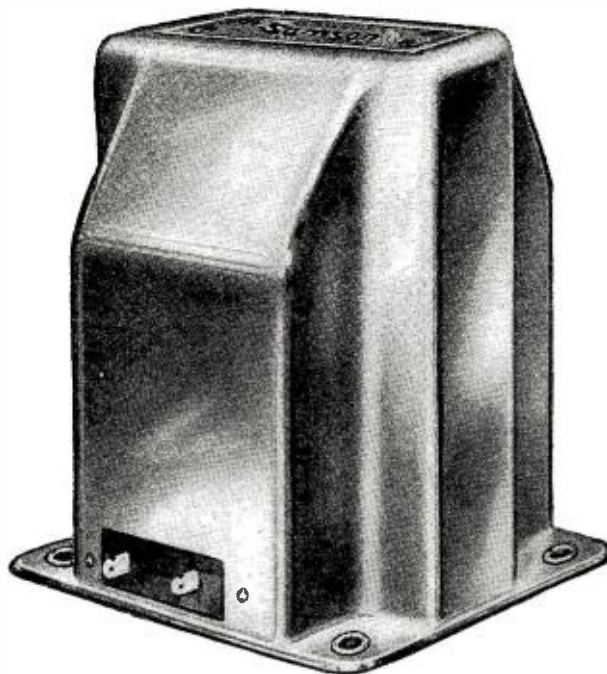

The Samson Electric Company offers five audio frequency units for the 1926 season. They form the most complete line of any manufacturer and are designed for use with the new tubes and tubes that may be announced at a later date.

No falling off in quality of reproduction nor burn-outs due to use with new tubes need be feared.

The astonishingly better tone quality from these units is permanent, unchanged by weather conditions due to hermetic sealing, and will result in their use by a majority of set manufacturers who are not handicapped by price considerations.

Each unit is uniform in appearance, size, and is interchangeable—each in its quality reflects Samson's nearly half century of experience.

Samson Symphonic Transformer, climax of several years' development, gives perfect reproduction of broadcast tones over greater range than average loud speakers can cover or is now broadcast. . . . . \$9.00  
The new Samson HWA3 Transformer, 2:1, 3:1, 6:1. Standard equipment with leading set manufacturers and home construction. Built for service as well as quality of reproduction. . . . . \$5.00

Samson Audio Plate Impedance. A high inductance choke for use with standard or high Mu tubes. . . . . \$4.50

Samson Audio Grid Impedance. forms ideal power amplification combination with Plate Impedance. . . . . \$4.50

Samson Output Impedance, keeps direct current component out of loud speaker. . . . . \$5.00

These parts may be obtained on or about June first from Samson distributors.

Set manufacturers, who believe we may be of assistance in solving their audio problems, are invited to write.

Send for attractive illustrated booklet No. 26 on Audio Frequency circuits.

### SAMSON ELECTRIC COMPANY

Manufacturers since 1882

Sales Offices in 30 Leading Cities  
Member RMS

Main Offices and Factory  
Canton, Mass.



100 AMP. \$10.50 RADIO BATTERY

TWO YEAR GUARANTEE BY THOMAS WITHERBEE

Send No Money

This is an actual 100 amp. Radio Storage Battery honestly built of purest materials by real battery builders. Solid Rubber Compartment Cases—

NO DEPOSIT OR ADVANCE PAYMENT REQUIRED

Simply order—and we will ship by express and you can examine battery at your express office to your heart's content. If you agree with us that it's the biggest offer ever made—pay the expressman \$10.50 plus express charges.

If you prefer to remit with order—deduct 50c.

WE ALSO BUILD AUTO BATTERIES FOR ALL CARS

THOMAS BATTERY CORP., 511 West 50th St., New York, N. Y.

## Why Pay Fancy Prices for Radio Cabinets?

Hardwood and Solid Walnut. Full length piano hinge, lid support, etc. Free base-board. Free Catalogue.

THE SOUTHERN TOY COMPANY, Inc., Dept. N. HICKORY, N. C.



# A TRIP to the CENTER of the EARTH

By JULES VERNE

In his immortal story, "A Trip to the Center of the Earth", Jules Verne has quite outdone himself. Not only was Jules Verne a master of the imaginative type of fiction, but he was a scientist of high calibre. Besides this, his intimate knowledge of geography, the customs and peculiarities of the various races, made it possible for him to write with authority on any of these subjects. So when he takes us to the center of the earth, via the route through Iceland, we get the feeling that, somehow, the story is real, and this, after all, is the test of any good story.

Instead of boring a hole into the bowels of the earth, Jules Verne was probably the first to think of taking the reader to unexplored depths through the orifice of an extinct volcano. No one has as yet explored the very center of the earth, for at no time have we descended deeper than about a mile below the surface of the planet. Who knows, therefore, but that there may be tremendous discoveries ahead of the human race, once we penetrate into the great depths of the globe?

Even life in the interior of the earth is not an impossibility. When our deep sea expeditions come home with specimens of fish that live at the bottom of the ocean, and under what appear to be unendurable pressures, where logic would assume there could be no life. Read Jules Verne's story of "A Trip to the Center of the Earth", in the June issue of AMAZING STORIES, now on all newsstands.



**25c**  
Per Copy

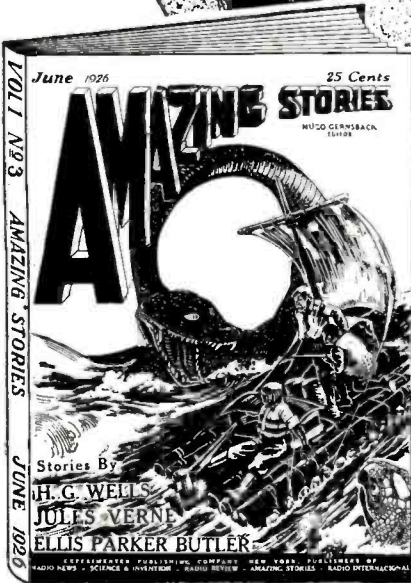

## SCIENTIFICTION

A new kind of Magazine — Scientific Fiction Stories by world-famed writers

YOU CAN BUY A COPY ON ALL NEWSSTANDS  
*But if there is no newsstand nearby, use this coupon*

Marvelous, Amazing Stories by great men such as Jules Verne, H. G. Wells, etc., appear in this new magazine AMAZING STORIES every issue.

Stories of flying into space at dazzling speed on a comet; Mesmerizing the dead, remarkable situations of all kinds. Tremendously interesting—yet instructive.

Keeps you in touch with the writings of the men with the greatest imaginations in the world.

Don't miss a single issue—ask your newsdealer for a copy. Price is 25c. Large size magazine, 8 x 11 inches. Buy one today.

Experimentor Publishing Co., Inc.  
53 Park Place, New York, N. Y.  
Gentlemen: I am enclosing \$2.50 for one year's subscription to "AMAZING STORIES."

Name.....  
Address .....

**Experimentor Publishing Company, Inc.**  
53 Park Place, New York, N. Y.



signals. After a station has been tuned in to its loudest point by means of the condenser, readjust the crystal detector for a more sensitive point and keep this up until the best position is found.

**INCREASING SELECTIVITY**

If you live in a congested district and find trouble tuning out one station when another one is operating, it may be advisable to separate the primary and secondary coils by a space of about half an inch. This can be done with the spider-web type by placing a block of wood half an inch thick between the primary and secondary coils. With the solenoid coil, a longer tube can be employed and the primary winding is merely slipped away from the secondary and then fastened

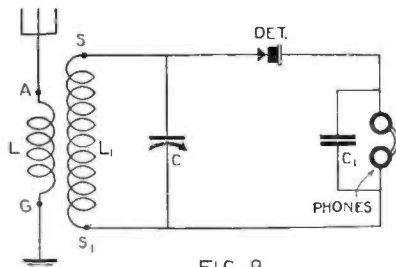

FIG 9

Simple hook-up for a crystal set using home-made coils and apparatus described in this article.

in new holes drilled in the tube. A decrease of coupling in this manner will increase the selectivity of the set and allow you to separate stations better, but it will also detract slightly from the reproduced volume.

Even to the experimenter who is familiar with vacuum-tube receivers, a small crystal detector set will be found of great advantage. It can be used for listening in on the more powerful local stations, and in this way will provide a means of great economy, inasmuch as it consumes nothing when it is operating. It can also be resorted to when tubes blow out or batteries run down, and will be found ready for action at any time when your vacuum-tube receiving set will not work. Therefore, both the beginner and the more advanced fan should be interested in crystal detectors, and should most certainly have a good crystal-detector receiving set on hand at all times.

**I Want to Know**

(Continued from page 1676)

watch for loose or broken connections. Also test the various instruments for open or short circuit; for instance the winding of coils or transformers should test complete. That is, if a "C" battery and head set are connected in series and the two loose ends which result are placed on the terminals of various windings (primaries and secondaries of coils and transformers), a click should be heard in the headphones, otherwise it is an indication of an open circuit. Note carefully the position of the coils used, be sure they are still rigidly fastened to the sub-base panel, as much of the efficiency is due to the position of these coils. A change in the "angle" of the coils will introduce magnetic coupling between each radio frequency stage and therefore cause the set to "oscillate," or "whistle" and "squeal" when tuning in.

**HONEYCOMB COIL DATA**

Q. 2. Can you furnish me with some sort of chart in which is given the various characteristics of honeycomb coils in the sizes that may be purchased. The essential characteristics that I refer to are: each coil's approximate inductance value in millihenries, and the maximum and minimum wave-length that may be covered, when shunted by an ordinary .001- $\mu$ f. variable condenser.

A. 2. The following is the data you desire:  
Approx. Inductance Max & Min.  
in Millihenries W. L. with  
0.001- $\mu$ f.  
Var. Con.

Size			
L— 25	.040	130—	375
L— 35	.075	180—	515
L— 50	.15	240—	730
L— 75	.3	330—	1,030

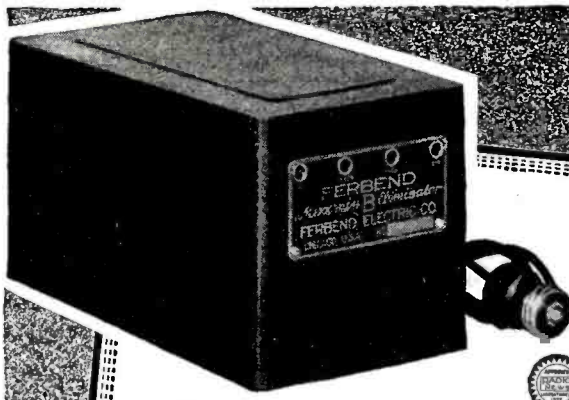

Complete, nothing else to buy.  
Replaces "B" Batteries.  
Operates Direct from Electric Light Socket.  
A. C. Model, \$12.50  
D. C. Model, 9.75

**\$12.50**

**FERBEND "B" ELIMINATOR**

**Superior Results!**

Costs scarcely more than new "B" Batteries. You get results combined with first-cost economy.

Operates at maximum efficiency at all times. Noiseless—no hum. A. C. Model gives FULL WAVE RECTIFICATION. Taps at 22½—45—90 volts. Maximum voltage, 100. (Add "B" Battery for higher voltage.) Cost of operation less than 50c a year. Lasts indefinitely. Manufactured, not assembled. Order yours today.

**Ask Your Dealer or Send Direct**

If you prefer, we will make shipment direct to you upon receipt of price, or C. O. D., if desired. Use for 10 days to convince yourself, and if unsatisfactory, return within that time and your money will be refunded. Use the coupon now.

**FERBEND ELECTRIC CO.**  
425 W. Superior Street  
Chicago, Ill.

**FERBEND Wave Trap**  
This Company also manufactures the famous Ferbend WAVE TRAP—the instrument which has been widely installed but never equalled. It is the only original and genuine. Priced at **\$8.50**

**FERBEND ELECTRIC CO., 425 W. Superior St., Chicago**  
 Send at once. Payment enclosed.  
 Send C. O. D.  Send Literature.  
 Send A. C. Model.  Send D. C. Model.

Name.....  
Address.....  
City.....  
State.....

**What Users Say:**

"Waterloo, Ia. March 5, 1926  
Ferbend Electric Co.  
Gentlemen:  
Your full wave "B" Eliminator certainly is a masterpiece. The reception is better than is possible to maintain with fresh "B" batteries. Volume practically doubled without distortion, clear reception, no crackling noises and greater distance. There is no need of a power tube with additional voltage which they require if one's set is equipped with the Maxim "B" Eliminator.  
(Signed) E. C. Garber"

"91 Pullman Ave. Rochester, N. Y. March 9, 1926  
Ferbend Electric Co.  
Dear Sirs:  
Your Eliminator is wonderful and can't be beat by one costing \$10.00, \$25.00, or even \$35.00 or more. I am more than satisfied because it is absolutely noiseless and brings in the stations much louder and clearer. I will tell all my Radio friends about it. Another satisfied customer.  
(Signed) H. C. Davis"

"Box 366 La Grande, Ore. March 15, 1926  
Ferbend Electric Co.  
Enclosed find draft for \$12.50. Please send me one of your Eliminators. At present I am using the one you sent to W. H. Perry and am very much pleased with it. Kindly rush shipment as I can only have Mr. Perry's for a couple of days while he is out of town.  
(Signed) E. C. Tuckey"

**CRUWALD ANT-TERRA**

THE SUPER-GROUND FOR RADIO RECEIVERS

A ground shielded within itself. Reduces static and power noises and is the ONLY successful system of grounding for short wave reception. Can be installed in 10 minutes. Carried by local jobbers and all reliable dealers.

PRICE \$6.50

Mailed prepaid on receipt of M. O.

Jobbers and Distributors Wanted.  
National Distributors

**B. KRUGER & CO.**

500 N. HUNTLEY DRIVE SHERMAN, CALIF.

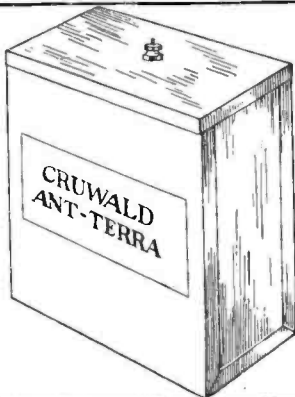



# It's Easy to Build a Powerful Set

Using the New and Improved FRESHMAN "TRF" Low Loss Kit



**Straight Line Wave Length Condensers With Low Loss Self Balanced Coils . . .**

These are the identical units which have made the FRESHMAN MASTERPIECE factory built Receivers the World's Greatest Radio Sets.

**\$9.50**

Complete instructions for building this powerful five tube receiver, written in plain everyday English, together with actual size schematic wiring diagram, are furnished with every FRESHMAN "TRF" Kit.

Sold by Authorized Freshman Dealers Only!

**CHAS. FRESHMAN CO., Inc.**  
Freshman Building, New York  
2626 W. Washington Blvd., Chicago



Tones clearer, voices more distinct, and volume greater with—AMPERITE. No moving parts. It brings the utmost out of each individual tube. Specified in all popular construction sets. Price \$1.10.

*Radiall Company*

Dept. R. N.-6 50 Franklin Street, New York City



Write for FREE Hook-ups

The "SELF-ADJUSTING" Rheostat

Insure your copy reaching you each month. Subscribe to RADIO NEWS—\$2.50 a year. Experimenter Publishing Co., 53 Park Pl., N.Y.C.

Size	Millihenries	Wave-Lengths
L-100	.6	450—1,460
L-150	1.3	660—2,200
L-200	2.3	930—2,850
L-250	4.5	1,300—4,000
L-300	6.5	1,550—4,800
L-400	11.	2,050—6,300
L-500	20.	3,000—8,500
L-600	40.	4,000—12,000
L-750	65.	5,000—15,000
L-1,000	100.	6,200—19,000
L-1,250	125.	7,000—21,000
L-1,500	175.	8,200—25,000

## New Developments in Radio Apparatus

(Continued from page 1648)

tral arm which travels around the plate. This arm short-circuits some of the resistance, which is relatively high, and thereby causes an increase in volume. The tips of the phone cords are inserted in the end of the plug in the customary fashion.

Although this accessory may seem relatively unimportant, those fans who have

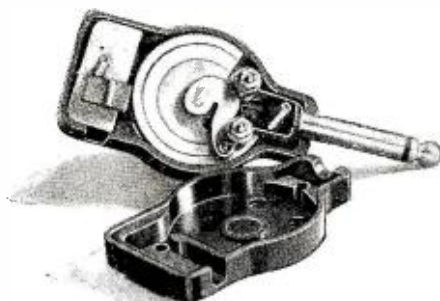

This shows the interior of the phone plug which will vary the volume. The rheostat, has a high resistance.

Courtesy of Central Radio Laboratories.

done much experimenting with different loud speakers and who are very particular about the quality of reception, will agree that a thing of this nature is a handy adjunct to have about the radio receiver. The quality of the reception can, many times, be vastly improved by the addition of a little more resistance in the loud speaker circuit, and here is an easy way to do it.

## Everyman's Receiver The Fenway

(Continued from page 1657)

"hooked-up" a good ground on that first coil condenser?

"After making these tests, break the circuit between the coil and the socket and connect a grid condenser and leak between these two points. Connect a pair of phones to the

Station  
**WRNY**  
NEW YORK

258.5 Meters - 1160 kilocycles  
is owned and operated by the  
publishers of this magazine  
Our Editors will talk to you  
several times every week—  
See your Newspaper  
for details

**TUNE IN ON  
WRNY**

**National Velvet Verner**  
DIALS and CONDENSERS

YOU control the reduction ratio with this new NATIONAL, Type B, Velvet Verner Dial. You'll be astonished at the difference in the tuning of your set. Price \$2.50. Write for Bulletin 109-RV.

NATIONAL COMPANY, Inc.  
W. A. Reedy, President  
110 Brookline St., Cambridge, Mass.

## From Amateur to Commercial Operator

Allen T. Powley, 22 years old, is Chief Radio Operator on the big cable ship "All America". A High School boy from Kingston, N. Y., he graduated from the "Y" Institute and now has this pleasant and profitable job.

Radio offers the same opportunities to you. Learn Radio at home in spare time or at our big School in New York City. Courses for Radio Operators, Mechanics, Broadcasting, Dealers, etc.

Write now for FREE Booklet, "Opportunities in Radio"  
**Y. M. C. A. RADIO INSTITUTE**  
158 East 86th St. New York City

## GOOD SOCKETS ARE IMPORTANT!

One experience will change the belief that it is economy to use inferior sockets. For best results you can do no better than choose B-T Sockets. They take both the old and new base tubes without an adapter.

Price type UL Socket 75c ea.  
Silent Socket (for Detector) \$1.25 ea.

The B-T PUSH TYPE Socket for those who want a less expensive socket. The compact size and sound design will appeal to many.

SEND FOR FREE CIRCULARS ON ALL B-T PARTS  
**BREMER-TULLY MFG. CO.,**  
532 So. Canal Street Chicago, Ill.

# PATENTS

If you have an invention and desire to secure a patent, send for our Evidence of Invention Blank and free guide book, "HOW TO GET YOUR PATENT." Tells our Terms, Methods, etc. Send model or sketch and description of your invention for INSPECTION and INSTRUCTIONS.

No Charge for the Above Information

**RANDOLPH & CO., Dept. 459 Washington, D. C.**

**PATENTS**

**DON'T LOSE YOUR RIGHTS**  
Before disclosing your invention to anyone send for free blank form "EVIDENCE OF CONCEPTION" to be signed and witnessed.

**LANCASTER & ALLWINE**  
Reg. Pat. Attys. in U. S. and Canada  
270 Ouray Bldg., Washington, D. C.  
Originators of the form "Evidence of Conception"

**PATENTS**

**C. L. PARKER**  
Formerly Member  
Examining Corps,  
U. S. Patent Office.  
PATENT - LAWYER  
McGill Bldg., Wash., D. C.

Patents, Trade Marks, Copyrights, Patent Litigation  
Handbook for Inventors, "Protecting, Exploiting and Selling Inventions," sent upon request.



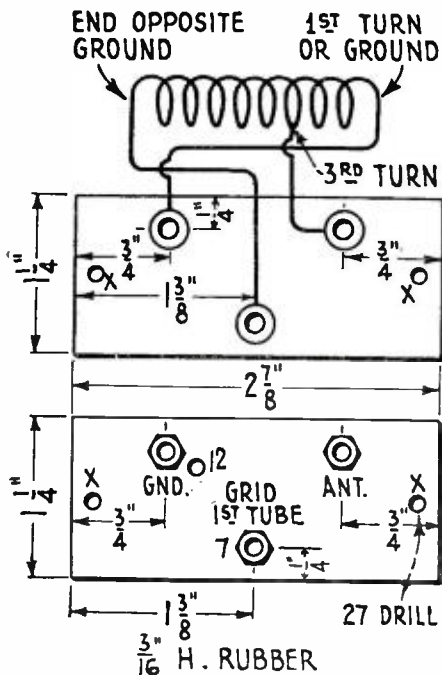

The working drawing for the construction of the antenna coil and its holder and sockets. This is coil L in the diagram on page 1656.

plate of this same socket and to the B battery +45 volts. If that first circuit is working you will be able to hear a local station. Now take the second circuit, and test it the same way. Next, the two circuits combined. Now test the oscillator as you have already tested the first two circuits. Forget that it is an oscillator circuit. Treat it as if it was the first can—the antenna circuit. Here's how you do it: Plug one tip of the phone cord under the plate binding post of the oscillator tube socket, connect 45 volts of B to the other; connect the antenna to the

**LIST OF PARTS FOR FOUNDATION UNIT**

- 1 Antenna coil (for waves from 35 to 550 meters) L, L<sub>2</sub>.
- 1 R.F. coupler (details page 1657)
- 1 Oscillator coupler (L3-L4-L5)
- 2 Mounting bases for couplers
- 3 Variable condensers, S.-L.-W., .00035- $\mu$ f (C1, C2, C3)
- 1 Panel, 8x28x3/16 inches
- 1 Rheostat, 6-ohm
- 3 Vacuum tubes, 201A type, and sockets
- 3 Vernier dials
- 1 Filament switch
- 1 D. C. Jack
- 1 Grid condenser, .00025- $\mu$ f., and grid leak, 2-megohm
- 1 Fixed condenser, 0.5- $\mu$ f.
- 1 Sub-panel, 4x12 inches
- 1 Piece insulating material, 2 1/2 x 2 1/2 x 3/16 inches
- 1 Tap switch and 3 taps
- 1 Safety fuse and mounting
- 1 Milliammeter, 0-50
- 1 Voltmeter, 0-8-80-160 (special type)
- 8 Binding posts (A, G, -A, +A, -B, +B Det., two + B Amp.)
- 1 Baseboard, 9 1/2 x 27 1/2 x 1/2 inches
- 4 Copper cans (3 are 5x6x6 1/2; 1 is 4x4x4)
- 50 feet No. 14 or 15 rubber-covered flexible wire
- 1/4 pound No. 32 copper wire, D.S.C. or D.C.C.

The material for the complete Fenway receiver, which will be listed in Part II, is estimated at \$133.



**Jobbers and Dealers**

Year after year there has been a tremendous increase in radio sales. 1926 will be the biggest year, by far. You want your share and we can help you get it.

The country has been flooded with "OFF" radio sets. The public is sick of it. They want merchandise. They want precision instruments that give positive reception—not just a good looking, non-functioning radio.

CASE RADIO APPARATUS has made good. It is one of the few merchandising successes—WHY?—because it is built right and priced right.

Case Radio will compare with any on the market for looks,—AND "beneath the hood" there is an electrical instrument, designed, engineered and re-engineered. We have exactly what the public demands,—Further,—we have a complete line, not one set but fourteen sets. Let them choose and lower your sales resistance.

Ask anyone that has sold Case Radio and they will tell you that it is in a class by itself. Good franchises still open.

**INDIANA MFG. & ELECTRIC CO.**

600 CASE BLOCK

**PERTINENT FACTS**

1. Five, six and eight tube models, all radio frequency.
2. Outdoor, indoor and loop antennas, with and without ground.
3. Batteries and no batteries.
4. Sold exclusively through recognized jobbers and dealers.

**5 TUBE RADIO SET FREE** for a name for our House Organ, which we accept. Open to everyone except persons living in Marion or connected with organization.



**Make Your Own Cone Loud Speaker and Save \$25<sup>00</sup>** (All Parts Supplied)



Why pay \$35 or more for a cone loud speaker when you can easily assemble a splendid super-sensitive one at home with the complete parts we send you—and save \$25?

We include a special complete cone unit, blue print, and simplified directions for assembling. You can easily set it up in a few interesting hours. Large size, 18 inches high, complete in every detail. Unmatched for beauty; reproduces with faultless accuracy. Yet cost is amazingly low—only \$10. You make this saving because we save the cost of assembling and packing and you save all dealers' profits.

**FREE TRIAL**

Write for complete details of this remarkable speaker and for our amazing 10-day Free trial offer and money-back guarantee. Act at once—write now.

SCIENTIFIC RADIO LABORATORIES, 254 West 34th Street, Dept. 46, New York City.

**LEARN Electricity** Great Shops of Coyne. Complete in 3 months. Massive electrical equipment. **Free Railroad Fare** Enter anytime. Special limited offer. Auto and Radio Courses FREE. Send for Big Free Catalog. Act now. Coyne Electrical School—Dept. A-594 1300-1310 W. Harrison Street, Chicago, Illinois

**BAKELITE KNOBS**

permanently hold their color and finish. Write for Booklet 24 **BAKELITE CORPORATION** 247 Park Avenue, New York, N. Y. Chicago Office: 636 West 22nd St. **BAKELITE CORPORATION OF CANADA, Ltd.,** 163 Dufferin St., Toronto, Ontario, Canada

**64 Illustrated Pages of Radio Bargains!** Write for Catalog Today **RANDOLPH RADIO CORP.** 159 N. UNION AV. Dept. 2 CHICAGO, ILL.

**RADIO PANELS OF GENUINE BAKELITE**

Cut, drilled and engraved to order. Send rough sketch for estimate. Our New Catalog on Panels, Tubes and Rods—all of genuine Bakelite—mailed on request. **STARRETT MFG. CO.** 520 S. GREEN ST. CHICAGO



# Two WONDER Books for Everyone

You can build hundreds of useful things at home

buy a copy of

FRESH FROM THE PRESS

## "HOW TO MAKE IT"

300 Illustrations

**Partial List of Contents**

- How To Make**  
 Furniture  
 Electric Motor  
 Tool Set  
 Radio Cabinets  
 Wind Power Saw  
 Ice Boats  
 Motor Speedster  
 Movie Camera  
 Phonograph  
 Toy Electric Railway  
 Drill and Lathe  
 Battery Charger  
 Cider Mill  
 Uses for old Pipes  
 Etc., Etc.

Building your own home furniture, cameras, radio cabinets, sport devices, etc., is easy if you know what materials you need, and have an illustrated explanation on how to proceed. Then too, you can save a good deal of money by making these valuable things yourself.

"How to make it" a big book compiled from the great magazine "Science and Invention," is full to the brim with hundreds of up-to-date things to make at home. Things that can be made by any man with only a few simple tools.

Every home in the United States should have one of these books handy—worth its weight in gold. Buy your copy today. Price 50c. Sold everywhere—or if you cannot obtain one nearby, send in the coupon on this page enclosing full price.

SOLD ON ALL NEWSSTANDS

**EXPERIMENTER PUBLISHING CO., Inc.**  
 53 Park Place  
 New York, N. Y.

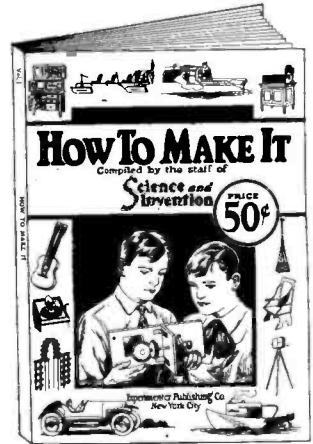

**PRICE 50c**

116 PAGES, 300 ILLUSTRATIONS. LARGE SIZE, 9 x 12 INCHES.

## Surprise Your Friends—Master Mystery!

Read

## POPULAR MAGIC

300 Illustrations

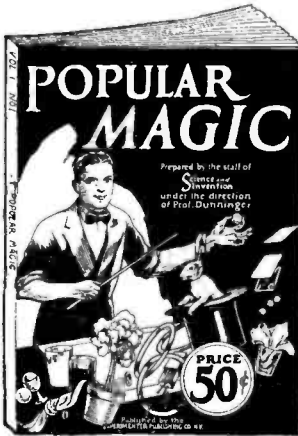

**PRICE 50c**

116 PAGES, 300 ILLUSTRATIONS. LARGE SIZE, 9 x 12 INCHES

Popular Magic contains  
 116 pages, large size, 9x12 inches.  
 300 Illustrations  
 Compiled by the Staff of  
**SCIENCE & INVENTION**

under the direction of  
**PROF. DUNNINGER**  
 the man who mystified the Prince of Wales, ex-Presidents **Harding, Taft, Roosevelt, President Coolidge** and other celebrities.  
 Contains card tricks, dice tricks, match tricks, a m a t e u r t r i c k s, chemical tricks, lyceum tricks, stage tricks, popular magic, spirit tricks.

Be the popular man in your circle of friends. You can entertain them and hold their attention with a thousand surprises and novelties.

POPULAR MAGIC is a book for you, for everybody, young or old. But especially for those who want popularity, those who want to realize how much the admiration of friends helps toward making life worth more.

POPULAR MAGIC contains thousands of simple, entertaining parlor tricks, as many puzzeling magical stunts and a whole book full of mystic spirit novelties. A new set of tricks for every day of the year. Compiled from the great magazine "Science and Invention."

**GET THIS GREAT BOOK TODAY.** Chock full of Tricks, Novelties, Mystic performances, Master sleights-of-hand, Gags, Disappearing acts. All kinds of fun. Buy a copy or order direct. PRICE, 50c.

SOLD ON ALL NEWSSTANDS

**EXPERIMENTER PUBLISHING COMPANY, Inc.**  
 53 Park Place  
 New York, N. Y.

EXPERIMENTER PUBLISHING CO., Inc.  
 53 Park Place, New York, N. Y.

Gentlemen: Enclosed find \$..... for one copy of  HOW TO MAKE IT.  POPULAR MAGIC.

Name .....

Address .....

City and State .....

Check magazine desired and enclose full price.



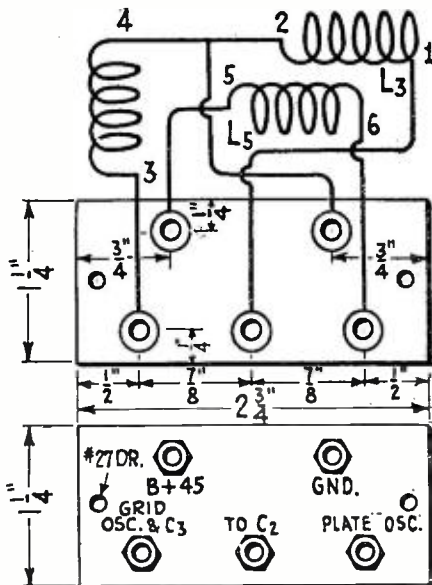

This sketch illustrates the mounting of the oscillator coil, L3, L4 and L5 in the diagram on page 1656.

fixed plates of the oscillator condenser and the ground to the can. (Of course you must put a grid leak and condenser in series between the grid of the socket and the coil.) Forget the plate winding on the oscillator coil. Just imagine it isn't there. The oscillator now becomes an aerial circuit, and as such should enable you to hear broadcast programs, as before."

"What I like about the first act of this drama," you can't help thinking, "is that, although the laboratory model must use certain makes of parts, the use of these parts

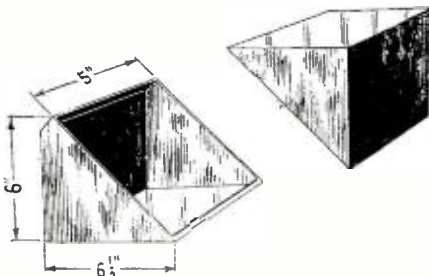

This diagram shows the type (can) and size of the copper shields used to isolate the different parts of the Fenway super-heterodyne.

is not entirely essential to the success of the set. The antenna and oscillator coils can be constructed at home, and all types of condensers of consistently high quality may be expected to approximate the results obtained by the laboratory model. So, as I consider this statement" you hear yourself saying, "I should commence work at once. Like most every radio enthusiast, I have enough spare parts on hand to form a foundation for the Fenway. I guess I'll build it now and own the outstanding—but, there goes the curtain on the second act!"

(To be concluded in July RADIO NEWS)

### A New Method of Amplifier Coupling

(Continued from page 1650)

The curve of resistance coupling, with the grid leak of one megohm, shows in a very interesting manner the low efficiency of the system on weak signals and the attainment of saturation at a very low input. With resistance coupling, if a large output is desired it is necessary to use a grid leak of low resistance. The effect of this is shown in the same figure on the curve for a grid leak of 0.1 megohm—a lower efficiency on weak signals but saturation at a higher value.



### 12-Cell-24-Volt Storage "B" Battery

Positively given Free with each purchase of a WORLD "A" Storage Battery. You must send this ad with your order. World Storage "B" Batteries give you economy and performance unheard of before. They deliver unflinching power that is clear, pure and quiet. Tested and Approved by Leading Authorities.

### Radio Station W S B C

Set your Radio Dials at 210 meters for the 1000-watt World Storage Battery Station, WSBC, Chicago. On the air nightly, between 6:30 P.M. and 8:30 P.M. and 10:00 P.M. and 1:00 A.M., with intensely interesting programs for your approval and enjoyment.

# You save 50%

Approved!

Listed as Standard by Leading Authorities including Radio News Laboratories, Popular Science Institute of Standards, Popular Radio Laboratories, Radio Broadcast Laboratories, Radio in the Home and Leisure.



WORLD "A" Batteries are famous for their guaranteed quality and service. Backed by years of successful manufacture—thousands of satisfied users. Built of finest materials possible to obtain from raw material producers of national reputation. Equipped with solid rubber one-piece containers, an insurance against acid, leakage and breakage. You save fifty per cent and get a

### 2-Yr. Guarantee Bond in Writing

with each Radio "A" and Auto Battery. WORLD Battery owners "tell their friends." That's our best proof of performance and is chiefly responsible for the tremendous growth of the Company. Compare these prices—then send your order in TODAY.

#### Solid Rubber Case Radio Batteries

6-Volt, 100-Amperes . \$11.25  
6-Volt, 120-Amperes . 13.25  
6-Volt, 140-Amperes . 14.00

#### Solid Rubber Case Auto Batteries

6-Volt, 11-Plate . . . \$11.25  
6-Volt, 13-Plate . . . 13.25  
12-Volt, 7-Plate . . . 16.00

### SEND NO MONEY!

Just state battery wanted and we will ship day order is received, by Express, C. O. D., subject to your examination, on arrival. FREE "B" Battery is included.

**EXTRA OFFER**—Five per cent discount for cash in full with order. Buy NOW and get a guaranteed battery at fifty per cent saving to you.

**WORLD BATTERY COMPANY**  
1219 S. Wabash Ave., Dept. 10, Chicago

## World Batteries for Radio

## LEARN THE CODE AT HOME

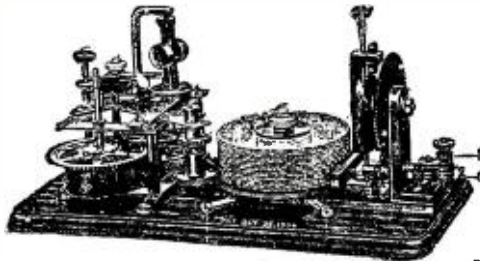

### WITH THE OMNIGRAPH

THE OMNIGRAPH Automatic Transmitter will teach you both the Wireless and Morse Codes—right in your own home—quickly, easily and inexpensively. Connected with Buzzer, Buzzer and Phone or to Sounder, it will send you unlimited messages, at any speed, from 5 to 50 words a minute.

THE OMNIGRAPH is not an experiment. For more than 15 years, it has been sold all over the world with a money back guarantee. The OMNIGRAPH is used by several Depts. of the U.S. Govt.—in fact, the Dept. of Commerce uses the OMNIGRAPH to test all applicants applying for a Radio License. The OMNIGRAPH has been successfully adopted by the leading Universities, Colleges and Radio Schools.

Send for FREE Catalog. DO IT TODAY!  
**THE OMNIGRAPH MFG. CO., 15 HUDSON STREET, NEW YORK CITY**  
If you own a Radio Phone set and don't know the code—you are missing most of the fun



### "Lighting Fixtures"

READY TO HANG  
(Direct from Manufacturer)  
Completely wired including glassware  
Send for new Catalogue No. 27  
(Just reduced prices)  
Special Proposition to Dealers  
**ERIE FIXTURE SUPPLY CO.**  
STATION R ERIE, PA.

## ATWATER KENT RADIO

FOR REAL SATISFACTION AND PERFORMANCE

### Sylvania Tubes

SYLVANIA PRODUCTS CO. EMPORIUM, PA.

## HEATH CONDENSERS

For Real Radio Reception

Write for Literature  
**HEATH RADIO & ELECTRIC MFG. CO.,**  
206 First St., Newark, N. J.

Insure your copy reaching you each month. Subscribe to Radio News—  
\$2.50 a year. Experimenter Publishing Co., 53 Park Place, N. Y. C.



**AT LAST! A Practical "B" Supply**



**The New Anderson "B" Unit**

**Works on either AC or DC**

You can now have plenty of current for any set without the cost or annoyance of replacing batteries.

The Anderson "B" Unit requires no tubes or replacements. It is a full wave rectifier and has no distortion.

Costs less than a year's supply of "B" batteries.

**Price \$21.50**

Order direct on money back guarantee. Sent post-paid for \$21.50 or C.O.D. plus postage.

Manufactured & Guaranteed by  
**T. T. RADIO CO.**  
1931 Broadway, New York, N. Y.

**\$75 A WEEK BUILDING RADIO SETS**  
*In Your Spare Time*



Join the Radio Association of America. Learn how to build and repair sets. The Association will train you—start you out in business, if you wish. Be the radio "doctor" of your community. \$3 an hour upwards easily made.

**EARN \$500 IN SPARE HOURS**

"I have at last found myself," writes Lyle Follick, Lansing, Mich. "I have already made over \$500." Werner Eichler, Rochester, N. Y., writes, "I have made over \$50 a week in my spare time." Our members are starting radio stores, increasing their salaries, securing better positions, passing radio operator examinations, earning big money in spare time.

**JOIN ASSOCIATION NOW!**

Are you interested in Radio for pleasure or profit? Join now because we have a Special Plan whereby your membership need not cost you a cent. Only limited number of these memberships acceptable. Write now for details—before it is too late.

**Mail This Coupon**

Radio Association of America,  
Dept. 156, 4513 Ravenswood Ave., Chicago  
Send me details of your Special Radio Association Membership Plan.  
Name \_\_\_\_\_  
Address \_\_\_\_\_  
City \_\_\_\_\_ State \_\_\_\_\_

**Buy Now Pay Later** You Radio Men Need This Lathe

Do your turning, drilling, threading, sawing, sanding, grinding and jig sawing on the

**BOICE-CRANE UTILITY LATHE**

Swings 8". Capacity 20" between centers. With attachments—a complete shop in itself. Send for catalog on Boice-Crane lathes, circular saws, band saws, jointers and the Boice E-Z Pay Plan



**W. B. & J. E. BOICE,**  
Dent. 806-B,  
TOLEDO, OHIO

From the curves of Fig. 1 it is obvious that the transformer is an efficient coupling device for weak signals but incapable of handling signals of great volume. Resistance coupling is inefficient and will handle still less volume than transformer coupling. And that, furthermore the new system of coupling is more efficient for signals of all intensities than resistances and yet is capable of handling a greater volume than the transformer.

**COMPARISON OF SEVERAL STAGES**

In Fig. 2 curves are shown, taken under similar conditions to those of Fig. 1 and the results given in arbitrary units, for the performance of two and three stages of this new system of amplifier coupling compared with two stages of transformer coupling and three stages of resistance coupling. The results indicated are too obvious to require a lengthy description. There are a few points, however, which should be mentioned. In the first place the two stages of the new system show considerably less efficiency than two stages of transformer coupling for signals of weak intensity; but as the intensity increases the new system equals transformer coupling and finally exceeds it, because the two stages of transformer coupling have become nearly saturated at a relatively low intensity.

The three stages of the new system show a very high efficiency for all signal intensities compared to two stages of transformer coupling. The curve for three stages of resistance coupling shows the usual characteristic of this system; that is, the attainment of saturation at relatively low input and even a falling off of the output as the input increases beyond the saturation point. It might be stated here that, on these curves for resistance coupling, above the point where saturation takes place the quality of reproduction is ruined, and the signal quality almost is totally destroyed when the input increases that point.

**QUALITY WITH EFFICIENCY**

The advantages of the new system may be summarized as follows: A very high quality of reproduction on signals of all intensities, with an efficiency per stage equalled only by a transformer on signals of low intensity, and equalled by no other system on signals of greater intensity. On account of the lack of regeneration between stages with the new system it may be used, and will in fact give the best performance, with three stages; under this condition it will exceed in efficiency the operation of two stages of transformer on signals of all intensities and will handle a signal volume considerably in excess of any other system. Furthermore, it may be arranged in a compact manner, is not readily affected by stray fields and may be connected into an ordinary circuit without the slightest difficulty.

**Radio Reception by Ground Alone**

*(Continued from page 1625)*

of the country which acknowledged the reception of these signals, thus verifying the efficiency of the underground system of propagating radio waves. Signals, transmitted underground from the Rogers Radio Research Laboratory, were received as far distant as Toulon, France. And, as a final word with respect to underground reception on a wavelength of 40 meters, Doctor Rogers goes on record as saying: "With a more suitable ground, the prediction of Mr. Gernsback will be fully realized; namely, that by using the ground alone, without any space propagation, communication may be established between any points on the globe."

**PATENTS**

To the Man with an Idea

I offer a comprehensive, experienced, efficient service for his prompt, legal protection and the development of his proposition. Send sketch, or model and description, for advice as to cost, search through prior United States patents, etc. Preliminary advice gladly furnished without charge. My experience and familiarity with various arts frequently enable me to accurately advise clients as to probable patentability before they go to any expense.

Booklet of valuable information and form for properly disclosing your idea free on request. Write today.

**RICHARD B. OWEN**  
PATENT LAWYER  
2 Owen Building, Washington, D. C.  
41A Park Row, New York City

**AVOID burnt-out TUBES**

and also get better reception



**Riga-BIRNBACH**

heavy A battery wires with soldered terminals to prevent loose battery connections

**A&B BATTERY CABLE \$1.00**

"It's a Real Good Cable"

SALES BY ALL RELIABLE DEALERS AND LEADING DEPT. STORES

**BIRNBACH RADIO CO. 370 SEVENTH AVE. NEW YORK CITY**

**AMBASSADOR**



SEND FOR FREE 4 PAGE FOLDER AND HOOK UPS

**TRANSFORMERS HAVE LOW RATIO FOR LOCALS; HIGH FOR DX.**

**AMBASSADOR SALES CO. 108 Greenwich St. N.Y.**

**READ "AMAZING STORIES"**

THE GREAT MAGAZINE OF SCIENTIFUNCTION

Price 25c  
SOLD EVERYWHERE

See Full Page Advertisement in this issue.



**AMAZING STORIES** JUNE, 1926

In This Issue:  
**"DOCTOR HACKENSAW'S SECRETS,"** by Clement Fezandit, unpublished story of the great and illustrious Dr. Hackensaw.

**"THE RUNAWAY SKYSCRAPER,"** by Murray Leinster, a story of the Fourth Dimension, in which the great Metropolitan Life skyscraper in New York vanishes into the Fourth Dimension. One of the most surprising tales we have ever read.

**"THE SCIENTIFIC ADVENTURES OF MR. FOSDICK,"** by Jack Morgan. Perhaps you did not know it, but there can be excellent humor in scientific. One of the most excruciatingly funny stories, which at the same time is an excellent piece of scientific fiction, is entitled "Mr. Fosdick Invents the Seidlitzmobile."

**"A TRIP TO THE CENTER OF THE EARTH,"** by Jules Verne. (second installment), wherein our heroes have now penetrated to subterranean depths and find a tremendous number of surprises.

**"WHISPERING ETHER,"** by Charles S. Wolfe, a radio story that holds your interest and injects quite a few new thoughts into a well-known subject. One of the greatest short stories we have seen.

Another weird story by Edgar Allan Poe, which we are sure you will like. Be sure to get your copy today. The magazine is edited by Hugo Gernsback.

PRICE 25c PER COPY  
 AT ALL NEWSSTANDS

**How Transformer Constants Are Measured**  
 (Continued from page 1665)

keep the alternating component at nearly the same value during a series of measurements.

Furthermore, in order to use a very sensitive current indicator, it is necessary to reduce the space current in T or to shunt the instrument. Another way in which to accomplish this is to use a Wheatstone's bridge\*\* in the output of T, in which the constant component is balanced out in the bridge adjustment, permitting the galvanometer to be actuated by the rectified alternating component.

All of these methods are open to serious objections, with the exception, perhaps, of the last; the main objection to this is that high non-inductive resistances are required in the bridge, which are not always available when needed.

**MODIFICATION SUCCESSFULLY USED**

In the present work, the arrangement shown in Fig. 3 proved highly satisfactory. T is operated on the straight portion of its characteristic. The two components of the plate current are separated in the transformer, the alternating component being rectified in the secondary by means of a crystal detector. A high resistance is placed in series with the galvanometer to bring the current into the required range.

With the addition of the switch D (Fig. 1) and its associated connections, the arrangement can be used to measure the remaining constants of the transformer. It may obviously be used also to measure the impedance and resistance of telephone receivers, loud speaker units, choke coils, etc.

The simple connections are shown in Fig. 2A and the corresponding vector diagram in Fig. 2B, the solution of which gives

$$\cos \beta = \frac{V_2^2 + V_3^2 - V_1^2}{2V_2V_3}$$

where  $\cos \beta$  is the power factor.

Also, if  $I_1$  represents the current through the transformer primary

$$I_1 = \frac{V_2}{r}$$

whence, the transformer primary impedance is:

\*\* Loc. cit.



The  
**Donle-Bristol  
 Type B-6**

*"The only tube of its kind in the world"*

Send for Descriptive Literature

Manufactured and Sold by

**The Donle-Bristol Corporation**  
 Meriden, Connecticut

**How Transformer Constants Are Measured**  
 (Continued from page 1665)

keep the alternating component at nearly the same value during a series of measurements.

Furthermore, in order to use a very sensitive current indicator, it is necessary to reduce the space current in T or to shunt the instrument. Another way in which to accomplish this is to use a Wheatstone's bridge\*\* in the output of T, in which the constant component is balanced out in the bridge adjustment, permitting the galvanometer to be actuated by the rectified alternating component.

All of these methods are open to serious objections, with the exception, perhaps, of the last; the main objection to this is that high non-inductive resistances are required in the bridge, which are not always available when needed.

**MODIFICATION SUCCESSFULLY USED**

In the present work, the arrangement shown in Fig. 3 proved highly satisfactory. T is operated on the straight portion of its characteristic. The two components of the plate current are separated in the transformer, the alternating component being rectified in the secondary by means of a crystal detector. A high resistance is placed in series with the galvanometer to bring the current into the required range.

With the addition of the switch D (Fig. 1) and its associated connections, the arrangement can be used to measure the remaining constants of the transformer. It may obviously be used also to measure the impedance and resistance of telephone receivers, loud speaker units, choke coils, etc.

The simple connections are shown in Fig. 2A and the corresponding vector diagram in Fig. 2B, the solution of which gives

$$\cos \beta = \frac{V_2^2 + V_3^2 - V_1^2}{2V_2V_3}$$

where  $\cos \beta$  is the power factor.

Also, if  $I_1$  represents the current through the transformer primary

$$I_1 = \frac{V_2}{r}$$

whence, the transformer primary impedance is:

\*\* Loc. cit.

Tested and approved by M. I. T., Yale, Radio News, Popular Radio and Popular Science.

Used by over 200 of America's leading set manufacturers.

# AEROVOX

By-Pass and Filter Condensers  
 "Built Better"

**AEROVOX WIRELESS CORPORATION**  
 489, 491, 493 Broome Street  
 BRANCH OFFICES: Chicago, Ill., 53 W. Jackson Blvd.      Boston, Mass., 104 Portland St.  
 Cincinnati, Ohio, 304 Palace Theatre Bldg.      Los Angeles, Cal., 324 N. San Pedro St.

*Special Library of Information*  
 on  
**RADIO PATENTS**  
 and  
**TRADE MARKS**

**JOHN B. BRADY**  
*Patent Lawyer*  
 Ouray Building      Washington, D. C.

Cable address:      Telephone:  
 RADIOPAT      Main 4806

**No More Guessing—**  
 With this ideal tuning combination  
**MRC—STATION LOG AND WAVE LENGTH  
 FINDER**

With this new chart you can easily tune your set to exactly the wave-length of the station you want to hear. Greatly simplifying tuning. Can be placed either above or below any dial not over 4 inches in size. Very simple to attach; no tools needed.  
**MADE OF HIGH GRADE BRISTOL BOARD**  
 Sent Postpaid 25c each or 3 for 50c—Stamps not accepted  
**MUELLER RADIO CO., 533 Bush St., Toledo, Ohio**

Insure your copy reaching you each month. Subscribe to Radio News—\$2.50 a year  
 Experimenter Publishing Co., 53 Park Place, N. Y. C.



# 60,000 Newsdealers are now selling the big new

# JUNE ISSUE

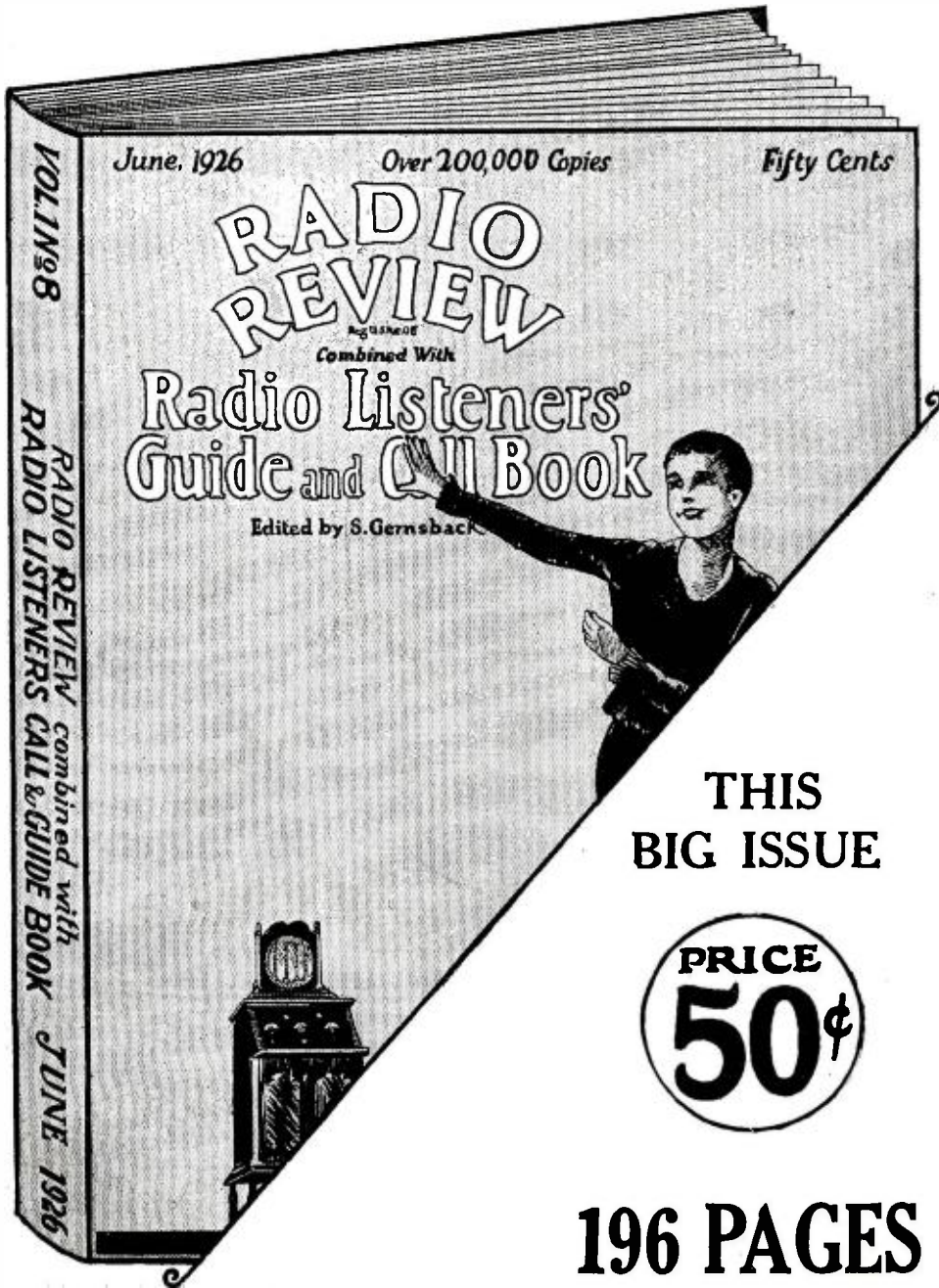

**JUST OFF THE PRESS—  
Fresh and New—Containing**

The finest and most up-to-date list of Broadcast stations obtainable—listed by Call Letters, Wave Length and cities, together with the broadcast schedule of each station for every day of the week. The book also lists all Canadian and Foreign Broadcast stations.

The second part of the magazine is devoted to articles of interest to the Radio Set Owner, giving him information on all subjects he ought to know, to better understand the operation of his Radio Set.

The third part contains a great number of constructional articles to delight the fancy of the hookup fan on many modern receivers.

The fourth part contains a new supplement of S. Gernsback's Radio Encyclopedia, profusely illustrated and complete in every respect.

In all a tremendously valuable book to have on hand by every user of a radio receiver. The *Call Book* for ready reference to stations received. The *constructional articles* for data on your new set. The *Encyclopedia* for an intimate and authentic knowledge of Radio and the *Listeners information* for first hand knowledge on how to care for your set and operate it properly.

This big June issue is now sold everywhere by 60,000 newsdealers and radio dealers. *Buy a copy NOW.*

For those who have no ready access to a newsdealer or radio dealer use the coupon on this page for ordering.

**THIS  
BIG ISSUE**

**PRICE  
50¢**

**196 PAGES  
LARGE SIZE  
9 by 12 inches**

**Hundreds of  
Illustrations**

*Published and Distributed by*

**The Consrad Company, Inc.  
64 Church Street New York, N. Y.**

**If your dealer cannot supply you,  
USE THIS COUPON**

THE CONSRAD COMPANY, Inc.,  
64 Church Street, New York, N. Y.

Gentlemen—I am enclosing 50c. Please send me at once one copy of "Radio Review" as advertised above.

Name .....

Address .....

City, State .....



$$Z_1 = \frac{V_3}{I_1} = \frac{V_3}{V_2} r$$

and the transformer primary reactance and resistance are:

$$R_1 = Z_1 \cos \beta$$

$$X_1 = Z_1 \sin \beta$$

The determination of the reactance, resistance and power-factor requires the measurement of  $V_1$ ,  $V_2$  and  $V_3$ .

$V_1$  is the product of the resistance  $R$  (Fig. 1) and the current through T.C. Keeping this constant, with switches A and B to the left, throw switch D to the left and note the output current of T. Throwing switch A to the right, and opening D,  $R$  is adjusted until the same output current is obtained in T. The voltage drop in  $r$ , or  $V_2$ , is then the product of  $R$  and the current in T.C.

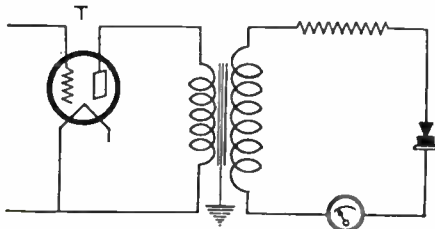

FIG. 3

Many variations are possible in the arrangement for the indicator in this system, but this is the most practical and simple.

$V_3$  is determined in a similar manner, with switch D thrown to the right.

The same set-up can be used to determine the mutual inductance between the primary and secondary windings. The secondary, for all practical purposes, can be considered as an open circuit; so that if  $V_4$  is the secondary voltage, measured by this method, and  $I_1$  the primary current, which is determined by  $V_2/r$ , then

$$\frac{V_4}{I_1} = 2\pi f M \text{ or } M = \frac{rV_4}{2\pi f V_2}$$

where  $M$  is the apparent mutual inductance. This will vary with the frequency due to the capacity in the windings of the transformer.

There are a few other measurements which can be made with this set-up of apparatus, such as the determination of the power losses in transformers which operate with a loaded secondary, i.e., the core-loss or open circuit test, and the impedance or short-circuit test. These tests, however are not of particular interest here.

There are likewise many variations of this method, either in the arrangement of the resistances or in the arrangement of the indicating instruments in the plate circuit of T. The present article, however, is meant to be only an outline of the method, for the reader must understand that all these things are easily put on paper, but when it comes to actually doing the work there are many precautions to be observed and many pit-falls to be avoided.



A RADIOPTIMIST



Model "C"

## Hear This Marvelous Receiver

Five Tubes . . . \$75  
Single Control

Highly selective and a long-distance getter. Easy to operate; coast to coast stations can be brought in time after time at the same point on the one large Vernier Dial. Encased in a beautiful Genuine Walnut cabinet.

# Distantone

Built By Craftsmen

TO DISTRIBUTORS

Other Models from \$37.50 to \$150

There are some unallotted territories in which we can offer a highly profitable proposition to reliable and financially responsible distributors and jobbers. Write for particulars or sample.

The Distantone line includes five tube receivers of two and three dial control and five and six tube sets with single dial control; all Tuned Radio Frequency type. Every model a superior value for the price.

**DISTANTONE RADIOS, Inc.,**

LYNBROOK, LONG ISLAND,  
NEW YORK

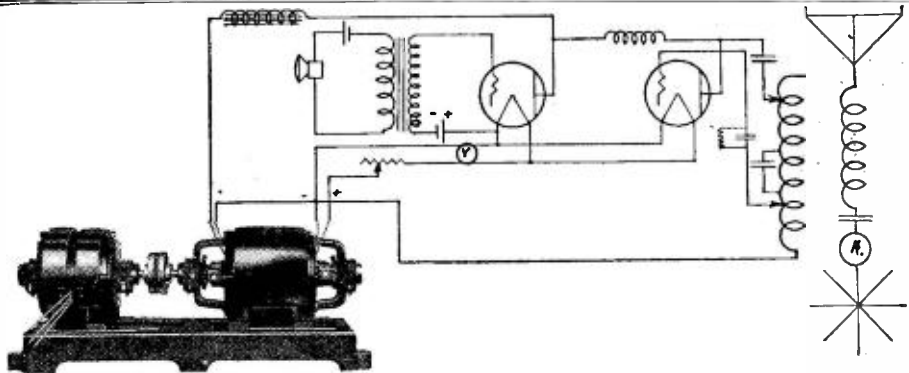

Item 37. 2 unit four bearing set, delivering 1000 volts, 600 watts for plate and 12 volts, 300 watts for filament. The "ESCO" Set is shown here furnishing Power Supply for 4-50 watters in a phone or telegraph set. This is the Item used by CBZ8 in pioneer achievement of the first two way amateur wireless communication between North and South America.

## ELECTRIC SPECIALTY COMPANY

Manufacturers of Motors, Generators, Motor-Generator Sets, Dynamotors and Rotary Convertors for all radio purposes. Have you got your copy of Bulletin 237B and ESCO Filter facts? If not, write for them.

TRADE "ESCO" MARK

211 South Street

Stamford, Conn.

"ESCO" Engineers will help you solve that Generator problem.

### MARKO

RADIO BATTERIES

are

ALWAYS DEPENDABLE

MARKO STORAGE BATTERY CO.  
Brooklyn, New York

For "UV" or UX Type Tubes  
NEW KLOSNER UNIVERSAL SOCKET

Hexagonal shaped holes for large prongs, spring grip terminal lugs, and ease in mounting make it the socket leader for 1926.

KLOSNER RADIO CORPORATION  
1022 East 178th Street - New York

### YOU CAN GET

Greater reflex or crystal set reception if you use the

BROWNLIE

VERNIER DETECTOR

\$2.00 At your dealer or Direct.

ROLAND BROWNLIE & CO.  
20 Saunders St. Medford, Mass.

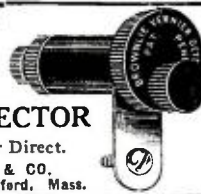

Have your tubes tested on the

### Superadio-Dynameter

MODEL 5 WATCH FOR THE B and C  
RECEIVER \$56 BATTERY ELIMINATOR

De Witt-La France Co., Cambridge, Mass.

Insure your copy reaching you each month. Subscribe to Radio News—\$2.50 a year. Experimenter Publishing Co., 53 Park Place, N. Y. C.



# An Instant Indicator of Storage Battery Conditions!

## TELLS AT A GLANCE

1. When the battery needs charging.
  2. When the battery on charge has been charged enough.
- Shows instantly whether your "A" Battery will operate the radio set. It also warns of approaching discharge—tells you whether the battery is good for a few hours' emergency reception.

### Sterling Charge Indicator

You can't go wrong with it. It can't get out of order or mislead you. It keeps you fully informed of your "A" power supply—vital to correct radio reception. No acid to spill or bother with. No time lost. No confusion. There is only one real Charge Indicator—a Sterling. Ask for it at your dealer's. If you can't be accommodated write direct to factory.

Price No. 32 Sterling Charge Indicator \$2.00  
 THE STERLING MANUFACTURING CO.,  
 Cleveland, Ohio Dept. H



# Sterling Charge Indicator

Wherever you find a popular circuit you will invariably find

# GENERAL RADIO Parts

Ask your dealer or write for this catalog

In building a set remember that its performance depends upon an efficient circuit, and the use of good parts. Through the merits of design, performance and price, General Radio parts are the standards of quality. Ask your dealer or write for catalog 924-N. It contains complete description of parts for use in all popular receiving circuits. Free on request.

GENERAL RADIO COMPANY  
 Cambridge 39, Mass.

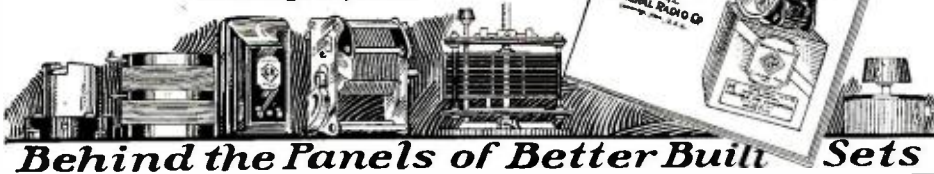

Behind the Panels of Better Built Sets

FOR

# FENWAY

PARTS AND SERVICE

— "LOOK UP DOWN" —

HE HAS THEM ALL

The Special Copper Cans, the Special Coupler, the Drilled and Engraved Panels, Sub-Panel and Baseboard, Royalty Resistance, Yaxley, Micamold, Gem Fuses, New National Dials, Celatsite Wire, Special Meters, Silver-Marshall and General Radio.

CHARLES W. DOWN, - - 711 Eighth Avenue, New York City  
 SEND FOR FREE PRICE LIST. SATISFACTION ASSURED OR MONEY REFUNDED.

Insure your copy reaching you each month. Subscribe to Radio News—  
 \$2.50 a year. Experimenter Publishing Co., 53 Park Place, N. Y. C.

## Sharpening the Tuning of Crystal Sets

By E. B. JUDSON\*

THE users of crystal sets often complain of the difficulty of cutting out interfering stations, but as a matter of fact this difficulty is due largely to the method of connecting the crystal to the tuned circuit.

The usual connection is shown in Fig. 1. Here the detector is shunted across the antenna inductance, or, in case of a coupled circuit, across the inductance of the secondary. This arrangement may be satisfactory when using an electron tube, or perhaps a carborundum detector, since these are of a resistance high enough to draw comparatively little current from the oscillatory circuit. But with low resistance detectors, galena, pyrite and the like, far too great a share of the available power is taken from the oscillatory circuit, either for good tuning or even for the loudest reception.

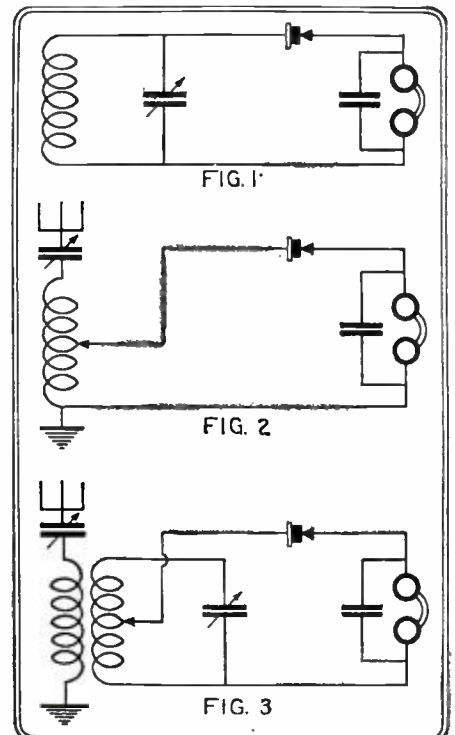

Fig. 1 shows the old style crystal detector circuit and Figs. 2 and 3 new recommended hook-ups.

It was known to some operators, even in the days of the electrolytic detector, that much better results could be obtained if the detector was shunted across rather less than half of the inductance coil.

The advantages of this connection are not, however, generally understood. This arrangement, for directly or inductively connected sets, is shown in Figs. 2 and 3. The broadcast listener who uses a crystal set will find his interference troubles very much reduced, and will generally get stronger reception, by changing to the circuits shown.

\* Published by permission of the Director of the National Bureau of Standards of the U. S. Department of Commerce.

### CALLS HEARD

H. T. SIMMONS, 75 NICHOLSON ROAD, SUBIACO, WEST AUSTRALIA, A-6KX

AMERICAN: 1avf, 1aci, 1ch, 1si, 2agb, 2ahm, 2avi, 2bx, 2clg, 2tm, 4ok, 4tv, 5afw, 5rj, 6ab, 6alv, 6anp, 6apw, 6awt, 6bpb, 6bq, 6bjx, 6bqr, 6bsw, 6cto, 6bx, 6bve, 6oi, 6vc, 8pl, 9bjk, 8bwy, 9cfy, 9elt, 9va.

OTHER COUNTRIES: Fi-8qq, j5m, ber, hag, sdk, hnj.

All on det and 1 low—all cards answered.



# 6-VOLT Storage Radio "A" BATTERY



**\$5.00 C. O. D.**  
**Send No Money**

Most amazing Battery value ever offered! A genuine World 6-Volt Radio "A" Storage Battery with 25 ampere capacity for only \$5.00! Just the thing for Trickle Charger. It is now possible for every Radio Set owner to obtain the most efficient source of power for lighting the tube filament—Storage Battery Power. It is dependable, pure and quiet. It is now placed within reach of all, and at a price that you can afford. This Battery is equipped with

### SOLID RUBBER CASE

No danger of acid leakage to rugs or floors. No breakage of box. Famous World quality assured throughout. World Batteries are backed by years of successful manufacture and thousands of satisfied users. Join the fast-growing family of satisfied World Storage Battery users now—

### MAIL YOUR ORDER TODAY

We ship same day order is received by express, C. O. D., subject to your examination on arrival. EXTRA OFFER: 5% discount for cash in full with order. ACT TODAY!

### WORLD BATTERY CO.

Dept. 110 1219 So. Wabash Ave., Chicago

**World**  
**STORAGE BATTERIES**

Dial 210 meters for the 1000 Watt World Storage Battery Station. WSRBC, Chicago



### LEAKANDENSER

Grid resistor and grid condenser in one. Space-saving. Moisture-proof—accurate—permanent. A radio product of true Daven quality. Ask your dealer.

**DAVEN RADIO CORPORATION**

159 Summit St.,

Newark, N. J.

### Build the New DUODYNE Circuit

with the Camfield Type 22 Duoformer, and the Camfield Type 886 .00025 mfd. Straight Line Condenser. Designed for new power tubes. 3 Tube Set.

Send 25c for Booklet

"The Duodyne Circuit," with complete instructions and drawings for building.

**CAMFIELD RADIO MFG. CO.**  
807 Harrison St. Oakland, Cal.

DERMOT M. AND DONAL F. O'DWYER, 9 UPPER LEESON STREET, DUBLIN, IRISH FREE STATE

AMERICAN (UNITED STATES): 1aao, 1adi, 1ahg, 1ahv, 1aiu, 1anz, 1aof, 1aou, 1apz, 1axa, 1azd, 1bs, 1bv, 1hx, 1cab, 1cal, 1ch, 1ckp, 1cmf, 1cpq, 1ga, 1ka, 1rd, 1sal, 1se, 1yb, 1za, 2adm, 2aes, 2ag, 2agq, 2ahm, 2aiu, 2ajq, 2akh, 2anm, 2apv, 2aum, 2ax, 2bm, 2brb, 2cus, 2crp, 2cth, 2cvj, 2cvs, 2cw, 2fk, 2gx, 2kk, 2ld, 2me, 2uk, 2xu, 2zv, 3bhv, 3bnu, 3bob, 3bss, 3bup, 3wn, 4rr, 5ahp, 6bjd, 6hu, 8aks, 8aly, 8am, 8ame, 8azu, 8bgn, 8bkm, 8hth, 8bpn, 8bwr, 8cau, 8chi, 8cib, 8cyl, 8dan, 8dcb, 8dgp, 8mc, 8rt, 8se, 8si, 8xe, 9aad, 9akd, 9apn, 9ctr, 9ds, 9gxx, 9pu, 9ua, nkf, nfv, wvd, ntt.

CANADIAN: 1ak, 1ar, 2ax, 2fo, 9bj.  
AUSTRALIAN: 2cm, 2yi, 3ef, 6ag.  
NEW ZEALAND: 2ac, 2xa, 4ac, 4as.  
ARGENTINE: Aa8, rth4.  
BRAZIL: 1ac.  
JAPAN: Jipp.  
Pse QSL QRA. Cards for all.

L. H. THOMAS, 33, Harpenden Road, WEST NORWOOD, LONDON, S. E. 27. ENGLAND. 6-6QB

1aao, 1aap, 1adi, 1ahv, 1aou, 1apv, 1asu, 1atg, 1awq, 1axa, 1ayg, 1ayi, 1beb, 1bef, 1bie, 1bke, 1bqd, 1bvb, 1bzb, 1caa, 1cal, 1caw, 1cax, 1ci, 1cjc, 1cmx, 1coe, 1ds, 1dy, 1ej, 1jr, 1nl, 1or, 1ou, 1sw, 1vc, 1vy, 1xae, 1zk, 2aan, 2acp, 2acf, 2aes, 2aev, 2ag, 2agb, 2agq, 2ajw, 2aky, 2amj, 2amp, 2anm, 2ann, 2aov, 2atp, 2bbb, 2bm, 2bn, 2bui, 2bwa, 2bxj, 2byg, 2caz, 2ccl, 2cgl, 2clg, 2cpq, 2cvl, 2cvu, 2cxl, 2cxn, 2czn, 2czr, 2cy, 2ds, 2fc, 2fo, 2gk, 2gp, 2hp, 2hu, 2ih, 2kp, 2mk, 2nj, 2nz, 2wh, 2xo, 2zh, 3acm, 3agf, 3ahl, 3ahp, 3bhv, 3bms, 3bwt, 3dh, 3ev, 3hg, 3io, 3jo, 3km, 3ld, 3xav, 4av, 4nx, 4ur, 5atr, 5atx, 5ew, 5fc, 5lh, 5yd, 6cto, 8adn, 8aig, 8aj, 8akk, 8aks, 8alf, 8bau, 8bde, 8bq, 8cau, 8chi, 8scr, 8dpa, 8dpe, 8djp, 8dri, 8drs, 8ed, 8ji, 8ks, 8oq, 8pl, 8rh, 8sy, 8xe, 8zu, 8zae, 9aio, 9aiz, 9aop, 9ci, 9ee, 9ek, 9hp, 9ne, 9xe.  
CANADIAN: 2ax, 2hg, 3kr, 3ml. Z: 2aq, 4ac, 4as, A: 2hk, 2yi, 3xo, BZ: 1ac, 1af, 1al, 1in, 2ab, 2af, 5ab, O: a4z, a6n, Y: hbk, crp.  
PSE QRK G-6QB on 43-45 meters?  
Cards waiting for all the above.

## The Manufacture of Mica Condensers

(Continued from page 1640)

bring its capacity to the desired value. It is then tested for capacity on direct reading instruments and after this, assembled in a bakelite housing.

At this point the condenser is complete, but it is again tested for capacity and leakage in order to check the preceding operators.

As many engineers have said, this is a laboratory process; but it is just this additional care which makes the receiver of 1926 so much better than that of 1923.

## The Jewell Audio Amplifier

(Continued from page 1651)

to separate the grid and plate circuits may be about 0.1- $\mu$ f., or, preferably, greater.

It has been mentioned above that at least three stages of this type of coupling are necessary to obtain the best results, but the constructor or experimenter need not stop here if he wants more amplification; for it will be found that this system gets away from the noises inherent in transformer-coupled amplifiers.

## Electric Train Operation by Radiophone

(Continued from page 1637)

between the front and rear end. Many such stops and starts were made and all of them proved that some means of signalling would greatly facilitate the handling of heavy trains. Voice transmission was used while standing and was clear and easily understood.

The maximum distance between the two locomotives at which practical signals could be exchanged was about six miles.

**SHORT-WAVE APPARATUS USED**  
Both the receiving and sending panels are enclosed in the same steel case, which is 30 x

# SM S-C KIT



The famous S-C Receiver is now offered exclusively by Silver-Marshall, Inc., as a complete, Armstrong licensed kit, including all parts necessary to build this remarkable set in a few hours time.

Behind the S-C Receiver is the reputation of POPULAR RADIO—Laurence Cockaday—McMurdo Silver. And behind each and every part stands the pick of radio manufacturers—Belden Mfg. Co.—Central Radio Labs.—Polymet Mfg. Co.—Poster & Co.—Silver - Marshall, Inc.—Thordarson Elec. Mfg. Co.—Yaxley Mfg. Co. and the S-C Merchandising Co. What better guarantee could be demanded—offered?

### Words of Praise

"My S-C more than lives up to your claims."  
"Assembled S-C in 2½ hours. Worked perfectly. S-C wiring harness is a marvel."  
"Absurdly easy for even an absolute novice to assemble the S-C perfectly."  
"Amazed that single control worked so well without adjustment."

**PRICE S-C KIT No. 620 \$59.00**

Licensed under Armstrong U. S. Patent No. 11113149. Manufactured by Tresco. Exclusive Distributing Agents: Silver-Marshall, Inc.



The Silver-Marshall Laboratories have perfected a new and radical method of transformer measuring that insures an unbelievable degree of selectivity and sensitivity to weak signals. All 210 long wave interstage and 211 tuned transformers are now measured by this remarkable system. Price singly or in matched groups, \$6.00 each.

For those experimenters desiring to avail themselves of this special service, S-M transformers will be measured and matched at 50c each. All other makes at \$1. each, when returned accompanied by remittance.

See S-M Parts At Your Dealers

**SILVER-MARSHALL, Inc.**  
848 W. Jackson Blvd., Chicago



# THE KONITE RECTI-TRICKLER

**\$4<sup>75</sup>**

**COMPLETE**

**BEST AND LOWEST  
PRICE CHARGER  
MADE.**



**T**HE RECTI-TRICKLER is a handsome piece of apparatus, designed expressly for charging A and B batteries from the house lighting current.

It can be used either on Alternating Current or Direct Current, and will charge batteries at the rate of about 1/4 of an ampere. The RECTI-TRICKLER, as its name implies, is a combination rectifier and trickle charger at the same time. At a low consumption of current and with no upkeep charges, it will keep your A and B batteries fully charged at all times.

Unlike other electrolytic rectifiers the RECTI-TRICKLER is self-contained. Practically all other electrolytic rectifiers require lamps or resistances in circuit with the rectifier in order to cut down the current, as well as messy wiring, which at times may become dangerous from short circuits, etc.

The RECTI-TRICKLER combines the electrolytic rectifier with the resistance, all contained in one unit. All you need to do is to plug in on the house lighting current, and connect the two battery clips to the leads of your battery. The charging operation then begins, while the RECTI-TRICKLER requires no additional attention whatsoever.

The RECTI-TRICKLER has been designed after an exhaustive series of tests to provide a self-contained unit at an extremely low cost, a unit that is practical and requires no attention.

Note that the RECTI-TRICKLER can be used to charge your 6-volt battery and your B batteries as well.

The weight of the complete RECTI-TRICKLER is only 3 pounds. It occupies no more room than a box of cigars.

The RECTI-TRICKLER is made of the best materials and is guaranteed by the makers against defects for six months.

You may procure the RECTI-TRICKLER from your dealer or direct from the makers if your dealer does not carry it in stock.

If Your Dealer Cannot Supply You — Use Coupon

The Konite Corporation,  
25-27 West Broadway, New York City.  
Gentlemen: Please send to me at once 1  
KONITE RECTI-TRICKLER as advertised,  
all charges paid, for \$4.75.  
Send at once  payment enclosed.  
 send C.O.D.

Name .....

Address .....

City and State .....

## DEALERS

We have an excellent proposition for those who desire to handle this new apparatus. Write or wire for information.

**THE KONITE  
CORPORATION**  
25-27 West Broadway  
New York City

**140 MILLIONS!**  
Prefer American Radio Apparatus

*It is now Winter  
in South America*

**RADIO  
INTERNACIONAL**

(Radio News in Spanish)

Serves 23 Spanish Speaking Countries with a population in excess of 140,000,000 and which are now enjoying winter radio reception.

Enlarge your market and increase your summer sales by advertising in RADIO INTERNACIONAL, the only radio magazine in Spanish reaching and appealing to the population of these twenty-two countries.

ADVERTISING RATES ON REQUEST

RADIO INTERNACIONAL is of standard size, 9 x 12 inches, printed entirely in Spanish.

PRICE 30c THE COPY. Subscription \$3.00 the Year.

THE POPULATION OF  
THESE 23 COUNTRIES, A  
LARGER MARKET THAN  
THE UNITED STATES,  
PREFER AMERICAN  
APPARATUS

- |                    |             |
|--------------------|-------------|
| Argentina          | Mexico      |
| Bolivia            | Nicaragua   |
| Brazil             | Panama      |
| Chile              | Paraguay    |
| Colombia           | Peru        |
| Costa Rica         | Philippines |
| Cuba               | Porto Rico  |
| Dominican Republic | Portugal    |
| Ecuador            | Salvador    |
| Guatemala          | Spain       |
| Honduras           | Uruguay     |
|                    | Venezuela   |

Published and Distributed by

**Experimenter Publishing Co., Inc., 53 Park Place, New York, N. Y.**



24 x 8 inches, designed particularly to be used in the cab of an electric locomotive and mounted against the partition in the motor-man's compartment. The outfit weighs approximately 160 pounds.

The power supply consists of a 32-volt storage battery, which is used to drive a 32-volt M.G. set, capable of producing 1000 volts DC, and also as a source of filament current, for the transmitting and receiving tubes. These units may be mounted at any convenient place in the locomotive. The total current required is 18 amperes. A 7-conductor cable with plug, is used to carry the low and high voltages to the set.

The transmitting panel contains all the necessary parts and circuits for generation of radio-frequency voltage of short wavelengths, i.e., 100 to 140 meters. These in turn may be used to carry voice or code; either of which may be selected at will, by throwing a switch on the front panel to transmit voice, or by using the code switch box for code signalling.

Three 50-watt tubes (203-A) are used, one acting as a radio-frequency oscillator, and two serving as audio modulator. Two controls, adjusting the transmitting panel for maximum output, may be locked in position by a screw arrangement.

The microphone, which is used only when the engine is stationary, is mounted on rubber and felt supports which absorb mechanical shocks. A circuit, used in conjunction with two of the tubes, is arranged to produce an audio voltage which serves as a source for code signalling and may be controlled at will by a small relay.

The receiver is carried in the steel case directly underneath the transmitter. Two controls for tuning the receiving circuits may be locked at any desired position.

The tuning coils have a wave-length range of 100 to 140 meters. The "B" batteries are contained on a strong metal tray and are held in position with suitable clamps. Every part contained in the receiver is easily accessible for repair. The receiver and transmitter may be secured in the steel case by means of a lock.

The control switch, used for code signalling, operates two relays in the transmitter. It is worked by pulling a bell cord, in the same manner as ordinary whistle signalling.

**STATEMENT OF THE OWNERSHIP, MANAGEMENT, ETC., REQUIRED BY THE ACT OF CONGRESS OF AUGUST 24, 1912.**

Of Radio News, published monthly at New York, N. Y. for April 1, 1926.

State of New York, County of New York, ss.

Before me, a notary public in and for the State and county aforesaid, personally appeared Hugo Gernsback, who, having been duly sworn according to law, deposes and says that he is the Editor of Radio News, and that the following is, to the best of his knowledge and belief, a true statement of the ownership, management, etc., of the aforesaid publication for the date shown in the above caption, required by the Act of August 21, 1912, to wit:

1. That the names and addresses of the publisher, editor, managing editor, and business managers are:

Publisher, The Experimenter Publishing Co., Inc., 53 Park Place, New York, N. Y.  
 Editor, Hugo Gernsback, 53 Park Place, New York, N. Y.  
 Managing Editor, Sylvan Harris, 53 Park Place, New York, N. Y.  
 Business Manager, R. W. DeMott, 53 Park Place, New York, N. Y.

2. That the owners are:  
 The Experimenter Publishing Co., Inc., 53 Park Place, New York, N. Y.

Hugo Gernsback, 53 Park Place, New York, N. Y.  
 Sidney Gernsback, 53 Park Place, New York, N. Y.  
 R. W. DeMott, 53 Park Place, New York, N. Y.  
 H. W. Secor, 53 Park Place, New York, N. Y.  
 Dr. T. O'Connor Sloane, 53 Park Place, New York, N. Y.  
 Mrs. Catherine Major, 53 Park Place, New York, N. Y.  
 M. M. Finucan, 720 Cass Street, Chicago, Ill.

3. That the known bondholders, mortgagees, and other security holders owning or holding 1 per cent or more of total amount of bonds, mortgages, or other securities are: None.

4. That the two paragraphs next above, giving the names of the owners, stockholders, and security holders, if any, contain not only the list of stockholders and security holders as they appear upon the books of the company but also, in cases where the stockholder or security holder appears upon the books of the company as trustee or in any other fiduciary relation, the name of the person or corporation for whom such trustee is acting, is given; also that the said two paragraphs contain statements embracing affiant's full knowledge and belief as to the circumstances and conditions under which stockholders and security holders who do not appear upon the books of the company as trustees, hold stock and securities in a capacity other than that of a bona fide owner; and this affiant has no reason to believe that any other person, association, or corporation has any interest direct or indirect in the said stock, bonds, or other securities than as so stated by him.

HUGO GERNSBACK,  
 Sworn to and subscribed before me this 16th day of March, 1926.

JOSEPH H. KRAUS, Notary Public.  
 (My commission expires March 30, 1927).

(SEAL)

# RADIO TOOLS

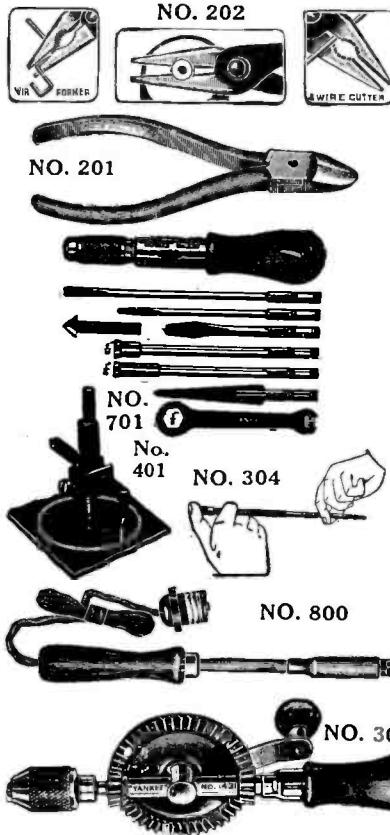

Combination Plier, Wire Cutter, Wire Former and Wrench. Drop forged, slender but exceptionally strong. 6 inches long.

No. 202—Combination Plier.....Price 75c

Side Cutting Nipper Lap Joint. For cutting all kinds of wire. Jaws hardened and oil tempered. Natural steel finish with polished jaws. Length 6 inches. No. 201.....Price 75c

Radio Tool Set. Contains the following: 1 Ratchet Screw-driver, 6 1/2 in. long holding all attachments; 1 Blade, 5 1/2 x 3/16; 1 Blade, 3 1/2 x 1/4; 1 Blade 2 1/2 x 1/4; 1 Countersink; 2 Socket Wrenches for all small nuts; 1 Reamer to enlarge holes in panel from 1/8 to 1/2; 1 Wrench, one end 5/16 in. square or hex. for jack, other 1/2 in. hex., etc.

No. 701.....Price per set \$3.00

Circle Cutter. It does three things at once. It drills its own pilot, cuts out plug and puts bead or scroll around the hole in one operation. Cuts holes 1/4 to 4 in. in diameter. No. 402 Price \$3.00

Circle Cutter. Same tool but smaller and not fitted with bead or scroll in one operation. No. 401.....Price \$2.00

Screw Starter and Driver. Holds any screw by its slot with a firm grip, makes it easy to place and start screws in difficult places. All parts heavily nicked and polished. No. 304.....Price \$1.00

Electric Soldering Iron. Operates either on 110-volt A.C. or D.C. The heat element is of Nichrome which prevents overheating and assures the desired even temperature. Size of iron, 10 1/2 in. long. A 4-ft. cord and plug is furnished.

No. 800.....Price \$2.00

Hand Drill. A beautiful balanced, small, powerful drill with 4 to 1 ratio of gears for speed. Special chuck 9/32 in. capacity, to take largest drill, mostly furnished with drill or tool sets. Length over all, 9 1/2 in. Weight 1 1/2 lbs. No. 302 Price \$2.75

Order all tools by order number. All goods are shipped free of transportation charges to all parts of the United States and possessions the same day as the order is received.

MONEY REFUND GUARANTEE—If you are not satisfied money will be refunded on return of goods.

**THE RADIOGEM CORPORATION**  
 66-R West Broadway New York, N. Y.

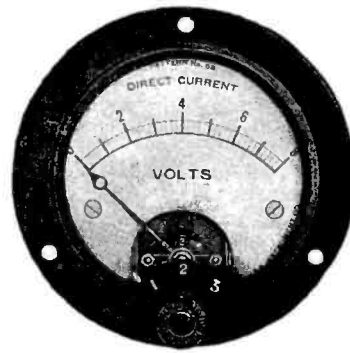

Pattern No. 55 Multiple Reading Voltmeter with Self Contained Switch

## Are You Preparing to Build a New Set?

Every Radio Set should have instruments on the panel for filament control and checking of batteries.

Leo Fenway and many other radio engineers are recommending Jewell Instruments on account of their accuracy, and other features specially applicable to radio sets.

Order from Dealer

## Jewell Electrical Instrument Co.

1650 Walnut St. - Chicago

"26 Years Making Good Instruments"

### Make any Good Receiver BETTER



C.E. MFG. CO.  
 Providence R.I.

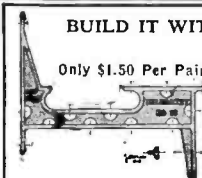

### BUILD IT WITH KELBRACKETS!

Only \$1.50 Per Pair

Make a sturdy, efficient, good-looking set. Kelbracket Booklet shows how, giving actual size and many uses. Mailed Free.

KELLERADIO, Inc.  
 821 Market Street, San Francisco, Calif.

**PATENTS TRADE-MARKS**  
 Edward C. Sasnett, Attorney at Law  
 Ex-Principal Examiner U. S. Patent Office:  
 Personal Service  
 544 MCGILL BLDG. WASHINGTON, D. C.



Write for Booklet  
 AMSCO PRODUCTS Inc.  
 Broome and Lafayette Sts.  
 New York City



# OPPORTUNITY AD-LETS

Follow these advertisements every month. Reliable advertisers from all over the country offer their most attractive specials in these columns.

Classified advertising rate twenty-two cents a word for each insertion. Ten per cent discount for 6 issues, 20 per cent discount for 12 issues. Name and address must be included at the above rate. Cash should accompany all classified advertisements unless placed by an accredited advertising agency. No advertisement for less than 10 words accepted.

Objectionable or misleading advertisements not accepted. Advertisements for the August issue must reach us not later than June 1st.

**CIRCULATION LARGER THAN THAT OF ANY OTHER RADIO PUBLICATION**

EXPERIMENTER PUBLISHING CO., INC., 53 Park Place, New York, N. Y.

## Agents Wanted

**Big Money and fast sales.** Every owner buys gold initials for his auto. You charge \$1.50; make \$1.55. Ten orders daily easy. Write for particulars and free samples. American Monogram Co., Dept. 133, East Orange, N. J.

**Guaranteed Genuine Gold Leaf Letters** anyone can put on store windows. Large profits, enormous demand. Free samples. Metallic Letter Co., 422 N. Clark, Chicago.

**Big Money—fast sales;** every owner buys gold initials for his auto. You charge \$1.50; make \$1.44. Ten orders daily easy. Samples free. World Monogram, Dept. 27, Newark, N. J.

**One Agent sold 160** quick action Money Rim Tools in 3 days. Profit \$1.25 tool. Another 13 of 15 demonstrated. For live agents, L. Money Rim Tool Co., Blissfield, Mich.

**10c puts your name on our mailing list year.** Latest money makers. Kentucky Agener, Covington, Kentucky.

**Lightning Electrolyte.** Charges storage batteries instantly. Gallon costs 50c, sells \$10.00. Make it yourself. Guaranteed formula \$5.00. Write for tree circulars. Murphy, Chemist, Tulunga, Calif. Box-D.

**Wanted—Dealers and State Distributors.** Exclusive territory. Noiseless Radio Battery Eliminator. Tremendous sales. Enormous profits. Large profits. Write Harcourt Electric, 2029 Indiana Ave., Chicago.

## Architecture School

**Wanted—Building-Draftsmen.** Train at home, in spare time, to be a Building-Draftsman. Big demand means big salaries and steady work. Get into Building, America's \$7,000,000,000 industry. Keep right on with your present work. We train you by mail. Free Trial Lesson and Blue Print plans to show you how easily and quickly you can learn. Get into the \$3,000 to \$10,000 salary class. Write for Free Lesson, Blue Prints and catalog. All free, no obligation. Chicago Technical College, Dept. 1635, 118 E. 26th St., Chicago, Ill.

## Aviation

**Boys—Get a three-foot model aeroplane free.** Write to Aero Shop, 3050 Hurbit Ave., Detroit, Mich.

## Books

**Mystify Your Friends.** become a master of magic, POP-ULAR MAGIC, 116 page book contains hundreds of magic and spirit tricks, 500 illustrations. Price 50c. Sold everywhere. Experimenter Pub. Co., Inc., 53 Park Place, N. Y.

**Amazing Stories,** the newest story magazine. Scientific Novels, issued every month, size 9x12 inches. Special yearly subscription offer \$2.50. Experimenter Pub. Co., Inc., 53 Park Place, N. Y.

**Radio Trouble Finder,** a new book to keep near your set, simple charts tell how to locate and correct all troubles. 52 pages, 6x9, illustrated. Price 25c. The Conrad Co., Inc., 64 Church St., N. Y.

## Builders School

**Become a Builder.** The World's Big Pay Field—building. Be an estimator, superintendent, or have a contracting business of your own. Train at home, in spare time, to earn \$5,000 to \$20,000 a year, or more. No matter what your job is now—there's a big opportunity for you. A virgin field with no overcrowding. Free book, "How to Retail Blue Prints," actual Blue Print Plans and Catalog sent free. See how quickly and easily you will learn this fascinating big-pay profession. If you are earning less than \$75 a week, write us now. Send for free books and Blue Print Plans today! Chicago Technical School for Builders, Dept. 2773, 118 E. 26th St., Chicago, Ill.

## Business Opportunities

**Free Book.** Start Little Mail Order Business. Pier, 996 Cortland Street, N. Y.

**Responsible manufacturer** wants competent men to manage office and salesmen. \$300 to \$1500 necessary; will allow expenses to Trenton if you qualify. Address Manager, 536 Forst Richey Bldg., Trenton, N. J.

## Chemistry

**Learn Chemistry at Home.** Dr. T. O'Connor Sloane, noted educator and scientific authority, will teach you. Our home study correspondence course fits you to take a position as chemist. See our full page ad on page 1681 of this issue. Chemical Institute of New York, 66 W. Broadway, New York City.

## Educational

**Used Correspondence School** courses save over half. Bargain Catalogue 1000 courses free. Save courses bought. Students' Exchange, Dept. A, 47 West 42d St., New York.

## Help Wanted

**Detectives Needed Everywhere.** Travel. Experience unnecessary. Write, George Wagner, former Government Detective, 1963 Broadway, N. Y.

## Incorporations

**Delaware Incorporator, Charters; Fees Small; forms.** Chas. C. Guyer, 901 Orange St., Wilmington, Del.

## Insects Wanted

**Why not spend Spring, Summer and Fall** gathering butterflies, insects? I buy hundreds of kinds for collections. Some worth \$1 to \$7 each. Simple outdoor work with my instructions, pictures, price-list. Send 10 cents (not stamps) for my illustrated Prospectus before sending butterflies. Mr. Sinclair, Dealer in Insects, Dept. 40, Box 1124 San Diego, Calif.

## Instruction

**Learn Chemistry at Home.** Dr. T. O'Connor Sloane noted educator and scientific authority, will teach you. Our home study correspondence course fits you to take a position as chemist. See our full page ad on page 1681 of this issue. Chemical Institute of New York, 66 W. Broadway, New York City.

## Miscellaneous

**Homeopathic and Brochemic preparations** sent postpaid to all parts of the world. Manual and booklets free. Halsey Bros. Co., 645 St. Clair St., Chicago, Ill. Established 1855.

**One thousand four-page Radio Logs.** your ad on cover \$14. Sample on request. Duell, 20 Beekman St., N. Y.

**I Catch from 45 to 60 Foxes** in from 4 to 5 weeks' time, can teach any reader of this magazine how to get them. Just drop me a card for particulars. W. A. Hadley, Stansstead, Quebec, Canada.

**Forms to Cast Tin Soldiers, Indians, Marines, Trappers, Animals.** Send 10c for catalogue. Henry T. Schlercke, 1034-72nd St., Brooklyn, N. Y.

## Motion Pictures

**Films for Toy Machines.** Hart—Mix—Chaplin. Complete stories 1000 feet \$3.50. Special 200 foot lengths \$1.50 postpaid. Big Boys List Free. Monarch Films, Department 3, Memphis, Tenn.

## Motorcycles, Bicycles

**Don't Buy a Bicycle Motor Attachment** until you get our catalog and prices. Shaw Mfg. Co., Dept. 6, Galesburg, Kansas.

## Old Coins

**German Gov't Bond 5,000,000 Mk. 1924.** \$1.50. 2,000,000 Mk Bond 1923. \$5.00. 500,000 Mk. Bill and Catalogue, 10c. Norman Shultz, Colorado Springs, Colo.

**California Gold Tokens—Quarter Size** 27 cents; half dollar size 53 cents. Catalogue and 500,000 German Mark bill 10 cents. Alexis Mengelle, Colorado Springs, Colorado.

## Old Money Wanted

**\$2 to \$500 each** paid for hundreds of Old or Odd Coins. Keep all old money, it may be very valuable. Send 10c for New Illustrated Coin Value Book, 46c. Guaranteed prices. Get posted. We pay Cash. Clarke Coin Company, 14 Street, LeRoy, N. Y.

## Patent Attorneys

**Inventors—Should write for our Free Guide** Books and "Record of Invention Blank" before disclosing inventions. Send model or sketch of your invention for our Free Inspection and Instructions. Radio, Electrical, Chemical, Mechanical and Trademark experts. Terms reasonable. Victor J. Evans & Co., 929 Ninth, Washington, D. C.

**Patents.** Send drawing or model for examination and report as to patentability. Advice and booklet free. Highest references. Best results. Promptness assured. Watson E. Coleman, Patent Lawyer, 644 G Street, N. W., Washington, D. C.

**Patents—My fee in installments.** Free personal advice. Frank T. Puller, Washington, D. C.

## Patent Attorneys (Continued)

**Patents—Send for form "Evidence of Conception"** to be signed and witnessed. Form, fee schedule, information free. Lancaster and Allwine, Registered Patent Attorneys in United States and Canada, 269 Ouray Bldg., Washington, D. C.

**Patent-Sense—As one of the oldest firms** in America we give inventors, at lowest consistent charge, a service noted for results, evidenced by many well-known Patents of extraordinary value. Book Patent-Sense, free. Lacey & Lacey, 631 F St., Washington, D. C. Estab. 1869.

## Patents

**Inventions Commercialized.** Patented or unpatented. Write Adam Fisher Mfg. Co., 278 Enright St. Louis, Mo.

## Printing Outfits and Supplies

**Print your own cards, stationery, circulars, paper, etc.** Complete outfits \$8.85; Job Presses \$12, \$35; Rotary \$150. Print for others, big profit. All easy, rules sent. Write for catalog presses, type, paper, etc. Press Company, A-13, Meriden, Conn.

## Radio

**Boys! Don't Overlook This.** The "Rasco" Baby Detector. Greatest detector ever brought out with molded base. Fully adjustable. See former advertisements in this publication, or our catalog. Detector with Galena Crystal, complete 50c, the same detector with Radiocite Crystal, 75c prepaid. Send for yours today. Radio Specialty Company, 96-98 Park Place, New York City.

**Attention!—50 Vacuum tube hook-ups.** The greatest collection of vacuum tube circuits ever brought under two covers at such insignificant cost. These diagrams will be found in the great "Rasco" catalog, which contains raw materials and parts in a greater profusion than any other catalog. 15c in stamps, or coin, will bring the catalog to you. Radio Specialty Co., 96-98 Park Place, New York City.

**Amateurs Handbook,** contains best Radio articles from "Radio News." 123 pages, size 9x12 inches, valuable, instructive. Price 50c. Sold everywhere. Experimenter Pub. Co., Inc., 53 Park Place, N. Y.

**500 Radio Wrinkles.** Just off the Press. Hints, helps for every Radio User. 100 pages, illustrated, size 9x12 inches, Price 50c. Sold everywhere. Experimenter Pub. Co., Inc., 53 Park Place, N. Y.

**Ivory Radio Panel** is a pure white grained Ivory 3/16" thick cut any size 7c square inch. Satisfy yourself, write for Free Sample to test. Shipped anywhere prepaid (C.O.D.). Ivorylite Radio Panel Co., 3222 Ave. F, Fort Worth, Texas.

**Build a Lifetime "B" Battery.** Use better Edison elements, welded connections at 7c pair. Sample cell 10c. Paul Mills, Woodburn, Oregon.

**New 50 Watt UV 211 Tubes.** Worth \$50., sell \$26. each. Transmitting Sets, Wavemeters \$7.50. S. Strobel Co., 3923 N. 6th St., Phila. Pa.

**Fans—Get Steinite Wave Trap.** will make your set more selective, 75c postpaid. Send for our free Radio catalog. Radio Specialty Shop, 525 Park Ave., Kent, Ohio.

**World's Finest Loud Speaker.** A three-foot cone speaker-unit developed by the inventor of the Troadyme. Can be assembled in fifteen minutes, saving 80% of the cost. Complete Kone Kit with blue prints sold on rigid money-back guarantee, shipped prepaid, \$10. Engineers' Service Company, Suite 203, 15 Park Row, New York.

**No More Batteries—Build "A" and "B" eliminator—** operates any set on AC or DC, no hum, satisfaction guaranteed. Complete plans \$2. Engineers' Service Company, Suite 203-15 Park Row, New York.

**Beautiful 5-tube radio set.** \$45.00. New! Order from Adv. P. V. Grasbetger, Bumpass, Va.

## Radio Outfits and Supplies

**\$16.50 buys a \$35.00 Solotone Loud Speaker** with Burns unit. Artistic design! Wonderful tone! Circular sent on request. G. Gelb, Distributor, 710 S. Sacramento, Chicago.

## Salesmen Wanted

**A Salesman wanted** in every town or city within 25 miles of a broadcasting station to sell Radiocem, the complete radio receiving set that retails for \$2.50. With Radiocem there is nothing else to buy—the outfit includes the Radiocem receiving apparatus, 1,000 ohm phone, and aerial outfit. The cheapest radio outfit on the market—yet as practical as the most expensive. Big money to the right men. Send \$2.00 for sample outfit. The Radiocem Corp., 68-R West Broadway, New York City.





# Read this amazing story of romance, mys- tery and Martian intrigue

by  
**HUGO GERNSBACK**  
Editor of Science and Invention,  
Radio News and Amazing Stories

Against an amazing background of mechanical, electrical and chemically altered life of mankind there is set a brilliant and colorful romance in the life of the greatest living scientist of that age.

Ralph's love for the beautiful stranger, his conquest of his rival and the worsting of the great saturnine Martian, culminating in a running fight in space with tragedy and terror conquered by almost unbelievable and incredible weapons, make one of the most interesting and gripping stories ever told.

**The Stratford Co.**  
Publisher

FOR SALE BY

**Experimenter Publishing Co.**  
53 PARK PLACE, NEW YORK, N. Y.

ORDER BLANK

Experimenter Publishing Company, Inc.,  
53 Park Place, New York City.

Gentlemen:—Enclosed find \$..... for which please send me ..... copies of "RALPH 124C 41+," by Hugo Gernsback.

Name .....

Address .....

PRICE \$2.15 POSTPAID RN6

### Scenery to Rent

Settings for Opera, Plays, Minstrels. Plush Drops. Address Awella Grain, Philadelphia.

### School of Electricity

Electricity—Short day or evening courses in Electricity, Drafting, Engineering, and Architecture. In Chicago earn while you learn. Part Time positions pay expenses. Faculty of experts. Special short courses. Diplomas in 2 years. B.S. Degree in 3 years. Small classes, individual instruction. 23 year old institution with thousands of successful graduates. Enter any time. Employment bureau. Moderate tuition—monthly payments. New College building—all athletics. All details in 72 page "Blue Book." A copy will be sent to you free. Write today. Chicago Technical College, Dept. 27, 118 E. 26th St., Chicago, Ill.

### Song Poem Writers

Write Song Poems?—write D1, Gillespie, Box 801, Cincinnati, Ohio.

### Song Writers

Songwriters: Let me furnish the music for your songs, guaranteeing you absolute satisfaction. Copyrights secured. Submit your scripts for estimate and free advice. Walter W. Newcomer, 1674 Broadway, New York.

Songwriters: Dardanella and Prisoners song made unknown writers famous. You win success. Send poems and obtain free criticism and marketing information. L. J. Turner, 5417-12th Ave., Brooklyn, N. Y.

### Stammering

Stop Stammering. Increase salary. Descriptive booklet free. Samuel Robbins, 399 Boylston St., Boston.

### Telegraphy

Telegraphy—Both Morse and Wireless taught thoroughly. Big salaries. Wonderful opportunities. Expenses low; chance to earn part. School established fifty years. Catalog free. Dodge's Institute, Cour St., Valparaiso, Ind.

### Wanted

Cash Paid for Dental Gold, False Teeth, Discarded Jewelry, Diamonds, Platinum, Mail, Florida Gold Refining Co., 21 Adams, Jacksonville, Fla.

### Wanted to Buy

Full Value Paid for Old Gold, Jewelry, Watches, Diamonds, crowns, bridges, dental gold, silver, platinum, gold or silver ore; magneto points, old false teeth. Packages returned if our offer is not satisfactory. United States Smelting Works (The Old Reliable) 39 So. State St., Dept. 16, Chicago, Ill.

## Attention! HIGH SCHOOL STUDENTS

We have a big money making proposition that requires no cash investment—only an hour or two of your spare time necessary.

If you live in New York City or surrounding local territory call in person to see M. B. Murray

For Full Particulars, write  
**M. B. MURRAY**

**EXPERIMENTER PUBLISHING  
COMPANY, Inc.**  
53 Park Place New York, N. Y.

### How to Make Your Own

## SPEECH AMPLIFIER

MICROPHONE Transmitter Buttons have been used for a number of years to make powerful sound transmitting elements. These very sensitive amplifiers offer every "Radio Fan" the means of building his own powerful speech amplifier. We offer herewith to the constructor these special Amplifier Units.

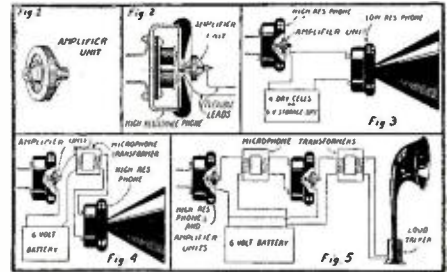

Fig. 1 shows the amplifier unit.

Fig. 2, shows how the unit is attached to a telephone receiver. The first procedure is to mount the unit on the diaphragm of a telephone receiver, which usually is a high resistance telephone, either 1,000 or 1,500 ohms.

Next we select the loud speaking telephone. If a low resistance telephone is available, it should have for maximum efficiency an impedance equal to the resistance of the amplifier unit, or about 10 ohms; it is connected up as shown in Figure 3. A 5 ohm telephone receiver is used in this circuit with a 6-volt storage battery.

Two telephones taken from a good double headset of 2,000 to 3,000 ohms which do not rattle on strong currents, are employed in Fig. 4, one at the receiving end, the other as loud talker. In this hook-up there is one instrument which must absolutely be used with this combination, the transformer. As stated before in connection with Fig. 3, the impedance of the telephone, if used in direct connection, should equal the resistance of the unit. But as the impedance of the telephone in Fig. 4 is much higher than the resistance of the unit, it may be 200 times as great, a transformer having a step-up ratio is used to match up the resistance of the unit with the impedance of the loud speaking telephone. In other words, the primary coil of the transformer should have an impedance (which is sometimes called "A. C. resistance") equal to the resistance of the unit, or about 10 ohms, and the secondary coil should have an impedance equal to the impedance of the high resistance telephone. This transformer may be purchased in any Radio Store and is called a microphone transformer or modulation transformer, designed primarily to use in radio transmitting sets. A 6-volt battery gives the best results. The current passing through the unit will vary from .1 to .25 ampere.

Fig. 5 shows a circuit for further increasing the volume of sound. This is simply two of the circuits, such as shown in Fig. 4, linked together. This arrangement is highly sensitive and the telephones on which the units are mounted should be packed in a box of cotton, as the slightest vibration or sound in the room will be picked up and heard in the loud talker. Any sensitive radio loud talker may be used in this particular circuit.

THESE and innumerable other interesting experiments are possible with these amplifiers. Every amateur should have at least one or two in his "Lab" or workshop. A four-page instruction pamphlet is sent with every unit.

**SPECIALLY PRICED**  
While they last ..... **95c** Per Unit  
OR TWO FOR \$1.75

**PRESS GUILD,**  
66-R W. Broadway, New York City, N. Y.

Enclosed find 95c—\$1.75 for which send me postpaid one—two amplifier units as advertised.

Name .....

Address .....

Town ..... State .....



*Approved and Purchased by  
U.S. Naval Research Laboratories*

# PILOT ISOGRAD

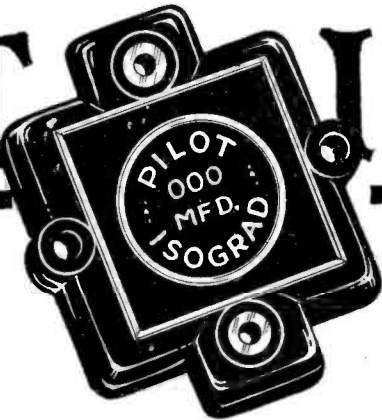

ACCURATE — PERMANENT — NOISELESS

## FIXED CONDENSERS

OF MICA MOULDED IN GENUINE BAKELITE

*Mounting Holes Independent of Contacts*

PILOT ISOGRAD Fixed Condensers having met the rigid requirements necessary for naval service, have been approved by the U. S. naval radio experts and purchased for use by them.

PILOT ISOGRAD fixed condensers are built to withstand, without changing capacity, atmospheric and climatic variations, which navy use will subject them to. *No finer recommendation can be given a product.*

---

Set manufacturers are invited to write for samples and prices. Amateur set builders are referred to any of the S. S. Kresge Co. Stores—or to local dealers. If your dealer has none in stock, write and send us your dealer's name and we will arrange to supply you through him.

---

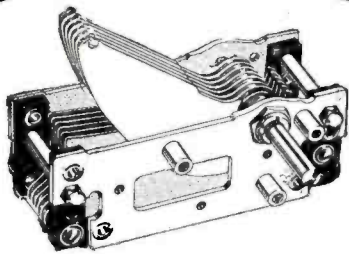

### PILOT WINS AGAIN

Pilot Straightline  
Frequency Condensers  
Used by the Winner  
of International  
Broadcast Contest

427 St. Marks Ave.,  
Brooklyn, N. Y.

Gentlemen:

Would it interest you to know I won first prize in the International Contest conducted by the Radio Broadcast, using Pilot condensers.

(Signed)  
THOMAS H. BUTLER

PILOT  
PARTS  
for  
PERFECT  
PERFORMANCE

PILOT ELECTRIC MANUFACTURING CO.

323 BERRY STREET — BROOKLYN, N. Y.

**Made By America's Greatest Radio Parts Manufacturer**



# Behind the "Mike" in 206 Broadcasting Stations

In supplying the steady current required for the best amplification of voice and music in 206 leading broadcasting stations, Willard Radio Batteries are doing the same good job that your customers wish done in their own radio sets.

# WILLARD RADIO BATTERIES

When you explain that the voice amplifying job of the broadcaster is identical with the amplifying job in the receiving set, you lay the foundation for quick sales—satisfied customers. And you can also tell the customer how easy it is to keep Willard Batteries charged, and why they *last for years*.

WILLARD STORAGE BATTERY CO.  
CLEVELAND, OHIO

## The Right Selling Plan for Radio Dealers

Your local Willard Service Station will act as your jobber on Willard Radio Batteries.

This means a quick source of supply for strictly fresh, well-charged batteries which you can turn over to your customers in the pink of condition.

No servicing problems for you. Your local Willard Service Station assumes the responsibility for service.

Months of operation have proved that this plan is effective, and profitable for all concerned.

Willard Radio Batteries are being advertised more extensively than ever.

Have your local Willard Service Station show you this advertising and explain the details of this practical plan for selling radio storage batteries. The advertisements are signed:

Sales and Service through  
**The Willard Battery men**  
and their  
Authorized Radio Dealers

Appropriate signs and window cards will identify you as an Authorized Dealer. Booklets and other valuable selling helps are also furnished.

*Your Nearest Willard  
Service Station is Your  
Nearest Willard Jobber*





## one fourth as much current as in 1921

When you tune in today on a storage battery set, your Radiotron UX-201-A uses only one fourth of the current a storage battery tube needed just five short years ago. This means that you need charge your "A" batteries only about one fourth as often!

The present Radiotron UX-201-A is also a better detector—is a better amplifier—has a greater output—all on less current!

RCA research has produced better tubes—better methods of making tubes, to lower their cost—and better test methods, too. These improvements have come from the laboratories of RCA and its associates, General Electric and Westinghouse—laboratories devoted to year-in and year-out study of vacuum tubes.

The standard of quality back in 1921 was an RCA Radiotron. And the standard of quality today is an RCA Radiotron!

RADIO CORPORATION OF AMERICA  
New York Chicago San Francisco

Radiotron  
UX-201-A

*is the standard tube for storage battery sets. Radiotron UX-201-A is exactly like it, but has the old type base.*



# RCA Radiotron

MADE BY THE MAKERS OF RADIOLAS