

RADIO NEWS

REG. U.S. PATOFF.

25 Cents

AUGUST

Over 200
Illustrations

Edited by H. GERNSBACK

**\$500.00
RADIATION
PREVENTER
CONTEST**
See Page 187

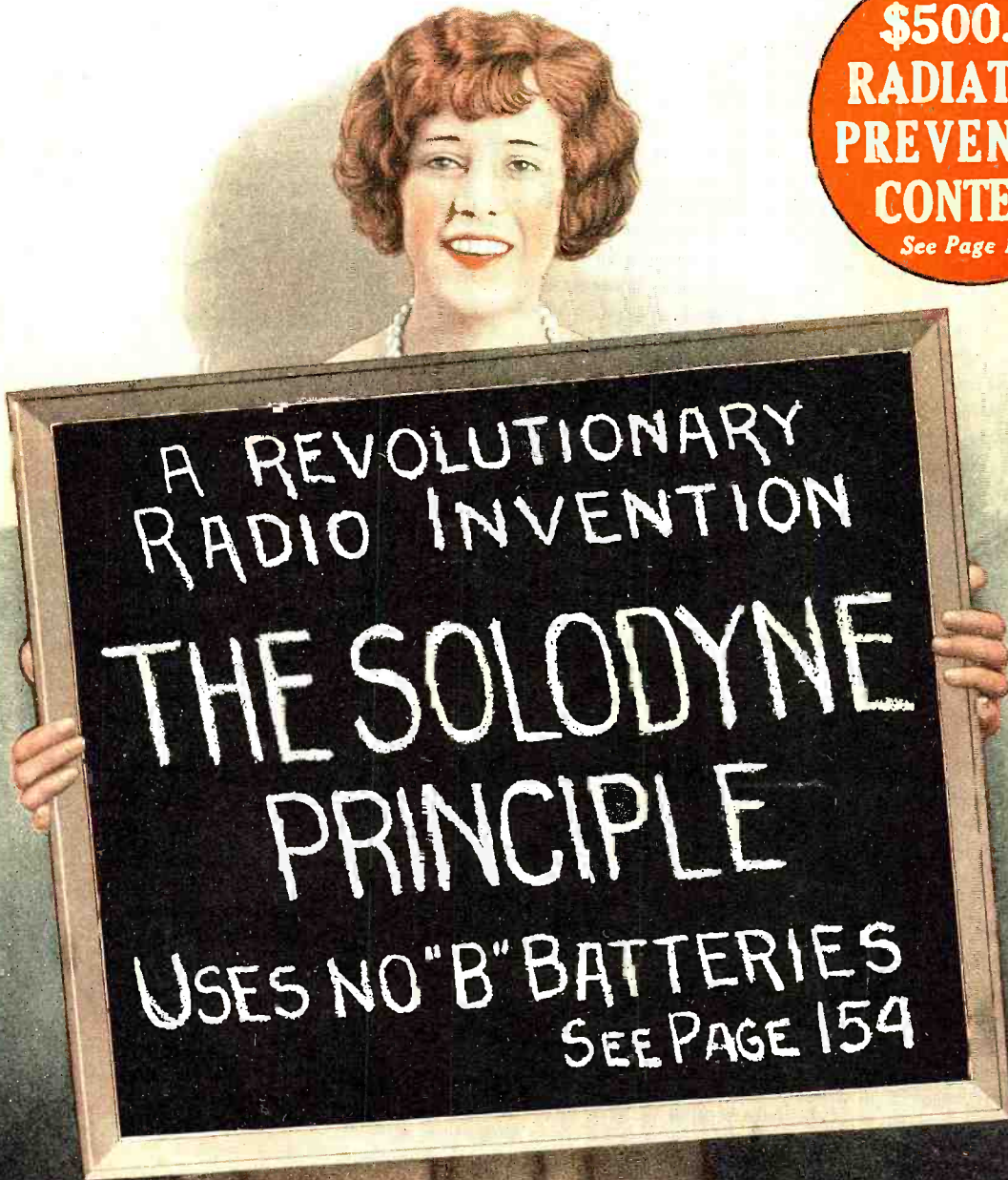

THE TROPADYNE CIRCUIT SEE PAGE 170

THE 100% RADIO MAGAZINE

EXPERIMENTER PUBLISHING COMPANY, NEW YORK, PUBLISHERS OF

SCIENCE and INVENTION

PRACTICAL ELECTRICS

MOTOR CAMPER & TOURIST

Cunningham

RADIO TUBES

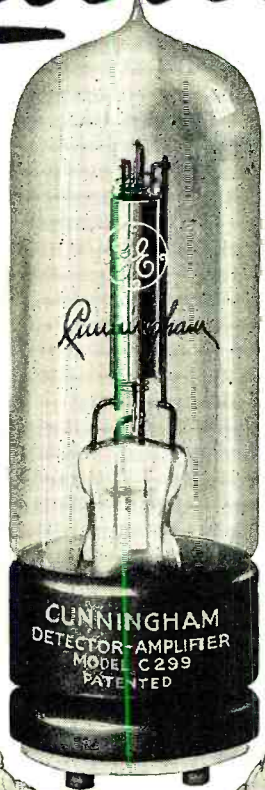

The Ideal TUBE for Vacation Time

AT the seashore—in one of our great national parks, or while motoring you will find the Cunningham Dry Battery Detector and Amplifier, Type C-299, the ideal Tube for your portable receiving set.

The special filament of this tube having a current so low that it may receive its supply from standard No. 6 Dry batteries or even from ordinary flashlight batteries, makes possible this entertaining application of Radio in places far remote.

Your dealer can give you useful suggestions for the purchase or construction of a highly efficient and practical portable Radio Set. Make this a Radio Summer.

Cunningham C-299 Detector and Amplifier Tube

C-299 3 volts .06 amp. Dry Battery Detector and Amplifier.....\$5.00

Other Cunningham Radio Tubes

C-301A—6 Volts 1.4 amp. Amplifier. \$5.00

C-300—6 Volts Gas Content Detector. \$5.00

C-11—1.1 Volts .25 amp. Dry Battery

Detector & Amplifier, Special Base \$5.00

C-12—Similar to C-11 with standard base\$5.00

Patent Notices Cunningham tubes are covered by patents dated 2-18-08, 2-18-12, 12-30-13, 10-23-17, 10-23-17 and others issued and pending. Licensed for amateur, experimental and entertainment use in radio communication. Any other use will be an infringement.

Cunningham 40-page Data Book fully explaining care and operation of Radio Tubes now available by sending 10c in stamps to San Francisco office.

C. J. Cunningham Inc.

Branch
CHICAGO

Home Office:
182 SECOND STREET
SAN FRANCISCO

Branch
NEW YORK

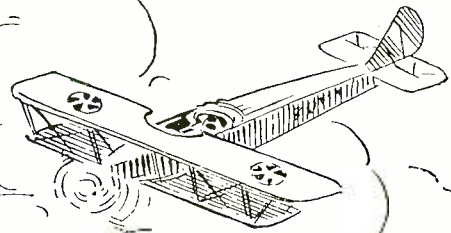
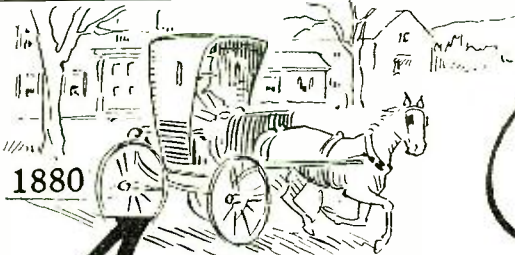

American Genius IN RADIO HEADSETS

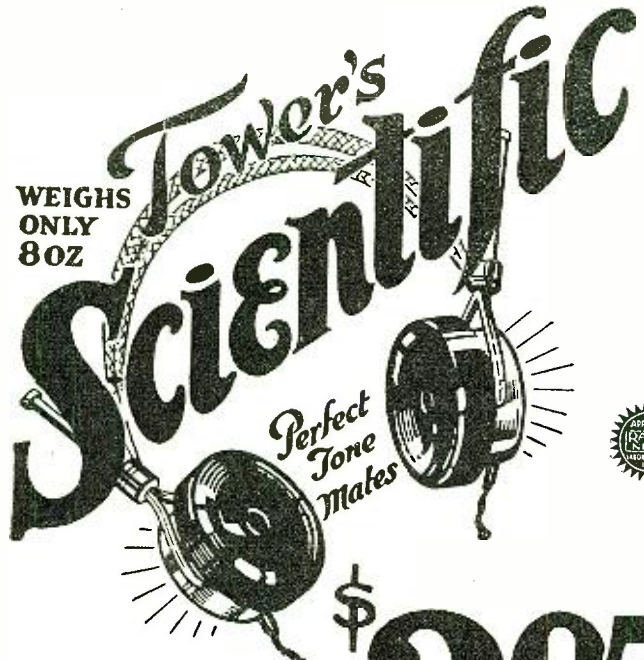

As in Transportation, American Genius has progressed from the old-fashioned, clumsy, obsolete phones of uncertain accuracy to the modern

TOWER'S SCIENTIFIC HEADSET

Lightest of all in weight, higher resistance, with elimination of distortion. Longer cord (full 5 ft.)

With increased production follows price reduction. As the **LARGEST EXCLUSIVE MFGRS.** of headsets in **THE COUNTRY**, we are able to produce the **TOWER'S SCIENTIFIC** Headset at the low price of \$2.95.

Companies of more limited production could not afford to sell such quality phones at anywhere near this price.

NOW \$2.95
Plus a few cents postage
YOUR PROTECTION

Every set tested and approved by licensed radio operators. Every set covered with money-back guarantee.

Production, over one million double headsets for this season.

Order at once by post card and we will ship immediately by Parcel Post C. O. D.

THE TOWER MFG. CO.

98 ^{Dept.} _U Brookline Ave, Boston, Mass.



RADIO NEWS

Published by EXPERIMENTER PUBLISHING COMPANY, INC.,
 Publishers of "Radio News," "Science and Invention," "Practical Electrics" and
 "Motor Camper & Tourist."
 Editorial and General Offices: 53 Park Pl., N. Y. C.
 H. GERNSBACK, President. S. GERNSBACK, Treasurer. R. W. DEMOTT, Secretary.

MEMBER: AUDIT BUREAU OF CIRCULATIONS

VOL. 6 CONTENTS FOR AUGUST 1924 NO. 2

	Page		Page
Editorial.....By Hugo Gernsback	153	Saving Tubes with Reflex Circuits	
The Solodyne Principle		By John Scott-Taggart	180
By G. V. Dowding and K. D. Rogers	154	Reducing the Summer Static Nuisance	
Solodyne Circuit Using Standard Tubes		By L. W. Hatry	183
By A. D. Cowper	157	With the Amateurs.....	184
Working Vacuum Tubes Without "B" Batteries		Ripples, Normal and Abnormal	
—Solodyne Principle....By John Scott-Taggart	158	By Edward W. Berry	186
Putting the Super-Heterodyne on Wheels		The Effect of Fog Upon Radio Signals	
By S. R. Winters	160	By A. A. Kubiak	187
The New French Broadcast Station.....	161	\$500 Radiation Eliminator Prize Contest.....	187
Radio Pictorial	162	Reflexing a Tuned Radio Frequency Receiver	
Radio News in Pictures.....	164	By Clyde J. Fitch	188
Allez, Houpla!.....By Robert Francis Smith	168	What to Expect from Your Radio Receiving	
Esperanto Radio World Language		Set	189
By James D. Sayers	169	A Real DX Transmitter.....By R. N. Jones	190
The Tropadyne Circuit.....By Clyde J. Fitch	170	Principles of C.W. and Radiophone Transmission	
Expanding the Beginner's Set...By A. P. Peck	173	and Reception.....By L. R. Felder	191
How to Build Radio Sets..By H. E. Benedict	175	Awards of the \$50 Radio Wrinkle Contest.....	192
The Importance of the Trivial, Part II		Radio Humor	194
By Sir Oliver Lodge	176	Radiotics	194
Radio Does Not Electrocute.....	177	Standard Hook-Ups	195
Loud Speaker Works on Crystal		Correspondence from Readers.....	197
By Capt. S. A. Huss	178	Radio News Laboratories.....	198
Oscillations.....By Willard Wilson	179	New Radio Patents.....	200
Radio Broadcast Advertising in Argentina		I-Want-To-Know	201
By R. A. Gibson	179	Calls Heard	230
Index to Advertisers.....	148		

RADIO NEWS is published on the 10th of each preceding month. There are 12 numbers per year. Subscription price is \$2.50 a year in U. S. and possessions, Canada and foreign countries, \$3.00 a year. U. S. Coin as well as U. S. Stamps accepted (no foreign coins or stamps). Single copies, 25 cents each. A sample copy will be sent gratis on request. Checks and money orders should be drawn to order of EXPERIMENTER PUBLISHING CO., INC.

All communications and contributions to this journal should be addressed to Editor, RADIO NEWS, 53 Park Place, New York, N. Y. Unaccepted contributions cannot be returned unless full postage has been included. All accepted contributions are paid for on publication. A special rate is paid for novel experiments; good photographs accompanying them are highly desirable.

RADIO NEWS, Monthly. Entered as second-class matter at the Post Office, at New York, N. Y., with additional entry at Long Island City, N. Y., under the act of March 3, 1879; formerly entered at Brooklyn, N. Y. Title registered U. S. Patent Office. Copyright, 1923, by E. P. Co., Inc., New York. The Experimenter Publishing Co., 53 Park Place, New York. The contents of this magazine are copyrighted and must not be reproduced without giving full credit to the publication. Copyright in Germany. Publication and reproduction of articles in German is reserved for Radio, Berlin 42, Germany.

New York City
 General Advertising Dept.
 53 Park Place

Western Advertising Representatives
 Fincan & McClure
 720 Cas. St. Chicago, Ill.

RADIO NEWS is for sale at all newsstands in the United States and Canada, also at The International News Co., Ltd., Bream's Building, London, E. C. 4, England, and at Brentano's, 37 Avenue de l'Opera, Paris.

HOW TO SUBSCRIBE FOR RADIO NEWS. Send your name, address and remittance to Experimenter Publishing Co., 53 Park Place, New York. Mention the name of the magazine you are ordering. We also publish SCIENCE AND INVENTION, PRACTICAL ELECTRICS and MOTOR CAMPER & TOURIST. Write early.

RATES AND TERMS. The subscription rate for RADIO NEWS is \$2.50 per year (12 numbers). When remitting do so by check, money order, or registered letter if cash is enclosed. Avoid sending cash through the mail if possible. Subscriptions for less than one year are not accepted. Subscription may be made in combination with SCIENCE AND INVENTION or PRACTICAL ELECTRIC.

POSTAGE. We prepay postage in all parts of the United States, Mexico and island possessions. For foreign or Canadian subscriptions we require 50 cents in addition to the subscription price for additional postage charges.

CHANGE OF ADDRESS. Notify us as far in advance as possible. It requires several weeks to make an address change on our records. Always write clearly.

ON EXPIRATION of your subscription we enclose a renewal blank in our last number to you; we stop our delivery to you on expiration.

Pacific Coast Advertising Representatives
 A. J. Norris Hill Co.
 Hearst Bldg., San Francisco, Calif.

Kansas City Advertising Representatives
 George F. Dillon
 Republic Building, Kansas City, Mo.

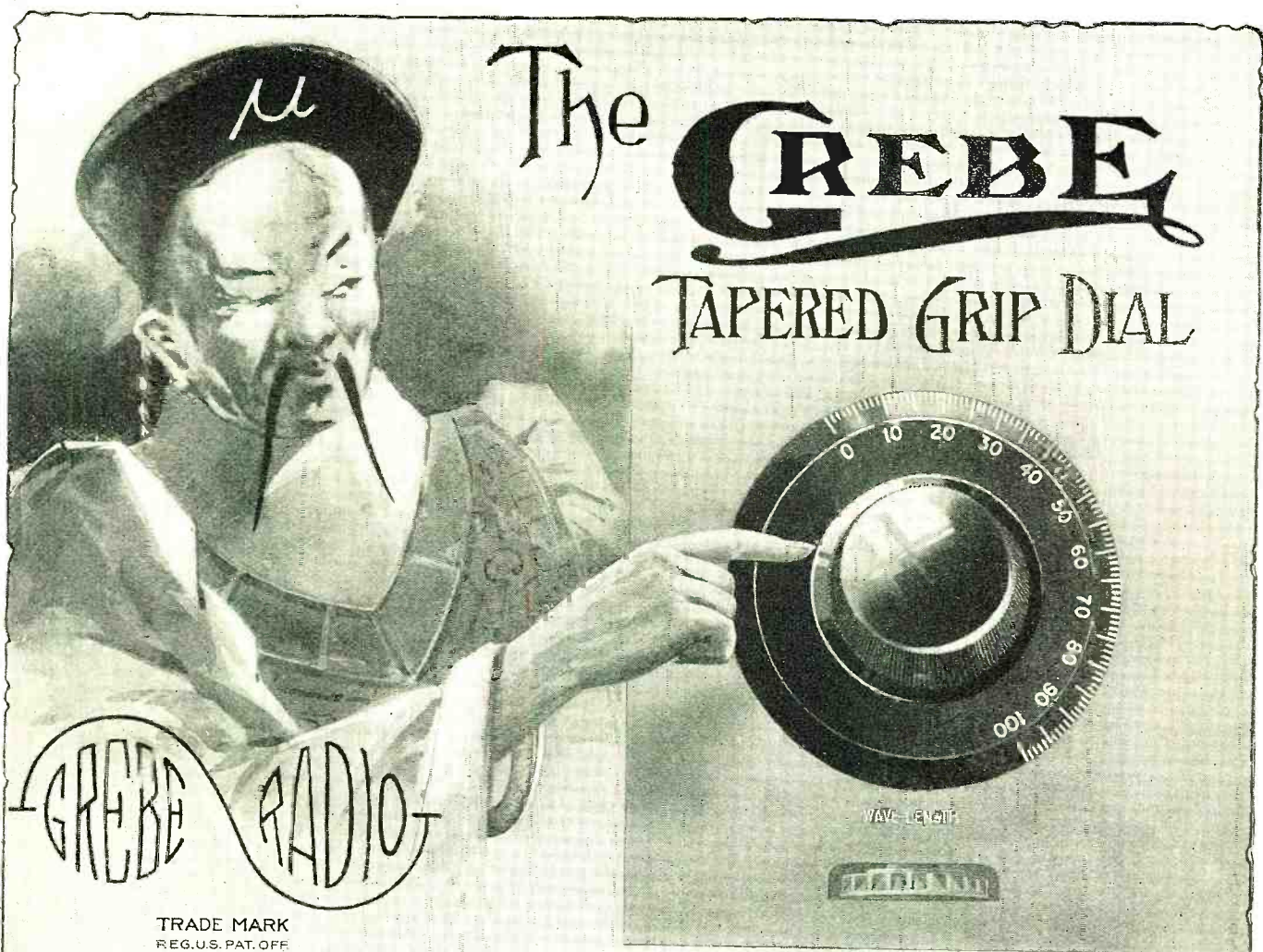

TRADE MARK
REG. U.S. PAT. OFF.

"A slight deviation leads to a great error."
— Confucius

In tuning in the distant stations there must be unflinching precision. The Grebe Tapered Grip Dial gives that precision.

Doctor Wu

THE first tuning dials were ungainly in appearance and crude in performance. Some years ago this company perfected the Tapered Grip Dial, moulded from lustrous black bakelite, that has since become standard equipment on all Grebe Receivers.

This and other details of Grebe craftsmanship are fully protected by patents granted and pending.

Ask your Dealer or write us

A. H. GREBE & CO., INC.

Van Wyck Blvd. - Richmond Hill, N. Y.

Western Branch: 451 E. 3rd St., Los Angeles, Calif.

Grebe Regenerative Receivers are licensed under Armstrong U. S. Pat. No. 1,113,149, Oct. 6, 1914

Index to Advertisers

A	Page
Ackerman Brothers, Inc.	277
Acme Apparatus Company	152
Adams-Morgan Co.	255
Adams Radio Mfg. Co., The	222
Alden Mfg. Company	224-271
Allen, Inc., L. B.	273
Allen-Bradley Co.	280
American Art Mache Company	232
American Hard Rubber Co.	226
American Radio Mfg. Company	212
American Specialty Company	250
American Transformer Com- pany	222
Amplex Instrument Laborator- ies	260-276
Andrea, Inc., F. A. D.	241
Apco Mfg. Co.	277
Arrow Battery Company	258
Atlantic & Pacific Radio Corp., Greater	260
Atwater-Kent Mfg. Company	243
Automatic Electrical Devices Co.	240
Autotyre Co., The	260
B	
B-Metal Refining Company	210
Bakelite Corporation	212
Barawik Company, The	223
Barkeley Electric Mfg. Com- pany	236
Bel-Canto Mfg. Co.	264
Bell Mfg. Co.	273
Benson Engineering Company	240
Blancke & Co., A. C.	259
Blue Seal Mfg. Company	269
Bogue, B. N.	220
Boice, W. B. & J. E.	269
Boonton Radio Corp.	238
Brady Company, A. C.	254
Brady, John B.	262
Brandes, Inc., C.	211
Branston, Inc., Chas. A.	261
Bremer-Tully Mfg. Co.	262
Bristol Company, The	277
Broadcast Service Co.	257
Brooklyn Metal Stamping Corp.	240
Brownlie, Roland	244
Bunnell & Company, J. H.	244
Burlington Watch Company	240
Burt Brothers, Inc.	258
C	
Cannon & Miller Sales Corpora- tion	248
Carter Radio Company	267
Chemical Institute of New York, Inc.	247
Chicago Salvage Stock Store	253
Chicago Solder Company	266
Clapp Eastham Company	238
Consolidated Instrument Com- pany of America, Inc.	228
Conrad Company, Inc. 208-228-234-248-251-264-268-276	
Continental Fibre Company, The	276
Cooper Corporation, The	258
Cosmopolitan Plusiformer Cor- poration	271
Coto-Coil Company	245
Coyne Electrical School	261
Crescent Mfg. Company	246
Crosley Radio Corporation, The	209
Cruver Mfg. Company	266
Cunningham, Inc., F. T. Inside Front Cover	
D	
D. R. V. Importing Co.	220
D.X. Instrument Co.	219
Dey's Radio Service	269

Diamond Electric Specialties Corp.	Page
Diamond Electric Specialties Corp.	265
Dictograph Products Corpora- tion	250
Dieterich, Albert E.	262
Dubilier Condenser & Radio Cor- poration	244
Duck Company, The Wm. B.	226
Durkee-Thomas Products Co.	224
E	
E. I. Company	206-244-258
Eagle Radio Company	246
Eastern Coil Corp.	270
Eiesmann Magneto Corp.	210
Electrad, Inc.	279
Electrical Research Laboratories	235
Electric Service Supplies Com- pany	264
Electric Specialty Company	228
Elgin Radio Supply Company	250
Erie Fixture Supply Co.	279
Evans & Company, Victor J.	262
F	
Fahnestock Electric Company	279
Fansteel Products Company, Inc.	263
Federal Telephone & Telegraph Company	249
Ferbend Electric Company	242
Ford Mica Company	234
Formica Insulation Company, The	229
French Battery & Carbon Com- pany	212
Freshman Company, Inc., Chas.	242-246
Friedlander-Kopple Radio Serv- ice	263
Frost, Inc., Herbert H.	204
G	
General Insulate Company	266
General Radio Winding Co.	242
Gillfillan Bros., Inc.	248
Globe Electric Company	254
Globe Radio Equipment Co.	240
Goldschmidt Corporation, Th., Inside Back Cover	
Gould Storage Battery Company	256
Graham Company, Alfred	222
Great Lakes Radio Co.	220
Grebe & Company, Inc., A. H.	147
Grewol Mfg. Company	262
H	
H & H Radio Company	242
Halldorsen Company	232
Hammarlund Mfg. Co.	263
Hammer Radio Co., S.	250
Harvard Radio Laboratories	267
Hayden Radio & Research Co., A. C.	252
Haynes-Griffin Radio Service, Inc.	259
Heath Radio & Electric Mfg. Co.	240
Herbert, Inc., Harold	236
Holtzer-Cabot Electric Co., The	216
Hommel & Company, Ludwig	270
Hudson-Ross	204-266-279
I	
International Correspondence Schools	268
Inter-State Signal Company	273
J	
Jones, Heward B.	244

Kellogg Switchboard & Supply Co.	Page
Kellogg Switchboard & Supply Co.	218
Keystone Elec. & Radio Co.	242
Kilbourne & Clark Mfg. Co.	248
Kimley Electric Co.	256
Klaus Radio & Electric Co.	246
L	
Lacey & Lacey	262
Lambert, Leon	270
Lancaster & Allwine	262
Lee Electric Mfg. Company	220
Leich Electric Company	254
Liberty Electric Corp.	254
Liggett & Myers Tobacco Co.	275
Lincoln Mfg. Company	266
M	
McSweeney Auto Tractor & Elec- trical Schools	254
M	
Magnavox Company, The	213
Marle Engineering Company	210
Martin-Copeland Company	214
Marvel Radio Specialty Com- pany	240
Michigan Radio Corporation	273
Midwest Radio Company, The	259
Miller Rubber Company of New York	230
Modern Electric Mfg. Co., The	220
Montrose Mfg. Co.	210
Mozart-Grand Company, The	257
Multiple Electric Products Co.	208
Mu-Rad Laboratories, Inc.	219
Murdock Company, Wm. J.	151-203
Music Master Corporation	205
Myers Co., Ltd., E. B.	232
N	
Nassau Radio Company, Inc.	210
National Airphone Corporation	217
National Carbon Company, Inc.	207
National Radio Institute	215
Newman-Stern Company, The	222
New York Institute of Photog- raphy	242
Norden, Hauck & Company	252
Nutrone Mfg. Company	233
O	
Ohio Radio Sales	273
Omnigraph Mfg. Co., The	218
O'Neil Mfg. Company	279
Owen, Richard B.	262
Ozarka, Inc.	230
P	
Pacent Electric Company, Inc.	250
Pacific Arms Corporation	260
Parker, C. L.	262
Pathé Phonograph & Radio Cor- poration	265
Pfanstiehl Radio Service Co.	256
Phenix Radio Corp.	221
Pioneer Radio Corporation	277
Precision Coil Company	232
Press Guild, Inc., The	266
Primary Mfg. Corp.	234
Pyramid Products Company	252
R	
R-C Mills Radio Corporation	222
Radiall Company	279
Radio Association of America	257
Radio Auto Distributors	214
Radio Corporation of America Back Cover	
Radiogem Corporation, The	255-266
Radio Industries Corporation	237

Radio Rabat Company, The	Page
Radio Rabat Company, The	230
Radio Shack, The	276
Radio Specialty Company	239
Radio Tube Exchange	268
Radio Tube Hospital	266
Randolph & Company	263
Rathbun Mfg. Company, Inc.	232
Rauland Mfg. Company	269
Reliable Parts Mfg. Company, The	268
Rolls Royce Tube Company	240
Ryder, Frank A.	256
S	
S & H Battery Supply Co.	216
Salisbury Bros. Furniture Co., 210-252-256	
Saturn Mfg. & Sales Co., Inc., The	238
Scanlon, Everett	269
Segal's	276
Service Battery Company	279
Shamrock Mfg. Co.	245
Shepard-Potter Company, Inc.	253
Shipman-Ward Mfg. Co.	252
Sidbenel Radio Equipment Mfg. Company	250
Signal Electric Mfg. Co.	268
Solderall Co.	256
Stanley Radio Supply Co., The	255
Sterling Mfg. Co., The	260
Stevens & Company	276
Stone Electric Co.	268
Stransky, John A.	234
Stromberg-Carlson Telephone Mfg. Co.	204
T	
Telephone Maintenance Com- pany	264
Terlee Electric & Mfg. Company	279
Thompson Mfg. Company, R. E.	266
Thor Radio Company	260
Torrington Mfg. Company, The	226
Tower Mfg. Co., The	145
Tresco Sales, Inc.	265
Triangle Rubber & Supply Co.	249
Trimm Radio Mfg. Co.	258
Tuska Company, The C. D.	228
U	
U. S. Tool Company, Inc.	220
Uncle Sam Electric Co.	279
United Electric Stores Co.	250
Unity Mfg. Company	261
V	
Valley Electric Co.	263
Van-Le Corporation	204
Vesco Radio Co.	250
W	
Walbert Mfg. Company	248
Walnat Electric Mfg. Co.	222
West Angus Show Card Service, Ltd.	232
Wetern Coil & Electrical Co.	220
Western Radio Mfg. Co.	240
Western Rubber Mould Co.	226
Westinghouse Union Battery Company	225
Weston Electrical Instrument Co.	226
Willard Storage Battery Co.	227
Wilmington Fibre Specialty Co.	254
Wireless Mfg. Company, The	264
Work-Rite Mfg. Co., The	260
World Battery Company	242
XYZ	
Y. M. C. A. Radio Institute	216
Zenith Radio Corporation	231

RADIO NEWS READERS' BUREAU

Time and Postage Saver

IN every issue of RADIO NEWS you undoubtedly see numerous articles advertised about which you would like to have further information. To sit down and write an individual letter to each of these respective concerns, regarding the article on which you desire information, would be quite a task.

As a special service to our readers, we will write the letters for you, thus saving your time and money.

Just write the names of the products about which you want information, and to avoid error the addresses of the manufacturers, on the coupon below and mail it to us.

If the advertiser requires any money or stamps to be sent to pay the mailing charges on his catalogue or descriptive literature, please be sure to enclose the correct amount with the coupon.

We will transmit to the various advertisers your request for information on their products.

This service will appear regularly every month on this same page in RADIO NEWS.

If there is any Manufacturer not advertising in this month's issue of RADIO NEWS, from whom you would like to receive literature, write his name, address and the product in the special section of the coupon below.

TEAR ALONG THIS LINE

READERS' SERVICE BUREAU,
Experimenter Publishing Co., Inc., 53 Park Place, New York, N. Y.

Please advise the firms listed below that I would like to receive detailed information on their product as advertised in the issue of RADIO NEWS.

NAME	ADDRESS	List here specific article on which you wish literature.	If Catalogue of complete line is wanted, check in this column
.....
.....
.....
.....
.....
.....
.....
.....
.....
.....

If you desire any special information from a manufacturer whose advertisement does not appear in this month's issue, use this space.

.....
.....
.....

If you are dealer check here.

Your own name here

Address

City State

*Watch
for these
Departments
in the*
**MOTOR
CAMPER &
TOURIST**

THE OPEN ROAD

One of the most valuable departments in this magazine is "THE OPEN ROAD." Each month, in this department, are shown different important highways and routes in the United States in map form so that in a short time anyone can become familiar with the best highways in the country.

CAMPSITES

This department is for the man who wants to camp in the outdoors on his motor trip. It shows the number and location of campsites in every state in the Union.

PARKS

One of the most desirable features of touring in America is the prevalence of wonderful, scenic parks, especially the great National Parks. There is a special department for these places.

RADIO IN CAMP

This is an unusual department for the man who is interested in Radio as a pleasant adjunct to the motor trip. It is compiled by a staff of the foremost Radio Experts in America.

ROADSIDE REPAIRS

Every autoist will welcome this department as a friend in need when the car breaks down on the road. Every line in it is of value to every motorist.

**AROUND THE CAMP-
FIRE**

New and interesting things that come up from day to day and are of value to the motor traveller are in this department. It is a section of the book in which the reader always feels a personal interest.

NEW ACCESSORIES

A department for the Motor Car in which every new and worthy accessory of value to the Motor Camper and Tourist is detailed.

Then there are many feature articles written by men who have travelled everywhere in America. They tell of their trips and experiences and give many valuable hints on what to take on a trip, what to look out for and how to get the utmost in pleasure from the trip.



**HAVE YOU SEEN A
COPY?**

*A New Magazine Is Now On All
Newstands*

Ask the nearest newsstand dealer to let you see a copy.

This magazine tells you how to get the most from your car.

It is the most beautifully printed magazine in America, 64 Pages, Printed in four colors and all Rotogravure with hundreds of pictures.

It is Edited by H. GERNSBACK, Editor of RADIO NEWS, SCIENCE and INVENTION, and PRACTICAL ELECTRICS.

**MOTOR
CAMPER &
TOURIST**

LET THE POSTMAN DELIVER THE MOTOR CAMPER & TOURIST TO YOU EACH MONTH. USE THE SUBSCRIPTION BLANK BELOW.

Germott Publishing Co., Inc.,

R.N.-8

53 Park Place, New York City

Enclosed you will find \$2.50 for my subscription to MOTOR CAMPER & TOURIST for one year.

Address

Name

**AT ALL NEWSTANDS
25c
THE COPY**

THE Murdock Neutrodyne Receiver, Type C. S. 32. Registered U. S. Patent Office. Licensed by Independent Radio Mfrs., Inc., under Hazeltine Patents.

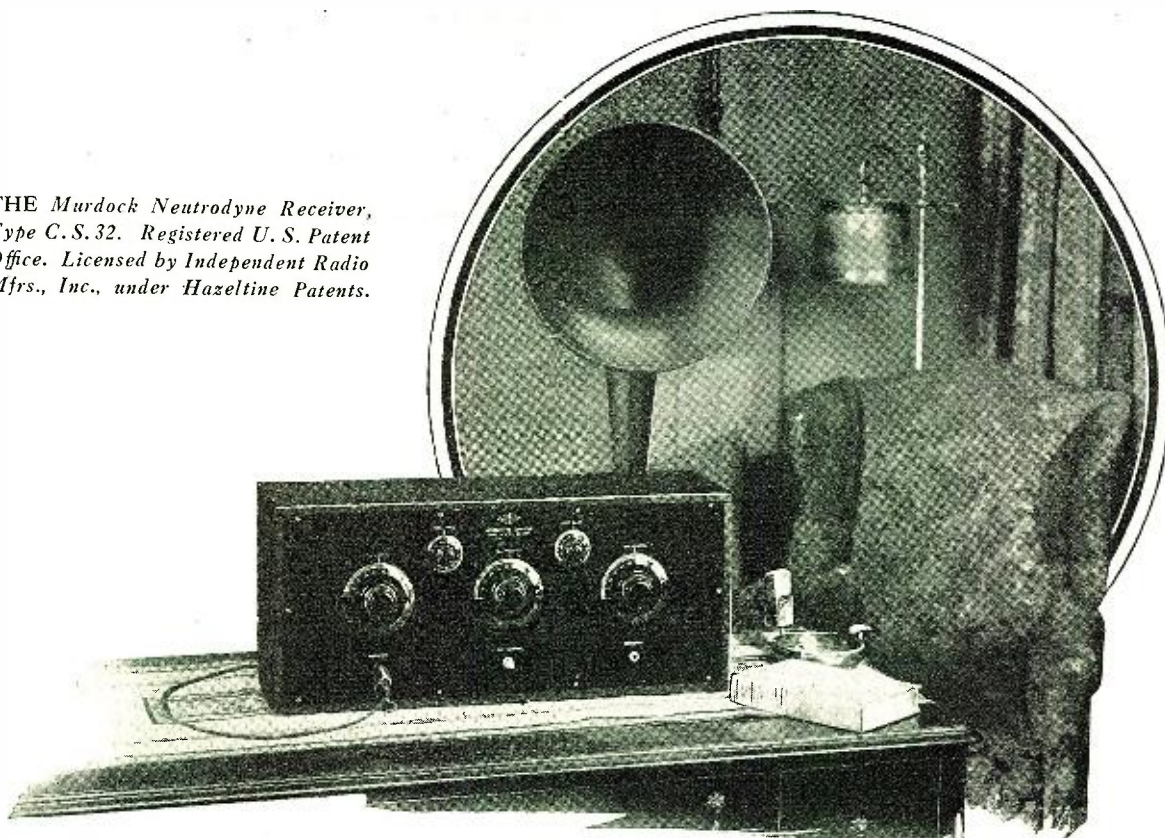

The Murdock Neutrodyne will end your search for the "right" receiver

THE Murdock Neutrodyne represents radio at its best. It is the product of one of the oldest radio manufacturers—a firm which has been making radio equipment of the highest efficiency since 1904. It embodies the famous Hazeltine Neutrodyne circuit with the finest materials and the most exacting New England craftsmanship. Every detail of manufacture is painstakingly carried out—to make this receiver an efficient, permanent instrument for the home.

Does not howl or squeal

THE efficient circuit and accurate assembly of units assure undistorted reception, free from disturbing squeals and noises.

Distant Stations can be tuned in with remarkable clearness and volume. All but the most distant can be heard on a loud speaker.

Local Stations can be tuned out

readily, enabling the user to choose the broadcast programs he wants to hear at will—without interference from other stations.

Easy to Operate. Anyone can learn to operate this receiver with ease and skill. A station once located and the dial readings recorded, that station can always be brought in again by returning to the same position on the dials.

Appearance. The handsome solid mahogany cabinet and black panel make the Murdock Neutrodyne acceptable to the most exacting environment.

Dependability. This receiver can be depended upon to give the most satisfactory results under all conditions where reception is possible.

Go to your dealer and let him demonstrate the Murdock Neutrodyne for you. He will arrange for installation. Our symbol is your guarantee of complete satisfaction.

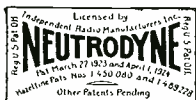

WM. J. MURDOCK CO., 365 Washington Ave., Chelsea, Mass.
Branches: New York, Chicago, San Francisco

MURDOCK RADIO PRODUCTS

Standard since 1904

Send for this free booklet

WM. J. MURDOCK CO.,
365 Washington Ave., Chelsea, Mass.
Gentlemen:
Please send me, without obligation, your Free Booklet describing the Murdock Neutrodyne Receiver.
Name
Street
City State

Improve your set with an ACME "lowest loss" condenser

Because of low losses and sharp tuning practically all the currents on the antenna can now be used

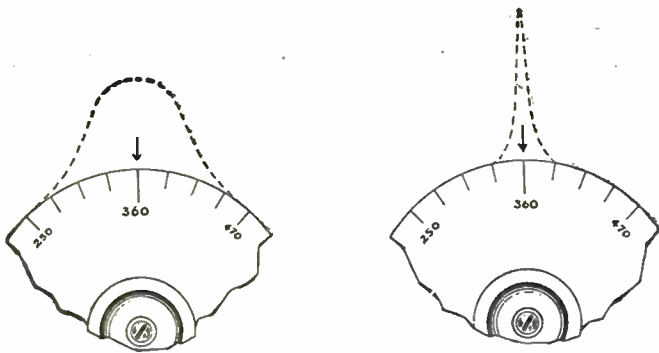

Which one is your tuning circuit
—the hump or the peak

HERE are the curves of two tuning circuits. The hump has a high loss condenser and the peak a low loss condenser. Both receive broad-casting, but the peak receives local and distant stations without interference, while the hump receives only the nearby stations with interference. The new Acme Condenser will change your tuning circuit from a hump to a peak.

The Acme engineers have been working for two years to bring a condenser which would give to Radio experimenters sharp tuning and minimum losses. The new Acme Condenser has these fundamental advantages and also has many new improvements in structure and equipment. See the illustration with explanation, and, for more information, write to us for booklet—"Amplification without Distortion," which contains many diagrams and helpful hints on how to build and get the most out of a set.

ACME APPARATUS COMPANY
 Dept. 67 Cambridge, Mass.

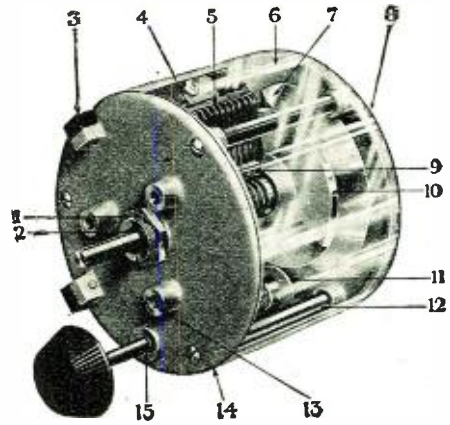

- 1—Steel brass cone bearings adjustable.
- 2—Lock nut for bearing.
- 3—Highest grade hand rubber Dielectric in that part of the field to prevent losses.
- 4—Brass separator to which both rotary and stationary plates are soldered, making continuous circuit for each.
- 5—Brass silver plated plates; rotary plates log-arithmetic.
- 6—Dust proof covering.
- 7—Stops at extreme end of movements.
- 8—Coiled connection between shaft and heads allowing lubrication of bearings.
- 9—Brass separator to which both rotary and stationary plates are soldered, making continuous circuit for each.
- 10—Counterweight which balances rotary plates.
- 11—Noiseless friction Vernier control seven to one ratio.
- 12—Brass separators to prevent twisting and to take strain off Dielectric.
- 13—Panel mounting holds for 120 degrees spacing.
- 14—Metal heads.
- 15—Steel bushing to prevent wear on Vernier shaft. ALL parts are of non-rusting metal, except steel bearing which is covered with nickel-plated protective surface. End plate capacity is .000016 m.f., full capacity is .0005 m.f. Price \$6.50.

Cut out and send this coupon

ACME APPARATUS COMPANY,
 Dept. 67, Cambridge, Mass., U. S. A.
 Gentlemen: I am enclosing 10 cents (U. S. stamps or coin) for a copy of your book, "Amplification without Distortion."

Name

Street

City

State

ACME ~for amplification

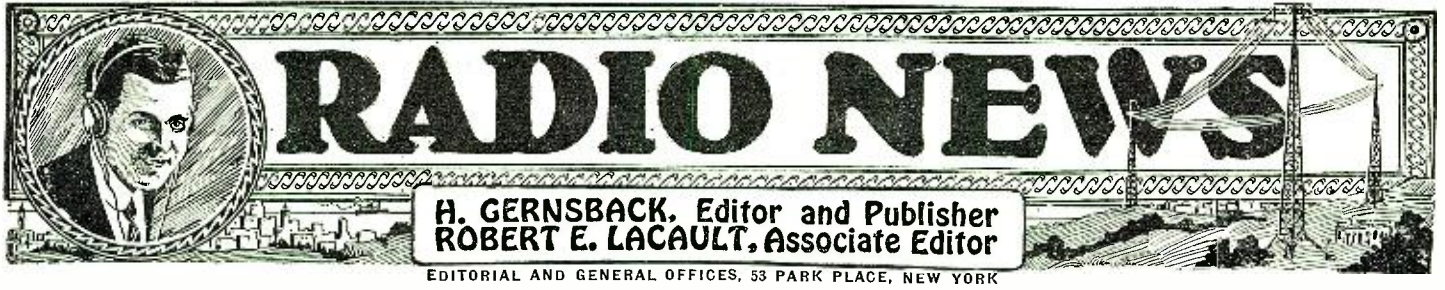

Vol. 6

AUGUST, 1924

No. 2

The Solodyne Principle

By HUGO GERNSBACK

IN radio, as in most of the other arts, efficiency brought about by constant simplification is usually the key-note of our endeavors. Always in quest of simplified radio, RADIO NEWS this month takes pleasure in presenting to its readers the *Solodyne* principle. The word *Solodyne* (*Solo* meaning single and *Dyne* meaning power) translated means *Single-power*. The present day radio receiving outfit uses two sources of power namely the "A" battery for the heating of the filament, and the "B" battery for the high tension current supply.

The *Solodyne* principle does away entirely with the "B" battery and all high tension current. The only source of power under this epoch-making system is the "A" battery, which is now made to do double duty.

It should be understood from the start that the *Solodyne* principle does not represent any one circuit. In a short time we will see hundreds and thousands of *Solodyne* circuits. The word *Solodyne*, therefore, means simply a "B"-batteryless high-tensionless radio circuit. It implies the same meaning as the phrase *Super-Heterodyne* principle or the *Neutrodyne* principle, which do not represent any one circuit. As is well known of the two latter, several circuits of each system are in use.

The *Solodyne* principle, known in England under the term of *Unidyne*, was brought to the attention of the public by Messrs. G. V. Dowding and K. D. Rogers, Editors of a well known English radio publication. These experimenters have achieved remarkable results with the new system, which is fully described in this issue. The key-note of all *Solodyne* circuits lies in the two-grid vacuum tube. It is the same old vacuum tube with the addition of an extra grid. It is this extra grid which makes for greater efficiency in the *Solodyne* circuits.

Here we must diverge from the subject and state that the *Solodyne* principle is by no means new. As a matter of fact, RADIO NEWS published such a circuit about five years ago. Two-grid tubes have also been known since 1918 and perhaps before. There have been many patents or such circuits, but the honors nevertheless go to Messrs. Dowding and Rogers for the simple reason that they were the first to forcibly bring the system to the attention of the public at large, with a receiving set which can actually be worked, using only an "A" battery, suppressing the "B" battery entirely. These remarks are made solely for the reason that these English experimenters have already been criticized vigorously by the English radio press for exploiting old and well-known principles. RADIO NEWS is well aware of the fact that the same criticism will be directed to its policy in thus bringing before the American public the *Solodyne* principle, which the Editors frankly admit is by no means a novelty.

When Marconi first came out with his Wireless it was heralded as one of the greatest inventions the world had ever seen. Nevertheless Marconi did not invent wireless itself. The principles were well known and had been known

to every scientist since Heinrich Hertz, the real inventor, first published his researches. But the chief trouble with great inventors is that they are not practical. Heinrich Hertz did nothing with his discovery and did not dream that it could be used to send intelligence over great distances without wires. That honor belongs to Marconi who took the well known principle and made it practical.

Exactly so with the *Solodyne* principle, which in reality is old, but now for the first time is put to practical use.

And here we wish to sound another note of warning. The practical applications of the *Solodyne* principle are as yet new. In presenting the articles in this month's issue of RADIO NEWS to our readers, it should be thoroughly understood that the circuits shown here are of an experimental nature. They are by no means finished products, although a number of manufacturers who have witnessed performances of the circuits have been sufficiently impressed and plan the immediate building of sets.

Our advice to experimenters is to try out the circuits and see just what they will do. One of the important points to remember in the *Solodyne* circuit is that everything must be in perfect condition and adjustment. There is not much energy to lose, and only the best of apparatus will bring in results. Low-loss condensers and coils will give results. Then, too, we have the two-grid vacuum tube, which is the most important of all. These tubes have been manufactured for a number of years in Europe. In America we are behind in the production of them, but it is hoped that tube manufacturers will see their opportunity and turn out a worthwhile product, because the *Solodyne* circuit stands or falls by the two-grid tube. While it is true that it is possible to get good results with *Solodyne* circuits using ordinary tubes, as disclosed in an article in this issue, it is our opinion that a two-grid tube will give better results.

As for performance, it should be well understood that nothing extraordinary is claimed for the new circuits. It should be understood that a good one-bulb *Solodyne* circuit will not give vastly superior results to the ordinary single circuit regenerative receiver, BUT the advantages of the *Solodyne* circuits are that the "B" battery noises are done away with entirely; consequently DX signals will come in better and clearer, although not louder. The quality of the received speech and music seems to be much better as reproduced by the *Solodyne* circuits, than with circuits using "B" batteries. Then, of course, the suppression of the "B" battery is a real advantage. Wiring and connections are vastly simplified, and most important in the *Solodyne* circuits, it becomes an absolute impossibility to blow out vacuum tubes by wrong connections. It is well known that over 80 per cent. of the tubes are blown out, while only about 20 per cent. burn or wear out naturally.

We are confident that during the next few years the *Solodyne* principle will be adopted in the majority of radio receiving sets. RADIO NEWS will bring from month to month new *Solodyne* circuits and full discussion of them.

The Solodyne Principle

By G. V. DOWDING and K. D. ROGERS

One of the greatest forward strides taken in the radio art in recent years is described in this article by two English technicians. It details the practical working of the ordinary radio tube receiver without the customary "B" battery.



Messrs. G. V. Dowding and K. D. Rogers with their first set working without "B" Batteries.

HAVING been engaged in radio research of one sort or another for a great many years and being in constant touch with the radio art, the inventors came to the conclusion about eight months ago that one of the most needed improvements to be made was the elimination of the "B" battery in connection with vacuum tube receivers. Immediately following this decision, there began experiments which have been brought to a successful conclusion through the circuit given in the accompanying illustration.

The inventors had been working with cold filament emission for some time before taking up the problem of the "B" battery elimination. Great advance made by others in the perfection of the platinum coated filament tubes led them to believe that a much more profitable advance for the radio world could be made by working on the problem of "B" battery elimination.

Following this decision on the part of the authors about six months ago they began immediately the series of experiments which are briefly sketched here.

Of course, since there was practically no information as to other investigations along the same lines, all work was pioneering. There was no precedent upon which to work. There was very little in the accepted theory of the working of the vacuum tube which could be considered a lead upon which to begin investigations.

From this condition, it will be seen that the authors were working to a large extent on "wild ideas." All the laws of radio and physics were constantly considered. It is not to be thought, from the assertion that "wild ideas" played a great part in the experiments, that it was customary to hook up apparatus as chance presented, in the hope that some clue would be discovered by accident which would lead to an idea worth while. Quite the contrary. Throughout the entire essays, the set-up of the apparatus was preceded by some well worked out idea. Nothing was done purely on the dictates of chance.

The inventors, having had long experience with the operation of vacuum tubes

WE are happy to present herewith the first of a series of articles on the SOLODYNE principle. These articles will be published exclusively in RADIO NEWS. There will be several articles, and we feel sure that all our readers will wish to read each and every one of them.

The original English circuit used three honeycomb coils, but inasmuch as these are not so much in favor now in American sets, the Editors have modified the English circuit by using a closely coupled variocoupler, as shown in the photographs.

With the set illustrated and described here, the Editor was able to duplicate the performance of a good single circuit tuner. In connection with a 60-foot, rather poor antenna the following stations were picked up from New York City on a hot summer night when static was rather bad:

- KDKA—Pittsburgh, Pa.
- WOO—Philadelphia, Pa.
- WDAF—Chicago, Ill.
- WDAF—Kansas City, Mo.

All of these were picked up within one hour.

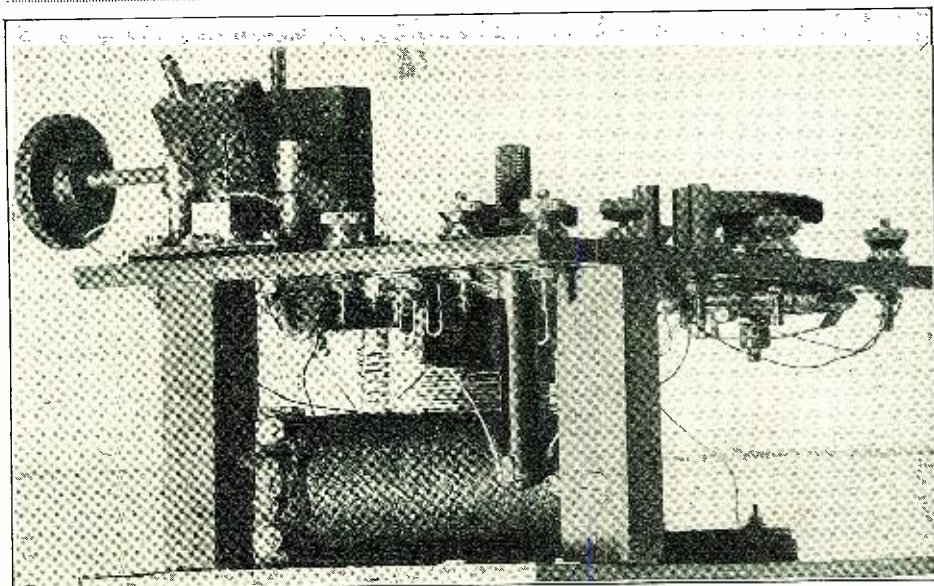

The experimental set built by the authors. Note the British apparatus used in its construction.

NOTICE: By special arrangement with POPULAR WIRELESS of London, RADIO NEWS has acquired the sole publication rights for the United States and Canada, on the entire SOLODYNE principle articles. These articles must not be reprinted unless full credit is given to RADIO NEWS.

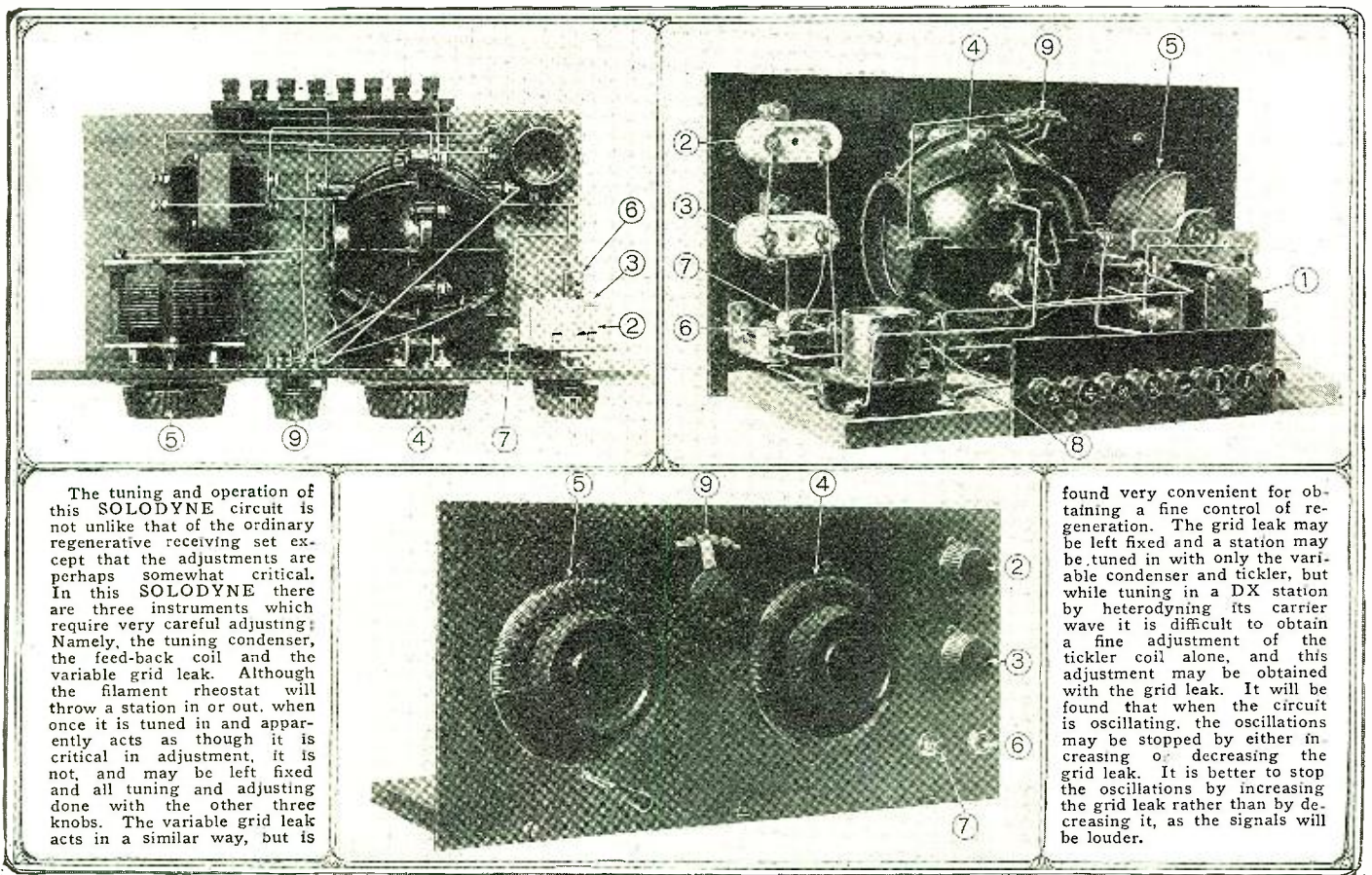

The tuning and operation of this SOLODYNE circuit is not unlike that of the ordinary regenerative receiving set except that the adjustments are perhaps somewhat critical. In this SOLODYNE there are three instruments which require very careful adjusting: Namely, the tuning condenser, the feed-back coil and the variable grid leak. Although the filament rheostat will throw a station in or out, when once it is tuned in and apparently acts as though it is critical in adjustment, it is not, and may be left fixed and all tuning and adjusting done with the other three knobs. The variable grid leak acts in a similar way, but is

found very convenient for obtaining a fine control of regeneration. The grid leak may be left fixed and a station may be tuned in with only the variable condenser and tickler, but while tuning in a DX station by heterodyning its carrier wave it is difficult to obtain a fine adjustment of the tickler coil alone, and this adjustment may be obtained with the grid leak. It will be found that when the circuit is oscillating, the oscillations may be stopped by either increasing or decreasing the grid leak. It is better to stop the oscillations by increasing the grid leak rather than by decreasing it, as the signals will be louder.

Three views of the Solodyne receiver built in the Radio News Laboratories. Although used but a short while it has proved quite efficient. In the photographs the numbers refer to the following parts: 1 audio frequency transformer, 2 variable grid leak, 3 rheostat, 4 variocoupler, 5 variable condenser, 6 jack, 7 switch, 8 grid condenser, 9 primary switch. This receiver embodies the step-up transformer which was used by the inventors in their original set. This transformer has been removed from the set since the picture was taken, as its use was found unnecessary for good operation of the circuit. See circuit on page 156, Fig. 3.

signal. The great saving on the "B" battery supply would also result, as is obvious, since no current would be consumed while there were no signals.

These facts led us more strongly than before into a furtherance of our investigations.

Actually, the signal in the phones is dependent upon variations in the constantly flowing "B" battery circuit. This variation is caused by the impression, more or less directly, of the minute currents of the aerial upon the grid of the tube. This is the generally accepted theory of the operation of the vacuum tube.

A complete circuit is formed when the filament of the tube is lighted. By virtue of the electron stream constantly flowing from the filament, when it is lighted, to the plate, a constant current flows from the "B" battery through the telephones, to the filament and across to the plate and back to the battery again. The actual value of the current is dependent upon the voltage of the "B" battery.

It is at once obvious, that during the time the filament is lighted there is a considerable amount of available current in the tube due to the electron activities in the tube. This is the case both with and without the "B" battery connected. Considering this, why, we thought, would it not be possible to make this current carry the variations of the current for the variations of the signal?

Upon this observation we worked to the final success of the experiments. As usual, the first trials were hopeless fail-

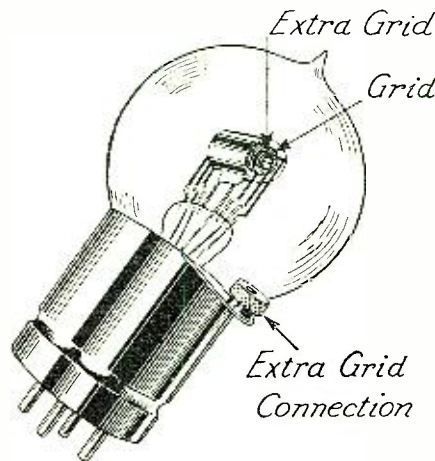

A typical double grid tube of European make.

ures. After setting up and trying many hook-ups that, we thought, should produce results, we heard not a single signal in the receivers—not even a peep from a near-by high powered station, operating but a few miles away. Disheartening? Yes. Such is always the case, however, so we continued the work.

The first sign of success made itself evident with the instruments connected, as shown in Fig 1. Postulating the fact that the constant flow of electrons through the tube would produce a current gradient of sufficient strength to assist in breaking down the resistance of

the tube, we made the connections as shown in the diagram. Following this assertion, and in order to increase the strength of this flow to a point where it would produce results, we connected the primary of a very high ratio transformer in circuit with the "A" battery, the phones and the plate. The secondary of the transformer was connected directly to the plate and filament circuit, as shown.

The actual results of this circuit were nil. However, when the secondary of the transformer was connected to a large plate situated on the exterior of the tube, signals resulted. This marked the turning point of the experiments and we definitely decided that we were working in the right direction for success.

The disclosure of this preliminary success did not create any great stir among the radio public. Possibly this showed discretion on the part of the skeptical. It has long been known that the ordinary three element tube will work well as a rectifier with the terminals of the "B" battery short circuited, or with it disconnected altogether. Fans who live near a powerful broadcast station may prove this for themselves.

Also, the use of an exterior plate—a plate outside the tube has been tried time and again by a number of experimenters.

After the first success the use of a powerful magnet as a diverter of electrons was tried. The results obtained were nil, so the idea was abandoned and work continued without it.

The term SOLODYNE has been trade-marked by RADIO NEWS in the United States as well as in Europe. Manufac-

turers and the trade are cautioned not to use it on any merchandise without the consent of RADIO NEWS.

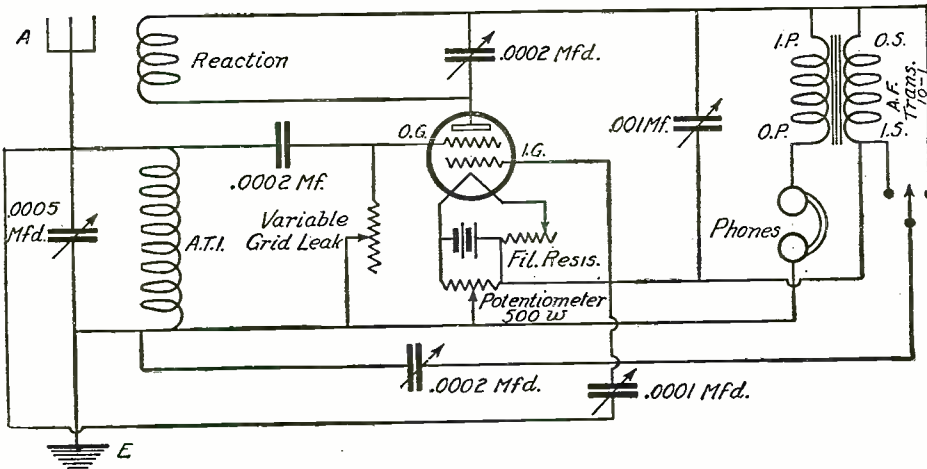

Fig. 2. A Solodyne circuit tried by the authors in their early experiments. O.G. is outer grid, I.G. is inner grid.

Since the external plate was found to produce good results, it was decided to place a second plate inside the tube in proximity to the original one. Such a tube was constructed and the results were surprising; at least, they were an exceptional improvement over the original ones obtained with the exterior plate.

Following this experiment, we passed to the third step in the perfection of the present circuit. Experiments such as the one detailed here necessitate many tubes. After the construction of the first two or three of them there ceased to be any novelty in their manufacture. And it was here that we took the third step, unknowingly.—Some may even lay its discovery to our laziness with regard to the manufacture of tubes.

Double grids have long been on the market. We had some of them lying about the laboratory and, with the expiration of our last home-made double plate affair, decided to try using the double grid tube instead of making more of our own vintage.

It might be well to note here that the double grid valves we obtained for use in these experiments were originally designed to be worked with exceptionally low "B" battery voltage. There had been a large number of circuits marked for use with this type tube, but the success obtained with them had been only fair so they had never come into wide use.

The first successful circuit involving the use of the double grid tube is shown at Fig. 2. This hook-up gave what seemed to us excellent results. They were, in fact, comparable to those obtained with a "super" circuit. And like all "supers," it was about as hard to keep under control. Its stability was not one of its chief virtues, to say the least.

Examination of the circuit will show that every possible means of coupling the plate with the grid circuit were employed. Magnetic coupling was introduced through the tickler coil at the tuning inductance. Electrostatic coupling was cared for through the two condensers.

The theory of the circuit is not difficult to follow. The small plate current due to the electron emission from the lighted filament passes through the tickler coil which feeds back to the main grid circuit in the usual way, the primary of a step-up transformer, through the telephone receivers and then back again to the filament of the valve. The electron stream passing from the filament to the plate inside the tube must pass the two grids. The first of these, which we will call the additional grid, is primarily made positive by connecting it directly to the positive terminal of the "A" bat-

tery. This, in itself, tends to assist the electron stream, to reduce the resistance of the vacuum of the tube. But the additional grid is assisted in its work by hav-

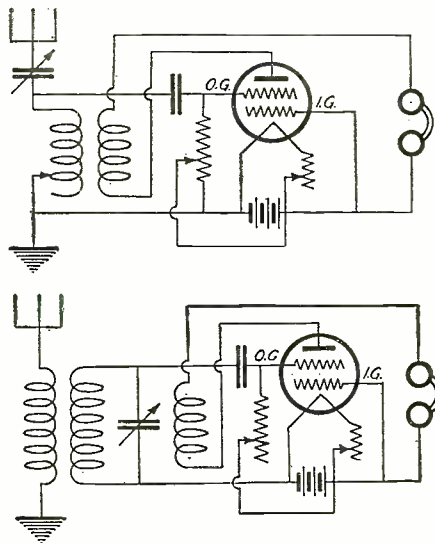

Figs. 3 and 4. Two Solodyne circuits also suitable for double grid tubes. The upper one is similar to that of Fig. 1 without the transformer. The lower one shows how an untuned primary may be used. O.G. is outer grid, I.G. is inner grid.

ing impressed upon it the stepped up voltage from the plate circuit due to the transformer, the secondary of which is in direct connection with the additional grid.

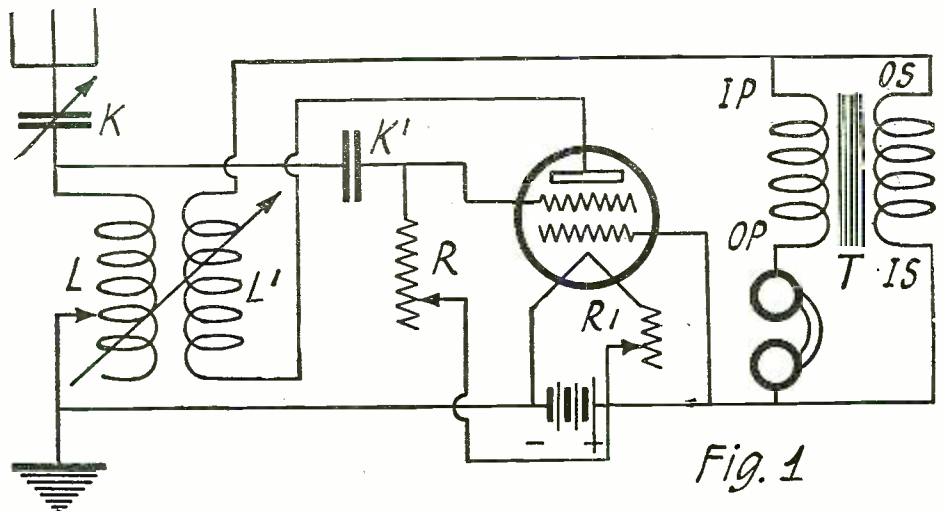

The Solodyne circuit used in the RADIO NEWS' set shown on page 155. In this circuit L and L¹ may be honeycomb coils or a variocoupler.

Thus a building up process is introduced, every possible electron of current primarily due to the electron emission of the filament of the valve being made use of and ultimately passing through the telephone receivers to be reproduced in the form of audible signals. The main grid functions in the usual manner, except that this, too, can be made to help the additional grid as well by giving it a strong positive bias.

In the experiments using the double grid the tubes used were all hard ones, such as could be used either for amplification or detection. As mentioned, many very interesting results have been obtained with the use of soft tubes and very little "B" battery voltage. It is usually impossible to make a hard tube function with low voltage on the plate, however, through any method known except the one shown here.

Soft tubes with four elements may be used in the circuit just described, but the results do not nearly measure up with those obtained for hard tubes. Another difficulty that is exceptionally annoying arises with the soft tubes. The circuits employing them become so unstable as to almost defy good operation. As is well known, it is impossible to amplify with any degree of efficiency through a soft tube.

One of the greatest advantages discovered in all the experiments carried out was the eviction of danger from burned out filaments on account of wrong connections. Since there were no "B" batteries in the circuit, it was, of course, impossible to burn out filaments by putting their voltage where it did not belong. This note is inserted simply to detail another advantage that will become obvious to the experimenter as soon as he begins to work with it.

Advanced amateurs will find the circuit as shown at Fig. 2 very interesting. Ease of operation cannot be promised. It is more or less unstable—worse than the Flewelling, in this respect—but it can be made to give super results. A bountiful supply of patience will be necessary on the part of the operator when he begins work with it, as there is only one position for each of the eight variable controls which will respond to a given wavelength.

The two-way switch is not absolutely necessary. A curious intense increase in signal strength manifests itself, however, at times when the switch is placed in the left position and the condenser is placed across the potentiometer.

(Continued on page 270)

Solodyne Circuit Using Standard Tubes

By A. D. COWPER, M. Sc.



Details of a new circuit using ordinary tubes without "B" battery and employing audio frequency feed-back, are given in this article. The author is a distinguished English experimenter.



THE problem of applying audio-frequency regeneration in order to increase the signal strength still further, on the analogy of the ordinary radio-frequency regeneration which is so effective in this way, has fascinated many experimenters. But the difficulty of controlling audio-frequency regeneration in any ordinary circuit, and the facility with which, on the other hand, an audio frequency oscillation or "howl" of a pitch and character determined by the constants of the particular circuit (rather than by received signals) is set up, have largely baffled them up to the present. Only by using two separate tubes, or a tube and a crystal, and thus disassociating the detecting or rectifying function from an audio amplification (as in ordinary reflex circuits) has the principle of audio reflex been successful in circuits which use ordinary tubes and "B" battery supply. In some two-tube reflex sets, as, for example, in some versions of the ST-100 circuit, there is undoubtedly a limited and controllable audio reflex action in addition to the regular feed-back via the crystal and A.F. transformer; but whenever this is present in practice, the very greatest care is necessary to avoid howling, and that kind of distortion which is due to incipient howling or oscillations of super audio frequencies. Two-tube reflex circuits without a separate crystal rectifier are particularly prone to this kind of trouble.

In order to produce an audio frequency howl there is necessary a certain amount of available energy, which is derived from the usual "B" battery. In R.F. regeneration it is possible to obtain a crude control over self-oscillation by tapping the "B" battery. If in addition the degree of damping in the grid circuit can be varied by controlling the amount of positive bias on it by means of the conventional potentiometer (of, say, 300 ohms resistance) connected across the "A" battery, quite fine control of self-oscillation is possible; this expedient is, of course, commonly used in multi-stage R.F. amplifiers.

HOW CONTROL IS SIMPLIFIED

If a very low value of "B" battery is used, or actually no external "B" battery at all,

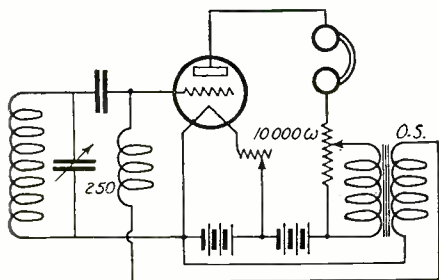

The potentiometer method of applying audio frequency feed-back.

merely about a 2-volt drop of potential in the filament resistance (if this be placed on the positive side of the filament) and a 6-volt "A" battery be used with a 4-volt tube, as is common, then there is very little power available to maintain an audio frequency oscillation, and control becomes a much simpler problem.

It is surprising how little audio regenera-

tion is needed to produce a powerful howl with ordinary circuits which have ample "B" battery supply. By using a potentiometer method of applying a slight audio frequency regeneration, as shown in Fig. 2, this can readily be tested. A variable resistance of, say, 10,000 ohms, made, for example, by smearing a paste of black lead and indian ink on a long strip of heavy paper, with a sliding contact on it (a paper-clip), is placed in series with the phones in an ordinary circuit, and the primary of an ordinary A.F. transformer is connected across the part of the resistance included in the circuit. The secondary of the transformer is connected to the "A" battery negative—or, better, to a potentiometer as in Fig. 3 across the "A" battery—and through a radio choke (to avoid R.F. short-circuits) to the grid of the rectifying tube. When connected up the right

becomes very simple. The primary of a regular A.F. transformer can now be placed boldly in the plate circuit, in series with the phones; and the only control, besides that provided by the filament resistance, is a potentiometer across the "A" battery, which will control the amount of average grid-bias and hence the degree of damping in the grid-circuit. The circuit in Fig. 1 results. It may be applied to any ordinary tube taking about four volts "A" battery and giving a liberal filament emission. No expensive special tubes or apparatus are needed; and the control of the audio frequency regeneration is simplicity itself by means of the potentiometer.

THE GRID CIRCUIT

For successful reception with these low values of "B" battery (two volts or less

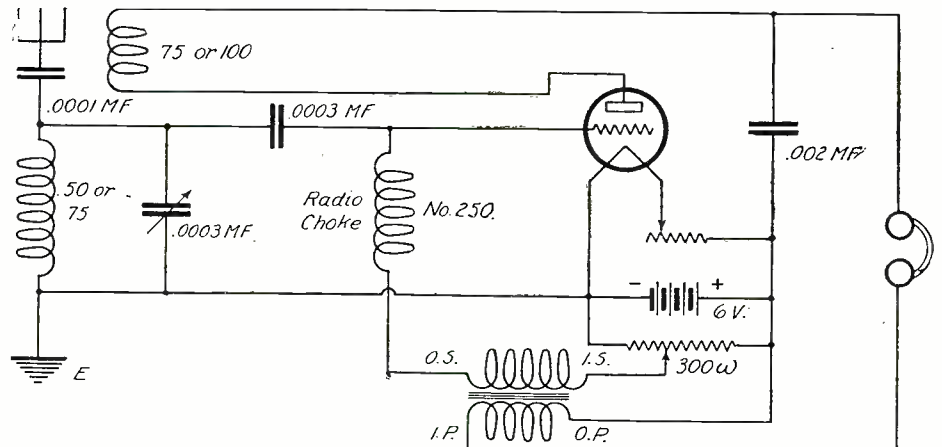

The Cowper circuit uses no "B" battery and is quite stable in operation. The numbers printed near each coil indicate the size of honeycomb or Duo-lateral coils to use in each circuit.

way, there is no need for much of the high resistance connected across the transformer primary to develop a powerful howl by audio regeneration. Actually the amount of safe build-up of signals obtainable this way is not worth the extra apparatus and trouble, so great is the tendency to howl.

MORE ELABORATE CONTROL

With a more elaborate mode of control, as in Fig. 3, a little useful increase of signals can be obtained by very careful adjustments, controlling both the grid-damping—by varying the potential of the point to which the grid leak is taken by means of the potentiometer across the "A" battery—and the efficiency of the feed-back by means of the high series resistance (a variable grid leak of large range). Quite low value of "B" battery will be necessary, if reasonable ease of control is aimed at. It is questionable again, though, if the comparatively small gain is worth the extra complication.

THE PROBLEM SIMPLIFIED

Where in the design of a receiver an attempt is made to cut down the "B" battery supply to a minimum—or even to dispense altogether with an external "B" battery, relying on the two volts or so of "A" battery available when a 6-volt "A" battery is used with ordinary tubes which require only 3.5 to 4 volts in the filament—the amount of power available is so very small that a powerful audio frequency oscillation or "howl" is scarcely possible, so the problem

from the "A" battery) it is necessary to have an extremely lightly coupled grid circuit. In the circuit illustrated, this is achieved by using Mr. Scott-Taggart's constant aerial tuning device of a small fixed series aerial condenser combined with a small parallel tuning variable condenser across the inductance. The radio choke on the grid must be good, preferably a honeycomb one of 250 turns; if of much lower value, the circuit will not respond much to regeneration. The tickler coil is brought very near to the tuning inductance.

To adjust the circuit the tickler coil is swung right up, and the filament made fairly bright. Then the potentiometer is adjusted so that the howl just vanishes. Then R.F. regeneration is somewhat loosened, and the station tuned in by the aerial tuning condenser. Small adjustments of tickler coil, potentiometer, and filament resistance will then generally give some little improvement in the strength and clearness of the signals.

THE TRANSFORMER

The A.F. transformer—of any reliable make—should be connected up as shown, if marked in the conventional manner. Some makes differ in the marking, so the connections should be changed around to find the best arrangement. The outside secondary (O.S.) is almost invariably to be connected to the grid via the radio choke.

(Continued on page 269)

Working Vacuum Tubes Without "B" Batteries—Solodyne Principle

By JOHN SCOTT-TAGGART, F. INST. P.

An interesting discussion on the suppression of the "B" battery in radio circuits, with explanations on how it is done.

THE object of a high-tension battery in a radio receiver is, fundamentally, to draw electrons, which are shot off from the filament of a vacuum tube to a plate producing what is called the plate current. The strength of the plate signal depends upon the variation of the plate current. If there is a small plate current and an incoming signal varies it between zero and maximum, a certain signal strength will be obtained. If, now, we increase the plate current and vary the increased power between

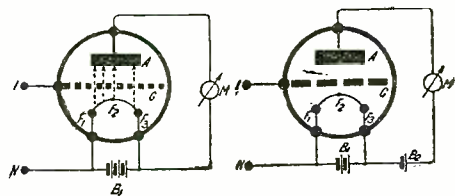

Figs. 4A and 4B. Here is shown the combination of the "A" and "B" batteries into one.

zero and maximum, the signal strength will increase. It is, of course, not possible to obtain something out of nothing, and the same applies to radio tubes. We cannot obtain signals unless we have a plate current of varying amplitude. If the total current flowing through a tube is only a small fraction of a milliampere, it is, theoretically and practically, impossible to get adequate signal strength. The average current flowing in the plate circuit of a tube may be said to be modulated by the potentials applied to the grid. When the grid is made positive, the plate current increases, and when the grid is made negative it decreases.

To establish a normal plate current it is necessary to give the plate a substantial voltage. To produce an average current of, say, 3 milliamperes, it may be necessary to have 100 volts on the plate of the tube. Positive impulses on the grid, if sufficiently large, may increase this average current momentarily to 6 milliamperes, while negative impulses on the grid might reduce it to zero. Such variations would produce very loud signals in a loud-speaker. If the steady plate current were much smaller, by using a lower plate voltage, for example, the maximum output obtainable would naturally be smaller.

It is, therefore, essential to have some plate voltage to produce a real flow of electrons

from the filament to the plate, although its amount will depend upon the type of tube used.

The question naturally arises, "Why is a large plate voltage necessary?" The reason, briefly, is that the resistance of the tube is so high, or to use a better expression—since we will be dealing with fluctuations of current—the impedance of the tube is so great. If we reduce the impedance of the tube, we will be able to use a much lower plate voltage. The resistance, or impedance, of a tube is due, not to the fact that there is a vacuum, but to an effect due to what is termed the "space-charge." A vacuum is an ideal medium for the passage of electrons from the filament to the plate, and we might, therefore, at first think that a very low plate voltage would be sufficient to draw up a large number of electrons shot off from the filament. To explain why this is not so we

the filament depends solely, in the case of a given tube, on the temperature of the filament. Except by altering the temperature of the filament, we cannot alter the number of electrons given off per second, but we can alter the number of electrons which pass to the plate. When an electron is shot off from the filament on account of the internal vibrations in the filament, two influences affect it. One influence is the electrostatic field produced by the plate. The plate being positive with respect to the filament, the electron, which is a negative charge, tends to move from the filament to the plate accord-

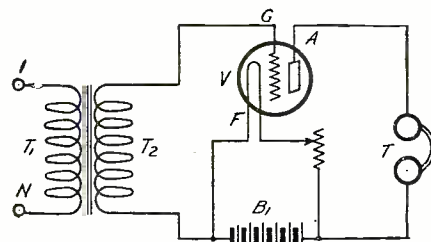

Fig. 5. This illustrates how the "A" battery is connected to apply a small positive potential on the plate.

IN connection with the SOLODYNE principle as printed in another section of RADIO NEWS, we are pleased to present herewith the views of Mr. John Scott-Taggart, the eminent English radio authority.

Mr. Scott-Taggart presents the other side of the story in which our readers will find much food for thought.

Mr. Scott-Taggart has gone into the problem quite thoroughly and the technical reader will find much of interest in this timely subject.

—Editor.

must examine closely the effect of a space-charge.

When a stream of electrons is flowing from the filament to the plate the space between these two electrodes is filled with a cloud of negative particles of electricity. This cloud acts in the same way as any other negative charge, except that instead of the charge being on a body, it is in space, and it is, therefore, called a space-charge. This space-charge, since it possesses the properties of any other negative charge, will tend to repel the electrons emitted from the filament.

Now the number of electrons emitted by

ing to the ordinary laws of electricity. The other force is one due to the repulsion exercised by the mass of electrons which exist between the newly emitted electron and the plate. The large total negative charge in the space between the filament and plate, due to the electrons on their way to the plate, makes it difficult for the newly emitted electrons to emerge from the neighborhood of the filament, and to join in the main stream to the plate. The electron does one of two things: it either goes back again to the filament, or it joins in the main stream. When the plate voltage is small the majority of electrons remain near the filament, but as it is increased, more of them pass. See Fig. 1.

The reason for this is that the electrons are not all emitted from the filament at the same speed; some of them are shot off at high speed and travel a greater distance than others, in spite of the repulsion of the space-charge, while others come out of the filament at a relatively low speed and are unable to overcome the repulsion of the space-charge. The effect of the space-charge varies at different distances from the filament; close

HEAVY CHARGE PROJECTS BULLET THROUGH BOARD TO TARGET

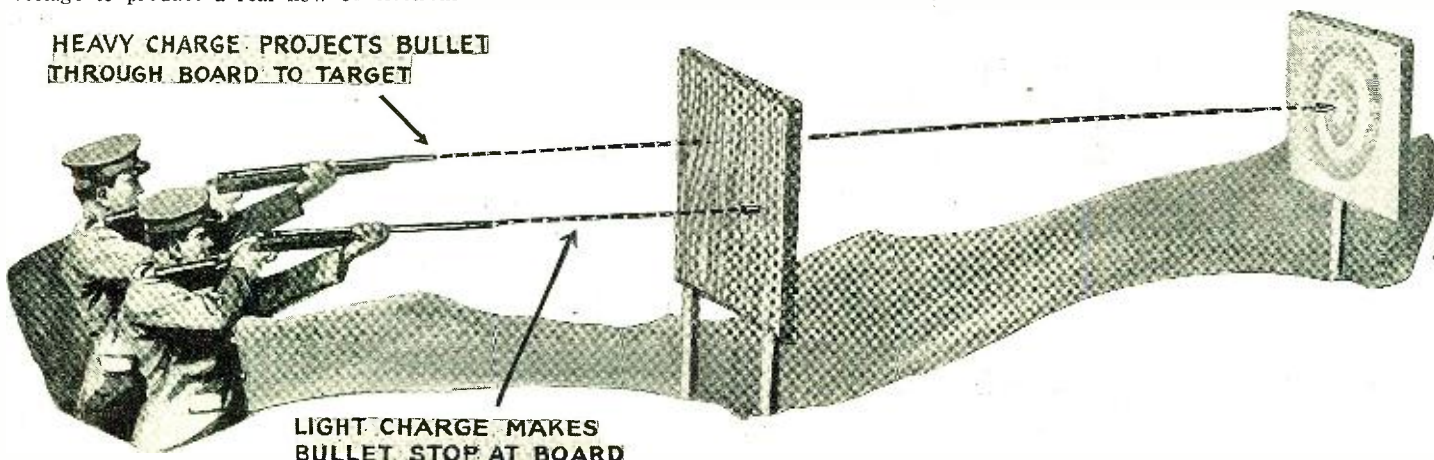

LIGHT CHARGE MAKES BULLET STOP AT BOARD

Fig. 3. This analogy makes clear the effect of the space-charge in a vacuum tube. The bullets represent the electrons and the board the space-charge which acts as a resistance to the bullets as they travel to the target, representing the plate.

to the filament its repulsion on a newly emitted electron is greatest. Moreover, near the filament the attractive force of the plate is weakest. The newly emitted electron experiences a strong repulsion from the negative charge very close to it, and an attraction, due to a larger positive charge at the plate, which is situated, however, at a very much greater distance from it. Under ordinary conditions, the slower moving electrons find the repulsion of the space-charge greater than the attraction of the plate, and they are consequently made to return again to the filament. Speedier electrons, however, are shot out further, since their additional speed enables them to penetrate the heavy space-charge cloud surrounding the filament, and enter a zone where the attractive force of the plate is greater than the repulsion exercised by the space-charge. Once they get through this cloud they are able to proceed to the plate.

This is so for two reasons: firstly, they approach the plate and so come under its attractive influence more; and secondly, once they have proceeded some distance towards the plate they are helped on their way by the negative space-charge *behind them*, which tends to push them on towards the plate; moreover, the space-charge ahead of them gradually becomes weaker. The electron is similar to a man traveling through a thick fog, which is very thick at the beginning, but gradually becomes clearer. Once he is clear of the heaviest part of the fog he can proceed on his way. Fig. 2.

Another comparison which may help the reader a little is one which considers a rifle bullet being fired through a thick wooden board at a target. If the bullet is shot from the gun at a slow velocity it will not pass through the wood. If, however, it leaves the gun at a high speed, it will pass through and, once through, will pass on and hit the target. The gun may be compared to the filament,



A FOG IMPEDES MAN IN HIS WALKING LEAVING FOG HE CAN WALK FAST

Fig. 2. Another analogy explaining the effect of the space-charge.

the wood to the space-charge and the target to the plate of the tube. See Fig. 3.

These comparisons, of course, do not show the whole picture, but they may be of assistance.

If we desire to obtain a substantial plate current with a low plate voltage, we must reduce the space-charge effect. The ordinary way of overcoming this effect is to increase the "B" battery voltage, but since we are assuming that we are to use a very low plate voltage, we must adopt some means of reducing the space-charge. One method of effecting this is to reduce the diameter of the plate and grid, but mechanical considerations limit the size of the plate, because in any case the grid must come between the filament and the plate if the normal construction of the tube is adhered to. It might be mentioned here, incidentally, that this defect has been overcome by having the grid in the form of a flat plate on one side of the filament, and the plate on the other side, both electrodes being very close to the filament. With such an arrangement excellent results have been obtained in Germany, using only a few volts on the plate.

The best example, probably, of a tube designed to operate without a "B" battery is that produced by a large American tube manufacturer in 1918. A very small plate was employed, and the voltage of the "A" battery which lighted the filament was used to supply the plate of the tube. The actual circuit was similar to Fig. 5. No attempt was made to overcome the space-charge effect by giving the grid a positive potential; the effect is obtained solely by reducing the diameters of the plate and grid.

Even before this, an effective arrangement was produced by the author; a description of it appears later.

Another method of attacking the problem consists in providing a separate grid in the tube, and connecting

this grid to the positive terminal of the filament battery, the object being to introduce a positive potential of about six volts very close to the filament in the particular zone where the space-charge exists, thereby counteracting, to a considerable extent, its effect. The principle of this solution dates back, I believe, to the middle of 1914, and it has been regularly employed in Holland and France.

Before actually describing different specific arrangements, it is best to consider a few preliminary matters in connection with the expression "receiving without 'B' batteries." There is, in fact, no such thing as a receiver capable of working without a voltage on the plate. This voltage is absolutely essential to the operation of a tube. To get the maximum results from an ordinary tube, a substantial plate voltage is required, but its actual value depends largely upon:

- (1) The purpose for which the tube is used, i.e., rectifying or amplifying.
- (2) The size of the electrodes in the tube.
- (3) The potentials applied to the grid.
- (4) The specific means adopted for reducing the space-charge effect.

A tube, for example, while giving good results as a detector for working telephone receivers, would be totally incapable of producing the output currents necessary to operate a large loud speaker. For the reception of weak signals in which a feeble or moderate output only is required, a small steady plate current is all that is required. When dealing with a substantial degree of amplification, substantial plate currents are used.

Fig. 4A shows an ordinary three-electrode tube in which a milliammeter, M is included in the plate circuit between the plate and the positive terminal of the six-volt battery B₁. The plate will have a potential of six volts with respect to the filament. Speaking a little more accurately, the plate has a potential of six volts with respect to the end F₁ of the filament, while the potential with respect to the end F₂ is zero. With respect to the middle point, F₃, the potential of the plate is three volts. The result is that electrons will flow from the negative end of the filament, i.e., the end nearest F₁, through the grid G to the plate A, and around through the milliammeter M. This steady plate current may be controlled by varying the potential applied to the grid G of the tube, but the plate current, being very small, will not give much in the way of output currents.

Fig. 4B shows the exact equivalent of the Fig. 4A circuit, but this time, it will be noticed, there is an obvious "B" battery B₂. B₁ is now a four-volt supply, and the extra two-volt cell is outside the filament circuit; the plate is now at a positive potential of six volts with respect to the end F₁ of the fila-

(Continued on page 266)

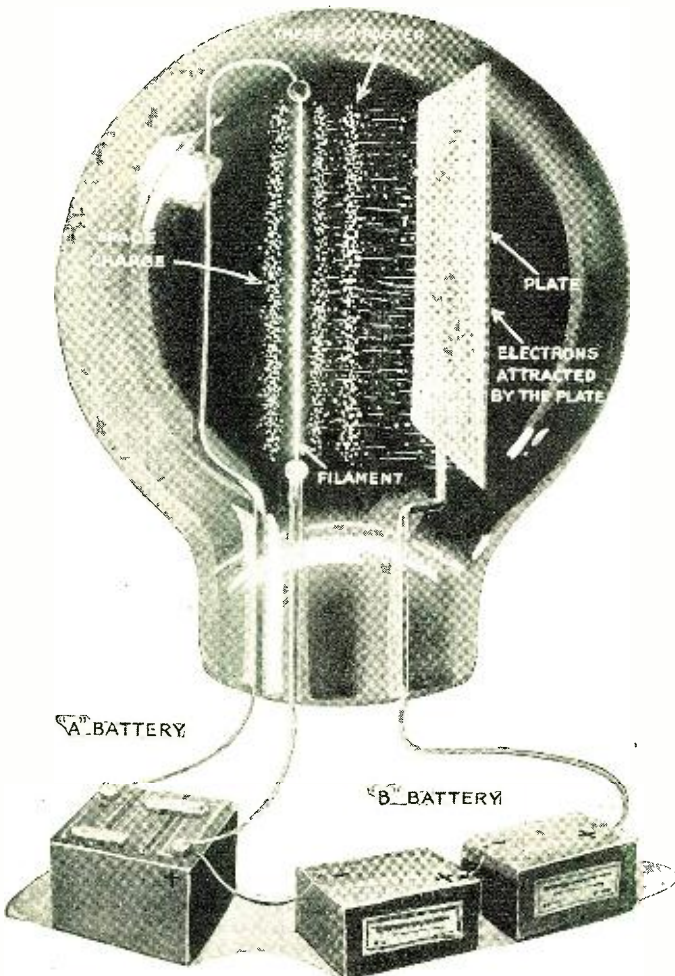
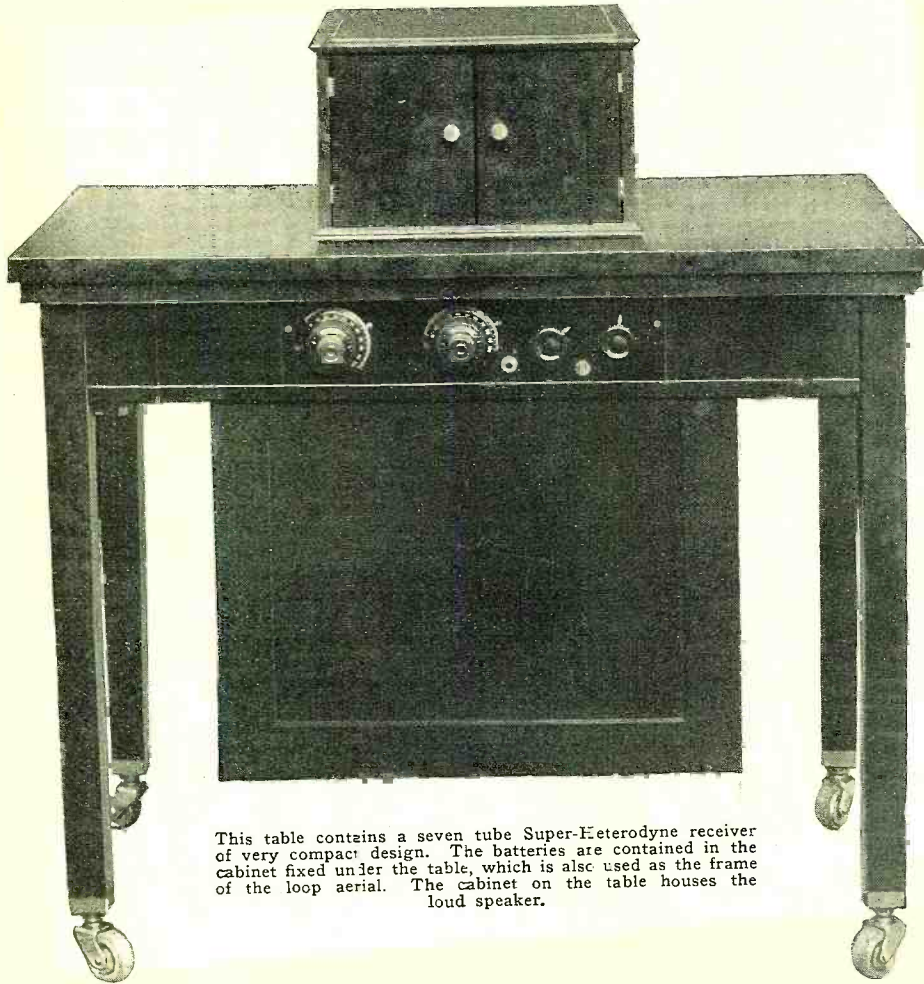

Fig. 1. This illustration shows how electrons are emitted from the filament and attracted by the plate, also the effect of the space-charge.

Putting the Super-Heterodyne On Wheels

By S. R. WINTERS

A Super-Heterodyne of novel design embodying several interesting features which might be adapted to similar and other receivers.



This table contains a seven tube Super-Heterodyne receiver of very compact design. The batteries are contained in the cabinet fixed under the table, which is also used as the frame of the loop aerial. The cabinet on the table houses the loud speaker.

MOUNTED on serviceable castors, with rubber tires, a radio receiving outfit of the Super-Heterodyne model was recently installed in the lounge room of the Racquet Club, Washington, D. C. Although home-made, this equipment harmonizes with furniture of any type or period and the radio instruments are so cleverly disguised that when locked in their container there is little indication of the presence of vacuum tubes, transformers, condensers, a loop antenna and a loud-speaking unit.

The principle of the Super-Heterodyne circuit is faithfully copied in the equipment. The designer, "Barney" Foy, a radio amateur, demonstrated originality and no little ingenuity in the distribution and balancing of the parts entering into the construction, in the reduction of wires to a minimum, and in the building of a cabinet resembling a piece of furniture.

The space required for this Super-Heterodyne receiver is about equal to that allotted to a Neutrodyne set. The amount of wire used is only one-twentieth of that ordinarily employed in such elaborate radio receiving equipment. Only five lengths of bus bar, approximately 120 inches, are utilized in connecting the eight vacuum tubes, transformers, condensers, and other working parts. In fact, in glancing at the outfit from the top, there is a conspicuous absence of wiring.

The instruments are placed on panels similar to the construction of the sub-chassis of an automobile—that is, they occupy a minimum amount of space in the interest of simplicity. Thus, in event of a short circuit or other wiring trouble, the wires are readily exposed and a checking of connections is facilitated to that extent. All of the wires are soldered to lug terminals thereby insuring absolute contacts without resorting to soldering of the fittings a practice all too prevalent, and one that is likely to impair the service of the various parts.

Audio frequency amplification in this instance is restricted to one stage. Contrary to ordinary practice, four instead of three intermediate stages of radio frequency amplification are employed, in addition to the usual input transformer. This departure, however, affords almost as great a degree of amplification as if two stages of audio frequency were invoked. This relatively great amount of radio frequency amplification is resorted to without producing distortion.

The loop antenna used with this set is 23 inches square, and is comprised of 15 turns of Litz wire, each turn being spaced three-fourths of an inch from the next one. Contrary to customary procedure, space is reserved in the battery compartment for operating this loop. The arrangement functions well.

One of the chief advantages of this set

lies in the fact that it is foolproof. That is to say, lock and key may be applied to prevent inexperienced operators tampering with the apparatus. Withdrawal of the key that locks the cabinet cuts off, automatically, the battery current. The possibility of an inexperienced operator burning out several tubes is thus averted.

Reception of radio signals, despite interference from violet-ray machines and other electrical equipment, includes programs from stations located in Denver, Davenport, Jefferson City, Mo., Chicago, New York, Providence, and Atlanta. These reception tests involved the use of a 24-inch loop antenna, with no connection to the ground.

THE RADIO FAN'S RIGHTS

Ohio has the honor of fathering the first group of men in the world to step to the front in protection of the radio fans' rights. The National Radio Association, Inc., has filed papers of incorporation at Columbus and taken temporary headquarters in the National City Building at Cleveland.

Thad Brown, Secretary of State, and a radio fan, is one of the incorporators. His statement of the organization's purpose follows:

"The broadcasters have organized to establish their rights; the amateurs also have an organization, and the Government sees to it that none interfere with its rights in the air. It is time for the radio fans to get together to assure themselves of their rights, otherwise they will soon find that they have none. Within the next few years there is going to be a great deal of fighting over who has a right to the air, and the fans will fare better if they are organized and ready for this fight when it comes."

(Continued on page 204)

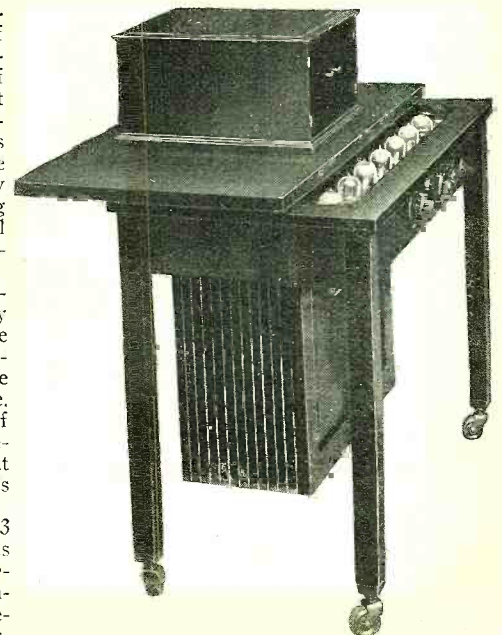

Side view of the set showing the loop aerial and the sliding top of the table. Note the seven tubes.

The New French Broadcast Station

Recently Installed Near Paris This High Power Station May Be Heard All Over Europe

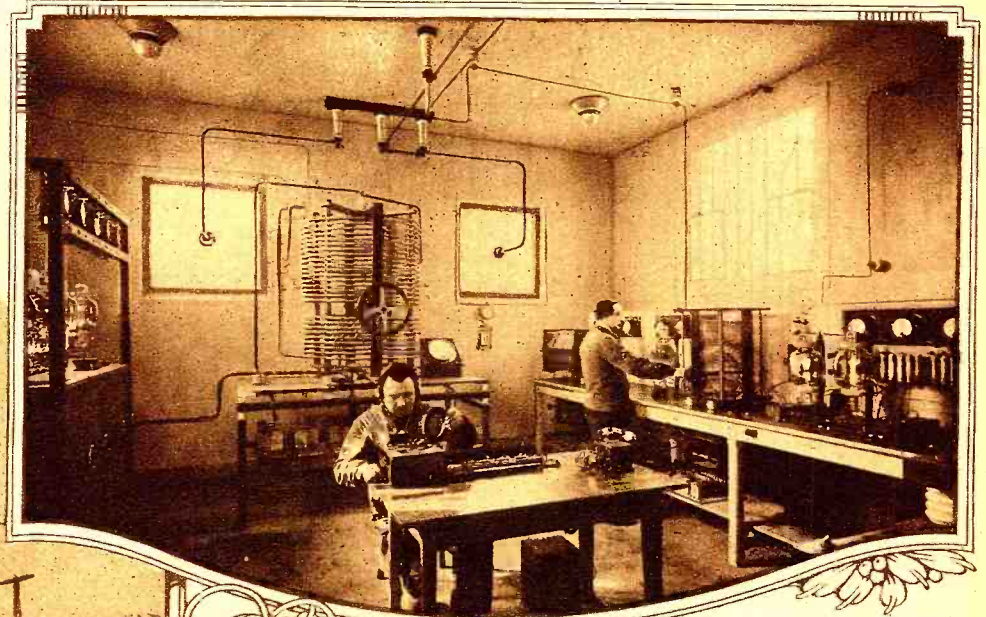

Above is shown the operating room of the new powerful French broadcast station which may be heard all over Europe. At the left is seen the voice amplifier, while the large oscillation transformer and the two aerial leads are in the background.

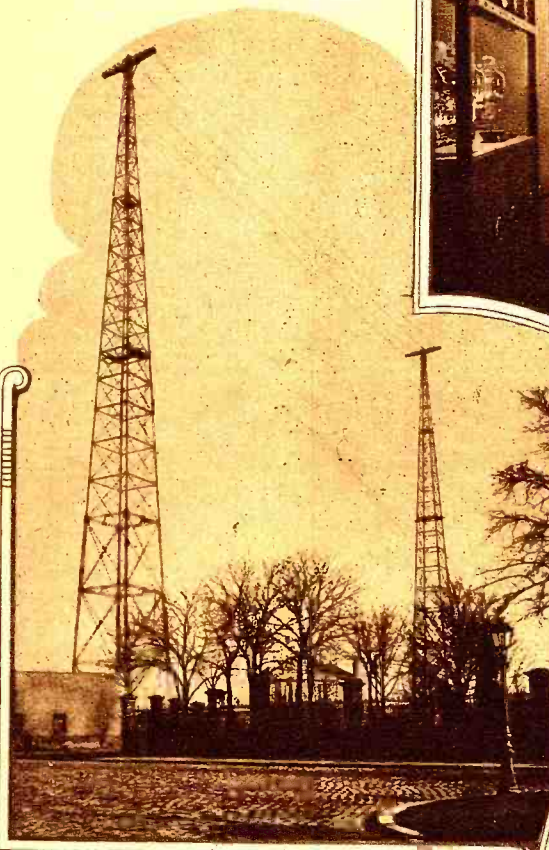

Here is shown the two 300-foot antenna towers used by the new French station, which is located about five miles outside of Paris. The station buildings may be seen beneath the antenna.

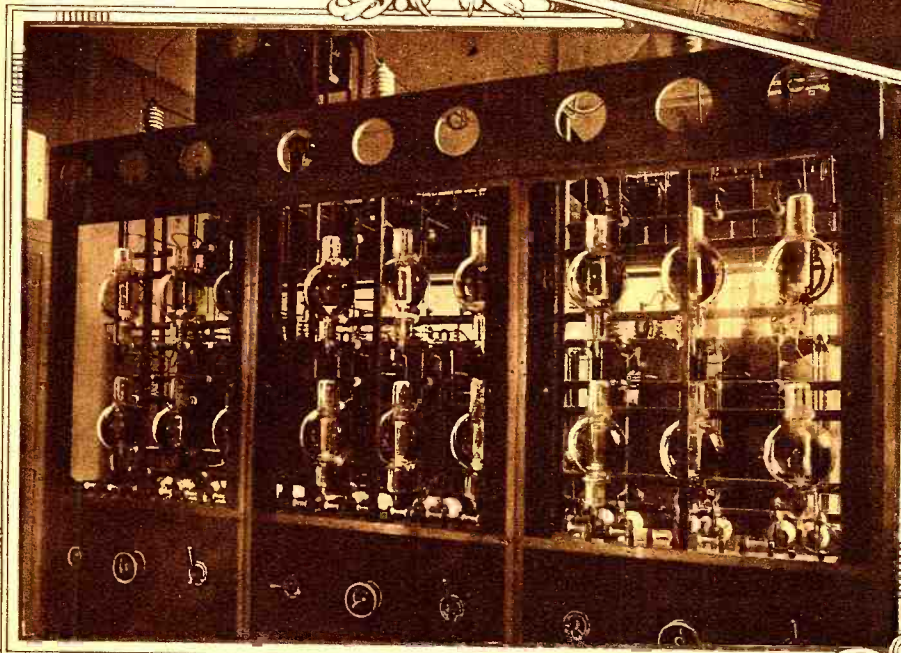
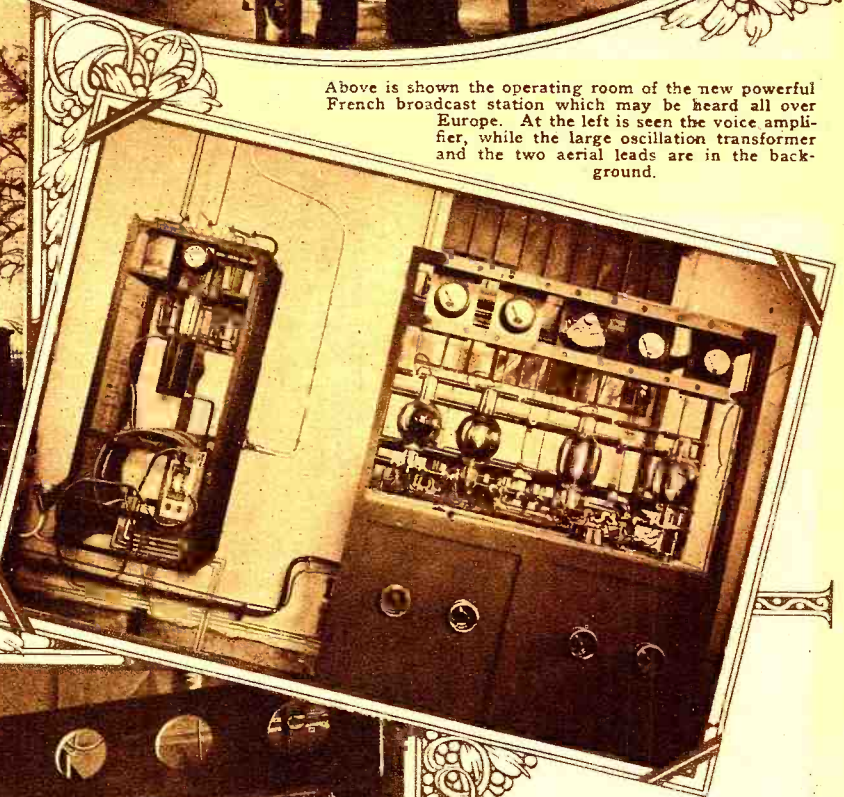

What is probably the most powerful broadcast station in the world is shown on this page. It recently went on the air and will cover the whole of Europe with its power—15 kilowatts in the antenna. As has become more or less the custom, the actual transmitting station is erected in a suburb of the French capital while a number of telephone land lines connect with studios in the city, or may pick up concerts and other broadcasts in the capital. Immediately above is shown the smaller of the station's two transmitters, which puts about one kilowatt into the antenna. At the left is shown the large 15-kilowatt installation. When operating with the large transmitter, the station is heard all over Europe regularly. Several U. S. and Canadian amateurs have logged it and ships just off the coast of the United States have little trouble listening to their concerts. This station uses a wave-length of about 1,780 meters.

Radio Pictorial

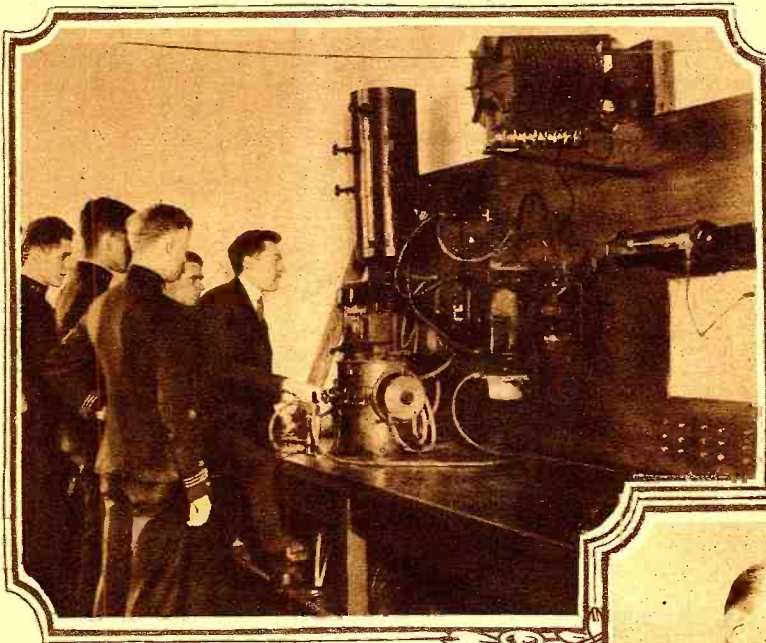

The importance the Navy attaches to radio is clearly shown in the above photograph. Every midshipman in the U. S. Naval Academy at Annapolis must have a complete understanding of radio before he is given a place in the first line of our national defense. The illustration depicts Prof. G. D. Robinson demonstrating the workings of a two-kilowatt transmitter to a class of future Naval officers. The middies must be able to build such a set complete as well as operate it proficiently before they are given diplomas. ©Fotograms, N. Y.

In recognition of the great advances he has given the radio art, the Institute of Radio Engineers conferred a gold medal upon Michael I. Pupin at the June 4 meeting of the Institute. In the illustration at the right Maj. Armstrong is seen presenting the medal to Prof. Pupin while Prof. J. H. Morecroft stands at the extreme right. ©Foto Topics Inc.

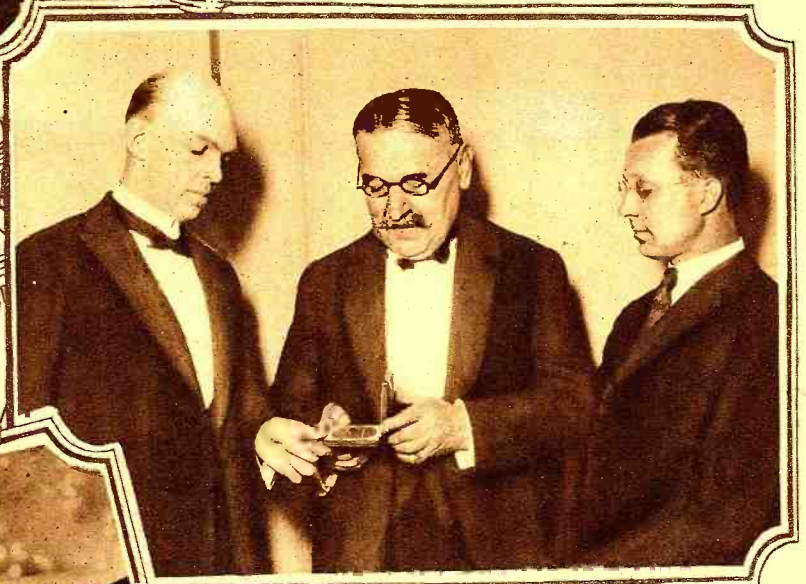

There is nothing like knowing of a coming increase in the price of dog biscuits. Mitzi Muffin, prize chow of Seattle, Wash., keeps in constant touch with the current market in dog food with the aid of her private radio set. In between times she whiles a weary hour away by listening to a jazzy tune. It is said that she eschews all bed-time stories religiously. ©International Newsreel.

The newest use of radio came to light recently in New York when the Salvation Army set up a complete Super-Heterodyne with loud speaker in front of the Public Library and operated it to attract crowds to their annual drive for funds. From preliminary reports the stunt was a complete success, as may be seen from the crowd gathered around the instrument. Concerts from both local and DX stations were released for the gathered audience. ©Kadel & Herbert.



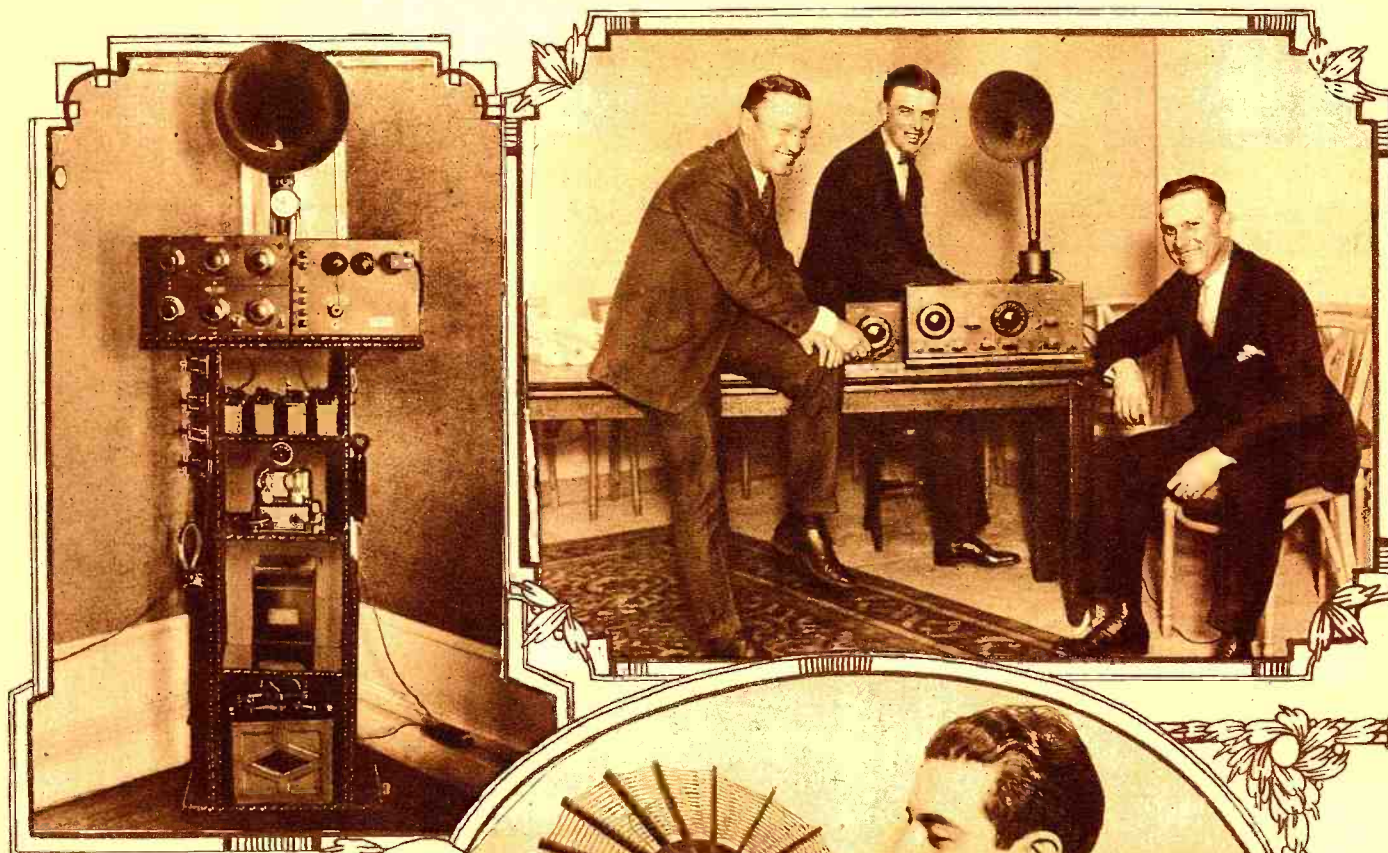

With the continual increase of radio's efficiency there has come more and more into general use a large number of accessories that have a terrible habit of scattering themselves all over the house. Above is shown a novel method used by Mr. D. Levitt of New York City to circumvent this untidiness. The receiver proper with the power amplifier and loud speaker are situated atop the cabinet. Just below is the storage "B" battery. Then there is the rectifier which furnished the power for the amplifier from the house A.C. line. Beneath that is the battery charger and the storage "A" battery.

Many advances are being made in connection with loop aerials. At the right is shown the latest development. It is wound in regulation spider web fashion and has shown itself, in preliminary tests, to be extremely efficient. © Kadel and Herbert.

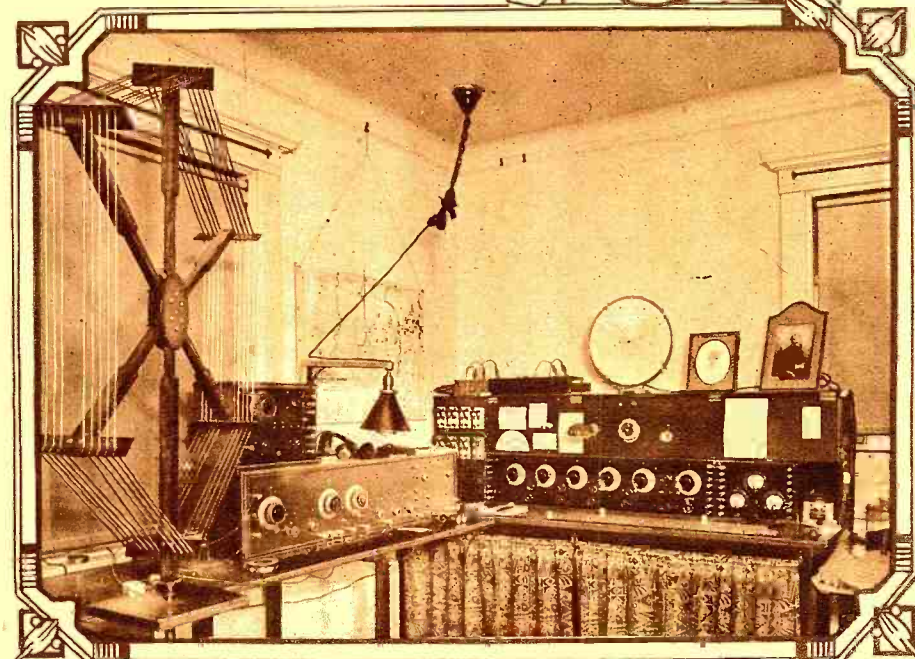
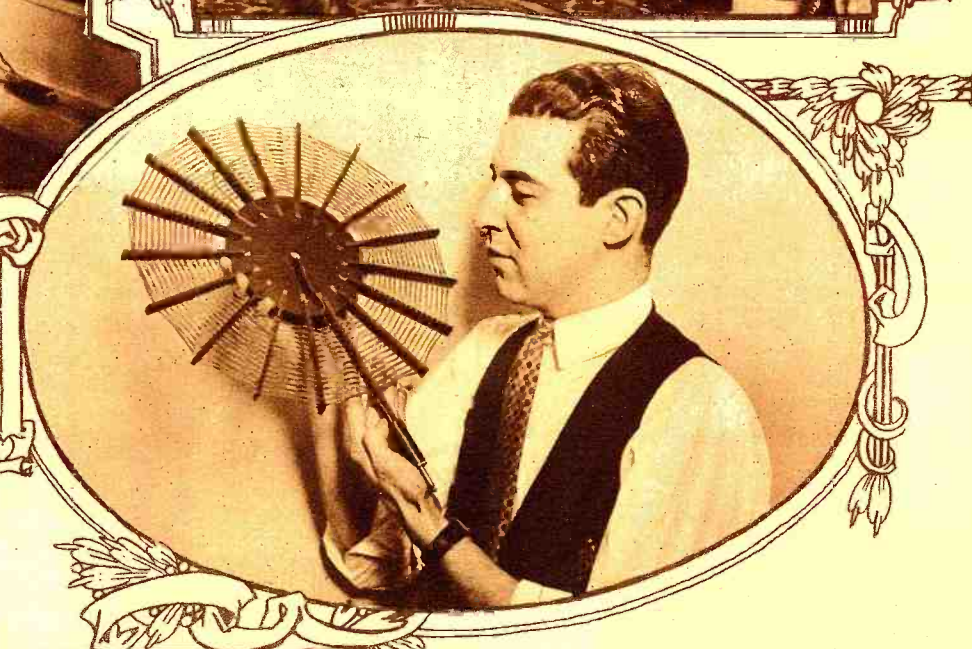

While J. Pluvius keeps the fans at their desks, the ball players of the New York Americans, alias the Yanks, take time off to engage in the greatest of all American Indoor Sports, i. e., listening to what's on the air. At the extreme top of the page to the right is shown a view of Urban, Roettinger and Johnson (left to right), all of that famous team. ©World Wide Photos.

The owner of the set shown in the illustration at the left may well be proud of his radio achievements. The mainstay of the station, which is owned by Charles C. Ritz of Forest Hills, L. I., N. Y., is a nine-tube Super-Heterodyne, which is used with a loop. Aside from this unit there is a single tube honeycomb long wave tuner and a four stage radio frequency tuner. There is also a voice amplifier consisting of one stage straight audio frequency amplification and a stage of push-pull amplification. As to results: During November last every large station on the West Coast as well as Havana and Mexico City were logged with ease. The log does not contain stations which have not been heard at least four separate times. Two outside aerials are also used with the apparatus to supplement the loop. One of these is 175 feet in length and the other about half that size. The longer antenna produces the better signal strength, but the shorter one gives a decided increase in the selectivity of the apparatus. Using the short collecting device, there is no trouble experienced in hearing WOC while WEA is transmitting. WOC is in Davenport, Iowa, while WEA is only a few miles from this station, and there is only a difference of eight meters in the waves of the two stations.

Radio News in Pictures

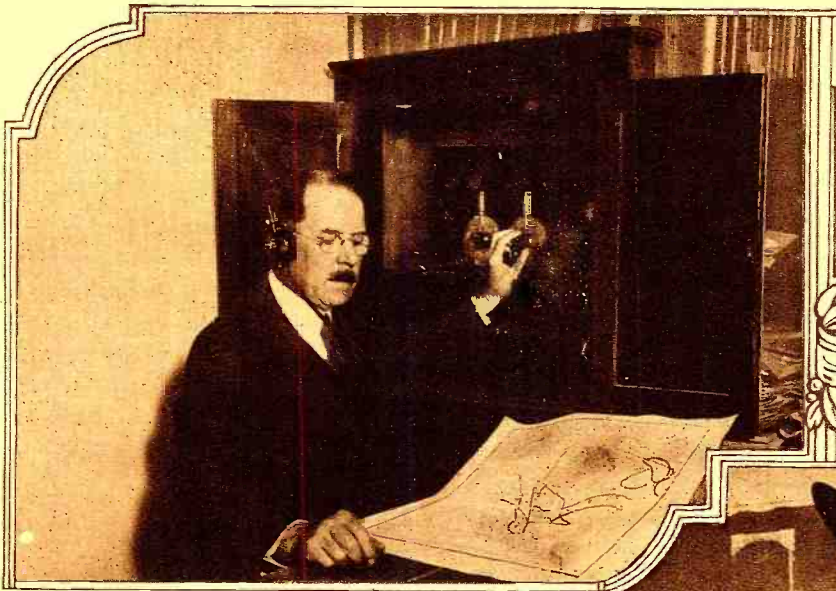

Every science is finding radioc of more and more use in investigations and of greater and greater assistance in the forwarding of their work. In the photograph at the left is shown Maj. Edward H. Bowie, Chief Forecaster of the U. S. Weather Bureau at Washington, D. C., listening to his own forecasts broadcast from the Government Radio Station at Arlington. These broadcasts are picked up by local stations and retransmitted over the whole country. P. & A. Photos.



During the last political campaign in France the contestants in the elections did their campaigning in de luxe fashion. At the right is shown a candidate with his car and loud speaker. His voice was spoken into a microphone and passed through an audio amplifier from which it was delivered to the horn atop the car which he used in traveling about his district. P. & A. Photos.



It is now the four "Rs" in the Little Red Schoolhouse, readin', ritin', 'rithmetic and radio. At the left is shown Miss Sarah Muller and her classes which have the distinction of attending school in the smallest schoolhouse in America. The pupils are shown doing their callisthenics out of doors to the tune of a radio concert. The school is known as District 30 and is located on Long Island, N. Y. Fotograms.

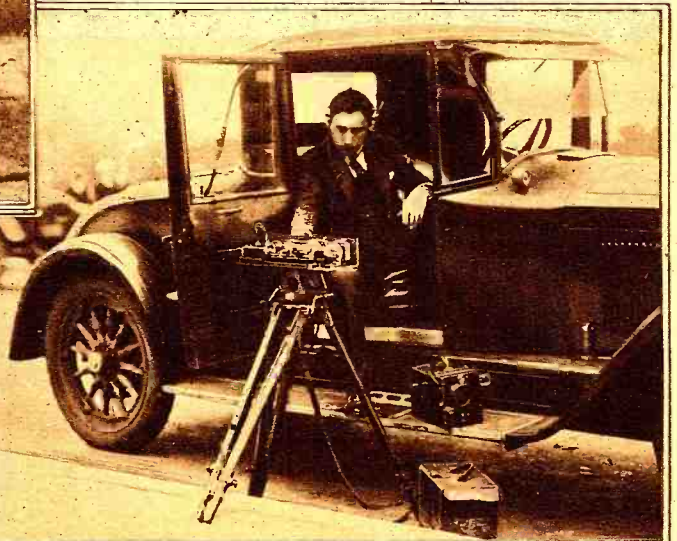

A Boston representative of the Pathe News found that there were long intervals between assignments, and while he was waiting for a contemplated event to take place, he took the most logical course to entertain himself—he erected a small Super-Heterodyne set which could be mounted on his camera tripod. At the right is given a photograph of the set as it looks set up and ready for action. The storage battery of the car lights the filaments of the vacuum tubes. © Keystone View.

With the approach of the fall political campaigns the photo at the right will be extremely interesting. Many a speaker has been cut short in the middle of a campaign on account of the great strain put upon his voice by halls and buildings of bad acoustics. All this is obviated by the new public address system recently gotten out by the Western Electric Company. Four stages of audio frequency amplification take the conversational voice of a speaker delivered before the microphone and boost it to dimensions huge enough to allow an audience of 6,000 to hear it comfortably. All the apparatus is housed in the truck. If occasion demands, it may be taken into a hall and installed as easily as it is out of doors.—©Western Electric.

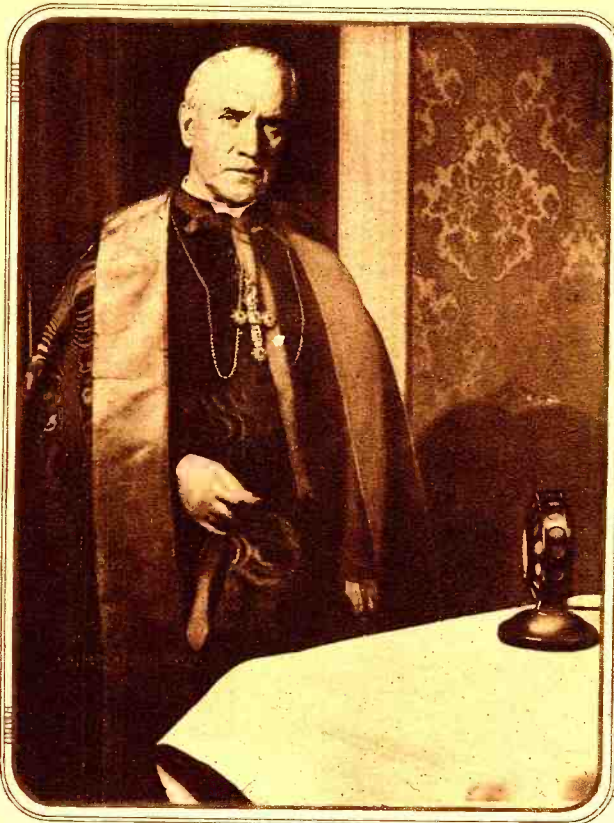

Shortly after his return from Rome, where he received the Red Hat, Patrick Cardinal Hayes, of New York, brought the Papal message from Rome and delivered it through the microphone of station WEAJ of New York City to the country at large. Below is shown a view of this prince of the church as he stood before the microphone delivering his message, ©Photo Topics, Inc.



General George O. Squier, inventor of "wired radio," puts a quarter into the ever gaping mouth of his newest invention and receives his money's worth of concert. This "pay as you receive" is one of the General's latest devices and the photograph above shows a demonstration he made of it recently while staying at a New York hotel. ©P. & A. Photos.

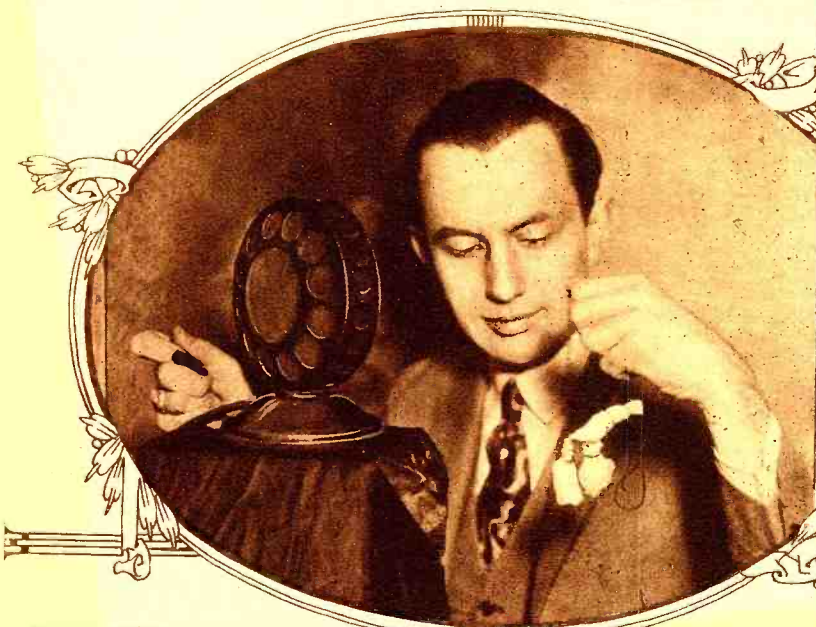

Much publicity has recently been given to insects and the noises they make. Here is shown Paul Specht, one of New York's favorite Jazz Band leaders, broadcasting the noises of two beetles and a cricket. Three or four nights a week his band entertains thousands by the dinner and dance concerts given direct from the Almanac Hotel, where he holds forth. ©Foto Topics, Inc.

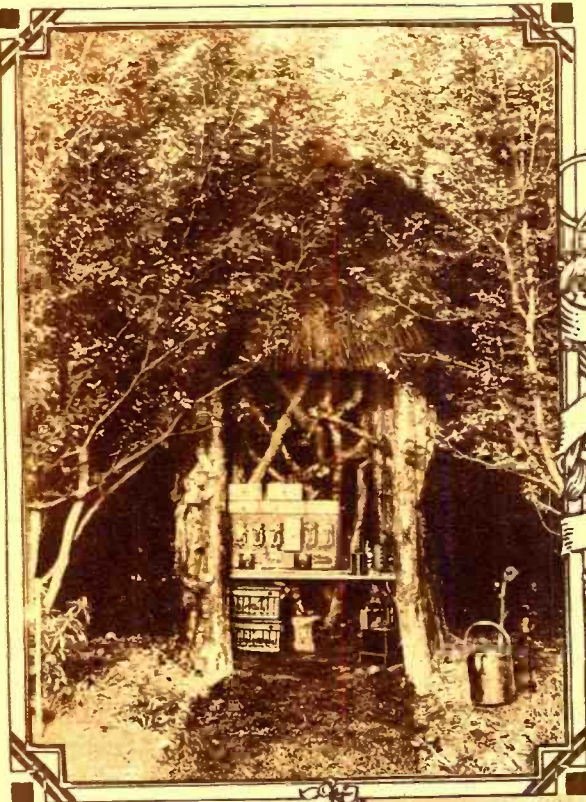

Eight: Monsieur Marius Latour, the noted French engineer, who recently paid a visit to America. M. Latour is a pioneer of radio, having taken out patents 19 years ago on step-up transformers for amplifying radio signals. We have him to thank for our present day transformer radio and audio frequency amplifiers. In 1904 he was consulting engineer for the General Electric Company, developing electrical commutating machinery, in which work he acquired a world wide reputation. During the war Mr. Latour did intensive work on radio receivers and amplifiers. © Foto Topics, Inc.



Above are two interesting photographs taken in the garden of the home of Colonel and Mrs. Harrison, London, where for the first time in history the song of the nightingale was picked up by sensitive microphones and broadcast to radio enthusiasts throughout the British Isles. The birds readily responded to the strains of Miss Beatrice Harrison's 'cello, which was played to coax them into song, and the radio reproduced their rich melody faithfully. The radio amplifier can be seen clearly in the left-hand photo, situated in the little summer house. The sensitive microphone which picked up the nightingale's song is shown in the right-hand photo, resting on a thick piece of felt to absorb stray vibrations. © International Newsreel.



Left: John L. Reinartz (left) receiving the cup of honor from the Executive Radio Council of the Second District for the excellent and beneficial work he has accomplished during the past year. The center figure is Lloyd Jacquet, Editor of Amateur Radio, and right, W. L. Howell, President of the Second District Executive Radio Council. Amateur stations 2BRB and 2XNA broadcast the proceedings. © Foto Topics.

Right: A scene at the Polo Grounds, New York, with Watson and McQuillan of the New York Giants as the central figures. They are tuning in a local broadcast station to get the baseball scores from the other teams and leagues while waiting their turn at the bat. © Foto Topics.

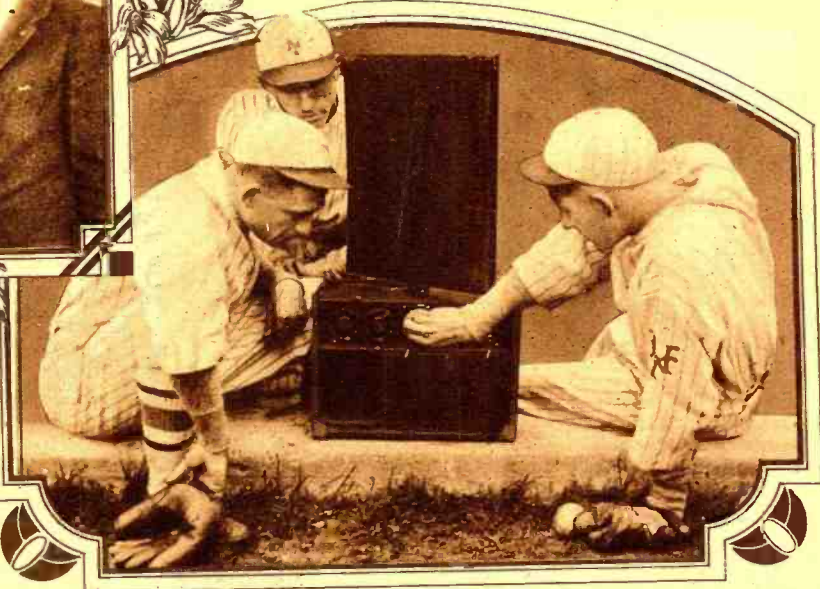

Right: This group of the foremost engineers in the radio industry are doing much in the way of propaganda against radiating receiving sets and at a recent meeting held in the Engineering Society's Building, New York, papers of a semi-technical nature were read to a large audience giving pointers on the care and operation of present day receiving sets. From left to right are: Prof. Alfred N. Goldsmith of the Radio Corporation of America; John V. L. Hogan, Consulting Radio Engineer; Prof. John H. Morecroft of Columbia University; Philip Torchio, Chief Engineer of the New York Edison Company; L. W. Chube and Prof. L. A. Hazeltine of Stevens Institute. © Kadel & Herbert.

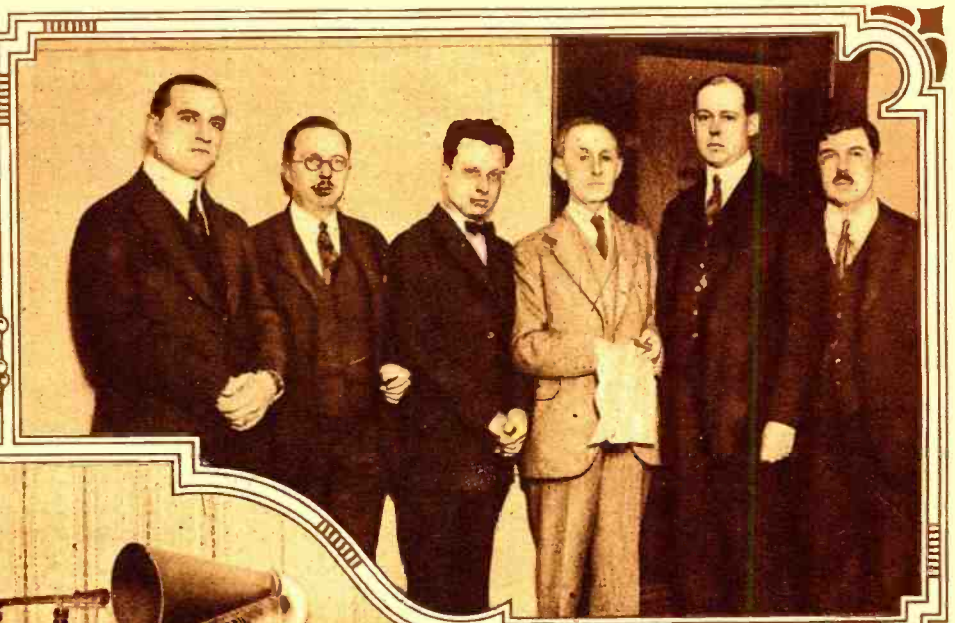

Left: Herbert Swason, owner and operator of amateur station 2CVN, Brooklyn, N. Y., is an Eagle Scout and wears a wireless merit badge, as well as forty-two others, on his right sleeve. Although but eighteen, he has spent six years in the radio game and holds a record in his locality for having received 151 amateur and broadcast stations in one evening. The transmitter can be seen in the cabinet to the right of the photo. It is a 1/4 K.W. spark set employing a rotary spark gap. Those who have heard 2CVN on the air have no doubt appreciated his "automatic fist" which shows up clearly in the photo. The apparatus atop the cabinet receiving set is employed for receiving long wave trans-Atlantic stations. It tunes up to 14,000 meters. © Foto Topics, Inc.

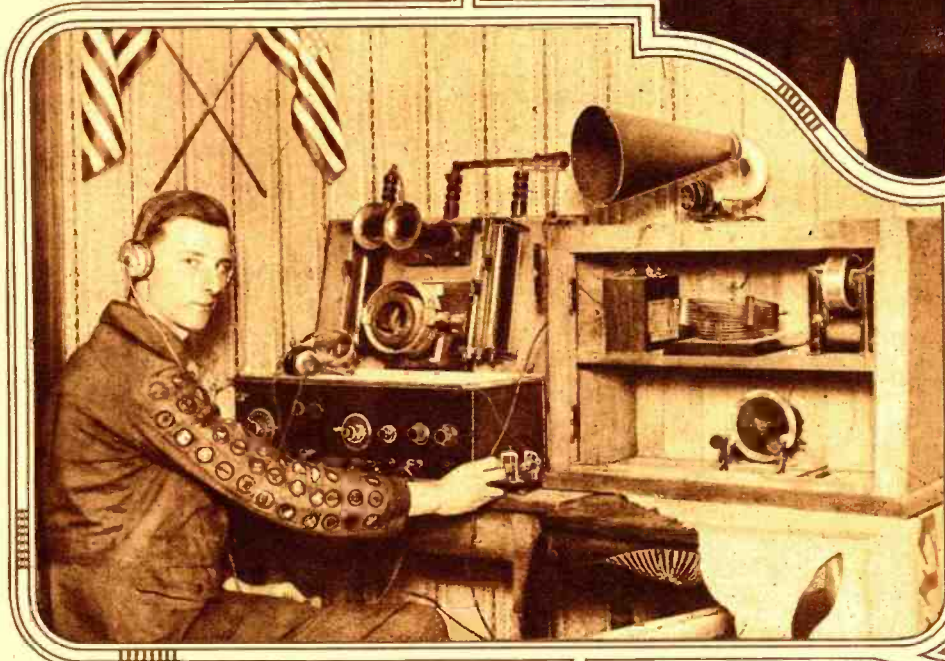

At the right is an interesting photograph of a group of teachers and students who recently gathered in convention at the Hotel Pennsylvania, New York, to try their mastery of stenographic symbols on dictation sent over the radio. Charles S. Swem, the acknowledged champion of the world at speedy shorthand writing, gave the dictation from station WJZ. © Gilliams Service.

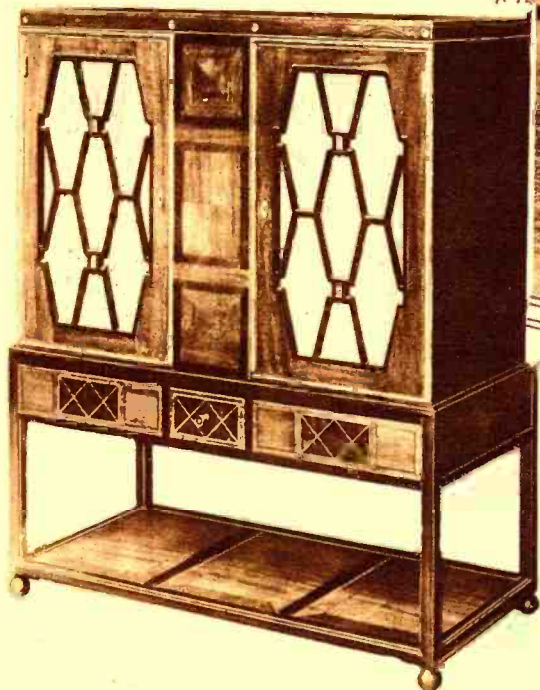

Left: The King of England is the owner of this exceptional radio receiving set. It stands complete, the aerial being of the condenser type consisting of two large copper plates, one at the bottom of the cabinet and the other underneath the shelf near the floor. The necessary batteries are within the cabinet, there being special compartments provided for them. This multi-tube receiver is extremely sensitive, having numerous stages of both radio and audio frequency amplification. Both sets of amplifiers are of the resistance coupled type which insures stability of operation and undistorted reproduction.

Allez, Houpla!

By ROBERT FRANCIS SMITH

TO tell the truth at the start, which is bad but necessary, I ain't no science-stiff; I'm an actor. Joe Hammerstein's my label, called Ham by the critics, Stein by my bootlegger, and a lot of coarse words by others. I play the big-time when it snows, and when the sun smiles and you shift from your heavies, me and the exemption take it easy down at Brightmere-on-the-Deep. Not that you give a rap about what we do, except that I like to get solid with my audience before I spill any intimate chatter.

The whole affair begins, of course, with the wife. You see, down here away from her scandal circles she gets kind of lonesome, there being no kick in talking to your husband after you've been yelling across stages at him all winter. So she suggests that we gets a radio. Me, all innocent, falls for the idea like an old maid for a blind lover. Naturally, she decides we should do it all up brown, so next day I takes a run into what passes for a town to see if they sell any radios there. There's six hundred and forty-seven people and eighteen radio shops in the burg, all shops doing a turn-away business, with "Listening Room Only" posted over the main entrances. I step into the nearest one and finally manage to get to the egg that's handing out the dope. So I slips him our tale of woe. He acts real nice about it, too.

"You want a complete new set?" asks he, sort of surprised-like.

I agrees with him.

He looks at me, not knowing whether to believe his own ears. So I pipes up and asks him why the astonishment.

"Why," says he, "every house in town has a radio in it. You must be of the family that moved into the green cottage at the end of the beach."

I sees this bozo has my number so I gives in. "You booked me correct," I replies. "As an afterthought, now that the formalities is over, how about that radio?"

"You see," says he, "since every house in town has a radio in it, we don't stock complete sets. But we can sell you the parts and you can put them together yourself."

"Nix, buddy," I tells him. "I can figure out a lot of ways to kill time that ain't half so expensive. Ain't there somebody I can

get that knows the why of these things? Don't you?"

He don't like this last line, but business makes him overlook the insult. "Oh yes, we could," he tells me, "only we don't, since most amateurs like to make their own sets, just like smokers like to roll their own cigarettes. It gives them individuality. So we maintain no workshop."

"Oh, I see," says I. "Does anybody?"

The dealer scratches his head. "None of the shops do," he informs, "but maybe Jerry Lawson might."

"And who," I asks politely, "might Jerry Lawson be?"

"He might be King Tut's flea chaser, but he isn't," comes back the dealer. "He's the greatest scientist in Brightmere-on-the-Deep."

Which ain't much of a recommend, but I lets it lay. "Where does this Mister Lawson reside?" I inquires.

"He lives in the big white house on Royal Hill. Right near your place."

The domicile in question is the town's show place, and I don't feel that any guy what lives there will fix me a radio. I says so.

"Oh, Jerry isn't any snob," says the dealer. "In fact, I shouldn't be at all surprised if he'd be tickled pink to build it for you, provided, of course, that you let him select the parts and design the hook-ups."

"Being of a perfectly providing nature," I responds, "I'll let him. All I knows about hook-ups is that they is an evil you got to take when you gets married."

He kind of grins, so I bid him good day and toddies along up the hill. I goes up to the big house and knocks on the door and one of them maids you sees in the movies, but no place else, opens the door and smiles. So I tells her who I wants and she points around to the garage and says "The Master is there."

The garage had once been a swell rest room for a team of prancing mares before we began to travel F.O.B. Detroit. The upstairs part had used to be a hang-out for the groom and his tribe, but since chauffeurs got aristocratic and demanded a room with the family, the apartment ain't been in active service. So the Master had turned it into what I later learns is a laboratory. Well, the stairs is on the outside, so I climbs up and knocks on the door. Somebody yells "Come in!" so I does.

This room is about fifteen by twenty and filled with more doodads and hymos than I ever saw in one place. Wires, lights and such, all over the place. By a bench at one side stands a kid, about twenty-two, dark-haired, pretty good looking, wearing among other ornaments a pair of black insulated glasses and a worthy expression. He looks up.

(Continued on page 243)



All of a sudden there is a "pftt," a fuse blows and the baby spot goes out. . . . "Hey, you!" yells Jakey O'Brien. "Watch your light!" Tom makes a dive for the door and calls, and Mr. O'Brien flies in and settles on Tom's shoulder.

Esperanto Radio World Language

By JAMES D. SAYERS



After a wide investigation it has been found that Esperanto is the most widely used of the auxiliary languages and is, possibly, the easiest with which to work, since it has a well established vocabulary. Therefore, RADIO NEWS accepts it as the international auxiliary language.



AMATTER of importance, vital to the future of radio is now coming up for decision by radio fans and wireless amateurs in America. In real fact, it has been decided in Europe. Very much confusion has been caused by an apparent existence of a number of different international languages, all clamoring for recognition as the international language for radio. Busy people who are interesting themselves in radio and would like to have at their command a language used commonly by all the world of radio, are deterred by what seems to them a din of chaos into which they do not wish to go. At a recent radio exposition in New York a man was heard to remark as he passed the Esperanto booth:

"If the advocates of an international language could just get together, it would be a great thing for radio."

No doubt such is the sentiment, more or less clearly fixed, in the minds of countless thousands of normally wide-awake fans. They are too busy to give up a great amount of time wading through the tremendous field of linguistics covering the proposed world languages. The majority are repulsed by the prospect. Many plunge blindly in and take up the first one that reaches their attention. Some very few take the trouble to investigate. It is to help the readers of RADIO NEWS by following the course of the latter type that we write this article.

The first and most important question that the real seeker in this field wants to have answered is:

"Does there exist already a language that stands out much above the general field of proposed radio languages, and, if so, what are its claims for perpetuation?"

When we look into the general field we find 150 more or less elaborated proposals for an international speech. Those that have been published to any noticeable extent perhaps do not number more than a dozen. Among them we find Volapuek, Esperanto, Ro, Occidental, Ido (which is now arrogating to itself the general title, International Language, abbreviated as "Ilo"), Romanic, Esperantido, and a few others. Volapuek was the first, but was abandoned quickly by its followers in favor of Esperanto when the latter appeared in 1887. Volapuek, Ro, Occi-

dental, Romanic and perhaps two or three other systems that have gained a few followers are the only ones that are not plagiarisms of the uncopyrighted Zamenhof original, Esperanto. They are either more difficult to learn than national languages, as in the case of Volapuek and Ro, or are too compromising with the irregularities and arbitrary word building systems of national languages, as exemplified in Romanic and

parts of the world, representing as many of the linguistic groups as possible, and of the Esperanto Academy, which is a smaller body of great scholars and experts in the language, who are the final arbiters of all questions affecting the growth of and improvements in the language. The logic of having such bodies of men, thoroughly versed in Esperanto, to propose and pass upon improvements in the language, is at once apparent to a reasonable mind. Such procedure insures that the language will be held to a conservative and standard growth throughout the world and not be butchered and botched here and there at will by every theorist who feels himself moved by a bright and shining idea.

Let us devote a paragraph or so to consideration of the three most promising of the myriad proposals for a radio and world language.

The original Esperanto was constructed by Dr. Zamenhof through many years of painstaking and scholarly labor. Being a master of the ancient classical languages and of seven of the leading modern languages, he was able to appropriate for his creation the cream of all languages. He discovered certain ingenious principles used only in a very haphazard, incomplete manner in national languages. He developed them to their maximum capacity. As a result we have a language of just 16 rules of grammar, 12 conjugations of verbs invariably regular, a simple and absolutely phonetic spelling with invariable penultimate accent. There are only five clearly distinct

vowel sounds (which makes it the ideal radio language), and a highly developed arrangement of affixes, making it possible to build hundreds of thousands of variations of thought upon a few thousand root forms. These root forms, or words, are taken almost entirely from the modern languages. The major proportion of them are recognizable by any person knowing one or more of the European languages. This, with the simplicity in construction of the language, accounts for the delightful ease and rapidity with which students master the language. Orientals find little more difficulty in mastery of Esperanto than Occidentals. The Chinese and Japanese are taking it up even more avidly than the

(Continued on page 204)

Speech made from Station WOR, Newark, N. J., May 5, 1924, by James Denson Sayers, heard in its entirety in Tokio by Hiroshi Ando, well known Japanese engineer, listening in at Imperial Laboratories.

Esperanto

Nun, Samideanoj de Esperantujo, de la tuta mondo. Mi estas che la stacio de Bamberger en Newark, Usono. Estas grandega plezuro al mi paroli la unuan fojon de Nord-Ameriko trans la oceanon al miaj samideanoj en aliaj landoj. Se vi sukcese audas min, faru por Esperanto la bonan favoron de sendi al la adreso antaŭe donita en la Esperanto gazetaro, kablegramon au almenau skribi al mi leteron. pri la fakto ke vi audas min. Chi tiu eksperimento estas atentata de multaj eminentaj personoj chi tie kaj estos historia okazajho se miaj esperantaj vortoj estas adataj en alial landoj.

Mi estas tre felicha kun vi, karaj samideanoj, vi idealistoj kiuj laboras senlace, pacience por nia amata afero, pro la kontentiga progreso antaŭe de Esperanto. Estas bona, justa idealo kaj tial venkos, nepre venkos, tra la tuta mondo, super chia barilo kaj spite de chia malbonkoraj homoj, kiuj chiam malamegas la progreson kaj felichon de homaro. Se la grandega bezono ne ekzistus por la benado de Esperanto al disigita, suferanta homaro, tiam la fina, glora venko de Esperanto estus dubema, sed progreso mem envenigos Esperanton kiel la beca, tutmonda helplingvo, kompreneble, per kaj kune kun nia laborado por ghi.

Esperanto estas la lingvo de la nuntempa mirindajho, la radio-telefono en la uzado de chi tiu trans landlimojn, kaj ankaŭ estos la lingvo de la parolantaj kinematografajhoj, kiuj baldau estos sukcesaj. Esperanto iros per saltogoj tra la mondo de nun antaŭe, char radio kaj parolantaj kinematografajhoj portos ghiin al chiu popolo.

Nun, karaj samideanoj, mi adiauas vin, kaj mi petas vin telegrafi, se eble, au almenau skribi letere tuj al mi lau la donita adreso. Baldau ni parolos pli libere kaj chiuage en nia amata lingvo. Ghis revido en pli felicha tago. Bonan nokton.

English

Now, dear fellow-Esperantists of the Esperanto world, of the whole world. I am at the Bamberger station in Newark, United States. It is a very great pleasure to me to speak the first time from North America across the ocean to my fellow-Esperantists in other lands. If you successfully hear me, do Esperanto the good favor of sending to the address previously given in the Esperanto press, a cablegram, or at least write me a letter, about the fact that you hear me. This experiment is watched by many eminent persons here and will be an historical event if my Esperanto words are heard in other countries.

I am very happy with you, dear fellow-Esperantists, you idealists who labor tirelessly, patiently for our beloved cause, because of the satisfactory progress forward of Esperanto. It is a good, just ideal and, therefore, will conquer, surely conquer, throughout the whole world, over all barriers and in spite of every sort of evil-hearted men who always hate the progress and happiness of humanity. If the tremendous need did not exist for the blessing of Esperanto to a divided, suffering humanity, then the final, glorious victory of Esperanto would be doubtful, but progress itself will bring Esperanto in as the beautiful, worldwide auxiliary language, of course, by and with our continued work for it.

Esperanto is the language of that modern marvel, the radio telephone in the employment of the latter across frontiers, and also will be the language of the talking moving pictures, which will soon be a success. Esperanto will go by leaps and bounds throughout the world from now on, because the radio and talking movies will carry it to all people.

Now, dear fellow-Esperantists, I bid you adieu, and I beg you to telegraph, if possible, or at least write by letter immediately to me according to the given address. Soon we shall talk more freely and every day in our beloved language. "Ghis revido" (pronounced "jees rayveedoh" and meaning, literally, "until re-seeing," or "until we see each other again") in a happier day. Good night.

Occidental. We find, therefore early in our investigations that Esperanto and its plagiarisms are the only proposed languages so far presented to the world that are very easily learned and can be used in actual conversation. The plagiarisms of the original Esperanto in most cases make the fatal mistake of going too far in applying theories in their adopted forms before first giving them the acid test of extensive practice, as did Dr. Zamenhof during the more than 15 years he spent in building Esperanto. It is admissible that improvements can be made in Esperanto. The originator, Dr. Zamenhof, and his early co-workers provided for this in the establishment of the Language Committee, which is composed of linguistic experts from all

The Tropadyne Circuit

By CLYDE J. FITCH



There are constant improvements being made in the Super-Heterodyne receiver. The latest one is that developed by Mr. Clyde J. Fitch and detailed here. A saving of two tubes as well as an increase of selectivity is obtained with this new circuit called the Tropadyne.

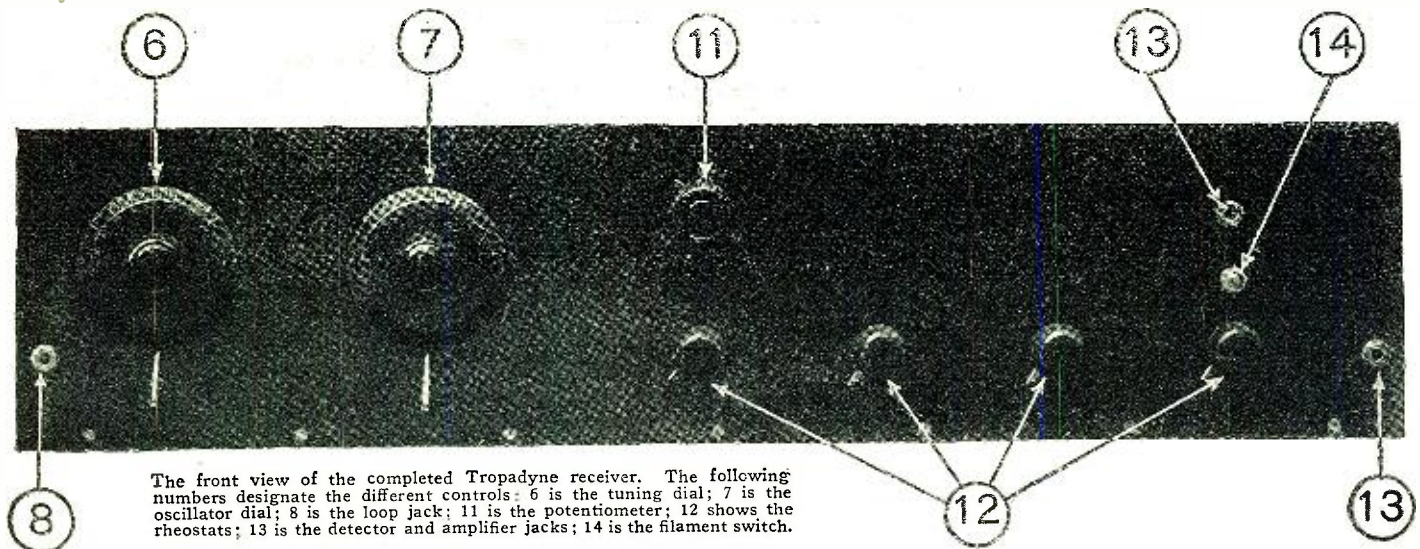

The front view of the completed Tropadyne receiver. The following numbers designate the different controls: 6 is the tuning dial; 7 is the oscillator dial; 8 is the loop jack; 11 is the potentiometer; 12 shows the rheostats; 13 is the detector and amplifier jacks; 14 is the filament switch.

SINCE the original appearance of the first Super-Heterodyne circuit there have been numerous improvements made in its design. Many of them have been along the line of increased selectivity, others have sought to combine tubes, but this latest one does both. It is well known that a properly constructed receiver involving the Super-Heterodyne principle will receive more stations with greater clarity and volume on a small indoor loop aerial than any other receiver, no matter what its refinements, using a large outdoor collecting agency. So there is little wonder at the constantly increasing popularity of the Super-Heterodyne.

Briefly, the Super-Heterodyne principle involves changing the wave-length of any incoming signal to a certain definite intermediate wave-length. This change in the period of the wave is effected very simply. The user of a regenerative receiving set will know the squeals and whistling sounds which are heard in his head telephones the instant the receiver is set into oscillation. These squeals are caused by the superimposition of a radio frequency wave generated by the receiver and that of an incoming signal. The two meeting in the detector circuit cause the production of what is termed a beat note, the tone of which is determined by the difference in the two frequencies. The superimposition of the two frequencies is called heterodyning. The heterodyning note can be changed, by shifting the dial, from a very high pitched squeal to a note so low that it passes from the range of audibility. In the Super-Heterodyne this "squeal" is made above the range of audibility. Nevertheless, all of the audio frequency modulations placed on the carrier wave at the transmitting station are faithfully reproduced at the new radio frequency affected through heterodyning.

It has been found that while making the squeal very high so as to be inaudible, the detector circuit of a regenerative receiver is detuned from the signal, thus decreasing its efficiency and the squeal becomes weaker and weaker as the pitch of the squeal rises. For this reason the standard Super-Heterodyne employs a separate tube for the oscillator

HERE is a remarkable Super-Heterodyne receiver which we warmly recommend to our readers. It has several new and unusual features. In the first place only six tubes are used giving as much volume as the average eight tube Heterodyne. The selectivity of this set is unusual. Unequalities of the intermediate transformers have now been done away with by tuning each transformer. After the transformer has been tuned, it can be left this way, no further tuning being necessary.

This system makes for maximum sharpness and maximum volume. Another outstanding point of superiority of the Tropadyne circuit is that it practically does not radiate, thereby not interfering with other nearby receiving stations. Most Super-Heterodyne circuits, as is well known, are powerful radiators.

—Editor.

and a separate detector tube to detect the inaudible squeal, also called the beat note. This requires two tubes to do the work of one, which is objectionable. Experimenters have tried using two tuned circuits on the one detector tube, making it a self-heterodyning or autodyning detector. The object was to tune one of the circuits to the signal frequency and tune the other circuit to the oscillating current frequency; but tuning one circuit detunes the other and one finds himself first swinging one dial and then the other and getting nowhere. This disadvantage is entirely overcome in the Tropadyne circuit. The Tropadyne employs a self-heterodyning detector having two independently tuned circuits in the grid circuit of the tube so arranged that tuning one has no effect on the tuning of the other and stations are easily and quickly tuned in. This is the main advantage of the Tropadyne circuit, the elimination of one tube from the standard Super-Heterodyne circuit.

It was just pointed out that the oscillator and first detector in the Super-Heterodyne give a new wave-length or frequency to the signal by producing beats. The two tubes, therefore, act as a frequency changer. In

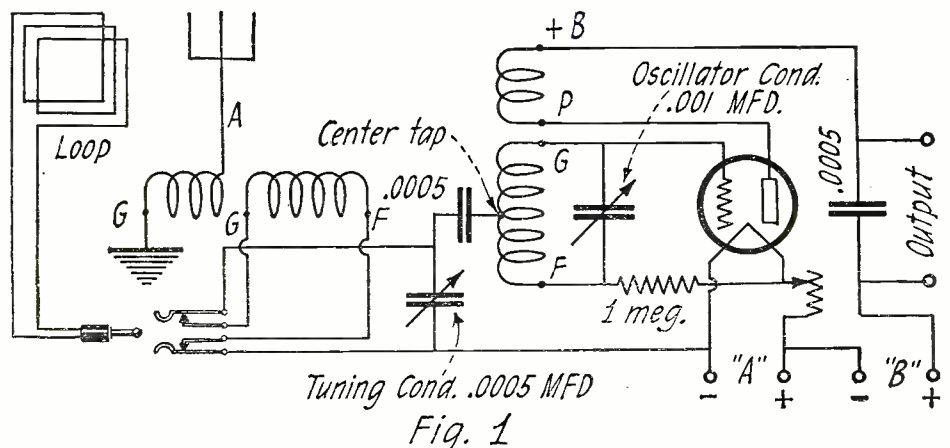

The principle of the Tropadyne circuit is shown here. Although only one tube is used for the detector and oscillator, it will not radiate and will cause no interference to other receiving sets.

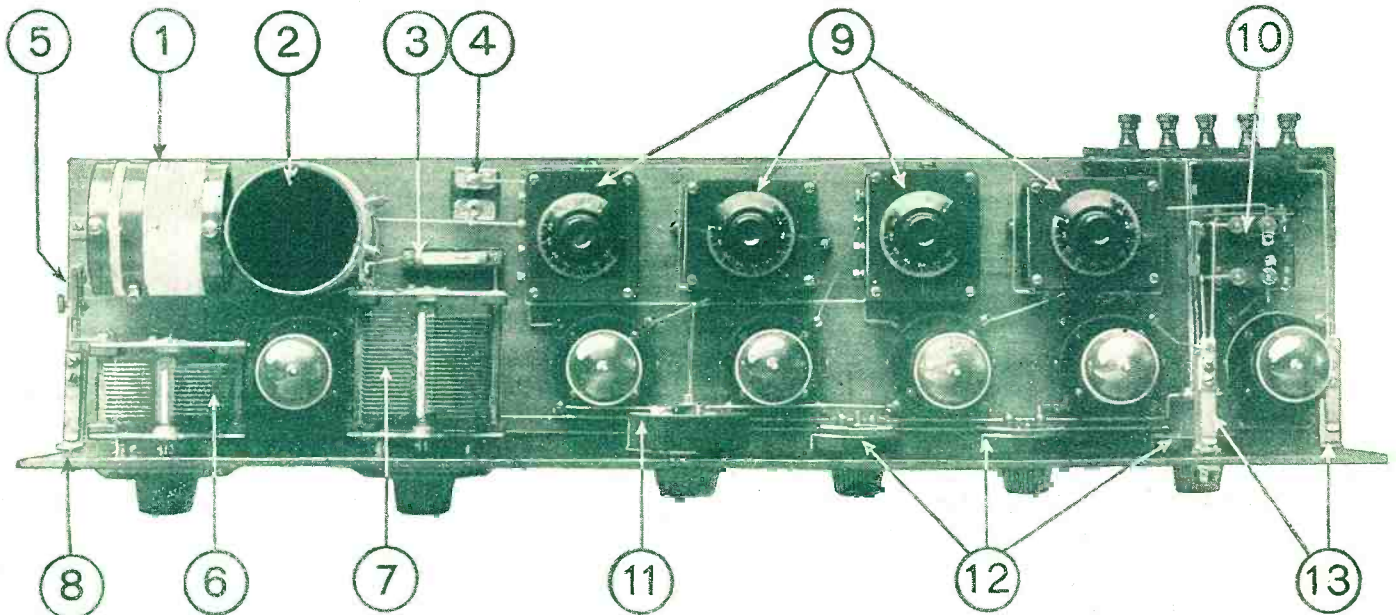

Top view of the Tropadyne showing the neat arrangement of the apparatus. The numbers designate the following instruments: 1, the tuner; 2, the oscillator coil; 3, the grid leak; 4 and 5, fixed .0005 condensers; 6, the tuning condenser; 7, oscillator condenser; 8, loop jack; 9, tuned R. F. transformers; 10, A. F. transformer; 11, potentiometer; 12, rheostats; 13, jacks for detector and loud speaker.

the Tropadyne circuit one tube acts both as oscillator and detector, and is a frequency changer. This is where this circuit gets its name; *tropadn* from the Greek, meaning change, and *dyne* meaning force.

Fig. 1 shows the Tropadyne circuit. Only one tube is shown, which is merely a frequency changer when used in a Super-Heterodyne receiver, and may be used with any type of Super-Heterodyne now in existence. As shown in the diagram, it is arranged for both loop and outdoor aerial, the loop being connected in the circuit through a plug and jack. The plate coil, with terminals marked "+B" and "P," is coupled to the oscillator coil. "G," "F" and the tube is continually generating an oscillating current, the frequency of which depends upon the setting of the oscillator condenser. It will be noted that one side of the oscillator coil is connected to the grid of the tube and the other side is connected, through a one-megohm grid leak, to a filament of the tube. The tuning, or loop circuit, is connected between the electrical center, or nodal point, of the oscillator circuit, and the filament of the tube. The grid condenser is placed between the oscillator circuit and the tuner circuit.

The electrical center of the oscillator circuit is approximately at the center turn of the coil. In practice, this connection is not critical. It may be two or three turns either side of the center, without seriously decreasing the efficiency.

Although radio frequency currents are flowing in the oscillator circuit, none of this current passes into the tuning circuit since the potential difference between the electrical center of the oscillating circuit and the filament of the tube always remains constant. Therefore, tuning the oscillator circuit has no effect on the tuning of the loop circuit.

The incoming signal current flowing in the loop or tuning coil circuit, is impressed on the filament of the tube and the center of the oscillator coil. The current divides equally at this point, part flowing through the upper half of the coil to the grid of the tube and the remainder flowing through the lower half of the coil to the grid leak. As the signal current divides equally through the oscillator coil, one-half flowing in one direction and one-half flowing in the other direction, the two oppose each other and prohibit current flowing in the oscillator circuit. Both the oscillator and tuning circuits may

be tuned independently to the same or different wave-lengths. This is a condition that has never before been attained by a single tube.

There are many variations that may be made with this circuit, employing the same underlying principle, but the arrangement shown gives the best results.

By tuning the loop circuit to the frequency of the incoming signal, the signal current is impressed upon the grid and filament of the vacuum tube. By tuning the oscillator circuit to a different frequency from that of the incoming signal, which current is also impressed on the grid of the tube, a beat note is produced in the plate circuit. This beat note may be audible, depending upon the adjustment of the oscillator condenser. If it is audible, it may be heard in telephones connected to the output terminals. In a Super-Heterodyne, however, the beat note is made inaudible and is amplified by the intermediate amplifier, which is connected to the output terminals.

It may be well to note that by tuning the antenna circuit to an incoming signal, this signal is impressed upon the grid and filament of the tube and is, therefore, repeated

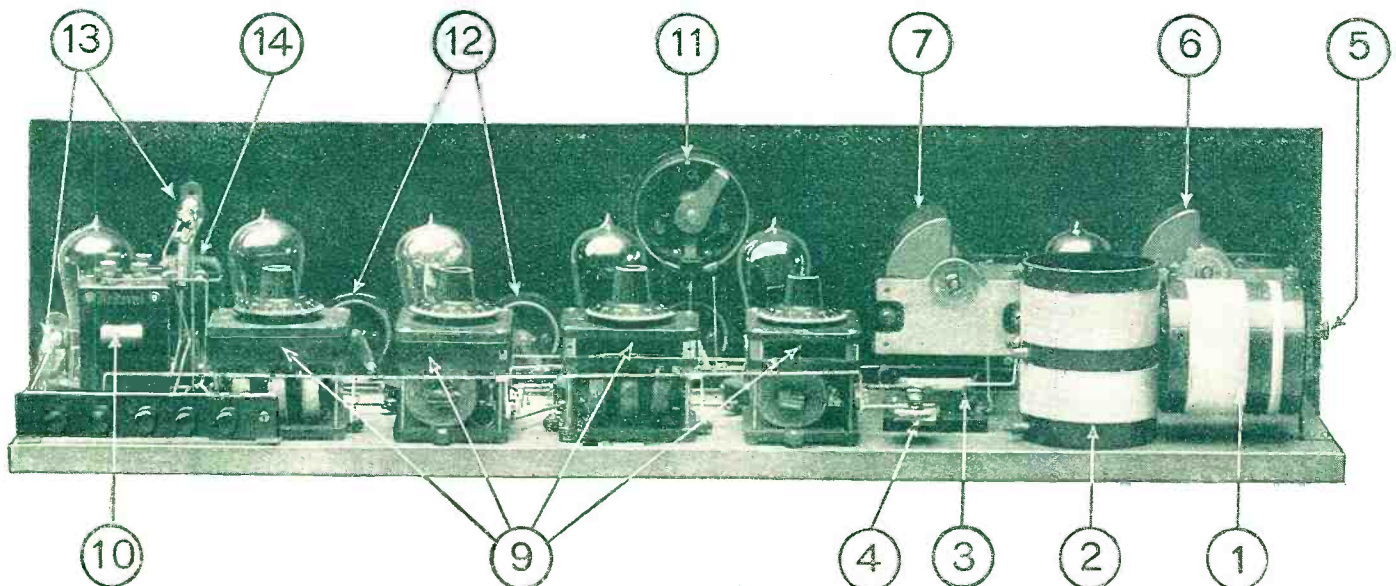

Rear view of the Tropadyne receiver. The spacing of the R. F. transformer coils can be clearly seen. The numbers and instruments correspond to those shown in the upper photograph.

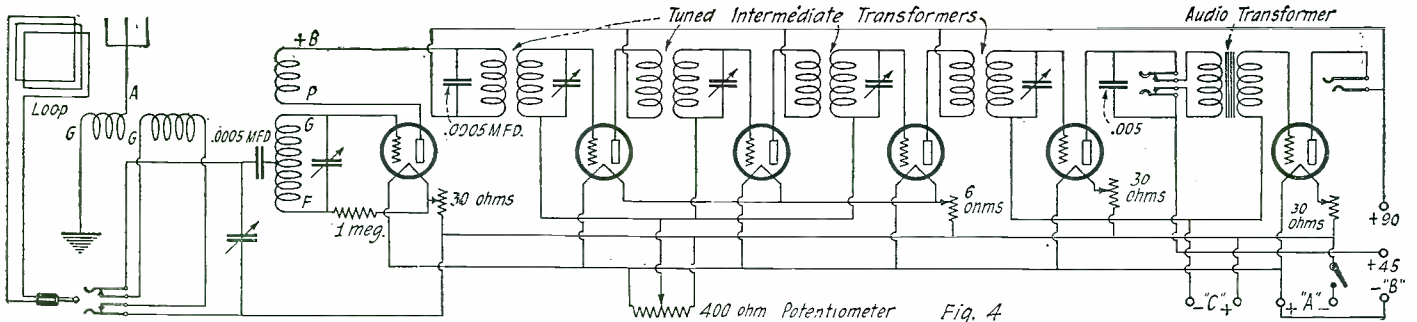

Schematic diagram of the Tropadyne circuit. Although only six tubes are employed, it compares favorably in volume with the ordinary Super-Heterodyne using eight tubes.

in the plate circuit. By means of the plate coil this amplified signal current is fed into the oscillator circuit and is further amplified by the phenomenon of regeneration. It is assumed in this case that the coupling between the plate and oscillator coils is variable and that the coupling is adjusted to a point just before the tube starts to oscillate. This makes a single tube regenerative receiver and the signals are heard in a telephone headset connected to the output. While adjusting this receiver the tube will sometimes generate an oscillating current in the oscillator circuit. But, as stated before, none of this current passes into the antenna circuit and hence this one-tube regenerative receiver is non-radiating. Some engineers have proven mathematically that if it is possible to transfer a radio frequency current from a primary circuit to a secondary circuit, the action is also reversed and a radio frequency current flowing in the secondary circuit will

between the plate circuit and the grid circuit of the tube.

These two coils should be constructed according to the drawings and mounted as shown in the illustrations. At the right of the photographs are shown the tuning condenser, oscillator condenser and antenna and oscillator coils. The frequency changer tube, which is the one shown in Fig. 1, is placed between the two condensers. This arrangement makes the connections very short.

The accompanying photographs also show the intermediate amplifier and the audio amplifier. The set shown has six tubes, the first of which is the frequency changer, and the next three the three-stage intermediate amplifier. The fifth tube is detector and the sixth is a one-stage audio frequency amplifier. For most purposes one stage of audio frequency amplification is sufficient, although for volume on DX stations, two stages are recommended.

of nine volts and a plate voltage of 45, the selectivity is so great that powerful local stations, otherwise broad in tuning, are tuned in and out with the vernier alone. This battery does not decrease the volume and the quality of reproduction is remarkable.

The question of air core or iron core intermediate frequency transformers is a much mooted one. While the air core type is very selective, it requires condensers for tuning each stage of amplification to the same wavelength. Usually fixed condensers are employed for this purpose, but it is difficult to obtain fixed condensers of uniform capacity and the result is that the amplifier operates at two or more wave-lengths. When this occurs, the same station is received at several settings of the dials. Iron core transformers, on the other hand, are very broadly

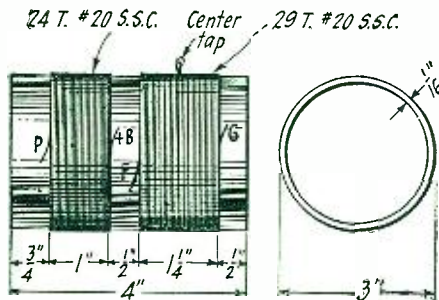

Fig. 3

Details of the oscillator coil. The plate and grid coils have 24 and 29 turns respectively.

be transferred to the primary circuit. They have, therefore, stated that the only possible way to prevent an oscillating regenerative receiver from radiating into the antenna is by the use of a blocking tube. An hypothesis disproved by the Tropadyne.

Since the object of regenerating in a receiving set is to apparently nullify the resistance of the antenna circuit, if the set does not regenerate into the antenna the efficiency, as far as DX reception is concerned, is greatly impaired. Therefore, it is doubtful if the one-tube non-radiating regenerative set will become very popular. Of course the sensitivity can be increased by employing one or two stages of radio frequency amplification before the regenerative detector tube.

Figs. 2 and 3 show the complete details of the antenna coupler and the oscillator coil. The drawings are self-explanatory and need not be described here. The end connections of the windings are lettered according to the lettering in the diagram, Fig. 1. In the diagram the coils are shown reversed in order to simplify the diagram; that is, the terminals "P," "G" of the oscillator coil are shown adjacent to each other in the diagram, whereas actually they are at opposite ends of the insulating tube. The object of bringing these leads out at opposite ends of the tube is to decrease the electrostatic capacity

This set shown has a 7 x 30-inch panel. This allows ample room for wiring. Although it is not advisable to crowd the instruments of a Super-Heterodyne, it is possible to mount a seven-tube set on a 30-inch panel. The two condensers, one potentiometer, four rheostats, three telephone jacks and a filament switch are mounted on the panels. The illustrated layout may be changed to suit individual requirements.

The Tropadyne principle, described above, is shown in Fig. 4 as incorporated in the complete six-tube Super-Heterodyne circuit. This circuit, with the exception of the connections of the first tube, is similar to the standard circuit. It will be noted, however, that no grid condenser and grid leak are used for the second detector. It has been found that a vacuum tube detector distorts signals, especially if they are very strong. This distortion has been practically eliminated from the second detector by operating the tube on the lower bend of its characteristic curve. This is accomplished by connecting the grid return lead to the negative side of the "C" battery, which acts as a grid bias for the audio amplifier tube. This applies a negative potential to the grid of the detector and, therefore, very little or no current is absorbed by the detector, and the selectivity of the intermediate amplifier is considerably improved. With a "C" battery

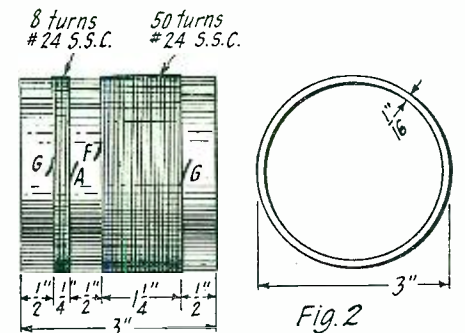

Fig. 2

A coupler having an untuned primary is used. Both primary and secondary are wound on the same tube.

tuned and give higher amplification than air core transformers. These transformers are so broad in tuning, however, that it is difficult to receive DX stations while local stations are operating. Manufacturers of iron core transformers usually supply one air core transformer, tuned by fixed condensers, for use in either the first or last stage of amplification. This air core transformer (often called a coupling, or filter transformer) is supposed to make the amplifier more selective, a situation not always obtained in practice. These disadvantages have been overcome by using the semi-iron core intermediate frequency transformers which are shown in Fig. 5.

The complete details of this transformer are shown in the illustrations. It will be noted that a variable condenser is permanently mounted on each transformer. This condenser is connected across the secondary winding and in this way each transformer may be accurately tuned, making the intermediate frequency amplifier very selective and efficient. "Rico" mica insulated variable condensers are used because they occupy less space than those employing air dielectric. These condensers have a maximum capacity of .0005 mfd. and, in connection with the coils used, the transformers may be tuned to any wave-length ranging from 2,000 to 7,000 meters. Although the coils used in these transformers were wound by machine, they

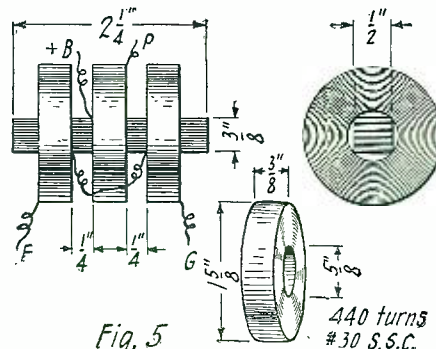

Fig. 5

The construction of the iron core intermediate transformers. Note spacing of coils.

(Continued on page 248)



Expanding the Beginner's Set

By A. P. PECK

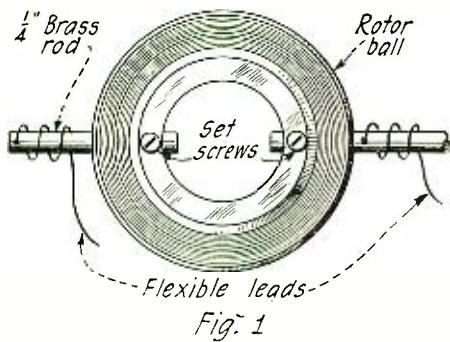

The variocoupler rotor shaft is in two parts as shown. Pigtail leads are soldered to each section for connections.

WELL, readers, how does it feel to be bitten by the radio bug and have a real radio set that you can point to and say you made it all yourself?

You undoubtedly found the radio set described in the last issue of this magazine very easy to build, and operate. Probably the only difficulty found (if you live in a district where there are many stations) was that the concert being received was often broken into by the broadcasting from another station. This was because the set described was not very selective. A set (an expansion of the one described in the last issue) which will enable you to overcome this interference difficulty will be described in this article. It is a little harder to construct than the first one, but most of the same parts may be used again.

To increase the selectivity of the simple radio set first described, the first step necessary is the conversion of the tuning coil into what is known as a variocoupler. Essentially this instrument consists of two coils of wire placed in inductive relation to each other, so a current of electricity flowing in

one of them will induce a like current in the other. The discussion of the theory of induction will be reserved for another article. Suffice it to say that the current in one coil will set up a current in the other one. When we place two coils in such a relation in a radio circuit, and connect them in a certain manner, the effect is to sharpen the tuning—enable you to tune out one station and tune in another, for the fullest enjoyment of the programs.

To make a variocoupler the entire tuning coil as described in the previous article may be used. Besides the parts used, a wooden rotor ball, $3\frac{1}{2}$ or $3\frac{3}{8}$ inches in diameter will be needed. A cardboard tube may be used for the rotor, but a wooden ball will serve more efficiently. Such a ball is very easy to work with. Usually it may be procured already wound. If you buy one not wound, get a half pound of No. 22 D.C.C. wire at the same time. Push the end of the wire through the hole which is drilled in one end of the winding space of the ball; this is at the smaller side. Wind that side of the ball full of wire, keeping the turns even and as close to each other as possible. At the middle division of the ball, cut the wire, leaving about three inches more than is necessary for the winding. Push the extra length through second hole, which will be found near the ridge. Start the winding towards the center. Make this winding in the opposite direction from the first one so when joined in the center, the entire winding will run in the same direction. This is important and failure to follow directions carefully may result in poor or no results.

At the completion of the winding, the next step is to mount it on a shaft. A shaft, in two parts, as shown in Fig. 1 is preferable. Following this method it is possible to make firm, electrically perfect connections to the rotor. It is poor policy to depend on the bearings of the rotor to provide connections to the winding. The best method is to use "pigtailed," as illustrated. For the shaft, procure two pieces of brass rod, $\frac{1}{4}$ inch in diameter. One piece should be about $1\frac{1}{2}$ inches long, and the other 2 or $2\frac{1}{2}$ inches long. The length of the second piece will depend on the distance between your tuning coil and the panel. This dimension is obtained from the instrument itself. Two $\frac{1}{4}$ -inch holes will be found drilled in opposite sides of the rotor. The rods will just fit these holes. Place them as shown in Fig. 1. Provision must be made for fastening the ball to shafts, which can best be done by two long wood screws. These will have to be on the order of $2\frac{1}{2}$ inches long and very thin. With about a $\frac{1}{8}$ -inch drill, bore a hole through the edge of the rotor and continue through the shaft. This drilling will have to be done very carefully, and the hand drill will have to be held very straight and rigid. Otherwise, the drill point is likely to break through the side of the

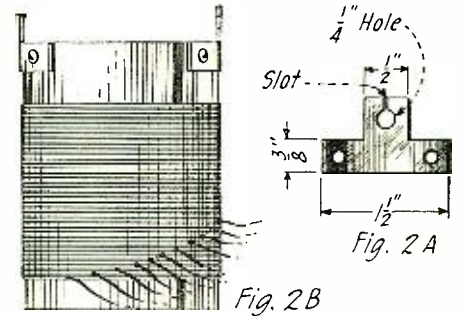

Bearings for the rotor shaft are made of 1/16-inch brass cut to the form shown here.

rotor and spoil it. After drilling the two holes, put the wood screws in as far as they will go and then tighten with a screwdriver.

Before making the connections of the windings, cut out the bearings for the shafts. These are illustrated in Figs. 2A and 2B. They are made from 1/16-inch brass which may be obtained from any hardware store. Both of the bearings can be cut from a piece $2\frac{1}{2}$ inches long by $\frac{7}{8}$ inch wide by overlapping them. In this way a saving in material will be effected. In the center of the $\frac{1}{2}$ -inch square lug, drill a hole $\frac{1}{4}$ of an inch in diameter, for the shaft to pass through. Then with a hack saw, cut a slot from the top of the lug through to the hole. By pinching the sides of the lug together slightly, the strip will hold the shaft tightly when it is placed in the hole. This pinching together will also prevent excessive play in the bearing. When the bearing surface becomes worn, through use, it will only be necessary to again pinch the lug slightly to restore a good bearing surface.

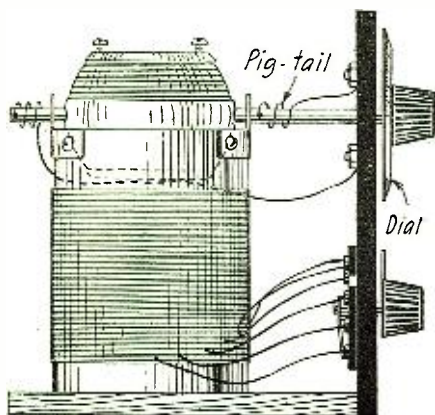

Fig. 3

The variocoupler as it appears when completed and mounted.

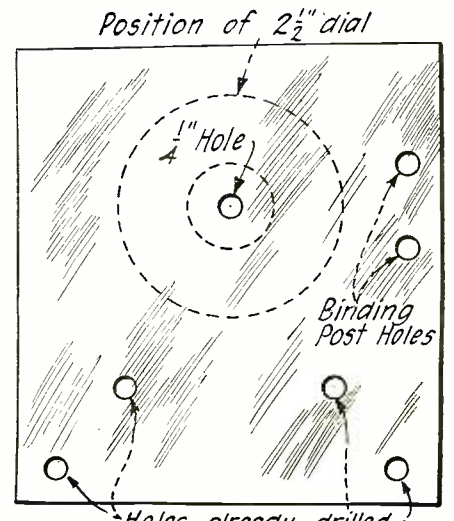
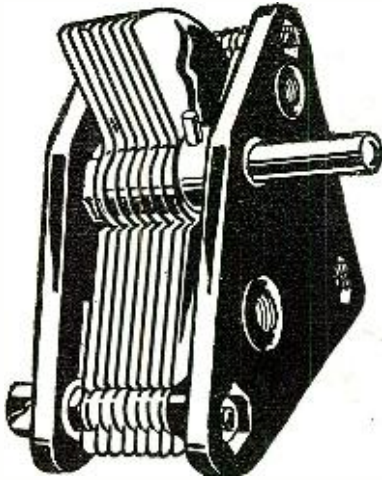

Fig. 4

Panel layout for variocoupler.



A 23-plate condenser as shown here is used to tune the secondary of the coupler.

After the hole is drilled and the slot cut, drill two other holes in each of the mountings, as shown in Fig. 2A. These are for fastening the bearings to the top of the tuning coil tube, as shown in Fig. 2B. This is accomplished by means of four small machine screws and nuts, two for each bearing. The bearings are not to be fastened to the tuning coil until the rotor shafts are placed in each bearing and the rotor connections are made in the following manner: Scrape the insulation from the two wires in the center, inside the rotor ball, and twist them tightly together, cutting off the surplus wire. According to good electrical practice this joint must be soldered.

To make a good soldered connection here or elsewhere, proceed as follows: Heat the soldering iron in a clean hot flame until the flame around the edges of the iron becomes green in color. Remove the iron from the flame and with a file, rub the four sides of the tip until they are bright. The bright part should extend about 1/2 inch back from the tip. Return the iron to the flame until the greenish tinge is again visible. Remove and place a very small amount of soldering flux or paste on the tip of the iron. Rub immediately the end of a piece of soft wire solder onto the iron. You will find that the solder will spread out and form a thin film or coating on the iron. This process is called "tinning" the iron. When the iron is to be used, take great care not to have it too hot, because excessive heat will destroy the tinned surface, necessitating its being cleaned again.

To solder the wire joint, place a very small quantity of paste on the twisted joint and a little more solder on the iron so that it melts and collects in a small drop at the tip of the iron. Touch this drop of melted solder to the joint and hold it there for a short time. If the wire is clean and there is enough, yet not too much flux on it, the

solder will "sweat" into the joint, joining the two wires together in an electrically perfect manner. If the wire is dirty, the solder will not stick. Do not leave a large lump of solder adhering to the joint; this indicates poor workmanship. If the solder sweats in there will be no occasion for such a lump. If the wire is dirty, scrape it carefully and try again.

The next connections to be made are those from the two outside ends of the winding to the shafts. Connect one end to one of the shafts and the other end to the other shaft, soldering the wire to the shaft. Clean the end of the shaft thoroughly with a file or sand-paper, and at the same time clean the wire to be fastened to the shaft. Place a small drop of solder on the iron and a little flux on the wire and the shaft. Hold the wire on the shaft with a pair of pliers and apply the iron. Hold the iron on the joint until the solder "sweats" as before. After the connections are soldered, slip the bearings into place.

Procure two pieces of flexible stranded wire to form connections between the shafts and the binding posts. One wire is soldered to each of the shafts. The flexible leads or "pigtails" are plainly shown in Fig. 3.

Before leaving the subject of soldering, let us sum up the essential points, so as to drive them home more firmly. They are:

1. Have everything clean; the iron, the objects to be soldered and the flux.
2. Have the iron hot enough to melt

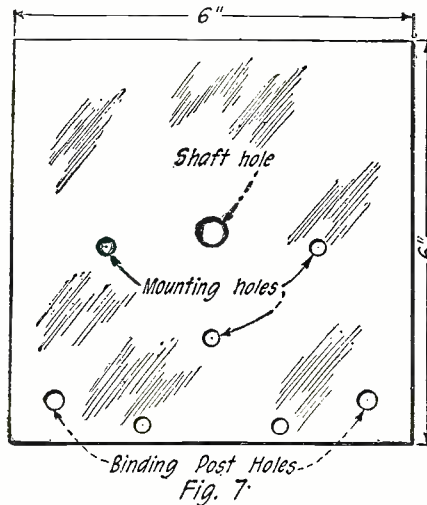

Panel arrangement for variable condenser

solder immediately, but never heat it to redness.

3. Always hold the iron in place long enough to allow the solder to sweat into the joint and make a perfect electrical connection.
4. Always use enough, but not too much flux or soldering paste.

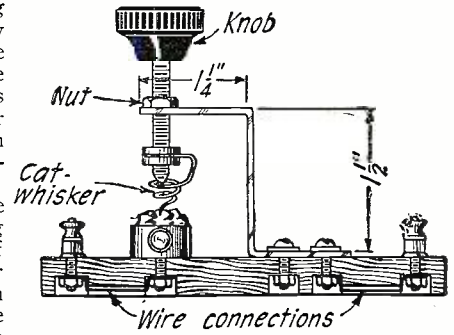

Fig. 5A

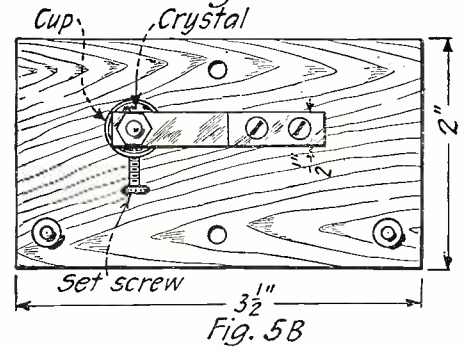

Fig. 5B

Constructional details of a good crystal detector.

5. Wipe all joints clean after soldering, but before the metals cool. In doing this, remove all excess flux or paste.
6. Keep the iron tinned and never use the iron for anything except soldering.

If the above facts and rules are kept well in mind, there is no reason why you should ever fail in soldering any kind of a joint.

Now that all the connections in and to the rotor are made, the next thing to do is assemble it with the tuning coil. First it will be necessary to drill three more holes in the tuning coil panel. One of these is for the shaft and the other for the binding posts to which the rotor leads are to be connected. These are plainly shown in Fig. 4. It is a good idea to take the tuning coil and the panel apart while converting it into a variocoupler. If this is not done, you stand a good chance of crushing the tuning coil tube or doing other damage. After you take the instrument apart, you can clamp the panel in a vise or to the work bench and drill it with ease and perfect safety.

Place the four machine screws in position and draw up the nuts on the inside of the tube so that the bearings are held in place. Then assemble the variocoupler on the base and panel. Fastening a dial to the shaft that projects through the panel completes the instrument.

Many detector elements work best when a heavy point with a firm pressure is used. This is impossible to obtain with the initial detector. Therefore, a detector that can,

(Continued on page 250)

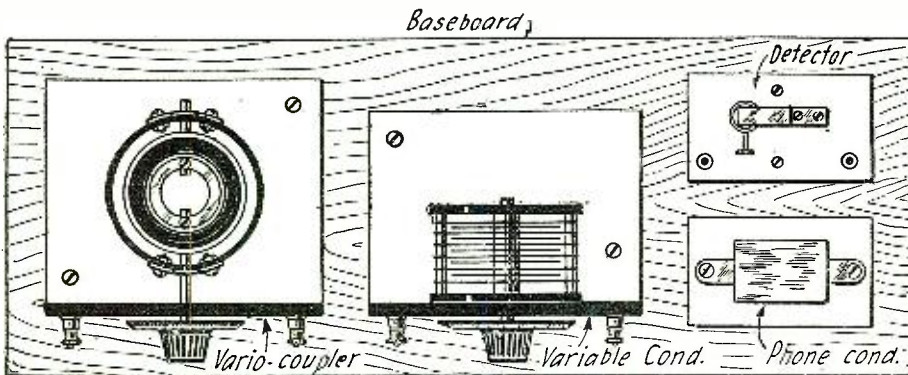

Fig. 8

A simple and convenient method of mounting the instruments on a baseboard.

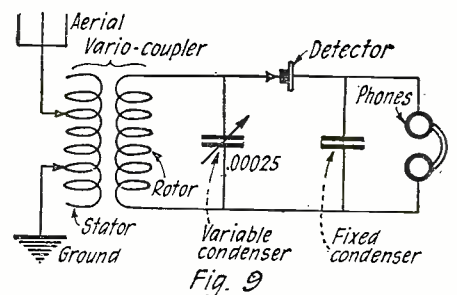

Fig. 9

Circuit using the variocoupler and crystal detector described in this article.

How to Build Radio Sets

By H. E. BENEDICT

An excellent article for the beginner who has in mind the construction of his own radio receiving set. Mr. Benedict tells the easiest and most practical way to go about it and has included many valuable hints that will assist in turning out a good and well appearing set.

IT is estimated that 80 per cent. of the radio receiving sets in use in America today are home built sets. And I venture to make the statement that the owners of most of these sets were more gratified by becoming the possessors of instruments of their own creation than they were by the substantial saving in the cost which they effected by constructing their own sets.

The real "dyed-in-the-wool" radio fan takes more pleasure in perfecting his radio set, tearing it down and building some new hook-up which may appeal to his fancy than the average 10-year-old boy takes in constructing a Brooklyn Bridge or a city skyscraper with the new mechanical constructing toy which he has just received as a present. This does not necessarily mean that Mr. Radiofan buys new parts for each different hook-up he makes. Far from it. He uses the same parts over and over again, buying, perhaps, some part which the new hook-up calls for and which he doesn't happen to have on hand.

There are probably a great many more who would build themselves radio sets if they did not feel that they lack the technical knowledge and mechanical ability to make their venture a success.

TECHNICAL KNOWLEDGE UNNECESSARY

It is a mistaken idea, however, to think that you must be an electrical wizard in order to build a radio set. As a matter of fact, you do not need to have any technical knowledge whatever of the principles of radio in order to hook up even one of the more complicated one, three, or even five tube sets.

Some of the wiring diagrams published in the newspapers and magazines every day may at first appear a little complicated to you, but they are not nearly so hard to

When, after putting the final touch to your first home-made set, it works right away, "it sure is a grand and glorious feeling."

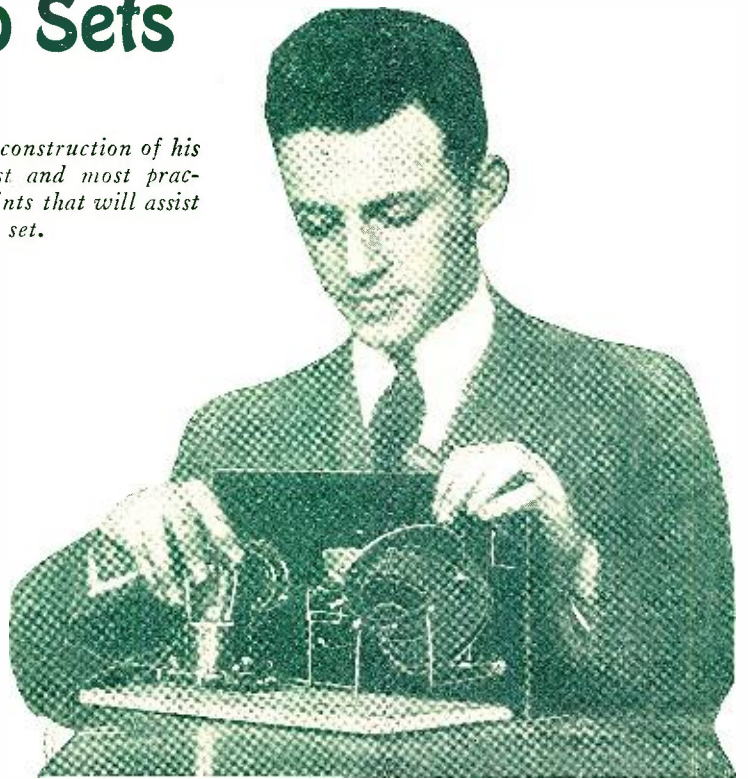

understand as they at first appear. As an illustration, suppose I should take you into the kitchen of your home, and with a piece of chalk mark each leg of the gas range with a letter of the alphabet, then give you four pieces of string and tell you to tie one end of each of the strings to the four legs of the gas range, specifying each by letter, with each of the other ends leading, respectively, to the door knob, to the electric light socket, to the water faucet, and to a chair; you wouldn't have the least bit of trouble in following my instructions, would you? And if an artist were to draw a diagram of these four strings leading from the four legs of the gas range to their respective terminals, you could do it by referring to the drawing just about as easily, couldn't you?

Wiring diagrams for a radio set may not be quite so easy to follow as the above illus-

tration, but with a little study, you will be able to follow almost any wiring diagram with very little difficulty.

If you have never attempted to make a set, it would perhaps be better for you to select a wiring diagram for one of the more simple sets—say, a crystal set, or a one-tube set.

The first thing for you to do is to pick out the wiring diagram of whatever set you prefer to build. There are so many wiring diagrams published in the newspapers, magazines, and by manufacturers of parts, that you may find it difficult to decide upon just which set you prefer to make. Your favorite newspaper or magazine will gladly mail you a wiring diagram, together with a list of exactly what parts you will need for your hook-up. And when you buy the parts, it is advisable for you to buy the very best parts obtainable.

It is a good policy to buy a blueprint to follow in wiring your set. It will not only show you the best method of wiring, but it will also show you a lay-out for assembling the parts on the panel and mounting board.

DRILLING THE PANEL

A good many dealers will furnish you with a panel already drilled if you buy the parts from them. In case you wish to drill your own panel, the following suggestions will help.

First cut a piece of plain heavy paper the exact size of your panel, and then, in accordance with your blueprint, lay out the plans for the holes to be drilled in the panel on this paper.

Place this paper on the panel and snap a few rubber bands over the paper to hold it firmly in place. Then, with a center punch, mark the panel through the paper at each of the places indicated by your lay-out to show where the holes should be drilled, and to prevent the drill from slipping and scratching the panel.

The blueprint, you will notice, calls for several different sized holes to be drilled in the panel. It is best to secure a set of drills, but if the exact size of drill is not at hand, a reamer tapered from $\frac{1}{8}$ inch to $\frac{1}{2}$

(Continued on page 252)

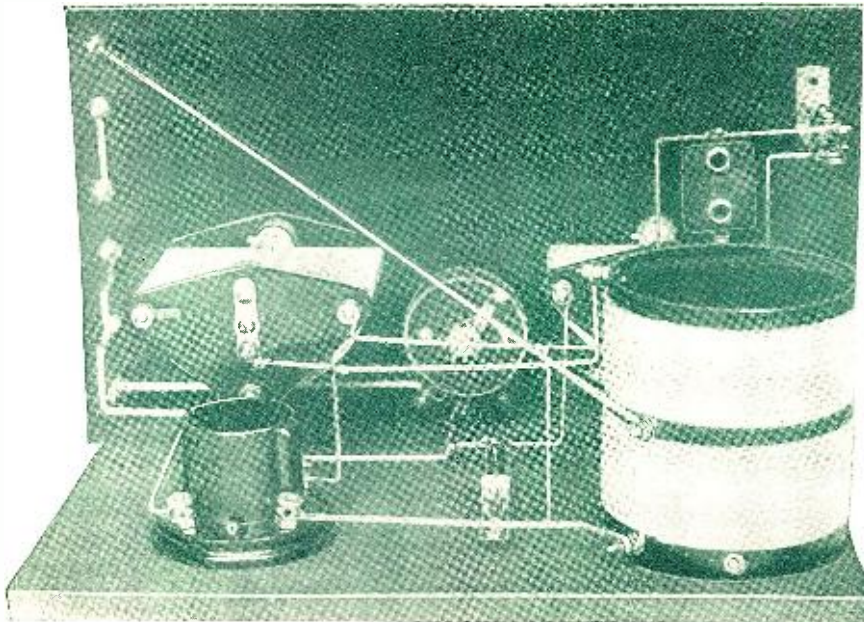

A single tube receiver which may easily be constructed by the average experimenter. Note how the bus bar connections are made and bent at right angles.

The Importance of The Trivial

By SIR OLIVER LODGE, D. Sc., LL.D., F.R.S.

PART II



In this, the second of the articles by the famous English scientist, further data and discussion of foundational radio facts are given that are many times lost sight of in the mêle of detail of construction. It is valuable to all radio enthusiasts.

WHEN two coils are coupled inductively, they react on each other with the result that the inductance of each is diminished and the resistance of each is increased. Resistance is never wanted, it is always a nuisance, though unavoidable. That is why coils are wound so as to give as much inductance as possible for a given length of wire; that is, for a given resistance. Inductance confers inertia on the current, like adding a mass of lead to a pendulum bob. It makes the oscillations persist, and it enables accurate tuning. Hence anything that diminishes the inductance and increases the resistance is deleterious. But there is more objection to reaction than that fact. A coil and condenser circuit, if free and uncoupled, has a definite period of oscillation of its own, and is capable of precise tuning. When coupled up to another similar circuit, its oscillations are not free. It is rather like coupling two pendulums together; they are both hampered; one tries to share its frequency with the other. The result is a kind of double vibration, something like a three-legged race. Two men run much better when their legs are not coupled together; the coupling is an interference. Neither has any longer an effective will of his own. This tight coupling is manifestly a disadvantage.

In ordinary transformers all this has to be put up with. What is wanted then is a transmission of energy from the primary to the secondary coil. And to get the maximum

transmission, the coupling must be tight. The two coils become in a sense one, and the connection thus obtained is rather like direct connection without a coil at all. It is, in fact, simply a mode of effecting connection and at the same time giving the option of increasing the voltage by what is called "transforming up," which is attained when the secondary coil has a great many more turns than the primary. This is not a case of reaction in the technical sense.

Indeed, in the technical sense, reaction has a still more objectionable significance. A current magnified by a valve (vacuum tube) and high tension (B) battery is made to react upon some other non-magnified part of the circuit and thus excite magnified vibrations in that circuit which once more increase the vibrations in the magnified part, and these react again; and so on, backwards and forwards, until the result is a mighty howl. Just as when an ordinary telephone and a transmitter, short-circuited together through a single cell battery, are made to talk to each other; the slightest disturbance in the telephone then affects the transmitter through the air, this affects the telephone through the wire and battery and once more it reacts on the transmitter through the air, and that again acts through the wire. So that in a short time—which need be only the fraction of a second,—the two set up a howl or scream of some kind, the pitch depending on the tone or tones of the telephone diaphragm.

Of course, this magnified kind of reaction gives more power; and if the coupling is fairly loose, so that the circuit is just on the verge of howling, the arrangement is very sensitive. But it is not a good arrangement, and does not lead to good tuning. If the coupling effects the aerial, it tends to increase the oscillations in the aerial, turning it into a transmitter. Moreover, the aerial operating as such a transmitter, oscillates at a note very close to that of the station being received. The result is, objurgations on the part of your neighbors, who are receiving from you instead of from the distant station both your set and their sets are tuned to. They receive not only the right note, but other notes nearby, excited by your coupling arrangements. They cannot well tune these out, because they are so near the right pitch, but it spoils their tuning; and if you press the coupling a little further they will receive your howls.

UNSUSPECTED INSTANCES OF REACTANCE

When a disc of metal is brought near a coil in which are oscillating currents, the disc of metal is, of course, a closed circuit, and currents—sometimes called Foucault currents—are induced in it. It acts, in fact, like a single-turn coil of very low resistance. And the currents may, therefore, be fairly strong, so that if the primary coil were conveying strong currents, the disc of metal would get quite hot. This phenomenon is

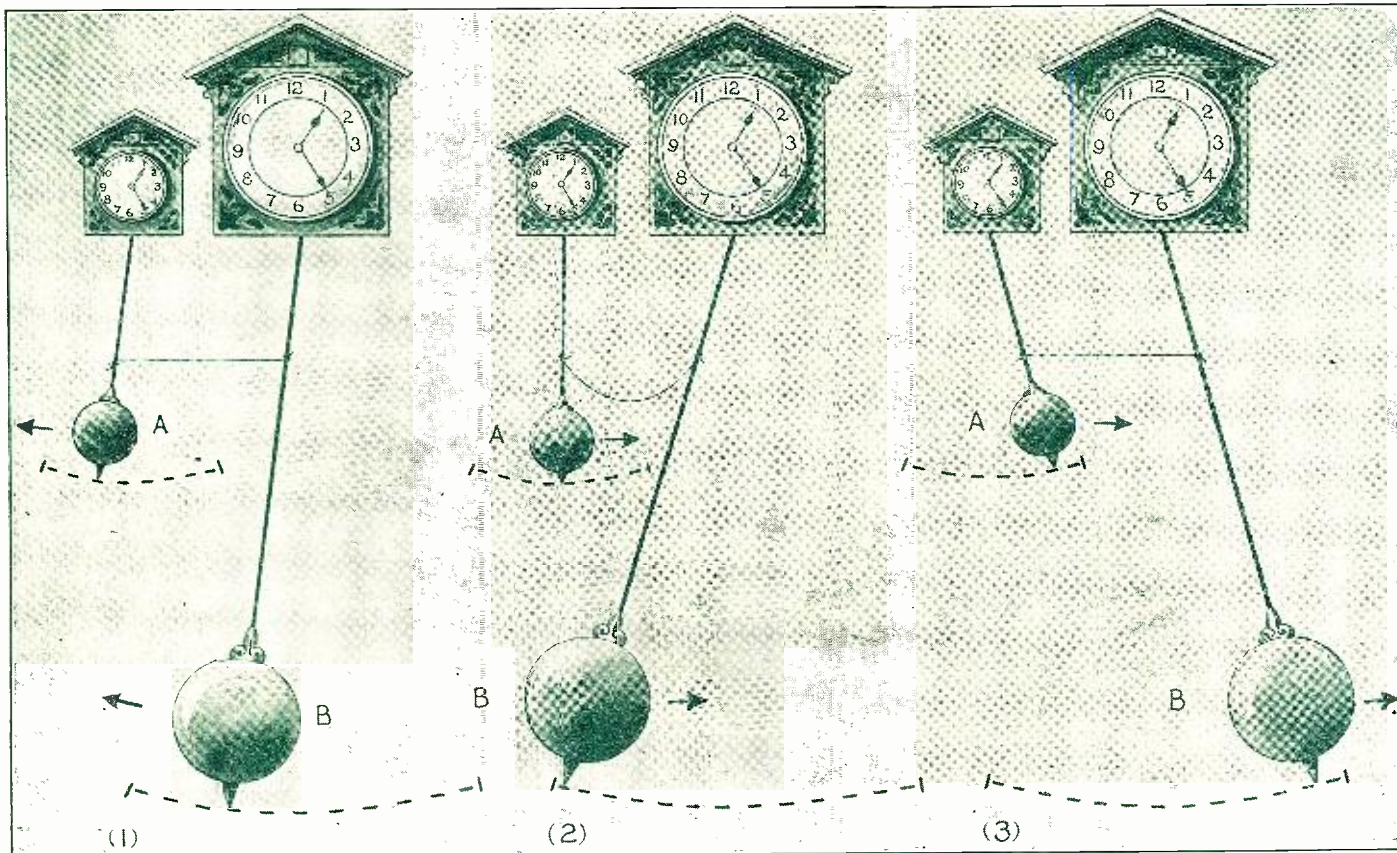

This drawing is an analogy showing how one circuit reacts upon another when coupled to it. The two pendulums A and B are tied together with a string so that the larger one imparts some of its momentum to the small one at each swing. The same thing happens in a radio receiver in which the primary circuit energizes the secondary at each oscillation. The resistance offered by the circuit may be compared to that caused by the small pendulum in the above analogy.

made use of in high frequency induction furnaces such as the one described in the February issue of RADIO NEWS under the title "Melting Metal Without Fire in a Radio Furnace."

With the kind of currents employed in radio receivers, there would be no perceptible elevation of temperature unless extremely delicate thermometers were used. But there would be reaction. The disc of metal would be like a secondary coil, and would react on the primary. When coils are thus coupled together, the effect is to diminish the inductance and increase the resistance, and therefore to put the coil out of tune if it forms part of a condenser circuit with free oscillations. The approach of the disc of metal leaves the oscillating circuit no longer free. It is virtually coupled to another circuit, and the disadvantages of reaction set in. Tuning is not only altered, but spoiled, for a double-note is generated. It is like coupling two pendulums together, or like a three-legged race.

But it may be asked: "Who brings discs of metal into the neighborhood of a coil?" The answer is: "You do, if you are using an ordinary variable condenser or other metallic object without precautions." A variable condenser consists of metal plates, all parallel to each other. And if they are parallel also to the plane of some coil, they will react upon it. Possibly they are not very near, and the reaction will not be very prominent. But none of such reaction is any use, and whatever there is is bad. What is the remedy? Either to keep the coils and the condensers far enough apart, or to arrange the plane of the coil at right angles to the plane of the plates in the condenser. Or, more accurately, to put them in what is called "a conjugate position," in which the mutual induction is zero, so that currents in one do not induce currents in the other. There are many such zero positions. A position of zero mutual induction is obtained when lines of force due to either coil do not thread the other; that is, do not pass through the condenser plates, in the particular case under consideration. They may dip into it, but they must rise out again, passing through the plate on both journeys. They must not pass through the plate and then return outside. In other words, they must not effectively cut or thread the plate, as if it were a secondary coil.

This is a kind of precaution that ought to be taken by makers of sets. And if they do not happen to be aware of it, they may be arranging metal conductors near coils without realizing that they are thereby introducing spurious effects, which, however, are no good, and which, if strong enough, will do harm.

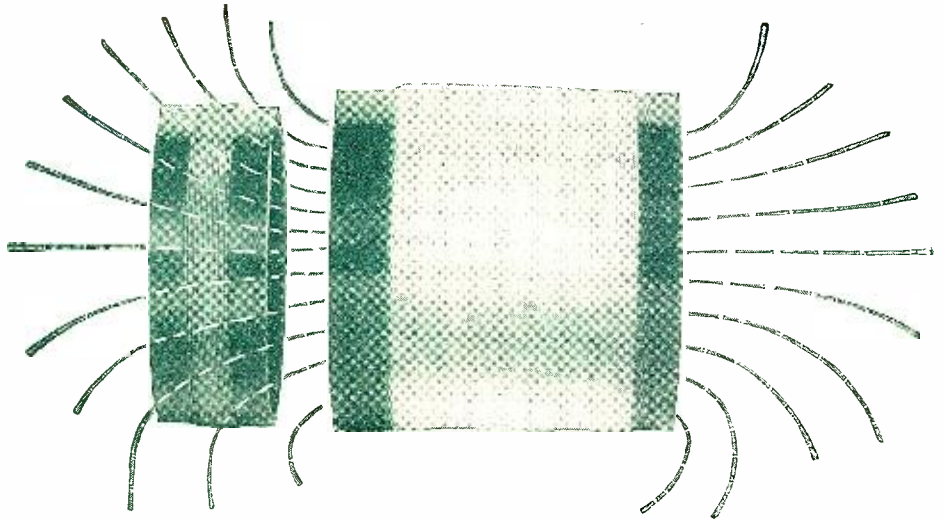

Illustrating the phenomenon of induction. When one coil is brought within the field of another in which the alternating current flows, a current is induced in it, but at the same time resistance is introduced in the coil imparting energy to the other.

It is pretty well recognized now that distributed capacity in a coil, though not wholly avoidable, is undesirable and disadvantageous. Capacity should be defined and localized, and not smeared about, along with resistance and inductance. The turns of a coil are intended to act inductively upon one another by magnetic induction. They do also act on each other by electrostatic induction, which is not wanted. That is what gives distributed capacity, and hence basket-winding and other devices. The separation of the wires diminishes their mutual inductance, which is bad, but it also diminishes their electrostatic or capacity induction, which is good, and the result is a compromise.

In addition to the recognized coils, there are also capacity and inductive effects between lead-in wires and the connection wires in the set. These should be kept to the minimum. We don't want capacity in a lead-in wire, we only want conduction. We don't particularly want inductance in a lead-in wire, though we cannot help it, moreover it does no harm. But what we certainly don't want is mutual induction and capacity between lead-in wires, and these can both be avoided to a great extent. They are no good, and though they do not do very much harm, they are better away.

To avoid them, the wires from different parts of the circuit should not run close together and parallel to each other. If they have to cross, they might cross at right-angles, being well insulated where they cross. Wires which lead to the binding posts of a transformer or a tube should not be bunched

together, even though perfectly insulated from each other. They should be separated. If they can radiate out from each other for a little distance, so as not to be even parallel, so much the better. If they are separated by a few inches, their parallel running will not matter. Some careful experimenters attach radiating projections to the sockets of their vacuum tubes, etc., so that the wires which lead away from the ends of these projections shall not be close together.

These are to some extent counsels of perfection, but radio receivers are so nearly reaching perfection, and tuning is becoming so remarkably accurate, that even these trifles are worth attention. Wires should, in fact, be not only insulated but isolated. The nearer and more parallel they are to each other, the more they are liable to introduce undesired disturbances and spurious effects. Even insulation is not always attended to as much as it ought to be.

The minor points to be borne in mind in a good radio set are, then:

Low resistance and perfect joints.

Stranded wire in the high frequency portions.

Avoidance of stray capacities and mutual inductance.

Keeping away earth connected surfaces from the immediate neighborhood of parts in which capacity is not wanted, such as lead-in wires.

Removal of metallic masses, especially copper plates, from the neighborhood of coils.

And most especially, good joints everywhere, no leakages or bad insulation, and highest conductivity wire.

RADIO DOES NOT ELECTROCUTE

Radio, unfortunately and unjustly, frequently gets a "black eye" through improper headlines and sometimes badly written stories in the daily press. The headline, "Electrocuted by Radio," which recently appeared in a large daily paper, was not only misleading, but wrong according to the brief story itself. In the first place, radio cannot electrocute except in case of transmitting stations where high power supply is used. At the radio receiving end, radio is not dangerous. It is even doubtful if the high frequency power put into transmitting antenna at big commercial stations could kill, although it is admittedly dangerous to touch bare wire, the motor generator, bus-bars, or the transmitting circuits, as a shock or burn might result. Only at high powered, low frequency power supply stations could serious results occur. Receiving sets are not

(Continued on page 241)

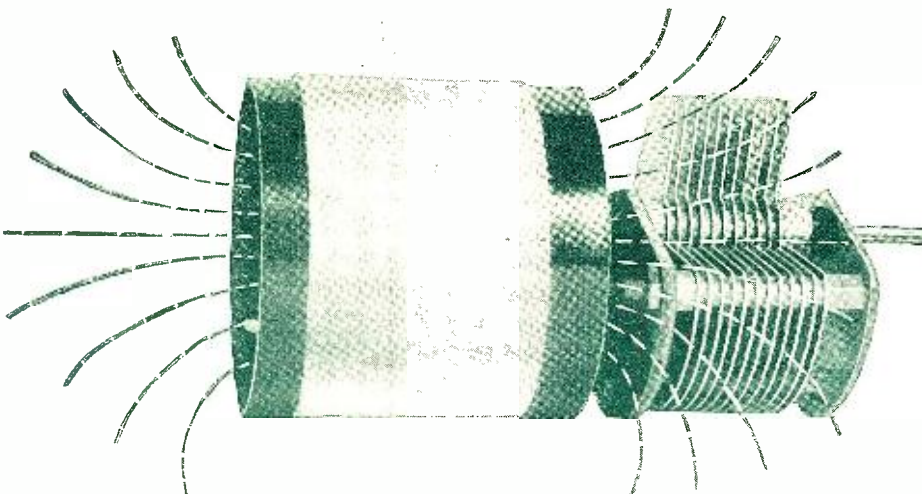

In radio sets coils should never be mounted so that metallic objects are in their field, as this introduces resistance in the circuit. The resistance not only decreases the signal strength but is responsible for broad tuning.

Loud Speaker Works On Crystal

By CAPT. S. A. HUSS



The serious experimenter will find this article of exceptional interest, for Capt. Huss has managed to produce excellent results with crystal receiving circuits, having operated a loud speaker from the minute currents rectified by a crystal. If enough pains are taken, the success that Capt. Huss has attained can, no doubt, be duplicated.

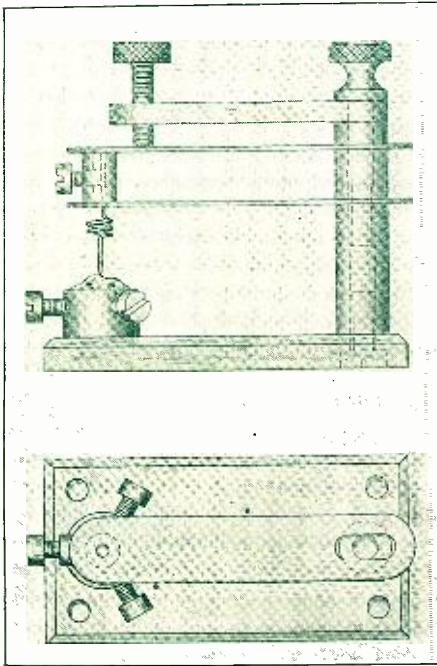

The type of crystal detector which the author found best in his experiments. Very fine adjustment and stable operation were obtained.

SINCE the introduction of the vacuum tube, the simple crystal has been relegated to a very minor position, and in consequence little serious experimenting has been done with the crystal. In fact, these experiments which I am describing really owe their origin to an arrangement to check wave-lengths accurately when transmitting from an amateur station.

The measurement of radiation from a broadcast station was tried out as a matter of curiosity on a Perikon combination, when by careful adjustments .25 milliamperes was registered.

Incidentally, many interesting Perikon combinations may be tried out by the experimenter in crystals, with such combinations as zincite in conjunction with the many synthetic galenas, which show very promising and interesting results. High resistance phones were tried, and as an experiment a pair of 120-ohm low resistance phones was also tried. The 120-ohm phones gave very loud signals, and thus suggested putting a loud speaker of 120 ohms in circuit, and although signals were audible more current was essential to operate it effectively. From then on, all efforts were directed with that end in view, namely: Increasing the current rectified by the crystal.

Although supplanted by the vacuum tube, it is recognized, I think, by all, that no tube as yet constructed can approach the crystal for perfect and pure rectification, and if, therefore, some means of perfecting the crystal were evolved, concerts, etc., could be received as nearly perfect as possible without causing interference to our neighbors, due to radiating regeneration receivers and tubes.

I will, therefore, give you a full description of the circuit and apparatus employed which enabled loud speakers to be operated from a simple crystal.

The apparatus consists of a coupled circuit in which the primary and secondary are tuned by means of their respective condensers; a microammeter reading to two milliamperes and having approximately a five-inch scale, thus enabling micro-amperes to be read fairly easily is essential. The phones were of 120 ohms resistance, and the loud speaker was a large one, also of 120 ohms resistance.

THE DETECTOR

The detector was a special one, designed by the writer, as it was soon found that the usual commercial type did not as readily admit of such necessary fine adjustment of pressure to be made, and it also permitted the points of contact with crystal being made truly parallel. The crystals employed were all of the synthetic galena variety and the writer would recommend that several kinds be tried, as some varieties did not substantiate the claims made for them. Also, contrary to the usual theory, a fine and springy cat-whisker and delicate contact did not prove satisfactory, in fact, as much as 50

continuous, forming six loops as in No. 3 aerial, 75 feet high. Readings: 1.4 to 1.85 milliamperes.

Note:—Both cage aerials, No. 2 and No. 3, had single leads-in of three strands of No. 22 wire.

It is noticed that no mention is made of a twin wire aerial; this is due to the fact that although tried, no apparent gain over the single wire aerial was noticed, although these wires were spaced from 5 feet to 12 feet apart during the test.

Experiments clearly showed that to gain an increase of current a greater height and an increase of surface area was necessary, but owing to the fact that the aerial was also to be used, for transmitting on wave-lengths of 100 to 200 meters, a compromise was made in the case of the last aerial (No. 4) with excellent results.

TESTS

The station used for testing in these experiments was 2LO, the London station of the British Broadcasting Company, which is rated at 1½ kilowatts, and is situated just over 10 miles from 5DT.

The procedure for tuning is to place the microammeter in circuit in place of the phones. Tune the instrument to the wave-length required and roughly adjust the contact on the crystal until a reading is obtained on the meter. Sharpen the tuning, and finally adjust pressure of contact on the crystal, searching for the most sensitive spot until the maximum reading is indicated on the meter. Then replace the meter by the low resistance phones or loud speaker.

High resistance phones were tried out, as has previously been mentioned, with resistances of 8,000 ohms, 4,000 ohms, and 3,000 ohms, but little or no difference was noted in signal strength on a current of 1.5 milliamperes, but by substituting a pair of 120-ohm phones, or even as low as 60-ohm phones full advantage of the increased currents was obtained as the signal strength was then enormously increased.

Variometer circuits were not tried, but equally good results might be anticipated.

Fine tuning of the circuits and crystal combined with a large surface area, and height of the aerial are indicated as the essential points to be kept in view, if good signal strength is desired on the phones or loud speaker.

A meter for checking current measurements is also an essential, as it is practically impossible to judge by the ear alone, this being proved by inviting a number of amateurs to attend a witness test and obtaining

(Continued on page 259)

WANTED

RADIO articles for the motor camper and tourist. Articles on portable radio sets to take along in your car and for camp use are desired, also any and all radio wrinkles of use to the man who goes camping with his car.

The radio department of **MOTOR CAMPER AND TOURIST** requires monthly articles for which regular space rates are paid. The Editor also requires radio photographs taken in camp or adopted for camp use.

Get a copy of the magazine at your newsstand in order to acquaint yourself with the policy of the publication. If your newsdealer cannot supply you, send for a free sample copy to:

Motor Camper & Tourist,
53 Park Place,
New York City.

per cent. increase of registered current was obtained on increasing the pressure of the cat-whisker. The cat-whisker may be a fairly stiff one of gold, silver, or copper. The crystal used by 5DT in his experiments is known as "Superite."

Results and data concerning the aerials tried out are as follows:

No. 1 Aerial. A single cable consisting of seven strands of No. 22 wire, 55 feet in height, horizontal portion 70 feet, lead-in 30 feet. Readings: .5 to .78 milliamperes.

No. 2 Aerial. Cage Aerial, six cables of three strands of No. 22 wire, 3-foot hoops, 75 feet in height, 65 feet horizontal, lead-in 32 feet. Readings: .75 to 1.25 milliamperes.

No. 3 Aerial. Same dimensions as No. 2, but ends of the six 3/22 wire joined, forming three loops. Readings: .8 to 1.35 milliamperes.

No. 4 Aerial. Cage aerial of 12 No. 18 enameled wire, 18-inch hoops, horizontal portion 45 feet, lead-in (cage) 32 feet, ends

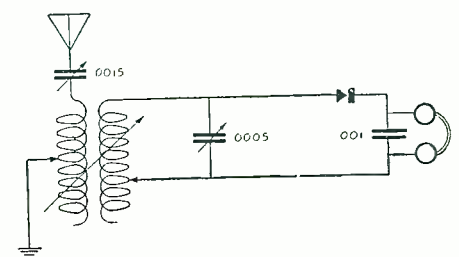

The circuit used for loud speaker operation. A variocoupler may be used for the tuner.

Oscillations

By WILLARD WILSON

TO the Editor of RADIO NEWS, which are rapidly becoming most popular nextdoor sport of generation.

Greetings:—

I have laterly become awake to much amplified discussion among radio mgs., fans, etc., about many authors, sing writers, and others which desire checks for having their labors sang forth from broadcast horns. Such discussion have made my soul oscillate extremely—at times I being unable to tune out Hon. squeal from such. Oh! To which deeps of greedliness such pepl. have fell!

I am no lawyer, yet I have cogitated out munificent plan for circumventing such claims, thusly.

All Hon. pigs who desire such payment for their copyrighted sing-song base claim on following reason. Namely, copyright law inform everyone that such song, often becoming copyright by payment of rich fee, is unable to be reproduced for public exhibition unless Hon. sing-song club of authors of U. S. give permish. Theirfore, they squeak, all Hon. radio broadcast stations must pay huge sum when anyone sing such song from their station.

Such is porkish desire of money which cause squealing spill-over of my soul. But I must proceed.

Such claim, I gurgle fiercely, are utterly unfounded. Because, as I shall proof exclusively, Hon. radio broadcasters does not reproduce sing-song; they produce them, and radio fan reproduce them with high powered receive set!

These argument is somewhat tense, so follow closely.

1st—Anything which are reproduced are able to be heard. Is Hon. broadcaster station able to be heard? Can we park ourselves calmly in Hon. atmosphere and hear orchestra in studio play copyright sing-song "Looking through Hon. crack in Father's Glass Eye"?

No! We cannot, I amplify two stagely. We must hook receiver set onto chicken wire arial and listen to Hon. loud speaker reproduce sing-song. We can not hear broadcast station, I whoop. We hear own receiver set reproduce—thusly we fans should pay damages to author and sing-song club if anybody perhaps may.

2nd—If nobody in world had receive sets, would Hon. club still try to make broadcasters pay ducats for sing-song? Of course no! But Hon. copyright law would still be good



When collector for such club appear he will receive warm welcome.

against reproducing of sing-song. Why wouldn't they raise huge oscillation against broadcasters, then, if they are breaking copyright law by singing such song? Because, I yell triumphly, broadcasters do not reproduce sing song. They merely produce them, as I negotiate before, and phones or loud speaker of fan reproduce them.

Therefore, I tune in, broadcasters are unforced to pay for copyright sing-song which are sang from their station, as they do not reproduce them, and thusly do not bust Hon. copyright law. If club of song and story grafters wish to collect damages for radio executioning of their labors, let them pick

on correct and more numerous opponent—namely, radio fan.

I am such, and also breake Hon. copyright law whenever possibly by reproducing sing-song of copyright club on my receive set. If they desire huge remuneration from me for such law bustage, I will furnish address upon copyrighted request. When collector for such club appear, to obtain large remunerating from me, he will receive warm welcome and also huge load of Chinese pepper shot in his Hon. eye.

I remain respectfully,

CHIN CHOO CHOW,
Shanghai, Ariz.

Radio Broadcast Advertising in Argentina

By R. A. GIBSON

AFTER reading a number of articles in RADIO NEWS on the subject of advertising, especially the one entitled "Radio Public Impatient with Advertising Talks," and the Editor's view, as expressed in his letter to *Printers' Ink*, I have felt that the situation in Argentina might be of interest to readers of RADIO NEWS.

There are three principal radio broadcast stations in Buenos Aires, the capital, as follows: "Radio Sud America," "Radio Cultura," and "Sociedad Radio Argentina." "Radio Sud America" is a station operated by the Radio Corporation of America and gives a nightly program like those transmitted in the United States. "Sociedad Radio Argentina" transmits during the evening when the opera season is on at either the "Colón" or the "Coliseo," two of the principal theatres in Buenos Aires.

The station of principal interest, due to the nature of this article, is "Radio Cultura," which transmits an afternoon and nightly program. The following is an excerpt of one of its programs: "1:00 p. m., Official Bulletin of the Argentine Department of Agriculture; 1:30 p. m., dance music, composed of the latest American music and Argentine tangos; 9:15 p. m., musical program, orchestral and vocal; also talks by authorities on educational features of the day; recitations, usually by the author. At 10:00 p. m., the official hour is given out."

The reason for the special interest in station "Radio Cultura" is the fact that the expenses of the station, figuring in erection, payment of artists, and maintenance, are taken care of by the proceeds derived from the advertising of products of local stores. In other words, the station was erected as

a commercial venture, the revenue to be derived from selling advertising by radio.

The advertising feature of the program is brought in between the announcements of the different numbers of the selections. While the translation from Spanish into English causes a loss in the effect, it is believed it will be conceded that the advertising is brought in in rather a clever manner. A translation of one of the advertisements is as follows:

Chinese Customs:

"Among the curiosities of the Chinese customs, the following is considered of interest: When a child becomes four weeks old, it is given a first name, which is a number in the order of the family, such as 'Yan No. 1,' 'San No. 2,' but at six years, when the child goes to school, it receives a more har-

(Continued on page 259)

Saving Tubes With Reflex Circuits

By JOHN SCOTT-TAGGART, F. INST. P.

The ever growing popularity of reflex circuits with their economies in tubes will make this article of great interest to the experimenter of limited means.

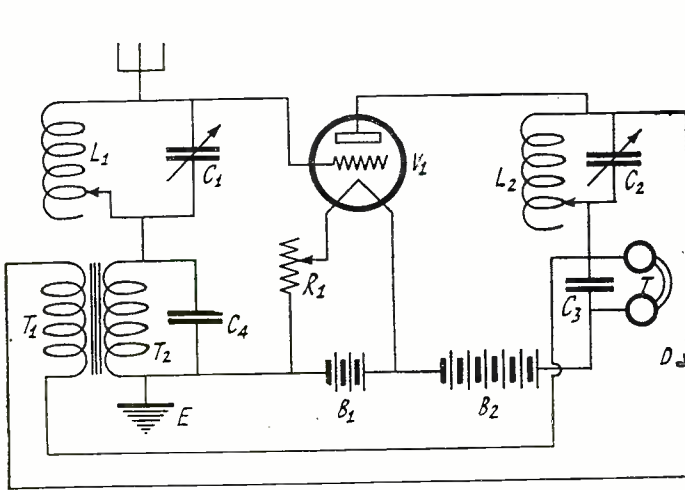

Fig. 1

A single tube reflex circuit. Tuned impedance is employed instead of an R. F. transformer.

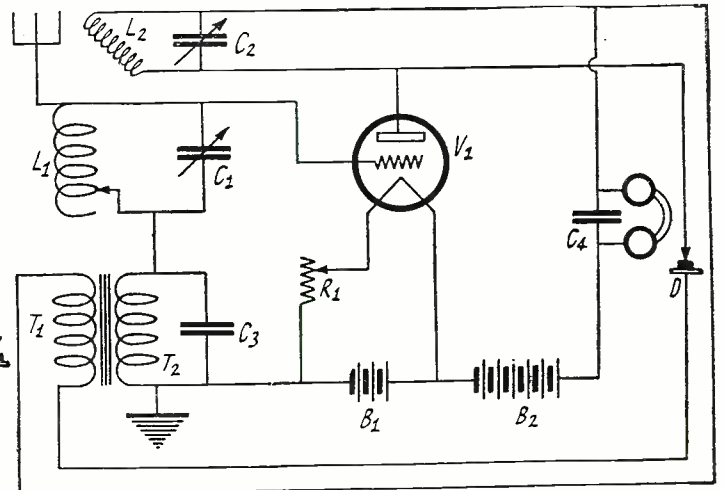

Fig. 2

Another single tube reflex circuit. Here regeneration is obtained by means of a tickler coil.

DUAL or reflex amplification circuits have recently become very popular and the beginner is anxious to know the characteristics of the various circuits and their application to practical use.

Unless one has had some experience with other forms of radio circuits it is not advised that he attempt the construction of a reflex receiver until he is more acquainted with its erratic qualities. Some explanation of the principles involved and working characteristics peculiar to this system should be given before plunging into a description of various diagrams and sets.

In an ordinary single tube non-regenerative circuit, received signals are rectified and partially amplified by the vacuum tube. To increase the volume of the incoming signals in this circuit the usual procedure is to incorporate one stage of audio frequency amplification. If the range of the receiver is to be increased, it is customary to incorporate one or more stages of radio frequency amplification. For every such stage added, another tube is necessary. Not so, however, in a reflex circuit where one tube is made to perform the duty of two or possibly three. The manner in which this is accomplished is quite simple. For example, suppose we wish to incorporate one stage of audio frequency amplification, the circuit is then connected up so that the incoming signals, of a radio frequency, pass through the tube where they are rectified and their resultant audio frequency current, instead of being passed to the head-phones, is fed back or reflexed through an audio frequency amplifying transformer, the secondary of which is connected in the grid circuit of the same vacuum tube. The audio frequency currents are thus amplified or reinforced by their passage through the audio frequency transformer and the vacuum tube. In a like manner, a single tube, providing a crystal detector is employed for rectification can provide one stage of radio frequency amplification which increases the range of the receiver and one stage of audio frequency amplification which increases the volume of the incoming signals.

In this case an incoming signal is amplified at radio frequency by the vacuum tube, passed through a crystal detector where it is

rectified and the resultant audio frequency currents are passed through an audio frequency transformer, which, as previously explained, has its secondary connected in the grid circuit of the vacuum tube. After these audio frequency currents have been amplified, they flow in the circuit containing the head-phones or loud speaker.

The chief trouble with reflex amplification circuits is that they tend to oscillate at audio frequencies, that is, a continual squealing or howling noise is often obtained when the circuit is first connected and no matter what adjustments are made, it is usually impossible of elimination. This difficulty is due, chiefly, to the individual characteristics of the component parts, or to the design of the circuit.

We have recently learned a great deal more about the effective design of reflex receivers, and whereas formerly, a few experimenters had tried out these arrangements, there are now tens of thousands who are not only interested in reflex circuits but are actually using them with success, and as a consequence have effected the saving of one or more tubes.

With a circuit of this type, employing one tube and a crystal detector, it is possible to operate a loud speaker and to receive over

considerable distances when employing the head-phones. With two tubes, of course, much better results can be obtained, but due to the added complications in the circuit the experimenter is open for more trouble.

A ONE-TUBE REFLEX SET

The constructor or experimenter who desires to use a single tube reflex receiver in conjunction with a crystal detector can not do better than employ the circuit illustrated at Fig. 1. We have here a single tube radio frequency amplifier in which the amplified incoming signals appear in the circuit $L_2 C_2$ of the tube V_1 . The circuit $L_2 C_2$ consists of an inductance, preferably the honeycomb coil type, and a variable condenser with an approximate capacity of .0005 mfd. This circuit is tuned to the same wave length as the aerial circuit (which includes the inductance L_1 , of the honeycomb type and a variable condenser C_1 of .0005 mfd. capacity and a fixed condenser C_4 which has a value of .001 mfd).

The radio frequency currents in the aerial circuit are communicated to the grid of the tube and amplified. These currents are then rectified by the detector D. The resulting

This circuit employs variometers for tuning. The plate variometer should be of large size.

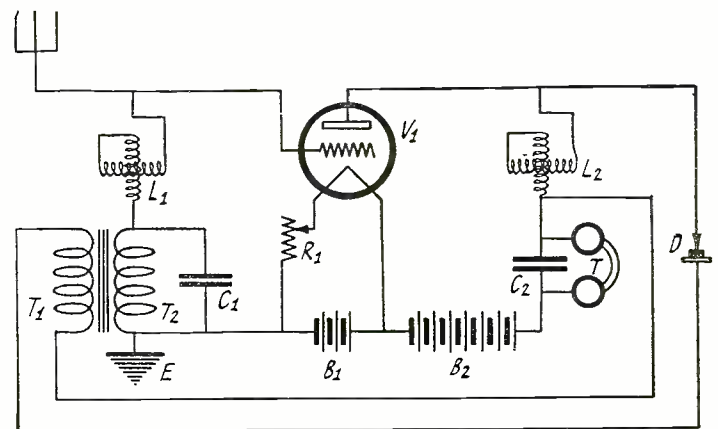

Fig. 3

audio frequency currents are then fed into the grid circuit of the tube once more. The tube now amplifies these audio frequency currents which pass through the inductance L_2 and through the head-phones T . These latter are shunted by a condenser C_2 of .002 mfd. capacity which acts as a by-pass for the radio frequency currents in the plate circuit of the tube. The outside secondary terminal of the audio frequency transformer T_1 , T_2 is connected to the grid through the inductance L_1 , while the inside secondary is connected to the ground terminal. The outside primary of this transformer is connected to the crystal detector D .

In this circuit there is no regeneration between the grid and plate circuits of the vacuum tube and consequently no trouble should be experienced by the experimenter in operating this set. The variable condenser C_1 may well be tried connected in series with the aerial lead, in which case, of course, a greater value in the inductance L_1 will be required.

Under the usual conditions, the coil L_1 will be either a D.L. 50 or a D.L. 75 and the coil L_2 will also be of the same value according to whether the broadcast wavelengths to be received are below or above 400 meters. As a matter of fact a D.L. 50 coil for both L_1 and L_2 will generally suffice for the whole wave-length band up to 600 meters, but then a larger value of variable condenser is required, which is not conducive to obtaining the maximum results.

ANOTHER SINGLE TUBE REFLEX

Another form of single tube reflex circuit is that illustrated in Fig. 2. This circuit is similar to the preceding one, only regeneration has been introduced into the aerial circuit by coupling the inductance L_2 to that of L_1 . This circuit must be adjusted very slowly so as to avoid oscillation. A regenerative or tickler coil should be, during preliminary tuning, loosely coupled to L_1 and all adjustments made on the two condensers C_1 and C_2 . The coupling between the two coils is now increased and the variable condensers readjusted. Following this step, the coupling is adjusted again for the best signal strength, after which the condensers are set again at the final tuning.

If regeneration is increased to too great an extent, the tube will oscillate and a musical whistle will be heard in the head-phones which will vary as one or the other of the variable condensers is adjusted. The moment this whistle is heard, the coupling between the two coils should be decreased. When reflex amplification circuits employing re-

In this reflex circuit the secondary of the A. F. transformer is connected to the grid through the choke coil L_3 .

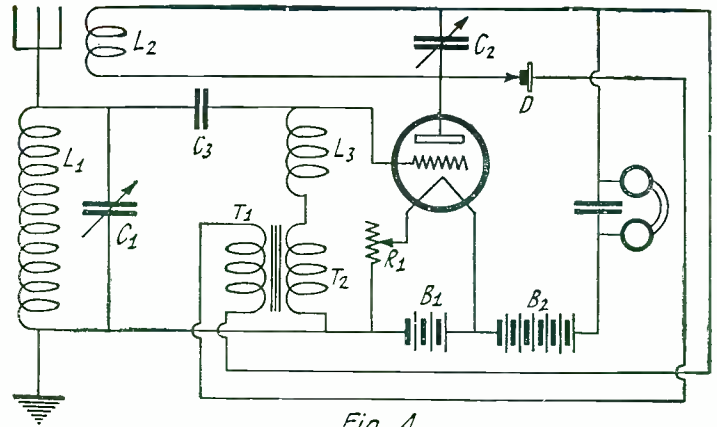

Fig. 4

generation are being used, a second phenomenon very often presents itself.

As the regeneration is increased the tube will suddenly begin to buzz. This is due to the self oscillation of the tube at an audio frequency. This noise is of a lower note than the whistle produced when the tube oscillates at radio frequency. In the latter case the tube is generating continuous oscillations which interact with the carrier wave of the station being received. The pitch

of the grid and plate circuits, the tube will tend to oscillate either at radio or audio frequency, but rarely at both. It is as if the tube is uncertain whether to oscillate at a radio or audio frequency and it frequently changes its mind. Usually the tube will first oscillate at radio frequency and then change over and start oscillating at audio frequency. The tube will try to oscillate at either radio or audio frequency if possible, and when regeneration is applied, the tendency is to oscillate at high frequency.

The moment radio frequency oscillations are generated, the operating conditions change and this change will make the tube prefer oscillation at audio frequency, which it immediately proceeds to do. In some cases the only way to stop this is by decreasing the filament current.

A STABILIZING HINT

A very good method of stabilizing a reflex circuit is to connect a 100,000-ohm variable resistance across the grid and filament of the tube. This will usually make no difference as to signal strength, but will control the circuit, which tends to get out of hand.

Do not be too ready to blame the circuit because your mal-

operation produces a roar. It would be a great advantage if "straight" vacuum tube circuits produced a roaring noise when regeneration was increased too far. One might then keep below the danger point.

It is, of course, well known that the present canary bird noises heard by the careless beginner when tuning in a station on his vacuum tube receiver are not sufficient to make him realize the nuisance he is making of himself to his neighbors. The reflex receiver, however, is far less guilty in creating disturbances in the ether than the straight regenerative set. The user of the reflex circuit is immediately informed of the condition if he tightens the regenerative coupling too much and has, immediately, to retract for his own comfort.

A VARIOMETER REFLEX CIRCUIT

The diagram at Fig. 3 shows a modified arrangement of Fig. 1 in which variometers are employed for tuning the grid and plate circuits of the vacuum tube. This arrangement will give good results, but it is important to note that the variometer L_2 in the plate circuit of the tube should be of a large size; the usual type of variometer sold for use in the aerial circuit is not large enough in value so a larger type of variometer should be employed, and should be shunted by a fixed condenser having a capacity of .0003 mfd.

This circuit is very simple to tune, the only adjustments being the two variometers, but on the other hand, the signal strength obtainable is not usually as great as is the

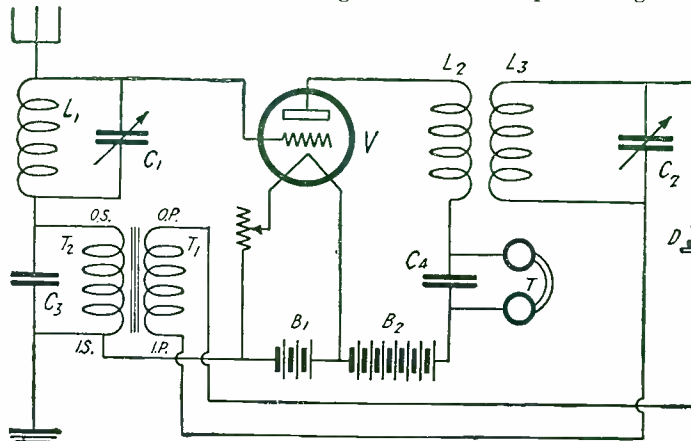

Fig. 5

Easier control is had by using a tuned R. F. transformer instead of an impedance coil. This may take the form of a Neutroformer.

of this note depends upon the position of the variable condensers and will vary with a change of either of them. The audio frequency buzzing, however, which is so often heard in a reflex circuit is independent of the high frequency circuit and the pitch of the note is not varied by altering the position of either of the variable tuning condensers.

Even in the best of reflex circuits, audio frequency whistles are often set up when regeneration is being used.

The peculiarity of the tube is that when both radio and audio frequency appear in

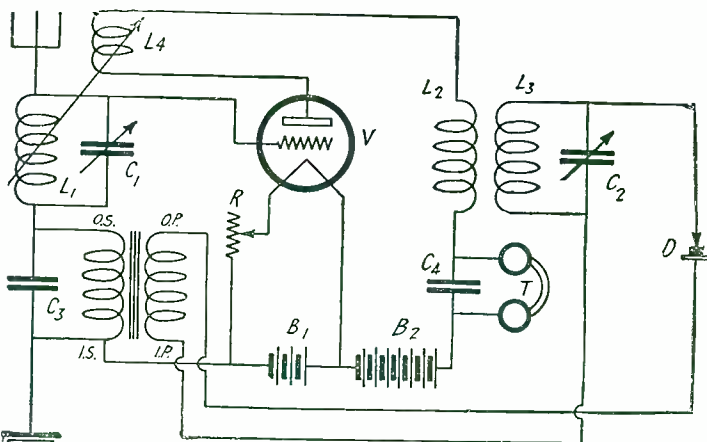

Fig. 6

This is the same circuit as shown in Fig. 5, but with the added feature of regeneration. This is obtained by means of the tickler L_4 .

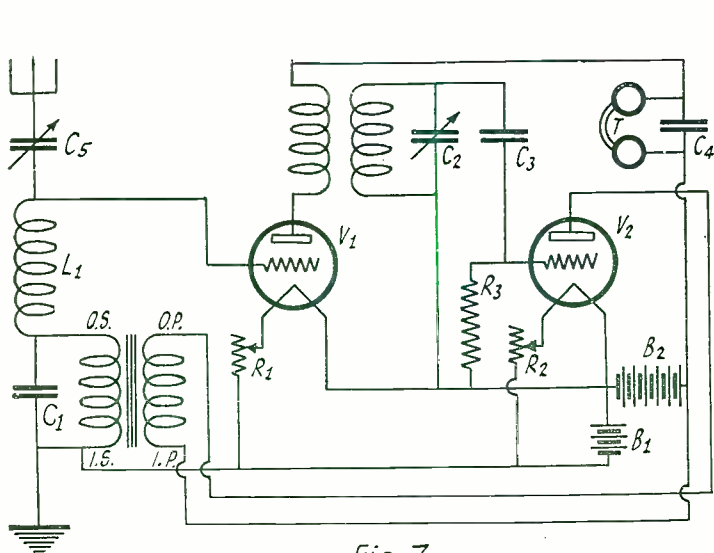

Fig. 7

No crystal is used in this circuit, a tube being employed as the detector. A tuned R. F. transformer is also employed.

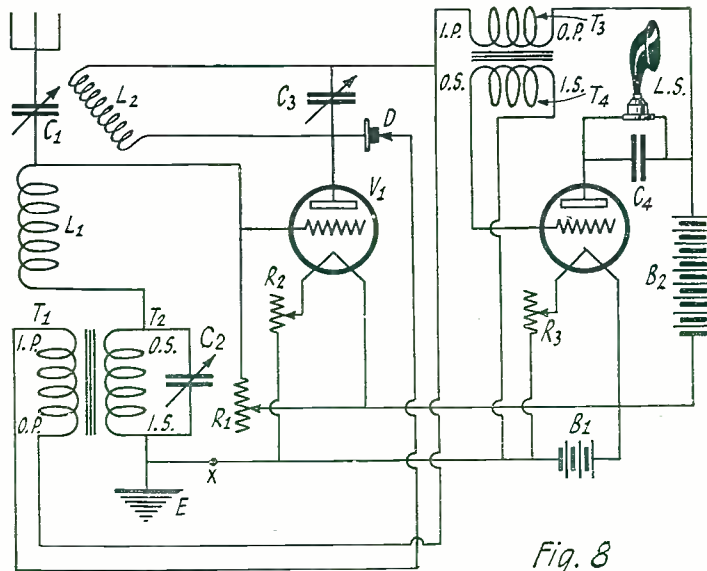

Fig. 8

Sufficient volume for a loud speaker is easily obtained with this circuit. An extra stage of A. F. amplification is employed.

case with a set equipped for regeneration and, of course, it is not possible to obtain an adjustable regenerative effect with the circuit depicted at Fig. 3. However, a certain amount of regeneration will, in most cases, be obtained through the inter-element capacity of the tube.

This circuit should find popularity with the beginner at reflex circuits on account of its simplicity and comparative dependability. A glance will show its more direct wiring. The slight disadvantage of decreased signal strength will be more than compensated for by the added simplicity.

Fig. 4 illustrates a reflex circuit in which, instead of connecting the secondary of the transformer in the aerial circuit (the principle advocated by the writer, particularly in connection with the ST-100 circuit, but applicable to all reflex circuits) a high frequency choke may be employed. The transformer secondary T_2 is connected in series with the air core choke L_3 , which consists of a honeycomb coil of 200 or 250 turns, and connected across the grid and filament of the tube is a condenser C_3 of .0003 mfd. capacity. The object of this condenser is to prevent the secondary T_2 being short circuited through the inductance L_1 . The object of the choke coil L_3 is to prevent the secondary T_2 from short circuiting the radio frequency oscillations applied to the grid of the tube by the circuit $L_1 C_1$. In this case the radio and audio frequency input circuits are in parallel, whereas in the preceding hook-ups they have been connected in series.

The object of using the air core choke is really the same as that which suggested the use of the secondary of the transformer in the aerial circuit. In short, we desire to keep the "A" battery, the "B" battery and the head-phones at ground potential and if the transformer secondary were to be connected between the earth and the "A" battery, as frequently appears in many circuit diagrams published, all the above mentioned components would have their potential varied at audio frequency with respect to the earth. Consequently, touching any of the parts such as the "A" battery or the head-phone terminals would result in a weakening of the signals and would probably set up audio frequency oscillations.

The use of a choke in Fig. 4, therefore, is for stabilization. It is preferable to use the arrangement with the transformer secondary connected in the aerial circuit, as the use of a choke seems to involve a certain loss in signal strength. On the other hand, the other arrangement is preferable where there is interference from A.C. lighting

mains, power lines, arc light, etc. When such interference is experienced, the connection of the transformer secondary in the aerial circuit often accentuates it. The plate circuit of the tube is the same as before and consists of an inductance L_2 shunted by a variable condenser C_2 . The crystal detector and the primary P_1 are connected across the oscillatory circuit.

HOW TO ACHIEVE GREAT STABILITY

Stability is not the chief aim of the experimenter who wishes to use reflex circuits; results are what he strives for and maximum output is very often attained at the expense of stability.

There are, however, some who, content to receive signals a little short of the maximum, are not content unless the signals are attained without undue forcing.

The simplest method of attaining stability in a reflex circuit is to separate the detector circuit from the plate circuit of the tube. Fig. 5 shows how this may be accomplished. Instead of having a tuned plate circuit, there is an inductance L_2 which is coupled to an-

other inductance L_3 , the coupling preferably being variable. The circuit $L_1 C_1$ is tuned to the incoming wave-length and the radio frequency oscillations in the plate circuit of the tube are induced into the circuit $L_3 C_2$. Across this secondary circuit we have a crystal detector D, and a primary T_1 of the step-up transformer $T_1 T_2$. The entire separation of the primary T_1 from the plate circuit of the tube insures the absence of the chain of audio frequency amplification which is so detrimental and which sets up audio frequency oscillations. The head-phones T are, of course, included in the usual position in the plate circuit of the tube, and they are shunted by the condenser C_4 of .002 mfd. capacity. The condenser C_3 across the secondary of the transformer has a capacity of .001 mfd.

ADDING REGENERATION

If it is desired to introduce regeneration into the circuit of Fig. 5 the arrangement of Fig. 6 will be found very satisfactory. In this circuit two inductance coils are pro-

(Continued on page 204)

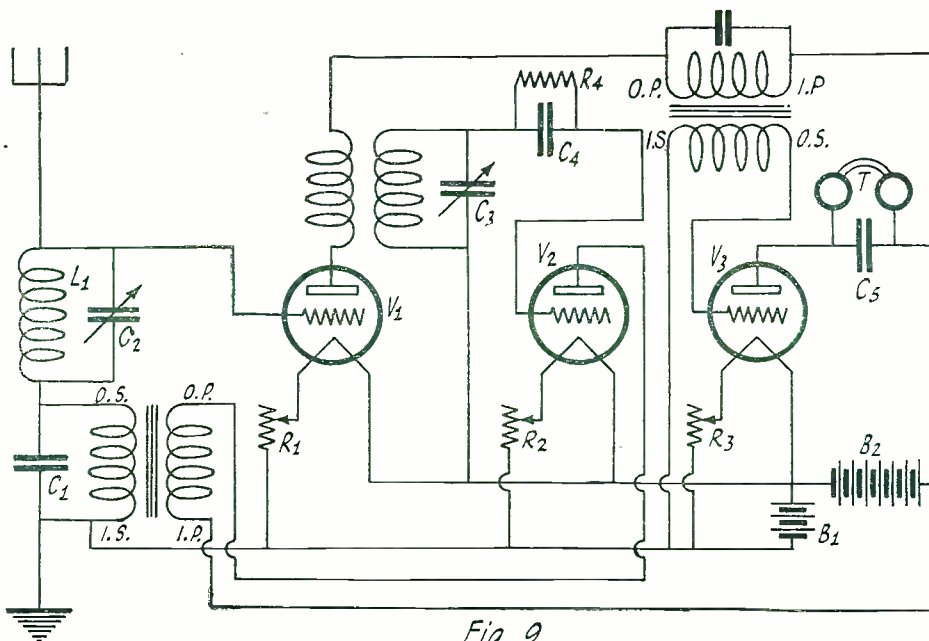

Fig. 9

An excellent three tube reflex circuit. The first tube is reflexed for one stage of A. F. and R. F. amplification. The second tube is employed as the detector and the third tube is straight audio amplification.

Reducing the Summer Static Nuisance

By L. W. HATRY, 5XU

We are sure that the active amateur will well appreciate this excellent article by Mr. Hatry. It is full of workable "dope" on systems for the betterment of the signal static ratio. Putting to practice the suggestions given here should increase the amount of traffic handled this summer.

EVERYONE is trying by the use of various ideas and devices to eliminate as much as possible static at the smallest cost in signal strength. If the strong signal that is unreadable through heavy static can be worked into a medium signal that is readable through the static left with it, satisfaction will result. So, we leave the signal as strong as possible and leave the static as weak as possible in any of the devices that follow.

The ideas given here are not cure-alls for QRN troubles, but merely a panacea for the inconvenience which only clear, cold weather ever eliminates.

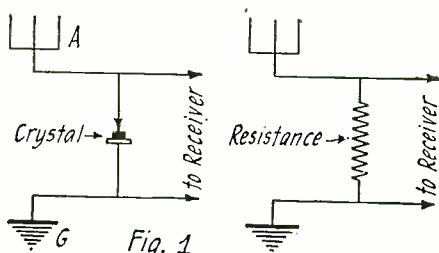

Isolated crashes of static can be reduced by connecting a crystal detector or a resistance from antenna to ground.

USE OF A SHUNT RESISTANCE

Two old methods embody either the use of the crystal or the grid leak (high resistance), and are fairly effective with most receivers, although they will not work with all. The first method consists in shunting the crystal across the aerial and ground binding posts of the receiver (see Fig. 1) and adjusting it for best static reduction point. The crystal should be a carborundum with a heavy, firm contact so that once adjusted it may be depended upon for a time. A little practice is necessary to obtain the best results, but little trouble will be experienced in making it work at first trial. The grid leak method is to shunt a high resistance across the aerial and ground binding posts of the receiver. As it is necessary to test for the correct value, it is best to use a home-made leak made of a fibre strip and pencil or india ink markings. The crystal, however, is the better of the two. These methods are both particularly good when the static manifests itself in strong, isolated crashes that are interposed with silent or comparatively silent spaces. Neither system will work with the single-circuit receiver, they must be used with apparatus involving capacitive or inductive coupling

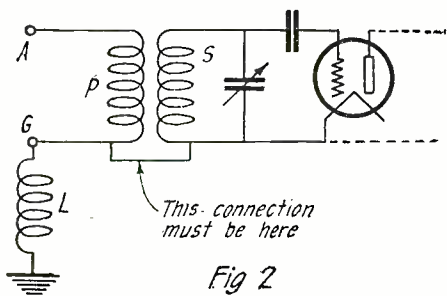

A large inductance connected in the ground circuit will also reduce static.

between the antenna and the secondary circuit.

Loose-coupling properly handled is also of great benefit in bettering static-signal ratio, and, if the coupling control on your receiver is unused, an excellent method of eliminating static noises is being neglected. Familiarity with the coupling only comes with practice.

A great many of us have our transmitters comparatively close to the receiver, usually from two to five feet away. This permits a very simple method of reducing QRN. On bad QRN nights, by tuning my receiver on or around the same wave, leaving the aerial on the transmitter and having only the ground connected to the receiver, a notable decrease in the QRN is evident. With this arrangement I have been able to copy 5's, 8's and 9's up to 1,000 miles without difficulty and to work them, when with the aerial connected to the receiver, static interference would not allow reading even the locals within a couple of hundred miles. This system is dependable for short distance work during bad weather. The method is, in effect, a loose coupling system, but it does not have the sharp peak that true loose-coupling provides in the tuning; instead, it is possible to receive effectively 30 to 40 meters off the actual transmitter wave. A carefully built low-loss receiver is best for this work and most others give indifferent results. Two different stations using this arrangement can work a very effective break-in with no difficulty.

In Fig. 2 is shown another simple method

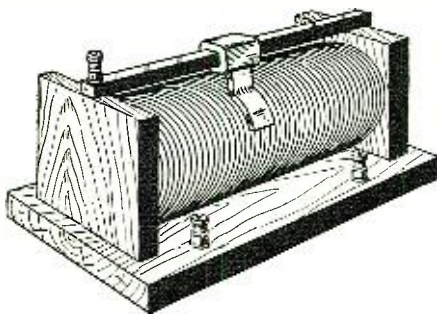

A Simple Type of Resonance Coil.

that, at least, works. The coil L may be any large inductance that is wound with a couple of hundred or more turns. It should be preferably of heavy wire (No. 18 to 20) and an ordinary type of coil; bank or honeycomb wound coils will not work well. Fig. 3 shows another connection of the coil that brings in more QRN and stronger signals; the weather should determine which is used. In operating the receiver on one of the afflicted nights, do not work at the edge of oscillation, as is usually the case. Instead, go noticeably deeper into oscillation. This reduces the volume of the C. W. chirp, but it also deadens QRN very effectively.

A single turn of wire used as the receiver primary with no further coupling or loading devices, instead of the usual tuned circuit, will give a better static-signal ratio. For the best results it is necessary for the receiver secondary and its components to be constructed from the low-loss viewpoint. Also, the antenna should have its fundamental wave outside of the range of the

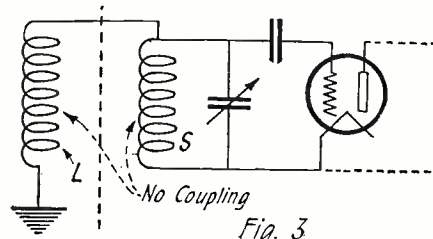

This scheme will reduce static somewhat while allowing strong signals to come through.

tuner or the wave range to be covered with this arrangement.

A low antenna, not too long, nor of too great capacity, is helpful in avoiding static. A good specification is 20 to 25 feet high and 75 to 100 feet long, or less. It should be of the single wire type and of low resistance. The simplest way to achieve the low resistance is to make the single wire of several strands of large wire, say No. 14, twisted together and soldered every two feet. The low resistance and height will give a better static-signal ratio than many another aerial. Some locations will not permit this, however.

In Fig. 4 is an arrangement that partakes of the resonance wave-coil idea and allows normal, or nearly normal signal strength, with proper adjustment. This is the test of all the systems detailed. The coil L must be wound with heavy wire and may be supported on a 3- or 4-inch form, preferably of paraffined cardboard; 400 turns are needed and No. 16 D.C.C. wire will work nicely. The coil may be mounted so that easy control of the metal piece, A, is available. This slide is moved over the coil for best adjustment. The metal piece may be of brass, aluminum or copper, and should be wide enough to cover about one-third the

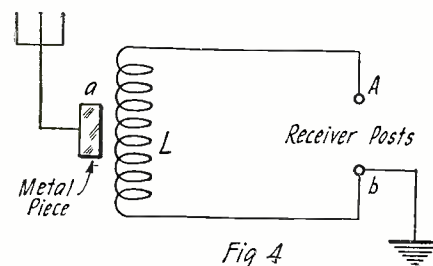

An adaptation of the resonance wave coil idea will prove beneficial in reducing QRN.

circumference of the coil, over a width of six or eight turns. The illustration in the center of the page shows the actual construction of the unit employed similarly to the resonance wave coil. The copper strip, of course, does not come in contact with the wire on the tube, but is merely placed in close relation to it. This provides a condenser effect and is the principle upon which the operation of the unit is based. The tuning is a little difficult to describe, but lies in adjusting the receiver to approximately the wave desired and then moving the metal strip for best adjustment of both C. W. reception and reduction of static. The actual resonance point will be well defined and trial will make the action very clear. The adjustments are, however, not very critical and the system is well worth installing.



Hamitorial The Reorganization of Amateurs

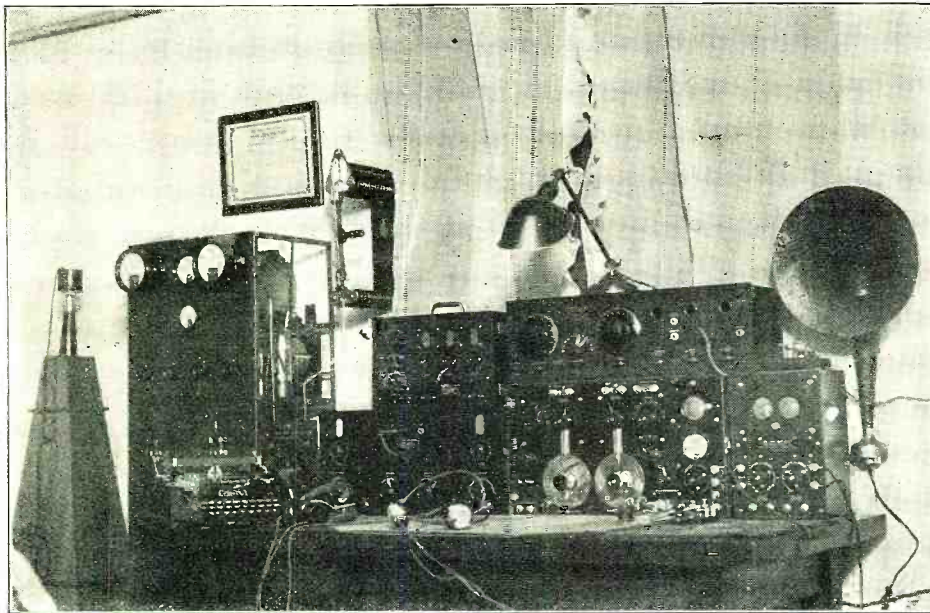

Station 6AQA, owned and operated by George C. Tichenor, Los Angeles, Cal. On the extreme left is a specially constructed horn of Philippine mahogany using a Westinghouse unit. The transmitter is a "200-watter" and has been copied in every state as well as Canada, Alaska, Honolulu and Australia. A motor generator delivering 12,000 volts is used for plate supply. A Navy IP501 receiver is employed for all general work.

wonderful spirit of co-operation has been the result.

Due to the fact that the licensed amateur has matters of a technical nature in which he is particularly interested and which would not make a program suitable for the general club membership under all conditions, the constitution has recently been amended to provide for a technical section to the club. Active membership in the technical section depends upon membership in the parent club and the holding of an operator's license in the grade of amateur, or higher, from the Department of Commerce. Attendance at meetings of the technical section is open to all. The constitutional amendment provides that, while the technical section may not transact business for the club, it may submit resolutions or recommendations to the parent body for action by the whole membership. All scientific papers and other material presented before the technical section become the property of the club proper, and will be filed permanently with the secretary.

Like most other movements, the organization of a radio club requires leadership . . . and the older amateurs throughout the country should associate themselves with prominent broadcast listeners and earnestly work out the details for the formation of healthy units for the districts in which they reside. Remember that, notwithstanding the large numbers now interested in radio, if we remain unorganized we shall have no strength, especially politically. No man can see what will develop in the future. Both the BCL and the licensed amateur is jealous of his rights and privileges. We have nothing to lose and everything to gain in associating ourselves in the manner indicated, and it is pleasing to note that the longer such an organization remains in existence the more the membership appreciates it, enjoys attending its regular sessions and understands the duties of the individual and the group.

PRIOR to the "broadcast period," amateurs were advised to form local clubs, and to affiliate these clubs with state and national organizations. The club, as a medium for the exchange of ideas and the advancement of individual amateurs, has always been a very necessary institution. Now that broadcast listeners are with us in such large numbers, it is eminently proper that the club should be reorganized to meet the current needs. Our local plan has been so successful that it is desired to offer an outline of the San Diego Radio Club methods in the hope that other centers throughout the country will take steps to act similarly.

To go back to the pre-broadcast period, there existed in San Diego the Sunset Radio Club, membership in which was held by practically every licensed amateur in the county. A year ago it was seen that the interests of the BCL and the old amateur were mutual, and that a slightly modified organization was necessary in order to embrace in its membership the broadcast station owner, the broadcast listener, the licensed amateur and all others interested in radio. Sunset Radio Club engineered this project with the result that the San Diego Radio Club was completed with an initial charter membership of over one thousand, consisting of a preponderance of broadcast listeners well sprinkled with the old Sunset Club membership.

A constitution and by-laws were adopted, the provisions of which may be obtained, if desired, from the secretary, Mr. Callaway, 642 Broadway, San Diego, Calif. The San Diego Radio Club holds only quarterly meetings, although its board of directors meets more frequently to take up matters of detail

which lie within its province. In the matter of fighting interference for both broadcast listeners and amateurs, the club has been eminently successful. At its regular meetings there have been speakers representing the Navy, the broadcaster and the amateur, and the radio inspector himself has addressed three regular sessions. The local power and light and street railway companies have addressed the club through representatives. A

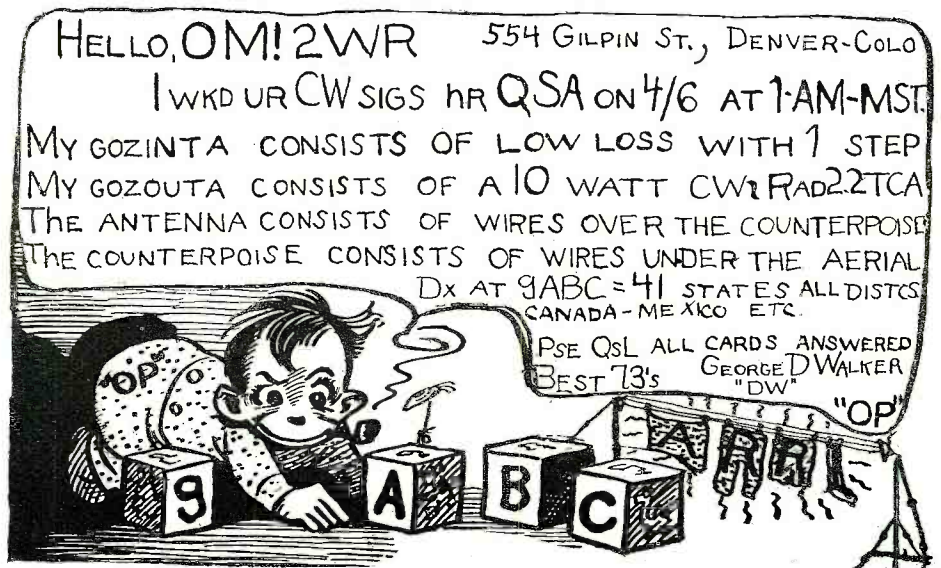

This is the QSL card of 9ABC. It is novel and amusing; we wish there were more of this kind.

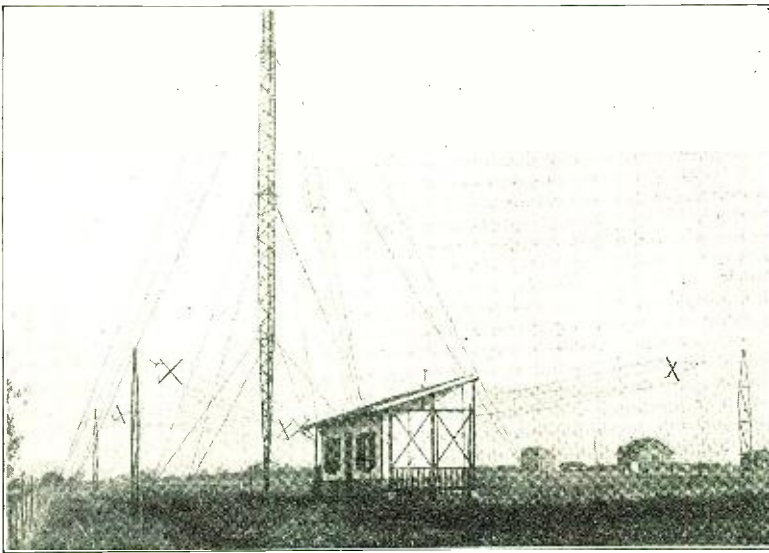

The antenna counterpoise, system at F8AE. The tower is a wooden one, 116 feet high.

To date, there has been no general movement for the formation of formal radio clubs throughout the country, nor has there been any definite plan adopted for the fusing of the clubs into a useful machine of national proportions. Why delay? It is earnestly suggested that within the next few months each county take steps to organize its radio club and work out a policy locally which will strengthen the resident amateurs of all classes. It is further urged that as clubs are formed, secretaries notify the editor of this magazine in order that publicity may be given.

Each radio district from one to nine should organize a district plan whereby at least once a year a convention could be held, made up of delegates from the component clubs, the convention to take up the thousand and one matters which pertain to radio for that district. The licensed amateurs have an organized plan, but theirs is merely one angle of the game, and while the old amateur has done better than well, he lacks the numbers to give him the political strength which some day may be so necessary to protect our mutual interests.

Already there have been controversies relative to broadcast methods, and it has been the custom to attack Washington on a purely personal basis, by means of individual telegrams and letters. How much more satisfactory the whole matter would be if, through a national headquarters organiza-

The inside of F8AE. On the back table is the transmitter equipped with three 500-watt tubes, and on the front table are the receiver and amplifier. Note the cage connections in the transmitting circuit.

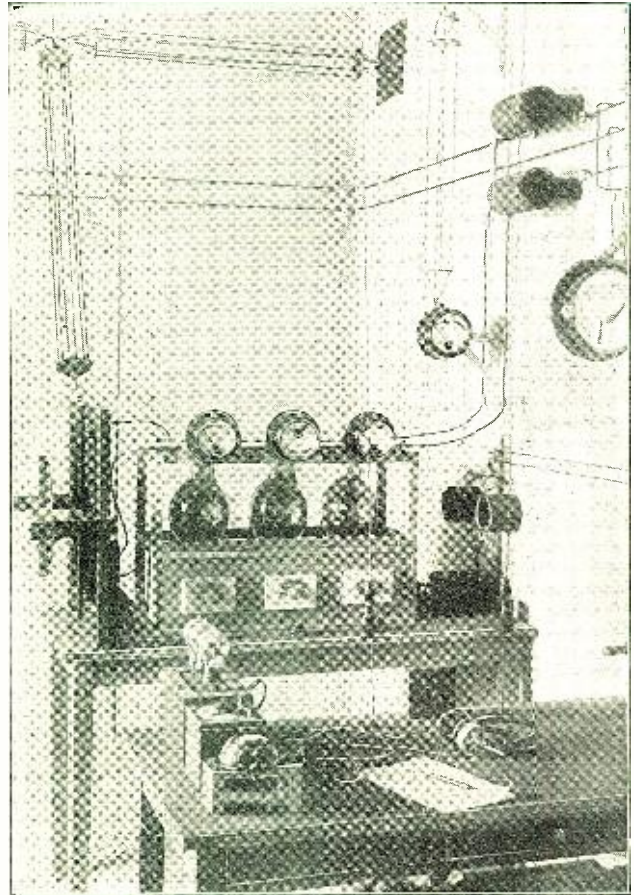

tion, we were personally represented whenever necessary at the Department of Commerce and Congressional hearings. Why procrastinate? Here is something good! Try it and see. Perhaps it does take a little effort. Did you ever stop to consider the selfishness involved in accepting free entertainments from the air for all time without making any personal effort for the betterment of radio?

Here is a very definite way of starting things, a very easy way, a very effective way. Let three old-time amateurs confer with three of the more experienced broadcast listeners in your community. Make up a list of the names and addresses of the residents interested in radio, including the radio merchants and the broadcasters, as well as the broadcast listeners and licensed amateurs. Call a meeting. Get the press interested in the movement and have plenty of

publicity for at least a week prior to the meeting. No matter how few attend, organization may proceed. Adopt a name for the club, elect temporary officers, appoint a committee on by-laws and constitution. (Our secretary will be glad to supply a copy of the San Diego Radio Club constitution and by-laws as a working model which can be changed according to needs.) Leave the charter membership open for 90 days. Carry on the publicity, and you will be surprised at your success within a very short time. No matter where you reside, you must have radio problems of some kind. It may be interference from some station. It may be that there is difficulty in understanding the use of a receiving set. The club is the clearing house for all such matters.

It is hoped that an awakening will occur throughout our ranks, and that we are about to enter upon a period in which we can be said to have taken a businesslike viewpoint of our status. This will never be accomplished without organization.

A. E. BANKS, 6XN-6ZB.

NEW QRA'S

9EGZ—R. W. Freitag, Preble, Ind. All QSL's appreciated and answd.

3TT—(re-assigned) H. B. Davenport, 1631 N. 61st St., W. Philadelphia, Pa. 5 watts C.W. and Fone. Will QSL all crds.

3APP—(re-assigned) (Portable) H. B. Davenport, 1631 N. 61st St., W. Philadelphia, Pa. Low power C.W. and Fone.

5ANE—Walter Merkle, 804 Parkman Ave., Selma, Ala. All crds answd.

8XT—(re-assigned) Oberlin College (E. W. Thatcher) Oberlin, Ohio.

9DDM and **9CRY**—Bernal C. Payne, 108 E. Pearl St., Jerseyville, Ill. 100 watts C.W.

6CTE—Tom Banzhaf, Brookdale, Calif. 50 watts C.W. and Fone. All crds answd. (Continued on page 226)

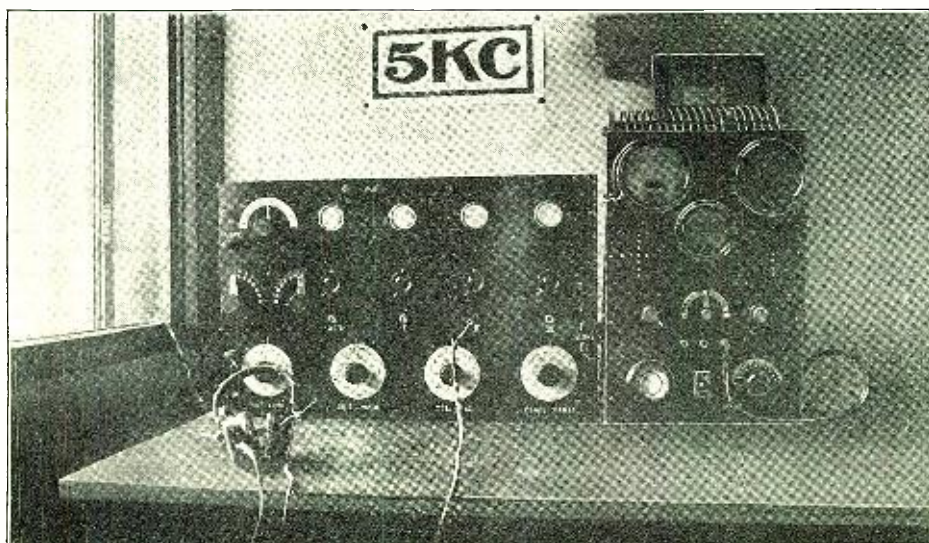

Every district worked in one night is the enviable record of Vincent Rosso, operator of Station 5KC, located at Plaquemine, La. The panel transmitter on the right employs the Hartley circuit and consists of four 5-watt bottles. A conventional short wave regenerative set is used for receiving. This is an unusually efficient and neat appearing station.

Ripples Normal and Abnormal

By EDWARD W. BERRY

There is much the amateur can learn about motors and generators, but it is particularly important that all those employing motor-generators for filament and plate supply know something of the whys and wherefores of machine complications and how to contend with them. Mr. Berry has covered the subject well in this article.



ONE of the greatest difficulties the amateur of today has to contend with is the elimination of ripples in his plate supply. It is hardly necessary to go into any lengthy discussion of the advantages of a pure D.C. supply, regarding both interference and distortion. In any system yet devised, with the exception of battery supply, it is necessary to employ filters to approach a satisfactory plate supply. The subject of sine wave filters for A.C. lighting supply has been well covered. We will, therefore, confine ourselves to the generator.

who had been granted a special license, brought in a machine of popular type, and condemned it as impossible to filter, adding that he had spent the value of the machine for filters. The set was put on test at full load and given the customary ripple test with phones. Nothing but the high pitched slot and commutator ripple could be detected. Further questioning of the owner immediately solved the problem. The set was being operated at about one-fifth normal load. Reduction of the test load to one-fifth produced noticeable sparking at the commutator, and the owner readily recognized his unfilterable sputtering and rasping in the phones. This sparking was of course, about as easy to filter as a 2-inch spark coil, a slight adjustment of the brushes and this young electrical storm entirely disappeared.

the load, and with an old pair of phones placed across it, the car can easily detect them, or load the generator entirely with lamps. (See Fig. 2A and 2B.) Be sure that the generator is not overloaded by the lamps.

Three additional causes, which are not easy to detect except with a tube arranged as in Fig. 3 or by coupling a receiver to the antenna inductance, are sparking brushes in the repulsion induction motor and in the direct current motor, and mechanical vibration of the tubes. The repulsion induction motor starts as a plain repulsion motor. During the starting period there is considerable current flowing in the armature and brushes. There is no "neutral plane" where commutation tends to be sparkless, coincident with good starting torque. The pick-up in comparison with a split phase motor is very rapid and the starting current much less. As soon as the motor has attained a speed considerably above its "pull out" point, that is, where it refuses to carry its load and breaks down, the commutator is mechanically shorted and in most cases the brushes are lifted off the commutator. The motor now runs as an induction motor with no current flowing through the brushes. If the short-circuiting device is defective, allowing current to flow through the brushes at normal load, or the motor is overloaded to such an extent that the speed drops to a point where the short-circuiting device opens, the sparking will produce an absolutely unfilterable racket in the set. Despite these facts a properly functioning repulsion induction motor is far superior to the split phase type and will give no hum to the station.

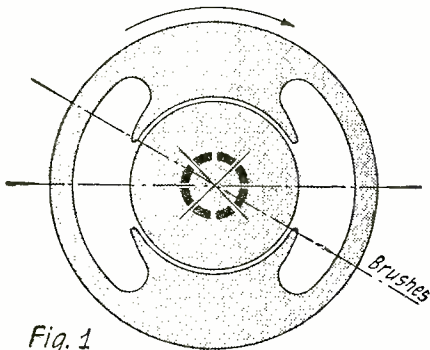

Fig. 1

To prevent sparking at the brushes of a generator they should be adjusted according to the load of the machine.

In order to intelligently develop a cure, it will be necessary to investigate and reduce the cause as much as possible. The cause for ripples may be divided into two classes: Normal and abnormal. Slot ripple and commutator ripple are normal; while they cannot be eliminated practically, they can be reduced satisfactorily by proper design and the use of filters. The abnormal conditions are faulty commutation, high bar or rough commutator and open or shorted armature windings. There is no filter cure for these, but fortunately they can be remedied.

Faulty commutation is one of the most common. On any generator the neutral zone or plane utilized for commutation, rotates with the load. In a large machine brushes set for sparkless commutation at full load may give noticeable sparking at half load, and at "no load" the light load of the field may cause considerable sparking. Therefore the brush boxes of a well designed machine of above 100 watts may well be on a moveable ring, so that the brushes may be set for the load desired. In setting brushes on a generator, care should be taken to see that they are set in the direction of rotation of the armature. (See Fig. 1.)

A short while ago, a well known amateur

High bars are another, but a less common source of trouble. A piece of mica may, through careless design or poor inspection, become loose, and slightly raise itself above the adjacent copper surfaces. The result is that the brushes, instead of short-circuiting the commutator bars at this point, ride upon the mica, break the electrical circuit and cause sparking. This will produce a note similar to that of raw 25 cycles on a tube. A light cut on the lathe is the best cure. A dirty commutator will have the same effect, except there will not be a distinguishable note. Sandpaper is the best remedy. In both cases, ring sparking will probably be noticeable and sparking at the brushes pronounced. Recently, the armature of the generator at a prominent broadcast station was returned for repair. The commutator had been slotted—undercut with a circular saw. That any intelligent operator should subject his generator to such abuse is beyond

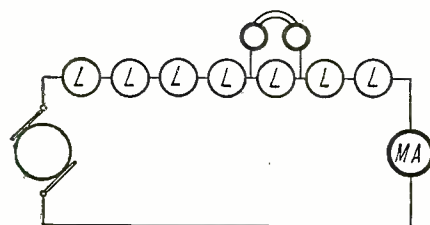

Fig. 2B

The generator can be loaded entirely by lamps and then tested with the head-phones in the manner shown.

belief. While he certainly had removed any chance of a mica high bar, he had roughened his commutator and reduced his insulation between commutator segments. The machine was a 2,500-volt, double commutator generator with 72 bars per commutator. The minimum voltage at one of the commutators must have been 1,250, and the average voltage between segments was 35 volts. It will, of course, take but little carbon dust to short these.

An open or shorted armature will make itself very evident, the former by a drop in voltage and excessive sparking with load, and the latter by a drop in voltage, excessive heating and in most cases, by a rumbling, due to the unbalanced conditions in the armature.

A good way to test a generator for any of these abnormal conditions is to put a resistance such as a lamp bulb in series with

The direct current motor is a little different proposition. Here we have current flowing through the motor brushes at all times. Regardless of the care taken to have commutation as sparkless as possible, there is a sliding contact which often causes a definite ripple. Both a smother filter in the supply (Fig. 8A) and bonding the negative terminal of the motor and the negative terminal of the generator and grounding will help. (See Fig. 8B.)

Mechanical vibration of the tubes, while rare in a well designed station, is a big source of trouble in the smaller stations. Those who are skeptical about the possibilities of this causing interference, should try placing a WD-11 or WD-12 in their receiving sets and strike it with a pencil. A local amateur, well known and well "cussed," has suspended his motor-generator set by leather straps,

(Continued on page 263)

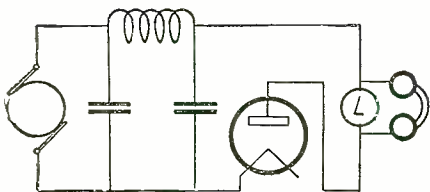

Fig. 2A

Method of testing for abnormal conditions in the generator with a lamp and a pair of old head-phones.

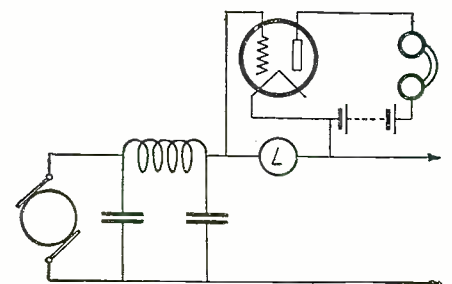

Fig. 3

Circuit arrangement employed for testing for sparking brushes and vibrating tubes.

The Effect of Fog Upon Radio Signals

By A. A. KUBIAC

EXTENDING over long periods during 1921, 1922 and 1923, the Bureau of Standards, assisted by hundreds of amateurs, conducted a very elaborate series of tests to determine the cause of fading signals at the wave-lengths lying between 200 and 400 meters. The nature of these tests were such as to show the relation of the various atmospheric agencies, such as temperature, barometric pressure, clouds, etc., to fading radio signals. The information gained was published in several magazines in August and September, 1923.

The writer, at radio station 3ZZ, located at Craddock, Va., participated in the greater part of these tests and sent in about 100 records. Unfortunately, however, the very heavy fog which is present in the vicinity of station 3ZZ, on numerous occasions completely masked all signals on short wave-lengths. For this reason many of the records sent in by this station contained very little information other than the fact that no signals were coming in through the heavy fog. The object of the Bureau of Standards test was not to explore any one particular atmospheric condition, but to analyze

the effect of all atmospheric agencies on the intensity of radio signals, consequently the writer set about to conduct a series of observations concerning fog only, and its effect on the intensity of radio signals. The results of these observations were very convincing, and are herewith offered, as they are of interest to everyone who owns a radio receiver.

The writer's radio station 3ZZ was, at the time of these observations, located only a few miles northwest of the great expanse of waste land, some 250 square miles in extent, known as Dismal Swamp. This location, while extremely unfavorable to consistent radio reception and transmission, is admirably suited to observing the effect of fog on radio operation. After sundown, great volumes of dense fog accumulate in the swamps. When the wind is from the southeast, the fog is carried in puffs or in steady streams in the direction of the station, at which times it completely submerges the station in a blanket for periods varying from a few minutes to several hours, according to the persistence of the wind.

The first series of observations were very successful and were quite by accident. On this occasion a power amplifier was in operation with two loud speakers mounted on the roof, so that the program to which the receiver was tuned could be heard for several blocks, thereby entertaining the entire village. The music from WOC had been rolling in with fine volume and steadiness for about an hour when a fog bank drifted up from the swamps, completely enveloping the station for a period of about 15 minutes. During the period when the station was enveloped by the fog, the signals from WOC died out completely, and no amount of tuning would return the signals or bring in any other broadcast station, although several were in operation at the time. As soon as the fog bank had drifted over and the air had cleared, the signals came in again with the same intensity as before. Several other fog banks drifted over during the course of the evening, always with the same result. The climax of the tests was reached when a steady stream of fog lasting for hours, very effectively isolated station 3ZZ

(Continued on page 224)

\$500 Radiation Eliminator Prize Contest

Who Will Make a Radio Muffler?

THE radio industry at the present time is confronted with one of the most serious problems that it has yet encountered. If you live in a city or other crowded section, it becomes almost impossible these days to enjoy a radio program. In the midst of a most beautiful violin solo, you will suddenly hear loud whistles, howls and shrieks, which are often strong enough to break up the entire concert. Thus, when we recently listened in to a speech by President Coolidge there were at least a dozen instances where whole words and even sentences were obliterated, due to this radiation interference.

As everyone knows, these whistles and howls are produced by nearby radio receiving sets. Ninety per cent. of the receiving sets used today are really miniature broadcast stations. When operated improperly they send out waves of their own. The minute the broadcast listener starts to twist the dials, he sends out into the surrounding space waves which produce this interference. Experience has shown that attempts to educate the public as to the correct methods of operating these interference creating sets are futile. The public simply does not understand the interference and the only practical solution seems to be a *Radiation Eliminator*—a muffler, in other words.

There has been much talk to suppress all the receiving outfits that produce oscillations. If a law were passed today to this effect, fully 95 per cent. of the receiving outfits would have to be junked. At the present time, the condition has become so acute that sooner or later our legislators will enact a law to do away with radiation.

It is not impossible to produce a radiation eliminator that can be mounted into the receiving outfit at a small cost. There may be a new circuit, a new hook-up, a new instrument or some new stunt that will do away with the whistles and cat-calls.

RADIO NEWS aims to bring about this solution in a novel manner. In order to encourage experimenters, RADIO NEWS of-

fers \$500 in prizes for an efficient radiation eliminator. It should be designed along the following lines:

(a) The device should be as simple as possible and must be adaptable to any standard receiving set. The total cost of its construction must not be above \$3.00.

(b) It should be possible to manufacture the device, not only at a reasonable cost, but it must be possible to install the device without necessitating completely disassembling the receiving set to which it is to be attached.

First Prize	\$250.00	in gold
Second Prize	100.00	" "
Third Prize	75.00	" "
Fourth Prize	50.00	" "
Fifth Prize	25.00	" "
TOTAL	\$500.00	

(c) It should not be necessary to adjust the device when tuning in. In other words the new device should be fixed—not variable; or, if it must be variable, the adjustment must be so that once it is made for a particular aerial it *should not have to be touched again thereafter, when tuning.*

It should be thoroughly understood that this contest is conducted by RADIO NEWS merely for the purpose of encouraging research along the lines mentioned. **In no case will RADIO NEWS derive any financial benefit from the invention.** All patent rights, and any and all other rights revert to the inventor.

RADIO NEWS reserves for itself only the publishing rights, and nothing else. Moreover, in order to show its good faith, RADIO NEWS, at its own expense, will finance the cost of taking out the patent for the inventor, in the inventor's name, at no cost to the inventor himself; this, providing the article or device can be patented. RADIO NEWS, however, will only finance the patent of the first prize winner—not of the other prize winners. The financing of this patent

by RADIO NEWS will be in addition to the prize money paid to the successful inventor.

Regarding the patent phase of the other prize winners, special attention is called to the fact that by publishing the device in RADIO NEWS, the inventor has practically two years during which he can apply for his patent. There is no better evidence than publication in a national journal. Had Dr. DeForest published his original sketches on regeneration in a magazine, he would have saved many years of litigation and a fortune in court costs.

RULES OF THE CONTEST

1—A working model of the invention should be sent with the manuscript describing it. Transportation charges will be paid by RADIO NEWS both ways.

2—Schemes using so-called blocking tubes are excluded from this contest.

3—Contestants may enter more than one device in the contest. There is no limit as to number.

4—All manuscripts should be typewritten or written clearly in ink, and all diagrams should be clear enough to show the details of the invention. A photograph of the inventor is required as well.

5—All manuscripts not accepted will be returned to the owners at the end of the contest, but the publishers will pay full space rates for all manuscripts published in RADIO NEWS.

6—For the protection of the inventor, he should retain a carbon copy of the original manuscript. Both original and duplicate should be witnessed and signed with date, names, etc., before a notary public.

7—All prizes will be paid upon publication.

8—Should two contestants submit identical devices, thus tying the prize, the same prize will be awarded to both.

9—Excluded from this contest are: Manufacturers and the publishers' employees and members of their families.

10—This contest closes in New York on August 20, 1924.

Address all contributions to Editor, *Radiation Eliminator Contest*, c/o RADIO NEWS, 53 Park Place, New York City.

Reflexing a Tuned Radio Frequency Receiver

By CLYDE J. FITCH

The description of a Reflexed Neutrodyne receiving set employing but three tubes yet equaling the results of a five tube set is Mr. Fitch's latest contribution to the readers of RADIO NEWS. The necessary details for the construction of this set are given in this article.

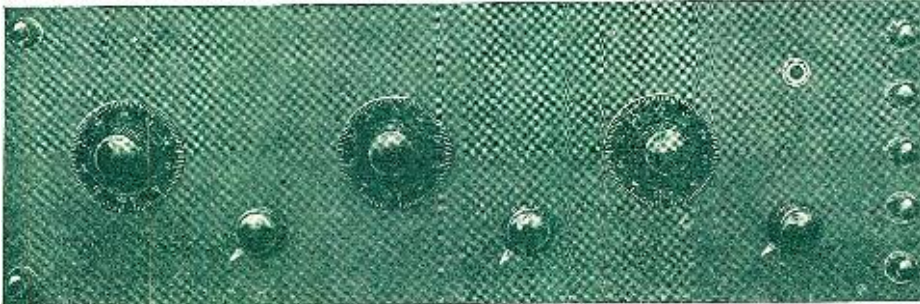

The Reflexed Neutrodyne receiver as it appears from the front.

ALTHOUGH most Neutrodyne receiving sets employ five tubes, two radio frequency amplifiers, one detector and two audio frequency amplifiers, these sets, as far as DX reception is concerned, are not better than the ordinary three tube, detector and two stage audio sets employing the simplest of regenerative hook-ups. But the five tube sets have many advantages over those of three tubes; they do not radiate into the aerial and cause interference in the neighborhood, as regenerative receivers do. Tuning always remains the same, and once a station is received the dial settings may be noted and the station will always be received at the same settings. Only three tuning dials are employed, and when a station is heard, the readings of each dial will be approximately the same, within a few degrees, which facilitates tuning.

On account of the two stages of tuned radio frequency amplification, the set is exceptionally selective. Such receivers are ideal for broadcast reception, but as they employ five tubes, the cost of upkeep is high on account of the drain on the "A" and "B" batteries, and for this reason many persons have chosen the three tube sets. The receiver illustrated and described herein is a three tube set having virtually all the advantages of the five tube outfits. This, of course, is accomplished by reflexing two stages; that is, by using two of the tubes simultaneously as both radio and audio frequency amplifiers. If a crystal detector is used instead of a vacuum tube detector, the same results may be accomplished with various combinations the three tube set was found the most efficient and practical. Although a crystal gives excellent quality, it is not as sensitive as a vacuum tube detector.

The illustrations show the general layout of the apparatus. The tuned radio frequency transformers are mounted on a 7 x 21-inch panel, on which are also mounted three filament rheostats, one telephone jack, and seven binding posts. The dimensions required for drilling the panel are given in one of the illustrations. The arrangement shown makes the wiring very simple and also leaves plenty of room. It may be changed, of course, to suit individual requirements. The illustrations show that no neutralizing condensers are employed, as it was found that by using "Rico" mica dielectric variable condensers, which have higher dielectric ab-

sorption losses than air dielectric condensers, neutralization was unnecessary and the same results could be obtained with this arrangement as with using a neutralized circuit with air condensers. The wiring is also simpler and there is less chance of howling in the audio amplifier due to feed-back through the neutralizing condensers. In mounting the instruments, it is important that

resulting in distortion. They also have a greater tendency to howl when used in reflex circuits.)

About 20 feet of bus bar wire will be required for making the connections, which should be as short and straight as possible. It will be noted that in the diagram only three fixed by-pass condensers are shown, one across each of the primary windings of the audio transformers and one across the telephone jack. These condensers are very important, and should be of good construction and have a capacity of .001 microfarad each. In many reflex circuits by-pass condensers are shown across the secondaries of the audio transformers, but in this one better results were obtained without them. Practically all known combinations were tried before building the set, including the inverse duplex system, but the combination shown in the diagram is not only the simplest, but produces the best results. No arrangement is made for plugging the loud speaker into the detector or first stage of audio frequency amplification, as this would complicate the wiring on account of using the same tubes as both radio and audio frequency amplifiers.

The main difficulty with most reflex receivers is that the radio frequency amplifier may be adjusted so that it will oscillate, and then the audio amplifier feeds back and howls by modulating the radio frequency oscillations, and the result is a lot of noise that lasts while tuning in a station. If the radio amplifier is neutralized so that it cannot oscillate, this noise is eliminated. This makes the neutralized receiver ideal for use in reflex circuits.

By using mica variable condensers, it may not be necessary to neutralize the circuit, but should it oscillate, the neutralizing condensers should be added. They are absolutely necessary if air condensers are used. The set shown in the illustrations is not neutralized and does not oscillate. It is not noisy, except when receiving local stations having powerful car-

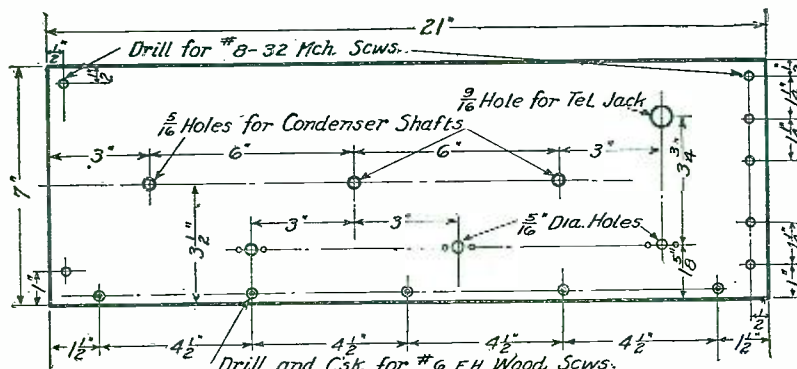

Panel layout for the three tube Reflexed Neutrodyne.

the tuned radio frequency transformers be spaced at least six inches apart.

The panel is mounted on a hardwood baseboard 6 1/2 x 20 1/2. On this board are mounted three standard vacuum tube sockets and two audio frequency amplifying transformers, preferably a low ratio type, about 3 to 1. (High ratio transformers cause unequal amplification of the various frequencies,

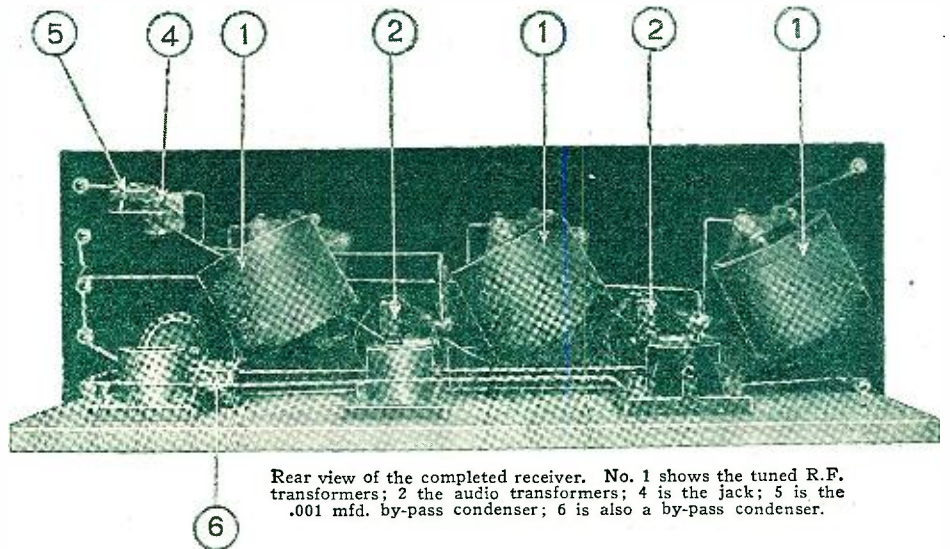

Rear view of the completed receiver. No. 1 shows the tuned R.F. transformers; 2 the audio transformers; 4 is the jack; 5 is the .001 mfd. by-pass condenser; 6 is also a by-pass condenser.

rier waves, in which cases the audio frequency amplifier modulates the wave and has a tendency to howl, but the noise is easily eliminated by slightly de-tuning one of the condensers. Should the set become noisy, grid leak resistances may be placed across the secondaries of the audio transformers, although these were not necessary in the set shown. It may be well to note that UV-201A tubes give the best results, although other types may be used if desired.

To build this receiver, it may be well to purchase standard parts and follow very carefully the instructions supplied with them. Take, for example, the tuned radio frequency transformers. These may be home-made, but if purchased, the instructions for mounting them should be carefully followed. As shown in the accompanying photographs, the transformers are mounted at an angle of approximately 60 degrees and spaced six inches apart.

If it is desired to construct these coils at home, they may be made as follows: On a tube having a 3-inch outside diameter, 2½ inches long, with a 1/16-inch wall, wind 65 turns of No. 26 S.S.C. wire. A tap is taken at the 15th turn, which may or may not be required, depending upon the operation of the set. On another tube 2¾ inches in diameter and 2½ inches long, wind six turns of the same gauge wire in the opposite direction. This is wound on one end of the

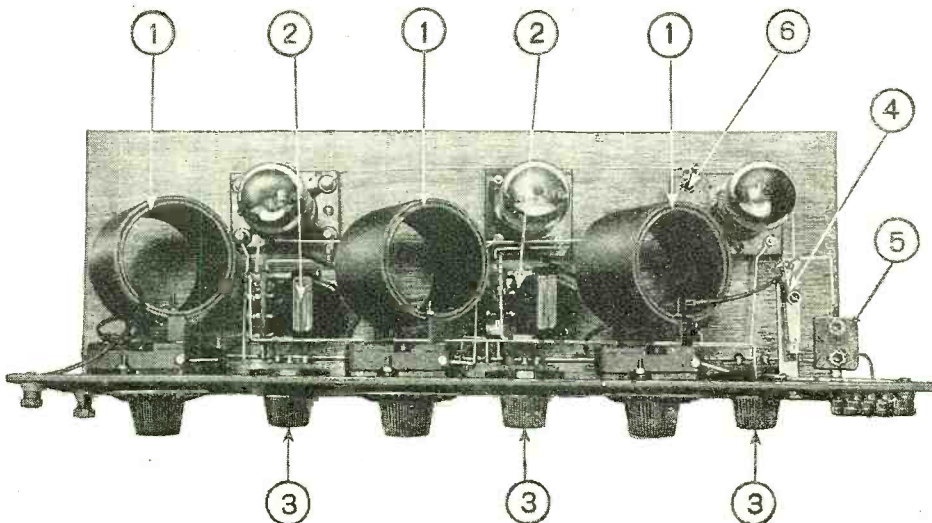

Top view showing the arrangement of the instruments. No. 1 shows the tuned R.F. transformers; 2 shows the A.F. transformers; 3 shows the rheostats; 4 is the jack; and 5 and 6 are by-pass condensers.

tube, and the turns are spaced about 1/16-inch apart. This tube is slipped into the first one, and the two together form the transformer, the inside winding is the primary and the outside the secondary. Three

of these transformers are required. The diagram shows that the primary coil is placed next to the filament side of the secondary coil, and that the tap is also next to the filament side. This tap is connected to the neutralizing condensers, as shown by the dotted lines.

In wiring the set, it is best to connect all the filament terminals first. This includes the leads from the "A" battery binding posts to the rheostats and sockets. It is important to connect the rheostats on the negative side of the "A" battery, as shown, so that the drop in potential across them will bias the grids of the amplifier tubes. When the filament wiring is completed, the tubes should be inserted into the sockets to see that all light up properly. The remaining connections may then be made and the batteries, loud speaker, aerial and ground connected to the set, after which stations may be tuned in.

Should the set be noisy when the three dials are adjusted to resonance, it will be necessary to neutralize the radio frequency amplifier. The method of neutralizing will not be described here, as directions are supplied when buying the apparatus.

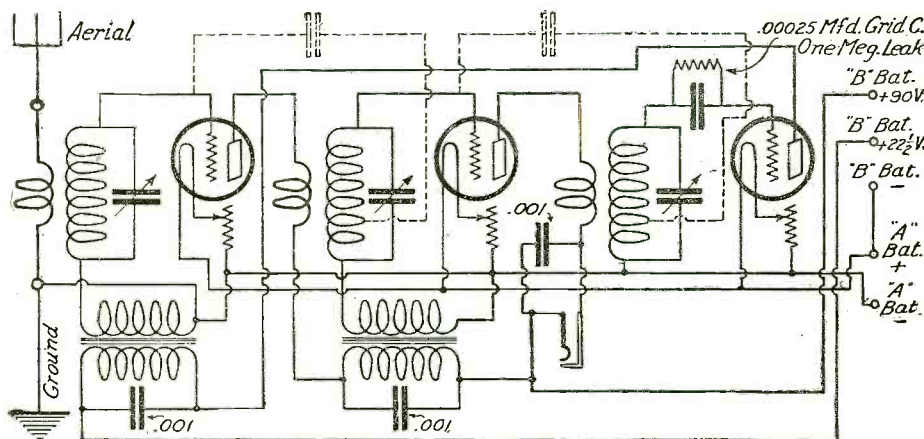

Schematic diagram of the Reflexed Neurodyne described in this article. No neutralizing capacities are required as a rule.

What to Expect from Your Radio Receiving Set

By PAUL G. WATSON

THE subject of just what to expect from your radio set is a very difficult one, as there are so many different angles and points from which to view the matter. Generally speaking, most of us get good results out of our sets.

A very conservative, but well informed radio engineer of the Western Electric Co. was asked what maximum range he would guarantee for radio work if he were allowed an unlimited amount of money for it, and the whole radio field from which to pick parts. He stated that 50 miles was the maximum range that could be guaranteed.

It is not my purpose to take issue with any advertising that may be done by manufacturers or dealers. I merely wish to point out some facts as they work out in commercial and Naval radio practice.

Usually, it is not considered wonderful to pick up daily a concert from Pittsburgh, or even occasionally from Los Angeles. If we were able to duplicate this work among ships or in commercial radio telegraph practice in general, and maintain it constantly, the commercial value of radio would be increased almost beyond imagination. It is

found, however, that one night local stations are the limit of reception. The next night, with the same adjustments, California is heard. Certainly something must be quite different to cause this variation in range. Geographic conditions do not vary to any appreciable degree in such a short space of time. Weather conditions do vary, however, and observation shows that some of the fading, or variation in signal strength may be due to the changes. It has been plainly brought out that when the receiving and transmitting stations are in the same, or nearly the same, pressure (Barometric) with no low pressure area intervening, signals will be good. Variation from this condition has a weakening effect on signals. Temperature seems to have a great deal to do with satisfactory reception, and in this connection it is needless to draw attention to static which often accompanies warm weather.

The idea seems to prevail that the more tubes in a set, the greater the distance over which it will work. This is entirely wrong. A single tube receiver under good conditions works sometimes over a distance of several thousand miles, while an 8-tube or

10-tube Super-Heterodyne receiver beside it may work only a few miles further. Refinements in receiver design and construction are not primarily intended to increase range. A very erroneous idea has arisen over the functioning of the Super-Heterodyne. It has been called the "Rolls-Royce" of receivers. Unquestionably it is, but not because of the distance covered, but because of the quality of the signals which are reproduced. We have on exhibition several forms of this type of receiver. They are covered by a very binding guarantee of workmanship, and it will be found upon examination that they are among the best sets made. They will not cover any greater range than that covered by a good regenerative receiver with audio frequency amplifier. But when pushed to the last degree, the Super-Heterodyne reproduces signals with the same clearness observed when listening to nearby stations. When a regenerative set of the common type is pushed to bring in similar distances, considerable distortion is evident with few exceptions. Questions will probably be asked as to the reason for using these modern

(Continued on page 258)

A Real DX Transmitter

By R. N. JONES, 9AE

A description of 9AE's 5-watt set, which has been heard in New Zealand, should be of considerable interest to those who are striving to better their own transmitters. Mr. Jones here gives complete information.

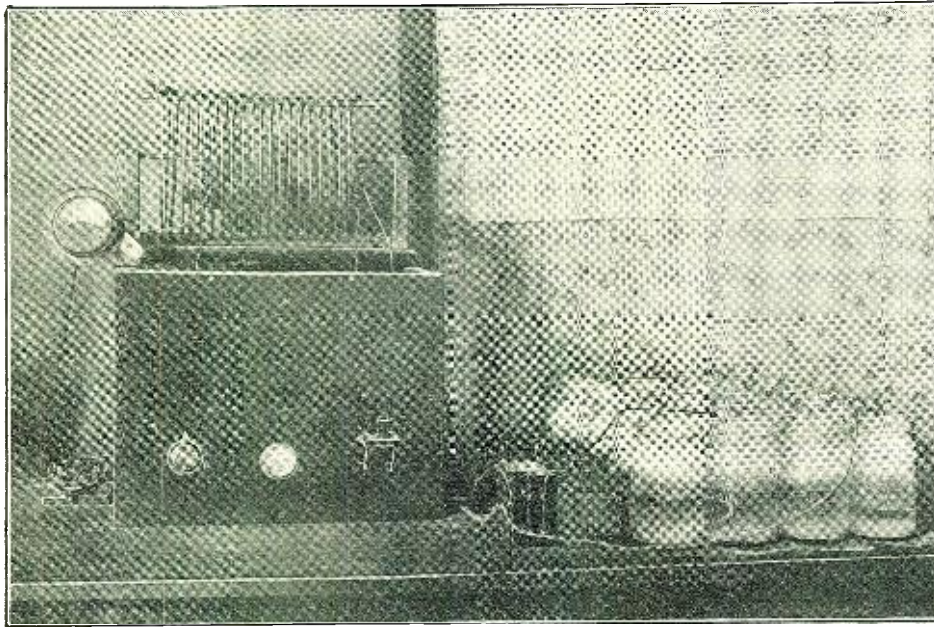

The transmitter at 9AE. Note its neat appearance and lack of useless accessories. The rectifier may be seen on the right.

poise are insulated with heavy porcelain throughout.

The success of this station is not due to luck, but to many years of hard experience. It was my intention to build a set that would really work, and this 5-watter has been the result. Careful planning and following of these plans has resulted in a set that really has some "kick" in it.

INSPECTORS FIND AUTOS AND LOOPS ESSENTIAL

PORTABLE receiving sets, with directional loops mounted in automobiles, are becoming an essential part of the equipment of the nine radio supervisory districts, according to officials of the Department of Commerce. Recently, through the operation of a direction-finding set mounted in an automobile in Oakland, a long offending, unlicensed station was located and dismantled. This station, operating at all hours of the day and night, sometimes under the fictitious call "6LL," was causing great interference, and was breaking the radio regulations as to fake "SOS" calls, improper messages, and what is constituted as proper language of the air. Many complaints came in, and Supervisor Dillon of the 6th District was at his wits end to close the unknown station.

Inspector B. H. Linden, with the aid of two local amateurs and a portable loop, finally found the house where the set was located by "cross bearings" somewhat after the fashion in which a vessel is located by two shore radio beacons. When the house was searched, with the co-operation of the police, the Miguel brothers, Charles and Frank, confessed to be the owners, and the set was dismantled and disposed of. Prosecution is yet undetermined, but severe punishment is unavoidable.

This is not the first time portable sets with loops have been used with excellent results. Unauthorized stations in New York, Detroit and other districts have been run down by enterprising Government inspectors, with the aid of automobiles and local sets.

It had always been my ambition to be heard in New Zealand, and I thought that at least 50 watts of power would be necessary to accomplish of this goal. However, by building a 5-watt set carefully I have been able to reach the island. It may be freak range, but when a 5-watter will reach a thousand miles every night, it is working.

The circuit used in this set is the standard Miessner, which was so popular during the war. The tube is overloaded slightly and puts about two amperes or 15 watts in the antenna. If care is taken, the tube will not be damaged. In my set I have used the same tube for about three months and no trouble has been experienced.

The first factor to be considered in building the set described here was the power. For several reasons a motor-generator would have been impracticable, so a rectified A.C. system was designed to give pure D.C. and a good note. The transformer has a 200-watt capacity. The rectifier consists of 24 pint fruit jars filled with borax and using pure aluminum and lead electrodes. The bridge circuit is used. The filter is the ordinary "brute force" type, consisting of a 50-henry choke and a 2-mfd. condenser shunted on each side of it. The key is placed in the negative power lead before it passes through the filter. The object of this placement is to eliminate key clicks, which are very bothersome to listeners trying to receive broadcast stations.

The inductance is made of No. 8 wire wound on insulating strips. It should not be wound on a tube, as there will be much loss through eddy currents. The plate and grid coils are in inductive relation with the main inductance, both being placed on a rod inside the inductance in much the same fashion as a loose coupler. The coils should be tapped for tuning.

The set is on a panel 12x16 inches. The only instruments in view on the panel face are a filament voltmeter, rheostat and the

110-volt switch. The inductance is placed up, away from the remainder of the apparatus, so that the radio frequency current will not be on the panel. The aerial ammeter is in the aerial lead-in. In wiring up the set, short leads are used throughout. All are of heavy transmitter cable, so there is no loss at any point.

The aerial and counterpoise have a great influence on efficiency. The aerial, 60 feet high and 70 feet long, is of stranded wires spaced three feet. The lead-in is a small cage. The counterpoise is made in the same way, of six wires. It is necessary for it to be 26 feet high to be directly under the aerial. The point of insulation has been closely followed. The aerial and counter-

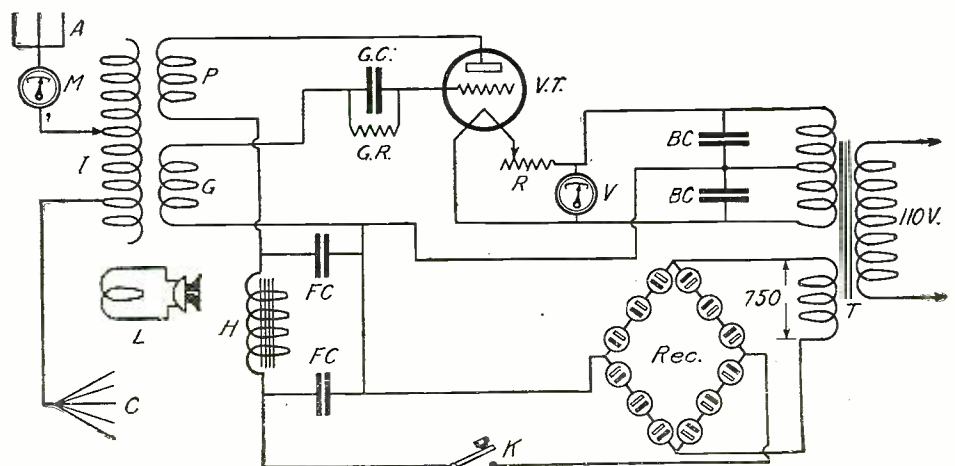

The hook-up of 9AE's C.W. set. M—Aerial Ammeter (.5 to 2.5 amps.). A—Aerial (70 ft. long, 50 ft. high). I—Main inductance (25 turns of No. 8, 6 in. in diam.). P—Plate coil (20 turns of bell wire, 4 in. in diam.). G—Grid coil (30 turns of bell wire, 4 in. in diam.). GC—Grid cond. (.002 mfd. capacity). GR—Grid resistance (10,000 ohms). VT—Five-watt oscillator and tube socket. R—Rheostat (2.5 amps. capacity). V—Voltmeter (0 to 10 volts). FC—Two mfd. condensers (1,500 volts capacity). H—50 henry choke coil. K—Key. Rec.—Chemical rectifier. T—200-watt transformer. C—Counterpoise. L*—Loop and microphone. BC—.001 mfd. fixed condenser. *If phone is desired place the loop in inductive relation to the inductance, press key down and talk.

Principles of C. W. and Radiophone Transmission and Reception

By L. R. FELDER



The difference between the wave transmitter from a C.W. telegraph station and a radiophone transmitter is made extremely clear in this latest article by Mr. Felder. He explains why one wave is broad and the other not

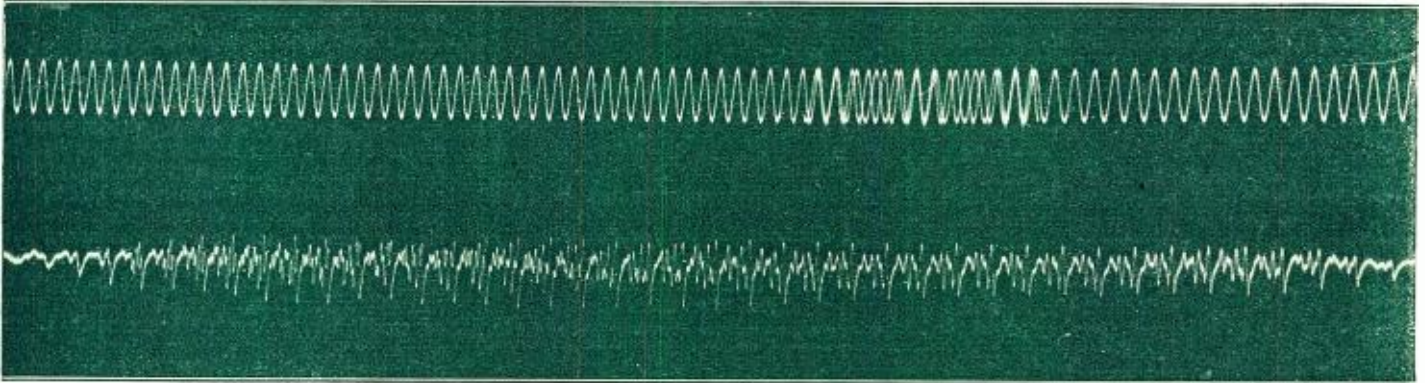

This picture is an oscillogram or photograph of oscillations. The top one is a continuous wave such as emitted by a C.W. transmitter, while the lower one is a modulated wave radiated by a broadcast station. Note the numerous variations in frequency.

IN the articles entitled "C.W. and Radiophone Transmission," which appeared serially in RADIO NEWS, there were discussed the various types of oscillator circuits and the different methods of telephone modulation which are employed both in C.W. telegraphy and radio telephony. At this stage it would be well to pause and consider the underlying principles of radiophone transmission, to see wherein C.W. telegraphy differs from telephony, what conditions must be met for good radiophone transmission, and how these conditions influence receiver design and construction.

In order to orient ourselves properly, and for purposes of comparison, it will be well for us to consider first the relatively simple problem of C.W. telegraph transmission. In this case we have a C.W. oscillator of any of the types described in the articles alluded to, the oscillator furnishing the antenna with current of a definite frequency and wave-length, and the antenna radiating oscillations of this frequency. When the operator opens his key while sending a message, the oscillator circuit is opened and no current flows. Therefore, no oscillations are radiated. When the key is closed, the oscillations are radiated. Thus in C.W. telegraphy there is only an intermittent radiation of oscillations, but the important point to note is that the wave-length or frequency of the radiated oscillations does not change. That is, a single frequency and wave-length are radiated. This point may sound ridiculously simple, but it is an extremely important point as will be shown further on.

Keeping in mind for the time being, that the C.W. transmitter radiates only one single frequency, let us pass on to a consideration of the radio telephone transmitters. The reader will immediately appreciate that this problem is radically different, since we are here concerned with two different orders of

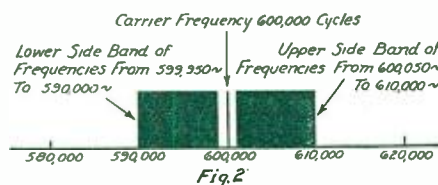
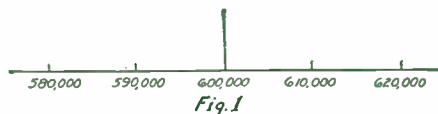

Showing the difference between a continuous wave and a modulated wave. Note the width of the side bands or modulated portion.

frequencies. We have a radio frequency oscillation generated by the C.W. oscillator. This is identical with that of the transmitter above. But we also have speech currents of audio frequency which are used to modulate the oscillations. Thus what is radiated from the antenna may not be a single radio frequency oscillation, as in the straight C.W. transmitter, but something more complex involving both radio frequency and audio frequency.

In order to find exactly what does happen, it is necessary to make a mathematical analysis of the problem. The exact form of this analysis need not concern us, since we are only interested in the conclusions to be drawn from it. These conclusions show that the frequency of the oscillations radiated from the antenna is altered by the audio frequency oscillations modulating the radio frequency oscillation; and also that instead of only one frequency being radiated, a number of different frequencies are radiated. To illustrate exactly how the audio frequency speech currents affect the frequency of oscillators radiated by the antenna, let us consider a typical simple case. Suppose a broadcast station has an assigned wave-length of 500 meters. This means that when the station is not modulating (that is, no speech, music or other audible signals are being transmitted) the radio frequency oscillations radiated by the antenna have a wave-length of 500 meters and a frequency of 600,000 cycles.

Now suppose that music is transmitted and one particular note only is sent out, say middle C, which has a pitch of 256 vibrations per second. This frequency of 256 vibrations per second is superimposed on the radio frequency oscillations of 600,000 cycles per second with the result that two new radio frequency oscillations are developed, one with a frequency of 600,000 minus 256 cycles per second, the other with a frequency of 600,000 plus 256 cycles per second. These new oscillations are radiated from the antenna simultaneously with the original 600,000-cycle oscillation. The same thing occurs when any other speech frequency is superimposed on the radio frequency. Thus, suppose that a note an octave higher is played and transmitted; this has a frequency of 512 cycles per second. Then two new radio frequency oscillations are transmitted having frequencies of 600,000 cycles plus 512, and 600,000 minus 512 cycles per second. In other words it is seen that for each speech frequency transmitted there are developed two new oscillations which are radiated besides the original frequency. The original radio frequency oscillation or wave is called the carrier wave, because it carries speech currents. The two new radio frequency oscillations due to the speech waves are called the side band waves, and their frequencies are equal to the carrier frequency plus the speech frequency, and also to the carrier fre-

(Continued on page 260)

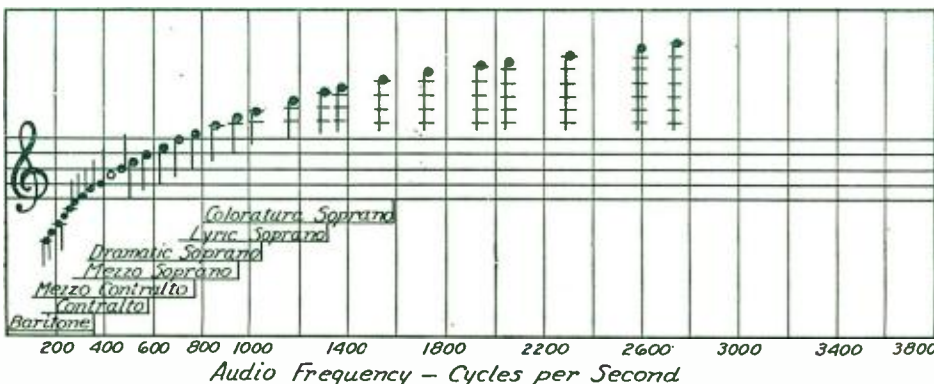

This chart shows the frequency of the various notes which must be all broadcast in the same proportion in order to avoid distortion.

Awards of the \$50 Radio Wrinkle Contest

First Prize

HOME-MADE TUBES OF ANY SIZE

By ELMER RING

Although a reader of RADIO NEWS for quite a while, there has never come to my attention any method where the experimenter might easily construct his own cardboard tubing for winding inductance coils. Standard sizes are sometimes readily obtainable, but where the circuit requires an odd size, such as one tube fitting tightly over another, this presents a problem.

Herein is described the easiest and most satisfactory method which may be employed to construct tubing of any size. Procure a roll of heavy 3-inch gum tape, sometimes called Kraft tape, at any paper goods or cordage store. No other size is needed, as three inches is wide enough for all couplers, variometers or any other coils. There will also be required two strips of wood about $\frac{3}{4}$ x 1 x 30 inches, and some small tin cans not over three inches high. These cans are used for forms and need not be the exact size, as they can easily be padded with a few turns of the gum tape. The two narrow strips of wood are fastened to an old table top or a smooth board about six inches wide and three feet long. These are used as guides in rolling the form over the gur.

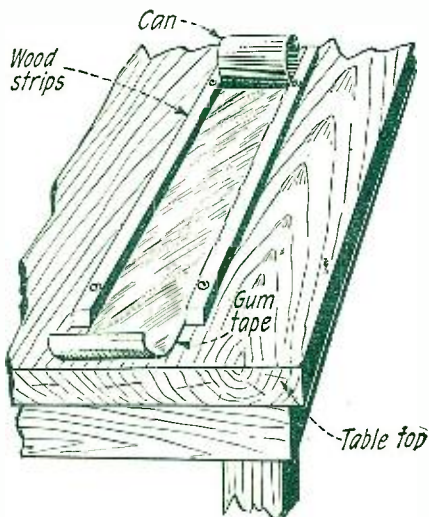

Showing arrangement of wooden strips on table top to make paper tubes.

tape. They are fastened on the table three inches apart with just enough clearance between them to accommodate the tape without binding. Take one of the forms (which is padded if necessary), and wind the tape on it until the desired size of coil and thickness of wall have been obtained. Cut off this strip of paper and measure it, so if more are needed they all will be of exactly the same size. Lay this strip of gum tape between the two strips of wood fastened to the table and proceed to wind. Make about one and one-half turns on the form evenly, then with a damp sponge or rag moisten the tape as the form is rolled over it, between the two wooden strips.

Care should be taken to just moisten the gum tape; if it is too wet, blisters will form. When it is perfectly dry, a light coat of shellac may be applied to the inside and outside of the tube.

By following these directions, a tube with a thin wall but of very rigid construction can be made and it will compare favorably in appearance with any tube that can be obtained on the market

Prize Winners

FIRST PRIZE \$25

Home-Made Tubes of Any Size

By Elmer Ring
3108 Tunnel Street,
Cincinnati, Ohio.

SECOND PRIZE \$15

Honeycomb Coil Sub-Panel

By Henry M. Bosland
214 Straight Street,
Paterson, N. J.

THIRD PRIZE \$10

A Contact Cleaner for Sockets

By John A. Dengler
218 1/2 N. Minnesota Street,
New Ulm, Minn.

Second Prize

HONEYCOMB COIL SUB PANEL

By HENRY M. BOSLAND

When building a three-coil honeycomb coil receiver, the wiring of the set is usually spoiled by the flexible leads that must be carried through the panel. These leads are fastened to various bus bar connections which go to the other instruments. This means that when the coils are moved the bus bar wires are pulled out of position. This is liable to cause a short circuit at some position, but the main point is that it makes a very untidy job. When I built my receiver I determined to wire it in a neater fashion and finally hit upon the idea of using a sub panel, as shown in the accompanying drawing. This sub panel is used with a standard honeycomb coil mounting and consists of a piece of hard rubber or bakelite $2\frac{3}{4}$ x $1\frac{3}{4}$ inches, mounted to the rear of the regular panel and about $\frac{3}{4}$ inch from it. On this are mounted six binding posts for the primary, secondary and tickler connections. The sub panel is fastened to the panel by means of four brass machine bolts of the required length. The flexible leads from the honeycomb coil mounting are passed through $\frac{1}{4}$ -inch hole in the panel and fastened to their respective binding posts on the sub panel. The cost of the material needed is very little and is quite compensated for by the improved appearance of the wiring of the set.

The constructional details of the honeycomb sub-panel are clearly shown here.

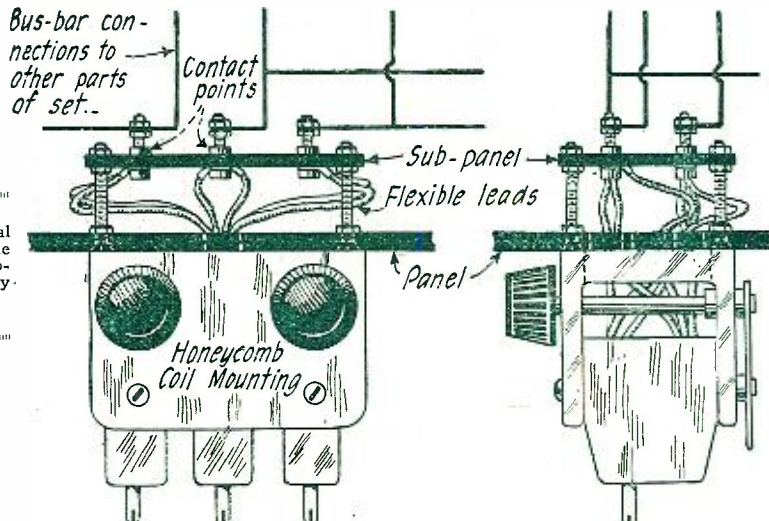

Third Prize

A CONTACT CLEANER FOR SOCKETS

By JOHN A. DENGLER

If your receiving set is to work at maximum efficiency, it is absolutely necessary that the tube socket contacts be clean. A dirty or corroded contact will often spoil what would otherwise be excellent reception. As a rule, these contacts are cleaned with a piece of sandpaper or emery cloth held in place on the end of a stick. This method, however, is clumsy and a good job is rarely done. If the little instrument herewith described is used for this purpose, it will be a simple matter to do this work, and clean contacts will always be assured. This contact cleaner can be used on both standard and UV-199 or C-299 sockets. It is made of a piece of round wood $1\frac{3}{8}$ inches in diameter and $4\frac{1}{2}$ inches long. One end of this piece of wood, for a length of one inch, is cut down to $\frac{3}{4}$ of an inch in diameter. The other end is also slightly cut down for a length of about $\frac{1}{2}$ inch. Two round pieces of emery cloth of a diameter $\frac{1}{2}$ inch larger than the ends of the contact cleaner are now forced over the ends by means of two copper rings $\frac{1}{4}$ of an inch wide. It might be advisable to cut slits about $\frac{1}{4}$ of an inch

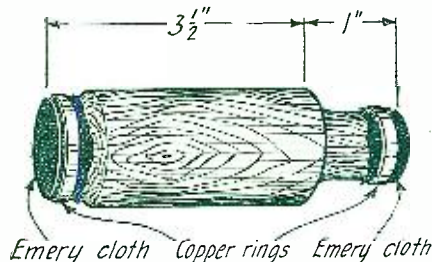

A socket contact cleaner cut to shape from a piece of round wood.

deep on the edges of the emery cloth disks so that when forced in place, a smooth surface will be obtained. To use this instrument it is only necessary to remove the tube, insert one end of the contact cleaner in the socket and while applying pressure, twist it from side to side. It will be found that the contacts can be cleaned in this manner very easily. The time and labor expended on this contact cleaner will be amply repaid by the knowledge that the efficiency of the receiver will not be lowered by imperfect tube contacts.

A TORCH FOR SOLDERING OUTSIDE JOINTS

The small alcohol torch would not stay lit in a high wind and the blow torch was out of order, so the following was improvised in order to solder the antenna joints on a recent installation.

First, a small baking powder can with a cover was secured and a hole was punched in the cover. Next a piece of cotton waste was rolled into a ball and a piece of stiff

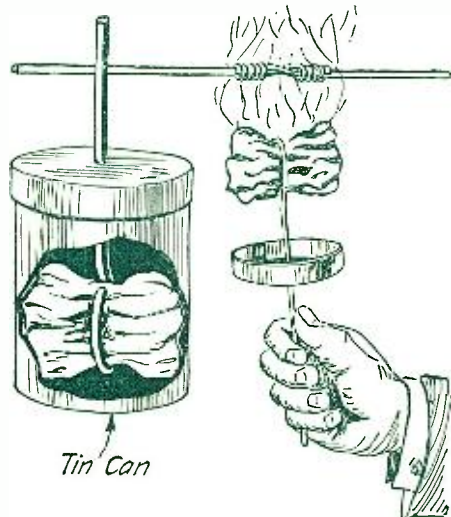

Here is a quick and easy method of soldering those outside joints.

wire was twisted around it in the form of a handle. The handle was passed through the hole in the can top and the burr on the punching pressed down so that it firmly gripped the handle. The top should be in such a position that when the ball of waste is placed in the can, the top fits in place and excludes all air.

After preparing the joint to be soldered in the usual manner, the ball of waste is soaked in gasoline and set afire with a match. The blazing waste is held under the joint until the flux flows and then the joint is touched with a piece of wire solder. A further application of heat causes the solder to flow in the joint, which is then wiped clean.

When finished with the torch, put the ball of blazing waste into the can and the cover fitting into place will extinguish the flame.

Contributed by Jesse J. Hipple.

NEUTRODYNE RADIO FREQUENCY CONTROL

With the average Neutrodyne receiver, local stations, as a rule, come in with tremendous volume, and one or more stages of radio frequency amplification could be dispensed with and good results still obtained. Regularly, it is not good practice to use any arrangement in a radio frequency circuit to control the separate stages, but in a Neutrodyne circuit this can be done without loss of efficiency. The accompanying diagram shows the method used. Two extra binding posts are employed and are connected to the middle tap on the secondaries of the neutro-

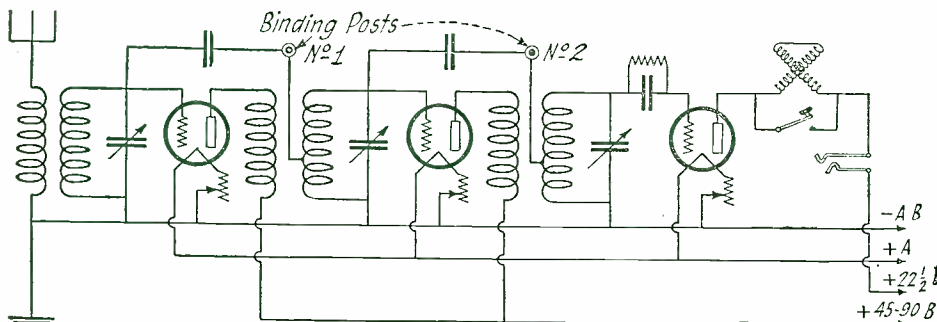

When close to a local station, radio frequency is not needed. By placing binding posts as shown, one or both R.F. stages can be eliminated.

formers, as shown. These binding posts may be placed on a separate hard rubber strip mounted on the rear of the baseboard or may be placed directly on the front of the panel. By connecting the antenna to either of these binding posts, the detector alone, or one stage of radio frequency amplification, may be employed. The ground is always left on the original binding posts. It might be preferable to use a three-point switch on the face of the panel for this purpose, instead of the binding posts. In this way any stage of radio frequency may be cut out by a turn of the switch, and it would be unnecessary to change the antenna from one binding post to another.

Contributed by B. A. Kinsey.

A COMBINATION TUNING AND GRID CONDENSER

Herein is described a combination tuning and grid condenser which will save considerable space and at the same time increase the efficiency of any receiver in which it is used. Instructions for building radio sets almost invariably advise the builder to use short leads in wiring the instruments. This is particularly true in the grid circuits. The resistance of leads six inches or more in length is not high, but when we take into

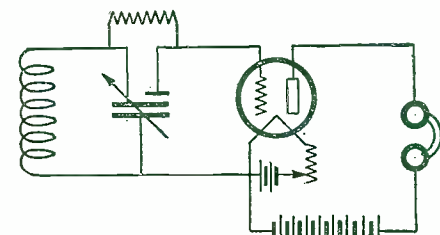
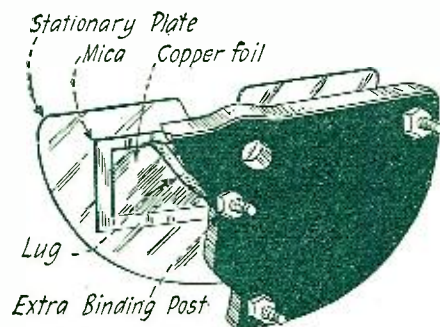

Circuit and construction of details of a combination tuning and grid condenser.

consideration the extremely low voltage induced in the secondary circuit, the value of short leads becomes apparent. In order to avoid body capacity effects, the grid condenser is usually connected to the stationary plates of the secondary condenser. Since the plate of the grid condenser is connected to the stationary plates, why not do away with one plate of the grid condenser entirely and substitute the stationary plates of the secondary condenser? A simple method of accomplishing this is to remove the end piece of the secondary condenser and fasten a clear piece of mica about .001 inch thick and

one inch square to the outside stationary plate by means of shellac. A piece of tin or copper foil may then be placed over the mica to form the other plate of the grid condenser. This plate may be fastened to an extra binding post placed on the end piece of the condenser by means of a small lug. The grid connection is made directly to this binding post. The details of construction can clearly be seen in the accompanying sketch.

Contributed by O. Johnson.

A VERNIER POTENTIOMETER

When using a potentiometer in a radio frequency circuit, great difficulty is sometimes experienced in bringing in weak stations

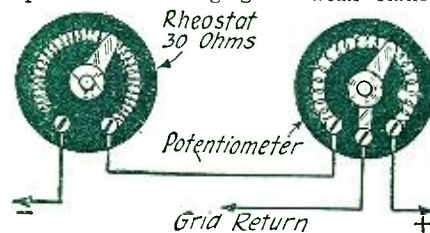

A 30-ohm rheostat makes a good vernier for the potentiometer.

without having the tubes spill over. This is especially the case with the usual wire wound instrument, as the variation is not even, but consists of small jumps as each turn of wire is passed. It is obvious that a vernier attachment cannot be used on the potentiometer itself as it is impossible to get any variation between the turns. The solution is to employ a variable resistance of low value in series with the potentiometer. This can take the form of a 30-ohm rheostat. If the potentiometer has a resistance of 300 ohms, it will readily be seen that, as a complete turn must be made on each instrument to vary the complete resistance, a ratio of 10 to 1 will be had. When using this rheostat, it should be placed in series with the potentiometer and the negative lead of the "A" battery. In operating this vernier, the movable arm should be placed about on the center of the resistance. Now, when as fine an adjustment as can be had is obtained with the potentiometer, a very fine vernier effect can be made with the rheostat. This attachment may be used with any radio frequency receiver and will prove extremely useful on long distance stations.

Contributed by S. Dominus.

AN EFFICIENT CONTACT SWITCH

If you have been using one or more

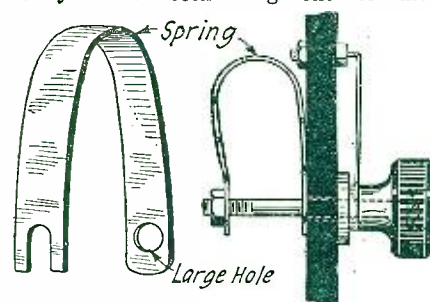

Method of mounting efficient contact switch.

switches on your panel, you undoubtedly know the inconvenience and trouble caused by a bad contact in the switch assembly. Herein is described a switch which can be depended upon for a good contact at all times. The only new feature incorporated in this instrument is a piece of spring brass bent and cut, as shown in the diagram. Any switch having a fairly long shaft may be used with excellent results. The pressure of the switch arm may be controlled by the thickness of the brass spring and also the degree of curve which the spring is made to take. The pressure may also be varied by

(Continued on page 242)

Radio Humor

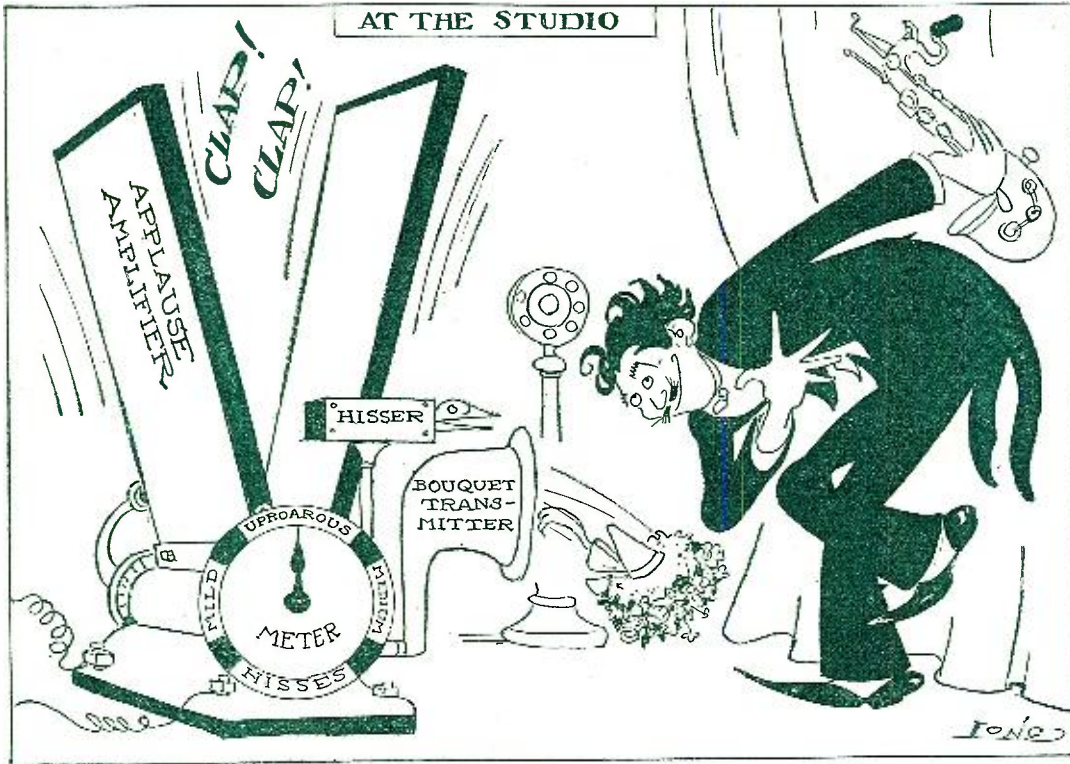

"This is station WOOF! Our artists would like to know how their program has been received by you—etc." All right! Here's a way to show your appreciation. The combination Applause, Bouquet, and Hisses Transmitter does the work, and lets the artists know how good or bad they are. Experiments are being made to add a Decayed Fruit Tosser to this hook-up, in response to the BCL demand for some way of expressing depreciation—when an artist lets go of "Yes, we have no—" etc. This system is a Reflex, as it reflects the listener's response back to the station by a special transmitter, with amplification and intensity controls, as shown in the illustration.

Radiotics

THE FOURTH DIMENSION



The following is an excerpt from the advertisement of the Radio Specialty Co., which was unearthed in your own June number. It reads — "ADAPTER BUSHING — MAKES 3/16" Dial FIT 1/4" SHAFT!" I think that

this *Rasco* is a rascal and I wouldn't believe him any more than I would an oil stock salesman.

Contributed by W. Yuchle.

A GOOD STATIC ELIMINATOR



This choice sentence appeared on page 1083 of the February issue of *Radio News*: "UV-201-A tube, 45 VOLTS ON THE FILAMENT, 90 volts on the plate." Although a UV-201A vacuum tube may have nine lives, 45 volts on the filament should cop them all at once. It would at least eliminate static—and signals.

Contributed by Gerald G. Smith.

A SET FOR THE POOR

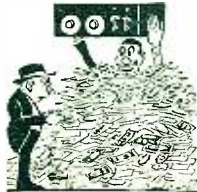

In the May 17 issue of *Radio World* the following ad. was found in the Classified Advertisement section. BARGAINS: COMPLETE PARTS FOR THREE TUBE NEUTRODYNE ASSEMBLED IN CABINET 7 x 27"

\$35,000. It ought to be a corking good set for that price!

If you happen to see any humorous misprints in the press, we shall be glad to have you clip them out and send to us. No RADIOTIC will be accepted unless the printed original giving the name of the newspaper or magazine is submitted. Never mutilate clippings by underlining the misprint. We shall pay \$2.00 for each RADIOTIC that is accepted and printed here. A few humorous lines from each correspondent should accompany each RADIOTIC. The most humorous ones will be printed. Address all RADIOTICS to

Editor RADIOTIC DEPARTMENT,
c/o Radio News

A NEW DISEASE



I found the enclosed advertisement in the *N. Y. Sun*, May 10, 1924. "ALL TUBES ARE TESTED FOR FILAMENT AND WE GIVE YOU FIVE DAY TRIAL FOR OSCILLATION."

I came to the conclusion that the Vim Electric Co., part of whose advertisement this is, has discovered a new sickness called "Filament" and it seems that vacuum tubes are not entirely immune from this malady.

Contributed by Alvin Tannenbaum.

A FEMALE ENTERS THE FIELD

From the Chicago *Daily Tribune* for Saturday, April 26, 1924: "FIVE TUBE NEUTRODYNE HAZEL PINE PATENT, \$75." This is a new one on me. I haven't been able to figure out whether Hazel Pine is some new girl inventor, or maybe Hazel does pine because her beloved Neut is going to be sold.

Contributed by Charles F. Holbrook.



CONSERVATIVE COLUMNISTS

The Cleveland (Ohio) *News* informs us of the wonders of science in the following: "The shortest waves used by the radio experts are about three feet long. The longest are about 20,000 meters long, WHICH IS MORE THAN TWELVE INCHES."

As Huxley once said: "Those who refuse to go beyond fact rarely get as far as fact." Our conservative Columnist has managed well.

Contributed by Jack Bront.

THE SET IS BEING SHADOWED!

In the *RADIO NEWS* for June, the advertisement of the Crosley Radio Corporation describes the "Model V set as a GENUINE ARMSTRONG REGENERATIVE TUNING AND DETECTIVE CIRCUIT."

That is just what we need now-a-days; a detective circuit to keep an eye on the grid leak and to put a stop to this terrible radiation.

Contributed by Raymond Kelmel.

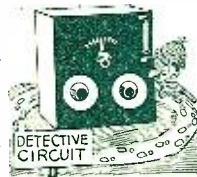

CONDENSERS BY THE YARD

The ROVA STORES tell us in one of their advertisements of Freshman Mercury Variable Condensers that there are "NO PLATES TOO SHORT." No doubt one is guaranteed his money's worth.



Contributed by Raymond Kelmel.

STANDARD HOOK-UPS

EVERY month we present here standard hook-ups which the Editors have tried out and which are known to give excellent results. This leaf has perforation marks on the left-hand margin and can be cut from the magazine and kept for further reference. These sheets can also be procured from us at the cost of 5c to pay for mailing charges.

RADIO NEWS has also prepared a handsome heavy cardboard binder into which these sheets may be fastened. This binder will be sent to any address, prepaid on receipt of 20c. In time there will be enough sheets to make a good-sized volume containing all important hook-ups. Every year an alphabetical index will be published enumerating and classifying the various hook-ups.

Handy Reference Data for the Experimenter

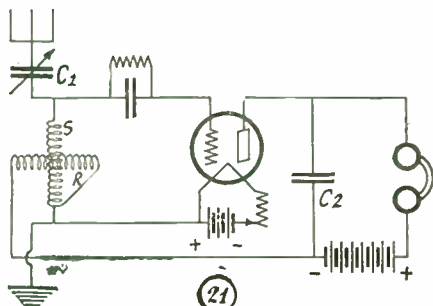

Simple single circuit regenerative receiver.

Circuit No. 21. Here is shown a very simple single circuit regenerative receiver using a single variometer for tuning and regeneration. This variometer should invariably be of small size, having no more than 40 or 45 turns on the stator, and the same number on the rotor. In this receiver the stator of the variometer acts as the tuner and is connected in the antenna circuit in series with a variable condenser C1, of .001 mfd. capacity. The ground is taken off at the intersection of the stator and rotor, as shown. The other end of the rotor is connected to the plate of the tube through the "B" battery and phones. A small variometer should be used because if one of standard size is employed in this circuit there will be too much wire on the stator to tune to the lower wave-lengths. The by-pass condenser shown at C2, may not be necessary and the receiver should be tried with and without it to determine which connection gives the better results.

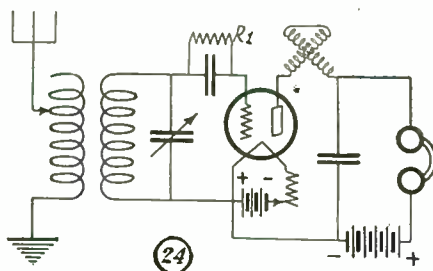

Three-circuit receiver with condenser tuned secondary.

Diagram No. 24 is the same circuit as No. 23 with the exception that a variable condenser is used to tune the secondary circuit instead of a variometer. By using this variable condenser the tuning will be slightly sharper and a wider band of wave-lengths will be covered. The grid leak R1 will have a resistance from one to five megohms depending upon the type of tube used. The tuning of this receiver is identical with that of diagram No. 23. If interference is experienced, the coupling between the rotor and stator coils may be loosened and the set slightly retuned. As the rotor is tuned at a greater angle to the stator, sharper tuning will be had. If the angle is very great, the signal strength will be lessened, but this is sometimes advisable to eliminate heavy interference. Under good conditions a receiver of this type should have a receiving range of 800 to 1,200 miles, if conditions are very favorable.

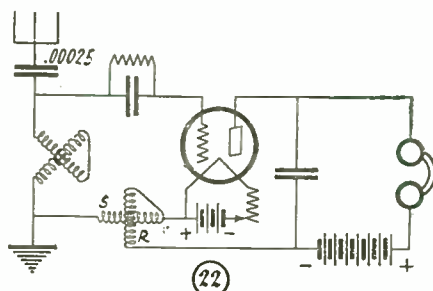

Two-variometer regenerative circuit.

Circuit No. 22 is a regenerative receiving set using two variometers, one of which is placed in the antenna circuit for tuning and regeneration. As will be seen, the filament connection is made at the junction of the rotor and stator of the second variometer. The stator of this variometer is connected between the filament and the ground side of the tuning variometer. The rotor is connected between the filament and the plate of the tube in series with the phones and the "B" battery. This variometer should be of small size having no more than 40 or 45 turns on the stator and the same number of turns on the rotor. As this receiver will cause great interference under certain conditions, care should be taken that it is operated correctly.

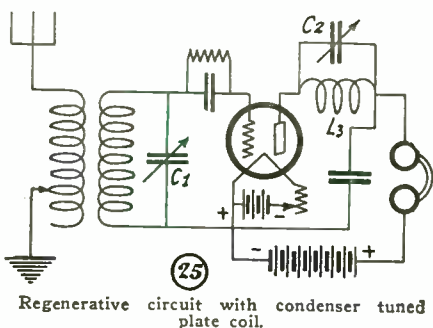

Regenerative circuit with condenser tuned plate coil.

Circuit No. 25 is also a three circuit regenerative receiver, but in this case instead of a variometer in the plate circuit for regeneration, a fixed inductance L3, shunted by a variable condenser C2, is used. This inductance should be approximately the same value as the secondary of the variocoupler. A honeycomb coil of 50 turns will give very good results in this position. The variable condenser C2, has a capacity of .0005 mfd. The condenser C1, also has a capacity of .0005 mfd. and is used to tune the secondary circuit. The tuning of this receiver follows the same method as employed in diagrams 23 and 24, both condensers being varied at the same time. The variocoupler used in this circuit should be of good manufacture and should contain from 45 to 50 turns on the secondary. The primary is tapped at every 8 or 10 turns and is varied by means of a switch. It is not necessary that this primary be finely tuned as it will be found that it will respond to a fairly broad band of wave-lengths at one switch setting.

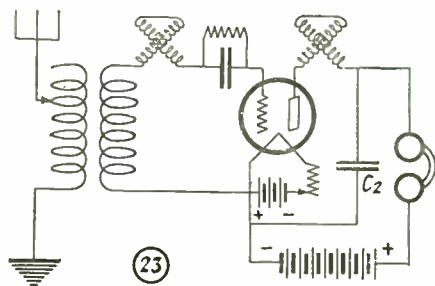

Standard three-circuit regenerative receiver.

Diagram No. 23 shows a receiver which will prove very selective, and for a one-tube receiver is very hard to excel. A standard variocoupler is used for tuning. A variometer is inserted in the grid, or secondary circuit, which will give very close tuning. Another variometer of the same size is used in the plate circuit for regeneration. A by-pass condenser C2, of .001 mfd. capacity, usually will be found necessary in this circuit. Contrary to the general opinion, the tuning of this receiver is not difficult. The primary switch is set on a switch point, usually the third or fourth, where broadcast stations will be received. Both variometers should be varied simultaneously, keeping just under the oscillation point. In this way, as the tuning of the secondary circuit is changed, the receiver is always at its most efficient point and weak stations can readily be heard.

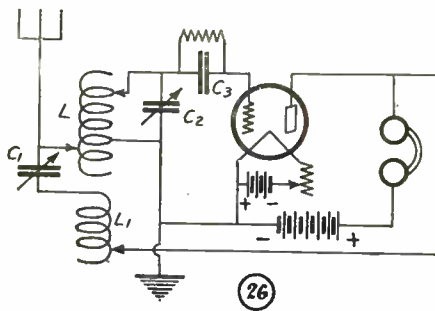

The selective Reinartz circuit.

In diagram No. 26 we have the well known Reinartz circuit. This receiver will give very selective tuning and is quite a favorite with the amateurs. This circuit was originally designed for C.W. reception, but it will also give very fine results on radiophone work. Coils L and L1 are wound in spider-web fashion on the same form. These coils have been described many times in various radio publications and they may be procured from any radio supply dealer. L1 in this circuit acts as a tickler coil, but regeneration is mostly obtained by capacity feed back through the variable condenser C1. This condenser has a capacity of .001 mfd. The variable condenser C2, with which most of the tuning is done, may have 17 or 23 plates. The grid condenser C3 has a capacity of .00025 mfd. and should be of good make. The "B" battery voltage will depend upon the type of tube used, but as a rule it will be approximately 22½ volts.

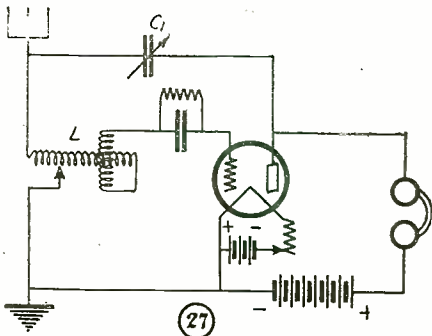

A simplified Reinartz circuit.

In diagram No. 27 is shown what is known as the modified Reinartz receiver. At first glance this circuit appears to be new, but it is nothing more than an untuned primary circuit having capacity feed-back for regeneration. The instrument shown as L is a standard variocoupler of the old type, where the secondary may be revolved through 180 degrees. The secondary winding is connected to the end of the primary winding as shown. The lower end of the primary winding should be tapped every turn for 10 turns and is controlled by a switch. By using more or less turns by means of this switch, great selectivity is obtained. The variable condenser C1 has a capacity of .001 mfd. and is used to produce regeneration. When tuning this receiver the switch may be set on any point and the rotor of the variocoupler turned until a station is picked up. Greater volume is then obtained by increasing the capacity of the variable condenser C1. It is best practice to make both of these operations at the same time, as in this way the receiver can always be kept at the maximum point of regeneration and very weak signals picked up.

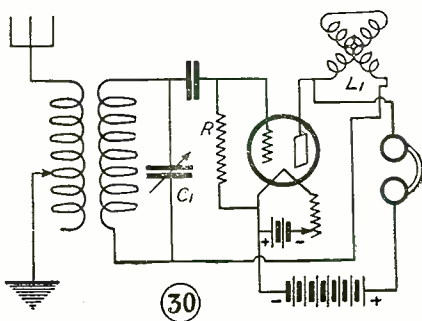

Three-circuit regenerative receiver.

Diagram No. 30 also shows a three circuit regenerative receiver, but in this case the phones and the "B" battery are removed from the oscillatory circuit. It will be noted that the grid return of the tube does not connect to the filament but goes to the plate through the plate variometer. In this circuit the grid leak R must be connected from the grid to the positive side of the "A" battery. The values of the various instruments in this circuit are the same as the two preceding diagrams. The tuning of this circuit is no different than the other three circuit regenerative receivers shown, the variable condenser C1 and the plate variometer L1 being varied at the same time. As the phones and "B" battery are removed from the oscillatory circuits, no by-pass condenser will be found necessary. This circuit will be found extremely sensitive, fairly easy to tune and under favorable conditions will bring in long distance stations. Any kind of tube may be used providing the "B" battery voltage is correct. A soft tube, such as the UV-200, will probably give best results and should be used with an "A" battery of 6 volts in series with a 6-ohm potentiometer.

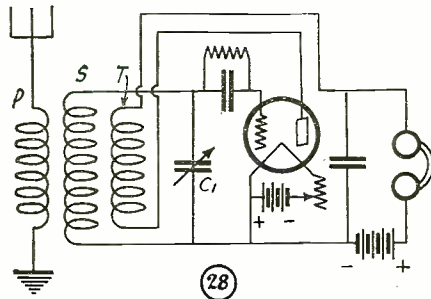

An untuned primary receiver.

In diagram No. 28 we have a simple regenerative receiver which combines selectivity with long distance reception. The tuner of this receiver consists of a rewound variocoupler. A coupler of the 180-degree type having a secondary winding of 35 to 40 turns is recommended. The primary winding should be removed and a new winding consisting of 42 turns of No. 20 S.C.C. wire wound on in its place. This winding will be the secondary of the instrument. The primary consists of 10 turns of No. 18 or No. 20 S.C.C. wire wound directly over the lower end of the primary and separated from it by two or three layers of cardboard or other insulating material. The variable condenser C1 has a capacity of .0005 mfd. and should preferably be of a vernier type. A non-vernier condenser may be used, but in this case a vernier dial is recommended. When connecting the tickler coil, the plate of the tube should be connected to the lower terminal if, when the tickler is horizontal in respect to the secondary, the grid is connected to the top terminal of this secondary coil. If these connections are correctly made, there will be no need to reverse the tickler connections afterward.

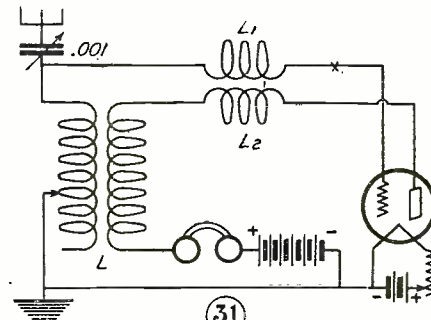

Super selective circuit.

Diagram No. 31 shows a simple regenerative receiver that is slightly different from the standard circuits. A standard variocoupler L is employed with a secondary winding consisting of not more than 40 turns. The primary should consist of about 80 turns tapped every 10 turns and is employed with a variable condenser of .001 mfd. in series with the antenna. The two inductances, L1 and L2, are spider-web coils of about 20 turns each. These two coils are mounted stationary, in inductive relation to each other and about three inches apart. One coil goes to the grid of the tube and the other is connected to the plate in series with the secondary of the tuner, the phones and the "B" battery. The tuning is accomplished by means of the primary switch and the variable condenser. Regeneration is obtained by varying the inductive relation of the secondary to the primary. The leads on one of the spider-web coils should be reversed when the set is in operation, to determine which gives best results. As a rule no grid condenser is required in this circuit, but one may be tried in the position shown at X. It will also be best to connect the grid return to the negative and positive of the "A" battery in turn, as one connection will work better with certain tubes.

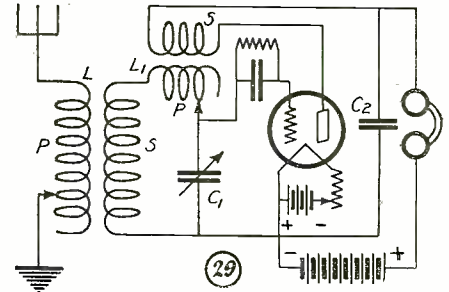

Two-vario-coupler receiver.

Diagram No. 29 shows a circuit with which a fairly wide band of wave-lengths may be covered with efficiency. In this circuit two vario-couplers are employed and are shown as L and L1. Regeneration is obtained by means of the secondary of the second vario-coupler acting as a tickler in the plate circuit of the tube. To obtain regeneration, part of the winding of the primary of L1 must always be used, and for this reason it is advisable that the variocoupler L have a secondary of about 30 turns. The variable condenser C1, with which the secondary tuning is accomplished, has a capacity of .0005 mfd. It will be found that for practically all broadcast stations only one or two taps on the primary of L1 will be used. Experiment will determine which taps to use on the primary of L for certain stations. As the secondary of this first variocoupler can be varied in its inductive relation to the primary, very sharp and selective tuning will be had. If the primaries have sufficient turns, a wave-length of 3,000 meters may be reached. The by-pass condenser C2 will have a capacity of .001 mfd. This condenser is not always necessary and the receiver should be tried with and without it to determine which gives best results.

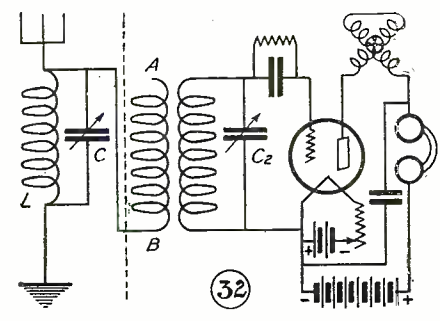

Method for increasing selectivity.

In diagram No. 32 is shown a circuit that is very little known, but which will prove very effective in eliminating interference. As will be seen, any type of two or three circuit tuner may be used in conjunction with this system to good advantage. In this case it is shown with a standard three circuit regenerative receiver. The inductance L will consist of about 35 turns of wire wound on a three inch tube. The size of this coil is only approximate, as it will vary in accordance with the size of the antenna employed. It might be advisable to wind 50 turns on a three inch tube tapped every 10 turns so that the size of the coil may be varied for any size of antenna. The variable condenser C may be .0005 or .001 mfd. capacity. It will be noticed that only one connection is made from the coil L to the primary of the tuner. This connection should be tried at both A and B, as one connection will work very much better than the other. The inductance L should not be in inductive relation to the tuner of the receiver. When tuning this receiver it will be found necessary to vary the condenser C and the condenser C2 at the same time, as both must be in resonance before any station will be heard.

Correspondence from Readers

HE IS GOING IN FOR STATIC!

Editor, RADIO NEWS:

We are now beginning to hear U. S. A. in Australia. A Chicago concert came in fairly loud, but badly broken up, about a week ago. Radio is very dull generally, chiefly on account of some of the heads who would make laws for radio, but somehow cannot make radio fit the laws. Meanwhile everybody who is interested listens in. Some pay the license fee (10 shillings) and some don't. The "don'ts" are in the majority. We have to be very careful when listening to concerts for fear some member of the family should overhear without having first paid their fee. So every night when I listen to our broadcast concerts (sic) I lock the wife in the bathroom and put the kid in the dog kennel. I'm a law-abiding citizen and am not taking any risks.

Honestly, I cannot see the need for half the regulations. The only law required is for the supervision of sending stations, a sort of traffic cop for radio, which law would be welcomed by all concerned.

The great joke here at present is a broadcasting concern which charges \$16 a year, besides the government fee, to hear their concerts. The government backs them to the extent of refusing you license until you have paid the company's charge. If this paternal government would extend the same privilege to butchers, bakers and tradesmen generally, what a happy debt-free crowd we would be.

Oh, radio, how many crimes are committed in thy name? Next year a whole crowd of experimenters will adopt a new course. We are cutting out radio experimenting and going in for studying static. Fortunately, static has not been monopolized so far, and we should be allowed to use it without a tax. Of course, we will get a lot of interference from radio, but it is anticipated that we will be able to eliminate this by using some of the up-to-date appliances used by the big monopolies and government stations. I've had a lot of fun out of static; in fact, it is easier to get here than radio, so why bother with radio?

When are we going to get a reliable detector? Somehow I think we are on the wrong track or, to say the least, not on the best track. Why should we think no higher than a telephone receiver? There must be other means of detecting and receiving. Who will discover it?

I might say that the experimenter in Australia is not charged a broadcasting fee, so he is practically unfettered except for the 10 shilling fee. Of course, he must experiment only. However, some of the "very bad" experimenters have been known to listen-in for amusement!

FRED C. JONES,
Sydney, N. S. W.

REGARDING A UNIVERSAL LANGUAGE

Editor, RADIO NEWS:

What is the relation of "Ilo," the international language put forward by Mr. Roos in the May issue of RADIO NEWS, to other proposed international languages, particularly to Esperanto? Most of the words and rules of grammar which Mr. Roos gives as examples in his article are Esperanto words and Esperanto rules of grammar. From the description given, it seems that "Ilo" is a modification of Esperanto.

I should be sorry to see another auxiliary language brought forward to compete for honors in the already overcrowded field. It probably does not matter a great deal which of the proposed international languages is adopted; the important thing is that one shall

come into use, rather than half a dozen. Esperanto, Ido, Esperantido, Idiom Neutral, Ro, Volapuk and a number of others have been proposed in the past, and some of these languages are already widely used. If several of these languages come into use, the purpose for which they were devised will be defeated.

The value of an international language depends very largely upon the extent to which it is in use. There is not much use in knowing a language unless there are plenty of people to whom you can talk in that language. I have no figures on the extent to which the various auxiliary languages are used—probably no one has—but I think it is generally considered that Esperanto and Ido are far ahead of the others, and that of these two Esperanto is well ahead of Ido.

MARS

THIS month, when the planet Mars is closer to us than it will be for many years to come, interest runs high as to whether the planet is populated by thinking creatures. Scientists have speculated for many years that if such creatures do exist, what their physical appearance will be.

Do not fail to read this very interesting article, entitled "Evolution on Mars," by Hugo Gernsback, in the August issue of SCIENCE AND INVENTION. This article sets forth the latest scientific speculations on the subject.

List of Radio Articles Appearing In the August Issue of "Science and Invention"

Radio on the S. S. DEUTSCHLAND
Four Improved Radio Hook-Ups
Vacuum Tube Data
New Radio Receiver with Detector and Three Stages of Audio Frequency
Radio Sets of Unusual Type
Photos of Latest Radio Events
Radio Broadcast Calls to Date
A Specially Designed Radio Receiver of Unusual Selectivity
By Herbert E. Hayden
Radio Wrinkles
Directive Radio Gives Information to Motorists
Radio "Drammer" As Its Awards in Crystal Detector Contest

All the enthusiastic statements which Mr. Roos makes of "Ilo" can also be made of Esperanto, and probably of most of the other auxiliary languages that have been put forward. It seems hardly reasonable to discard all the work that has been done toward the advancement of international language in the past by adopting some comparatively little used language, even though it may be to some extent an improvement on those that have been in use before.

Therefore, I suggest that RADIO NEWS make an investigation of the different international languages in use, taking into account the extent to which they are already used and their relative merits, and on the basis of that investigation recommend a language for use in radio communication. I believe that the influence of RADIO NEWS is great and that its decision here will have considerable weight and will help to avert the danger of too many auxiliary languages.

FRED SAUER,
Box 646,
Palo Alto, Calif.

[In response to the above and many similar communications, we are printing an interesting article on Esperanto in this issue.—EDITOR.]

IN FAVOR OF ESPERANTO

Editor, RADIO NEWS:

I have read with interest in your May number the article by Mr. O. C. Roos entitled "A Radio Auxiliary Language for Trans-Oceanic Work."

It is needless to say that the increasing use of radio and the fact that it will be but a short time before regular inter-communication by radio broadcasting between all parts of the world will be an established fact, will necessitate the adoption of some international language.

In my opinion, Ilo, advocated by Mr. Roos, is not, by any means, the ideal international language. There is a language, however, from which Ilo has been adapted which is ready for international radio use. This language is Esperanto.

The points in favor of Esperanto over Ilo are as follows: It is more widely known and used and numbers its followers by the thousands all over the world. Its text-books in all languages are easily obtainable, and experienced users of the language are found everywhere. It has international societies ready to co-operate. But greater far than these is the fact that it has been in existence for a number of years, and in these years has been found worthy of international use. Esperanto publications are found in every land, yearly congresses are held to which various governments send accredited representatives, the language has been investigated and adopted by many international associations, among which is the League of Nations.

In Europe, broadcast stations are taking advantage of the wide-spread knowledge of Esperanto by using the language in their programs, and in our own country and Canada it has been used by different stations.

As an Esperantist and a radio enthusiast, I am in constant correspondence with many foreign radio amateurs, and I have yet to find one who would favor the adoption of Ilo.

ROBERT S. WOOLF,
Blairsville, Pa.

INDIFFERENCE

Editor, RADIO NEWS:

I have just read with interest the article by Mr. O. C. Roos entitled "A Radio Auxiliary Language for Trans-Oceanic Work." May I supply a few statements of facts?

First: Mr. Roos asserts that "since 1907 we have had just such an auxiliary language named 'Ilo.' It is absolutely dependable and already in extensive use."

With all deference to Mr. Roos' more intimate relation to Ilo, the project named "Ilo" or "Ilo," proposed as a modified form of Esperanto in 1907, has been repeatedly changed and is at present merely enjoying a temporary respite from grammatical tinkering. It is, therefore, somewhat equivocal to say that "just such a language has been in use since 1907."

Second: Mr. Roos aptly states that Ilo is a "tool," not a "paintbrush," and that it requires a logical mind. Of course, a paintbrush is a tool; probably he means that it is necessary to use logical precision like that of a mechanical tool when using the Ilo language. The Paris Chamber of Commerce decided that "this so-called perfection was only a further complication." Now it is true that with only a postcard to write, a few may have time for careful and logical word-building and analysis, but for conversation or transmitting and receiving broadcasts, machine precision gives way to the human

(Continued on page 208)



**APPROVED
RADIO NEWS
LABORATORIES
1923**

RADIO NEWS LABORATORIES



RADIO manufacturers are invited to send to RADIO NEWS LABORATORIES, samples of their products for test. It does not matter whether or not they advertise in RADIO NEWS, the RADIO NEWS LABORATORIES being an independent organization, with the improvement of radio apparatus as its aim. If, after being tested, the instruments submitted prove to be built according to modern radio engineering practice, they will each be awarded a certificate of merit, and a "write-up" such as those given below will appear in this department of RADIO NEWS. If the apparatus does not pass the Laboratories tests, it will be returned to the manufacturers with suggestions for improvements. No "write-ups" sent by manufacturers are published on these pages, and only apparatus which has been tested by the Laboratories and found to be of good mechanical and electrical construction is described. Inasmuch as the service of the RADIO NEWS LABORATORIES is free to all manufacturers whether they are advertisers or not, it is necessary that all goods to be tested be forwarded prepaid, otherwise they cannot be accepted by the Laboratories. Address all communications and all parcels to RADIO NEWS LABORATORIES, 53 Park Place, New York City.

Apparatus Awarded Certificates

TRIMM HEAD-SET

The Trimm Professional Head-Set is of the conventional two-pole construction with moulded shells. This head-set is very sensitive and reproduces with exceptional clearness. Its maximum sensitivity is in the neighborhood of 2,000 cycles. The resistance of the sample head-set submitted is 3,017 ohms and the impedance at 1,000 cycles is 34,000 ohms. It is manufactured by the



Trimm Radio Manufacturing Co., 24 So. Clinton Street, Chicago, Ill. Arrived in excellent packing.

AWARDED THE RADIO NEWS LABORATORIES CERTIFICATE OF MERIT NO. 453.

REINARTZ MOUNTING AND TRIPLE SWITCH

The builder of a Reinartz set will find this combination mounting and switch very convenient. On a Bakelite base are mounted three inductance switches having four points, seven points, and four points respectively. A metal rod is furnished that fits the base and supports the standard Reinartz spider web coil. In this way the complete unit is



very conveniently mounted. This instrument is manufactured by the Bruno Radio Corp., 300 Water St., New York City.

AWARDED THE RADIO NEWS LABORATORIES CERTIFICATE OF MERIT NO. 473.

ADAMS PERFECTED RADIO JACKS

The Adams perfected radio jacks are made in several sizes. The illustration shows the single circuit jack. The springs are of phosphor bronze securely mounted on the nickel-



plated support. Any standard radiophone plug fits these jacks. They are manufactured by the Adams Radio Mfg. Co., 716 W. Madison Street, Chicago, Ill.

Arrived in excellent packing. AWARDED THE RADIO NEWS LABORATORIES CERTIFICATE OF MERIT NO. 456.

CONNECTICUT TRIPLE RANGE CONDENSER

This variable condenser type D-10 is small in size, measuring only two inches in diameter and one inch high. It consists of two variable mica condenser units with three terminals so the units may be connected in parallel or series, or either one or the other may be used separately. With the two units in parallel, a 180-degree turn of the dial changes the capacity from 96.38 mmf. minimum to 960.01 mmf. maximum. The dielectric absorption losses at 1,000 cycles are equivalent to a series resistance of 800 ohms, which is low for a mica insulated condenser. Manufactured by the Connecticut Telephone & Electric Co., Meriden, Conn.



Arrived in excellent packing. AWARDED THE RADIO NEWS LABORATORIES CERTIFICATE OF MERIT NO. 472.

U. S. TOOL CONDENSER

The variable condenser shown in the illustration, is manufactured by the U. S. Tool Co., Inc., 117 Mechanic Street, Newark, N. J.; it is of the vernier type, having 24 plates and is complete with knob, dial and a special vernier knob, as shown. The capacity range is from 15.21 to 443.9 mmf. and the dielectric losses at 1,000 cycles are equivalent to a series resistance of 250 ohms. The instrument is of excellent mechanical construction.



Arrived in good packing. AWARDED THE RADIO NEWS LABORATORIES CERTIFICATE OF MERIT NO. 321.

MAR-CO 9-POINT INDUCTANCE SWITCH

Much trouble has been caused from loose contact points on inductance switches. In the Mar-Co Ratchet type 9-point switch, loose connections are almost impossible. The wire connections are clamped in rugged binding posts which also served as contact points. The lever arm has a tendency to stop on the

contacts and not between them. This instrument is two inches in diameter, highly finished and is furnished with a white celluloid dial with black engravings. Manufactured by the Martin Copeland Co., Providence, R. I.



Arrived in excellent packing. AWARDED THE RADIO NEWS LABORATORIES CERTIFICATE OF MERIT NO. 470.

RICO GRAND OPERA LOUD SPEAKER

A moderately priced loud speaker giving excellent quality and great volume is a recent product of the Radio Industries Corp., 131 Duane Street, New York City. This loud speaker employs a phone unit of the conventional two-pole design. The clamping arrangement for the diaphragm is of somewhat unusual construction. The diaphragm is clamped between rubber gaskets which are compressed by tighten-

ing the phone cap, thus varying the magnetic air gap between the diaphragm and the pole tips. This adjustment is obtained by moving a lever called the volumeter on the instrument.



ing the phone cap, thus varying the magnetic air gap between the diaphragm and the pole tips. This adjustment is obtained by moving a lever called the volumeter on the instrument.

Arrived in excellent packing. AWARDED THE RADIO NEWS LABORATORIES CERTIFICATE OF MERIT NO. 480.

INSIDE AERIAL

The 12-wire cage type inside aerial shown in the illustration is manufactured by the Inter State Signal Co., Columbus, Ohio. This aerial is 11 feet long and 12 inches



in diameter. Stranded wires are employed. It is furnished complete with spacers, insulators, screw hooks

and turnbuckle. It is easily installed in a room of average size and gives excellent results for a small antenna.

AWARDED THE RADIO NEWS LABORATORIES CERTIFICATE OF MERIT NO. 462.

BRUNO 14-POINT INDUCTANCE SWITCH

The 14 contact points of the Bruno inductance switch are mounted on a bakelite disk and the complete instrument requires only one hole for mounting on a panel. The lever arm makes very good contact with the switch points. It is furnished with a knob and pointer and also a 1/4-inch bushing in case it is desired to use a dial instead of the knob and pointer. Manufactured by the Bruno Radio Corp., 300 Water St., New York City.



AWARDED THE RADIO NEWS LABORATORIES CERTIFICATE OF MERIT NO. 474

NEON LAMP ARRESTER

The Neon Lamp, sometimes called glim lamp, so extensively used for advertising signs, forms an excellent lightning arrester for the protection of radio receiving apparatus. The illustration shows a typical Neon lamp having two electrodes enclosed in a glass bulb containing Neon gas. The gap between the electrodes breaks down a pressure of about 200 volts. This type of arrester may be used inside and it fits the standard lamp socket. Manufactured by the Neon Lamp Works, Inc., 62 W. 14th Street, New York City.



Arrived in excellent packing. AWARDED THE RADIO NEWS LABORATORIES CERTIFICATE OF MERIT No. 406.

MAR-CO PHONE PLUGS

The Mar-Co Sta-Put, Double Sta-Put and Shur-Grip radiophone plugs are of very simple and durable construction. The plugs differ only as to the inside connections to the phone-cord tips. The Sta-Put plug accommodates one headset or loud speaker, and requires no tools for

connecting. The Double Sta-Pat accommodates two headsets or loud speakers and requires a screw-driver for attaching the cord tips. The Shur-Grip plug is more highly finished than the other two and employs a chuck type of binding post in which the cord tips are clamped. This plug accommodates one headset or loud speaker. Manufactured by Martin-Copeland Co., Providence, R. I.



Arrived in excellent packing. AWARDED THE RADIO NEWS LABORATORIES CERTIFICATE OF MERIT NOS. 465, 466 and 467.

MAR-CO SUPER VERNIER CONDENSER

This miniature variable air condenser will make fine adjustment possible on any receiving set. This condenser has five plates having a minimum capacity of 2.40 mmf. and a maximum capacity of 16.80 mmf. It is highly finished, insulated with



a good grade of hard rubber and is furnished with a 3/4-inch knob and pointer. Manufactured by the Martin-Copeland Co., Providence, R. I.

Arrived in excellent packing. AWARDED THE RADIO NEWS LABORATORIES CERTIFICATE OF MERIT NO. 471.

A-C PLAIN RHEOSTAT

The No. 201 plain rheostat manufactured by the A-C Electrical Manufacturing Co., Dayton, Ohio, has a resistance of 30 ohms and is of durable construction. The contact piece is held against the inside of the resistance element by a small coil spring, making the instrument exceptionally smooth running. A

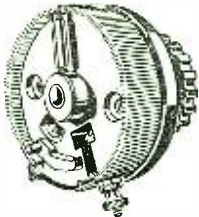

bakelite form supports the resistance element. It is furnished with a 1 1/4-inch knob.

Arrived in excellent packing. AWARDED THE RADIO NEWS LABORATORIES CERTIFICATE OF MERIT NO. 477.

CHAMPION STACKABLE "B" BATTERY

The Champion Ad-On 22 1/2 volt "B" battery which may be stacked employs medium size cells with terminals taken off from the side instead of the top of the battery. By so doing, several of the batteries may be conveniently stacked on top of each other. This not only allows for placing them in a small space, but makes the connections very short. Connection strips are sup-

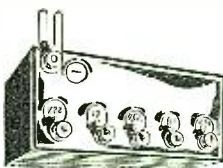

plied with the battery, as shown. The cells are securely sealed and the battery gives excellent service. Manufactured by the Champion Carbon Mfg. Co., Cincinnati, Ohio.

Arrived in excellent packing. AWARDED THE RADIO NEWS LABORATORIES CERTIFICATE OF MERIT NO. 461.

PFANSTIEHL TUNING UNITS

The Pfanstiehl tuning units type P300 and P301 may be used in a variety of circuits. The type P300 unit comprises one 86-turn spiderweb coil and one 80-turn coil having four taps. The coils are mounted so that the coupling between them is easily varied by means of the control knob. An efficient single circuit receiver can be constructed with this tuning unit. The type P301 unit is of similar construction except that it employs two 50-turn spiderweb coils. This unit may be used as a variometer or variocoupler. Manufactured by the Pfanstiehl Radio Service Co., Highland Park, Ill.

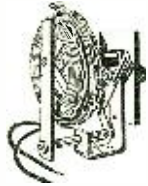

Arrived in excellent packing. AWARDED THE RADIO NEWS LABORATORIES CERTIFICATE OF MERIT NOS. 459 and 460.

WINCHESTER 22 1/2-VOLT "B" BATTERY

This "B" battery No. 5516, is manufactured by the Winchester Repeating Arms Co., P. O. Box 906, New Haven, Conn. The 22 1/2-volt battery employs the larger type cells and is of standard con-



struction. Five taps are provided, giving voltages ranging from 16 1/2 to 22 1/2. This battery gives very good service.

Arrived in excellent packing. AWARDED THE RADIO NEWS LABORATORIES CERTIFICATE OF MERIT NO. 484.

VACUUM TUBE SOCKET

The Type S-12 bakelite vacuum tube socket shown in the illustration is manufactured by the Marshall-Gerken Co., Toledo, Ohio. This socket has a bakelite base and a metal receptacle. There is nothing unusual about this socket except that its exceptionally simple construction makes it mechanically very efficient and offers positive electrical contact with the vacuum tube prongs.



Arrived in excellent packing. AWARDED THE RADIO NEWS LABORATORIES CERTIFICATE OF MERIT NO. 440.

NOL-LOS CONDENSERS

The Nol-Los condensers have low dielectric losses, are highly finished and require only one hole for mounting. The 9-plate type has a minimum capacity of 24.40 mmf. and a maximum capacity of 239.33 mmf. The dielectric absorption losses at 1,000 cycles are equivalent to a series resistance of 200 ohms. The 17-plate type has a minimum capacity of 35.99 mmf. and a maximum capacity of 476.84 mmf. The dielectric absorption losses of this instrument are equivalent to a series

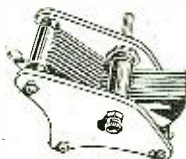

resistance of 140 ohms at 1,000 cycles. These condensers are of the grounded rotor type. Manufactured by B. Grosser & Sons Co., 55 Sudbury Street, Boston, Mass.

AWARDED THE RADIO NEWS LABORATORIES CERTIFICATE OF MERIT NOS. 463 and 464.

BRUNO DOUBLE INDUCTANCE SWITCH

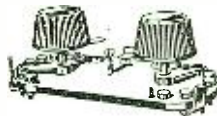

The Bruno double inductance switch is of similar construction to the single switch described in these columns. The double switch has two 7-point switches. This instrument will be found very convenient in many circuits. Only one hole is required for mounting this switch. Manufactured by the Bruno Radio Corp., 300 Water St., New York City.

Arrived in excellent packing. AWARDED THE RADIO NEWS LABORATORIES CERTIFICATE OF MERIT NO. 475.

PERFECTION VERNIER

This vernier attachment consists of a forked arm which may be

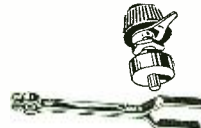

clamped to the shaft of practically any variable air condenser, and by means of a cam attached to the vernier knob a very fine adjustment of the condenser is possible. The arm is mounted behind the panel and in order to make room for it, spacers are furnished for mounting the condenser a little distance away from the panel. This attachment is manufactured by the Perfection Radio Mfg. Co., Philadelphia, Pa.

Arrived in excellent packing. AWARDED THE RADIO NEWS LABORATORIES CERTIFICATE OF MERIT NO. 458.

A-C VARIABLE CONDENSER

The illustration shows No. 710 .0005 mfd. variable air condenser manufactured by the A-C Electrical



Mfg. Co., Dayton, Ohio. This condenser has hard rubber end plates and pig-tail connections. It has the very low minimum capacity of 9.15 mmf.; the maximum capacity is 439.63 mmf. The dielectric absorption losses at 1,000 cycles are equivalent to a series resistance of 170 ohms.

Arrived in excellent packing. AWARDED THE RADIO NEWS LABORATORIES CERTIFICATE OF MERIT NO. 478.

MAR-CO 199 TUBE SOCKET

The Mar-co type 500 B 199 tube socket is small in size, highly finished and of durable construction. The socket is of nickel finish with a bakelite base. The contacts are tightly held against the tube prongs



with small coil springs. The socket is furnished with a felt cushion for mounting, so as to reduce the vibration of the tube elements as much as possible. Manufactured by Martin-Copeland Co., Providence, R. I.

Arrived in excellent packing. AWARDED THE RADIO NEWS LABORATORIES CERTIFICATE OF MERIT NO. 468.

DAVEN CONDENSER AND RESISTANCE UNIT MOUNTINGS

The Daven Radio Co., 11 Campbell St., Newark, N. J., submitted samples of their condenser and resistance unit mountings. The No. 50 mounting is shown in the illustration and is designed for mounting standard resistance units or grid leaks. The No. 51 mounting accommodates both condenser and resistance units. The No. 52 mounting accommodates the condenser unit only. The mountings have moulded bases supporting the spring clips and binding posts.



Arrived in excellent packing. AWARDED THE RADIO NEWS LABORATORIES CERTIFICATE OF MERIT NOS. 481, 482, 483.

GEN-WIN VARIOMETER

The illustration shows the wooden variometer as manufactured by the General Radio Winding Co., 214 Fulton St., New York City. This instrument is of the standard size and construction. The windings are supported on wooden forms equipped with large Fhanestock terminals. Connections are made to the rotor winding by means of flexible wires, thus avoiding noisy rubbing contacts.

Arrived in excellent packing. AWARDED THE RADIO NEWS LABORATORIES CERTIFICATE OF MERIT NO. 457.

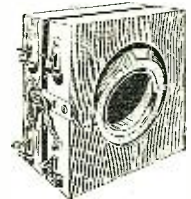

A-C BAKELITE VARIOMETER

The Type A moulded bakelite variometer is manufactured by the A-C Electrical Mfg. Co., Dayton, Ohio. This variometer is of simple construction and is arranged for both base and panel mounting. It has a 1/2-inch shaft and pig-tail connections to the rotor winding. It is designed to cover the broadcast wave-length range when used in connection with other tuning instruments.

Arrived in excellent packing. AWARDED THE RADIO NEWS LABORATORIES CERTIFICATE OF MERIT NO. 479.



MAR-CO ARMORCLAD POTENTIOMETER

The Mar-co 600-ohm Armorclad potentiometer is of rugged construction and the resistance winding is well protected by a nickel finished metal shield. The instrument is 2 1/2 inches in diameter. The resistance of the sample potentiometer submitted by the Martin-Copeland Co., Providence, R. I., is 580 ohms, which is very close to the rated value.



Arrived in excellent packing. AWARDED THE RADIO NEWS LABORATORIES CERTIFICATE OF MERIT NO. 469.



By JOHN B. BRADY*

HIGH SPEED TRANSMITTING CURRENT
(Patent No. 1,486,134, H. Gerdien. Filed Nov. 30, 1921, issued March 11, 1924. Assigned to Siemens and Halske artengesellschaft.)
MEANS FOR TRANSMITTING SIGNALS FOR WIRELESS TELEGRAPHY comprising a signal modulation circuit which includes an iron core coil device connected in the antenna circuit. High frequency energy is delivered to the antenna through a coil disposed on the iron core in inductive relation to the antenna coil. A direct current

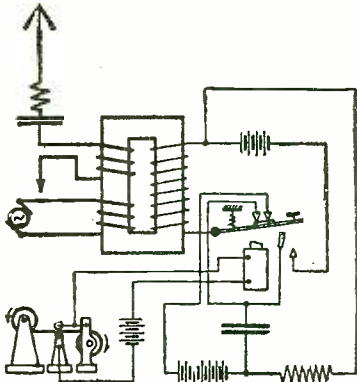

Patent No. 1,486,134.

coil is wound on the same core and supplied with low potential direct current. A separate source of direct current is also provided with a circuit arrangement for quickly raising the saturation of the core to the desired point before the low potential direct current supply is connected to the coil whereby the time constant of the system is greatly increased and signals more sharply defined.

RADIO BUOY

(Patent No. 1,485,776, J. K. M. Harrison. Filed Jan. 3, 1920, issued March 4, 1924.)
MARINE SIGNALING APPARATUS for giving a signal as a marking buoy. A galvanic battery is provided with pole elements exposed to the sea water as electrolyte. The energy derived from this battery is utilized for energizing the circuits of a radio transmitter, which may be of the buzzer excitation type.

HEADSET

(Patent No. 1,486,049, G. B. Spring. Filed Oct. 21, 1912, issued March 4, 1924.)
RADIO TELEGRAPH AND TELEPHONE INSTRUMENT consisting of a headset for a radio receiver where the receiver caps are provided with metallic ear pieces contacting with the ears of the operator with connections to the radio receiver whereby the human body may be utilized as the antenna.

RECEIVING ANTENNA

(Patent No. 1,487,308, H. H. Beverage. Filed Jan. 20, 1921, issued March 18, 1924. Assigned to General Electric Company.)
RADIO RECEIVING SYSTEM where the receiving apparatus may be at a distant point from the receiving antenna. The receiving antenna is a long horizontal unidirectional type with a transmission line for conveying signaling currents from

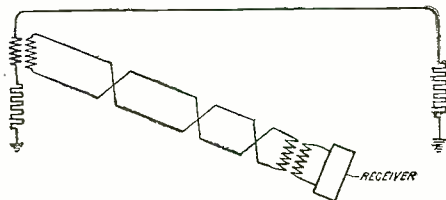

Patent No. 1,487,308.

a selected point in the antenna to a distant receiving station. A circuit arrangement is provided for eliminating in the receiving apparatus the effect of currents received upon the transmission line due to the exposure of said line to effect of ether waves.

WATER COOLED TUBE

(Patent No. 1,487,353, H. J. Nolte. Filed Sept. 8, 1921, issued March 18, 1924. Assigned to General Electric Company.)
ELECTRON DISCHARGE APPARATUS wherein a water cooling system is provided for maintaining the anode at a fairly low temperature. The anode projects into a cooling tank through which cooling fluid is continuously circulated through a long spiral heat radiating coil.

ELECTRON TUBE CIRCUIT

(Patent No. 1,487,451, J. F. Farrington. Filed Oct. 16, 1922, issued March 18, 1924. Assigned to Western Electric Company, Inc.)
CIRCUITS FOR ELECTRIC DISCHARGE DEVICES wherein the cathodes are heated by alternating current. According to the present invention, the disturbances which arise in the output circuit of an electron discharge in consequence of the alternating current used for heating its cathode may be neutralized by opposing thereto like disturbances produced in the output circuit of a similar discharge device.

FIXED CONDENSER

(Patent No. 1,487,617, D. C. Stoppenbach. Filed Aug. 17, 1920, issued March 18, 1924. Assigned to General Electric Company, Inc.)
ELECTRICAL APPARATUS or condenser built up of alternate sheets of conducting and insulating material. Resilient plates of metal are provided on each end of the stack, which plates are tightly clamped together uniformly, pressing the condenser elements together throughout their area.

DUPLEX RADIO SYSTEM

(Patent No. 1,488,006, R. A. Heising. Filed Sept. 29, 1919, issued March 25, 1924. Assigned to Western Electric Company, Inc.)
RADIO TRANSMISSION SYSTEM in which two-way communication may be attained at each station over a single antenna. A circuit is provided for presenting the production of sidetone in the receiver at the radio station by energy from the local transmitter. According to this invention, a normally operative receiving set and a

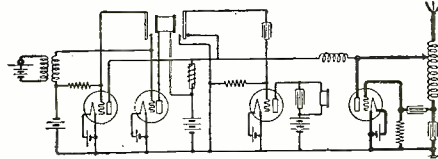

Patent No. 1,488,006.

normally inoperative transmitting set are connected to the same antenna. Voice or sound operated relays serve, when energized, to render the receiving set inoperative and to render the transmitting set operative. A feature of this invention consists in the provision of a normally oscillating oscillator which serves both for production of oscillations for the transmitter and as a detector. This considerably simplifies the necessary apparatus and makes the control of the system quick acting.

CRYSTAL DETECTOR

(Patent No. 1,485,524, H. H. Pickron. Filed March 8, 1923, issued March 4, 1924. Assigned one-half to W. E. Copp of Rock Island, Ill.)
CRYSTAL DETECTOR FOR RADIO INSTRUMENTS enclosed in a casing with the mineral supported at one end and a helical telescopic spring member located in the other end and adapted for engagement with the mineral.

RADIO CALL SYSTEM

(Patent No. 1,485,773, L. Espenchied. Filed Sept. 12, 1921, issued March 4, 1924. Assigned to American Telephone and Telegraph Company.)
RADIO CALLING OR SIGNALING from a radio transmitter to remote receiving stations. In brief, the invention consists in using what may be termed the "carrier-off" method, that is, the transmitting station transmits a carrier wave continuously on which a message may from time to time be impressed. When it is desired to call a station, the transmission is suppressed and, as a result, certain operations take place at the receiving station giving some audible or visible signal suitable for calling the attention of the attendant.

CIRCUIT FOR REDUCING INTERFERENCE AT RECEIVERS

(Patent No. 1,485,485, H. G. Cordes. Filed Sept. 29, 1919, issued March 4, 1924.)
RADIO SIGNALING SYSTEM where a circuit arrangement is provided at the receiving station for reducing the effect of undesirable signals of comparatively short duration and great intensity such as are produced by static disturbances from affecting the receiving circuit. This object is attained by placing a signal sifter in series with the receiving antenna circuit so that signals tend-

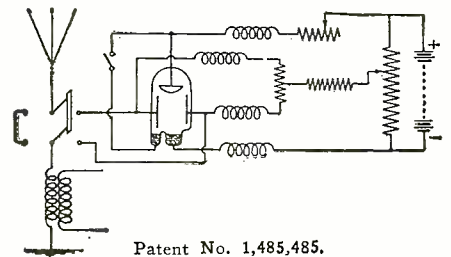

Patent No. 1,485,485.

ing to produce current exceeding a predetermined amplitude cannot pass through the sifter, or are made to pass through the sifter with increased difficulty as the intensity of the undesirable signal increases. The presence of the sifter in the antenna circuit introduces only a small additional resistance into the circuit for currents of comparatively small amplitude which are produced by the desirable signals.

NEW VALVE

(Patent No. 1,486,237, J. A. Fleming. Filed Nov. 6, 1919, issued March 11, 1924. Assigned to the Radio Corporation of America.)
THERMIONIC DEVICE which consists of a vacuum bulb, a filament, a pair of collecting plates and a pair of potential plates, the four plates being arranged substantially symmetrical to and closely surrounding the filament. When a filament is rendered incandescent, negative electricity escapes from the filament and passes across the vacuum space into the plate C, and then returns by the external circuit passing through the instrument F to the positive terminal of the filament. If now the plates D, which are called potential plates, are connected to some source of high or low frequency alternating or even direct potential, this variation of potential will cause a sudden and marked diminution in the thermionic current, which can be observed in an instrument or can be utilized to actuate a relay.

TUBE CONSTRUCTION

(Patent No. 1,486,221, E. Berry. Filed March 5, 1921, issued March 11, 1924. Assigned to Radio Corporation of America.)
MEANS FOR CONTROLLING THE FLOW OF ELECTRONS IN ELECTRON DISCHARGE DEVICES comprising a tube having a cathode, a pair of anodes and two plate electrodes located either within or without the vessel and arranged one on each side of the path between the cathode and the anodes so as to apply

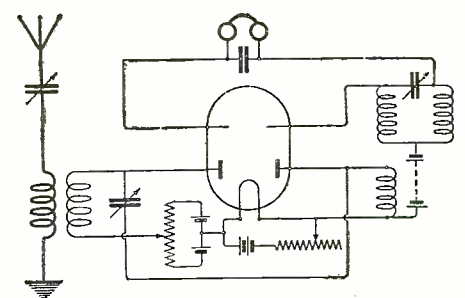

Patent No. 1,486,221.

a potential to the path of the electrons, which are thereby caused to fall in the two anodes alternately. The receiving circuit is connected to the electrodes, and the detector is connected between the anodes.

(Continued on page 275)

*Patent Lawyer, O'ray Building, Washington, D. C.

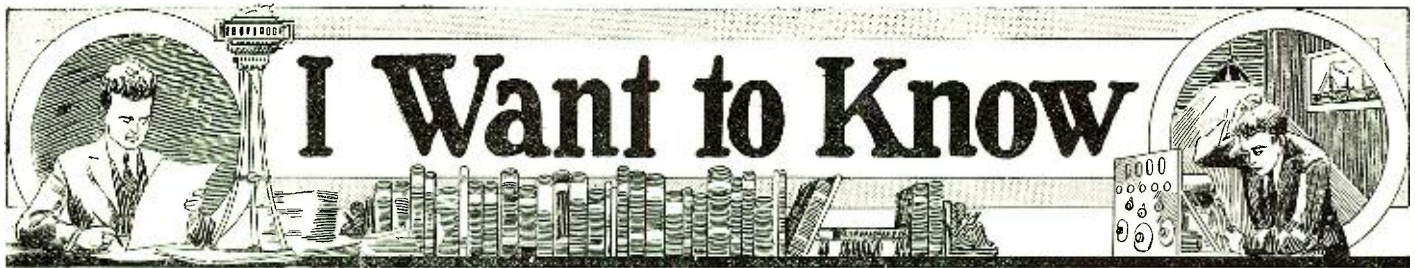

THIS Department is conducted for the benefit of our Radio Experimenter. We shall be glad to answer here questions for the benefit of all, but we can publish only such matter as is of sufficient interest to all.

1. This Department cannot answer more than three questions for each correspondent.
2. Only one side of the sheet should be written upon; all matter should be typewritten or else written in ink. No attention paid to penciled matter.
3. Sketches, diagrams, etc., must be on separate sheets. This Department does not answer questions by mail free of charge.
4. Our Editors will be glad to answer any letter, at the rate of 25c for each question. If, however, questions entail considerable research work, intricate calculations, patent research, etc., a special charge will be made. Before we answer such questions, correspondents will be informed as to the price charge. You will do the Editor a personal favor if you will make your letter as brief as possible.

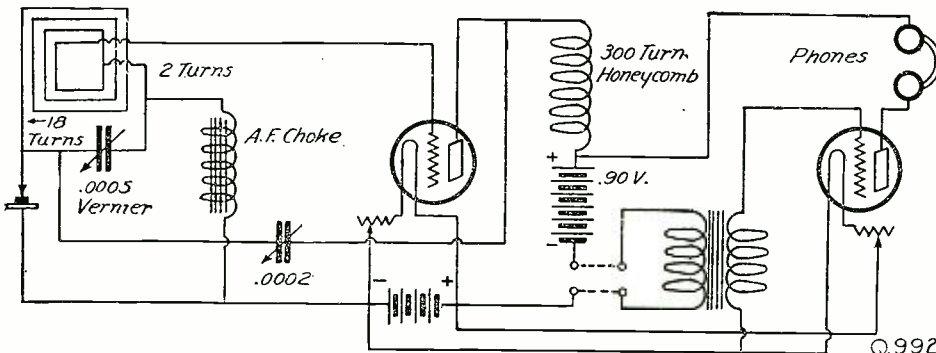

This British reflex circuit is worthy of trial. It is the simplest circuit of this type yet developed.

CONDENSER SYMBOL

(934) Mr. Garrett S. Parson, Rommy, W. Va., asks:

- Q. 1. Does the head of a variable condenser arrow, as used in radio diagrams, denote the rotor or stator plates?
A. 1. Heretofore no significance has been attached to the arrowhead position. Starting with this issue of RADIO NEWS, all circuits in the "I-Want-To-Know" department will show the rotor plates on the same side as the arrowhead.
- Q. 2. Does it make any difference if variable condenser connections are reversed?
A. 2. Connection of the rotor plates to the side of lowest potential greatly reduces "hand-capacity" effect.
- Q. 3. Please show the Colpitts transmitting circuit, using one tube.
A. 3. This circuit appeared in answer to question No. 708 in the "I-Want-To-Know" column of the May, 1923, issue of this magazine.

SHARPENING SUPER-HETERODYNE TUNING

(985) Mr. Thomas Eddy, Sheffield, Mass., wants to know:

- Q. 1. Can the tuning of my Ultradyne be sharpened?
A. 1. We are illustrating a method of greatly sharpening the tuning of sets of the Super-Heterodyne class. The sharpening of the tuning is obtained by the addition of a "C" battery of 4½ to 16 volts in the detector circuit. In using this system the grid leak and condenser must be removed from the circuit.
- Q. 2. Are condensers required across the secondaries of the intermediate frequency transformers, to increase selectivity?
A. 2. Condensers may be used for this purpose, but they must be very accurately balanced to the transformers. The diagram illustrates a simpler method for securing increased selectivity.
- Q. 3. Do resistance coupled amplifiers have as great a tendency towards self-oscillation as transformer-coupled or tuned-impedance coupled radio frequency amplifiers?
A. 3. Self-oscillation is not as easy to secure in resistance-coupled amplifiers, as in those of other types, hence the use of a "compensating condenser," developed by the French Army for controlling oscillations, to permit of either phone or C. W. reception.

AUTOPLEX VARIOMETERS

(986) Mr. Arlan Sholes, Palo Alto, Calif., writes:

- Q. 1. Can variometers having honeycomb windings be used successfully in the Autoplex receiver?
A. 1. If these variometers will tune to a wavelength of 600 meters they will probably work in the Autoplex.
- Q. 2. Should the grid return of the Autoplex be to the positive or negative lead?
A. 2. Most tubes will work best with a negative connection. Try both.

COMPENSATING CONDENSER

(987) Mr. D. W. Nearing, New Britain, Conn., requests:

Q. 1. Please publish the diagram of the radio set used by the McMillan Arctic Expedition.

A. 1. This diagram appeared in answer to question No. 961 of the July, 1924, issue of RADIO NEWS.

Q. 2. Where are the headquarters of the American Radio Relay League?

A. 2. The A. R. R. L. headquarters are at Hartford, Conn.

Q. 3. How is a compensating condenser connected in a radio frequency amplifier?

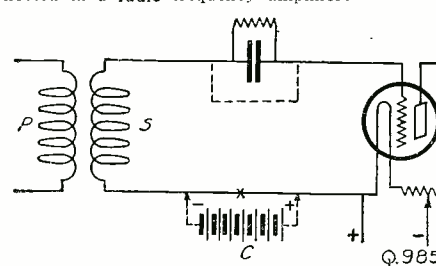

Replacing grid leak and condenser with a "C" battery often increases Super-Heterodyne selectivity.

A. 3. The moving plate connects to the grid of the first tube. One fixed plate connects to the plate of the second tube and the other fixed plate connects to the plate of the third tube. This is the connection when three stages of radio frequency amplification are employed. By this means a positive or negative current may be induced to the grid of the first tube, thus controlling regeneration and oscillation without the need for a potentiometer.

COCKADAY COIL DATA

(988) Mr. John Earls, Jersey City, N. J., asks:

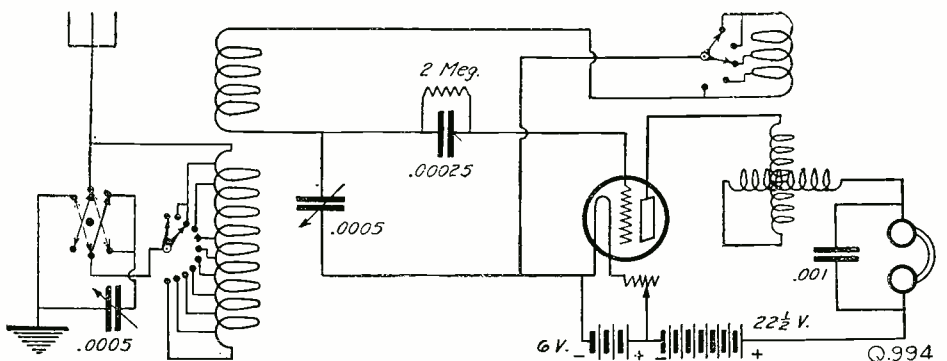

This Kennedy Type-220 regenerative receiver diagram illustrates another variation in three-circuit tuners.

Q. 1. Will a loop function if fastened to the radiator cap of an automobile?

A. 1. Yes, very well.

Q. 2. Please give data of the Cockaday coil unit.

A. 2. The Cockaday coil combines four windings. One is an absorption circuit consisting of an inductance across which a 17-plate condenser is connected (.00025 mfd.). The grid tuning coil also has a condenser connected across it of the same size. There is also an aerial loading coil and an aerial coupling coil. The absorption coil consists of 34 turns of No. 18 D.C.C. wire wound on a 3½-inch tube. The grid coil consists of 65 turns of the same size wire, on the same tube. The aerial loading coil consists of 43 turns of No. 18 D.C.C. wire, double bank wound on a 3½-inch tube and tapped at the 7th, 13th, 21st, 31st and 43rd turns. This coil must be placed in non-inductive relation to all the other inductances. The aerial coupling coil consists of one turn of No. 14 wire, wound on the same tube as the grid and absorption coils.

Q. 3. Please publish a diagram for a 10-watt C.W. and phone transmitter.

A. 3. This diagram appeared in answer to question No. 708 in the "I-Want-To-Know" columns of the July, 1923, issue of RADIO NEWS.

CHOKE COIL

(989) Mr. Clyde C. Smith, Anita, Iowa, requests:

Q. 1. What is the design for a 30-henry choke coil to be used with a power amplifier?

A. 1. Illustrated constructional data covering such a coil was given in the June, 1923, issue of RADIO NEWS, in the "I-Want-To-Know" columns.

Q. 2. What circuit is used in the Supertone long range receiver?

A. 2. The circuit used in the Supertone set is that of the standard three circuit tuner, with two stages of audio frequency amplification. Tickler feed back, tuned grid and untuned aerial circuit are used.

Q. 3. Is a 5,000-mile range guarantee of broadcast reception legitimate?

A. 3. Such a range cannot be guaranteed with any type of set, due to the uncertain atmospheric conditions that control the distance over which reception is possible.

RADIOLA GRAND

(990) Mr. C. W. Scriver, Palmyra, Pa., writes:

Q. 1. How bright should a Sodiion tube filament be kept for best operation?

A. 1. Bright yellow is about the right brilliancy for the Sodiion tube. Signal strength and filament life are greatly reduced when the filament is operated at too high a temperature.

Q. 2. Please publish a diagram of connections used in the Radiola Grand.

A. 2. The circuit you request appeared in the August, 1923, issue of RADIO NEWS, in answer to question No. 731, in the "I-Want-To-Know" section.

PREVENTING CAPILLARY ACTION

(991) Mr. C. C. Tucker, Howe, Nebr., wants to know:

- Q. 1. What do the initials I. C. W. mean?
- A. 1. Interrupted Continuous Waves.
- Q. 2. What is the transmitting range of a 10-watt phone set?
- A. 2. Ranges of sets cannot be given with any degree of accuracy.
- Q. 3. How can the creepage of storage battery electrolyte, due to capillary action, be prevented?
- A. 3. Vaseline applied to the top of the battery will prevent it.

ENGLISH REFLEX CIRCUIT

(992) Mr. C. Hail, Somerset, Ky., asks:

Q. 1. Can a reflex set be constructed without using the regular audio frequency and radio frequency transformers?

A. 1. We are showing in these columns, a reflex set of the type you desire. One stage of straight audio frequency amplification has been added to it. This stage of audio frequency amplification is transformer-coupled in order to get a high voltage step-up resulting in increased signal strength. The reflexed tube utilizes choke coil audio frequency amplification. Need for a radio frequency transformer has been eliminated by the use of the loop. The .00025-mfd. condenser is for regeneration control. The choke coil may be an audio frequency transformer secondary. The loop is wound on a 16-inch square frame.

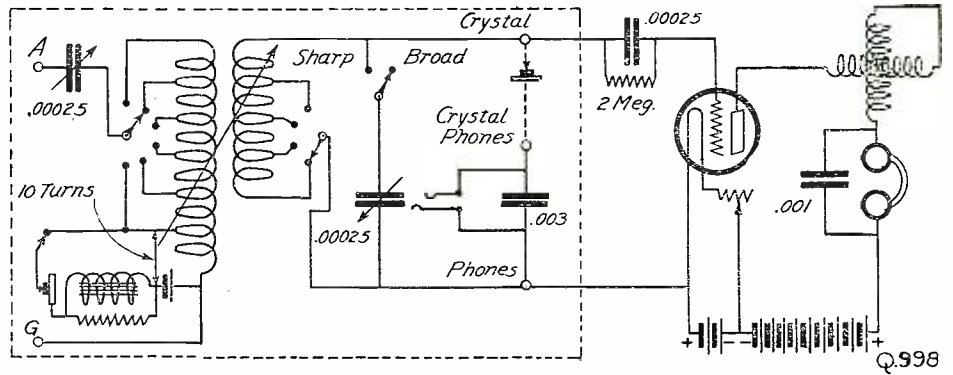

A Signal Corps crystal set may be changed into an efficient tube unit, as shown here.

torily, so far as we know, is by the use of the "Tropadyne" principle developed by Clyde J. Fitch and described in this issue.

HOME MADE VARIOMETERS

(996) A. Edgar Cudmore, Hensale, Ontario, wants to know:

Q. 1. What type of receiver is the Autoplex?

A. 1. The Autoplex circuit is in the Super-Regenerative class.

Q. 2. Would home-made variometers be efficient enough for this circuit?

A. 2. When a cadmium stick is inserted in a storage battery cell, it forms a small battery, when in relation to either the positive or negative plates. The voltage of this small battery determines the condition of the positive or negative plates, depending on which plates are being tested.

Q. 3. What is the advantage of a cadmium test?

A. 3. It enables an easy check-up to be made upon the relative states of charge of the individual groups of plates, or even in the individual plates of a cell, thus quickly indicating an undercharged plate.

Q. 2. Can a loop be used with a one tube reflex set?

A. 2. Only for stations a short distance away. The two tube circuit we show here is more practical.

Q. 3. Should an aerial on a closed automobile be inside of the car?

A. 3. Much better results will be had by putting the aerial outside. The car body will shield the signals from the set to too great an extent otherwise.

RADIATE OR RE-RADIATE?

(993) Mr. P. P. Pellen, New York, N. Y., requests:

Q. 1. What is the meaning of "re-radiate?"

A. 1. This term is often incorrectly used in reference to radiation of energy from a receiving set. Radio frequency current, picked up by bridges, girders, and other large metallic objects may often be re-radiated.

Q. 2. Please show the Cockaday circuit using two stages of audio frequency amplification.

A. 2. This diagram appeared in answer to question No. 770, in the October, 1923, issue of RADIO NEWS.

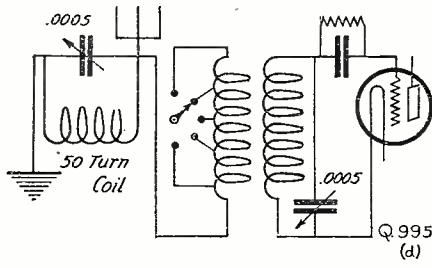
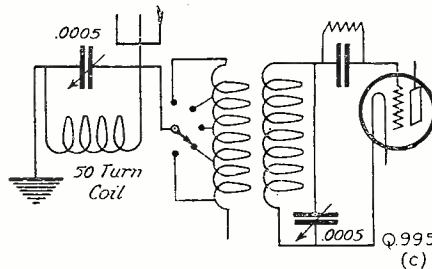

A simple method of sharpening tuning. Both connections shown in "C" and "D" should be tried.

KENNEDY TYPE-220 RECEIVER

(994) Mr. Luther A. John, Jr., Washington, D. C., writes:

Q. 1. Please show the wiring diagram of the Kennedy Type-220 receiving set.

A. 1. The diagram you request is shown in these columns.

Q. 2. What is the wave-length range of this receiver?

A. 2. 185 to 3,350 meters.

Q. 3. Please give the circuit for the Grebe CR-12 set.

A. 3. This diagram appeared in answer to question No. 788, this department, in the November, 1923, issue of RADIO NEWS.

SHARPENING THE THREE-CIRCUIT TUNER

(995) Mr. William E. DeVault, Lanham, Md., writes:

Q. 1. Can the tuning of my three-circuit tuner be sharpened without changing any of its connections?

A. 1. We are showing a system that has given very good results. It is important that the additional coil used be in non-inductive relation to the set. The two connections shown should be tried to determine the best one. Either a variometer or a coil-and-condenser may be used to vary the wave-length.

Q. 2. Can the oscillator and first detector of a Super-Heterodyne be combined, as in the "Second Harmonic" set, without using the second harmonic principle?

A. 2. The only way this can be done satisfac-

A. 2. It is doubtful if home constructed variometers would be sufficiently accurate for this circuit. High maximum and low minimum inductance are difficult to obtain without the use of precision instruments.

CADMIUM TEST

(997) Mr. E. H. Usher, East Donningtown, Pa., asks:

Q. 1. What is cadmium?

A. 1. Cadmium is an element which, in the electro-chemical series, is between lead-peroxide and sponge lead.

Q. 2. How is it used in connection with storage batteries?

STORAGE BATTERY SEPARATORS

(999) Mr. Howard Tamplin, Dayton, Ohio, asks:

Q. 1. What woods are used as storage battery separators?

A. 1. The woods used, in the order of their life under storage battery use, are: Basswood, poplar, Douglass fir, California redwood, white cedar and cypress.

Q. 2. How are separators sawed?

A. 2. Separators of quarter-sawed wood are the best.

Q. 3. How can radio frequency amplification be added to the Reinartz circuit?

A. 3. An efficient method of adding radio frequency amplification to the Reinartz circuit, retaining the regenerative feature, was shown in answer to question No. 878, in the April, 1924, issue of RADIO NEWS.

STORAGE BATTERY QUERY

(1000) Mr. John Smith, N. Plainfield, N. J., writes:

Q. 1. What is the voltage, when a storage battery begins emitting gas while on charge?

A. 1. Approximately 2.35 volts per cell.

Q. 2. What is the specific gravity at this point of the charge?

A. 2. Approximately 1.325.

Q. 3. How can an efficient wave trap be constructed?

A. 3. See answer to question No. 892, in the April, 1924, issue of this magazine. The secondary has 50 turns of wire on a 4-inch tube.

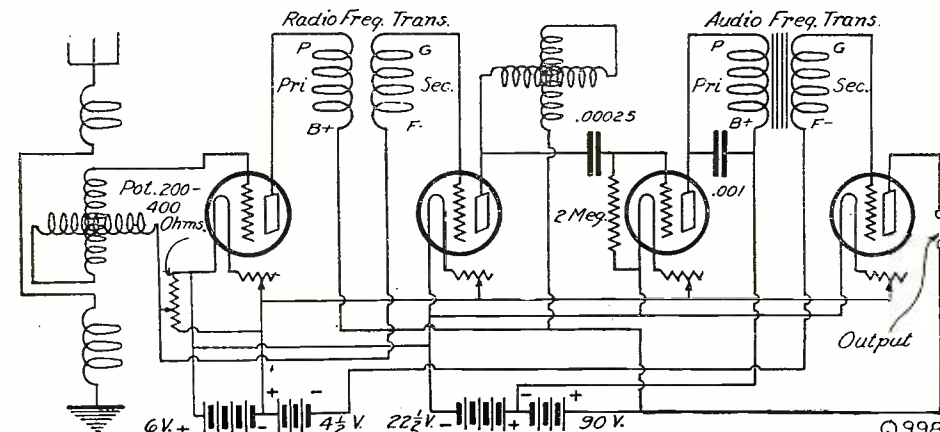

Good selectivity and long range are embodied in this circuit.

RADIO OR AUDIO FREQUENCY?

(1001) Mr. S. L. Rees, Toronto, Ont., requests:

Q. 1. I desire to put up an aerial, but can only have a length of 400 feet, also it cannot be higher than 25 feet. How many wires should be used, how should they be separated?

A. 1. Two wires separated six feet will be satisfactory. The two wires are connected at the end opposite the lead-in.

Q. 2. Should radio or audio frequency amplification be used to increase the audibility of a very faint station, when headphones are used?

A. 2. Radio frequency amplification will be best.

Q. 3. In adding to a one tube set, is audio or radio frequency amplification to be preferred?

A. 3. If additional range is desired, radio frequency amplification will be best. Audio frequency amplification will increase the audibility of stations usually received.



They're as comfortable— as your hat!

DINNER is over. You want to relax. You sit down at your radio—to see what's on the air. You have a great many programs to select from—local and distant. You choose the one that suits your mood. The enjoyment you get depends upon the headphones you use. If they are inferior—the results will be unsatisfactory.

Murdock Radio Phones are famous for clear reproduction—and comfort. They are equipped with powerful magnets and sensitive diaphragms—correctly seated and clamped. This permits you

to receive distant broadcastings—with great volume and clearness.

The headband is of new design. It is flat and feather-weight—and does not bind the head. The ear caps are moulded to fit the ears and exclude outside noises. Result—you can wear Murdocks for a whole evening without being conscious that you have them on.

Murdocks sell at a moderate price. They will bring out the latent possibilities of your receiving set. Get a pair from your dealer today. They are fully guaranteed.



Built, not assembled

Murdocks are made in a single unit, of superior moulded insulation. Each part is fitted by one process into its proper place. They are moulded together—assuring firmness, strength and durability. And they can't get out of adjustment.

WM. J. MURDOCK CO.

365 Washington Ave.,

Chelsea, Mass.

Branch Offices: New York, Chicago and San Francisco

MAIL COUPON FOR FREE BOOKLET

WM. J. MURDOCK CO.
365 Washington Ave., Chelsea, Mass.

Gentlemen: Please send me, without obligation your free booklet, "The Ears of Radio," which explains the importance of radio 'phones to efficient radio reception.

Name

Street

City..... State.....

MURDOCK RADIO PHONES

Standard since 1904



FROST-RADIO
No. 618 SHOCK ABSORBER
 Standard Base Single Socket
 Sponge rubber cushion absorbs jars and jolts—prevents tube noises. Base and socket are moulded polished BAKELITE. For Standard basetubes. Nickel plated brass binding posts. Panel or table mounting. A tremendous value, \$1.00

Sockets and adapters bearing the name **FROST-RADIO** are made from genuine moulded BAKELITE. They are scientifically designed and finely finished.

FROST RADIO



No. 617 SHOCK ABSORBER SOCKET.

Construction same as our No. 618, except that this type is for C-299, UV-199 Tubes. Panel or table mounting. Moulded BAKELITE. List, \$1.00



No. 616 3-GANG SHOCK ABSORBER UNIT.

Made up of 3 No. 617 Sockets mounted on moulded BAKELITE base suitable for panel or table mounting. Sponge rubber cushions; flexible lead wires; nickel silver contact springs. List, \$2.75



No. 619 3-GANG SHOCK ABSORBER UNIT.

Construction is identical with our No. 616 Gang except for sockets, which are for Standard Base Tubes. We guarantee this socket to be non-microphonic. It offers freedom from noises, is compact and low priced. List, \$2.75

Catalog Free!

A post card from you will bring this 40-page catalog of Frost-Radio Products. Address Dept. 10F501

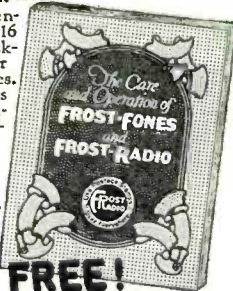

HERBERT H. FROST, Inc.
 154 W. Lake Street, CHICAGO
 NEW YORK CITY CLEVELAND
 KAN SAS CITY LOS ANGELES

Saving Tubes with Reflex Circuits

(Continued from page 182)

vided, L_1 and L_2 . The coil L_1 is coupled to L_1 in such a manner as to introduce regeneration into the aerial circuit, while the coil L_2 is coupled to the inductance L_3 of the circuit $L_3 C_2$; this circuit incidentally will be found considerably selective.

TWO-TUBE CIRCUIT

A useful two-tube reflex circuit which can be thoroughly recommended is that illustrated in Fig. 7. In this circuit a series aerial condenser is employed and the coupling between the plate circuit of the first tube and the grid circuit of the second tube is by means of a transformer, the two windings L_2 and L_3 being variably coupled. The second tube acts as a detector, and the rectified audio frequency currents are communicated to the grid of the first tube through the transformer $T_1 T_2$, the secondary of which is in the grid circuit. In the plate of the first tube we also have the head-phones T shunted by a fixed condenser of .002 mfd. capacity. If it is desired to introduce regeneration, a portion of the plate inductance may be coupled to the aerial inductance.

The Radio Fan's Rights

(Continued from page 154)

The aims of the association will include: Co-operation with existing bodies to rid the air of unnecessary and avoidable interference; to enforce all quiet hours; to investigate complaints made by radio fans; to protect fans against adverse legislation; to work toward the advancement of radio. The publication of a loose-leaf log book is also proposed.

The association aims to co-operate with broadcast stations and work toward the perfection of programs, and also to furnish advice in constructing apparatus and preventing fire hazards.

Esperanto Radio World Language

(Continued from page 169)

Western World.

From the first appearance of Esperanto there were certain types of critical minds that wanted to make changes in it. They didn't like the supersigned letters, or they thought certain sounds which add to the strength and comprehensibility of the language should be eliminated. The wise men in control of the language, the Language Committee and the Esperanto Academy, refused to inculcate every will-o'-the-wisp proposal. The proponents of changes at last gave up the fight to mutilate the language and withdrew to form their own plagiarism of Esperanto. In 1907 some of them sat in conference in Paris for a while and brought forth "Ido," so-called from the Esperanto suffix "-id," which means an offspring or child, "Ido" being the offspring of Esperanto. The Idists did away with the supersigned letters, which are a great economy in Esperanto; they didn't like the most important prefix in the language, "mal-" which reverses the meaning of any root that has a direct opposite, as darkness is the opposite of light, bad of good, etc. Doing away



Log Every Worth While Station with Perfect Ease

Be able to get the programs you like best any time and with that smoothness and clearness of tone that makes Radio most enjoyable. It's easy with

Stromberg-Carlson

HEAD SETS and LOUD SPEAKERS

Their powerful magnets give extreme sensitivity. The layer wound and layer insulated coils enable these instruments to stand up under the highest voltages and to retain their sensitivity permanently.

Ask your dealer

Stromberg-Carlson Tel. Mfg. Co., Rochester, N.Y.



The Van-Le Reproducer

Electric Lamp Type

An entirely new and radical departure in the amplification of sound waves.

Big improvement over Horn Type of Loud Speaker. All throaty tones eliminated.

Sound waves carry equally to every part of room. Made in three types: Electric Lamp (as illustrated) Fruit Bowl, and Cabinet.

Ask your Dealer or Write us.

Dealers Write For Special Proposition

VAN-LE CORPORATION

100 Sip Avenue Jersey City, New Jersey

5000 RADIO DEALERS buy from **HUDSON-ROSS** 123 W. Madison St. Chicago Send for dealers discount.

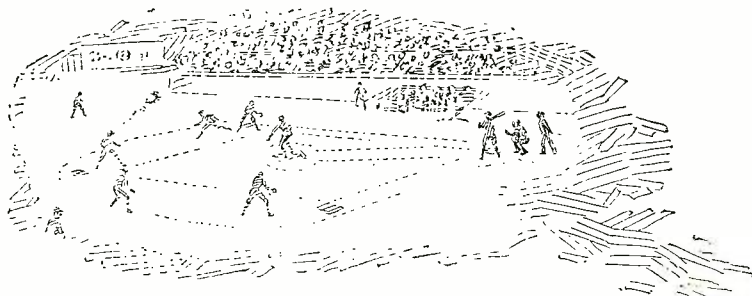

Enjoy Your Radio This Summer

Music Master with its rich, clear tone—unmarred by muffling, blast or distortion—will make radio a pleasure, such as you have never known before.

Summer opens a new world to good radio sets equipped with Music Master. Picnics, camping trips, boating parties, open-air dances—these are only a few of the occasions which Music Master can enliven for you.

No other reproducer is so well fitted for summer conditions. The extremely sensitive precision instrument in the base, the scientifically tapered tone chamber, and the now famous wood horn, the natural and perfect resonator—make up an instrument of balanced proportions and unequalled effectiveness.

Your radio dealer is waiting to demonstrate Music Master for you or to send one for trial with your own set.

Dealers Everywhere

Music Master Corporation

Makers and Distributors of High-Grade Radio Apparatus

10th and Cherry Streets
Chicago PHILADELPHIA Pittsburgh

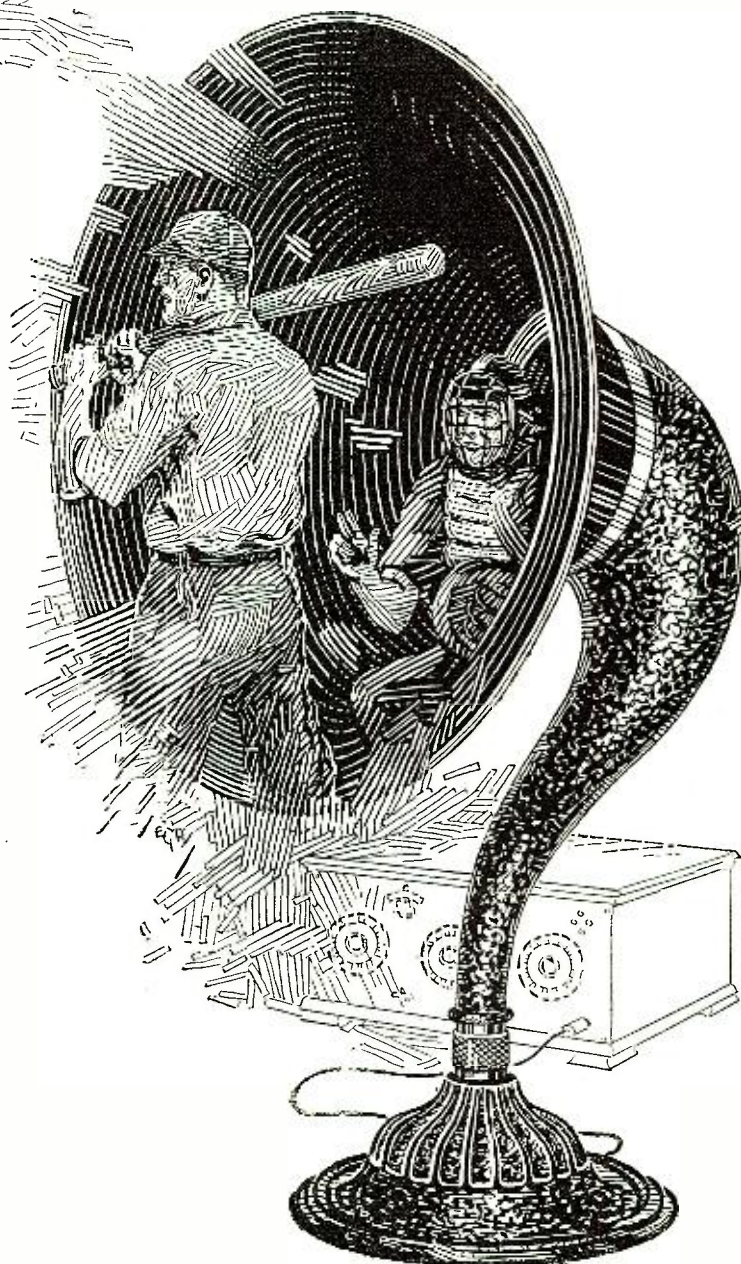

14-inch Model, for
the Home **\$30**

21-inch Model, for Concerts
and Dancing **\$35**

Connect MUSIC MASTER in
place of headphones. No batteries
required. No adjustments.

Music Master

RADIO REPRODUCER

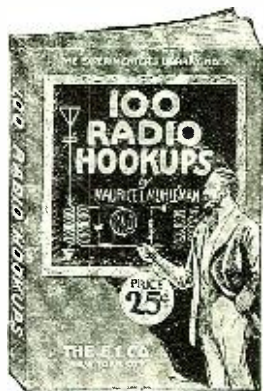

2nd Edition of the Most Complete Hookup Book Published

**100 Wiring
Diagrams with
Complete In-
structions On the
Following:**

- Crystal Receivers
- Regenerative Receivers
- Neutrodyne Receivers
- Radio Frequency Receivers
- Audio Frequency Receivers
- Super Heterodyne Receivers
- Amplifiers
- Reflex Circuits, etc.

Book has 48 pages, size 5 x 7 inches. Two color printed cover.

At Your Dealer or
Direct from Us.

25c A Copy
Postage
Paid

The E. I. Company
Conrad Co., Selling Agents
233 Fulton St., New York City

with this, they made it necessary to burden the memory with 60 or 75 per cent. more arbitrary word forms than are necessary in Esperanto. In their supersensitive desire to acquire greater cuphony of sound, they eliminated some of the most important sounds and grammatical rules that give greater strength and regularity to Esperanto, weakening their "Ido" and adding a few exceptions in grammatical rules that further confuse the student. Desirous of making a big showing to the superficial investigator, they set about building a large vocabulary in a hurried manner, appropriating thousands of arbitrary words for certain expressions that in Esperanto are formed by the more resilient root forms and affixes system. Boasting of having a vocabulary of 20,000 words as against the Esperanto 4,300 is an appeal that gains the allegiance of a superficial investigator. Those who go more deeply learn that in Esperanto an infinitely greater variety of finer nuances of meaning can be constructed instantly by the Esperantist than can be expressed in any other language extant.

Some other would-be changers of Esperanto have more recently brought out a less radical corruption of the original, called Esperantido, also signifying an offspring. It has some good points which, most likely, will eventually find gradual adoption into Esperanto in order not to interrupt the even growth and uniformity of the latter.

Now, what of the relative strength in support have these languages, or, more properly, Esperanto and its two most noticeable "dialects"?

I, after some years of investigation and study, being an adherent of Esperanto, might make the bald statement that Esperanto is the most widespread, and not be very convincing. I can give some comparative figures which speak for themselves. Esperanto has an extensive literature, in original works and translations, including very beautiful, fine poetic works, mounting up to several thousand volumes; Ido has a small list of portions of such works as the Bible and Shakespeare, and a few others, mainly in pamphlet form. Esperanto has about 100 publications, composed of one weekly paper, many monthlies and bi-monthlies, 25 at least of which are well supported, some of high literary quality. Ido has three publications, only one of which receives the major portion of its sustenance from its readers, the other two being of uncertain and sickly existence. An Idist stated in an article in the May issue of RADIO NEWS that Ido had no ambition as a language of literature and poetry, but recognized its limitations as purely a "shop language," or words to that effect. Esperanto is capable of development into the highest, most perfect literary medium in the ken of men. It is capable of finer shades of expression than any other existing language.

Esperantido, having most of its support from Esperantists who remain faithful to the authority of the Esperanto Academy, can hardly be considered as a distinctly different language.

Briefly, what is the attitude of the world organizations of radio fans?

During the past winter the heads of the A. R. R. L., having been attracted by the propaganda of Idists, were inclined favorably to that "dialect" of Esperanto. Mr. Warner had a circular letter sent out to all the radio associations in other countries, asking their opinion as to which, if any, existing language they preferred as a possible radio language for international use, stating that A. R. R. L. leaders somewhat preferred Ido. By the first of March about 15 associations, including practically all those of Europe, had replied. Without exception up to that time, their responses declared not only for Esperanto, but in most cases declared further that under no circumstances, even if the A. R. R. L. should urge Ido, would they accept the latter. As a result, the A. R. R. L. has definitely aban-

YOU CAN LEARN NEWSPAPER WORK

**Experienced Editor Will Teach You
How to Become a
Reporter**

FACINATING WORK--GOOD PAY

**Only a Few Months' Work Required
To Qualify You for a
Better Position**

Regular reporters earn from \$40 to \$125 a week. Good deskmen on a daily paper are paid from \$60 to \$100 a week. A "Star" Reporter can command his own salary. Hundreds of ambitious men and women enhance their income materially by corresponding for newspapers or writing for magazines in their spare time.

We Will Teach You at Home

We can develop your talent for writing and lead you into this well paying profession. Our Practical Course in Journalism was personally prepared by Henry J. Brockmeyer, Assistant City Editor of the New York Evening Post. Mr. Brockmeyer has trained hundreds of men and women, many of whom have, under his guidance, developed into front rank reporters or feature writers.

Mr. Brockmeyer's course will teach you what it would take years of actual newspaper work to learn. It consists of six comprehensive lessons just brimful of everything a reporter must learn. The following are only a few of the subjects covered.

Starting in Journalism. What is a Newspaper? What is News? Start and Finish of a News Story. Technical Terms. The Type Point System. Styles of Type, Proof Reading. Capitalization and Punctuation. A Late Fire Bulletin. Court Stories. Libel Laws, Copyright. Hints to Reporters. Personal Conduct. Re-Writing and Condensing Stories. Paragraphs and Short Items. Good and Bad Styles. Broadening the Vocabulary. Aids to Good Style. Special Stories. Suggestions for Stories. Rhetoric. Preparing Your Story. Don'ts for Writers. Office Organization. Syndicated Matter. Business Office. Mechanical Department. Hints for Headline Writers. The Make-Up. The Country Correspondent, etc., etc.

Use Coupon—Save 50%

Although the price for the entire course is \$10, entitling the student to full consulting services directed by Mr. Brockmeyer personally, we will accept enrollments, if the coupon below is used before Sept. 20, at \$5—exactly half price.

Five Days' Trial

Just pin a check, money order or five dollar bill to the coupon below and mail. Then take five days after the course arrives to decide whether you want to keep it. If not, return it at our expense and your money will be immediately refunded.

THE PRESS GUILD, Inc., 66-R West Broadway, N. Y.

THE PRESS GUILD, Inc. (Expires Sept. 28, 1924)
66-R West Broadway, New York City.

Enclosed find \$5 for which you are to ship me at once, prepaid, Henry J. Brockmeyer's complete course in Practical Journalism with the distinct understanding that if I return the course in five days my full \$5 will be refunded and no questions asked.

(Name)

(Address)

(City) (State)



“THE AIR
IS FULL OF THINGS
YOU
SHOULDN'T MISS”



Sustained power!

WHERE table or cabinet space is limited, use this *new* vertical 45-volt Eveready “B” Battery No. 772. It has the same long life, the same steady high power as the horizontal Eveready 45-volt “B” Battery, but because it stands upright it takes less than half the table space.

Tables and most battery cabinets have more headroom than floor space. This battery is built in recognition of that fact. It fits the Radiola Super-Heterodyne cabinet perfectly.

Many multi-tube receiving sets use a “hard” detector tube which does not require fine adjustment of “B” voltage, so the new Eveready Vertical 45-volt “B” has but three plainly marked terminals, negative, plus 22½ and plus 45 volts.

Standing upright to save space, made of large, powerful cells to last longer, here is the battery you've been looking for.

Manufactured and guaranteed by

NATIONAL CARBON COMPANY, Inc., New York—San Francisco

Headquarters for Radio Battery Information

Canadian National Carbon Co., Limited, Toronto, Ontario

If you have any battery problem, write G. C. Furness, Manager, Radio Division, National Carbon Co., Inc., 122 Thompson Ave., Long Island City, N. Y.

EVEREADY Radio Batteries

—they last longer.

Eveready “B” Battery No. 772 for detector and amplifier. Connections at 22½ and 45 volts. Three Fahnestock Clips. Approximate over-all dimensions, 8¼ in. x 3¼ in. x 7¾ in.

Eveready 6-volt Storage “A” Battery

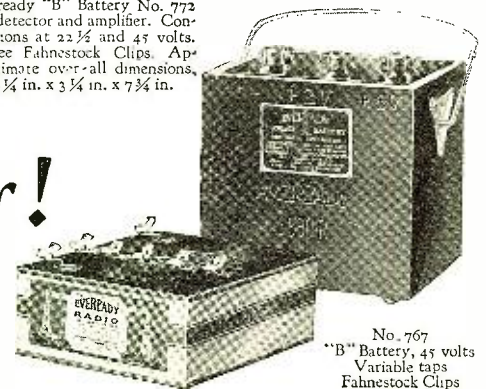

No. 767 “B” Battery, 45 volts Variable taps Fahnestock Clips



No. 766 Eveready “B” 22½ volts Six Fahnestock Spring Clip Connectors



No. 771 Eveready “C” Battery. Clarifies tone and prolongs “B” Battery life

No. 764 The Space Saver Vertical 22½-volt “B” Battery



No. 7111 Eveready Radio “A” Dry Cell Specially manufactured for use with dry cell tubes

Atlas

TRADE MARK

RADIO REPRODUCTION Speaker

*floods the room
with the best
that's in your set*

ATLAS is an instrument designed for clear, lifelike reproduction of every type of program, with any good receiving set.

Since its base, of mahogany colored Bakelite, highly polished and permanent, contains no iron, no external magnetic field can influence the sound-producing coils.

Responsible dealers everywhere sell Atlas speakers for \$25.00. Informative booklet on request.

Multiple Electric Products Co., Inc.
26 Spring St., Newark, N. J., Dept. F
New York, Boston, Philadelphia, Baltimore, Pittsburgh, Detroit, Chicago, St. Louis, Denver.
550 Howard Street, San Francisco.

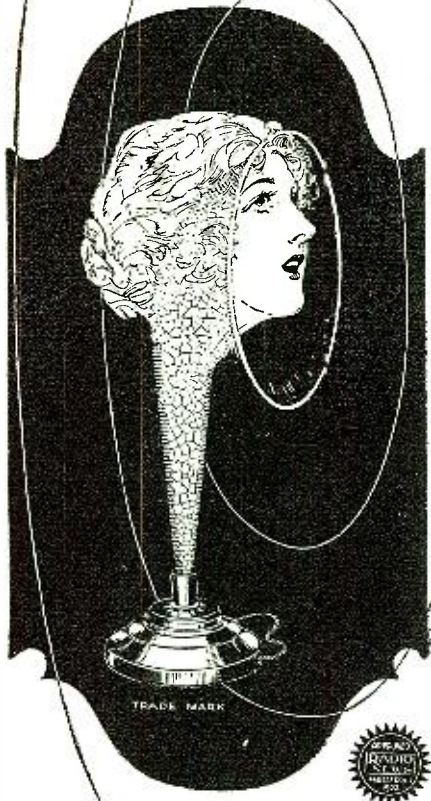

With the Atlas Unit and phonograph attachment coupling at \$13.50 your phonograph may be converted in a twinkling for Atlas Radio Reproduction.

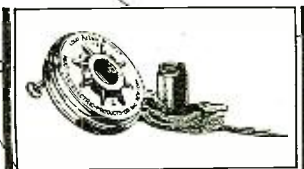

doned consideration of Ido. I would not presume to make any statements about their present position toward Esperanto. That will come from Mr. Warner and Mr. Maxim in their own time, but I feel very confident for Esperanto. Mr. Maxim recently returned from a trip to Europe, where he met leaders of the radio associations in conference. Immediately upon his return, statements by him appeared in the press to the effect that Esperanto was the only project for a radio language worthy of consideration.

Just recently The Radio Association of Greater New York, including in its jurisdiction all the hundreds of members of radio clubs in the metropolitan district, with Mr. E. Jay Quimby as its president, appointed a committee to investigate the radio language problem. Although the head of this committee, Mr. Roland Harvey, initially was favorable to Ido, the report unanimously declared for Esperanto. As a result, Esperanto is being taught to the members of the association and Mr. Quimby himself has been elected the American secretary of the Internacia Radio Asocio, with central office in London. American radio fans interested in this feature should address Mr. E. Jay Quimby, President, Radio Association of Greater New York, 181st Street and St. Nicholas Avenue, New York City. At the organization meeting of the American branch of the I. R. A., two days previous to the writing of this article, 25 enthusiastic fans joined, and Mr. Quimby is to call a general meeting of the federated clubs soon, at which he expects a much larger number to affiliate with the International Association and learn to use the radio language.

In conclusion I would emphasize to all radio fans who are interested in a radio language (and where is the wide-awake person not so interested?) that such a big advance has already been made in adopting the much more widely used Esperanto as the radio language of the world that one who devotes time to one of the lesser projects will later find it necessary to undo much of their learning and start over again with Esperanto. Do not be worried by the claims that Esperanto hasn't a radio vocabulary or cannot be transmitted in telegraphy. I am to participate personally in the work of committees this summer at the World Congress in Vienna, which will adopt and publish a radio vocabulary already in manuscript and being used in Europe, and will also solve the question of greater economy in telegraphing the supersigned letters. Having been a wireless operator and a press telegrapher, I am qualified to participate understandingly in such work.

JAMES DENSON SAYERS,
Box 223, City Hall Station,
New York City.

Correspondence from Readers

(Continued from page 197)

element. One can agree that Ilo and logic are good as a mental discipline.

Third: Mr. Roos claims that "the Russian Communists have officially adopted Ilo and made it compulsory in their propaganda." He must have later information than my own, which is to the effect that Zinoviev, feeling disappointed with results in making Communists of all the Esperantist labor movement, sneered at all international languages, and that no support was given to any by the Third Internationale. Perhaps,

RADIO MUSIC



RADIO JAZZ

A new Radio Song being broadcast from the leading Broadcast stations throughout the country. It is a stirring dance melody mixed with the real syncopated jazz that keeps the dancers stepping lively through the entire number.

35c per copy at all Radio dealers or sent direct on receipt of request.



LISTEN IN

A melody, soft and catchy through the verse and chorus. Ideal for the parlor concert. A song that reflects the spirit of Radio in its novel, new strain. "Listen In" is one of the songs now being Broadcast from the best known Radio Broadcast stations in America.

35c the copy at Radio Dealers or write direct.



RADIO MARCH

The kind of a march that gives you a stir at any time with a swing that makes you feel as though you want to swing in line with the waving banners. It has become popular everywhere.

35c the copy at Radio Dealers or direct.

Published by the

THE CONSRAD CO., Inc.
233 FULTON ST. NEW YORK CITY

CROSLEY

Announcing — The New Models — each a leader in its line

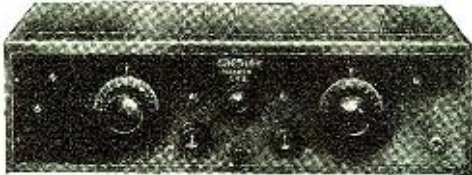

Crosley Trirdyn 3R3, \$65.00



Crosley Trirdyn 3R3 Special, \$75.00

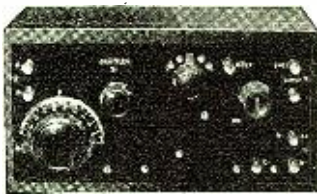

Crosley 51, \$18.50



Crosley 51-P Portable, \$25.00



Crosley 52, \$30.00



Crosley 51-A, \$14.00



Crosley 50, \$14.50



Crosley 50-A, \$18.00

Guaranteed Satisfaction at a Reasonable Price

CROSLEY 50—A new one tube Armstrong Regenerative Receiver. We believe this to be the most efficient one tube receiver ever put on the market. Uses any standard storage battery or dry cell vacuum tube. Price \$14.50

CROSLEY 50-A—A new two stage Audio Frequency Amplifier to match the new Model 50 Receiver. When used in connection with the Crosley Model 50 Receiver, it gives the equivalent of a three tube regenerative receiver. Price \$18.00

CROSLEY 51—In twenty-four days this receiver became the biggest selling radio receiving set in the world and it holds that position today. Will bring in local stations on the loud speaker at all times and distant stations under favorable conditions. Price \$18.50

CROSLEY 51-A—A new one stage Audio Frequency Amplifier to match the Model 51 Receiver. Combined they give the equivalent of a three tube receiver. Price \$14.00

Write for descriptive circular.

CROSLEY 52—A new three-tube Armstrong Regenerative Receiver. Provides loud speaker volume on distant stations under practically all conditions. Price \$30.00

CROSLEY 51-P—This is our new portable set. It is the Crosley Model 51 two tube receiver mounted in a leatherette covered carrying case, batteries and all self-contained. Price \$25.00

CROSLEY TRIRDYN 3R3—This three tube receiver gives the efficiency and volume of a five tube receiver. We believe it is the most efficient receiver on the market at any price for bringing in long distance stations. Price \$65.00

CROSLEY TRIRDYN 3R3 Special—This receiver is exactly the same as the Trirdyn 3R3 except the solid mahogany cabinet is larger to contain "A" and "B" Batteries required when standard dry cell tubes are used. Price \$75.00

For Sale by Good Dealers Everywhere

THE CROSLEY RADIO CORPORATION
822 ALFRED STREET POWEL CROSLEY, JR., President CINCINNATI, OHIO

Licensed under Armstrong
U. S. Patent No. 1,113,149

Crosley Owns and Operates
Broadcasting Station W L W

CROSLEY
Better - Cost Less
Radio Products

Salisbury Radio Table

THE dignified simplicity, sturdy lines, fine workmanship and beautiful finish of Table No. 81—appeal to every one who loves fine furniture. Cabinet contains space for two "A" batteries and "B" batteries—hook for headphones and magazine rack. Four insulated holes are provided at the rear for lead-in wires. Top measures 36x20 inches. Guaranteed to support weight of over 200 pounds. Choice of plain solid oak—or hardwood (birch) in mahogany or walnut finish.

Send no money

Just mail the coupon below—and pay the expressman, \$22, on delivery, plus the small express charge. Save by buying direct from the manufacturers. Absolute satisfaction guaranteed.

SALISBURY BROS.
FURNITURE CO.,
Randolph, Vt.



\$22

from the factory

Mail this coupon today.

Salisbury Bros. Furniture Co., Dept. A-1, Randolph, Vermont

Send the Salisbury Radio Table, No. 81, finished in (check) . . . solid oak, (check) . . . mahogany finish, (check) . . . walnut finish. I will pay the expressman \$22 and expressage on delivery.

Name
Address
City

MARLE TRANSFORMERS

The Heart of a Good Receiver

Your dealer will tell you why Marle Transformers do not howl or distort. Uniform amplification up to as many as 3,500 cycles.

Marle Engineering Co.
Orange New Jersey

however, Mr. Roos refers to the Soviet Republic of Abkhasia, which *did* pass a resolution favoring Ido and its teaching in the schools. Communistic fans may seek the facts in *Rote Fahne* of Vienna, to which I suggest Mr. Roos' attention.

Germany during the war published an illustrated monthly bulletin in *Esperanto* (not Ilo) and sent it out over the whole neutral world. The Red Cross used Esperanto extensively and has so testified. The League of Nations has even printed a report on the facts of Esperanto, and its Assembly only last fall refused to allow a hostile committee to squelch a recommendation that all member nations of the League institute teaching Esperanto in the schools.

The following scientific bodies have carefully investigated the subject and gone on record as proponents of Esperanto: The International Associations (1920), the French and Italian Associations for the Advancement of Science (1922), the French Academy of Science (1922), and the British Association's committee (Jan., 1924). The Paris Chamber of Commerce is officially urging that all chambers of commerce use Esperanto, and is having Esperanto taught in its schools. The 21 great fairs of Europe use Esperanto for part of their advertising.

The comparative forces of Esperanto and Ilo are approximately as 25 to 1, which is indicated by the text books being sold and by the attendance at International Congresses. (In 1921, over 2,500 Esperantists at Praha and less than 100 Ildists at Vienna, the same season.) Figures are not an argument as to the theoretical and logical value as between Esperanto and Ido, but they are an indication of what the "fan" will be up against when he wants to hear from the rest of the world. For getting in touch with Eurasia, however, Esperanto is an already living language. One can decide later whether or no to seek some of the modifications, but the main necessity just now is to get some of those broadcasts that Europe is pouring out in Esperanto.

The Internacia Radio Asocio—Dr. Corret, of Paris, president—will be glad to enroll you and help you get them. Write for facts to E. A. N. A., 507 Pierce Bldg., Boston 17, Mass.

N. W. FROST,
12 Ash St. Place,
Cambridge 38, Mass.

A VOICE FROM THE TROPICS

Editor, RADIO NEWS:

Little did I think, when I wrote the article which you published in the January issue of your magazine, that I would overwork the Postal Department, but that is just what I have done. Radio is the cause of plenty of trouble, both in and out of the home—ask any married man about this and he will vouch for it. But I hope that the postal department men will never get "hep" to me.

I certainly appreciated all the "dope" that was handed to me in answer to my query, and I am taking this method of answering the letters, as I would never finish if I were to attempt to answer them individually. Most of the letters contained hook-ups that I have already tried, with more or less successful results, but what I call good reception and what other people consider it to be, must be two different things.

The new Cockaday four-circuit tuner has a very appealing look to me, but with the amount of money that I have already put into radio, the cost of this has stopped me from becoming too interested in it. At the present time I have four drawers of my desk completely filled with useless parts, for every set that you see advertised, or written

Write for a copy today



A new twenty-four page booklet will be sent, gratis, to those interested in building their own receiving sets.

A simplified method of construction is described. Illustrations and diagrams.

On Request

EISEMANN MAGNETO CORPN.
William N. Shaw, President
165 BROADWAY, NEW YORK

The Peak of Radio Perfection

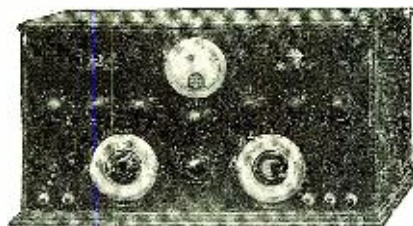

Type LR-170, 3 Stages Radio, Detector 3 Stage Audio Frequency Amplification

Uni-Tune
TRADE MARK

Receiver and the LOOP TUNER
TRADE MARK

Eliminates Aerial and Ground with Clearer Reception. EXTREME SELECTIVITY with easy manipulation. FLEXIBILITY—4 to 7 tubes may be used at will. RANGE—DX stations on the Loud Speaker. SPECIAL WESTON VOLT-METER—Showing A and B-Battery voltages. Contains all batteries for dry cell operation. Write for Circular "R."

NASSAU RADIO CO., Inc.
60 COURT ST., BROOKLYN, N. Y., U. S. A.



Ask Your Dealer For a MONTROSE VERNIER CONDENSER

The condenser with genuine bakelite end pieces. Has positive contact between the vernier plate and main shaft. Will get the results where others fail, guaranteed to give entire satisfaction.

MONTROSE MFG. CO.
1333 Fulton St., Brooklyn, N. Y.
Phone Decatur 7382

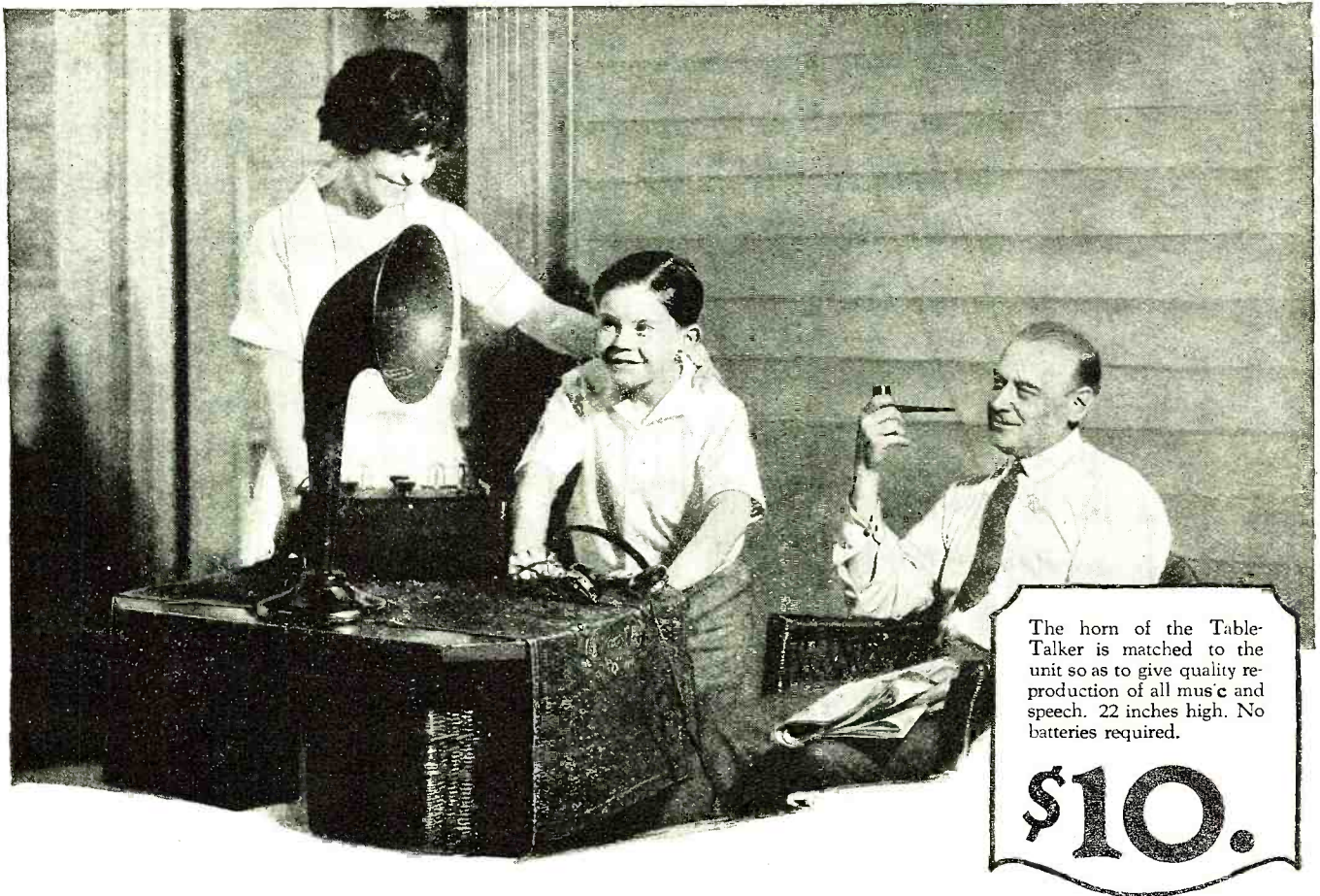

The horn of the Table-Talker is matched to the unit so as to give quality reproduction of all music and speech. 22 inches high. No batteries required.

\$10.

Home-comfort and entertainment!

Enjoy the cool comfort of an easy chair and all varieties of music, sports, helpful talks and speeches. On the cool side of the porch—the calm pleasure of restful evenings with an entertainer of infinite versatility—radio and a Table-Talker.

The Brandes Table-Talker spreads its mellow tone among your guests. It brightens the evening meal with concerts that fill your largest room. It generously reproduces every part of the fascinating radio program. You comfortably enjoy the entertainers of summer nights.

Brandes

*
Superior
Matched Tone
Headset
\$6
\$7 in Canada

Table-Talker
\$10.
50¢ extra west
of the Rockies
In Canada \$14



*The name
to know in Radio*

Navy Type
Matched Tone
Headset
\$8
\$11 in Canada

BAKELITE

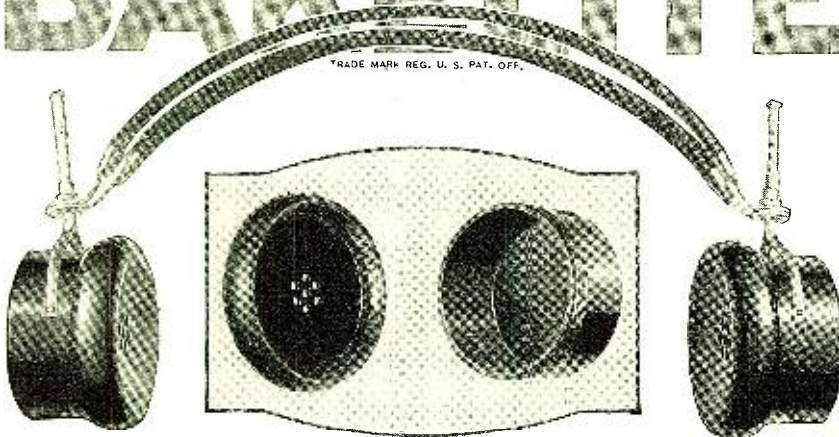

Baldwin and Bakelite

The clear tone of this popular headset, made by Nathaniel Baldwin, Inc., of Salt Lake City, has been developed by careful experimentation in every phase of its manufacture, from the selection of raw materials to the final testing of the completed instrument.

Bakelite is used for the receivers because it is strong, and light in weight. After years of service

under varying atmospheric conditions, Bakelite shows no signs of deterioration. Its color does not fade and its fine finish is impervious to oils, acids and moisture.

"The Material of a Thousand Uses" possesses many valuable properties which make it peculiarly suitable for use in radio equipment.

Send for a copy of Booklet B.



**BAKELITE
Condensite
REDMANOL**

are the registered Trade Marks for the Phenol Resin Products manufactured under patents owned by **BAKELITE CORPORATION**

Send for our Radio Map

The Bakelite Radio Map lists the call letters, wave length and location of every broadcasting station in the world. Enclose 10 cents to cover the cost and we will send you this map. Address Map Department.

BAKELITE CORPORATION

247 Park Avenue, New York, N. Y.
Chicago Office: 636 West 22d Street

THE MATERIAL OF A THOUSAND USES

RAY-O-VAC
The most satisfactory batteries you can buy. There is a style for every radio use and need.
RAY-O-VAC
Radio's Best Batteries

CATALOG L-25-148 PAGES FREE!

SUPER-HETERODYNE—NEUTRODYNE!

New Complete Branston Kits Including Oscillator Coupler, Antennae Coupler, 3 Inter. R.F. Trans. and Special Transfer Coupler. Complete Kit Lists, \$56.50. Acme 30 Kilo Cycle R.P. Trans., \$5.00. All American 2,000 to 10,000 Meter Trans., \$6.00. Hilco Antennae Coupler, \$8.00—Oscillator Coupler, \$7.00. Gen. Pada Neut. Part, 5 tube, \$65.00; 4 tube, \$64.00; Kit, \$25.00.

AMERICAN RADIO MFG. CO.
WHOLESALE DISTRIBUTORS
Dept. A, WEST 14TH ST. KANSAS CITY, MO.

Insure your copy reaching you each month. Subscribe to Radio News—\$2.50 a year. Experimenter Publishing Co., 53 Park Place, N. Y. C.

up, has different parts specified in it. I have a hunch that they do this to keep the parts circulating.

One letter in particular that other fans ought to know about is that from Horace Shafer, Warba, Minn. Here is a fan who wants a set that will bring in *static*. He claims that there is no such thing! Now all of you know that there *is static*; write him and try to convince him that he is mistaken. He speaks of trying to import static from Havana, which makes a big opening for a good discussion. My idea of static is that you cannot get into trouble from static unless you happen to be in its way or in the immediate neighborhood of it. If Mr. Shafer or his friends will spend as much money as I have in building sets that proved useless, and will take a trip here or to any other semi-tropical country, he will get enough static to last him a lifetime.

Some of the fans want to know what stations we have here. We have plenty of spark and navy, but *no* broadcast stations, and we have to depend on the United States for our entertainment programs.

While the Navy is here for its annual maneuvers, it is possible to get plenty of "dope" from the fellows, but it is a funny thing that they are allowed to work on the lower wave-lengths which become so broad that you cannot tune them out. This and the Army portables are a genuine nuisance. Test—Test—Test, seems to be the watch-word with them, and of all the annoying things that occur here, the biggest is to *think* you have something coming through. As one hears the carrier wave, suddenly he is interrupted by getting one, two, three, four, five, six, seven all the way down the line from a whisper to a roar, and when he thinks he is going good, a roar something like a Victor record drilled off center comes in, high and low in spots, "How is my modulation?" If the man who said that could hear his own voice, he would forever hold his peace. If you fans have never gone through anything like this, you certainly don't know what you have missed.

One can get KDKA here with most any kind of an old junk set, for they surely have the power to put it over. Yet to sit back and tune them all in, is what I am after.

Well, friends, if the Editor is good enough to let this get into print, I hope all of you who have written me will see it and consider it an answer to your letters. Don't hesitate to write again, for I must have letters to console me with the fact that there is someone, some place, who is satisfied with what he is getting.

L. D. VAN VALKENBURGH,
P. O. Box No. 58,
Pedro Miguel, C. Z.

A CRYSTAL SET ROOTER

Editor, RADIO NEWS:

I should like to take exception to two statements you made in the first article of the May issue of RADIO NEWS, entitled "The Radio Beginner." These statements are as follows: 1—"It is not possible to attach a loud speaker to a crystal set, as the power delivered by it is very minute." 2—"It does not work well, as a rule, for greater distances than 15 miles."

I am now operating a loud speaker on a crystal set consisting of three bank wound coils, a galena crystal, and a single wire aerial about 80 feet long. This set is located about a mile from WJAR and entertainments broadcast from this station can be heard distinctly 100 feet from the loud speaker. The ear-phones cannot be placed on the ears without discomfiture, the noise is so great.

As for outside stations, WBZ, 60 miles away, can be heard on the phones at any time in the evening; KDKA, WGY and WHN almost any time, 120 miles; WDAP,



MAGNAVOX

The Reproducer Supreme with a Human Throat

The marvelous semi-dynamic mechanism of M4 shown in sectional view at right.

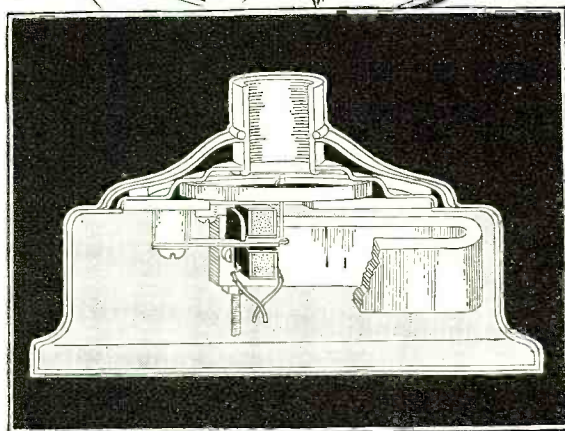

BETWEEN Magnavox and ordinary "loud speakers" there are certain essential differences hidden away in the base of the instrument, insuring for Magnavox utmost clearness of tone.

The quality of radio speech or music is largely determined *before* the sound enters the horn—which makes it so important to select a Reproducer on account of its scientific construction, not merely its outward appearance.

Among instruments operated without a battery, nothing compares with the clear, sweet tone, always true in pitch, produced by the new Magnavox M4.

With the R3 and R2 Reproducers the user secures the advantage of perfect *volume control*—an exclusive feature which greatly increases the enjoyment of radio reception.

The strongest guarantee of mechanical excellence is the Magnavox trade mark — always look for it.

Reproducers

M4—the latest Magnavox achievement: requires no battery \$25.00

- M1—also constructed on the semi-dynamic principle, requiring no battery \$30.00
- R3—famous electro-dynamic type: new model with Volume Control \$35.00
- R2—same as R3 but larger size: new model with Volume Control \$50.00

Combination Sets

A1-R and A2-R—the only instruments combining electro-dynamic Reproducer and Power Amplifier in one unit \$59.00, \$85.00

Power Amplifiers

A1, AC-2-C, AC-3-C—the most efficient audio-frequency Amplifiers: one, two and three stage \$27.50 to \$60.00

To obtain the fullest enjoyment from your receiving set, equip it with the Magnavox — for sale at good dealers everywhere.

THE MAGNAVOX COMPANY
OAKLAND, CALIFORNIA

New York Office: 350 West 31st Street

Canadian Distributors:
Perkins Electric Limited, Toronto, Montreal, Winnipeg



M4



R3



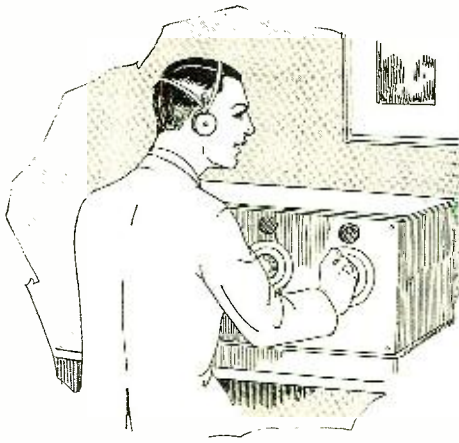

Small parts have more to do with DX work than you may think . . .

SUMMER TIME may be hard, very hard on D-X work. Yet there are some who "drag 'em in" in spite of everything.

What is their secret of summertime results? It is nothing more than a simple, common-sense buying rule.

Knowing that they're up against difficulties, they make the most of the feeble impulses that do get thru' . . . they select their small parts and accessories just as carefully as their major instruments.

They make sure—when they buy—that the least important part

is an asset to their sets, not a leak that drains energy away!

When they buy jacks or plugs, sockets or switches, variable grid leaks or neutralizing condensers, they look for more than a low price. They look first for the quality that insures full value out of their larger instruments.

They look for the MAR-CO name, for the "leak-proof" precision that name implies. For then they know there are no unsuspected leaks to let energy escape. They know that each MAR-CO part does its full share to help summertime reception!

MAR-CO





NEW TUBES EXCHANGED FOR OLD

275

All Types

Send any type
or make of tube \$
in any condition
199-201A-12-200

We will replace your old Burnt-out or Bad Tube with another of similar Type and guarantee it to function as well as any Standard Tube made. Our Tubes are made in all types—201A—200—WD-12—WD-11—199, etc. Any tube that does not oscillate and amplify will be replaced Free of Charge if Filament is not burned out.

RADIO AUTO DISTRIBUTORS
H-544 920-D N. W. WASHINGTON, D. C.

800 miles, frequently; while I have occasionally reached WCAE, WIP, 8XG (Cleveland) and various others. Of these stations I am sure the following were not re-radiated from a tube set. WBZ, KDKA, WGY, and WHN, as the length of time they could be heard, the frequency with which they could be tuned in, and their characteristic fading, all argue against such an explanation. I doubt of WDAP was re-radiated, as I heard them all one evening without a break. I am a strong crystal rooter and hate to hear it maligned.

I have also used the familiar two-slide tuning coil (cylindrical) with results quite satisfactory, although of course I had no third coil to use as a wave trap, so the set is not very selective.

A loud speaker must be used that has an adjustable diaphragm, which must be moved very close to the magnets. A power input loud speaker would give even more volume, but the present speaker is quite loud enough, and if I used a battery-input unit I would spoil one of the chief advantages of the crystal set—"getting something for nothing!"

Kindly accept this criticism as a friendly remonstrance against slighting the poor crystal sets which are often overlooked and not given their due.

J. P. PUTNAM,
Instructor in Electrical Engineering,
Brown University,
Providence, R. I.

[Evidently you are not a constant reader of RADIO NEWS, otherwise you would have noted the very many editorials on crystals in the past. The editor himself has always rooted for the crystal—BUT your case and many similar ones are exceptional and by no means the rule. Working a loud-speaker on a crystal for a distance of one mile from a broadcast station is a well known experience of many fans. But can you do it over a distance of 10 or even five miles, without some sort of amplification?]

As to the DX reception on crystals, we have in the past published many such records. RADIO NEWS' sister magazine, SCIENCE AND INVENTION is just now conducting a prize contest on crystal sets that can receive over long distances.—Editor.]

FROM A "COW TESTER"

Editor, RADIO NEWS:

I feel that I should say a few words regarding the pleasure that free radio broadcasting gives to me.

I am a milk or cow tester, which work necessitates my traveling continuously on a regular monthly route.

Last summer, while in Chicago, I was tempted to buy a non-regenerative single circuit set; from that date I have been a radio fan. At the present time I have a four-tube set with one stage radio frequency and two of audio frequency.

This I have set up in my car, and when arriving at a place I run an insulated wire from the car to a handy tree, barn or post, and presto, the outfit is ready. I usually use a ground, but the set will work without it. The posts of my starting battery have two other wires attached, so that I do not have to take my radio battery out to be charged, it is always ready.

I doubt if I could now get along without my set. A turn of the dial and the music of an orchestra floats in, another turn and "How in the world can the old folks tell," etc.; another, and the beautiful tones of a pipe organ come in, or an oration may be tuned in; a talk about some heretofore unheard of town or city, inviting tourists to visit the place; weather reports, market reports, plays and church services.

To sit in my "flivver," away out in the country, and get this material for pastime and thought seems a godsend indeed, and free.

While the roads were impassable for a car last winter, I carried the outfit around

"This Free Book Showed Me the Way to Big Money in Radio"

It has Started Thousands on the Road to Independence and Success—has Lifted Them Out of the Rut of Office Routine and Helped Them Become Experts in This New, Fascinating, Profitable Profession. Let It Do the Same For You.

SIX months ago I was what you might call "a handy man about the office." I had what I considered a good job with a large manufacturing concern. Having taken a two years' business course, I knew enough of stenography and elementary bookkeeping to be of real value in general office work.

I took special dictation from the President, assigned general correspondence to the regular typists, was responsible for the purchase of office supplies, approved petty cash vouchers for the errand boys and clerks, and was entrusted with the responsibility of making deposits at the bank and bringing in the payroll.

In addition to these, I was often privileged to arrange accommodations for the President when he went off on a trip. And when he wanted some personal matter attended to, such as purchasing theatre tickets or having his evening clothes brought down to the office, I was always selected for such tasks. I was, in fact, an assistant to the President. And accordingly I was paid \$40 a week.

I won't say that I was satisfied with this salary—although it was more than the other clerks were getting—but the fact that the President had confidence in me gave me a certain standing among the others which kept me fairly contented.



Then one day, having a little extra money on hand, I bought a small radio receiving set.

Several of my chums had radio outfits and I had always wanted one in order to enjoy the broadcast programs in the evenings at home. There was ordinarily nothing unusual about this, yet that little radio set changed my whole slant on life and opened up my future overnight.

I didn't know a thing about radio, but I soon got onto the tricks of operating a receiving set and rapidly became a real "fan." But much to my surprise, I got more fun out of the mechanical operation of my set than I did from the music, speeches, reports and regular programs of the nearby stations.

Then I began to take my set apart, reassemble it and experiment. I rigged up an outdoor aerial and installed a tube set. Then I bought a loud speaker and gradually added part by part until I had a first class outfit with a wave-length capable of "picking up" the programs from distant stations.

Naturally, I didn't stop there. Several of my friends had "sending" sets and I wanted nothing less. I began to study the code and longed for the day when I could get a license and have a "call letter" of my own. My routine, humdrum work at the office began to lose its appeal. I could hardly wait until evening came so that I could get home to the "work" I actually enjoyed.

One day the traffic manager at the office mentioned that he was going to buy a radio and flattered me by asking my advice. I offered to help him select a set and install it. He told me to go ahead, rig one up for him and let him know what I wanted for my trouble. It wasn't trouble—it was *real fun*—and I made \$30 for a single night's amusement.

That set me thinking. Why not get into radio in earnest? Two fellows I knew had given up office work and were making big money as Certified Radio-tricians. One was a salesman for a large radio manufacturer, with a fine office of his own in his home town; the other was a ship operator, traveling around the world, seeing the things I had always wanted to see—and getting *big money* for doing it.

I decided to study radio and train for a real job. But I wasn't in a position to give up my work at the office, for I had saved little or nothing, and had to contribute something at home every week.

Then one day I noticed an advertisement in RADIO NEWS. The heading first attracted me, for it read—"Men Wanted in Radio—You Can Train at Home for One of These Big-Paying Positions—This Free Book

Will Tell You How." Here was a chance, I thought. At least it wouldn't cost anything to get the book for it was *free*.

I sent for the book—"Rich Rewards in Radio." That was six months ago. What this free book meant to me is best explained by the fact that, as a Certified Radio-trician, my income this year will be at least \$5,000. And that's only the beginning. For I can already see the enormous possibilities for trained men in this fascinating, profitable profession. And I'm going to get my share of the big money being made by those who are "growing up" with this fast growing industry.

Thanks to the splendid training which I got from the National Radio Institute, *in my spare hours at home*, and with a Government First Class License in my pocket, the rest is up to me. But the opportunities for money, independence and success are unlimited in radio and I'm going to go the limit.

I won't attempt to tell you all the details of the wonderful opportunity that awaits you in radio. The Free Book of the National Radio Institute—the same one that I sent for—will tell you all you want to know. It showed me the way to *big money in radio*—it lifted me out of the rut of office routine and made me an expert in this fascinating profession. Why can't it do the same for you? It *can*—the 32-page, fully illustrated free book will tell you how. The coupon will bring it to you—without obligation. Why not send for it—TODAY?

NATIONAL RADIO INSTITUTE

DEPT. 13-HA

WASHINGTON D. C.

NATIONAL RADIO INSTITUTE,
Dept. 13-HA, Washington, D. C.

Without obligation on my part, please send me the free book, "Rich Rewards in Radio," with full details as to how I can quickly train for a big money radio position in my spare hours at home. Also tell me of your special free offer, and how your free Employment Service will help me secure a good paying position. Please write plainly.

Name..... Age.....
Street..... Occupation.....
City..... State.....

<p>What Our Course Has Meant to Just a Few of Our Recent Graduates</p> <p>Triples His Salary As Radio Engineer</p> <p>Thanks to your course and help it gave me, I have had another boost in pay. This is the third one in less than a year. Today I am getting three times as much as I got before I began your course.</p> <p>MERLE WETZEL, Chicago Heights, Ill.</p> <p>\$300 a Month's and All Expenses as Salesman</p> <p>Your course was worth \$5000 to me, but I wouldn't take ten times that for the value I've gained from it. I signed up with a company for \$300 a month and expenses paid. I owe this to your course.</p> <p>EMMET WELCH, Peuliar, Mo.</p> <p>Prepares For All Radio Jobs</p> <p>It will interest you to know that since completing your course I was 1st operator on Steamship Lake Giltedge. Last summer I had charge of broadcasting station WIAI and in December connected with the Calin B. Kennedy Radio Corp., as sales correspondent, handling all technical inquiries, which I enjoy immensely.</p> <p>N. R. I. WILLIAM WEST, St. Louis, Mo.</p>	<p>A Few of Many Letters We Receive Which Explain How We Place Graduates in Radio Position</p> <p>Dear Sir:</p> <p>We are in need of the services of a competent radio engineer who has a thorough knowledge of radio, together with selling ability, and would appreciate it if you could recommend to us any person or persons that could fill a position as outlined above.</p> <p>Very truly yours, DX-INSTRUMENT CO. By John F. Whittiku, Vice-President.</p> <p>Good Future</p> <p>I want a man who can show the customer about circuits, and answer questions. One who can set up sample sets.</p> <p>He must hold at least a third grade commercial license in order that our broadcast station may be operated at least twice a week. This position offers a fine future to the right man. Yours very truly, JOHN R. KOCH.</p> <p>Executive Position</p> <p>Gentlemen:</p> <p>We thought you would be in a position to cooperate with us in securing men with executive ability as well as knowledge of the Radio business to take charge of our offices as local managers.</p> <p>Yours very truly, UNIVERSAL RADIO CO.</p>
---	--

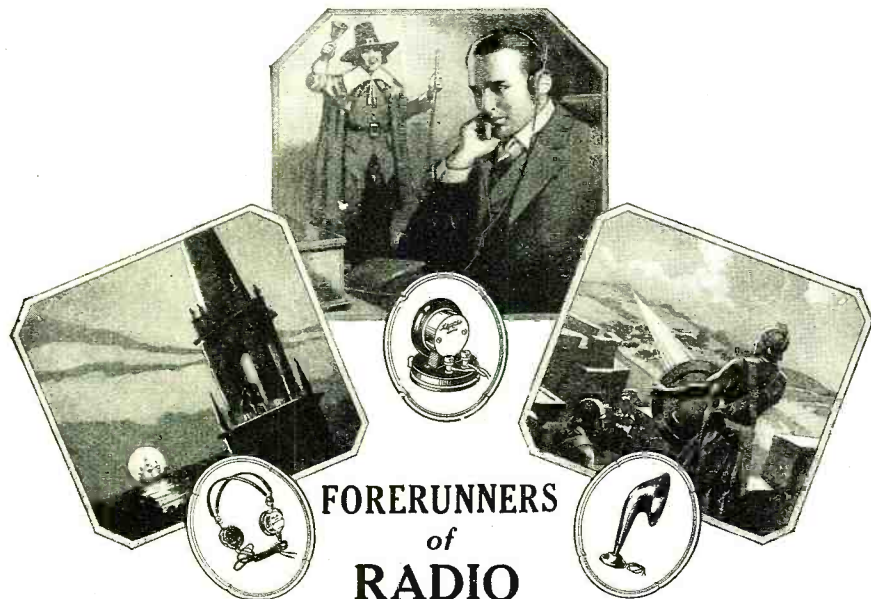

THE reflecting shield of the ancient Roman—the Town Crier of a generation or more ago—these were some of Radio's historic forerunners.

That Radio has developed to its present perfected state is due to the genius of great scientists and the painstaking experiments of manufacturers of electrical equipment.

The Holtzer-Cabot Electric Company, for 35 years leaders in their electrical field, through their experience and equipment have produced for you three remarkable instruments. With the utmost quality, volume and sensitiveness they transform the electrical energy produced by the receiving set into the original music or spoken word.

It pays to buy Holtzer-Cabot equipment.

- Holtzer-Cabot Loud Speaker \$25.00
- Loud Speaker Phonograph Attachment 10.00
- No. 2 Universal Headphones 9.50
- No. 4 National Headphones 6.00

Write for booklets explaining how the exclusive features of these instruments enable you to enjoy the wonders of Radio

THE HOLTZER-CABOT ELECTRIC CO.
 125 Amory Street, Boston, Mass.
 6161-65 South State Street, Chicago, Ill.
 Dept. D1

Holtzer-Cabot
 BUSINESS ESTABLISHED 1875

**Good Instruction
 In a Short Time**

can only be given in a completely equipped laboratory under expert instructors. We have both. Correspondence and Resident Courses.

Write for illustrated booklet

**Y. M. C. A.
 RADIO INSTITUTE**

158 East 86th Street New York

DON'T BLAME IT ALL ON STATIC !!



A run down "B" Battery plays more havoc with efficient reception than the grandest static you ever heard.

S & H "B" BATTERIES

are not two days' old when they're sent to you. And they are built right. Made of finest materials to give extra service. After you've used them if you don't feel they're the best buy, send them back and your money will be refunded.

	Large	Medium	Small
22½ V. Variable	\$1.80	\$1.60	\$1.00
45 V. Variable	3.80	2.75

WE PAY POSTAGE

S & H BATTERY SUPPLY CO.

41 Nevins Street Brooklyn, N. Y.

in my buggy and sled, setting it up 20 or more times per month in the houses on my route.

This method is tiresome in a sense and may be rather hard on the receiver, but for the pleasure it gives to most of the people and myself it is worth the trouble.

It is very rarely that I have the instrument and aerial set up as it should be, but I have had very fair results on the whole, and at times excellent returns for the work.

True, at times, there are days during which nothing satisfactory can be picked up, but on those days, I am not the only one who suffers.

W. ERIC CONSTABLE.
 Boyceville, Wisconsin.

ONE TUBE SHIP WORK

Editor, RADIO NEWS:

Many commercial operators preparing for long voyages believe they must go forth armed with a varied assortment of amplifiers and equipment purchased at their own expense.

Whether apparatus should be purchased to supplement the ship installation has long been a troublesome question among seagoing operators.

Also, it has been questionable, on the other hand, if most men obtain the best results from the equipment at hand. Most government vessels have equipment, such as it is, of excellent, fool-proof rugged design, which, if used to the utmost efficiency, will do wonderful work. Patience, care and time must be applied to obtain the necessary results. Conditions, however, are not always the best and at sea may vary from howling, tropical static to a bedlam of interference in congested areas such as the English Channel.

However, good results can be obtained if reasonable care is taken, without the addition of personal property to supplement ship's equipment.

The following cited examples are given—and although not records or freak work, show what may be done aboard ship with a single tube, the C.W. 930 being employed in these instances with a 200-foot aerial 60 feet high.

In blinding squalls, rough seas and wallowing rails, St. Paul, Alaska, was copied with clear signals at a distance of approximately 8,000 miles (arc).

Nauen spark at approximately the same distance was used to check time signals received from Mare Island up to a distance of 7,000 miles, at which point the sailing route doubled back from Magellan Straits, although the high Andes between were intervening, and a radio shadow might have been expected.

The Mare Island signals were copied daily from San Francisco, through Magellan and as far north as Santos, Brazil, where radio work was discontinued.

While traversing the precipitous canyon of Magellan Straits, with walls blanketed with snow and ice, the "overland" stations of the Federal Telegraph Company at Los Angeles and Palo Alto were copied on a typewriter!

Portland was heard with fair success, although not copied on the mill.

Press from Mare Island was copied clearly practically all the way from San Francisco to Magellan, then northward along the east coast of Patagonia and Brazil.

Immediately off Punta Arenas in the Straits, some Japanese spark on long wave was copied, but had a poor swing and no sine was heard.

Checking of European (Central) time signals with those from California was an interesting experiment.

Using an accurate stop watch, and comparing with a chronometer of known rate of gain or loss daily, the time signals from Nauen and those from Mare Island coincided exactly, to the fraction of a second. This was quite an engrossing experiment,

Monodyne PORTABLE Outfits

Technical Description Model G T-20

The illustration shows the two tube model G T-20 portable Monodyne set. This set with telephone receivers will easily receive all broadcast within a range of 1,000 miles or more. Will operate a loud speaker within a radius of 100 miles with moderate volume. Only one control knob used, under ordinary conditions. New volume control shown in upper left hand corner for very fine regulation when receiving long distance. *The outfit does not include phones, tubes or batteries.* The battery compartment is located underneath the instrument board. There is sufficient space to carry telephone receivers and aerial equipment. With the outfit is furnished FREE a complete aerial equipment. On the inside of the cover there is a neat leather holder in which three tubes can be carried. Size of case $7\frac{1}{2} \times 9 \times 14\frac{1}{4}$ ", covered with Walrus Grain Fabrikoid. Weight complete with batteries, phones, tubes, aerial, etc., 15 lbs. Solid brass fittings, leather corners —A BEAUTY. Strongly reinforced and braced leather handle.

MONODYNE—the perfect portable radio set, entirely self contained. Concealed dry batteries, only one tuning control, *new volume control*, nothing to adjust, nothing to get out of order.

MONODYNE Three Tube Portable Set Model G T-30

This set is full panel mounted, with automatic filament control jacks on each tube and has one vernier tuning dial and volume regulator. Marvelous for volume and loud speaker reception. Extremely sharp tuning, eliminating all interference. The ideal set for the vacationist, tourist or motorist.

Size $11\frac{1}{2} \times 14 \times 6\frac{3}{4}$.

GT-30—three tube MONODYNE complete without batteries, tubes or loud speaker, but with complete aerial equipment—

\$75.00

Order from your dealer, or sent postpaid to any address in the United States. Dealers write or wire for exclusive Agency proposition.



Price
\$55.00

G T
20



ANY months of patient experiments and research tests under all possible conditions by masters of radio engineering have at last produced the perfect portable radio receiver—just in time for the out-of-door season.

Now you can have the finest possible radio reception—clear and loud, free from distortion, wherever you may go, best in camp,—auto tours—at the seashore—in the mountains,—on the lakes,—at summer hotels—anywhere. Think of listening to this summer's political speeches while in camp or on your auto trip!

NATIONAL AIRPHONE CORPORATION

18 HUDSON ST.

NEW YORK

—S-E-N-D N-O M-O-N-E-Y—

National Airphone Corporation,
18 Hudson Street,
New York City.
Gentlemen:

R.N.-8

Please send prepaid one No. MONODYNE portable outfit, for which I will pay the postman, upon delivery, the advertised price.

Name

Address

City..... State.....

KELLOGG RADIO

This Kellogg Radio Kit saves time and money - Say the Radio Bugs.

Everything complete for assembling

two stages of audio frequency amplification. The panel is drilled for three tuning units, which together with this No. 501 Kit will complete a radio set using your favorite hook-up, or most any other that you may desire to try.

This universal panel makes the changing of from one circuit to another an easy matter. Every piece is standard Kellogg radio equipment and guaranteed.

"Build Your Own" with this Kellogg No. 501 Radio Kit. At your dealers for \$43.00.

Kellogg Switchboard & Supply Co.
1066 W. Adams St., Chicago, Ill.

as Nauen was 8,000 miles away to the north-eastward, and San Francisco 7,000 land miles to the northwestward.

A whimsical thought at the time considered the possibilities of radio cross bearings taken on the two stations, then corrected for Mercator charting and laid down for comparison.

In this regard an interesting experiment was conducted on an ocean-going towboat in the Gulf of Mexico, where an antenna of four wires, 60 feet long, were so connected as to form a great loop 60 feet long and 45 feet high.

On the way into Tampico Harbor an estimated nearly correct check was kept on the vessel's head through comparison with chart bearings of XDA, PWA, NAR and the station at Pinar del Rio.

JACK BRONT,
Cleveland, Ohio.

REGARDING THE "NEW" NAA

Editor, RADIO NEWS:

Referring to comment on the new tube transmitter at NAA, the consensus of opinion seems to be unanimously against the new installation.

The poor code and the "dead" emissions are greatly inferior to the old spark.

Practical observations on signals, from Cape Horn northward, show a decided falling off in "distance."

Why the Navy Department decided to install such inefficient apparatus, and why such impractical operators are allowed to transmit the vital government emissions, is one of the mysteries of the department.

JACK BRONT.

INQUIRY ON THE REFLEX CIRCUIT

Editor, RADIO NEWS:

I have a set which I built last month, but it does not work. It is equipped with the newest Ford carburetor, with a cut-out in series with the antenna and the left hind binding post. The variable condenser is of the lead plate type, with hot-air dielectric. Its capacity lies somewhere between $17\frac{1}{4}$ and 432 horsepower. The variometer is rotated by a $\frac{1}{2}$ -horsepower motor. Do you think that if I increased the speed to 14,000 r.p.m. I would get better results? Also would you advise me to equip my amplifiers with 16 valves in head motor?

The antenna consists of 700 feet of $\frac{3}{4}$ -inch copper pipe, running at right angles to the equator, at an altitude of 2,340 feet, with lead-in 2,500 feet long, insulated with transparent garden hose. Would a condenser of .00025 mfd. capacity connected between the lead-in and the neighbors still increase my selectivity?

The sockets are of the double contact type, designed to take special 2,000,000 candle-power bulbs. The jacks are warranted to lift 2,600 pounds.

The rheostats have a resistance of six megohms and are wound with No. 46 weather-proof gold-plated steel piano wire. Binding posts are designed to carry 1,000,000 amperes without overheating, and are equipped with a special cooling system and radiators. The grid condenser is of .000001 mfd. capacity and is equipped with a leak of 16 drops per minute. Transformers are 3 KYW type.

All connections are made with No. 0000 trolley wire and are securely welded where necessary. The panel is of three-ply nickel plated fibre 7 inches thick, 40 inches high and 106 inches long, and is insulated at each end by a rubber ball 2 inches in diameter.

The ground consists of a counterfeit half-dollar, buried 4 inches below the

LEARN THE CODE AT HOME

"Just Listen—The Omnigraph will do the teaching"

with the

OMNIGRAPH

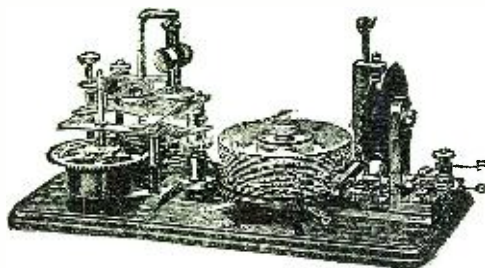

THE OMNIGRAPH Automatic Transmitter will teach you both the Wireless and Morse Codes—**right in your own home**—quickly, easily and inexpensively. Connected with Buzzer, Buzzer and Phone or to Sounder, it will send you unlimited messages, at any speed, from 5 to 50 words a minute.

THE OMNIGRAPH is not an experiment. For more than 15 years, it has been sold all over the world with a money back guarantee. **THE OMNIGRAPH** is used by several Depts. of the U.S. Govt.

—in fact, the Dept. of Commerce uses the **OMNIGRAPH** to test all applicants applying for a Radio license. The **OMNIGRAPH** has been successfully adopted by the leading Universities, Colleges and Radio Schools.

Send for **FREE** Catalog describing three models.

DO IT TODAY.

The Omnigraph Mfg. Co., 20 Hudson St., New York City

If you own a Radio Phone set and don't know the code—you are missing most of the fun

Insure your copy reaching you each month. Subscribe to Radio News—
\$2.50 a year. Experimenter Publishing Co., 53 Park Place, N. Y. C.

New!

FIL-KO-STAT

SCIENTIFICALLY CORRECT RADIO RHEOSTAT

with Battery Switch Attached

\$2.00
AT YOUR DEALER



at no extra cost. Still \$2.00. Still the filament control of proven supremacy. *The only rheostat and battery switch in one.* If you want perfect control of any type tube in any hook-up—if you want DX stations you never heard before—if you want silent tube operation—maximum signal regeneration—longer tube and battery life—then you must use FIL-KO-STAT, the *Filament Control of Infinite Adjustment.* The Battery switch (patent applied for) attaches to regular mounting screws. No extra holes to drill.

Write for a free copy of our new booklet
“Improved Reception Through Scientific Tube Tuning”

New!

FIL-KO-SWITCH

SCIENTIFICALLY CORRECT

Simple-Sturdy-Sure

50¢
AT YOUR DEALER



A necessity on any radio set. “Current on or off at the touch of your finger.” It takes minimum space both on the panel and behind it. The single-hole mounting makes it easy to attach. Fitted with double connections—connect wires to the terminal screws or to the solder lugs. Sturdy interior members give positive contact. Metal parts heavily nicked.

New!

FIL-KO-LIGHTNING ARRESTER

SCIENTIFICALLY CORRECT

Prevents Leakage Losses

\$1.50
AT YOUR DEALER

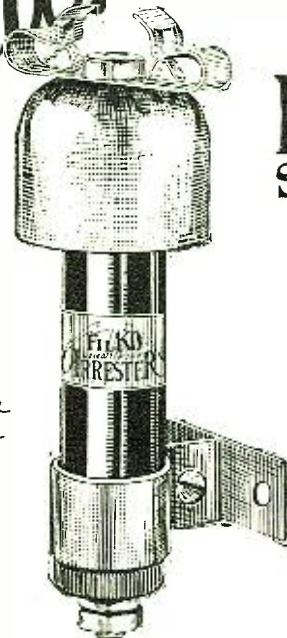

This arrester with its bell-shaped shield will positively keep dry and not gather dust or other conductive matter which causes short-circuits from aerial to ground. This makes certain that all radio impulses reaching the aerial pass through your set, insuring maximum reception. Insulation is of polished Bakelite—the best, most moisture-proof dielectric. It is hermetically sealed—no dirt or moisture can reach the gap. Rugged mounting bracket keeps FIL-KO-Lightning Arrester rigid under all conditions.

MADE AND GUARANTEED BY



HARRISBURG — PENNSYLVANIA

Foreign Representatives

RADIO STORES CORP.

New York City

New York Office
220 WEST 34TH STREET

(Address All Mail to the Factory)



U. S. Tool Condensers

—the Surest Part of Your Set

Designed for most accurate capacity and guaranteed to give 100% satisfaction—the guarantee that is bringing U. S. Tool to the fore with careful set-builders.

Buy Condensers By Capacity
—Not Plates

100% GUARANTEED
End Plates of CELORON

For Superheterodyne
Inverse Duplex
Superdyne and
Four Circuit Tuner Circuits

Condensers of recommended capacity for all known circuits are also carried in stock by leading radio retailers.

Write for booklet

U. S. Tool Company, Inc.
118 Mechanic St., Newark, N. J.



Simplify Your Set!

Increase Your Range—
Improve Your Control—
Hook Up a

LEMCO
EQUIPMENT
TRIPLE DUTY TUNER

Insist on Lemco Products. If your dealer hasn't them we'll forward prepaid on receipt of purchase price.

- No. 100. Broadcast Tuner (less dials) ... \$7.50
- With Bakelite dials (as illustrated) ... \$8.70
- No. 340. Crystal Set (as illustrated) ... \$7.50
- No. 250. Reflex Coils ... \$3.00
- No. 275. Reflex Units (with 17-plate condensers) ... \$8.00

Illustrated, descriptive circulars sent on request.

LEE ELECTRIC & MFG. CO. Dealers and Jobbers
Write for Attractive Proposition.
220 Eighth St. - San Francisco, Cal.

R A D I O D Y N E

NO LOOPS—NO AERIAL

Ready for operation by grounding to a water pipe or radiator, and throwing a few feet of wire on the floor. Uses any standard tubes—dry cell or storage battery. Extremely selective. Simple to operate—only two controls. Wavelength from 200 to 700 meters. Write for Folder describing this (antennaless) receiver.

WESTERN COIL & E. CO.
314 Fifth Street Racine, Wis.

surface in a continuously damped spot with welded connections.

The circuit is the celebrated re-flux, high-pressure, non-backfiring, self-starting, non-corrosive, regenerative type, equipped with auxiliary air compressors and fire extinguishers.

Please give reasons for set not working at once.

Anxiously awaiting your reply,
I am,
Most certainly,
ROLAND KLEINHANS,
Secor, Ill.

A TRIBUTE TO R. H. W.—KIRZ

Editor, RADIO NEWS:
I am a regular subscriber to RADIO NEWS, and have been receiving it for the past two or three years. Just finished reading the "Correspondence from Readers," and found a letter that has interested me a lot. It was published in the issue of May, 1924, and signed R. H. W., KIRZ. (Master).

Being an operator, I can see and understand what is meant in his letter. Strange to say, I quite agree with the opinions of this Shipmaster. He is correct in his views toward wireless operators, because I've known both the types he mentions in his letter. Without boasting, I might class as one of his "boys." However, I'm glad that he knows that some operators are worth while.

Having served under several Masters, it seems to me that he classes himself with the best of them. I can say this much, an operator is greatly encouraged when his work is appreciated. Of course, to be appreciated the work should be well done. Being a "knocker" never has helped an operator, or anyone, therefore, there is no necessity of acting that way. After all, an operator is not a passenger aboard a steamship, but an employee and has his work to do as well as the other officers.

I am sure that if there were more Masters like R. H. W., some operators would be different. If operators are not satisfied, it is their own fault, but of course they must do their share.

A VERY YOUNG OPERATOR.

SQUARE DEALS AND OTHERWISE

Editor, RADIO NEWS:
Regarding your editorial in the June issue of RADIO NEWS. After I had read the opening paragraph, I was called away. Now I find that I have left the magazine behind, so I have not read the entire article, but I know its contents.

The purchase of radio material is a task so unpleasant and so unsatisfactory that the hold radio has on the public is proven by the increasing popularity, in spite of the incivility, discourtesy and absolute lack of salesmanship on the part of some of those with whom we have to deal. Dealing by mail is often equally unsatisfactory.

For instance: I purchased three radio transformers of what I supposed to be standard make. I desired an inverse duplex, or at least a reflex hook-up of three stages of radio frequency amplification, using this particular transformer. I wrote the company, and in about three weeks received a letter of two lines in which they advised that they were enclosing their reflex hook-up. No explanation accompanied it, and the hook-up called for one tube only. Would I have purchased three transformers if I had not intended to use them? As this company makes a pretty full line of radio material, there is a great deal I would have purchased from them, or rather through their dealers, had they given me any attention whatever. As it is, I would not purchase another piece of apparatus manufactured by that company. The sale of radio merchandise should not be complete until the customer is getting full benefit from the product! If I were selling radio parts, knowing the troubles encoun-

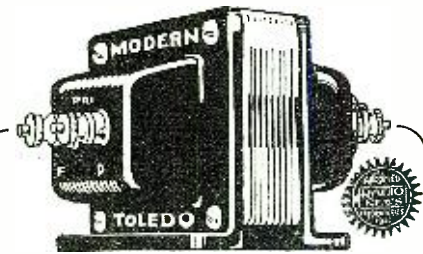

Amplify the MODERN way!

The use of Modern transformers will be a revelation to those not familiar with the fine, clear tones which it is possible to bring out over the entire band of useful audio frequencies.

No note in the musical scale is too high nor too low to escape utmost amplification without the slightest noticeable distortion. Modern "Push-Pull," "Reflux" and Standard Audio transformers are sold by all good dealers.

Send for New Modern Bulletin

The Modern simplified bulletin of hook-ups clearly illustrates and describes the various hook-ups so that anyone can understand without other assistance. Sent free upon request.

The Modern Electric Mfg. Co.
Toledo, Ohio



DUTCH RADIO VALVE

D-201-A

2.5 Amp. 5-6 Volts
Detector-Amplifier
Guaranteed

Rigidity tested by expert engineers.

List Price \$4.00

Special discount to dealers. A few more distributors wanted.

Sole Distributors for U. S.
D. R. V. Importing Co.
515 Orange St., Newark, N. J.



Dealers, write to distributors in your territory

Distributors
OHIO—Ohio Radio Sales
723 Rose Bldg., Cleveland, Ohio
MISSOURI—St. Louis Radio Tube Laboratory
3572 Olive Street, St. Louis, Mo.
Canada—Consolidated Electric Lamp Co., 43 Queen St. East, Toronto, Ontario

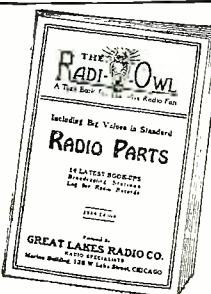

FREE
SEND FOR THIS
Catalog
AND
Save Money
ON
Standard
Quality Parts

GREAT LAKES RADIO CO.
Marine Bldg. Dept. C
136 W. Lake St. Chicago, Ill.

You can be quickly cured, if you STAMMER

Send 10 cents for 288-page book on Stammering and Stuttering, "Its Cause and Cure." It tells how I cured myself after stammering 20 yrs. B. N. Bogue, 6951 Regue Bldg., 1147 N. Ill. St., Indianapolis.



Ultradyne Kit

Consists of 1 type "A" Ultraformer, 3 type "B" Ultraformers, 1 Tuning Coil, 1 Oscillator Coil, 4 matched fixed Condensers.

The Ultraformers are new improved long wave radio frequency transformers, specially designed by R. E. Lacault, Consulting Engineer of this company and inventor of the Ultradyne. To protect the public, Mr. Lacault's personal monogram seal (R.E.L.) is placed on all genuine Ultraformers. Ultraformers are guaranteed so long as this seal remains unbroken.

\$26⁰⁰

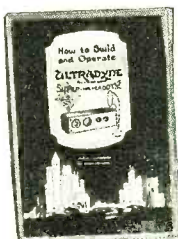

Send for the 32-page illustrated book giving latest authentic information on drilling, wiring, assembling, and tuning 6 and 8 tube Ultradyne Receivers.

50c

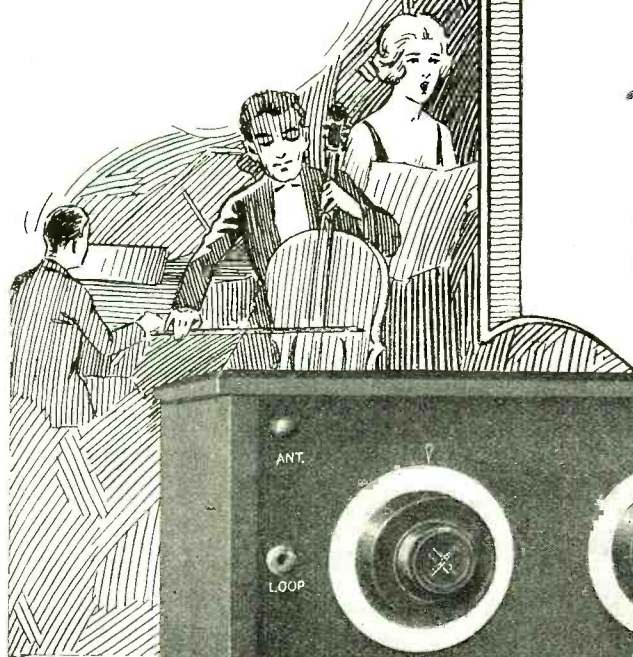

"The Standard of Comparison"

Selectivity

WDAR—PHILADELPHIA—395.
 12.02 P. M.—Arcadia Concert Orchestra, organ recital.
 2.00 P. M.—Arcadia Concert Orchestra.
 3.15 P. M.—Dance music.
 7.30 P. M.—Dream Daddy.
 8.00 P. M.—Palestina Choir and soloists.
 10.00 P. M.—Features from Fay's Theatre.

WDAF—KANSAS CITY—411.
 5.30 P. M.—Musical program.
 10.00 P. M.—Dance music and comedy.
 1.45 A. M.—Starhawk Frolic: Gene Sanders Orchestra.

PWX—HAVANA, CUBA—400
 7.00 P. M.—Realtime story for 1000.
 Hotel Kimball studio, Springfield.
 7.40 P. M.—French Night at the Hotel Kimball studio; program to be announced by Attorney Daniel La-figre.
 8.30 P. M.—Concert by Laurilla Baillargeon, soprano; Joseph Jansen La-figre, bary.

WOR (405 Meters)
 3:00 P. M.—Alabama Pictovocal and instrumental ex-service unit under direction of Professor Gray.
 8:30 P. M.—Continuation of program by Anna Barwig, soprano. Program—"The Rosary," "Nocturne," "Light," "Four-leaf Clover."
 8:45 P. M.—Phonograph solos by Lillian Dell.
 9:15 P. M.—Music While You Dine!

WEAF (492 Meters).
 4:00 P. M.—Bob Fridkin's Clifford Lodge Orchestra.
 4:30 P. M.—Marjolia Fullerton, coloratura soprano, accompanied by Eleanor Owens. Program—"Ho! Mrs. Piper" (Cherub); "The Graces" (Kleber); "If No One Ever Marries Me."
 4:50 P. M.—William P. Sweeney, baritone, accompanied by Whitford T. Barry.
 5:00 P. M.—Women's program under the supervision of the Women's League of the

—A dominating feature

An Ultradyne receiver operating in New York City easily tunes out the powerful broadcasting of WOR Newark, N. J.—405 meters and brings in WDAR Philadelphia—395 meters; PWX, Havana, Cuba—400 meters; WDAF, Kansas City—411 meters.

Regardless of close similarity in wavelength, the Ultradyne selects any station within range—brings in broadcasting clearly, distinctly, faithfully.

The "Modulation System" of radio reception is used exclusively in the Ultradyne. It is the latest achievement of R. E. Lacault, A.M.I.R.E., Consulting Engineer of this company and formerly Radio Research Engineer with the French Signal Corps Research Laboratories.

The "Modulation System" increases the sensitiveness of the Ultradyne over that of any known receiver. Weakest signals are made to operate the loud speaker.

In addition the Ultradyne incorporates every good feature of the famous Super-Heterodyne.

Ultradyne performance is the envy of the radio industry.

Write for descriptive circular

ULTRADYNE

The Improved

SUPER-HETERODYNE

PHENIX RADIO CORPORATION
 3-7 Beekman St. New York

PLAIN TYPE

3-Plate	\$1.25
5-Plate	\$1.50
13-Plate	\$2.00
17-Plate	\$2.50
23-Plate	\$2.75
43-Plate	\$3.00
at Dealers.	



VERNIER TYPE

13-Plate	\$4.00
23-Plate	\$4.50
43-Plate	\$5.50
at Dealers.	

A SCOTCHMAN HAS NOTHING ON THESE CONDENSERS

If a Walnut Condenser ever let go of more than .00000? it'd probably buckle up with shame. In which event we'd replace it free. Like the Scotch, these condensers are record-holders for "low losses." And, in addition, they stay tight for life.

WALNART VARIABLE CONDENSERS

are the last place to look for trouble. Plates accurately pressed, aligned and locked to stay in strong, slotted studs. Bakelite end plates. Ask your dealer first, please.

"Makers of good goods only"

WALNART ELECTRIC MFG. CO.

DEPT. 612

CHICAGO

tered in successfully building any but the most simple sets, I would secure the address of every purchaser, and if they failed to return I would write them, asking what success they had had, also if I could be of further service. The same for mail orders. It is certain that 90 per cent of many first sales would mean repeats! Would I jump with joy to find a company like that? Rather! They would receive my patronage for everything I needed from a binding post to a complete Super-Heterodyne set.

I have found one company at least that stands back of their merchandise, and I believe they should be publicly commended for it. I am sure other fans would appreciate it. I know I would, for we need a list of reliable companies with whom we can deal, knowing that they will cater to us.

I purchased a standard carbon pile rheostat last summer for use in a portable set. We camped along the lakes of Michigan. Perhaps it was the dampness which caused the shaft to gradually tighten until it could be turned only by much effort. Finally the composition knob broke off. A few weeks ago I discovered the rheostat with some miscellaneous parts. I intended to throw it away, when it was suggested that I return it, and that the manufacturing company would probably replace the knob, a new shaft also, for a reasonable charge. Expecting no results, I did so.

Today I received their latest model rheostat, a decided improvement over the one I purchased, and there were no charges whatever! An entirely new instrument!

It is a safe bet that from now on any article I need in this company's line will be one of their instruments!

I believe all instances of this kind should be reported. And also all inferior merchandise or unjust treatment. This might work temporarily against the best (immediate) interests of the magazine because of discontinued advertisements, but in the end it would prove of benefit, because of the sustained interests of the fans in radio, instead of disgust, as the present method of the majority of manufacturers and radio dealers create.

LESTER REAT,
c/o Harley Sadler,
P. O. Box 846,
Sweetwater, Texas.

HAMS TAKE NOTE

Editor, RADIO NEWS:

As a regular English reader of your magazine, would you be so good as to trace, through the medium of its pages, the origin of some of the signals heard by me early on the morning of May 4 (G. M. T.) on wave-lengths between 150 and 200 meters. The set used was a single tube regenerative and as the coils have only been used for a week, exact wave-lengths cannot be calculated, although the set has received KDKA and WGY quite strongly on three occasions.

Perhaps the amateurs responsible for these excellent signals, which are given below, would be good enough to let me have a card, and I should mention that I should be more than pleased to arrange tests with anyone over there at all times. I have a set with R.F. Amplification.

Time (GMT) Signals heard
3:55 A. M.—CQ. u 2 CEE.
4:23 A. M.—5TTD u 1AAL
4:20 A. M.—CQ u 1CDO
4:30 A. M.—CQ u 2AAY
4:33 A. M.—CQ u 1IW
4:40 A. M.—9DVW u 1ABT
4:45 A. M.—CQ u 4ER
4:50 A. M.—9ACX u 1DLJ
4:55 A. M.—CQ u 1AV
4:55 A. M.—C 5MI u 2CX
5:15 A. M.—CQ u 2BSC

S. W. WOOLFORD,
13 Elsinore Rd.,
Forest Hill,
London, S. E. 23, England.

Improve your set with an AmerTran

—and enjoy radio this summer as never before.



THE AmerTran Type AF-6 (Turn ratio 5), has long been acknowledged the Standard of Excellence for audio amplification.

Type AF-7 (Turn ratio 3½), is now, after long study and experiment, offered in response to the demand for a companion transformer designed expressly for second or third stage amplification. In this use AF-7 decreases the tendency to overload the last amplifying tube on loud signals.

Henceforth, then, it is possible to obtain a low ratio AmerTran audio transformer, which insures perfect tone quality and full amplification of low notes when used in combination with an AmerTran AF-6 in the first stage.

Type AF-6 (Turn ratio 5)
Type AF-7 (Turn ratio 3½)
Price, either type, \$7
At your Dealer's.
Send for Circular.

American Transformer Company, 177 Emmet St., Newark, N. J.
Designers and builders of radio transformers for over 23 years.

SET MANUFACTURERS Attention!!

We operate a cabinet factory. We finance a manufacturer of a very fine independent make 6 volt and 1½ volt tube, and further cater for the manufacturers by having on hand from time to time transformers, sockets, rheostats and various hardware parts. You can save a great deal in your radio material requirements by getting in touch with us.

R-C MILLS RADIO CORP.
303 Fourth Ave., New York
Use "R-Everlast-C" "B" Batteries

Ask Your Dealer—



RADIO JACK WRENCH

Fits all Standard Jack Nuts

10c from your dealer.....12c from us
ADAMS RADIO MFG. CO.
1044 W. Van Buren St. Chicago, Ill.

RED-HEAD PHONES Used and praised the world over
3000 Ohm \$6.50 Complete with Cord and Headband.
2000 Ohm \$5.00 At your dealer's, or sent direct.
THE NEWMAN-STERN CO., Cleveland, Ohio

AMPLION The World's Standard Loud Speaker

BUILD YOUR SET WITH BARAWIK QUALITY PARTS

OUR SPECIAL VARIOMETER
B410 Variometer
 Each \$2.10
 Perfect in design and construction. Accurate wood forms thoroughly seasoned. Correct inductive reactance. Solid bakelite windings. Plenty of large sized wire insures highest efficiency. A strong high grade instrument that will give you lasting service. 3/16 inch shaft. Range 180 to 650 meters.



OUR SPECIAL VARIOCOUPLER
B418 Variocoupler
 Each \$2.45
 The most efficient type of coupler, insures better tuning and louder signals. Primary and secondary wound on a natural uncolored genuine bakelite tubes. Primary tapped for fine tuning. Can be panel or table mounted. 3/16 inch shaft. Range 180 to 650 meters.



SUPER MOULDED VARIOMETER
B412 Each \$2.48
 Polished bakelite moulded rotor and stator forms. Maximum inductance with greatest efficiency and minimum distributed capacity. A high grade instrument that will get the best results. Wave length 180 to 600 meters.



PANEL MOUNTING VARIABLE CONDENSERS
 These are especially high grade condensers and guarantee them to be mechanically and electrically perfect. Fine polished end plates of heavy bakelite. Shafts 3/4 inch diameter. Sturdy, heavy aluminum alloy plates perfectly spaced to insure smooth, even reliable capacity. Our low prices save you money.

B815 - 3 plate 38c
B816 - 5 plate 97c
B814 - 11 plate .00025 mfd. \$1.13
B813 - 21 plate .0005 mfd. 1.27
B812 - 35 plate .001 mfd. 1.47



VERNIER VARIABLE CONDENSERS
 Including Dial and Knobs
 These condensers are of the very best make and are not to be compared with many inferior, cheap condensers offered. We guarantee them to please you or your money back. The vernier style has one separately controlled plate which permits of the finest tuning.

B825 - 14 plate .00025 mfd. \$2.45
B824 - 22 plate .0005 mfd. 2.70
B826 - 14 plate .001 mfd. 2.95



SUPERIOR RADIO JACKS
 Finest grade jacks. Unimproved design. Best materials. Phosphor bronze springs. Silver contact points. Nickel finish. Mount on panels 1/2 to 3/4 in.

B390 Open circuit, Each 36c
B391 Closed circuit, Each 45c
B392 Tin circuit, Each 54c
B393 Single circuit filament control 66c
B394 Two circuit filament control 68c



SUPERIOR RADIO PLUG
B395 With Set screws for fastening cord. Each 35c



STRANDED ANTENNA WIRE
 Cabled of fine copper strands. Very flexible. High tensile strength. Best for aerials.

B248 100' coil 58c **B249 500' coil \$2.75**

ANTENNA INSULATORS
B260 Size 1x3/4, Composition, metal eyelets. Two for 17c
B263 Ribbed Porcelain Insulator, 2 1/2 in. long. Ea. 6c Dozen 55c



JEWELL LIGHTNING ARRESTER
B981 Each 85c
 A dependable protector always on guard. Small and compact. Weatherproof porcelain case. Easily fastened and connected. Underwriters approved. Lists for \$1.10.



RADIO SOLDERING IRON
B540 \$1.35
 Soldered connections in radio sets produce better results. This guaranteed iron is exactly right for radio work. A new solid connection quickly and easily made. Operates on any lighting current 100 to 120 volts. 6 ft. cord with attaching plug. Length 13 inches. Heats quickly. Will not overheat.



OTHER STANDARD BRANDS RADIO FREQUENCY TRANSFORMERS
B568 Our special—as good as any of them \$.48
B562 Dubilier, Each 3.48

SEND FOR BULLETIN SHOWING COMPLETE ERLA LINE. SENT FREE ON REQUEST.

WE PAY TRANSPORTATION CHARGES IN U. S. East of the Rockies
 PRESERVE THESE PAGES—ORDER FROM THEM AND SAVE MONEY
 FAST SERVICE—TRY US AND BE CONVINCED
OUR GUARANTEE PROTECTS YOU—We handle only the best goods, carefully tested and checked by expert radio engineers. And while our goods are low priced, we do not attempt to deceive or mislead. Our reputation for fair dealing is our most valued asset.

HOW TO ORDER—Write your Order plainly, state Article Number, Description and Price of items wanted. Send Postoffice or Express Money Order, Certified Check or Bank Draft for Total of Order. Prompt Shipment is assured when these directions are followed.

STANDARD NEUTRODYNE PARTS
B851 Licensed Neutroformer (combined transformer and condenser). Each \$4.78
B852 Licensed Neutrodyne Kit \$14.95
 Includes 3 WorkRite Neutroformers, 2 WorkRite Neutrodynes, panel layout, paper template and book of instructions.
B853 Licensed Neutrodyn, Each 43c
 A very accurate and easily adjusted condenser for neutralizing tube.

COCKADAY COILS
B298 Per Set \$1.95
 Complete set coils for Cockaday circuit. Properly calculated and made to give best results on circuit.



STORAGE "A" BATTERY
 A high grade battery. Guaranteed for three years. Made of best new materials. Full capacity. The best battery buy on the market. Try one of these batteries on your set for 10 days. If at the end of that time you are not fully satisfied with the battery return it and we will refund the purchase price.

B194 6 volt, 60 amp. size, Each \$ 9.90
B196 6 volt, 100 amp. size, Each \$13.25



HOMECHARGER BATTERY CHARGING RECTIFIER
 Charge your battery at home overnight for a few cents. Simple and easy to use. Connect to any 110 volt 60 cycle light socket, turn on current and rectifier does the rest automatically. Will work for years without attention. Simple connections. Give a full charge which batteries should have. You can make it pay a profit charging your friends' L. O. batteries. Long connecting cords with pair of battery clips.

B201 For 4 volt battery \$12.95
B203 For 12 volt battery 12.95





PLATE CIRCUIT "B" BATTERIES
 You can make real savings on these batteries. We guarantee them to equal any on the market regardless of price. Extra long life. Don't throw away your money on cheaper inferior useless batteries.

B180 Signal Corps type, small size, 15 cells, 22 1/2 volts, Each \$1.10
B182 Large size, 5 taps 16.5, 18, 19.5, 21 and 22 volts, Each \$1.45
B184 Variable Large Navy size, 6 1/2 x 1 1/2 inches, 5 taps, giving range from 16 1/2 to 22 1/2 volts in 1 1/2 volt steps, Each \$1.70
B188 Combination Tapped 45 volts, 30 cell, 13x13x3 battery. Tapped to give 45, 22 1/2, 21, 19 1/2, 18 and 16 1/2 volts. Handles both detector and amplifier tubes. Ea. \$3.28



TINNED COPPER "BUS BAR" WIRE
 Size 14 tinned copper wire. For wiring sets. Best size for neat job and easy soldering.

B957 Round, Ten feet for 12c
B958 Square, Ten feet for 14c

SPAGHETTI
 For covering connecting wires in sets. For size 12 and 14 wires.

B955 Finest quality braided and saturated with best baked lustrous transparent insulating varnish, 3 feet for 19c
B956 Best quality braided and covered with black insulating compound, 3 feet for 9c

RADIO SWITCH
B287 Each 28c
 Cuts current on and off instantly by a push or pull. Very neat. Well made. Durable. Saves tubes and batteries.



BARAWIK QUALITY HEADSETS
B770 Per Set, 2000 ohms \$2.60
 These headsets have proven on rigid tests to be one of the very best on the market. The tone quality is excellent with an unusual volume. The receiver cases are fine polished finish with polished black ear pieces. Comfortable fabric covered head band. Supplied with 5-foot cord. These sets were designed to sell for much higher prices than we ask and at our price are a wonderful bargain. We guarantee that you will be pleased with them.

STANDARD BRAND HEADSETS
B754 Baldwin Type C with universal Jack plug \$8.95
B764 Frost, 3000 ohm 3.30
B766 Frost, 5000 ohm 3.25
B751 Murdock 56, 2000 ohm 3.25
B752 Murdock 56, 3000 ohm 3.90
B768 Brandes Superior, 2000 ohm 5.25
B769 Brandes Navy, 3000 ohm 6.95



VACUUM TUBES
 Standard Brands—Cunningham, Radiotron. Every one guaranteed new and perfect. We will ship brand in stock unless you specify otherwise.

B105 Detector UV200 C500 Each \$4.45
B112 Amplifier, UV201A C301A Each 4.45
B118 5-Watt Transmitter 7.70
B107 WD11 C11, Each 4.45
B101 WD12 C12, Each 4.45
B102 UV199 C299, Each 4.45
B104 UV199 Adapter fits 199 tube to standard socket43
B108 WD11 Socket, Each34
B109 WD11 Adapter, Each42



BAKELITE TUBE SOCKET
B140 Standard base 39c
B141 UV199 base .39c
 Moulded of genuine red brown bakelite. Binding post connections. For table or panel mounting. Neat and strong.



FILAMENT CONTROL RHEOSTATS
B132 6 ohm, Each 38c
B139 20 ohm, Each 40c
B131 20 ohm, Each 44c
B135 6 ohm Vernier, 95c
 Best grade. Will give real service. Durable and lasting. High heat resistant base, diam. 2 1/2 in. Tapered polished black knob 1 1/4 in. diameter. Potentiometers. Match above rheostats. Same high grade construction.

B151 200 ohm, Each 50c
B152 400 ohm, Each 55c



STANDARD BRAND VARIABLE GRID LEAKS
B177 Freshman back of panel style 59c
B178 Freshman back of panel style with .00025 Condenser 79c
B171 Freshman base mounting type with .00025 Condenser 79c

DUBILIER MICADON TYPE 601
B502 .0001 28c **B507 .0025** 32c
B503 .0025 28c **B508 .001** 40c
B504 .005 28c **B509 .001** 40c
B505 .001 32c **B510 .005** 48c
B506 .002 32c **B511 .006** 60c



SWITCH CONTACT POINTS
 Brass polished nickel finish. All have 5/8 in. long size 6-32 screws and two nuts. All prices the same.

Dozen 15c **Hundred \$1.00**

Order by Article Number.
B360 Head, 3/4" diam., 3/4" high
B362 Head, 3-16" diam., 3/4" high
B363 Head, 3-16" diam., 1-16" high

Solder Lugs to Fit Contact Points
 Also for connecting wires to binding posts, etc.

B365 Dozen 8c **Hundred 30c**



SWITCH LEVER STOP
 Brass polished nickel finish.
B386 Dozen 18c **Hundred \$1.05**



SWITCH LEVERS
 Very neat polished black composition knob. Exposed metal parts polished nickel finish. Fitted with panel bushing and two set nuts. A high grade switch.

B381 1 1/4" Radius, Each 14c



BINDING POSTS
 Brass, polished nickel finish. Washer and 6-32 in. screw extending 3/4 in.

B570 Large size—barrel and knob 3/4" long. Dozen 70c
B370-2-4 **B372 Smaller size** B376-8
 barrel and knob 9-16" long. Dozen 70c
B374 Large size with composition knob 45c
B376 Large size with hole for phone tin wire, Dozen 80c
B378 Small size with hole for phone tin wire, Dozen 35c



OUR SPECIAL AUDIO FREQUENCY AMPLIFYING TRANSFORMERS
B550 Each \$2.25
 In quality of tone and volume of sound, nothing a transformer is built for we guarantee it to equal or surpass any other transformer. Neat in appearance. Carefully made. Fully mounted with plainly marked binding post connections. Wonderful results on one, two or three steps without distortion or howling. A quality item in every respect.



OTHER STANDARD BRANDS AUDIO FREQUENCY TRANSFORMERS
 Fresh Clean Stock in Original Containers
B232 THORADSON Ratio 3 1/2 to 1 \$3.30
B233 THORADSON Ratio 6 to 1 3.70
B553 Acme, Each 4.20

TRICOIL RADIO FREQUENCY AMPLIFYING TRANSFORMER
B560 For 201A or 301A Tubes \$1.58
B561 For 199 or 11 or 12 Tubes 1.58
 This transformer will produce wonderful results in any type of regular or reflex radio frequency circuit. Perfect for one, two or three stages. Compact, convenient form, easily mounted. Range 175 to 600 meters.



CABINETS
 Fine looking cabinets solidly built. Elegant hand rubbed mahogany finish. You will be proud of your set mounted in one of these cabinets. Hinged tops. Front rabbeted to take panels. Panels not included. Prices are transportation paid. Note that our prices are prepaid.



Panel Size	Inside Dimensions (High) x (Wide) x (Deep)	Art. No.	Price Each
6x7	5 1/2" x 7 1/2" x 7"	B420	\$1.95
6x10 1/2	5 1/2" x 10" x 7"	B422	2.45
7x14	6 1/2" x 13 1/2" x 7"	B423	3.20
7x18	6 1/2" x 17 1/2" x 7"	B424	3.45
7x21	6 1/2" x 20 1/2" x 7"	B425	3.85
7x24	6 1/2" x 23 1/2" x 7"	B429	4.35
7x26	6 1/2" x 25 1/2" x 7"	B431	5.50
9x14	8 1/2" x 13 1/2" x 10"	B428	3.55
12x14	11 1/2" x 13 1/2" x 10"	B430	4.00

RADIO "BAKELITE" PANELS
 Notice our very low prices on this fine quality material. We supply genuine Bakelite Condensers, Formulas, all of which are materials with practically identical mechanical, chemical and electrical properties. Machines well without chipping. Highest mechanical and dielectric strength. Attractive natural polished black finish which can be sanded and oiled.

Panel Size	Art. No.	Price	Art. No.	Price	Art. No.	Price
6x7	B450	\$5.55	B460	\$8.89	B470	\$1.15
6x10 1/2	B451	.86	B461	1.10	B471	1.73
7x14	B458	1.38	B468	1.73	B478	2.76
7x18	B453	1.78	B463	2.27	B473	3.45
7x21	B457	2.05	B467	2.65	B477	5.10
7x24	B459	2.42	B469	2.97		
7x26			B462	3.25		
9x14	B454	1.85	B464	2.35	B474	3.56
12x14	B455	2.42	B465	2.97	B475	4.78

COMPOSITION DIALS
B921 Diam. 2 in. for 3-16 in. shaft. Ea. 16c
B922 Diam. 2 in. for 1/4 in. shaft. Ea. 16c
B923 Diam. 3 in. for 3/8 in. shaft. Ea. 22c
B924 Diam. 3 in. for 1/2 in. shaft. Ea. 22c
B925 Diam. 3 1/2 in. for 3/4 in. shaft. Ea. 27c
 Lustrous dials moulded in one piece of polished black composition. 2 inch size has 270° scale marked 0 to 100 finely engraved in contrasting white enamel. 3 and 3 1/2 inch size have 180° scale marked 0 to 100.

SUPERIOR INDUCTANCE SWITCH
B288 Each 85c
 Quickly and securely mounted by drilling one hole. Only knob and pointer show in front of panel. Connections can be soldered before fastening switch, making assembly much easier.



NICKEL PLATED BEZELS
B399 Diameter 3/4 inch, Each 15c
B400 Diameter 1 1/2 inch, Each 15c

STANDARD BRAND LOUD SPEAKERS AND TUNTS
B613 Parawak Special \$8.95
B615 Pathe Loudspeaker 15.95
B616 Atlas Loudspeaker 22.50
B612 Magnavox K3 Loudspeaker 29.50
B614 Magnavox M1 Loudspeaker 29.50
B617 Music Master Loudspeaker 27.00
B755 Genuine Baldwin type C unit, 5.50
B618 Brandes Pathe Loudspeaker 9.25
B620 Baldwin Loud Speaker 22.50
B608 Atlas Unit, Each 10.75

SEND FOR FREE BULLETIN SHOWING PRICES ON APPARATUS NOT LISTED IN THIS AD.

The Effect of Fog Upon Radio Signals

(Continued from page 187)

from the broadcast stations, although the signals from the government station NAA, at Arlington, Va., on 2,650 meters, were of normal intensity on the same receiver. It was also possible to tune in the signals of ships and shore stations on 600 meters, but they were of considerably less than normal intensity. It appears that the signals from the stations transmitting on the longer wavelength are less affected by fog than are those on the short wave-lengths. However, these observations are not conclusive since station NAA and many of the ships employed several times the power at the transmitter as the broadcast stations.

FOG ISOLATES STATION

The second series of observations were much like the first, except that they show how fog in the vicinity of the transmitting station will prevent signals carrying to any great distance. The setting for these observations embraces three transmitting stations as follows: Station 3ZZ, at Craddock, Va.; station 3ACK, at Portsmouth, Va., three miles northwest of station 3ZZ; and station 3BNU, at Bethlehem, Pa., about 300 miles north of 3ZZ. Communication was established between stations 3ZZ and 3BNU during the procedure. After an hour of unbroken communication between 3ZZ and 3BNU, the air in the vicinity of 3ZZ suddenly became dead. The signals from 3BNU could no longer be heard at 3ZZ, and at this point 3ACK reported to 3ZZ that he could still hear the signals of the distant station 3BNU and that 3BNU was reporting the fact that he could no longer hear the signals of 3ZZ. An investigation disclosed the fact that a very heavy fog had drifted in from Dismal Swamp engulfing station 3ZZ and was heading in the direction of station 3ACK three miles away. The operator at 3ACK continued hearing signals from 3BNU and other distant stations for perhaps half an hour when the fog had reached his station with the same effect as that experienced at 3ZZ.

SWAMP PRODUCES PECULIAR INTERFERENCE

The third series of observations disclosed the fact that a large expanse of swamp land in the vicinity of a transmitting station is one reason why receivers several hundred miles away can hear the signals consistently, while others located between 50 and 100 miles from the station are unable to pick up the signals.

The presence of Dismal Swamp has always been a bugbear to the consistent operation of station 3ZZ in preventing communication, after sunset, with stations located about 50 miles distant on the opposite side of the swamp. Communication in the daytime was not affected by the presence of the swamp. No fog is present in the swamp in the daytime under ordinary conditions.

In order to learn more about this peculiar effect, arrangements were made for a test with station 4EK in Elizabeth City, N. C., directly across the swamp from station 3ZZ and about 35 miles distant. The operator at 4EK remained on watch at his instruments, standing-by for the scheduled call from 3ZZ every half hour beginning at about 4 p. m., and continuing until well after sunset. As long as daylight lasted, communication was very consistent, but about two hours after sunset, which is the time fog usually appears in the swamps, it was impossible to pick up signals in either



The Super-De Luxe Dial

The Na-ald Super-De Luxe Dial is the crowning achievement of dial design and manufacture. It is a truly beautiful creation, which gives that final touch of dignity and attractiveness to the quality set.

All Na-ald dials express beauty. They have generous knobs which fit fingers perfectly and help to tune. Graduations, placed on the bevel of Na-ald Dials, are even, and marked with a permanent, brilliant white.

Na-ald dials are made of genuine Bakelite, with patented construction. They are trued with a diamond and provided with a generous-sized, positive-gripping set screw. No special screw driver is required for setting.

- Na-ald Super-De Luxe (with large knob).....\$1.00
- Na-ald 3 7/8" Dial75
- Na-ald 3" Dial 35c, or 3 for 1.00
- Na-ald 2" Dial 35c, or 3 for 1.00

The new rotograde booklet, "What to Build" now packed with each Na-ald product. If your dealer's stock hasn't this, send cover of any Na-ald carton or 15c for it.

ALDEN MANUFACTURING COMPANY
DEPARTMENT K, SPRINGFIELD, MASS.

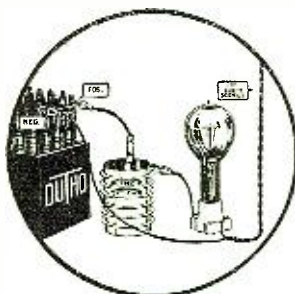

Don't blame summer static when it is the fault of your dry cell "B" Battery—use

SUPER-DUTHO Rechargeable Storage "B" BATTERIES

They give a constant plate current superior to any other "B" Battery—at a much lower price. Dutho "B" Batteries have every essential of any good battery and many exclusive features. Super-Dutho (Type L) has special Hydrometer, which shows exactly how and when to recharge. No more guesswork necessary. Upon receipt of purchase price, shipped anywhere, fully charged, but dry—with solution in separate container.

Write for booklet on Storage "B" Batteries

DURKEE-THOMAS Products Co.
1228 Folsom Street, San Francisco

Duthoid \$1.80
Chemical Rectifier charges up to 90 volts at one time

You need this "B" Battery to get perfect reception—loud—clear—uninterrupted

Here's what they cost you delivered

Super-Dutho 3500 ma hours
24 v \$9
45 v \$17
90 v \$32

S Type Dutho 750 m a hours
24 v \$5
45 v \$9
90 v \$17

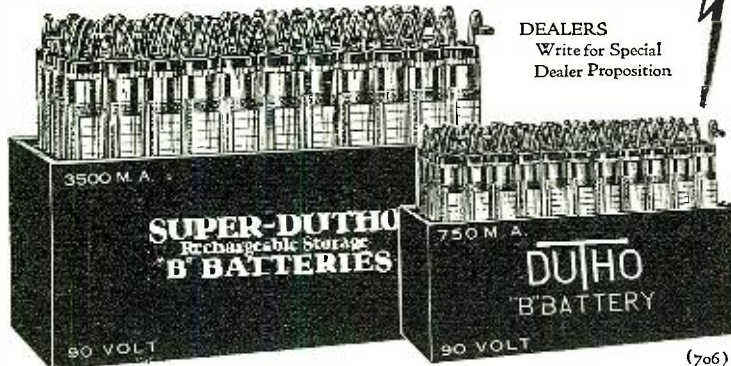

DEALERS
Write for Special Dealer Proposition

(706)

Insure your copy reaching you each month. Subscribe to Radio News—\$2.50 a year. Experimenter Publishing Co., 53 Park Place, N. Y. C.

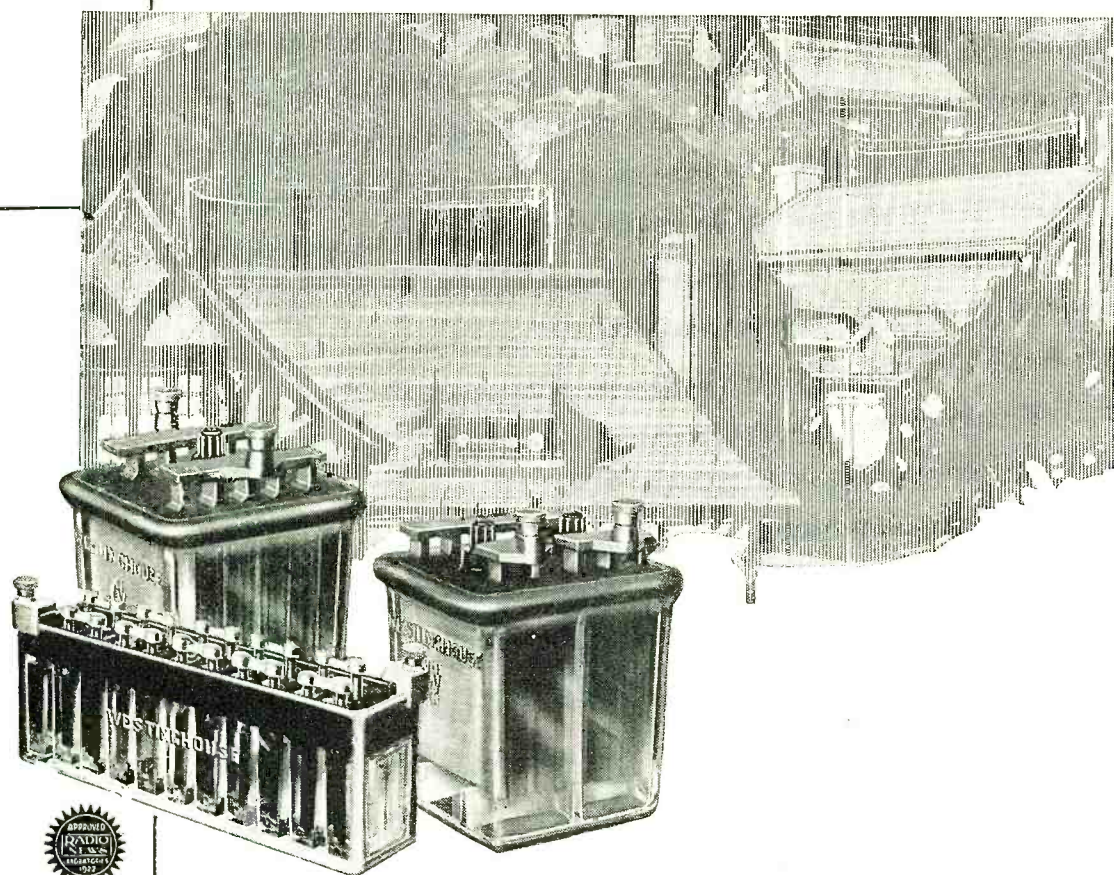

FULL voltage battery current all the time! That's what you want. Westinghouse Radio Storage Batteries will give it to you. No more operating with run-down batteries! No more sudden drops in battery voltage! No more throwing away worn-out batteries! Westinghouse Batteries last. They hold their charge. They can be easily recharged. There's a size and type for every radio need. Built by Westinghouse, you *know* it's **RIGHT!**

Westinghouse **CRYSTAL CASE** Batteries have one-piece clear glass cases, with solid glass cell partitions and high plate rests (deep sediment spaces). Perfectly insulated against current leakage. "A" Batteries. 2 volts, for low-voltage tubes, such as WD-11 and WD-12. 4 volts, for tubes like UV-199. 6 volts, for tubes UV-201A or C-301A. Also rubber-case types. "B" Batteries. 22 volts. Regular and quadruple-capacity types. "C" Batteries in 6-volt units.

WESTINGHOUSE UNION BATTERY CO., Swissvale, Pa.

WESTINGHOUSE

RADIO

"A," "B" and "C"

BATTERIES

Specializing in the manufacture of
BRASS V. T. SOCKET SHELLS
 in quantities of 10,000 or more.



BRASS AUTOMATIC SCREW MACHINE PARTS

Quick Deliveries, Guaranteed Accuracy
 and prices which will interest you
 Send Sample or Blue Print for Estimate

THE TORRINGTON MFG. CO.
 TORRINGTON, CONN.

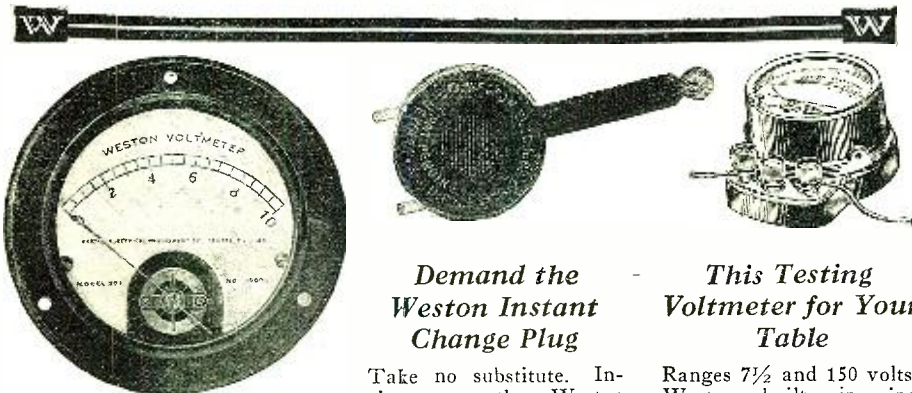

Prolong the Life—

by operating tubes at correct filament voltage. This Model 301 Weston Voltmeter costs little more than a tube. You need it for quick tuning and good reception. Case diameter 3 1/4 in.

**Demand the
 Weston Instant
 Change Plug**

Take no substitute. Insist upon the Weston Instant Change Plug. Interchangeable in 2 seconds. No tools. Its superiority admitted everywhere. Get one today.

**This Testing
 Voltmeter for Your
 Table**

Ranges 7 1/2 and 150 volts. Weston built, insuring lifetime service and satisfaction. One of seven described in Circular J. Write today for full particulars.

WESTON ELECTRICAL INSTRUMENT CO., 173 WESTON AVE., NEWARK, N. J.

Electrical
 Indicating
 Instrument
 Authorities
 Since 1888

WESTON

STANDARD - The World Over

DUCK'S 5 Tube Super Tuned Radio Receiver \$120.00.
 Extreme simplicity of operation, wonderful selectivity, unmatched tone and maximum volume. The finest workmanship and highest quality instruments characterize this receiver. Backed by 16 years of continuous radio experience. Sold on money back guarantee.

4 Tube "Bear-Cat" Tuned Radio Receiver \$95.00. Same workmanship and quality of instruments as in our 5 tube set.

Jobbers and Dealers, write for literature and proposition. Literature mailed to anyone on request.

Our 256 page radio catalog No. 16 mailed for 25c in coin. Not sent otherwise.

The William B. Duck Co., Dept. 3 711-12 Adams St., Toledo, Ohio

BATTERY CHARGER \$7.75

Electrolytic type—Noiseless—Direct or alternating current—no bulbs or contact points to burn out. Charges auto batteries. Sold direct to you from factory.

WESTERN RUBBER MOLD CO.
 907-913 W. 19th St. Chicago, Ill.

RADION

The Supreme Insulation

Panels, Dials, Sockets, Knobs, Insulators

AMERICAN HARD RUBBER CO.
 11 Mercer St. New York

direction and repeated calls on schedule failed to bring any response.

At about 10 p. m., after all attempts at re-establishing communication had failed, the operator at 3ZZ tuned in station 2RK in Brooklyn, N. Y., who, to the astonishment of the operator at 3ZZ, was communicating with 4EK in Elizabeth City, N. C. The signals of station 4EK were strong and constant at station 2RK in spite of the fact that they could not be heard at 3ZZ. This condition would tend to indicate that the fog of the swamp deflected the waves so as to produce a "shadow" similar to that produced by a high mountain. Station 3ZZ being in this shadow could not hear the signals of 4EK, although they were picked up with good intensity in Brooklyn, N. Y., about 300 miles away. The waves were going right over our heads, but did not seem to produce any effect on the ether in our location in the shadow. This theory was further strengthened when communication was established between station 3ZZ and station 4BY in Savannah, Ga., a few minutes later. This time the signals from station 3ZZ were going right over station 4EK without being heard, although they were reported strong and steady at Savannah.

While this report is not intended to emphasize the presence of fog as a cause of fading radio signals, it is plain to see from the foregoing observations that a heavy fog shifting about the vicinity of a broadcast station will have a tendency to cause the signals to fade badly at the distant receivers. These observations are in no manner conclusive, but they are very significant and should furnish a basis for further investigation along the same lines.

New QRA'S
 (Continued from page 185)

- 2AHK—Nelson Palmer, Roosevelt Apts., Poughkeepsie, N. Y. 5 watts C.W. Will QSL all crds.
 - 9DWV—Sam Woodson, Jr. RFD 4, Box 2, Liberty, Mo. 10 watts C.W. Pse QSL.
 - 3HI—Milton W. Hickman, 81 Cove St., Crisfield, Md. 2 watts C.W. All crds answd.
 - 5APM—Tom Serur, Box 146, San Marcos, Texas. 5 watts I.C.W. Reports on sigs appreciated. Will QSL.
 - 8DMA—Vernon S. Foote, 1442 Milton St., Grand Rapids, Mich.
 - 8DOW—Robert S. Brown, 521 S. Paris Ave., Grand Rapids, Mich.
 - 5WC—(re-assigned) J. B. Gaines, 724 S. Winnetka St., Dallas, Tex. 10 watts C.W. and Fone. QSL's answd.
 - 4DY—(re-assigned) David Walker, 836 E. Anderson St., Savannah, Ga. 50 watts C.W. All crds answd.
 - 9EJN—Frank H. Barrett, 1637 Cook St., Denver, Colo. Will QSL all crds.
 - 3SJ—James Lazzatti, Box 34 Finderne, N. J.
 - 8AJF—(re-assigned) Edward Roy, 3802 Dover Ave., Cleveland, Ohio. Will QSL all crds.
- Correction—3MD (Portable 3KB) S. Sabaroff, 2936 W. Norris St., Philadelphia, Pa.



Stations You Want When You Want Them

At one time or another you have heard most all of the big stations. That proves your set has the power to reach out and get them. But can you hold them? Do you have to retune constantly?

Steady current in the plate circuit will help you. Willard B's give you this type of current, because they can be kept at full capacity at all times, and they are practically free from the internal electric leakage which causes unsteadiness in some batteries.

Willard Radio Battery equipment all the way through the set is the ideal line up. That's why so many Broadcasting Stations use Willards in their own receiving sets.

Your Willard Service Station or Radio dealer will be glad to demonstrate the superiority of Willard Radio Batteries. Ask him for booklet "Better Results from Radio," or write direct to the Willard Storage Battery Company, Cleveland, Ohio. In Canada, Willard Storage Battery Company of Canada, Limited, Toronto, Ont.

Willard Rechargeable Batteries for Radio

Have you heard WTAM,
Willard's own Broadcasting
Station? Wave length 390
meters.



Willard B Batteries

Willard Rechargeable B Batteries are made in two types, one of 2,500 m. a. h., the other of 4,500 m. a. h. capacity. Each of these types can be purchased in 24 or 48 volt units. Glass jars enable you to see the condition of your battery at all times and help prevent electrical leakage.



Willard A Batteries

Good A Batteries are as important as good B Batteries. There are several types of Willard A Batteries in a range of prices, including the Willard All-Rubber A Battery, with rubber case and Threaded Rubber Insulation. Capacities from 90 to 120 ampere hours.



For Peanut Tubes

A leak-proof, noise-free storage battery that costs little, lasts for years and has many advantages over the ordinary peanut tube battery. See your Willard Dealer, or send for descriptive literature.

WM. JUSTICE LEE
JACKSONVILLE, FLORIDA
P.O. BOX 373

March 7th, 1924.

The Electric Specialty Co.,
Stamford, Conn.

Gentlemen:

You will be interested to hear of the results obtained from the type 11-A 1000 volt, 300 watt motor generator set purchased from you thru the Chase Co. Jacksonville.

This little generator operating at Radio 4XE, has furnished the plate current for 2-way communication with amateur stations in Canada, Porto Rico, France and Holland. When you consider that such a distance of over 5000 miles can be spanned with a power supply of actually 330 watts, (10% overload) and that this motor generator set does the work in first class manner, it seems quite remarkable.

We believe the Esco generator to be the best and most conservatively rated of any we have used to date.

You may use this letter if you please.

Yours truly,

Cooper and Lee
Owners of Experimental Station 4XE

WJL/MP

TRADE **"ESCO"** MARK
Quality always Supreme
ELECTRIC SPECIALTY COMPANY
STAMFORD, CONN., U. S. A.

THE ULTRADYNE and— "Modulation"

The ULTRADYNE is the improved Super-Heterodyne, that employs the special system of "Modulation" as developed in a famous research laboratory by ROBERT E. LACAULT, A.M.I.R.E., one of the best known Radio Experts in America and Associate Editor of RADIO NEWS.

The ULTRADYNE is the latest word in high powered RADIO sets. The Modulation system amplifies the weak signals to such a high degree that the faintest impulses on the Aerial are magnified and made audible in the Loud Speaker.

The CONSRAD Pattern No. 10 tells you how to build the ULTRADYNE. It includes Blueprints for Drilling the panel, wiring diagrams, etc., all complete, ready for the man who wants to build this set.

PRICE

50^c

POSTPAID



Pattern No. 10 consisting of full sized Blueprint 18 x 29 inches, four page instruction folder with constructional details; in two color printed envelope 9 x 12 inches.

THE CONSRAD COMPANY, Inc.
233 Fulton Street New York City

THE GOODYEAR RADIO CLUB

There is in existence among employees of the Goodyear Tire and Rubber Company an organization known as the Goodyear Radio Club, which has a membership of approximately 200.

The members range from the office boys to the executives, and include members of the sales force, as well as of the engineering department.

The club has in process of construction a special laboratory where the educational development of its members and the active research on the part of the engineering profession represented in its personnel will be carried on. The club has, and expects to entertain, national speakers of repute in the field of radio broadcasting.

"LISTENING IN" IN LOMBARDY

The Italian society "Amici del'Arte" has constituted a new branch of its activities, the "Radio Club Lombardo," with headquarters at Milan, via Amedei 8, and with sections in other cities and towns of Lombardy.

It appears to be the intention of the organization to encourage students and amateurs of radio communication, to advance the adoption and improvement of radio, promoting and supporting the erection of well-organized distribution stations and obtaining for the members of the club all possible facilities for the purchase of apparatus and for obtaining the necessary license, etc.

The society's activity is so far seriously limited by the fact that while a person or an organization may purchase a radio outfit, it has been up to the present time impossible to obtain the Government's sanction to use it. The scope of the new club will, therefore, undoubtedly be more educational than otherwise, until the Italian Government announces its decision relative to radio work in this country.

This club would be interested in receiving any publication on radio activities in the United States, Consul C. Carrigan reports.

CANADIAN 4CR GETS ACROSS

A radio message transmitted by Canadian Amateur Radio Station 4CR, operated by B. G. Jones, 588 Lipton Street, Winnipeg, was picked up by F. C. Hogg, 57 Bishop's Road, Highgate, London, England.

This is the first instance that a Manitoba station has bridged the Atlantic and amateur radio officials now look forward to establishing two-way communication between Winnipeg and the Old Country on the restricted low wave-length.

Station 4CR has been heard in Alaska and Mexico, and was the first station to pick up signals of a trans-Atlantic amateur, having logged 8AB at Nice, France.

DENMARK TALKS TO CHICAGO

What is thought to be the first actual radio message sent from Denmark and delivered in Chicago was received May 11, at 1:30 a. m. central standard time. It was for Mr. Lawrence W. Mammen, a certified public accountant. The message was simple, reading: "Brother Alfred and family in Denmark send best wishes. Please confirm reception by letter." This message was picked up and telephoned to Mr. Mammen by amateur station 9XBF, also called 9BT, operated by Mr. E. C. Page at 725 Noyes Street, Evanston, Ill. It was received from Cambridge, Mass., Station 1XAH relaying it from the British Station 5GV. The Danish station sending the message was not given.

CICO
Automatic Plugs

Instantaneous connection. Just insert cord tips. No tools. Nothing to take apart. Price80c

Consolidated Inst. Co. of America, Inc.
41 East 42nd St., New York

IN THE FOREFRONT

TUSKA
TRADE MARK
REQUIREMENT OF
RADIO

Tuska Superdyne, four tubes, produces astonishing results in distance-getting. High quality, too. Why use eight tubes when four are plenty?

The C. D. Tuska Co.,
Hartford, Conn.

TUSKA RADIO

125 Leading Radio Manufacturers Use Formica!

AND Prof. Michael Pupin of Columbia University says: "What the amateur really needs to know is which one material will give him the best and most lasting service. Probably the best way for him to discover this ideal material is for him to find out what the great makers of really dependable radio sets are using."

Judge radio insulation as Prof. Pupin suggests and you are sure to choose Formica. A product is known by the customers it keeps and from that standpoint Formica leads all the rest in radio insulation.

Amateurs everywhere know these facts. They know that Formica gained its position by more uniform quality, better finish, and by leading the trade in the development of beautiful new finishes like Mahogany, and advances like the production of a panel with an absolutely pitless surface.

Dealers feel the pressure of the universal popularity of Formica in their stores every day. They find Formica service, Formica advertising and sales helps, the best in the business.



THE FORMICA INSULATION COMPANY

4618 Spring Grove Avenue, Cincinnati, Ohio

Sales Offices

50 Church St., New York, N. Y.
422 First Ave., Pittsburgh, Pa.
1142 Granite Bldg., Rochester, N. Y.
419 Ohio Bldg., Toledo, Ohio

1210 Arch St., Philadelphia, Pa.
1026 Second Ave., S. Minneapolis, Minn.
585 Mission St., San Francisco, California
Whitney Central Bldg., New Orleans, La.

516 Caxton Bldg., Cleveland, Ohio
9 S. Clinton St., Chicago, Ill.
708 Title Bldg., Baltimore, Md.
47 King St., Toronto, Ontario

FORMICA

Made from Anhydrous Bakelite Resins
SHEETS TUBES RODS



MILLER

The Ideal

RADIO HORN

Miller Radio Horns of inert, cellular rubber with a hard, reflecting outside surface, give ideal acoustical results with any instrument. They give utmost assistance in the reproduction of natural tones throughout the audible range.

Durable and beautiful, these horns are not affected by any weather or climatic conditions. Will not chip, peel, warp or crack.

Made in four standard sizes in any quantity desired, or specially built according to specifications. Our prices are competitive.

The Miller Rubber Co. of N. Y.
AKRON, OHIO U. S. A.



This proves again the high value of the amateur service and their international organization, that makes such a practical test possible.

PLEASE NOTE!

Would like to communicate with H. B. Blackman and Albert Glaser, both commercial brass pounders.

A. L. FARAGO. RMlc, U. S. N.
U. S. Naval Radio Station,
Guantanamo Bay, Cuba.

Calls Heard

- 2AKJ, FREEHOLD, N. J.
- 1ADN, 1AEZ, 1AF, 1AGH, 1AHZ, 1AJ, 1AJZ, 1AMI, 1ANR, 1AOB, 1ABM, 1ARH, 1ARP, 1ARY, 1ASD, 1ASF, 1ATJ, 1AUR, 1AW, 1AY, 1BCD, 1BDI, 1BEL, 1BER, 1BES, 1BET, 1BGA, 1BGN, 1BHR, 1BIS, 1BKA, 1BKO, 1BNG, 1BOG, 1BOI, 1BOO, 1BOD, 1BOM, 1BRB, 1BRI, 1BRQ, 1BSZ, 1BTT, 1BVR, 1CAB, 1CDO, 1CGR, 1CGS, 1CIK, 1CJH, 1CKP, 1COP, 1CRE, 1CRU, 1CSW, 1CTT, 1CUH, 1FD, 1CL, 1HN, 1IV, 1KX, 1LC, 1LT, 1MC, 1MX, 1OE, 1ON, 1RD, 1SU, 1VC, 1VV, 1XAA, 1XM, 1XZ, 1XB, 1YD, 1XK, 1BQQ, 1ER, 1ASK, 1ARP, 1BZL, 1AMM, 1BOO, 1JV, 1AVJ, 1AW, 1AFP, 1TV, 1HR, 1HX, 1GS, 1CUN, 1KC, 1AZ, 1VA, 1KW, 1BOK, 1CIB, 1BEP, 1AJX, 1AZT, 1ARJ, 1CMP, 1BLN, 1GR, 1AFA, 1EZ, 1RR, 1UO, 1CPI, 1ZH, 1ASU, 1AXO, 1UO, 1UJ, 1BRK, 1AYI, 1IJ, 1AJT, 1WO, 1AQM, 1CI, 1AQY, 1BVD, 1CPA, 1CSX, 1MQ, 1NT, 1BBE, 1ACB, 1XK, 2s too numerous to mention. 3AAO, 3AB, 3ACV, 3ADV, 3AEC, 3AEN, 3AHP, 3AHV, 3AJJ, 3ALM, 3ANO, 3AQR, 3ARO, 3ASV, 3AWA, 3BCH, 3BD, 3BFW, 3BIF, 3BLO, 3BMO, 3BMZ, 3BQX, 3BRC, 3BRW, 3BSS, 3BTR, 3BUC, 3BV, 3BVA, 3BVC, 3BVL, 3CAH, 3CBB, 3CC, 3CEL, 3CHG, 3CS, 3DS, 3BZ, 3DZ, 3EB, 3FP, 3GN, 3GT, 3HK, 3II, 3JJ, 3LD, 3MB, 3PG, 3PS, 3PZ, 3QW, 3SU, 3TB, 3TJ, 3WW, 3XM, 3YV, 3ZO, 3ZV, 3ZW, 3ZZ, 3JT, 3AEK, 3CAQ, 3CEJ, 3UK, 3CCX, 3ABJ, 3CEZ, 3IW, 3ALN, 3BTI, 3CFI, 3OO, 3ACC, 3JY, 3AEZ, 3AS, 3YP, 3BCN, 3AJW, 3OM, 3ALE, 3ZAX, 3ADN, 3MV, 3TA, 3UJ, 3IA, 3TF, 3BA, 3OI, 3CHH, 3BVL, 3ZI, 3BDU, 3XI, 3AFP, 3BWI, 3BUS, 3EK, 3ZT, 3BMS, 3CJB, 3ADA, 3BTA, 4AF, 4AI, 4BA, 4BQ, 4BX, 4BY, 4EA, 4EB, 4EF, 4EL, 4EP, 4FA, 4FG, 4FT, 4HS, 4KC, 4KL, 4KZ, 4LT, 4MB, 4NV, 4OF, 4IJ, 4AH, 4AJ, 4OL, 4OO, 4EQ, 4IR, 4RR, 4ER, 4EB, 4DB, 4PD, 4ABW, 4HN, 4ZL, 4FZ, 4JK, 4HI, 4OL, 4CS, 4IT, 4LA, 5AIR, 5AJP, 5AP, 5DN, 5EK, 5ER, 5JO, 5JS, 5JV, 5LB, 5MO, 5UP, 5VV, 5XK, 5XA, 5ZAX, 5HK, 5AKN, 5KM, 5AMJ, 5AFQ, 5HL, 5ADH, 5ACM, 5AEC, 5XV, 5ABY, 5AMH, 6CK, 6CNH, 6AT, 7SC, 8AAF, 8AAL, 8AA, 8AAJ, 8AAL, 8AB, 8ABH, 8ABL, 8ADA, 8ADH, 8AEA, 8AEN, 8AEN, 8AFQ, 8AFU, 8AGC, 8AGG, 8AGO, 8AGO, 8AHA, 8AIA, 8AIG, 8AIK, 8AIM, 8AIQ, 8AIB, 8AIB, 8AIP, 8AJT, 8AJY, 8AKO, 8ALF, 8ALT, 8AMC, 8AMM, 8AMQ, 8AMR, 8AMU, 8ANM, 8ANP, 8AOK, 8AOL, 8AOS, 8APN, 8APT, 8AOA, 8AOP, 8ARB, 8ARD, 8ARF, 8ARL, 8AVT, 8AWF, 8AXX, 8BAU, 8BAY, 8BBF, 8BBT, 8BBU, 8BBW, 8BCH, 8BCI, 8BCK, 8BCP, 8BCU, 8BDA, 8BDB, 8BDP, 8BDR, 8BDV, 8BEF, 8BEK, 8BF, 8BFC, 8BFM, 8BFO, 8BFR, 8BFU, 8BFY, 8BGE, 8BHF, 8BHU, 8BIA, 8BIO, 8BIX, 8BK, 8BKL, 8BKY, 8BLG, 8BMB, 8BNF, 8BMH, 8BNK, 8BNH, 8BNN, 8BNU, 8BOA, 8BOD, 8BOM, 8BOW, 8BOY, 8BOZ, 8BP, 8BPH, 8BPN, 8BQI, 8BRM, 8BRT, 8BRU, 8BRX, 8BSF, 8BSI, 8BTV, 8BUX, 8BYD, 8BVR, 8BVT, 8BVN, 8BX, 8BXH, 8BXM, 8BXT, 8BNV, 8BXX, 8BYI, 8BYN, 8BYO, 8BYD, 8BZC, 8BZD, 8CAZ, 8CCO, 8CDD, 8CDC, 8CED, 8CEI, 8CEJ, 8CEO, 8CF, 8CFD, 8CFP, 8CFQ, 8CFE, 8CEJ, 8CGU, 8CGV, 8CGX, 8CHB, 8CIA, 8CJC, 8CKF, 8CKO, 8CLI, 8CON, 8CP, 8CPK, 8CPX, 8CQH, 8CRB, 8CRV, 8CSE, 8CTD, 8CTP, 8CTZ, 8CUQ, 8CUV, 8CUX, 8CVT, 8CZZ, 8DAA, 8DAE, 8DAJ, 8DAT, 8DRF, 8DBL, 8DCI, 8DDT, 8DDY, 8DEC, 8DED, 8DGI, 8DGN, 8AGO, 8DGV, 8DIE, 8DII, 8DID, 8DIF, 8DJR, 8DKI, 8DKL, 8DLA, 8DLH, 8DX, 8FO, 8FM, 8FU, 8GP, 8GU, 8GZ, 8HD, 8HG, 8HF, 8HJ, 8HN, 8IJ, 8JJ, 8KG, 8KH, 8KJ, 8MT, 8MZ, 8NB, 8NZ, 8OD, 8OM, 8OS, 8PD, 8PJ, 8PI, 8PT, 8QD, 8QK, 8RI, 8RM, 8RR, 8RY, 8SD, 8SE, 8SJ, 8TC, 8TJ, 8TT, 8UE, 8UP, 8UP, 8VP, 8VO, 8WA, 8XE, 8YAF, 8YN, 8YR, 8ZD, 8ZP, 8ZO, 8ZZ, 9AAR, 9ADC, 9APY, 9AEM, 9AGB, 9AGL, 9AHI, 9AHY, 9AIM, 9AIO, 9AIP, 9AMB, 9AMU, 9AND, 9ANP, 9ANY, 9APS, 9AOV, 9ARP, 9APD, 9ARH, 9ARP, 9ARS, 9ARZ, 9ARZ, 9ASE, 9ASH, 9ATZ, 9AHV, 9AVN, 9AWR, 9AWT, 9AZH, 9BAC, 9BAK, 9BAZ, 9BB, 9BRK, 9BCB, 9CI, 9BDE, 9BED, 9BEN, 9BEZ, 9BFF, 9BHD, 9BHH, 9BHR, 9BJI, 9BR, 9BKU, 9BIF, 9BLY, 9BMF, 9BMO, 9BMU, 9BOO, 9BRK, 9BRX, 9BSD, 9BSP, 9BSZ, 9BUC, 9BUO, 9BYZ, 9BWV, 9BYF, 9BYV, 9BYX, 9CAH, 9CCN, 9CCS, 9CDJ, 9CEJ, 9CEN, 9CGD, 9CCG, 9CGW, 9CHN, 9CIT, 9CKW, 9CLA, 9CLZ, 9CMC, 9CNV, 9COR, 9CR, 9CPA, 9CSC, 9CTB, 9CTE, 9CTG, 9CTU, 9CUI, 9CVI, 9CVO, 9CYF, 9CYJ, 9CYW, 9DAG, 9DBI, 9DBN, 9DCR, 9DDU, 9DEN, 9DHR, 9DHz, 9DKK, 9DKV, 9DLG, 9DLW, 9DMW, 9DOE, 9DPX, 9DQU,



The RABAT Junior \$3.96

A Rechargeable Wet 'B' Battery. Capacity 800 Mil-Amps.
12 CELLS 24 VOLTS

Your Ultimate "B" Battery

The Rabat (Acid Type)

If a battery is worth having it should be built right. That means proper construction making it trouble-proof. It means ability to give effective continuous service. And it means good appearance as well as quality at a reasonable price. That is the story of the RABAT—known for its long life, its high continuous voltage and the ease with which it can be charged from the ordinary house current. Being built right you can depend upon it. Its reasonable price and its low cost of upkeep makes it an economical battery to buy. Sold at the majority of radio stores.

Prices F. O. B. Cleveland, Ohio

If your dealer cannot supply you give us his name or order direct.

The Radio Rabat Company
714 Bangor Building, Cleveland, Ohio



The RABAT Senior

A Rechargeable Wet 'B' Battery. Capacity 2800 Mil-Amps. 48 VOLTS \$17.88

Radio Wherever You Go

Vacation—Outing—Touring

This year go with Radio. Camp, fish, hunt, tour with Radio. Make your vacation complete. Listen up the rainy days and long, dull evenings. Take the new, wonderful Ozarka Portable, Long-Distance Receiver with you. Get the sports returns—the concerts—the special features of hundreds of broadcasting stations. And, best of all, you'll have it for home use when you return. Ozarka is built for long distance—1000 miles is not unusual. Simple to operate. Convenient and light to carry. Only weighs 15 lbs. complete. Case is 16x10x5 inches. Completely equipped with aerial, "A" and "B" Batteries, three Nc. 199 tubes, and one set of head phones. Ready for instant use. Price complete ready to listen in, \$85.00. Extra phones, \$5.50. Big demand. Order at once. Send \$10.00, pay balance on delivery. Satisfaction guaranteed.

Local Representatives Wanted

Ozarka Radio offers the greatest opportunity to make money. Big market—easy sales. Over 1800 Ozarka Agencies now doing wonderful business. Some territory now open. You're interested, so write today for the "Ozarka Plan." Don't fail to give name of your county.



OZARKA, Inc., 63 North Peoria St., Chicago

ZENITH

TRADE MARK

Radio Companion

A six-tube set completely self-contained! No need to open case to operate. No exterior loop or antenna required.



Zenith — MacMillan's Choice Encased in a Light Traveling Bag!

Here's a six-tube radio set that's entirely self-contained—tubes, "A" batteries, "B" batteries, loud speaker and loop antenna complete, and it's a *Zenith!*

Packed into a small, beautifully finished traveling case—much smaller than the average suitcase—this new Zenith is the most compact set ever made giving clarity, quality, volume and distance.

Do you see those two little buttons close to the handle? Those are the controls. In order to operate the new Zenith Radio Companion you simply turn the controls to bring in the station you want—then for maximum volume you swing the case so that the loop is facing that particular station. You will be astonished at the clearness with which the music and the voices come through—and in what volume!

Think what it would mean to you to be able to take one of these new Zeniths with you on your travels and outings. A real radio set—the exclusive choice of Donald B. MacMillan for his Arctic expedition—yet so compact that it takes up no more space than a light traveling bag!

Think of the fun you could have with this set—the dance music you could listen to on moonlit nights—the orchestras that would play for you as you and your pals gathered round the camp fire—the com-

panionship it could give you on your motor parties—at the bathing beach. Picture the enjoyment it could bring your guests at the house-party or the weekend gathering.

Again, think how such a set would while away a lonesome evening in that dreary out-of-town hotel—what a god-send it would be to that invalid mother—to that dear relative or friend who must spend weeks and months in the hospital!

But if you have already been initiated into the wonders of the Zenith, you don't need be told the extraordinary use you could get from this new model or the fun it could give you.

Just the knowledge that you could pick up this beautifully finished case—even as you would pick up your hand bag—and take it with you across city, country, lakes, mountains, and *still* turn those two controls and be able to listen at a moment's notice to the world you have left behind—that thought alone should be enough to suggest the infinite delights provided by this new Zenith Radio Companion.

You will want to know more of this remarkable set—so light and compact, so easy to operate, so wonderfully convenient. You will want to see it for yourself, at the very earliest moment. No ear-phones, you understand. No outside antenna. Yet clarity, volume, quality, distance! A real Zenith, packed into a traveling case!

Your name and address on the coupon, and the coupon placed in the mail, will bring you full particulars.



Listening, with the keenest pleasure, to music and voices in the cities they have left behind!



Lively orchestras entertain these boys, miles and miles from civilization.

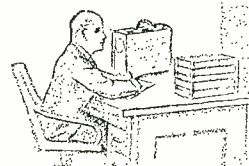

Receiving the latest market reports, the latest news developments, with the aid of the Zenith Radio Companion.



The height of luxury—motoring to music!



When three is company at the bathing beach.

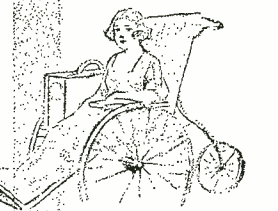

A constant source of entertainment and delight to the invalid.

Zenith Radio Corporation
McCormick Building
Chicago, Illinois

ZENITH RADIO CORPORATION,
Dept. 2-M 328 S. Michigan Ave., Chicago, Ill.

Gentlemen:

Please send me illustrated literature on Zenith Radio, including full particulars of the new Zenith Radio Companion.

Name

Address

RATHBUN

SINGLE-HOLE MOUNTING

SUPERIOR CONDENSERS

PRICES
Plain Types

3 Plate Vernier. .00002	\$1.00
11 Plate Variable. .00025	3.00
13 Plate Variable. .0005	3.00
15 Plate Variable. .00055	3.25
23 Plate Variable. .0005	3.50
43 Plate Variable. .001	4.50

Combination Vernier Types

3-11 Vernier Variable	.. \$4.50
3-23 Vernier Variable	.. 5.00
3-15 Vernier Variable	.. 6.00

Combination Types
Include Knob and Dial

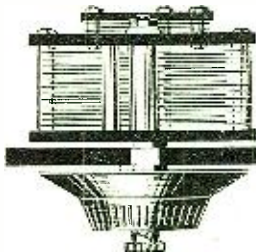

"Extremely Low Losses"

Tests by "Lefax" and other dependable laboratories invariably find that the losses in Rathbun Condensers are "negligible"—not worth mentioning. Point for point, these condensers give you the best value first and continually. Mechanically and electrically as perfect as fine engineering can make them. Ask your dealer to show you some of the Rathbun "points of superiority"—single hole mounting, self-wiping contacts, anchored stator plates, non-magnetic materials, remarkably sturdy mechanical structure and other advantages. These are all extra value, more for your money than you can get in any other condenser.

Write for Literature TODAY

RATHBUN MANUFACTURING CO., INC.
Jamestown, New York

Around the World

A New Zealand amateur got Alabama (10,000 miles) on one Myers Tube—heard the signals and message perfectly. Certified by Radio News.

This remarkable performance indicates that there is no limit to long-distance reception with Myers Tubes because their design is right.

Myers Tubes

Practically Unbreakable

add to the efficiency of any set by cutting out noise, tube hiss and interference.

Two types: Dry Battery and Universal (for storage battery). Write for free circuit diagrams.

Insist on the New Improved Myers Tubes—at reliable dealers—otherwise send purchase price and be supplied postpaid.

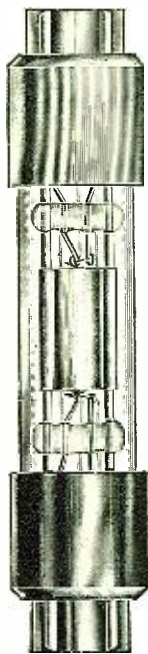

Actual Size of Tube

\$5 Each, complete with clips ready to mount on your set; no sockets or other equipment necessary.

E. B. Myers Co. Ltd.
Radio Vacuum Tubes
240 Craig Street W., Montreal Canada

9DRO, 9DSN, 9DSO, 9DSV, 9DTE, 9DTT, 9DUL, 9DUY, 9DYW, 9DXY, 9DYY, 9DYZ, 9DZV, 9DZY, 9EBI, 9EDO, 9EFL, 9EG, 9EJA, 9EKF, 9EKY, 9EL, 9ELD, 9ELL, 9ELY, 9EP, 9EQ, 9FM, 9FP, 9GS, 9GT, 9IJ, 9IU, 9IU, 9KD, 9KM, 9LN, 9LZ, 9MC, 9MO, 9PF, 9PR, 9PW, 9QE, 9QI, 9QR, 9SR, 9SS, 9TZ, 9UB, 9VK, 9VM, 9VN, 9WV, 9XAC, 9XXN, 9ZT.
Canadian—3ABZ, 3AR, 3AS, 3GT, 3IF, 3MS, 3NF, 3OH, 3PZ, 3SP, 3TF, 3ZT.

9DAU, NICHOLS, IOWA

C. W.—1ACB, 1ACR, 1ALA, 1ANR, 1AOL, 1ARE, 1ASU, 1AW, 1AXN, 1AZR, 1BBO, 1BEF, 1BGQ, 1BOM, 1BSV, 1BVB, 1CBP, 1DON, 1EZ, 1FD, 1FN, 1GV, 1HE, 1SE, 1XM, 1XV, 1YB, 1YZ, 2AAY, 2AIS, 2ATE, 2ATZ, 2AYF, 2AZY, 2BAW, 2BKL, 2BNI, 2BQQ, 2BQU, 2BYI, 2CE, 2CFB, 2CGB, 2CJR, 2CJX, 2CPD, 2CPH, 2CQI, 2CRC, 2CRQ, 2CSZ, 2CVU, 2CWP, 2CYS, 2EL, 2GK, 2RK, 2SQ, 2SY, 2XNA, 2ZB, 3AFS, 3AFZ, 3AJD, 3APB, 3ATB, 3AVA, 3AVY, 3BAY, 3BBX, 3BCJ, 3BDO, 3BDR, 3BDU, 3BEL, 3BGY, 3BHV, 3BKL, 3BLP, 3BO, 3BP, 3BVA, 3BVN, 3CDG, 3CDQ, 3CEL, 3CHH, 3CKG, 3COC, 3CV, 3EH, 3EK, 3EH, 3JX, 3KO, 3LG, 3LK, 3LR, 3MB, 3MF, 3MN, 3MS, 3NF, 3OH, 3OQ, 3PZ, 3SM, 3TE, 3TR, 3UU, 3YV, 3ZO, 4AY, 4BK, 4BZ, 4CG, 4CS, 4EQ, 4ER, 4ES, 4FG, 4FT, 4GH, 4GZ, 4IK, 4IO, 4IT, 4IU, 4JE, 4JR, 4MA, 4NV, 4OA, 4OG, 4ON, 4RF, 5AAC, 5AC, 5ACM, 5ADB, 5ADE, 5AES, 5AFQ, 5AGS, 5AHJ, 5AIC, 5AIR, 5AIU, 5AJB, 5AJT, 5AJU, 5AKN, 5ALC, 5ALM, 5AMB, 5AMF, 5AMH, 5AMI, 5AMU, 5BE, 5DQ, 5EK, 5FX, 5GC, 5GF, 5GN, 5JB, 5JH, 5JL, 5KA, 5KC, 5KG, 5KV, 5KW, 5LG, 5LP, 5LR, 5MI, 5ML, 5NK, 5NT, 5NV, 5NW, 5OC, 5OV, 5PH, 5PK, 5QL, 5QY, 5RG, 5RO, 5RV, 5SD, 5SP, 5TC, 5TI, 5UA, 5UK, 5UN, 5VC, 5VF, 5VM, 5VT, 5VU, 5XAB, 5YD, 5YL, 5ZA, 5ZAS, 5ZAV, 6AAO, 6AB, 6ADH, 6AGK, 6AJA, 6AJH, 6AK, 6AKZ, 6APE, 6AVT, 6AWQ, 6BBW, 6BCL, 6BH, 6BM, 6BPI, 6BPM, 6BQB, 6BUO, 6BVU, 6CDG, 6CFG, 6CGW, 6CIB, 6CJV, 6CMM, 6CMU, 6CNG, 6LV, 6MH, 6NE, 6OJ, 6UN, 6ZA, 6ZH, 7ACI, 7ACM, 7ADF, 7ADI, 7AJT, 7CO, 7FQ, 7GH, 7HG, 7IW, 7OM, 7QC, 7QD, 7TQ, 8's and 9's too numerous.

Phone—2RB, 2XB, 3BOP, 3BHY, 4CS, 4IK, 4FT, 5AFU, 5AGT, 5AKI, 5ALW, 5AMF, 5ANW, 5GG, 5LJ, 5MA, 5ML, 5PH, 5QP, 5SP, 5XAC, 5XAJ, 5YE, 5ZA, 7CO, 8AB, 8APV, 8DAT, 8IA, 8IV, 8KG, 8MT, 8RJ, 8YD, 8XS, 100 meters, 9AHJ, 9AKE, 9AQH, 9ASO, 9BGT, 9BJO, 9BSP, 9CHE, 9DC, 9DDJ, 9DDN, 9DFC, 9DHB, 9DIB, 9DID, 9DKW, 9EBO, 9EFO, 9IT, 9MM, 9XAW, 9XAZ, 9XN, 9YAE, 9YAU.
Canadian C. W.—2BE, 2CG, 2EI, 3BM, 3BO, 3MN, 3MI, 3NF, 3PZ, 3WS, 3ZT, 4HH, 4FZ.
Phone—3GG, 9BM.
Pse QSL to Drew D. MacDougal, Nichols, Iowa.

6CDP, 955 SHATTUCK AVE., BERKELEY, CALIF., NEW 2RA (1 TUBE)

C. W.—3LG, 3MB, 4IO, 5AAM, 5ADB, 5AIC, 5CV, 5EF, 5FT, 5LR, 5NA, 5QD, 5VW, 6AAJ, 6AAO, 6AAK, 6ACL, 6ADH, 6AGD, 6AGK, 6AHP, 6ALO, 6ALQ, 6BAD, 6BHI, 6BKO, 6BLD, 6BLQ, 6BQA, 6CDI, 6CDU, 6CGK, 6CGW, 6CIH, 6CIS, 6CIX, 6CKV, 6CMF, 6AK, 6BH, 6IZ, 6KT, 6NB, 6OF, 6OZ, 6GB, 6GH, 6ZBI, 7ADJ, 7ADS, 7AKK, 7ALD, 7BJ, 7EM, 7NF, 7FA, 7FR, 7FS, 7GO, 7GR, 7HG, 7IO, 7KN, 7OB, 7OT, 7PZ, 7QC, 7QD, 7RD, 7TO, 7TH, 7VM, 7VN, 7ZW, 8XW, 8ZK, 9AX, 9AK, 9CO, 9DR, 9ER, 9AM, 9LZ, 9AS, 9AHZ, 9AMT, 9APE, 9ATN, 9AVN, 9AVS, 9AXX, 9BDZ, 9BED, 9BGS, 9BTH, 9BZE, 9CAA, 9CDV, 9CEK, 9CHC, 9DAJ, 9DAW, 9DRO, 9DSL, 9DSW, 9DYR, 9EKY.
Canada C. W.—5G, 5CN, 5CT.
PSE QSL or MY 5 watts C. W.

9MM, CONVERSE, INDIANA

CW—IAAC, (IAAP), 1ADN, (1AKL), 1AM, 1APC, 1ASR, 1ATC, (1ATI), 1AWW, 1AYT, 1BAV, 1BDI, 1BHJ, 1BIE, 1BKP, 1BOM, 1BOO, 1BRL, 1BVL, (1BWJ), (1CAB), 1CAC, 1CCX, 1CGO, 1CMP, (1CMX), 1ER, 1HX, 1IL, (1KA), 1NC, 1ON, 1SK, 1VC, 1XZ, (1YB).
Fones: (1AAP), 1XU.
CW—2AAY, 2ADM, (2ANM), 2ATE, (2AZY), 2BIC, (2BM), 2BOH, 2BSC, 2BTE, (2BYG), 2CJR, 2CON, 2CPH, 2CPZ, 2CRH, (2CSR), 2CTN, 2NC, 2TS, 2WR, (2XNA).
Fones: 2EL, (2RB).
CW—3AAO, 3ADB, 3ADE, (3ADR), 3ADV, 3AFS, 3AJD, 3AJ, 3AOU, 3AP, (3APC), 3APV, 3AOR, (3AVU), 3AVK, 3AWF, 3BDO, 3BEI, (3BGT), 3BLU, 3BMN, 3BNO, (3BPF), 3BVN, 3BWJ, 3BWT, 3CAN, 3CEZ, 3CHG, 3EK, (3MB), (3MF), 3NF, 3OE, (3WF), 3WS.
CW—4BZ, 4EL, 4FS, 4FZ (4GU), (4GZ), 4IC, 4IO, 4IU, 4JE, 4IR, 4IV, 4KR, 4MI, 4MY, (4OA), 4OG, 4PB, 4PK, 4QY, 4SF.
Fones: 4CS, 4IK.
CW—5AAC, 5AAT, 5ADE, 5ADO, 5GH, 5AHH, 5AHR, 5AIA, 5AIR, 5AIU, 5AJP, 5ALV, 5ALX, 5AMP, 5AMG, 5AMH, 5AMU, (5ANC), 5APG, 5BM, 5CV, 5DM, 5EK, 5FC, 5FT, 5GG, 5GJ, 5HE, (5HM), 5JL, 5KA, 5KR, (5LG), 5NA, 5NK, 5NW, 5OC, 5OH, (5PA), 5PL, 5PW, 5QF, 5OI, (5OL), 5OO, 5OY, 5RG, 5RV, (5SZ), 5TJ, 5TS, 5UA, 5UK, 5UU, 5VC, 5VM, 5VO, (5VT), (5XD), 5NV, 5YD, 5ZAV, 5ZH.
Fones: (5AMF), 5AMW, 5ANA, 5LJ, 5SP.
CW—6AAO, 6ABK, 6ADH, 6AKZ, 6APE, 6ARF, 6ATZ, (6AVR), 6AWT, 6BBW, 6BGC, 6BKX, 6BM, (6BNY), 6BRI, 6BU, 6BVD,

To Manufacturers of Radio Receivers

- 1 We will make horns or concealed loud speakers and sounding boxes to order, using Madera Die-cast wood any size, shape, or quantity.
- 2 Or, we will supply our regular Madera "Clear-Speakers," in quantities, to be offered by you as standard equipment. This will insure the 100% performance of your sets and protect you from being blamed for the "rightfulness" of metal loud speakers.

AMERICAN ART MACHE COMPANY,
343 West Austin Avenue Chicago, Illinois

HALLDORSON

\$65 Radio Receivers

4-Tube Sets Designed and created with deliberate scientific foresight—not a "rush job" for immediate demand. Write today for facts on the most popular set for the home.
HALLDORSON COMPANY
1772 Wilson Ave. Chicago, Ill.

EARN MONEY AT HOME

YOU can earn \$1 to \$2 an hour in your spare time writing show cards. No canvassing or soliciting. We instruct you by our new simple Directograph System, supply you with work and pay you cash each week. Write today for full particulars and free booklet.

WEST-ANGUS SHOW CARD SERVICE LIMITED
Authorized Capital \$1,250,000.00
154 Colborne Building, Toronto, Can.

Distance! The Only AUTHORIZED COCKADAY COIL

Gets distant stations easily and clearly. Made in strict accordance with specifications by L. M. Cockaday, inventor of the famous Cockaday Four Circuit Tuner. Greater volume, sharper tuning, maximum selectivity. Guaranteed. At your dealers—otherwise write us direct.
PRECISION COIL COMPANY
209-D Centre Street New York

AT LAST!

The Announcement the Radio world has been waiting for

A new tube—a wonderful discovery—a tube that absolutely eliminates the "B" Battery and makes the New SOLODYNE circuit possible! RADIO NEWS has spared no effort nor expense in perfecting this new SOLODYNE Circuit that is so fully described in this issue of RADIO NEWS. No further description of the circuit is necessary here. It is essential, however, to remember that in order to get the best results, secure the tube that was especially designed for the SOLODYNE circuit by our engineers. Working in conjunction with the designers of this circuit our engineers have perfected—

THE NEW NUTRON SOLODYNE TUBE



The Tube that Eliminates the "B" Battery

Only Nutron Solodyne Tubes should be used in the Solodyne circuit because this circuit hooked up with Nutron Solodyne Tubes gives certain definite advantages that a circuit using ordinary tubes will not give.

Nutron Solodyne Four Element Tube

Standard Bases—.25 Amp.—5 to 6 volts.

(No changes necessary for use with the Standard Vacuum tube sockets.)

Besides being preferred in the Solodyne Circuit, the Nutron Solodyne Tube, being a four element tube, can be used in many other standard circuits very popular in this country and abroad, thereby eliminating the "B" Battery. Suggested circuits and diagrams are furnished free with Nutron Solodyne Tubes when requested.

The impossible has been achieved, namely the DETECTION and AMPLIFICATION of Radio Signals without a "B" Battery.

Be sure to secure your Nutron Solodyne Tubes early—\$6.00.

HERE ARE TWO GOOD OLD FRIENDS

Two Standard Tubes You Will Instantly Recognize

NUTRON Type 201A
NUTRON Type WD12

These and many other equally good tubes have been manufactured by this company for the past 18 years. Nutron Type 201A have valuable characteristics not obtainable in any other tube of this type. The mutual conductance of this tube at 90 volts is over 800. As a power amplifier they are not equaled by any other tube. A super tube for your set. They are guaranteed in every way—provided the filament still lights and replacements are made immediately, no waiting. Distributors especially will appreciate this unusual service.

- Type WD12, 1½ volt tube, Standard socket, Platinum filament.
- Type 201A\$4.00
- Type WD12\$4.00
- None better at any price. Get acquainted

DISTRIBUTORS ATTENTION

To provide for the enormous demand that will be made for NUTRON SOLODYNE Tubes we urge all distributors to order their supply as early as possible. Full protection is extended to recognized distributors as to discounts, replacements, dealer helps, etc. All orders will receive prompt attention, preference being given those first received.

NUTRON MANUFACTURING COMPANY

715 MAIN AVE.

PASSAIC, N. J.

Don't wait another day to enjoy the delights of the SOLODYNE Circuit as made possible by the wonderful NUTRON SOLODYNE Tubes. Clip the coupon, fill it out and mail today.

NUTRON MANUFACTURING CO.,
715 Main Street, Passaic, N. J.

Please send me the following tubes as indicated by X. Enclosed is check, money order for same. (Payment must accompany all orders.)

- NUTRON SOLODYNE Tubes (including full diagrams and complete instructions for the SOLODYNE Circuit) \$6.00
- NUTRON Type 201-A Tube with Instructions\$4.00
- NUTRON Type WD-12 Tube with Instructions\$4.00

Name
Street
City..... State.....

JUMBO "A" BATTERY

For WD12 or UV201A Tubes

Instantly Recharged Without Electrical Equipment

The single Jumbo for WD12 tubes, the double Jumbo for UV201A tubes will each operate 3 tubes 4 hours daily for 40 days—renewal cost 65c and 95c, respectively, including free home delivery service within Greater New York.

Outside of New York Jumbo Batteries can be recharged at the same rates by any Jumbo service dealer **WHILE YOU WAIT**—or in your own home without electrical equipment.

30 DAY TRIAL AND 5 YEAR GUARANTEE

Write or phone for our 30-day trial plan, which permits you at moderate cost to test Jumbo performance. Our guarantee, together with the unique method of recharging Jumbo Batteries, protects you against heavy depreciation and costly repairs common to other types of storage batteries.

Single Cell, \$5.25. Double Cell, \$10

Capacity: 100 amp. hours

Primary Manufacturing Corp.

85-87 Mercer Street, New York

TELEPHONE CANAL 3852-8853

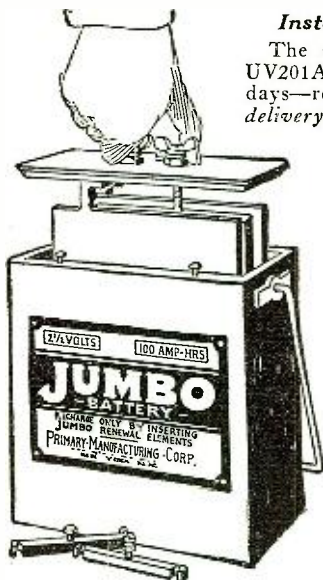

6BWI, 6CBB, 6CDG, 6CEK, 6CFP, 6CHL, 6CHE, 6CV, 6FP, 6GT, 6MH, 6NB, 6NX, 6RN, 6TU, 6UX, 6ZH, 6XAD.

CW—7ADR, 7AFU, 7AHC, 7AJO, 7CO, 7FN, 7FO, 7IO, 7ID, 7LY, 7NT, 7PF, 7QC, 7QD, 7SC, 7TQ, 7WA, 7ZU, 8S and 9S CW to mani. over 400 heard.

Fones: 8AEA, 8AGO, 8AWP, 8DAT, 8FS, 8JY, 8KG.

Fones: 9AAQ, 9AHJ, 9AKE, 9AYL, (9BPT), 9BQS, 9BSP, (9CAZ), 9CBB, 9CCN, (9CFN), 9CHE, 9CRR, (9CYU), 9DCM, 9DDN, (9DID), (9DIM), (9DLF), (9DTH), (9DWA), (9EBQ), (9EGB), (9EJU), (9HX), (9QD), (9WV).

Canadian CW—1AN, 1AR, 2AN, (2EI), 3AD, (3ADU), 3AFP, 3AG, 3DB, 3HI, 3IA, 3JE, (3ML), (3NF), (3NI), 3PZ, 3RG, 3TF, (3ZT), (4FZ).

Fone: (3GG).

Mexican: 1B.

6CIX-6ABO, WHITTIER, CALIFORNIA

1BCR, 1CPN, 1XAK, 1XFK, 1KC, 1XW, 2CSL, 2BG, 2BN, 3BJ, 3CKJ, 3AA, 3BJ, 3MB, (3MO), 3NI, 4CG, 4CR, 4EM, 4EO, 4HS, 4IO, (4LL), 4MB, 4XC, 4XE, 4XP, 4XQ, 5AAT, 5AAW, 5ADB, 5AGL, 5AIC, 5AUI, 5AJJ, 5ALV, 5AMI, 5AMO, 5APN, 5XAB, 5ZAV, 5AK, 5AZ, 5CN, 5DW, 5EH, 5EK, 5FT, 5FU, 5LA, 5LP, 5LR, 5NW, 5QH, 5QL, 5QY, 5RG, 5TJ, 5VA, 5VM, 5XA, (5XD), 5XJ, 5XP, 5XV, (6ACL), (6ADB), (6AFE), (6AMS), (6APC), 6BLH, 6CBU, (6CIP), 6CJL, (6DT), (6EI), 6ZT, 7ACM, 7ADF, 7ADI, 7ADM, 7ADS, 7AEA, 7AFK, 7AIV, 7AJD, 7ALD, 7CO, 7EO, (7EY), 7FQ, 7FR, 7FS, 7GO, 7GW, 7IJ, 7IO, 7IW, 7JU, 7KE, 7KR, 7LH, 7LN, 7MS, 7OB, 7OM), (7OT), 7QC, (7QD), 7RQ, (7SH), 7SY, 7TD, 7WE, 7ZL, 7ZU, 8ADA, 8ADO, 8ALA, 8APT, 7CTF, 8CYZ, 8DGP, 8XBH, 8XBP, 8AA, 8ES, 8PL, 8ND, 8RY, 8XB, 9AEP, 9AGB, 9AFZ, 9AMB, 9AMI, 9AMY, 9AY, 9AOC, 9ARJ, 9AVM, 9AVN, 9AZG, 9BAL, 9BAV, 9BDF, 9BDJ, 9BEO, 9BEU, 9BEZ, 9BLY, 9BMX, 9BRK, 9BRN, 9BSG, 9UN, (9BVV), 9CAA, (9CAJ), 9CCH, 9CCM, 9CCS, 9CCU, 9CDV, 9CEN, 9CFK, 9CIQ, 9CJ, 9CJL, 9CJU, 9CKA, 9CLO, 9CLY, 9CTO, 9CVO, 9DAI, 9DAY, 9DBH, 9DCP, 9DEJ, 9DJX, (9DKK), 9DGU, 9DHG, 9DHS, 9DPX, 9DQR, 9DRO, 9DTE, 9DUM, (9DUN), 9DXR, 9DYM, 9EAE, (9EAK), 9EBT, 9EEP, (9EHT), 9EKY, 9ELZ, 9ERK, 9XAX, 9XBE, 9AA, 9BW, 9DK, 9DN, 9DY, 9EM, 9EO, 9HM, 9LB, 9MC, 9RC, 9RY, 9SH, (9SS), 9SV, 9XW.

Fone: WGY, KDKA, KFZ, KDEF.

Mexican: (BX).

Canadian: 3OS.

Any reports on my signals will be greatly appreciated. All cards answered.

EDWIN C. SHAW, 400 N. 3rd STREET, DE SOTO, MO. (2 TUBES)

1SB, 1XAE, 1ZE, 2RB, 3APP, 3BHY, 3BOF, 3XA, 4CS, 4DX, 4EL, 4ES, 4HS, 4IT, 5AA, 5AAC, 5AAG, 5AAO, 5AAZ, 5ABY, 5AFQ, 5AFU, 5AGT, 5AHD, 5AHR, 5AUI, 5AK, 5AKE, 5AKF, 5AKI, 5ALI, 5ALJ, 5ALV, 5AMB, 5AMC, 5AMP, 5AMG, 5AMW, 5AMZ, 5ANA, 5DR, 5EK, 5EW, 5FC, 5FU, 5FV, 5GG, 5GM, 5GT, 5HZ, 5JD, 5JL, 5KH, 5LJ, 5LP, 5MA, 5MF, 5ML, 5MO, 5NH, 5NK, 5NR, 5OD, 5OZ, 5RK, 5RM, 5TH, 5UD, 5UH, 5UK, 5UN, 5VC, 5WE, 5WG, 5XAB, 5XAC, 5XAJ, 5YE, 5YH, 5YL, 5YW, 5ZA, 5ZAS, 5ZAN, 5ZS, 5ZN, 5ZY, 6CGW, 7LS, 8ADK, 8AFC, 8AGO, 8AJS, 8ALB, 8ANB, 8APT, 8ART, 8ATC, 8BAG, 8BCU, 8BHG, 8BZC, 8CGU, 8CHY, 8CMU, 8CNR, 8CPA, 8CPL, 8CO, 8COJ, 8DAT, 8DCG, 8DDQ, 8DFQ, 8DHQ, 8DID, 8FG, 8FU, 8JY, 8MO, 8MR, 8NB, 8TT, 8WX, 8YAJ, 8YN, 8AAI, 9AAQ, 9AAU, 9ABD, 9ABX, 9ADP, 9ADY, 9AFB, 9AHF, 9AHI, 9AHZ, 9AIB, 9AID, 9AII, 9AIL, 9AIO, 9AID, 9AKE, 9ALI, 9AMI, 9AMT, 9APF, 9AQC, 9ARM, 9ASH, 9ASO, 9ASX, 9AVN, 9AVT, 9AWP, 9AWQ, 9AYL, 9AYX, 9AZI, 9BCA, 9BD, 9BDV, 9BEL, 9BEX, 9BFB, 9BGS, 9BHI, 9BHY, 9BIE, 9BIT, 9BV, 9BJ, 9BK, 9KB, 9BLG, 9BLW, 9BLY, 9BOB, 9BOZ, 9BQT, 9BRA, 9BSH, 9BSI, 9BSP, 9BSS, 9BUF, 9BUI, 9BY, 9BYT, 9BYV, 9CBM, 9CC, 9CCM, 9CCN, 9CCZ, 9CDC, 9CDI, 9CDN, 9CDU, 9CFE, 9CFI, 9CFK, 9CGC, 9CGN, 9CHE, 9CHM, 9CIC, 9CIC, 9CJ, 9CK, 9CKA, 9CKC, 9CKH, 9CKJ, 9CKP, 9CL, 9CLA, 9CLE, 9CLH, 9CLS, 9CLT, 9CMC, 9CMK, 9CNH, 9CNV, 9COP, 9COW, 9CPB, 9CSN, 9CVI, 9CVO, 9CVX, 9CW, 9CWH, 9CZ, 9CZB, 9CZM, 9DAI, 9DAW, 9DAY, 9DBP, 9DCW, 9DDJ, 9DAJ, 9DAW, 9DAY, 9DBP, 9DCW, 9DDJ, 9DDN, 9DEB, 9DEN, 9DEY, 9DG, 9DHB, 9DIB, 9DID, 9DIO, 9DIY, 9DJZ, 9DLF, 9DKI, 9DLY, 9DMI, 9DMT, 9DMU, 9DMW, 9DMX, 9DPT, 9DQT, 9DQU, 9DRD, 9DRO, 9DRX, 9DSO, 9DSW, 9DV, 9DW, 9DWA, 9DXN, 9DYX, 9DUZ, 9EAC, 9EAD, 9EBB, 9EBF, 9EBI, 9EBQ, 9EDB, 9EES, 9EFH, 9EHV, 9EIL, 9EKF, 9EKY, 9ELA, 9ELK, 9EV, 9HK, 9IV, 9IV, 9IC, 9LE, 9MC, 9MK, 9MM, 9MV, 9NU, 9OI, 9RF, 9SA, 9UT, 9VM, 9WE, 9WG, 9XAV, 9XW, 9YAM, 9ZT.

Canadian fones—3GG, 9CE.

Hams please QSL cards.

BUILD "PRACTICAL" SETS

—for Practical Results

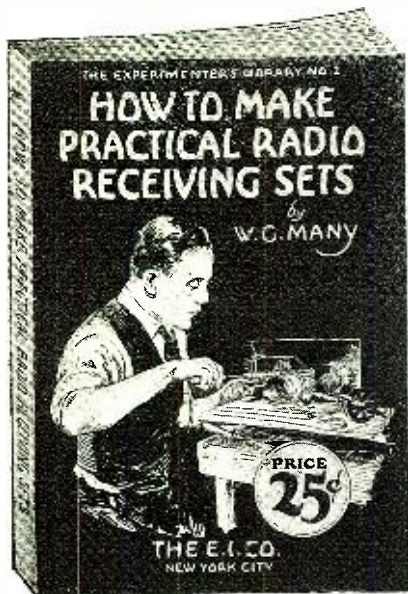

For the man who wants to select a Radio Receiving Set that is practical, efficient, tried and tested by time, the E. I. Co. Book No. 2 will be invaluable to him. This book contains a selection of the best practical Radio Hookups on the market today from the small but efficient crystal Receiving set to the standard Radio and Audio frequency hookups so popular today.

The book gives complete instructions on how to build each set, with a wiring diagram of each circuit. It is profusely illustrated and is written in plain language so that the instructions can be followed quickly and easily.

Book No. 2 HOW TO MAKE PRACTICAL RADIO RECEIVING SETS, size 5½x7¾ inches, 48 pages. Profusely illustrated, bound in stiff cardboard two-color printed cover. Price postpaid 25c.

You can obtain one of these books at your local Radio Dealer or by writing direct and enclosing 25c to

THE CONSRAD COMPANY, Inc.

233 Fulton Street

New York City

Automobile Makes 27 Miles On Air

An automobile goes 27 miles on air by using an automatic device which was installed in less than 5 minutes. The automobile was only making 30 miles on a gallon of gasoline, but after this remarkable invention was installed, it made better than 57. The inventor, Mr. J. A. Stransky, 973 Eleventh Street, Pukwana, South Dakota, wants agents and is willing to send a sample at his own risk. Write him today.—Adv.



Registered U. S. Patent Office

The Certified Audio!



Write for our free literature and prices.

FORD MICA COMPANY, Inc.

33 East 8th Street

New York

Insure your copy reaching you each month. Subscribe to Radio News—\$2.50 a year. Experimenter Publishing Co., 53 Park Place, N. Y. C.

HOWARD MacGUIRE, 4222 ALLENDALE AVE., DETROIT, MICH. (1 TUBE)

C. W.—1ABY, 1AJG, 1AJX, 1AKI, 1AWA, 1AWE, 1AZY, 1BES, 1BGO, 1BSZ, 1BVB, 1CAC, 1CD, 1CI, 1DB, 1ER, 1II, 1KX, 1MY,

Superior Erla Circuits Are Now Also Easiest to Build

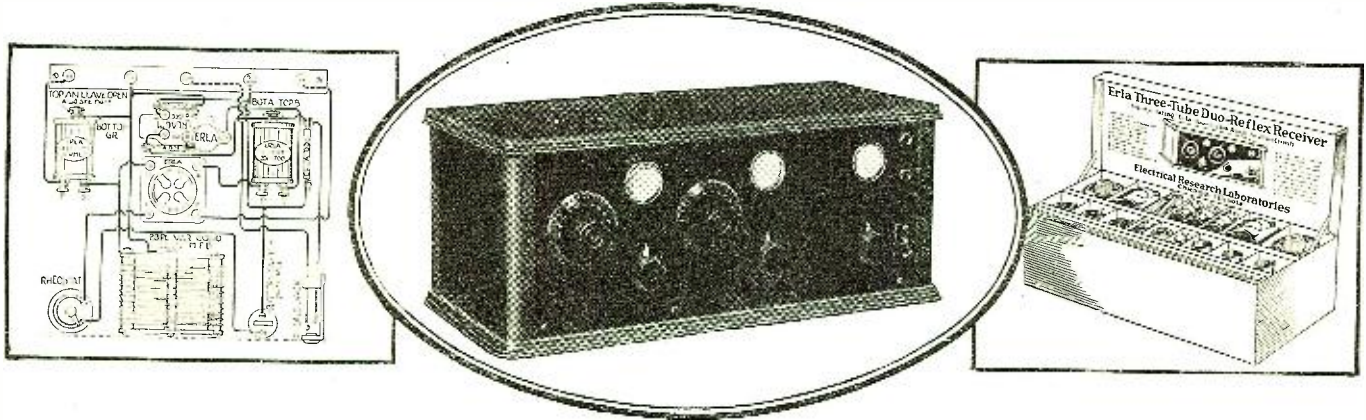

Factory Sealed Parts Guarantee Perfect Results

TO the singular efficiency of Erla Duo-Reflex circuits, tube for tube, the most powerful circuits ever built, now is added maximum ease of construction.

Complete parts for each circuit, down to the last screw, nut and wire, are packed in sealed factory cartons that eliminate all difficulty and doubt in the purchase and assembly of proper materials.

Synchronizing reflex and audio transformers, tested capacity condensers, balanced crystals, every unit especially designed for correct performance in the circuit in which it is to function—these positively assure success to the amateur builder.

And, as final guarantee of accurate, flawless assembly, there is included also a drilled and lettered panel, stenciled baseboard, giving the exact location of each piece of apparatus, and full-size blueprints that make child's play of wiring. Even soldering is eliminated, through Erla solderless connectors.

For surest enjoyment of all that radio affords, for purest tone quality, maximum selectivity and ease of control, as well as range and volume, ask your dealer about Erla knock-down receivers, in the factory sealed carton. Or write direct, giving your dealer's name.

Electrical Research Laboratories

Dept. C

2500 Cottage Grove Ave., Chicago

ERLA



Providing greatly improved selectivity and simplified control in reflex circuits, Erla Selectoformer records material advancement. \$5 ea.



Unrivalled ability to meet the requirements of high resistance loud speakers gives first place to Erla push-pull audios. Pair \$10



Panel layouts are improved 100% through patented Erla bezels, in 1" and 1 1/8" diameter, for 3/8" to 1/2" panels. Nickel, black, gold. 20-30c



Nicker shell and moulded Bakelite base of Erla sockets combine maximum beauty, electrical efficiency and strength. Two sizes, 65-75c



Materially improved range and volume, over the whole broadcasting waveband, follow installation of Erla reflex transformers. List \$5



Exclusive core construction is but one of many reasons for unduplicated Erla ability to amplify three audio stages without distortion. List \$5



Maximum rectifying quality of Erla fixed crystals assures utmost sensitiveness together with perfect stability in circuits of all types. \$1



Erla condensers alone are individually certified as to their value. Look for the words "tested capacity" on the label. 30c to 75c each

Dealers and Jobbers—High turnover of Erla dependable radio products conserves invested capital while yielding maximum rate of profit

ADVERTISING TESTIMONY!

EXHIBIT C

This is the third of a series appearing each month in Radio News. Watch for Exhibit D.

ACME APPARATUS COMPANY

TRANSFORMER AND RADIO ENGINEERS AND MANUFACTURERS

SALES OFFICES
NEW YORK—1270 BROADWAY
CLEVELAND—3701 EUCLEID AVENUE
KANSAS CITY—208 BALTIMORE BLDG.
SAN FRANCISCO—RIALTO BUILDING
CHICAGO—440 90 DEARBORN STREET

186 MASSACHUSETTS AVENUE

CAMBRIDGE 39, MASS., U.S.A.

April 26, 1924

Experimenter Publishing Co.
53 Park Place
New York City

Gentlemen:



Although you have not asked us, we are glad to tell you that Radio News has become for us the best advertising medium that we have used to date in the radio business, and as a concern of long standing in this industry, we have had plenty of opportunity to test all the national magazines.

The full page ad that we had in March Radio News has brought for us to date over 2800 inquiries for our booklet Amplification without Distortion, with ten cents in stamps or coin enclosed. We consider this a very remarkable showing.

We also placed a full page ad in your magazine in March on our new variable condenser, and we had strngly brought to our attention the excellent advertising value of Radio News because of the fact that we did not have distribution on condensers when the ad appeared, and we received letters from all over the country, asking where our condenser could be obtained.

We follow the editorial policy of Radio News very closely, and wish to take this opportunity to compliment you on this as well. We believe Radio News is not only a good consumer medium, but an excellent dealer and jobber medium.

Yours very truly,

ACME APPARATUS COMPANY

Claude Cairns
per Claude F. Cairns

cfc/ebw

ADDRESS ALL COMMUNICATIONS TO THE COMPANY

RADIO NEWS has the Greatest National-wide Radio Audience in America

Over 300,000 Copies Monthly

1NT, 1YB, 1YK, 1ZK, 2ACY, 2ANA, 2ANR, 2ATB, 2ATW, 2AW, 2AY, 2BAW, 2BBR, 2BGI, 2BTW, 2BWJ, 2BXR, 2BY, 2CPQ, 2CR, 2GA, 2GK, 2GL, 2SM, 2WR, 2XQ, 2ZO, 3AAO, 3ABW, 3ANA, 3AVU, 3BCF, 3BDO, 3BEZ, 3BGI, 3BGO, 3BHV, 3BJO, 3BLP, 3BM, 3BMM, 3BMN, 3BMS, 3BO, 3BOF, 3BQD, 3BQP, 3BQU, 3BSS, 3BUV, 3BVA, 3BWT, 3CBL, 3CCB, 3CCX, 3CED, 3CEL, 3CF, 3CGB, 3CK, 3CL, 3CQ, 3CJX, 3DT, 3JY, 3LG, 3LK, 3LL, 3MF, 3MG, 3MN, 3NF, 3NL, 3NY, 3PH, 3PZ, 3RB, 3RG, 3SW, 3TF, 3TM, 3WS, 3WN, 4AB, 4AF, 4AI, 4BA, 4BG, 4BZ, 4EQ, 4ER, 4EW, 4FR, 4FI, 4GU, 4GZ, 4HS, 4IO, 4JR, 4LA, 4LO, 4ME, 4MI, 4MR, 4MS, 4NA, 4NV, 4OA, 4QF, 4QW, 4RR, 4SU, 4WZ, 4XL, 5AAT, 5AAZ, 5AFQ, 5AGJ, 5AGN, 5AHR, 5AI, 5AIC, 5AIR, 5AIU, 5AIW, 5AII, 5AJJ, 5AJP, 5AKN, 5AM, 5AMH, 5AMW, 5ANL, 5AO, 5AOL, 5AN, 5CG, 5DES, 5EK, 5EQ, 5FA, 5FX, 5GA, 5GG, 5GJ, 5GN, 5HP, 5IR, 5KP, 5KR, 5LR, 5ME, 5MI, 5ML, 5OV, 5PR, 5OF, 5OL, 5OW, 5RG, 5RH, 5RO, 5RT, 5RV, 5SE, 5SP, 5SR, 5ST, 5SY, 5SZ, 5TQ, 5UA, 5UK, 5UM, 5UT, 5VM, 5VT, 5VU, 5XA, 5YD, 5YW, 5ZA, 5ZAV, 5ZB, 5ZG, 5ZL, 6AAO, 6AJH, 6AMH, 6APE, 6BA, 6BFN, 6BIC, 6BMB, 6BQB, 6CGW, 6CMU, 6FP, 6ZH, 7ACZ, 7CO, 7FA, 7IO, 8AAB, 8AAE, 8ABH, 8ABP, 8BAX, 8AC, 8ACA, 8ACE, 8ACN, 8ACX, 8ACY, 8ADB, 8ADD, 8ADK, 8ADT, 8ADW, 8AEC, 8AEG, 8AEP, 8AF, 8AFE, 8AFI, 8AFN, 8AFQ, 8AGA, 8AGC, 8AGO, 8AGP, 8AH, 8AHL, 8AHY, 8AIH, 8AIQ, 8AJA, 8AJH, 8AK, 8AL, 8ALT, 8ALW, 8AM, 8AMK, 8AMM, 8AMN, 8AMT, 8ANB, 8AO, 8AOT, 8AP, 8APE, 8APN, 8APS, 8ATC, 8AQH, 8ARB, 8ARD, 8ARR, 8ARV, 8AT, 8ATC, 8ATK, 8ATL, 8ATN, 8ATP, 8ATR, 8ATZ, 8AU, 8AUC, 8AUE, 8AUH, 8AVA, 8AVC, 8AVE, 8AW, 8AXN, 8AYF, 8AYR, 8AZM, 8BA, 8BAU, 8BB, 8BBD, 8BBI, 8BBP, 8BBQ, 8BBW, 8BCU, 8BD, 8BDA, 8BDE, 8BDR, 8BFB, 8BGA, 8BGH, 8BGO, 8BHO, 8BIF, 8BIV, 8BK, 8BLR, 8BMB, 8BMD, 8BN, 8BNH, 8BNI, 8BMV, 8BOB, 8BOY, 8BPA, 8BPR, 8BRQ, 8BRR, 8BRU, 8BRV, 8BSF, 8BT, 8BTH, 8BTHM, 8BTU, 8BTV, 8BTW, 8BU, 8BV, 8BVV, 8BVI, 8BX, 8BXH, 8BXV, 8BYI, 8BYN, 8BZ, 8BZA, 8BZB, 8BZC, 8BZD, 8BZP, 8BZT, 8BZY, 8CA, 8CAL, 8CAT, 8CAV, 8CAW, 8CAN, 8CAZ, 8CBK, 8CBT, 8CDC, 8CDZ, 8CFI, 8CFP, 8CES, 8CET, 8CGE, 8CGI, 8CGN, 8CGU, 8CGX, 8CHY, 8CIA, 8CIC, 8CIN, 8CIZ, 8CJ, 8CK, 8CKE, 8CKO, 8CKU, 8CLR, 8CML, 8CNL, 8CNP, 8CNW, 8COW, 8CPW, 8CQH, 8CQS, 8CR, 8CRF, 8CRU, 8CRV, 8CRW, 8CS, 8CSE, 8CT, 8CTZ, 8CUD, 8CVH, 8CVM, 8CW, 8CWA, 8CWD, 8CWL, 8CWP, 8CXU, 8CY, 8CYC, 8CYO, 8CZ, 8CZB, 8CZC, 8CZD, 8CZK, 8CZY, 8DA, 8DAA, 8DAB, 8DAC, 8DAV, 8DAY, 8DB, 8DBL, 8DCT, 8DDA, 8DED, 8DEU, 8DFO, 8DGO, 8DGP, 8DHQ, 8DHS, 8DIE, 8DIF, 8DII, 8DIL, 8DIZ, 8DJ, 8DIP, 8DK, 8DKA, 8DKJ, 8DL, 8DLB, 8DLE, 8DLM, 8DLO, 8DLR, 8DLZ, 8DPC, 8DQ, 8DNK, 8DW, 8ER, 8FC, 8FG, 8FO, 8FX, 8GA, 8GG, 8GH, 8GI, 8GU, 8HI, 8HQ, 8HT, 8HV, 8IA, 8ICY, 8ID, 8IDK, 8IE, 8IF, 8IFN, 8IGP, 8IH, 8II, 8IJ, 8IM, 8INN, 8IO, 8IP, 8IV, 8KJ, 8IO, 8IR, 8IS, 8IT, 8IJ, 8IT, 8JY, 8JZ, 8KH, 8KJ, 8KS, 8KU, 8KUV, 8KZ, 8LT, 8LU, 8LV, 8MC, 8MP, 8MR, 8MT, 8MW, 8NF, 8OJ, 8OM, 8OZ, 8PL, 8PV, 8PW, 8PX, 8PY, 8PZ, 8QK, 8QM, 8RA, 8RG, 8RM, 8RO, 8RR, 8RS, 8RV, 8SG, 8SM, 8SP, 8SS, 8SZ, 8TG, 8TJ, 8TL, 8TN, 8TR, 8TS, 8TT, 8TZ, 8UA, 8VN, 8VT, 8VY, 8WA, 8WO, 8WU, 8WX, 8XE, 8XP, 8YX, 8ZA, 8ZE, 8ZH, 8ZK, 8ZZ, 9AAB, 9AAH, 9AAJ, 9AAL, 9AAP, 9AAR, 9AAU, 9AAV, 9ABB, 9ABK, 9ADP, 9ADQ, 9AEL, 9AFI, 9AFY, 9AGL, 9AHH, 9AHJ, 9AHV, 9AHY, 9AIB, 9AIF, 9AII, 9AIM, 9AIO, 9AIX, 9AJD, 9AJN, 9AIW, 9AKY, 9ALL, 9ALN, 9ALZ, 9AMD, 9AMF, 9AMI, 9AMQ, 9AMS, 9AMT, 9AMU, 9AN, 9ANF, 9ANT, 9AOL, 9AOM, 9AP, 9APM, 9AQD, 9AQK, 9AR, 9ARF, 9ARM, 9ARP, 9ART, 9ARU, 9ARV, 9ASN, 9ASR, 9ATO, 9ATT, 9AUD, 9AUE, 9AUS, 9AUY, 9AW, 9AWG, 9AWP, 9AWR, 9AWU, 9AWY, 9AXH, 9AXN, 9AYL, 9AZA, 9AZG, 9AZH, 9AZN, 9BAB, 9BAC, 9BAO, 9BAV, 9BAZ, 9BBC, 9BBG, 9BBR, 9BBY, 9BCB, 9BCC, 9BCE, 9BCH, 9BCI, 9BCM, 9BCS, 9BCX, 9BD, 9BDH, 9BDZ, 9BE, 9BED, 9BEW, 9BEY, 9BEZ, 9BFI, 9BG, 9BGB, 9BGH, 9BHD, 9BHE, 9BHI, 9BHJ, 9BHK, 9BHR, 9BHW, 9BHX, 9BHY, 9BIS, 9BIZ, 9BJR, 9BKC, 9BLG, 9BLY, 9BMR, 9BMX, 9BN, 9BNA, 9BNK, 9BO, 9BOE, 9BOF, 9BOH, 9BOO, 9BOZ, 9BPZ, 9BOL, 9BQN, 9BQO, 9BQV, 9BOY, 9BRH, 9BRK, 9BRS, 9BRT, 9BRX, 9BSG, 9BSH, 9BSI, 9BUN, 9BUO, 9BV, 9BVN, 9BVT, 9BVZ, 9BWC, 9WY, 9BUO, 9BV, 9BVN, 9BVT, 9BVZ, 9BWC, 9BWI, 9BYA, 9BYE, 9BYF, 9BYI, 9CZ, 9CCY, 9CCZ, 9CDI, 9CAO, 9CCM, 9CCN, 9CCS, 9CCV, 9CCG, 9CGB, 9CEH, 9CEL, 9CFI, 9CFK, 9CG, 9CIC, 9CII, 9CGU, 9CHC, 9CIC, 9CIM, 9CIP, 9CIC, 9CII, 9CIM, 9CIT, 9CK, 9CKS, 9CLE, 9CMK, 9CMS, 9CNV, 9CPC, 9CPK, 9CPZ, 9CQH, 9CRA, 9CRW, 9CRX, 9CTG, 9CTT, 9CUG, 9CUI, 9CVI, 9CVS, 9CVV, 9CWB, 9CXX, 9CYD, 9CYO, 9CYW, 9CZM, 9CZO, 9CZO, 9DA, 9DAY, 9DBF, 9DCC, 9DCH, 9DCP, 9DCW, 9DCY, 9DD, 9DDA, 9DDP, 9DDU, 9DDF, 9DDT, 9DGE, 9DGV, 9DHE, 9DHG, 9DHK, 9DHO, 9DHR, 9DHU, 9DHW, 9DIC, 9DIX, 9DIZ, 9DKV, 9DKY, 9DLN, 9DLO, 9DLW, 9DMI, 9DMI, 9DMV, 9DNI, 9DNN, 9DNP, 9DOE, 9DOZ, 9DP, 9DPC, 9DPG, 9DPP, 9DPV, 9DYN, 9DQO, 9DRC, 9DRN, 9DRO, 9DRS, 9DRX, 9DS, 9DSO, 9DSV, 9DTC, 9DUI, 9DVG, 9DVP, 9DWA, 9DWA, 9DVK, 9DWN, 9DXK, 9DXN, 9DYS, 9DY, 9DYC, 9DYL, 9DYR, 9DYZ

RADIO
FOUR-PHONE PLUG
for
STANDARD JACKS
CONNECTS IN SERIES ONE TO FOUR HEAD SETS
The BARKELEW ELEC. MFG. CO.
MIDDLETOWN, OHIO. CAT. NO. 616 PRICE 1.50



NEW YORK'S FINEST RADIO SHOP
offer
SELECT RADIO APPARATUS AND PARTS
Send for
LATEST CATALOGUE
Which Includes a Complete Log
(To cover cost of mailing please send 10c. This will be credited to your first purchase of Radio supplies over \$1.)
HAROLD HERBERT, INC.
160 WEST 46th STREET NEW YORK CITY
Just East of Broadway

Insure your copy reaching you each month. Subscribe to Radio News—\$2.50 a year. Experimenter Publishing Co., 53 Park Place, N. Y. C.

Nationally Advertised.

RICO

The Mark of Guaranteed Products

THE BEST BY TEST

Sooner or later you will build your own and you will want the best. The "RICO" Kit is made of only the highest grade materials obtainable and manufactured under the supervision of Radio experts. It has been tested by 3 Radio Laboratories and passed by them. You therefore have the opinion of technical men to guide you in your selection. And the cost is not prohibitive — \$15.00 complete.

Tuned Radio Frequency

BUILD YOUR OWN WITH THIS SET.

Complete "RICO" Kit \$15.00

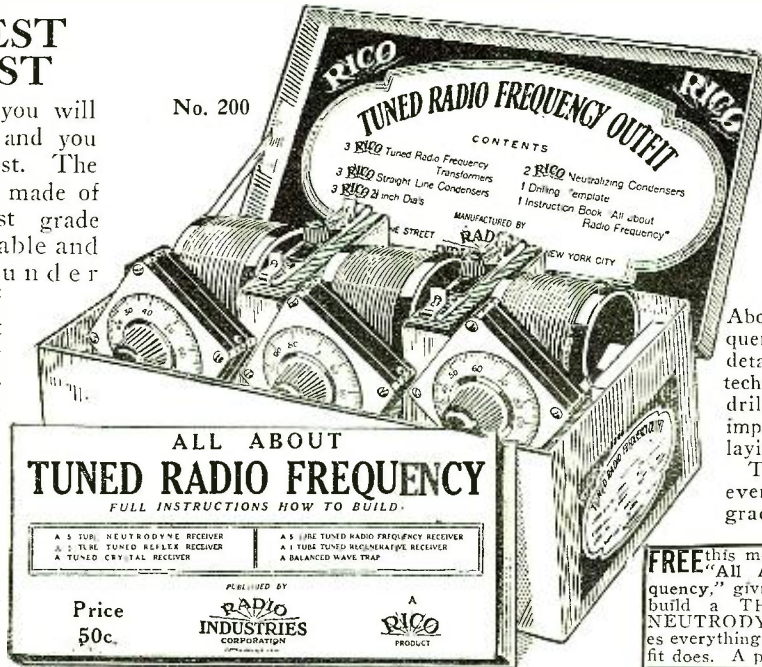

Contains 3 "RICO" Radio Frequency Transformers, coupled with the "RICO" Straight Line Condensers and Dials and two "RICO" new model Neutralizing Condensers. The booklet "All About Tuned Radio Frequency" is complete in all details, without the use of technical language. Two drilling templates make it impossible to go wrong in laying out the panels. This is the greatest value ever offered for a high grade product.

FREE this month. Eight page booklet, "All About Tuned Radio Frequency," giving full instructions how to build a THREE TUBE REFLEX NEUTRODYNE outfit that accomplishes everything a five tube neutrodyne outfit does. A postal-card will bring it.

ALL ABOUT TUNED RADIO FREQUENCY

FULL INSTRUCTIONS HOW TO BUILD.

Price 50c.

"RICO" STRAIGHT LINE CONDENSER

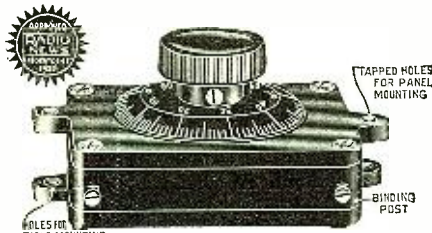

All Types \$1.75 Each

As the electric tramway has replaced the horse-drawn street cars, so will the RICO Straight Line Condenser replace the old mesh plate type.

The Rico Straight Line is dustproof and constant. It occupies two-thirds less space and can be had in .001, .0005 or .00025 mfd. capacities. Made for both panel and table mounting. One complete revolution of the dial from minimum to maximum. The dial has 100 point marking over 360°.

Solidly built and impossible to short.

- No. 411—Straight Line Condenser .00025.....\$1.75
- No. 425—Straight Line Condenser .0005.....1.75
- No. 450—Straight Line Condenser .001.....1.75

"RICO" NEUTRALIZING CONDENSER



No. 205

Another "RICO" Product to help make a good circuit better. Made of unbreakable parts, Bakelite base, easy to adjust. Simply turn the knob. Extremely low capacity to give the best results.

Tried, tested and approved by leading laboratories.

This is the same neutralizing condenser contained in the famous RICO Tuned Radio Frequency Kit and is sold separately to meet the popular request of radio fans.

No. 205 Condenser each \$0.50

WHEN A BETTER PRODUCT IS MADE, RICO WILL MAKE IT

DEALERS EVERYWHERE:

Consistent advertising in all leading periodicals is creating a tremendous demand for "RICO" Products. Write to us for our complete catalog and proposition of live wire merchandise at money making prices. Be in line to supply your trade with "RICO." the 100% guaranteed merchandise.

RADIO INDUSTRIES CORPORATION
131 Duane Street
New York

Cable Address: Ricotrade, New York

COUPON

Radio Industries Corp., 131 Duane St., New York, N. Y. GENS

Gentlemen:

As my dealer cannot supply my needs, kindly ship to me direct the following material, for which I will pay the postman on arrival.

.....

Name

Address

City

My dealer's name is.....

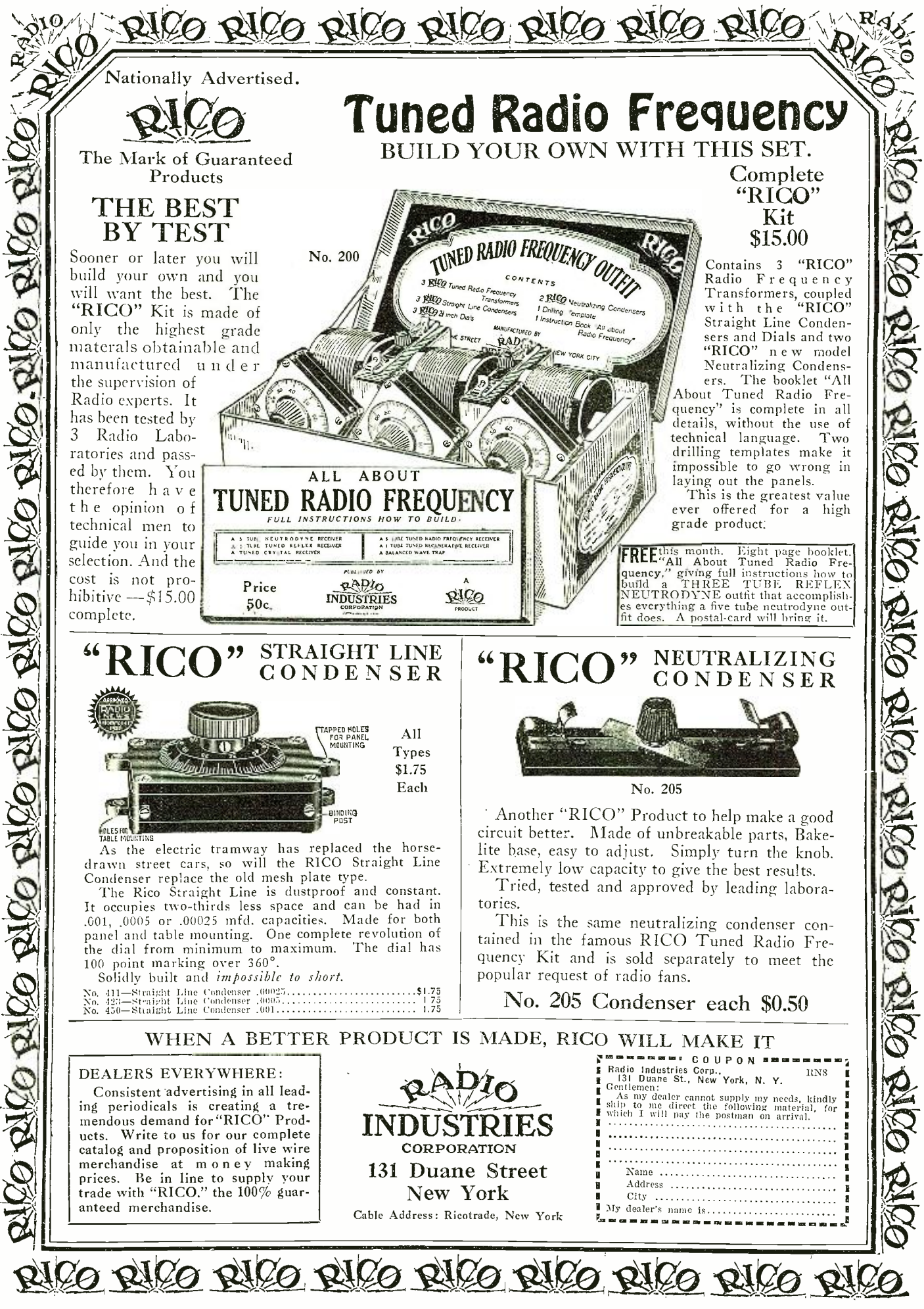

BOONTON PORTABLE RECEIVER

"THE LIGHT FOUR"

Designed by Radio Engineers for head-phone reception of Broadcast, wave lengths 250 to 550 meters, 1000 miles and over. Will operate Loud Speaker properly at distances of 50 to 500 miles depending on local conditions, and the antenna used.

Built by Manufacturers with Thirty years' experience in the Electrical Industry.

Beautiful Workmanship - Rigid Construction

SIZE

4 1/2" x 8" x 1 3/4"

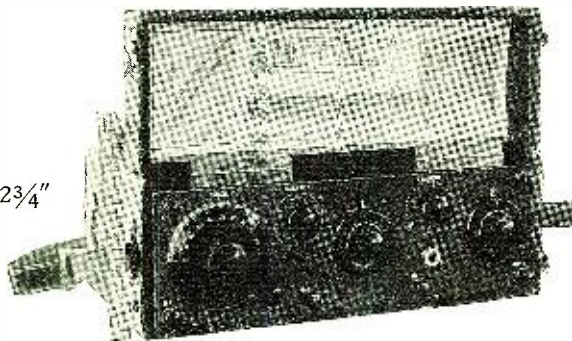

WEIGHT

7 POUNDS

\$75

Price does not include tubes, dry batteries or phones.

SPECIFICATION: Genuine Leather covered Case and Strap. Multiple socket for four U.V.199 vacuum tubes with damped spring suspension. U. S. NAVY type.

Solid bus-bar and lock washer connections.

Two Ballantine Variotransformers.

Special Tuner with Vernier on 3" dial.

Engraved Panel and uniform Knob control.

VERY COMPACT AND EASY TO OPERATE

Go To Your Dealer

Order your Set to-day—if he can't supply you, or if there is no Dealer in your vicinity—write us. Bulletin sent on request.

BOONTON RADIO CORPORATION

624 FANNY ROAD

BOONTON, NEW JERSEY



The Saturn

Perfect Jack and Automatic Plug
Write for Literature

Your order filled by mail promptly.
Every article absolutely guaranteed.

The SATURN Mfg & Sales Co., Inc.

48 Beekman St.
New York, N. Y.

RADAK

RELIABLE RECEIVING SETS

Licensed Under Armstrong Patent
1,113,149

BUILT BY AMERICA'S OLD-
EST MANUFACTURER

Clapp Eastham Co.
107 Main St. Cambridge, Mass.

9DZI, 9DZO, 9DZU, 9DZV, 9EA, 9EAC, 9EAR, 9EBU, 9ECV, 9EDB, 9EDO, 9EFE, 9EFZ, 9EGT, 9EGV, 9EI, 9EKF, 9EKY, 9ELB, 9ELL, 9EP, 9ER, 9ES, 9ESI, 9EVC, 9EZH, 9FN, 9HC, 9HH, 9HK, 9IBB, 9IR, 9IVE, 9IWW, 9LE, 9LN, 9MA, 9MM, 9MR, 9NU, 9NV, 9ON, 9PB, 9OL, 9RC, 9RS, 9SR, 9SS, 9ST, 9TA, 9TR, 9TW, 9UR, 9UZ, 9VC, 9VK, 9VM, 9VR, 9YB, 9ZL, 9ZT, 9ZV.

Canadian—3BQ, 3CG, 3GN, 3IR, 3MN, 3MS, 3MTH, 3MX, 3NF, 3PZ, 3WV, 3ZT.

I would appreciate cards from any of the above.

CHARLIE E. ECKELS, 1108 GLADYS AVE., BEECHVIEW, PITTSBURGH, PA. (1 TUBE)

1CK, 1XAL, 2CAG, 2RB, 2RX, 2XB, 2XQ, 3ADS, 3BHY, 3BQS, 3BP, 3BQP, 3CA, 3DJ, 4AV, 5AI, 8ABS, 8ADB, 8AFU, 8AGA, 8AGO, 8AGX, 8AGY, 8AHH, 8AHD, 8AHI, 8AJ, 8AIA, 8AIG, 8AIO, 8AJR, 8AKJ, 8AQI, 8AQR, 8ARB, 8ARD, 8ARO, 8ASU, 8AXQ, 8AYH, 8AYW, 8AZB, 8BAB, 8BAD, 8BAK, 8BAL, 8BAO, 8BAP, 8BAZ, 8BBL, 8BBV, 8BHN, 8BHS, 8BHY, 8BIG, 8BIM, 8BIO, 8BJP, 8BKS, 8BMB, 8BMV, 8BMV, 8BNG, 8BNK, 8BNO, 8BPV, 8BQS, 8BOY, 8BRI, 8BSD, 8BTM, 8CUV, 8BVW, 8BX, 8BXG, 8CBS, 8CDO, 8CED, 8CEF, 8CEJ, 8CFK, 8CGO, 8CI, 8CIK, 8CIN, 8CK, 8CKA, 8CKO, 8CO, 8COO, 8CR, 8CSK, 8CTS, 8CUK, 8CUV, 8CV, 8CX, 8CXB, 8DAG, 8DAH, 8DAO, 8DIO, 8DIP, 8HK, 8HV, 8LG, 8LW, 8NH, 8PK, 8PN, 8SK, 8SS, 8UN, 8UP, 8XS, 9AAU, 9AHJ, 9AIC, 9AIL, 9APN, 9AQH, 9ARS, 9AYW, 9BBR, 9BYB, 9CA, 9CBR, 9CFX, 9CGC, 9CGS, 9CHO, 9CIG, 9CZ, 9CZS, 9DRO, 9QV, 9XAW.

Canadian—3ADS, 9BM.

Cuban—2BY, 2DW, 6KW, 7NR.

All whose calls are listed above, pse QSL.

8BDG, HAVEN, PENN.

1AAP, 1AEZ, 1ALA, 1ALJ, 1AKL, 1AMJ, 1AMU, 1ANR, 1ARY, 1ASU, 1ATZ, 1ARN, 1AXZ, 1AY, 1ATI, (1BCR), 1BEL, 1BEZ, 1BIE, 1BIP, 1BIS, 1BU, 1BJL, 1BKR, 1BNL, 1BOM, 1BOQ, 1BWJ, 1CAZ, 1CDE, 1CI, 1CJ, 1CKP, 1CJR, 1CTL, 1ER, 1FH, 1GS, 1GV, 1HC, 1II, 1IT, 1JV, 1RX, 1LK, 1LS, 1LU, 1ML, 1MO, 1SE, 1UL, 1XAM, 1XM, 1XW, 2ABN, 2ADB, 2ADC, 2AFD, 2AGB, 2BJ, 2BJO, 2BUM, 2BQH, 2BY, 2CAJ, 2CBL, 2CKL, 2CRC, 2CRI, 2CXL, 2CXY, 2CZ, 2LE, 2TP, 2XNA, 3ACD, 3ADB, 3ADE, 3ADV, 3AIS, 3AVM, 3AQR, 3AWE, 3BAG, 3BCG, 3BCN, 3BDI, 3BDU, 3BEI, 3BGZ, 3BHL, 3BJ, 3BKL, 3BLD, 3BMN, 3BMS, 3BTL, 3BUA, 3BUR, 3BUY, 3CCB, 3CCY, 3CCX, 3CDM, 3CDN, 3CDV, 3CEG, 3CEL, 3CEI, 3CEZ, 3CHB, 3CIW, 3CIN, 3DI, 3DK, 3DT, 3EL, 3EK, 3HE, 3LL, 3LY, 3MB, 3MK, 3MO, 3OQ, 3PI, 3RG, 3SM, 3TF, 3TR, 3WC, 3WF, 3WV, 4AB, 4BA, 4BQ, 4BZ, 4CS, 4DG, 4DV, 4EQ, 4FZ, 4HS, 4IQ, 4ME, 4MY, 4NA, 4OG, 4QW, 4SI, 4SU, 4ZA, 5AAC, 5AAT, 5AAV, 5ABW, 5ADO, 5AF, 5AIR, 5AIT, 5ALV, 5AMH, 5AMW, 5EK, 5IA, 5MI, 5QL, 5RV, 5VC, 5VV, 5LA, 6AJH, 6BUR, 6CBU, 6TU, 6ZH, 7CO, 7FO, 7LN, 8ABM, 8ACY, 8AFQ, 8AJH, 8AJV, 8AK, 8AMM, 8ANE, 8AOK, 8APT, 8AVJ, 8AXF, 8AZG, 8BBC, 8BBH, 8BCE, 8BCP, 8BDA, 8BDU, 8BK, 8BKM, 8BNH, 8BQI, 8BQP, 8BOY, 8BR, 8BTM, 8BTL, 8BVY, 8BWB, 8CBU, 8CCR, 8CHM, 8CHJ, 8CHY, 8CK, 8CMF, 8CMU, 8CPK, 8CTA, 8CTP, 8CUN, 8CZZ, 8DBL, 8DDY, 8DED, 8DFI, 8DHB, 8DIA, 8DIF, 8DJ, 8DL, 8DLZ, 8DMT, 8DO, 8DP, 8DUV, 8DWD, 8ES, 8GZ, 8HV, 8II, 8IH, 8RH, 8RI, 8RM, 8RW, 8RV, 8SF, 8TT, 8VQ, 8WX, 8YO, 9AAU, 9AAV, 9ABL, 9ADO, 9AEM, 9AIO, 9AMB, 9AMJ, 9AMV, 9ALZ, 9AON, 9APD, 9APE, 9APS, 9ASR, 9ATO, 9AVB, 9AVN, 9AXD, 9AZM, 9BBI, 9BBU, 9BAB, 9BCB, 9BCC, 9BCE, 9BED, 9BFP, 9BHI, 9BIE, 9BIZ, 9BIF, 9BLL, 9BOR, 9BSI, 9BUN, 9BVI, 9BUZ, 9BYE, 9BZO, 9CAA, 9CCM, 9CCS, 9CCW, 9CFY, 9CGU, 9CHC, 9CHN, 9CJM, 9CKA, 9CRA, 9CVI, 9CVV, 9CWZ, 9CVO, 9CYW, 9CZE, 9CZO, 9DAP, 9DBH, 9DCW, 9DDS, 9DFQ, 9DGE, 9DIX, 9DLW, 9DXO, 9DOZ, 9DOO, 9DOV, 9DRK, 9DRO, 9DTE, 9DTH, 9DTN, 9DUV, 9DWX, 9DXL, 9DY, 9DYZ, 9DZU, 9EAM, 9EAR, 9EBA, 9EDO, 9EGC, 9EHY, 9EIS, 9EJA, 9EKY, 9ELA, 9ELD, 9ES, 9LB, 9LN, 9IY, 9PR, 9PF, 9VC, 9VK, 9WU.

Phone—2RV, 3AWE, 3FZ, 8AGO, 8CK, 8KG, SXBO, 9BCB.

Canadian—2EI, 2HV, 3DB, 3NF, 3TY, 3WV.

French—8BF.

Pse QSL, all crds ansd.

1IV, BRIDGEPORT, CONN.

U. S.—(4hs), (4io), 4iz, (4xc), (4xe), (4xr), 4xs, (4xw), 4xx, (5dw), 5ti, (5xat), (6bel), 6cgv, 6fp, 6ka, 6lv, 6pl, 6xaq, 6xbx, 6xhc, 6zh, 7co, 7lu, 7zd, 7zu, (9aem), (9aii), 9amb, (9bmx), 9bxq, 9caa, (9cbg), (9ccm), (9cf), (9dpx), (9em), (9eq), (9er), (9xha), (9xbd), (9xhe), (9yy), 9zt.

Porto Rico—4ja, 4jc.

Canadian—(1dt), (2bn), (3tb), 4cr, (9bl).

English—2kf, 2nm, (2od), (2sz), 2wj, 2yt, 5at, 5if.

French—8ab, 8az, 8bf, fl (daylight 100-meter test).

Dutch—pa9, (pci).

2AEY, ELIZABETH, N. J.

1aap, 1aaw, (1acb), (1adn), 1aez, (1afx), (1alj), (1alk), 1ary, (1axz), (1azr), (1btk), (1bzb), 1bsz, (1caz), 1cda, (1gl), (1la), 1zs, 3adp, 3ahp, (3auv), 3buv, 3buy, (3cjin), 3ckl, 3xar, 3dt, (3ek), 3lx, 3uz, 4af, (4ll), 4mb, 4my, 4oq, 4rr, (4rz), 4sh,

Insure your copy reaching you each month. Subscribe to Radio News—\$2.50 a year. Experimenter Publishing Co., 53 Park Place, N. Y. C.

"BUILD YOUR OWN" WITH "RASCO" PARTS!

Buy from the Oldest and Original Exclusive Radio Parts House in the United States

We pay ALL transportation charges in U. S. ALL GOODS SENT PREPAID IN 24 HOURS

Order direct from this page.

NEW AND EXCLUSIVE "RASCO" GOODS

Money refunded if goods do not satisfy

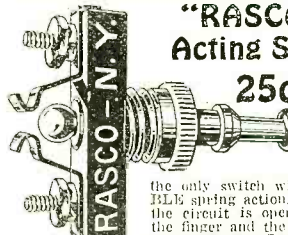

"RASCO" Double Acting Snap Switch

25c

At last a REAL radio switch constructed for radio purposes, not just a battery switch that may be adapted for radio. The RASCO switch is the only switch with a POSITIVE DOUBLE spring action. No more guess work if the circuit is open or closed. A push of the finger and the current is on. A slight pull and THE HANDLE SNAPS BACK of its own accord. An internal coil spring pushes the handle back when a little pull is applied. This switch is intended as a battery switch to disconnect your "A" batteries.

Only one hole to drill. No tools required to mount except your finger and thumb. Also this switch takes up a minimum of room, much less than other switches, the base of the switch measuring only 1 1/4" x 1/2". All metal parts nickel plated. A switch you will be proud to possess.

No. G 4850—RASCO Snap Switch, each.....\$0.25

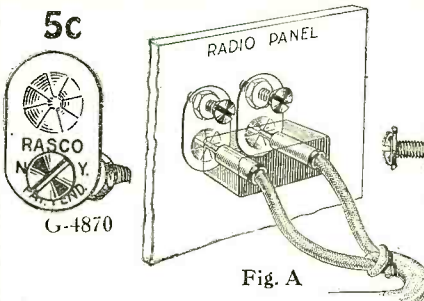

5c

"RASCO" "Jiffy" Cord Tip Jack

Fig. A

Fig. B

This jack has been specially designed for our No. G-4860 cord plug shown on this page. It is the simplest and most efficient cord tip jack ever designed. It is stamped from a single piece of metal and it grips any style cord tip of any make phone or loud speaker. The "Jiffy" Jacks take but a minimum of room. All you are required to do is to drill two small holes in your panel and mount the "Jiffy" Jacks with screw and nut furnished. No soldering is necessary as the wire goes right under the nut. Our X-Ray view, Fig. A, shows how two of the "Jiffy" Jacks are used in conjunction with our cord plug. Note that Jacks go on back of panel; only the screws show in front. The illustration, Fig. 4870 of the "Jiffy" Jack is full size. They take practically no room at all when mounted and will not extend more than about 1/8" from back of panel. Made of best spring brass, that will not wear out, even through extended use.

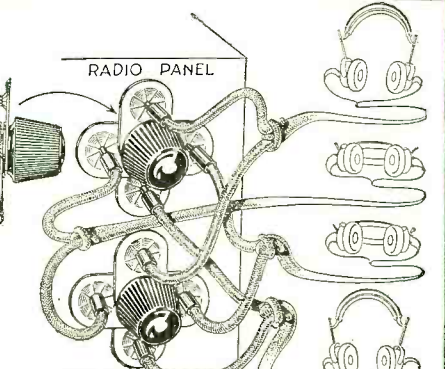

"RASCO" Phone Cord Plug

Again RASCO leads with a small but important radio novelty. Here is a bit of semi-hard rubber into which the tips of your phones or radio speaker are pushed. This makes positively the cleanest and simplest radio jack ever designed. Its small size and neatness has made it famous over night. Illustration is full size (1" long, 1/2" wide, 3/8" thick). No tools of any kind are required to attach. Just wet the metal cord tips and push them through the openings, where they will be held firm until you wish to withdraw them. This plug can be used with any standard cord tip jack, but preferably with the new JIFFY RASCO cord tip jacks shown on this page. (See also Fig. A.). For experimental purposes THE RASCO cord plug is finished neatly in a good grade of black rubber and will last for years.

No. G-4860 RASCO Plug, each....\$0.10



10c

No. G-4860 RASCO Plug, each....\$0.10

We also show a few illustrations of some other uses for the "Jiffy" Jack. Eight of them can be mounted on two binding posts as shown (Fig. B) which will make it possible to connect a pair of phones to your outfit. The same system can be used by mounting eight of the jacks behind the panel by drilling a few simple holes; then the cord tips may be pushed through these holes, making it possible to connect one or more phones in the circuit.

We will pay \$1.00 for every new use for Jiffy Jacks.

No. G-4870 RASCO Jiffy Jack, complete with nut and screw, each.....\$0.05

No. G-4871 RASCO Jiffy Jack, without nut and screw, two for.....\$0.05

Wanted

THIS Company is always in the market for new ideas. Any small specialties in demand by the radio fan will be highly welcomed by us. Some of the articles shown on this page originated with our customers, whom we paid well for the ideas. Send your sketch or model addressed to Research Department, c/o this Company.

Dealers and Jobbers

WRITE or wire for territory that is still open on the specialties described on this page. These articles are widely advertised and you will have a demand for them almost immediately. We shall be glad to send samples to responsible and rated concerns. Address all wholesale inquiries to

RADIO SPECIALTY COMPANY,
Wholesale Department.
25A West Broadway New York City

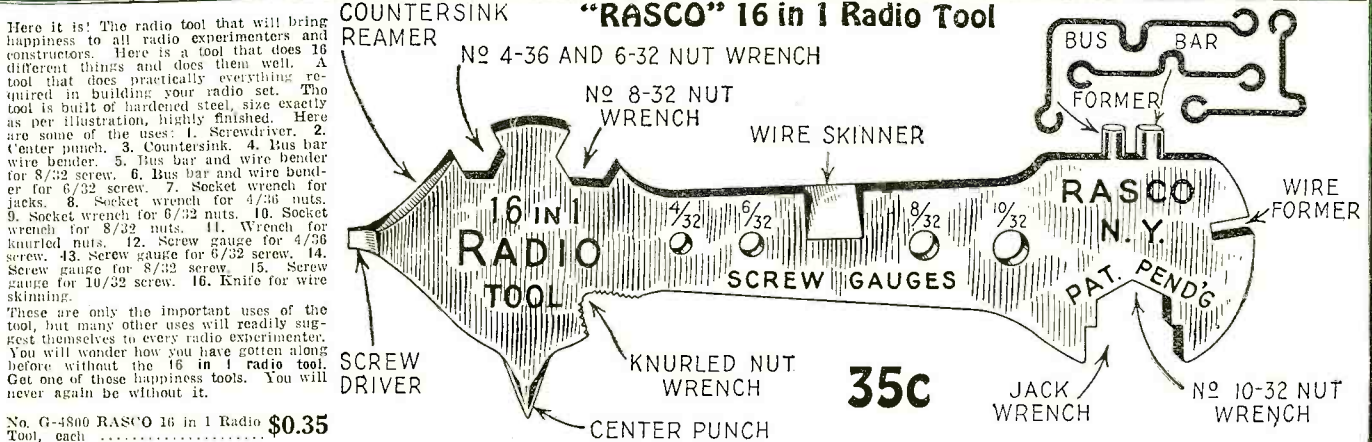

"RASCO" 16 in 1 Radio Tool

35c

Here it is! The radio tool that will bring happiness to all radio experimenters and constructors. Here is a tool that does 16 different things and does them well. A tool that does practically everything required in building your radio set. The tool is built of hardened steel, size exactly as per illustration, highly finished. Here are some of the uses: 1. Screwdriver. 2. Center punch. 3. Countersink. 4. Bus bar wire bender. 5. Bus bar and wire bender for 8/32 screw. 6. Bus bar and wire bender for 6/32 screw. 7. Socket wrench for jacks. 8. Socket wrench for 4/36 nuts. 9. Socket wrench for 6/32 nuts. 10. Socket wrench for 8/32 nuts. 11. Wrench for knurled nuts. 12. Screw gauge for 4/36 screw. 13. Screw gauge for 6/32 screw. 14. Screw gauge for 8/32 screw. 15. Screw gauge for 10/32 screw. 16. Knife for wire skinning.

These are only the important uses of the tool, but many other uses will readily suggest themselves to every radio experimenter. You will wonder how you have gotten along before without the 16 in 1 radio tool. Get one of these happiness tools. You will never again be without it.

No. G-4860 RASCO 16 in 1 Radio Tool, each.....\$0.35

NEW THINGS FROM CATALOG No. 11 AT CUT PRICES

 <p>Dial Marker</p> <p>The big little thing you have been waiting for. Just drill a hole in the panel and mount the marker above the dial. Very neat, nicely nickel plated and polished.</p> <p>G7788 Dial Marker, each.....\$.05</p>	 <p>Vacuum Tubes</p> <p>Only best make tubes carried in stock. All tubes guaranteed to work or exchanged if filament lights.</p> <p>G201A 5 v., 25 amp. \$2.50 G199 3 v., .06 amp. 2.50 G12 1 1/2 v., 25 amp. 2.50</p>	 <p>Three-Gang Socket</p> <p>Aluminum shells, genuine heavy bakelite base, 3 brackets for mounting, 12 nickel binding posts. Length 7 1/4".</p> <p>G5995 Three-gang socket.....\$1.50</p>	 <p>Cockaday Coil</p> <p>Guaranteed best make. Three windings of No. 18 D C C Magnet wire. Has brass brackets for panel or base mounting. Results guaranteed or money back.</p> <p>G2750 Cockaday coil \$1.50</p>	 <p>Neutralizing Condenser</p> <p>Latest pattern. Genuine bakelite base. Pahnstock connectors, hard rubber composition knob, easiest to regulate. Size 5/8" long, 1" wide and 1" high.</p> <p>G1202 Neutralizing condenser.....\$.40</p>	 <p>Neutro-Transformer</p> <p>Can be used for all neutrodyne circuits, also for all tuned radio frequency circuits. Made for usual broadcast waves. Secondary has one center tap. Two genuine bakelite tubes. Two nickel mounting brackets.</p> <p>G6909 Neutro-transformer.....\$1.65</p>	 <p>Sponge-Rubber Cushions</p> <p>Get rid of tube noises due to vibration. Softest sponge rubber made. Also used under cabinets to absorb shock and vibration. Size 2 1/2"x3", 3/8" thick.</p> <p>G6989 Sponge-rubber cushions, each.....\$.12</p>
---	--	---	---	---	--	--

RADIO SPECIALTY CO., 98 Park Place, New York City

Factories Brooklyn, N. Y. Elkridge, Md.

TRI-JACK

TRI-JACK is the most notable improvement that has ever been made in radio jacks! Put **TRI-JACK** on your radio set and you will eliminate all those little annoyances which are so common to ordinary jacks.

TRI-JACK is super-compact, being moulded of solid Bakelite 1" x 1". It is dustproof, solderless, and combines a single and a double circuit jack in one. And it is the nearest to Zero Capacity so far produced!

Insist upon **TRI-JACK**. Your set needs them for good results!

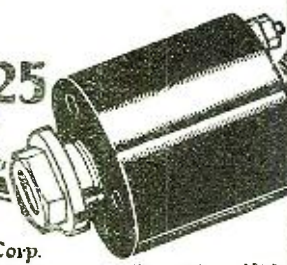

\$125

BROOKLYN METAL STAMPING Corp.
718 Atlantic Avenue, Brooklyn N.Y.

4su, 5aiu, 5amh, 5he, 5mo, 5rg, 5wi, 6xad, 6fp, 7co, 8aal, 8abx, 8ada, 8aep, (8amr), 8asz, 8axf, (8bci), (8bfe), (8bjs), 8bcw, (8cpl), 8cnw, (8dca), (8daj), (8dbm), 8dft, 8dga, 8dgs, (8dgp), 8dmc, 8dnf, (8bk), (8oi), 9abt, 9aci, 9azp, 9bbg, 9bep, 9bfi, 9bhd, 9bis, 9bly, 9bnc, 9bwg, (9cmc), 9ctb, 9cte, (9cyw), 9day, 9dbm, 9dbw, 9dfn, (9dma), 9dyy, (9ecb), 9edo, 9efo, 9eji, (9ba), 9qr.

Canadian—(3fc), 4co.
Mexican—bx.
Would like reports on my 15-watt C.W. All crds answered.

3ABH, PHILADELPHIA, PA. (ONE TUBE)
(1ajx), 1arp, 1ary, 1beb, 1bfu, 1bmi, 1bto, 1bzb, (1caz), 1cde, 1cdo, 1cib, 1ctp, 1ii, 1kr, 1qr, 1uo, 1zr, 2acs, 2awv, 2cjq, 2cpa, 2cpz, 2cur, 2cxd, 2by, 2dx, (2gk), 2kf, 2qu, 2wk, 2zk, 3ahp, 3ass, (3tr), 4bx, 4eb, 4ek, 4gu, 4gx, 4jj, 4jr, 4my, 4on, 4sb, 4su, 4wc, 5eb, 5tw, 5xx, 6jr, 6ka, 8adb, 8afy, 8ago, 8aib, 8aig, 8aiz, 8ajy, 8akk, 8anb, 8aqm, 8axf, 8bbf, 8bcp, 8bfe, 8bnk, 8bnh, 8bq, 8bqi, 8boy, 8brc, 8bro, 8bsf, 8bus, 8bwk, 8cci, 8cco, 8cnw, (8cpl), (8cuv), 8cyw, (8daa), 8daf, 8dgi, (8dgo), 8die, 8dkm, (8dmk), 8drw, 8ah, 8bf, 8fm, 8fu, 8mu, (8uk), 8wu, 8xc, 8zu, 8zz, 9aag, 9aau, 9afy, 9ahj, 9baz, 9bhh, 9brx, 9cqw, 9ctb, 9cos, 9dhr, 9dro, 9dww, 9dwx, 9dyy, 9bk, 9ep, 9gi, 9lz, 9vk, 9zt.

Canadian—(2fu), 4bk.
French—8bs.

4AI, ROME, GA.
6auu, 6acm, 6ajf, 6agk, 6aao, 6avr, 6arf, 6aur, 6akw, 6adt, 6agd, 6bm, 6bbc, 6bri, 6bg, 6bm, 6cdg, 6cgv, 6lw, 6nx, 6la, 6zh, 6zcd, 6ux, 6fp, 7zu, 7fq, 7adf, 7qc, 7coz, 7co, 7fu, 7if.

Canadian—3uz, 3pz, 3oh, 9cf.

5A0X, PORT LAVACA, TEXAS
U. S.—C.W.—1cpr, 1cpr, 2by,* 3mo, 3kq, 4gx, 4oa,* 4qy, 4tj, 4er, 5aac, 5air, 5amu, 5aki, 5ajp, 5akn,* 5ac, 5ak, 5cd, 5on, 5gb, 5mm, 5kr, 5ho, 5uk, 5zas, 5ou, 5kc, 5xa,* 5hl, 5qz, 5wi, 5jw, 5qq, 5xac, 5jb, 5xd, 5xao,* 5ajp, other 5s too numerous, 6ajj, 6ava, 6jj, 6zn, 8ata, 8atc,* 8axb, 8bcj, 8cgr, 8atx, 8cfm, 8bk, 8vc, 8dp, 8zc, 8vc, 8zu, 9akl, 9cc, 9cyf, 9zz, 9ebq, 9dfw, 9wm, 9hm, 9dj, 9as, 9ou, 9ai, 9zu, 9bvd, 9avs, 9cf, 9csl, 9dun, 9caa, 9vm, 9dzi, 9ck, 9bid, 9cco, 9dyy, 9ake, 9cde, 9lp, 9ckm, 9euj, 9rp, 9dak, 9axb, 9elw, 9awg, 9ear, 9ta, 9btu, 9dml, 9cmv, 9cgv, 9edo, 9ba, 9bfp, 9ehv, 9efo, 9ai, 9crm, 9dmg, 9dkx, 9awr, 9dng, 9ckj, 9hsp, 9auy, 9cju, 9bfi, 9ccn, 9acd, 9aau, 9day, 9bpy, 9cao, 9djh, 9ay, 9eky, 9cvu, 9cju, 9aed, 9ch, 9hh, 9aau, 9lb, 9bhp, 9dmw, 9ee.

Phone—5gt, 5mf, 5rq, 5ci, 5lr, 5ka, 5za, 5sk, 5mn, 5jr, 5akn, 5cd, 5th, 5zal, 5xaj, 5jb, 5ma, 5aki,* 5ahw, 9ehq, 9aaq, 9aj, 9csl, 9cit, 9cop, 9cgu, 9caq, 9cdl, 9ff,* 9kc.

Spark—5tg, 5gy, 9ees, 9abp, 9hm.
Canadian—C.W.—5cn.
Mexican—C.W.—ng, qra?
Qra???—gj (vy qsa hr).

B. C. (over 1,500 miles)—cfen, cjca, ckcd, cfac, kgo, wbz.

kdka* and wgy strong on 100 meters.
Stations marked * hrd hr in datime.

6CTE, BROOKDALE, CALIF.
1bsz, 4aw, 4bz, 4my, 5aar, 5adb, 5aes, 5aiu, 5akx, 5amu, 5be, 5ch, 5ct, 5dq, 5eh, 5it, 5lp, 5lr, 5mm, 5og, 5qd, 5ql, 248 6s, 7af, 7abh, 7aby, 7aci, 7adf, 7adg, 7adi, 7afe, 7afk, 7age, 7aho, 7ahz, 7aim, 7aiv, 7akh, 7akk, 7ald, 7ali, 7alk, 7amu, 7bj, 7co, 7cr, 7cs, 7di, 7dr, 7dz, 7em, 7eu, 7fq, 7fr, 7fs, 7fw, 7gs, 7gu, 7gy, 7hun, 7if, 7io, 7it, 7iu, 7iw, 7ja, 7ju, 7ke, 7ks, 7lh, 7lu, 7nt, 7ob, 7om, 7ot, 7ps, 7qc, 7qd, 7qu, 7rc, 7ry, 7sh, 7ut, 7vn, 7wo, 8ago, 8cmv, 8dac, 8gh, 8kk, 8uh, 8vy, 8xan, 8yn, 8zc, 9abc, 9acc, 9aim, 9aka, 9akv, 9amb, 9amp, 9amu, 9aps, 9aqd, 9asw, 9avv, 9awm, 9awv, 9bav, 9beu, 9bfp, 9bjk, 9bly, 9bof, 9bpt, 9bpv, 9bpy, 9bqj, 9bre, 9brk, 9bto, 9btt, 9bun, 9bxa, 9bxq, 9hzi, 9caa, 9cdv, 9cdy, 9cht, 9cjc, 9cjb, 9cju, 9cjr, 9cka, 9ckj, 9cra, 9cvo, 9day, 9dbf, 9dcp, 9dgi, 9dkb, 9dlq, 9dpr, 9dpx, 9dvw, 9dwn, 9dxn, 9dxx, 9dyy, 9dyr, 9dzo, 9eak, 9ebm, 9ebt, 9eep, 9efh, 9ekf, 9eky, 9hg, 9mc, 9ql, 9rc, 9ry, 9ss.

Canadian—4co.
Will qst checks on above calls.
Pse report my 50-watt C.W. and phone. Every card answd.

7AJT, BASIN, WYO.
C.W.—1avf, 1axn, 1xah, 1xc, 2cpx, 2cqz, 2el, 2sq, 2vh, 2xna, 3aa, 3adb, 3blu, 3cju, 3dq, 3xir, 5aaq, 5ad, 5ae, 5ald, 5amu, 5ek, 5lp, 5lr, 5ql, 5rg, 5rm, 5sk, 5sp, 5zh, (6aan), 6adb, 6age, 6agk, 6akz, 6alc, 6amm, 6apw, 6aqm, 6arb, 6atn, 6avm, 6bbw, 6bm, (6bqs), 6brf, 6bcd, 6cc, 6cdg, 6cfz, 6cgd, 6cgg, 6cgv, (6che), 6ckh, 6ckr, 6clq, (6cmu), 6dd, 6eb, (6fm), 6ja, 6kj, 6rn, 6vd, 6xb, 6zu, 7abb, 7aby, (7acf), 7adi, 7ads, 7aek, (7ahs), 7aim, 7aix, 7ald, 7alk, 7bt, 7dz, 7ia, 7iq, 7is, 7gi, 7go, 7gr, 7iu, 7jh, (7ju), (7kc), 7ig, 7lk, 7lh, 7ma, 7mi, 7no, 7qc, 7ry, 7sh, 7sy, (7ut), 7vn, 7zj, 7zz, 8abx, 8acm, 8ah, 8amr, 8apt, 8arp, 8atc, 8axf, 8bn, 8bpy, 8bsq, 8bum, 8bxx, 8bys, 8cbw, 8cko, 8cnw, 8cpl, 8crw, 8cyi, 8ddx, 8dhs, 8dil, 8dij, 8fc, 8fm, 8hn, 8ig, 8ij, 8pl, 8ry, 8tt, 8ur, 8vt, 8xb, 8xbh, 8xbp, 8yv, 8zz, 117 9s hrd.

Canadian—3ws, 4aa, 4bk, 4cb, 4cr, 4dq, 4eo, 4er, 4fm, 4jo, 5ah, 5ef, 9cf.
Phone—5akf, (6fm), (7co), 9ej.
I.C.W.—2sq, (6fm), 8apt, 8cis, 8dmx, 9acc, 9beu, 9ccv, 9dlm, 9rc, 9xba.
Spark—9aau (spk?), 9btx, 9cs or 9csn?, 9rr.

"Rolls Royce" Radio Tubes



Like their name, significant of quality. Durable and powerful. Bring in distance with a maximum of volume and clearness.

Type 201A—5 v., 25 amp. Amplifier and Detector
Type 199—3.4 v., .06 amp. Amplifier and Detector
Type 199—3.4 v., .06 amp. With Standard Base—Amplifier and Detector
Type 12—1½ v., .25 amp. Platinum Filament—Amplifier and Detector
Type 200—5 v., 1 amp. Detector Tube

"The Rolls Royce of Radio Tubes"

All Types \$2.50 Every Tube Guaranteed

To work in Radio Frequency. Especially adapted for Pentode, Reflex and Super Heterodyne. Shipped Parcel Post C.O.D. When Ordering mention tube.

ROLLS ROYCE TUBE CO.
21 Norwood St. (Dept. N) Newark, N. J.

DEALERS

OUR LIBERAL DISCOUNTS Will Save You MONEY

Standard Quality Parts. Send for this Free Catalog.

All Orders Shipped the Same Day.

WESTERN RADIO MFG. CO.
Manufacturers and Distributors
138 W. Lake Street, Chicago, Illinois

SUPER-HETERODYNE KIT

\$15

Original Globe Coils

consisting of
Oscillation Coupler
One Input Transformer
3 Intermediate Transformers

All transformers are matched and mounted as a single unit. Complete wiring diagram with each kit sent parcel post.

Globe Radio Equipment Co.
217 West 125th St. New York City

21 Jewels

Nothing less than 21 Ruby and Sapphire jewels is good enough for Burlington watchprice

Quality and Style

Adjusted to the second—temperature—magnesium—positions, 25 year Gold Strata Case, in 100 designs. \$1 down. Balance in small monthly payments. Send for free book.

Burlington Company
19th Street and Marshall Blvd. Dept. C-594 Chicago, Illinois

VACATION SPECIALS

\$25.00 Crosley Portable 51-P	\$19.61
125.00 5 tube Heterodyne; can play on loop if desired	55.00
SUPERDYNE KIT, complete parts	28.90
6.50 Ritter Collapsible Stik Loop	4.00
45 V. large B Batteries, \$2.00; medium	2.00
22½ V. large B Batteries, 1.45; small75

Remittances must include postage. No C. O. D.
MARVEL RADIO SPECIALTY CO.
132 Nassau St., New York

Charge Your Battery For A Nickel

The Gold Seal Homecharger Charges Radio and Auto Batteries at home overnight for a nickel. Your dealer has it. Write for FREE booklet and list of broadcasting stations.

The Automatic Electrical Devices Co.
118 W. 3rd St., Cincinnati, O.

IT IS A PORTABLE

No aerial, ground or loop required for Local Stations. You can take it with you when visiting. Use it in your Hotel room—On your vacation—Anywhere, Anytime.

LONG RANGE
—coast to coast—

Reception Loud and Clear. Wide range on loud speaker.
Single Tube "SUPERFLEX" in Leatherette Case, Very Neat.

Order NOW—Will be sent C. O. D. parcel post anywhere on receipt of \$1.00 with order, to cover postage.

PRICE..... \$65.00 COMPLETE
Ready to operate. Dealers write
BENSON ENGINEERING COMPANY
2125 N. Halsted Street. Chicago, Illinois

HEATH RADIANT CONDENSERS

The ONLY condenser worth buying is one that will be permanently accurate! Plates that cannot vary their alignment the thousandth part of an inch because stamped and tempered to PERMANENT FLATNESS.

Geared Vernier
Minute adjustment without the slightest backlash.

Write for Literature!
Jobbers and Dealers Write for Proposition
HEATH RADIO & ELECTRIC MFG. COMPANY
206 FIRST ST. NEWARK, N. J.
Canadian Distributor: Marconi Wireless
Telegraph Co., Montreal, Canada

Dalite—5air, 5aiu, 5amw, 5lg, 5na, 5qi, 6sm, 7kc, 9aby, 9ac, 9atl, 9avv, 9aws, 9bav, 9bex, 9beu, 9bfp, 9bhd, 9btm, 9bts, 9bx, 9caa, 9ccs, 9cen, 9cju, 9ekj, 9ctg, 9ddi, 9dmv, 9dro, 9dwn, 9dyy, (9dxr), (9cbl), 9ecn, 9ejn, 9iw, 9eky, 9elw. W1 qsl abv if requested.

8RRB, APOLLO, PA.

C.W.—1afn, 1ahr, 1alr, 1are, 1axn, 1ayl, 1bgi, 1hbl, 1bom, 1by, 1bym, 1ci, 1ck, 1cnk, 1cti, 1cv, 1fn, 1gv, 1kc, 1mr, 1yb, 2aar, 2abt, 2ajg, 2ana, 2aoo, 2axn, 2azy, 2bgi, 2bgu, 2bab, 2brb, 2cdd, 2edp, 2ece, 2cfx, 2cpa, 2cpd, 2cpx, 2cur, 2cvj, 2cwj, 2kq, 2qi, 2rb, 2r, 2s, 2t, 2u, 2v, 2w, 2x, 2y, 2z, 3afu, 3ahp, 3ajo, 3aoy, 3aav, 3ayp, 3bm, 3bms, 3brf, 3buy, 3bwj, 3bx, 3ech, 3ecu, 3col, 3cgs, 3ckl, 3cqz, 3cu, 3ds, 3hh, 3ii, 3iv, 3jx, 3lc, 3lk, 3lg, 3mu, 3pi, 3ti, 3uh, 3yu, 3zd, 4af, 4ai, 4dy, 4eq, 4ft, 4fz, 4gs, 4gt, 4jm, 4jr, 4ll, 4pv, 4qu, 4su, 5ek, 5ka, 5kc, 5lr, 5xb, 6lv, (8aig), (8ago), (8arb), (8bci), (8bct), (8bdw), (8bgz), (8bjt), (8bkh), (8brc), (8ca), (8ccj), (8cci), (8cko), (8cen), (8cfd), (8cfs), (8chf), (8cut), (8cum), (8cuv), (8cx), (8dlw), (8lli), (8dnf), (8dnu), (8hk), (8jq), (8qd), (8sf), (8st), (8ve), 9adp, 9agb, 9agn, 9ajr, 9amj, 9ana, 9aps, 9arf, 9ave, 9aug, 9ayx, 9az, 9aza, 9azj, 9baz, 9bbg, 9bby, 9bol, 9bdr, 9bhb, 9bhq, 9bmu, 9bof, 9bre, 9bri, 9bt, 9btl, 9bvk, 9bum, 9bvw, 9bwu, 9ca, 9ccm, 9ccw, 9cci, 9cli, 9chf, 9chk, 9ck, 9cly, 9cm, 9cut, 9cuv, 9cuv, 9cyn, 9dlf, 9dej, 9dew, 9dlz, 9dnp, 9dqu, 9drd, 9eev, 9efz, 9eht, 9eja, 9elb, 9fz, 9hm, 9ib, 9lz, 9rc, 9rr, 9kdf, 9ip.

I.C.W.—8vq, (8ckd), (8ago), (8cci).
Spark—(8bou).
Phone—(8euv), (8bkh), (8chf), (8cci).
Pse qsl mi 5 watts hr. tux. W1 qsl to those requesting.

8WY, AKRON, OHIO

1ci, 1ml, (1qr), 1uj, (1uo), (1ual), 1acr, 1acp, 1ags, (1aiv), 1ajg, (1anx), 1atj, 1axz, (1bef), (1bet), 1bgq, 1bwj, (1caz), 1coe, (2at), 2kx, (2sq), 2adc, 2acy, 2ayp, 2bco, 2coo, 2cci, 2cjj, (2cvf), (2cyn), 3ii, 3ly, 3rg, 3sh, (3ti), 3zt, (3adq), 3adt, (3ale), (3ale), 3aoy, 3apv, 3atb, 3bdo, 3bms, (3ccx), (3edk), (3cjm), (4bw), 4bz, 4eg, (4gv), 4hw, (4it), (4jr), (4js), 4ll, 4og, (4pk), 4qw, 4rf, 5cg, 5en, 5ht, 5na, 5uk, 5vc, 5xa, 5za, 5zr, 5afh, (5aiu), 5ajj, (5aku), (5auw), 6aoo, 6adt, 6agk, (6ahp), 6ahv, 6aja, 6xad, (7fa), 7iw, 7iy, 7xt, 7adg, 7ahs, (9bk), 9db, (9eg), 9if, 9kk, 9ual, 9aap, 9aqq, (9asr), (9bdb), 9bis, 9bmu, 9bsi, 9bye, (9caa), (9caj), 9cdo, 9cjh, 9cop, 9cut, 9cyd, (9dz), (9dlf), (9dpp), 9dro, 9eki.

Daylite—2hoi, 3lc, (3buy), (4fz), 4sh, 9abl.
Canadian—3gg, (3nj), 3ud, 3vw, 3yv, 3ada, 4fz, 5am.

9CRG, COOPERSTOWN, N. D.

(Detector only)
C.W.—2awp, 5agn, 5aiu, 5amw, 5aw, 5dc, 5ql, 5aaq, 5lr, 5aco, 6blw, 6bnh, 6bur, 7dc, 7co, 7ahv, 7do, 8ah, 8at, 8diz, 8epk, 8do, 8aqm, 8wx, 8fg, 9aau, 9agb, 9ahy, 9ahh, 9agu, 9aim, 9ait, 9bst, 9bis, 9bvw, 9brx, 9bvc, 9bgh, (9bht), 9brn, 9bly, (9cis), (9cwn), 9epz, 9epo, 9caa, 9cjt, 9cc, 9cft, (9csi), 9eyw, (9cdv), 9eld, 9civ, 9ekd, 9cli, 9cft, 9cvg, 9egq, 9exp, 9day, (9daw), (9dkr), 9dwn, 9dit, 9did, 9dyr, (9dxr), 9dec, (9dre), 9dfz, 9dyh, 9dzu, 9dix, 9df, (9dig), 9dro, 9dkb, (9cbl), 9dt, (9dm), (9dbr), (9cgu), (9eak), (9efn), (9emc), 9ahq, 9zt, 9mc, 9aim, 9ach, 9eka, 9ega, 9acc, (9ack).
Phone—5qd, 8wx, 8ka?, 9dhy, 9mm, 9did, (9cdv), 9cwn, (9dig), (9emc), 9cvc, 5xaj.

Radio Does Not Electrocute

(Continued from page 177)

dangerous, according to all well-informed experts, unless, of course, they are charged by outside electric power.

The story tells of an unfortunate lad who, it developed, let his antenna come into contact with an electric wire carrying 2,300 volts. It is readily seen that he was not electrocuted by radio but by an electric power line. It would have been the same had he been stringing a wire clothes-line, although his death would not have been charged to a clothes-line. An autoist who stalls his machine on a railway track and is killed by an express train is not said to have been killed by an automobile.

USE A PLUG

SHE: "Stop hammering on that radio and come to bed!"

INEXPERIENCED RADIO FAN: "Just a minute, dear, I'm trying to find out where the grid leaks."—James Day.



Transformers and Variable Condensers

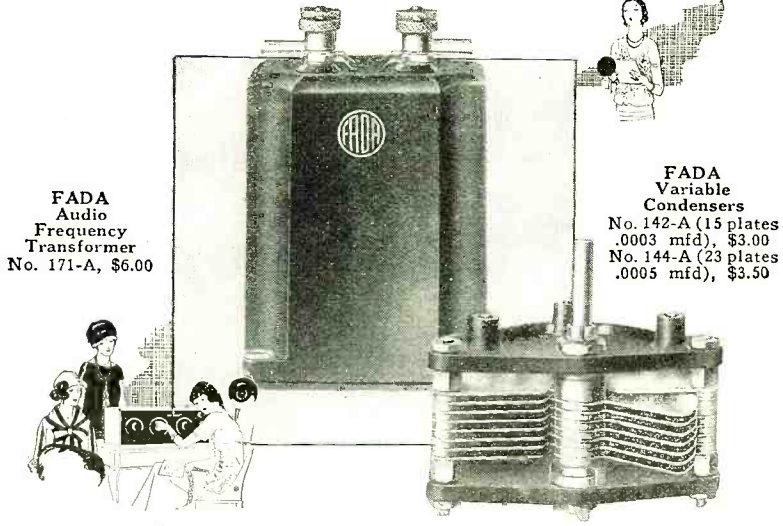

FADA Audio Frequency Transformer No. 171-A, \$6.00

FADA Variable Condensers
No. 142-A (15 plates .0003 mfd), \$3.00
No. 144-A (23 plates .0005 mfd), \$3.50

More volume—finer tuning

POOR condensers absorb radio power—that cuts down volume. Poor condensers add resistance—that broadens tuning. You can sharpen your tuning, increase selectivity and get greater volume with the new FADA "low-loss" variable condensers. Use them. The low power factor and low equivalent series resistance prove their superiority. FADA "low-loss" condensers are more efficient than many of the so-called precision condensers and have a capacity ratio of 40 to 1 as compared with 30 to 1 which is usually encountered. Two sizes—No. 142-A (15-plate .0003 mfd) at \$3.00 and No. 144-A (23-plate .0005 mfd) at \$3.50.

Performs as well as it looks

The new FADA Audio Frequency Transformer is encased in bakelite with nicked binding posts and soldering lugs. It looks "quality" all over. And it performs up to its appearance. It has a high average amplification over all the broadcasting wave-bands and reproduces voice and music with a volume and tonal fidelity that is surprising. A wonderful addition to the audio frequency stages of Neutrodyne receivers and equally efficient in other types. This new transformer, No. 171-A, is made possible by correct FADA engineering principles and by uniform production methods. Ratio 4 to 1. Price \$6.00.

Ask your dealer for FADA Transformers and Variable Condensers

F. A. D. ANDREA, INC., 1581 Jerome Avenue, New York



Unequaled for
Clarity of Tone
Volume and
Long Life



201-A
TYPE

\$3.50

GUARANTEED

KEYSTONE VACUUM TUBE

The Keystone Vacuum Radio Tube is the result of the very latest research into the principles underlying vacuum tube construction.

The Keystone Tube has a larger mutual conductance factor which insures greater clarity of tone than the ordinary tube.

The Keystone Tube also has a larger amplification factor, which means much louder signal strength than the average tube. Operates equally well for radio or audio frequency amplification.

FULLY GUARANTEED
to give satisfactory service

If your dealer does not have Keystone Tubes we will ship prepaid anywhere as many as you need upon receipt of price.

KEYSTONE ELECTRIC & RADIO CO.
110-116 Nassau Street, New York, N. Y.
Some dealer territory still open

ANTENNELLA

Overcomes Static and Re-radiation!
No Outside Wires or Lightning Arresters Needed!

Why pay \$10.00 or more for an aerial, spoiling the appearance of your home?

Antennella eliminates all unsightly wiring, lightning arresters, etc., and precludes the possibility of dangerous grounding on a power line. It also stops "canary bird" re-radiation from nearby oscillating sets interfering with your reception.

ANTENNELLA

is not only a real distance getter but also successfully overcomes static interference and electrical annoyances.

The complete, efficient, **\$1.25** and economical aerial

AT YOUR DEALER'S OR SEND PURCHASE PRICE AND YOU WILL BE SUPPLIED POSTPAID

FREE! Write for building plans and hook-ups of Super-Heterodyne, Reflex and other Popular circuits. Ask for list K-101.

Chas. Freshman Co. Inc.
Radio Condenser Products
106 Seventh Ave.,
New York City.

COCKADAY UNIT—Full Set A, B, C and D Coils
PRICE \$5.50
Three large blue prints, illustrated instructions and material lists for building the 1, 3 and 5 tube Cockaday sets
Price 50c (Free with order for unit)
General Radio Winding Co. 214 Fulton St. New York

An Efficient Contact Switch

(Continued from page 193)

unscrewing the nut on the end of the switch shaft. Contact to this switch may be made directly to the brass spring. With this switch in service you will no longer be troubled by loose contacts.

Contributed by Bert E. Parsons.

A QUICK-CHANGE A. F. TRANSFORMER

This article is a description of a method whereby the formerly immovable A. F. transformers in a receiving set can be moved from one set to another as quickly as a vacuum tube and without disturbing any wiring or loosening and tightening any nuts or binding posts. This arrangement makes the purchase of more than two or three transformers unnecessary, no matter how many different receiving sets the experimenter may use.

The scheme, as can be seen from the drawing, consists of mounting the transformers upon separate, identical bases of bakelite or formica on which four contacts made from switch stop pins are fastened. The contacts are wired to the terminals of the transformers. If different makes of transformers are used, be sure the G P B+ and F terminals are wired to corresponding contacts on the bases to prevent reversed connections as the transformers are moved from socket to socket.

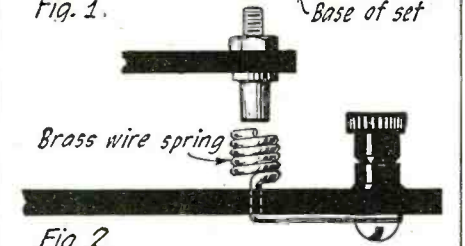
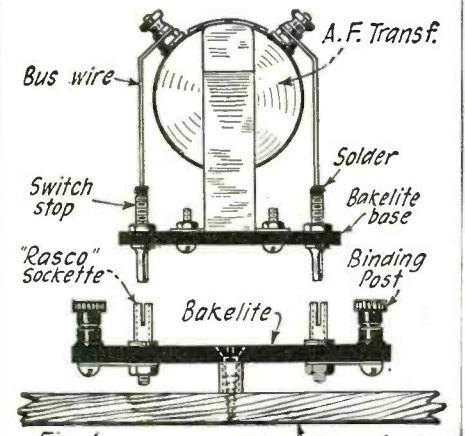

Fig. 2
A quick transfer of A.F. transformers for test is possible with this arrangement.

The sockets consist of pieces of formica or bakelite cut slightly larger than the transformer bases. On each of these are fastened four binding posts and four "Rasco Sockettes" (small size). If the "Sockettes" cannot be obtained, cord tip jacks which will accommodate stop pins or the arrangement shown in Fig. 2 may be used.

To avoid placing the transformers in the sockets incorrectly, do not arrange the contacts in a square or rectangular formation, but place the primary contacts closer together than the secondary contacts.

This idea is also useful in making comparative tests between different transform-

FREE

To Each Purchaser of a World Battery

A 24-Volt "B" Storage Battery positively given FREE with each purchase of a WORLD "A" Storage Battery. The WORLD Battery is famous for its guaranteed quality and service. Backed by years of Successful Manufacture and Thousands of Satisfied Users. You save 50%.

Prices That Save and Satisfy

Auto Batteries	Radio Batteries
6-Volt, 11 Plate \$12.25	6-Volt, 80 Amps. \$10.00
6-Volt, 13 Plate 14.25	6-Volt, 100 Amps. 12.50
12-Volt, 7 Plate 17.00	6-Volt, 120 Amps. 14.50
	6-Volt, 140 Amps. 16.00

Shipment Express C. O. D. subject to examination. 5 per cent discount for cash in full with order.

2-Yr. Guarantee Bond in Writing With Each World Storage Battery

proves satisfactory World performance. Mail this ad with your name and address—we will ship battery day order is received; and give you your choice of "B" Storage Battery or a handsome nickel finish Auto Spotlite. **FREE. Write TODAY.**

WORLD BATTERY COMPANY
1219 So. Wabash Ave. Dept. 10, CHICAGO, ILL.

This FREE "B" Storage Battery takes the place of dry cell "B" batteries. Can be recharged and will last indefinitely. To be sold retail for \$6.00. It is the only battery of its kind equipped with solid rubber case—and insurance against acid and leakage. Take advantage of this remarkable introductory offer NOW. (To those who prefer it, we will send FREE a handsome nickel finish Auto Spotlite, instead of the "B" Battery. Be sure to specify which is wanted.)

GIVEN FREE

To introduce this new and superior World "B" Storage Battery to the Public.

We repair the following RADIO TUBES and Guarantee Them

WD-11 ... \$2.50	UV-199 ... \$2.50
WD-12 ... 2.50	C-299 ... 2.50
UV-200 ... 2.50	UV-201A ... 2.50
UV-201 ... 2.50	C-301A ... 2.50
C-300 ... 2.50	Marconi ... 2.50
C-301 ... 2.50	Moorehead ... 2.50
DV-6 ... 2.50	6 v. Plain Detector ... 2.50
DV-1 ... 2.50	6 v. Plain Amplifier ... 2.50
DV-2 ... 2.50	
DV-6A ... 2.50	

Mail Orders solicited and promptly attended to. Dealers and Agents write for Special Discount.

H. & H. RADIO CO.
P. O. BOX 22-H
Clinton Hill Sta., Newark, N. J.

The Traffic Cop of the Air

He arranges in orderly fashion the mass and jumble of Broadcasting Stations that are seeking entrance to your set and brings 'em in, one at a time, so you can enjoy them! Never reduces, but nearly always increases volume. Add a Ferbend Wave Trap to your set and "Police" your reception. Regulate the Traffic!

Guaranteed to tune out any interfering station. The price is \$8.50. Shipment is made parcel post C. O. D. plus a few cents postage. If you prefer, send cash in full with order and we will ship postage prepaid. Send us your order today.

FERBEND ELECTRIC COMPANY
Wave Trap
25 E. South Water St.
Chicago, Ill.

BECOME A PROFESSIONAL PHOTOGRAPHER

EARNING \$35 TO \$125 A WEEK

Three to six months' course Motion Picture, Commercial, Portraiture. Practical instruction. Day or Evening Classes. Ask for Catalog No. 56.

N. Y. INSTITUTE OF PHOTOGRAPHY
NEW YORK CHICAGO BROOKLYN
141 W. 36th St. 630 S. Wabash Ave. 505 State St.

ers, and also the best position in the circuit for different ratio transformers.

Contributed by C. T. Hagerstrom.

COMBINATION CRYSTAL AND TUBE RECEIVER

For local stations a crystal detector gives sufficient volume for headphones and is also recommended to conserve "A" battery current. A combination crystal and tube receiver can be employed so that either one or the other can be used. There have been many circuits advanced for this purpose, but none have proven very successful. The accompanying diagram shows a circuit that will prove very satisfactory, as it incorporates all of the good points that such a receiver should have. This circuit, when using the tube, is regenerative, being of the ultra-audion type. It changes from crystal to

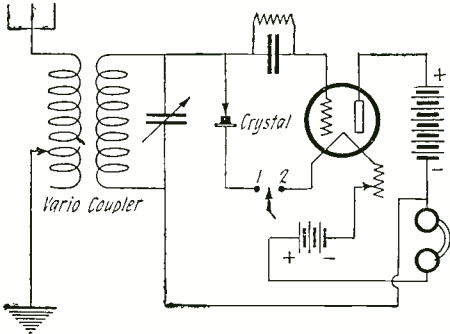

A clever combination tube and crystal receiver.

tube with a single switch, at the same time lighting the filament. On changing back to crystal, no current is used in the filament, as the "A" battery is automatically disconnected. When the switch lever is on the switch point at the left, the crystal is being used and no current is flowing through the filament of the tube. When it is placed on the switch point at the right, the tube is being used and the filament is automatically lighted. This set is recommended to those who cannot afford to use many batteries and like to listen in on the local stations on the crystal.

Contributed by K. Kricherets.

Allez Houpla

(Continued from page 168)

"I begs your pardon," I says, "but I'm looking for a gent named Master Jerry Lawson."

"I am he," replies the individual with the Harold Lloydys. "What can I do for you?"

"Do you build radios?" I asks.

"I design instruments, and create new wiring systems," he says, "but I am not engaged in commercial production."

"Well, they told me at the store that you did the dirty work and maybe you might build me a outfit, seeing as how I ain't been inoculated with the bug long enough for it to take."

The gentleman smiles and scratches his head. "As I said, I ordinarily do not enter the commercial end," he states. "But—just what kind of a set do you wish?"

"Is they kinds?" I asks.

"There are," he replies, giving me a look that don't pass no credit. "I presume you wish to hear the broadcasting?"

"That's the general presumption," I comes back. "I confess I don't know nothing about this radio game except that you turns a knob and either you gets some guy in the Bronx singing *Oi Ve Ain't Got Hardly a Banana Yet* or else you gets tactics."

ATWATER KENT

RADIO EQUIPMENT

Master Workmanship and Scientific Precision

IT is a significant fact that as the public becomes more experienced with radio equipment, and better qualified to discriminate, the preference for "ATWATER KENT" grows.

Master workmanship and scientific precision combined have made it what many consider perfection in radio construction.

Literature describing Atwater Kent Receiving Sets and the Atwater Kent Loud Speaker sent on request.

ATWATER KENT MFG. COMPANY
4943 STENTON AVENUE
PHILADELPHIA, PA.

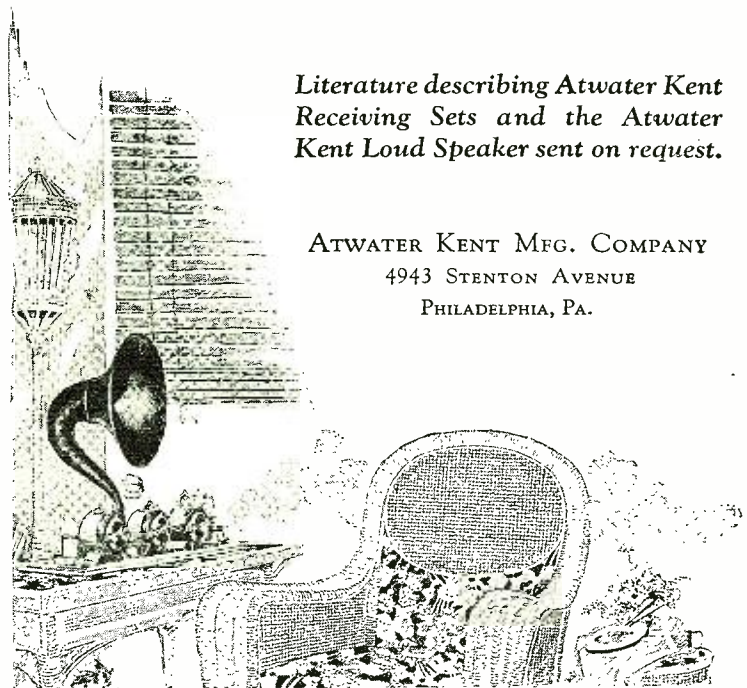

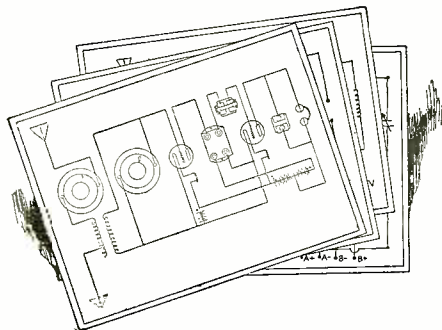

Free Blueprints Show How to Increase Your Range

Ask your dealer for free blueprints of Duratran radio frequency hook-ups. If he has none, write to us for them and give us his name. They show how a Dubilier Duratran will convert your one-tube set into a sensitive radio-frequency receiver.

Don't throw your one-tube regenerative set away because you can't get the distant stations.

Simply add a stage of Duratran radio-frequency amplification. And you will save the ten or fifteen dollars you would spend in building a new radio-frequency set.

The Duratran will enable you to bring in the distant stations because it amplifies on all broadcasting wave-lengths twenty times. All the stations come in with equal clarity because of this unrivalled uniform amplification.

Your dealer sells Dubilier Duratrans. Price \$4.00.

DUBILIER CONDENSER & RADIO CORPORATION
40-46 West Fourth Street
NEW YORK

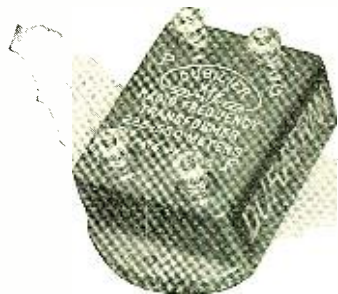

Jones Multi-Plug & Cable



Put this type on your new set; it is small and may be mounted anywhere. With cord and plug, \$1.00 Type P. M.



Put this type on seven binding posts of your present set. With cord and plug, \$3.00 Type B. P.



Put your Batteries on shelf in basement and run this 8-ft. cable through floor to set.

5 A and B. battery wires in cable. Antenna and ground are separate leads from cap. Guaranteed not to impair efficiency of set. For sale by all Jobbers and Dealers. Fully covered by patents applied for. Manufactured by

612 S. Canal St. HOWARD B. JONES Chicago

Insure your copy reaching you each month. Subscribe to RADIO NEWS—\$2.50 a year. Experimenter Publishing Co., 53 Park Pl., N. Y. C.

The Master smiles. "You mean static," he informs me. "Shall I explain to you the general rudiments of radio communication?"

I sees I'm in for it. I know these bugs. They talks for three hours about how long it took to get WBN and KFS and when I puts in that it takes longer to get KKK they hands me a nasty smirk. But I puts on a brave front and tells him to open the show.

Well, this bozo has been so long in the game he really knows what he says. He begins by asking if I ever threw a stone in the water and seen the ripples go out all around. I says that was just like springing a line that nobody but a fat man in Row L gets. He laughs, and everybody else begins to laugh around him.

The Master emits a snicker. "I see you are alert," he goes on. Then he tells me that a radio is just like the stone or the fat man. Pretty soon I begins to get the original idea. It ain't so much, after all. Jerry talks for an hour or so, and in the end I have a fair head full of radio terms and germs. So finally I orders him to build a four-tube set of his own design, which he agrees to have ready in a week. So I tells him goodbye and he invites me to come often, him liking to talk and me on my vacation having a chance to listen.

A couple of days later I accepts his invitation and drops in on him. He gives me the glad hand and tells me to sit down, which I does. He shows me a panel on which he is working which he explains is to be my set. Well, we talks on various subjects for a while, that is. I asks a question and he answers with a treatise. As it happens, the tide of our talk turns to new inventions. I should have known every experimenter has a pet invention hid up his sleeve somewheres. And just my luck I strikes his little brain orphan.

There was a queer looking do-funny in a corner that looked like a lot of nothing in particular, and I casually asks him what it is. And right away he freezes up.

"An invention I'm working on," he says, short and snappy. I sees it ain't polite to talk further on the subject so I switches to another field and asks him how he likes swimming. Pretty soon he gets back to normal. Well, we chins a while longer, and then I says so long and beats it home.

The rest of the day I keeps wondering what that dingus was. Guys what says that women is the only curious folks ain't never been denied no information. I keeps getting worse and worse, so next day I decides to ask him point blank, and I does.

He seems a bit better about it. "An invention," he repeats.

"What for?" I inquires. He eyes me closely. "You're not—no, you couldn't," he says.

"Thanks," I remarks. "And since I couldn't, what is it? My curiosity is just burning me up."

"That," he tells me, sort of half-sadly, "is an, as yet, incomplete device to be attached to a radio to provide a voice-throwing effect similar to that used by ventriloquists on the stage. It should throw the voice, but it doesn't—yet!"

The way he says "yet" lets me in on it all. The thing won't work, and he don't know why. So I puffs up and gives the apparatus the above, around and under.

"To throw the voice?" I asks casually. "My man, I fear your work will be to no avail." This last line I remembers from a one-act sketch we trouped with a couple of seasons ago. But The Master takes it all for what it sounds like.

"Won't work?" he asks quickly. "And why not?"

Not having the slightest idea why it wouldn't, I spars for time by poking the horn and making goo-goo eyes at a pair of

WHEN TROUBLE COMES!

When something happens to their Radio Set five people out of ten do not know what to do. CONSRAD has a book that tells you what to look for, just as the Auto instruction book tells you how to locate troubles in your car. How to test the batteries to see if they are fully charged, how to trace all leads to and from the batteries, how to locate faults in the Radio frequency and Audio frequency circuits, etc. The book is complete in that it takes every step in the modern radio receiving sets and outlines what possibly might happen to each.

AT ALL RADIO DEALERS
The price of this handy, 52 page book is only 25c. All orders are taken care of within 24 hours.

PREPAID **PRICE 25c**



The E. I. Company
(Consrad Co., Selling Agents)
233 Fulton St., New York City

GHEGAN RADIO RELAY

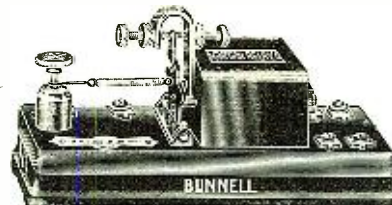

Taps permit tubes of various impedances to be used. With Bunnell Register this Relay will copy telegraphic signals at a speed of 60 to 90 words per minute. With Siphon Recorder speeds up to 200 words per minute have been obtained. Normal operating current is 1/2 to 2 Milli-Amperes. Send stamp for catalogue No. 45-B.
Ghegan Radio Relay \$40.00
Special Price to Dealers
J. H. BUNNELL & CO., 32 Park Pl., New York City

BROWNLIE CRYSTAL

Guaranteed the Best **\$1.00**

"REFLEX SPECIAL" QUICK CONTACT RECTIFIER
Withstands Heavy Plate Voltage
The Acme Apparatus Co. says "prevent distortion and howling by using a BROWNLIE CRYSTAL in REFLEX SETS."
Order From Your Dealer or Direct
ROLAND BROWNLIE & CO.
22 Saunders Street Medford, Mass.

knobs. "It won't work," says I, "because no man of scientifics has ever made a mouth what can talk, and until some noble brow does so you can't throw no speech. I knows several ventriloquists, and they agrees with me."

This last is a nice whitewashed fib, but it gets the results. The Master stands up. "Ventriloquists!" he exclaims. "How did they do it?"

I gives him a look of pure disgust. "My dear sir," I explains, "them facts is professional secrets."

"Oh," he says and sits down again. "But I'll succeed!" he declares. "I'll succeed!"

"I ain't aiming to discourage you none," I says, "but what's the use of this thing if it does work?"

Now it's his turn to ship me the look of tolerance. "Use!" he cries. "Use! Why man, it's just the principle of the thing at this moment. Uses will develop in good time. Think what it might mean to radio! One big community horn, throwing the concert into a thousand homes!"

"About which I knows no more than a June bug and cares less than Eva Tanguay," I tells him. "Howsomever, I wishes you success. When you gets it to ventril, give me the buzz"

"I'll do that," he declares. "Most certainly. I shall do that."

Nothing more is said of it, and a few days later my outfit is done. As a personal favor. The Master comes over and sets her up.

It's a jake rig six ways from the foot-lights. There's four tubes on it, a lot of fancy dials that twist easy and make a lot of difference, and a horn which Jerry says is a loud speaker. I pipes up that I already got one of them, he asks where, and I nods at the wife. Seeing as how there's company, the better fraction don't pull no rough stuff, so pretty soon we has the set going, and I'm saying she works slick. We listens to a lecture on "How To Train Silkworms To Spin Overtime" which some goof in Chicago is telling the world, and to a concert by the choir of the Eighth Baptist Church of Green Meadows, Arizona. Then The Master turns some more of the knobs, and we gets Detroit. And right there me and Doris gets the jolt of the evening. The announcer speaks:

"The next devastation by this air desecrator will be Mr. Sigmund Everett Clancy singing "My Sweetie Went Away! *Allez Houpla!*"

I jumps up. "I know——" I begins.

"Why, that's Barry Dunhaven," exclaims the wife. "Don't you remember, dear? He did a comedy single with us on the coast tour last year."

Of course I remembers, having lost more jack than I'd care to mention playing draw poker with Barry in Pullman smoking compartments.

It's Barry, sure enough, for each time he finishes his announcement he says "*Alley oop!*" which same is primarily a cue cry for acrobats in vaudeville. It happened that most of last season Barry was on the same bill with a troupe of muscle twisters, he playing right after them in the deuce spot. So he grabbed the expression and worked it into a gag. Every time Barry'd sing he'd yell "*Alley oop!*" and kept it up until it got to be a sure-fire laugh. When things were running slow, Barry would step in on our act and clown a bit with us, still working his pet line which, because it didn't have no sense to it, got funnier every time he said it. Doris tells the tale to The Master. He smiles faintly.

"Theatrical customs are so quaint," he offers, which we admits and changes the topic. After Detroit is done, we trys a few more stations, all coming in like the Twentieth Century Limited. Both me and the adjunct gets real interested, and to help us along, The Master leaves some books on

Now! the best features of each Neutrodyne Reflex Regenerative combined in one single receiver

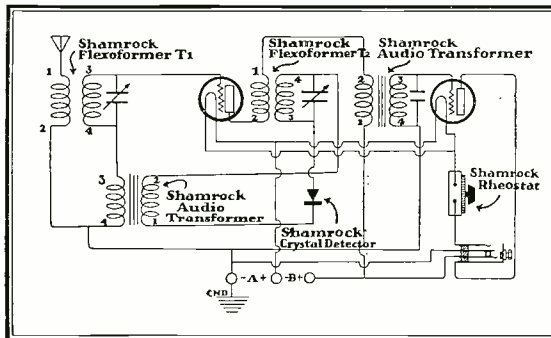

Shamrock Harkness

Kit containing every-
thing necessary to
build this set

\$35

Our Laboratories

AFTER months of research and experimentation, we are now presenting to the radio public a receiver combining the best features of every leading circuit. Shamrock is a licensee of the Harkness patent rights.

Volume from the regenerative

THE two audio transformers found in the regenerative are responsible for its powerful loud speaker volume. Shamrock-Harkness contains both of these.

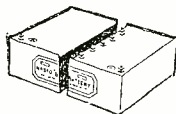

Cuts battery costs 60 per cent

Distance and selectivity from the Neutrodyne

RADIO frequency controlled by variable condensers mounted on air core transformers gives the Neutrodyne its remarkable distance and selectivity. Two of these are combined in the Shamrock-Harkness.

Buy only genuine Shamrock parts

THE Shamrock-Harkness Kit contains two Shamrock-Harkness Flexoformers, Shamrock Crystal Detector, two Shamrock Audio Frequency Transformers, Shamrock Rheostat—and all other parts to build this wonderful set. Buy only the genuine (guaranteed) Shamrock parts. Only when you buy the genuine Shamrock parts will you be sure of getting maximum results with this set. Before building your set, send for the "Shamrock Radio Builder's Guide Book." Send coupon below.



Two tubes do the work of five

Clarity from the Reflex

JUST one unit is responsible for the reflex's well known tone clarity. This is the crystal detector. You will find it in the Shamrock-Harkness.

SHAMROCK MANUFACTURING CO. Dept. 62, Market St. Newark, N. J.



Shamrock

FOR SELECTIVE TUNING

SHAMROCK MANUFACTURING CO., Dept. 62, Market St., Newark, N. J.

I enclose 10 cents (U. S. Stamps or coin) for copy of "Shamrock Radio Builder's Guide Book," containing log record. Also diagrams and complete instructions for building 10 sets—at prices ranging from \$15 to \$50.

Name

Address

Dealer's Name

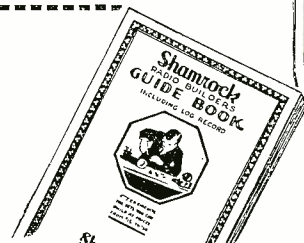

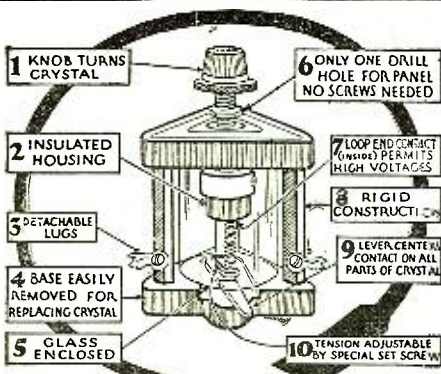

Best Crystal Ever Designed!
FRESHMAN

Double Adjustable Crystal Detector

At last the experimenter who has searched for the ideal crystal can now depend upon a perfect detector. The new Freshman Double Adjustable Crystal Detector has met every requirement of the ideal unit. It affords uninterrupted, noiseless, distortionless reception, yielding extraordinary volume with entire absence of squeals and howls often introduced by vacuum tube detectors.

The World's Best for Crystal or Reflex Sets

No more searching for the sensitive spot—merely turn the knob as you would a dial.

Freshman Double Adjustable Crystal Detector for panel or base use, complete **\$1.50**

Freshman Super-Crystal with Non-Metallic Housing. Fits any standard detector unit **50c**

At your dealer's or send purchase price and you will be supplied postpaid.

FREE! Write for building plans and hook-ups of Super-Heterodyne, Reflex and other popular circuits. Ask for Circular L-109.

Chas. Freshman Co. Inc.
Radio Condenser Products
 106 Seventh Ave., New York

Production Cuts Costs!

"Push-Pull" Crescent Transformers

Audio transformers 3 1/2 to 1 **\$2.95**
 "Push-Pull" transformers sets of (2) **\$8.50**

Complete wiring diagram and full information free. Send today. Satisfaction guaranteed.

CRESCENT MFG. COMPANY
 Box 337, Central Sta., Toledo, Ohio

Coto
 GUARANTEED RADIO PRODUCTS
 Coto-Coil Co.
 Providence, R. I.
"Built First to Last"

the subject, so we can learn while we listens.

Well, things goes smooth for a couple of weeks. I spends hali my time at the set, the wife using it while I ain't. I studies the books, and honest, I begins to learn. I only burns out nine tubes before I finds it makes a difference which wires you connects to which battery.

By the end of the second week our household is run according to the broadcasting schedules. We manages to work in meals here and there, when none of the big splashes is on the air, and altogether we lives free and easy. Also, it happens that our outfit is one of the best in the burg, the others having little insignificant crystal sets or maybe one tube. Add to that the prestige of the system having been constructed by The Master, and you have what constitutes an "A number one" social card in Brightmere-on-the-Deep. We gets real popular, and our house becomes a convention hall for DX fans. The wife, in all her glory at being able to get her whispers first hand once more, nearly weeps over the radio, even saying her prayers on a long wave-length.

It's a rainy Saturday evening about seven o'clock, and for once there's nobody in the house but us, when someone knocks at the door. To our surprise, it's our old traveling mates, Tom McKenna and Mabel, his wife, with the reason for their act in a gold cage with a rubber cover on it. As soon as the greetings is over Tom takes the hood off the cage and his meal ticket blinks one eye at me.

Tom and Mabel does what used to be a small-time patter act until they annexed Shakey. And for explanation Shakey is not just a crow with a split tongue, but almost a human. He talks, sings, and can sort of reason. I know it sounds funny, but that crow is a marvel. Well, Shakey recognizes me and tells me so.

"Hello, Joe," he caws. "How's the old hooper?"

"Fine, Shakey," I replies. "How's the wise bird?"

He blinks his eye again and does what passes for a smile.

"I'm aces, kid, I'm aces," he says.

We sets down and gabs for a while, Shakey being very much one of us, up on all the latest scandal and not averse to publishing it. Suddenly Tom lamps the radio.

"So you've got one of 'em, too," he comments.

"Absolutely," says I. "Have you?"

Tom shakes his head. "Don't know nothing about 'em," he confesses.

"Nor much else," pipes Shakey, and we gets a good giggle. Finally Tom picks up the cage and asks me where his bread and oleo can do the hypnotic act for the night. I tells him to put the bird in the conservatory. This opens Tom's jaw.

"The what?" he demands.

"The con-ser-va-tory," I repeats. "Where plants grow and young couples snuggle."

"You got a conservatory here?" inquires Tom.

"Why, of course," says I. "A regular one, too. The gent what owned this castle before us didn't care much about de luxe bath-rooms or spare flops, but he was a bee on the posies. So we got a conservatory. It's got some flowers, and vines, and goldfish in a pool, and a canary what can't sing, and a broken window pane in the skylight. Take a look—see."

Tom grins and puts the crow in with the green stuff. Then he comes back to us.

"Tell me about this radio," he requests.

Well, he brings it on himself, which ain't my fault, so I gives him a spiel.

"Well, it's like this," I begins. "The principle upon which radio is based is called oscillations."

"Do tell!" remarks Tom. Is called what?"

"Is called oscillations," butts in the frau. "It means a lot of electricity wiggling in the air like an eel in water."

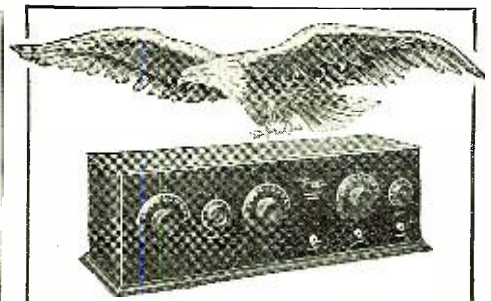

The Eagle
Balanced Neutrodyne
"King Of The Air"

The painstaking care maintained provides a balance comparable, figuratively, with the poise of the soaring eagle. Demands upon quantity production are forgotten in the effort to provide the balance of tube capacities that has made the Eagle supreme.

Eagle Neutrodyne cannot reradiate nor regenerate. Its ease of operation makes certain the reception of any station, once logged. As wonderful in simplicity as the phonograph; more wonderful in performance.

Licensed by Independent Radio Manufacturers, Inc., under Hazeltine Patent Nos. 1,450,080, dated March 27, 1923, and 1,489,228, dated April 1, 1924. Other patents pending.

We Soar Above

EAGLE RADIO COMPANY
 20 Boyden Place, Newark, N. J.

Dealers: Write to

KLAUS
About the NEW RADIOLA LINE

The New Radiolas are going to multiply sales for dealers everywhere. There is a model for every purse. Klaus regular authorized dealers will obtain preference in deliveries. If you are not one of our regular dealers write us today for our proposition.

KLAUS DEALERS BULLETIN

Expert advice regarding the merchandising of radio equipment and the newest information is in the Klaus Radio Bulletin. Send us your name for the Bulletin and get our trade discount list.

KLAUS RADIO & ELECTRIC CO.

Authorized Distributors

Dept. 200 EUREKA, ILL.

Insure your copy reaching you each month. Subscribe to RADIO NEWS—\$2.50 a year. Experimenter Publishing Co., 53 Park Pl., N.Y.C.

I gives the other portion a meaning look and she lets me go on. "Y'see, Tom," I continues, "when the bozo at the business end begins the useless talk, his hot air expands the waist line of the transmitter, which opens the flood gates and lets loose a spasm of Marconi's choicest ether waves. These—"

"Either waves or what?" demands Tom.

I feels like socking him beneath where his chin should be, but I sees he really means it.

"Just ether waves," I explains kindly.

"You just said it was electricity."

"So it is," I tells him patiently. "Y'see—"

"How can electricity be ether? I'm asking you."

Not having no weapon handy, I lets Tom suffer along. "I ain't no medic," I fires at him. "Sufficient to say, it can."

"Then proceed," orders Tom.

I wipes my brow and releases some more energy. "Well, these ether waves travels through the air—well, like an eel in water—so we puts some wires on the roof. One wire is enough, stretched straight between—"

"A straight wire for a crooked wave?" asks Tom.

"Why not?" returns I. "Ain't a straight jacket good enough for a crooked man?"

"But, man, it ain't logical!"

By this time murder seems too gentle. "But it's so," I nearly yells. "These waves sights our wires and sort of takes a run down 'em to see who's playing here this week. We captures the waves, and—"

"You capture the waves?"

I'm desperate and don't deny it. "See here—"

"It ain't fair for you guys with the big sets to cop all the big waves so the little fellows can't get any. I tell you it's un-American!"

The undertaker loses out on a nice six-foot job just then because the doorbell rings. Doris opens the portal and in comes The Master, half wet and all excited. He can hardly wait to tell me something.

"It works!" he cries. "It works!"

"Who? What?" I inquires exhaustedly.

"My ventriloquial radio set!" he exclaims. "It works!"

Well, I introduces him as best I can and grabs my hat. The others wants to come along and The Master craves an audience, so we all bustles out into the drizzle and hops into my bus. Soon we is at the laboratory.

When we gets in he has the dingus all dolled up, and she don't look no more like a radio than Santa Claus resembles Doc. Cook. There's a loud speaker, with a lot of wires, switches and the like, all setting on a big cabinet next to the window. The Master is more excited than ever, and ain't disguising it none.

"The marvel of the age!" he cries. "Watch!"

Being as that's what we come for we obeys orders and sits down. The window is open, and Jerry turns the horn so it faces us, with a thing what looks like a baby spotlight pointing outside the window.

"First," he says. "I'll use the loud speaker and radio in the usual way, until we pick up that station I just had."

We tries several barkers, none of which pleases The Master, until at last we lands the one he had, right in the middle of a concert.

"Ah," says Jerry, "this is the one. At the start of the next number I shall throw the music out into those trees."

Just then the number ends and the announcer booms out like a firecracker under a tin pail.

"Mr. Jakey O'Brien will sing Does The Spearmint Lose Its Flavor On The Bedpost Over Night? *Allez Houpla!*"

"Why, that's Barry Dunhaven," exclaims Tom. "He's broadcasting for the summer in Detroit."



THE EXECUTIVE

Every executive is at some time called upon to make decisions which involve applied Chemistry. If he does not know Chemistry, he must rely entirely upon his factory chemists or high priced consultants. A knowledge of Chemistry, easily gained through our Course, would strengthen your position greatly and save you thousands of dollars.



THE BUSINESS MAN

Better buying and bigger sales are the rewards of the man who understands Chemistry. Manufacturers, buyers, salesmen, advertising men, cost accountants and clerks can all benefit by learning Chemistry. Our course teaches you in the shortest and most practical way.



THE PROFESSIONAL MAN

Every professional man needs a working knowledge of Chemistry whether he is practicing law, medicine, engineering, dentistry, or any other calling. Too often he finds this all important science was neglected in his earlier training. Our course removes the handicap. Most important, it gives you information in a form that can be readily used.



THE DAILY WORKER

Workers in any industry can raise their own wages by learning Chemistry, for every industry is based on Chemistry. Write and tell us what your work is and we will show you how Chemistry can fatten your pay envelope.

CHEMISTRY

Insures Your Climb to Success

No matter what your vocation you can increase your Proficiency and earn bigger pay by a thorough training in Chemistry

TO be successful today is to know Chemistry! Every line of business, every branch of industry depends upon Chemistry in some form. You may not realize it, but your own proficiency in whatever work you are doing would be increased by a knowledge of Chemistry. In many lines such knowledge is absolutely essential. In others it is a guarantee of promotion and more money.

It is no longer necessary to enter college in order to learn this fascinating science. Our Home Study Course trains you just as thoroughly, and with the same assurance of success, as those who took the longer way. And our methods are so simple that we can teach you no matter how little previous education you may have had. Many of our graduates now hold responsible positions or have materially increased their incomes from private enterprises as a result of taking our course. Hundreds of letters from students testifying to the benefits they have derived from our training are here for your inspection.

Remember that you do not need to study Chemistry with the idea of actually practicing as a chemist, although a great many of our students are taking our course with this object in view. If you want to know more about what Chemistry will do for you, if you want to know what our home study course offers, sign and mail the coupon today for FREE BOOK "Opportunities for Chemists."

DR. T. O'CONOR SLOANE Will Teach You Practical Chemistry In Your Own Home

The Chemical Institute of New York, of which Dr. T. O'Conor Sloane is Educational Director, was founded to fill the need of ambitious, far-sighted men who realize and recognize the splendid future Chemistry offers them, but who cannot spare either the time or the money to attend college. Dr. Sloane, a foremost authority on Chemistry, will teach you and will give you all the individual help you require. He will personally go over your papers, correct them, point out your faults and teach you in a practical and interesting way. No special education needed except the ability to read and write English. One student has characterized our lessons as "The course that takes the mystery out of Chemistry."

Easy Monthly Payments

You do not have to have even the small price of the course to start. You can pay for it in small monthly amounts—so moderate that you won't feel them. The cost is low, and includes everything, even the Laboratory Equipment—there are no extras to buy. Our plan of easy monthly payments places a chemical education within the reach of everyone.

Laboratory Equipment Given To Every Student Without Additional Charge

We give to every student without additional charge his chemical equipment, including forty-nine pieces of laboratory apparatus and supplies, and forty different chemicals and reagents. These comprise the apparatus and chemicals used for the experimental work of the course.

Special 30-Day Offer

For a short period we are making a special offer that will be worth your while to take advantage of. Write for particulars, using the coupon below or simply a postal card. This will not obligate you in the least. Do not wait until tomorrow. Send the coupon now while you think of it.

The CHEMICAL INSTITUTE of New York, Inc.

Home Extension Division 8

66-R W. Broadway, New York City

Sign and Mail this Coupon for FREE BOOK

CHEMICAL INSTITUTE OF NEW YORK, Inc.
Home Extension Division 8
66-R—West Broadway, New York City.

Please send me at once without any obligation on my part, your Free Book "Opportunities for Chemists," and full particulars about the Laboratory Equipment furnished to every student. Also please tell me about your plan of payment and your special 30 day offer.

NAME

ADDRESS

CITY

STATE

R.N.8-24



A REAL HEADSET
\$3.50

There's a wealth of radio enjoyment that is yours if you invest \$3.50 in a Camco Cannon-Ball Radio Headset. The quality of tone and sensitiveness of this popular price headset will please your ears. The Camco.

Cannon-Ball Headset
Weights Ten Ounces

complete with headband and cord. Of course, you realize that this means head and ear comfort—"listening in" with pleasure.

Ask your dealer to remove the caps and let you examine the interior of the phones. See how perfectly the cores are ground and how smooth the top of the case upon which the diaphragm rests, is finished. Notice the quality of material and craftsmanship, and you'll readily realize that the Cannon-Ball Headset is perfectly balanced electrically.

Camco craftsmen specialize on radio headsets and loud speaker units—visualize what that means.

Invest your money wisely—Camco Cannon-Ball, \$3.50; Camco Grand, \$5. And the Camco Loud Speaker Unit, \$8.

At your dealers

CANNON & MILLER SALES CORP.
47 W. HURON ST. BUFFALO, N.Y.

"Yes——"
The Master puts his finger to his lips. "Ssssh!" he warns.

He throws in a switch and the baby spot sends off a yellowish light into a big tree across the street. And sure enough, we faintly hears the song being plugged from the top of the tree. The Master is jubilant.

"You see!" he cries. "It works!"

"How?" demands Tom, so interested he forgets that he won't understand anyway.

"The waves of sound travel on the rays of light," explains The Master. "When the light is reflected, the rays are thrown back. But listen!"

We does, me especially. I got a memory for voices, and if I ain't heard Mr. O'Brien before I'll eat a dozen cracked vacuum tubes. Jerry sort of prances around, talking in one-word admonitions, saying "Listen!"

All of a sudden there is a "pftt!", a fuse blows and the baby spot goes out. The Master turns to put in a new fuse, but pauses. The voice is still singing. Then it quits in the middle of a bar.

"Hey, you!" yells Jakey O'Brien. "Watch your light!"

Tom makes a dive for the door and calls. And Mr. O'Brien flies in and settles on Tom's shoulder.

"Between me and you," says Shakey, "they got some awful hams for electricians in these tank towns."

We four gets a good cackle out of that, but The Master is paralyzed. Finally he begins to come out of it.

"I—I don't understand," he mumbles. "That b-bird——"

I bows low-like. "Mr. Lawson, meet Mr. Shakey," I introduces.

Shakey eyes The Master a moment. Then he blinks. "What act do you do?" he caws.

Jerry don't answer, so I lets him in on it.

"You see," I explains royally, "that announcer in Detroit was on the same bill with us and Tom last season. He used to drop in on our acts and clown a bit. Also, he'd step on and announce Shakey's songs, using that line I told you about, 'Alley-oop!' Shakey got so used to it that several times he wouldn't sing until Barry had come on and yelled. It came quite naturally tonight."

"B-but——"

"Oh, yes." I continues, "your light rays finished the job. Shakey always sang his songs dark stage with an amber spot."

This arouses another laugh from us. Then Tom cranes his neck at Shakey.

"How the devil did you get into that tree?" he asks.

Shakey blinks his eye again. "Had to," he says. "Flew through the broken window."

"Had to?" demands Tom.

Shakey pecks Tom behind the ear. "Had to, you sap," he crows. "Shakey's a gentleman."

"Had to?"

"Sure!" declared the bird. "That dum flapper canary in there was taking a bath." Even The Master laughs at this.

Have You Tried the 5 TUBE COCKADAY With Push - Pull Amplification



CONSRAD PATTERN NO. 11

This new 5 Tube Cockaday combines all the selective features of the old Cockaday with added refinements of Push-Pull Amplification and special improvements that make it one of the Best 5 Tube sets in existence today.

The Conrad Pattern No. 11 tells you how to build this fine outfit. It contains full sized blueprint 18x28" of the wiring and drilling requirements with a four page instruction sheet so that you can't go wrong in constructing this set.

Contained in heavy two color printed envelope.

The price is only 50c at all Radio Dealers or it can be had by writing direct to us and enclosing the price.

50c PRICE Postage Paid
THE CONSRAD CO., Inc.
233 Fulton Street New York City

Essential For Any Set K. & C. Series Automatic PLUG



Enables you to add any number of headsets or loud speaker in the circuit *instantaneously*. No multi-jacks or terminal blocks to fuss with.

Just "plug plugs" into each other. Any other make of standard plug can be used with the K. & C. Series Automatic Plug.

Ask your dealer to show you this handy device. Price \$1.25.

Kilbourne & Clark Mfg., Co.
Seattle

Branches: 591 Mission St., San Francisco; 305 Larrabee St., Portland, Ore.; 1103 West 10th St., Los Angeles; Steelman, Inc., 24 Murray St., New York Representative; O. P. Smith Co., 205 W. Harrison St., Chicago Representative.

K. & C. Parts Set The Standard

The Tropadyne Circuit

(Continued from page 172)

may easily be wound by hand, haphazardly, on a suitable form, or spool. The number of turns, which in this case was 440 in each coil, is not critical. Two coils connected in series form a secondary and one coil forms a primary. It is important to separate the coils at least 1/4 inch. The core iron used is exceptionally thin, japanned silicon steel. This steel may be obtained from manufacturers of iron core radio frequency transformers and is not the same as that used in the construction of audio frequency transformers. When constructing these

Genuine Gilfillan Radio Parts can



always be identified by this trade-mark —look for it.

GILFILLAN BROS. Inc.

Kansas City Mo. Los Angeles Cal. New York N. Y.

FREE

Ask your dealer for a FREE copy of the **UNI-VERNIER Log**. Every set owner needs this handy, pocket-size Log Book. Includes valuable suggestions on how to improve your tuning. Shows how to compile a permanent Log Book.

If your dealer fails you send his name and 2c to **Walbert Mfg. Co.** 935 Wrightwood Ave. Chicago, Ill.

WALBERT UNIVERNIER Log

WALBERT MFG. CO.

Micro-Selective Tuning Control

Insure your copy reaching you each month. Subscribe to **RADIO NEWS**—\$2.50 a year. Experimenter Publishing Co., 53 Park Pl., N.Y.C.

CELESTO-PANELS

HARD RUBBER knows no equal in the field of radio insulation—and when the hard rubber bears the CELESTO mark you are doubly certain that the insulating properties of your radio panel are perfect.

CELESTO Panels are made from the finest grade of genuine hard rubber. CELESTO Panels are packed in individual wrappers for your protection. CELESTO Panels are for sale by the better dealers everywhere.



This trademark upon the wrapper identifies the genuine CELESTO Panel. Look for it!

CELESTO Panels are available in the following stock sizes:

7x9	7x30	6x24
7x10	7x40	6x26
7x12	6x9	6x28
7x14	6x10	6x30
7x18	6x12	6x40
7x21	6x14	8x12
7x24	6x18	8x40
7x26	6x21	9x28
7x28		

(Black and Mahogany Finish)

Some CELESTO Distributors

Bay State Panel Co.
738 Broadway, New York
Peerless Panel & Radio Co.
38 Park Place, New York
Viking Radio Co.
16 Hudson St., New York
Hub Cycle & Supply Co.
19 Portland St., Boston
New England Electric
99 Bedford St., Boston
Noble Radio Distrib. Co.
9 S. Clinton St., Chicago
Scott Bros., Ltd.
332 St. Catherine St., Montreal
Perkins Electric Co.
247 Bleury St., Montreal

Northern Electrical Co.
121 Shearer St., Montreal
Vimy Supply Co.
567 College St., Toronto
Radio Engineers of Canada
70 Granville St., Halifax
Albert A. Bergman Co.
12 N. Ninth St., Philadelphia
Langsburch & Densten
700 Bl. E. Balti. St., Baltimore
Fulton Electric Co.
65 Pryor St., Atlanta
Sumter Radio Mig. Co.
Telephone St., Sumter, S. C.
Perry-Mann Electric Co.
Columbia, S. C.

Some Territories Are Still Open!

TRIANGLE RUBBER & SUPPLY CO. 68-74 South St. Boston, Mass.

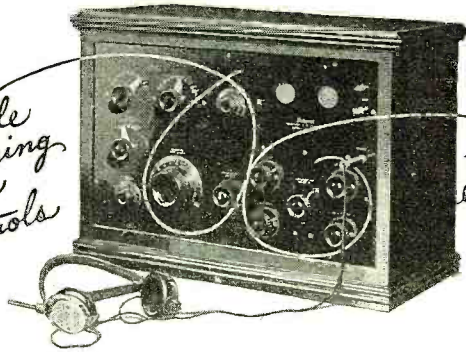

*Simple Tuning
Three Controls*

These to produce exceptional tone refinements

IT has been the tradition of the Federal Company over its 25 years in manufacturing Electrical Communication Equipment, that it must give its users the highest refinements of the art.

Federal tradition will not permit the manufacture of a radio set just for radio noises. Each and every manufacturing necessity to produce a harmonious set is known to Federal Engineers, and no Federal set is produced without them.

Federal radio sets are built with two thoughts in mind—first: simplicity of operation, but three controls being necessary—second: special controls for refinement if the user is interested in reproducing all the beauty of tones that fill the air.

“Lovers of good music” know why Federal is better, and know the real value of the refinement placed at their command to make it easy to obtain the clearest tone reception.

FEDERAL TELEPHONE & TELEGRAPH CO.
Buffalo, N. Y.



Federal

Standard **RADIO** Products

Boston New York
Philadelphia Chicago
Pittsburgh San Francisco
Bridgeburg, Canada
London, England



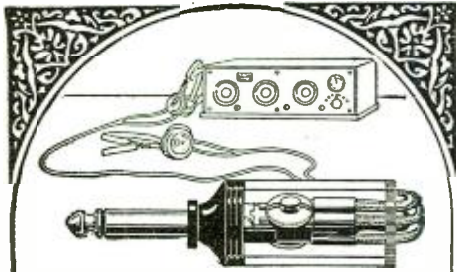

Nothing Complicated About the DUOPLUG!

It takes two headsets—four phone tips—and yet is so simple that no tools are necessary to make the connections.

Unscrew the handle and look inside—you can tighten the special thumb-nut connectors with your fingers or a dime, and be assured of a secure and perfect contact.

A substantial plug—with genuine bakelite handle and heavily nickleled metal parts. Good radio shops have it—at \$1.00.

PACENT ELECTRIC CO., INC.
22 Park Place New York, N. Y.



Write for Catalog N-8 of

Pacent
RADIO ESSENTIALS

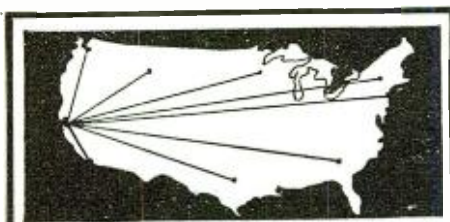

ON ONE TUBE

Broadcasting from Atlantic Coast, Mexico, Hawaii, Canada and Cuba heard in California by users of CROSS COUNTRY CIRCUIT. Range due to simplicity of set and only one tuning control. Easily and cheaply built by any novice. Dry cell tubes may be used. All instructions, blueprint panel layout, assembly photo, etc. Postpaid, 25c. Stamps accepted. VESCO RADIO COMPANY. Bx. RN-117, Oakland, Cal.

transformers, it is important that all coils be wound in the same direction and placed on the core, as shown in the illustrations. The leads are lettered to correspond to the vacuum tube connections.

As stated before, the Tropadyne principle may be incorporated in any Super-Heterodyne receiver. Those who already have a seven or eight-tube Super-Heterodyne may take out one tube by changing over to the Tropadyne circuit and in doing so may improve the efficiency and decrease the operating expense of the set. Some experimenters have reported phenomenal results by converting this tube into a one-stage short wave radio frequency amplifier before the first detector instead of removing it entirely. For ordinary purposes, such extreme amplification is not recommended.

If the six-tube Tropadyne receiver has been built according to the specifications given, little trouble should be experienced in operating and tuning distant stations. After the construction of the set has been completed the tuned intermediate transformers should be adjusted for maximum efficiency. This is accomplished by tuning in a nearby station that comes in loudly. The dials of the transformers should all be set at about 80 degrees. After the station is tuned in with the oscillator and tuning condenser, the potentiometer should be turned towards the positive side of the filament until the amplifier does not oscillate. Leave the last transformer set and slowly turn the dials of the others, one at a time, and leave them set at the positions in which the station is received at its loudest. It may be necessary to change the setting of the oscillator dial slightly after adjusting the transformers. It will be noticed that the adjustment of the transformers is not very critical when receiving loud local stations, but is very critical when receiving distant stations. It is well to adjust the transformers again after tuning in a DX station. Once the transformers are adjusted they need not be changed. Should the oscillator squeal when the dial is turned toward the minimum, the oscillator filament rheostat should be turned down slightly. 201A tubes are recommended.

Practically as good results may be obtained from this set when using a loop aerial as when using an outdoor aerial, but as many already have outdoor aerials, it is well to build the antenna coupler into the set. A 15- or 20-foot indoor aerial gives excellent results with this circuit and occupies less room than a loop. In regard to the sensitivity of this set, it has been compared side by side with other Super-Heterodyne sets employing more tubes and the Tropadyne was not only more selective, but received the distant stations just as loudly and clearly as the other sets. The sensitivity of the six-tube Tropadyne set was found to be practically the same as that of other seven tube Super-Heterodyne receivers.

Expanding the Beginner's Set

(Continued from page 174)

with few changes, be used with almost any kind of crystal or mineral will be described. This instrument is illustrated in Figs. 5A and 5B.

The base of this detector is the same size as the first one. It may be of either bakelite or a similar insulating material, or it may be made of wood, treated as described in the previous article.

The cup that holds the crystal may be purchased complete, with a set screw for holding the crystal and a mounting screw, at any radio store. A good home-made

POWER
from
Electric Light Socket

A Permanent Power Plant for Your Radio

Operates Your Set from Your Lamp Socket

Or from Your Lighting Plant

No More Buying of Batteries

Write for Descriptive Literature

Sidbenel Radio
Equipment Manufacturing Co.
29 WEST MOUNT EDEN AVENUE
NEW YORK, N. Y.

FREE!

Radio "Applause Cards"*

"— Station W-E-A-F signing off. If you have enjoyed the artist's program, won't you write in and tell them?"

By all means! Quickly and easily with "Applause Cards"*. They're handsomely printed mailing cards. All ready for you to fill in with your comments, sign, and drop in the mail box. Keep a pack of them near your receiving set. You can use "Applause Cards"*. liberally because they are FREE AT YOUR RADIO DEALER'S.

(* "Applause Cards" were originated by this Company, makers of the popular Dictograph Loud Speaker and the Aristocrat Dictograph Headset. The only "Applause Cards" are Dictograph Copyrighted "Applause Cards"*. A big FREE package of them awaits you at your dealer's. Or if he has not yet stocked, we will send you a large package of "Applause Cards" prepaid direct to you, providing you will furnish us with your dealer's name. Dept. D-8.

DICTOGRAPH
PRODUCTS CORPORATION
220 West 42nd Street, New York City
*Copyrighted

S. HAMMER RADIO CO.
307 Atkins Avenue Brooklyn, N. Y.

N & K Phones 4000 ohms Model D. List \$8.50	\$5.90
Dr. Selbt Phones, 6000 ohms, List \$12.00	\$5.75
Superdyne Coils or Ambassador Coils	\$4.95
\$12.00 Baldwin Phones (Type C, Double)	\$7.95
Federal Type No. 65 Transformer	\$5.25
Amertran Transformers	\$5.50
Como Duplex P.P. Transformer	\$9.75
Music Master Loud Speaker	\$24.00

Write for Price List. Not Insured Unless Insurance Charges Included. Orders over \$5.00 shipped Prepaid.

REGAL

QUALITY RADIO PARTS INSURE THE BEST POSSIBLE RESULTS FROM ANY TYPE OF CIRCUIT

Write for complete literature and prices

AMERICAN SPECIALTY CO.
BRIDGEPORT, CONN.

ELGIN SUPER-REINARTZ
The Set Which Copied
2LO LONDON, ENGLAND

ON ONE TUBE

Send Stamp for Descriptive Circular

ELGIN RADIO SUPPLY CO.
207 E. Chicago Street, Elgin, Ill.

UNITED ELECTRIC STORES CO.

Wholesale Radio Equipment

East Pittsburgh, Pa. Next door to KDKA

Same Day Shipments

cup may be made from a cap taken from the center or carbon binding post of an old dry cell. The detector element or crystal may be held in the cup by means of the soft metal procurable at any radio store, or by packing tinfoil around it. Soft metal may be made by dissolving as much tinfoil as possible in ten cents worth of mercury. Knead the foil and mercury thoroughly and keep adding the foil until no more can be forced into the mixture. This mass will melt below the boiling point of water and can readily be used for mounting crystals without harming them. Detector minerals or crystals must not be exposed to excessive heat, as it tends to spoil their sensitiveness.

In constructing the improved type of detector, another length of 1/16-inch spring brass; 3 3/4 inches will be required. Drill a 3/16-inch hole 3/8 inch from one end of the strip. In order that the threads of the nut may be kept clear of solder and that the hole in the metal strip may clear the screw, it is best that the soldering be carried out with a screw in the nut. This screw should be left in place during the entire work of soldering.

Then drill a hole 1/4 inch from the opposite end and another 3/4 inch from the same end. These should be just large enough to pass small machine screws which are to be used for holding the bracket to the base. The strip is then bent, as shown in Fig. 5A, making the bends square and even. For the sake of appearance it would be a good idea to polish the finished bracket at this point. Metal polish or fine sand-paper may be used for this purpose.

The next step is to drill the base. The necessary holes are shown in Figs. 5A and 5B. All of them, with the exception of those for the mounting screws, are countersunk on the under side of the base. This is done in order that the base may be placed flat with none of the mounting screws touching the surface upon which the detector is placed. If a regular countersinking tool is at hand, use it. If not, a 1/2-inch drill will serve very nicely. Also, a drill of this size often finds many uses in the hands of an experimenter.

The remainder of the detector consists of a piece of threaded brass rod, 2 1/2 inches long. This can be bought at any radio store, or from any mail-order firm. With a file, sharpen one end of the rod to a point. Screw an insulating knob on the other end, and turn the rod into the nut soldered on the bracket. This is shown in Fig. 5A. This detector will operate with any kind of mineral or rectifying substance. The point may be used on such material as carborundum, which demands a coarse point with heavy adjustment, or two nuts may be placed as shown and a cat whisker clamped between them for use on materials which require a light contact. Thus this detector is universal in its scope.

Now we come to something new. Last month a fixed condenser was described, so readers who have been following this series know what a condenser is. For this set, a variable condenser will be needed. It is not advisable to give constructional details for such an instrument, because few readers would be able to construct one, as it takes a skilled machinist to do so. Professional tools and equipment must be used in its construction if results are satisfactory. Therefore, a few hints on the purchase of a condenser will be given to guide the reader in purchasing the instrument.

In the first place, the condenser should have a maximum capacity of .0005 mfd. This usually means that it will have 23 plates, 12 stationary and 11 movable. This, however, does not always hold good, as a condenser may have a few more or a few less plates for the same capacity. The size of the plates helps to determine the capacity.

Be sure to obtain a good condenser. It is

RADIO

BOOKS

PATTERNS



RADIO DATA

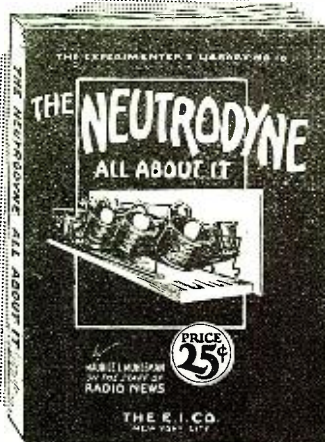
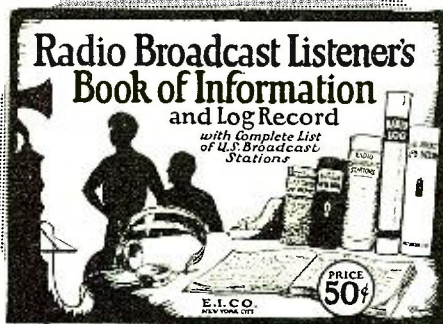

CONSRAD

Publishes
Over 45
Radio Books
written and
edited by
over 40 of
the Most
Prominent
Radio Experts
in America

The Consrad Co., Inc.
233 Fulton Street, New York City

CONSRAD PUBLICATIONS

"The Experimenter's Library" Series

Tips for the Radio Amateur Constructor. How to Make a Radio-Phone Receiving Set. Radio Questions Answered. Radio Frequency Amplification. Loud Talkers and How to Build Them. How to Tune Your Radio Set. One Hundred Radio Hookups. All About Radio Parts. History and Operation of Vacuum Tubes. The Neutrodyne and All About It. How Radio is Received. How to Locate Trouble in Your Radio Set.

25c EACH

"The Radio Constructor" Series

Radio Map of the U. S. on Cloth. How to Make the S. T. 100 Re-

ceiver. How to Make a Neutrodyne Receiver. How to Make a Reinartz Receiver. How to Make a Reflex Receiver. How to Make a Cockaday Receiver. How to Make a Short Wave Regenerative Receiver. How to Make a Radio-Phone Crystal Set. How to Make One or Two Stage Amplifiers. All About Aerials and Their Construction. 20 Radio Diagrams and Hook-ups. Radio Amateurs' Practical Design Data. How to Make the Ultradyne Receiver. How to Make a Five Tube Cockaday Receiver. How to Make a Portable Receiver.

50c EACH

Radio Books

Radio News Amateur Handbook \$1.00
Radio For All 2.00
The How and Why of Radio Apparatus75
Wireless Course in 20 Lessons 2.00
Experimental Electricity Course in 20 Lessons 1.25
A Thousand and One Formulas 1.50
Radio Reading Course in 5 Volumes 1.25
The Beginners Radio Guide ea.10
Building an Inexpensive Radio Crystal Set10
Radio Log Book50
Radio March35
Radio Jazz35
Listen In35

"RADIO'S FOREMOST PUBLISHERS"

Consrad

Salisbury Radio Table



SOLID OAK

\$7

A REMARKABLY substantial, handsomely finished piece of furniture (No. 29), particularly fashioned for holding Radio Sets. Choice of finish: Golden or Fumed Oak or Imitation Mahogany. The top is 18x24. There is one long drawer, and underneath is a

FROM THE FACTORY

Handy shelf for batteries

JUST check the finish you want in the Coupon below. Do not send money. Pay the expressman \$7, plus the small express charge, on delivery, and thus have the advantage of buying direct from the makers. Absolute satisfaction guaranteed.

SALISBURY BROS. FURNITURE CO.
Dept. A-1, Estab. 1863 Randolph, Vt.

SEND NO MONEY—Just mail this

SALISBURY BROS. FURNITURE CO.,
Dept. A-1, Randolph, Vermont.
Send the Salisbury Solid Oak "Community" Radio Table No. 29, finished in (check)....
Golden Oak, (check).... Fumed Oak, (check)....
Imitation Mahogany. I will pay the expressman \$7 and expressage on delivery.
Name
Address
City

\$3 Brings you a Genuine **UNDERWOOD** TYPEWRITER

10 DAYS FREE TRIAL Your \$3.00 unconditionally returned if at end of 10 days you are not satisfied with this late model UNDERWOOD typewriter rebuilt by the famous Shipman Ward process.

GREAT PRICE SAVING Direct to you from the largest typewriter factory in the world by our money saving methods.

EASY MONTHLY PAYMENTS So small, that notice it while you enjoy the use of this wonderful machine.

FREE BOOK OF FACTS Explaining Shipman Ward's wonderful system of rebuilding typewriters and also valuable information about the typewriter industry both instructive and entertaining.

Act Today! Mail Coupon

5 Year Guarantee

Shipman Ward Mfg. Company
C-195 Shipman Building
Montrose & Ravenswood Aves., Chicago

Please send me a copy of your free book of facts, explaining bargain offer.

Name.....
St. and No.....
City..... State.....

worth while, as this is an instrument which is always used. The first thing to look at is the material of the end plates. Do not buy one in which the end plates are of "mud" or an inferior composition. Insist on bakelite or hard rubber. "Mud" can usually be detected by rubbing a corner of the material on a sheet of paper. "Mud" will leave a mark similar to that of a heavy marking crayon. Bakelite and hard rubber are very hard and will leave little or no mark when tested in this manner.

The next point of importance is the metal plates. They should be of aluminum or brass, firmly mounted and evenly spaced. The rotary or movable plates should be free from side play and they must not touch the stationary ones. An excellent type of instrument is shown in Fig. 6. This latter adjunct permits very fine and close adjustment of the capacity and is a valuable asset in any equipment. These condensers cost a little more, but are worth it.

After obtaining the instrument, it is necessary to mount it on its unit panel, which should be of the same size as the one on which the variocoupler is mounted. One hole is drilled for the shaft and three more for the mounting screws. Method for this procedure is shown in Fig. 7. Make the shaft hole of such a size that there will be no binding when the mounting screws are tightened. Leave a margin for it; better too large than too small. When the screws are put in place, draw them up as tightly as possible. Then make connections from one of the binding posts to the rotary plates and from the other to the stationary plates. Screw a base board to the panel so that the instrument can be mounted on the large base.

The condenser completes the instruments needed. Mount them all on the large base, as shown in Fig. 8, and connect them together with bell wire, as shown in Fig. 9. The circuit may easily be followed, as all the instruments are labeled.

The operation of the two switches are much the same as they were with the tuning coil. The additional adjustments are the rotor of the variocoupler and the variable condenser. The adjustment of the detector was described in the preceding article. To operate the new set, adjust the detector, set the switches at the points where a station was heard formerly. Place the rotor so that its winding is parallel with the stator winding (formerly the tuning coil). Then vary the condenser until the station is heard. Readjust the detector for the loudest signals, and try readjusting all of the controls, until best results are obtained. If the tuning is not sharp enough—that is, if two stations interfere with each other—turn the rotor slightly and readjust the other controls. You will soon get the knack of tuning the set and will find it much more selective than the first one.

Keep a log of all stations received. This was described last month. Add two columns to the log as described, one for the rotor and the other for the condenser settings.

How to Build Radio Sets

(Continued from page 175)

inch, which may be purchased at any hardware store, will be useful. It will be easy for you to ream the holes out to the exact size desired.

The reamer is used with an ordinary carpenter's brace, and care must be taken not to attempt to ream the holes out too quickly, for fear of breaking the panel.

Super Heterodyne

We specialize in super heterodyne receivers and after making exhaustive tests find the circuits and parts designed by THE EXPERIMENTERS INFORMATION SERVICE to be the best known to the art today.

THEREFORE WE OFFER Complete model "C" super heterodyne parts including panel, cabinet and constructional drawings \$108.15

FEATURES VERY DESIRABLE BUT NOT ESSENTIAL

Drilling and Engraving Panel.....	\$10.40
Special model "C" voltmeter, reading all tubes and "B" battery and model "C" Ammeter, per pair	19.50
Geared vernier attachment for heterodyne condenser	2.75
Resistors and Filament Switch.....	3.00
Antenna Adapter "K," including Drilled and Engraved Panel, Cabinet and Drawings	29.00
Model J 2-Stage Tuned Regenerative R. F. Amplifier for Model C or any other 3-Tube Super making a 10-Tube Set. Incl. Eng. Panel, Cab. and Drawings.	67.00

INDIVIDUAL PARTS

WE OFFER SEPARATE PARTS

Oscillator Coupler	\$5.00
R. F. Coupler (Filter), 10,000 M.....	5.00
E. I. S. Improved 10,000 M. Transformers	7.50
21-K. W. E. Bypass Condensers.....	1.75
Standard R. C. A. Loops, 30" sq.....	19.00
Western Electric 10-D Loud Speaker.....	43.00
Selected R. C. A. Tubes, 201A or 301A (only with Model C Parts).....	4.25
Wire, Tubing, Sockets, Jacks, Audio Transformers, etc., also.	
Model "C" Sets Rewired according to standard by experts	60.00
All Shipments F.O.B. Philadelphia or New York	

NORDEN, HAUCK & CO.

Engineers and Purchasing Agents

25 SOUTH ASHMEAD PLACE

GERMANTOWN PHILADELPHIA, PA.

A Pleasant Surprise Awaits the User of the A. C. H. SHARP TUNER DIALS

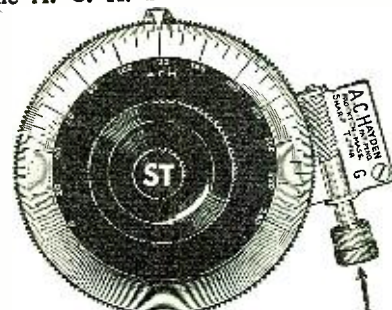

Why the A.C.H. is different

- 3 in. DIAL (156-T0-1)
- 4 in. DIAL (215-T0-1)

Will improve any receiving set, making difficult tuning easy Money Back Guarantee

Price 3" size... \$2.50 Price 4" size... \$5.00 Regular fitting 5/16 shaft 1/4 and 3/16, 5c each extra

- Extra Advantage of the A.C.H.
1. Can be attached or removed from any instrument.
 2. Rough tuning same as any dial.
 3. Movement so fine that the eye cannot detect but the ear can.
 4. Automatically locks instrument so no jar can disturb it.
 5. Dial grounded reducing the body capacity to a minimum.
 6. Special dial 2 graduations where ordinarily one.

MAIL ORDERS SENT PREPAID IN U. S. A.
A. C. HAYDEN RADIO & RESEARCH CO.
BROCKTON, MASS., U. S. A.

2-LO, LONDON



His goal—at last! Using a DE-TEC-TONE Crystal Detector in a 3-tube reflex receiver, 2-LO, London, was heard in Hannibal, Mo. It is not uncommon to get stations 1000 miles away on simple crystal sets with DE-TEC-TONE Dealers or direct. \$1.50 postpaid.

PYRAMID PRODUCTS CO., 117 N. Dearborn St., Chicago.

Insure your copy reaching you each month. Subscribe to RADIO NEWS—\$2.50 a year. Experimenter Publishing Co., 53 Park Pl., N.Y.C.

No Static For "Shepco" Users

With practically every fan in Ontario stopped by static from getting even nearby stations, W. T. Clarke, Lion's Head, Ontario, received WGY, Schenectady, N. Y., with a "SHEPCO" "All Wave" Coupler.

"SHEPCO" "ALL WAVE"

Trade Mark—Patents Granted and Pending

Non Radiating DX Coupler



"All Wave" Sr.
\$7



"All Wave" Jr.
\$6

"The finest tuning unit in existence," says Mr. Clarke. You'll say the same. Build your set the "SHEPCO" way and we guarantee results.

Exclusive "SHEPCO" bankwound and tapped primary and tapped secondary give the "All Wave" Coupler the high efficiency of elaborate honeycomb coil outfits. Eliminates all variometers, vario-couplers and loading coils. Permits building low cost, single tube receiver with selectivity, distance and volume equal to expensive, many-tubed sets.

Short Aerials No Handicap

Guaranteed wave lengths: "All Wave" Jr., 150 to 1,000 meters in single circuit, 150 to 700 meters in non-radiating triple circuit; "All Wave" Sr., 150 to 3,000 meters. 1,500 miles minimum guaranteed.

"SHEPCO" "All Purpose"

Trade Mark—Patents Granted and Pending

Receiving Set

A ready built, complete one tube receiving set incorporating "SHEPCO" "All Wave" Jr. Coupler and other highest quality parts. Beautifully finished, hand rubbed genuine mahogany cabinet.

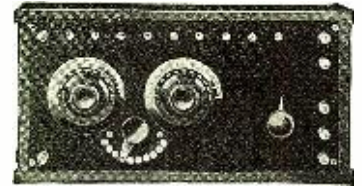

A wonderfully selective distance getter with volume equal to one step of audio frequency.

The ideal set for home or camp. Compact, portable, easy to operate. Interchangeable circuits. Hook-ups changed quickly without tools. Appeals to merest novice or expert experimenter.

The parts bought separately would cost more than this assembled set. Without accessories.

\$21

Two Stage Audio Amplifier for use with "All Purpose" or any other set.

\$21

At all Dealers in Standard Radio Parts or Sent Prepaid on Receipt of Price

ABSOLUTE MONEY BACK GUARANTEE

SHEPARD-POTTER CO., Inc.

Plattsburgh, N. Y.

6 efficient hook-ups in every box or sent for 10 cents in stamps to cover mailing cost.

RADIO CORP. CABINETS

Genuine 5-ply Veneer Mahogany Cabinets—the same Cabinet used in the R. C. Radiola set. These Cabinets cost the Radio Corp. \$4.20 in thousand lots.

\$2.95
each

Our Special Price



BRADLEY STAT or LEAK

New Type UNIVERSAL **\$1.25**
each

Our Special Price

VARIOMETERS and VARIOCOUPERS

Moulded **\$3.65**
each

VARIABLE CONDENSERS

\$7.00. value, 43. Plate. Vernier	\$3.95
\$6.50. value, 23. Plate. Vernier	3.45
\$6.00. value, 11. Plate. Vernier	2.95
\$1.75. value, 3. Plate. Vernier	1.15
\$4.30. value, 43. Plate. NOW	1.75
\$3.70. value, 23. Plate. NOW	1.45
\$3.30. value, 11. Plate. NOW	1.35
\$2.25. value, 5. Plate. NOW	1.25

MAIL ORDERS: Address, Dept. N-6, CHICAGO

When You Buy Radio Remember that

SALVAGE MEANS Save, Service, Satisfaction

In buying radio apparatus from the Chicago Salvage Stock Store, the world's greatest radio store, you can be certain of these three things:

1. You have saved money through the hundreds of radio bargains made possible by our enormous buying power.
2. Your orders have been filled intelligently by men who are qualified radio experts.
3. You have bought quality apparatus because we handle nothing but brand-new merchandise GUARANTEED to give complete satisfaction.

Western Electric Type 194 U. S. A. Signal Corps PHONES

Each Phone Cap is covered with large, soft rubber ear cushions. These are the only phones to pass the Government specifications for sensitivity and loudness, the requirements called for in aircraft reception.

\$7.95
each

Coils for COCKADAY CIRCUIT

Special at **\$1.75**
each



\$10.00 Value

Automatic Electric Headset
\$3.65

Complete Parts for FOUR-TUBE ACME REFLEX

Including:
Drilled and Engraved Panel
Ready to Mount

Complete Parts as Follows:

- 3 Acme A-2 Transformers; 1 Acme R-2 Transformer;
- 1 Acme R-3 Transformer; 1 Acme R-4 Transformer;
- 4 Vacuum Tube Sockets; 1 Acme Low Loss Condenser, .0005 mf.; 1 Acme Pot. Rho. 6-Ohm for .25A Tubes; 1 Crystal Detector Stand; 1 .00025 mf. Fixed Condenser with Gridleak Clips; 1 .0025 mf. Fixed Condenser; 2 .002 to .005 mf. Fixed Condensers; 1 .005 mf. Fixed Condenser; 8 Binding Posts Complete; 1 2-ft. Length Belden Braid Shielding; 1 Variable Condenser Knob and Dial; 1 2-ft. Length Spaghetti; 1 Base Board; 1 Standard Formica Panel, 21x7 inches; 1 "Carter" Double Circuit Phone Jack 20-ft. No. 14 Solid Wire; 1 "C" Battery; 1 50,000-Ohm Grid Leak.

Our Special Price **\$42.50**

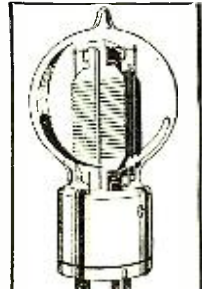

Western Electric VT-2 Tubes
\$7.45



*If there's a Better Set Made
—we haven't heard it!*

Globe Duo-Dyne No. 900 is a distinctive 5-tube set—a double-powered, long distance receiver with unusual volume and true tone reception. Tunes easily—without squeals or carrier wave sounds. Can be perfectly logged. Non-radiating—does not interfere with your neighbor. Can be used with loop or outside aerial. An ultra-fine, efficient outfit.

To learn about this new development in Radio, write for literature on Globe No. 900. Ask for Bulletin No. 25A.

GLOBE ELECTRIC COMPANY
14-28 Keefe Ave. Milwaukee, Wis.

GLOBE
RADIO

*The New
and Perfect
Variable Grid Leak*
65¢



Can be installed in any set in a second! Does not change calibration with age or use! Officially adopted for Ultra-dyne, Polydyne, etc., circuits.



COMPLETE WITH MICA CONDENSER AND PERFECT LEAK MOUNTING \$1⁰⁰

At your dealers or direct by mail on receipt of purchase price.

A.C. BRADY CO.
Improved Radio Apparatus
108-SEVENTH AVE. NEW YORK CITY

VULCANIZED FIBRE Be sure and specify "WILMINGTON FIBRE"
Sheets, Rods, Tubes, Washers, Etc., Specialties
Wilmington Fibre Specialty Co., Wilmington, Del.
Branch Offices "Everywhere"

Insure your copy reaching you each month. Subscribe to RADIO NEWS—\$2.50 a year. Experimenter Publishing Co., 53 Park Pl., N.Y.C.

It is a good plan to have your parts at hand when using the reamer, and to remove the reamer and try each part in its respective hole occasionally in order to insure a snug fit. When drilling the panel, hold it firmly against a smooth board, to avoid chipping when the drill comes through.

After you have finished drilling the holes to their proper size, take a pocket knife and scrape the burrs from the edges of the holes, so that the parts will fit smoothly into place.

CONSTRUCTING FRAMEWORK

When you have finished drilling the panel, attach it to the mounting board with three or four round-headed screws. The mounting board should be a trifle shorter in length than the panel, so that it will fit into a cabinet, should you desire to use one. It is also a good plan to brace the panel and mounting board by placing two upright pieces of wood about 1/2 inch by 1 inch at the two rear corners, with two more pieces placed horizontally leading from the top of each of these uprights to the panel. (See Fig. 1.) Attach with screws.

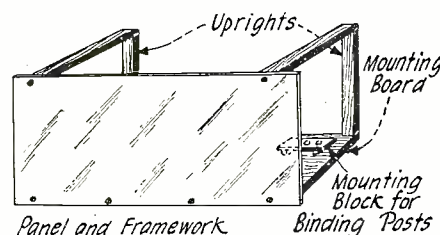

Fig. 1

How the panel is fastened to the baseboard.

This gives a substantial framework for preliminary experiments. Near each of the rear corners of the mounting board place a strip of bakelite panel material or a thin, smooth piece of wood about 4 or 5 inches long by 1 inch in width. These strips should be attached with screws and raised about 1/2 inch by placing two small round rubber feet underneath each end. Round rubber stoppers, such as are used in water valves, will answer admirably for this purpose. Fasten the binding posts for the aerial, ground and battery connections to these terminal blocks. Thus all wires lead to the back of the set, so when placed in a cabinet it will be necessary only to drill the required number of holes in the back of the cabinet to insert the wires.

The next step will be to mount all of the parts and binding posts on the panel and mounting board. Binding posts may be marked as follows:

Aerial, A; ground, G; and the posts for the battery connections, A+, A-, B+, and B-, respectively. Binding posts may be purchased with these markings already on them, if desired.

If you are not following a blueprint for the lay-out, it is well to keep in mind, when mounting the parts, the importance of having short wiring connections—the shorter the better. Do not have too many wires running parallel. Also the wires should be kept well separated and should cross at right angles wherever possible. Use either No. 12 or 14 tinned copper bus-bar wire.

CONVENIENT METHOD OF WIRING

Practically all of the better grades of radio parts which are now being offered for sale are equipped with convenient binding posts to which may be attached the various wiring connections.

Small, flexible copper washers (called terminals) having projecting tongues with clips for fastening and soldering to bus-bar wire are almost indispensable in wiring your radio set. These washers, when properly soldered to the wires and tightly clamped to the bind-

\$27.50

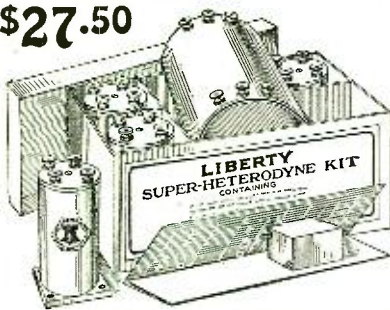

LIBERTY

SUPER-HETERODYNE KIT No. R-40

1 Special Input Transformer, 3 Intermediate Wave Transformers, 1 Oscillator Pick-up Coil, 1 By-Pass Condenser, with complete plans, drawings and specifications.

**Any Amateur Can
Now Build His Own
Super-Heterodyne at
A Moderate Price**

Astounding results are being obtained daily with home built receivers using Liberty units—the heart of the successful super-heterodyne.

The homebuilder who uses the Liberty Kit and follows the plans is assured of a receiver that is noted for simplicity, exceptional tonal quality, distance, the utmost in selectivity, and easy to tune. Liberty Kits contain complete specifications, working drawings, list of additional parts, etc., to build this exceptional receiver complete on an 8" x 28" panel.

All stations may be logged and only a small 17 inch loop is necessary.

Back of the Liberty Kits stands a broad guarantee and a dependable company with five years of successful Radio engineering.

Ask your dealer. If he has no Liberty Kits in stock, order direct, sending us your dealer's name. Immediate shipments—send no money—pay the post-man \$27.50.

FREE—Send for free descriptive circular. Also a complete set of blueprints and instructions mailed free if you will send us your dealer's name.

Liberty Electric Corporation
Department 102
Stamford, Connecticut

BIG JOBS!

\$150 to \$400 per month for men trained in auto, tractor and electrical fields. You can qualify after eight weeks in the McSweeney Schools—where you learn by working with real tools on real jobs instead of studying from books. Special tuition offer, R. R. fare paid, 8 weeks board free. Get catalog.

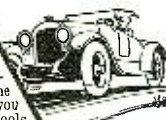

Good Pay

Get In Now

McSWEENEY
Auto, Tractor and Electrical SCHOOLS

Operating Rahe Auto School at Cincinnati & Cleveland Auto School 9th & Walnut, Cincinnati, O. 1815 E. 24th, Cleveland, O.

Dept. 440

LEICH ELECTRIC CO.

Leich Headphones, Non Tune Rectifiers
L-Radio Jacks and Plugs
Write for complete Radio Bulletin 101-C
GENOA, ILLINOIS

ing posts, make practically as good and permanent a connection as though the wires were soldered directly to the posts themselves. And it is not only a much more convenient method, but it eliminates the possibility of spoiling any of the parts.

Four or five dozen of these washers should be on hand before you start wiring the set. It is an excellent plan to prepare several pieces of bus-bar wire in advance by cutting them in varying lengths from two inches up to 18 or 20 inches, and then soldering one of the washers to one end of each.

A few pieces of wire may also be bent double and soldered to the washer at the bend, so that two leads of wire may be attached to any one of the binding posts, when specified in the diagram. (See Fig. 2.)

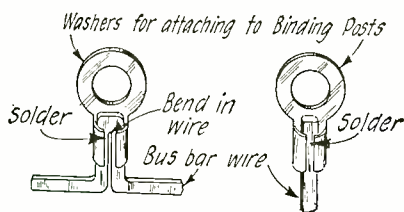

Fig. 2

Soldering lugs are employed and soldered to the wires as shown.

These prepared wires will save you considerable time when you start wiring up your set. Select one as near as possible the length required, bend it to the desired shape, cut off any surplus and solder another washer on to the opposite end for the other terminal.

SOLDERING AND HOW TO DO IT

The importance of having all of the connections in a radio set soldered properly cannot be emphasized too strongly. If you expect to obtain the best results from your set, it is absolutely necessary that all of the wiring connections, including the lead-in from the aerial, ground, batteries, jack, and all of the wiring connections within the set, be well soldered. Do not use an acid soldering flux. Use resin core solder, which comes already prepared, or resin flux, either of which may be obtained at any radio store.

A soldering iron, even one of the smaller electric irons, is rather a clumsy tool for soldering small wires and parts such as are used in a radio set. It is a much more convenient method to use an alcohol lamp, such as a jeweler uses, for this class of work; and a much neater job will be the result.

For soldering the wires to the washers, proceed as follows: First, clamp the projecting points of the washer tightly over the wire. Then hold the wire at the opposite end from the washer and hold the washer in the flame for about 10 seconds, or until it becomes heated; then touch the spot to be soldered with the end of your "stick" of resin core solder until a drop melts off. Hold the wire and washer in the flame just long enough for the drop of solder to flow down around the wire. Then remove instantly and allow it to cool. Do not allow the work being soldered to become too hot or the solder will flow too fast and drop off. If it is not hot enough, it will not adhere to the work. A few trials, however, will soon show the proper temperature for best results.

This method will apply to any other class of work you may have to solder about your set. Keep in mind that whatever you are soldering must be heated—not too hot—before the solder will stick.

If the work you are soldering is not clean, it must be cleaned by filing or scraping with a knife before the solder will stick to it. When soldering insulated wire from which

USE "RAGECO" TOOLS TO BUILD BETTER RADIO SETS

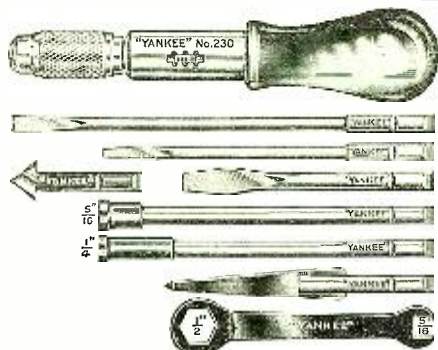

BR 701 RADIO TOOL SET

This is the handiest set of tools ever made for Radio Work by the makers of the famous "Yankee" tools. It contains the following: One ratchet screwdriver, 6½ in. long, holding all attachments; one blade, 5½ x 3/16"; one blade, 3½ x 1/8"; one blade, 2½ x 1/4"; one countersink; two socket wrenches for all small nuts; one reamer to enlarge holes in panel from 1/8" to 1/2". One wrench, one end 5/16" square or hex., other 1/2" hex. for jacks, etc. Price per set in cardboard box, \$3.00.

PRICE (Per Set).....\$3.00



BR 703—TOOL CHEST

Set consists of "Lockgrip" Master Handle, 5 inches long, black Rubberoid finish with very strong steel chuck, nickel plated and buffed, and the following nine tools: Saw, Bradawl, Large Screwdriver, File, Scratch Awl, Gimlet, Reamer, Chisel, Small Screwdriver. Each tool made for real service, about 4 inches long, fine steel, drop forged, hardened and tempered and nicely finished.

PRICE\$1.85

The set comes in a well made leatheroid covered tool box, 3¼" x 5½", with tray. Price, \$1.85.



BR 303—HAND DRILL

The hardwood handle is hollow to store drills. Iron frame, nickeled parts, ball bearing, three-jawed chuck holding and centering accurately round shank drills from 0 to 3/16. Length of drill, 12 inches. Price, \$2.25.

PRICE\$2.25

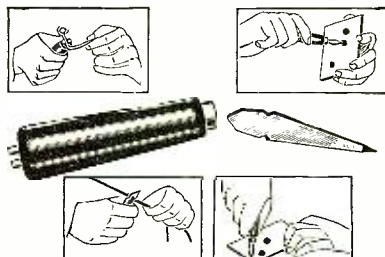

BR 702 RADIO HANDITool

Bends Bus bar or wire, strips and scrapes wire, bores and reams holes, countersinks holes, etc. Tool consists of 4" black japanned handle with nickeled ferule, to which is attached wire bending device and 3" long two sided reamer. Price, 50c.

PRICE50c



BR 800—ELECTRIC SOLDERING IRON

Perfect tool for the Radio Constructor. Works either on 110-volt A.C. or D.C. The heat element is of Nichrome, which prevents overheating and assures the desired even temperature.

PRICE\$2.00

Size of Iron, 10½ inches long. A 4-foot cord and plug is furnished. Price, \$2.00.

Order by order numbers. Remit by check, money order, stamps or cash. All goods are shipped free of transportation charges to all parts of U. S. and possessions same day as order is received. If not satisfied, money will be refunded upon return of goods.

The Radiogem Corp.
66-R-West B'way, N. Y. City

Write for complete illustrated FREE Catalog of
PARAGON
Reg. U. S. Pat. Off.
RADIO PRODUCTS
ADAMS-MORGAN CO.
6 Alvin Place Upper Montclair, N. J.

Perpetual Radio Fuse \$2.50
\$100.00 reward if you can blow your tubes with this protector in your circuit according to our instructions.
SUPER ULTRADYNE Transformers, complete set including blue print\$16.00
ULTRA SYNCHRODYNE Coils, set of three.....\$7.00
Including blue print. With condensers.....\$17.00
DEALERS and JOBBERS we have an attractive territory proposition.
THE STANLEY RADIO COMPANY, Manufacturers.
2947 Lorain Avenue Cleveland, Ohio

Insure your copy reaching you each month. Subscribe to Radio News—\$2.50 a year. Experimenter Publishing Co., 53 Park Place, N. Y. C.

Salisbury Radio Table

OUR Radio Table No. 82 combines exceptional strength, durability and handsome appearance. The low price is possible only because of economical manufacturing—which enables us to sell direct to you at a substantial saving. The top measures 30x20 inches. There is one roomy drawer, and a strong shelf for batteries. May be had in solid oak or imitation mahogany.

Don't send a single cent

CHECK the finish you desire in the coupon below. Do not send any money. Just pay the expressman \$10.50, plus the small express charge, on delivery. We stand behind this table with an absolute guarantee. Send in your order today.

SALISBURY BROS. FURNITURE CO.,
Randolph, Vt.



\$10.50

direct to you

Mail coupon and we'll do the rest

SALISBURY BROS. FURNITURE CO.,
Dept. A-1, Randolph, Vermont.

Send the Salisbury Radio Table, No. 82, finished in (check)...solid oak. (check)...imitation mahogany. I will pay the expressman \$10.50 and expressage on delivery.

Name

Address

City

For that Summer Portable You Want
Efficiency and Compactness

Therefore
use the
new

Pfanzstiehl
VARIOMETER
and
VARIOCOUPLER

\$4.75
Postpaid
or at your
dealer's

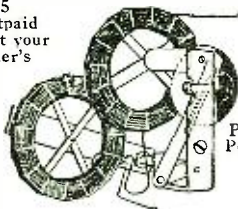

Patents
Pending

Pfanzstiehl Variometer, P-301.....\$4.75
Pfanzstiehl Variocoupler, P-300..... 5.00

PFANZSTIEHL RADIO SERVICE CO.
Highland Park, Ill.

Chicago: 1001 W. Washington St. Haymarket 8010

the insulation has been removed, the end of the wire must be scraped bright and clean before attempting to solder it.

HOW TO MAKE AN ALCOHOL LAMP

The alcohol lamp may be purchased at any wholesale jewelry house for about 25 cents. If you are unable to get one, however, you may make one very easily by cutting a 1/4-inch hole in the center of a cork of the proper size to fit a one-half pint cream bottle. Through this hole in the cork insert a piece of copper tubing, such as is used for the gas leads, etc., on an automobile, and which may be purchased at any garage. Allow this tubing to extend through the top of the cork about 1/2 inch, and insert a round wick of the proper size through the tubing. A metal washer of suitable size may be slipped over the tubing as a precautionary measure against burning the cork. (See Fig. 3.)

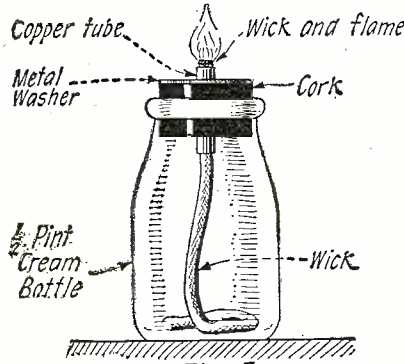

Fig. 3

Appearance of the completed alcohol lamp.

Either denatured alcohol or wood alcohol may be used in the lamp. To extinguish flame, smother with a cover. A large thimble will do. Keep the end of wick covered to prevent evaporation of alcohol when not in use.

If you prefer to use a soldering iron, the iron must first be cleaned and then "tinned"—that is, it must have a coating of solder, which will give it a bright appearance similar to tin. Clean the iron by filing it until bright, or polish it with a piece of emery cloth or sand paper. As the tin soon burns from the iron, it is necessary to re-tin it occasionally. A convenient method of doing this is to have a brick at hand, into the side of which you have gouged out a hollow place. Put a little solder and flux into this hollowed out place, and rub the end of the hot soldering iron briskly into this now and then to clean and re-tin it.

When the iron is tinned and heated to the proper temperature, it will "pick up" the solder. To make the solder stick to the work, the iron must be held on the work for a moment to allow the work to become heated.

The iron must be hot enough so that the solder will flow freely. If the solder becomes "sticky," the iron is too cold. If the iron is too hot, the solder will flow too freely and drop off.

PRECAUTION AGAINST BURNING OUT TUBES

After you have finished wiring the set, it is best to check it carefully to be sure that all wires are in the proper place.

If you are building a tube set, it is a good idea to take a precautionary measure, before trying it out, against burning out the tubes in case some of the wiring is incorrect.

To do this, proceed as follows: First, put the tubes in their proper sockets. Then hook up the "A" battery to the A+ and A- posts. Turn on your battery switch or rheostat. The filament in the tube should light if the wiring is right. Second, disconnect the "A" battery leads from binding posts and connect them to the B+ and B- of the

Radio Safeguards

STORM KING LIGHTNING ARRESTER

Approved by
the National
Board of Fire
Underwriters



\$1.00 at all dealers

Solderall
Solders All
Joints Per-
manently.
SOLDERALL CO.
NEWARK, N.J.

A Buffalo Radio Fan Gets London with the help of a KIC-O

Mr. E. C. Lewis on March 18th heard Mr. Marconi's voice on a Model 10 At-water Kent Machine. He said it would have been impossible without a KIC-O Battery. Improve your set with a KIC-O. Our guarantee protects you.

GUARANTEED

Your money back on any KIC-O Battery if not satisfied within 30 days' trial.

Write for full information on "A" and "B" Batteries

	Price	With
Volts	Plan	Panels
22	\$5.50
32	7.25	11.75
48	9.50	14.00
68	12.50	17.00
100	17.50	22.50
145	23.50	28.50

Kimley Electric Company

2665 Main St.

Buffalo, N. Y.

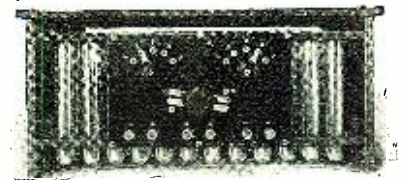

100 Volt Type

"HARMONIC"

The Best Transformer Money Can Buy
Correspondence Invited
Frank A. Ryder
19 South La Salle Street, Chicago

Operate your radio from your
lamp socket with a

Gould Unipower Battery

For complete information address

GOULD STORAGE BATTERY CO.,

30 East 42nd Street.

New York

"B" battery posts. Turn on the battery switch or rheostat. The filament in the tube should *not* light. If it does light with the "A" battery connected to the "B" battery posts, there is some mistake in the wiring and it must be rectified before attempting to use the set. No harm can come from this, however, as only the "A" battery is used. But if you should have connected the higher voltage "B" batteries to their posts, and this current had passed through the filament of the tubes, they would have probably burned out—an expensive experiment.

The plate in the tube requires from 22½ to 90 volts, which is obtained from the "B" battery, while the filament requires much lower voltage, usually ½ to 6 volts, according to the kind of tube being used. Therefore, great care must be taken not to get any of the battery wiring hooked up wrong.

If the filament of the tube does not light when the "A" battery is connected to the "B" battery posts, your battery wiring is probably correct, and it will be safe to hook your batteries to their proper posts and try out the set.

AERIAL AND GROUND

The aerial should be bare, preferably stranded wire, and should be as high as possible and at maximum distance from neighboring objects, such as trees, metallic buildings, chimneys and conducting wires. Also, it should be thoroughly insulated at all points of support.

The length of aerial and lead-in may vary considerably, but a 75-foot aerial with a 25- or 30-foot lead-in has been found the most desirable. Where conditions do not permit the erection of a single wire of this length, the aerial portion may be divided into two equal parallel sections, spaced two or three feet apart and connected at both ends.

Where conditions do not permit the use of an outside aerial, excellent results may be obtained by running insulated wire the full length of the attic or, if above the first floor, through several rooms along the top of the picture molding.

Have the lead-in from the aerial as short as possible and keep it well separated from the ground wire. Solder the lead-in wire

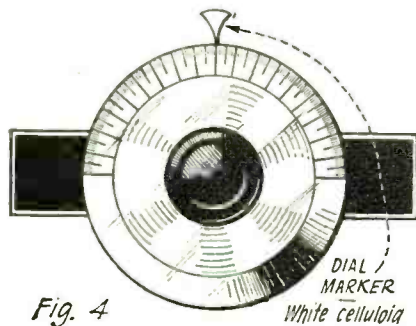

Fig. 4

DIAL MARKER
White Celluloid

White celluloid dial markers will improve the appearance of the panel.

to the aerial. The lead-in wire should be at least as large as the aerial wire.

Connect your ground to a cold water pipe with a ground clamp. Solder the wire to the clamp. First, clean the pipe thoroughly with emery cloth until it looks bright and clean. Place tinfoil around this cleaned place and bolt the ground clamp tightly to the pipe over the tinfoil. This will give you a good connection.

TO MAKE DIAL SETTING MARKERS

Markers for your dial settings may be cut to the desired shape from white celluloid (see Fig. 4). You may obtain this celluloid at any 5 and 10 cent store by buying a pin tray or a soap dish, or some other inexpensive article made of white celluloid. These may be attached to the panel above the dials

**"Reflected Tone" in
The MOZART Baby GRAND**

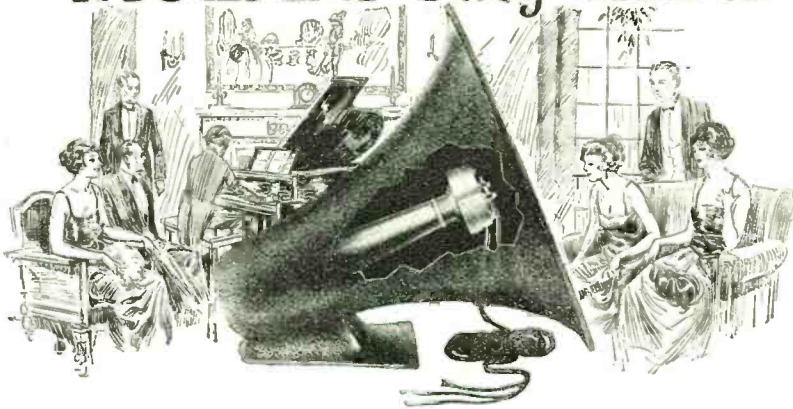

THERE has been so much advertising under the heading of tone, volume, acoustics, resonance, etc., that it was not our intention of even alluding to the subject in this series. Recently, however, we ran across a competitor's ad, which we consider of sufficient interest to quote from as follows:

"Two horns are used—the smaller throws the sounds against the major or reflecting horn. The operation is similar to the strings and sounding-board of your piano.—We found that this was the only way we could reproduce all tone really round and full. The middle tones sound well on practically any good loud speaker, but we found that high and low tones were true only when they were 'reflected'."

Assuming our respected friends also made this discovery themselves, independently, we take off our hats to them. The system is exactly similar to the Mozart-Grand and is only another reason for the latter's phenomenal success to date.

PRICES . . . F. O. B. Factory.

- Reproducer complete with (gold plated) unit and polarity-indicating cord \$12.00
- Unit only with polarity-indicating cord, gold plated 5.00
- Unit only with polarity-indicating cord, nickel plated 4.00
- Shipping weight of reproducer, 8 lbs. (approx.).
- Dimensions—Diameter of bell, 12". Length and height over all, 12½".
- No extra Batteries required.
- Orders shipped direct from the factory or through your dealer.

(Radio Division)

THE MOZART GRAND CO.

Manufacturers of Fine Instruments

NEWARK, N. J.

U. S. A.

RADIO
BIG MONEY IN A BIG FIELD
Wanted — and wanted quick are men who can qualify for big pay positions in the enormous, fast growing Radio Industry. Once in a lifetime chance. Fast, easy to learn. No previous experience needed.
Be A Radio Expert
\$3000 to \$10,000 a Year
Learn at home, by actual practice, to design, construct, install, operate, repair and sell Radio Equipment. Pleasant, fascinating, profitable. My methods are simple, clear and successful. Turn your spare time into cash.
FREE WONDERFUL 1000 MILE TUBE RECEIVING SET.
Write today for Booklet "Radio Facts" FREE.
A. C. Mohaupt, Radio Eng., Radio Assn. of America
4813 Ravenswood Ave., Dept. 158, Chicago

8 TUBE SUPER-HETERODYNE
Genuine ULTRADYNE Parts
COMPLETE, including 30 in. MAHOGANY CABINET with Drilled and Engraved Panel,
Accuracy Dials and Everything needed—down to the last screw—32-page book.
"How to Build and Operate the ULTRADYNE" FREE WITH EACH ORDER.
Literature on request.
\$85
Ask About Our Building and Repair Service
BROADCAST SERVICE CO.
1 Union Square New York City

Insure your copy reaching you each month. Subscribe to Radio News—\$2.50 a year. Experimenter Publishing Co., 53 Park Place, N. Y. C.

The NEUTRODYNE

The Circuit of No Regrets

The Neutrodyne is undoubtedly one of the most popular Radio Receiving Sets in existence today—FIRST because it is highly efficient, obtaining great distance, fine clear reception, and little or no distortion.

SECOND because it does not whistle or howl inherently as do so many receiving sets on the market today, and THIRDLY because it is an extremely simple circuit to construct and has very few parts that can get out of order.

The CONSRAD book No. 10 written by Maurice L. Muhleman of the staff of RADIO NEWS contains complete, practical data, information and notes about the Neutrodyne. This handy book tells How to construct the Neutrodyne, How to care for it, and How to get the most from it. It tells everything there is to know about this popular circuit.

AT ALL RADIO DEALERS
Or order direct from us.



The E. I. Company
(Consrad Co., Selling Agents)
233 Fulton St., New York City

We Cut Rub-Mika Panels



to meet your requirements

Not necessary to order standard sizes. Cut to any sizes you desire. Rub-Mika is high grade panel material, low absorption, high tensile and dielectric strength. Let us quote you on your requirements. Fill in the coupon for samples and prices.

The Cooper Corporation
Manufacturers
Cincinnati, Ohio

The Cooper Corporation,
Cincinnati, Ohio.

Please send me samples and prices on Rub-Mika Panels.

Name
Address

with a little glue. They are easy to make, inexpensive, and add greatly to the appearance of the set.

The entertainment derived from radio programs will repay, time and again, the trouble and expense of building a radio set, yet no program you will ever listen to will give you the thrill of satisfaction obtained when you hook up the last wire of your radio set, don the head phones, turn on the rheostat, tune in a station, and gleefully exclaim, "Oh, Boy, It Works!"

What to Expect from Your Receiving Set

(Continued from page 189)

receivers when the other will cover the same range. I have mentioned the fact that they reproduce clear signals at all times. They have the additional power of eliminating practically all interference from ships, amateurs and other sources which would be annoying with another type. The super does not require the old cumbersome outside antenna. The sets now on display work with self-contained dry batteries—something new in the radio field.

Now let us take up the relative efficiencies of the single and three circuit, or loose coupled receivers. In the single circuit sets the antenna is directly connected to the vacuum tube. All impulses impressed on it by atmospheric electricity, power lines and so on, reach the tube before they are grounded, and consequently are all reproduced in the head telephones. The single circuit receiver, and a very few types of three circuit tuners are responsible for the many howls and squeals that creep into the music while you listen. Remember that while a set is oscillating it puts out into the air a wave exactly like a broadcast transmitting station, and that it is wilfully breaking up everybody's music within several miles. I have mentioned that some types of inductive, or three circuit tuners, do this.

I have already mentioned that all impulses striking the antenna of a single circuit tuner are carried to the telephones. Any interference caused by nearby stations cannot be eliminated. There is no way to tune it out. In the three circuit tuner the secondary coil may be moved away from the primary with a great increase in the sharpness of tuning. In such hook-ups there is a direct connection to ground through the primary coil which will carry off static and other noises to a large degree. A Super-Heterodyne receiver incorporates most of the good points of both types, and very few of the bad.

Another point in the operation of any receiver is the personal element. A man skilled in the operation of apparatus in general will get more out of any set than a novice. The main points causing this are his patience in tuning and the accuracy with which the tuning is done. He will also realize when a set is doing its best, and will not try to force it beyond its normal range. This accounts in a very large degree for the good work done by some and the very poor work of others with even better sets. It is not necessary to be a radio engineer to work a set properly, but a basic knowledge of what is taking place within the set is certainly desirable.

In one location a set may give nearly perfect results, while another spot in the same city may produce no results worth mentioning. Do not blame the set. Tune around, and you will find another set of adjustments that will work, possibly better than the first. The direction of the antenna, whether over roofs or not, and the amount of power and telephone wires in the vicinity of the antenna all have some bearing on the working of the set. Do not tear the set to pieces just



RADIO CABINET No. 1000

Specifications

Selected, matched mahogany veneers. Adam br. finish, rubbed dull, or figured American Walnut. Top 37 x 19. Height 43".

PRICE

Freight prepaid, east of Mississippi River, \$60.00. CASH MUST ACCOMPANY ALL ORDERS.

Horn and battery compartment 32 x 17 x 14" high. Will take any loud speaker on its side, or a 14" speaker upright with plenty of room for batteries.

Ingenious idea for set opening,—removable panels are furnished to fit and cover openings for sets from 18 x 7 up to 32 x 10.

We have manufactured high-grade furniture for 45 years, and guarantee you best of workmanship with piano finish.

BURT BROS., INC.

2000-14 S. 9th Street Philadelphia, Pa.

Territories open for Agents and Distributors for our up-to-minute line of Radio Cabinets.

ARROW BATTERY SLASHES Prices TO CONSUMERS

Prices Smashed!
Quality Not Sacrificed

Here is real battery quality, guaranteed to you, at prices that will astound the entire battery-buying public. Order direct from factory. Put the Dealer's Profit in your own pocket. You actually save much more than half, and so that you can be convinced of true quality and performance, we give a **Written Two-Year Guarantee**

Here is your protection! No need to take a chance. Our battery is right—and the price is the lowest ever made. Convince yourself. Read the prices!
Special 2-Volt Radio Storage Battery, \$3.75
Special 4-Volt Radio Storage Battery, 6.00
6-Volt, 60 Amp. Radio Storage Battery, 7.00
6-Volt, 80 Amp. Radio Storage Battery, 8.00
6-Volt, 100 Amp. Radio Storage Battery, 9.50
6-Volt, 120 Amp. Radio Storage Battery, 11.50
6-Volt, 140 Amp. Radio Storage Battery, 13.00

We ask for no deposit. Simply send name and address and style wanted. Battery will be shipped the day we receive your order Express C. O. D., subject to your examination on arrival. Our guarantee accompanies each battery. We allow 5% discount for cash in full with order. You cannot lose! Act quick. Send your order today—NOW.

Arrow Battery Co.
1421 South Wabash Ave.
Dept. 6 Chicago, Ill.



HEAD SETS LOUD TALKERS
PHONO ATTACHMENTS

TRIMM

RADIO MFG. CO., Dept. 66
24-30 S. Clinton St. Chicago, Ill.

because it does not work on one or two occasions. Call up some of the other set owners and ask if they are getting satisfactory results. There have been several nights recently when we heard no signals. If there is trouble, test the storage battery with a hydrometer, and the "B" battery with a voltmeter. Both are common causes of weak signals. Do not expect a set to work without the necessary power.

With careful handling there is little to get out of order in most receivers. Unless you know what each part is for and how it functions, do not tamper with it. Take it to someone who does know, and ask him if there is anything wrong. A very important "don't" to keep in mind is the fact that it is not necessary to turn the rheostat knobs after they have been set. Such movement results only in shortening the lives of the tubes. They are put there for adjustment on various types of batteries, and are distinctly not a part of the tuning control. Generally speaking, burning tubes too high simply spoils them. It not only cuts down their lives, but their sensitiveness.

In summing up briefly the facts mentioned, let me draw your attention to the fact that the number of tubes has very little to do with the range of a set; that the range depends on your ability to properly tune it; and that the life of the tubes depends on not turning the rheostats too high. Some of the single circuit sets have heard the Pacific Coast stations, while others have not. Don't blame the set. Try to understand it and then see what an improvement there is in its range. A set may be guaranteed for a 3,000-mile range, and will work that far in an experienced man's hands under good conditions, and it is purely the personal element in it, weather permitting, that prevents another from doing the same thing.

Loud Speaker Works on Crystal

(Continued from page 178)

their views on volume of sound through the ear phones, but not revealing the meter readings, and in all cases they could not detect any difference in a signal strength by phones after the crystal was rectifying above 200 microamperes, although it was useless to try to work the loud speaker, until at least one milliamperere of current was registered.

Further lines for research may be suggested for the experimenter, such as using variometer tuned circuits, studying the results obtained by the use of various crystal combinations, and DX work on crystals, as by tuning to a level station by means of the meter operators would be sure of obtaining the most sensitive spot on their crystal before searching for the DX stations.

Radio Broadcast Advertising in Argentina

(Continued from page 179)

monious name, such as 'Merited Birth,' 'Elegant Writer,' 'Perfect Ink,' 'Olive at the point of ripeness,' etc. The Chinese demonstrate with the last name the appreciation that this fruit merits, and from which they make an excellent olive oil such as the brand 'XXXX' which is imported by Smith & Company of this city, and Jones & Company of Rosario."

Perfumes:

"In all ages, perfume has been a constant preoccupation of man, and more than of man, of women. The Egyptians wor-

Haynes-Griffin

RADIO SERVICE, Inc.

41 West 43rd St., N. Y. City



Here is advance information on something really new in radio. It tells all about air core and iron core transformers; what Mr. Haynes has found out about matching transformers; how to match your own transformers; what improved results you can expect.

HAVE YOU MATCHED YOUR TRANSFORMERS?

Here is a tip from the experience and research work of A. J. Haynes, Associate Inst. Radio Engineers, covering years of personal experimentation and trouble shooting for countless numbers of other radio enthusiasts.

It will save you hours of fruitless tinkering and useless building and rebuilding of your Super-heterodyne, ever seeking to find the error that hides the secret of perfect success.

MR. HAYNES SAYS:

"The improper matching of intermediate wave radio frequency transformers used in the Super-heterodyne or for long wave amplification is almost invariably the one barrier that stands between the average experimenter and the marvelous accomplishments promised by this best-of-all circuits.

It is now, and I believe always will be, physically impossible in the process of manufacture to wind a large number of transformers to the same resonant frequency."

"Hence they must be matched in sets of four, after manufacture, selecting those

for each set that bear exactly the correct proportion one to the other.

This matching must be done in careful laboratory tests by experienced radio engineers independent of the manufacturing force. The improved results derived from this plan, which, I believe, is exclusive to ourselves, have surpassed my highest expectations.

I am glad to pass this information along to those experimenters who have the facilities to do this themselves. I am glad also to have devised a plan which makes it easy for others to secure properly matched transformers at the very start."

Every Set of HAYNES-GRIFFIN TRANSFORMERS Now Laboratory Matched

After the exact resonant frequency of each transformer has been measured, they are grouped in sets of four ALL IDENTICALLY ALIKE.

\$20.00 For a Complete Set of four consisting of one input and three inter-stage transformers.

If you are about to build a "Super" or if your present one is not delivering the goods the way you know it should, you owe it to yourself to read Mr. Haynes' treatise on the necessity for matched transformers. Send handy coupon and 4c to cover cost of mailing and it will be mailed to you at once.



Never furnished individually. Sold only in matched sets of four packed in a single sealed carton.
HAYNES-GRIFFIN
 41 W. 43rd St.
 New York City
 I enclose 4c. in stamps to cover cost of mailing to me a copy of the booklet entitled "Trouble Shooting in the Super," by A. J. Haynes.

Name.....
 Address.....

HAYNES-GRIFFIN RADIO SERVICE, Inc.
 41 W. 43rd St., N. Y. City. 111 S. Clark St., Chicago, Ill

Agents Wanted!

Salesmen-Distributors

to use and introduce attachment that makes Fords run on 94% air. THERMOSTAT on exhaust automatically turns down needle valve as engine warms, exactly as Ford Manual says do by hand.

Blancke Auto Thermo

An Automatic Carburetor Control Makes Fords start easier winter or summer—saves half gas and oil—cuts repair bills one-half—reduces carbon formation one-half. Sells on sight to every Ford owner as easily as giving him a \$100 bill, because it saves \$100 every 10,000 miles. Cadillac now uses carburetor control under Blancke license. You can make Big Money selling this wonderful proven device. Experience not necessary. Blancke plan will start you without capital in a business of your own that makes you from \$250 to \$2,000 a month profit.

Writes for free circulars Now!

A. C. Blancke & Co. 602 W. Lake Street Dept. 90, Chicago

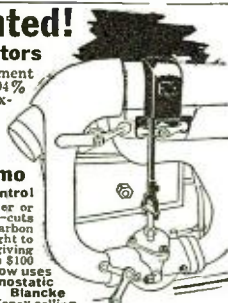



MIRACO
GETS 'EM FROM COAST TO COAST
 PRICE ONLY \$29.50

At rock-bottom prices you get the efficiency of sets costing three times as much. Users tell us that Miraco Radio frequency receivers pick up stations from coast to coast. Operate either on dry cells or storage battery. Solid mahogany cabinets—finest workmanship throughout. Order direct or send for bulletin.
 Two tube outfit \$29.50
 Four tube outfit 54.50
DEALERS, AGENTS—Write for proposition quickly—it's a winner.
THE MIDWEST RADIO COMPANY
 804 Main Street Cincinnati, Ohio

Get a Handy Binder for your RADIO NEWS. Holds and preserves six issues, each of which can be inserted or removed at will. Price 65c. Experimenter Pub. Co., Inc., Book Dept., 53 Park Place, N. Y.

Something Better to Put New Life in Receiving

A Microcondenser Especially Designed for Equalizing Radio Frequency Circuits

A Turn of the Screw Slot In the Visible Plate Sets It In the Equalized Position.

The Equalized Position Then Remains Fixed Without Any Further Manipulation.

The Use of a Long, Dry Stick, Sharpened at the End, Makes Perfect Equalization Possible without Any Error Due to Hand or Other Capacity.

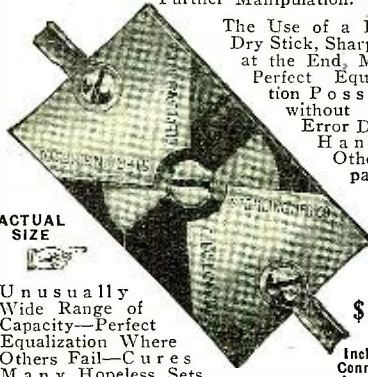

ACTUAL SIZE

Unusually Wide Range of Capacity—Perfect Equalization Where Others Fail—Cures Many Hopeless Sets. Reflex and Others.

\$1.00

Including Connecting Lugs and Screws.

Convenience and Simplicity of Installation.

Extraordinary Ease of Adjustment—A Turn Sets It and It Stays Put.

Sterling

R 311 MICROCONDENSER

The Sterling Manufacturing Co. Cleveland Ohio

AMPLEX GRID-DENSER Improves ANY Circuit

Replaces Fixed Condensers and Gives

\$1.25



Unbroken Range from (.0 to .0005) plain or with (.0002 to .001) Grid leak Clips

ABSOLUTELY ESSENTIAL IN Cockaday, Tobias, Super-Heterodyne, Ultradyne, Superdyne, Neutrodyne, Etc.

No two tubes or Circuits are alike. Each requires a different EXACT capacity for maximum efficiency. A slight turn of the GRID-DENSER knob finds the CORRECT capacity for you.

Permits operating set at highest point of regeneration, controls oscillations, maintains perfect stability. SPECIFIED by Haynes, Tobias, Cockaday, Grief, M. B. Steper, Lescarboursa, Foote, Pfeiffer, in ALL circuits for GREATER Distance, Louder and Clearer Signals.

FREE booklet with hook-ups showing how to double the efficiency of your set.

At your Dealers, or send \$1.25 to AMPLEX INSTRUMENT LABORATORIES 57 Dey Street Dept. 8 New York City

Own the World's Best Arms



Luger Pistols barrels 4, 6, 8, 12 and 16 inches. Mauser Pistols, long barrels; holster stocks for both. Mauser, Mannlicher and all other arms. Catalog R 10 cents.

PACIFIC ARMS CORPORATION Liberty Bank Bldg. San Francisco, Calif.

shipped certain aromatic mixtures. It appears to have been definitely proven that Cleopatra seduced Marc Antony and changed the whole course of history by the intensity of her ultra-exquisite perfumes. The Greeks burned intoxicating herbs and the Romans used extraordinary combinations. In modern times, odors have reached unheard of heights. Apart from the superior power of perfumes, there is a gamut which decides really interesting situations. Perfume and love form a part of the same kingdom, for it is not possible to live without spirit, looks, sighs, ravings and perfumes. Some one has said: 'Perfume is the kiss of chastity, the excitement of happiness. Love without fragrance is like a banquet without wine. A dressing room without a flask of "Coty" is more like an office room. "Coty" is the supreme accomplice of love.'

Merchandise: "Nothing defines a civilization so much as its features of feminine esthetics. People think and feel as they dress. This is the truth. Who of you do not know of some such person of the most influential countries in the history of the world? If we examine the details of their manner of dress, their harmonious sobriety, or their striking diversity, there will be found a profound relation between their exterior aspect, their way of thinking and the character of their spirit.

"Amongst all people, the French 'esprit' is that which has determined the feeling of elegance, based and modeled upon the figure of the woman. Therefore, the French woman always impresses us as a living work of art. The secret of her charm belongs only to those who show the discrete and delicate tones of 'Manon' hosiery."

"Radio Cultura" broadcasts one of the best programs in the city, and, inasmuch as its advertising is carried on in an interesting manner, there is little complaint on this score from radio fans. It is impossible to state whether the scheme on the part of the owners of the broadcast station is a success financially, but it evidently is, because the station continues to improve its programs.

There have been several projected laws before the Argentine Congress, and one at the present time proposes a tax of ten thousand pesos on stations destined to the service of institutions, clubs, and commercial, industrial, exchange or banking corporations, or, at par of exchange, something like \$4,240, United States currency, per year. It further provides that the President has the power to authorize the working of radio electric stations for broadcasting, installed with the object of broadcasting news of general interest, conferences, concerts (vocal or instrumental), records, theatre performances, excluding all other communications of personal or private character, or commercial propoganda excepting that which concerns call signals. In the event of the passage of this law, the situation would be radically changed with regard to advertising by radio stations.

Principles of C. W. and Radiophone Transmission and Reception

(Continued from page 191)

frequency minus the speech frequency. Thus in a radiophone set there are three radio frequencies transmitted or radiated from the antenna for a single speech frequency.

What makes the problem of radio telephone transmission a little more complicated is the fact that there are so many audible frequencies which a radiophone station must transmit. Consider the everyday phenomenon of speech. The audible frequencies contained in normal understandable speech range

You Know These HEADBANDS

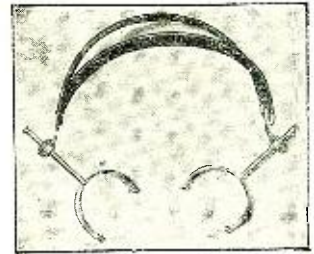

Simple friction slide adjustment. Most satisfactory on the market. No thumb screws to bother with or to catch in the hair. Two yoke sizes fit any 'phones. Bands covered in Black or Khaki webbing.

Prompt deliveries on any quantity. \$500,000.00 worth of special and automatic machinery assures quantity output and guaranteed delivery for manufacturers and dealers on any radio equipment.

Submit sample of product. Write for prices.

THE AUTOYRE CO. OAKVILLE, CONN.

NEUTRODYNE A & P 5 TUBE SET KNOCK-DOWN

Every part that is needed to build an A & P NEUTRODYNE is included in the kit at this remarkably low price.



PRICE \$25.95

Enclose Postage with Order

These parts are constructed in our factory according to NEUTRODYNE specifications, and are guaranteed to be the BEST MONEY CAN BUY. No shellac or varnish to cover defects. Silk wire wound on all genuine Bakelite.

GREATER ATLANTIC & PACIFIC RADIO CORP. 223 West 34th St., New York City

Thor Reproducer



serves as a table lamp when set is not being used. NON directional perfect reproduction evenly diffused to all parts of the room. Far handsomer than ugly, unsightly horn. Price \$30.00. Order one today through your dealer or from

THOR RADIO COMPANY 1243 Sutter Street San Francisco

Insure your copy reaching you each month. Subscribe to RADIO NEWS—\$2.50 a year. Experimenter Publishing Co., 53 Park PL, N.Y.C.

from 100 to 5,000 or more cycles per second. In the case of music, the range of frequencies is still greater, from 50 cycles per second (produced by bass viols and kettle drums) to 10,000 cycles per second (produced by reeds, picolos, etc.). A good radiophone broadcast station transmits all audible frequencies between 50 and 10,000 cycles. From our discussion in the previous paragraph, the reader may well imagine the wide variety of radio frequencies which must be radiated. For each audible frequency between 50 cycles and 10,000 cycles there will be developed two different frequencies and all of these will be radiated from the antenna besides the original carrier wave. If the carrier frequency is 600,000 cycles, as above, let us see exactly what range of frequencies will be developed and radiated. First, the carrier itself. Second, a group of frequencies represented by the carrier *plus* each audio frequency from 50 to 10,000 cycles, namely, the new radio frequencies above the carrier range from 600,050 cycles to 610,000 cycles per second. Third, frequencies represented by the carrier *minus* each audio frequency from 50 to 10,000 cycles, namely, the new radio frequencies below the carrier range from 599,950 cycles to 590,000 cycles per second. In other words, in radio telephony a very wide band of frequencies is radiated from the antenna, whereas in telegraphy only a single frequency is evident.

Fig. 1 is a very descriptive illustration of what happens. A straight line is drawn at 600,000 cycles to represent the only frequency radiated by a telegraph station operating at this frequency. In Fig. 2 is shown the different frequencies which are radiated by a radio telephone station. It is seen that the radio telephone station transmits also the carrier wave of 600,000 cycles similar to the telegraph station, but besides this, it also transmits two large bands of frequencies, one below and one above the carrier, as shown by the shaded areas on each side of the carrier frequencies.

The above gives us the clue to the method by which the radio frequencies transmitted by a radio telephone station are converted back into audio frequencies. Suppose we consider our original case of a radio broadcast station transmitting the note middle C. Then the station actually transmits the following three frequencies: (1) the carrier frequency of 600,000 cycles; (2) 600,000 cycles minus 256 cycles, or 599,744 cycles; and (3) 600,000 cycles plus 256, or 600,256 cycles per second. These frequencies are picked up by the receiver. The process whereby these frequencies are converted into the original audible frequency of 256 cycles is that of heterodyning, or beat reception.

When two different frequencies are present in the same circuit, there is produced a third frequency, called the beat frequency, which is equal to the difference of the two original frequencies. In the above case we have first the carrier present with one side frequency. The difference is exactly 256 cycles or the frequency of middle C, the note sung into the transmitter at the broadcast station. Secondly, the carrier frequency also has with it the other side, and the difference between these is also 256 cycles, middle C. Thus by the process of heterodyning in the receiver the frequencies transmitted by a broadcast station are actually converted into the original audio frequencies which are heard. The carrier frequency beats or heterodynes with the side frequencies, and the resulting beats are the original signals. A little consideration will show that in reception this is really undoing what is done at the transmitter. At the transmitter the carrier radio frequency combines with the audio frequencies to make more radio frequencies. At the receiver the carrier frequency combines with these new radio fre-



BRANSTON KIT No. R-99
CONSISTING OF
CHAS. A. BRANSTON, Inc. Buffalo, N. Y.

Branston Kit
No. R-99
\$36.50



Add Miles and Smiles with Branston Standard Radio Parts

BRANSTON RADIO

(Reg. U. S. Pat. Office)

You'll be surprised when you learn how easy it is To build a Super Heterodyne Receiver!

BRANSTON Standard Radio Parts



Honeycomb Coils, 16 Sizes
Coil Mountings all Styles

Licensed under DeForest Patents.

Audio Frequency Transformers
Intermediate Radio Frequency Transformers
Air Core Transformers
Radio Frequency Transformers
Lightning Arresters
Multiphone Jack Boxes
Series Parallel Switches
Jacks
Telephone Plugs
Head Sets, etc., etc.

ALTHOUGH the Super Heterodyne is acknowledged by radio experts to be the best method of reception yet devised, it is an easy set to build. The essential parts are contained in the Branston Kit No. R-99 illustrated above. These consist of 1 Oscillator Coupler, complete with mounting brackets, bank wound inductance and adjustable coupling coil with locking device; 3 Intermediate Radio Frequency Transformers, very sharply tuned and completely shielded; 1 Special Transfer Coupler for first or last stage of Intermediate Frequency; and 1 Specially Designed Antenna Coupler so that either loop or antenna can be used. This apparatus has been specially designed for Super Heterodyne, Ultradyn and similar circuits. It has been rigorously tested and proved better than any heretofore obtainable.

"Super Heterodyne Construction"

(Price One Dollar)

This book gives large circuit blueprints and full size panel layout. With its complete instructions any radio amateur can very easily build a Super Heterodyne Receiver that will be extremely selective, free from interference and will give unusual volume and range with great clarity.

Your dealer has Branston Kits or can get them for you

CHAS. A. BRANSTON, Inc.

817 MAIN STREET

BUFFALO, N. Y.

In Canada—Chas. A. Branston, Ltd., Toronto

In England—Chas. A. Branston, Ltd., London

UNITY VERNIER RHEOSTAT



The Highest Type Instrument Made
Any Resistance \$2.00
"Hear a Set That Uses One"

ELIMINATE THE NOISES IN YOUR SET

The book "TUBE CONTROL," written for the amateur, and for the benefit of Radio Reception, by J. Elliott Jenkins, Engineer of Broadcasting Station W. D. A. P. will tell you how to clear up your signals.

Every set owner should have this book.
10c at your dealers, or 14c postage to
UNITY MFG. CO., 224 N. Halsted St., Chicago
NEW YORK OFFICE, 50 Church Street

Learn Electricity

By ACTUAL WORK in only 12 weeks in the Great Shops of Coyne



Make \$3,000 to \$10,000 a Year!

Not a correspondence school. We pay your railroad fare to Chicago—to the Great Shops of Coyne. You don't need education or experience. 3 months' work at Coyne on vast outlay of actual equipment makes you a Big pay Electrical Expert. Two extra courses FREE. Write NOW for FREE Book.

New catalog just off the press. Send for it NOW!

COYNE
Electrical School
1300-1310 W. Harrison St.
Dept. C594 Chicago, Ill.

The oldest and largest electrical school in the world!

Insure your copy reaching you each month. Subscribe to Radio News—
\$2.50 a year. Experimenter Publishing Co., 53 Park Place, N. Y. C.

GREWOL

The
**PERMANENT
DETECTOR**

\$1.50



Like a vacuum tube—always set and ready, at the peak of sensitivity. Vibration proof adjustment, all enclosed away from dust and any possible danger. The *ONLY* standard, nationally advertised REFLEX crystal detector. Best for all circuits.

*Sold by Good Dealers
Everywhere or Direct Upon
Receipt of Dealer's Name
and \$1.50*

Patented May 15, 1923
Serial No. 1454997

Infringement subject to prosecution.

GREWOL 2 in One Crystal
Two surfaces instead of only one.
Double life, double value.
50c each



GUARANTEED BY

GREWOL MFG. CO.

NEWARK, N. J.

106 Stations Logged in Two Nights with B-T Nameless R. F. Circuit

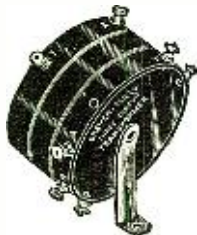

KIT No. 1

1 Set of three—3 circuit Trans-**\$10.50**
formers

KIT No. 3

1 set of 3—3-circuit R. F. Transformers.
3—.0005 Vernier Variable Condenser.
2—3-plate control Condenser.
1 book of diagrams and in-**\$26.50**
structions. Price of Kit No. 3

One Chicago Engineer has reported 106 stations logged in two evenings in the month of May. One Radio Editor heard Havana on the loud speaker at Chicago in mid-afternoon.

The distance selectivity, volume, and tone quality of this set is positively amazing. If built on the now famous "step-by-step" plan we will absolutely guarantee the results.

See your Dealer at once or write us.

Bremer-Tully Mfg. Co.
Canal and Harrison Sts., Chicago, Ill.

quencies and unscrambles them to form the original audio frequencies or sounds.

Further consideration of the essential difference between radio telegraphy and telephony will show that it determines design of both receiving and transmitting equipment and also the quality of transmission. Inasmuch as only one frequency is radiated by a telegraph station it is important and desirable that the oscillating circuit and antenna circuit of the transmitter be extremely selective, so that it will transmit one frequency most efficiently. In the same way the receiver should be extremely selective so it will receive only one frequency to the exclusion of all others. The same cannot be said of the radio telephone transmitter and receiver. As explained, the radio telephone transmitter must be capable of transmitting not one frequency, but an extremely wide range of them, hence its antenna circuit must be more broadly tuned to be able to accommodate all these frequencies efficiently. Also, the receiver designed for radio telephone reception must not be so selective that it will not receive efficiently a very wide range of frequencies. The old style hair line selectivity of the telegraph receiver is not desirable for radio telephone or broadcast work, and an examination of present day receivers will show that they are capable of receiving a wide range of frequencies efficiently.

Unless these requirements of not too sharp selectivity and broader tuning are adhered to, it will be found that the quality of telephone or broadcast transmission and reception will be very much impaired. Thus consider the question from the transmitter point of view. Suppose that the antenna circuit is so sharply tuned that it can only radiate frequencies 4,000 cycles above and below its tuned carrier frequencies. In the case of our 600,000-cycle station, this means that it can transmit only from 596,000 cycles to 604,000 cycles. This means that speech sounds or musical sounds having frequencies higher than 4,000 cycles will not be transmitted. Very high notes of the piccolo or organ reeds, or harmonics of the violin will be dropped out, resulting in the music being distorted. In the same way speech will sound unnatural, for such letters as "s" and "sh," which are made up of frequencies above 4,000 cycles, will not be transmitted.

The same thing applies to the receiver. If the broadcast or telephone station transmits all frequencies satisfactorily, the quality may be ruined by the fact that the receiver is too sharply tuned. If it cannot receive efficiently a broad band of frequencies, it will naturally cut off higher frequencies with the consequent distortion noted above. It, therefore, appears that the principles of extremely selective tuning are somewhat upset by consideration of the principles underlying the transmission of radiophone signals. This does not, however, mean that receivers and transmitters for telephony should be too broadly tuned, for this would again result in too much interference from other stations. But they must have sufficient broadness of tuning to enable them to transmit and receive efficiently a band of radio frequencies about 20,000 cycles wide, which, in the broadcasting range of wave-lengths, means transmitting over a wave-length range from 5 to 10 meters wide. Thus at 500 meters, the transmitters and receivers must have enough broad tuning to enable maximum results to be secured from about 494 to 506 meters.

PRETTY GOOD FOR ENGLAND

HE: "Say, dearie, a friend of mine got London on an \$8 crystal set."
SHE: "Where is he located?"
HE: "He lives in Liverpool, England.—
Milton Ader.

PATENTS

To the Man with an Idea

I offer a comprehensive, experienced, efficient service for his prompt, legal protection and the development of his proposition. Send sketch, or model and description, for advice as to cost, search through prior United States patents, etc. Preliminary advice gladly furnished without charge. My experience and familiarity with various arts frequently enable me to accurately advise clients as to probable patentability before they go to any expense.

*Booklet of valuable information
and form for properly disclosing
your idea free on request.
Write today.*

RICHARD B. OWEN PATENT LAWYER

2 Owen Building, Washington, D. C.
2276A Woolworth Bldg., N. Y. City

Special Library of Information on

RADIO PATENTS and TRADE MARKS

JOHN B. BRADY

Patent Lawyer

Ouray Building Washington, D. C.

Cable address:
RADIOPAT

Telephone:
Main 4806

PATENTS WRITE for our Three Guide Books and "RECORD OF INVENTION" before disclosing inventions. Send model or sketch and description of your invention for Examination and Instructions. Electrical cases a specialty. Highest references, reasonable terms, prompt attention.

No charge for the above information.

VICTOR J. EVANS & CO.
919 NINTH ST., WASHINGTON, D. C.

PATENTS

DON'T LOSE YOUR RIGHTS
Before disclosing your invention to anyone send for blank form "EVIDENCE OF CONCEPTION" to be signed and witnessed. Form and information concerning patents free.

LANCASTER & ALLWINE
270 Ouray Bldg., Washington, D. C.
Originators of the form "Evidence of Conception"

PATENTS

Trade-Marks, Copyrights and Patent Litigation
Write for advice and instructions how to proceed, costs, etc. Hand Book with illustrations of 100 Mechanical Movements sent free on request.

ALBERT E. DIETERICH Patent Lawyer and Solicitor

Successor to Fred G. Dieterich & Co.
690A Ouray Bldg., Washington, D. C.

PATENTS

C. L. PARKER
Formerly Member
Examining Corps,
U. S. Patent Office.
PATENT - LAWYER
McGill Bldg., Wash., D. C.

Patents, Trade Marks, Copyrights, Patent Litigation
Handbook for Inventors, "Protecting, Exploiting and Selling Inventions," sent upon request.

INVENTORS

who derive largest profits know and need certain simple but vital facts before applying for Patents. Our book *Patent-Sense* gives those facts; sent free. Write **LACEY & LACEY**, 631 F St., Washington, D. C. Established 1869.

Ripples, Normal and Abnormal

(Continued from page 186)

from his operating table, directly beneath his tubes. In spite of all attempts with filters he is consistently reported I.C.W. with key, and ripple strong with phone, while with transformer and electrolytic rectification the reports are good. The suspension of the motor-generator from the straps is good, and also the use of a concrete base for the larger sets, but both require a slight amount of intelligence regarding location.

NORMAL RIPPLES

Having disposed of the abnormal ripple conditions, we can turn to the normal. In the generator supply there are two well defined ripples. These are a slot ripple and a

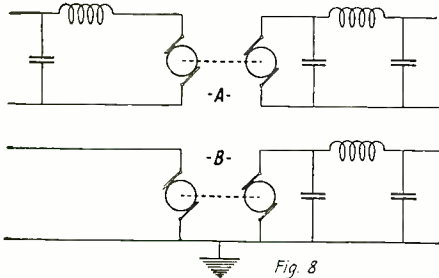

Two effective methods for eliminating commutator ripples.

commutator ripple. In the high voltage machines now used the slot ripple has the greater amplitude.

The value of the voltage in the conductors depends upon the amount of flux they are cutting, and the speed. In actual operation the speed of the generator remains fairly constant so we can drop this as a constant. Fig. 4 shows the magnetic paths or flux irrespective of the field caused by the armature in the typical machine. The flux has a tendency to uniformly saturate the pole piece, but passing through the armature it divides into separate paths through the armature teeth. The reluctance of the slots is very great and little flux threads them. We can induce an E.M.F. in a coil by moving it through a magnetic field, likewise we can induce an E.M.F. in a coil by moving or changing the value of the flux threading it. The Alexanderson alternator employs this latter method. Every time a tooth first comes under the tip of the pole piece it is highly saturated, and as it leaves the flux threading, it rapidly diminishes. As each slot passes the pole tip the flux jumps to the following tooth. Each little interruption and jump causes a surge in the armature winding. The armature winding is a continuous electric path consisting of a series of coils placed around the periphery of the armature. As the brushes are approximately the width of two commutator segments and their included mica, the brushes are at all times electrically connected to the winding, and consequently transmit every fluctuation in the armature. An armature with 24 slots turning at a speed of 24×1800

R.P.M., would have a slot ripple of 60

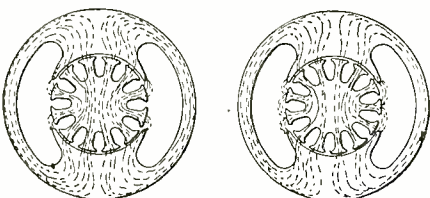

Fig. 4. Magnetic flux in a machine with an even number of armature slots. Fig. 5. The flux created by an uneven number of slots.

Tested and listed as standard by Underwriters' Laboratories



The FANSTEEL Balkite battery charger

PATENTS
APPLIED FOR



has no vibrators, bulbs or moving parts and is entirely noiseless

The Fansteel Balkite Battery Charger for Radio "A" Batteries [6 volt] is an entirely new type of rectifier, based on the use of Fansteel Balkite, a new and rare metal developed for this purpose. It is entirely noiseless. It cannot deteriorate through use or disuse. It has nothing to replace, adjust, or get out of order. It cannot discharge or short circuit the battery, and requires no attention other than an occasional filling with distilled water. It will not overcharge, and cannot fail to operate when connected to the battery and line current. It is unaffected by temperature or fluctuations in line current. It is simple, efficient, and indestructible except through abuse. The charger may be used while the radio set is in operation. Without added attachments it may also be used to charge "B" storage batteries.

FANSTEEL BALKITE

is a new metal developed for this charger. It acts as a valve, allowing current to flow into the battery but not out of it. It is the most efficient charger valve made, is practically indestructible, and does away with noisy, delicate vibrators and fragile bulbs.

The Gould Storage Battery Company is also marketing, under the Fansteel Balkite Patents, a complete battery and recharging unit known as the Gould Unipower, into which this charger, under the name, "The Fansteel Balkite Rectifier," has been incorporated.

The Fansteel Balkite Battery Charger will charge the ordinary 6 volt radio "A" or automobile storage battery at 3 amperes, from 110-120 AC, 60 cycle current. It comes complete and ready for use. Get it from your dealer, or use the coupon below.

Price, \$19.50 [West of the Rockies] \$20.00

FANSTEEL PRODUCTS CO., Inc., Dept. 8-A, North Chicago, Ill.

FANSTEEL PRODUCTS CO., Inc., Dept. 8-A
North Chicago, Illinois

Enclosed please find \$19.50 (\$20.00 west of the Rockies). Send me the Fansteel Balkite Battery Charger for Radio 6 volt "A" Batteries. If I am not entirely satisfied I will return it and you will refund my money.

Name

Street

City..... State.....

PATENTS

If you have an invention and desire to secure a patent, send for our Free Guide Book, HOW TO GET YOUR PATENT. Tells our Terms, Methods etc. Send model or sketch and description for our opinion of its patentable nature.

RANDOLPH & CO.

Dept. 459 Washington, D. C.

8 TUBE SUPER HETERODYNE

Complete parts and engraved panel for building Radio Receptor 8- \$110 tube Super Heterodyne

FRIEDLANDER-KOPPLE
RADIO SERVICE
149 Church Street New York City

Hammarlund Condensers

Grounded Rotor—Brass Plates
Increase Your Volume and Distance!

WRITE FOR FREE DESCRIPTIVE CIRCULAR AND PRICES

HAMMARLUND MFG. CO., 144 W. 18th St. N. Y. C.



One Charger for All Batteries

Charges 2-volt peanut tube batteries, 6-volt A Batteries, 6- and 12-volt automobile batteries, and 1 to 4 B Batteries. It's the

Valley Type ABC
Battery Charger
VALLEY ELECTRIC CO., St. Louis, Mo.

Get a Handy Binder for your RADIO NEWS. Holds and preserves six issues, each of which can be inserted or removed at will. Price 65c. Experimenter Pub. Co., Inc., Book Dept., 53 Park Place, N. Y.

RADIO READING COURSE

The Radio Book of Knowledge

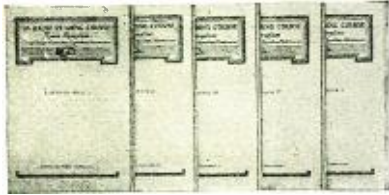

Learn All You Can About Radio
Take This Short Reading Course

All the technical details and a thorough explanation of radio reception, written in easily understood, non-technical language by a foremost radio engineer and inventor. The five Lecture Books with over 100 graphic drawings give you the knowledge to intelligently buy, design, build, operate and maintain radio receiving apparatus. Tells you how to locate and correct troubles, how to make your apparatus more efficient and gives you a thorough knowledge of radio science.

Send No Money

By special arrangement you can own this \$10 Course comprised in the set of five books for only \$1.97—if you act at once. Simply send us your name and address. Upon receipt pay the postman only \$1.97 plus postage and the books are yours. The supply is limited so order at once.

This set of five handsome Lecture Books are a complete radio library. To own them is like having a trained engineer or instructor at your side, answering questions, pointing the way. No matter what your interest in radio, take advantage of this attractive special offer and be the owner of this fine set of books.

Sold By Dealers or They Can Be Ordered Direct From Us

The CONSRAD CO., Inc.
233 Fulton Street, New York City

KEYSTONE RADIO LIGHTNING ARRESTERS



NEW TYPE
\$1.50

Do not delay installing a Keystone Arrester. Most practical type having heavy discharge capacity. Made of genuine Bakelite, absolutely weatherproof, no vacuum to lose, approved by Underwriters.

Mfr's of over a million lightning arresters



ELECTRIC SERVICE SUPPLIES CO.
17th & Cambria Streets, Phila.
50 Church St., NEW YORK
Monadnock Bldg., CHICAGO

on 720 cycles per second. Here it is well to note that the wave form is not the sine wave of the alternator, but looks similar to Fig. 9A, where $T = 1/720$ of a second. The actual amplitude of the slot ripple in a 2,000-volt 24-slot machine is about 45 volts. There

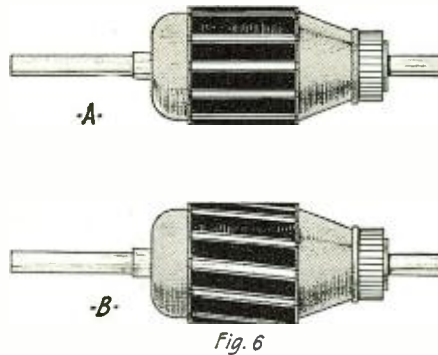

Fig. 6

A twisted armature core weakens the magnetic flux and consequently diminishes the ripple.

are two ways that this condition may be helped and twisting the armature core is one method (see Fig. 6). A is the straight core type, while B has approximately half a slot twist. This half slot twist will cause a weakening of the flux as a slot passes the pole tip, but not an actual interruption. The result will be a wave form similar to Fig. 9B. Another method is to employ an armature with an uneven number of slots. Fig. 4 shows the conditions existing in a machine with an even number of slots, as two opposite teeth are leaving the pole tips and a second pair approaching. If we employ an uneven number of armature slots as in Fig. 5 we have accomplished two things: First, we have reduced the amplitude of our ripple by not having a pair of teeth leave the poles simultaneously; and second, we have doubled the frequency of the slot ripple, thus making it easier to filter. The resultant wave is similar to Fig. 9C.

Multibar commutators are more easily adapted to the present-day design of generators than the multi-slot armature. The result is that the commutator ripple frequency may be several times that of the slot ripple and correspondingly its amplitude much less. An extensively used combination is three coils in series to each slot resulting in the use of a commutator with segments aggregating three times the slots. This may, to all practical purposes be considered as a single coil tapped in three places. (See Fig. 7.) The commutator ripple then shows three distinct cusps during the time required for one slot to undergo commutation. The highest amplitude for the slot must necessarily be that of the highest single cusp. Due to the flux distribution these cusps will not in all probability be of the same amplitude. Fig. 9D shows the comparison of the wave of a single segment per slot (upper line) and a three segment per slot (lower line) machine. Here it is easy to see the frequency of the lower is three times that of the upper. If T represents the slot ripple frequency, then 3T represents the commutator ripple frequency. The highest amplitude



Fig. 7

An armature slot containing three coils connected in series and running to separate commutator segments.

\$25 for \$10

The Famous

THE ACOUSTICAL AMPLIFIER
BEL-CANTO
TRADE MARK

LOUD SPEAKER

You cannot buy the BEL-CANTO through any dealer.

Only direct from us. We save you these three profits —DISTRIBUTOR, JOBBER and DEALER.

PRICE **\$10**
Delivered Free To Your Door.

Adjustable Unit-Fabric Horn

GUARANTEE: WE GUARANTEE TO REFUND YOUR MONEY IN FULL ANY TIME WITHIN TEN DAYS IF DISSATISFIED.

Adjustable Phonograph Loud Speaking Unit, \$3.50. Delivered free.

Sent Free—Radio Logging Chart—Get One.

BEL-CANTO MFG. CO.

Bensel-Bonis Co., Inc. Dept. RN
General Office & Factory 417-419-421 E. 34th St. New York City
Tel. Vanderbilt 8959

TELMACO RADIO GUIDE 10

Describes the Best In Radio

20 Latest Circuits in Blue in New 64 Page Book

These include the Super-Heterodyne, Neutrodyne, Grimes Inverted, Colpitts, Flewelling, Reinartz, Push-Pull Amplifier, Diode Electrad, Super-Regenerative and many others.

Standard Guide for Thousands

The Telmaco catalog has become the standard guide for thousands of radio users in their selection of quality radio. Besides blue prints, it describes and illustrates the best products of America's leading radio manufacturers. Sent postpaid for 10c. Each circuit worth double. Send for your copy today.

Dealers! Dealers' Catalog and Price List FREE to all bonafide dealers making request on their business stationery.

Radio Division
TELEPHONE MAINTENANCE CO.
20 So. Wells St. Dept. B Chicago, Ill.



Quality Radio Exclusively Est. 1918

199 NECESSITIES

WIMCO 199 SOCKET\$.75
WIMCO 199 C SOCKET 1.00
WIMCO 199 ADAPTER75

Send for free literature
Jobbers' inquiries solicited

THE WIRELESS MFG. CO., Canton, O.
MANUFACTURERS—DISTRIBUTORS

of any cusp of the latter never reaches that of the former. The total amount of fluctuation, that is, the summation of the area beneath each curve referring from the lowest potential reached, will show the single seg-

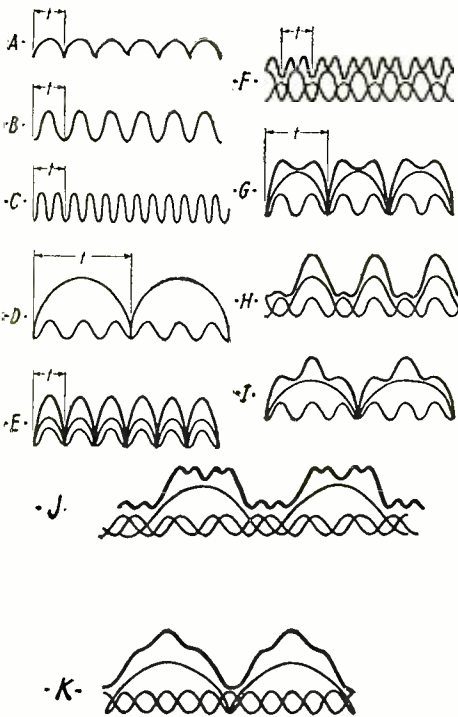

Fig. 9. Characteristic wave forms of ripples produced in generator under various conditions.

ment per commutator to be by far the greatest. Comparison of the two types then shows a higher frequency and a lower amplitude for the three segments per commutator type. Here it is well to note that the higher the frequency of a ripple the easier it is to filter, and the lower its amplitude the less pronounced its interference, but not necessarily the easier to filter. This is shown by the fact that a 2-mfd. condenser across the line will eliminate most of the high pitched whine and whistle, but will not make any noticeable change in the hum.

The wave form of the ripple of the generators now in use is complex, to say the least. We may, however, divide it into its two components—slot and commutator ripple. Likewise, we can build it up. As the first requires an oscillograph, which for most of us the expense makes prohibitive, we will resort to the latter; in Fig. 9, E and F show the two ripples, and their resultant for a single segment per slot combination. E shows the two ripples in phase. Here the resultant has a frequency of T and an amplitude equal to the sum of the peaks of the component waves. This is the highest amplitudes possible. F shows the brushes shifted so that the peak of the commutator ripple is reached $\frac{T}{2}$ seconds later than that of the slot ripple. Now we have twice the frequency and a much less amplitude than in E, both conditions being possible in the same machine simply by shifting the brush ring.

Time and space prohibit very many interesting examples of these combinations. We will, nevertheless, take up a few of the more common. In Fig. 9, G shows the two segments per slot combination "in phase." This is the familiar form of a fundamental and a third harmonic, with the resultant wave rectified—yet the minor wave is but twice the major. Possibly these little wave sketches will help to explain the strong tendency for some stations to radiate harmonics. Shifting the brush ring as in 9-F will not help in this case. A half slot shift results in G again, while a quarter slot twist produces H. Here the major peak has the same



"Type "P" Phusiformer Possibilities"

A Special Booklet

56 pages—filled with successful hook-ups with lists of parts and necessary directions. The more important circuits are covered by step-by-step assembling instructions, photos showing all views, panel and base-board layout—all in clearest detail.

Experimenters and Beginners

The Phusiformer booklet shows you easy construction of circuits, from simple crystal hook-ups to the Pathé "Minute Man" 5-tube Receiving Set, so famous for its wonderful clarity of tone. Using Pathé Type "P" Phusiformers throughout, the experimenter can build various circuits without added expense.

Set Owners —get the booklet and see how adding Pathé Type "P" Phusiformers will give your set greater distance and increased power.

Send the Coupon Today

The Phusiformer booklet will be sent immediately upon receipt of the coupon with remittance of 50 cents.

Ask your dealer for the book

PATHE' PHONOGRAPH AND RADIO CORP.

10 GRAND AVENUE,
BROOKLYN, N. Y.

Pathe Phonograph and Radio Corp.,
10 Grand Avenue, Brooklyn, N. Y.

I enclose 50c (stamps, coin or money order) for one copy of Pathe "Type 'P' Phusiformer Possibilities."

Name

Address

City State.....

A RADIO SENSATION

Patent Applied For

A tuner that works without "B" batteries. Something new. Reliable, Portable, Fool-proof and a hook-up that will revolutionize the art. It positively does not re-radiate and works with loop or aerial. Works loud speaker with one tube on local signals.

Circulars two cents

TRESCO SALES, INC.

DAVENPORT

IOWA

Radio **DIAMOND** Plate

"B" BATTERIES

Hook them Up and Forget Them—Good for Months

DIAMOND ELECTRIC SPECIALTIES CORP.

103 South Orange Avenue, Newark, N.J.

Dealers—Jobbers, Write for Proposition

Get a Handy Binder for your RADIO NEWS. Holds and preserves six issues, each of which can be inserted or removed at will. Price 65c. Experimenter Pub. Co., Inc., Book Dept., 53 Park Place, N. Y.

KESTER SOLDER

Self-Fluxing

for Radio Work

For heavier Radio and general soldering, use Kester Acid-Core Solder—(Underwriters' Laboratories inspected).

For delicate Radio work use Kester Rosin-Core Solder.

For household and general mending, use Kester Metal Mender.

Kester Solder is genuine solder that supplies the necessary flux from tiny pockets within itself as it is consumed. Radio, Electrical, Hardware and Auto Supply dealers can supply you.

"Requires Only Heat"



The Last Word
The Best Word
In Condensers

The
PROUDFOOT

Nothing like them on the market for accurate logging of stations! Group plate adjustment and finer vernier plate tuning are accomplished with one knob. Exact readings show on two distinctly separate scales. Once you find a station, you can always "tune in" in the future.

Losses Cannot Be Measured!

Stator plates are mounted on two rods instead of the customary three—this cuts inefficient capacities and losses to a negligible quantity. The vernier on the Proudfoot One-Knob Condenser turns a full 360°. Three spring wiping contacts insure positive connection. This eliminates the inefficient and easily broken pigtail.

For best results, install a Proudfoot today! 13 plate (M.F.C. .00025)—\$3.75; 25 plate (M.F.C. .0005)—\$1.50; 45 plate (M.F.C. .001)—\$3.75. Accept no substitute if you want real results. If your dealer cannot supply you, write us.

CRUVER MANUFACTURING CO.
2456 W. Jackson Blvd. Chicago, Ill.

THE "LINCOLN"

Enclosed Fixed Adjustable Detector Kills your Reflex Troubles

New List Price **\$1.50**

Manufactured by
The LINCOLN MFG. Co.
Los Angeles, California
Dept. E-1

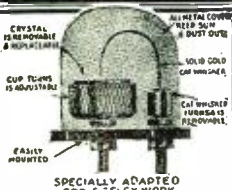

HUDSON-ROSS

Wholesale radio only.
One of the first and still in the lead.
Write for discounts.
123 W. Madison St. Chicago

THOMPSON

NEUTRODYNE and SPEAKER
\$150 \$35

Representing 14 years' experience by an organization devoted to wireless and radio apparatus.
R. E. THOMPSON MANUFACTURING CO.
150 Nassau St., New York
Factory: Jersey City, N. J.

frequency as in G and is in reality G inverted.

To turn to the more common type—three segments per slot. Fig. 9T shows the resultant—again a harmonic form—a fundamental and a fifth harmonic, in phase, rectified—and likewise more phenomenal receptions on harmonics.

The use of multiple commutators presents another interesting study. The slot ripple at both commutators will always be in phase, but its amplitude will depend upon the voltages at the respective commutators. This is because the same core serves both commutators but the windings may vary for each commutator, this accounting for difference in amplitude. The phase relation between the slot ripple and the two commutator ripples with each other, depends upon the brush ring settings. Fig. 9J shows a combination of three segments per slot with all three ripples 1/3 out of phase. Fig. 9K shows a ripple of a machine wound for the same voltage at both ends, with brushes so set that one curve ripple is 1/2 out of phase with the second, which in turn is in phase with the slot ripple. The result is that the two commutator ripples tend to neutralize each other, and the result is a fairly simple wave. This condition is hard to attain, due to mechanical imperfections and the fact that the middle cusp per slot is usually of a slightly higher amplitude than the other two. While the curves look big on paper it should be remembered that they are very small in the machine. The ratio of maximum ripple to effective potential in the machine previously mentioned was 45:2000 while for straight A.C., the ratio is 2:1.

Working Vacuum Tubes without "B" Batteries

(Continued from page 159)

ment, and at a potential of two volts with respect to the end F₃. If the filament of the tube, in both cases, will operate effectively from four volts, the insertion of a rheostat in the positive lead in Fig. 4A will turn that circuit into the exact equivalent of Fig. 4B, and the results will be identical. It matters little, therefore, whether the high-tension battery is included in the filament circuit as well, a rheostat being provided, or whether a portion of it is included outside the circuit.

Fig. 5 shows an actual audio-frequency amplifier circuit which might be said to dispense with the "B" battery. It will be seen that an "A" battery B₁, having a number of cells, is used to supply both the plate voltage and the filament current. In some sets the "A" battery B₁ gives as much as 24 volts, and this sort of circuit has actually been used by large commercial radio companies. It is, however, only a question of degree which separates the Fig. 5 circuit from the circuit of Fig. 4A. A receiver using no "B" battery is really a receiver which uses only a small plate voltage, which is derived from the "A" battery.

Having decided to use the "A" battery as the plate supply, the next problem is to use it in the most effective way. In the case of an ordinary tube, the most effective way is illustrated in Fig. 6. It will be seen that the filament rheostat R is included in the positive

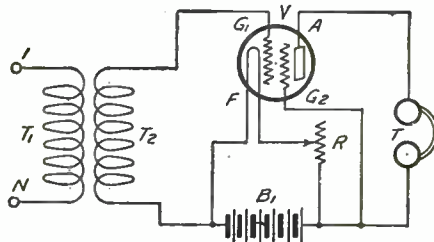

Fig. 7. One way to connect a double grid tube as an amplifier.

"INSULATE"

(Molded Composition)
Registered Trademark

Also
"HI-HEET"
(Bakelite)



200 Styles
Knobs, Caps, Condenser Plates, Binding Posts, Dials, etc.
stocked for quick delivery

GENERAL INSULATE CO.
1025 Atlantic Ave., Brooklyn, N. Y.
Established 1904

TUBES REPAIRED AND EXCHANGED \$2.50

ALL TYPES
CUNNINGHAM R. C. A., ETC.
We will either repair your tube or give you a brand new tube at the same price. Price without old tube, \$2.75. All tubes shipped same day order received.
SATISFACTION GUARANTEED
OR MONEY REFUNDED
RADIO TUBE HOSPITAL
206 BROADWAY DEPARTMENT N NEW YORK
Cor. Fulton St., Room 418

This Complete Radio Receiving Set

Consisting of Radiogem Gemphone and Aerial
\$2.50



(Patented Jan. 8, 1924)

This outfit is absolutely complete. It includes everything you need to hear the Broadcast Programs, market reports, time signals, ship calls or land station messages. Nothing more to buy—no batteries or tubes needed—no upkeep of any kind. The simplest radio outfit made—yet as practical as the most expensive. A crystal receiving set that you can operate and enjoy even though you know absolutely nothing about radio. You receive the RADIOGEM unassembled, together with a clearly written instruction book, which shows you how to quickly and easily construct the set, using only your hands and a scissors. The instruction book explains simply and completely the principles of radio and its graphic illustrations make the assembling of the RADIOGEM real fun.

- Complete Radiogem Outfit.....\$2.50
- The Radiogem, only 1.00
- The Gemphone, only 1.00
- Aerial Outfit, only..... .50

If your dealer cannot supply you order direct from us.
All orders shipped within twenty-four hours.

The Radiogem Corp.
66-R-West Broadway, N. Y. City

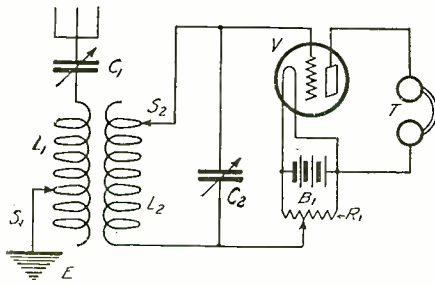

Fig. 6. One way to use an ordinary tube without a "B" battery.

lead. This is a very important point in all circuits using the "A" battery for plate supply. If the tube filament operates at $3\frac{1}{2}$ volts effectively, a rheostat R will obviously be necessary, not only to obtain the best adjustment, but also to cut down the six volts from the battery B₁. The six volts from B₁ are distributed over the filament to the extent of $3\frac{1}{2}$ volts, the left side of the filament being negative, and the right side positive, and the other $2\frac{1}{2}$ volts appear across the used portion of the rheostat R, the slider being negative, and the foot of the rheostat positive. The result is that the two and one-half volts across the rheostat R acts in series with the three and one-half volts across the filament. If the rheostat R were included in the negative lead to the filament, the plate voltage would only be three and one-half volts.

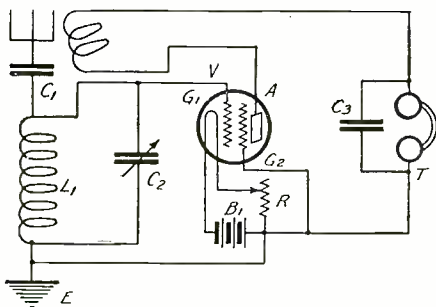

Fig. 8. A simple circuit for double grid tubes. A grid condenser and grid leak may be used.

Coming now to specific arrangements, the most successful for general purposes is probably that which employs a tube using a grid kept at a positive potential for the purpose of lessening the space-charge in the tube.

The new Cowper single tube circuit, using an ordinary tube, is, however, excellent. A double grid tube amplifier may be added to the circuit.

A particular form of tube in which the space-charge is reduced is described in the author's patent 154,364, of September 8, 1918. In this case a grid electrode, connected to the plate so as to form one structure, surrounds the filament, and this arrangement may be used as a rectifier, or an additional grid may be introduced so as to obtain a three-electrode tube effect, at the same time reducing the space-charge in the tube by the

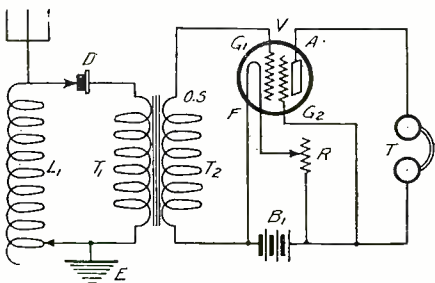

Fig. 9. A crystal receiver with one stage amplifier, and without "B" battery.

"Built up to a high standard. Not down to a low price"

CARTER Jack Switches

The only switch that shows "On and Off"



Two springs; closes one contact, used to close the A battery circuit.
Code No. 2 Jack Switch. Price...\$1.00 ea.



Four springs; closes two contacts; used for cutting in second head set, also for adding a second cell in parallel.
Code No. 4 Jack Switch. Price...\$1.30 ea.



Three springs; opens one and closes one contact, for switching from long to short wave and from one dry A battery to another.
Code No. 3 Jack Switch. Price...\$1.25 ea.



Six springs; opens two and closes two contacts; can be used to switch battery charger and loudspeaker on and off, etc.
Code No. 6 Jack Switch. Price...\$1.60 ea.

No unreliable sliding contacts used—all wire connections soldered.
Furnished complete with "On and Off" Name Plate, Knob and Pointer.

CARTER VERNIER CONTROL RHEOSTAT

Small spiral coil of resistance wire gives VERNIER CONTROL

Smooth-running contact; wide surface.

Clock spring pig-tail insures positive connection. No bearing contacts used.

Disc is Finished in a Special Satin Silver.

Wide spaced solder terminals

Knob with Pointer adjustable to panels of varying thickness.

Heavy phosphor-bronze springs

Mounts in any position. One-hole Mounting

Any Dealer can supply



SALES OFFICES

- | | | | |
|--|--|--|---|
| New York, N. Y.
P. W. Mack,
1270 Broadway | Philadelphia, Pa.
Hartzell Sales Co.,
623 Victory Bldg. | Huntington, W. Va.
Hartzell Sales Co.,
1028 4th Ave. | Pittsburgh, Pa.
Hartzell Sales Co.,
708 Granite Bldg. |
| Detroit, Mich.
F. A. Krue, Jr.,
714 Lafayette Bldg. | Boston, Mass.
G. K. Thompson,
25 Huntington Ave. | Minneapolis, Minn.
A. A. Hume,
217 Kasota Bldg. | |
| San Francisco, Cal.
Atlantic & Pacific Agency
Corp.,
204 Rialto Bldg. | St. Louis, Mo.
R. W. Bennett,
1326 Syndicate Trust Bldg. | | |

Save 1/2 Cost of New Tube

GUARANTEED VACUUM TUBE REPAIRS AT POPULAR PRICES.

- We try to maintain 24-hour service.
- All repairs guaranteed.
- Tubes satisfactory or money refunded.
- Special discounts to dealers.
- Send broken and burned out tubes parcel post.
- Repaired tubes returned parcel post, C. O. D.

HARVARD RADIO LABORATORIES
200 OLD COLONY AVE. SO. BOSTON, MASS.

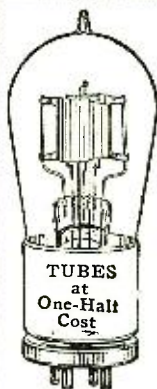

Every Question ANSWERED for only \$1

At last you have under one cover a Complete Radio Handbook



JUST OUT 514 PAGES

Compiled by HARRY F. DART, E.E.

Formerly with the Western Electric Co., and U. S. Army Instructor of Radio. Technically edited by F. H. Doane.

40,000 ALREADY SOLD

NO more need you turn from book to book, hoping to find what you want. It is all here, in 514 pages crammed full of every possible radio detail. Written in plain language, by engineers for laymen. Clears up the mysteries, tells you what you want to know. A complete index puts everything within your reach in a few seconds.

IT EXPLAINS: Electrical terms and circuits, antennas, batteries, generators and motors, electron (vacuum) tubes, every receiving hook-up, radio and audio frequency amplification, broadcast and commercial transmitters and receivers, super-regeneration, codes, license rules. Many other features.

Under one cover. Yes, it is all in one volume of 514 pages of clear type with hundreds of diagrams and illustrations. Takes the place of eleven or more specialized texts, each costing from two to ten times the dollar you pay for this single book. Belongs in every radio-equipped home, on every amateur's table.

Send \$1 to-day and get this 514-page I.C.S. Radio Handbook—the biggest value in radio to-day. Money back if not satisfied.

TEAR OUT HERE

INTERNATIONAL CORRESPONDENCE SCHOOLS
Box 8281-C, Scranton, Penna.

I enclose One Dollar. Please send me—post-paid—the 514-page I. C. S. Radio Handbook. It is understood that if I am not entirely satisfied I may return this book within five days and you will refund my money.

Name.....

Address.....

RADIO TUBE EXCHANGE

We Repair All Standard Makes of Tubes Including

W.D.-11 or 12
U.V.-199 or C.-299
C.-11 or 12
U.V.-201A or C-301-A
D.V.-1 or D.V.-2
U.V.-200 or 201
C.-300 or 301

All tubes guaranteed to do the work.

\$2.50

RADIO TUBE EXCHANGE
200 BROADWAY NEW YORK CITY, N. Y.
All Mail Orders Given Prompt Attention
Orders Sent Parcel Post C. O. D.

SIGNAL ELECTRIC MFG. CO.
Menominee, Mich.

Manufacturers of Radio Apparatus, Receiving and Sending. Dealers send for discounts and catalogs.

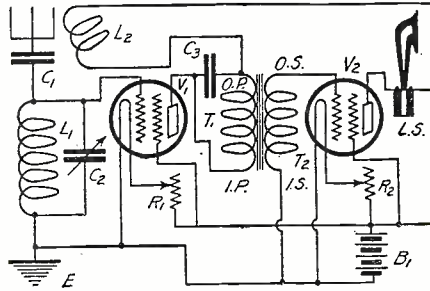

Fig. 10. A regenerative receiver and one stage amplifier in which double grid tubes are used without a "B" battery.

extra grid. A suitable circuit for such a tube is shown in Fig. 7. Long before this, however, a grid electrode at fixed positive potential was used to reduce the space-charge and the most interesting facts in connection with the whole matter are concerned with arrangements in quite common use in France and Holland, which have not attained any popularity in the U. S. for the very simple reason that suitable tubes have not been available. Double-grid tubes have certainly been made, but their price has been prohibitive to the ordinary experimenter. The French and Dutch have a considerable number of circuits using double-grid tubes in which the "B" battery is either altogether missing or consists of two or three dry cells. In some French and Dutch circuits using double grid tubes the inner grid is given a positive potential by a battery B₂, consisting of two or three volts, and the "A" battery B₁. The two batteries may, of course, be connected together and constitute the filament battery, a rheostat being used in the positive lead. The actual tubes have been on sale for a long period for the very purpose we are concerned with.

Fig. 8 shows the arrangement in which the very small "B" battery and "A" battery are joined into one, a six volt "A" battery B₁ being employed, and also a rheostat R in the positive lead.

Most good double grid tubes function very well without "B" batteries or with 2 to 10 volts on the plate.

Fig. 8 shows a circuit which the average experimenter will want to try out with a double-grid tube. The condenser C₁ is a 0.0001 mfd. fixed condenser, for constant aerial tuning, while the inductance L₁ is, say, a 50 turn honeycomb coil shunted by a variable condenser C₂ of 0.0005 mfd. capacity. This will enable any of the broadcast wavelengths to be received, although for wavelengths above about 430 meters the coil L₁ may be of the 75 turn variety. The usual grid condenser and leak is provided, while in the plate circuit is a tickler coil which is a 75 turn honeycomb coil. The telephones are shunted by a condenser C₃ of 0.002 mfd., while the inner grid G₂ is connected to the positive terminal of the six-volt storage battery B₁, the rheostat R is included in the positive lead; particular care should be taken to see that the rheostat is so placed.

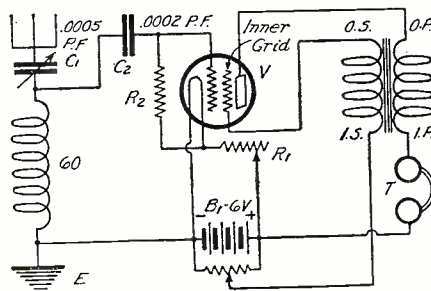

Fig. 11. A reflex circuit of experimental interest.

Build Your Own "HARKNESS"

A TWO-TUBE Radio Outfit that Gives Volume, Distance, Selectivity and Clarity. It is simply designed. Easy to build at a low cost and easy to operate.

CONSRAD PATTERN NO. 13



HOW TO BUILD THE HARKNESS RECEIVER

Complete set of blueprints consisting of two full sized sheets 17x19" and 4-page instruction pamphlet gives complete details for constructing the original 2 tube Harkness Receiver. Furnished in beautiful two-color printed heavy envelope 9x12 inches.

PRICE 50c PREPAID

AT YOUR DEALERS or direct from us.

THE CONSRAD CO., Inc.
233 Fulton Street New York City

Get Them All ANY PLACE ANY WAVE ANY TIME

WITH THE RELIABLE NEUTRALIZING CONDENSER

Reach out into the most remote places, or isolate any nearby stations from several others, and hear what you want with this little condenser. Better neutralizing—longer range finest adjustment possible.

PRICE MOUNTED \$1.00 THE RELIABLE PARTS CO. 2819 Prospect Ave., Cleveland, Ohio

- KDKA KZM
- WLW
- KZM WAK
- WOC WBY KLZ
- WAB WABU
- WCX
- WDAL
- WDAQ WFAF
- KOXY WGAN
- WFAA WGI
- WAB WEAR
- WFC WTAX
- WOR WPG
- WOAY WTAM
- WOAX
- KOYM
- KSS
- KGY
- KFLA



Free Log Book With Each Purchase

FACTORY GUARANTEED MDSE. BY MAIL

Genuine New Radiotron or Cunningham Tubes

UV-199-200-201A-WD-11-12 \$3.98

C299-300-301A-C11-12

Fresh Burgess or Everready "B" Batteries

2 3/4 Volt large size \$1.68—15 Volt \$5.00 size \$3.33

6 or 30 Ohm Rheostats 29c

Standard Sockets 48c

Guaranteed 3000 Ohm Phones 2.40

Djongs or Killark Audio Transformers 1 to 1 2.00

Jensen Star Audio 3 to 1 2.50

All American 3-5 or 10 to 1 3.85

All American Push Pull—Pair 3.88

Eria Audio 3 or 6 to 1 3.00

Eria Reflex No. 1 or No. 2 3.00

Alex Radio Frequency Transformer 2.60

11 Plate Variable Condenser \$1.00 Vernier 2.15

23 Plate Variable Condenser 1.15 Vernier 2.15

43 Plate Variable Condenser 1.30 Vernier 2.45

Storage Battery, 120 Amps, 2 year Guarantee 14.50

Battery Charger—Guaranteed 6.50

Brandes Loud Speaker 7.95

Brandes Superior Phones 4.69

Raldwin Type C Phones 7.45

Steinle Tube Set (1500 mile radius) 10.00

Write For Price List

Stone Electric Co., 714 Pine St., St. Louis, Mo.
All Mdse. F.O.B. St. Louis, Mo. Dept. R

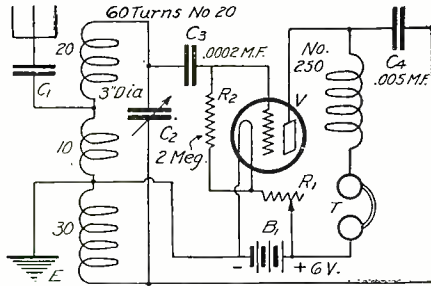

Fig. 12. This circuit using no "B" battery works well with most tubes; designed by Mr. Cowper.

The circuit will give surprising results and will enable audible signals to be obtained on a loud speaker at 10 miles from a broadcast station, although the results will be weak. This will prove true provided the set is used with a good aerial erected in a favorable location. With phones, however, excellent signals are obtainable even on a very short aerial.

Fig. 9 shows the use of a crystal detector and an "A" battery plate supply audio frequency amplifying tube. With this circuit good loud speaker results are obtainable up to about 20 miles from a broadcast station, but results are not equal to those obtained with a set using a "B" battery.

If any difficulty is encountered in any circuit without "B" battery as regards regeneration, try tuning the tickler coil with a .0005 mfd. variable condenser.

We have worked an ST-100 receiver without "B" battery by connecting the rheostats in the positive leads of a six-volt storage battery and, using double-grid tubes connecting the inner grids to the positive terminal of the battery.

It is, in fact, possible to convert any set using ordinary tubes into a receiver without "B" battery by connecting the rheostats in the positive leads using double-grid tubes, and connecting the inner grids to the positive terminal of the filament battery.

It is quite possible, moreover, that the general interest aroused by the present Solodyne discussion may lead to the design of tubes using lower plate voltages. The Dutch and French tubes using double grids seem to work best when an additional six volts is used as "B" battery, although they work perfectly well with the six volts of the filament supply. Any voltage over the extra six volts will not result in an increase in signal strength.

An interesting effect of the discussion will be to draw attention to double-grid tubes and if these will be manufactured at a reasonable cost, a host of new circuits will be available to experimenters. Many circuits have already been published, but owing to the expense of the tubes, few have been tried.

Solodyne Circuit Using Standard Tubes

(Continued from page 157)

RESULTS

As shown, the signals from a One-Kilowatt broadcast station 13 miles away came in at noon on a good aerial at a strength which made the program easily audible in the next room. Only an "A" battery of six volts was used. On the 70-foot single low aerial the reception was also excellent. In each case distortion was conspicuous by its absence. With a four-volt "A" battery alone, and suitable readjustment of the potentiometer and regeneration, the station was audible with the phones hung on the wall, and came up to the same moderate loud speaker

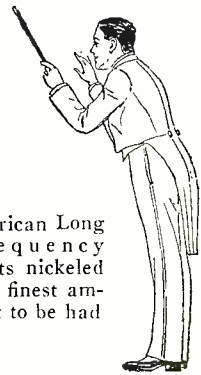
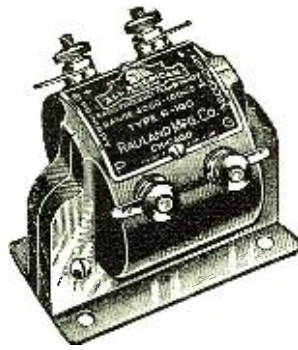

The new All-American Long Wave Radio Frequency Transformer, in its nickeled shield at \$6, is the finest amplifying instrument to be had at any price.

A MASTER INSTRUMENT for the Super-Heterodyne

Designed to perform in all long wave radio frequency circuits as instrumental masterpieces in the hands of artists, each of these new All-Americans actually "plays its part" in perfect harmony with other fine radio instruments that compose the "ensemble." Here are the facts you should know to judge the supremacy of the All-American: (1) Highest amplification, without distortion, of any transformer on the market; for wave lengths 4,000 to 20,000 meters. (2) Quiet in operation; shielded to prevent inter-stage coupling or reaction. (3) Stable; free from any tendency to oscillate. (4) Windings specially designed to eliminate capacity; properly treated to exclude humidity. (5) Every transformer "circuit-tested" for accuracy and precision to insure uniformity and highest efficiency. (6) The best long wave transformer that can be made. Fully guaranteed. All the better dealers recommend the All-American. Built by pioneers in the industry.

SPECIAL OFFER!

Just out! New All-American booklet, "Hook-Ups and Hints" — 32 pages of up-to-the-minute-radio information. Tells you how to hear farther and better. Send 10c. coin or stamps, to

RAULAND MFG. CO., 2646 Coyne St., Chicago



ALL-AMERICAN
AMPLIFYING TRANSFORMERS
Largest Selling Transformers in the World

A type for every circuit

It's Easy To Make Money
with a

JUNIOR BENCH SAW

Hundreds of people will pay liberally for a handsome cabinet to cover their radio. You can make them easily and quickly with the Junior Bench Saw. It does your ripping, mitering, rabbeting, tenoning, sanding, grinding with ease and accuracy. Special blades cut bakelite. Saws 1 1/2" stock. Driven by 1/3 to 1/4 h.p. motor attached to any light socket. Sold On Money Back Guarantee.

Write for descriptive folder.

W. B. & J. E. BOICE

Dept. 808 1730 Norwood Ave., Toledo, O.



Tubes Repaired

Only Middle West Tube Service Station
8 Hour Service. No Extra Charge for Broken Glass.
WD-11, WD-12, C-11, C-12\$3.00 Ea.
UV-201, C-301 3.00 Ea.
UV-201-A, C301-A, UV-199, C-299 3.00 Ea.
UV-200, C-300 2.75 Ea.

We Buy Burnt Out Tubes

All Tubes GUARANTEED and Returned P.P. C.O.D.

DEY'S RADIO SERVICE

Dept. J, 5413 Race Avenue Chicago, Ill.



Have a balloon aerial for peak reception. 'Enlarge' your 'picture' from a good, undistorted 'negative.' Costs only a few cents for each inflation of balloon. Gas comes in tanks or make it. Complete \$5 with three 30-inch pilot balloons, gas fixtures and windlass.
Everett Scanlon, RadioSpecialties, Lakewood, R.I.

BRANCH MANAGERS WANTED
FOR BLUE SEAL GUARANTEED RADIO
If you have \$500 to \$1,000, and have a store or can get suitable space in a store, tell us about it and we will consider appointing you as our representative in your community.
BLUE SEAL MANUFACTURING CO.
1406-8 South Michigan Ave., Chicago, Ill.

EASTERN COUPLER and Inductance

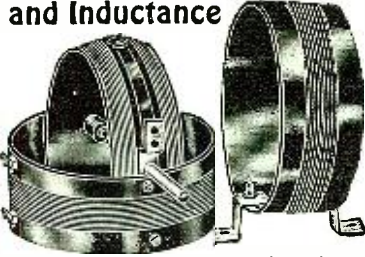

Price
\$6.00
An
Unrivalled
Value

100% Efficient for the SUPERDYNE CIRCUIT

This circuit, which uses only four tubes, is the ONLY RIVAL of the SUPER-HETERODYNE and surpasses all other circuits for all around efficiency.

Radio engineers all endorse the EASTERN COUPLER for maximum results with the Superdyne Circuit.

Wound with double silk wire on genuine bakelite tubing, with moulded rotor.

This circuit is less expensive to construct than most 3 tube sets.

Picture hook-ups and material list FREE with each coupler.

KIT OF COMPLETE PARTS

For 4 Tube Set

With Drilled Panel, Base-Board.
All high-grade parts, **\$35.00**
and picture hook-up.

GENUINE LAVITE RESISTANCES



The ONLY perfect, distortionless resistances, for resistance coupled amplification.

12,000 Ohms
48,000 Ohms
50,000 Ohms
100,000 Ohms

Price **\$1.50 Each**
Special sizes to order.

Mail Orders Filled. Dealers Communicate.

Eastern Coil Corporation

22 Warren St., Dept. R.N. New York, N. Y.

strength with a single flashlight battery as "B" battery supply. Any reasonably good tube appeared to work in this circuit.

Curiously enough, it was noticed that the circuit seemed to oscillate more easily with this audio reflex in action than with the radio choke, etc., substituted by the customary grid-leak to "A" battery plus (or to the potentiometer). Thus C.W. around 500 meters came in clearly with six volts, heterodyned by the oscillating circuit; while in ordinary single-tube reception with the identical equipment only, a noisy station could be heard, i.e., R.F. oscillation was scarcely possible, unless a very small series condenser was used.

It is extremely doubtful whether, except as an interesting experiment, this kind of low-power circuit has any permanent practical value. There is no reserve of power, and the small "B" battery which is available is obtained very extravagantly at the expense of a needlessly large storage "A" battery.

CORRECTION NOTICE

In the article entitled "Radio, a Leading Industry" published in our July issue, we showed several illustrations giving figures on radio. These figures were originally compiled by "ELECTRICAL MERCHANDISING" of this city to which publication we are indebted for the information.

The Solodyne Principle

(Continued from page 156)

After two or three months of simplifying the hook-up and a detailed study of the operation and various arrangements of the apparatus, the circuit illustrated in Fig. 1 was evolved. In its final form the variable elements are reduced to a minimum, there being only a variocoupler, variable condenser and grid leak. It should be understood that this is made possible only by the accurate design of the apparatus employed in the circuit, and any deviation from the constants given will result in indifferent operation. The builder of the set should be particularly careful in his selection of the grid leak, since it is very critical, as is mentioned above, and results will run in direct ratio to its quality or inefficiency. Of course, the whole success of the apparatus is dependent upon the added element in the tube which is of material assistance in decreasing the internal resistance of the tube to the electron flow. This might lead one to believe that the increased sensitivity resulting from such an arrangement would allow the use of a loop aerial for reception from local stations which, as we know, is possible with the ordinary type of regenerative circuit employing "B" battery supply. With this circuit, however, it is imperative that an aerial and a ground be utilized. It will be noted that aside from the hook-up to the extra grid and the step-up transformer that the circuit is a plain single circuit tuner with regeneration. The true action of the step-up transformer is a bit hazy, there having been numerous explanations given as to its probable functioning. Although it is possible to operate a Solodyne set without this step-up transformer, it has been noted that by its use the circuit seems a bit more lively and there is a certain amount of regeneration lag introduced. It is possible that at times the plate of the vacuum tube

Step Inside the Electrical Laboratories with these men

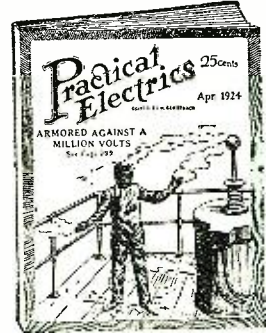

THE Electrical Engineers who spend days and months in the great research laboratories of America discover many marvelous uses for that modern Wizard, "ELECTRICITY."

PRACTICAL ELECTRICS is the only magazine, written for the layman, that brings these wonderful developments of the laboratories direct to you. PRACTICAL ELECTRICS takes you into the laboratories with these men as they develop step by step the new and interesting things in Electricity. Everything in PRACTICAL ELECTRICS is written so that you can understand it easily. It is profusely illustrated with pictures and drawings.

You can obtain PRACTICAL ELECTRICS on all newsstands for 25c the copy. Or fill out the coupon below and mail it to us with \$2.50 and we will have it delivered to your door for twelve months.

Practical Electrics

is Sold on
**ALL
NEWSSTANDS**

25c the
copy

Published by

**Germott Publishing
Company**

INCORPORATED

53 Park Place, New York City

Owners
Licensed Publishers—Experimenter
Publishing Co., also

Publishers of
RADIO NEWS, SCIENCE AND INVENTION and
MOTOR CAMPER AND TOURIST

Let HOMMEL'S experience guide you



This organization was one of the pioneer wholesale distributors of radio equipment. They have seen hundreds of retailers come and go—they know from experience "what and when and how" dealers can best sell radio supplies and enjoy a satisfactory margin of profit.

HOMMEL'S Dealer Service Department is maintained for your benefit,—their experience and advice will prove helpful to you in many ways, and this service is cheerfully given any time without charge.

Get in touch with us today,—write for the new HOMMEL encyclopedia 256S—profit by HOMMEL'S experience—it is paying hundreds of other dealers—why not you?

WHOLESALE EXCLUSIVELY
LUDWIG HOMMEL & CO
929 PENN AVENUE PITTSBURGH, PA.

Don't You Get Tired

of only hearing LOCAL stations on your Crystal Set? There's music on your aerial every night from stations far away. If you want to hear it without buying a tube set, WRITE ME TODAY.

LEON LAMBERT

595 South Volusia Wichita, Kansas

is supplied with a momentary charge of a potential higher than that of the filament supply that tends to further increase the sensitivity of the tube. Such an action would be periodical, taking place at constant cycles somewhat similar to the action of an auto-transformer.

The operation of the extra grid has already been fully covered. The action of the tickler coil is practically the same as in any other circuit. The aerial tuning inductance is of .0005 mfd. capacity. The tuning inductance is a rewound variometer, the primary of which consists of 80 turns of No. 20 D.S.C. wire tapped at the 20th, 40th, and 60th turns. The secondary consists of the same number of the same size wire and is used as the tickler coil. This size tickler coil will no doubt seem too large to the ordinary builder of regenerative sets. However, the number of turns given is absolutely essential to the proper operation of the Solodyne.

In the interest of selectivity, the constructor may wish to form a coupled circuit to eliminate any possibility of high powered local stations interfering with programs received from out of town stations. It is suggested that the untuned primary system be employed in order that the operation of the receiver is not made complicated by the otherwise necessary addition of a third control.

Such an arrangement is shown in the diagram of Fig 3, where the antenna series condenser has been connected across the former aerial tuning inductance, now the secondary coil, and a coil consisting of six turns of No. 20 D.C.C. wire has been wound directly over and in the center of the secondary coil. The two leads from the untuned primary coil connect directly to the aerial and ground, as shown. In this case the former aerial tuning inductance need only consist of 40 turns of wire, the same size, and taps will be unnecessary.

In the set illustrated, a 5 to 1 audio frequency transformer was used in the plate circuit and gave fully as good results as the 10 to 1 ratio transformer in the earlier experiment.

In view of the extreme importance of the grid leak in this circuit it is advisable to use nothing except the carbon pile type, since adjustment must be over a fairly wide range and must be very stable.

The blocking condenser in the main grid lead is the ordinary .00025 mfd. capacity type.

One exceptional advantage of this circuit, which many experimenters will find lies in the factor that since there is no high potential battery, blown out tubes will become things of the past. This advantage cannot be overlooked, since more than 80 per cent. of the receiving tubes put out of commission cease their period of active service through the agency of misplaced "B" battery leads.

Since this circuit is still in an extremely experimental stage of its development, the writers look forward to a large and healthy future for it. Experimenters everywhere will find no little amusement in working with this, the newest principle in the radio field.

The following has been reprinted for the sake of completeness of the English series. It will be noted that the authors refer to the three Honeycomb set which is not the one shown in our photographs for the reason that Honeycomb coil sets are rather obsolete in America today. —Editor.

The receiver, the full constructional details of which we are going to give in this article, is the set which was used at both the expert and Press demonstrations

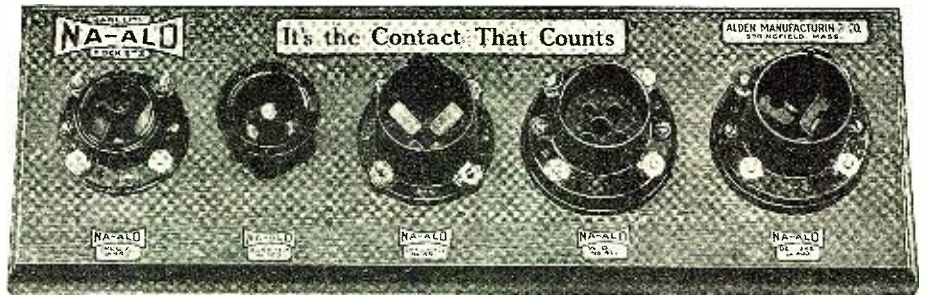

Look for the socket board

In leading radio stores you will find the Na-ald Socket Board, displaying the five standard Na-ald Sockets: For the 200 and 201 tubes, the De Luxe at 75c, and also the Small Space at 35c; for the UV 199, No. 499 at 50c and adapter at 75c; for W. D. 11, No. 411 at 75c.

Ask your dealer to show you the self-cleaning arrangement of contacts in Na-ald De Luxe, No. 400. These dual-pressure contact strips cut into the sides of tube terminals, keeping their surface clean and bright, and resulting in perfect contact.

These sockets have the highest dielectric properties, obtained by the thorough cure of the Bakelite used, and made possible by uniform cross-section.

There can be no noisy circuits due to poor contact with these sockets in use.

New rotograzure booklet "What to Build" now packed with each Na-ald product. If your dealer's stock doesn't have this booklet send cover of Na-ald carton or 15c for it.

Alden Mfg. Co. Dept. K Springfield, Mass.



UNIFORM CROSS SECTION OF THE NA-ALD DE LUXE SOCKET

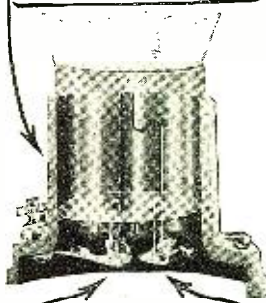

SPECIAL DIPPED BRIGHT PHOSPHOR BRONZE CLIPS. LAMINATED AND EXERTING DUAL-WIPE PRESSURE.

THIS ILLUSTRATION SHOWS HOW THE CONTACT STRIPS CAN BE MADE TO CLEAN TUBE TERMINALS AUTOMATICALLY BY ROTATING TUBE SEVERAL TIMES.

DO YOU KNOW—

That you can change your present Regenerative Receiver into a five tube set that

WILL NOT OSCILLATE, WILL NOT RADIATE, WILL BE SUPER SENSITIVE WILL BE SIMPLE TO OPERATE is INEXPENSIVE TO CONSTRUCT by using

Cosmopolitan Phusiformers



COSMOPOLITAN PHUSIFORMER CONVERSION SET

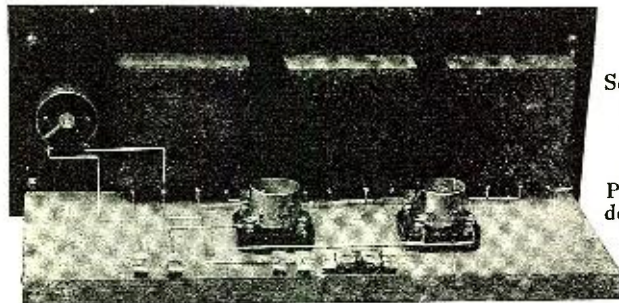

Send 50c for Manual showing Sixteen Circuits, Photographs, descriptions, etc.

Send for Blue Print No. 500, showing details of construction for this Unit

COSMOPOLITAN PHUSIFORMER CORP.

15 West 18th Street

New York City

Western Representatives

SURE SALES CO.
123 W. MADISON ST., CHICAGO, ILL.

Science and Invention

IN PICTURES



**35
Radio
Features**

SPECIAL

\$500 PRIZE CONTEST

Open to Everybody

See the July Issue Now

ON ALL NEWSSTANDS

A Fascinating Magazine with a Non-Technical Radio Section

*Over 35 Selected Radio Articles
Each Month*

The Radio Section of SCIENCE and INVENTION is Written and Edited by the foremost Radio Experts in America. Everything of interest to the Experimenter or Scientific Radio Enthusiast is included in this section.

SCIENCE and INVENTION is the most fascinating magazine ever published. Every article is explained in pictures that are quickly and easily understood. SCIENCE and INVENTION offers each month hundreds of dollars in prizes for special contests that are open to everybody.

You can obtain a copy of SCIENCE and INVENTION on all newsstands for 25c the copy. If you prefer fill out the coupon below and enclose \$2.50 and we will have the postman deliver your copy to you each month for twelve months.

Experimenter Publishing Company, Inc.,
53 Park Place, N. Y. C.

R.N.-8

Enclosed you will find \$2.50 for my subscription to SCIENCE AND INVENTION for one year.

Name

Address

Experimenter Publishing Co., Inc.
53 Park Place, New York City, N. Y.

Publishers of

**SCIENCE and INVENTION, RADIO NEWS,
PRACTICAL ELECTRICS, and MOTOR
CAMPER & TOURIST**

which have been reported in recent issues of *Popular Wireless*. It is similar in many respects to an ordinary single-tube regenerative set, but it is easier to handle, as easy to construct and capable of providing clearer signals. Readers must remember we do not claim that a Solodyne receiver will produce louder signals or cover greater ranges of reception than ordinary sets, but we do claim that results are quite as good in these respects.

RESULTS OBTAINED

Perhaps we might claim with perfect justification that the clearer reception possible with a Solodyne receiver renders weak distant stations more easily audible. Anyway, regarding distant stations, it is interesting to note that with what we shall call the original model in future articles, the set shown in the accompanying photographs, we and others who have handled it privately and at more or less public demonstrations have received 2LO (London) on a loud speaker at a distance of seven miles, all the B.C.C. (British Broadcast Co.) stations, Radiola (Paris), Brussels, and WGY New York (3,000 miles) on telephone receivers. This on one tube it will be admitted is a performance equalling even that expected but not often possible with the most efficient one tube set employing a "B" battery. However the above is not the guaranteed range of the one tube Solodyne and we do not anticipate that it will be repeated by every reader who builds it; the range of reception of the one tube Solodyne is equal to that of a standard one tube regenerative receiver.

Figure 1 is the theoretical diagram, and we will not waste time by repeating the theory of the operation of the circuit; as this was covered above.

SIMPLE TO CONSTRUCT

The cost of the material and components necessary should be comparatively small; the 2 grid vacuum tubes are not critical and no difficulties will be met with in making the circuit function. As a matter of fact, constructors will find it is even easier to get this set working than an ordinary single tube set.

The tuning elements detailed will be suitable for broadcast reception; any value of plug-in honeycomb coils can be used if desired, as the circuit can be employed as efficiently for long wave-length reception as for shorter wave-length stations. The components that we advise constructors to purchase, although more energetic amateurs can construct them themselves if they desire, are: .0005 mfd. variable condenser, one two way coil holder, a .0002 mfd. grid condenser a variable grid leak—this is almost essential—a 10 to 1 ratio audio frequency transformer, a filament rheostat, and of course, a four electrode tube, several suitable types of which are being or will be advertised in the advertising columns of *RADIO NEWS*.

MOUNTING THE COMPONENTS

Mounting the instruments requires care when one is working on a small panel, and it should be ascertained that the right sizes are purchased. A .0005 mfd. variable condenser was used in the original model. The filament resistance should preferably be wire-wound, and of fairly high total resistance. The grid condenser must be .0002 mfd. while, as mentioned previously, it is essential if it is desired to get the most out of the receiver to employ a variable grid leak. This latter curiously enough will be found most useful for controlling oscillation, and really excellent long-distance reception can be accomplished when the "knack" concerning its adjustment has been learned. Should it be desired to reduce the variable controls to a minimum, it will be found that results equal to an ordinary one tube set is obtained when a two megohm fixed grid leak is used.

With respect to the honeycomb coil holder,

A Beautiful Set and a good one



Michigan Four

In the New Michigan four the old and the new meet. All the art of the world's oldest and best cabinet makers have been built into this set. Walnut—with two tone inlaid panel drop front—artistic metal parts all combine to make this the most beautiful set in America. The receiver is Non-Radiating—has a built-in loud speaker adjustable to regulate volume. Its tone quality is unequalled.

Ample space is provided for dry batteries. (Wet battery tubes can be used if desired.) Also B Batteries.

There are fewer controls, making for ease of operation, maximum selectivity and perfect logging of stations.

MRC guarantee, immediate shipment. Price, \$150.00.



MICHIGAN RADIO CORPORATION

33 Ottawa Street,

Grand Rapids, Michigan

10 cents will bring one can of ALLEN SPECIAL RADIO SODERING PASTE if you mention this advertisement. A limited number of booklets on "How to Soder Radio Sets" will be given free to early replies.

L. B. ALLEN, Inc.
4564 N. Lincoln St.
CHICAGO, ILLINOIS

RADIO TUBES REPAIRED

Like new \$2.50 and guaranteed. ALL TYPES.

Mail in your burnt-out or broken tubes. Satisfaction guaranteed. Prompt service on mail orders. OHIO RADIO SALES, Distributors 723 ROSE BLDG. CLEVELAND, OHIO. Dealers: Write for our proposition.

BELL DIALS and SOCKETS

Handsome molded Bakelite. The neatest and most efficient for your set. Bell Sockets give the unique double wipe contact, unlike any other. Write us for prices and details.

BELL MANUFACTURING CO.
11 Elkins St. Boston 27, Mass.

INSIDE-AERIAL

11 FEET LONG
Separator Insulator Turnbuckle

Substitute for Outside Antenna
130 Feet Stranded Copper Wire

NOT A LOOP BUT A FULL SIZE ANTENNA.

Often doubles tone getting for stations in series with outside antenna

12 INCHES DIAMETER
Separator Insulator

Suspend near ceiling

COMPLETE \$7 POSTPAID

No DANGER from LIGHTNING
Or \$5, if four set owner's addresses are sent to us.
(Certificate of Merit Radio News Laboratories)
INTER-STATE SIGNAL CO., DEPT. 3, COLUMBUS, O.

Insure your copy reaching you each month. Subscribe to *Radio News*—\$2.50 a year. Experimenter Publishing Co., 53 Park Place, N. Y. C.

WorkRite Radio-King, a five tube (2 radio amplifier, 1 detector and 2 audio amplifier) super neutrodyne receiver. Beautiful mahogany cabinet, 22 in. x 20 in. x 14 in. This set operates with outdoor or indoor aerial and is highly selective. Long distance stations come in full and clear on the built-in loud speaker. Complete except tubes, batteries and aerial wire - - \$220.

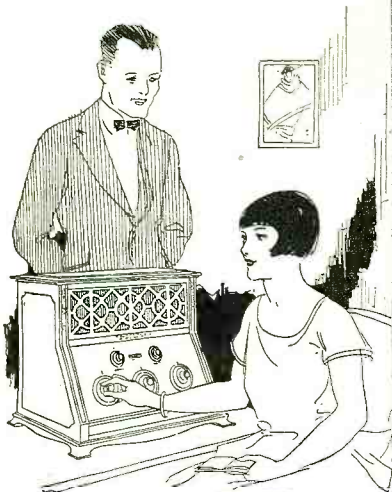

Now You May Choose Your Set With Certainty of Satisfaction

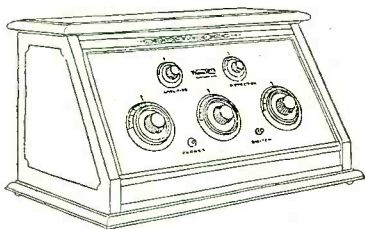

WorkRite Air-Master, same as Radio-King except without built-in loud speaker. Mahogany cabinet 21 in. x 14 in. x 14 in. Without batteries and loud speaker, tubes or aerial, \$160.

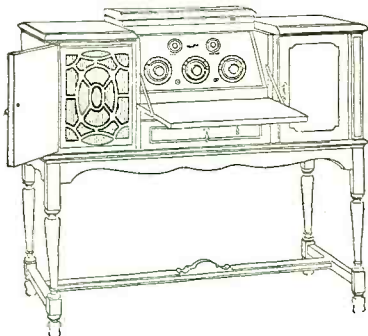

WorkRite Aristocrat, a most beautiful mahogany console model 42 in. x 40 in. x 20 in. This set employs the same super-neutrodyne receiving apparatus. The cabinet contains a built-in loud speaker and space for A and B batteries. Not only a wonderful receiving set but also a charming piece of furniture. Complete except tubes, batteries and aerial - - \$350.

THESE new WorkRite super neutrodyne receiving sets bring an assurance of lasting satisfaction in every phase of radio performance.

Combining ease of operation and remarkable selectivity these sets receive clear across the continent with full volume on the loud speaker. Even over extremely long distances music is heard with striking clearness and freedom from distortion.

And, because these receivers are neither experimental sets or playthings, they have been built into beautiful cabinets of genuine mahogany. You will be as proud of the appearance of a WorkRite set as you are of its performance.

See these sets at your dealer, or write for the new illustrated literature

Licensed under Hazeltine Patent Nos. 1,450,080-1,489,228

The WorkRite Manufacturing Co., 1800 E. 30th St., Cleveland, O.

BRANCHES:

New York City, 1023 Knickerbocker Bldg. Chicago, 536 Lake Shore Dr. Los Angeles, 239 So. Los Angeles St.

WORKRITE SUPER NEUTRODYNE RADIO SETS

this can be purchased complete with base, and the base itself mounted on the panel. Wiring up is quite a simple matter, 18 gauge tinned copper wire or bus bar wire is to be recommended for this purpose.

The circuit does not depend upon such critical factors that constructors are obliged to adhere to instructions absolutely and without the slightest divergence. Treat the circuit much as one would treat an ordinary single tube regenerative circuit, and one cannot go wrong, whether a panel 12 in. by 12 in. be employed, or the receiver condensed into a chalk box. Naturally, the elementary rules in respect of careful connections—soldering, if possible, etc., must be followed just as much as they must be followed when one is constructing a crystal set.

NORMAL REGENERATION OBTAINED

Honeycomb coils are recommended for short wave broadcast reception, but here again amateurs can follow the dictates of their own fancy. There is one point, however, in which the set will differ from an ordinary one tube set in respect of tuning, and that is that a larger tickler coil may be required to make the circuit oscillate. For broadcast reception, the variable condenser being in parallel, a 35, 40 or 50 turn coil will be necessary while at least 75 to 100 turns will be required in the case of the tickler coil. This might even have to be increased to 125 turns.

Tuning is carried out in just the same way as with an ordinary one tube receiver. At first the absolute quietness of the circuit when no signals are being received and the quiet way in which extraordinarily efficient regeneration is obtained will prove disconcerting, and the constructor will be apt to think that something is wrong, but when signals do commence to come in then he will ask himself why, until then, he never noticed the amount of distortion and extraneous noises present in ordinary receivers.

Finally, we would also like to emphasize the importance of taking the grid leak direct to the filament battery; this is a vital point, and is one of those little things that has caused failure to others who have endeavored to eliminate the B battery.

(Next month we will deal with a Solodyne audio frequency amplifier.)

New Radio Patents

(Continued from page 200)

C. W. RECEIVER WITHOUT HETERODYNE
(Patent No. 1,489,158, W. Schaffer. Filed Aug. 18, 1922, issued April 1, 1924. Assigned to Gesellschaft Fur Drahtlose Telegraphie m. b. h.)

ARRANGEMENT FOR THE AUDIBLE RECEIVING OF UNDAMPED OSCILLATIONS wherein the received energy is used for producing and controlling energy of a different frequency from the received frequency. The frequency thus produced may, therefore, be kept so low that it is audible in a telephone so as to make possible the direct hearing of inaudible incoming high frequency. An audio frequency generator is provided at the receiving station consisting of an electron tube having a grid for controlling the oscillations in the generator circuit. The receiving circuit is connected to the grid. The detector of the receiving circuit causes a direct current potential to be impressed on the grid in proportion to the received energy to thereby control the effect of the low frequency generator upon a signal indicator.

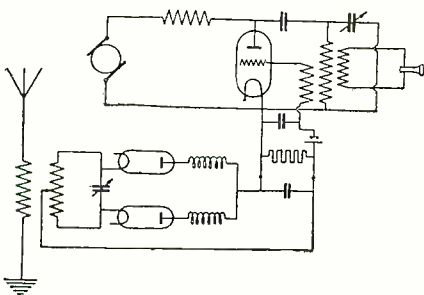

“What a whale of a difference just a few cents make!”



— all the difference

between just an ordinary cigarette and—**FATIMA**, the most skillful blend in cigarette history.

RADIO! RADIO!

20 Complete Lessons in One Book

the Practice, Theory, Fundamentals and Principals of Radio explained and simplified

PRICE \$2.00

The Standard Radio Text Book

By S. GERNSBACK, A. LESCARBOURA and H. W. SECOR

Size 6 x 9 inches. 264 pages. 500 Illustrations. Binding de Luxe. Semi-flexible Leatherette Cover. Genuine Gold Stamped, Round Covers, Red Edges.

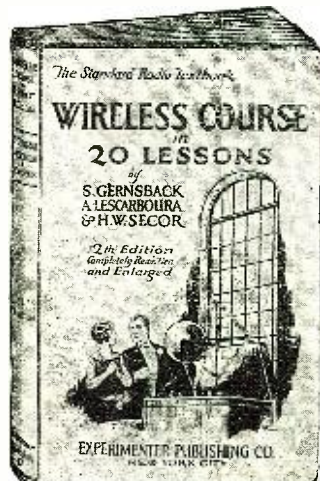

Experimenter Publishing Co.

53 Park Place

New York, N. Y.

The Practicable Portable Receiver

For Camp, Travel, Home or Country



PRICE
50c
POSTPAID

A set that is designed to get the utmost in good reception and distance within the weight limitations and compact requirements. Standard parts are used throughout and every possible effort is made to secure efficient compactness. Operates on dry batteries alone, using one tube with a crystal detector arranged in such a way that the set in operation is virtually a three stage receiving circuit.

CONSRAD Pattern No. 12 tells you how to build this outfit in your home. This pattern contains three full sized blueprints, each 16 1/2 x 18 inches, wiring diagrams, 4-page instruction sheet, and everything necessary for the man who wants to build his own Portable Receiving Set. The whole contained in heavy, two color printed envelope.

THE CONSRAD COMPANY, Inc.
233 Fulton Street, New York City

Build Your Set the AMPLEX Kit Way

Save ¹/₃ Every part in every Kit has been selected, tested and guaranteed by our engineers as the most efficient for that particular circuit. Drilled Panel, Blue Print and Complete Instructions with every Kit. No technical skill or knowledge required. Complete in every detail.

	List Price	Kit Price
Cockaday Improved 5 tube	\$70.85	\$56.50
Neutrodyne (with Genuine Fada Kit)	59.70	39.75
Superdyne (4 tube)	45.00	33.75
Tobias (Described in Popular Radio 30' Indoor Aerial brings in DX)	1 tube 27.00	19.75
	3 tube 45.50	33.50
Superheterodyne (8 tube)	125.00	95.00
Journal Famous One Knob	15.00	4.95

FREE booklet with hook-ups showing how to double the efficiency of your set.
Amplex Instrument Laboratories
57 Dey Street Dept. 8K New York City

RADIO MAP FREE

Big Broadcasting Station List. Also Radio Bargain List. Just Out. America's Largest Radio Dealers Dept. RN-8 55 Vesey St. New York

Insure your copy reaching you each month. Subscribe to Radio News, \$2.50 a year. Experimenter Publishing Co., 53 Park Place, New York City.

SINGLE WAVE HIGH POWER TRANSMISSION

(Patent No. 1,490,198, O. A. Brackett. Filed Jan. 24, 1921, issued April 19, 1924. Assigned to Westinghouse Electric and Mfg. Co.)
SYSTEM OF CONTROL for radio signal transmission where a non-radiating absorbing circuit is provided for the signaling energy between the signal characters. A magnetic core is provided which interlinks inductances connected in the antenna and absorbing circuits. The magnetic characteristics of the core are then changed for producing signals whereby said radiating and absorbing circuits may be selectively rendered effective or non-effective.

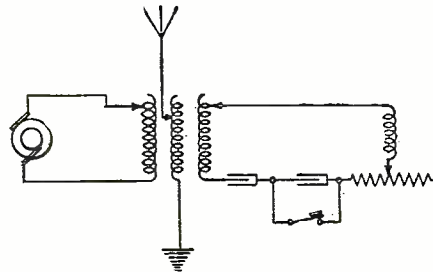

ELECTRON TUBE CIRCUIT

(Patent No. 1,489,228, L. A. Hazeltine. Filed Dec. 28, 1920, issued April 1, 1924. Assigned to Hazeltine Corporation of N. J.)
METHOD AND MEANS FOR NEUTRALIZING CAPACITY COUPLING IN AUDION comprising a coil connected between the grid and filament electrode and an auxiliary coil and neutralizing capacity connected in series between the plate electrode and the filament. The auxiliary coil is coupled electromagnetically with the first coil with a coefficient of coupling substantially equal to unity and having a ratio of turns thereto equal to the ratio of the coupling capacity to the neutralizing capacity.

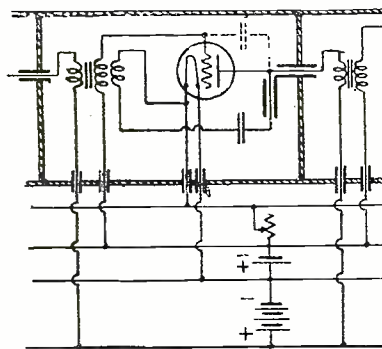

RADIO RECEIVING CIRCUIT

(Patent No. 1,491,543, A. Meissner. Filed May 3, 1922, issued April 22, 1924.)

METHOD OF AND APPARATUS FOR ELIMINATING DISTURBING EFFECTS by employing two receiving systems each tuned to substantially the same frequency with circuits for modulating the signaling energies of the received effects at different frequencies adapted to produce beats at different frequencies with the signal frequency. A circuit is provided for opposing the differentiated received effects and detecting the resultant of the combined effects.

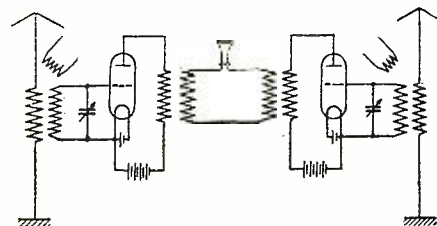

SELECTIVE RECEIVING CIRCUIT

(Patent No. 1,491,372, E. W. F. Alexanderson. Filed Oct. 28, 1921, issued April 22, 1924. Assigned to General Electric Company.)

RADIO RECEIVING SYSTEM having a high degree of selectivity. The receiver includes a detector and two circuits associated with said detector upon which received signaling current may be impressed. A circuit is connected to one of these circuits for integrating the phase of the signaling current flowing therein. An indicator is associated with one of said circuits and separate means associated with the other circuits for causing said indicator to respond only to currents which are in phase with the signaling current. The receiver will then respond only to currents which are in phase with the signaling currents.

Perfect Panels

—for any set, big or little

Supreme for super-heterodyne or single circuit! No other material known possesses the many combined advantages of Bakelite-Dilecto for radio paneling! You can now tell it is genuine by its center *red stripe*.

Once the installation is completed, Bakelite-Dilecto panels remain absolutely unchanged, no matter what abuse is given by heat, cold, water, steam, oil, solvents and weather elements. They do not warp, swell, shrink, crack, check or split. Highest in dielectric strength. Surpassingly tough, yet readily machined. Your dealer can get Bakelite-Dilecto cut and drilled to fit your needs. Look for the *red stripe*!

The Continental Fibre Company

Factory: Newark, Delaware

Service on Bakelite-Dilecto (also Continental-Bakelite Comite, Contex and Vulcanized Fibre) from:

NEW YORK, Woolworth Bldg.
PITTSBURGH, 301 Fifth Ave.
LOS ANGELES, 307 S. Hill St.
CHICAGO, Wrigley Bldg.
SAN FRANCISCO, 75 Fremont St.
SEATTLE, 1041 Sixth Ave., So.

Offices and Agents Throughout the World

Bakelite Dilecto

(A Laminated Phenolic Condensation Material)

Spintite

For Round or Hex Nuts

It's great fun to build a radio set with Stevens Spintite Wrenches. They spin up the tough little nuts in a jiffy—tight as if soldered.

Set of 3 Round Spintites \$1
Set of 3 Hex Spintites \$1

Write for Radio Tools Booklet No. 24
STEVENS & CO.
Toolsmiths since 1899
375 Broadway New York

SEGAL'S

719 Central Ave. CINCINNATI, OHIO

Send for our free catalog chock full of radio bargains.

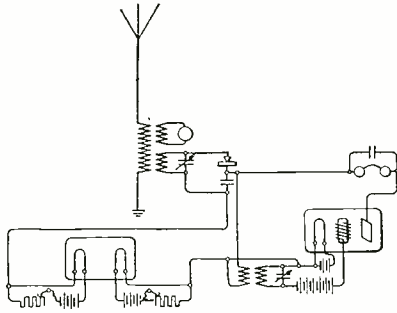

KEYING CIRCUIT FOR RADIO TRANSMITTER

(Patent No. 1,491,450, W. C. White. Filed Feb. 4, 1920, issued April 22, 1924. Assigned to General Electric Company.)

HIGH-FREQUENCY SIGNALING SYSTEM consisting of an electron tube transmitter wherein signals are produced by a keying circuit connected in the grid of the electron tube. The keying circuit operates to charge the grid to a value sufficiently negative by an accumulation of electrons from the cathode to prevent the production of oscillations so that signaling characters may be produced.

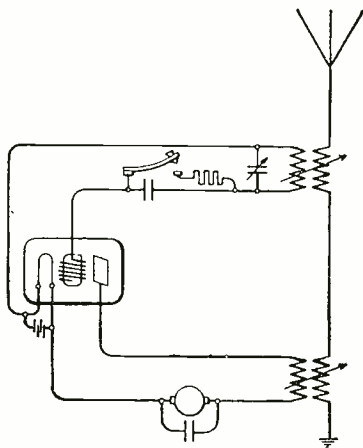

RECEIVING ANTENNA

(Patent No. 1,487,339, E. W. Kellogg. Filed Jan. 20, 1921, issued March 18, 1924. Assigned to General Electric Company.)

RADIO SIGNALING SYSTEM having an antenna for receiving signals from a desired direction to the substantial exclusion of signals coming from other directions. A long horizontal receiving antenna is employed and the received energy conveyed along a transmission line to a distant receiving station located along the length of the antenna, from a point in the antenna where the signaling currents received are strongest.

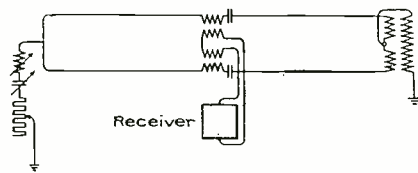

SELECTIVE MULTIPLEX RADIO SYSTEM

(Patent No. 1,491,774, J. H. Hammond, Jr. Filed May 13, 1912, issued April 22, 1924.)

MULTIPLEX RADIO TELEPHONY AND TELEGRAPHY where selectivity is secured by employing distinctive wave-lengths and wave-group frequencies of periodic amplitude variations. A still higher degree of selectivity is obtained by using a combination of high-frequency waves and

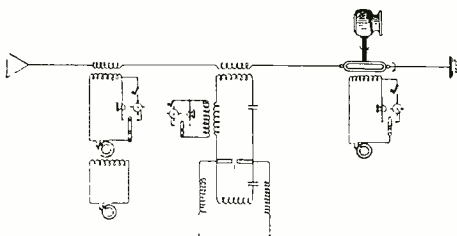

at least one series of wave groups or periodic amplitude variations for the transmission of telephone conversations, and a combination of high-frequency waves and at least two series of wave groups or periodic amplitude variations for the transmission of telegraph signals.



Bristol Single Control Radio Receiver

Complicated combinations are eliminated when tuning in with Bristol Single Control Radio Receiver—every station is on the one dial. It gives the joys of radio with technicalities left out.

The well known Grimes Inverse Duplex System (non reradiating) is utilized in this Receiving Set. Because of the reflex, only four tubes are required to give power equivalent to six. The price, without accessories, \$190.00.

Audiophone Loud Speaker

You forget the radio equipment when listening thru the Audiophone Loud Speaker. The tone is full, clear and pleasing. It gives a true reproduction of the original. Made in three models—Senior \$30.00, Junior \$22.50, and Baby \$12.50.

Ask for Bulletins Nos. 3014 and 3015-S

Made and Sold by
THE BRISTOL COMPANY
Waterbury, Conn.

Keeps Radio Batteries Charged!

It's important to keep radio batteries charged when you're away for the summer. APCO Battery Charger does this over-night—without disconnecting set—and for less than a dime per battery. It's noiseless, clean and as easy to hook up as your electric flat iron. There's an APCO Charger for 'A' and 'B' batteries. Write for interesting circular and nearest dealer's name.

APCO MFG. CO.
Chapman St., Providence, R. I.

Ackerman

ADJUSTABLE LOUD SPEAKER UNITS

\$5.00

COMPLETE WITH 5 FOOT CORD

ACKERMAN BROTHERS COMPANY, Inc.
301 West 4th Street, Dept. RN-8 New York

Pioneer Radio Corporation
101 Pioneer Avenue, Galesburg, Illinois
Moulded Bakelite Parts

OPPORTUNITY AD-LETS

Follow these advertisements every month. Reliable advertisers from all over the country offer their most attractive specials in these columns.

Classified advertising rate eighteen cents a word for each insertion. Ten per cent discount for 6 issues, 20 per cent discount for 12 issues. Name and address must be included at the above rate. Cash should accompany all classified advertisements unless placed by an accredited advertising agency. No advertisement for less than 10 words accepted.

Objectionable or misleading advertisements not accepted. Advertisements for the October issue must not reach us later than Aug. 1st.

CIRCULATION LARGER THAN THAT OF ANY OTHER RADIO PUBLICATION

EXPERIMENTER PUBLISHING CO., INC., 53 Park Place, New York, N. Y.

Agents Wanted

Agents Wanted in every city and town to sell standard radio apparatus. Attractive discounts given. If interested write us at once stating age and radio experience. Wilmington Electrical Specialty Co., Inc., 405 Delaware Ave., Wilmington, Delaware.

General Agents—Service Men! Genuine Gold Letters for store windows easily applied. 20 per cent cash commission on all orders from local agents appointed by us anywhere. 50 per cent discount on your own orders. Free samples. Metallic Letter Co., 422 N. Clark St., Chicago.

Sell, Big-Ben Radio Crystal Receiver Sets, guaranteed sample and working outfit to agents (\$1.00) prepaid. Southern Sales Co., Box 217H, Washington, D. C.

Agents—Write for Free Samples. Sell Madison "Better-Made" Shirts for large Manufacturer direct to wearer. No capital or experience required. Many earn \$100 weekly and bonus. Madison Mills, 581 Broadway, New York.

Agents wanted in every city and town to sell complete line of Radio Cabinets. Burt Bros., Inc., 2000 S. Ninth St., Phila., Pa.

Agents Wanted Full or Part Time to Sell on liberal commission new Thermostatic Automatic Carburetor control Attachment for Ford cars. Increases mileage 100%. No holes to drill. Attached in 2 minutes. Does automatically exactly what Ford Manual instructs driver do by hand. Cadillac now using Thermostatic Carburetor Control under Blawie license. Write at once. A. C. Blawie & Co., Dept. 91-A, 602 W. Lake St., Chicago.

Big Money and fast sales. Every owner buys gold initials for his auto. You charge \$1.50; make \$1.35. Ten orders daily easy. Write for particulars and free samples. American Monogram Co., Dept. 133, East Orange, N. J.

We want Salesmen and Agents, either whole or side line, to sell our low priced radio books to the trade. Excellent proposition for live wires. The E. I. Company, Publishers, 233 Fulton St., New York City.

Big Money and Fast Sales. Every owner buys gold initials for his auto. You charge \$1.50, make \$1.44. 10 orders daily easy. Samples and information free. World Monogram Co., Dept. 27, Newark, N. J.

Business Opportunities

Make \$100 Weekly in Spare Time. Sell what the public wants—long distance radio receiving sets. Two sales weekly pays \$100 profit. No big investment, no canvassing. Sharpe of Colorado made \$955 in one month. Representatives wanted at once. This plan is sweeping the country—write today before your county is gone. Ozarka, 813 Washington Blvd., Chicago.

Chemistry

Learn Chemistry at Home—Dr. T. O'Connor Sloane, noted educator and scientific authority, will teach you. Our home study correspondence course fits you to take a position as chemist. See our ad on page 247 of this issue. Chemical Institute of New York, 66 West Broadway, New York City.

Experimenters—try MAGTO the universal experimental metal. Its powdered, highly magnetic variable temperature resistance, transformers core metal, and other uses. Five pounds for one dollar, postpaid. American Chemical Co., Dept. 3, East Youngstown, Ohio.

Exchange

Sale. Detector two stage amplifier panel \$15. Conn. cornet with case \$25. Violet Ray machine without attachment \$15. Wm. Grus, Box 115, La Mesa, Calif.

For Sale—3 Bristol power amplifiers at \$12 each. Lawrence Dana, Kane, Pa.

For Advertisers

24 Words—353 Rural Weeklies \$14.20. Adneyer, 4112-R Hartford, St. Louis.

For Inventors

Inventors' Educator: 900 Mechanical Movements. 50 Perpetual Motions. How to procure and sell patents. Mechanical movements greatly assist inventors, suggest new ideas. Explains how to select an attorney and avoid Patent Sharks. Price \$1.50. Postage free. Albert E. Dieterich, 690 Ouray Building, Washington, D. C.

Health

Free—Stop using tobacco. We will give free information how to conquer habit easily and permanently. Results guaranteed. Anti-Tobacco League, Box M, Omaha, Neb.

Help Wanted

We Want Salesmen and Agents, either whole or side line, to sell our low priced radio books to the trade. Excellent proposition for live wires. The E. I. Company, Publishers, 233 Fulton St., New York City.

Earn \$25 Weekly, spare time, writing for newspapers, magazines. Experience unnecessary; details free. Press Syndicate, 973, St. Louis, Mo.

All Men, Women, Boys, Girls, 17 to 65 willing to accept Government Positions \$117-\$250 traveling or stationary; Write Mr. Ozment, 251, St. Louis, Mo., immediately.

Detectives Needed Everywhere. Travel. Experience unnecessary. Write George Wagner, former Government Detective, 1968 Broadway, N. Y.

Information

Guaranteed information, any subject, strictly confidential. \$1.00. Doris Chemical Laboratories, East Cleveland, Box 594, Cleveland, Ohio.

Instruction

Learn Chemistry at Home—Dr. T. O'Connor Sloane, noted educator and scientific authority, will teach you. Our home study correspondence course fits you to take a position as chemist. See our ad on page 247 of this issue. Chemical Institute of New York, 66 West Broadway, New York City.

Used Correspondence Courses bought and sold. Bargain catalogue 1,000 courses free. Students' Exchange, Dept. 5, 47 West 42 St., New York.

Motorcycles, Bicycles

Don't Buy a Bicycle Motor Attachment until you get our catalog and prices. Shaw Mfg. Co., Dept. 6, Galeburg, Kansas.

News Correspondents

Earn \$25 Weekly Spare Time writing for newspapers, magazines. Experience unnecessary; details free. Press Syndicate, 972 St. Louis, Mo.

Patent Attorneys

Patents. Send drawing or model for examination and report as to patentability. Advice and booklet free. Highest references. Best results. Promptness assured. Watson E. Coleman, Patent Lawyer, 644 G Street, Washington, D. C.

Lacey Patent-Sense. See page 262.

Patents—Send for form "Evidence of Conception" to be signed and witnessed. Form, fee schedule, information free. Lancaster and Allwine, 269 Ouray Bldg., Washington, D. C.

Inventors—Should write for our Free Guide Books and "Record of Invention Blank" before disclosing inventions. Send model or sketch of your invention for our Free Examination and Instructions. Radio, Electrical, Chemical, Mechanical and Trademark experts. Terms reasonable. Victor J. Evans & Co., 922 Ninth, Washington, D. C.

Patents—My fees in installments. Advice book free. Frank Fuller, Washington, D. C.

Personal

Lonely Hearts—Exchange letters, make interesting new friends in our jolly club. Eva Moore, Box 908, Jacksonville, Fla. Enclose stamp.

Lonely—Join our club—make acquaintances everywhere. Big illustrated book with descriptions and photos, sent in plain wrapper for ten cents. Bonafide Co., Dept. 58, Kansas City, Mo.

Exchange cheery letters with new friends. Write Betty Lee, Inc., Box 820 City Hall Station, New York City. Stamp appreciated.

Photo Finishing

Films Developed 5¢—Prints 3¢ each. The new Davo finish. Davis Photo Shop, Dept. R, Cincinnati, Ohio.

Radio

Boys! Don't Overlook This. The "Rasco" Baby Detector. Greatest detector ever brought out with molded base. Fully adjustable. See former advertisements in this publication, or our catalog. Detector with Galena Crystal, complete 50¢, the same detector with Radiocite Crystal, 75¢ prepaid. Send for yours today. Radio Specialty Company, 96-98 Park Place, New York City.

Attention!—50 Vacuum tube hook-ups. The greatest collection of vacuum tube circuits ever brought under two covers at such insignificant cost. These diagrams will be found in the great "Rasco" catalog, which contains raw materials and parts in a greater profusion than any other catalog. 15¢ in stamps, or coin, will bring the catalog to you. Radio Specialty Co., 96-98 Park Place, New York City.

Build Your Own. The best hook-up I ever tried. Yours for a dollar. Any complaint your money back. E. F. Walts, Corinth, Miss.

Panel Tool for cutting deep or meter holes in radio panels. Cuts smooth hole one to five inches in diameter, with little effort. Only \$2.50 postpaid. Homer Malcomb, Whitewater, Wis.

If your Neutrodyne won't "Neut" o.k., send 10¢ for details of Kladax Coast to Coast circuit, bill of materials, etc., to change over your Neut into a set that will bring them all in from Mexico City to Tunuca, Cuba, on a loud speaker. Or send \$5.00 for all extra parts, blue print, etc., you need to do this. Stamps accepted. Radio list for stamp. Super Heterodyne specifications, 10¢. Kladax Radio Laboratories, Kent, Ohio.

Stop Experimenting. Marvelous Mineral Set. Powerful. Sensitive. Assembled. Ready to Work. Aerial, etc. Neat Cabinet. Over 75 Miles. Accommodates Eight Headsets. \$5.00. Money Back Guarantee. Colebrooke's Exchange, 7 Leyten Avenue, Medford, Mass.

Master Radio Code in 15 minutes. Ten word speed 3 hours. Our students made these world records. Qualifying records 100 Licensed Students free. Method \$2.00. Dodge Radio Shortkut, Dept. N, Manaroneck, N. Y.

Condensers. 11-23-43 Plate Never been used. \$2.50—\$3.50—\$5.00 values. Made by prominent manufacturer and guaranteed perfect or money refunded. Will sell for \$1.25—\$1.75—\$2.50. Only five of each. A. L. Parke, 56 Montgomery St., Waterbury, Conn.

Radio Generators: 500 volt 100 watt \$28.50 Battery Charging Generators \$8.50. High Speed Motors—Motor Generator Sets, all sizes. Motor Specialties Co., Crafton, Penna.

Crosley 4 tube, Crosley 2 tube and Amrad 5 tube. With or without tubes and batteries. Ray Baskerville, Symerton, Ill.

Audio Amplification comes clear and loud with: Flint transformer—postpaid \$3.00. If not satisfied after 10 days' trial, money refunded—equal to any over twice the price. (Circular on request. Flint Radio Co., 1801 Wilson Ave., Chicago.

\$3.95 Tubes \$3.95. Guaranteed New Genuine Radiotrons. All types sent postage prepaid. General Sales Service, Onset, Mass.

Make your set complete! Two step amplifier with mahogany cabinet; special introductory price \$12. Complete one step units ready for panel mounting \$5. Sent postpaid on order. Price, satisfaction guaranteed or money refunded. Descriptive circular sent free on request. Iremy Radio Mfg. Co., 105 Fourth Ave., Brooklyn, N. Y.

Magnavox M4. Latest nationally advertised battery-less reproducers. Magnetically balanced. Sensitive. Improved rubber cushioned diaphragm. List \$25. Introductory \$21. Magnavox B3 with electrical modulator. List \$35. Introductory \$28. The factory sealed carton is your guarantee. Radio Central, Dept. R, Abilene, Kansas.

The How and Why of Radio Apparatus, by H. W. Secor, E. E. This newest book on radio matters fulfills a distinct gap in wireless literature in that, while the treatment is made as understandable and as free from mathematics as possible, it at the same time incorporates a wealth of technique and instruction for the Radio Amateur—the Radio Operator—the Installation and Designing Expert—as well as teachers and students of the subject in general. A very broad field has been covered by the author, at the same time giving a great deal of information not found in other text books. If you are engaged in any branch of the Radio or allied arts at all you will surely need this latest contribution to radio literature, which is destined to be found on every radio man's book shelf before long. A glance at the following list of chapters gives but a very scant idea of the extensive and useful radio knowledge provided in its text. The Induction Coil; The Alternating Current Transformer; Radio Transmitting Condensers; The Spark Gaps; Radio-Transmitting Inductances; Radio Receiving Tuners; Radio Amplifiers; Construction of a Direct Reading Wave-meter and Decimeter; Antenna Construction; The Calculation and Measurement of Inductances; Appendix containing very useful tables covering all subjects treated in this very unusual book. This newest of Radio Works, cloth bound in Vellum de Luxe, Gold Stamped and Hand Seved, has 160 pages. Size of book, 6x9 inches. The How and Why of Radio Apparatus. Postpaid, \$1.75. Experimenter Publishing Co., Book Dept., 53 Park Place, New York City.

WHY PAY MORE?



RECHARGEABLE

50 Volts	\$5.50	100 Volts	\$10.00
75 Volts	\$7.75	125 Volts	\$12.50

Recharge from any 110 volt A.C. line with small home recharger. Shipped fully charged and ready for use after adding acid. Will last for years with ordinary care.

SERVICE "A" BATTERY



6 Volt		\$14.00
80-100 Amps		
6 Volts		\$16.00
100-120 Amps		

2 YEAR GUARANTEE
INDESTRUCTIBLE RUBBER CASE

SERVICE BATTERY CO.
704 East 102nd St., Cleveland, Ohio

HUDSON-ROSS

Largest exclusive Radio Jobbers in middle West.
Write for discounts.
123 W. Madison St. Chicago

O'NEIL AUDIPHONE

All music and speech re-vivified by "laminated voice-core." Complete with connecting cord **\$30**

O'NEIL MFG. CO.
719 Palisade Ave., West New York, N. J.

MU-RAD RECEIVERS

THE ULTIMATE IN RADIO RECEPTION

"Lighting Fixtures" READY TO HANG

(Direct from Manufacturer)
Completely wired including glassware. Send for Catalogue No. 26. (Just off the Press)
Special Proposition to Dealers
ERIE FIXTURE SUPPLY CO.
STATION R ERIE, PA.

Cuts Out Interference!

Electrad Indorarial overcomes static and re-radiation, gives wonderful directional effects. Cuts out local stations when you want distance. Hang or lay it anywhere. Price \$1.50. At all dealers or direct. Satisfaction guaranteed or money back.

ELECTRAD, INC.
Dept. H, 428 Broadway, N. Y. C.

FAHNESTOCK CLIPS

"Popular Wherever Radio Is Used"
14 Sizes in Beautiful Display Case.

Dealers write for big money-making proposition.

FAHNESTOCK ELECTRIC CO.
Long Island City, L. I.

Radio—(Continued)

Radio parts, all standard, and as good as new. Wonderful bargains, send for list, Carl P. Schroeder, 309 So. Prairie St., Prairie du Chien, Wisconsin.

How to Make Radio Frequency Amplifiers. This book is for the more advanced amateur, showing the construction of the Radio Frequency Amplifying Transformer and giving complete constructional data. It shows the application of Radio Frequency to amplifying units that the amateur may already possess and gives 15 hook-ups showing practically every use Radio Frequency Amplifying Transformers can be put to. 32 pages, 15 illustrations; bound in beautiful two-color cover. Prepaid 25c. The E. I. Company, 235 Fulton St., New York City.

Make Money making Supersensitive crystals. Less than one cent each. Manufacture easy. Materials any hardware. Guaranteed Formula, \$1.00. Colbrook's Exchange, 7 Leyden Avenue, Medford, Mass.

Experimental Electricity Course in 20 Lessons. By S. Gernsback and H. W. Secor, E.E. A course of the theory and practice of Electricity for the Experimenter. Every phase of experimental electricity is treated comprehensively in plain English. New experiments are described and explained and nearly every application of Electricity in modern life is given. 160 pages—100 illustrations. Flexible cloth cover, 75c. postpaid. Stiff cloth cover, \$1.25 Postpaid. Experimenter Publishing Co., Book Dept., 53 Park Place, New York City.

Salesmen Wanted

A Salesman wanted in every town or city within 25 miles of a broadcasting station to sell Radiogem, the complete radio receiving set that retails for \$2.50. With Radiogem there is nothing else to buy—the outfit includes the Radiogem receiving apparatus, 1,000 ohm phone, and aerial outfit. The cheapest radio outfit on the market—yet as practical as the most expensive. Big money to the right man. Send \$2.00 for sample outfit. The Radiogem Corp., 66-R West Broadway, New York City.

Scenery to Rent

Settings for Opera, Plays, Minstrels. Plush Drops. Address Amelia Grain, Philadelphia.

Song Poems Wanted

Poems Wanted—Sell your song-verses for cash. Submit Mss. at once, or write New Era Music Co., 152 St. Louis, Mo.

Stammering

St-Stu-t-tering and Stammering cured at home. Instructive booklet free. Walter McDonnell, 121 Potomac Bank Bldg., Washington, D. C.

Stamps and Coins

California gold, Quarter size 27c; half-dollar size 53c; Half-dime and Catalog 10c. Norman Schultz, Colorado Springs, Colo.

158 Genuine Foreign Stamps. Mexico War Issues, Venezuela, Salvador and India Service. Guatemala, China, etc., only 5c. Finest approval sheets 50 to 60%. Agents wanted. Big 72-p. Lists Free. We buy stamps. Estab. 20 years. Hussman Stamp Co., Dept. 146, St. Louis, Mo.

Telegraphy

Telegraphy—Both Morse and Wireless taught thoroughly and quickly Tremendous demand. Big salaries. Wonderful opportunities. Expenses low; chance to earn part. School established fifty years. Catalog free. Dodge's Institute, Cour St., Valparaiso, Ind.

Wanted to Buy

Full Value Paid for Old Gold, Jewelry, Watches, Diamonds, crowns, bridges, dental gold, silver, platinum, gold or silver ore; magneto points, old false teeth. Packages returned if our offer is not satisfactory. United States Smelting Works (The Old Reliable) 120 So. State St., Dept. 16, Chicago, Ill.

ONE THOUSAND AGENTS WANTED

We want one thousand agents to sell subscriptions to RADIO NEWS, SCIENCE AND INVENTION, PRACTICAL ELECTRICS and MOTOR CAMPER & TOURIST. We will pay a generous commission for this work and help you in every way. Our four publications are leaders in their fields, ready sellers and this is an offer well worth your while. A few spare hours a day will bring you a handsome return. Write regarding our proposition at once and be the first one to get started in your vicinity.

EXPERIMENTER PUBLISHING CO.
HERBERT H. FOSTER, Circulation Manager
53 Park Place, New York

3-

360 Meter Stations

WGI
WHN
WMAX

360 METERS



Price **\$5.50**
At All Good Dealers

Broadcasting at once

Tuned In Without Interference
with the
Uncle Sam Master Coil Tuning Coil

Ask your dealer for free diagram, or just send us self-addressed, stamped envelope for circular and panel layout of this wonderful set.

UNCLE SAM ELECTRIC CO.
Plainfield, New Jersey

TERLEE

"INS-UR-TUBES"

Provide 100% Tube Protection

against tube burnouts. Beware of devices that give you only partial protection. Terlee "Ins-ur-tubes" connected to each positive "B" battery terminal in use are ever on guard against "shorts" within the set and misconnections. They're positive protection in EVERY emergency. For both storage battery and peanut tubes. Price \$1.00 each.

Terlee Vario Couplers

What's your energy loss in your vario couplers? If it's high, try a Terlee. They're built to cut this loss. Low dielectric and low distributed capacity increase their selectivity and range. Arranged for panel or table mounting. Type "S" for crystal and audion circuits—\$6.00 each. Type "R" for regenerative and non-regenerative circuits using radio frequency amplification—\$7.50 each.

Terlee Hook-Up Blue Prints

Get these hook-ups! They're tried and proven with great results. Six 8½x11" detailed blue prints to the set. Price 15c set.

For best results, demand Terlee Products. If your dealer can't supply you, send your order direct to us.

Terlee Electric & Mfg. Co.
Dept. A-8, 443 S. Dearborn Street
CHICAGO, ILL.
"Makers of Radio's Best for Better Radio Results"

AMPERITE

The "SELF-ADJUSTING" Rheostat

PERFECT for every CIRCUIT

Simplifies wiring.
Eliminates hand rheostats.

RADIALL COMPANY
320 W. 42nd St., N. Y.



\$1.10

Write Dept. N-1 for Free Hook-up From Your Dealers

For Summer Radio

* Bradleyleak

THE PERFECT GRID LEAK
 Range— $\frac{1}{4}$ to 10 Megohms.
 A grid condenser of 0.00075
 mf. supplied extra. Endorsed
 by Cockaday, Amrad,
 Flewelling, Crosley, etc.
 Price . . . \$1.85
 Condenser . . .35

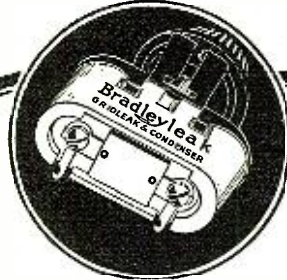

* Bradleystat

PERFECT FILAMENT CONTROL
 Noiseless, stepless filament
 current control for ALL
 tubes. Is standard equip-
 ment on many sets, includ-
 ing Amrad Console models.
 Price . . . \$1.85



Bradleyohm

THE PERFECT RESISTOR
 An adjustable resistor for ra-
 dio circuits. Made in three
 ranges:
 10,000 to 100,000 ohms
 25,000 to 250,000 ohms
 50,000 to 500,000 ohms
 Price, any range, \$2.00



The Bradleystat holds first
 place for long distance re-
 ception in many contests.



Bradleyswitch

PERFECT BATTERY SWITCH
 For A- and B-battery circuits.
 Only ONE hole required in
 panel to mount the switch.
 Nickel-plated and totally en-
 closed.
 Price 60c

Bradleyometer

THE PERFECT POTENTIOMETER
 A stepless, non-inductive po-
 tentiometer for all radio cir-
 cuits. Complete range in half
 turn of knob. Made in 200 and
 400 ohms. Price, 200 ohm,
 \$2.00; 400 ohm, \$3.00.



Use Allen-Bradley Products

Summer Radio Sets are portable sets! This means that they must be built for abusive service, and must operate under conditions that are often unfavorable for good reception. Short antenna, loop antenna, and similar receptive devices call for extremely sensitive sets. This, again, means that the parts used must be of high efficiency for maximum signal strength.

Allen-Bradley Radio Products are known the world over for excellence of construction and perfection in operation. They make any good set better, and insure a full measure of enjoyment in summer camps when used in portable sets. Make your set a *good* set. The above radio parts are the finest obtainable. Follow the advice of radio experts. Use them!

Allen-Bradley Co.,
 287 Greenfield Ave., Milwaukee, Wis.
 Please send me a complete set of your de-
 scriptive circulars on Allen-Bradley radio
 products.
 Name

Address

Allen-Bradley Co.
 Electric Controlling Apparatus

287 Greenfield Ave. Milwaukee, Wis.



The Allen-Bradley Guarantee

Every Allen-Bradley radio product is guaranteed for ONE YEAR against defects in material and workmanship. Any defective material will be repaired or replaced, without charge, within the guarantee period.

Stop Amplifying Static!

GET good radio results all summer! Take advantage of the better receiving sets—of the better broadcasting.

And use N & K Imported Phones.

Because N & K Phones, used with detector unit alone, bring in the entire range of broadcasting—both high and low tones—with utmost clearness and without exaggeration of interfering noises.

Recent laboratory tests made with N & K Phones showed a *maximum audibility over the wide range of 300 to 6000 cycles*. We believe this to be the widest range of any phone made.

Most radio users this summer will *stop amplifying static* by giving their loud speakers a rest. If they use N & K Phones, the amazing clearness of N & K reception will permit them to suppress static and get the full effect of the better broadcasting.

Take home a pair of N & K Phones today and be your own judge. Any authorized N & K dealer will sell you a pair on our money-back guarantee basis. If your dealer is not yet supplied, order from us direct.



TH. GOLDSCHMIDT CORP.
Dept. R8, 15 William St., New York

DEALERS:

Put an N & K Head Set into the customer's hands and tell him to try it. N & K does the rest! N & K is backed by widespread advertising which goes direct to radio fans all over America. Display N & K Phones and you cannot fail to cash in on this advertising. Packed in display cartons of ten with cards, folders, etc. If your regular jobber cannot supply you, get in touch with us.

N & K Head Set—Model D

4000 ohms, has extra large diaphragms, which give greater clearness and greater comfort. Neat, leather-covered head bands. Six foot cord. Sold under Guarantee: "Your money back if N & K Phones do not give clearer, mellower, more natural tone and fit more comfortably." Price \$8.50. Send for free folder—"The Phones the Fans Are All Talking About," describing N & K Phones

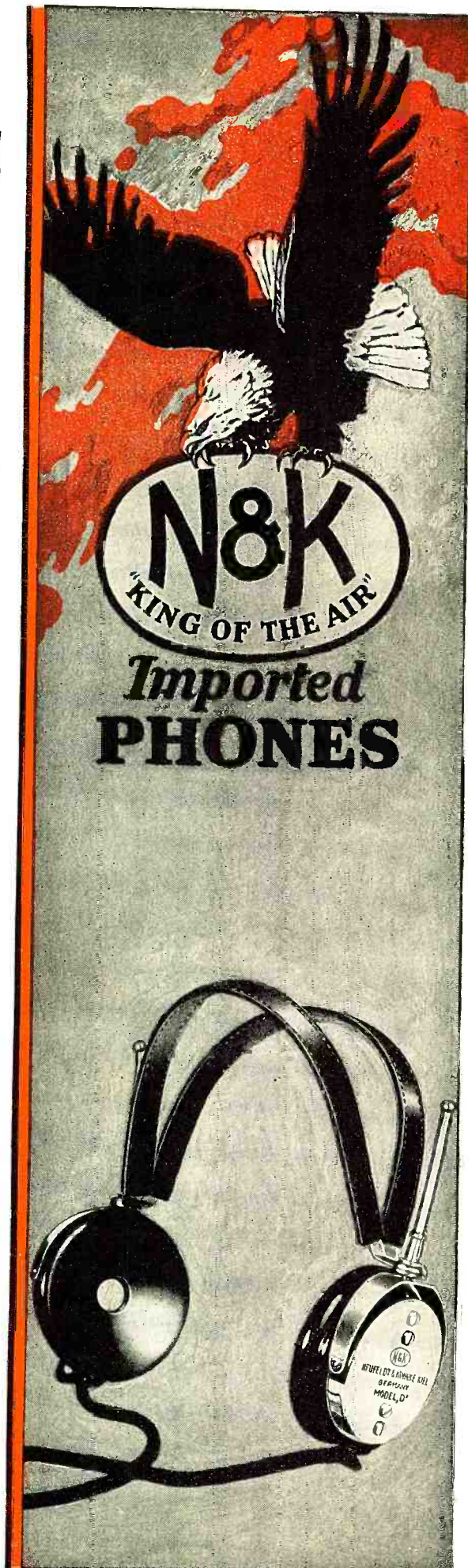



Radiola Regenoflex, with Radiola Loudspeaker, and 4 Radiotrons WD-11; with space for batteries inside; (complete except batteries and antenna). . . . \$206



With a Radiola on the Front Porch

All the jazz of the big orchestras in far-away big towns comes through clearly for dancing. The fine music is true, sweet toned, undistorted. The sports news rings out with all the thrill of bleachers or ringside. The Regenoflex is a leader among the new Radiolas that are making this a great radio summer!

A Radiola Regenoflex on the front porch—and that porch can be way up in the mountains, or off at the seashore—but it's not too far away to be in on the fun.

The improvements in its mechanism offer greater sensitivity and greater selectivity; clearer tone; and complete simplicity. Where quality of reception counts as much as distance, the Regenoflex is the receiver for this summer's fun!



This symbol of quality is your protection.

"There's a Radiola for every purse"

Send for the free booklet that describes every Radiola.

Radio Corporation of America

233 Broadway, New York
433 California St., San Francisco, Cal.

Sales Offices:

10 So. La Salle St., Chicago, Ill.

RADIO CORPORATION OF AMERICA
Dept. 28 (Address office nearest you.)
Please send me your free Radio Booklet.

Name _____
Street Address _____
City _____ R. F. D. _____
State _____

Radiola

REG. U. S. PAT OFF