

OVER 225,000 COPIES OF THIS ISSUE PRINTED AND DISTRIBUTED

H.O. Smith

RADIO NEWS

REG. U.S. PAT. OFF.

25 Cents
October

1923

Over 200 Illustrations

Edited by H. GERNSBACK

"WHY GIRLS LEAVE HOME!"

IN THIS ISSUE

Sir Oliver Lodge, D.Sc., L.L.D., F.R.S.

Dr. A. J. Fleming, M.A., D.Sc., F.R.S.

John Scott-Taggart, F. Inst. P.

Dr. Eugene Nesper

Dr. Lee De Forest

Ellis Parker Butler



THE 100% WIRELESS MAGAZINE

CIRCULATION LARGER THAN ANY OTHER RADIO PUBLICATION

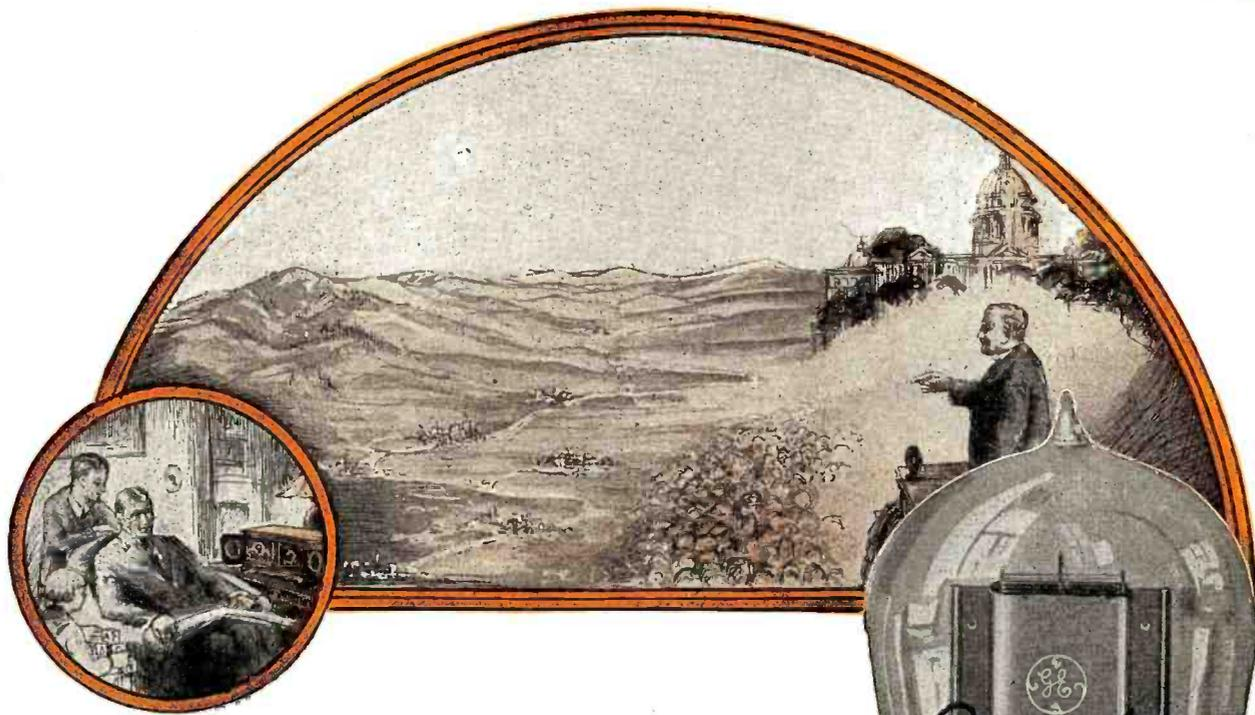

Carries Great Messages Around the World

THAT statement adequately expresses what is perhaps the greatest influence of radio in developing and bettering human fraternal interest, not only between the people of one community, of one country, of one state, or even a single nation, but between all nations and all peoples of the world.

Be these messages from government leaders—from the heads of the world's greatest educational institutions or from those who stand foremost in the arts of the world—they will serve to bring the human race into closer contact.

In the past ages great orators and writers, famous poets and musicians have swayed the destinies of nations, and have been instrumental in the rise and downfall of mighty empires.

In the future these same influences of similar great minds will, through radio, create a better understanding and a greater fraternal spirit between the people of the nations.

It is the vacuum tube that has made possible this broad and far reaching application of radio telephony, and that plays the most important part in the operation of your receiving set.

Cunningham Vacuum Tubes, standard for all makes of receiving sets—built by one of the world's largest manufacturers with unlimited resources—are the product of years of manufacturing experience and the creative genius of the engineers of that great scientific organization, the Research Laboratory of the General Electric Company.

Cunningham Radio Tubes	
C-301A—6 Volts ¼ amp. Amplifier.....	\$6.50
C-299—3 Volts .06 amp. Dry Battery Det. & Amp.....	6.50
C-300—6 Volts Gas Con- tent Detector.....	5.00
C-11—1.1 Volts .25 amp. Dry Battery Det. and Amp. Special Base.....	6.50
C-12—Similar to C-11 with standard base.....	6.50

Patent Notice: *Cunningham tubes are covered by patents dated 11-7-05, 1-15-07, 2-18-08, and others issued and pending. Licensed for amateur, experimental and entertainment use in radio communication. Any other use will be an infringement.*

E. J. Cunningham Inc.

Home Office
248 First Street
San Francisco, Calif.

154 West Lake Street
Chicago, Illinois

30 Church Street
New York City, N. Y.



CUNNINGHAM
National
Tube Week

September 24 to
October 1, 1923

\$5000 in Cash Prizes
to Radio Dealers

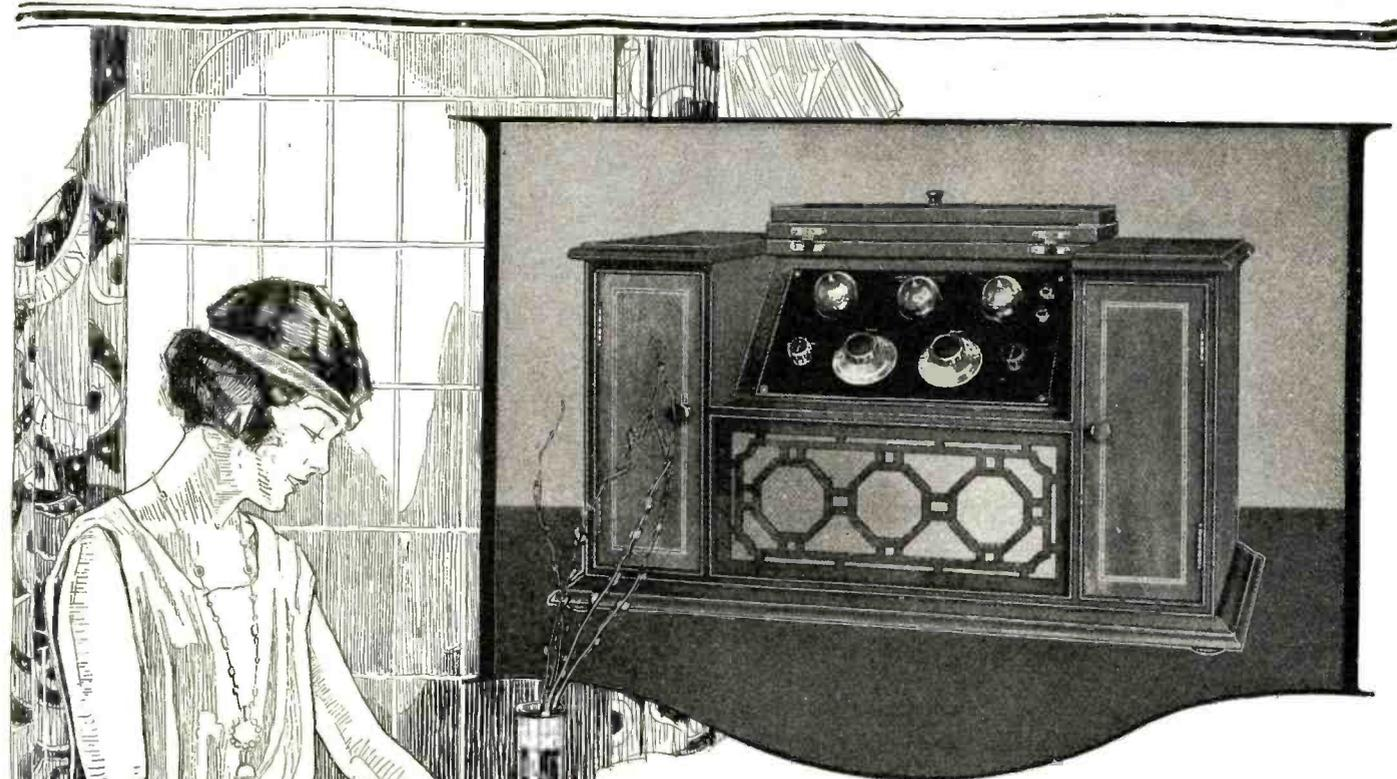

STRIKING BEAUTY *in this new Kennedy Set*

THIS NEW ADDITION to the Kennedy line has a three-fold appeal for you. First, its artistic beauty—simple, refined lines. Second, the faithfulness and unusual tonal purity of its reproduction. Third, it is a self-contained unit, all batteries and loud speaker unit enclosed in the cabinet. Ample volume is assured for dancing or entertainment.

In this set extreme simplicity of operation has been obtained, at the same time retaining the selectivity of tuning and long distance reception that has distinguished all Kennedy receiving sets. Only two dials are used—one to bring in the desired station, the other to regulate volume. Truly a set of which the Kennedy laboratories can justly be proud.

You can arrange with the nearest Kennedy dealer for a demonstration, or write us direct for descriptive literature.

THE COLIN B. KENNEDY COMPANY
SAINT LOUIS SAN FRANCISCO

K E N N E D Y

The Royalty  of Radio

THE KENNEDY MODEL X

This beautifully inlaid mahogany cabinet encases a complete, self contained radio receiver (wave length range 150 to 600 meters.) Two stages of audio amplification, built-in loud speaker. Formica panel. Dials and metal trimmings gold plated. All dry batteries—three dry battery tubes—phones for weaker signals or individual reception—complete, \$285.00

All Kennedy radio receiving sets are regenerative—licensed under Armstrong U. S. patent No. 1,113,149.

RADIO NEWS



CONTENTS

VOL. 5

FOR OCTOBER

No. 4

	Page		Page
Editorial	373	Reaching the New Wave-Lengths By W. L. Pearce	399
The Radio Amateur in a New Field By Herbert H. Foster	374	Positive and Negative	399
Learn While You Sleep.....	375	1600 Miles on a Crystal Receiver By Edward T. Jones	400
How It Feels to Broadcast, By Thornton Fisher	376	More Light on the Reinartz Tuner By Howard S. Pyle	400
Pioneer Work in Ether Waves, By Sir Oliver Lodge	377	The Galena Loud Talker ..By Clyde J. Fitch	401
Radio as a Means of Expression and Contact, By Dr. Lee de Forest	378	With the Amateurs	402
Radio Can Be Sold on a Sane Basis By Edward T. Jones	379	Awards of the C. W. and Phone Contest	404
Enlarging the Classroom..By Golda M. Goldman	380	The All-Purpose ReceiverBy M. B. Sleeper	406
When Radio Clubs Vie With Pig and Corn Clubs	381	A Capacity Coupled Receiver for Short Wave Reception	408
Pictorial Review of Radio Broadcasting	382	A Rubber Ball Variometer..By George Sutton	409
Latest Advance in the Radio Field	384	Construction of Push-Pull Transformers By H. N. Bliss	410
Radio in Front and Behind the Microphone....	386	Compact Amplifier Using Low Voltage Tubes, By Deane S. Kintner	411
Radio Aboard the "Albert Ballin"	388	An Efficient Honeycomb Coil for Short Waves, By E. A. Schall	412
Broadcasting Pays Song Writers, By W. A. Eisenhauer	390	A Reinartz Tuning Coil for a Quarter, By L. C. Eberle	412
A New Arrangement of Antenna	391	Definition of Radio Terms	413
NAA Gets a New Voice	391	Awards of the \$50 Radio Wrinkle Contest	414
The Celebrated Pilkey Radio Case By Ellis Parker Butler	392	Radio News Laboratories	416
Experiments with the ST-100 Circuit By John Scott-Taggart	393	Radio Humor	418
Electrons, Electric Waves and Wireless Tele- phony—Part IX	394	Correspondence from Readers	419
Radio Frequency Amplification ..By Louis Frank	396	With the Sea-Going Op's	420
An Experimental Radio Cabinet By Dr. Eugene Nesper	398	I-Want-To-Know	421
Index to Advertisers	364		

RADIO NEWS is published on the 10th of each month. There are 13 numbers per year. Subscription price is \$2.50 a year in U. S. and possessions. Canada and foreign countries, \$3.00 a year. U. S. coin as well as U. S. Stamps accepted (no foreign coins or stamps). Single copies, 25 cents each. A sample copy will be sent gratis on request. Checks and money orders should be drawn to order of EXPERIMENTER PUBLISHING CO., INC. If you should change your address notify us promptly, in order that copies be not misrouted or lost. No copies sent after expiration.

All communications and contributions to this journal should be addressed to Editor, RADIO NEWS, 842 Jamaica Avenue, Jamaica, New York; or 53 Park Place, New York, N. Y. Unaccepted contributions cannot be returned unless full postage has been included. All accepted contributions

General Advertising Dept., 53 Park Place, New York City. Western Advertising Representatives, Finucan & McClure, 720 Cass Street, Chicago, Ill. Kansas City Representative, Geo. F. Dillon, Republic Bldg., Kansas City, Mo. Pacific Coast Advertising Representatives, A. J. Norris Hill Co., Hearst Bldg., San Francisco, Cal.

Published by EXPERIMENTER PUBLISHING CO., INC.,
Publishers of "Radio News," "Science and Invention" and "Practical Electrics."
Publication Office: Jamaica, N. Y. Editorial and General Offices: 53 Park Place, New York City
H. GERNSECK, President S. GERNSECK, Treasurer R. W. DEMOTT, Secretary

are paid for on publication. A special rate is paid for novel experiments; good photographs accompanying them are highly desirable.

RADIO NEWS, Monthly. Entered as second-class matter at the Post Office at Jamaica, N. Y., under the act of March 3, 1897. Title registered U. S. Patent Office. Copyright, 1921, by E. P. Co., Inc., New York. The Experimenter Publishing Co., 53 Park Place, N. Y. The Contents of this magazine are copyrighted and must not be reproduced without giving full credit to the publication.

RADIO NEWS is for sale at all newsstands in the United States and Canada; also at The International News Co., Ltd., Bream's Buildings, London E. C. 4, England, and at Brentano's 37 Avenue de l'Opera, Paris.



“Music and Beauty make life pleasant”
Yang Chu.

The New **GREBE** Broadcast Receiver

delights both ear and eye—

Doctor My.

REGENERATION and Tuned Radio Frequency Amplification find their first successful combination in this Receiver. The 20-foot silk-covered wire, readily concealed behind the picture moulding, is the only antenna required.

The attractively finished walnut cabinet has compartments for all necessary batteries.

Write for “GREBE Radio in the Well-Appointed Home”

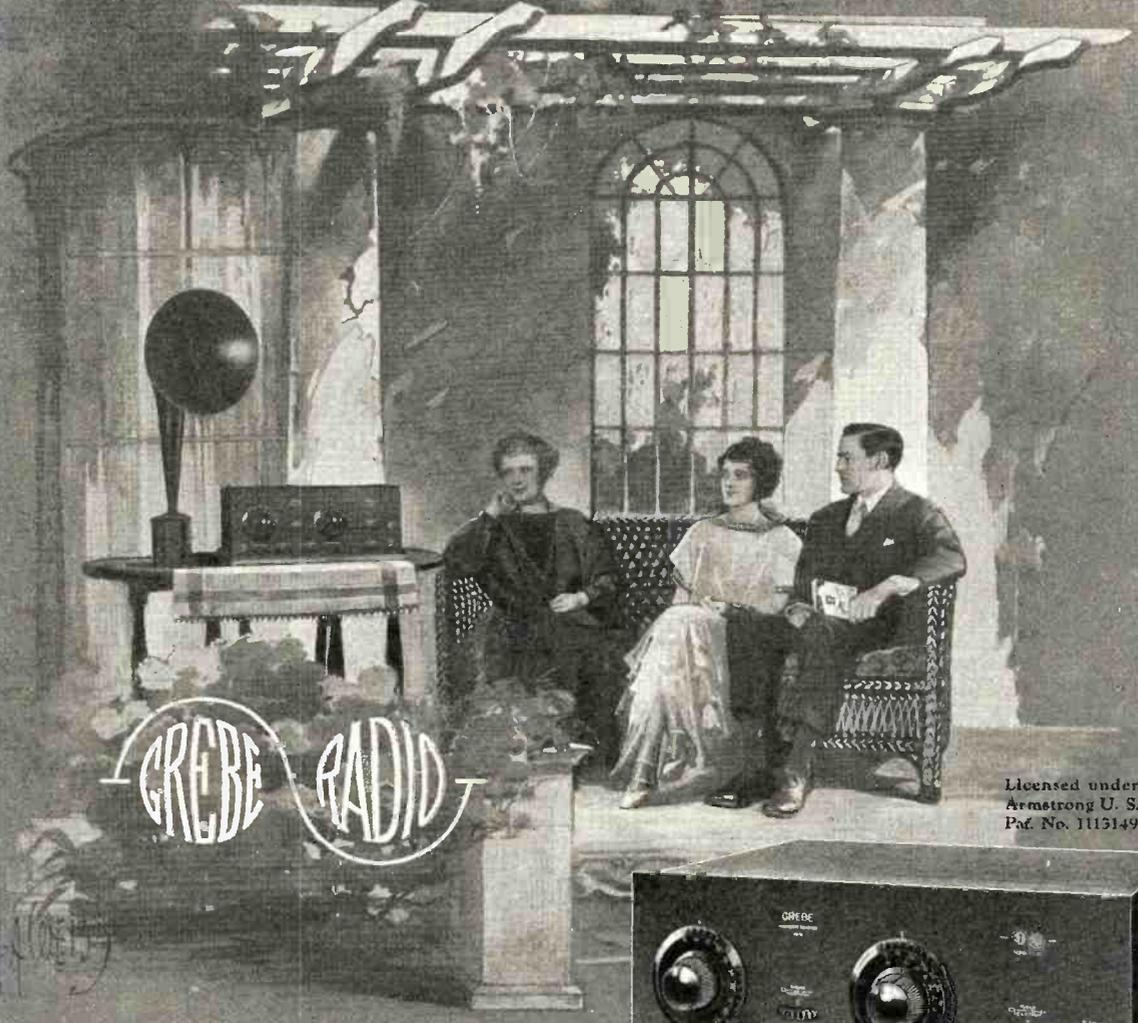

GREBE RADIO

Licensed under
Armstrong U. S.
Pat. No. 1113149



A. H. GREBE & COMPANY, Inc.
Richmond Hill, N.Y.
Western Branch, 451 East 3rd St., Los Angeles, Cal.

Type CR-12

"Tune In" on a Real Job and Get the Pay of a Specialist

*This Free Book Will Show You
How to Earn \$1,500 to \$10,000
Yearly as a Radio Expert*

The man who would be a success in business today must be a specialist. The market is already crowded with clerks, stenographers, accountants and detail men of every description. And as the number of applicants increases, the pay and opportunities diminish. Not that these men are unnecessary, for their work is important and essential. But the competition has always been keen in general work of this kind and it is bound to increase in proportion to the number of good men available.

Radio Needs Trained Men

There is perhaps no other field today where specialists are needed more than in Radio. Trained men are required in every branch of this fascinating, profitable profession. And the opportunities are great—almost without limit! Radio has swept across the face of the whole earth with a speed as surprising as it was sudden. Almost overnight it jumped into the front rank of the world's leading industries. Yet it is here to stay—and grow!

PICK OUT THE JOB YOU WANT WE WILL HELP YOU GET IT

This is a brief list of the positions in the Radio field today, and the salaries paid—

Radio Mechanic, \$1,500 to \$4,000 a year.

Radio Inspector, \$1,800 to \$4,500 a year.

Radio Salesmen, \$2,000 to \$10,000 a year.

Radio Engineer, \$3,500 a year and up.

Radio Executives, up to \$15,000 a year.

Radio Instructor, \$200 to \$500 a month.

Radio Draftsmen, \$7 to \$15 a day.

First Class Ship Operator, \$105 a month, all expenses paid.

Second Class Ship Operator, \$95 a month, all expenses paid.

Third Class Operator, \$85 a month, all expenses paid.

Commercial Land Station Operator, \$150 a month and up.

Broadcasting Station Operator, \$125 to \$250 a month.

For that reason Radio needs good men. It is ready to treat them right and pay them well. And for the men who "get in" NOW, the best is none too good.

Get Into This Big Paying Profession

Consider for a moment the possibilities of Radio. The shores of every continent are dotted with transmitting and receiving stations. Practically every vessel is now equipped for communication with land and other ships. Hotels, railroad terminals, public buildings and Government stations are flashing their business messages 'cross cities, rivers, mountains and seas. At night, millions of men, women and children are "listening in" to music, speeches, news, important events and business reports, broadcast for their amusement and education. Factories, stores, banks, laboratories, business houses and newspaper offices are employing Radio experts in every branch of the profession. Yet the demand for good men is far greater than the supply. If YOU are sick of plugging along in the daily grind of monotonous office routine—held down by the thousands of men who are doing the same work as you—get out of the rut into this big paying profession.

You Can Qualify at Home Easily and Quickly

On land and sea, the news of the world's progress is flowing under the skilled fingers of Certified "Radio-tricians"—men who are well-paid, honored and respected for their specialized knowledge and important work. A short course of training at home for the enjoyable work of Radio, will quickly enable you to be independent, to travel and see the world if you wish, or establish yourself in a permanent position in your own town. Radio will take you out of the rut of a bare existence, into the enviable standing of a specialist—with unlimited opportunities for honor, power, wealth and satisfaction. It will make you a doer of real things, a vital force in the world and an important factor in your own community. Start to train NOW for a Radio position while the profession is growing. You can start TODAY—in your spare hours at home. The National Radio Institute is training



**This
FREE
BOOK
Will Tell
You How**

men, in their spare hours at home, for every important branch of the big Radio industry. To any man who is eager to better his conditions and make a place for himself in this fascinating and profitable profession, we will gladly send a copy of this timely, helpful book—*absolutely free*. It is called "Your Opportunities in Radio" and it will open up a chain of opportunities that you will do well to carefully consider.

You assume no obligation whatever in sending for this interesting, helpful book. It is yours for the asking—FREE. For that reason you can hardly afford to miss it. Ask for a copy today and learn the tremendous opportunities that are open in Radio, how we are preparing men at home to take advantage of these opportunities, and how we aid them in securing the kind of positions that lead to independence and success, "Tune in" on a real job—mail the coupon for this Free Book today—and then "stand by" until it arrives by return mail. It will PAY you! National Radio Institute, Dept. 13-J, Washington, D. C.

This Will Bring It

NATIONAL RADIO INSTITUTE,
Dept. 13-J, Washington, D. C.

Without any obligation on my part, please send me a FREE copy of your book, "Your Opportunities in Radio." Also tell me how your Free Employment Service will help me secure a position, and send me details of your special short-time offer.

Name

Street

City State.....



**Clear Reception
at Lowest cost**

*Armstrong
Regenerative
Receiver*

Licensed under
Armstrong
U. S. Patent
No. 1,113,149

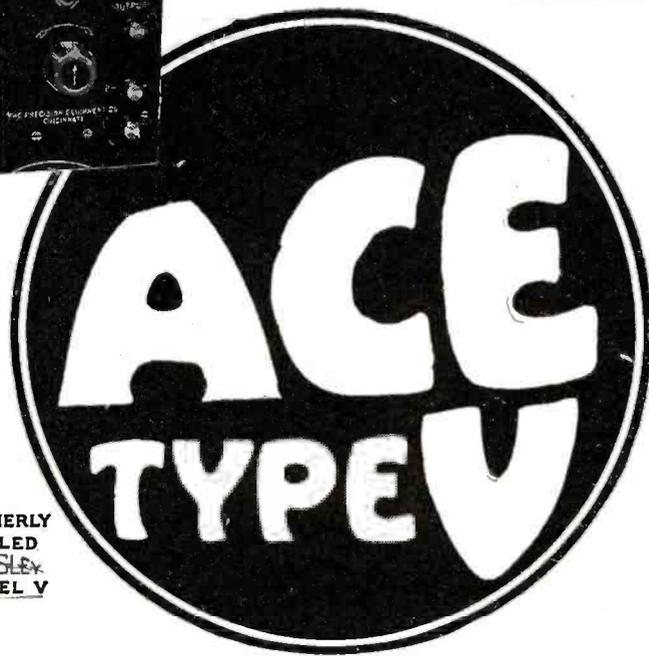
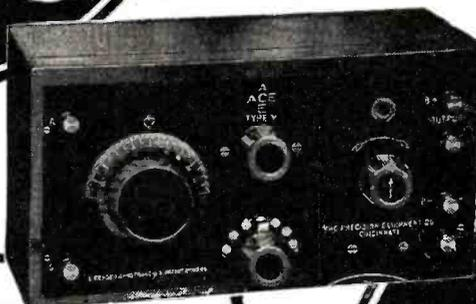

FORMERLY
CALLED
CROSLY
MODEL V

THE ACE Type V is a long range regenerative radio receiver. Signals received on it are clear and distinct.

Stations from coast to coast are heard under ordinary conditions by owners of this set. Wonderful efficiency, simplicity of operation and low cost are the chief factors in the growing success of this receiver. They are the things that have made it the most popular on the market. Thousands of the Ace Type V have been sold—hundreds of letters from owners are proof of their success. Can be used with dry cell or storage battery tubes.

Those who desire to operate a loud speaker in connection with the Ace Type V, later can add an Ace Type 2 B, a new two-stage audio frequency amplifier, to the set. Then music or voice being received from a far-away station will be heard throughout the room or house. The price of the Ace Type 2 B amplifier is \$20.00.

If your dealer cannot supply you, order direct, mentioning his name. Ask for "Simplicity of Radio." Your copy is FREE.

DEALERS—Write on your letterhead for attractive sales proposition.

THE PRECISION EQUIPMENT COMPANY

Russell Crosley Jr. PRES.

1022 Vandalia Ave. Cincinnati, Ohio

The New Ace Type 3 B

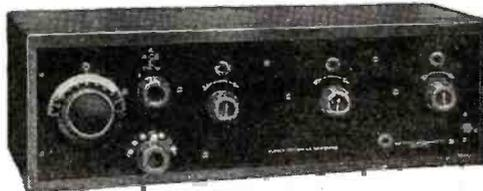

A new member of the Ace family selling for \$50, which is equal to a combination of the Ace Type V and the Ace two-stage amplifier. Like the Ace Type V it is manufactured under Armstrong U. S. Patent No. 1,113,149. This set is new, but months of research work have brought it to a high degree of perfection. Out-performs receiving sets costing great deal more. A filament switch eliminates necessity of turning out rheostats when set is not in use. A person hearing a broadcasting station may turn off the set by throwing switch and come back later without retuning. A telephone jack is between first and second stage of amplification. This is for use of persons who desire to use head phones instead of loud speaker. Crosley Multistats, universal filament control rheostats for all makes of tubes, Price \$50 also are used in the Type 3B.

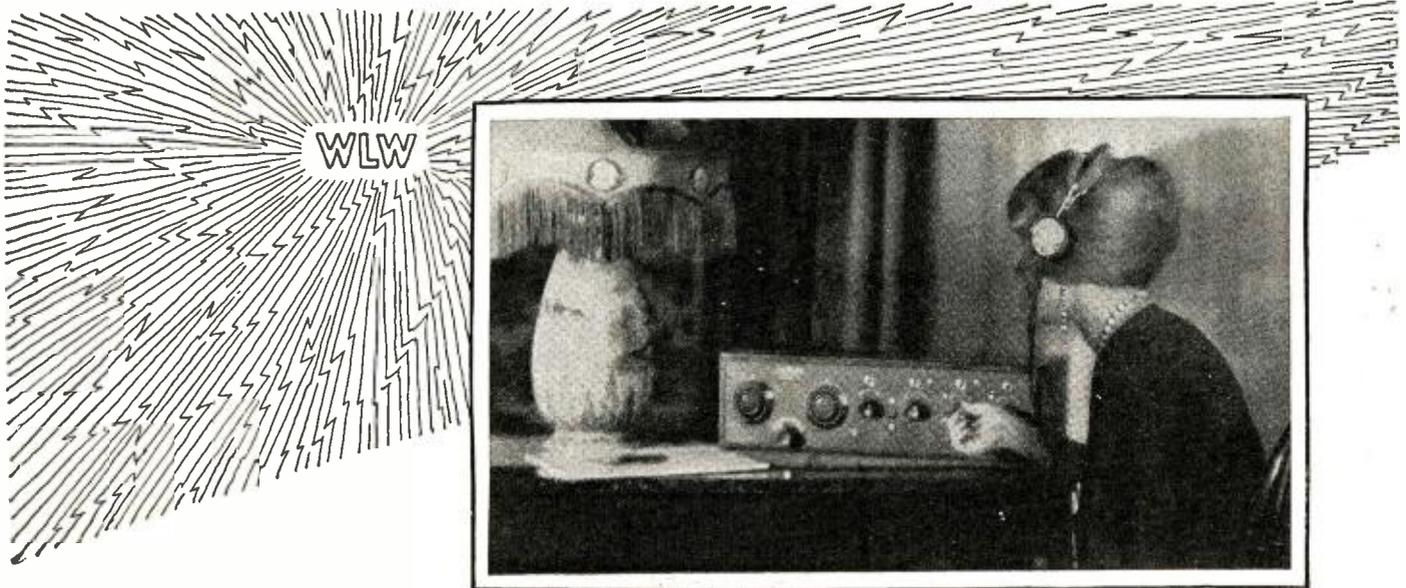

Announcing -
THE NEW CROSLY MODEL X-J
PRICE \$ 65.00

The Crosley Model X, has in just a year's time established itself as the most popular and successful receiver ever marketed. Hundreds of unsolicited endorsements like the following constantly come to us. A man writing from Belleville, Kansas, says:

"I have found the Crosley Model X to be the best radio receiving set I have used and permit me to say that I have been interested and using radio sets since spring of 1922, including all standard makes."

Now comes a companion, the new Crosley Model X-J, embodying all the good points of the Model X together with greater refinement of detail. Some of the new features of this wonderful receiver which make for greater distinction and beauty are:

1. Knobs and Dials—larger, easier to control and better looking.
2. Filament Control Switch—snaps filaments on and off.
3. Jack—allows you to plug in with head phones on three tubes. When tuned in, just pull the plug and you are switched to the loud speaker.
4. Elimination of Binding Posts on Front Panel. By removing the binding posts to the rear the beauty of the set is greatly enhanced.
5. Sockets—Porcelain sockets are replaced with black compound sockets which are just as efficient and better looking.
6. Condenser—The New Molded Crosley Condenser made of specially prepared compound will out-perform any condenser on the market.
7. Multistat—Allows the use of all makes of tubes. (Now a feature of the standard Model X.)
8. RFTA Coil—New low resistance coil permits sharper tuning.

Write for descriptive pamphlet

For Sale by Good Dealers Everywhere

Crosley Manufacturing Co.
1022 Alfred St. Cincinnati, Ohio

New York Office: C. B. Cooper, 1803 Tribune Bldg., 154 Nassau St., Beekman 2061
 Boston: B. H. Smith, 755 Boylston St., Room 316.
 Chicago Office: 1311 Steger Bldg., 28 E. Jackson Blvd., R. A. Stemm, Mgr.
 Philadelphia Office, J. H. Lyte, 65 North 63rd St.
 St. Louis Office: Robert W. Bennett Co., 1326 Syndicate Trust Bldg.



CROSLY MODEL X-J, WITH BATTERY CABINET. This combination makes the set completely self-contained. The batteries are housed in this handsome mahogany, wax finished cabinet. Price of cabinet alone, \$16.00.

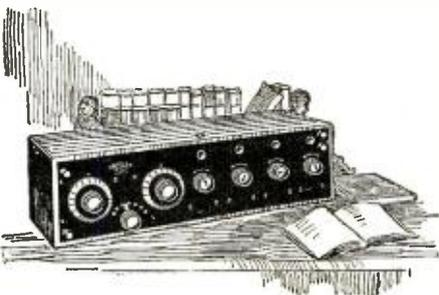

CROSLY MODEL X. This remarkable receiver—still priced at \$55.00—contains many new features such as the R. F. T. A. Coil and the Multistat. The battery cabinet, illustrated above, may be fitted to it, thus adding to its present beauty.

CROSLY
 Better - Cost Less
 Radio Products

A Triumph in Radio

The Single Tube Radio Frequency Receiver

Performs the Function of 2-Tubes

Only One Control
All Wave Lengths

\$10⁰⁰ Without Tube

Including Two Interchangeable Inductance Coils for Wave Lengths ranging from 200 to 600 Meters

Entirely new circuit. One tube performs the double function of radio frequency amplifier and detector.

Simplicity and Economy. One simple tuning control gives selectivity equal to sets costing hundreds of dollars.



"A WONDER"

Dear Sirs:

When your Monodyne sample arrived, to be entirely frank, we did not believe it capable of doing very much on long distance work. After carefully testing the set, we feel that we owe you an apology.

The National Monodyne naturally percolated all over the place; we heard Davenport, Chicago, Dallas, Texas, and Atlanta, Ga. The next night we took it to the home of Mr. McCreary, President of the Western Radio Company here, and we heard another string of stations, using the WD-12 tube with two 22½ "B" batteries.

Your Monodyne is certainly a wonder.

We are enclosing our initial order, which kindly rush at the earliest moment.

The Radio-Electric Shop, Inc.
225 East Tenth Street,
Kansas City, Mo.

1000 MILES ON THE MONODYNE
Gentlemen: Having purchased your Monodyne set I was more than pleased over the results obtained from it. I think it is one of the best one-tube sets on the market today.
I have heard the following long distance stations—WDAF Kansas City, WDAP Chicago, WSB Atlanta, WOO Philadelphia, WGY Schenectady, WOC Davenport, and a Canadian station whose call letter I could not obtain.
Using hook-up No. 4 gives very selective tuning and volume. Your set cannot be praised too highly.
WILLIAM BROWN
65 East 117th St., N. Y. C.

NATIONAL MONODYNE

PAT. TRADE MARK PDG.

TUBE SET

MODEL GT-1

The **MONODYNE CIRCUIT** is one of the most radical advances in radio engineering since the advent of the Armstrong Circuit. Parts heretofore considered essential are omitted and one simple tuning control gives a selectivity equal, if not superior, to that of sets costing hundreds of dollars. A child can operate it.

SIMPLICITY

The NATIONAL MONODYNE uses but one dry cell tube, preferably the WD-12 or any other standard dry cell tube, such as the UV-199 or C-299 types. Local broadcasting comes in astonishingly loud and clear, without distortion.

The tube socket is of a new design and most practical because it holds the tube with a positive grip on all four prongs for a depth of more than one-quarter of an inch.

The NATIONAL MONODYNE AIRPHONE will find especial favor with experimenters because of its adaptability in many different hook-ups, a thing not possible with any other low priced outfit.

LONG DISTANCE

In our New York laboratory tests, we repeatedly heard stations KYW at Chicago, WOC at Davenport, Iowa, and many others, quite loud and clear. This without resorting to any mode of amplification.

The NATIONAL MONODYNE is the most practical tube set made, and is complete in all details. It is only 6½ inches long, 4¾ inches wide, and 2¾ inches high of durable, compact and rugged construction. The entire casing is moulded from hard rubber composition.

The NATIONAL MONODYNE has a receiving capacity and range of about 1500 miles. 75-foot aerial is recommended for best results.

No more Hunting for stations. You know in advance at what point of the scale your favorite station is located—only the highest priced sets accomplish this.

Dealers, Jobbers and Distributors—Send for Samples and Prices

----- **SEND NO MONEY** -----

National Airphone Corporation, R. N. 10
18 Hudson Street, New York City, N. Y.

Gentlemen:
Please send me prepaid One (1) NATIONAL MONODYNE tube set, Model GT-1, for which I will pay the postman \$10.00.

NAME

STREET AND NO.

CITY STATE

NATIONAL AIRPHONE CORPORATION

18 HUDSON ST. NEW YORK

NATIONAL Interference Eliminator

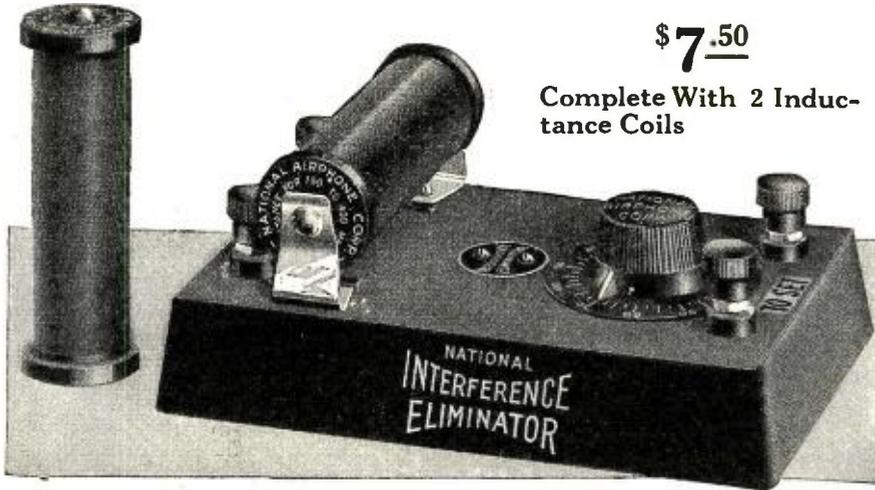

\$7.50

Complete With 2 Induc-
tance Coils

Adds selectiv-
ity to your
set.

Tunes out side
waves or har-
monics of pow-
erful broadcast-
ing stations.

Will make
your set tune
sharper.

Two coils go with
instrument, one
for short and
another for long
wave lengths.



The National Interference Eliminator can be used with all radio outfits no matter what make, tube or crystal. Will bring in stations you never heard before. Nothing else required with set as illustrated. Just connect it with two short wires to your outfit.

A NATIONAL STANDARD INSTRUMENT OF MERIT AND RELIABILITY

Eliminates Broadcasting and Code-Signal Interference

Can be used to increase or shorten Wave Lengths

AN ABSOLUTE NECESSITY TO CLEAR RECEPTION

NATIONAL AIRPHONE "GOLD-GRAIN" DETECTORS



Actual Size
Now \$1.50
Mounted

After you have fussed with catwhiskers, springs, balls and adjustment handles, and after you have almost become a nervous wreck, hunting for "the elusive sensitive spot"—you will welcome with open arms our 100 per cent. GOLD-GRAIN DETECTOR.

This Detector is foolproof; has no catwhiskers; no springs, no balls, no adjusting handles; no fussing. The detector is Entirely enclosed in hard rubber composition cartridge, but it is NOT a fixed detector.

A special crystal is used, while contact elements are made of pure gold. There is always a multiplicity of contacts. The Detector is sealed hermetically. The contact with the crystal is always perfect.

This detector has been pronounced by experts as the greatest detector in existence. It reproduces voice, and music in natural color of tone, without distortion. You will be surprised at the wonderful results and satisfaction obtained with the "GOLD GRAIN" Detector.



\$1.00

Actual Size
FOR PANEL
MOUNTING

Most Practical for Reflex and Crystal Sets

Dealers, Jobbers and Distributors—Send for Samples and Prices

NATIONAL
AIRPHONE
CORPORATION

20 HUDSON ST.

NEW YORK

SEND NO MONEY

National Airphone Corporation
20 Hudson Street, New York City, N. Y.

R. N. 10

Gentlemen:

Please send me prepaid the
articles crossed, for which I will
pay postman on delivery the ad-
vertised price.

One National Monodyne
One Interference Eliminator
One Panel Detector

NAME

STREET AND NO.

CITY STATE

BUILD YOUR SET BETTER -- AT LOWER COST

BUILD YOUR SET WITH BARAWIK STANDARD RADIO GOODS

EXCEL 180° VARIOCOUPLER

R522 Each\$1.79
 Properly designed and well made. Green silk windings over natural uncolored genuine bakelite tubes. Primary has taps every 7 turns and last 6 turns tapped every turn. Cast aluminum support with panel mounting screw. 1/4 inch shaft. Produces best results in any type circuit for 175 to 625 meters.



SUPER 180° VARIOCOUPLER

R521 Each 98c
 A wonderful value, produces excellent results. Green silk windings on black fibre tubes. Rigid mounting support for table or panel mounting. Primary tapped for fine tuning. 1/4 inch shaft. Suitable for any type circuit 200 to 600 meters.



SUPERIOR VARIOCOUPLER

R523 Each\$3.15
 A handsome instrument of superior design and construction. Stator tube and rotor ball of moulded red brown bakelite. Large size green silk windings insure highest efficiency. Table or panel mounting. 1/4 inch shaft. Superior results in circuits for 180 to 650 meters. Tapped primary for finest tuning. Noiseless contacts.



R526 Special single circuit type.....\$3.60

SUPER MOULDED VARIOMETER

R412 Each\$2.60
 Polished black moulded rotor and stator forms. Maximum inductances with greatest efficiency and minimum distributed capacity. A high grade durable instrument that will make up into a set that will get the best results. Wave length 180 to 900 meters.



EXCEL MOULDED VARIOMETER

R524 Each\$3.68
 A wonderful value at our price. Properly designed and constructed. Polished black bakelite rotor and stator forms. Large size. Green silk wire insures greatest efficiency. 1/4 inch shaft. Noiseless pigtail connection. Table or panel mounting.



SUPERIOR VARIOMETER

R525 Each\$4.45
 Forms moulded of red brown bakelite. A neat handsome instrument. Green silk windings calculated for highest efficiency. 1/4 inch shaft. Noiseless pigtail connections. Table or panel mounting. Produces superior results in any type circuit 180 to 650 meters.



RADIO INDUCTANCE COILS

Carefully made—fine looking coils. Highest efficiency. Low distributed capacity effect, low resistance—high self inductance. Very firm impregnation. Range given in meters when varied with .001 variable condenser. Mounted coils have standard plug mountings.



Turns	Range	Art No.	Not Mtd.	Art No.	Price
25	120-250	R301	\$0.39	R320	\$0.85
35	175-450	R302	.42	R322	.95
50	240-720	R303	.49	R323	1.02
75	390-910	R304	.54	R324	1.08
100	500-1450	R305	.58	R325	1.13
150	600-2000	R306	.63	R326	1.17
200	900-2500	R307	.72	R327	1.26
250	1200-3500	R308	.78	R328	1.35
300	1500-4500	R309	.82	R329	1.36
400	2000-5000	R310	.97	R330	1.57
500	2800-6100	R311	1.12	R331	1.63
600	4000-10000	R312	1.27	R332	1.78
750	5000-12000	R313	1.43	R333	1.93
1000	7900-15000	R314	1.70	R334	2.25
1250	9750-19500	R315	1.92	R335	2.45
1500	14500-26500	R316	2.18	R336	2.60

INDUCTANCE COIL MOUNTINGS

R340—3 Coil. Ea. \$3.40
 R341—2 Coil. Ea. 2.75
 Sturdy, rigid durable construction. Made of polished black bakelite.



COIL MOUNTING PLUGS

Made of moulded bakelite.
 R344 Plug for mounting "honey-comb" inductance coils. 48c
 R345 Stationary plug to fasten mounted coil stationary to panel 89c
 R346 Movable plug to fasten mounted coil to panel so it can be rotated \$1.10



HIGH-GRADE LIGHTNING ARRESTER

R981 Each75c
 A dependable protector, always on guard. Small and compact. Weatherproof porcelain case. Easily fastened and connected.



OUR SPECIAL VARIOMETER AND VARIOCOUPLER



Build into your set reliable instruments. You can depend on this variometer and variocoupler to give you the best results in any circuit working from 180 to 650 meters. In design and construction they are the best. Only the highest grade materials are used. The prices quoted save you 30 to 40 percent. Why pay more?



R418 Variocoupler. Each\$2.45
 The most efficient type of coupler. Insures better tuning and louder signals. Primary and secondary wound on natural uncolored genuine bakelite tubes. Handsome green silk windings. Primary tapped for fine tuning. Can be panel or table mounted. 1/4 inch shaft.

R410 Variometer. Each\$2.10
 Perfect in design and construction. Accurate wood forms thoroughly seasoned. Correct inductive ratios. Solid baked windings. Plenty of large sized wire insures highest efficiency. A strong high grade instrument that will give you lasting service. 1/4 inch shaft.

MAGNET WIRE

Insulated copper wire. Best quality even drawn wire, one piece to a spool. Prices quoted are for 8 oz. spools unless otherwise stated.

Double Cotton Covered		Enamelled Insulation		Double Green Silk Covered	
Number	R990	Number	R992	Number	R991
Gauge	Price	Gauge	Price	Gauge	Price
18	43c	20	39c	20	\$0.78
20	55c	22	50c	22	.95
22	70c	24	55c	24	1.10
24	80c	26	60c	26	1.38
26	90c	30	65c	30 (4 oz.)	1.25
28	\$1.05	32	70c	32 (4 oz.)	1.65
30	1.45	36	90c	36 (4 oz.)	2.20

ANTENNA INSULATORS

R260 Size 1x3/4. Two for17c
 R264 Size 1 1/2x4. Two for69c
 R266 Size 1 1/2x10 1/2. Two for\$1.28

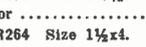

LEAD-IN INSULATORS

R270 For 4 inch walls or less42c
 R271 For 9 inch walls or less69c

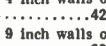

The only practical lead in insulator for aerial wires. Small, neat, effective, durable. Fits 1/2 inch hole. Securely locked by two adjustable nuts.

OUTDOOR LIGHTNING ARRESTER

R980 Price\$1.55
 Protect your instruments with this lightning arrester. You cannot afford not to. Weatherproof porcelain case. Air gap type. Permanent. Durable. The most practical quality arrester obtainable. Underwriters approved.



SPIDER WEB COILS

R290—25 turn. Each.....35c
 R291—35 turn. Each.....37c
 R292—50 turn. Each.....43c
 R293—75 turn. Each.....48c
 R294—100 turn. Each.....52c
 A new popular type of inductance of highest efficiency. Lowest distributed capacity and high frequency resistance. Firm green silk windings with fibre mounting strips.

REINARTZ INDUCTANCE

R296 Each\$1.10
 Made of green silk covered wire, spiderweb wound to produce greatest efficiency and lowest losses. 21 taps so arranged that crossing is avoided. Two fibre strips and wooden rod furnished permit various styles of mounting. With this coil a high grade set can be built at a low cost. Directions included.



ULTRA AUDION COIL

R296 Each78c
 Spider web wound of green silk covered wire. Four taps. Produces wonderful results. Fibre strips and wooden rod for mounting included. Directions furnished.

PANEL MOUNTING VARIABLE CONDENSERS

These are especially high grade condensers and we guarantee them to be mechanically and electrically perfect. Fine polished end plates of heavy bakelite. Shafts 1/2 inch diameter. Sturdy, heavy aluminum alloy plates perfectly spaced to insure smooth, even, reliable capacity. Our low prices are you money! These condensers are of the very best make and are not to be compared with many inferior, cheap condensers offered. We guarantee them to please you or your money back. The vernier style has one separately controlled plate which permits of the finest tuning.



REGULAR STYLE

R815—3 plate79c
 R816—5 plate97c
 R814—11 plate .0025 mfd.\$1.35
 R813—21 plate .0005 mfd.1.45
 R812—43 plate .001 mfd.1.73

VERNIER STYLE

Including Dial and Knobs
 R825—14 plate .0025 mfd.\$2.45
 R824—28 plate .0005 mfd.2.85
 R826—46 plate .001 mfd.3.15

STRANDED ANTENNA WIRE

Cabled of fine copper strands. Very flexible. High tensile strength. Best for aeriels.
 R248—100 ft. coil 58c ..R249—500 ft. coil \$2.75

OUR SPECIAL AUDIO FREQUENCY AMPLIFYING TRANSFORMERS

R550 Each\$2.25
 The result of years of research work and experienced engineering. In quality of tone and volume of sound, the things a transformer is built for, we guarantee it to equal or surpass any other transformer. Neat in appearance. Carefully made. Fully mounted with plainly marked binding post connections. 5 to 1 Ratio. Wonderful results on one, two or three steps without distortion or howling. A quality item in every respect. Not to be compared with articles built for price only.



OUR SPECIAL SHIELDED TRANSFORMER

R551—3 1/2 to 1 Ratio. Each\$2.75
 R552—6 to 1 Ratio. Each\$2.75
 The same high grade style of transformer as above, enclosed in a metal case which completely shields it from any outside magnetic influences. Very attractive appearance and sturdy construction. Free from howling and local disturbances.



THORADSON AUDIO FREQUENCY AMPLIFYING TRANSFORMERS.

R232 Ratio 3 1/2 to 1. Each\$3.40
 R233 Ratio 6 to 1. Each\$3.80
 Recognized by leading radio engineers as the best balanced and most efficient transformer. Correct characteristics for any standard tube. Wonderful results without distortion on one, two or three steps. Plainly marked binding post connections on bakelite panel.



OTHER STANDARD BRANDS AUDIO FREQUENCY TRANSFORMERS

Fresh, clean stock in original containers.
 R553 Acme. Each\$4.45
 R554 Coto. Each4.45
 R555 Federal. Each4.45
 R712 Radio Corp. Each6.40

RADIO FREQUENCY AMPLIFYING TRANSFORMER

R560 For 201A or 301A Tubes.\$1.70
 R561 For 199 or 11 or 12 Tubes1.70
 Due to its special design this transformer will produce wonderful results in any type of regular or reflex radio frequency circuit. While low in price we believe it equal or superior to higher priced transformers. Perfect for one, two or three stages. Compact, convenient form, easily mounted. Range 175 to 600 meters. Try it. If you are not satisfied return it and get your money back.



OTHER STANDARD BRANDS RADIO FREQUENCY TRANSFORMERS

R562 Dubilier. Each\$4.45
 R563 Coto. Each4.45
 R564 Rasia. Each4.45
 R565 Acme. First stage. Each4.45
 R566 Acme. Second stage. Each4.45
 R567 Acme. Third stage. Each4.45
 R714 Radio Corp. Each5.95
 R995 All American. Each3.75

LONG NOSE PLIERS

R970 Price95c
 The handiest pliers for radio work. Made of fine hardened steel. Length, 5 inches.



DIAGONAL JAW NIPPERS

R972 Price\$1.05
 For fine electrical work. Made of hardened steel. Length 5 inches.



SUPER BLOW TORCH

R544 Each39c
 Burns denatured alcohol. Vest pocket size. Blowing on tube produces a hot pointed flame. Lights with a match. Works fast. Burns 10 minutes on one filling. Easy to solder joints in hard places. 3 inches high, 1/2 inch cylinder. Long rubber tube. Produces fine joints with Tinol listed above.



FOUR-IN-ONE SCREW DRIVER

R974 Each55c
 Especially suitable for radio work. Will handle any size screw used. Smaller drivers nest inside larger one and are held in place with screw cap. Made of steel, nickel finished.

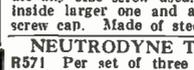

NEUTRODYNE TRANSFORMERS

R571 Per set of three\$4.95
 An air core transformer for use in neutrodyne method of reception. Can also be used for tuned radio frequency or as a fixed coupler with condenser across secondary. Proper design for results and efficiency. Green silk windings on bakelite tubes with adjustable mounting brackets to fit most any condenser.

NEUTRALIZING CONDENSERS

R572 Per set of two40c
 Simple, inexpensive, effective precision type. Micrometer adjustment is attainable. Easily mounted in circuit.

ENCLOSED VARIABLE CONDENSERS

One of the best made condensers. Rigid, accurately spaced aluminum plates. Formica ends. Engraved scale. Knob and pointer. Clear transparent case.
 R806 43 plate .001 Mfd. \$2.80
 R808 21 plate .0005 Mfd. 2.45



THE BARAWIK CO.

Chicago's Original Radio Supply House Beware of Imitators

102 South Canal Street

CHICAGO, ILL.

WITH BARAWIK STANDARD RADIO GOODS

VACUUM TUBES

Standard Brands—Cunningham Radiotron. Every one guaranteed new and perfect. We will ship brand in stock unless you specify otherwise.

- R105 Detector, UV200 C300 Ea. \$4.30
- R112 Amplifier, UV201A C301A 5.95
- R107 5 Watt Transmitter..... 7.70
- R107 WD11 C11. Each..... 5.95
- R101 WD12 C12. Each..... 5.95
- R102 UV199 C299. Each..... 5.95
- R104 UV199 Adapter fits 199 tube to standard socket..... 42c
- R108 WD11 Socket, Each..... 35c
- R109 WD11 Adapter. Each..... 48c

STANDARD TUBE SOCKET

R140 Each.....39c

Moulded of genuine red brown bakelite. Binding post connections. For table or panel mounting. Neat and strong.



METAL TUBE SOCKET

R146 Each.....42c

A strong durable socket for panel or table mounting. Metal tube and base. Plainly marked binding post connections well insulated.



TWO AND THREE GANG SOCKETS

These sockets make it easy to build detector and amplifier units and make a neat, compact workmanlike job. Perfectly made of high grade materials. Quickly mounted on panel or base.

- R147 Two-gang socket.....95c
- R149 Three-gang socket.....1.30

199 SOCKET

R145 Each.....49c

Moulded of high insulating material. Sponge rubber base prevents ringing in tube. Plainly marked binding post connections. Neat and compact.



FILAMENT CONTROL RHEOSTATS

- R132 6 ohm. Each.....45c
- R129 20 ohm. Each.....52c
- R131 30 ohm. Each.....59c
- R135 6 ohm Vernier.....95c

Best grade. Will give real service. Durable and lasting. High heat resisting base, diam. 2 1/2 in. Tapered polished black knob 1/4 in. diam.



POTENTIOMETERS. Match above rheostats. Same high grade construction.

- R151 200 ohm.....79c
- R152 400 ohm.....79c

SUPERIOR RHEOSTATS

- R153 6 ohm. Each.....69c
- R154 20 ohm. Each.....76c
- R155 30 ohm. Each.....83c

The finest rheostat. Smooth, even action. Best design, best workmanship. Supplied with attractive dial and knob. A rheostat for high grade sets.



POTENTIOMETERS to match above rheostats, with dial and knob.

- R156 375 ohm.....98c

QUICK ACTING VERNIER RHEOSTAT

- R124 6 ohm.....79c
- R125 15 ohm.....88c
- R126 30 ohm.....99c

Vernier adjustment at every degree of resistance. Pushing knob in turns off the filament.



THREE INCH DIAL

- R923 For 3-16 inch shaft. Each.....19c
- R924 For 1/4 inch shaft. Each.....19c
- R925 For 3/8 inch shaft. Each.....19c

A handsome neat looking dial moulded in one piece of polished black composition. 180° scale marked 0 to 100 finely engraved in contrasting white enamel. Diameter 3 inches.



TWO INCH DIAL

- R921 For 3-16 inch shaft. Each 16c
- R922 For 1/4 inch shaft. Each 16c

A handsome dial moulded in one piece of polished black composition. 270° scale marked 0 to 100 finely engraved in contrasting white enamel. Fine for rheostat or switch control. Diameter 2 inches.



BAKELITE DIALS

- R931—2 in. Diam for 3-16 inch shaft. Each.....32c
- R932—2 in. Diam for 1/4 inch shaft. Each.....32c
- R933—3 in. Diam. for 3-16 inch shaft. Each.....33c
- R934—3 in. Diam. for 1/4 inch shaft. Each.....33c
- R935—4 in. Diam. for 1/4 inch shaft. Each.....40c

Moulded in one piece of genuine bakelite in polished black finish. Finely engraved scale in contrasting white enamel. Sure grip knob that fits the fingers. Higher grade dials for good sets. Sizes match perfectly.



COMPETITOR JACKS

- R387 Open circuit. Each.....27c
- R388 Two circuit. Each.....35c

Well made, durable smooth working, nickel finished frame. Well insulated.



WE PAY TRANSPORTATION CHARGES EAST OF THE ROCKIES PRESERVE THESE PAGES—ORDER FROM THEM AND SAVE MONEY FAST SERVICE—TRY US AND BE CONVINCED

THE PRICES QUOTED DELIVER THE GOODS TO YOUR DOOR OUR GUARANTEE PROTECTS YOU—We handle only the best goods carefully tested and checked by expert radio engineers. You are assured of getting guaranteed apparatus that will give superior results. And while our goods are best, our prices are lowest. Our goods equal or surpass the claims we make for them. We do not attempt to deceive or mislead. Our reputation for fair dealing is our most valued asset.

HOW TO ORDER—Write your Order plainly, state Article Number, Description and Price of items wanted. Send Postoffice or Express Money Order, Certified Check or Bank Draft for Total of Order. Prompt Shipment is assured when these directions are followed.

VERNIER DIAL ADJUSTER

R941 Each.....19c

Easily installed at edge of dial gives finest vernier adjustment of condenser or inductance. A great value. Polished black knob.



ENCLOSED DETECTOR

One of the finest crystal detectors on the market, supersensitive galena crystal enclosed in heavy glass shield. Quick, positive adjustment. Brass parts polished nickel finish.

R730 Each.....89c



GALENA DETECTOR

Easy fine adjustment. Crystal mounted in cup. Moulded base and knob. Brass parts polished nickel finish. An unequalled value.

R732 Each.....59c



DETECTOR PARTS

R725 Price set.....23c

All metal parts for crystal detector. No base included. Easily assembled. Polished nickel finish.



SUPERIOR RADIO JACKS

Finest grade jacks. Improved design. Best materials. Phosphor bronze springs. Silver contact points. Nickel finish. Mount on panels 1/2 to 3/8 in. thick.

- R390 Open circuit. Each.....38c
- R391 Closed circuit. Each.....46c
- R392 Two circuit. Each.....55c
- R393 Single circuit filament cont.....59c
- R394 Two circuit filament cont.....76c



SUPERIOR VARIABLE GRID RESISTANCE

R167 Each.....80c

R168 With .00025 Condenser.....95c

Eliminates hissing, clarifies signals. Capacity smoothly varied from 0 to 8 megohms by half turn of knob. Easily mounted on any panel.



TUBULAR GRID LEAKS AND CONDENSERS

Very convenient. Permit of quick change of leaks or condensers of varying capacity. Cut shows leak mounted. Leaks and condensers have same appearance. Each part priced separately.

- R849 Grid Leaks. Each.....18c

RESISTANCES—1/2, 1, 1 1/2, 2, 3, 5, 7 and 10 megohms. Specify which size is wanted.

- R831 Grid and Plate Condensers. Each.....39c

Capacities—.00025, .0001, .00025, .0005 mfd. Specify which size is wanted.



MOUNTINGS

Bakelite base. Spring clip contacts.

- R840 Single mounting. Each.....29c
- R842 Double mounting. Each.....49c
- R844 Triple mounting. Each.....69c

HYDROMETER

R190 Each.....48c

Accurately tells you the condition of your storage battery. Helps you keep your battery in better condition.



BARAWIK QUALITY HEADSETS

R770 Per Set. 2000 ohms.....\$3.25

These headsets have proven on rigid tests to be one of the very best on the market. The tone quality is excellent with an unusual volume. Skilled workmen make them from only the best selected materials. The receiver cases are fine polished finish with polished black ear pieces. Fabric covered head band comfortably and quickly fitted to the head. Supplied with 5-foot cord. These sets were designed to sell for much higher prices than we ask, and at our price are a wonderful bargain. We guarantee that you will be pleased with them and agree that they are the best value by far yet offered. If they don't suit you we will cheerfully return your money.

STANDARD BRAND HEADSETS

- R754 Baldwin Type C with universal jack plug.....\$11.75
- R756 Red-Head, 3000 ohm 5.78
- R768 Brandes, 2000 ohm 5.35
- R751 Murdock 58, 2000 ohm.....4.20
- R769 Brandes, 3000 ohm 6.95
- R752 Murdock 58, 3000 ohm.....4.95
- R764 Frost, 2000 ohm.....4.20
- R766 Frost, 3000 ohm.....4.35
- R758 Western Electric.....9.50



SWITCH LEVERS

Very neat polished black composition knob. Exposed metal parts polished nickel finish. Fitted with panel bushing, spring and two set nuts. A high grade switch.

R381 1 1/4 in. Radius. Each 15c



SWITCH LEVER STOP

Brass polished nickel finish.

R386—Dozen 18c Hundred \$1.05



CABINETS

Fine looking cabinets solidly built. Elegant hand rubbed finish. You will be proud of your set mounted in one of these cabinets. Hinged tops. Front rabbeted to take panels. Panels not included. Prices are transportation paid.

Panel Size	Inside Dimensions			Art. No.	Price Each
	High	Wide	Deep		
6x 7"	5 1/2"	6 1/2"	7"	R420	\$2.35
6x10 1/2"	5 1/2"	10"	7"	R422	2.75
7x14"	6 1/2"	13 1/2"	7"	R423	3.35
7x18"	6 1/2"	17 1/2"	7"	R426	3.75
7x21"	6 1/2"	20 1/2"	7"	R425	3.85
7x24"	6 1/2"	23 1/2"	10"	R429	4.65
9x14"	8 1/2"	13 1/2"	10"	R428	3.55
12x14"	8 1/2"	13 1/2"	10"	R430	4.65
12x21"	11 1/2"	20 1/2"	10"	R432	5.45



RADIO "BAKELITE" PANELS

Notice our very low prices on this fine quality material. We supply genuine Bakelite, Condensite Celoron or Formica, all of which are materials with practically identical mechanical, chemical and electrical properties. Machines well without chipping. Won't warp. Waterproof. Highest mechanical and dielectric strength. Attractive natural polished black finish which can be sanded and oiled.

Panel Size	Inches	1/4" thick			3-16" thick			1/2" thick		
		Art. No.	Price	Art. No.	Price	Art. No.	Price			
6x7	R450	\$0.50	R460	\$0.75	R470	\$0.98				
6x10 1/2	R451	.75	R461	1.11	R470	1.47				
7x14	R458	1.20	R468	1.80	R478	2.40				
7x18	R453	1.55	R463	2.30	R473	3.10				
7x21	R457	1.78	R467	2.65	R477	3.60				
7x24	R459	2.10	R469	3.16						
8x14	R454	1.66	R464	2.30	R474	3.10				
12x14	R455	2.10	R465	3.10	R475	4.15				
12x21	R456	3.15	R466	4.65	R476	6.20				

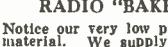

INDUCTANCE SWITCH

R365 Price including knob and dial.....\$1.29

Mounts switch points and contact lever behind panel. Only one hole needed to mount. 15 switch points, any number of which may be used. Smooth wiping contacts. Attractive tapered knob.



SUPERIOR INDUCTANCE SWITCH

R386 Each.....79c

Quickly and securely mounted by drilling one hole. Only knob and pointer show in front of panel. Connections can be soldered before fastening switch, making assembly much easier. Metal parts nicked. Bakelite knob and supporting base.



PLATE CIRCUIT "B" BATTERIES

You can make real savings on these batteries. Don't pay more. We guarantee them to equal any on the market regardless of price. Absolutely uniform. Extra long life.



R180 Signal Corps type, small size. 15 cells, 22 1/2 volts. Each...\$1.05

R184 Variable Large Navy size, 6 1/2 x 4 x 3 inches 5 taps, giving range from 16 1/2 to 22 1/2 volts in 1 1/2 volt steps. Each.....\$1.95

R188 Combination Tapped 45 volts, 30 cell. 13x4x3 battery. Tapped to give 45, 22 1/2, 21, 19 1/2, 18 and 16 1/2 volts. Handles both detector and amplifier tubes. Each.....\$3.75

"B" BATTERY METER

R189 Each.....98c

Reads 0 to 50 volts. Accurately tells you the exact condition of your B Battery. Convenient watch size. Polished nickel case with wire lead.



STORAGE "A" BATTERY

A very high grade battery made especially for radio service. Guaranteed for three years. Properly cared for will give many more years of service for filament lighting. Made of best new materials. Full capacity. The best battery buy on the market. Try one of these batteries on your set for 10 days. If at the end of that time you are not fully satisfied with the battery return it and we will refund the purchase price.

- R194 6 volt, 40 ampere size. Each....\$10.75
- R196 6 volt, 80 ampere size. Each.....13.25



HOMERCHARGER BATTERY CHARGING RECTIFIER

Charge your battery at home over night for a few cents. Simply connect any 110 volt 60 cycle light socket, turn on current and rectifier does the rest automatically. Will work for years without attention. Simple connections. Gives a tapering charge which should leave. You can make it pay a profit charging your friends' auto batteries. Long connecting cords with pair of battery clips.

Prices are Transportation Paid.

- R201 For 6 volt battery.....\$12.95
- R203 For 12 volt battery.....12.95



BATTERY CLIPS

R198 Two for.....28c

Clip onto storage battery terminals, lead coated. Make positive non-corrosive contact at all times.

WIRE CONNECTING CLIPS

R199 Per dozen.....30c

Small connecting clips for quick fastening leads onto binding posts, etc. Handy and useful. Every radioist should have at least a dozen.



SWITCH CONTACT POINTS

Brass polished nickel finish. All have 1/2 in. long size 6-32 screws and two nuts. All prices the same.

Dozen 18c Hundred \$1.05

Order by Article Number.

- R360 Head, 1/4 in.; Diam. 1/4 in. High
- R362 Head, 3-16 in.; Diam. 1/4 in. High
- R363 Head, 3-16 in.; Diam. 1-16 in. High

Solder Lugs to Fit Contact Points

Also for connecting wires to binding posts, etc.

R365 Dozen 8c Hundred 30c



BINDING POSTS

Brass, polished nickel finish. Washer and 6-32 in. screw extending 3/8 in.

- R370 Large size—barrel and knob 3/4 in. long, dozen.....85c
- R372 Smaller size—barrel and knob 9-16 in. long, dozen.....70c

VARIABLE GRID LEAKS

- R160 Standard style.....16c
- R161 De Luxe style with extra heavy screw top finely finished.....32c

1/2 inch mark type for panel mounting. Resistance may be varied exactly as needed.

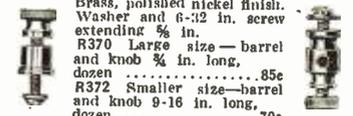

GRID CONDENSERS

Well insulated. Paper covering. Each.....8c

- R163 Highest grade. Mica insulated. Polished nickel case. Each.....23c

Fit over posts of above leaks. The combination makes an efficient unit. Cap. .00025 mfd.

SUPERIOR RADIO PLUGS

- R395 With set screws for fastening cord. Each.....35c
- R397 Two-way takes two pair any style cords. Each.....59c

Highest grade plugs. Fit any standard jacks. Polished round barrels.



BUILD YOUR SET WITH BARAWIK STANDARD RADIO GOODS



30 OHM
ARMORCLAD
RHEOSTAT \$1.00

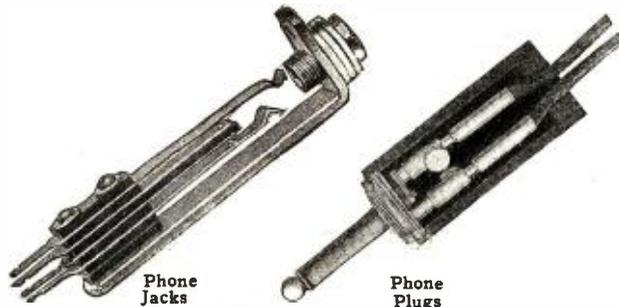

Phone
Jacks
65c. to \$1.10

Phone
Plugs
25c. to \$1.00



WD 11 Socket
75c.

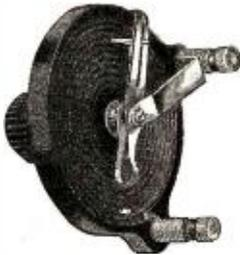

6 OHM VERNIER
RHEOSTAT \$1.50

American Dealers Sell Nothing Better



In addition to the
articles shown we
manufacture many
other accessories.

Circulars on request

MARTIN-COPELAND CO.

Providence, R. I., U. S. A.

Branches: New York. Chicago. San Francisco

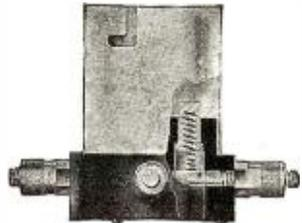

UV 199 Socket
75c.



Bezels
Any Finish
20c. to 35c.

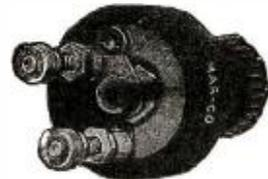

Variable Grid
Leak \$1.50



Pull Switch 90c.

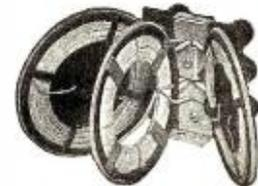

Tuner \$7.00

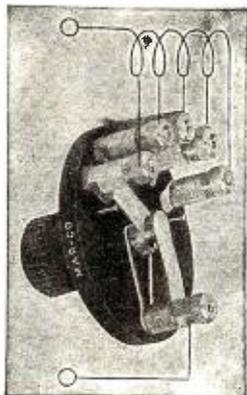

5 to 19 Point
Switches
\$1.00 to \$2.00



UV 199
Adapter
65c.



WD 11
Adapter
65c.



Multi-Plug
\$2.00



Knife Switches
60c. to \$1.50

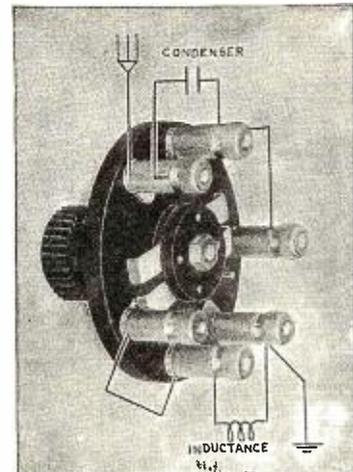

Series-Parallel
Switch \$1.25



RADIO NEWS

H. GERNSBACK—Editor and Publisher
ROBERT E. LACAULT—Associate Editor

EDITORIAL AND GENERAL OFFICES, 53 PARK PLACE, NEW YORK

Vol. 5

OCTOBER, 1923

No. 4

Needs Of the Radio Industry

THERE are a number of things in the radio industry which are at the present time very much mismanaged and which in the end act to the detriment of the entire art. Certain forces which do not show at all the old established American spirit have made themselves felt during the last year and it is of these that the writer wishes to speak.

At the present time the industry in many spots has sunk to the level of a "catch-as-catch-can" attitude. For example: A certain manufacturer who for eight or ten years has manufactured and gradually evolved a fine radio head set, suddenly finds that his product is copied by about a dozen imitators. The new-comers who do not know very much about the business, took the old established product—on which there are no patents—and copied it from the diaphragm down to the last nut. To be sure, after they got through with the copy it was not at all the same article as manufactured by the experienced manufacturer, for as everyone knows, there are tricks in all trades. Making a telephone head set is about one of the most difficult things that can be copied by an inexperienced manufacturer.

The same method of procedure has been followed with almost every radio instrument: rheostats, variocouplers, loud speakers, vacuum tubes and a host of others. In this the new-comers are actually being encouraged by the dealers and jobbers of radio materials. Here is the reason: The writer, not very long ago, happened to be in the main office of a well-known radio chain corporation which operates a number of stores throughout the country. He was speaking to the proprietor who is also the moving spirit. During the conversation a young inventor strolled into the office and pulled out a new sort of socket that looked extremely good and certainly was an improvement over the present sockets. It had no binding posts at all, but had something that was much better. It took up at least 25 per cent less room than the ordinary socket, and it was well made. The proprietor of the chain stores looked it over quizzically and praised it sky high. Very much encouraged, the inventor of the socket eagerly asked if he could get an order. The proprietor laughed and said, "Why should I give you an order and make trouble for myself? You have a fine article, but I cannot afford to 'buck' the conventional sockets. This socket would no doubt sell lower than the ones we carry now. This means more sales to be made, less profit to us and more work. Also, every time we would try to sell your socket it would mean an explanation by our salesmen. We are not in the business to make explanations—we want to sell goods in the minimum of time. The more explanations we have to make the less time we have to sell goods."

The inventor listened to all this and became much crestfallen and finally ventured to ask what the solution was. The chain-store operator told him that if he would advertise the article and create a demand for it then there would be no trouble about selling his product, but that he was not in the business as pioneer for unknown manufacturers.

And so it goes. The above should be an object lesson to all would be inventors and designers of radio material. If they are not prepared to spend some money in introducing and popularizing their products, nine times out of ten, the proposition will not go over. For that reason most inventors become discouraged and simply copy everything in sight, thereby following the un-American path and at the same time the path of least resistance.

If an example of the socket instance is needed, we might cite the case of a famous loud talker. For several years it would not sell at all. It was a high-grade, high-priced instrument and there was but little demand for it. The manufacturers had an excellent

product—of this they were convinced. Finally, after interesting capital, they started an advertising campaign in all the national magazines and many of the newspapers throughout the country. They kept this up and are still at it now in an ever increasing way. The product today is famous. Every ten year old child knows it by name and there is hardly a dealer in the country who can afford to keep it off his shelves. Here is an article that had merit in the first place and that was built up and put over in a big way despite early handicaps.

There are other types of manufacturers who become convinced, to their own satisfaction, that their new radio apparatus is a world beater. Without thought they rush into the manufacture of such an article, tooling up for it at a great expense and ordering thousands and tens of thousands of screw machine pieces, stampings, windings and what not. The last thought in their minds is: Will the thing sell? After the first few thousands have been turned out and orders perhaps secured, it is found that the article, for some reason or other, does not take with the public. Whereupon the manufacturer closes up shop. This happened in quite a good many instances. It shows how not to do it.

The right procedure is to make a model and take it around to one or two dozen dealers. *No time and money should be spared to make this model look like the ultimate article.* Write down carefully the answers and the impressions of the dealers. Then in addition to this, visit personally twelve or more radio amateurs, by which is meant those who really understand radio and are not merely broadcast fans who do not know much about the art. Write down their answers and impressions. If more than half of each group, dealers and amateurs, condemn the apparatus or instrument, or are lukewarm, it is a safe bet that it should be left alone. Its success will not be assured. If, however, the consensus of opinion is that the article is a good one, then there should not be any hesitancy in going ahead. It is better to be sure than to be sorry later.

It is our recommendation that in spite of the instance of the chain-store operator cited above, we should leave the beaten track. There is room for many improvements in much of our radio material today. Just to mention a few: Most of our instruments are vastly too large. Take for instance our variocouplers and variometers. There is no reason at all why they should be so big and clumsy. Our present mesh plate condensers are a monstrosity from an electrical and radio standpoint. They take up too much room and accumulate dust between the plates which decreases the efficiency; they have sharp edges and sharp corners from which the radio energy leaks like water through a sieve. We venture to predict that within five years such condensers will be found only in museums.

Our present telephone receivers are anachronisms of a bygone age. These are not radio instruments at all, having never been designed as such. The Germans are fast getting the better of us in telephone receivers and soon their competition will become serious if we don't watch out. They already have on the market head sets that weigh less than 1-6 of ours, some of them small enough to actually fit the ear opening. The English are also making one designed upon sound radio principles, one-fourth of the thickness of our present-day receivers and built along strict radio lines.

We are still waiting for the single control, single dial radio outfit that the layman can really operate without being a radio expert.

Someone will make some of these changes and if he does so in the right way, he will make a fortune.

Get off the beaten track!

H. GERNSBACK.

The Radio Amateur in a New Field

By HERBERT H. FOSTER

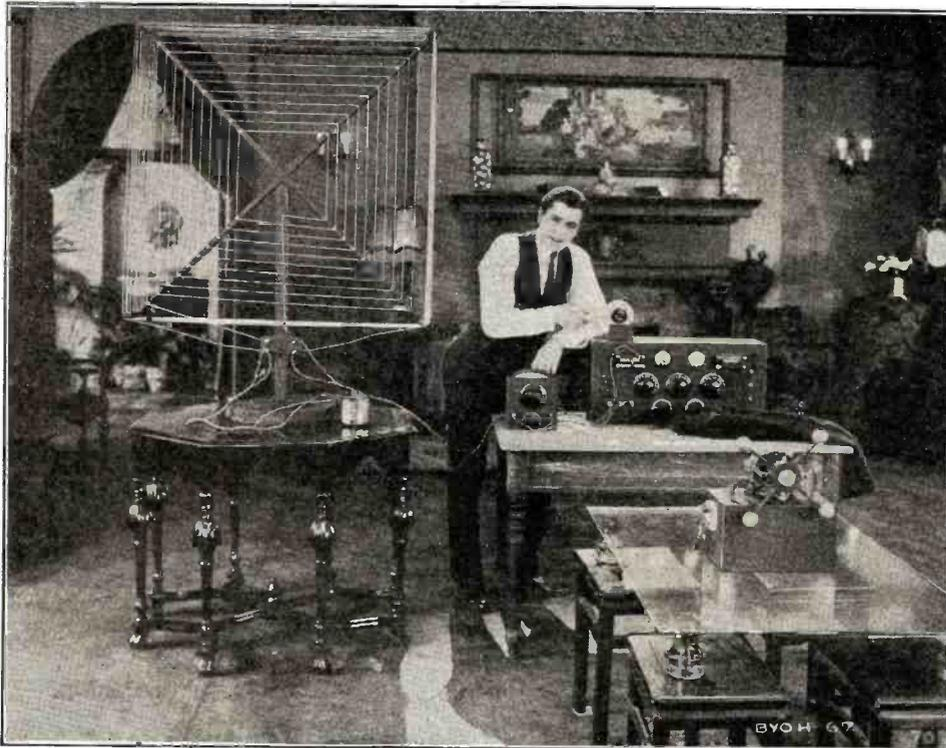

Courtesy of Film Booking Office
Warner Baxter, As Jack Dunbar, Is Telling the World That His Set Brings In Hong Kong As Clear As a Bell On Nothing More Than An Indoor Loop Aerial.

IN the last issue of RADIO NEWS Mr. Foster explained how the inclination of authors and scenario writers to gradually bring the employment of radio into their plots would open up a new field to the radio amateur who is even now finding a permanent place on the technical advisory staffs of the better producing companies. Mr. Foster witnessed the production of a picture adapted from "Blow Your Own Horn," the successful play by Owen Davis, in which the radio amateur has been called to direct the installation and operation of as fine an array of radio apparatus as has ever been used in a motion picture. In this issue Mr. Foster has written a synopsis of the picture as he saw it run, upon its completion. *Editor's Note.*

"Blow Your Own Horn"* SYNOPSIS

JACK Dunbar returns from the World War broke and jobless; Buddy, his little brother, and all that remains of his family, is determined to meet Jack, money or no money. So he quits the farm of Mr. and Mrs. Smedley where he was staying during Jack's absence and boards a box car, arriving in Boston early in the morning, and after many setbacks, he finally finds Jack.

Jack and Buddy, after a three weeks' sojourn in Boston start for home. On the road they meet Mr. Small, a man of means, tinkering with his car. Jack volunteers to help and finally succeeds in getting the engine in running order.

As Jack and Buddy continue up the road, Buddy spots a farmhouse and suggests that they try to get some lunch. Cutting across the lots they meet Ann, the daughter of Mr. Small, who was taking a walk while her father struggled with the car.

Mr. Small and his daughter are on their way to the Jolyon mansion where they are eagerly awaited by Mr. Jolyon who, being in financial straits, hopes to form an alliance

between Augustus, his son, and Ann, the heiress to the Small fortune. But Augustus is at present absorbed in an invention with which he hopes to bring about the wireless transmission of power.

Mrs. Yates, together with her daughter, Julia, and her small son Percy, is the guest of Mr. Jolyon. Mrs. Yates is constantly on the lookout for two husbands, one for herself and one for her daughter, Julia. She has already picked Mr. Dinsmore Bevan, a bitter business enemy of Mr. Small's, as fair game for herself.

Meanwhile, Jack and Buddy have arrived on the Jolyon grounds. Jack sends Buddy to the village for food, while he applies for a job. Buddy is to meet him there when he returns. Mr. Small recognizes Jack, and watches him hesitantly ring the bell. He conceives the humorous situation of thrusting Jack on the guests as a millionaire. A guest of the house overhears Mr. Small talk of Jack's wrecked Rolls Royce and very rapidly and effectively spreads the news that Mr. Small is entertaining a millionaire on the grounds. The guests all gather round him and make him welcome, fitting him out, also Buddy, when he arrives, in clothing borrowed from Augustus and little Percy.

Augustus tries to interest Bevan in his invention, a means of transmitting power by radio, but the financier doesn't believe it practical. Augustus tells Jack of his invention, and Jack says that with the aid of his knowledge of wireless, he will be able to make the thing work. Augustus promises Jack half interest in the invention if it is successful. Bevan buys Jack's half interest for a half million giving him a check for \$50,000 on account. Small remonstrates with Jack, but Bevan's sarcasm decides Mr. Small to let Jack go ahead with the plan.

The interest between Jack and Ann is growing steadily and Mrs. Yates looks on jealously, as she was hoping to be able to make a match with Jack for her Julia.

Ann and Augustus, in accordance with their respective fathers' wishes, announce their engagement. Jack is heartbroken and buries himself in an attempt to perfect Augustus' invention. Upon its completion a test is made, and their efforts are crowned with success on a small scale. Jack's suggestion that Ann will be pleased, and Augustus' wistful expression that he would like to find some way out of the marriage proposition makes Jack realize that there is no real love between the two. He presses his suit and is accepted by Ann, but he is denounced

(Continued on page 424)

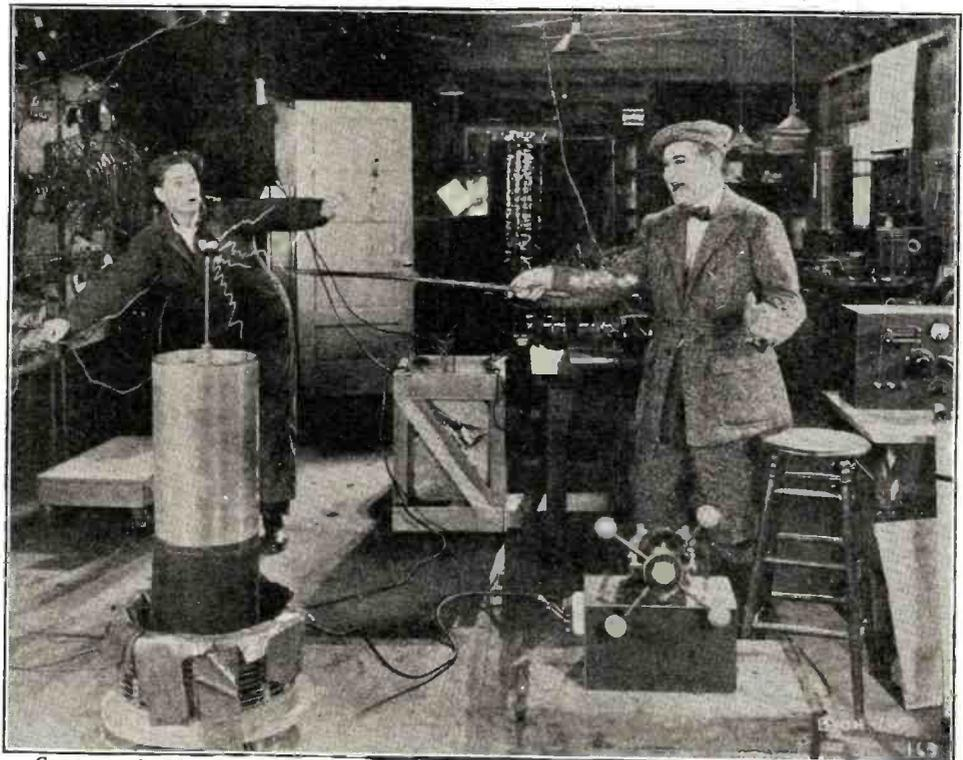

Courtesy of Film Booking Office
And Here We Have the Villain, Ernest C. Warde, Who As Gillen Jolyon Is Trying To Wreck Dunbar's Apparatus and His Hope of Proving His Success In Transmitting Power Via Radio. William H. Turner, As Dunbar's Pal, Dinsmore Bevan, Is Just Getting Ready To Take the Air and Pull the Hook In the Nearest Fire Alarm Box.

(*From the play of that name by Owen Davis)

Learn While You Sleep

By J. N. PHINNEY*

IN order that no one in the naval service may be subjected to criticism for ascribing actual results obtained to a heretofore little understood branch of scientific investigation, I will confine my description of the experiments and their results very closely to the ground covered in reports made on them. These reports are substantiated by the written statements of the students who benefited by the experiments. I will be allowed considerable more leeway, however, in commenting on observations that led up to these experiments, as no one is implicated but myself.

In my early youth I greatly admired the achievements of Thomas A. Edison as telegraph operator and experimenter and decided to follow his example. In the old days, however, our present scientific methods of instruction were not available, so I became a "ham operator" by hanging around railroad telegraph offices, exchanging my services for the chance to learn.

LEARNED WHILE HE SLEPT

At the age of seventeen, between terms at a school of technology, I landed my first job as a railroad telegrapher, handling a night trick on a slow line. I was quickly forced to conclude that I could not hold down the job unless I increased my speed at once in some miraculous manner. I was desperate. I deliberately slept alongside the main line relay, which was always clattering away much faster than I could copy.

In a surprisingly short time I was able to read the fastest operator on the main line. The miracle had occurred; somehow I had learned while I slept.

Contact with many operators in after years has convinced me that a large percentage of the best of them have acquired their speed in the same manner—nature's miraculous method, accidentally rather than scientifically applied as in the device so well conceived by H. Gernsback, the Editor of *Science and Invention*.

An SOS awakens the radio operator. His station call will arouse any railroad telegrapher. Subconscious mind calls the sleep-

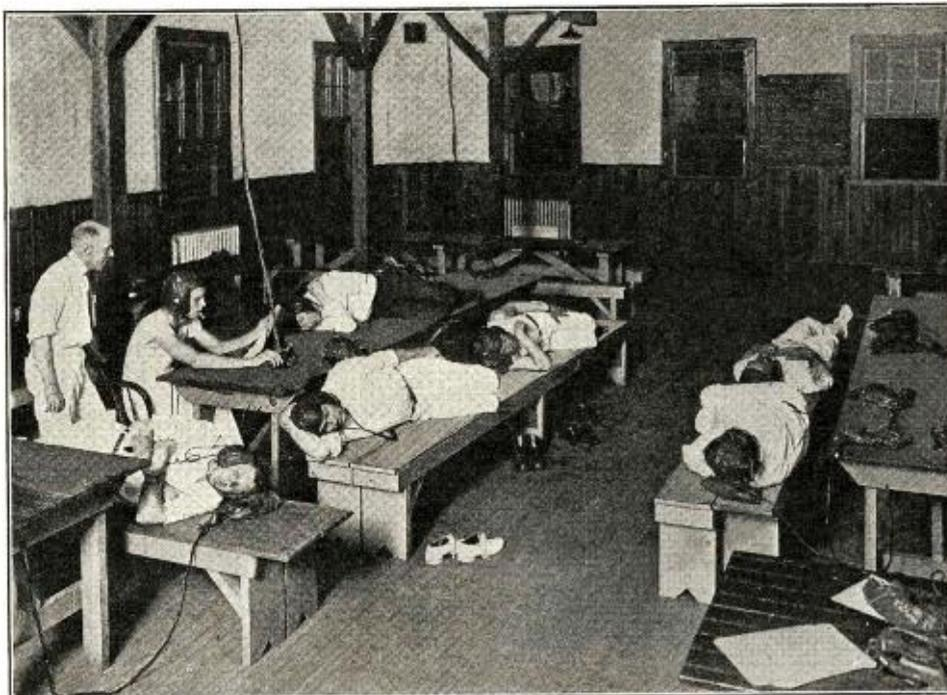

Probably One of the Most Interesting Experiments in Connection with the Sub-Conscious Mind Was That Carried On at the Navy Training School, Pensacola, Fla., in Which Men Were Taught the Continental Code While Asleep. J. N. Phinney, the Originator, is Seen in the Photograph, Directly Behind the Man at the Key.

IN the December, 1911 issue, Mr. H. Gernsback, then Editor of *Modern Electrics*, in his story, "Ralph 124 C 41 +", described the *Hypnobioscope*, an instrument to teach and impart knowledge to a sleeping individual. In the December, 1921 issue, Mr. Gernsback in *Science and Invention* again brought the matter to life, but treated the subject somewhat differently. While fantastic at the time of writing, the two articles proved prophetic as will be seen from the fulfillment of the invention from Mr. Phinney's article.

ing traveler when the bell boy falls down on the job. The drunkard escapes injury in miraculous ways when his active mind is completely befuddled and the sleep walker never comes to harm if not awakened. Psychology or what not, these things we all know are true.

I was again forced in 1914 to apply the principles of subconscious learning to myself. I was radio operator at the Naval Radio Station, Jupiter Inlet, Florida. The cable broke between Nassau and the United States and all cablegrams had to be handled by radio. I was the only land wire operator and the excess traffic handled necessitated my working with a crack operator at Jacksonville whose speed was too great for me. A few nights' sleep alongside an electrically driven automatic sending device fixed me right up.

NUMEROUS SUBJECTS CAN BE LEARNED

I concluded at that time that I could learn other subjects besides radio and telegraph codes if I could get an automatic device that would repeat the subject matter desired over and over while I slept.

Since then I have tried every automatic dictating device procurable, including an

apparatus similar to the one so well described in the December, 1921, issue of *Science and Invention* by H. Gernsback, on myself and others, and have conclusively proved from actual results obtained that many difficult subjects can be easily learned while asleep.

As a result I have become firmly convinced from these observations that, as eminent psychologists state, a part of the human brain continues to function while the body and the conscious brain remain dormant and that the device explained by *Science and Invention*, therefore, will do its work. This system was first tried on a doctor.

About a year ago, twelve medical officers of the U. S. Navy started our flight course. They were to qualify as pilots, taking all ground school subjects, including the dreaded radio. One, who was a noted specialist in psychology, expressed a willingness to try my "Learn While You Sleep" method, after I had explained the foregoing ideas.

I equipped his bedroom with a key and the regular aviation radio telephone head set as shown in the illustration, and myself and assistants sent radio code to him all night. We started at 10:30 p. m. He had copied with pencil about thirty minutes and then retired, dropping asleep about an hour later. He had acquired a speed of fifteen cipher groups per minute in class, but had never copied plain English words or sentences.

AWAKENS AT THE WORD "DOCTOR"

One conclusive proof of the feasibility of the idea was to be gained by our ability to awaken him with a message. Look at the cipher group. It never had meant anything to him or any other person, being in fact purposely undecipherable.

B X 3 Z F

Even while awake, no one had ever sent him a message by radio. His training had been copying letters only. How make his subconscious mind group letters into a word and react to the word? We started politely,

(Continued on page 476)



We Have Reproduced Herewith the Cover of *Science and Invention* Magazine, Portraying Mr. Hugo Gernsback's Conception of a Machine for Impressing Thoughts Upon the Sub-conscious Mind. This Is But Another Case Where Past Predictions Have Manifested Themselves in Systems of Actual Practice.

*Chief Radioman, U. S. Navy.

How It Feels To Broadcast

By THORNTON FISHER*



"Good Evening Ladies and Gentlemen," I Managed to Blurp (Having Heard the Announcer Use That Line as a Stock Phrase). There Was No Response. Somehow or Other One Expected an Answer. Instead, That Mute Disc Just Stared. It Seemed So Utterly Stupid Just to Be Talking Into That Thing—a-ma-jig at the Other End of Which There Was No Sign of Life.

I HAVE had six teeth extracted, earache, Neuralgia and a couple of carbuncles. I have looped and nose dived in an aeroplane over New York City and raced in a roaring, death-defying speedster at the rate of 110 miles per hour. Not once, but many times. Sitting at the ringside it has been my function to watch champions fall from cruel killing blows calculated to annihilate anything save a well conditioned youth long trained to assimilate fearful physical punishment but — I experienced the supremest thrill of all a few nights ago when I stood before a silent staring diminutive disk at the other end (or *was* it the other end) of which, a conscienceless announcer explained, sat three or four hundred thousand radio nuts. It was the thrill that comes once in a lifetime. You tell 'em!

In my career as a newspaper cartoonist I have had many thousands of drawings published, but none is so indelibly stamped upon my memory as that first crude humble thing which a beneficent editor had the courage to print. Likewise I shall never forget my initial introduction to that devilish broadcasting instrument which threw me into a panic, the effects of which rise up in the night to cause cold beads of perspiration to moisten my burning pillow.

"Nothing to it at all—its the cat's eyebrow," I said to my companion on our way to the station; she had broadcast once before and therefore was a veteran.

"Well I wouldn't go around boasting about it," she replied. "You've got a thrill coming to you."

"Blah—blah!" I returned, "I've talked before audiences in crowded auditoriums when you had to look 'em in the face. Anybody who has done that can certainly do this stuff when they are seated anywhere from one to one thousand miles out of sight."

"Well, you've got a shock due, that's all," she returned.

And I had. Perhaps 50 persons were in the reception room devoted to the talent. Artists about to broadcast and those who had finished. Among them was a famous movie star, another a noted concert singer, another a distinguished orator, a full sized band and a miscellaneous flock of musicians. A few invited guests were present too. All in all, it promised to be a large evening. I began to wonder if I had pulled a "bone" by accepting the request to speak that night. There was still time to withdraw, get a sudden headache or remember a previous appointment. Yes, but the newspapers had announced that I would speak over the radio at 9:30 P. M. and it was then 9:25. Too late to find an "out." Besides, the announcer grabbed me by the sleeve and exclaimed "all ready." I felt very much the same sensation that a patient must feel when the nurse tells him to get ready for the operating room.

Many of my friends knew that I was elected to say something. Said they'd sure be listening in and all that sort of thing.

The consciousness of this struck me like a blow. "This way please," the announcer said quietly, and held a door open, and closed it when I was safely in. In that small but heavily draped awe inspiring room, not more than eight by eight in dimensions, waited six or seven visitors to watch the performance and perhaps witness my personal debacle.

"Sit down in this chair please," directed the announcer in the tone of the dentist when he says "now open wide." I obeyed implicitly. "I am going to have the Moon Man introduce you first and then I will follow with another introduction. Savy!" I instinctively searched about for a funny looking Moon Man. Instead I saw a chic young fellow attired in a tuxedo. He was the Moon Man and was going to a dance later, so it seems. For a moment all was quiet. Nothing could be heard except the wild pulsations of my panicky heart against the third rib. Then the announcer's voice shouted "All ready—on." Someone outside threw on a switch and the wire or wireless was open. I remember vaguely hearing the voice of the Moon Man speaking into that fearful little disc. Like a voice far away in the wilderness I heard my name mentioned. Then he arose and the announcer talked to what seemed to be himself. It was impossible that that silent little instrument was carrying his voice over mountains and states into cities and hamlets, into palatial homes and snug farmhouses buried in the hills.

(Continued on page 458)

*Sport Cartoonist New York Evening World

Pioneer Work in Ether Waves

By SIR OLIVER LODGE, D. Sc., LL.D., F. R. S.

Part II

TO Clerk Maxwell we owe the epoch-making discovery that light was not a mechanical oscillation at all, that the ordinary mechanical properties of matter did not apply to it, but that it was explicable solely and wholly in terms of electricity and magnetism. It is impossible to sum up his discovery in a few words, but roughly we may say that the most obvious outcome was:

(1) That if electric waves could ever be generated they would travel with the velocity of light.

(2) That light was essentially an electromagnetic and not a mechanical phenomenon.

(3) That the refractive index of a substance was intimately related to its dielectric coefficient.

(4) That conductors of electricity must be opaque to light.

He showed further, though he did not then express it in language of this character, that the ether had two great and characteristic constants of value utterly unknown to this day, though guessed at by a few speculators like myself—one of them the electric constant of Faraday called K ; the other, the magnetic constant of Kelvin called μ . It was impossible then, and it is impossible now—though it is not likely always to remain impossible—to determine the value or even the nature of either of these constants. But he did perceive a way of measuring their product; and he was the first to measure it. Their product is known; and it is equal—as Maxwell showed it must be—to the reciprocal of the square of the velocity of light.

Well, now, this great discovery aroused in us young physicists the greatest enthusiasm. And in the early '70's—I think about 1871 or '72—I remember discussing it with J. A.

Other things supervened. One had to earn a living; we all got immersed in teaching. Some of us got married, and the pursuit of the ether had to be accommodated with a

Leyden jar, if only we had the means of detecting such waves when they were generated.

PRODUCTION OF WAVES

In 1887 and 1888 I was working at the oscillatory discharge of Leyden jars (initially in connection with the phenomena of lightning), and I then found that the waves could be not only produced but detected, and the wave-length measured, by getting them to go along guiding wires adjusted so as to be of the right length for sympathetic resonance. Thus I obtained the phenomenon of electric nodes and loops, due to the production of stationary waves by reflection at the distant end, and in my own mind thus verified Maxwell's theory.

Transmission along wires popularly sounds different from transmission in free space, but it was well known to me that the process was the same, and that the waves travel at the same speed, being only guided by the wires, much as sound is guided in a speaking-tube, without the velocity of transmission being to any important extent altered. The theory is given near the end of my paper—an important one as I think, in the *Phil. Mag.* for August, 1888,

where the experimental production of much shorter waves is foreshadowed.

The beginning of my experiments was reported to the Society of Arts in April 1888; they are recorded in the *Philosophical Magazine* for August, 1888, and they were more completely described orally at the British Association at Bath that year. (See *The Electrician*, Vol. 21, pp. 607-8, Sept., 1888.)

In that year, also, I heard for the first time of Hertz's brilliant series of experi-



© Keystone View Co.

EDOUARD BRANLY

few hours of spare time every now and then.

I used to discuss the possibility of producing these waves with my great friend, G. F. FitzGerald, whose acquaintance I made at the meeting of the British Association in Dublin in the year 1878; and he wrote some mathematical papers discussing the possibility of experimentally producing such waves. I myself also spoke at the British Association about them in 1879, 1880, and again in 1882 at the Royal Dublin Society. FitzGerald, as I say, mathematically examined what then seemed the abstruse question of electric wave production; and after some hesitation came to the conclusion that direct artificial generation of waves was really possible on Maxwell's theory, in spite of certain recondite difficulties which at first led him to doubt it. (See "Scientific Writings" of FitzGerald, edited by Larmor, pages 90 to 101.) Indeed, one of his papers on the subject was originally entitled "On the Impossibility of Originating Wave Disturbances in the Ether by Means of Electric Forces." The prefix "im" was subsequently dropped, although his first, or 1897, paper concluded thus:

"However these (displacement currents) may be produced, by any system of fixed or movable conductors charged in any way, and discharging themselves amongst one another, they will never be so distributed as to originate wave-disturbances propagated through space outside the system."

In other words, Hertz's discovery was impossible on Maxwell's theory.

In 1882 he corrected this erroneous conclusion, and referred to some early attempts of mine at producing the waves. ("Scientific Writings," page 100.) I state all this in order to emphasize the difficulty which in those early days surrounded the subject on its theoretical as well as on its practical side.

In 1883, at the Southport meeting of the British Association, FitzGerald took a further step and surmised that one mode of attaining the desired result would be by utilizing the oscillatory discharge of a



HEINRICH HERTZ

ments, where, by the use of an open-circuit oscillator, he had obtained waves in free space, and by reflection had also converted them into stationary waves and observed the phenomena of nodes and loops, and measured the wave-length.

(Continued on page 478)



SIR WILLIAM CROOKES

Fleming, who at that time was a fellow student with me in Professor Frankland's advanced chemical laboratory at the brand-new College of Science, South Kensington.

A year or two later, at Heidelberg, I studied Maxwell's treatise pretty thoroughly and formed the desire to devote my life, if possible, to the production and detection of Maxwell's electric waves.

Radio As A Means of Expression and Contact*

By DR. LEE de FOREST

TO celebrate its first anniversary, WOR has tonight assembled representatives from the three great principles of expression, the newspaper, the motion picture and the radio, and has done me the honor to speak on behalf of radio as a medium of expression. I like better to consider radio broadcasting as a medium of contact, for without question it has already demonstrated the fact that radio broadcasting brings the millions of our citizens, high and low, in cities and in the most remote districts, into contact with our leaders in every field of activity; political leaders, leaders of the drama, of art, great editors, captains of industry, singers and musicians—in a manner in which no other medium, since the beginning of civilization, has begun to approach. And I hold that it is in this peculiar property of personal contact between the widespread millions of our citizens and the comparatively few gathered nightly in the small auditoriums of our broadcasting stations, which is responsible more than any other factor for the immense and ever-increasing popularity of radio.

FIRST BROADCASTING IN 1909

In 1909 when the idea of radio broadcasting first occurred to me, and the music of the Metropolitan Opera singers was for the first time launched upon the ether, and again in 1916 when for the first time regular radio concerts were maintained from the old station at Highbridge, when I had a small but intensely interested audience growing in numbers nightly—there began to dawn before me a vision of the astonishing potentialities of the radio broadcast, which vision the last eighteen months has been bringing more and more into reality. But I confess that in those early pioneer days my eager imagination fell far short of picturing the astonishing hold with which this idea so suddenly gripped our entire Nation. And not alone the American people, for I have found that in England, France, Holland, and even in Germany, wherever the fame of American broadcasting has penetrated it has enkindled to an astonishing degree the imagination of classes which one might doubt would respond so quickly. In truth, the broadcasting idea which America may be justly proud of originating is already outgrowing national boundaries. Already the radio telephone is beginning its benign work of breaking down the artificial barriers erected by politics or race. Nothing since the early days of the discoverers has so appealed to the imagination of a nation. No other medium in man's history has demonstrated its unique powers for uniting far separated sections of a great country, for causing to become acquainted dwellers in distant districts from North to South—from East to West. More than the newspaper, more than the postal service, this mighty service of hearing the spoken voice in greeting, the public address, the sermon, the lecture, the musical program, is actively uniting us in a bond of common fellowship, common acquaintanceship, as no other conceivable instrumentality can accomplish. I predict that as an educational medium the radio telephone broadcast will in time prove second in importance only to the public school. Already

we see a closer interlinkage between the people of Canada and ourselves due to the broadcasting idea; and soon these benefits will extend to Europe, between the peoples of the old world, always heretofore strangers, enemies because strangers and personally unacquainted. When, night after night, the citizens of foreign lands will hear the friendly words, the music and the songs from across strange frontiers, then gradually will the feelings of enmity and suspicion, based chiefly on distance and ignorance of each other, change to understanding and good will. Thus I maintain that radio

BROADCASTING A MEANS OF UNIVERSAL EDUCATION

When one seriously considers the human side of this broadcasting idea and its possibilities, one must admit that it possesses potentialities for universal education, and for all the train of good which results from universal education, which can be compared only to that brought about during the past five centuries, by the art of printing. Only this new revolution will grow to maturity in a decade, instead of 500 years—a graphic commentary on the acceleration of man's present progress.

I have for a long time maintained that this educational value of radio broadcasting will prove by far its greatest worth—to the people of our country—and later of all nations. No doubt just now the entertainment feature is the most striking, the phase most appealing to the popular desire, naturally enough. Unquestionably the fine programs which are now being given by the large broadcasting stations are accountable for the astonishing spread of receiving stations during the past eighteen months.

But comparison of radio broadcasting to the introduction of the printing press is not too bold. When newspaper and press syndicates realize its full possibilities in their own field (and their leaders are rapidly coming to this realization), this comparison will become commonplace. Editors now have a medium where antenna wires take the place of Mergenthaler type-setters, ether waves of ink and press paper, head phones of spectacles and ears of eyes. It is indeed gratifying to me to note the wholehearted and enthusiastic co-operation of the American press generally to the broadcasting idea. Without this broad vision on the part of newspaper men the present popularity and astonishingly rapid growth of broadcasting would have been quite impossible.

It is, therefore, a great pleasure for me to speak to you tonight in company with that Nesper of the American Press, Melville E. Stone, who earlier than any other American newspaper man (as far back as 1899) foresaw something of the immense possibilities of wireless in newspaper service, and who has ever since those early years stood out conspicuously as a believer and advocate in the future of wireless as a medium of contact with the people.

Such occasions as this tonight, when I again take part in the radio telephone broadcasting which I have labored so many years to bring about, are occasions of profound personal satisfaction. They bring back vividly to me the countless nights of experiment, frequently discouraging, the step by step up-building of this idea, and the device which has made it finally a reality. And with them comes a profound sense of gratitude. For I realize on such occasions as this the personal sense of contact and friendship with the untold thousands of listeners who are realizing with me the actuality of an old dream. And so I bid you all Good Night.

*Speech Broadcast from WOR on July 23

PARIS HAS BOULEVARD RADIO CONCERTS

Le Matin, the well-known Parisian Daily, is operating a concert radio receiving set in front of its office on a popular boulevard, where crowds gather to listen to news, con-

(Continued on page 485)

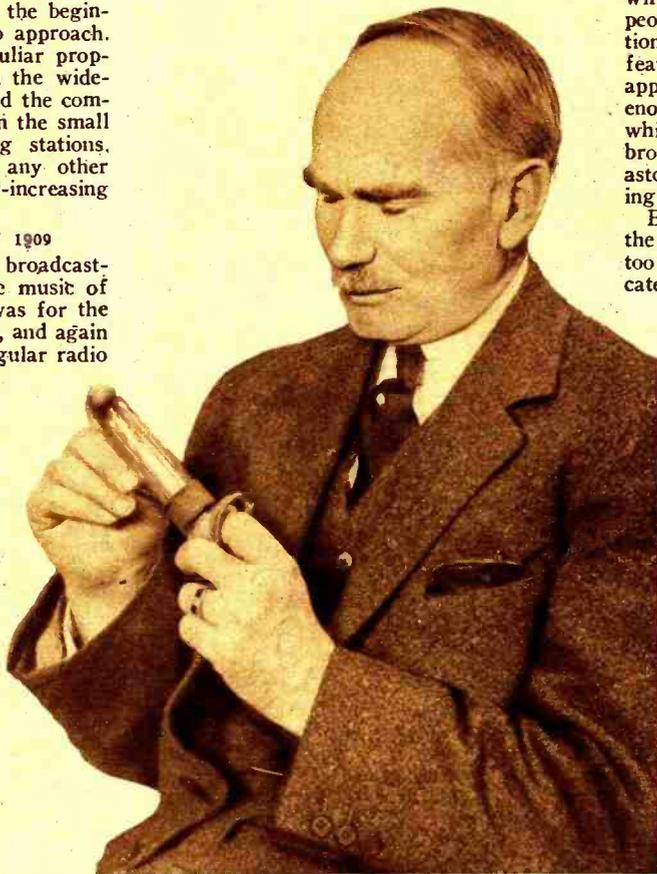

DR. LEE de FOREST

broadcast with its irresistible educational influence is destined to prove one of the most potent powers for the abolition of war.

TIME OF CENTRAL STATIONS NEAR

So rapidly is this movement growing that it will not be long before the necessary high power broadcasting stations will be planted in all our cities, each covering a sufficiently wide area to enfold the entire land in a mantle of music, to breathe into every ear which cares to listen, voices of comfort, of nightly companionship with the world's doings and the world's best minds. "Just a Song at Twilight"—but its lovely echoes are being heard in the miner's cabin, in the rancher's hut, in the living room of the old farmhouse, over the mountain range, beyond the desert, across the silent prairie, over the wastes of sea. And who can say what minds are not awakened, what souls that were deadened, what hearts long embittered by loneliness, will not be stirred to a new life, a new outlook by that sound?

Radio Can Be Sold on a Sane Basis

By EDWARD T. JONES, A.M. I.R.E.

THE potential buyers of radio receiving installations have bought or will buy radio apparatus in order to intercept the exceptional programs being broadcast from the powerful transmitting stations located throughout the United States—and not in an attempt to master the subject.

If every one interested in the sale of radio apparatus would bear the above in mind, they would proceed to sell radio installations on an entirely different basis. They would not endeavor to make a radio expert out of every prospect they are fortunate enough to interview.

More radio prospects are driven to bed with headaches and a perfect dread of radio than is suspected. The average youngster who has, to some extent, mastered the subject, is over anxious to tell prospective purchasers all about radio in five minutes; where, as a matter of fact, it took them years to learn the little they do know.

THE PHONOGRAPH AS AN EXAMPLE

Regarding the phonograph, when a prospect is interviewed, with the exception of the few features embodied in the instrument which point out the superiority of the instrument over other makes; the salesman does not give the prospect 13 of Tyndall's lectures on sound and acoustics in order to effect the sale. It is quite probable that the customer would have ordered either a taxi-cab or an ambulance before the end of the eighth.

On account of the misinformation which is being spread like wildfire through the press and by well meaning individuals, the radio buyer (being hemmed in from all sides with mis-statements) is determined to get the best he can purchase with his money. He is skeptical.

The phonograph prospect is not skeptical. He has confidence in certain phonograph manufacturers and it is mainly a matter of appearance which affects the sale and not the tone qualities, as they are all good.

Some day, we hope it is not far distant, radio will be placed on the same plane, and salesmen will no longer talk in technical radio language, which, to the majority of prospects, sounds like so much Chinese.

What do you think would happen if the phonograph prospect should spring the following on the salesman? After listening to half a selection played on a Victrola he explodes: "I don't like the sound of this instrument; the diaphragm should be an inch larger, etc., etc.;" Of course the salesman would take it out and have the diaphragm enlarged, and have the horn lined with felt or cork, etc.; ad infinitum. Yes, he would—not!

This is the main thing we have to do—Break down this kind of resistance. If the prospective purchasers of radio were not told so many different things about the same kind and type of apparatus they would not be forced into the "Bughouse Fable" class and the sale of radio apparatus would be made on what could be termed a sane basis.

WRONG IMPRESSIONS GIVEN

A man of means, from up the country somewhere, related to me his experience in trying to purchase his first receiver. He admitted to all of the radio dealers in this particular city, that he did not know the first thing about radio but was going to install one at his home. After having visited five dealers he was confident that it was not the right time to buy radio. He was also confident that there was not a manufacturer in the business who could build a



The Phonograph Salesman Does Not Give the Prospect 13 of Tyndall's Lectures on Sound and Acoustics in Order to Effect the Sale; Nor Does He Take the Machine Apart and Describe Its Inward Mysteries. It Is Quite Probable That the Customer Would Have Ordered Either a Taxi-Cab or an Ambulance Before the End of the Eighth.

receiving set with which he could pick up the broadcast concerts—and, still there were thousands doing it every night. This was the effect produced by these dealers' sales methods.

He told me that each one claimed to have the best set, and that according to their accumulated reports and data, each set was not just a trifle better than the others, but was far superior and, in fact, the others could not receive the broadcast programs from a distance, with what would be considered favorable reception. He was left in the lurch. And, as a matter of taking the odds (the short end) he purchased a set manufactured by one of the largest manufacturers of electrical machinery and devices in the country, feeling that with these odds, he would stand a better chance of winning out.

Instead of using legitimate competitive methods, these dealers were guilty of laying plans to kill radio in that section of the country, and their own business as a consequence.

The truth about the whole matter, and likewise the unfortunate part, is, that no matter how crude a receiver is constructed, it will, in most cases, respond to the powerful stations' signals. This permits some very unscrupulous manufacturers to place on the market radio apparatus of very inferior quality and yet get by with what appears to be exceptional claims as to dis-

tance reception. In time, the apparatus falls down miserably and so do the manufacturers. It will take time before the field is clear of this type of manufacturer, but the day surely is approaching when radio salesmen must talk in everyday language in order to sell the large amount of radio apparatus that is going to be sold.

AMPLIFIERS NOT UNDERSTOOD

Let's take the subject of amplification into consideration:

Today, everyone is talking, either directly by word of mouth or through advertisements, telling the wonders of radio frequency amplification. This means nothing to the average radio enthusiast or newcomer unless it is put to him in the right way.

In the first place, what is the difference between the two? Is it necessary to use both of them, or only one, and which one? These questions are running through their minds and they cannot be made clear by lengthy technical discussions. The radio dealer should explain it to them somewhat in this manner:

In order to receive broadcast concerts at all, it is first necessary to have a receiver or tuning unit (which connects you with the various transmitting stations). It is also necessary to have a detector of some kind. This instrument converts the electrical vibra-

(Continued on page 471)



Enlarging the Classroom

By GOLDA M. GOLDMAN



A Photograph Taken in the Haaren Cooperative High School, New York City, Where Radio Has Played an Important Part in Connection with the Instruction of the Student-Body. A Number of Loud-Speakers Are Used So that the Lessons Transmitted by Radio Can Be Heard Throughout the Class-Room. Mr. Fred Siegel, the Faculty Director, is Shown in the Left-Hand Photo.

THE first radio work that was done along educational lines was that of the western colleges which set up their own broadcasting stations, and sent out regular courses of lectures, which were of tremendous benefit to students who were unable to attend the colleges themselves. At least one of the western high schools also adopted radio for its own immediate service, installing a system whereby the principal might talk to all the classes in their separate rooms at the same time.

But for radio to be of importance in a large system requires the co-operation of a large station, and this has been furnished by two of the eastern stations, WOR in Newark, N. J., and WJZ in New York City.

WOR has not attempted to reach the schools in the daytime, but has confined itself to broadcasting series of educational talks and lectures by various high school instructors in the evenings, when both adults and children might derive benefit from them. For instance, Mr. William Strader of the Dickinson High School in Jersey City gave a course in elementary algebra, with instruction and problems, just as it would be given in the classroom. This appears to have been both enjoyable and profitable to those listeners-in who either had never taken algebra or were taking it in school at the time, or who wished to brush up on a for-

gotten subject. In the same way, radio lessons were given by Albert Sonn, radio editor of the Newark *Sunday Call*. Once a week Philip Gordon, musical director of the South Side High School of Newark, gave a talk on music, illustrating it on the piano as he proceeded. Samuel B. Howe, of the South Side High School, gave a series of lectures on the problems of American democracy, based on his book, "Actual Democracy," and Doris Doscher, physical culture expert of the New York Board of Education, also gave weekly talks.

WOR AND WJZ ARE SUCCESSFUL

However, all of these instructive courses of the past year have been given independently by WOR, with no guidance or direct collaboration from the Newark Board of Education. In New York City, on the other hand, the most significant experiments took place, as WJZ co-operated directly with the Board of Education of the City of New York.

The work started in this way! Most of the high schools of the city had organized radio clubs, which built their own receiving set held dances to broadcast music, etc. One of the most flourishing of these clubs was in the Haaren Cooperative High School. The faculty director of the club, Mr. Fred Siegel, himself a radio enthusiast, became impressed with the potentialities of radio as an aid to educational systems, and arranged with WJZ for the first experiment. This took place April 4, when a lesson in machine calculation was broadcast by the head of the commercial department at Haaren, Mr. Harry Leyenberger. Loud speakers were

placed in the school room at Haaren, and others were at the Board of Education building. In the studio at WJZ two students took the lesson, others took it at the Board of Education Building, and the remainder of the class took it at school. Perfect results were achieved, although the problems dictated were entirely new to the students.

As a result of this first success, a series of experiments were conducted, chiefly in the month of June. Miss Margaret Lindquist of Morris High School, under the direction of Dr. John Tildsley, broadcast one lesson in modern history and one in economics, with her entire class at the studio, so that an actual class recitation went out. Mr. Rexford, in charge of the social science work of the city, gave a talk on community civics; Dr. Chew Chew, of the New York Tuberculosis Association, gave one of his inimitable health talks; and Mr. Frank Arnold of Haaren dictated a Gregg shorthand contest. All of this material was received in 15 of the city high schools, which had been fitted up with loud speakers by the engineers of WJZ.

Each of these features was meant to demonstrate a definite way in which radio may assist in the actual school work. The machine calculation lesson, with students in three different places, proved that one instructor at a central point can conduct a lesson which can be taken by many classes simultaneously. Therefore, if for any reason there is a shortage of teachers in a given subject, it will not be necessary for students to go untaught, as some degree of instruction can come to them over the radio,

(Continued on page 482)

When Radio Clubs Vie With Pig and Corn Clubs

By S. R. WINTERS

THE pig club and corn club, as well as other juvenile organizations engaged in animal and crop production, for many years, have factored in the development of boys in the countryside. These co-operative enterprises are not only doubling the crop yield per acre over ordinary methods of culture, but are proving to be socializing agencies in rural life. The agricultural extension activities of 1922 included a new project among the massed interests of farm boys, namely, the radio club. This unit of organized efforts, not unlike the raising of pigs and the growing of corn, is destined to dispel the isolation of a country-minded existence and render the term "back-to-the-farm" a misnomer.

For, with the radio telephone bringing the city nearer to the farm, figuratively if not literally, there will be no occasion for the hue and cry that the urban communities are de-populating the countryside. The farm boy who formerly sought recreation in the distant town, will not now have to go beyond his own doorsteps to hear the strains of the greatest musicians, vocal and instrumental, and the news of the day's events, including baseball scores, the prices of farm commodities, and the forecast of weather conditions. The point where the radio-telephone receiving outfit is installed will vie with the crossroads' store as the meeting place for the boys of the community. The wireless receiving set will at once become the source of information and forum for the expressed interests of both young and old. The terms watts, vario-coupler, condenser, and the call letters of broadcasting stations, will be on the tongues with quite the glibness that the farmer and his wife now discuss the merits and demerits of their neighbor's Berkshire hogs or Barred Plymouth Rock chickens.

Toward the end of developing the latent possibilities of the radio telephone among the rural population, especially among boys, the States Relations Service of the United States Department of Agriculture, for the first time, in 1922, recognized the

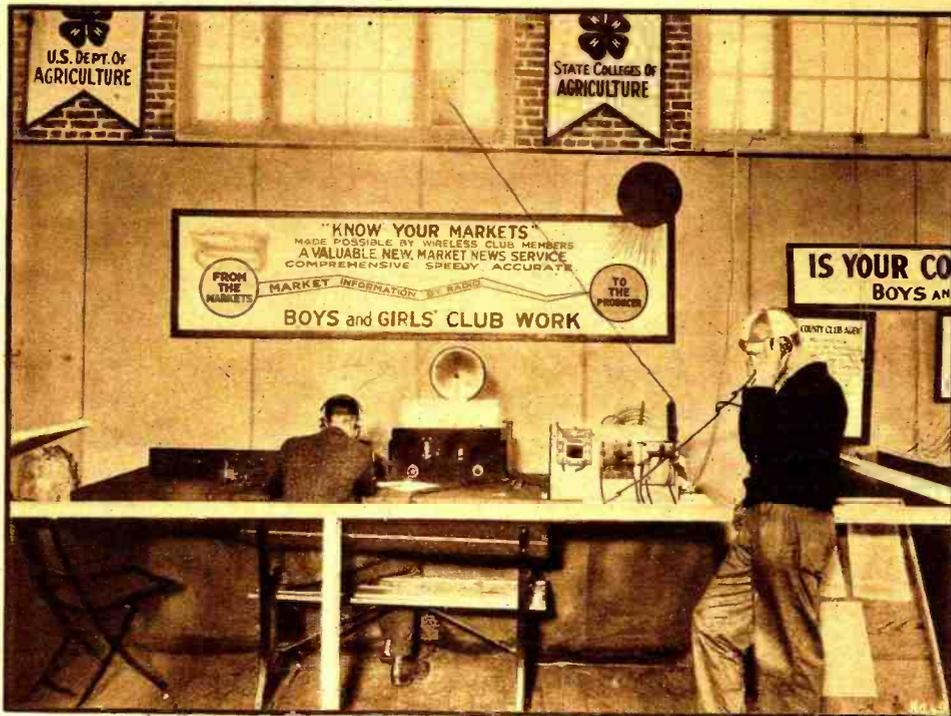

The Transmitting and Receiving Station of the State College of Agriculture, Washington, D. C., Which Has Organized a Radio Club for Boys and Girls in Order to Extend the Market Report Service Now Given to the Farmers.

validity of the term "radio club," among the diverse juvenile organizations promoted by the constituted agricultural authorities—already varying from bean to bee clubs. Representatives of the United States Department of Agriculture, usually termed States Club Leaders, have recently filed their reports of extension activities for the year 1922 with the Washington office. This writer, curious to know the scope of the formation of radio clubs in the rural communities under the Federal and State co-operating agencies, scanned the narrative accounts of boys' and girls' clubs, from 48

States for the purpose of determining the extent to which radio had entrenched itself as an organized effort.

RADIO CLUBS PROVE A BOON TO FARMERS

Of course, the term "radio club" appears sparingly compared with the frequency of the appearance of such major projects as dairy, beef, corn and pig clubs. This new socializing influence, however, is scattering found from Texas to Colorado. The enthusiasm with which this newly found interest is received among the juvenile activities is marked throughout these agricultural extension reports, the wireless receiving set serving as a nucleus of diverse interests, varying from the receipt of news of the wrecking of a passenger train and the announcement of the discovery of a gusher of oil to the less spectacular reports of the fluctuations in farm commodities and forecasts of weather conditions. The purchase price of radio-telephone receiving outfits for the respective organizations are made available by various methods, ranging from the applications of the proceeds of a community dance to that of a farm bureau donating funds outright for the acquisition of radio instruments as a community asset.

A radio club has been formed in Hot Sulphur Springs, Colorado, the expenses for organizing and equipping this unit being defrayed from funds obtained as results of two benefit dances. On the occasion of the dance for the obtaining of funds, a demonstration of radio instruments was given. Three days later three such sets had been duplicated by members of the club. Small receiving and sending outfits were first built by the Hot Sulphur Spring club, and, having demonstrated skill in that direction, the members of this organization are now constructing regenerative receiving sets.

The agricultural authorities of Linn County, Missouri, are responsible for the installation of a \$360 radio receiving outfit in the office of the Farm Bureau, probably one of the most expensive units of its kind yet installed in any rural community. A

(Continued on page 483)

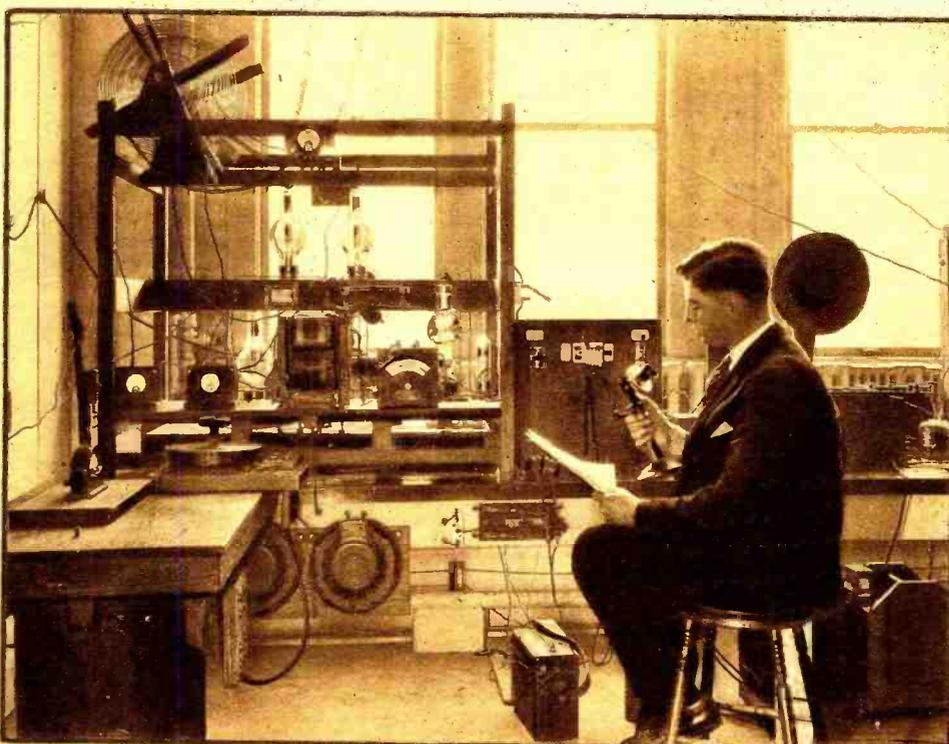

The Large Radiophone Transmitting Station of the Department of Agriculture at Washington, D. C., Daily Transmits the Market and Weather Reports Which Are Picked Up by Thousands of Listeners.

Pictorial Review Of

Right: When Daddy Told the Youngsters That There Were Birdies In the Radio Box, He Did Not Realize What He Had Started, and When He Left His Set Out On the Lawn One Afternoon, and Had His Back Turned For Awhile, the Kiddies Decided It Was a Good Chance To Find the Birdies and Started to Work With the Results Shown. A Good Time Was Had By All.
© Kadel & Herbert.

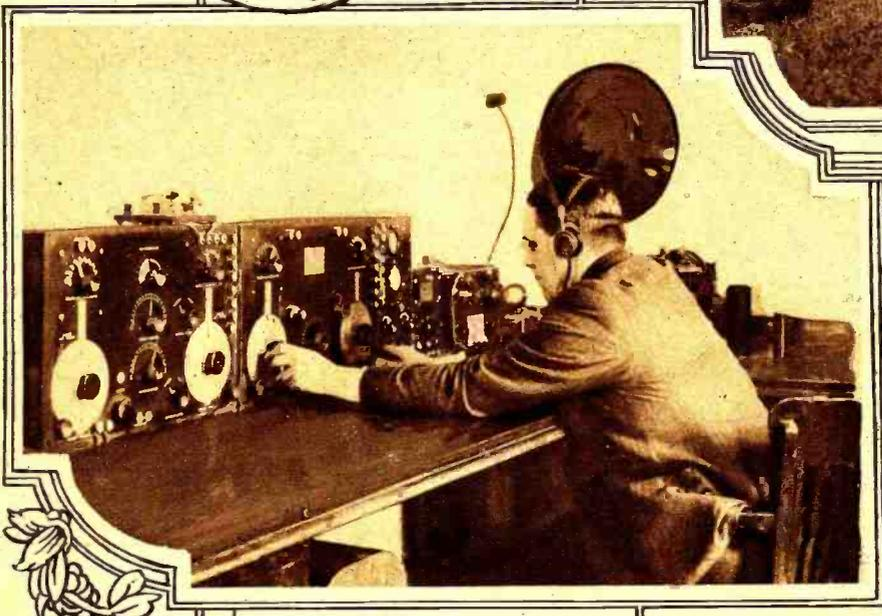

Left: Showing the Long-Range Receiving Apparatus Installed In the New Wireless Station of the United States Shipping Board In the Recently Opened London Home of the Bush Terminal Company. The Short and Long-Wave Receivers and Amplifiers Are of the Navy Type, Designed During the War. © U. & U.

Right: The Large Loop Aerial Employed For Reception Purposes At the New U. S. Shipping Board Wireless Station In London. The Frame Is Mounted On Castors, So That the Aerial Can Be Swung Into Any Desired Position. Mr. Redmond, Who Installed It, Is Seen Standing On One of the Supports. © U. & U.

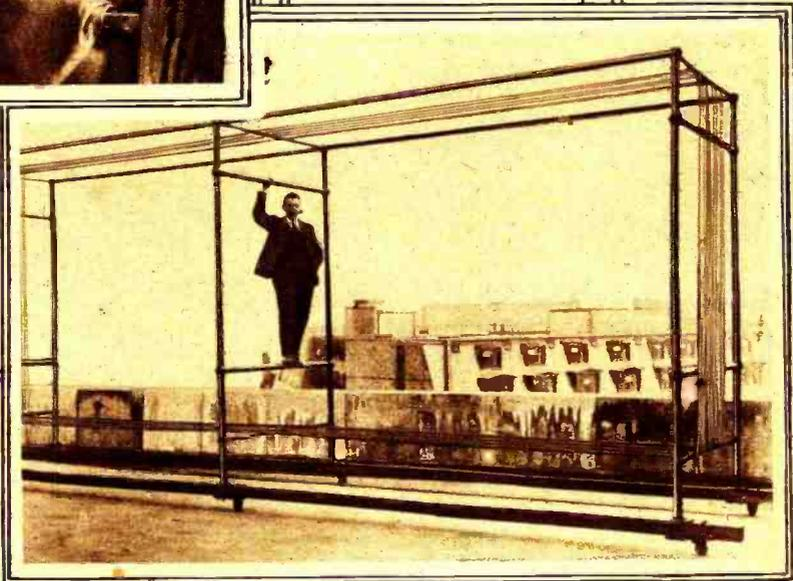

Left: This Portable One-Tube Receiving Set Employs a Circuit That Has Proven To Be Quite Successful. The Receiver Has Picked Up Local Stations Within a 100-Mile Radius, Using No Aerial Or Ground. Miss Helen Conroy, the Owner, Listens In On This Set As a Means of Diversion During Lunch-Hour.
© Kadel & Herbert.

Radio Broadcasting

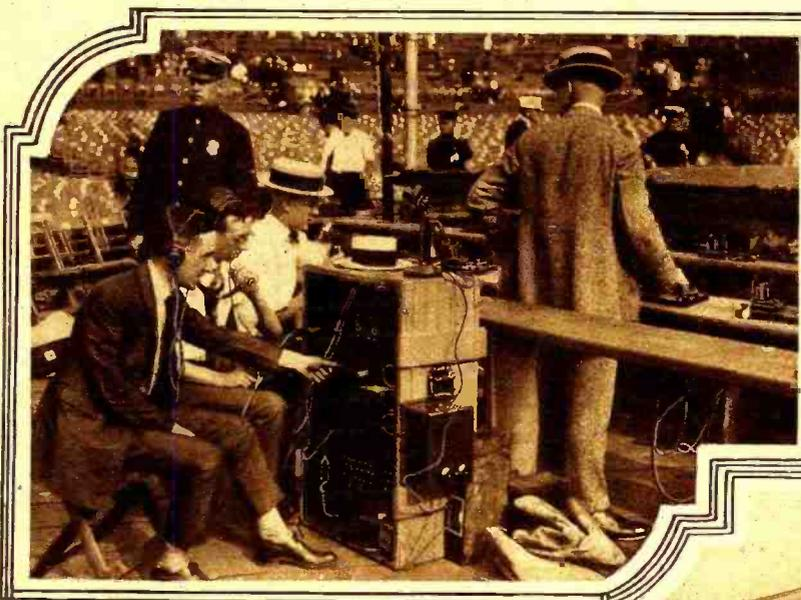

Left: While Approximately 100,000 Fight Fans Saw Firpo Knock Out Jess Willard, Probably Three Times That Number Listened In On Their Home-Radios and Got the Reports As Each Blow Was Struck. In the Photo, the Apparatus Shown Is Entirely Regulated At the Ring-Side For the Broadcasting. The Power Is Generated At the Home Station and the Announcer, Speaking Into the Receiver, Hears His Own Voice Through the Ear Phones. © Acme Service.



Right: Through the Medium of This Six-Foot Horn, With Special Amplifier Attachments, the Organ Recital From KPO and the Orchestra From KFBK Were Heard Throughout the Mountains and Canyon of Woodleaf, California, To a Distance of Three Miles. Photo by courtesy of G. W. Roberts Electrical Works.



Left: Doctors and Nurses Agree That At Times the Radio Is As Effective As Morphine and Other Narcotics In the Treatment of Suffering Patients. The Photograph Shows Patients In the Beth Israel Hospital, New York, Listening To Radio Concerts. © United Newspictures.

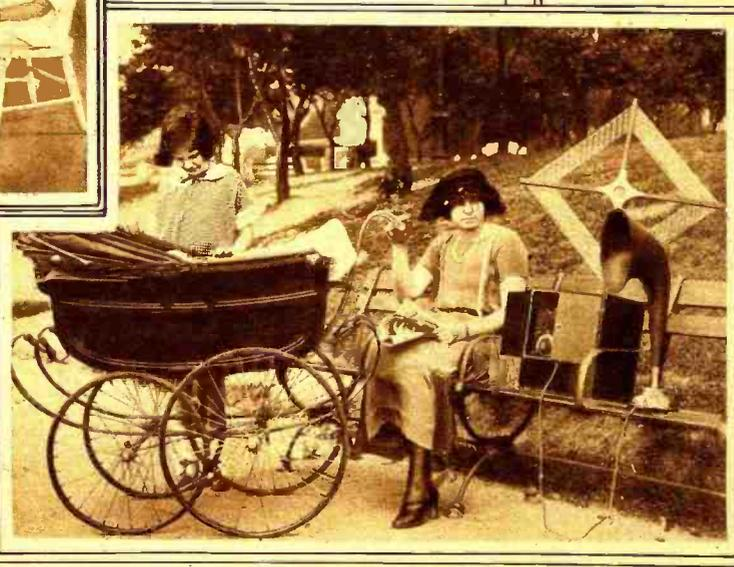

Right: Mothers Who Have Trouble In Keeping Baby Quiet Might Try the Idea of This Enterprising Mother, Who Takes a Portable Radio Set With Her When She Takes Baby Out In the Park. The Whole Outfit Is Carried Nicely In the Baby's Carriage and On Arriving At the Park It Is Set Up On a Bench and Presto, Mother Enjoys a Good Concert and Baby Goes To Sleep To the Music. © Kadel & Herbert.

Latest Advances

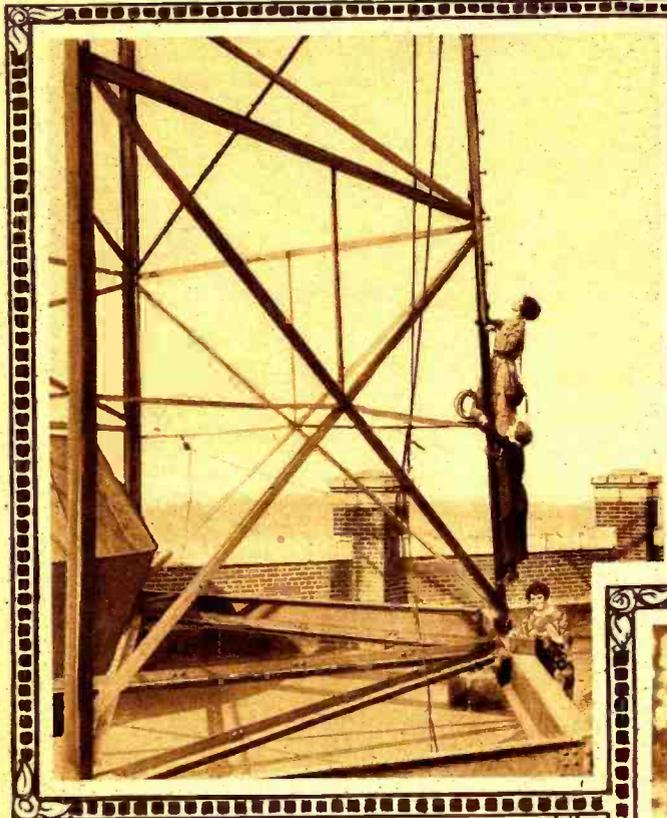

Above: Photo Shows the Girls Operating the Entire Station, Which Also Included the Enormous Steel Antennae Masts That Are 30 Stories Above the Ground. They Claim They Like the Part of Climbing the Antennae to Make Repairs and Adjustments Best of All. © Kadel & Herbert.



Above: For the first time one of the great broadcasting Stations Has Been Operated Entirely by Women. All the Operators Were Replaced by Women, Recruited Entirely from WEAF's Regular Force. © K. & H.



Above: An Interesting Photograph Showing Lieutenant Salcedo of the Peruvian Army (standing) and Captain Marvidal of the Cuban Army, Listening in on a Pries Loop Receiver at the K.O.T.C. Signal School, Camp Alfred Vail, N. J. © U. & U.

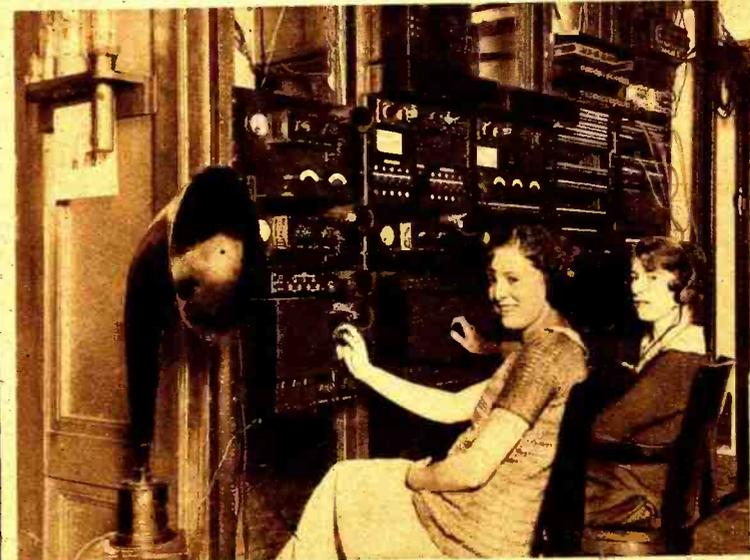

Left: L.R. Anna Chevereau and Elsie M. Charles Operating the Elaborate Speech Input Equipment of Station WEAF. This Apparatus Controls the Amplification and Quality of the Music. It Requires Ability to Handle, But These Women Are Well Trained and Know Their Business. © Kadel & Herbert.

In the Radio Field

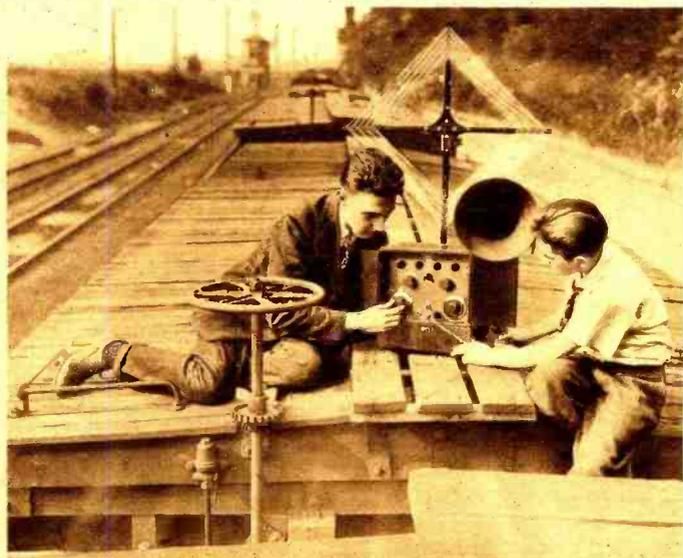

Above: Edmund Keene and Richard Bourne, two New York Amateurs, Managed to Pick Up Numerous Concerts from Distant Points With Their Loop Receiver Atop a Box Car. © Kadel & Herbert.

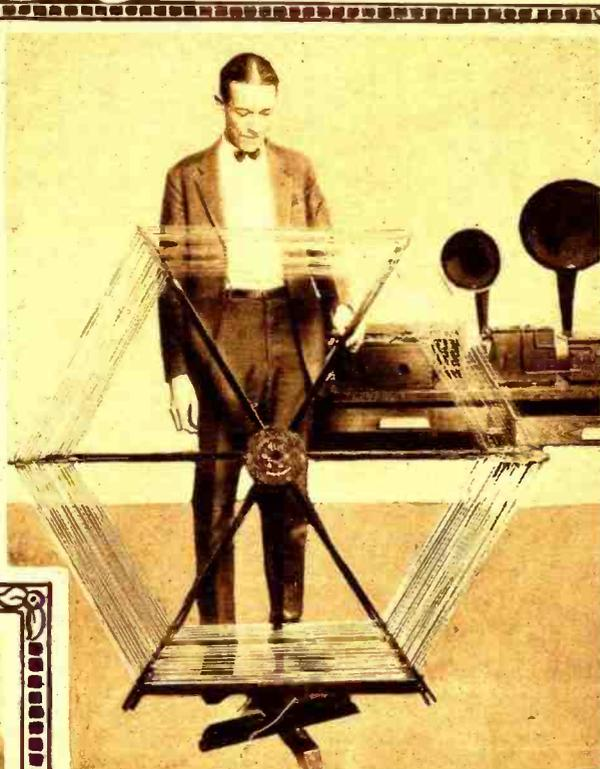

Above: Here is Probably One of the Most Efficient Loop Aerials Ever Constructed. It Has 10 Turns of a Conductor Made Up of 12 Wires, These Being Connected in Parallel, to Cut Down Radio Frequency Resistance. Dr. Rogers, of Under-Ground-Aerial Fame, is the Originator.

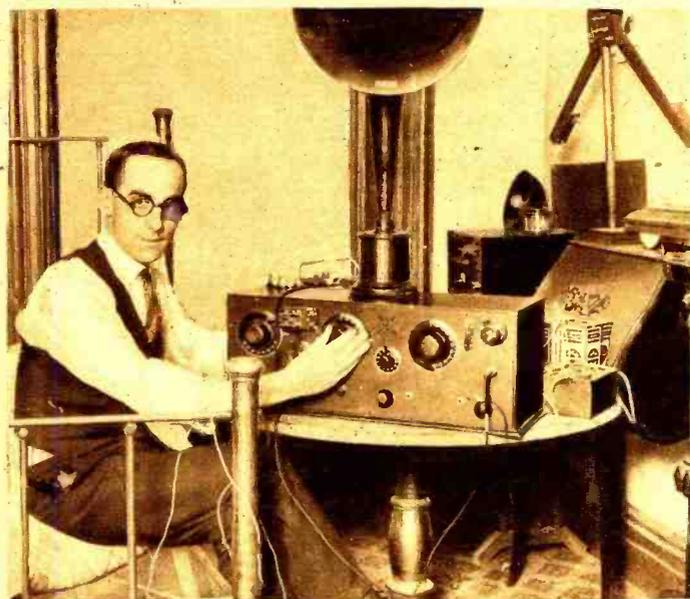

Above: Charles Hall, of 356 West 57th St., Has Made a Hook-up, Consisting of a Combination of a Neutrodyne and Tuned Radio Frequency. Using Five Tubes, Mr. Hall Has an Unusual Cut-off Arrangement with Which He Can Use His Crystal Detector, One Tube, Three, Four or Five in Combination. © Kadel & Herbert.

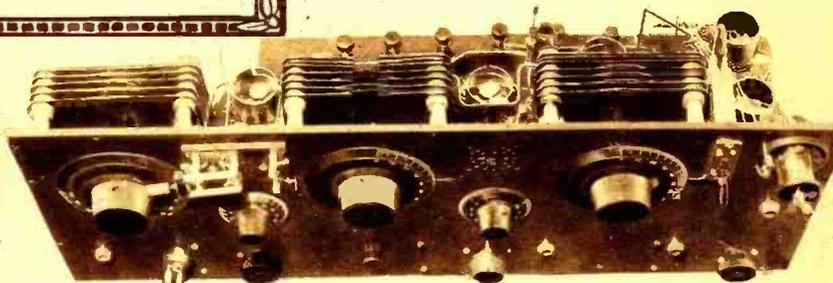

Right: A Top View of Mr. Hall's Tuned Plate Neutrodyne Receiver. "D" Coil Variometers Are Used in the Plate Circuit of Each Amplifier Tube. Mr. Hall Has Obtained Excellent Results With But a Bedspring for an Aerial. © Kadel & Herbert.

Radio in Front and



Left: (Chicago, Mr. Gallagher? No! Pittsburgh, Mr. Shean!) Gallagher and Shean, the well-known comedians, are here seen "listening in" to some station. The exact location was not learned, due to the fact that, when the photographer left, they were still arguing as to whether it was Chicago or Pittsburgh. © Kadel & Herbert.

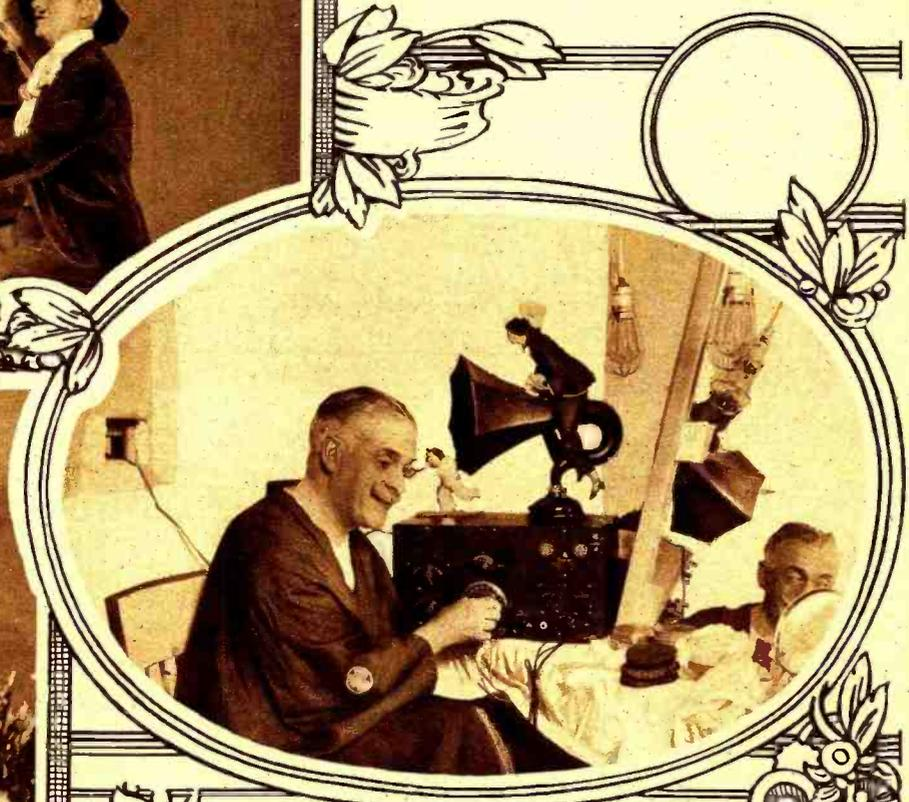

Above: Cyril Maude, the well-known English actor, claims that having a radio set in his dressing-room helps him to make up. Mr. Maude finds the art of making-up much less tedious, especially in hot weather, when listening to soothing music. © Kadel & Herbert



Above: This little English girl has rigged her "dolly pram" up with a portable radio receiver, so that mother and daughter can listen in on the "Children's Hour" Broadcasting. © U. & U.

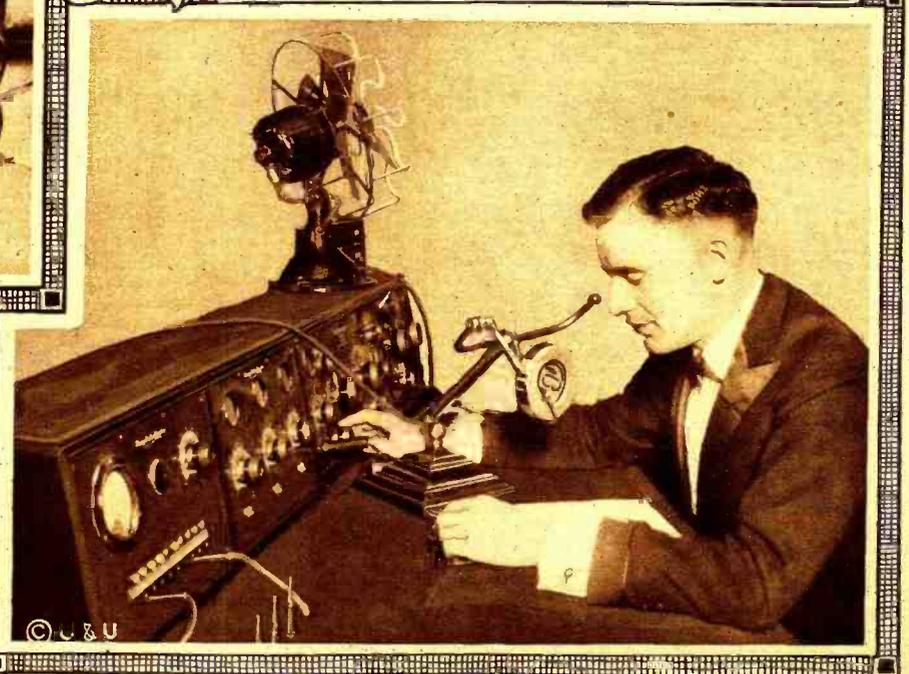

Right: Mr. L. E. Clausing, station engineer and announcer, at Station WJAZ, Chicago, who supervises all performances. He can hear himself announcing by means of a delicate receiving set, which is part of the equipment shown in front of him. © U. & U.

Behind the Microphone

Right: The two broadcasting sets at CHYC, Montreal, Canada. The pair of panels at the right forms the 500-watt set, and the pair at the left the 100-watt set. On the top of each set may be seen the antenna switch for changing over from broadcasting to receiving. The switch is operated by pressing a button.

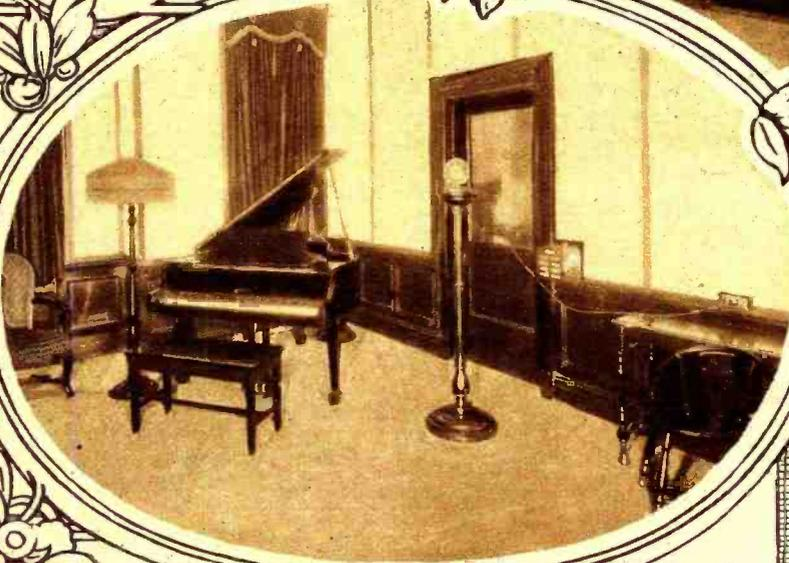

Above: This photograph shows the corner of the studio of Station WBAP, the Fort Worth Star-Telegram, a 500-watt Western Electric broadcaster. The room is soundproof and acoustically perfect, having been corrected by leading engineers.



Above: The "Hired Hand" of WBAP in a characteristic pose. The "Hired Hand," who is known the Nation over for his humorous remarks, is President of the WBAP Radio Truth Society.



Left: The studio of Broadcasting Station CHYC, Montreal, Canada. The panel at the left contains the speech input amplifying apparatus, and the microphone is shown in the foreground. The acoustic properties of the studio are improved by heavy draperies.

Radio Aboard the "Albert Ballin"

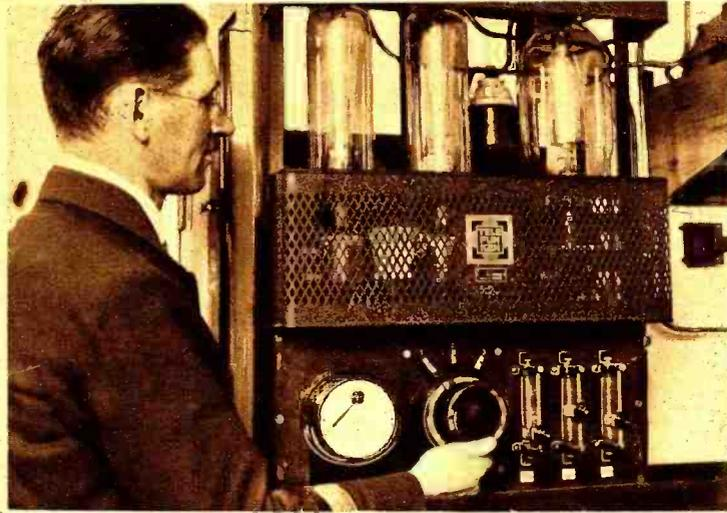

Left: Chief Operator William M. Hannemann, and the 1,000-Watt Telefunken Transmitter Aboard the "Albert Ballin." The Two Smaller Tubes On the Left Are 500-Watt Modulators, While the Large Tube Is a 1,000-Watt Oscillator. Note the Filament Rheostats On the Lower Portion of the Panel. © K. & H.

Below: This Peculiar Looking But Extremely Efficient Receiver Is of the Three-Circuit Regenerative Type and Covers Wave-Lengths From 250 to 25,000 Meters. At the Top Is a Variocoupler With a Sliding Action, and the Jacks On It Are Used To Cut In More Or Less Turns of the Windings. © K. & H.

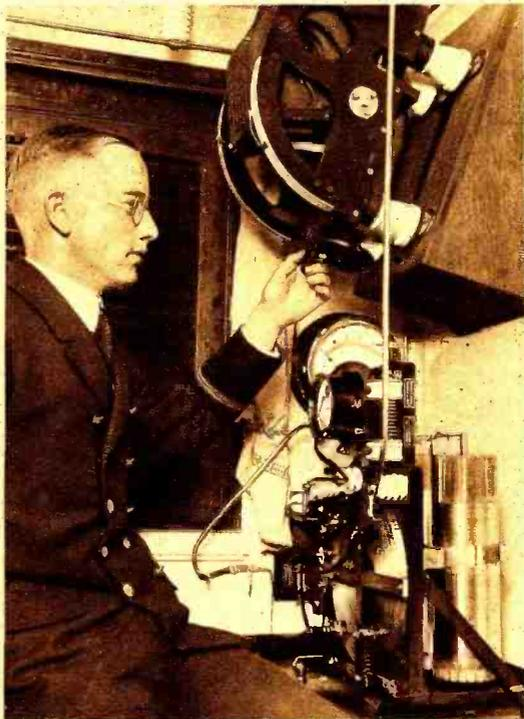
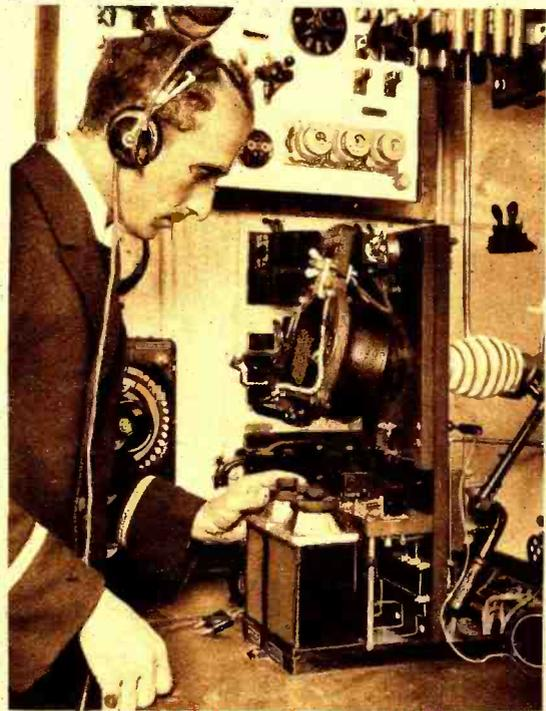

Above: The 1/2-K.W. Spark Transmitter Used When the Large C.W. Transmitter Is Idle. The Wave-Length Is Sharpened by a Huge Variometer Shown On the Top. This Variometer Works More On the Order of a Large Condenser, For It Is Built of Segments Which Slide Into One Another. ©Kadel & Herbert

Right: The Equipment That Will Be Used In Broadcasting the Music From the "Albert Ballin's" Orchestra As Soon as a Permit Can Be Obtained. Both of the Panels On the Wall Contain Speech Amplifiers, Which Will Amplify the Music Picked Up By the Microphones. © Kadel & Herbert.



Radio Oddities

Right: This Is the Life of Riley, According to Betty Smith and Flora Greenfield, Who, After Taking the Life-Saver's Catamaran at a Local Beach, Placed a Radio Set on Same and Treated the Bathers and Themselves to a Radio Concert. The Radio-Frequency Set Worked Perfectly With Two 20-Foot Wires Thrown in the Water as an Aerial. © Kadel & Herbert.



Left: Bees Evidently Like Radio Concerts, According to John Bilon, Who Takes Care of a Number of Bee-Hives on Long Island. He Claims That Radio Music Has Not Only Increased the Bees' Honey Output, But It Also Protects Him Against Being Stung by the Bees When He Handles Them. © Kadel & Herbert.



Right: When the Successful Amateur Passes His Test for an operator's license, He Is Given a Talk by J. W. Swanson, Radio Inspector, Who Is Seen at the Left. He Is Asked Not to Transmit During Broadcasting Hours, Listen for SOS Signals, and Generally Aid for the Good of Amateur Radio. © Kadel & Herbert.

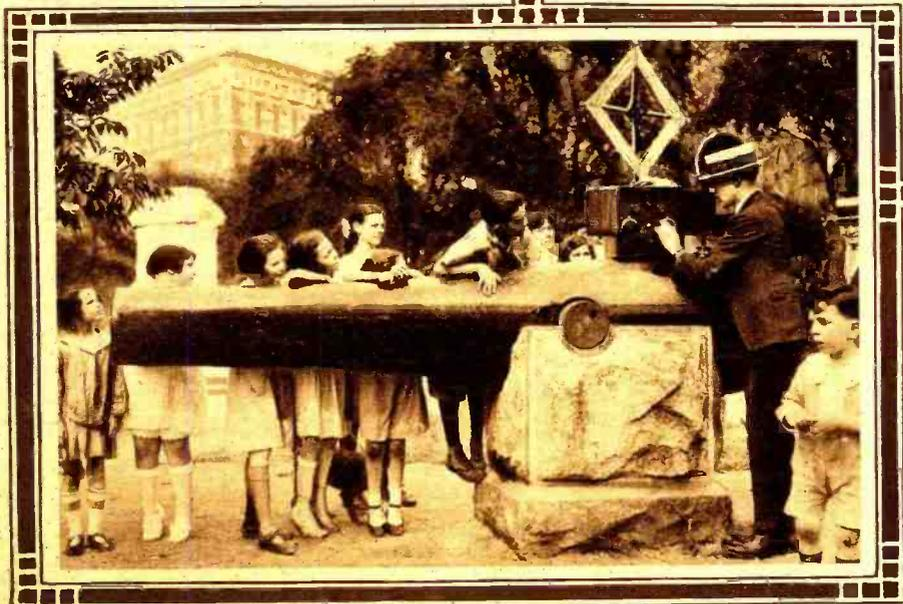

Left: Richard Bourne, a New York Amateur, Is Here Seen Testing His Loop Radio Receiver on a Steel Cannon, to Find the Effect of Steel on the Directional Qualities of the Loop Receiver. He Found That, When Tuning In, the Signals Were Somewhat Stronger, But That the Loop Antenna Was Then Non-Directional. © Kadel & Herbert.

Broadcasting Pays Song Writers

By W. A. EISENHAUER

HOT ROASTED PEANUTS

(A NUTTY SONG WITH A CRACKIN' GOOD TUNE)

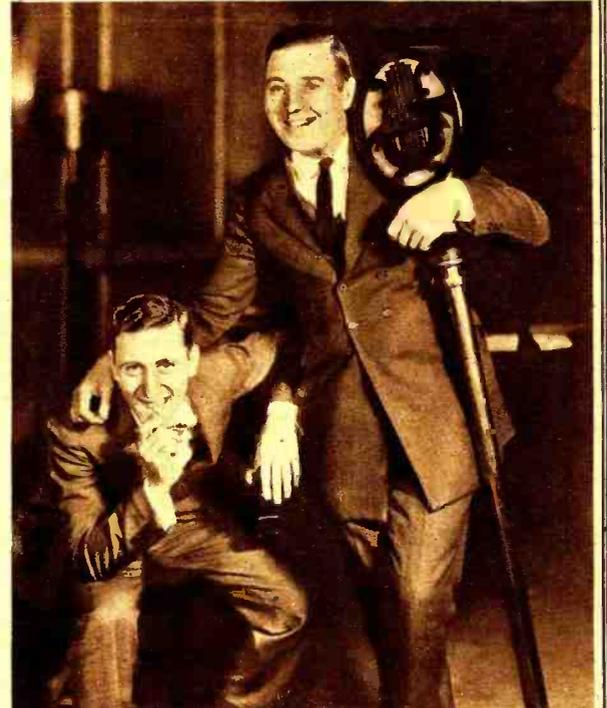

Tremendous Sales of "Hot Roasted Peanuts," Due Solely to Broadcasting, Convinces Louis Breaux and Charles Tobias, Popular Song Composers, That Radio Broadcasting is of Invaluable Aid to Song Writers for Introducing New Compositions to the Public.

"RADIO Broadcasting is killing the sale of sheet music."

That is one of the main arguments advanced by the American Society of Authors, Publishers and Composers for demanding that broadcasting stations pay them a royalty for permission to broadcast their copyrighted musical compositions.

"Radio broadcasting of music, especially the popular variety, makes the compositions more popular, and consequently a larger sale of sheet music results."

Such is the counterclaim of the broadcasting stations which have flatly refused to meet the demands of the authors, publishers and composers.

For months the argument has been going on with the case of the music publishing society getting weaker and weaker as the real facts of the controversy are brought to light. The broadcasting stations, championing the cause of their millions of "listeners-in," have unearthed many specific cases proving the tremendous value of advertising through broadcasting. However, these cases mainly have only proven their contentions indirectly.

It has remained for Louis Breaux and Charles Tobias, composers and publishers of "Grand Daddy," "Steady Eddie," "Keep It Under Your Hat," "The Voice With a Smile" and many other successful compositions, to come forward with undisputable and positive evidence to prove that radio broadcasting is the greatest direct advertising method for the sale of sheet music.

\$300.00 Prize Contest

\$150.00 FOR A RADIO MARCH

\$150.00 FOR A RADIO JAZZ

JUDGES

Hugo Riesefeld—Musical director and famous conductor of the Rialto, Rivoli and Criterion Theaters, New York.

Ted Lewis of the well known Ted Lewis Band and the Ted Lewis Frolics. The Jazz Master.

Vincent Lopez—Leader of the Pennsylvania Hotel Orchestras.

Leo B. Riggs—Musical director of the Hotel Astor Orchestras, N. Y. City.

Milton J. Cross—"Announcer AJN" of "Broadcast Central" "WJZ" New York, member Institute of Musical Arts, and member of Paulist Choristers.

H. Gernsback, Editor.

This contest closes October 1, 1923

For further particulars, see the September issue of Radio News.

The details of how these popular composers were convinced of the true advertising value of radio broadcasting are most interesting, and therefore Mr. Louis Breaux's version of how their latest song, "Hot Roasted Peanuts," was successfully introduced by radio is deserving of mention.

"Some time ago we had an idea that radio broadcasting might help to popularize some of our musical compositions, so we broadcast a program from a station at Roselle

Park, New Jersey. Whether the broadcasting produced any direct sales of our songs we were unable to tell, simply because we had been using the usual advertising methods of the music publishing business for those songs which we broadcast. We also believed that due to the small number of receiving sets in use at that time we could not reach an audience of sufficient size to pay us for our efforts. Therefore, we did not continue broadcasting.

"Less than two months ago the idea once more occurred to us. But this time the idea was much improved.

"Like hundreds of other song writers, we were discussing the merits of the controversy about the broadcasting of copyrighted music. Suddenly we hit upon a plan which would positively prove to our own satisfaction the value of broadcasting to song writers.

"So we sat down and wrote our latest song, 'Hot Roasted Peanuts.' We had a few thousand copies of it printed. We arranged a broadcasting date at Station WJY in New York City. We decided to use the usual music publishing advertising methods only after we had first learned the results of sales from our broadcasting.

"Our program at Station WJY opened by putting 'Grand Daddy,' one of our recent well advertised numbers, on the air. For the second number we offered 'Hot Roasted Peanuts,' the song especially written for making our test. Next we rendered another one of our successful compositions. We were preparing to sing our fourth and concluding number when those in charge of the broadcasting station asked us to repeat 'Hot Roasted Peanuts' to satisfy the many radio listeners who had telephoned such a request to the broadcasting station.

(Continued on page 484)

A New Arrangement of Antennà

THE utilization of wireless on board automobiles, motorboats, aeroplanes and the like has led to a new construction of antenna. Mr. Archibald Montgomery has patented a special arrangement, the principle of which is given herewith.

This antenna is adapted for use on all vehicles carrying an internal combustion engine. The escaping gases from the exhaust are utilized as an antenna. The India rubber tube A, or any other insulating conduit, is provided as a means for insulating the muffler B and the exhaust pipe D from the rest of the car. Non-conducting supports are also used to suspend the muffler and exhaust pipe, so that it will be, as well, electrically insulated from the chassis of the car. The escaping gases traverse this casing in which are placed a certain number of points over which the current of gases is obliged to pass before escaping into the air through the exhaust pipe D. The inventor has found by experimentation that this arrangement will insure the capture of wireless waves in the most efficacious manner. It is the exhaust gases, driven out into the atmosphere, which form the collector of waves, as well as the ground connection made to the chassis of the car. The antenna is naturally connected to the proper apparatus, either transmission or reception sets. In the case of Fig. 1, there is employed a receiving set with the usual inductance coupling E-D.

The grounding is easily obtained in a motorboat, more difficult with the automobile and still worse with the aeroplane. In

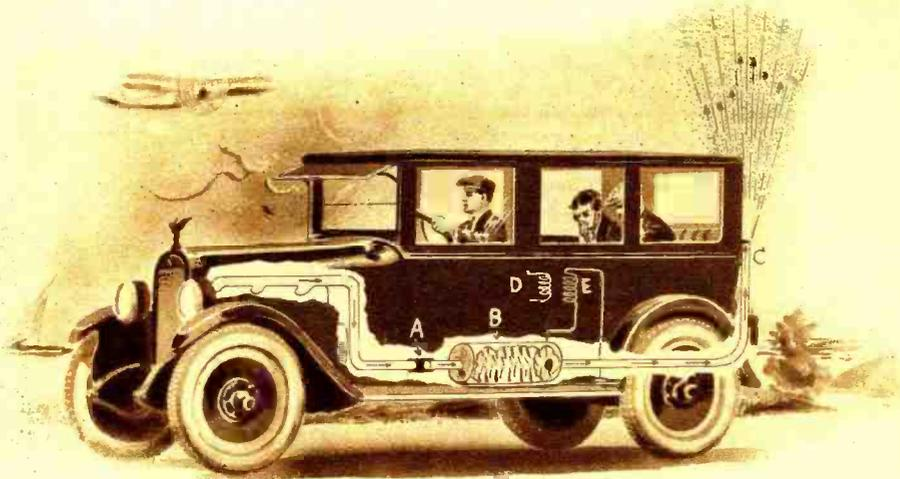

Here is a New Idea in the Way of Aerials. Advantage is Taken of the Exhaust Gases from the Muffler, Which Are Conductive and Absorb Energy from Passing Radio Waves, Directing It to the Receiving Set.

the last case, it is constructed by a group of metallic wires, fastened to the frame or body of the aeroplane, or wound about its wings and fuselage.

The trials carried on with this arrangement have given most excellent results, reception having been accomplished over considerable distances.

NAA Gets a New Voice

SEA-GOING radio operators, many skippers and landsmen who listen in will note a change in the "voice" of NAA at Arlington 2650 meters. The peculiar tone of the old Fessenden spark will no longer carry the time signals, weather reports and information of great interest to mariners; this famous spark set, installed in December, 1912, was replaced on Sunday, July 8, by a new tube

transmitter.

Operating on the same wave-length, 2650 meters, the new set will carry all the Governmental broadcasting formerly done on the spark. Although its power is not quite as great, the range of the tube set by tests has proven a little greater than the old 100-K.W. spark. After 11 years of almost constant operation, the Fessenden set is to be retired from active service, and it is un-

derstood that it may be presented to the National Museum, where many radio experts believe it should have the honor accorded to the early locomotive of Baldwin and the Morse telegraph key.

Even before its installation in 1912, as the first high powered radio transmitting set in the United States, the Fessenden set was used in test work for nearly two years between the Plymouth, Mass., radio station and the Mackaranish station in Scotland by the Fessenden Company. A service of almost 13 years is believed to be a record for even a modern radio set.

Besides the sea-faring radio operators, many ship masters will miss the tone of the Fessenden spark. Careful skippers, it is said, check their chronometers personally in the radio shack when NAA broadcasts twice each day. Trusting their operators in everything else, they prefer to put on the receivers themselves and count the dashes preceding the time signals at noon and 10 p.m. noting the number of seconds fast or slow when the hour is designated by the long dash. Masters on the Atlantic and Mediterranean runs whose daily progress is noted in degrees of longitude, rely almost solely upon the time by radio, especially when the sun is not visible, and never miss an opportunity to check their ships' clocks.

In the old days before radio time transmission, east and west navigation was a more difficult task, since the mariners had no means of calibrating their time pieces while on a cruise, requiring from 10 days to two weeks. An accurate record of the chronometer's gain or loss in time per day had to be kept, and every observation had to carry the correction multiplied by the number of days out of port. This of necessity increased any unknown error and made navigation far from the accurate science it has become with the advent of radio time. Once in port, the master carried his chronometer carefully ashore to a reliable clock maker or

(Continued on page 484)



This Entire Set is Self-Contained, the Loop Being on a Swinging Door Under the Handle and the Loud-Speaking Horn, of Special Construction, Inside, Throwing the Sound Through the Cane Front. A Six-Tube Murad Radio Frequency Receiver is Mounted in the Side of the Table.

Photo by Courtesy of Durham and Company, Inc.

The Celebrated Pilkey Radio Case

By ELLIS PARKER BUTLER

"Author of Pigs Is Pigs"



For Another Instant Dear Edbert Held His Head Up, Sniffing the Air to Right and Left, and Then He Pushed Anna May Roughly From His Knee and Opened His Mouth and Let Out One Long Howl at the Ceiling, and the Next Instant He Was Down, on His Hands and Knees and Loping for the Front Door.

Of course, no sane human being can doubt that radio is the greatest invention of all the ages—and nobody does—but any invention may have its unpleasant sides. The automobile is a great invention, and nobody would think of denying that, but the man over whom a ten-ton truck loaded with pig iron has just passed may be excused for not being awfully fond of automobiles. One can excuse that man, if he recovers—which he doesn't usually do—for not voting for Hen. Ford for President of the Gasoline States of America.

What brought this to my mind was this affair of Edbert Pilkey and Anna May Bunce, two charming young people who were enthusiastic radio fans up to the night of July 16, 1923, but are so no more. You may remember that on that night the well known author, Orlando Biggs himself, broadcast from Station WUMP, one of his delightful bed-time stories. Thousands of little boys and girls heard it and went to bed better and nobler and happier children. You will remember that the story was the one called "Uncle Foozy Fox And Little Trembly Rabbit." In the story Little Trembly Rabbit tells Uncle Foozy Fox about a big rat that comes poking its nose into Little Trembly Rabbit's home and frightens the whole Rabbit family into fits. So little Trembly Rabbit asks wise old Uncle Foozy Fox what to

do about it, and wise old Foozy Fox tells Little Trembly Rabbit to pretend to be brave, and to scare the rat away.

"The next time Old Snarly Rat comes to your house," said Uncle Foozy Fox to Little Trembly Rabbit "you must face him bravely and bark like a dog, and that will frighten him away. Pretend you are a rat hound."

That is the way the story goes, and it is

Of all the stories by Mr. Butler we have ever read, we found the present one the most amusing. At least, so it seems to us. It struck us as even funnier than the one we presented last month.

If this story does not make you laugh, and even roar, you had better see a doctor at once.

At any rate, we are certain you will like Mr. Butler's latest.

—EDITOR.

a very sweet and pretty story, but all I want you to remember is that Uncle Foozy Fox says to Little Trembly Rabbit: "Pretend you are a rat hound." As it turned out that was an extremely unfortunate thing for Uncle Foozy Fox to say just when he said it—unfortunate for Edbert Pilkey.

You see, Edbert Pilkey was to be married

to Anna May Bunce on Tuesday, July 17, 1923, and Anna May Bunce's father figured that, with the caterer and the palms and the orchestra and all the usual trimmings, the wedding was costing him a thousand dollars, but he was glad to pay it because Edbert and Anna May were madly in love with each other. They had fallen in love one evening when Edbert went to the Bunce's to listen to Mr. Bunce's radio, and they were both radio fans of the direst brand from that moment on.

Of course, the preparations for the wedding were wonderful, and six bridesmaids and six ushers were stopping at the Bunce's, and only one thing worried Mrs. Bunce. That was the Kaggerty's dog. Kaggerty lived next door and had a rat hound, and most of the time he had to keep the rat hound tied because it was so eager to hunt rats that if let loose it would start off across the country at about forty miles an hour, trying to get to some place where rats were, so it could catch and kill them. The trouble was that when the hound was tied it howled all the time. It never rested its voice for a moment. It put up its head and wailed into the air, and sounded like fourteen lost souls being crushed to death in a loud-speaker. The only thing Mrs. Bunce hoped was that the Kaggerty's rat hound would not howl, and she said so so

(Continued on page 450)

Experiments With The ST-100 Circuit

By JOHN SCOTT-TAGGART, F. Inst. P.

IN a reflex circuit of the kind shown in Fig. 1, or in fact, in any reflex circuit, i.e., one in which valves act in the dual capacity of high and low-frequency amplifiers, self-oscillation at audible frequencies is very commonly experienced. If properly handled, and when using suitable components and values of high-tension voltage and filament currents, the ST 100 is a relatively stable circuit, and personally I have had no trouble, although several different sets have been made to my specifications and have given excellent results.

SOURCES OF TROUBLE

As several readers, however, have stated that they are troubled by the set oscillating and producing a howling noise, I propose to give some information which may prevent this from happening.

In the first place the 100,000 ohms resistance R, is a very important factor in stabilizing the whole circuit, and many experimenters who use home-made resistances or some of the variable grid-leaks at present on the market will have trouble. These resistances, in most cases, do not go down to a sufficiently low value. The resistance may have a value from 20,000 to 100,000 ohms according to individual circumstances. It is not, of course, permissible to use regeneration on the aerial circuit on broadcast wavelengths by coupling the two coils. This tends to make the set howl, although if the set be properly arranged and handled, regeneration may be introduced without any fear of howling. If too much regeneration is introduced, the set will oscillate at high frequency and then begin howling at low frequency, and when this happens the coupling should immediately be loosened, when the low frequency oscillation should stop.

Another likely source of trouble is the crystal detector. Make sure that the crystal detector is doing its full duty. If it is a poor crystal, or if signals are very strong in the first place, the absence of the crystal detector will not make very much difference, and signals may be heard with the crystal point lifted from the crystal. This, of course, should not happen when no regeneration is used, but the effect may be obtained when regeneration is employed. To adjust the crystal detector it is as well to detune the aerial circuit until signals are very weak, then adjust the crystal detector and retune the aerial circuit. A very light pressure between the spring and the crystal detector may tend to make the set howl. If it is possible to obtain a fairly firm pressure without sacrificing signal strength, the apparatus will remain more stable. Also try reversing the leads to the detector.

To enable the different components, coils etc., to be tried out, I would advise the ex-

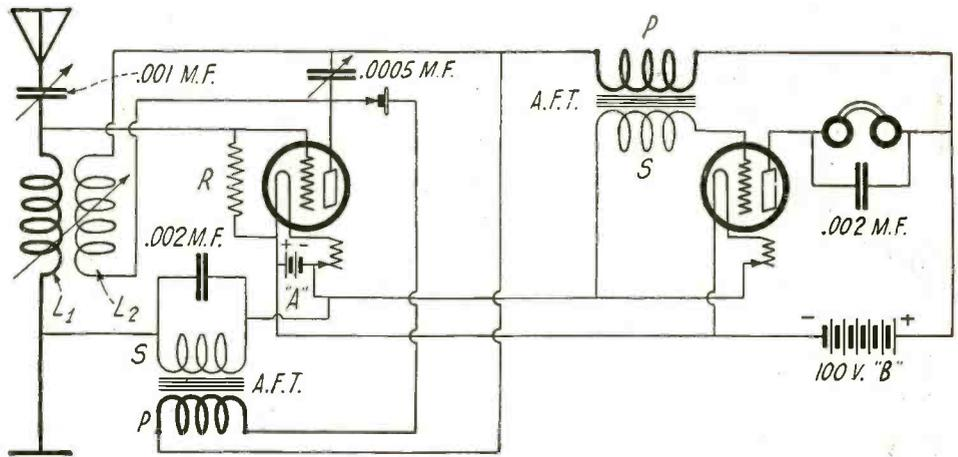

Fig. 1. The Diagram of the ST-100 Circuit Described in the September issue of RADIO NEWS. Although This is a Form of Reflex Circuit, the System of Amplification is different.

perimenter, if he has any trouble, to wire up the circuit shown in Fig. 2, which is a straight-forward arrangement. If first-rate results are obtained with this circuit, the different components may be wired up for the .ST 100 circuit with the addition of the extra transformer and resistance.

If very loud results are obtained with the Fig. 2 circuit, there is obviously no point in trying to convert it to the ST 100, as it

LOUD SPEAKER MORE PRACTICAL THAN PHONES

The question of whether phones or a loud speaker is employed is also one of considerable importance. I find that when phones are used there is a greater likelihood of howling owing to the capacity of the human body in relation to earth and different parts of the receiver. This particularly applies when certain types of phones are used. If you fear that low frequency howls are due to this trouble, try placing the phones on a sheet of dry paper on the table. If the howl persists, the source of the trouble lies elsewhere.

The circuit is essentially one for obtaining results with a loud speaker.

Further experiments with the ST 100 circuit have resulted in obtaining even louder results than before, and a number of highly successful demonstrations have been given.

GRID BATTERY IMPROVES QUALITY

I find that applying a negative potential of from four to nine volts on the grids of both tubes materially improves the quality of speech and the amplification. Two flashlight batteries connected in series will be found suitable. An intermediate tapping between the two batteries will enable the experimenter to apply about four volts to the grid.

The new circuit, in which is incorporated a one-microfarad condenser across the "B" battery, should be tried by all who have operated this circuit.

Many experimenters will probably find the circuit easier to tune by connecting the variable condenser across the aerial inductance, rather than in series with it.

Hundreds of letters have been received indicating the success which has attended the use of this circuit, but there are also a number which indicate that some experimenters are having difficulties. Quite a number who have never made a set before, have commenced with this circuit.

Allow me to assure you all that there is nothing tricky about the circuit or apparatus. Everything works in a perfectly straight-forward manner, and no trouble should be experienced by the average experimenter.

Some readers are obviously not using the correct values of inductance for tuning purposes. The aerial inductance should be a No. 25, 35 or 50 honeycomb coil. The tickler coil should be a No. 75 honeycomb coil. Other coils of corresponding value may be employed.

THE article appearing under the above title was reproduced from a similar article appearing in "Modern Wireless" Magazine. RADIO NEWS has the exclusive rights in the United States for republishing all articles appearing in "Modern Wireless." The articles are, therefore, copyright, and rights to publish a reproduction are strictly reserved.—Editor.

is only possible to obtain a certain signal strength with two valves on loud signals.

I have found that the circuit is not very effective on long distance signals. This is because there is only one stage of high-frequency amplification. Its chief use seems to be in obtaining very loud results, when within 50 miles of a broadcasting station.

The voltage of the "B" battery is an important factor, and 100 volts is recommended. It is preferably shunted by a one-microfarad condenser.

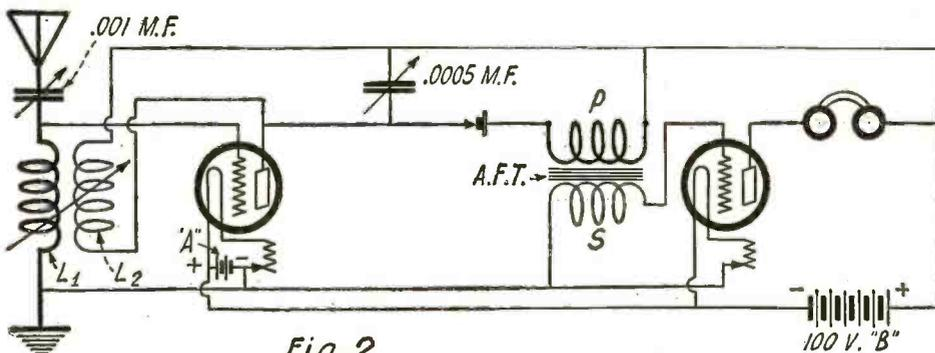

Fig. 2

Here is a Modification of the Original ST-100 Circuit. The Results Obtained from This Arrangement Are Most Satisfactory.

Electrons, Electric Waves and Wireless Telephony

By DR. J. A. FLEMING, M.A., D. Sc., F.R.S.

Part IX

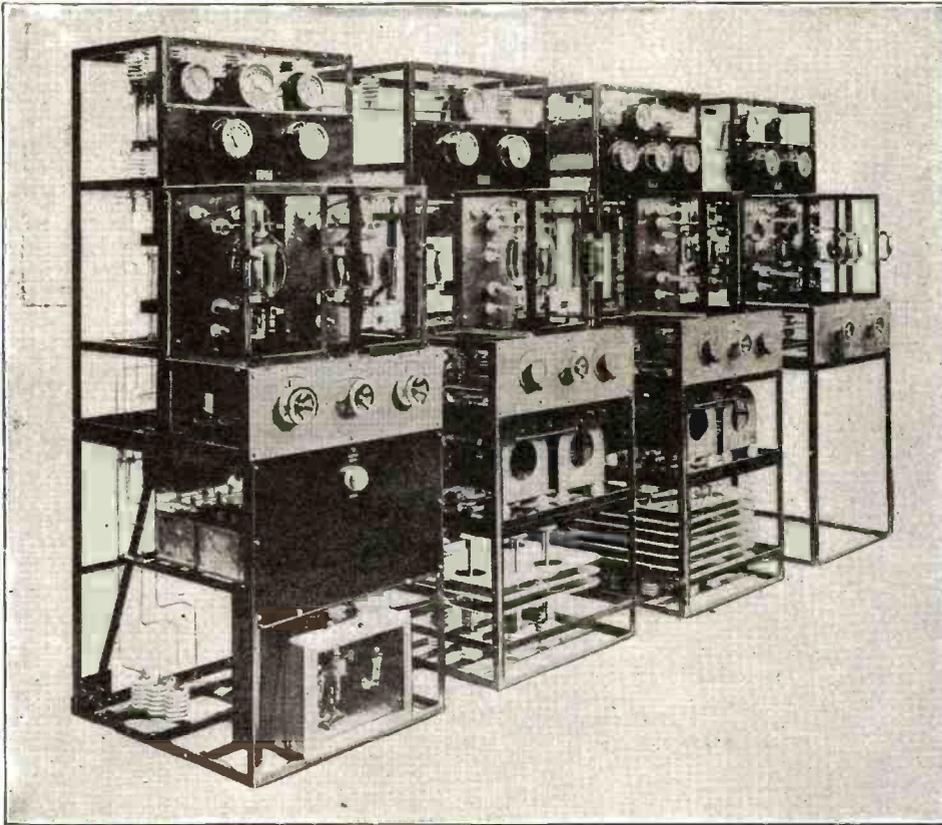

Fig. 107. Latest Broadcasting Apparatus, With Thermionic Valve Transmitters, Designed by the Marconi Company. (Courtesy of Marconi Wireless Telegraph Company, Ltd.)

A MATTER which greatly interests the general public at the present time is the future of the so-called "broadcasting" in this country. By this term is meant the diffusion over large areas from certain transmitting stations, of music, addresses, lectures, sermons, recitations and other information or news of public interest by wireless telephony, which can be picked up within range by those possessing a suitable aerial and receiving apparatus. This new form of entertainment and of news distribution has attained already enormous dimensions and popularity in the United States.

Arrangements are now being organized for some such public supply of telephonic talk and music in Great Britain, and probably before long it will be developed into a great feature of modern life. Owing to the comparatively small area of Great Britain and the important use of wireless telegraphy and telephony in naval and maritime intercommunications, strict regulations have had to be imposed to prevent irregular use of either transmitters or of valve receivers which may act as transmitters prejudicial to these public services.

According to the official regulations of the British Postmaster-General at present in force, the wave-lengths set apart for such broadcasting must be between the limits of 350 and 425 meters in wave-length. Also, to limit the receptive powers of amateurs, if a single external aerial wire is employed, it must not be more than 100 ft. long or 100 ft. high. If a double wire aerial is used the total length of aerial wire may be 140 ft., making an aerial 70 ft. long, and these wires may be spaced a few feet, generally about 4 ft. apart. These total lengths of wire include any down lead into the room or house in which the receiver is placed.

There is, however, no regulation to prevent any adjustment the amateur may give to his apparatus, as far as he can, to enable it to receive or pick up electric waves of longer or shorter wave-length than those

of the broadcast wave-length, provided of course that he has obtained a wireless reception license from the General Post Office. The wave-lengths of 300 and 600 meters are reserved for ship and coast stations. The Croydon, Lympne and Pulham aerodromes work on a 900-meter wave, and the large long-distance stations, such as Carnarvon, on a wave-length approximating to 20,000 meters. A great deal of the continued popularity and utility of broadcasting will, of course, depend upon the character of the utterances sent out from the transmission centers. It is capable of enormous services in the interests of popular education and elevation, or it may be degraded to the level of a mere amusement for the frivolous and uneducated listeners-in.

Whereas now a notable public lecturer or orator can address at most two or three thousand hearers in a very large hall, by wireless broadcasting he could, with no greater effort to himself, address two or three hundred thousand, or even two or three million listeners-in, if they were provided with aerials and proper receiving apparatus, and that without the discomfort of travel necessary to get to or from a public building.

The dulcet notes of some prima donna can in this manner reach vaster audiences than any opera house will hold, and popular preachers may be able to address and teach congregations who are never found inside a church.

The problem of providing for and regulating this broadcasting and its reception in the case of radiotelephony has had to be carefully considered by the public authorities from various points of view.

One of the first questions considered was that of meeting the cost of erection and working of the special radio stations necessary for broadcasting purposes. This cannot be supplied as a gratuitous public service. Moreover, some method had to be devised

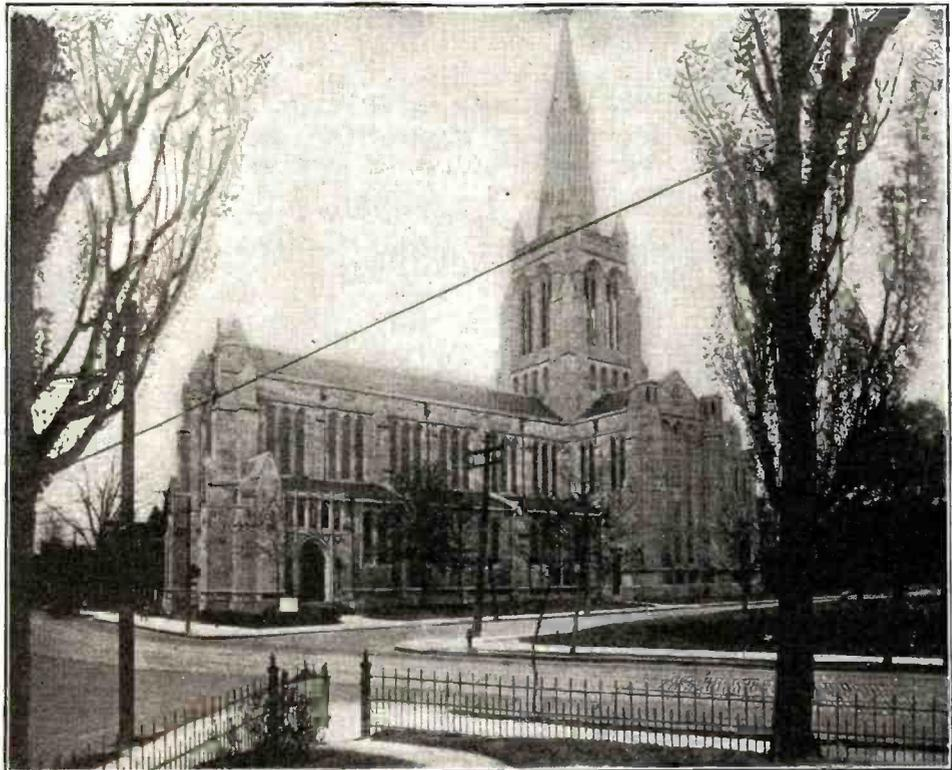

Fig. 108. View of the Calvary Episcopal Church in Pittsburgh, Pennsylvania. From Which Sermons Have Been Regularly Broadcast Not Merely to Individual Listeners But Also to Other Churches. (Courtesy of "Conquest.")

for preventing the broadcasting from being picked up and taken advantage of by listeners employing imported apparatus or unauthorized self-made receivers. The only method by which the working costs of such stations could be met was by some contribution from the license fees of all receivers and from royalties on the sale of this receiving apparatus.

A plan has, however, been evolved after many conferences between the representatives of manufacturers of radio apparatus and the representatives of the British Postmaster-General which seems, as far as can be judged at present, likely to meet the difficulties of the case.

It is recognized that such broadcasting would not only introduce a new kind of interest into domestic life, but might become a new and powerful means of popular instruction and amusement, whilst it would create a fresh industry likely to afford occupation to very many workers.

This plan consists in the formation in Great Britain of a public company called the British Broadcasting Company, Ltd. (abbreviated into B.B.C.).

The executive agency in the matter of broadcasting in Great Britain will be this British Broadcasting Company, the capital of which has been guaranteed by six other public companies, viz., the British Thomson-Houston, The General Electric, Marconi's Wireless Telegraph, Metropolitan-Vickers Electrical, Radio-Communication, and the Western Electric Companies, all of which are interested in extending the use of radio-telephony. The British Broadcasting Company will be a public utility service for the broadcasting, by wireless telephony, of news, information, music concerts, lectures, educational matter speeches, weather reports, and entertainments. Any bona-fide British manufacturer of radio apparatus can join the Company or become a member by taking one or more shares in it.

Each member undertakes that the radio apparatus he sells is to be made in Great Britain. The apparatus sold must be engraved or marked so that its origin and maker are known. This is to prevent the importation into this country of cheap, foreign apparatus. Only members of the Company can have radio sets approved for sale by the Postmaster-General, and each set must be stamped with the mark "Type approved by P.M.G. B.B.C."

To meet the expenses of broadcasting,

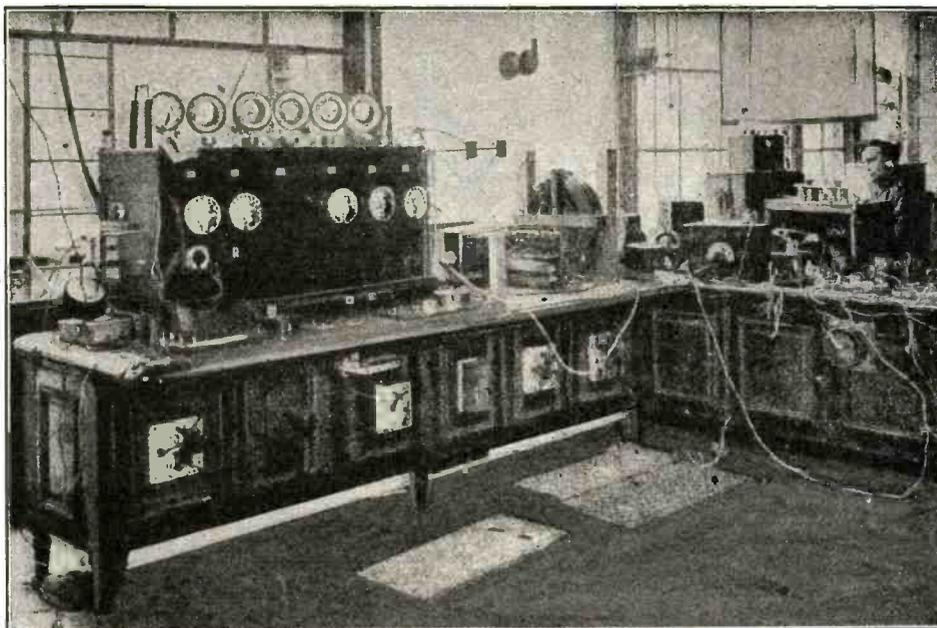

Fig. 109. The Eiffel Tower Wireless Telephone Broadcasting Station With Valve Transmitters.

each set sold must pay a royalty to the Broadcasting Company as follows:—

Crystal set, 7s. 6d.; Microphonic amplifier, without valves, 7s. 6d.; crystal set and one valve, £1 7s. 6d.; crystal set and two valves, £2 2s. 6d.; one-valve set, £1; two-valve set, £1 15s.; three-valve set, £2 5s.; four-valve set, £2 15s. Also small royalties are payable on each telephone, loud speaker and thermionic valve sold. These amounts may, of course, be changed or varied to suit necessities.

For transmission purposes every member who has inventions must grant the use of them to the Broadcasting Company, that is, all inventions are to be pooled.

In the license for transmission which the Postmaster-General will give to the British Broadcasting Company it is agreed that no foreign made receiving sets will be allowed to be sold for broadcasting purposes in Great Britain for at least two years.

The functions of the Broadcasting Company will furthermore comprise the erection and working of the necessary broadcasting stations in Great Britain.

It is proposed that stations shall be erected in London, Cardiff, Plymouth, Birmingham,

Manchester, Newcastle, Edinburgh or Glasgow and Aberdeen. By this wide distribution everyone who purchases a receiving set duly stamped and who has furthermore taken out a Post Office license for wireless reception by it will be within reach of one at least of these broadcasting stations. Each station is estimated to cost about £50,000 to erect, and £20,000 annually for working.

The first broadcasting will probably be conducted in London from Marconi House in the Strand, and in Fig. 107 we give a view of the latest broadcasting apparatus with thermionic valve transmitters, designed by the Marconi Company for this work.

The provision of broadcasting stations at Birmingham, Newcastle, Plymouth, Glasgow, Aberdeen and Cardiff will immediately receive attention from the British Broadcasting Company. When this broadcasting begins in earnest it is intended to provide every day from each station a six-hour program from 5 p.m. to 11 p.m., with the exception of Sunday. On this latter day the all-day program will include the broadcasting by wireless telephony of sermons by leading preachers. In the United States the broadcasting not only of sermons, but of whole services with prayers and hymns is undertaken, and is the means of bringing religious worship and exhortation to those who would not generally be found, or were unable to be, within the walls of a church (see Fig. 108).

One can easily see that this broadcasting of not only music and entertainments, but of serious instruction or religious discourses, may powerfully assist in relieving the isolation of country districts or farmhouses far from town centers.

It will no doubt be the policy of the Broadcasting Company to engage the services of public men, eminent lecturers or attractive speakers, as well as musical celebrities, who will by wireless telephony instruct or charm far vaster audiences than could be reached by their unaided voices.

In these broadcasting stations the transmitters employed will unquestionably be valve transmitters of large size and adequate power, the general principles of which have already been explained.

In Fig 109 is shown a view of the valve transmitters in the Eiffel Tower Station in Paris employed there for broadcasting work. In Fig. 110 is shown a view of the aerials of the Marconi Broadcasting Wireless Telephone Station at Writtle, in Essex.

We have in the next place to consider the arrangements which the amateur listener-in or place of public entertainment must

(Continued on page 466)

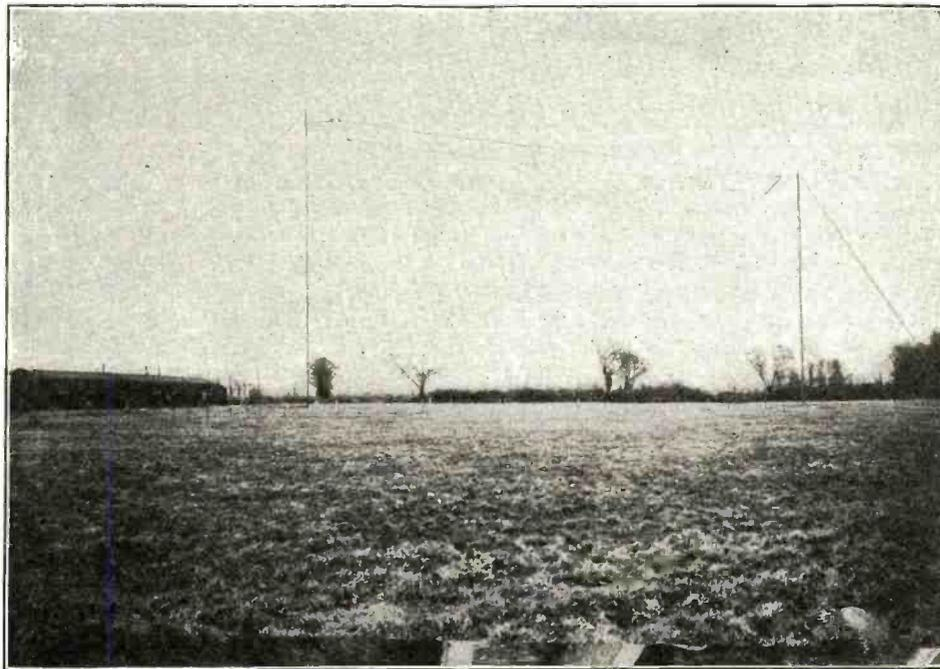

Fig. 110. The Marconi Broadcasting Wireless Telephone Station at Writtle, Essex, From Which Concert Music Is Sent Out on Regular Schedules.

(Courtesy of Marconi Wireless Telegraph Company, Ltd.)

Radio Frequency Amplification

By LOUIS FRANK

HAVING reached the subject of detection and having discussed it thoroughly in the last article of this series, our next logical and important subject is that of amplification, namely magnifying the intensity of the received signal. There are two im-

portant methods of amplification, (1) radio frequency amplification, and (2) audio frequency amplification. Each of these methods has its own special sphere of application, and it is important that the radio fans should understand thoroughly the difference between the two methods.

FUNCTION OF RADIO FREQUENCY AMPLIFIERS

If we amplify the signal after detection we simply make the signal louder, for after detection the signal is already audible, but amplification increases the loudness. In other words audio frequency amplification serves to *increase the volume of the audible signal*. It is used if the detected or audio signal is too low in the telephones or when it is desired to have a number of people hear the signals simultaneously, in which case it is necessary to increase the loudness or volume of the audio signal so that it can be heard throughout a room.

The function of radio frequency amplification, on the other hand, is entirely different. The detector rectifies the radio frequency currents in the receiver and so makes them audible. Now the efficiency of the detector depends upon the radio frequency voltage which is applied to it. Actually it is proportional to the square of the radio frequency voltage applied to it. Thus, if a radio frequency signal is made twice as strong as ordinarily, the efficiency of detection, or the audibility of the telephone signal, will be four times as great as ordinarily. So the greater the radio frequency signal applied to the detector is, the greater will be the telephone signal. But the detector has a peculiar property. If the radio frequency signal is lower than a certain value it will not detect, in other words no signal will be heard. Suppose then we receive a signal

All methods of amplification are based on the one important fact that a vacuum tube is itself an amplifier. If a very small voltage is applied between the grid and filament of a vacuum tube, a very large current will flow between the plate and filament when there is a positive voltage on the plate. This

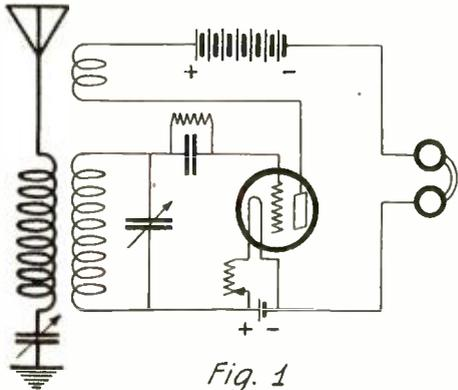

Fig. 1
The Simplest Form of Radio-Frequency Amplifier; the Tickler Feed-Back Regenerative Circuit.

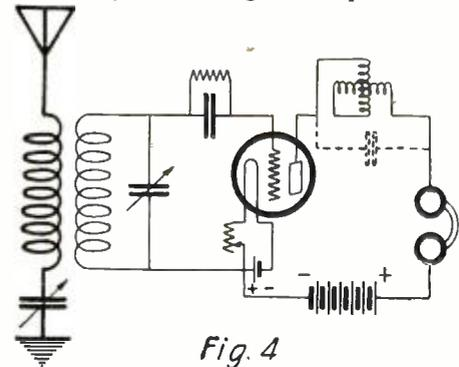

Fig. 4
A Radio-Frequency Amplifier of the Tuned-Plate Type, Wherein Regeneration Is Obtained by the Use of a Variometer in the Plate Circuit of the Vacuum Tube.

portant methods of amplification, (1) radio frequency amplification, and (2) audio frequency amplification. Each of these methods has its own special sphere of application, and it is important that the radio fans should understand thoroughly the difference between the two methods.

is due to the construction of the elements of the tube. In other words small currents, voltages or power applied to the grid circuit will produce large currents, voltages and power in the plate circuit, if the circuit is properly built. The vacuum tube is thus inherently an amplifier and this property is utilized in the actual amplification of signals.

MEANS OF OBTAINING RADIO FREQUENCY AMPLIFICATION

There are a number of different ways in which the incoming radio frequency signals may be amplified. The first of these is one which is most commonly employed by a large number of amateurs, but which they do not recognize as radio frequency amplification. This method is that of *regenerative reception*. We have in Fig. 1 a simple receiving circuit with a plate tickler coil coupled to the grid circuit. The method by which radio frequency amplification is effected is as follows: The original received signal is applied to the grid of the tube. This signal is then amplified by the tube itself and the amplified radio frequency signals flow in the plate tickler coil. By coupling back into the grid this amplified radio frequency signal is again injected into the grid and is once more amplified. This repeated process of amplifying the output is seen to be amplification of radio frequency currents, hence this method of regeneration is essentially radio frequency amplification.

In a regenerative receiver, therefore, we have two important processes going on simultaneously; (1) Radio frequency amplification by regeneration and (2) detection. This explains why long distance work is done by amateurs with simple regenerative receivers.

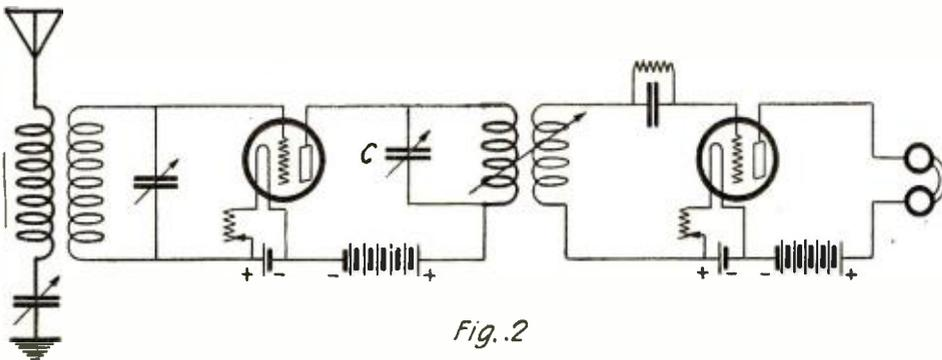

Fig. 2
A One-Stage Tuned Impedance Radio-Frequency Amplifier and Detector. The Impedance of the Plate Circuit Is Varied by Condenser C, Being Brought In Tune with the Wave of an Incoming Signal in This Manner.

The current which flows down the antenna and into the receiver is a radio frequency current, whereas the current which flows in the telephone receiver after detection is an audio frequency current. We may either amplify the antenna current before it is detected (radio frequency amplification), or we may amplify the signal after detection when it is audible (audio frequency

from a great distance. The radio frequency current in the receiving antenna may be very small, and although it is applied to the detector, no signals will be heard because the detector cannot rectify such low radio frequency currents. In order then to enable the detector to rectify and detect these low signals it is necessary to increase their value to the point where detection can take place. In other words, we must here employ radio frequency amplification. This is employed to increase the efficiency of detection, and, as implied above, is used essentially to make audible *distinct stations which would otherwise not be heard*.

We thus see that the chief difference in the use of these two forms of amplification is the following: Radio frequency amplification is employed where long distance work is the objective point, whereas audio frequency amplification is employed when loud signals are desired. Radio frequency amplification is employed before detection, audio frequency amplification is employed after detection. Having these differences clearly in mind we will now proceed to take up the first form of amplification, namely radio frequency, and the various methods by which this is effected today.

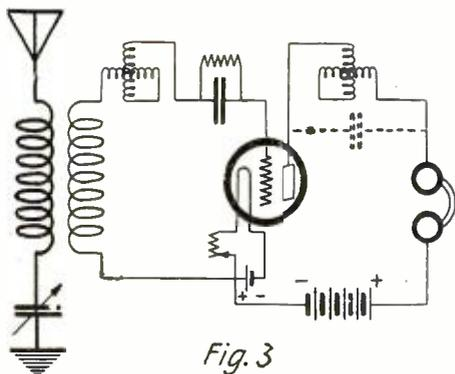

Fig. 3
Another Simplified Form of Radio-Frequency Amplifier, Better Known as a Three-Circuit Regenerative Receiver.

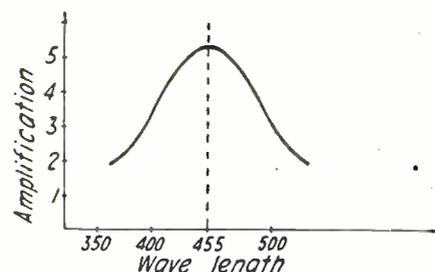

Fig. 5
A Curve Illustrating How Amplification Varies With the Received Wave-Length. The Wave At Which the Amplification Is Maximum Is the Wave To Which the Plate Circuit Is Tuned.

Their receivers amplify the incoming radio frequency so well that far distant stations are made to actuate the detector tube. This will also serve to explain to the novice the reason for the frequently occurring statement that regeneration is equal to one or even two stages of radio frequency amplification. It is not only equal to it, but it is radio frequency amplification.

TUNED CIRCUIT AMPLIFIER

A second method of radio frequency amplification is the so-called "tuned circuit" amplifier. This method is now considered because of its close similarity to the above method of regenerative amplification. In this method a tuned radio frequency circuit is used in the plate circuit of the detector tube or amplifier tube. Thus in Fig. 2 we have represented an antenna which is coupled to the grid circuit of a vacuum tube amplifier. In the plate circuit we have a coil and variable condenser which may be tuned to any desired wave-length. This circuit is also coupled to the grid circuit of another vacuum tube which is the detector tube. The radio frequency voltages which are applied to the grid of the first amplifier tube are amplified by the tube, and appear in the plate circuit. It is found that when the radio frequency circuit in the plate of the first tube is tuned to the same wave-length as that of the antenna or incoming signal, the amplification is increased greatly. This is due to the phenomenon of resonance which magnifies all ef-

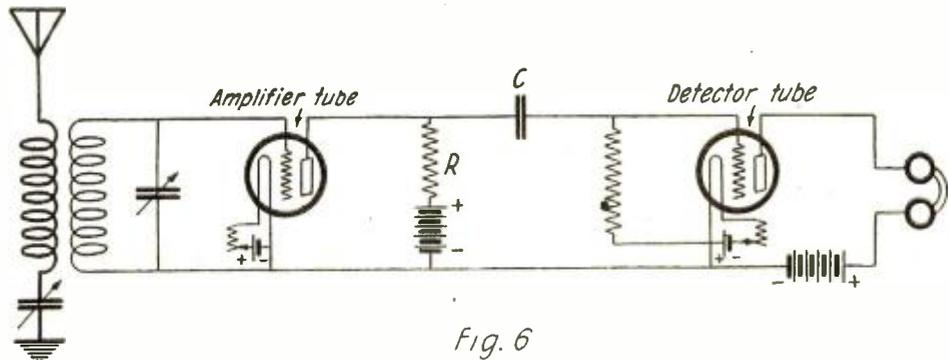

Fig. 6
A Circuit Incorporating One Stage of Resistance Coupled Radio Frequency Amplification and a Detector. This Form of Amplification Is Effective Only On High Wave-Lengths.

condenser in the grid circuit, as shown in Fig. 4, the grid variometer is not necessary; but for regeneration the plate variometer is required. For a given wave-length, maximum regeneration is obtained at a definite setting of the plate variometer, which has a certain distributed capacity. This distributed capacity forms a tuned radio frequency circuit with the inductance of the variometer as shown by the dotted capacity in Figs. 3 and 4. In other words, by adjusting the plate variometer we tune the plate circuit of the tube so that this circuit is in resonance with the antenna and incoming signals, and as a result of this resonance increased frequency amplification is secured. Here also the tube performs the function of regenerative radio frequency amplifier and detector simultaneously. We thus see that this favorite method of regenerative reception is in reality a case of tuned circuit radio frequency amplification.

The radio frequency amplifier described above, having a tuned plate circuit, has a certain marked characteristic which is best shown in Fig. 5. This curve shows how the amplification varies with the received wave-length. It is seen that the amplification is a maximum for a given wave, and then falls off markedly at other wave-lengths. The wave at which the amplification is a maximum is the wave to which the plate circuit is tuned. Hence by adjusting the plate circuit wave-length, either by means of the condenser C of Fig. 2, or by means of the plate variometer of Fig. 4, to the wave-length being received, as say 455 meters as used by WJZ, the amplification will be a maximum. This scheme has a great additional advantage. The broadcast listener experiences frequent interference from other stations. From Fig. 5 we see that the amplification is a maximum at the tuned wave-length, say 455 meters, but falls off very rapidly as this wave-length is departed from. In other words interfering wave-lengths are not amplified very much, hence interference is considerably reduced. Amateurs and broadcast listeners will do well to try out this simple plan for eliminating much of their interference, as they will find it quite successful.

RESISTANCE COUPLED AMPLIFIERS

One of the earliest forms of radio frequency amplifiers used is the "resistance coupled amplifier." A simple circuit of this type of amplifier is shown in Fig. 6. The radio frequency signal from the antenna is induced in the grid coil and is then impressed on the grid of the vacuum tube amplifier. This small current in the grid circuit causes a much larger current to flow through the plate circuit, as explained at the beginning of this article, on account of the amplifying properties of the vacuum tube. This increased current is made to flow through a high resistance R, as a result of which a very high voltage exists across this resistance. This voltage, which is of the same type as the original voltage in the antenna, only very much larger, is then applied to the detector tube and rectified and made audible in the telephones. The object of the condenser C through which this voltage is

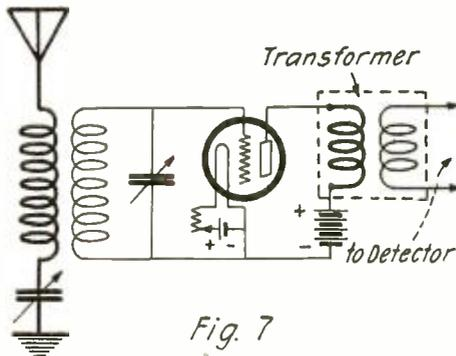

Fig. 7
Showing the Connections For a Stage of Transformer Coupled Radio Frequency Amplification.

fects, as was thoroughly explained in the article on "Resonance Phenomena" in the May, 1923 issue of RADIO NEWS. This magnified radio frequency voltage is then applied to the grid of the succeeding detector tube which rectifies and makes it audible. By the simple device of placing a tuned circuit in the plate of your amplifier, very great radio frequency amplification may be obtained.

One of the methods of regenerative reception is shown in Fig. 3, namely where a variometer is used in the plate circuit and grid circuit. The variometer in the grid circuit is not essential, but is simply used to tune the circuit in the same way that a condenser tunes the circuit. If we use a

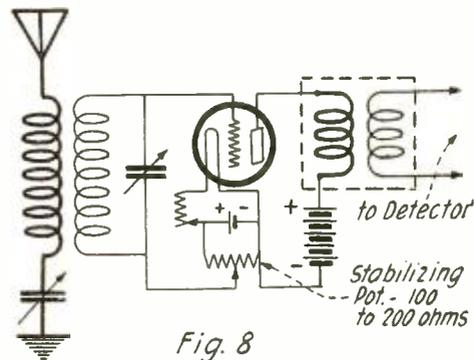

Fig. 8
The Same As Fig. 7, With the Addition of a Potentiometer, For Stabilizing the Circuit.

applied to the grid of the detector tube, is to prevent the high positive plate voltage from being applied to the grid of the detector as it would prevent the tube from operating. Because a resistance is used in the plate circuit of the amplifier it is called a "resistance coupled amplifier." For best results the resistance R should be several times the resistance of the amplifier tube, and in general this value of R should be between 20,000 and 30,000 ohms. These resistance units are made in small tubular or cartridge forms and are easily obtainable in any size required. This type of amplifier is more suitable for the long waves than for the short waves.

TRANSFORMER COUPLED AMPLIFIERS

By far the most important method of radio frequency amplification is the "transformer coupled amplifier." Such a simple amplifier is shown in Fig. 7, where T is a radio frequency transformer. In this system the antenna voltages are induced on the grid of the amplifier tube, as a result of which large plate currents flow in the plate circuit. These currents flow through the primary of the transformer as a result of which large voltages are induced in the

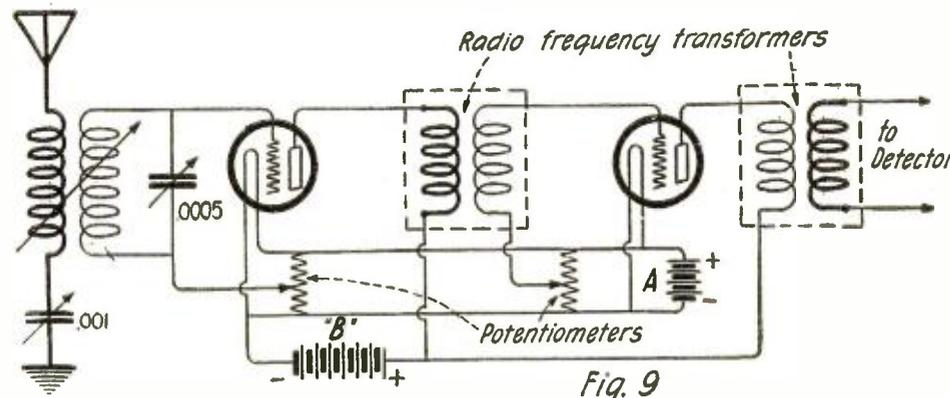
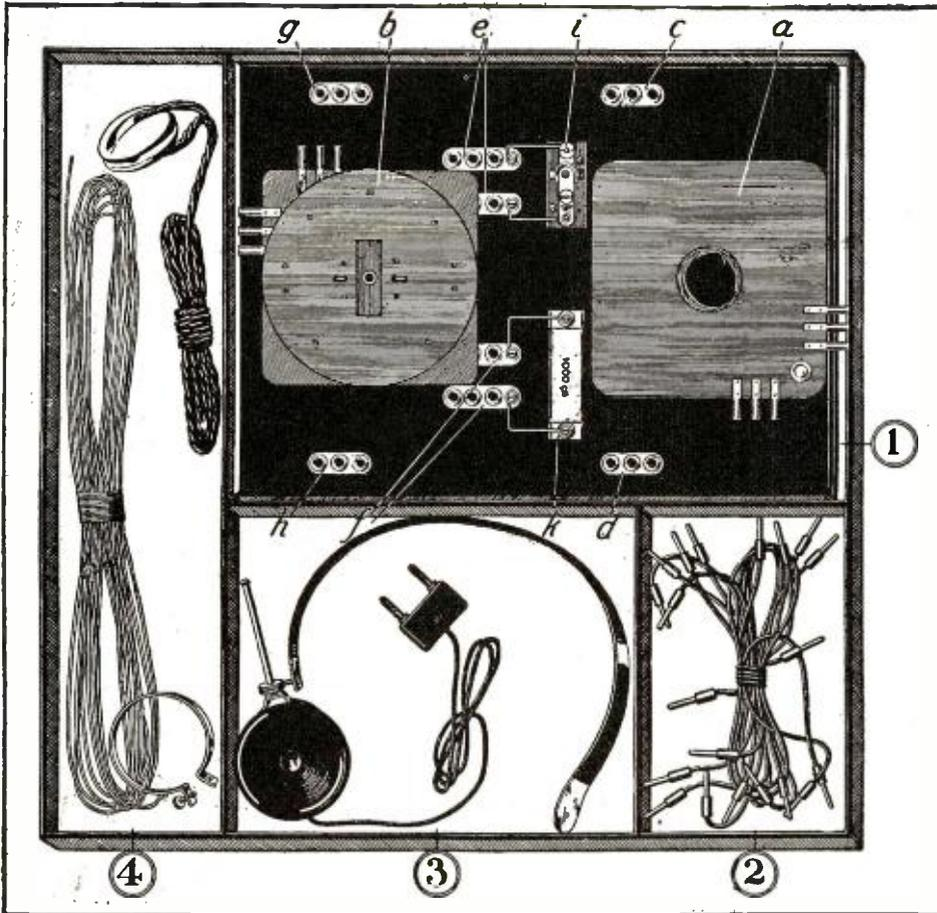

Fig. 9
A Two-Stage Radio Frequency Amplifier of the Transformer Coupled Type. Two Potentiometers Are Used So That Perfect Control of Both Amplifier Tubes Can Be Had

(Continued on page 424)

An Experimental Radio Cabinet

By DR. EUGENE NESPER, Berlin



This Gives the Reader a Good Idea of the General Appearance and Layout of the Experimental Radio Cabinet. This Consists Mainly of Two Inductance Coils, a Crystal Detector and Fixed Condenser, and a Pair of Head-Phones. By Means of Connecting Wires With Plugs On Their Ends, a Variety of Circuits Can Be Tried Out By Inserting These In the Jacks Mounted On the Base For This Purpose.

MANY radio amateurs who have neither the capability nor the means to build for themselves radio apparatus or to buy it, have often expressed the wish to possess an experimental apparatus, which at a low price would make it possible for them to try out a very great number of receiving hook-ups and to use it for radio reception in general. The solution of this problem naturally lies in the fact that the parts used for this apparatus, in spite of their necessarily high grade quality and construction, will be procurable at a reasonable price, and will cover the most varied fields of experimentation.

The radio experimental apparatus brings this result about, when, for example, the

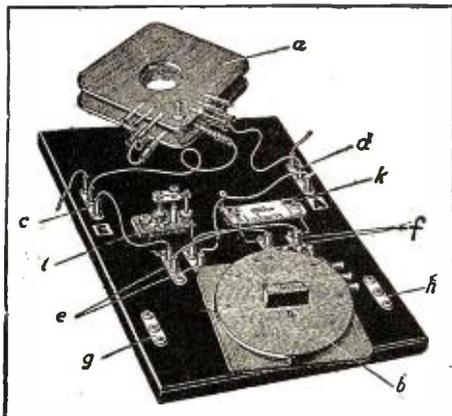

A View of the Apparatus Board, Showing How Connections Are Made With the Small Jacks and Plugs.

inductance coils as well as the condensers are provided with adequate taps, which by simply plugging-in without any difficulty will instantly give the results which may be desired.

Built on these lines, the radio experimenter's cabinet made by a Berlin company, provides a fundamental apparatus to which according to one's desires, a number of auxiliary apparatus can be added, by which naturally the possibility of use and the hook-ups to be made with the experimenter's cabinet, will be extraordinarily increased in every way in number and efficiency.

In the principal cabinet, shown in Fig. 1, there are a number of divisions in which the various most essential parts are contained. In division No. 1, a ground plate is provided, on which a tapped coil arrangement *a* and a flat variometer *b* are mounted. Besides these there are a number of plug leads recognizable as *c*, *d*, *e*, *f*, *g*, and *h*, which serve for the various hook-ups to be described. Moreover there is shown a crystal detector *i* and a fixed condenser *k*.

In division No. 2 can be seen a number of flexible cords cut to various lengths, each provided with a plug contact at each end, which serve to carry out the various hook-ups.

In division No. 3 are a single telephone headset and a fixed condenser with plug connections.

In division No. 4 is material for a small antenna, about 16' long, provided with porcelain insulator and connecting flexible cord.

A great number of simple reception hook-ups can be carried out with the ground plate seen in division No. 1 in Fig. 2, to which the single pieces of apparatus mentioned

above for the greater part can be connected, and with due regard to the tapped coil and variometer, all the hook-ups in the diagrams Figs. 3 to 19 can be carried out.

PRIMARY DETECTOR HOOK-UPS

Diagram Fig. 3 shows the simplest possible hook-up, in which the detector is connected directly to the antenna. To carry this out, the flexible cord from the antenna is plugged into one of the three-plug receptacles of *d*, the lead *c* by plugging in is connected to the ground, by a sufficiently long "litz" wire, *e* is connected with the one lead of *e* which brings the detector into circuit. For connecting the fixed condenser *k* the other lead from *e* is connected with the lead *f* and by connecting the other ground lead of *f*, with the hitherto disconnected leads from *e*, closes the detector circuit. In the lead of *f*, moreover, the head set is plugged. In this way the hook-up, according to diagram No. 3, is obtained, in which no tuning of any kind is provided for.

A somewhat better connection is shown in the hook-up, Fig. 4, in which an inductance is put in series with the antenna, with which the detector is in parallel. To carry out this idea, the lead *d* is again connected to the antenna and the lead *c* is plugged to the ground.

Again the lead *d* is connected to the tapped coil *a*, by a contact plug, while the other end of the tapped coil is plugged into the fixed condenser included in diagram Fig. 3, whose other terminal is connected to the ground lead *c*. The plugging in of the detector *i* of the fixed condenser *k*, together with the parallel telephone, is followed out exactly as in diagram Fig. 3. This connection is repeated in general in all the following connections.

This hook-up makes possible a tuning within definite limits and is adapted especially for short wave-lengths. It can be considerably improved by introducing continuous wave variation. To carry this out, the honeycomb coils, *a*, are turned with refer-

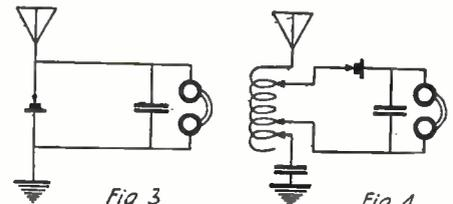

Two Simple Receiving Circuits That Can Be Employed With This Set.

ence to each other, so as to bring about a variometer effect, never going outside of a decidedly limited range, or else, what is more practical, the coil mountings, *a*, are connected up in series with the variometer, *b*, which is carried out by use of the various plug openings. In this way the honeycomb coils, *a*, and the variometer, *b*, are connected in series.

By carrying out this idea a little further according to diagram Fig. 5, with somewhat longer waves, the coils alone are used and all suitably plugged in while rotated with reference to each other.

(Continued on page 472)

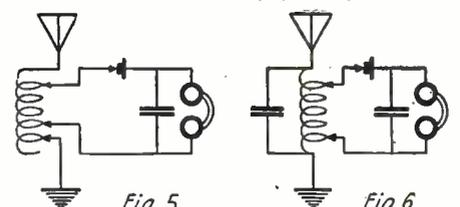

These Two Circuits Are More Selective Than Those Shown In Figs. 3 and 4.

Reaching the New Wave-Lengths

By W. L. PEARCE

SINCE the change of wave-lengths of most of the broadcast stations, the average novice is at a loss to discover a way to tune to the higher waves. Most of the receivers in use before the change were designed for a

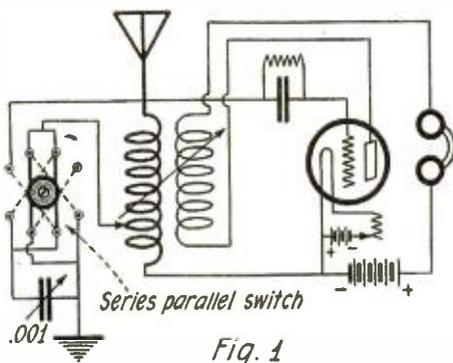

Fig. 1
Long and Short Waves Can Be Reached By Using a Series-Parallel Switch in Conjunction With the Variable Condenser.

maximum range of about 450 meters. As a good many stations now transmit on waves of 450 to 550 meters, these receiving sets are missing a good many stations. This holds true only of those sets which use standard fixed inductances for tuning and does not apply to honeycomb-coil receivers. In this type, the higher waves can be reached by simply substituting larger coils; however, since a honeycomb-coil receiver is tuned by two variable condensers, one in the primary circuit and another in the secondary, it is usually possible, by the proper selection of coils, to be in a position to tune from 200 meters or so to 600, without the necessity for a change. In most receivers it is possible to tune to the higher waves without the addition of extra coils or condensers. Those requiring consideration are the single-circuit, two-circuit and three-circuit re-

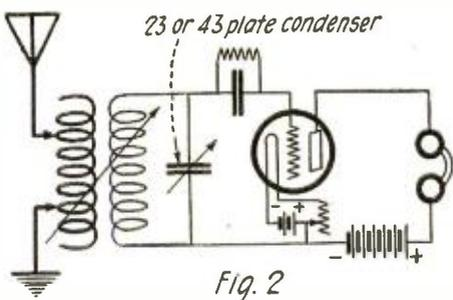

Fig. 2
A Variable Condenser Across the Secondary Coil Will Enable the Reception of Long Waves.

ceivers, employing variocouplers for the purpose of tuning and tickler feed-back or a tuned-plate circuit for producing regeneration.

The average single circuit receiver needs no additional apparatus to cover all the new wave-lengths. The usual hook-up of the single-circuit receiver employs a variable condenser in series with the antenna or ground, for close tuning. This naturally reduces the wave-length of the set and it may be necessary to take the condenser out of the antenna or ground circuit, and connect it across the coil, in order to reach the higher wave-lengths. A good plan would be to use a series-parallel switch, so that the condenser can be placed in either position at will, thus enabling reception on both high and low waves. This circuit is shown in Fig. 1. If a tickler coil with about 45 turns is used, regeneration should be obtained over the entire band of broadcast wave-lengths.

In a two-circuit tuner, the secondary circuit is the one that usually requires some means for increasing the wave-length. If

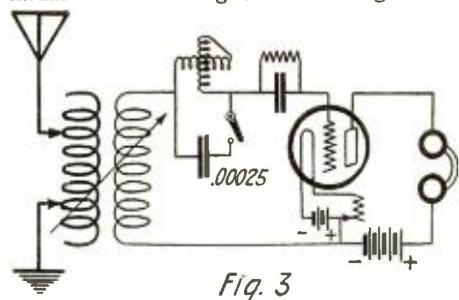

Fig. 3
A Fixed Condenser Across the Variometer Will Also Serve the Purpose.

the secondary contains 50 turns of wire, and is shunted by a 23-plate condenser, it should tune from 200 to 500 meters. This arrangement is shown in Fig. 2. If difficulty is had in reaching this wave-length, a variable condenser of 43 plates may be used in place of the smaller one. No trouble should be experienced, if this change is made. If the secondary is tuned by means of a variometer, the wave-length will not, as a rule, go higher than 450 meters. In this case, a 23-plate condenser may be connected from the grid side of the variometer to the battery side of the secondary. This, however, adds another control to the set and makes tuning more difficult. The best plan would be to connect a small fixed condenser of about .00025 mfd. in this position, controlled by a switch, so that it can be cut out of the circuit at

will. A condenser may also be shunted across the variometer for higher waves. (See Fig. 3.)

Where regeneration is obtained by means of a variometer in the plate-circuit of the

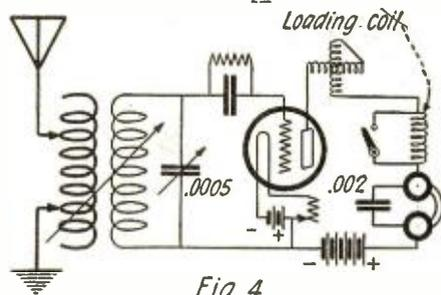

Fig. 4
The Plate Circuit Can Be Loaded With a Coil. For the Long Waves.

detector, some method must be used to obtain regeneration on the higher waves. A coil of about 25 turns of No. 24 S.C.C. wire, on a 3" tube, connected in series with the variometer, will increase the wave-length of this circuit. It should be shunted by a switch, as shown in Fig. 4, so that it can be short-circuited for reception on low waves. Without this, it would prove difficult to keep the detector from oscillating on the lower waves. An 11-plate variable condenser can be shunted across the plate-variometer with satisfactory results. Regeneration will then be easily obtained on a wave-length of 600 meters. It would be cheaper to use a fixed condenser of .00025 mfd. in this position, controlled by a switch, as mentioned before. Fig. 5 shows a standard three-circuit receiver, using fixed condensers in the secondary and plate circuits, for increasing the wave-length. If switches are used to vary the primary inductance, this circuit will respond to the higher broadcast wave-lengths without change.

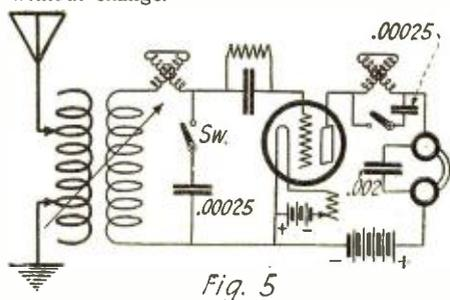

Fig. 5
A Three-Circuit Regenerative Receiver Will Reach the Long Waves With the Addition of Two Fixed Condensers, As Shown.

Positive and Negative

ONE is apt, sometimes, to overlook the fact that electrical potential, like position and time, is purely relative and that just as height is measured up or down from a reference datum so is electrical potential positive or negative in relation to an arbitrary zero.

In the case of the vacuum tube it has become customary to regard the negative end of the filament as being at zero potential—i.e. to make this our datum—and in receiving tubes the plate is maintained at a potential some 50 volts positive in relation to the filament. In other words, the plate, on account of the "B" battery, carries a considerable excess of positive electricity. The grid carries a small excess of positive or negative electricity, and is relatively positive or negative as the case may be.

Now the incandescent filament emits particles of negative electricity or electrons, just as boiling water emits steam, and as these travel to relatively positive points, when free to do so, most of them will flow to the plate where a continuous neutralization of positive electricity gives rise to a make-up current from the "B" battery.

One end of the incandescent filament is positive in relation to the other, hence there is a constant, though much smaller, stream of electrons from the negative end through the vacuum to the positive end; and if the grid is positive in relation to the filament, it will receive its stream of electrons also. If the grid is negative in relation to the positive end of the filament, but positive in relation to the negative end, it will still collect

electrons, for there remains a portion of the filament that is relatively negative.

When we say that electrons travel to relatively positive points, we are referring to points relatively positive in the circuit, for although the individual electrons may be said to have potential—this varies during its travels according to its position in the circuit. In practice it is with the circuit therefore that we are concerned when we talk of electrical potential or voltage. Thus, when free to do so an electron will flow from a point in a circuit that is highly positive to a point that is more highly positive, just as it will flow from a point that is negative to one that is positive, and it may be noted that in so doing it will reduce its own (negative) potential.

H. M. C. C.

1600 Miles on a Crystal Receiver

By EDWARD T. JONES*

CRYSTALS for the detection of very feeble waves coming from very distant points was thought to be a thing of the past; however, they came back strongly when broadcasting first began. It provided a detector which, together with an ordinary tuning coil, a condenser and a pair of tele-

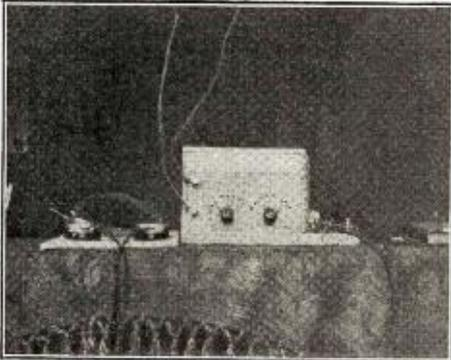

The Crystal Receiver Built by David Harris, on Which He Was Able to Receive Broadcast Stations Up to a Distance of 1,600 Miles.

phone receivers, was within the reach of a great majority of pocket-books.

David Denekamp Harris, a sixteen-year-old lad with radio on the "mind" from morn till night, residing at St. Francisville, La., being one of the majority, built himself a receiving set of the type which is not generally rated for long distance stuff.

After concluding a little more than a year's experiments with electrical apparatus of his own make, David felt as though he were proficient enough to take on the task of constructing a crystal receiver.

FIRST SUCCEEDED WITH CODE ONLY

At first, and until he became well enough acquainted with the receiver he so efficiently and patiently constructed, he only succeeded in getting the "code," or telegraph signals. Now he spends his evenings entertaining the many small children in the neighborhood, who enjoy the bedtime stories broadcast from the powerful stations. Grown-up folks soon learned of David's success in radio and many nights his room has been crowded with those eager to listen. One by one they would put on the headphones and listen to many well known broadcasting stations.

The receiving set complete, with telephone receivers, is clearly shown in the photograph. This young genius constructed everything on the set with the exception of the

receivers. The coil was wound on an oatmeal box, taps being brought to contact points as shown. The switch levers are of his own make and work very well. The set comprises a tuning coil tapped with "units" and "tens" for fine adjustment of its windings; a crystal detector of his own design and a standard head-set. A .001 M.F. fixed condenser is shunted across the telephone receiver terminals.

His antenna is but 35' high and consists of one wire 150' long. A very good ground has been installed and the lead running from the receiver to it does not exceed 8' in length.

David has entertained numerous friends on many occasions with concerts from the following broadcasting stations:

Call	Station	Distance
KSD	St. Louis Post Dispatch	500
WBAP	Ft. Worth Star Telegram	400
WWJ	Detroit News	950
WMC	Commercial Appeal, Memphis	350
WFAA	Dallas News, Texas	350
WOC	Davenport, Iowa	775
WOAI	San Antonio, Texas	450
WDAF	Kansas City, Mo.	650
WHB	Kansas City, Mo.	650
WSY	Birmingham, Ala.	350
WOAW	Omaha, Neb.	800
WEAY	Houston, Texas	250
WGM	Atlanta, Ga.	450
WSB	Atlanta, Ga.	450
WHAS	Louisville, Ky.	650
KHJ	Los Angeles, Cal.	1600
CJCA	Edmonton, Alta., Canada	1150
WAAP	Wichita, Kan.	600
PWX	Havana, Cuba	715
WCX	Detroit, Mich.	950
WLW	Cincinnati, Ohio	700
CKAC	Montreal, Canada	1400
WEAO	Columbus, Ohio	800
WGAM	Orangeburg, S. C.	650
WLAJ	Waco, Texas	400
WAAK	Milwaukee, Wis.	900
WOO	Philadelphia, Pa.	1100
WJZ	Newark, N. J.	1100
KDKA	Pittsburgh, Pa.	950

This list of stations received at David's home on a crystal receiver tells the whole story. While this young man has not installed the units in a cabinet which compares favorably with a newly finished piano, he has obtained the most important thing and that is efficiency throughout.

LOCATION MUCH TO DO WITH SUCCESS

A majority of the radio experts who have

passed through St. Francisville, La., attribute David's remarkable "crystal set" range to his extremely favorable location. His antenna is out in the open for the full length with nothing whatsoever in the way to obstruct the waves before they reach the wire. They also attribute the youngster's success to his ability to manipulate the receiver to a fine degree of selectivity as well as sensitivity. He selected his crystal from several hundred pieces of different minerals and in that way obtained one of the most sensitive crystals procurable.

A diagram of the connections is given herewith. The coil is tapped in two sections and the taps brought to switch contacts so that any number of turns of the coil can be cut into the circuit at the will of the operator, by simply operating the two rotary switches. The first six taps are of one turn each and the second six taps of 10 turns each. The telephone receivers and crystal detector are in series with the connections leading to the two rotary switches, while a .001 M.F. fixed condenser shunts the receivers.

Note that the detector "point" (which is operated by hand) is connected in the ground side of the circuit. This insures against deadening the signal while adjusting the de-

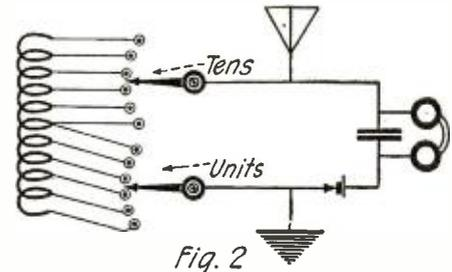

Here Is the Circuit Diagram of the Long-Distance Crystal Receiver Described in This Article.

detector. You can easily demonstrate the effect this has on the received energy by simply placing your hand on your antenna lead-in while receiving.

The remarkable results obtained by young David Harris may prove a surprise to many—but to others it should bring home the important message about "efficiency" in design and construction. It will prove a revelation to those who have in their possession what appear to be better receiving installations (from the looks of the cabinets), but who do not get such remarkable results.

More Light on the Reinartz Tuner

By HOWARD S. PYLE, A.M. I.R.E.

SINCE the appearance of the description of a Reinartz tuner designed by the writer, in the March issue of RADIO NEWS, he has been flooded with letters of inquiry on many minor details. It has accordingly been thought advisable to offer some further light on a few indefinite points.

By far the largest number of inquiries have to do with the proper use of an external coil to reach greater wave-lengths than is possible with the inductance incorporated within the set. A number of correspondents are of the impression that three separate and distinct external coils are required, arranged in inductive relation. Not so; merely one inductance; single layer, spider-web, honeycomb, or any type that pleases the fancy of the builder, may be used. The only requirement is that such

coil have sufficient inductance to cover the desired wave band. This coil is then tapped exactly as the one described in the March issue, except that the proportions will be different. For instance, if the total turns of wire on the external coil are five times the number on the original inductance, then the number of turns at which taps are taken must be multiplied by five. For example, where the taps are taken for the plate inductance at 0, 15, 30 and 45 turns in the original coil, they will be at 0, 75, 150 and 225 turns and the same with the grid and antenna taps. If a total number of turns exceeding five times the number called for in the original coil is used, it is recommended that the number of taps be increased in proportion, for better tuning.

THREE LEVER SWITCHES NECESSARY

This external coil must be provided with three lever switches, *separate and apart* from those contained in the set itself. The taps are brought out to these switches in identically the same way as for the self-contained inductance of the set. The blades or levers of the external switches are then connected to binding posts 1, 2 and 3 provided on the original panel.

A neat and effective mounting for the external coil and its switches would be to place the inductance in a small cabinet, having a panel of formica or bakelite on which the switches are mounted, together with three binding posts to which the switch levers are connected. The binding posts

(Continued on page 462)

*Former Associate Editor of RADIO NEWS.

The Galena Loud Talker

By CLYDE J. FITCH

THERE are many styles and types of radio loud talkers now in use, but how many of these reproduce music and speech with all their original tones and characteristics? Take a horn from any loud talker and put it on another and note the difference in the sound. This is a simple test which indicates that the shape of the horn affects the quality of the reproduced sounds. Now take a number of loud talkers without horns and quickly connect them, one at a time, to a receiving set, and note the difference in the quality of the reproduced concerts. All sound slightly different, but which produces the tones more like the original? As a matter of fact, none of them are perfect; all are far from it. In other words, the loud talker is the cause of much of the distortion in modern radio receiving sets.

Perfect microphones, for picking up the sound waves in the broadcast studio, are now in use. These pick up all the complex vibrations of speech and music and cause corresponding vibrations in an electric current. Vacuum tube amplifiers have been brought to a high state of perfection, and it is possible, with resistance coupled amplifiers, to amplify these complex currents without distortion. Iron core amplifying transformers distort the currents only slightly. If we had a perfect loud talker, radio would be considerably improved; we could not dis-

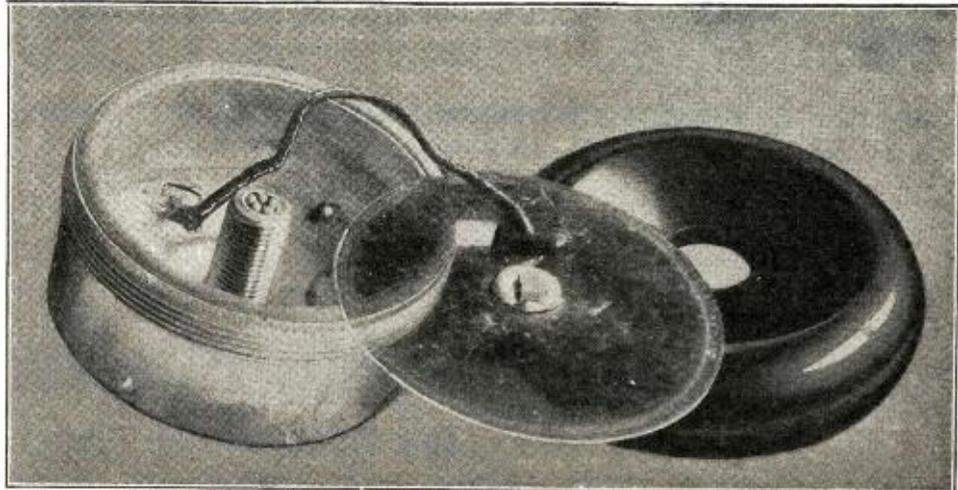

A Photograph of the Galena Loud-Talker. The Galena Crystal is Mounted Directly Upon the Mica Diaphragm and, When the Unit is Assembled, Makes Contact with the Small Carbon Balls Seen in the Hollow Rod.

the diaphragm corresponding to the original vibrations of the speech or music.

As this talker unit is strictly a resistance and is non-inductive, it has no electrical period of its own and will, therefore, cause no distortion due to electrical effects. The diaphragm is always pressing against the carbon balls, so that the natural vibrating period of the diaphragm is highly damped, and there will be very little, if any, mechanical distortion. There probably is a distorting effect caused by the sluggish action of the heat, but this is not noticeable; the reproduced speech is exceptionally clear.

A model was made with a carbon diaphragm having the galena crystal pressing against its center. The galena was supported by the brass rod which screwed through the metal phone shell. The threaded rod, which was $\frac{3}{8}$ " in diameter, allowed for varying the contact pressure between the galena and carbon diaphragm. This phone was very sensitive, but had a tendency to burn out.

MICA DIAPHRAGM USED

The next model was made as shown in the accompanying photograph and in the drawing, Fig. 1. The galena was fastened to the center of a mica diaphragm by means of a low melting point alloy, such as is used for mounting detector crystals. The threaded rod carried the carbon balls, as shown, and the contact pressure was adjusted by turning the rod. From three to five balls were employed, and excellent results were obtained with the phone connected directly to the output terminals of a three-tube receiving set. The resistance of the galena-carbon contact was only 40 ohms, and to be efficient it should have a resistance equal to the plate-to-filament resistance of the vacuum tube, or from 10,000 to 30,000 ohms.

To increase the resistance of the phone, a deep hole was drilled in the center of the $\frac{3}{8}$ " brass rod, as shown in the illustration, Fig. 2, and in this were placed alternately four galena crystals and four sets of carbon balls. This increased the resistance to about 200 ohms, and the expansion of the crystals and balls, acting upon each other, produced a greater effect on the diaphragm. The sig-

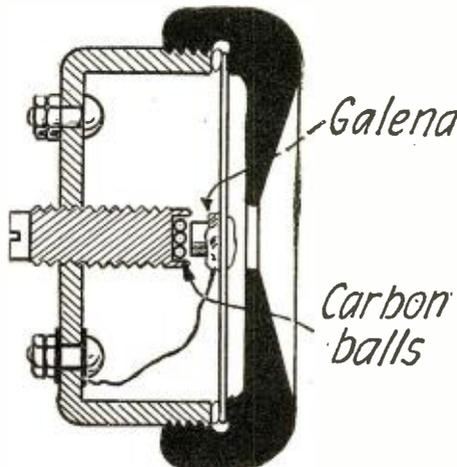

Fig. 1

This Was the Type Used in the First Experiments, in Which But One Piece of Galena Was Used.

tinguish the reproduced sounds from the original.

The galena loud talker about to be described is a possible solution to the perfect loud talker problem. The only trouble with the galena loud talker is that it does not talk very loudly. On a two-stage audio amplifier the received programs from near-by radio stations are barely audible two feet from the horn, but this is remarkable, considering the simplicity of the device.

As shown in the photograph, the galena loud talker is nothing more than a galena crystal mounted on a mica diaphragm and placed in an ordinary telephone receiver. The threaded rod, passing through the back of the receiver shell, carries a few carbon balls which make contact with the galena. The passage of an electric current from the galena to the carbon, or vice versa, heats the junction and causes expansion, thus exerting an outward pressure on the diaphragm. Therefore, if telephonic currents, corresponding to the vibrations of the human voice or music, pass through the galena-carbon contact, vibrations will be set up in

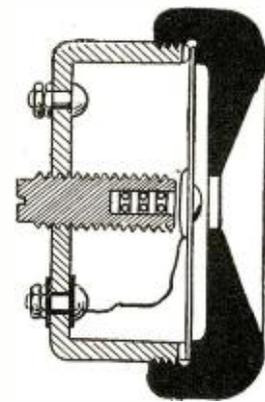

Fig. 2

This Arrangement Proved More Successful. The Hollow Rod Contains Alternate Layers of Galena and Carbon Balls.

nals were considerably strengthened with this arrangement.

It should be noticed in the circuit, as shown in Fig. 3, that a step-down transformer may be employed between the output of the receiving set and the phone. With its use, greater efficiency may be obtained. The primary winding of the transformer should have an impedance equal to that of the vacuum tube, and the secondary should have an impedance equal to that of the phone. A polarizing battery of two to six volts should be connected in series with the secondary winding in order to avoid the double frequency phenomenon. That is, both positive and negative halves of the current will exert an outward pressure on the diaphragm, whereas with the polarizing battery only the increasing currents push out on the diaphragm. Without the polarizing battery the speech is very peculiar and is entirely unintelligible.

It is well to keep in mind that the rectifying or detecting property of the galena crystal has nothing to do with its property
(Continued on page 476)

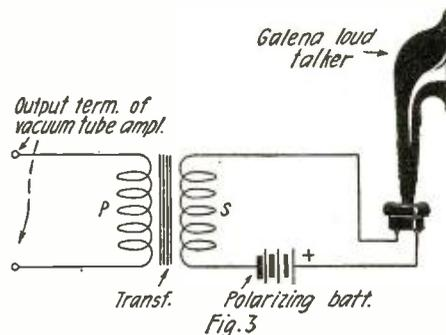
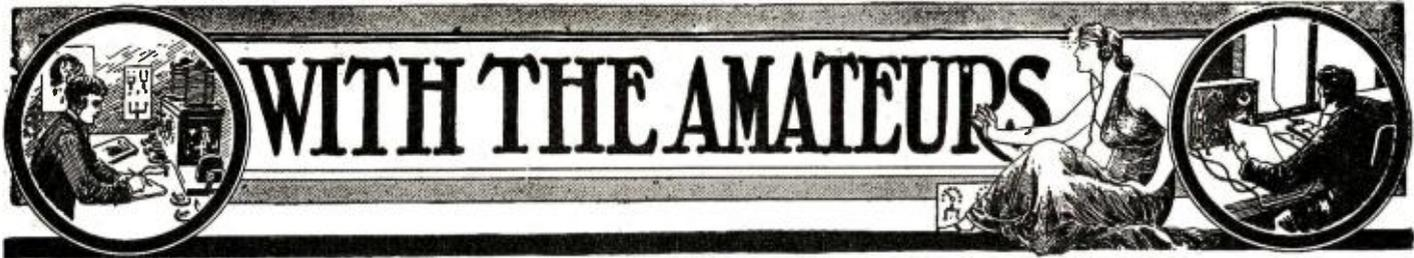

Diagram of Connections for the Galena Loud-Talker. As Seen, It is Connected to the Secondary of an Audio Frequency Transformer, with a Battery in Series.



THIS Department is open to all readers. It matters not whether subscribers or not. All photos are judged for best arrangement and efficiency of the apparatus, neatness of connections and general appearance. In order to increase the interest in this department, we prefer to publish photographs of stations accompanied by a picture of the owner. We prefer dark photos to light ones. The prize winning pictures must be on prints not smaller than 5 x 7". We cannot reproduce pictures smaller than 3½ x 3½". All pictures must bear name and address written in ink on the back. A letter of not less than 100 words giving full description of the station, aerial equipment, etc., must accompany the pictures.

PRIZES: One first monthly prize of \$5.00. All other pictures will be paid for at the rate of \$2.00 each.

Station 1-All, Kittery, Maine

This Month's Prize Winner



Mr. Blake, the Owner of 1AII, Has Certainly Succeeded in His Endeavor to Make His Station Compact and Neat in Appearance. The C.W. and Phone Transmitter Is on the Left-Hand Panel. The Motor-Generator for the Transmitting Set Is Directly Underneath the Desk.

FOLLOWING is a description of my Radio Station 1AII.

The radiating system consists of a six-wire flat top aerial, 65' long and 40' high, with a tapering cage lead-in, 14" in diameter at the large end, 6" in diameter at the small end, and about 10" long.

The ground system consists of the City water-pipes, also the steam-heating pipes. A 14-wire fan counterpoise, to be 65' long, is under construction and will be in use in the early fall. The transmitter, at the left of the panel in the picture, is a C.W., I.C.W. or phone outfit and by manipulating the various double-pole, double-throw switches, the transmitter can be used for the following: 5, 10 or 20 watts on straight C.W.; 5 or 10 watts on phone and 5 or 10 watts on I.C.W.

On the transmitter panel will be seen three rings of switch-points and levers. The top ring controls the wave-length, which can be set from 180 to 500 meters; the middle ring controls the plate inductance to the tubes, and the bottom ring controls the grid

inductance to the tubes. A Radio Corporation motor-generator supplies the high D.C. voltage to the tubes. 350 volts are used with one or two tubes in circuit, and 500 volts when four tubes are on the line. 500 volts, if used on one or two tubes, will cause the plates to get white-hot, thus causing short life to the tubes.

The filaments are lighted by a filament-heating transformer, which supplies 9½ to 10 volts and is cut down to 8 volts by the rheostats.

The circuit used is the Hartley oscillating and Heising modulation, and very good records have been made with the phone on 10 watts, radiating 1.8 amperes.

Owing to the short time Station 1AII has been furnished and also to the bad time of the year for QRN signals have not been reported from any districts but 1's, 2's and 8's, but it is hoped that 1AII will be heard at some good distance when the cooler weather comes along and some of the QRN ceases.

The receiving outfit, as shown at the left

of the panel in the picture, is a more or less complicated one, which operates on any wave-length, by inserting honeycomb coils on the mounting at the top of the panel. With the two anti-capacity switches thrown to the down position, the honeycomb coils are thrown out and the regenerative set, which operates between 150 and 200 meters, is in commission. Detector and two stages of audio frequency amplification are the equipment of either the honeycomb or regenerative outfit, and are changed automatically when the anti-capacity switches are thrown. Plug and jacks are used for the phones on set No. 1 or No. 2, at will. The storage battery and charger are also kept on the shelf under the receiver, and on the shelf under the transmitter are the filament-heating transformer and microphone batteries, which make the outfit neat-appearing and give short-power leads.

It may be noticed that a pointer and knob are on the outside of the panel, between the receiver and transmitter. This throws a send-receiver switch, which was designed and built by the owner. It also starts the motor-generator and filament transformer.

The complete outfit, receiver and transmitter, was built by the owner, Walton E. Blake, and although it is not the typical "Ham" station, it may be stated that 1AII has not conveniences for a "shack," so this compact set was built, to save space, in his bedroom.

Station 1AII will be glad to hear from anyone who happens to hear him. Also, any further information regarding the construction and operation of the outfit will be given to those who ask for it.

Station 9US, Chicago, Ill.

We are enclosing a photograph showing the apparatus at 9US, Chicago, Ill., and a brief descriptoin.

Recently we completely remodeled the station. Where formerly we had 30 Watts with Colpitt's circuit, we now have 200. The outfit is all contained in a "shack" 14' square. The following is a complete description of the station:

The aerial is suspended between two steel masts—the one on "the lead-in end" 55' high—the other on the open end 80' high. The length is 40'. The spreaders are 14' wide on the closed end and 26' on the open end. Five wires in the flat-top with a tapering cage lead-in; all of the aerial wire is No. 12 solid Belden enamel. The insulators are rod type, heavy glazed porcelain. The counterpoise ground is buried directly under the aerial at a depth of 6' in clay which is moist the year round. It is composed of three strips of heavy galvanized metal, spaced 9' apart. Each strip is 14" wide and 50'

long. When they were laid in the 6' ditches, three 6' ground rods were driven through each strip, one at each end, and one in the middle. All this was then soldered.

The ground connections come together fan-shape, and are insulated all the way to the set, thereby eliminating any possibility of a "high-resistance" ground before the energy reaches the proper ground.

The installation beginning at the left is as follows: Long wave receiver with a full set of "QSA" coils; next is the short wave regenerative set (above which can be seen the detector and three stage audio amplifier); to the right of it can be seen the spark control panel. This panel has impedances and resistances at the back for decreasing power and controlling the gap speed. (The cobwebs on this panel are almost visible.)

In the corner stands the new C.W. transmitter. The following is a detailed description of this unit:

The panel is 18" by 24" with four rectangular bezels (nickel-plated) at the top. In the center can be seen three meters; milli-amp, radiation and volt-meters respectively. Directly below is the filament control rheostat which is varied by means of a nickel-plated control handle. On either side and in the lower corners are two nickel-plated tumbler switches, the one on the left controlling the filament current while that on the right breaks the motor-generator circuit. The wiring of the C.W. set throughout is with 3/8" tubing.

This outfit comprises four 50-watt tubes as oscillators. The connections resemble Colpitt's circuit. The tubes are mounted at the back; each directly behind a bezel upon a bakelite panel, supported by brass angle strips. The inductance, an R.C.A., is to the rear of the tubes. Below the tube support is the filament lighting transformer re-wound on an old spark coil core. A de Forest oil-immersed condenser is used in the ground lead. The source of power is a General Electric two bearing machine which supplies 2,000 volts at 1/2 ampere. This current can be reduced to 1,000 volts at 1 ampere by varying the field rheostats (shown on the extreme right). The motor is 1 1/2 horse power and runs at 1,800 R.P.M., 72 segments in the commutator. This supplies a very clear current to the plates.

The spark transmitter is 1 K.W. The units are as follows: Acme transformer,



9US is a Regular "He Station" and Has a Creditable Transmitting Record. The C.W. Transmitter Panel is Seen Just to the Left of the Aerial Change-Over Switch. Note the Large Motor-Generator Under the Table. The 1 K.W. Spark Transmitter is Under the Table Also, to the Left of the Motor-Generator.

glass plate condenser, rotary-gap, and heavy O.T.

To the right of the C.W. transmitter can be seen the 200-meter DX receiver consisting of Turney spiderweb coils, detector and two stages of audio-frequency. The selectivity of this unit is unsurpassed. Due to occasional heavy local QRM, a one tube reflex set is used with a loop antenna shown in the extreme right corner.

Baldwin phones and a Magnavox are used for reproducing the "dope" to the ears of the operators. A separate M.G. (a re-wound Delco) charges the "A" batteries. A view of the panel controlling this unit can be seen at the extreme right hand corner.

The "dope" is copied on a Harris Visible mill. The station is equipped with a private Bell Telephone for efficient handling of A.R.R.L. messages and also to subdue local QRM. A Marconi change-over switch with several modifications permits operating any of the units. All of the apparatus has been constructed by myself.

In closing it might be well to give a list of the operators who pound brass here:

- Owner and First Operator
V. A. Kamin (IH).
- Second Operator
T. R. Lowenthal (XG).
- Third Operator
G. Z. Weston (VQ).

The Reception of American Amateur Stations

A recent issue of your magazine contained a description of some real DX work, done by Mr. Thomas A. Marshall. As an addition to this DX chapter, I believe you will find of interest some particulars about my reception of 78 (official number) amateur stations of your country, including 28 with exact code words. The aerial employed here was a four-wire cage aerial, 66' long, with a four-wire cage lead-in, 60' long. This was supported by two masts, one 60'

high and the other 83' high. Ground connection was made to the water-pipes and the metallic frame of the building in which the set was housed. The apparatus comprised two stages of radio-frequency amplification and three stages of audio-frequency amplification. The principle of the periodic aerial developed by Mr. J. Reinartz was employed. The complete circuit, excluding one R. F. and the three A. F. stages of amplification, is given in the diagram herewith. The principal

values of the apparatus are as follows: L-1, spider-web coil with inside diameter 1 1/3", wound with 22 turns of No. 24 D. C. C. wire, with the first eight turns tapped at each turn for the aerial circuit. L-3, variocoupler primary, wound with 20 turns of Litzendraht. L-4, a spider-web coil with same diameter as L-1, wound with 30 turns of No. 24 D. C. C. wire, tapped at the 15th turn for the plate connection. L-5, secondary of the variocoupler, wound with 20 turns of Litzendraht wire. C-1 and C-2, .001 mfd. variable air condensers with vernier adjustment. C-3, .0002 mfd. grid condenser with mica dielectric. The audio-frequency amplifier unit offers no extraordinary feature, being of the regular transformer coupled type. As will be noticed on the diagram, a loop is used in conjunction with the antenna system, to obtain directional qualities. With this set we heard most of the stations several feet from the phones.

In conclusion, I wish to congratulate our American fellow amateurs on the wonderful efficiency of their transmitters.

G. PERROUX, ING. ESE,
96 Boulevard Montparnasse,
Paris, XIV. Eme.

(Continued on page 438)

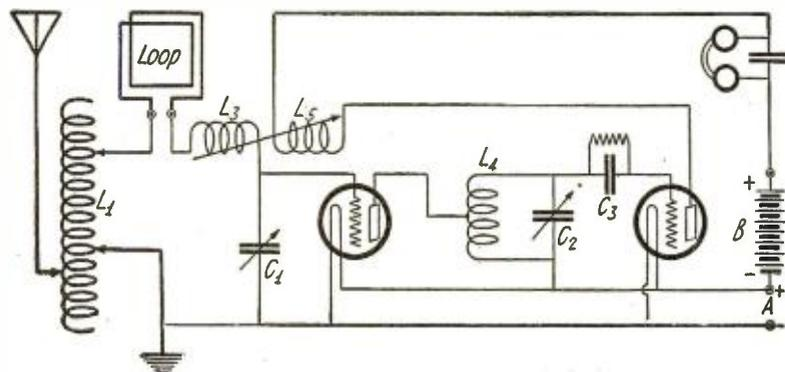

The Simplified Circuit of the Receiver Employed by Mr. G. Perroux During the Amateur Trans-Atlantic Tests. A Loop Was Used in Conjunction With an Outside Aerial to Obtain Directional Effects.

The rectifier which I previously had, used electrodes $\frac{1}{2}$ " x 4" in size and had only 24 jars. A borax solution was used. Upon replacing this rectifier with the 40-jar rectifier already described, the radiation would only fall .1 of an ampere during one transmission. The aluminum which I used in my rectifier was purchased from the Aluminum Co., of America, which has offices in many of the larger cities.

Q—Radio Corp. 1 M.F. condensers, tested for 1750 volts D.C.

R—An audio frequency choke consisting of 2000 turns of S.C.C. wire on an iron core $1\frac{1}{4}$ " x $1\frac{1}{4}$ ". This coil was shunted by a 1 M.F. condenser. This arrangement, together with the two 1 M.F. condensers, was found to be very effective in smoothing out the rectified A.C.

The original 1DH circuit tuned the positive high power lead on the same tap as the counterpoise was tuned. The modification which makes the positive lead a separate tap I found to improve the operation of my transmitter about 33 per cent. This circuit is a ready oscillator and is very easily and quickly tuned. Using the average amateur antenna and counterpoise their respective taps should be about 10 turns apart for a wave-length of 200 meters. The plate tap should be about one or two turns above the antenna tap and the positive high voltage tap about six or eight turns above the counterpoise tap. Upon tuning the grid coil with the variable condenser,

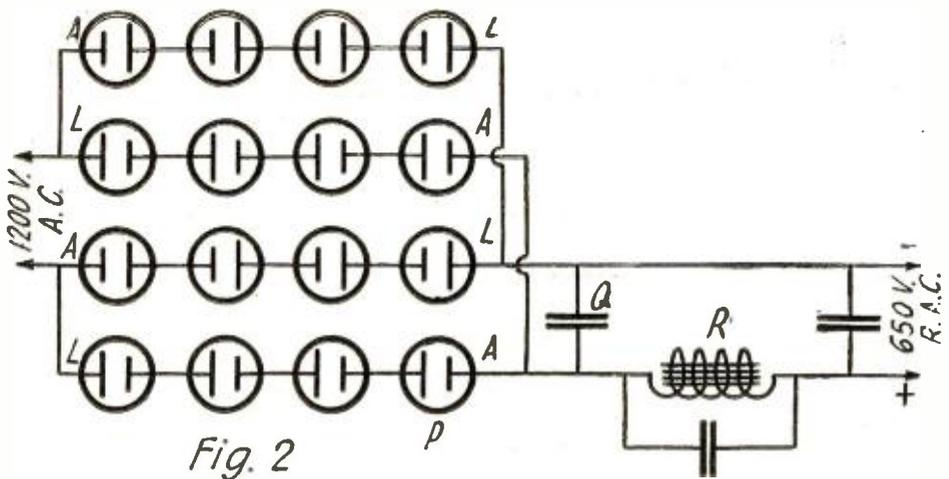

The Rectifier and Filter System Used at 8BNH. 650 Volts Are Obtained at the Output Side for the Plates of the Two Tubes. The Three Fixed Condensers in the Filter Circuit Each Has a Capacity of 1 M. F.

a point will be reached where the antenna current suddenly takes a quick jump to its highest reading. The condenser should be left at this setting. The radiation of my transmitter was 3.4 amps. with 650 volts R.A.C., 80 milliamps. on the plates and $7\frac{1}{4}$ volts on the filaments. As for results the transmitter had a reliable working range of

about 1200 miles at night and a daylight working range of 200-500 miles. The best DX on the transmitter was Fort Worth, Texas, several stations in that city having been worked. About 250 cards reporting my signals in 34 states were received. I also worked about 330 stations outside of the 8th district with this transmitter.

Fourth Prize A Five-Watt C.W. Set For the Amateur

By HENRY JOHN ENGLISH

THE following article, written expressly for this contest, includes, the author feels, all the necessary information for constructing this simple set. Since everyone has his personal taste in regard to the mounting of the apparatus and the positions of the respective parts, this episode is intentionally left out.

This, as designated by the title, is a five-watt set, although it was built to take either 5 or 10 watts. Such a detail of construction is, of course, optional. For plate supply, a 75-watt Acme transformer is used, which furnishes 750 volts for the plate and 10 volts for the filament. The plate supply is smoothed out by running it through a chemical rectifier, consisting of 20 jars, containing lead plates measuring 4" x $1\frac{1}{2}$ ", and

aluminum plates measuring 4" x 1". There is used a saturate solution of borax, and a teaspoonful of ammonium-hydroxide and sodium-phosphate in each jar. An Acme 2 M.F. filter condenser is used in conjunction with this rectifier circuit and works fine. I am using the "sure fire," or reversed feedback circuit, as it puts more energy into the antenna system than any other. The aerial plate inductance L_1 consists of 30 turns of seven-strand aerial wire, wound on a tube 4" in diameter, tapped every turn after the first

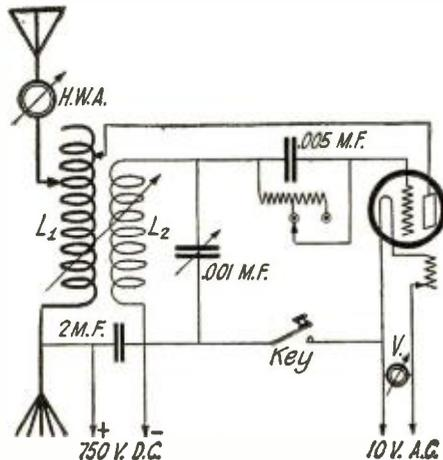

Again We Have the 1DH Circuit. Note That a Semi-Variable Grid Leak Is Employed.

turn. Taps are merely humps made in the wire, contact being obtained with Eureka clips. The grid coil is made to fit snugly inside of the aerial coil. It is wound on a tube $3\frac{3}{4}$ " in diameter, and consists of 20 turns of No. 18 bell wire. A 43-plate condenser is used to tune this coil and it will be found that it is the only critical adjustment of the whole set.

Referring to the front view of the set, the two meters at the top are the filament volt-meter and radiation ammeter respect-

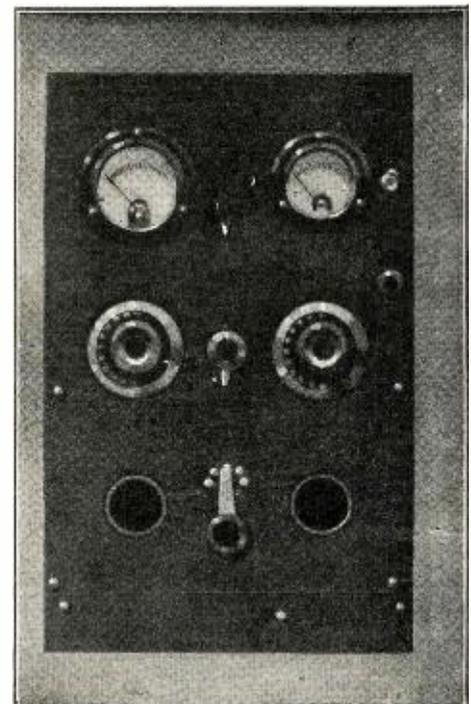

A Front View of the 5-Watt Set Described in This Article. A Radiation Ammeter and a Voltmeter Are Mounted at the Top. These Are Important Where Efficiency is Concerned.

ively; the volt-meter being a 0-15 volt, manufactured by the Jewel Instrument Company, and the ammeter a General Radio 0 to $2\frac{1}{2}$ amperes. A loading coil is situated between these two meters, but is not necessary and, in fact has since been discarded. The two dials control the grid coil condenser and antenna series condenser. The latter is seldom used. A Fada 5-ampere filament rheostat is situated between the two variable condensers. This, by the way, will handle
(Continued on page 471)

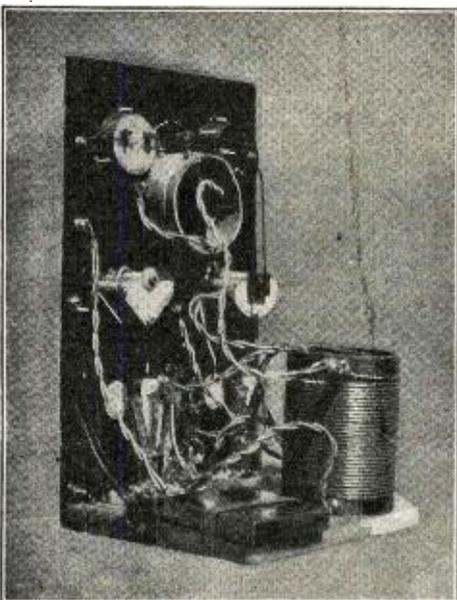

A Rear View of the C. W. Set Owned by Mr. English. Space Is Provided for Two 5-Watt Tubes, Although Only One Is Being Used.



The All-Purpose Receiver

A TWO-STEP AMPLIFIER WHICH CAN BE ADDED TO THE RECEIVING SET AND DETECTOR PREVIOUSLY DESCRIBED

By M. B. SLEEPER

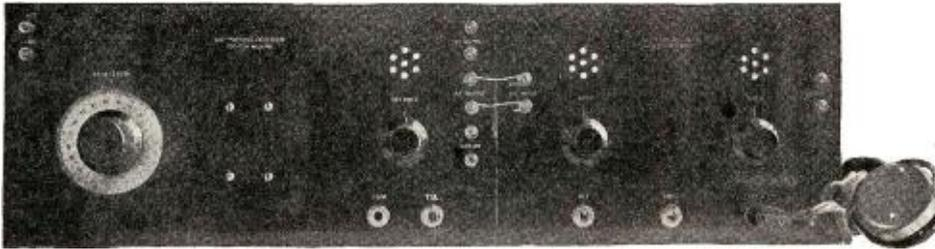

A Photograph of the Receiving Set and Detector Described in the September Issue of Radio News, Together With the Two-Stage Amplifier Described in This Article.

IF you are like most all radio experimenters you will want to add an amplifier to your receiving set as soon as you have that in satisfactory working order. A two-step amplifier will bring in some stations which are not audible with the detector alone, although the real purpose of an audio frequency amplifier is to make signals, which can be heard with the detector, still louder. Experiments made on this outfit showed that, when the All-Purpose Receiver is used with a variometer, making it regenerative, sufficient amplification for head-phones is obtained at the first step, but the second step is necessary to operate a loud speaker. While this amplifier has been designed primarily for the All-Purpose Receiver, described in the September, 1923 issue of RADIO NEWS, it can be added to any type of receiving set. The front view shows the amplifier, connected to the tuner mentioned. You will see that the audio frequency output binding posts of the receiver line up with the audio frequency input binding posts of the amplifier.

This instrument can be used with regenerative or non-regenerative receivers or added as a power amplifier to an outfit using radio frequency, reflex, or inverse duplex circuits. It is also an excellent type to be used in conjunction with one-tube Flewelling receivers.

The audio frequency amplifying unit is mounted on a formica panel 7" by 10" by 3/16". This is a standard size available in the radio stores where cabinets of that size can be purchased also. The height is the same as is used for the tuner so that the units match in appearance. Moreover, the rheostat and potentiometer controls and the telephone jacks are lined up to be symmetrical in appearance.

Be very sure that your panel is cut exactly to size with perfectly square corners, or your measurements will not come out right. All holes should be made with a No. 18 drill except those marked otherwise. Clearance holes are allowed for the potentiometer and rheostat shafts so that they will not bind. Follow the drilling instructions given in the previous article and no trouble will be experienced.

It may be necessary to change slightly the locations of the holes if other than the parts illustrated are shown. The rheostat and

tion. There is plenty of space allowed for transformers of larger size, but the type shown is very convenient and neat in appearance and has the advantage of being entirely moisture proof.

When the panels have been drilled, the rheostat, potentiometer, binding posts and end jacks should be mounted on the front panel. The two end jacks are used to support the base panel. The center jack is not used for that purpose because the fastening screws would interfere with the mounting of the forward transformer. When you are ready to fasten the base panel in place remove one of the screws which hold the jack springs together. Then put a 1" 6-32 flat head screw through the panel and into the hole from which the original screw

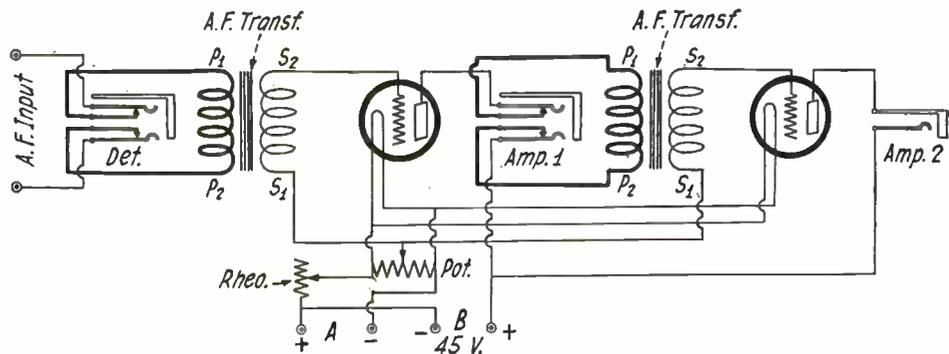

The Diagram of Connections of the Two-Stage Audio Frequency Amplifier Described in This Article. Note That a Potentiometer Is Used to Apply a Negative Potential to the Grids of the Amplifier Tubes. This, For One Thing, Tends to Eliminate Distortion.

potentiometer are of Fada manufacture, the jacks from Pacent and the audio frequency transformers from Sleeper Radio Corpora-

tion. Turn this in tightly and put a nut on the outside to clamp the springs. Repeat this process with the other three

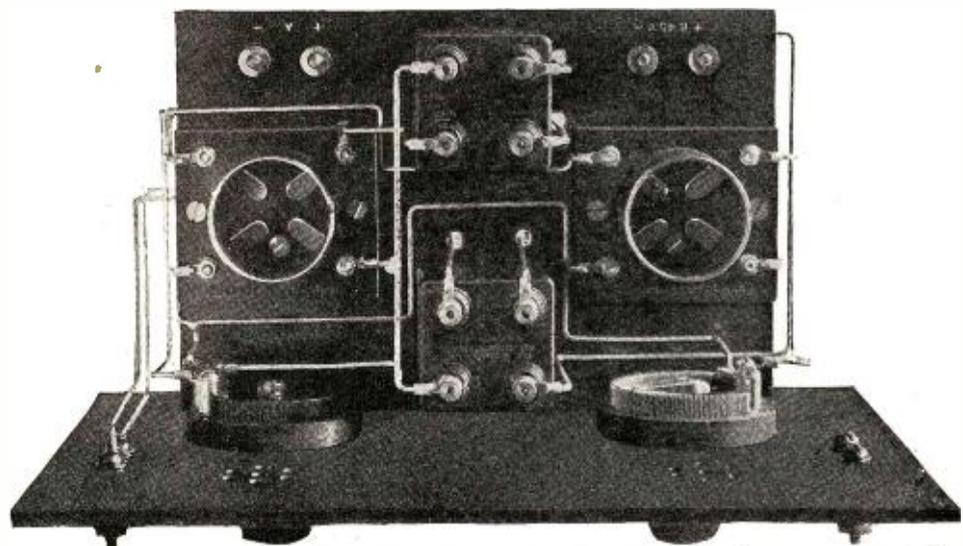

A Top View of the Completed Amplifier, Showing the Positions of the Component parts. The Potentiometer Is Mounted on the left of the Panel.

screws. Then you will have the base panel securely fastened to the outside jacks.

That done, mount the transformers and sockets; then put the center jack in place. You may find it necessary to cut off a part of the jack frame which is against the panel so that it will not interfere with the cabinet.

Now put the "A" and "B" battery binding posts on the base panel and the set will be ready for wiring. This is a little more complicated than the receiver, since more wires are required in connecting the jacks and transformers.

To start off, connect the upper input binding post to the upper spring on the detector jack and the lower input binding post to the bottom spring on that jack. Then, connect the upper inside spring to P1, or primary P, on the rear transformer. Connect the lower inside spring to P2, or primary plus. S1 or secondary F is connected across to the same terminal on the other transformer and down to the center terminal of the potentiometer. S2 or secondary G goes to the grid of the left-hand socket. You will notice that some of the wires are brought through holes in the base panel. This is done to simplify the connections.

The plate terminal of the first socket goes to the upper contact of the center jack, the upper inside spring to P2 or primary plus of the forward transformer, the lower inside spring to P1 or primary P, and the bottom spring to the bottom spring of the third jack from which a wire is lead to the plus "B" binding post. The upper terminal of the third jack goes to the plate terminal of the second socket. S2 or secondary G of the second transformer goes to the grid of the second socket.

The filaments are connected in parallel by wires carefully fitted to run along the top of the base panel. The F minus terminal of the first socket is then joined to the "A" minus binding post and also to the upper terminal of the potentiometer. The F plus terminal of the second socket goes to the upper rheostat terminal while the lower rheostat terminal runs along the side of the panel and underneath it to the "A" plus binding post. The "B" minus binding post is joined to the "A" plus binding post.

The wiring as described should be carefully checked against the diagram given here so that there will be no mistakes or omissions. Two binding posts marked "output" are shown at the right-hand side of the front panel.

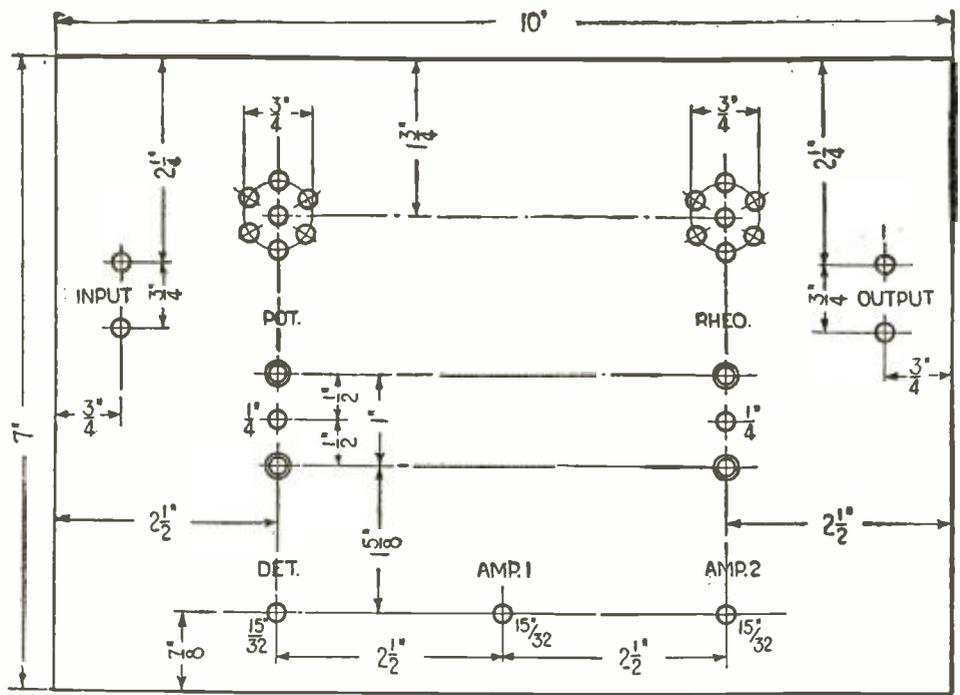

ALL HOLES NO. 18 DRILL UNLESS OTHERWISE SPECIFIED
The Panel Layout and Exact Dimensions for the Necessary Holes. If Apparatus Is Used. Other Than Specified, Only the Positions of Center Holes Should Be Considered.

In the photograph, however, they are not connected, as they are intended only for use

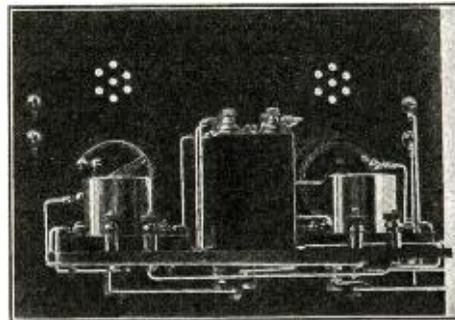

A Rear View of the Amplifier, Showing the Method of Mounting the Sub-Base to the Jacks.

when a power amplifier is to be added. In case you want to use those binding posts you

will have to substitute a closed circuit jack for the open circuit jack shown at the last step and put the two binding posts in series with that jack in the plate circuit.

Although sockets for the standard base tubes are shown, this amplifier is suitable for any type. Best results are, of course, obtained with the UV-201A but, with suitable sockets or adapters the UV-199 tubes can be employed. It is a good idea to use standard sockets and then equip them with adapters if you do want UV-199 tubes. The Fada rheostat shown is of 8 ohms resistance, correct for UV-201 or UV-201A tubes. In case the UV-199 tube is to be used, an extra resistance, such as is supplied by the Cutler Hammer Company, should be employed or a 60-ohm rheostat in place of the 8-ohm one. Only one rheostat is provided for both tubes, as that is sufficient and in practice it is considerably more convenient to have only one control to switch off.

The Fada potentiometer has a resistance of 200 ohms. This is furnished so that a slight negative potential can be applied to the grids of the amplifying tubes. This prevents overloading and distortion and is a very useful control to have on an amplifier. Connections are arranged so that, when the tubes are turned off by means of the rheostat, no current flows through the potentiometer. Consequently no current is wasted.

A few general words may be useful concerning the operation of an amplifier. The purpose of an amplifier is not to produce noise, but clear signals in greater volume than can be obtained on the detector. Consequently care should be taken not to overload the amplifying tubes. This can be regulated by means of the potentiometer. There is a very definite limit beyond which the signal strength is not increased by increasing the filament current. Therefore, the rheostat should be turned up until signals come in at full strength, and then the current reduced to a point just before the signals diminish in volume. If this adjustment is made there will be no sacrifice in the signals, they will be of the purest tone, and the tubes will last several times longer than if they are operated at maximum filament brilliancy.

(Continued on page 476)

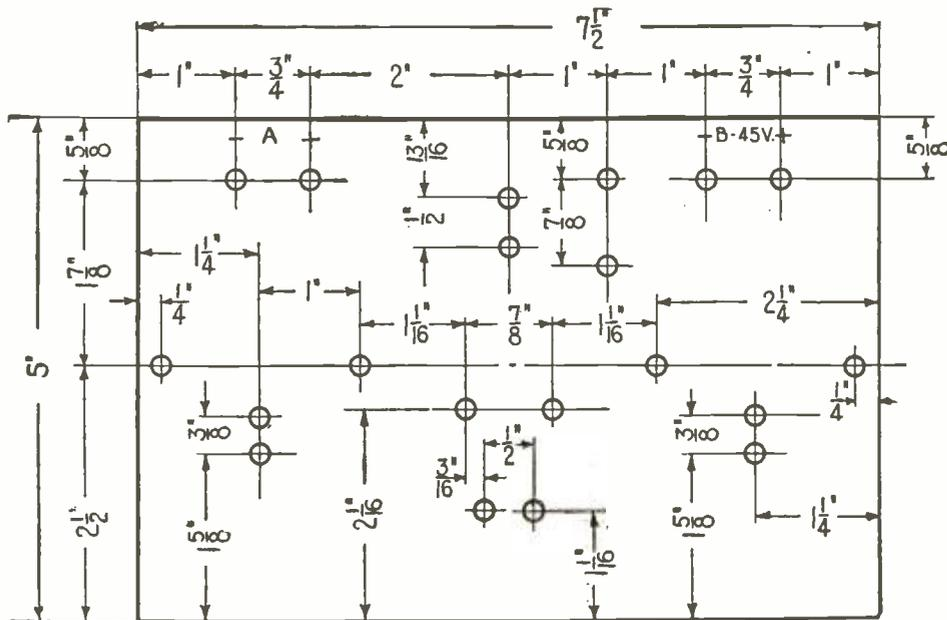

ALL HOLES NO. 18 DRILL

Layout and Dimensions of the Sub-Base Panel. If Apparatus Other Than Specified Is Used, the Positions of the Majority of Holes Here Given Should Not Be Considered.

A Capacity Coupled Receiver For Short Wave Reception

By PAUL G. WATSON, A.M.I.R.E.

THE receiving set described in this article is one designed for amateur and broadcast receiving through a reasonable amount of interference. It is radically different from the usual forms of receiving sets, either the single or double circuit, in that it does not depend upon magnetic lines of force to

transfer the energy from the antenna circuit to the detector circuit. The coupling is accomplished by means of two equal capacities which form the only connecting medium between the antenna circuit and the detector circuit. It is regenerative, using the tickler coil to couple the plate and grid circuits in the usual manner. The usual form of inductive coupled receiver is fairly sharp, but if the stations are close by, considerable interference results. I have found that this tuner, with the capacity coupling, will eliminate much more, and in some cases, all of the interference and at the same time reproduce music clearly and with good volume. The primary coil consists of 45 turns of No. 20 single cotton covered wire wound on a bakelite tube 3" in diameter. Taps are taken from every third turn and lead to the switch marked "Primary" in the assembly drawing. The short wave condenser is controlled by the dial at the extreme left of the panel, and in conjunction with the inductance switch, controls the wave-length of the antenna circuit. The secondary coil is wound on a 3" or a 3½" bakelite tube, starting about ¾" from the end, which is later to be drilled for the tickler shaft. The secondary coil consists of 45 turns of No. 20 single cotton covered wire, leaving nine turns at the end where the tickler is mounted, and then tapping every third turn, to the secondary inductance switch, thus controlling the wave-length of the detector circuit. This tube should be about 5½" long, and should be placed directly back of the secondary switch so that the tickler shaft will be in the position shown in the drawing. Two holes should be drilled in the blank portion of the tube, to serve as bearings for the tickler shaft. These holes should be about ⅜" from the top of the tube. The bottom of the tube can be cut to lower the center line of the tickler shaft, if necessary. The tickler is wound on a ball form, available in any radio store, and has about 18 or 20 turns of No. 20 single cotton covered wire. Connections may be made with flexible leads or the shaft may be cut at the center of the ball and contact made at the bearings with two spring brushes. The grid leak and condenser, "GL," are the standard types, the condenser of about .0004 Mfd. and a pencil mark grid leak. The rheostat used in the original is a vernier, for close regulations of the filament current. The tube socket used here was a type 156, and if a WD-11 tube is to be used, an adaptor should be used in the socket. This makes it possible to change from a 6-volt to a 1½-volt tube by changing only the tubes and batteries. The "B" battery or plate battery should be a 45-volt variable, to get the best results with the "soft" tubes now in use as detectors. Connections to the filament battery are made to the two binding posts "A1," the antenna and the ground to the posts marked "A" and "G." The connections for the headset, or amplifier, if used, are made at the two binding posts marked "P" in the assembly drawing. A single circuit jack may be substituted for this pair of binding posts, if it is desired to use a plug and jack arrangement to connect the phones.

paratus is ¼" thick, 7" high and 16" long, of black bakelite. This panel is to be mounted on a base-board and braced with small brass brackets. The wiring should be done with wire not smaller than No. 18, and should be well insulated with spaghetti, or other good form of covering. Needless to say, all joints must be soldered tightly and extreme care used to get all the solder off the panel. No cabinet details are given here, as ideas on this subject differ greatly. The cabinet should be made of cabinet wood, such as oak or mahogany and finished to suit the room in which it is set up. The set described here was used on a two-wire antenna, 100' long, and would tune from 150 to about 650 meters, covering all the amateur broadcasting and commercial traffic wave-lengths in use at this time. A 6-volt "Radiotron" U.V.-200 was used in the set and gave excellent results without an amplifier.

The fundamental circuit using condensers to couple the circuits was worked out by the Bureau of Standards some time ago and is known as the "Static Coupled" or "Capacity Coupled" circuits. The principle of operation depends upon the transfer of energy from one circuit to another by means of electrostatic lines of force, and it is by this means that energy is taken from the antenna circuit by the detector circuit

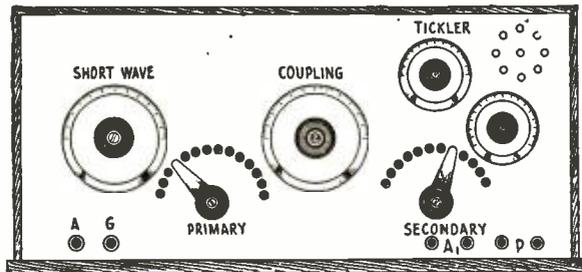

The Disposition of the Apparatus Is Such That the Important Controls Are In the Most Convenient Positions For Manipulation. The Dials Marked "Short-Wave" and "Coupling" Control the Three Variable Condensers.

transfer the energy from the antenna circuit to the detector circuit. The coupling is accomplished by means of two equal capacities which form the only connecting medium between the antenna circuit and the detector circuit. It is regenerative, using the tickler coil to couple the plate and grid circuits in the usual manner. The usual form of inductive coupled receiver is fairly sharp, but if the stations are close by, considerable interference results. I have found that this tuner, with the capacity coupling, will eliminate much more, and in some cases, all of the interference and at the same time reproduce music clearly and with good volume.

The primary coil consists of 45 turns of No. 20 single cotton covered wire wound on a bakelite tube 3" in diameter. Taps are taken from every third turn and lead to the switch marked "Primary" in the assembly drawing. The short wave condenser is controlled by the dial at the extreme left of the panel, and in conjunction with the inductance switch, controls the wave-length of the antenna circuit. The secondary coil is wound on a 3" or a 3½" bakelite tube, starting about ¾" from the end, which is later to be drilled for the tickler shaft. The secondary coil consists of 45 turns of No. 20 single cotton covered wire, leaving nine turns at the end where the tickler is mounted, and then tapping every third turn, to the secondary inductance switch, thus controlling the wave-length of the detector circuit. This tube should be about 5½" long, and should be placed directly back of the secondary switch so that the tickler shaft will be in the position shown in the drawing. Two holes should be drilled in the blank portion of the tube, to serve as bearings for the tickler shaft. These holes should be about ⅜" from the top of the tube. The bottom of the tube can be cut to lower the center line of the tickler shaft, if necessary. The tickler is wound on a ball form, available in any radio store, and has about 18 or 20 turns of No. 20 single cotton covered wire. Connections may be made with flexible leads or the shaft may be cut at the center of the ball and contact made at the bearings with two spring brushes. The grid leak and condenser, "GL," are the standard types, the condenser of about .0004 Mfd. and a pencil mark grid leak. The rheostat used in the original

is to be operated from a single panel knob, thus meeting the requirements of this circuit. The knob is marked "Coupling" on the panel drawing.

A construction point that must be kept in mind, is that no magnetic coupling should exist between the primary and secondary windings. The secondary coil position is determined by the tickler shaft, while the primary coil may be in any position and must have its center line at right angles to the center line of the secondary. By using the panel arrangement shown in the drawing and keeping the coils at right angles, no coupling will exist. The primary coil is directly back of the primary switch with the secondary coil in like relation to the secondary switch, thus placing the coupling condensers between them.

No sizes are given for the various holes in the panel, as these depend upon the actual material used, for example, the tickler shaft may be either 3/16" or ¼" brass, and should have a 1/32" clearance in the panel hole, likewise the condensers and rheostat shafts. The panel for mounting the ap-

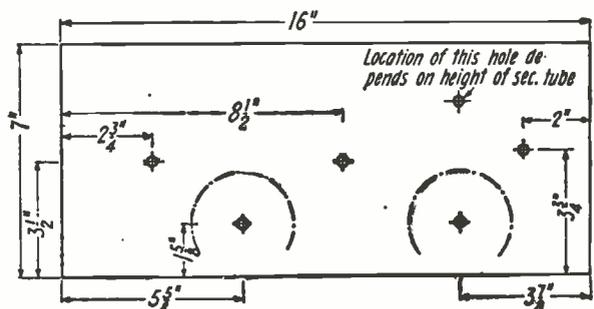

The General Layout of the Panel, Together With the Exact Dimensions.

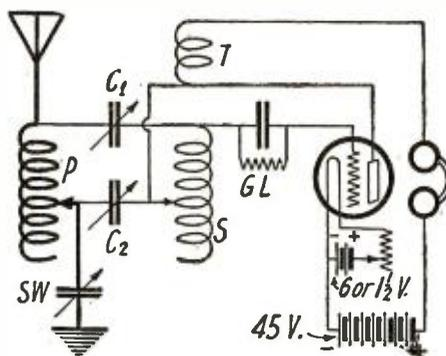

The Hook-up of the Capacity Coupled Regenerative Receiver. Coupling Is Accomplished by Variable Condensers C-1 and C-2.

through the condensers C₁ and C₂. The operation of the set will be very much like that of an inductively coupled set. The tickler will function in a similar way to a plate variometer, the primary switch and short-wave condenser in the usual manner, with an additional adjustment on the secondary winding. The coupling condensers will function, when turned, much like magnetic coupling, except that the coupling is much more critical, and when using only 20 or 30 degrees of condenser, it is practically impossible to have interference from other wave-lengths than those to which the set is tuned.

BUREAU OF STANDARDS CIRCULARS

Very simple radio receiving outfits are described in a series of circulars issued by the Bureau of Standards of the Department of Commerce, and published at the request of the States Relation Service of the Department of Agriculture. The circulars are fully illustrated.

The first two, which are Bureau of Standards Circular Nos. 120 and 121 describe receiving sets using crystal detectors. Circular 120 describes the receiving antenna and ground connection also.

(Continued on page 436)

A Rubber Ball Variometer

By GEORGE SUTTON, London, England

THE American Wireless Amateur has been earlier than his English contemporary in his appreciation of the merits of the variometer and the variocoupler as tuning devices, but there are now abundant signs that he is rapidly over-taking the lead thus given.

One reason perhaps for this precocity on

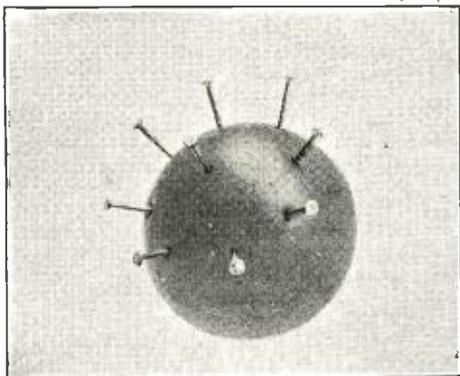

Fig. 1. Method of Fitting the Rubber Ball For the Shaft and the Rotor Coil Windings.

the part of the American "Ham" is the comparative freedom of the ether which he has enjoyed, as there is no doubt that official restrictions have hampered the path of progress of the English Radio man.

The cost of the variometer, professionally made, is quite a deterrent to its acquisition, even if a minor one, and it is the purpose of this article to show how this cost may be reduced from several dollars to a few cents.

The amateur in general felt that if it were only a question of winding enameled wire on a postal tube, he could manage that himself, and the success he achieved encouraged him, or deterred him from going on any further with the construction of his own radio receiving apparatus.

An ordinary unburstable, or rubber sponge constructed child's playing ball, of about 2 3/8" in diameter, would doubtless be procurable in the United States at something in the neighborhood of fifteen cents, and this is to be the rotor of our variometer. There is no need to boil it in paraffin wax to improve its insulation, as that is already pretty good.

METHOD OF CONSTRUCTION

There is generally a seam on the ball where the two halves of the mould used in making it closed up, and which divides the ball into two accurate halves. In most balls there is also central in each half, and corresponding with the bottom of the center of the mould, a small pip, to which we shall later on refer.

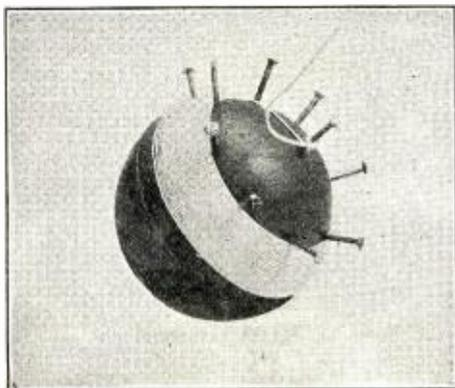

Fig. 2. Showing the Rubber Ball With the First Section of the Rotor Winding In Place.

At a point on the central seam, insert the end of a steel knitting needle, and push it through the ball so that it emerges at the diametrically opposite point on the seam. If the ball is now spun on the steel knitting needle as a pivot, it will not "lump" round, but spin smoothly if the needle is central. Care should be exercised to make it so, or the completed instrument will not work as well as it might.

Now heat the projecting point of the steel knitting needle to red, in a gas flame or spirit lamp, and gently withdraw it into the ball. It will make quite an objectionable smell, but it will also make a permanent non-closing hole lined with sticky burnt rubber. Do this on the other side of the ball as well, and you will have this permanent hole through the exact center of the ball. If you are going to use a hardwood penholder for the pivot, it may be necessary to repeat this process with a thicker metal rod, but the hole should be made a tight pushing fit on the shaft, without the latter disturbing the shape of the ball.

Now at the pip, before mentioned, or in its absence, at the exact center of each half of the ball, so as to be equidistant from

AMATEUR NUMBER

THE November issue of RADIO NEWS will be our big Amateur number and some of the best known amateurs are contributing to it.

This no doubt will be the greatest radio amateur number that has ever been put out by a radio magazine. In order not to be disappointed, put in your order with your newsdealer at once.

Here are a few of the famous amateurs and ex-amateurs contributing to the November issue.

John L. Reinartz, A. L. Groves
Howard S. Pyle, Asst. U. S. Radio Inspector of the 8th Radio District
Ralph E. Batcher, E.E.

PRINCIPAL ARTICLES TO APPEAR IN THE NOVEMBER ISSUE OF RADIO NEWS

Low Frequency Amplifiers and Their Operation, by John Scott-Taggart.
Vacuum Tubes for the Amateur, by Jesse Marsten.

The Homodyne Receiver, by Maurice L. Muhleman.

Loop Antennae for Transmission, by Allan R. Kenworthy.

Some Practical R. F. Notes for Operating Amateurs, by A. Reisner.

100-Meter Continuous-Wave Transmission, by S. R. Winters.

Crystal Detectors and Their Possibilities as Amplifiers and Oscillators, by John W. Millon, Jr.

How To Make Your Own Grid Leaks, by Carter Fiske.

the meridional moulding line, insert a strong pin or a small wire nail. With this nail as a center, describe a circle of one inch radius, and at equidistant points on that circle insert eight more wire nails (Fig. 1.).

If the circle is first quartered, and the four quarter nails first pushed into the ball, the insertion of the other four, in between those first inserted will be an easy matter.

Now with No. 26. D.C.C. copper wire mark off about six inches at the central nail, and then start winding around the ball, the first turn lying against the eight nails in the ring, and the next turn against the first, and so on up hill until 20 turns are wound on (Fig. 2.).

Mark off the finishing end on to the spindle. Turn the ball around and wind the other half in a similar manner. Both windings should be "overhand" or "underhand," according to whether you are right or left handed, but either case from the center of the nail rings on one side to the similar center on the other side, the windings must be in the same direction.

The two finishing ends of the windings can now be taken off the shaft, twisted together and soldered, and the ends tucked into a hole made in the ball. The two beginning ends should be threaded into a stout needle, one at a time, and threaded through, across the inside of the ball, from inside the two-inch circle, to emerge near the shaft, one end at the top and the other at the bottom.

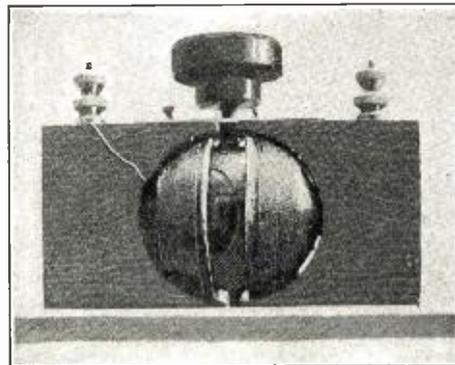

Fig. 3. A View of a Completed Rubber Ball Variometer, Having Wooden Forms For the Stator Windings.

Varnish the windings with several coats of shellac, to bind down the wire to the ball, and your rotor is complete.

DETAILS OF A SPHERICAL STATOR

If you desire a spherical stator, a hollow rubber ball of about 2 3/8" in diameter can be used and wound as described above, remembering that, being hollow, it will want a great deal more care exercised in pushing the nails in, and in the subsequent handling, or it will collapse. The rotor might be used as a former, by covering it with several wrappings of paper or cotton tape, and forming the coils on it, then shellacking and transferring them when set to the inside of the hollow ball; but the first described way is the easier, leaving the stator windings outside.

If the stator windings are made on the outside of the hollow ball and have been varnished well, then with a pair of scissors cut the ball into two equal parts and trim out any inside projections with a sharp knife kept well wetted while cutting. Shape out two pieces of wood, as shown in the photograph (Fig. 3.), and with a small brass washer and a wood screw, fasten the two half balls on to the two wooden brackets.

An "endplated" hole should be made in the base board, and a brass plate bridging across the top of the blocks will serve the double purpose of a pivot hole and to secure the two wooden uprights.

Connect the rotor windings in between the two halves of the stator windings with a short piece of flexible wire, to allow for

(Continued on page 428)

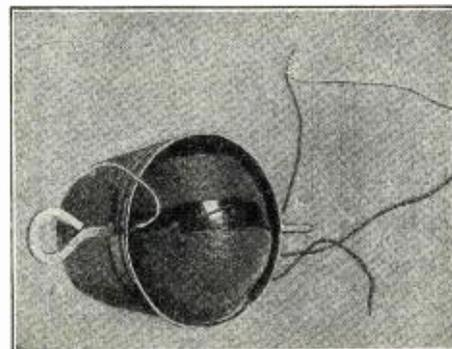
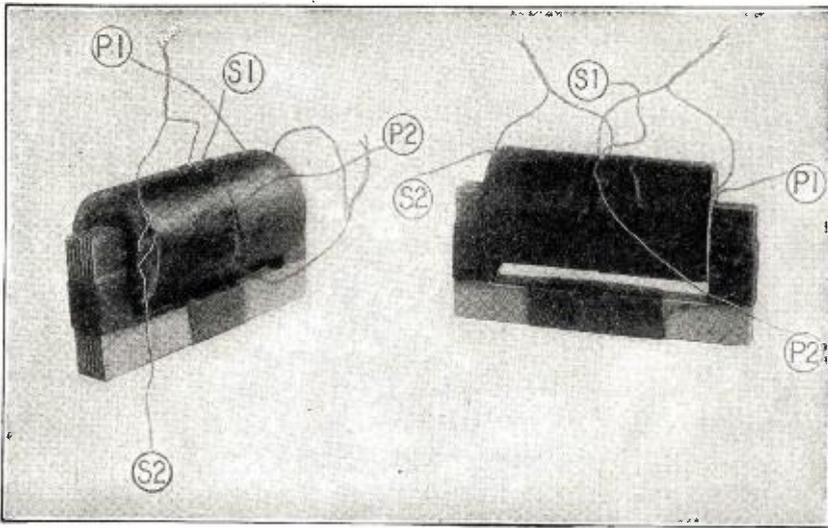

Fig. 4. Another Completed Rubber Ball Variometer With the Stator Coils Wound On a Cardboard Tube.

Construction Of Push-Pull Transformers

By H. N. BLISS



Photograph of a Completed Push-Pull Transformer. The Two Views Clearly Show the Respective Positions of the Connecting Wires.

THE following is a description of a pair of push-pull transformers constructed by the writer with the object of obtaining sufficient distortionless amplification to operate a Baldwin "C" phone attached to the tone arm of a Victrola under all conditions of signal strength.

The apparatus described has proven very satisfactory and will amplify signals which are barely audible on the detector so that they may be easily heard in any part of a large living room, while a strong signal

Next, a sheet of silicon transformer steel for the core. This should not be heavier than No. 28 gauge (.017), and can be secured from any large dealer in steel. This steel can be cut into strips by hand but the best way is to take it to a tinsmith and have it cut on the squaring shear which will leave it flat and straight and make a much better job.

Cut enough strips $\frac{1}{2}$ " wide to make 60 pieces $4\frac{1}{2}$ " long, and cut enough strips $\frac{5}{8}$ " wide to make 60 pieces $3\frac{7}{8}$ " long, 60 pieces $1\frac{7}{8}$ " long and 60 pieces $1\frac{1}{4}$ " long.

Next cut a piece of wood $4\frac{1}{2}$ " long by $1\frac{7}{8}$ " wide and about $\frac{1}{2}$ " thick, and be sure that the edges are square. Nail thin strips of wood around three sides of this to form a shallow box $\frac{1}{2}$ " deep inside with one long side open as shown in Fig. 1. Cut a notch an inch long in the center of the long side and notch the bottom back for a half inch to assist in removing the core when finished. This box forms the mould in which the core is built, as follows:

Lay one of the long $\frac{5}{8}$ " wide strips in the box against the long side and against one end. Next lay one of the $1\frac{7}{8}$ " pieces against the end of the box filling the gap left by the long piece and one of the $1\frac{1}{4}$ " pieces against the other end of the box abutting the long strip. Now lay another long strip over the first one, only against the opposite end of the box and put in the short pieces as before. This is shown in Fig. 2.

Alternate until the core is $\frac{1}{2}$ " thick, which in the case of No. 28 gauge steel will take 28 layers. The finished core may now be clamped tightly into the box by means of a strip of wood held down by wood screws while a clearance hole for a 6-32 screw is drilled through each short leg $\frac{3}{4}$ " down from the open end. The core

should be clamped as tightly as possible while drilling to prevent chips from working between the laminations. A small "C" clamp on the center of the long leg will hold the core together while it is lifted out and bolted together with 6-32 screws and nuts. The clamp can then be removed and the long leg bound tightly with a layer of tape. Two of these cores are needed.

THE CONNECTIONS

Two of the windings should now be placed end to end with their primary terminals facing in the same direction. These particular coils have both the primary terminals on one end and both the secondary terminals on the other and before assembly it is a good plan to mark the wires in some way to distinguish which is the beginning and which the ending of the winding as the two coils must be connected together to form a continuous winding. The writer used spaghetti tubing of different colors. Push through these two coils enough of the $\frac{1}{2}$ " wide strips to fit snugly without cutting into the paper tube and even up the ends. The two coils should be pushed tightly

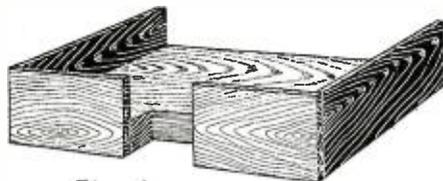

Fig. 1

The Wooden Form Used in Building Up the Core of the Transformer.

produces results that compare favorably with any loud speaker and still retain excellent quality. The push-pull, or balanced circuit method of amplification consists of two tubes in one stage with their grids connected to opposite ends of a transformer secondary having an exact center tap, and their plates connected to opposite ends of a transformer primary which also has an exact center tap. These taps connecting to the common or ground lead and to the "B" battery respectively.

It will be seen that these tubes are therefore opposed to each other, that is, when the grid of one is negative the grid of the other will be positive and vice versa thus producing continuous action, and in actual practice considerably reducing distortion and at the same time practically doubling the available power. This system of amplification is patented and used only in power amplifiers and in certain sets recently placed on the market, so that the special transformers required are not available to the man who "builds his own." The following instructions will, however, permit anyone to build a pair of very efficient transformers at a cost only slightly exceeding that of one standard high grade transformer.

THE WINDINGS AND CORES

First secure four of the Radio Specialty Co. $4\frac{1}{4}$ to 1 ratio transformer windings.

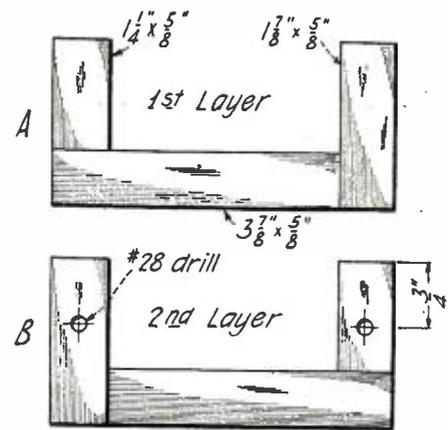

Fig. 2

Constructional Details of the Transformer Core. Note That Every Other Layer Overlaps.

together, first protecting the terminal wires with spaghetti tubing or small rubber tubing and being careful that none of the wires cross over each other.

The coils with their core are now placed on top of one of the "U" shaped cores forming a closed rectangular core and four pieces of core steel $\frac{5}{8}$ " wide by an inch long are pushed down between the laminations two on each end.

These help to hold the core together and form a slight magnetic gap between the different parts of the core, the looseness of

Line Drawing of the Completed Transformer With Mounting and Terminal Strip.

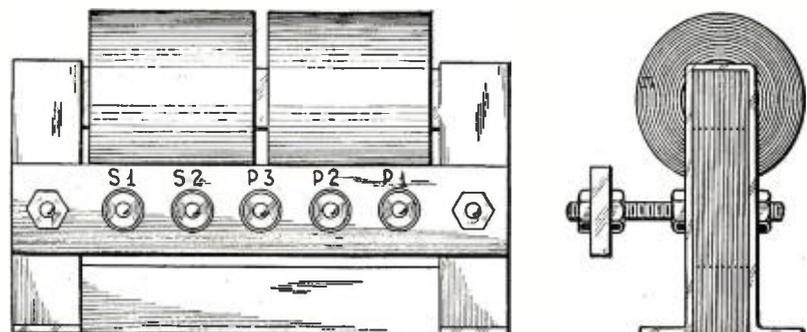

Fig. 3

this coupling avoiding saturation of the core.

These transformers may be mounted in a variety of ways but in the writer's opinion the neatest and most satisfactory way is that shown in Fig. 3, in which brass strip $\frac{5}{8}$ " wide and $\frac{1}{8}$ " thick is bent to surround the core on each end and outward at the bottom to form feet.

These are drilled to match the holes through the short legs and the whole held together by means of 6-32 threaded brass rods with nuts on each side of the core and extended to support a $\frac{3}{8}$ " bakelite panel upon which the binding posts are mounted. This is shown plainly in Fig. 3. Five binding posts are required on each transformer panel although the writer used eight and brought each wire to a post so that the coils could be connected up in different ways.

Using the five posts and facing the panel the connections are made as follows: The inside secondary which comes out on the end goes to the end post, marked S-1. The outside secondary of the same coil is soldered to the inside secondary of the second coil; the outside secondary of the second coil goes to the next post, marked S-2.

The inside primary which comes out on the other end goes to the end post, marked P-1, the outside primary of the same coil is soldered to the inside primary of the second coil and a tap led to the center post, marked P-3. The outside primary of the second coil is now led to the last post and marked P-2.

This completes the transformer with the

tapped primary, and the other is connected in exactly the same manner except that the tap for the center post is taken from the

sections of transformer T₂ and T₃ in Fig. 4 in parallel. It may be also advantageous to connect in parallel the secondary wind-

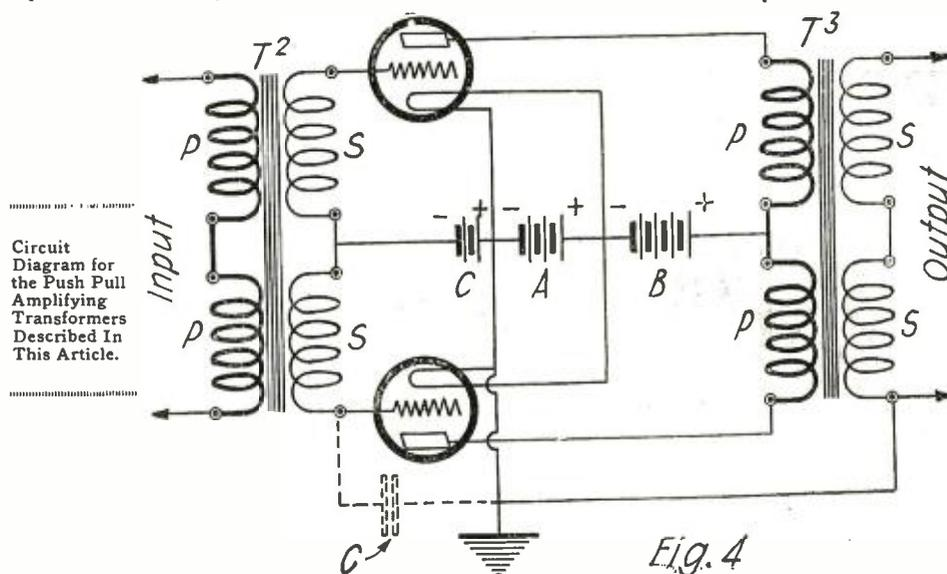

junction of the two secondaries and marked S-3.

It was found by experiment that owing to the high turn ratio and the extra impedance of these transformers better results were obtained, when using the new tubes now on the market, by connecting the two primary

windings of both transformers; the best method depends upon the loud speaker used in the output circuit. In conclusion, it is advised that experiments be made to determine the most suitable connections of the coils for the particular work they are put to.

Compact Amplifier Using Low Voltage Tubes

By DEANE S. KINTNER

WHEN I had occasion to assemble a two-stage, audio-frequency amplifier, using the so-called "peanut" tubes better known as WD-11 Radiotrons, I found that conventional arrangements of

separation of these instruments, and of grid (control) and plate (power) circuits, and compact and convenient location of instruments.

The binding posts on the panel serve for

third to the first panel post cuts out the second stage.

In actual practice I use both stages on the loud speaker and, without removing the connection between the plate terminals of the first tube and the second transformer, listen in on the first stage with the phones in tuning. Even with the primary of the second transformer in circuit with the first stage, signals in the phones when so used are amply loud.

I obtained wide separation of the two cross-over circuits from other connecting wires by running the negative "A" and positive "B" battery leads under the base (as indicated by the dotted lines).

Grid leaks connected as shown will be found to improve the quality of music and speech without material reduction in volume. The convenience of location of these leaks is obvious. Mine are 1 megohm.

The hook-up used puts the filament rheostats in series with the negative filaments of the tubes and with the leads from transformers to negative filaments, thus aiding in keeping the grids at negative potential, and making unnecessary the use of "C" batteries with the normal plate potential of 40 volts.

As will be seen, Radio Corporation UV-712 transformers and Bradleystats were used in my amplifier, but instruments of other types should lend themselves readily to the same arrangement.

My base measures 7" by 15", and the panel 2½" by 11", giving a 5" separation between transformers. The size of the base could be reduced somewhat without undue crowding of instruments, particularly if less bulky rheostats and transformers were used.

Since my amplifier was intended chiefly for experimental use, it is not enclosed in a cabinet, but that could be done readily.

Results obtained with the amplifier have been very gratifying. It is remarkably quiet in operation, very convenient, and neat in appearance.

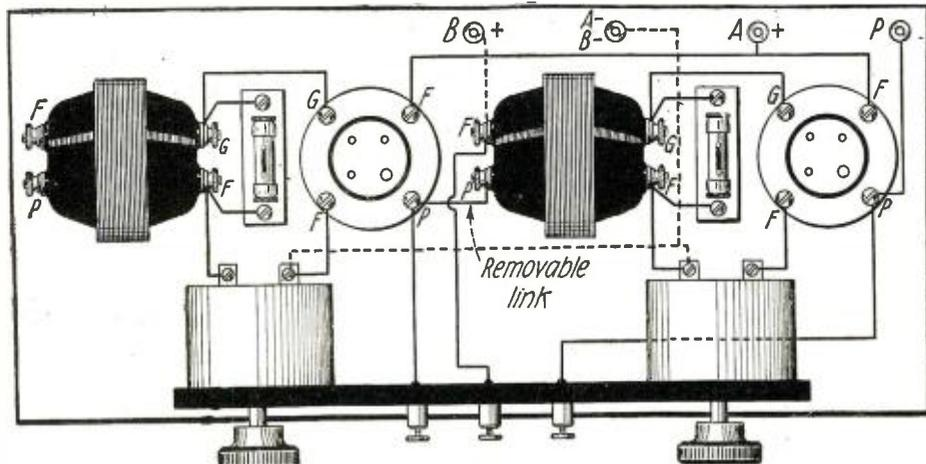

Layout of Instruments for a Two-Stage Amplifier Designed Especially for WD-11 Tubes. This Arrangement Allows for the Shortest Possible Leads from and to the Instruments.

the component parts of the amplifier did not work out to good advantage, because of the peculiar placing of terminals on the "peanut" tubes as compared with the 6-volt type.

After considerable cogitating and experimenting, I hit upon the plan illustrated by the accompanying diagram, which I hope will prove helpful to other amateurs who are giving these new tubes a tryout.

The chief ends sought in arranging the instruments as shown were to avoid interaction of transformers and tubes by ample separation, and to prevent capacity effects, howling and loss of signal strength by using short, direct connections with a minimum of parallel and cross-over wiring.

It will be noted that this plan gives very short leads between the grid and plate terminals of transformers and tubes; wide

attachment of phones to the two stages (the middle post serving as a common positive), and those in the rear for battery and loud-speaker leads.

For the sake of simplicity in wiring, use of jacks was avoided, the input of the first transformer being connected directly to detector, with the first and second stages of the amplifier normally hooked together. But the second stage can easily be thrown out of circuit by disconnecting the short, readily removable link between the plate terminals of the first tube and the second transformer (see diagram).

With this link in place and the phones connected to the second and third panel posts, both stages are heard, while the loud speaker operates from the first and fourth posts in the rear. Removal of the link and shifting of the negative phone cord from the

An Efficient Honeycomb Coil for Short Waves

By E. A. SCHALL

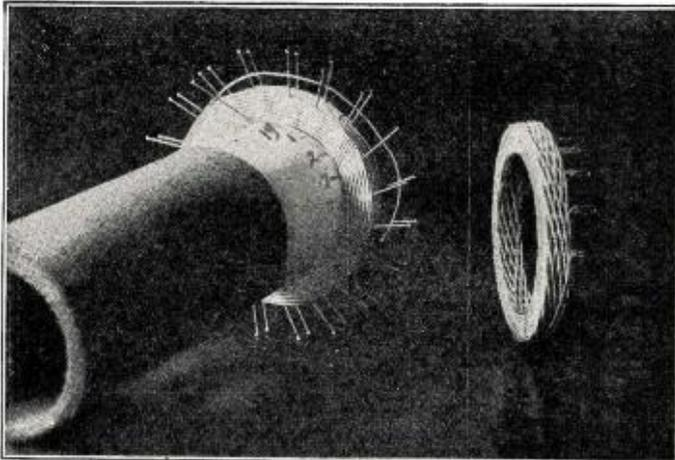

This Photo Gives a Good Idea of How the Forming Tube is Constructed, and as to the Manner in Which the Coils are Wound. A Complete Coil is Shown on the Right.

THE general opinion seems to be that standard honeycomb or D. L. coils, while fine for tuning the longer waves, lose much of their efficiency when used in broadcast receiving, or other short-wave work.

The reason is plain, when we consider that a short-wave coil of this type, say 35 or 50 turns, contains very few layers of wire, is wound on a core and is usually covered with a strap as well so that all the wire in the coil is spaced more or less closely to both core and cover, which must result in large losses due to reaction between these parts. Also each layer contains too many turns for so small a coil, making the capacity between layers higher than it should be.

The coil I shall describe was designed with these faults in mind and will be found to eliminate them to a large degree. It has also the advantage of being very easy to make, and when finished should have the fine appearance of a factory product. It is a true honeycomb coil and is wound around a 2" cardboard tube, but the two rows of pins used as winding guides are spaced only 1/4" apart. Nineteen pins are required in each row, 38 in all. They must be evenly spaced

around 2 and 3, across and around 7 and 8 and so on.

Hold wire with just enough tension to bring it into place, which is easy, as there are no long spaces between pins. Each complete layer contains 10 turns. A 50-turn coil of No. 24 D.C.C. wire will measure only about 3" in diameter by 3/8" thick, and as many as 140 turns can be readily wound using ordinary pins.

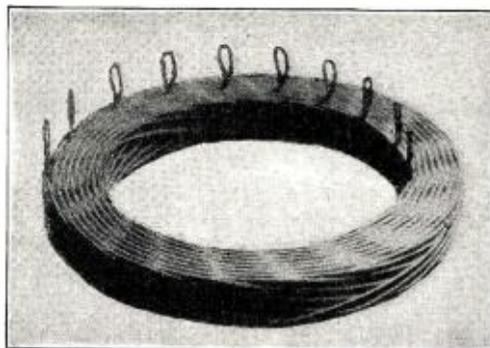

One of the Completed Tapped Honeycomb Coils. Note the Even Winding and the Well-Formed Structure.

in pairs around the tube.

A strip of paper 1/4" is wound around the tube four or five times between pins; this is to aid in removing the coil later on. It will help, in placing pins, if a double pointed awl is first made by forcing two needles, eyes first, into a stick 1/4" apart, this to be used in piercing guide holes for pins.

We are now ready to wind, as follows: Outside of pins 1 and 2, across and around 6 and 7, back and around 11 and 12, across and around 16 and 17, back and

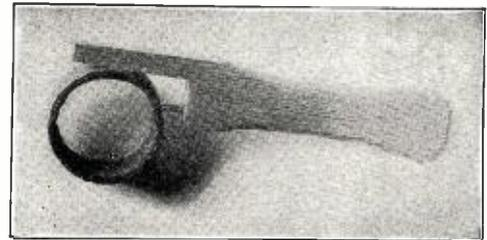

A Double-Pointed Awl Used for Piercing Guide Holes for the Pins.

Size of coil is figured the same as you would figure any honeycomb or D.L. coil.

If taps are desired the loops for same can be easily formed while winding, as the pins will keep in place the turns already wound. Every ninth turn can be tapped, which will bring each loop one space behind the preceding one; single turn or eleven turn taps can be taken, each loop coming one space ahead of the preceding one, etc.

When completely wound, go over coil, spacing the honeycomb cells with a stiff wire until all the turns of wire line up properly, and see that the two rows of pins also are correctly aligned.

The coils, pins and all, should next be well brushed with insulating varnish. This can be made for a few cents by adding as much scrap celluloid (from auto curtain windows) as will dissolve in an ounce or two of banana oil, then thinning with an equal amount of wood alcohol. This varnish can be prepared in a few minutes. It is far better than white shellac as an anti-capacity varnish and when dry the coil will have its original color.

At that time the pins are drawn, and a thin knife blade carefully worked around under the coil. The coil can then be slipped off the tube and any paper sticking to the inner turns removed. The two ends of wire should be fastened in place by sewing through holes in coil with a needle and thread. Give an additional touch of varnish wherever needed. The coil will now be firm and will need no support other than something to hold it in place.

Coils of this construction have been used in place of spider webs, single layer windings, etc., with very gratifying results.

A Reinartz Tuning Coil For A Quarter

By L. C. EBERLE

THE writer of this article does not lay any claim to originality, the aim being simply to give the benefit of his experience in describing a Reinartz Tuning Coil to

the fan who likes to make his own. The cost of this coil should not exceed twenty-five cents.

This type of coil, when made the size

mentioned, is far superior to the popular spider-web wound on heavy cardboard, for after laying on 20 or 30 turns of wire on a cardboard frame it is almost impossible to keep it flat, especially if the windings are made tight.

The coil made as described is of a sturdy, substantial type and requires absolutely no shellac or cement to hold it together. Its efficiency therefore is higher than the self-supporting type which is held together only by numerous coats of some adhesive cement.

In describing the coil, details of construction of the framework and the method of winding only will be given, as hook-ups and the number of windings have been published in most all the radio magazines.

Make the core first (see side view). Cut this from a piece of dry straight-grain wood 2 3/8" in diameter and 3/8" thick. Lay off each side into 15 equal divisions, and draw a pencil line from center line to outer edge; carry these lines across outside face, and a line all around it midway between the two faces; the points of intersection are the centers of holes for the spokes. Take some

(Continued on page 469)

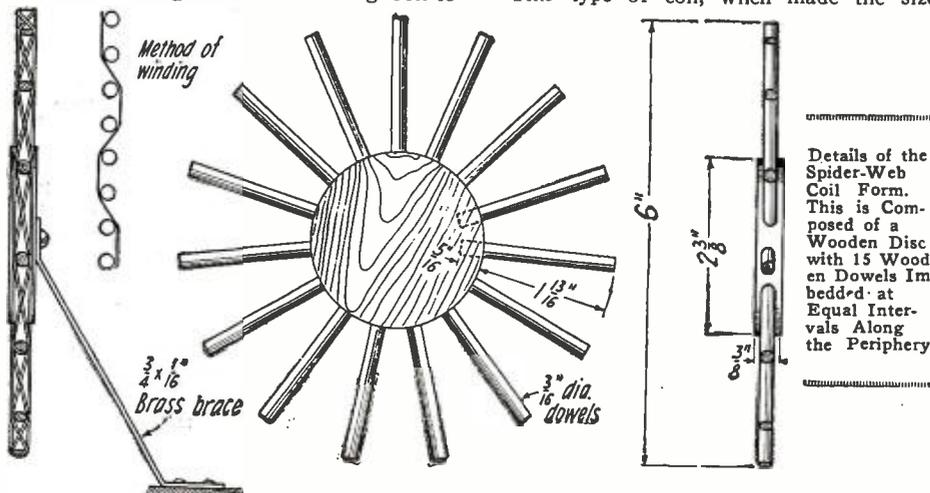

Definition of Radio Terms

CONTINUED FROM THE SEPTEMBER ISSUE

THE following definition of technical terms and symbols used in radio was compiled by the Committee on Standardization under the auspices of the Institute of Radio Engineers. This report is reprinted by Special permission.

Equivalent Decrement: The equivalent decrement of a radio wave is one of several quantities used as a measure of the distribution of the radiated power or wave amplitude with respect to frequency.

Utilizing the customary method of measurement, this quantity is defined by the aid of the expression:

$$\delta = \pi \frac{f_1 - f_2}{f_r} \sqrt{\frac{I^2}{I_r^2 - I^2}}$$

where f_1 and f_2 are in the frequencies at which the same value of current I is measured, and f_r is the resonance frequency at which I_r is measured; it being conventionally accepted that the frequencies be selected over the range power between the limits $0.9 f_r$, and $1.1 f_r$, and that the values of I^2 do not exceed one-half of I_r^2 .

When the value of δ is found to be not independent of the frequency f_1 , the equivalent decrement is taken as the value of δ that corresponds to the lowest conventional resonance curve that does not fall below the given curve in the whole range delimited by the inequalities—

$$\frac{I^2}{I_r^2} < -\frac{1}{2} \quad f_1 - f_2 < \frac{1}{10} (f_1 - f_2)$$

Account should be taken of the effects introduced by the measuring apparatus.

It is desirable that the determination of the resonance curve should be made at a distance greater than one wave-length, in order to secure freedom from local disturbance.

Fading: A diminution of the strength of received radio signals over prolonged, temporary or varying periods.

Feed-Back Coil: A coil designed to cause mutual action between the input and output circuits of an amplifying device, thereby increasing the amplification.

Feed-Back or Reaction Coupling (Sometimes termed "Tickler" Coupling): The process by which a part of the output power of an amplifying device reacts upon the input circuit thereby increasing the amplification.

Feed-Voltage Modulation: The process of varying the amplitude of a radio-frequency alternating current in accordance with any desired wave form by systematically introducing additional power into the circuit of the radio-frequency generator in accordance with the desired wave-form variations. In the three electrode tube this involves systematically varying the supply voltage of the plate circuit.

Ferromagnetic Modulator: A device for varying the amplitude of a radio-frequency alternating current in accordance with any desired wave form by utilizing either the hysteretic energy absorption of iron, or the variation of inductance of iron-core coils when worked at different portions of the iron characteristic curve ($B-H$ curve).

Filter, Band Pass: A combination of electric circuits which present low attenuation to alternating currents of all frequencies between certain limiting border frequencies and comparatively high attenuation to alternating currents

of all frequencies below the low, limiting border frequency or above the upper, limiting border frequency.

Filter, High Pass: A combination of electric circuits which present high attenuation to alternating currents below a certain frequency and comparatively low attenuation to currents above that frequency.

Filter, Low Pass: A combination of electric circuits, which present high attenuation to alternating current above a certain frequency and comparatively low attenuation to currents below that frequency.

Flat Top Antenna: An antenna having horizontal conductors at the top.

Forced Alternating Current: A current having a frequency and wave form which are equal to the frequency and wave form of the impressed electromotive force.

Form Factor: The form factor of a symmetrical antenna for a given wave-

alternating current following a transient electro-magnetic disturbance in a circuit; with no external emf. acting.

Frequency Changer: A device delivering alternating current at a frequency which differs from the frequency of the supply current.

Frequency Transformer: See Frequency Changer.

Full-Wave Rectifier: A rectifier so arranged as to rectify and render available all successive half cycles of an alternating current.

Fundamental of an Antenna (Frequency): The lowest frequency of free alternating current in an unloaded antenna, (No series inductance or capacity).

Fundamental Wave-Length: The wavelength corresponding to the lowest frequency of free alternating current.

Grid Leak Resistance: (Usually called a grid-leak.) A resistor connected between the filament and the grid of a three-electrode tube used in association with a condenser to give the potential of the grid a certain average negative value.

Ground Wire: A conductive connection to the earth.

Group Frequency: The number of trains of damped waves or current per second.

Note: The term "group frequency" replaces the term "spark frequency."

Harp Antenna: An antenna composed of vertical, or approximately vertical, conductors, all in one plane.

Heterodyne Receiver: A radio receiver for continuous waves employing the principle of reaction between locally generated oscillations and incoming oscillations. (See Beat Frequency.)

Heterodyne, Self: See Self-heterodyne.

Homodyne Reception: A method for the reception of radio signals, in which the carrier frequency component has been suppressed, by restoring this component by means of a local generator at the receiving station.

Hot Wire Ammeter, Expansion Type: An ammeter dependent for its indications on the change in dimensions of an element which is heated by a current through it.

Impact Transmitter: A radio transmitting set in which the transfer of energy from the exciting to an oscillatory circuit is effected during one pulse of the exciting circuit current.

Impulse Emf.: An emf. the maximum value of which is large compared with its average value, the average value being taken over a time equal to the time-constant of the circuit in which the emf. is impressed.

Impulse Excitation: A method of producing free oscillations in a circuit in which the duration of the impressed voltage is short compared with the duration of the current produced.

Inductive Coupling: The association of one circuit with another by means of inductance common or mutual to both. (This term when used without modifying words is commonly used for coupling by means of mutual inductance, whereas coupling by means of self-inductance common to both circuits is called "direct inductive coupling.")

Input Reactance of a Three-Electrode Tube: The ratio of an alternating sine-wave input voltage to the portion of the resulting input current which is an alternating sine-wave current of the

(Continued on page 428)

\$12,000.00 In Prizes For Pictures

SCIENCE AND INVENTION for the next twelve months will give \$1,000 each month in prizes for pictures or suggestions for pictures.

A great number of radio pictures are required and you would do well to see the October issue for details.

LIST OF RADIO ARTICLES IN OCTOBER SCIENCE AND INVENTION.

- Radio For Coal Mines.
- The R. C. Detector and Two-Step Amplifier—Complete Details and Hook-ups.
- Loading Different Types of Receiving Sets For Long Wave-lengths, by Marius Logan.
- Short Wave Broadcast Relaying, by Howard Allan Duncan.
- Radio Controlled Torpedoes For Future Wars, by Graser Schornstheimer.
- Radio Broadcast Station Call Letters Up-To-Date.
- Radio For The Beginner—Rheostats—All About Them, by Armstrong Perry.
- Leviathan's Radio Set.
- Four Dependable Single Tube Hook-ups.

length is the ratio of the algebraic average value of the effective currents measured at all heights to the greatest of these effective currents.

Note 1: For a given effective current at the base of the antenna, the field intensity at distant points is proportional to the form factor times the height from ground or counterpoise to highest point of the antenna.

Note 2: The effective height (of an antenna) is equal to the form factor times the height from ground and other objects as above.

Note 3: The limiting values of the form factor for various types of antennae are as follows:

	Linear or Vertical Antenna	Flat Top Umbrella Antenna
Long waves	Lower limit, $\frac{1}{2}$	Upper limit, 1
Fundamental	Lower limit, 2π	

Note 4: The form factor varies in a given antenna at various wave-lengths owing to variation of the current distribution.

Note 5: See also "Effective Height of an Antenna."

Free Alternating Current: A damped

Awards of the \$50 Radio Wrinkle Contest

First Prize A MICA VANE VERNIER CONDENSER BY C. W. HALLIGAN

The vernier condenser about to be described has several features to recommend it to the amateur. It is simple, easy to construct from odds and ends, and best of all, the effect of body capacity in tuning is entirely eliminated. The principle upon which it is based is rather novel in that the capacity is varied by changing the dielectric itself.

A glance at the accompanying drawing will suffice to explain its construction. Two condenser plates BB, which may be salvaged from a discarded condenser of the conventional type, are mounted on the rear of the panel as shown. F and G are fibre or bakelite washers, the separating washer G being about 1/16" thick. The rotating element A consists of a mica vane, cut to shape and punched for the shaft H. The vane is secured to the shaft by lock nuts, and the whole rotates in a short piece of brass tubing D, which is fitted into a suitable hole in the instrument panel. A dial completes the device. Leads to the set are taken from the two fixed plates, thus eliminating sliding contacts and at the same time rendering the shaft electrically "dead," so that here is no chance of body effect from this source. Since mica has a dielectric constant of about five times that of air, it can

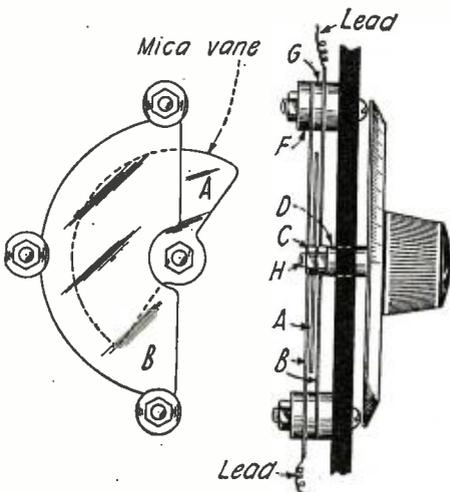

A. Rear and Side View of the Mica Vane Vernier Condenser. The Movable Member Changes the Dielectric Between the Two Stationary Plates, Thus Increasing or Decreasing the Capacity Very Gradually.

be readily seen that rotation of the dial produces a change in capacity amply sufficient for the purpose of sharp tuning. The writer has found the device quite satisfactory. The experimenter can easily adapt the details of construction to meet his own resources, and is assured of a worthwhile addition to his set.

Second Prize A PRACTICAL VARIABLE GRID LEAK By LEROY WESTERN

One of the bug-bears of the amateur constructor seems to be the making of a variable grid leak which will give half-way good results and will maintain its efficiency over a considerable length of time. Most of the home-made leaks become inoperative after being used for any period of time during which time resistance has to be varied occasionally.

The leak described herewith does away

with all of these objections and when once it is constructed properly it will retain its efficiency, no matter how many times its value may be varied. Still another advantage is that the leak is absolutely dustproof.

The main part of this little instrument consists of an ordinary tubular fuse. It may be of any size that the amateur happens to have on hand. In order to have a good form for mounting, it is advisable to procure

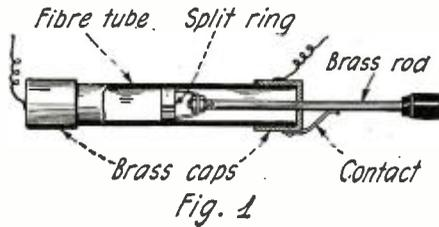

This Unique Variable Grid Leak is Composed of a Fibre Fuse Case Coated on the Inside with a Mixture of India Ink and Carbon. The Movable Plunger Provides the Variable Contact.

a fuse block into which the tube will fit. Connections can then be made to the clips instead of to the brass ends of the tube as shown in Fig. 1.

After obtaining the fuse, remove the two

This removes the excess of resistance material. The boiling process impregnates the fibre tube so that the carbon deposit will not wear off under frequent use.

The brass cap in which no hole was drilled may now be slipped over the end of the tube which was placed in the India ink.

Next make a contact ring as illustrated in Fig. 2, from thin phosphor-bronze. The edges of this link should be hammered slightly so as to turn over on the inside of the edge and present a smooth running surface to the inside of the tube. The yoke is to be soldered to the split ring and the rod fastened here by means of two nuts, or by soldering.

In order to make good contact with the brass rod, it is desirable to bend a piece of phosphor bronze strip, as shown in Fig. 1, and solder it to the brass cap. The other end is to be bent so as to make firm contact with the rod.

Several of these instruments may be made and tested against one another in order to find out which one gives the best results. If some method of measuring resistances is available, it is advisable to calibrate them so that you will not be working in the dark.

Third Prize A COMPACT SPIDER-WEB COIL BY A. R. CROOKSHANK

The diameter of a spider-web coil, with a fairly large number of turns, may be kept down so that the coil will be of a

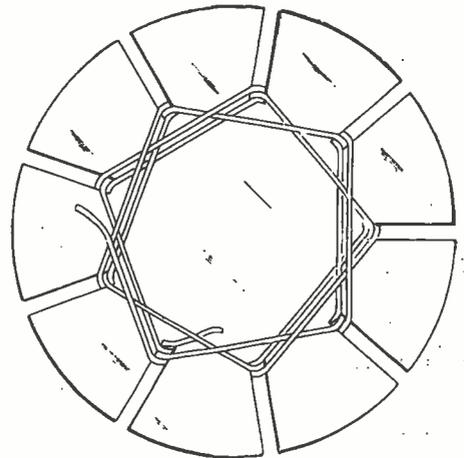

By Winding a Spider-Web Coil, as Shown Above, It Is Possible to Place More Wire on a Smaller Form Than If Wound in the Usual Manner.

Prize Winners

FIRST PRIZE, \$25

A Mica Vane Vernier Condenser
By C. W. HALLIGAN,
323 E. Main St.,
Ephrata, Pa.

SECOND PRIZE, \$15

A Practical Variable Grid Leak,
By LEROY WESTERN,
626 E. Second St.,
Plainfield, N. J.

THIRD PRIZE, \$10

A Compact Spider-Web Coil
By A. R. CROOKSHANK,
P. O. Box 1393,
St. John, N. B.

end brass caps and clean the interior of the fibre tube. Remove all solder from the caps. In one cap drill a hole of the correct size to allow a brass rod to slip through. This rod need not be more than 1/8" in diameter. Next secure some India ink and a pencil lead. With a file, work off a quantity of filings from the pencil lead and add to the India ink. Boil the mixture. While still hot, apply liberally to the inside of the tube.

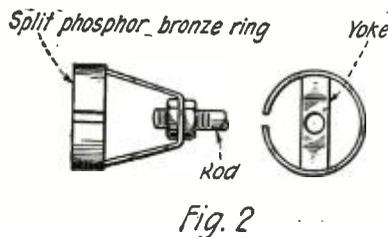

Details of the Contact Used in the Variable Grid Leak. Note That the Ring is Split so That a Snug Fit Can Be Made Without Binding.

During this process the tube should be kept warm. By so doing the material will soak into the fibre tube. Dip one end of the tube into the mixture so that some of the liquid will be deposited on the outside of the tube for a space of about 1/4" from one end. Allow the tube to dry and go over the inside of it with very fine sandpaper.

size that can be conveniently used with the ordinary radio sets by another method than the double form windings, as shown in the June issue, page 2081.

To obtain twice the number of turns that may be obtained by the regular method of winding on a given sized spider-web form, you wind in the ordinary way except that you skip a slot each time.

To treble the number of turns, skip two slots each time; and so on for any other desired increase in the number.

Two things must be considered. First, you must see that the number of slots is such that you will be either ahead or behind one slot of the previous turn when you complete each winding. And secondly, you must increase the number of slots with each additional slot you skip, so that the windings will not get too far from the circular shape.

This method not only allows more turns to a given diameter of form but also gives somewhat of a honeycomb coil winding effect.

A VACUUM TUBE PROTECTOR

As to the need of protection for the filament of vacuum tubes against the excessive flow of "B" battery current, due to wrong connections, etc., there can be no question. Why use a piece of tinfoil or a lot of fuses, to hunt and replace when blown when nearly

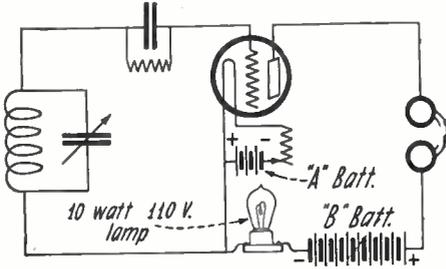

This is a Safe and Sane Way of Protecting the Filament of Your Vacuum Tube. If a Mistake is Made in the Connections, the 110-Volt Lamp Will Light, but the Filament of the Tube Will Not Be Harmed

100 per cent protection with automatic visible indication and positive reset can be had at nearly zero cost and labor? A 10-watt, 110-volt electric light bulb, connected in the circuit between the "A" and "B" batteries, will have absolutely no noticeable effect on the small normal flow of plate current, but will not allow enough "B" battery current to pass even to burn out one of the new 1/4-ampere filament tubes. This arrangement gives instant visible signaling of wrong connections and protects the "B" battery from damage by short-circuits in the set.

Contributed by Harry H. Strong.

A HONEYCOMB COIL MOUNTING

When designing a radio receiving set employing honeycomb coils, one usually desires to improve the appearance of the outfit where it is possible, as well as the over-all efficiency of operation. By placing the honeycomb coil mountings on the rear of the panel and extending long arms through slits cut in the panel, the coupling of the coils is just as easily controlled. The arms employed for moving the coils are usually supplied with the mountings; however, they can easily be constructed from lengths of brass rod, with small composition knobs on their ends, for manipulation, and the elimination of body-capacity effects.

Referring to the sketches of Fig. 1, it will be seen that the mountings are behind the panel. On each side is a slit, 1/8" wide and about 2" long, through which the controlling arms pass. For further convenience, scales are marked on the panel directly above the slits. These can be either in degrees of coupling or marked in fractions of an inch.

Contributed by Belgrave F. Gostin.

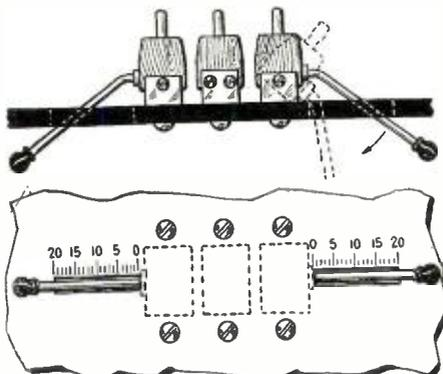

This Illustrates the Clever Arrangement of the Three-Coil Honeycomb-Mounting on the Rear of a Panel, with the Controls on the Front.

SUPER-SENSITIVE MICA DIAPHRAGMS

It is a known fact that mica diaphragms are more efficient when used with telephone

receivers than the ordinary metal type. Since mica is a non-magnetic material, it is necessary to include in the center of such a diaphragm a piece of magnetic metal, so as to bring about the attraction and repulsion of the diaphragm to and from the pole pieces. The average person experiences difficulty in attaching such a piece of metal to the diaphragm. The following description of the method that I employ makes the task an easy one: With a piece of mica, of a good grade, and using the regular phone diaphragm as a pattern, cut out two circles, and in the center of each place a splotch of glue, the same size as the magnetic poles of the receiver, and directly above them. On this sprinkle some fine iron filings, until the glue is entirely covered. When dry, a bit of shellac, or more glue, should be spread over the top of the filings, to prevent rust. This means has the extra advantage of being more flexible, and vibrating more easily than the ordinary mica diaphragm. It works to perfection.

Contributed by James A. Able.

A PRACTICAL WAY TO USE A HOME BATTERY CHARGER WITH A RECEIVING SET

A simple, convenient, and practical way to use a home battery charger of the vibrating type is to fix it in a permanent position. This will obviate the necessity of setting it

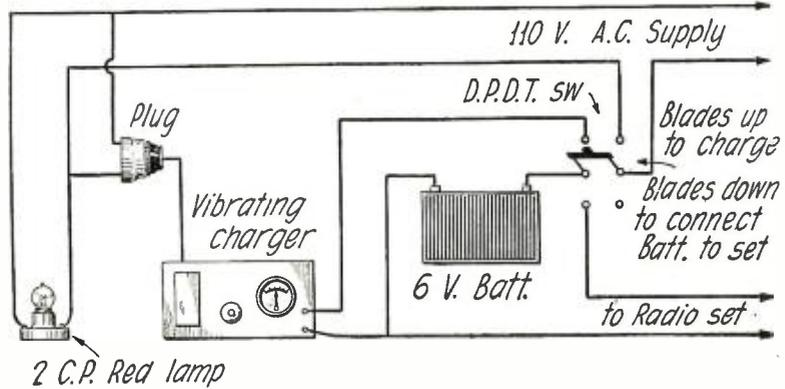

By Using This Circuit Arrangement, It Is a Simple Matter to Place the Battery on Charge, or Connect It to the Receiving Set, Merely by Throwing the D. P. D. T. Switch

The next issue of Radio News will be the Great Amateur Number. You are sure to be interested in it.

up each time a charge is to be given to the battery. Also, the cords will not wear out prematurely through rough usage and damage to the charger is not so likely to occur. The diagram shown above represents a layout that works perfectly. All that is necessary to do to charge the battery is to throw the switch blades in the "up" position. This will connect the charger to the battery and the alternating current supply at the same time.

The red lamp may be omitted but it serves a good purpose. It shows that the charger is connected to the battery. Of course the vibrator gives audible indication but sometimes a charger will get out of adjustment and stop vibrating. If the red lamp is burning and the charger not vibrating, the switch must be opened to prevent the battery from discharging. If the vibration ceases because of no line current the red lamp will be extinguished. The switch should be kept open until the line current is restored. If the lamp burns and there is no action on the charger it is probable that an adjustment is needed. Sometimes merely opening and closing the switch will start the charger vibrating again.

Contributed by Kenneth A. Schaaf.

NEW USE FOR INNER TUBES

Some time ago I was bothered by the racket caused by the vibration of a motor-generator outfit I had in my room upstairs. The noise could be heard all over the house, especially downstairs. It was necessary that I eliminate this. I thought of the idea of placing a partly inflated automobile inner-

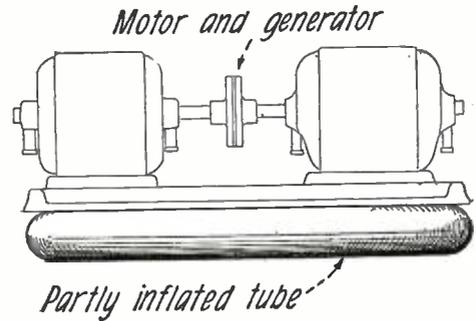

If You are Troubled by Vibration from Your Motor-Generator, a Partly Inflated Automobile Tube, Placed Underneath the Frame, Will Eliminate It.

tube under the base of the machine. I tried this out and found that it eliminated practically all the previous racket the motor-generator made. Those of you who are having similar difficulties would do well to try this stunt.

Contributed by Russel C. Nelson.

THE COSTLESS VERNIER

This Vernier is very easily made, allows for a very fine adjustment and eliminates nearly all body capacity effects caused by the operator's hand. To provide this system, take a 3/8" drill and drill a hole (not clear through, but as shown in illustration) near the edge of the dial. This hole should then be countersunk to about the same angle shown. Now take a pencil with an eraser on the end, insert it in this hole and turn.

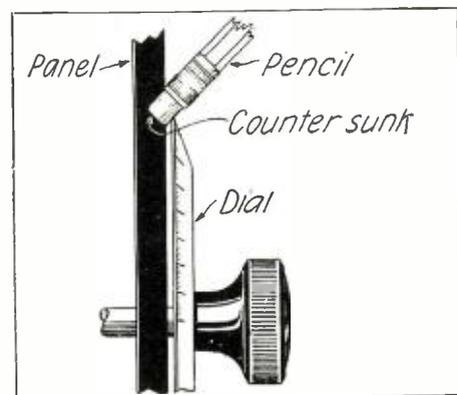

By Twisting the Pencil, the Friction of the Rubber Against the Periphery of the Dial Will Turn It at a Slow Rate.

One rotation of the pencil turns the dial but slightly, thus providing a means for fine tuning, a necessity in the average vacuum tube receiver of today.

Contributed by Harold Luther.



Apparatus Awarded Certificates

"ALL-AMERICAN" RADIO FREQUENCY TRANSFORMER

It is often desirable in radio frequency amplifiers to substitute one transformer for another in the different stages. For this reason, the Rauland Manufacturing Co., of 35 South Dearborn St., Chicago, Ill., has designed its radio frequency transformer to fit a standard vacuum tube socket as well as to be mounted permanently on a base or panel. The metal casing, which acts as a shield, is nickel-plated and is highly polished.

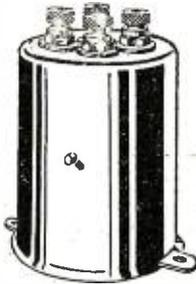

Maximum amplification was obtained on wave-lengths ranging from 150 to 500 meters, although fair amplification was obtained on a wider range.

Arrived in excellent packing.

AWARDED RADIO NEWS LABORATORIES CERTIFICATE OF MERIT NO. 209.

"ERLA" REFLEX TRANSFORMER

This radio frequency transformer, which is designed especially for use in reflex receivers, is manufactured by the Electrical Research Laboratories, 2515 South Michigan Ave., Chicago, Ill. This transformer can be attached permanently to a base or panel, or it can be inserted into a standard vacuum tube socket, thus allowing the operator to quickly connect one size of transformer into the circuit in place of another. The casing



is of fibre. Maximum amplification was obtained on wave-lengths ranging from 150 to 700 meters.

Arrived in excellent packing.

AWARDED RADIO NEWS LABORATORIES CERTIFICATE OF MERIT NO. 210.

RADIO SAFETY FUSES

Many vacuum tubes have been burned out through accidental contact with the "B" battery circuit, or other high-voltage wiring. To prevent this accidental burning-out of vacuum tubes, the Radio Equipment Company, 620 Washington St., Boston, Mass., has designed the safety fuses shown in the

illustration. This fuse fits directly on the filament terminal of a vacuum tube and does not interfere with placing the tube into its socket. The fuses are made in several sizes.

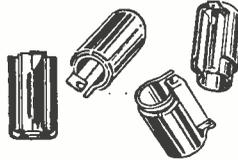

A box containing four 1/4-ampere fuses was submitted. Each fuse "blew" at .27 amperes.

Arrived in poor packing.

AWARDED RADIO NEWS LABORATORIES CERTIFICATE OF MERIT NO. 211.

CHELSEA AUDIO FREQUENCY TRANSFORMER

This transformer, which is manufactured by the Chelsea Radio Company, 150 Fifth St., Chelsea, Mass., was found to possess a gradually rising characteristic curve as the frequency was increased from zero to 2,390 cycles per second, after which the curve increased slightly as the frequency was increased to 6,000 cycles. The amplification



factor is high. The mechanical construction of this instrument is rugged and accurate.

Arrived in excellent packing.

AWARDED RADIO NEWS LABORATORIES CERTIFICATE OF MERIT NO. 220.

ACME APPARATUS COMPANY'S TRANSFORMERS

The Acme Apparatus Company, of Cambridge, Mass., has submitted for test its Type A-2 audio frequency transformer and also its Type R-2 radio frequency transformer. The radio frequency transformer is shown in the illustration. The audio frequency transformer was found to possess a straight-line, rising, characteristic curve at frequen-

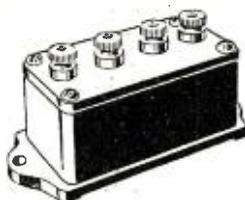

cies from zero to 2,390 cycles per second, after which the curve is flat from 2,390 to 6,000 cycles per second. The amplification factor is very high. The Type R-2 radio

frequency transformer was found to give very high amplification at a wave-length range of from 200 to 600 meters. Both of these instruments are of excellent mechanical and electrical construction.

Arrived in excellent packing.

AWARDED RADIO NEWS LABORATORIES CERTIFICATE OF MERIT NOS. 221 AND 224.

LOOSELY COUPLED RADIO FREQUENCY TRANSFORMER

For maximum results in radio frequency amplification, the Kilbourne & Clark Manufacturing Co., of Seattle, Wash., has designed a loosely coupled air-core transformer, shown in the illustration. The coupling be-



tween primary and secondary windings is variable and, in order to avoid unnecessary controls when two or more stages of amplification are used, the instruments are designed so that they can be mounted tandem fashion and all-controlled with one knob and dial. The windings are of resistance wire, which broadens the wave-length range and also the tuning. Maximum amplification is obtained on wave-lengths ranging from 250 to 600 meters, although fair amplification is obtained on wave-lengths from 250 to 1,000 meters.

Arrived in excellent packing.

AWARDED RADIO NEWS LABORATORIES CERTIFICATE OF MERIT NO. 223.

SCHINDLER RADIO FREQUENCY TRANSFORMER

Where space is an important factor in the construction of vacuum-tube receiving sets, this radio frequency transformer, which is manufactured by Charles Schindler, of 1401-03 W. Delaware Ave., Toledo, Ohio, will be found convenient, due to its exceptionally

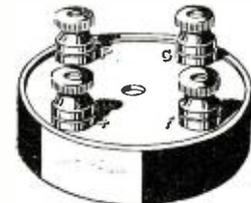

small size. It is of the air-core type and is entirely shielded. Maximum amplification was obtained on wave-lengths ranging from 150 to 500 meters.

Arrived in excellent packing.

AWARDED RADIO NEWS LABORATORIES CERTIFICATE OF MERIT NO. 212.

"RADIANT" CONDENSER

The "Radiant" condensers, which are manufactured by the Heath Radio & Electric Mfg. Co., 206-210 First St., Newark, N. J., are noted for their mechanical accuracy and

hardness of the condenser plates. The plates are stamped out with a special die, which leaves small indentations in the metal, thus forcing out slight irregularities and also allowing free escape of air. By this method a perfectly flat plate is produced, which is also exceptionally hard and brittle. The bearings are mechanically accurate and insure perfect alignment of the plates at all times. A 45-plate condenser, with vernier attachment, was tested. A capacity range of from 20.65 to 912.20 micro-microfarads was

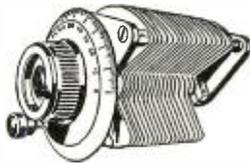

obtained and the dielectric loss resistance, at 1,000 cycles, was 245 ohms. The illustration shows the unique vernier-control attachment.

Arrived unpacked.
AWARDED RADIO NEWS LABORATORIES CERTIFICATE OF MERIT NO. 207.

CARDWELL CONDENSER

This condenser, which is manufactured by the Allen D. Cardwell Mfg. Corp., of 81 Prospect St., Brooklyn, N. Y., is of unusual construction and is designed to have minimum losses. The stationary plates, which are on the inside, are supported by two small insulating members. This construction produces a condenser having a long leakage path between the two sets of plates with very little insulating material. The dielectric resistance loss at 1,000 cycles on the 21-plate



condenser was only 75 ohms. A capacity range of from 14.75 to 490.87 micro-microfarads was obtained. The construction is mechanically accurate and rugged.

Arrived in excellent packing.
AWARDED RADIO NEWS LABORATORIES CERTIFICATE OF MERIT NO. 208.

KELLOGG VARIABLE CONDENSER

The Kellogg Switchboard & Supply Co., of Adams and Aberdeen Sts., Chicago, Ill., has submitted for tests the instruments shown in the accompanying illustrations. The 43-plate variable condenser, with the 5-plate vernier, although of large size, was found to have very low losses. The dielectric loss, in ohms, at 1,000 cycles, is only 90. A capa-

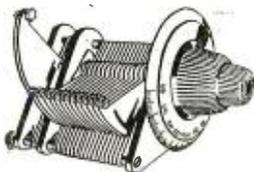

city range of from 45.14 to 1,800 micro-microfarads was obtained. The vernier increased the capacity from 45.14 to 187.53 micro-microfarads. A special dial, designed to fit the condenser, is supplied.

Arrived in excellent packing.
AWARDED RADIO NEWS LABORATORIES CERTIFICATE OF MERIT NO. 213.

KELLOGG RHEOSTAT

The Kellogg Switchboard & Supply Co.'s

rheostat, which is shown in the illustration, was tested for four hours at 1 1/4 amperes and stood up well under the test. This is a

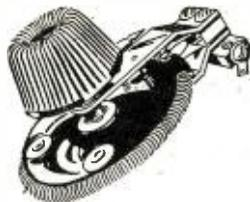

very smoothly running instrument and is designed to be mounted on the back of a panel. The disc is of bakelite, around which the coil of resistance wire is fixed.

Arrived in excellent packing.
AWARDED RADIO NEWS LABORATORIES CERTIFICATE OF MERIT NO. 214.

KELLOGG VARIOMETER

This variometer, which is manufactured by the Kellogg Switchboard & Supply Co., is of excellent mechanical construction. It is designed for both panel and table mount-

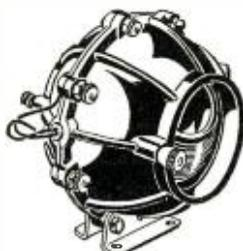

ing. When connected in series with the secondary winding of this company's variocoupler, a wave-length range of from 240 to 450 meters was obtained.

Arrived in excellent packing.
AWARDED RADIO NEWS LABORATORIES CERTIFICATE OF MERIT NO. 215.

KELLOGG TELEPHONE JACKS

The Kellogg Switchboard & Supply Co. has submitted several sizes of telephone jacks, one of which is shown in the illustration. These jacks are of excellent mechanical construction and are designed, of course, for use with the standard telephone plug. They are arranged for panel mounting and



are prevented from turning by means of two pins which fit into holes drilled in the back of the panel.

Arrived in excellent packing.
AWARDED RADIO NEWS LABORATORIES CERTIFICATE OF MERIT NO. 216.

WEBSTER RADIO FREQUENCY TRANSFORMERS

For covering the various wave-lengths used in radio transmission, the Webster Electric Company, of Racine, Wis., has de-

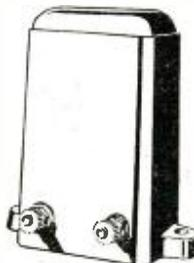

signed three sizes of transformers, one of which is shown in the illustration. The

transformers are of excellent appearance and are mounted in a moulded casing of insulating material, with holes for screwing to a base or panel. A wave-length range of from 200 to 2,000 meters was efficiently covered by means of the three transformers.

Arrived in excellent packing.
AWARDED RADIO NEWS LABORATORIES CERTIFICATE OF MERIT NO. 217.

MODERN AUDIO FREQUENCY TRANSFORMER

A shielded transformer of mechanical accuracy is shown in the illustration. This transformer is manufactured by The Modern Electric Mfg. Company, of Toledo, Ohio. The amplification factor is fairly high and the characteristic curve uniform. The curve rises as the frequency is increased from zero to 630 cycles, and then falls slightly as the frequency is increased to 4,700 cycles. The curve rises slightly as the frequency is increased to 6,000 cycles, which is desirable as modern radio transmitting apparatus has a tendency to transmit the lower frequencies more efficiently than the higher frequencies.

Arrived unpacked.
AWARDED RADIO NEWS LABORATORIES CERTIFICATE OF MERIT NO. 219.



"WESKEN" LOUD-TALKER

This loud-talker unit is designed to be mounted on a phonograph or other horn, and is noted for its extremely small size and sensitivity. The diaphragm is only 1 13/16" in diameter and the pole tips are both 1/4" by 1/8". This instrument is extremely sensitive to weak signals and reproduces loud concerts with great volume and clearness. The shell is of insulating material and the diaphragm is clamped directly on a metal back support, so that variations in the temperature of the room will not affect the length of the air gap due to unequal expansions of the materials in the phone. This instrument was submitted by Stevenson Brothers Sales



& Engineering Company, Finance and Richard streets, Pittsburgh, Pa.

Arrived in excellent packing.
AWARDED THE RADIO NEWS LABORATORIES CERTIFICATE OF MERIT NO. 200.

DICTOGRAPH LOUD-SPEAKER

This instrument, which is manufactured by the Dictograph Products Corporation, 220 West 42d street, New York City, was found to be very efficient electrically and acoustically.
(Continued on page 464)

Radio Humor

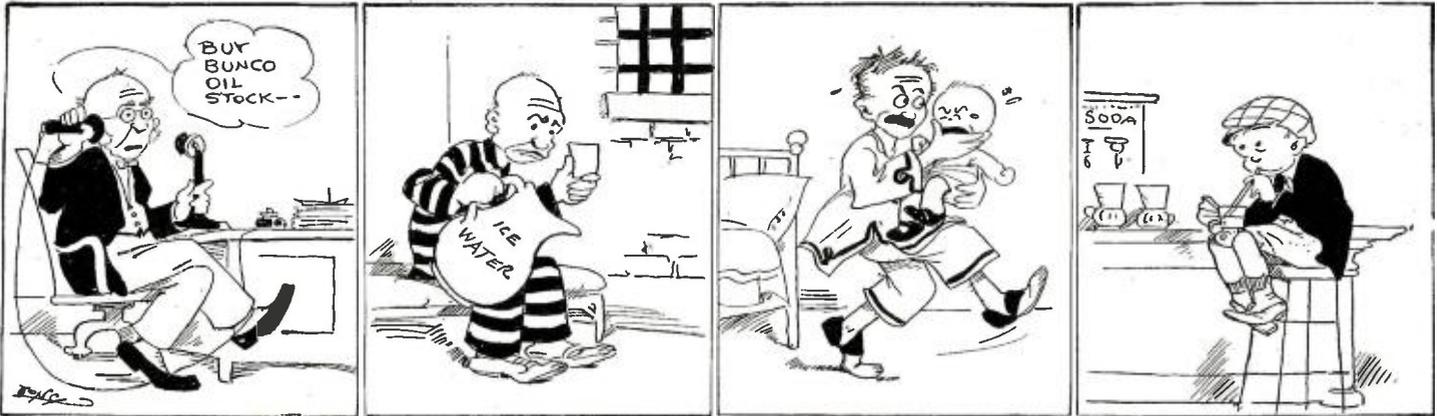

A "PHONE" TIP

A DRY CELL

ELIMINATING THE "SQUEALS"

A ONE TUBE SET

A WIRELESS JOKE

On March 9, the staff of the Newcastle-on-Tyne Electric Supply Co. held their annual smoking concert in the Crown Hotel,

Newcastle. Mr. J. S. Watson occupied the chair and some 200 members attended. The function proved a great success.

A feature of the evening was a pseudo nine-valve wireless receiving set, the equip-

ment of which was very complete, if not very compact. Concertina expansion joints were provided in the aerials, a large diameter wooden pulley fitted with a weathercock served as a tuning coil, a large size grease cup was employed as a crystal holder, and the grid resistance was recorded on a converted ammeter, the movement of which appeared suspiciously mechanical. With the aid of a microphone, a power amplifier and a loud-speaker, a speech from a gentleman in the next room was distinctly received except when most realistic representations of atmospheric and inductance intervened. The interference of a spark station sending in Morse code was most pronounced!

Queer Queries and Ready Replies

By I. R. TANNEHILL

Useless questions addressed to this Department will receive prompt answers as pointed as a jab in the eye with a sharp stick. No attention will be paid to questions not accompanied by money, postage, radio apparatus or smoking tobacco.

Q. I have an aerial across the back yard, 100' long and a lead-in wire 75' to the kitchen and 40' along the wall to the living room. I cannot hear Kansas City, which is 1,000 miles away. Do you think I should move the set nearer the aerial? **FARAWAY.**

A. No, you should move the set nearer to Kansas City.

Q. Last night I went to my sweetheart's home with a single tube receiving set and tried to make a hit with her father, who is a radio fan. I could get only local stations and he kicked me out of the house. I am going back tonight. What would you advise to improve receiving conditions? **B. V. D.**

A. Try a good geography in parallel with the seat of your trousers.

Q. What are peep-holes for? **CURIOUS.**

A. Take our advice and let peep-holes alone. Remember the old adage: a sock in the eye is worth two on the foot.

Q. I cannot get my regenerative receiver to oscillate without wetting my fingers and touching them to the binding post of my condenser. This does not always work. Is there any easier way of bringing about the oscillating condition? **GUMCHEWER.**

A. Try throwing a couple of wet towels across your ground clamp.

Q. I have been using my neighbor's clothes line for an aerial, but never could tune below 400 meters on Mondays. Have found that this is because they hang out his

(Continued on page 436)

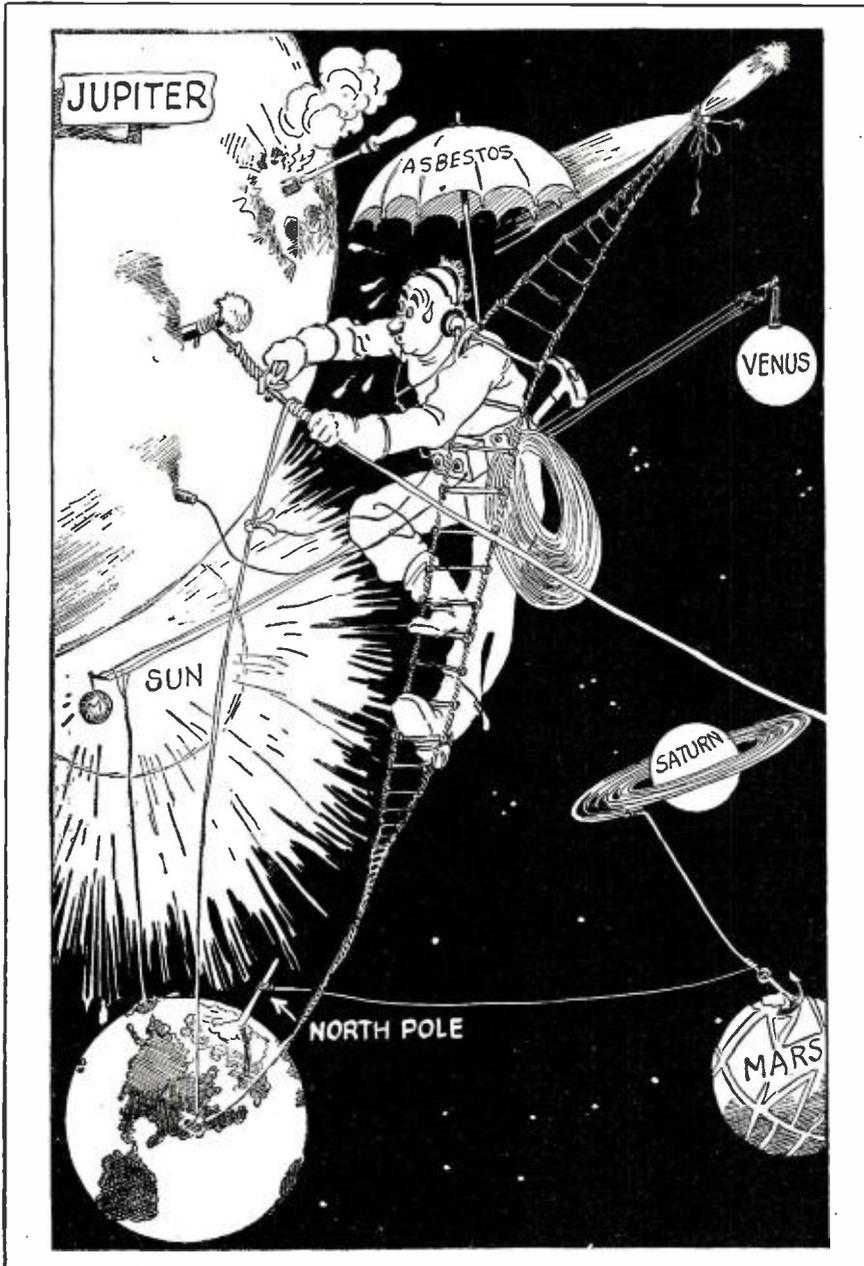

When Mr. Pecksniff Got the "Radio Bug" He Fell Hard. He Decided To Put Up a "Man's Size" Aerial and Is Still Up Around Jupiter Installin'. He Never Will Hear Nothin'.

Correspondence From Readers

IN ANSWER TO MR. BRACKENRIDGE

Editor, RADIO NEWS:

Referring to Mr. Brackenridge's letter in the July issue of RADIO NEWS about single circuit tuners, I must say there are a few points in it to which I cannot agree. It strikes me that Mr. Brackenridge has touched only the desirable features of the single circuit tuner.

He says that three-fourths of the cards sent to amateurs by their brother amateurs are due to single-circuit tuners at the receiving end. Where he obtained this information I do not know, but I will say that he is mistaken. The average amateur uses the "Reinartz" tuner or the three-circuit tuner—some use honeycombs, but as to the antique single circuit—! So far as Hartford is concerned I know of but ONE amateur using a single circuit tuner, out of about 35 others using either Reinartz or three-circuit tuners. In the vicinity of Hartford there are no single-circuits to my knowledge. The amateur is looking for utmost selectivity and not loud signals. That is to say—he is willing to sacrifice a little noise for selectivity.

Mr. Brackenridge states that the single-circuit can get stations that the three-circuit can not get. That being the case, why didn't Paul Godley take a single-circuit tuner over to England with him to get American amateurs? Had he done this I am afraid the tests would have turned out to be unsatisfactory.

It requires skill to operate a Reinartz tuner or a three-circuit tuner, but after the skill is acquired by practice the results will be much more satisfactory—not as loud as a single-circuit but more stations.

The novice likes the single-circuit tuner because it is simple in construction, but he never stops to think that all desirable tuners are not simple.

The manufacturer has his business reasons for favoring the single circuit. They are very cheaply constructed, little time being used in their assembly. The radio dealer can show us that it is "so simple a baby can tune it." A good tuner that is selective and highly efficient in every detail is NOT "so simple a baby can tune it." Quite the contrary—a good tuner is only good when in the hands of a practiced operator.

The radio dealer does NOT tell you that the single-circuit tuner sets up howls and squeals in every other receiver in the neighborhood. No matter how good a receiver may be, it is always subject to all the howls of the single circuit in the neighborhood. A Reinartz tuner does not do this, nor does the three-circuit or other types of good receivers.

Right below Mr. Brackenridge's letter is another one about receiving set interference written by Mr. Brigham. I believe that if all the single circuit tuners were eliminated from his neighborhood his trouble would be solved.

Another "squawk factory" is the Ultra-audion. This is worse than the single circuit.

About the best way to fix the receiving set QRM is to JUNK the single circuit.

FREDERIC L. STAFFORD
Hartford, Conn., Radio 1 BAG.

RIGHTO

Editor, RADIO NEWS:

I have noticed lately that a very extensive use is made, particularly among broadcast listeners, of the term "Code" to designate radio telegraphy. Would it not be a good idea to start a little campaign against this, and substitute "telegraphing," "telegraph

signals" or "telegraphy"? "Code" used in this connection is not correct, as very few ship or amateur stations transmit messages containing code, which means a method of arranging letters in words so as to make the message unreadable to persons for which it is not intended.

The word "Code," when used in the connection referred to, has become more of a term of impoliteness, to my notion; something similar to calling a colored person a "nigger," or an Englishman a "chirper."

H. S. GOWAN
Kitchener, Ontario.

CONCERNING THE PHANTOM CIRCUIT

Editor, RADIO NEWS:

In glancing through the July issue of RADIO NEWS, I note that you published in your "I-Want-To-Know" columns a circuit diagram of what purports to be the Phan-

tom circuit as used in the Oard Phantom Receptor.

The circuit, as shown in RADIO NEWS bears practically no similarity to the true Phantom Circuit, nor is the plate of the detector tube tuned as indicated in your diagram. We consider the marketing of this circuit as a direct "steal" upon the advertising of this concern and our agents, on the part of the concern advertising it as a "Phantom" circuit.

As would any concern that has expended considerable expense upon the development of a new type of receiver, and the advertising necessary to the marketing thereof, we feel justified in withholding the Phantom Circuit until such time as we may wish to place it upon the market in commercial form.

OARD RADIO LABORATORIES,
Stockton, Calif.

A CANADIAN'S OPINION

Editor, RADIO NEWS:

Am glad to see you are hammering single circuit and other sets that re-radiate easily, thus spoiling other listeners-in reception, particularly in congested districts. The novelty will hold a new beginner possibly through some of this, but in time he wants good reception; impossible, as now met within many localities.

If an exchange could be got up whereby these howlers were sent to the Country districts while old users got other circuits for City uses, it would be a good thing.

We are unable to get WJZ or WEAJ here as we used to. The change of location of station has apparently canned it here. A peculiar thing about Chicago is that we get Drake Hotel, Board of Trade and the new Hotel station, but do not get Westinghouse station and have never heard it in a year's use of Radio although they claim long distance. One of our best stations now is Buffalo, just about perfect transmission and a good varied program.

In announcers, the clap at the Capitol Theatre in New York carries off the ham; he has a way all his own and is the best we hear. Static so far has not been bad.

H. A. CROSBY
Hamilton, Canada.

ABOUT SINGLE CIRCUIT RECEIVERS

Editor, RADIO NEWS:

I should like to differ with Mr. Brackenridge in his letter which was published in the July issue of RADIO NEWS.

In the first place, I don't believe that broadcast listeners dislike the amateurs because they take a rap at single circuit tuners. Most people will admit that the majority of single circuit tuners are "the bunk" so far as selectivity goes. Of course you can make one that will be just as sharp as any double or triple circuit tuner, provided it is constructed right, but the rub is that very few of them are. We have to admit that so far as volume and DX reception go, the single circuit tuner takes the cake. It's only natural that inductively coupled tuners should have energy losses, but that does NOT mean that a good two-vario-meter coupler set such as the CR-3, has losses due to capacity and resistance. Since there are no condensers in such a set, the only capacity is that which is distributed throughout the coil windings, and if Mr. Brackenridge would take the trouble to measure this, I believe he would find that it is smaller than he thinks. It is doubtful if there is any capacity to speak of due to parallel wires. Also, the wire used offers

(Continued on page 458)

Perpetual Motion

YEARS ago when the editor was still in his teens he conceived the brilliant idea of hitching a motor to a dynamo so that the current developed from the dynamo would drive the electric motor.

In addition to all that, in order to make up the losses, he tried to foil nature in a number of other ways, but did the device work?

See the story of this interesting experiment in the October issue of PRACTICAL ELECTRICS. You will enjoy every bit of it.

Other interesting articles appearing in the October issue of PRACTICAL ELECTRICS are as follows:

Four-Way Switches. By O. E. Bricker.

Storage Battery for Demonstrations. By Francis G. LeMerle.

New York's Electric Map.

High Voltage Laboratory Battery.

By Harry R. Lubcke.

Thermic Telephones.

Living Electric Batteries. By Harry Van Demark.

tom Circuit, and which readers would assume to be the circuit used in the Phantom Receptor as manufactured by this company.

The circuit as published by RADIO NEWS under Question 704, is a circuit put out by the Vesco Radio Shop of Vacaville, California. It is as you state, an ordinary, single circuit, tuned plate receiver. This circuit was advertised by the Vesco company following the advertising matter of this concern and Atlantic Pacific Radio Supplies Co. of San Francisco, our agents. We have no doubts that many purchasers paid the Vesco people the sixty cents asked for the diagram, under the impression that they would receive a diagram of the circuit as used in the Oard Phantom Receptor.

The word "Phantom" is registered as a trade mark in the U. S. Patent Office by Oard Radio Laboratories. The use of the word as a trade name for a certain type of receiving instrument, was as far as known, original with us, and first used by us in an advertising campaign. Other concerns, as well as the Vesco people, have since advertised circuits under the name of "Phantom." None of the so-called "Phantom" circuits coming to our attention bear any relation



The Utility of Radio on the Great Lakes

By S. K. CULBERTSON



Two Great Lakes Vessels Caught in an Ice-Jam. When in Such a Predicament, the Radio Helps Much in Expediting the Movement of the Vessels, Keeping Them in Touch With the Agents From Whom Assistance Can Be Obtained If Necessary.

ONE hundred and thirty-eight ships plying the Great Lakes are now equipped with radio. It is a significant fact, that 15 years after the inauguration of Great Lakes radio, shippers and vessel owners of the bulk freighters are beginning to recognize the intrinsic value of this service and its application to their maritime needs. Its value is indisputable, not alone as a safety first adjunct, but as an all around sound business proposition.

The Master may proceed up-lake without definite orders; his ship may be diverted to some other lake, and the port of call canceled; the steamship management may reassign his cargo while enroute; and the vessel agent is kept in constant touch with the steamer and its movement. Then too, the timely arrival of tugs has, many times averted impending disaster.

This radio traffic expedites the movement of the vessel as no other known means of communication could. When running time is figured in hours, as it is on the Great Lakes, a few hours' delay may sometimes mean several days layover in a congested port where ships must

wait their turn at the docks. Just one such delay curtailed via radio will more than compensate maintenance costs for an entire season.

Radio also plays a major rôle when ice jams are prevalent at the head of the lakes during early spring navigation, and the big fellows are trying to break through. As late as May 16, of this year, immense ice packs extending from the Sault Ste. Marie (Michigan) Canal for many miles out into the open waters of Lake Superior, has offered an almost impenetrable barrier.

VESSELS FORCE PASSAGE THROUGH THE ICE

Forcing a passage through an unbroken ice field two to three feet thick, and wind-rows hummocks 15' or more in depth stretching across the horizon like long jagged embankments, is not accomplished without considerable hazard.

The larger vessels in ballast, generally pair off in couples; one taking the lead, proceeds until further progress becomes impossible. Then the second vessel which has followed in the wake, backs up for several hundred yards and with "full

ahead" crashes into the ice. Breaking loose the first vessel which has become wedged in, it proceeds as far as possible—often less than half a boat length. The released vessel then repeats the operation and kicks into the ice along-side.

If both vessels become stuck fast, a third and fourth may venture out of the rank and file of the fleet which is following in the wake, and an effort is made to break them loose. Should these also become fast or wedged in, each vessel's forepeak and forward ballast tanks are filled with water until the added weight breaks through the ice, but the slow process of pumping out again must be completed before the battle can be renewed. The prow of the ship must float high in order to climb upon the ice flows and escape injury to the steel plates.

ONLY LOW POWER CAN BE USED

The process of bucking ice soon settles down to a slow and tedious one bereft of romance, except for the radio man—he gets an ear full. Imagine 25 or 30 vessels equipped with radio clustered in a radius of less than one mile, each with several rush messages. All reports from the ice field are considered rush, by the operator, and he must use normal power to reach the nearest land station—Sault Ste. Marie, Ontario (VBB).

In the grilling, some vessel has broken her crank-shaft, another has lost her wheel and still another's rudder is missing! Such mishaps invariably occur when ships are not equipped with radio. However, first aid is always given and the unfortunate skipper's message of tribulation is relayed via megaphone to passing ships until it eventually reaches a vessel equipped with radio, when it is shot ashore.

As dusk settles over the fleet,—some seventy odd vessels—operations cease for the night, and soon the motley convoy is at a standstill. Completely ice-bound, they await the break of day, for under cover of darkness the hazards are greatly multiplied. As the shadows thicken, the light from a thousand Mazdas shimmer on the snow-clad ice, which glistens like a great white way, one, however, upon which few would care to venture for an evening stroll.

Atlantic Ferry Happenings

By J. E. DAVIES

THE number of vessels equipped with their own radio compass installations is becoming increasingly large, showing that this modern aid to navigation is not merely a paper success.

Operators on these vessels have had, and in some cases are still having, a hard fight to convince a certain "antique" type of Mariner that the radio compass is of real

use and has come to stay. The many very practical successes of the radio compass are, however, at last convincing the "shell-backs" that there is something in it.

It is a somewhat strange paradox that America, the nation which has so encouraged and so practically helped wireless direction finding does not appear to have done much with radio compass installations on ship-

board. On the other hand, Great Britain, which has few radio compass shore stations, has a large and growing percentage of vessels fitted by private enterprise with wireless direction finding apparatus. All classes of vessels are beginning to find the life and money saving value of what the British call "The D.F." (Direction Finder). These are

(Continued on page 446)



I Want to Know

THIS Department is conducted for the benefit of our Radio Experimenters. We shall be glad to answer here questions for the benefit of all, but we can publish only such matter as is of sufficient interest to all.

1. This Department cannot answer more than three questions for each correspondent.
2. Only one side of the sheet should be written upon; all matter should be typewritten or else written in ink. No attention paid to penciled matter.
3. Sketches, diagrams, etc., must be on separate sheets. This Department does not answer questions by mail free of charge.
4. Our Editors will be glad to answer any letter, at the rate of 25c for each question. If, however, questions entail considerable research work, intricate calculations, patent research, etc., a special charge will be made. Before we answer such questions, correspondents will be informed as to the price charge. You will do the Editor a personal favor if you will make your letter as brief as possible.

RECEIVER DESIGN

(757) Mr. Raymond Herr, Fort Madison, Iowa, asks:

Q. 1. In building a single-tube set, do you have to use both variocoupler and variometer?

A. 1. A variometer in conjunction with a variocoupler would make a good combination, but if a single-circuit receiver is desired, the variocoupler alone can be used.

Q. 2. If not, what one will be the best?

A. 2. The primary of the variocoupler should be used as the tuner, and the secondary placed in the plate circuit of the detector for regeneration. A variable condenser of .001 mfd. should be placed in series with the antenna for fine tuning.

Q. 3. What size and how much wire must be used to wind a variocoupler?

A. 3. The primary should be wound with about 64 turns of No. 22 S.C.C. wire, tapped every eight turns. The secondary should be wound with 50 turns of No. 24 S.C.C. wire. The primary should be 4" in diameter and the secondary 3".

TUBE QUERIES

(758) Mr. E. Hook, Fulding, Sask., wants to know:

Q. 1. Will two radio frequency transformers and one audio frequency transformer, taken from a Northern electric set, give good results with the UV-199, WD-11 and UV-201A tubes?

A. 1. These transformers will give good results with the tubes mentioned. The UV-201A tube, however, will not be very efficient when used in a radio frequency circuit, when a potentiometer is used as a stabilizer.

Q. 2. Is the UV-199 as good for radio amplification as the UV-201A?

A. 2. The UV-199 is much more efficient when used for radio frequency amplification.

ELECTROLYTIC BATTERY CHARGER

(759) Mr. Edwin Kelly, Marshall, Texas, writes:

Q. 1. How many electrolytic rectifier jars are necessary to rectify 110 volts, A.C. to charge a storage battery? Please show the hook-up.

A. 1. Four jars are usually used for this purpose. Hook-up will be found on these pages.

Q. 2. Could electric-lights be used to reduce 110 volts, so that a six-volt storage battery might be charged?

A. 2. Electric-lights are used in parallel on one side of the 110-volt line, to allow the right current to pass. This has also been shown on the diagram.

STORAGE BATTERY CONNECTIONS

(760) Mr. Rodney Ware, Jr., Wadsworth, Ohio, wants to know:

Q. 1. What is the best form of connector to use on a Gould storage "B" battery, for receiving?

A. 1. The best connection for any type of battery is a good, strong battery clip. This clip should not be made of copper, if good contact is to be had at all times.

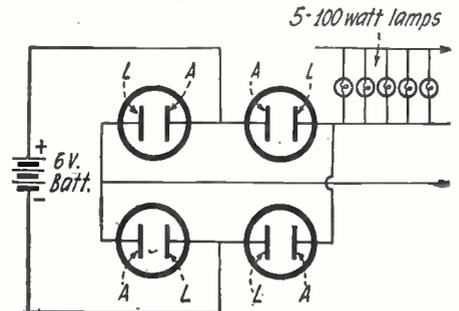

(Q. 759) The Circuit Used for an Electrolytic Battery Charger. An Electric Light of 100 Watts Is Placed in One Side of the Line for Every Ampere Desired. In This Case, the Battery Is Charged at Five Amperes.

Q. 2. How can the corrosion on a copper, nickel-plated clip, formed by fumes from a storage battery, be removed and good contact regained?

A. 2. This sulphate can be removed by removing the clips and connecting them to the output terminals of your battery charger, and inserting them in a bowl of salt-water. The current should be turned on for about five minutes, and the clips then taken out and wiped off with a rag. However, as stated above, copper clips should not be used for connections on a storage battery.

Q. 3. Please give formula for determining the natural wave-length of an ordinary antenna.

A. 3. The length of antenna and ground is multiplied by 1.33, which will give the approximate wave-length in meters. If the length of the antenna and ground is 130', then the wave-length is $130 \times 1.33 = 172.9$ meters.

"FLIVVER" RECEPTION

(761) Mr. R. J. Coupin, Cape Town, South Africa, asks:

Q. 1. What is the maximum distance telephony signals can be received, using the Radio Flivver described on page 1624 of the March issue of Radio News, using a loop or small antenna?

A. 1. This would depend a good deal upon local conditions and the skill of the operator. Under good conditions, a range of 500 miles might be expected when using a loop. This type of receiver will not function well when an antenna and ground are used.

Q. 2. What alterations are necessary for C.W. reception?

A. 2. None. C.W. signals can be received without any alterations.

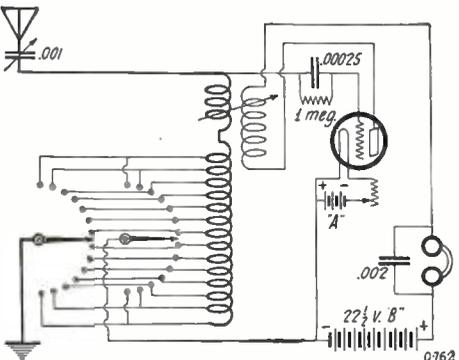

Here Is the Circuit Used in Pattern No. 1. Issued by the Consolidated Radio Call Book Co. Two Switches Are Used on the Primary of the Variocoupler, Which Gives the Selective Tuning Obtained by a Two-Slide Tuning Coil.

Q. 3. Using a multi-range coupler, does this set operate efficiently on long wave-lengths?

A. 3. A multi-range coupler is not recommended, as the "Super" does not operate efficiently above 600 meters.

SINGLE-CIRCUIT RECEIVER

(762) Mr. Roger S. Walcott, Providence, R. I., requests:

Q. 1. Please publish the hook-up of the short-wave regenerative receiver, as per plan No. 1, published by the Consolidated Radio Call Book Company.

A. 1. This circuit will be found in these columns.

QUESTIONS ON AERIOLA SR.

(763) Mr. Ivan H. Loucks, Ulysses, Pa., wants to know:

Q. 1. What is the circuit of the Aeriola Sr. Receiver?

A. 1. This circuit was published in answer to Q. 636, in the April issue of RADIO NEWS. Full information is given.

Q. 2. How can this be used to transmit phone or C.W., for short distances?

A. 2. A key or microphone can be inserted in the ground-lead for short-distance transmission. As large a plate voltage as possible should be used.

Q. 3. How can it be used with a crystal detector for one stage of radio frequency?

A. 3. A crystal detector cannot be used with this circuit. If radio frequency is desired with a crystal detector, the entire hook-up must be changed.

AUDIO FREQUENCY WITH "FLEWELLING"

(764) Mr. Geo. B. Filbert, Elizabeth, N. J., requests:

Q. 1. Please publish a diagram giving all values and showing the proper manner in which

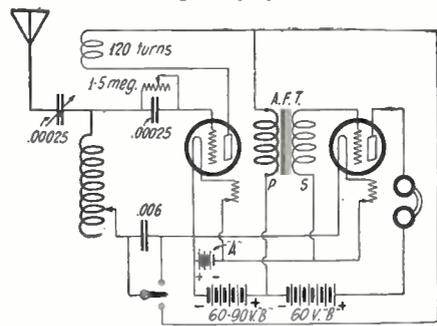

One Stage of Audio Frequency Amplification Can Be Added to the Simplified Flewelling Circuit in the Usual Manner.

to add audio amplification to the latest "Flewelling" circuit, printed under Q. 728 in the August issue.

A. 1. This circuit appears herewith. An audio frequency transformer, with a ratio of five to one, can be used.

Q. 2. Will one stage of audio amplification be sufficient to operate a loud-speaker on local stations, with an indoor antenna?

A. 2. One stage will prove sufficient to operate a loud-speaker with this circuit, for local stations.

R. F. TRANSFORMERS FOR REFLEX

(765) Mr. Donald McCammon, Lebanon, Ky., wants to know:

Q. 1. Are special radio frequency transformers necessary in a reflex?

A. 1. Certain radio frequency transformers work better than others in this type of circuit. It is usually necessary to experiment with different transformers to find the one best suited for the particular circuit used.

Q. 2. Does a vacuum tube or crystal work better in a reflex set?

A. 2. The vacuum tube will give louder signals, but the crystal is a better rectifier and will give clearer speech.

TUNGAR BATTERY CHARGER

(766) Mr. Geo. Allen, Chicago, Ill., wants to know:

Q. 1. Is it possible to charge a battery with a Tungar bulb without using a transformer? Please show the correct hook-up.

A. 1. This circuit appears in these columns. Some method must be used to control the current-flow through the tube. In this case, a bank of lamps is used. To use this rectifier, the double-pole switch shown as "X" is closed. The single-pole switch is now closed at "B" and the filament is lighted by the battery. The single-pole switch is now thrown over to "A", which connects both ends of the filament together and insures an even temperature. The filament will be kept lighted by the charging current.

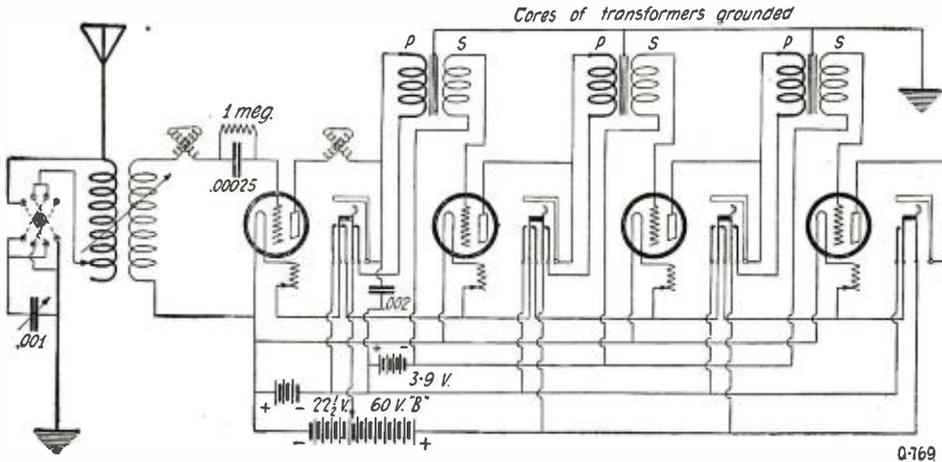

A Standard Three Circuit Receiver With Three Stages of A.F. Amplification. The Cores of the Transformers Are Grounded, to Eliminate Capacity Effects Between Them.

MISCELLANEOUS QUERIES

767) Mr. Alden S. Martin, Lisbon, N. H., writes:

Q. 1. In assembling a three-circuit tuner employing a variocoupler and two variometers, is it better to install the coupler between the variometers, or would regeneration be better if the latter were placed side by side?

A. 1. The usual arrangement is to place the coupler between the variometers. The coupler may be placed before them, if the variometers are separated by about 6". It is not a good plan to have the variometers in inductive relation to each other.

Q. 2. In dealing with commercial electricity, it is a well-known fact that transformers cannot be used on direct current. How is it, then, that they operate successfully on rectified current after it has passed through the detector tube?

A. 2. Pure, or nearly pure, direct current will not work on a transformer. The current delivered by the detector tube, however, is not pure D.C.; it is, rather, a pulsating or interrupted direct current. Take the spark coil, for an example. Current from a battery is usually employed for its operation. This is a pure D.C., but it is broken up, or interrupted, by a vibrator. This interrupted current acts on a transformer the same as an alternating current. We would suggest that you obtain some standard text-book on radio, where this is fully explained.

Q. 3. In winding three spiderwebs, of 35, 50 and 75 turns, which is the primary, secondary and tickler?

A. 3. If an aerial of about 125' is employed, they can be used exactly as shown for primary, secondary and tickler, respectively. It would, however, be best to try different combinations for different wave-lengths.

SUPER-HETERODYNE

(768) Mr. David E. Hasting, Mt. Vernon, Ind., asks:

Q. 1. If honeycomb coils were substituted for the variocoupler in the Super-Heterodyne circuit published on page 24 of the July issue of RADIO NEWS, would the set respond to all wave-lengths?

A. 1. This circuit would respond to all wave-lengths, but the super-heterodyne effect would be lost as the wave-length approached the natural wave-length of the transformers, which, in this case, is about 5,000 meters. On wave-lengths above this, the results would be inefficient.

Q. 2. What capacity is condenser No. 6?

A. 2. The capacity of this condenser is .001 mfd.

Q. 3. What kind of tubes are used as oscillator and detector?

A. 3. All of the tubes in this circuit are hard, or amplifying tubes.

THREE-CIRCUIT RECEIVER

(769) Mr. Edwin Cummins, De Soto, Mo., requests:

Q. 1. Please publish a hook-up of a two-variometer, variocoupler regenerative set, with a series-parallel switch, with three stages of A.F. amplification. Filament-control jacks are to be used.

A. 1. This circuit will be found in these columns.

FOUR-CIRCUIT TUNER

(770) Mr. H. L. Nillson, New York City, desires:

Q. 1. Please publish a diagram of the Cockaday four-circuit tuner, showing the number of turns on the different coils.

A. 1. This circuit will be found in these columns. "B" and "C" are both wound on the same tube, separated about 1/8". "A" is one turn of tinned bus-bar wire, wound over "B". "D" is double bank-wound and is mounted in non-inductive relation to "B" and "C".

VOLUME ON TWO-STAGE

(771) Mr. C. H. Mohr, Baltimore, Md., inquires:

Q. 1. Will the Atwater-Kent two-stage amplifier, in conjunction with an efficient receiver, give enough volume to operate a loud-speaker?

A. 1. This combination should operate a loud-speaker, if handled correctly.

NECESSARY WAVE-LENGTH

(772) Mr. A. T. Jester, Houston, Tex., asks:

Q. 1. Will you kindly explain what change in wiring of rotor and stator of the Aeriola Sr. is necessary to receive the broadcasting stations above 500 meters?

A. 1. If this receiver is used with an antenna of average length, there should be no trouble in tuning to 600 meters. The wave-length can be increased by connecting a variable condenser of 17 or 23 plates across the main tuning variometer.

CHANGE OF CIRCUIT

(773) Mr. Carlton C. Alder, Holliday, Utah, wants to know:

Q. 1. Can a Westinghouse R.C. single-circuit set be converted into a standard three-circuit receiver?

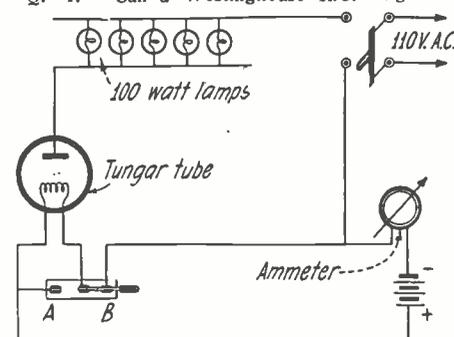

A 6-Volt Storage Battery Can Be Charged By Using a Tungar Bulb Alone. All Details Are Explained in the Text.

Q. 1. The R.C. set cannot be converted into a three-circuit receiver. The R.C. set uses a variometer as the tuning inductance instead of a variocoupler, as is necessary.

THE WD-11 AGAIN

(774) Mr. Rufino Ramerey, San Juan, P. R., asks:

Q. 1. Is the WD-11 tube good for DX work, and can it be used in a reflex circuit?

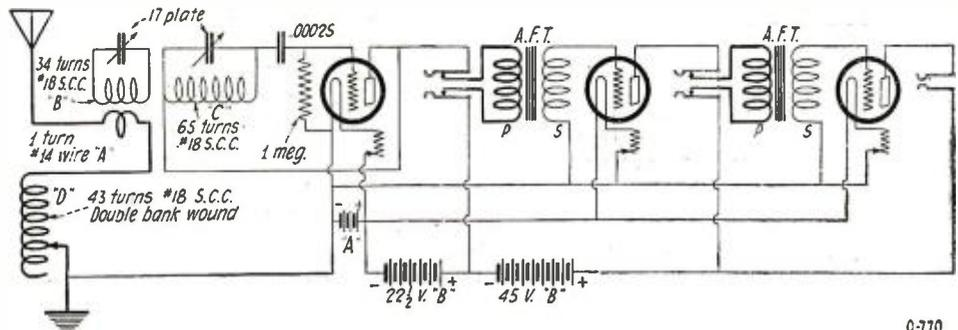

Very Selective and Efficient Results Are Obtained With the Four-Circuit Receiver. Two Stages of A.F. Amplification Are Used With This Circuit.

A. 1. This tube has proved very good as a detector and will also give good results in a reflex circuit.

Q. 2. What audio frequency transformer ratio should be used?

A. 2. In a reflex, the transformers should have a ratio of three to one.

Q. 3. Is it proper to connect a variometer between the plate and the primary of the radio frequency transformer?

A. 3. No. If regeneration is desired by means of a variometer, it should be inserted in the plate-circuit of the detector tube. This will not, however, give good results if radio frequency is used.

NEUTRODYNE TRANSFORMERS

(775) Mr. D. Miller, San Leandro, Calif., requests:

Q. 1. Please publish sufficient information to make Neutrodyne transformers; method of attaching to condensers and capacity of condensers.

A. 1. These transformers are made by winding 55 turns of No. 24 S.C.C. wire on a 3" tube. This constitutes the secondary. The primary consists of 13 turns the same size wire, wound on a tube small enough to fit closely inside of the secondary. The variable condensers have a capacity of .0005 mfd. and are connected across the secondary of the transformers.

MISCELLANEOUS QUERIES

(776) Mr. Leland E. Hildreth, 117 Main St., Phelps, N. Y., asks:

Q. 1. Will a two-slide tuning coil give better results than a variocoupler for tuning?

A. 1. A variocoupler will give much sharper tuning and better all-around results than a two-slide tuner.

Q. 2. What size wire should be used in connecting up the various parts of a radio receiving set?

A. 2. The filament circuit may be connected with No. 12 or 14 rubber covered wire, and the rest of the connections made with standard bus-bar wire.

Q. 3. Should WD-11 tubes be mounted upright or in a horizontal position?

A. 3. They should be mounted in an upright position.

Q. 4. Is it injurious to a vacuum tube to jar it?

A. 4. If a vacuum tube is jarred severely, there is a possibility of the elements coming in contact with each other and the tube being rendered inoperative. The filament might also be broken under such conditions. Slight jars, however, will not affect them to any extent.

ELIMINATING THE TICKLER COIL

(777) Mr. Francis Gum, 315 West Vine St., Stockton, Calif., writes:

Q. 1. What is meant by short-circuiting the tickler coil of a honeycomb set?

A. 1. To short-circuit the tickler coil of a radio receiving set you merely connect a piece of wire, or copper strip, as desired, across the terminals of the tickler coil. The effect in such an action is to change a regenerative circuit into a straight detection circuit.

Q. 2. Are three variable condensers any better in a honeycomb coil receiving set than two?

A. 2. In a three-coil honeycomb set a third variable condenser, shunted across the tickler coil, is advantageous and gives sharper tuning than would otherwise be obtained.

THE FUTURE OF RADIO

(778) Mr. W. M. Fuller, 2437 Clifton Ave., Cincinnati, O., asks:

Q. 1. What is your viewpoint concerning the future of radio, particularly to the public?

A. 1. No doubt radio telephony holds a future for all those connected with it. The time will come when practically every home in the country will be equipped with a radio receiving set, and this indoor sport will become as popular as the movies and theatre are today. Great strides will no doubt be made in the simplification of both transmitting and receiving apparatus, so that the average home instrument will be controlled by

(Continued on page 482)

USE Gilfillan Radio Parts

Highest in Quality — Economical in Price

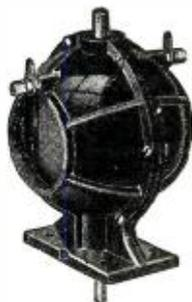

VARIOMETER
Embodying the highest electrical efficiency. Moulded brown bakelite split bronze bearings. Obtainable in two sizes.

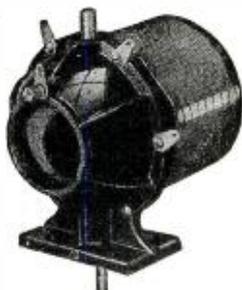

VARIOCOUPLER
The finest that can be produced. Moulded brown bakelite, split bronze bearings; winding tapped at 15 points for very close tuning. Obtainable in two sizes.



POTENTIOMETER
Moulded of best brown bakelite. Resistance unit machine wound with highest grade resistance wire. Provided with solder lugs for attaching wires.

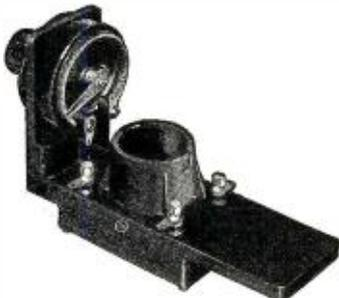

DETECTOR UNIT
Combining tube socket, filament rheostat, grid and phone condensers, binding posts, solder lugs, knob and dial. The most compact unit made.

Ask your dealer to show you Gilfillan Radio Parts. A few are illustrated on this page. Note their superior workmanship and finish; the precision construction—scientifically correct, which assures absolute accuracy and dependability of operation.

Gilfillan Radio Parts, built in accordance with best professional standards, are not expensive; even when their cost is compared with devices of inferior merit.

All Gilfillan Radio Parts are made in our own factory by a highly skilled organization long noted for the manufacture of high quality automotive ignition parts.

Select "Gilfillan" for best performance. If your dealer does not handle this superior line write us for name of nearest dealer, descriptive folder and price list.

DEALERS: Gilfillan Radio Parts offer you a splendid merchandising opportunity. Write for detailed information, or inquire through your jobber.

GILFILLAN BROS., INC.

1925 McGee St.,
Kansas City, Mo.

1815 W. 16th St.,
Los Angeles, Cal.

225 W. 57th St.,
New York, N. Y.

Genuine Gilfillan Radio Parts can always be identified by this trade-mark. Look for it.

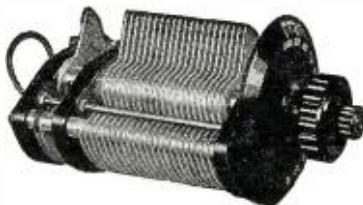

CONDENSER
With Vernier and pigtail connection. Obtainable in 43 plate, 23 above, and 23 plate sizes.

Gilfillan Radio Parts are not sold for use on patented circuits.

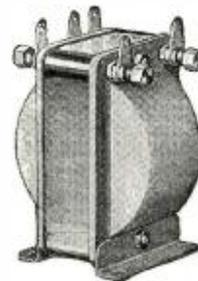

AUDIO FREQUENCY TRANSFORMER
Exceptionally well made and dependable. Completely shielded in aluminum case.



PRIMARY INDUCTANCE SWITCH
15 point. Provided with solder lugs. Moulded brown bakelite; black knob and dial.



TUBE SOCKETS
R. 300 takes any standard amplifier or detector tube. Phosphor bronze positive contact springs. Terminals marked; with binding posts and solder lugs.
R. 925—Adapter for 199 tube. fits any standard type socket.
R. 500—Small tube socket to take 199 tube.

FRESHMAN RESISTANCE LEAKS

The largest and most Complete line in the World

Our new construction of all types Variable Resistance Leaks produces a product which we can now guarantee as being scientifically correct, mechanically perfect and built for unusual durability.



Every tube and every circuit requires a different leak resistance. You do not know what value is necessary until your circuit is tested. Freshman Variable Resistance Leaks give an unbroken range of 180 degrees from zero to five megohms.

Base Mounting Type with either .00025 or .0005 Freshman Condenser **\$1.00**
Without Condenser 75c.



PANEL MOUNTING

FRESHMAN VARIABLE RESISTANCE LEAKS

will enable you to get stations you have never heard before. Can be mounted on any panel in a few seconds. The latest and most essential part of an efficient tube set.

With either .00025 or .0005 Freshman Condenser **\$1.00**
Without Condenser 75c.



FRESHMAN "FIX-O"

FIXED RESISTANCE LEAK COMBINATION IN ONE

Freshman Condenser .00025 Leak Mounting Freshman Resistance Leak Safe-T Handle } **Price Complete 65c.**



FRESHMAN FIXED

RESISTANCE LEAK with SAFE-T handle

The only Resistance Leak using no carbon, graphite or lamp black. Guaranteed to remain permanently constant.

Furnished in any value of Resistance from 1/4 Megohm up..... **30c.**



FRESHMAN NOISLESS

TESTED MICA CONDENSER and LEAK MOUNTING

The Freshman Condenser is so designed that constant equal pressure is exerted over the entire area of the condenser plates and the mounting is part of the condenser itself, which makes this new product the only True and Perfect Leak Mounting on the market.

Combination Condenser .00025 and Leak Mounting.. **40c**

At your dealers'—otherwise send purchase price and you will be supplied without further charge.

Also ask your dealer for our free diagrams of the Neutrodyne, Kaufman, and Flewelling Circuits.

Chas. Freshman Co. Inc.
Radio Condenser Products

106 SEVENTH AVE. NEW YORK

The Radio Amateur in a New Field

(Continued from page 374)

as an impostor by Mr. Small, who has surprised the lovers.

Jack, driven to desperation, declares that regardless of what they think of him, the success of the invention is assured, and he'll prove it to them that night.

Mr. Small, determined to make the experiment more difficult goes to the workshop to cut the main aerial lead which he knows will cripple the transmitter, and by mistake cuts one of the high tension lines. When the test is made that evening, with Ann and Augustus in the cabin, and Jack and the rest of the party at the other end, the cabin is electrified by the high voltage of the tension wire, and Jack is forced to admit the thing a failure. He is threatened with the penitentiary by Mr. Bevan for perpetrating a hoax, but Mr. Small assumes all responsibility and craftily offers to buy Mr. Bevan's share in the invention. The deal is closed when the first radio power transmitter begins to operate at Jack's end of the line, augmented by the tremendous voltage of the power line. Jack telephones to the cabin and is told by Ann that Augustus is unconscious from an electric spark, that the cabin is electrified and that they are unable to get out.

Mr. Small confesses that he cut the wire to make the experiment more difficult and so that Mr. Bevan would not get away with the best proposition of the year. Jack denounces him and rushes to the aid of Ann and Augustus in the cabin followed by the rest of the party. Jack, after a hair-raising climb to the steel tower of the power line, leaps in the air and, catching hold of the wire, cuts it and is dropped to the ground; his fall is broken by the branches of a tree. He then rescues both Ann and Augustus from the flaming cabin.

Waiting only to see that Ann and Augustus were safe, he calls Buddy, and starts up the road. Ann follows him and a reconciliation follows, accompanied by many explanations.

THE END.

Radio Frequency Amplification

(Continued from page 397)

secondary and are then applied to the grid of the detector tube and rectified. The transformers used for radio frequency amplification must be air core transformers generally and are best purchased on the open market as it is quite a difficult task to make a good one. An interesting feature about radio frequency transformer amplifiers is that, like the tuned circuit amplifier described above, they amplify most on a certain wave-length or in a certain narrow band of wave-lengths. Thus, experimental measurements on these transformers show that they amplify somewhat as shown in Fig. 5. The reason for this is that these transformers behave very much like tuned circuits, due to the fact that they have distributed capacity and this distributed capacity tunes the transformer to a certain wave-length. At these wave-lengths, therefore, the amplifier has very high amplification. This will explain to those who have wondered about it, why it is that some manufacturers state that their radio frequency amplifying transformers have a range of say 250 to 400 meters, with maximum at 360 meters. This simply means that the transformer will give good amplification between 250 meters and 400 meters, but the

Hear them all, all the time



Don't miss a program Charge your A and B Batteries at home with a Valley Battery Charger

Simple:

Plugs in on a light socket just like a lamp. Clamps to battery terminals.

Safe:

Cannot overcharge your battery. Ammeter immediately indicates incorrect connections.

Quick:

Will charge the ordinary radio battery from bedtime one night to listening-in time the next.

At radio dealers—or write us.

Valley Electric Co.
St. Louis, Mo.

WOI WMC WDAP KDYX PWX

\$3 Makes your PHONOGRAPH the best loud speaker



Unscrew Head Phone Cap and Replace with Huguenot. Sizes to fit all Standard Head Phones

Fits All Standard Phonograph Tone Arms. For Special Makes Use Bushing Extra 50 Cents

HUGUENOT RADIO PHONOGRAPH ATTACHMENT

No Metal Parts to Bend or Vibrate No Leaks or Loose Connections. Quickly and Easily Attached Made of Black Polished Hard Rubber Double Phone Attachment.....\$3.00 Single Phone Attachment.....\$1.00

Mail orders filled promptly on receipt of remittance. Specify make of phonograph and head-phones.

MCKENZIE ENGINEERING COMPANY
NEW ROCHELLE, N. Y.

Dealers—Order from Your Usual Jobber Special discounts to the trade. AMPLIFY WITH YOUR PHONOGRAPH

SEE OUR GUARANTEE

REDUCED PRICES ON STANDARD QUALITY PARTS

SERVICE AND QUALITY BUILT THIS HOUSE

WE PAY TRANSPORTATION CHARGES IN THE UNITED STATES ONLY



Genuine Frost, Baldwin and Brandes head sets complete with cords. Frost A162—Double head sets, 2000 ohm\$4.25

MADERA CLEAR SPEAKER

Natural tone from radio made possible by a new process. Die cast wood horns. Now you can have REAL SPEECH—and REAL MUSIC without any distortion.



A700 Madera clear speaker\$12.55 A170—Radio Magnavox\$29.50

MAGNAVOX

JACKS AND PLUGS

Jacks are polished nickel, nickel-silver springs, pure silver contacts. Nickel washers for mounting on any panel 1-8 to 3-8 inch thick.

VARIABLE GRID LEAK

Penicil mark type. Removable black enameled cap. A50—Grid leak18c.

GRID AND PHONE CONDENSERS

Mounting Holes spaced to fit screws of above Grid Leak. Mica insulation, wrapped with varnished cambric tape. Capacity, .00025 Mfd.

FRESHMAN MICON TESTED MICA CONDENSERS

A62—.00025 mfd. Condenser.....\$0.29 A63—.0005 mfd. Condenser......29 A64—.001 mfd. Condenser......33

FRESHMAN VARIABLE GRID LEAK AND GRID CONDENSER

For unbroken range—zero to 5 megohms, clarified signals, lowers filament current, increases battery life, eliminates hissing.

CRYSTAL DETECTOR

A very high grade glass enclosed crystal detector including the crystal. All metal parts nickel plated.

TESTED CRYSTALS

Selected and tested galena or silicon. Each box contains enough for four to six ordinary crystals.

LIGHTNING ARRESTER OR PROTECTOR

Mounts indoors. Porcelain base, nicked cover. Listed by the Underwriters' Laboratories under April, 1922, regulations.

OUR GUARANTEE YOUR PROTECTION

Your satisfaction guaranteed. If for any reason you do not feel satisfied with your purchase, you may return it and we will refund your money. We will pay return transportation charges.

180° VARIOCOUPLER

The primary and secondary windings of this coupler are properly proportioned and spaced. The center of the secondary is always in the center of the primary field.

180° MOULDED ROTOR TYPE COUPLER

This 180 degree variocoupler has heavy black tube and moulded rotor ball. Wound with green silk wire and has 10 taps on the primary.

VARIABLE CONDENSERS

Condensers are made of heavy aluminum plates, evenly spaced with high grade bakelite ends.

VERNIER VARIABLE CONDENSERS

For fine tuning, neat appearance, this condenser is just the thing. Made of heavy aluminum plates and high grade bakelite ends.

INDUCTANCE COIL MOUNTINGS

For base or panel mounting. Connecting leads furnished, coil settings are adjustable by means of knobs.

INDUCTANCE COILS

Tightly wound, nicely finished, low distributed capacity. All coils are equipped with standard mountings.

ANTENNA WIRE

The following are 100-ft. coils of 7 strand cable of No. 22 wire, which makes the best Aerial.

INSULATORS

These are very strong strain type insulators. Each Doz. type insulators shown.

VARIOMETERS

For efficiency, perfect inductive ratio, low capacity effect and neatness of design these variometers are unexcelled.

MOULDED TYPE VARIOMETERS

This variometer is made of high grade black moulded composition. Wound with green silk wire. Metal parts are nickel plated.

ERLA RADIO FREQUENCY TRANSFORMER

ERLA REFLEX TRANSFORMER

AUDIO FREQUENCY AMPLIFYING TRANSFORMERS

Correctly designed for minimum distributed capacity and low core loss. Shielded, beautifully finished in nickel and black enamel.

THORDARSON AUDIO FREQUENCY AMPLIFYING TRANSFORMERS

There is probably no better known transformer. Made by a company that specializes in transformers.

BURGESS "B" BATTERIES

Standard high grade radio "B" batteries. Never over five days old.

INDUCTANCE SWITCH

For neat appearance and time saving, we suggest this inductance switch, as it needs but one hole in the panel to be mounted.

BINDING POSTS

Complete with screw and washer. All brass finished in polished nickel or with black composition top as listed.

SPAGHETTI AND WIRE

Yellow finish spaghetti. A33—Per 4-ft. length.....27c A32—Tinned Copper No. 16 Wire.....2c

SWITCH POINTS AND STOPS

Brass, polished nickel finish. Screw size, 6/32x3/8 ins. long, two nuts with each contact point and one with stops.

HOW TO ORDER

Order from this page. Please give number, description and price of the articles you order to help us avoid mistakes.

VACUUM TUBES

Genuine Cunningham or Radiotron made by the General Electric Co. Every tube guaranteed new and in original package.

METAL AND BAKELITE SOCKETS

Bakelite brown finished socket for base mounting. Double spring contacts held rigidly in place.

WD11 BAKELITE SOCKET

This socket is to be used with the above tube. A1077—Bakelite socket.....\$0.49

VACUUM TUBE RHEOSTATS

This is a reasonably priced, smooth acting rheostat that will mount directly on back of panel, Bakelite argon knob.

HOWARD POTENTIOMETER

DIALS

Genuine Bakelite Dial as pictured. Sharply engraved divisions and figures filled with a brilliant white. Set screws included.

CABINETS

Fine finished cabinets with hinged top, sturdily built. These make a wonderful appearance. These cabinets are made to fit panels listed below.

PANELS

Genuine Formica Panels, to fit our cabinets. A267—6x7 1/2\$0.85 A269—7x9 3/480

MAGNET WIRE

Quality magnet wire. We carry three types in stock. Each spool is 8 oz. Double cotton covered Green silk Enameled

SWITCH LEVERS

A high grade, polished nickel-plated lever with solid moulded black composition knob. Complete with panel bushing.

ATWATER KENT

RECEIVING SETS
AND PARTS



2-stage Amplifier

If you are now working with a one-tube set, the 2-stage amplifier shown here will give you the necessary volume of sound to make a loud speaker possible.

It is a compact unit—transformers are sealed in the base so that no dampness can affect the working quality of the instrument.

To demonstrate the damp-proof qualities, one of these instruments was soaked in a tub of water for several hours, then put into a circuit and tested for reception with perfect results.

Send for an illustrated folder showing all parts and complete sets.

ATWATER KENT MFG. CO.
4943 Stenton Ave., Philadelphia

maximum amplification is secured at 360 meters because the transformer tunes to this wave-length with its distributed capacity.

CONTROLLING OSCILLATION

In using radio frequency amplification there is one great difficulty which may account for the fact that people keep away from it, namely, the amplifier has a tendency to oscillate, and thereby creates all sorts of noises and howls. In the last article of this series on the subject of "Detection," (see September issue of RADIO NEWS), the method of heterodyne reception was taken up and it was explained how oscillations were generated by a tube. Any regenerative circuit will oscillate, if the coupling to the grid from the plate is made large enough. Now in all radio frequency amplifiers there is generally a very strong coupling which exists because the plate circuit is tuned, or because the transformers form tuned circuits, as explained in the foregoing paragraph. Added to this we have the fact that there is always some internal coupling in the tube itself; this exists in every tube. But in radio frequency amplifiers, this coupling is increased by virtue of the tuned plate circuits or plate transformers. This is why tubes having small internal capacity are best for radio frequency amplification. Hence there is always present a tendency to howl or oscillate, and this howling kills reception. In order to avoid this, an arrangement such as that shown in Fig. 8 should be used across the filament battery, namely a potentiometer, with the terminal from the plate battery coming to the variable post on the potentiometer. This potentiometer is called a "stabilizer" and has the effect of stabilizing the amplifier tube and preventing it from howling or oscillating. This in effect alters the effective voltage on the plate and grid of the tube and a position is easily found in which the tube will be stable and not oscillate.

The radio frequency amplifier has a very great advantage over the audio frequency amplifier which will be readily understood by this explanation, although the subject of audio frequency amplification has not yet been taken up. There are certain irregularities in the operation of the filaments of all tubes and batteries which result in all kinds of scratchy noises being heard in the phones. The reader knows that when he scrapes a lead in his detector set against a binding point, or if there is a loose connection, he hears such noises in the phones. Well, variations in battery performance and filament operation result in the same noises which are very objectionable. These variations have an audio frequency rate, since they make themselves heard in the phones. If they take place in an audio frequency amplifier they will be amplified just the same as an audio frequency signal, and as a result very loud interfering noises will be heard in the phones or loud speaker, so loud that they may make the signals unintelligible. In the radio frequency amplifier this does not happen, because only radio frequency signals are amplified and not audio frequency signals, hence even though these irregularities be present they will not be amplified by the radio frequency tube and will, therefore, cause no disturbance or interference. This is a tremendous advantage which the amateur will realize better after he has done some work with radio frequency and audio frequency amplifiers.

MULTI-TUBE AMPLIFIERS AND LOOP AERIALS

In the foregoing we have represented only a single tube as amplifier. It is possible to use many more tubes, one after the other, as shown in Fig. 9, in what is called a "multi-stage" amplifier. The circuits for the succeeding tubes are identical with those used for the first tube. By using two or more tubes the amplification may be made very

Radio Frequency Filter

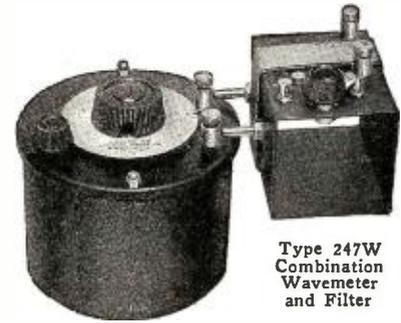

Type 247W
Combination
Wavemeter
and Filter

Have you a Broadcasting station you would like to eliminate? You can do it with our Type 247W Combination Wavemeter and Filter.

This combination, consisting of our Type 247 low loss condenser and a special coil, will enable you to cut out objectionable Broadcasting and similar annoyances. The wave-length scale is read directly on the condenser dial. Range 150 to 500 meters. Simple and efficient.

Price \$10.00

Send for Bulletin 916N

GENERAL RADIO COMPANY

Manufacturers of
Radio and Electrical Laboratory Apparatus
CAMBRIDGE MASSACHUSETTS
5642



THE B-T UNIVERSAL VERNIER TUNER

is 1st—The best Reinartz Tuner available.

2nd—Will give better control and maximum results on any single circuit Regenerative, any of the Ultra-Audion or practically any of the Reflex circuits, including Hazletine.

It's the biggest new thing in Radio. Photo diagrams of various circuits make assembly easy. Endless combinations are possible. No more ideal part for the experimenter is made.

See your dealer first. If he does not yet carry it, send his name and address and \$5.00.

Bremer-Tully Mfg. Co.
Canal and Harrison Sts., Chicago, Ill.

Forget your battery troubles

The complete line of Exide Radio Batteries meets every requirement in radio receiving

YOUR success in radio receiving depends largely on the quality of your batteries. And you are sure of satisfactory battery performance when you use Exides. A specially designed Exide Battery is now available for every type of vacuum tube.

Whether you want a long-life storage battery for six-volt tubes, an A battery for low-voltage tubes, or a B battery, you can take your choice of Exide Radio Batteries and be sure of getting the right batteries for your set.

For low-voltage tubes

The two newcomers in the Exide radio family are two- and four-volt A batteries for tubes consuming .25 amps. at 1.1 to 1.5 volts and those using .06 amps. at 3.0 to 3.5 volts. These sturdy little batteries were specially designed to meet the requirements of WD-11 and UV-199 vacuum tubes. Weighing less than 6 lbs. each, they are midgets in size, but giants in power.

Exide Radio Batteries give steady, dependable current with only occasional recharging. They

make it possible for you to reproduce broadcast selections in clear, bell-like tones. When your set is hooked up with an Exide, you have ample power for maximum signal strength at all times. You can tune in distant stations with the most satisfactory results.

In service over a generation

For more than a generation the famous Exide Storage Battery has helped to turn the wheels of industry. Long before radio broadcasting achieved its present popularity, the Exide proved its worth in commercial and marine wireless. It is used today in a majority of all government and commercial wireless stations. When the American public found in radio a new form of entertainment, the Exide became by reason of superiority the leading radio battery.

You can get Exide Batteries from a nearby radio dealer or Exide Service Station.

Ask the dealer for booklets describing in detail the complete line of Exide Radio Batteries, or write direct to us.



For six-volt tubes

Like all Exide Storage Batteries, the Exide A Battery for six-volt tubes is dependable and long-lasting. It is made in four sizes, of 25, 50, 100, and 150 ampere hour capacities.



Two- and four-volt A Batteries

The new Exide A Batteries consist of one and two cells, respectively, with rated capacities of 12 and 24 ampere hours. The two-volt A Battery will heat the filament for 96 hours; the four-volt A Battery for 200 hours.



Exide B Batteries

give noiseless, full-powered service over a long period of discharge. Designed throughout to prevent electrical leakage. Capacity, 3 ampere hours.

Exide

RADIO BATTERIES

THE ELECTRIC STORAGE BATTERY COMPANY, PHILADELPHIA
Service Stations Everywhere
Branches in Seventeen Cities



NOW
IS THE TIME TO BUY A
World
Storage Battery

**BE SURE TO READ BELOW
SPECIAL OFFER
LIMITED TO
RADIO NEWS READERS ONLY**

**We Save You
50%
and you get a
WRITTEN 2YR.
GUARANTEE**

"WORLDS OF PERFORMANCE"
We maintain the same high quality material and workmanship found on the most expensive batteries and still are able to allow our remarkably low sale price by greatly reducing our overhead and sale costs.

Thousands of users enjoy the dependable qualities of our battery. World battery owners "tell their friends." This is our best proof of performance.

COMPARE THESE PRICES
SPECIAL 2 VOLT STORAGE BATTERY for W. D. 11 \$5.00 W. D. 12

Will Run 200 Hours on One Charge Rechargeable

6-Volt 60 Amps.....	\$10.00
6-Volt 80 Amps.....	12.50
6-Volt 100 Amps.....	14.50
6-Volt 120 Amps.....	16.00

SEND NO MONEY

We ship C. O. D. subject to inspection. Or, if you prefer, send money order, check, etc. and take 5% discount. Shipment made same day order is received. Save 50% on your next battery and get better service and longer life. Our written 2-year guarantee is your proof of satisfaction. Order today—Now.

**WORLD BATTERY CO.
DEPT. 10
1219 So. Wabash Ave. Chicago Ill.**

Just clip this ad, mail in with order, and we will include one Ever-ready "B" Battery, free of charge. Accept this liberal offer now before it is withdrawn.



great. It is not advisable, however, to go beyond two or at most three stages of amplification, as other difficulties may arise. For all practical purposes it will be found that two tubes are quite sufficient as radio frequency amplifiers and that very large distances can be covered with them.

The reader should make a note of this very important point as regards radio frequency amplification; it will not work well when used to amplify strong signals. Its object is to amplify very weak signals so as to improve detection. Therefore, never use radio frequency amplification for nearby stations unless you are using a loop for an antenna. Incidentally it might be mentioned that radio frequency amplification permits the use of loops, hence it is an advantage where aerials are not possible, or where landlords do not permit the erection of antennae.

After the incoming signal has been amplified by radio frequency tubes, as described above, the amplified radio frequency signal is passed to a detector tube and rectified. The rectified signal may then be heard in a pair of phones as explained in the two previous articles on detection. This rectified signal may be loud enough to be heard in the telephones, but not in a loud speaker so that a room full of people may also hear the signals. In order for this to be accomplished, the rectified signal must be amplified by audio frequency amplifiers. This subject is, therefore, our next logical step, and will be treated in the next issue.

A Rubber Ball Variometer

(Continued from page 409)

rotation, though a stop should be arranged to prevent the ball from being turned around further than one complete revolution.

In one position of the rotor, all the windings, rotor and stator, must follow the same way round, otherwise the variometer has not been properly made.

The stator wire may be wound on a cardboard or other cylinder as in the photograph Fig. 4, where a cardboard ice-cream carton has been used. In this case the stator windings have not been split, but the rotor is connected at one end of them.

Many applications of this principle can be devised, and it is as easy as Columbus found it to make the egg stand on its end, when it occurred to him how to do it. Its use should lead to the elimination of cylindrical tubes and their unsatisfactory slider arrangements for many an amateur's set.

Definition of Radio Terms

(Continued from page 413)

same frequency as the input voltage and ninety degrees out of phase with it. **Input Resistance of a Three-Electrode Tube:** The ratio of an alternating sine-wave input voltage to that portion of the resulting input current which is an alternating sine-wave current of the same frequency as the input voltage and in phase with it.

Interrupted Continuous Waves: Interrupted continuous waves (I C W) are waves obtained by the modulation at audio frequency, during signaling, of an otherwise continuous wave.

Inverted L Antenna: A flat-top antenna in which the down lead is taken from one end of the horizontal portion.

USE A C H SHARP TUNER DIALS

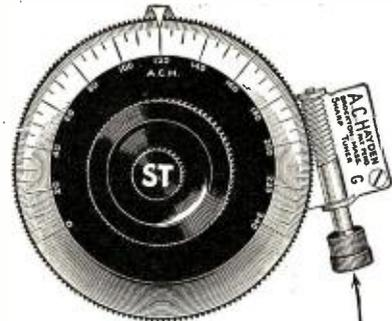

Why the A.C.H. is different

3 in. DIAL 156-10-1
4 in. DIAL 215-10-1

Rough tuning with dial or one thousandth of an inch in either direction.

Money Back Guarantee

Price ACH 3" Dial complete \$2.50
Price ACH 4" Dial complete 5.00
Regular fitting 5/16" hole, 1/4" and 3/16". Bushings, 5c. each extra. 10c for all.

LONG DISTANCE A C H DETECTOR SET UNWIRED

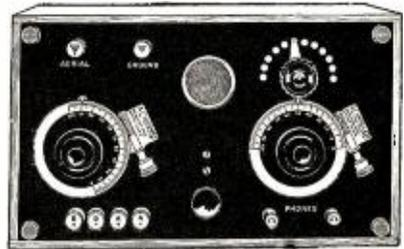

PRICE \$20.00 Including 2-3" ACH Dials
WRITE FOR 3 WAYS TO PURCHASE

A. C. HAYDEN RADIO & RESEARCH CO.

Brockton, Mass., U. S. A.

Mail Orders sent prepaid in U. S. A.

It's the contact that counts

A careful examination will show that each contact in Na-ald sockets and adapters is of a wiping nature on a broad surface, and of sufficient tension, and so designed that tension is permanent, no matter how often the bulbs may be removed and how much the connecting prongs in the tubes vary.

It is little realized that sockets are being sold which, owing to faulty choice or control of material, develop current leakage from plate to grid that rob many otherwise well-made sets of their efficiency. Na-ald sockets in their design avoid all these troubles.



NA-ALD Special Socket No. 499



De Luxe Contact



NA-ALD De Luxe No. 400

- NA-ALD SOCKETS**
- No. 499 Socket, 199 tubes... \$0.50
 - No. 429 Adapter, 199 tubes... .75
 - No. 400 De Luxe, 200 tubes... .75
 - No. 401 Small Space, 200 tubes... .35
 - No. 411 W. D. 11 tubes... .75
 - No. 450 Two in One, W. D. 11 or 200 tubes... .50

Booklet with diagram of Hazeltine's Neutrodyne Circuit and other selected circuits packed with each Na-ald product.

Alden Manufacturing Co.

Manufacturers of Sockets for Every Tube and Requirement

Dept. K 52 Willow Street Springfield, Mass.

CABLE ADDRESS: ALDENCO



CARTER

INDUCTANCE SWITCH

No sliding contacts; panel numbering eliminated; 15 good contacts; adjustable stop pin. Price \$2, including knob-dial.

Ask your Dealer Send for free large catalogue.

CARTER RADIO CO., 207 S. State St., Chicago



OPERATE YOUR RADIO FROM YOUR LAMP SOCKET—WITH A Gould UNIPOWER Battery

TRADE MARK

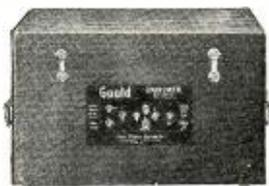

The Gould Unipower Combination Set
Closed Cabinet Type for any "A" or "B" Circuit

The Gould Unipower principle finds its fullest expression in this combination set. Each set is in itself a complete source of current for your radio receiving set. It combines Unipower "A" and "B" Batteries with other Unipower apparatus in a handsome cabinet. All wires and connections are protected from corrosion and surface leakage, resulting in absolute quietness of operation of the radio set. The "A" battery has adjustable series resistance which will enable you to secure fractional voltages. The "B" battery has its entire voltage range available in two-volt steps. All necessary contacts for "A" and "B" circuits are conveniently accessible on the outside of cabinet, as shown in illustration. This set is especially appropriate for cabinet type radio sets.



The Gould Unipower "A"
Open Case Type for any "A" Circuit

The Gould Unipower "A" is a continuous source of "A" current for your radio set, complete in itself. Can be charged and operated simultaneously. Its adjustable series resistance enables you to secure fractional voltages.

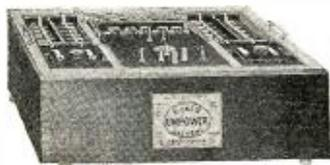

The Gould Unipower "B"
Open Case Type for any "B" Circuit

The Gould Unipower "B" is the latest word in convenient and efficient "B" current supply. Has all the necessary accessories for recharging by connecting to houselighting circuit. Its entire voltage range is available in steps of two volts. Equipped with non-corroding, easily applied "grip." More convenient than dry "B" batteries. Will last for years.



If your dealer hasn't yet stocked Gould Unipower Batteries send the coupon below direct to us for complete information.

Gould Storage Battery Co.
30 East 42nd St., New York, N. Y.
Works: Depew, N. Y.

Radio's newest development—a complete, compact, convenient and economical power plant for radio sets.

GOULD UNIPOWER BATTERY is the most notable advance made in the development of radio power. By an ingenious combination of a storage battery and other apparatus (patent applied for) in a compact and portable unit, you are now able to operate your radio set from your house circuit and Unipower set combined,—from your Unipower set alone,—and to keep the Unipower Batteries fully charged at all times.

The only wires necessary are from your electric light socket to your Unipower Set, and "A" and "B" wires from your Unipower Set to your radio set. All Unipower Sets have connections brought to a contact plate, where it is possible to obtain any connections or voltages required for practical operation of the radio set by the use of "grip" terminals, which are slipped over connection posts.

This extraordinary new development in power for radio sets gives you—

1. Years of constant, uninterrupted service, with
2. The ultimate mile of distance, plus
3. Noiseless operation and finer tone quality.

It does away with

4. All need for continuing to use unsatisfactory dry batteries requiring frequent and expensive replacements and
5. Finally banishes the bogey of troublesome recharging of storage batteries.

Operates your set from any houselighting circuit—either alternating or direct current.

"Just hook it to your lamp socket"

GOULD STORAGE BATTERY CO.,
30 East 42nd St., New York.

Please send me prices and complete information regarding Gould Unipower Batteries.

Name of radio set..... Is current A.C. or D.C.?.....

Number of tubes..... If A.C. current, what cycle?

Trade name of tubes..... Voltage of "A" Battery.....

Voltage of house current..... Voltage of "B" Battery.....

(Fill in above information and write your name and address, together with name of your radio dealer, in margin below.)

**Reliable
RADIO
Goods**

**Distributors for
Radio Corporation
of America**

- Grebe
- Kennedy
- Magnavox
- Brandes
- Nath. Baldwin
- Burgess
- Se-Ar-De
- Acme
- Remler
- Dubilier
- Gould
- Signal
- Cutler-Hammer
- Frost
- Pacent

and other manufacturers of high standing.

We carry a comprehensive stock of the latest receiving sets, parts and supplies of the leading manufacturers, and ship from stock promptly.

SEND FOR THESE

- Univernier—A geared dial for close tuning. Mention size of condenser or variometer shaft. Complete with dial\$1.25
- Howard 25-Ohm Rheostat—Suitable for the new UV-201-A tubes 1.00
- Cutler-Hammer 25-Ohm Resistance—A variable resistance which attaches to any rheostat to fit it for UV-201-A tubes 0.25
- Cutler-Hammer "A" Battery Switch—Requires only one hole in panel.... 0.70
- Barkelew-Lightning Arrester Switch—A combination of ground switch and lightning arrester 3.50
- Rubber Ear Muffs—Fit any American make of phones. Made by B. F. Goodrich Co.pr. 0.80
- Magnavox M-1—Requires no battery. Best loud speaker for permanent magnet type35.00

FREE Illustrated,
CATALOG sent on request.

Dealers

Buy reliable equipment from a house of established reputation. Send for catalog of tested and approved apparatus and our discount sheet.

JULIUS ANDRAE & SONS Co.
117 Michigan St., Milwaukee, Wis.

ANDRAE In Business Since 1860

Key: A device for closing and opening transmitting circuits in the act of transmitting signals.

Lead-In: (See Down Lead.)

Logarithmic Decrement: The Napierian logarithm of the ratio of two successive current amplitudes in the same direction, for an exponentially damped alternating current. The logarithmic decrement can also be considered as a constant of a simple radio circuit, being π times the product of the resistance by the square root of the ratio of the capacity to the inductance of the circuit.

Loop Antenna: (See Coil Antenna.)

Loud Speaker (Radiophone): An assembly of devices, with or without special amplifying circuits, by means of which received sounds are made audible without the use of telephone receivers held to the ears.

Meter-Amperes: The product of the antenna current in amperes at the point of maximum current and the antenna effective height in meters for any radio transmitting station. It constitutes a factor for indicating the radiating strength of radio transmitting stations.

Modulation, Double: See Double Modulation.

Modulation Frequency Ratio: The ratio of modulation frequency to wave frequency.

Multiple Tuned Antenna: An antenna with connections to ground through inductances at more than one point, the inductances being so determined that their reactances in parallel present a total reactance equal to that necessary to give the antenna the desired natural frequency.

Open Antenna: See Condenser Antenna.

Oscillations: (In Radio Work). See Damped Alternating Current.

Parallel Resonance: When a single lumped capacity and a single lumped inductance are connected in parallel between terminals to which an alternating emf. is applied, and the inductance or capacity or frequency is varied, the condition of parallel resonance exists when the current supplied by the source is a minimum.

Note: In series resonance the entire current supplied by the source flows through both the inductance and the capacity. In parallel resonance the current supplied by the source is (vectorially) the sum of the current flowing through the inductance and the current flowing through the capacity.

Every part of every actual circuit possesses a certain amount of distributed capacity and inductance, and in practice complex arrangements of a considerable number of inductances and capacities are often used. For this reason the assumption as to a single lumped capacity and a single lumped inductance made in the above two definitions are not strictly realized in practice, and the resonance conditions attained are a combination of series resonance and parallel resonance. This is particularly true in circuits of radio frequency, in which the reactances due to leads and other parts of the circuit may be factors.

Photo-Electric Effect: A change in the electrical conductivity of a gaseous or solid substance when exposed to radiation of certain wave-lengths; particularly rays of the visible spectrum, and ultra-violet and infra-red rays.

Plate Current: The current passing between the plate and the heated cathode in a three-electrode tube.

Positive Linkage: The linkage of a magnetic flux with a circuit will be denoted as a positive quantity if it links with the circuit in the same direction

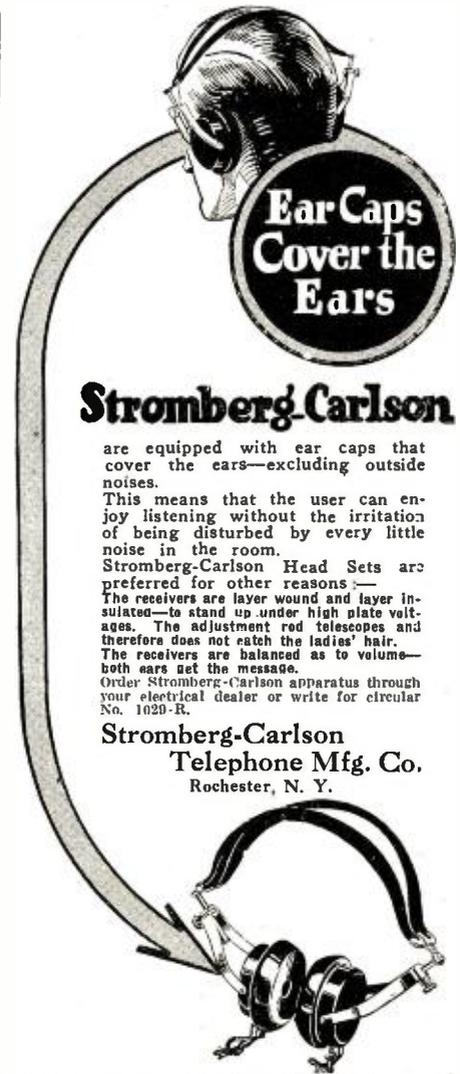

Stromberg-Carlson

are equipped with ear caps that cover the ears—excluding outside noises. This means that the user can enjoy listening without the irritation of being disturbed by every little noise in the room. Stromberg-Carlson Head Sets are preferred for other reasons—The receivers are layer wound and layer insulated—to stand up under high plate voltages. The adjustment rod telescopes and therefore does not catch the ladies' hair. The receivers are balanced as to volume—both ears get the message. Order Stromberg-Carlson apparatus through your electrical dealer or write for circular No. 1020-R.

**Stromberg-Carlson
Telephone Mfg. Co.**
Rochester, N. Y.

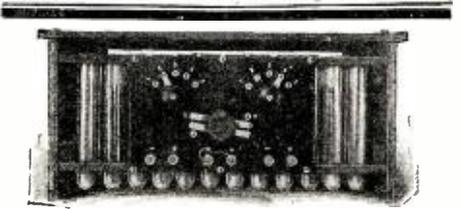

100 VOLT PANEL (New Type)

KICO Storage "B" Batteries Give Long Service at Low Cost.

Alkaline type, will not sulphate or buckle. Life unlimited. Not harmed by short-circuiting, overcharging, or standing idle. Panel switches afford single cell variations. Easily re-charged from any 110-volt A.C. line by means of small home rectifier. One charge lasts three to six months in detector plate circuit.

Prices		Plain	(With Panels)
without	16 cell 22 volt	\$ 5.50	
	24 cell 32 volt	\$ 7.25	\$11.75
rectifier:	36 cell 48 volt	\$ 9.50	\$14.00
	50 cell 68 volt	\$12.50	\$17.00
	78 cell 100 volt	\$17.50	\$22.50
	108 cell 145 volt	\$23.50	\$28.50
	Unmounted rectifier	\$ 1.00	
	Mounted rectifier	\$ 2.50	

Satisfaction Guaranteed

All batteries are sold with the privilege of receiving your money back if not satisfied within a 30 day trial. Write for full information on "A" and "B" Batteries.

Kimley Electric Company, Inc.

2665 Main Street

Buffalo, N. Y.

YOU DON'T NEED

Tubes to get out of town. Even in the summer I hear Omaha, Kansas City, Fort Worth and Davenport on my crystal set without amplification. Works over 1,000 miles in winter. Send self-addressed envelope for further information or \$1.00 for complete copyrighted drawings and instructions. Everything clearly explained. Satisfaction GUARANTEED.
Leon Lambert, 595 South Volusia, Wichita, Kan.

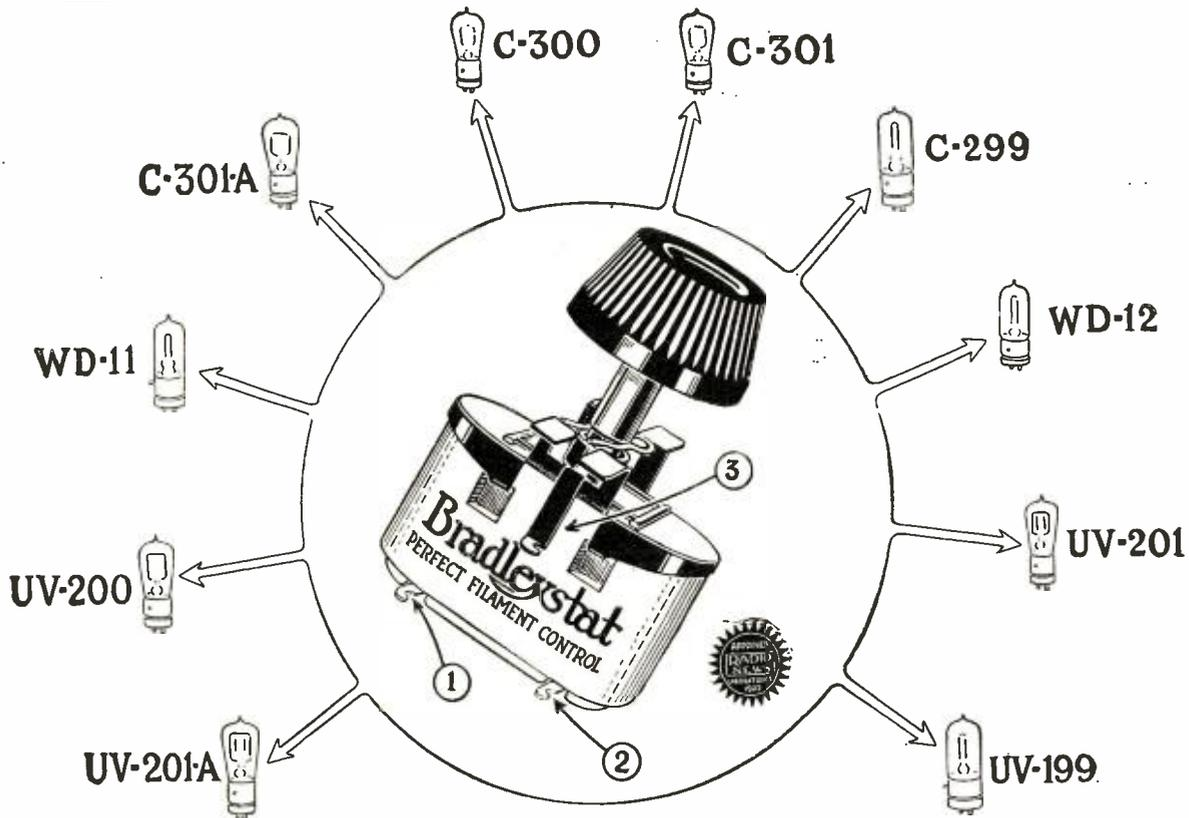

One Rheostat for ALL Tubes -the Universal Bradleystat

The most perplexing problem in radio has been solved! It now is possible to use one rheostat for all tubes. This means that you can take advantage of all recent developments in receiving and amplifying tubes without rebuilding your set to make room for a new rheostat or an extra resistance unit to give the necessary control. The Universal Bradleystat with three terminals handles the entire range of radio tubes. A simple change of connections provides stepless, noiseless, perfect filament control for every tube.

Radio Dealers

The Universal Bradleystat is one of the greatest merchandising successes in the radio field. Dealers everywhere are capitalizing on Bradleystat superiority.

"Our electrician has requisitioned six Bradleystats for use on our steamers in connection with their radio equipment."

Department of Marines and Fisheries
Halifax, N. S., Canada

"I find the Bradleystat very successful. It is compact, indestructible and all that one could wish for in radio work."

G. A. Iler, Atlanta Journal

"The improvement rendered by the Bradleystat was remarkable and beyond all my expectations."

Chas. H. M. White
Massachusetts Institute of Technology

The Universal Bradleystat is a graphite compression rheostat. This means that the marvelously smooth control and long range, for which the Bradleystat is famous, are obtained by compressing two columns of graphite discs with a single control knob. In this way, you get vernier control without vernier complications.

There is no carbon dust in the Universal Bradleystat, because carbon dust can trickle out of the rheostat or become packed into a solid mass. It was abandoned many years ago by the Allen-Bradley Co. as unsatisfactory and unreliable. For your protection, the name Bradleystat is embossed on the porcelain container. Be sure to ask for the Universal Bradleystat. Try one, tonight!

Allen-Bradley Co.

Electric Controlling Apparatus

287 Greenfield Avenue, Milwaukee, Wis.

Manufacturers of Graphite Compression Rheostats for Twenty Years

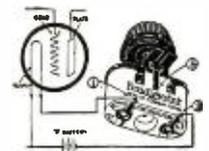

For .06 amp. tubes

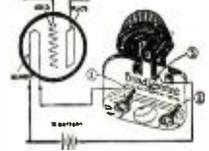

For 1/4 amp. tubes

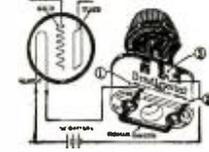

For 1/2 and 1 amp. tubes



Mr. E. N. Fiskerell, Chief Radio Officer, S. S. Leviathan—formerly a student of the Radio Institute of America.

Travel—Good Pay and a Big Future in Radio

All over the world, our graduates are traveling—with the rank of ship's officer—the title of "radio operator." The growth of radio opens up new opportunities, on shipboard and on shore. And the men at the top are our graduates—thoroughly trained—recognized as capable.

Study at Home

You need know nothing of radio to start. The course begins with the beginnings of electricity, and includes code and modern commercial radio operation. A few months' study prepares you for a U.S. Government operator's license. And the license indicates your readiness for your first radio job, at a good beginning salary.

This School Teaching Radio Since 1909

The oldest school. The school conducted by the Radio Corporation of America. 90% of the operators of the Corporation, which places more men than any other radio organization in the world, are our graduates. Others, too, give them first preference. If you are looking for a profession that holds the biggest future promise, write us for more information about the radio field, and our home course.

Advanced Radio Course

Great popular demand by the advanced student, experienced amateur and wireless operator has led to the opening of an **ADVANCED HOME STUDY RADIO COURSE**, specializing in C. W., I. C. W., telephone and radio measurements. Investigate!

Radio Institute of America

(Formerly Marconi Institute)

Established 1909

328 Broadway, New York City

Indicate by a cross X the course you are interested in:

Radio Institute of America,
328 Broadway, New York.

Please send me full information about radio opportunities today, and your

COMPLETE RADIO COURSE

ADVANCED RADIO COURSE

Name.....

Address.....

as the flux which would be set up by a positive current in the circuit. This presupposes that a positive direction for a current in the circuit has been selected.

Pulsating Current: A periodic current (that is, current passing through the successive equal cycles of values), the average value of which is not zero. A pulsating current is the sum of an alternating and a direct current.

Radiation Efficiency: The radiation efficiency of an antenna at a given wavelength is the ratio of power radiated to the total power delivered to the antenna (resistance).

Radiation Resistance: The ratio of the total power radiated by an antenna to the square of the effective current at the point of maximum current.

Radio Channel: A band of wave-lengths or frequencies of a width sufficient to permit of its use for radio communication without the radiation of subsidiary waves of more than a certain intensity at wave-lengths or frequencies outside of such band.

Radio Communication: The transmission of intelligible signals by means of electromagnetic waves originating in a constructed circuit, without connecting linear conductors guiding the waves.

Radio Frequencies: The frequencies higher than those corresponding to normally audible sound waves. (See also Audio Frequencies.)

Note: It is not implied that radiation cannot be secured at lower frequencies, nor that radio frequencies are necessarily above the limit of audibility.

Radio Frequency Selectivity: The radio frequency selectivity of a simple circuit of a receiving system is the ratio of resonant response (in terms of effective voltage or current, or their squares measured at the indicator) to the non-resonant response when the radio frequency portions of that element of the system are detuned by a stated fraction of the resonant frequency. A simple circuit as referred to is a combination of an inductance, a capacity and a resistance, or their equivalent.

Radiogoniometer: See Direction Finder.

Radiogram: A telegram sent by radio.

Radiophone (verb): To transmit speech by radio.

Reflection Coefficient: (Of a surface of discontinuity between two media.) The ratio of the reflected field intensity near the surface to the incident field intensity near the surface.

Regenerative Coupling: (See Feed-back Coupling.) A receiving system designed to increase amplification in a three-electrode tube.

Rejector: (See Acceptor.) (Sometimes called a "shunt trap.") A rejector is a supplementary closed resonant circuit, comprising a small inductance of low resistance and a large condenser of low resistance and tuned to the frequency of the desired signal, connected as a loop in shunt across the receiving primary or acceptor circuit and acting to provide a low impedance by-pass for all frequencies except that of the desired signal.

Resistive Coupling: The association of one circuit with another by means of resistance common to both.

Secondary Emission: Electron emission in which the exciting agency is bombardment of the emitting material by electrons.

Series Resonance: When a single lumped capacity and a single lumped inductance are connected in series between terminals to which an alternating emf. is applied, and the inductance or capacity

RIGGS RECTIFIER

\$12.50



Prepaid Anywhere in the U. S.

Money Back Guarantee

We guarantee the Type B-3 to please you. If it does not, return it and we will return your money.

THE RIGGS MFG. CO.

Eastern factory Urbana, Ohio
Western factory Everett, Wash.

You Know These HEADBANDS

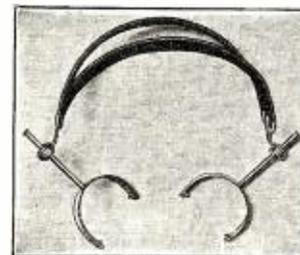

Simple friction slide adjustment. Most satisfactory on the market. No thumb screws to bother with or to catch in the hair. Two yoke sizes fit any 'phones. Bands covered in Black or Khaki webbing. Prompt deliveries on any quantity.

\$500,000.00 worth of special and automatic machinery assures quantity output and guaranteed delivery for manufacturers and dealers on any radio equipment. Submit sample of product. Write for prices.

THE AUTOYRE CO.
OAKVILLE, CONN.

RADIO SCHOOL

All our graduates are placed. Shortage still exists. Wages going up.

Send for Catalog

MASSACHUSETTS RADIO & TELEGRAPH SCHOOL, Inc.
18 Boylston St. Boston, Mass.
G. R. ENTWISTLE, Radio Director

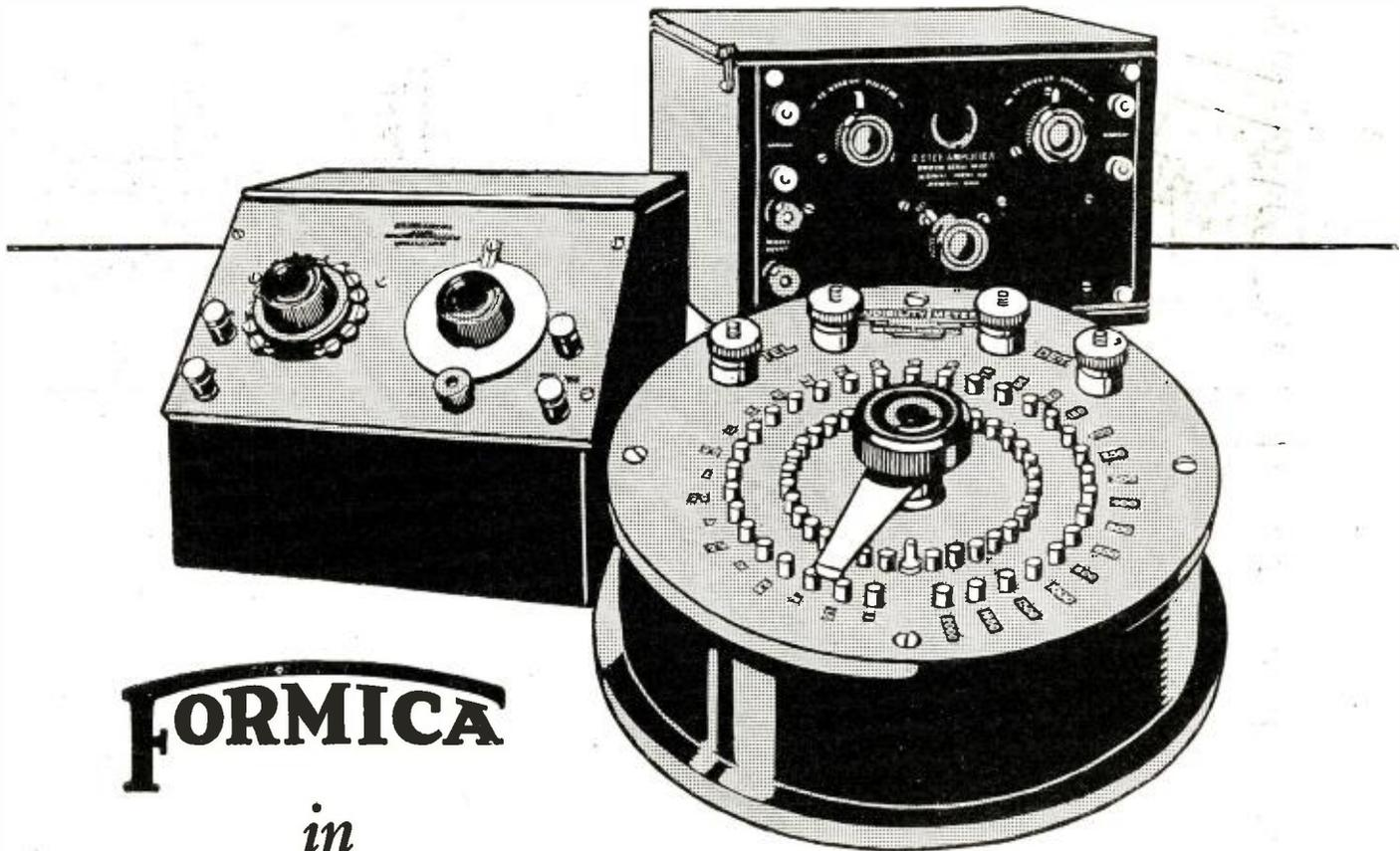

FORMICA
in
GENERAL RADIO Apparatus

THE General Radio Company, makers of precision instruments for use in radio and electrical work is one of the oldest as well as the most consistent users of Formica.

The high quality of the General Radio product is assurance to amateurs and dealers everywhere that when they use Formica insulation, they are using the best material that the market affords.

Formica service is as good as the product. It supplies promptly a panel or tube of just the size that is wanted — no need to confine yourself to so-called standard sizes that some one else wants to sell.

THE FORMICA INSULATION COMPANY
 4618 Spring Grove Avenue, Cincinnati, Ohio

Sales Offices

50 Church St., New York, N. Y.
 422 First Ave., Pittsburgh, Pa.
 1042 Granite Bldg., Rochester, N. Y.
 415 Ohio Bldg., Toledo, Ohio

1210 Arch St., Philadelphia, Pa.
 1819 Lyndale Ave., S. Minneapolis, Minn.
 Sheldon Bldg., San Francisco, California
 Whitney Central Bldg., New Orleans

414 Finance Bldg., Cleveland, Ohio
 9 S. Clinton St., Chicago, Ill.
 313 Title Bldg., Baltimore, Md.
 47 King St., Toronto, Ontario

FORMICA
 Made from Anhydrous Redmanol Resins
SHEETS TUBES RODS



~ Gold Stripe HEAD Sets



Guaranteed Absolutely Equal or Superior to Other Standard Makes at Much Higher Prices

No. 500--2200 Ohm \$6. No. 501--3200 Ohm \$6.50

Delta Gold Stripe Radio Headsets talk up loud and clear—perfectly tuned and matched—inspection standards very high. Satisfactory performance fully guaranteed.

The DELTA is far more beautiful in appearance—receiver cups of light brass with highly polished nickel finish—head webbing individualized by one-eighth inch gold stripe thru center, and in every detail DELTA HEADSETS present the highest quality appearance

DEALERS AND JOBBERS

Write or Wire Today For Discounts.

DELTA ELECTRIC COMPANY

470 Delta Block **MARION** Marion, Ind.
INDIANA
KNOWN BY HER PRODUCTS

Standard Makers of Radio Apparatus, Bicycle Lamps, Auto Spotlights, Lanterns, Flashlights and Flashlight Batteries
 NEW YORK SAN FRANCISCO WINNIPEG

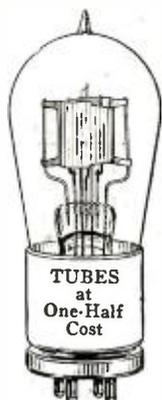

IT HAS HAPPENED TO ALL OF YOU IN A FRACTION OF A SECOND!

WHEN the filament burns out, at least \$5.00 goes with it to put the set in operation again.

WHY not save nearly one-half the cost of a new tube by sending us your burned out or broken tube to be repaired?

WE REPAIR EVERY TYPE of tungsten wire filament receiving tube. All our tubes are TESTED and GUARANTEED to function as well as when new.

All tubes returned P.P., C.O.D.

HARVARD RADIO LABORATORIES

BOSTON P. O. BOX 1781 MASS.

or frequency is varied, the condition of series resonance exists when the current is a maximum.

Self-Heterodyne: A system of reception of continuous wave signals by the production of audio-frequency beats, through the use of a device which is both a radio-frequency generator and a detector of the audio-frequency beat currents produced.

Sharpness of Resonance: A quantity expressing the fractional change of current in a simple series circuit, for a given fractional change in either capacitive or inductive reactance at resonance; given mathematically by

$$\sqrt{\frac{I_r^2 - I_1^2}{I_1^2}} \text{ or } \frac{\sqrt{I_r^2 - I_1^2}}{I_1} \text{ or } \frac{\sqrt{I_r^2 - I_1^2}}{I_1^2}$$

$$\frac{C}{Cr - C} \text{ or } \frac{L}{Lr - L} \text{ or } \frac{f^2 - f_1^2}{f^2}$$

where the subscript *r* denotes value at resonance and *I*₁ is some value of current corresponding to a capacity *C* which differs from the value at resonance. (The mathematical expression given is equal to the ratio of one of the reactance components to resistance of a simple series circuit.)

Signal Stray Ratio: See Strays.

Static: Static is conduction or charging current in the antenna system resulting from physical contact between the antenna and charged bodies or masses of gas.

Stopping Condenser: A condenser used to provide direct-current insulation, but which permits alternating current to flow in a circuit.

Strays: Electromagnetic field causing disturbances in radio reception, other than those produced by radio transmitting systems or by alternating current induction from wire circuits. The term "Strays" includes atmospheric disturbances and disturbances caused by electrical apparatus such as sparking commutators; sparking contacts in fire alarm apparatus, Tirrell regulators or elevator controllers; sudden current changes through arc lamps; transient or sparking grounds on power systems; electric ignition systems of internal combustion engines, or sparking at third rail or trolley contactors. (A reduction of the effect of Strays on radio reception increases the Signal-Stray ratio.)

T Antenna: A flat top antenna in which the down lead is taken from the center of the horizontal portion.

Three-Electrode Tube: A combination of a heated cathode, a relatively cold anode, and a third electrode for controlling the current flowing between the other two electrodes, the whole contained within an enclosure evacuated to a low pressure.

This device is variously known as an Audion, Audiotron, Aerotron, Electron Relay, Electron Tube, Pliotron, Triode, Oscillion, Radiotron, etc.

Tickler: See Feed-Back Coil.

Umbrella Antenna: An antenna the conductors of which form elements of a cone with the apex at the top to which the Down Lead is connected.

Undamped Alternating Current: A periodic current (i. e., current passing through successive equal cycles of values) whose average value is zero.

Wave Antenna: A horizontal antenna the physical length of which is approximately equal to the length of signaling waves to be received, and which is so used as to be strongly directional.

Wavemeter: A radio instrument for measuring frequency.

Waves, Continuous, Key Modulated: See Continuous Waves, Key Modulated.

Waves, Continuous, Modulated at Audio Frequency: See Continuous Waves at Audio Frequency.

NEW 25c BOOKS

That Every Novice or Amateur Needs

100 Radio Hook-ups

By M. L. MUHLEMAN

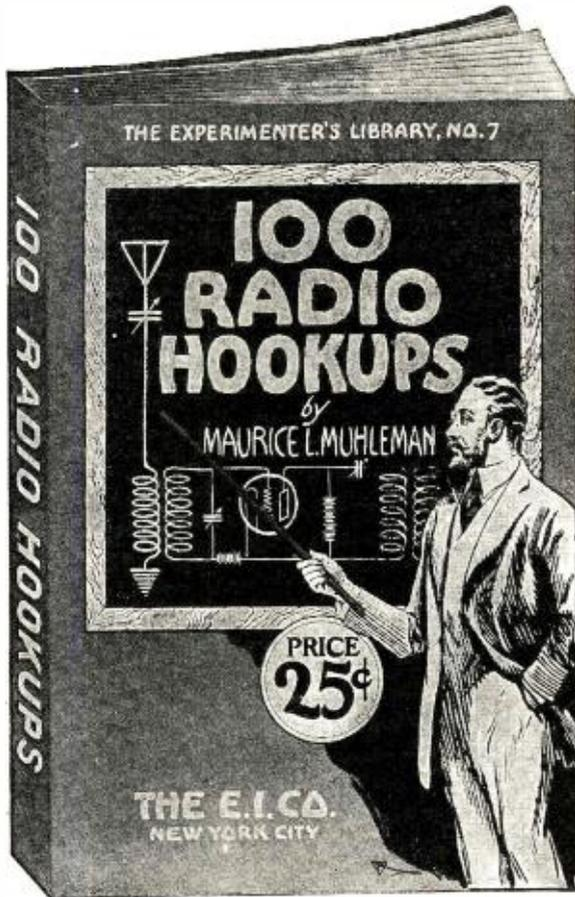

A book for both the novice and advanced radio amateur containing a varied selection of hook-ups from the simple crystal to the more elaborate circuits, with a circuit for every requirement. Crystal hook-ups, combined crystal with radio and audio frequency amplifiers, non-regenerative, and regenerative vacuum tube circuits with and without radio and audio amplifiers. Amplifier units, with straight jacks, filament and switching arrangements, power amplifiers, choke coil, resistance coupled and transformer coupled radio frequency amplifiers.

Includes all of the latest, one and multi-tube hook-ups including the numerous types of Reflex, super regenerative, super-Heterodyne, Neutrodyne, Reinartz, Flewelling, and Bishop. The values and constants of all apparatus employed in the hook-ups are given. A list of radio symbols is included, which are of material help to the reader in determining the meaning of the conventional hook-up diagrams. The text includes much helpful information.

52 Pages—Two-Color Cover **25c.**

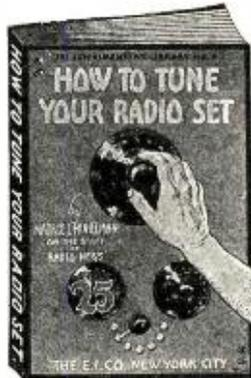

This book covers in comprehensive form, the fundamental principles of tuning. The characteristics of radio waves are fully described and illustrated. Illustrations are used so that the non-technical reader can easily understand the identical actions as applied to radio. Several chapters are devoted to the use and functions of all radio apparatus. The book describes how to tune such sets as the Reinartz, Flewelling, Neutrodyne, radio frequency amplifier receivers and other.

52 pages, 25 Illustrations
Prepaid **25c**

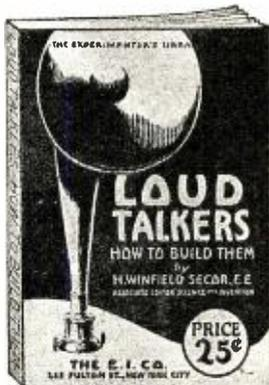

This book describes and gives complete data for building two distinct types of loud talkers. One chapter deals with improvised loud talkers, and gives complete instructions on how to build suitable horns for use in loud receivers of the Baldwin and other types. In preparing these designs, the point has been constantly kept in mind to use the simplest parts possible, so that anyone can build a successful loud talker, equivalent to the commercial types, costing \$40.00 or more.

48 pages, Profusely Illustrated
Prepaid **25c**

A non-technical book for the beginner. Gives complete constructional data on the building of a complete Crystal Detector Set, Tuning Coil, Loose Coupler and a Single Audion Tube Set with Amplifying Units. It furnishes all dimensions and working drawings of every part that must be constructed by the amateur. Written in plain, simple language that anyone can understand. The opening chapter gives a complete description of the theory of radio and tells what it's all about, teaching the principles of wireless so that the constructor knows what he is doing.

48 Pages, 26 Illustrations
Bound in Beautiful Two-Color Cover. Size, 5½ x 7½ in. Prepaid **25c**

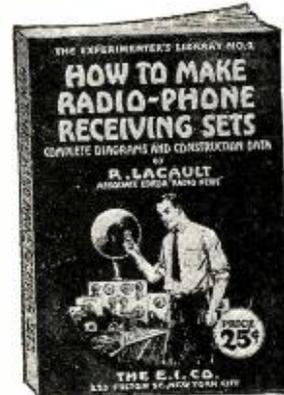

This book is for the more advanced amateur, showing the construction of the Radio Frequency Amplifying Transformer and giving complete constructional data. It shows the application of Radio Frequency to amplifying units that the amateur may already possess and gives 15 hook-ups showing practically every use Radio Frequency Amplifying Transformers can be put to.

32 Pages, 15 Illustrations
Bound in Beautiful Two-Color Cover. Size, 5½ x 7½ in. Prepaid **25c**

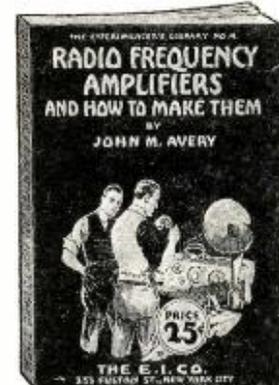

A complete list of dealers carrying these books will be found on page 494

If your dealer cannot supply you—order direct from us—giving dealer's name and address.

THE E. I. COMPANY (THE CONSRAD CO.) 233 Fulton St., N. Y. City
Selling Agents

Out of date! →



The dawn of a new era in radio merchandising

GONE forever in many cities, and going fast in others, is the sign which read "Positively No Refunds or Exchanges on Radio Purchases." *You now buy radio with the same certainty of "satisfaction or your money back" as you do any other staple merchandise.*

The broad guarantee placed on Frost-Radio by the manufacturer has been in large measure responsible for this improvement in the sale of radio.



Every Frost Dealer knows that Frost-Radio is sold under this positive guarantee. It must be right, or it could not be guaranteed so strongly!

Your dealer handles Frost-Radio. Order from him today, and learn the dependability of this apparatus.

HERBERT H. FROST, Inc.
154 WEST LAKE STREET, CHICAGO, ILLINOIS.
30 Church Street, New York
Makers of the famous Frost-Fones

Bureau of Standards Circulars

(Continued from page 408)

Circular No. 133 describes an electron tube detector unit which can be substituted for the crystal detector in either of the two sets previously described.

Circular No. 137 describes telephone shunt and series antenna condensers and loading coil for use with the simple receiving sets.

The fifth circular of this series is Circular No. 141. It describes an audio frequency amplifier unit of such proportions that in external appearance it matches the electron tube detector unit. One or two of these amplifier units may be used with the equipment previously described to amplify the signals detected by the electron tube detector unit, or the detector unit may be omitted and one or two amplifier units used with the crystal detector.

Copies of these circulars may be obtained from the Superintendent of Documents, Government Printing Office, Washington, D. C.

Queer Queries and Ready Replies

(Continued from page 418)

shirt, pair of socks and their sheets on the line every Monday. I want to tune on 360.

WORRIED.

A. Connect the socks in parallel, the sheets in series and take a lead-in from the fifth button on the bosom of the shirt. If it is a stiff shirt, your tuning will be very selective on 360 meters.

Q. Last week I began getting signals backward. The station would sign off and then begin the program. Is it possible that I have reversed my tickler coil, thus getting the back end of the program in front?

UPSET.

A. It is hard to say without seeing your set. Perhaps your aerial and ground leads are interchanged. Try a left-handed grid condenser and reverse your "A" battery. If static is hind side before, reverse everything; or maybe your tube backfires.

Q. I have built a reflex set that the diagram says is portable; one stage audio and one radio. It takes 135 volts on the plate. The storage battery weighs 50 pounds and the "B" batteries weigh 25 pounds. What do you use in this set to make it portable?

UNDER WEIGHT.

A. Try a good wheelbarrow in series with the antenna.

Q. Three times last week while tuning in a faint station my aerials came down. What can I get to keep them up?

MORTIFIED.

A. Try a good pair of suspenders.

Q. My sweetheart and I have a receiving set and he comes down every night to listen in. It has only one tuning dial. Do you think he could do better if he had two dials to turn?

LOVESICK.

A. No, sister, the one arm control is the thing.

Q. I have a detector and two-stage, using the water pipe for a ground and an outside aerial. What can I do to make this set portable?

CARRY ITT.

A. Mount the receiver on the dashboard of a good motor truck, and load the aerial, house plumbing, batteries, water plug, and about 200' of the sewer system in the rear of the truck.

MIGNON SCORES AGAIN!!



New Model Tremendous Success Open End Type Vernier Condenser

No Condenser at any price can give you more than this—correct capacities, rigid, reinforced end plates, plates of logarithmic curve, special insulation reducing losses to minimum, Patented Vernier eliminating body capacity, extremely low dielectric losses, Rotor Shaft with friction adjustment, independent Vernier control.

Prices
13 Plate—.0002 M.F. \$2.75
23 Plate—.0005 M.F. 3.25
43 Plate—.001 M.F. 3.50

MIGNON ELECTRIC MFG. CORP.
25-35 S. WATER ST., ROCHESTER, N. Y.

Radio Catalogue Free—

**Write us
a post card—**

and we will send you free this 52 page catalogue of radio sets and parts. It also contains explanation of radio terms, map and list of broadcasting stations and much radio information, including an explanation of successful hook-ups and circuits.

You will be amazed at the low prices Ward's quote. A complete set for \$32.50 equalling sets at \$60 elsewhere—a \$23.50 set that under favorable conditions has a radius of 500 miles and more.

This catalogue contains everything for the expert and amateur. Complete sets and every improved part for building sets all the most up-to-date devices—at the lowest possible prices.

Headquarters for Radio

Montgomery Ward & Co. is headquarters for Radio, selling everything direct by mail without the usual "Radio-profits." Why pay higher prices? Ward quality is the best and the prices will often save you one-third. Everything sold under our Fifty Year Old Guarantee,—Your Money Back if You Are Not Satisfied. Write today for your copy of this complete 52-page Radio Book.

Write to the house nearest you. Address Dept. 2-R

Chicago Kansas City St. Paul Portland, Ore. Fort Worth

Montgomery Ward & Co.

The Oldest Mail Order House is Today the Most Progressive



New York Coil Company's Radio Products

Have An Established Reputation for Honest Value, Maximum Results and Ease of Installing

Our Perfected Radio Frequency Transformers deliver extraordinary results. A set of two will give the satisfaction you have so long desired. Price,\$4.00



New York Variable
Condensers remain the
Leaders. Price
11 Plate\$1.50
23 Plate 2.00
43 Plate 3.00



A Variable Grid Leak of quality and precision. Price\$1.50



Supplementary Vernier
Condenser. Just what you
need for sharp tuning.
Price, \$1.00.



Mica Fixed
Condensers

Couplers, Variometers, Amplifying
Transformers

NEW YORK COIL COMPANY
338 PEARL ST. NEW YORK CITY, N. Y.

With the Amateurs

Continued from page 403)

NEW AMATEUR RULES AND REGULATIONS

All radio inspectors throughout the United States have been authorized to recall all general, restricted and special amateur radio transmitting licenses and amend them as to wave-lengths allowed and "quiet hours" as outlined below.

A new status for the radio amateur operator has been established and is known as the Amateur Extra First Grade. The licenses for this grade will be issued to persons passing a special examination on apparatus with a rating of 75 per cent and who can also transmit and receive at a speed of not less than 20 words per minute, counting five characters to the word. To obtain this grade, an amateur must have been a licensed operator for two years without ever having been penalized for an infringement of the radio laws of the United States.

The following bands of wave-lengths have been assigned. Pure C.W. stations may operate on wave-lengths of from 150 to 200 meters, while spark, I. C. W., unfiltered C.W. and phone are assigned to a range of 176 to 200 meters. In all cases the exact type of the transmitter to be used must be specified in the license.

Special licenses are assigned for operation of pure C.W. on 150 to 200 meters. C.W. transmission is defined in the new regulations as follows:

"A system of telegraphy by continuous oscillations in which the power supply is substantially D.C. as obtained from (1) a generator, (2) a battery or (3) a rectifier with adequate filter. (A filter is not deemed adequate if the supply modulated exceeds 5 per cent)."

The power used by any amateur transmitting station shall not exceed 1 K.W. input. In the case of tube transmitters where the input of a tube is not specified by the manufacturer, it shall be assumed to be twice as great as the specified output.

The following paragraph is to be inserted on all amateur licenses.

"This station is not licensed to transmit between the hours of 8 and 10:30 P. M. local standard time nor Sunday mornings during local church services."

In spite of the objections which may arise among the amateur class at the last paragraph, still this law is made with everybody interested in radio in mind. It is necessary for the amateur to give way somewhat to the broadcast listener in order to preserve harmony among all radio fans. The broadcast listener is far in the majority and the amateur is not greatly handicapped by any of the above restrictions. Also such laws as those outlined above are comparatively easy on the amateur as compared with those enforced in some of the foreign countries.

REGULATIONS GOVERNING AMATEUR, EXPERIMENTAL AND BROADCASTING STATIONS IN NEW ZEALAND

By a New Zealand Order in Council dated February 12, 1923, the New Zealand Radio Telegraph Regulation for Amateur, Experimental, and Broadcasting Stations as published in the New Zealand Gazette of January 18, 1923, shall apply to Samoa with the exception of certain clauses which limit the use of radio equipment receiving and transmitting to British subjects.

The new regulations are more liberal to the amateur and are established with a view to regulating broadcasting stations before interference is brought about.

Samoa is created the fifth Radio District of New Zealand, with the Office in Charge of the Apia Station as Radio Inspector.

HYGRADE SPECIALS

- 200 ft. 7 strand No. 22 Copper aerial wire...\$1.25
- Morse Eureka Test Clips, per dozen..... .50
- Skinderviken Transmitter Buttons95
- No. 763 Eveready 22½ V. Variable B. Bat. 1.25
- No. 766 Eveready 22½ V. Variable B. Bat. 1.98
- No. 767 Eveready 45 V. Variable B. Battery... 3.98
- 2000 Ohm Murdock No. 56 Head Sets..... 3.50
- 3000 Ohm Murdock No. 56 Head Sets..... 4.25
- Federal or Brandes Head Sets Complete... 5.50
- Dictograph 3000 Ohm Head Sets..... 5.98
- Fada or Framingham Rheostats65
- Acme Amplifying Transformers (new type)... 3.75
- Acme R. F. Transformers, Types R2—R3—R4 3.98
- 6 Volt Marko Storage Batteries..... 8.95
- Firco (Bull Dog Grip) Phone Plugs..... .75
- Federal Amplifying Transformers..... 4.75
- 23 Plate Var. Cond. Bakelite Ends..... 1.49
- 43 Plate Var. Cond. Bakelite Ends..... 1.95
- No. 164A Fada Neutradon Condenser..... .98
- No. 163A Fada Neutroformer..... 6.49
- No. 165A Fada Hazeltine Parts..... 21.50

All orders must include Parcel Post charges
Hygrade Electrical Novelty Co.,
41 West 125th Street New York, N. Y.

PRECISION RESISTANCE UNIT



Insure
Clear and silent operation with Fixed Resistances.
Correct resistances of known value must be used for
clear, distortionless reception. Each Unit individually
calibrated. Our interesting discount schedule will be
mailed you on request.

DAVEN RADIO CO.,
144 Bleecker Street, Newark, N. J.

Volume! Clarity!! Delight!!!

*With
Correct
Hook-up—
Proper
Inductance
and
Capacity
—and Good
Detection*

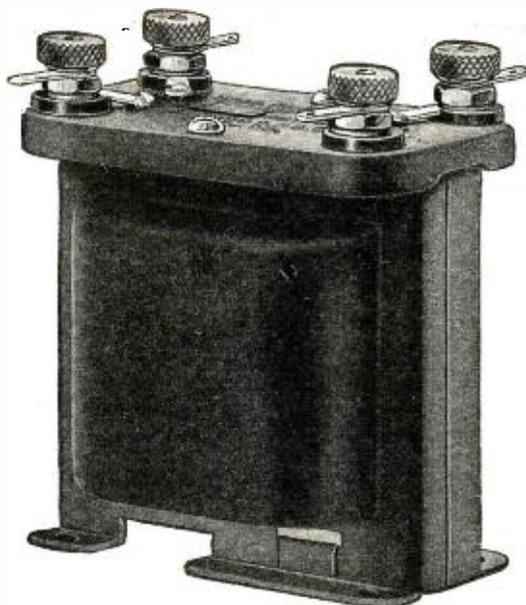

*You Are
Assured a
New and
Better
Amplifica-
tion—
Maximum
Volume—
Minimum
Distortion*

With Kellogg Shielded Type Transformers

Correct audio frequency amplification is important in the satisfactory operation of loud speakers. Proper amplification [with KELLOGG transformers] results in a clear reproduction with minimum distortion and maximum volume.

Kellogg transformers are designed to overcome any defects of existing types and to furnish the very best of amplification.

They are built complete by the Kellogg Company, using magnet wire with the very best insulation, and of exactly the correct number of turns. The metal case is heavily enameled in maroon with a Kellogg Bakelite connecting rack. The laminated cores of silicon steel are correctly proportioned and shaped for the most effective electrical field.

The primary and secondary binding posts are accessibly placed at the top of the transformers, and clearly marked so that there need be no error in connection. Every Kellogg transformer is thoroughly tested before leaving our plant and we guarantee the purchaser a product of exceptional efficiency.

No. 501—Ratio $4\frac{1}{2}$ to 1—\$4.50 each

No. 502—Ratio 3 to 1— 4.50 each

Kellogg Switchboard & Supply Company

Adams and Aberdeen Streets, Chicago

REMLER

APPARATUS
THAT RADIATES
QUALITY



Remler Socket Adaptor Type 499
For using C-299 or UV-199 Tubes in sockets designed for C-11 and WD-11 Tubes.
Price \$1.00



Remler Socket Adaptor Type 599
For using C-299 or UV-199 Tubes in sockets designed for use with standard storage battery tubes.
Price \$1.00



Remler Dry Battery Tube Socket, Type 399
For Table or Panel Mounting, Price \$1.00

Three New REMLER Items

of unquestionable merit, for use with C-299

These three new appliances, a socket and two adaptors, for the C-299 and UV-199 dry battery tubes, are in every detail representative of *Remler Quality Apparatus*.

They are perfect not only from the standpoint of manufacturing quality and appearance, but from the standpoint of mechanical and electrical design.

Each of these items provides for the easy insertion of the tube in such a manner that it will not be jarred and become damaged, and have that strong positive

contact so essential in any tube socket or adaptor to insure quiet and efficient operation of the circuit in which it is used.

We are pleased to recommend these three items to the public as being representative of the quality of all Remler apparatus. We are confident that your use of any of these articles will make you permanent Remler customers. Ask your dealer to show them to you, or write direct for our complete descriptive bulletin.

REMLER RADIO MFG. COMPANY

Factory and Home Office
248 FIRST STREET, SAN FRANCISCO

Eastern Sales Office
154 W. LAKE STREET, CHICAGO, ILL.

RADIO OPERATORS

are always in demand. On board ship they rank as officers and live as such. Their pay is good and the work congenial. We can train you to become a radio operator in six or eight months. Our code rooms equipped with modern automatic transmitters. Laboratory equipped with latest and complete apparatus. Expert instructors.

Dormitory—Restaurant—Swimming Pool.

Write to the nearest school for
Illustrated Booklet

Y. M. C. A. RADIO SCHOOLS

158 East 86th Street
New York City

Central Branch Y. M. C. A.
Seattle, Wash.

715 So. Hope St.
Los Angeles, Cal.

Boyd's Radio Lists

19-21 Beekman St., New York City

New List, just prepared, of 10,522 *Radio and Wireless Equipment and Supply Dealers and Jobbers*, for United States, price \$50.00 Typewritten form, necessary street addresses, indicating estimated standing of \$5,000, \$10,000, \$50,000 and \$100,000 or over.

If you prefer a smaller list, we are working on other selections restricted to Dealers worth \$5,000, \$50,000, etc. We also supply these names for local territory, single states or cities, New England, Middle Atlantic, Central, Western and Southern Divisions.

Send for *New General Price List No. 54*
just issued.

Telephones: BEEKMAN 4540-4541-4542.

No radio apparatus used for radio telegraph including telephone (receiving or transmitting) can be installed or operated for amateur, experimental, or broadcasting purposes, except under license issued by the Minister of Telegraphs.

Amateur receiving stations are unrestricted except for the general provisions requiring a license. However, a license will not authorize the use of circuits which unduly energize the receiving antenna (an example of such type is that in which one coil of a two coil tuner is used as a reaction coil, inductively coupled to the antenna coil).

Amateur transmitting stations are divided into two classes, Grade 1 and Grade 2, both of which must be in charge of licensed operators. The following wave-lengths are available at the discretion of the Minister of Telegraphs for Grade 1 Amateur Stations:

- (a) A general wave for all classes of service excepting damped waves, 150 meters.
- (b) A band of waves for radio telephony (C.W. modulated by speech) 151-160 meters.
- (c) A band of waves for I.C.W. (C.W. modulated at audio frequency) 161-170 meters.

- (d) A band of waves for C.W. key modulated 171-180 meters.

Power at the discretion of the Minister is limited to 50 watts.

Grade 1 operators must have a proficiency of, in Morse operating, both sending and receiving, of ten words per minute and an adequate knowledge of the principles and adjustment of the authorized radio apparatus and of the laws and regulations governing amateur stations.

Amateur Stations of Grade 2 are limited to a general wave-length of 140 meters for all types of waves except damped waves, which are prohibited.

Maximum power permitted to Grade 2 shall be five watts.

Grade 2 stations must be in charge of an operator holding Grade 2 amateur operator's license, which requires the holder to send and receive Morse at the rate of eight words per minute.

Amateur transmissions of all kinds are prohibited between 7:00 P. M. and 8:00 P. M.

Broadcasting stations are classified as follows:

(a) Private broadcasting stations at which no charge is made for the broadcasting of radio communications.

(b) Toll broadcasting stations at which charges are made for broadcasting radio communications.

Broadcasting stations must be operated by a person holding Grade 1 amateur license or higher, but the requirements as to Morse operating are waived.

Broadcasting stations shall be classified and controlled by the Minister of Telegraphs in such a manner as to reduce to a minimum mutual interference.

At the following and such other broadcasting centers as may be decided upon by the Minister, the normal power of a broadcasting station shall be one-half kilowatt, and the wave-length shall be as indicated hereinunder, or as varied by the minister from time to time.

(New Zealand Stations)

Whangarei	330 meters
Auckland	260 meters
Hamilton	360 meters
New Plymouth	385 meters
Gisborne	335 meters
Napier	380 meters
Palmerston North	340 meters
Wellington	275 meters
Nelson	335 meters
Greymouth	265 meters
Christchurch	380 meters
Timaru	330 meters
Dunedin	370 meters
Invercargill	270 meters

The normal power of the broadcasting station shall be one-quarter of a kilowatt; wave-lengths shall be as indicated hereinunder:

- and They Cost You LESS to Own!

Willard Radio "B" Battery economy is so marked that it was mentioned 109 times when 150 owners reported upon the results they had obtained.

Greater efficiency was mentioned 122 times; elimination of battery noises 70 times, and seven other advantages such as increased volume, more range, convenience and ruggedness of construction by varying numbers.

For the same reasons, Willard Rechargeable "B" Batteries have been adopted for voice amplifying by 48 broadcasting stations in the last six months.

Willard Rechargeable Radio Batteries are carried in stock fully charged yet bone dry. Never deteriorate. Always instantly ready for use.

Sold by Willard Service Stations and Radio Dealers everywhere. Ask your dealer for the free booklet "Better Results from Radio" or write Willard Storage Battery Co., Cleveland.

Willard

Rechargeable Batteries for

Radio



All These Broadcasting Stations Use Them

- | | |
|--|-----------------------------------|
| WJAX and WHK
Cleveland, O. | WDAE and WMAQ
Tampa, Florida |
| WWJ and WCX
Detroit, Mich. | WDAP
Chicago, Ill. |
| WDAF and WHD
Kansas City, Mo. | KLZ
Denver, Colo. |
| KSD
St. Louis, Mo. | WJH and WCAP
Washington, D. C. |
| WSB and WGM
Atlanta, Ga. | WWI
Dearborn, Mich. |
| WBAP
Ft. Worth, Texas | WHAM and WABA
Rochester, N. Y. |
| WDAO and WFAA
Dallas, Texas | WDAL
Jacksonville, Fla. |
| WAAW, WOAW, and
WIAK
Omaha, Nebr. | WQAM
Miami, Fla. |
| WEV and WCAK
Houston, Texas | WMC
Memphis, Tenn. |
| WCAG
New Orleans, La. | WOAI
San Antonio, Texas |
| WOC
Davenport, Ia. | KZN
Salt Lake City, Utah |
| WHA
Madison, Wisc. | KFCK
Colo. Springs, Colo. |
| WGF
Des Moines, Ia. | WSY
Birmingham, Ala. |
| WBAH
Minneapolis, Minn. | WLW and WSAI
Cincinnati, Ohio |
| WHAZ
Troy, N. Y. | KGW
Portland, Ore. |
| WJAR, WTAG, and
WEAN
Providence, R. I. | WNAR
Butler, Mo. |
| | KFI
Los Angeles, Calif. |
| | CFCA
Toronto, Ont. |

"A"

Willard "A" Batteries at a range of prices, including the Willard All-Rubber Battery, with rubber case and Threaded Rubber Insulation. It's the finest A battery made. Five sizes, 20 to 125 a.h.



"B"

Willard "B" Batteries in 24 volt or 48 volt units, each in two capacities, 2500 and 4500 m.a.h. Use of glass jars enables you to see condition of battery at all times.



A new battery charger, noiseless and indestructible



FANSTEEL BALKITE

is a new metal developed for this charger. It acts as a valve, allowing alternating current to flow into the battery but not out of it. It is the most efficient charger valve made, is practically indestructible, and does away with noisy, delicate vibrators and fragile bulbs.

The Gould Battery Company is also marketing, under the Fansteel Balkite Patents, a complete battery and recharging unit known as the Gould Unipower, into which this charger, under the name, "The Fansteel Balkite Rectifier," has been incorporated.

The Fansteel Balkite Battery Charger for Radio "A" Batteries is an entirely new type of electrolytic rectifier, based on the use of Fansteel Balkite, a new and rare metal developed for this purpose. It does away with all noise, cannot deteriorate through use or disuse, has nothing to replace, adjust, or get out of order, cannot discharge or short circuit the battery, and requires no attention. There are no moving parts, bulbs, or fuses. It will not overcharge, and cannot fail to operate when connected to the battery and line current. It is unaffected by temperature or fluctuations in line current, and will charge a completely dead battery. It is simple, efficient, and indestructible except through abuse.

This charger can be operated while the set is in use without affecting the set or its operation, and without disturbing noises.

FANSTEEL
Balkite
PATENTS APPLIED FOR
Battery Charger

The Fansteel Balkite Battery Charger will charge the ordinary 6 volt radio "A" battery at 3 amperes, and a 12 volt at 1½ amperes, from 110 AC, 60 cycle current. It comes complete and ready for use. Get it from your dealer, or use the coupon below.

Price, \$18

\$18.50 West of the Rockies

FANSTEEL PRODUCTS CO., Inc., No. Chicago, Ill.

Dealers and Jobbers: The Fansteel Balkite Battery Charger does away with complaints and replacement troubles. Write for literature and discounts.

Dept. 5A

FANSTEEL PRODUCTS CO., North Chicago, Ill.

Enclosed please find \$18. (\$18.50 west of the Rockies.) Send me the Fansteel Balkite Battery Charger for Radio "A" Batteries. If I am not entirely satisfied I will return it and you will refund my money.

Name

Street

City..... State.....

GIVE YOUR EARS A TREAT!—USE
'RED-HEADS'
3000 Ohms
Now \$6.50
With Military Head-Band and Cord
At your dealers or direct on receipt of price.
A Triumph in Radio, Receiver Design
The Newman-Stern Building
Newman-Stern Building
Cleveland, O.

WHY—
Do users of Silvertone A-F Transformers get unusual results?
Write
W-K ELECTRIC COMPANY,
Kenosha, Wisconsin.

SELLING OUT
We have left 200 of the famous long distance \$132.50 Westinghouse R.C. three tube regenerative sets which must be sold quickly. We are offering these to the Public at \$55.00. Every set guaranteed and in original box. Real bargain, take advantage of it. \$10.00 money order or check must accompany each order; balance, C. O. D. Immediate shipments.
BROOKLYN RADIO SHOP
654 Quincy St. Brooklyn, N. Y.

(New Zealand Stations)

Kaitiaki	220 meters
Dargaville	190 meters
Thames	195 meters
Tauranga	225 meters
Rotorua	190 meters
Whakatane	250 meters
Te Kuiti	240 meters
Taumarunui	210 meters
Hawera	190 meters
Hastings	195 meters
Wanganui	220 meters
Dannevirke	250 meters
Masterton	195 meters
Westport	190 meters
Kaikoura	220 meters
Camaru	225 meters
Queenstown	190 meters
Roxburgh	250 meters
Gore	195 meters

Where only one broadcasting station is licensed, the operating hours subject to the discretion of the Minister are unlimited, but where there are two or more stations licensed to broadcast, the Minister shall determine the hours of operation.

Neither direct nor indirect advertising shall be undertaken by a broadcasting station, but at the commencement of each separate item the broadcasting station shall repeat its call letters three times and may announce the full name and address of the station.

Broadcasting stations shall be restricted to the dissemination of matter of an educational or entertaining character, such as news, lectures, useful information, religious services, music or elocutionary entertainment, and such other items of general interest as may be approved by the Minister.

On Sundays, during the hours of 11:00 A. M. to 12:30 P. M. and 6:30 P. M. to 8:00 P. M., priority shall be given to the broadcasting of religious services and kindred matter.

Experimental stations may be licensed to use wave-lengths from 390 to 410 meters. These stations must be in charge of a person holding an amateur operator's license of Grade 1 or higher. Hours of transmission shall be determined by the Minister and additional privileges may be granted to facilitate temporarily approved investigations.

Annual fees to be paid in respect to licenses are as follows:

Amateur Operator, Grade 1	£0—5—0
Amateur Operator, Grade 2	0—5—0
Amateur Station (for receiving only)	0—5—0
Amateur Station (transmitting and receiving, Grade 1)	2—0—0
Amateur Station (transmitting and receiving station, Grade 2)	1—0—0
Experimental transmitting and receiving station	3—0—0
Private broadcasting station	2—0—0
Toll broadcasting station	5—0—0

The only copies of Order in Council, dated January 17, 1923, and Order in Council, dated February 12, 1923, applying the foregoing regulations to Western Samoa, available in Apia are filed in the archives of the Consulate at Apia for reference.

AMATEURS INCREASE BY 1,334 IN FIVE MONTHS

Lest some fans believe that the reception of broadcasts is the only popular phase of the radio art, be it known that amateurs are still entering the game of "key pounding" at the rate of nearly three hundred a month. Since January 1, 1,334 amateur licenses have been granted by the Department of Commerce, and on June 5 there were 18,232 such stations in the United States.

The distribution of amateur stations by districts June 5th was as follows:

District Headquarters	Total
1 Boston	2,490
2 New York	2,629
3 Baltimore	1,994

WANTED—Back numbers of Radio News, Dec., 1921, Jan. and Feb., 1922. Experimenter Publishing Co., 53 Park Place, New York City.



"I traveled 20,000 miles in one evening!"

Mr. M. J. Doherty of Oak Park, Ill., writes: "Many nights I hear Station KHJ (Los Angeles), CFCN (Calgary, Canada), WEAJ (New York) and others as far away. In one evening of four hours and twenty minutes I heard 30 stations, scattered all over the continent. These stations were a total distance of 20,575 miles from my home."

Many wonderful and unsurpassed distance records have been made during 12 years wide use of Tuska-made radio instruments.

Tuska Popular No. 225 3-bulb Regenerative Receiving Set. Piano finish mahogany cabinet. Amplifier switch. Concealed binding posts. Armstrong circuit, licensed under Patent No. 1,113,149. Price \$75, without bulbs, batteries or loud speakers. Ask for special circular 11-D describing this set.

Let the day's troubles sink with the sun

Then turn to your Tuska Radio, and be whisked around the world as if by magic. A touch of the dials, and you are in Davenport, listening to a singer with a voice like a nightingale. A slight movement brings you to Philadelphia to hear the rolling, majestic music of the greatest organ. Regretfully, you turn away, to pick up the latest flashes of news from New York. In those few precious hours between work and sleep, you live in Radio Fairyland, where you are master of distance and ruler of a host of entertainers.

Will you give your family or yourself the pleasures of Tuska Radio, which educates, soothes, amuses, and

takes all of you traveling inexpensively? Here is the receiver that always works; that annihilates miles; that brings in music and voices sweetly, clearly and undistorted. It is the ideal set for busy people who want the thrills of radio without the tinkering.

For a dozen years, Tuska-built radio receivers have been famous for advanced design, and painstaking New England workmanship. The Tuska receiving set of today is not only up-to-date; it will still be good for service in five years or more. Tuska Radio will give you hundreds of dollars of value in joy for every dollar it costs you. It will never disappoint you or your company.



The C. D. TUSKA CO.
Hartford, Conn.

TUSKA RADIO

4	Norfolk	444
5	New Orleans	941
6	San Francisco	2,172
7	Seattle	901
8	Detroit	2,932
9	Chicago	3,729

Total18,232

The above table does not include special amateurs, of which class there are 201, no new licenses having been issued recently. It has been decided by the Department that hereafter District Radio Supervisors will issue special amateur station licenses instead of the Washington Office.

The waves assigned to special amateurs are between 150 and 220 meters for use in C.W. telegraph. Regular amateurs operate on 150 to 200 meters.

LOOK OUT FOR FAKE RADIO INSPECTORS

A "fake" radio inspector has been issuing "licenses" to amateur and broadcasting stations in Minnesota, the Department of Commerce has been advised. Using the return stub of an amateur application blank secured from the Department, an individual giving his name as Cecil Osborne is said to have supervised the installation of a radio station in Minnesota, and issued what he called a license.

This imposter claimed that he was a former radio operator of the Navy Department and a member of the Naval Reserve. The only record of a man of that name in the files of the Navy Department, is that of a deserter who served for a time as an apprentice and seaman. He deserted in San Francisco in July, 1922, the official records state.

All radio inspectors of the Department, the officials in Washington point out, are supplied with means of identification, including official badges and identification cards bearing their photographs. Amateurs and broadcasters are advised to ask for identification cards and to pay no fees for licenses. Although the White Radio bill contemplated the payment of fees for licenses, it failed to pass; the present law provides for the licensing without charge.

TITLES OF RADIO INSPECTORS CHANGED

The titles of all radio inspectors in charge of the different radio districts have been changed to "Supervisor of Radio." In future, the correspondence should be addressed "Supervisor of Radio," in lieu of Radio Inspector.

9 AYX

The call 9AYX has been reassigned to Ray Keller, of 1315 N. 2nd St., Belleville, Ill.

8 CDC

QRA 8CDC; John Taylor Galey, 363 Third St., Beaver, Pa.

4 QS

The call 4QS has been assigned to W. H. Knowles, Jr., Pensacola, Fla. Any reports on my I.C.W. sigs. will be appreciated.

8 CQN

QRA 8CQN; Mr. Ralph Powers, 5138 Gratiot Ave., Port Huron, Mich. All cards answered.

6 IQ

The call 6IQ has been reissued to Mr Chester Glass, of Glendale, California.

7NT

The call 7NT has been issued to Abner R. Willson, of 1321 West Platinum Street, Butte, Mont. Have 10-watt A.C.C.W. 20-watt C.W. phone and B.M. C.W. Schedule—Monday, Wednesday and Saturday, 11 P. M. to 1 A. M.



HEAR YE!

THE beautiful tone of a Stradivarius or the wonderful technique of a famous voice cannot be reproduced by inferior headphones.

The successful performance of your receiving set depends upon the quality and perfection of the headset you purchase.

Twenty-five years of constant and painstaking manufacture by the Holtzer-Cabot Electric Co. has produced for you the perfected No. 2 Universal Headset.

This light weight, sanitary set reproduces positively and faithfully with an exceptional purity of tone and extreme sensitiveness.

Holtzer-Cabot No. 2 Universal, \$8.50
Holtzer-Cabot No. 4 National, 5.50

If your dealer is unable to supply you, write us direct, giving us his name. We shall be pleased to send you a copy of our booklet, "What You Should Know About Radio Reception."

THE HOLTZER-CABOT ELECTRIC CO.
125 Amory St., Dept. D Boston, Mass.
6161-65 So. State St. Chicago, Ill.



HEAD-SETS

LOUD SPEAKING CRYSTAL SET

At Last



You can add a loud speaker to any crystal set by using the STEINMETZ Amplifier costing only \$3.50. Guaranteed to operate on any kind of crystal set regardless of what type it is, or we will refund your money.

By using your crystal set with this amplifier music is brought in as clear as a bell and can be heard all over the room. Amplifier uses dry cell tube. Write for our complete catalog and information on a highly efficient detector and two-stage amplifier at \$22.50.

STEINMETZ WIRELESS MFG. CO.
Manufacturers and Engineers
5705 Penn Ave. Pittsburgh, Pa.

WORKING KNOWLEDGE

Of Radio Code and License

In 3 to 10 days. Learning Records Licensed Students all districts FREE on request.

C. K. Dodge, Dept. N, Mamaroneck, N. Y.

BECOME A PROFESSIONAL PHOTOGRAPHER



EARNING \$35 TO \$125 A WEEK

Three to six months' course. Motion Picture, Commercial, Portraiture. Practical instruction. Modern equipment. Ask for Catalog No. 56.

N. Y. INSTITUTE OF PHOTOGRAPHY
NEW YORK CHICAGO BROOKLYN
141 W. 36th St. 630 S. Wabash Ave. 505 State St.

No wireless receiving set complete without

Magnavox Radio

The Reproducer Supreme

IT has been the dream of every Radio user to own in one unit a Power Amplifier and electro-dynamic Reproducer, thus insuring perfect Radio reproduction.

After exhaustive study and tests by our engineers, this has been successfully accomplished, and the new instruments of the unit type here illustrated in one and two stages of amplification may now be had through Magnavox dealers everywhere.

There is now a Magnavox for every receiving set. The full line embraces:

Magnavox Reproducers

- R2 with 18-inch curvex horn . \$60.00
 R3 with 14-inch curvex horn . 35.00
 M1 with 14-inch curvex horn.
 Equipped with binding posts
 and a five foot flexible cord;
 requires no battery for the field. 35.00

Magnavox Combination Sets

- A1-R consisting of electro-dynamic
 Reproducer with 14-inch curvex
 horn and 1-stage of amplification 59.00
 A2-R consisting of electro-dynamic
 Reproducer with 18-inch curvex
 horn and 2 stages of amplification 95.00
 Special: with 14-inch curvex
 horn as illustrated . 85.00

Magnavox Power Amplifiers

- A1—new 1-stage Power Amplifier 27.50
 AC-2-C—2-stage Power Amplifier 55.00
 AC-3-C—3-stage Power Amplifier 75.00

Magnavox Products can be had of
 good dealers everywhere. Ask for
 a demonstration.

THE MAGNAVOX CO.
 OAKLAND, CALIFORNIA

370 Seventh Ave., New York

World pioneers in the development and manufacture of
 sound amplifying apparatus



*New Magnavox
 Combination Set*

A2-R insures convenient and perfect Radio reproduction. Designed especially to meet the requirements of receiving sets used in the home.

Magnavox Reproducers and Amplifiers

MU-RAD ★ RECEIVERS

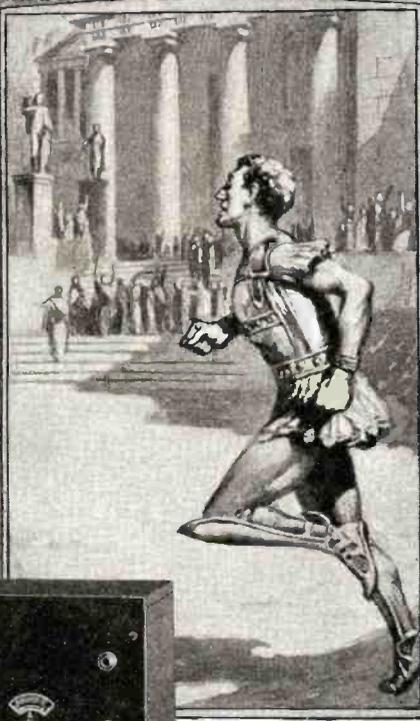

The Ultimate in Radio Reception



To bring the news of the Greek victory over the Persians at Marathon a runner was dispatched to Athens, 24.85 miles away. Reaching the market place, he cried out, "Rejoice, we conquer!" and fell dead.

The New Star in the Radio World



EVERY ADVANCE of civilization has depended upon the progress of communication. From the Athenian runner, to the instantaneous transmission of intelligence by radio is a triumph of science. As one Athenian runner was preferred over another for speed and accuracy, so today MU-RAD Receivers are chosen for the most perfect reception of radio broadcasting. Four thousand miles and more are spanned with delightful ease by the MU-RAD Receiver. Uses only a two-foot loop aerial. Utmost efficiency with utter simplicity. Guaranteed conservatively for 1000 miles reception. *Be satisfied with nothing less than the ultimate attainment of the radio science — a Mu-Rad Receiver.*

WRITE FOR LITERATURE

MU-RAD LABORATORIES, INC.
801 FIFTH AVE. ASBURY PARK, NEW JERSEY

9AXB
The call 9AXB has been reissued to Charles Bennet, Aurora, So. Dak. Am using 5-watt I.C.W. Would appreciate reports on my signals.

5AHC
QRA-5AHC—Mr. Lee Wilkinson, 725 Texas Street, Denison, Tex.

2AUR
The call 2AUR has been issued to Harry M. McMenimen, Jr., of Scotch Plains, N. J. All cards answered.

4PM
QRA-4PM—L. C. Hull, Cherryville, N. C. 10-watt C.W.

5LG
The call 5LG has been reissued to Kenneth Tatum, of Alamogordo, N. Mex., 10-watt C.W. All cards answered.

5AKZ
The call 5AKZ has been issued to John Porter, Alamogordo, N. Mex. 5-watt C.W. All cards answered.

Atlantic Ferry Happenings

(Continued from page 420)

fitted by the British Marconi Co. and are an improved Belleni-Tosi type, two triangular aerials at right angles to one another being utilized instead of the movable frame.

It is reported that the first Wireless Beacon in the United Kingdom will be experimentally installed by the Mersey Dock and Harbor Board on the Bar Lightship at the entrance to the River Mersey, Liverpool. It is more than probable that others will follow, once its utility has been proved to the "powers that be."

The British Postmaster General has announced that owing to the interference which the long range C.W. station at Devizes, England, is subjected to, a receiving station is to be erected at Weston-super-Mare on the Bristol Channel. This will be welcome news to all operators on board those trans-Atlantic vessels equipped with long-wave transmitters. Weston-super-Mare, by the way, was the spot chosen by Marconi during his first tests in England when communication across the Bristol Channel between Weston and Lavernock near Cardiff was successfully accomplished. The new station is to be fitted with automatic reception and transmission to cope with the larger vessels fitted with "Auto" apparatus. Both the *Majestic* and *Olympic* are now fitted with automatic transmission and reception, and some exceedingly good work has been carried out intership and with Chatham (WCC).

The 600-meter spark station at Valentia, Ireland (GCK), is still without land line communications, but vessels may now clear their traffic to him with the assurance that it will be subjected to very slight delay. Arrangements have been concluded whereby vessels in communication with an English Coast Station will forward any messages which Valentia may give them without extra charge.

The eleventh anniversary of the sinking of the *Titanic* was specially observed by the U. S. Ice Patrol in mid-Atlantic, when wreaths were dropped overboard in the vicinity of the disaster. Thanks to the excellent work of the Ice Patrol and the use of radio, such disasters have become, we hope, things of the past. Suggestions are on foot that the broadcasting of ice warnings should be made on a longer wave, as those issued by the Ice Patrol and Cape Race on 600 meters are frequently mutilated by QRM. All operators who believe that such an alteration will help in the reception of these warnings should bring the matter to the attention of their respective administrations without delay.

RUSONITE

CRYSTAL RECTIFIER
(Patent Pending)

THE PERFECT SYNTHETIC CRYSTAL DETECTOR SENSITIVE OVER ENTIRE SURFACE

No Hunting for "Spots." Loud and Clear. Endorsed by Thousands of Satisfied Users.

Sensitiveness	Price	50c
Guaranteed	Mounted	
14 K. Gold Supersensitive		
RUSONITE CATWHISKER. Price		25c
Permanent. Will not Oxidize.		
RUSONITE REFLEX CRYSTAL		
Manufactured Expressly for Reflex Circuits		
Will Stand Up Under Heavy Plate Voltage		
Guaranteed	Price	\$1.00
Mounted		

Order from your dealer or direct from
RUSONITE PRODUCTS CORP.
15 Park Row New York, N. Y.

NOVO "B" BATTERIES

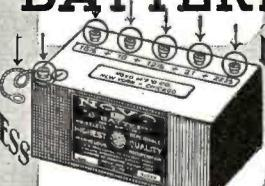

NOISELESS

DEPENDABLE

NOTE THE INSULATED BINDING POSTS AND 7/16" WIRE CONNECTOR

NOVO M'FG CO.
424 W. 33rd ST. NEW YORK
531 SO. DEARBORN ST. CHICAGO

Three Tubes Is All You Need

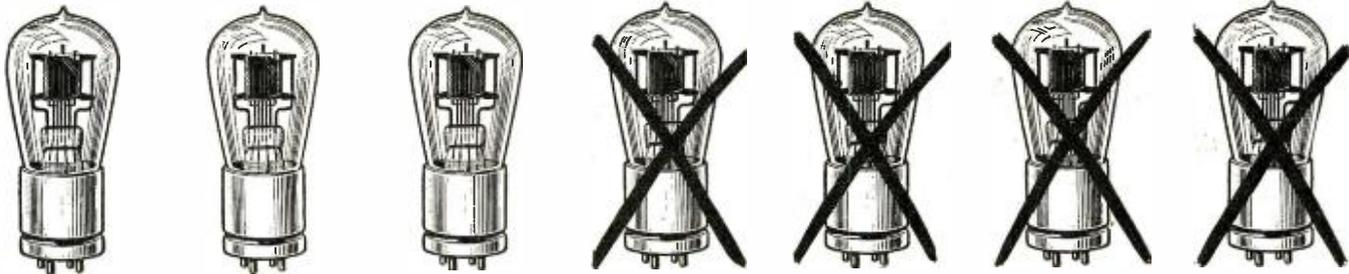

With Erla Synchronized Transformers



Perfect synchronization of Erla transformers assures unequalled range and volume, with no trace of distortion. Cascade \$4. Reflex \$5



Especially constructed for reflex work, the Erla fixed crystal guarantees success. Proof against disturbance through jolt or jar. List \$1



Every Erla fixed condenser is individually tested to the exact capacity shown, an exclusive feature. Made in eleven sizes. 35c to \$1



Precision workmanship and highest grade materials in Erla sockets lend extra attractiveness to the costliest receiving set. List \$1

Transcontinental reception, through a loud speaker, is assured when you tune in with the new Erla Triplex circuit, using three vacuum tubes and Erla synchronized radio frequency and audio frequency transformers.

Results obtained surpass conventional six and seven-tube circuits in range and volume. Moreover, tone quality is remarkably improved, with complete absence of the parasitic noises common to hook-ups less advanced.

For all except the most distant stations, outdoor antenna can be dispensed with, an inside aerial serving equally well. Wet batteries, likewise, are no longer essential, low current consumption enabling satisfactory use of dry cells.

Accounting in large measure for the amazing efficiency of this circuit, and guaranteeing its successful operation, are Erla synchronized radio and audio frequency transformers. For the first time, perfect inter-relation and co-ordination between transformers has been secured in reflex work, producing unequalled amplification without distortion.

A further notable contribution to radio improvement is embodied in the new Erla fixed crystal detector. Providing maximum sensitiveness and purity of reception, with complete freedom from disturbance through jolt and jar, it antiquates the costly vacuum tube for detector purposes.

Detailed working diagrams and descriptions of the Erla Triplex and other advanced Erla reflex circuits are included in Erla Bulletin No. 14, obtainable gratis from leading radio dealers. Or, if your dealer should be unable to supply you, write us direct, giving your dealer's name.

Electrical Research Laboratories

Dept. C

2515 Michigan Avenue, Chicago



One of the most notable improvements of recent years is disclosed in the new Erla synchronized audio frequency transformer. List \$5



No high grade panel assembly is complete without Erla bezels, in bright nickel or dull enamel. Fit any panel, in 1" and 1 1/2" sizes. 20c ea.



Handling two sets of phones, with maximum simplicity and ease, the Erlaphone plug is unexcelled, in practicability and intrinsic value. 75c

JOBBERS—Sample Triplex receiving sets, mounted in a solid mahogany cabinet, will be supplied upon request, at manufacturing cost, for demonstrating Erla synchronized transformers in real service.

ERLA

TRADE MARK REGISTERED

The Receiver famous thru Performance Telmaco



Type B-R Receiver

fully meets the requirements of the discriminating purchaser because of the following features:

EFFICIENCY OF OPERATION: Securing volume, distance (1500 miles with single tube is not unusual), selectivity: broadcasting stations one-half mile distant are tuned out by a slight turn of condenser dial.

EASE OF OPERATION enabling the novice to secure satisfactory results.

HIGHEST QUALITY OF WORKMANSHIP AND MATERIALS.

\$25.00 PRICE within the reach of everybody.

Manufactured exclusively for us by

Tri-City Radio Electric Supply Co., licensed under Armstrong U.S. Patent No. 1113149, Oct. 6, 1914.

Telmaco BA 2-Stage Amplifier for the Above \$20.00

**Our New Radio Guide Book
Sent at Your Request**

Our new 64-page Catalog No. TCR contains twenty of the most popular radio circuits printed in blue. These include the Hazeltine Neutrodyne, Grimes Inverted, Colpitts, Flewelling, Reinartz, Diode Electrad, Heterodyne, Super-Regenerative and many others. Each article used in circuit is attractively pictured instead of appearing in straight schematic form. Besides containing blue prints, the best in radio is also illustrated and described. Catalog sent postpaid for ten cents. Each circuit worth double."

Send for your copy today

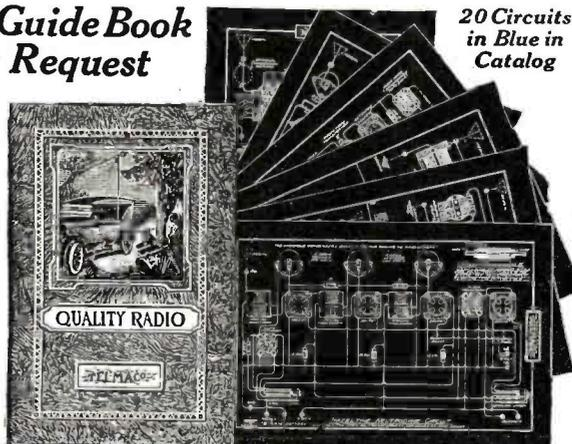

20 Circuits
in Blue in
Catalog

JOBBERS We have an attractive proposition for a few more bona-fide Jobbers

DEALERS If your Jobber cannot supply you order direct

TELMACO
Quality Radio Exclusively

Radio Division
TELEPHONE MAINTENANCE CO.

20 So. Wells St., Dept. B, Chicago, Ill.

"COPPERWELD"
THE IDEAL RADIO ANTENNA

COPPERWELD IS 50% STRONGER than Copper, can be strung taut, stays up when other wires stretch and break, and gives 100% electrical efficiency.

COPPER CLAD STEEL COMPANY
BRADDOCK P. O., RANKIN, PA.
Directions for Antenna construction on reverse side of carton

**THE FRANSEN TUNER
AND VARIOCOUPLER**

AT LAST THE PERFECT TUNER for Broadcast Reception.

The most efficient and selective tuner made. For single circuit with tickler or variocoupler with loose coupled primary and secondary circuits.

Perfect and continuous variation of the inductance of the antenna circuit without SWITCHTAPS and without a VARIABLE CONDENSER in the antenna circuit.

Complete for panel mounting, postpaid, \$7.50.

RADIO RESEARCH LABORATORIES
ATASCADERO, CALIFORNIA

The Cunarders, *Berengaria*, *Aquitania* and *Mauretania* claim to be the first vessels to print a daily newspaper on linotype machines. This is largely due to the enterprise of the London *Daily Mail*, which supplies special News Bulletins to the vessels and also edits the same on board these vessels. It is rumored that a leading New York paper is about to follow suit on other large trans-Atlantic liners.

The new Red Star liner, *Belgenland*, has just concluded her maiden voyage under that name. Built during the war, she was utilized before completion, owing to the shortage of tonnage. As the *Belgic* she rendered excellent service in the conveyance of freight—her tonnage making her the largest and her speed the fastest "cargo" boat afloat. Her old call letters are being retained.

RADIO AGAIN PROVES OF VALUE

Another instance where Radio played an important part on the sea, occurred recently, when by its use six stowaways were transferred from the steamer *Southseas* bound from the West Indian ports, to the steamer *Southlands* bound for West Indian ports. Both ships belong to the same company. When communication was established between them, Capt. Dees, commander of the *Southseas* suggested that Capt. Kristofferson, of the *Southland* take charge of the stowaways.

Agreement was made and the two ships met in the central part of the Gulf of Mexico, the *Southlands* taking the stowaways and returning them to their home country.

AUTOMATIC TRANSMISSION AND RECEPTION

During the last ten years commercial companies developed automatic printing telegraph equipment for the transmission over land wires of typewritten characters from one point to another. The present means of copying signals with the tape requires the employment of two or three extra men for translating purposes. Due to the reduction in operating personnel in the Naval Service, it became imperative to devise means to operate stations with reduced personnel. Experiments conducted in 1922 proved conclusively that automatic printing equipment could be applied to radio as well as to land wire. So much faith was placed in this new method of transmission and reception that automatic recording telegraph equipment has been installed in Naval high power circuits at San Diego and Washington.

RADIO TRANSMISSION RECORDS BY CRUISER "OMAHA"

By WASHINGTON RADIO NEWS SERVICE

Naval radio experts are delighted with the performance of the radio equipment on the new Scout Cruiser *Omaha*, which recently broke all long-distance records transmitting during her "shake-down" cruise in the Pacific.

While maneuvering at sea off the coast of Washington, the newly installed radio transmitting sets were given a thorough test. Code messages transmitted with the 20-k.w. arc set, such as the larger Naval craft are now equipped with, were copied by all Naval radio stations along the west coast from lower California to Saint Paul, Alaska, and on the East Coast at Bar Harbor, Me., Washington, D. C., and Key West, Fla. One of the stations reached was San Diego, 1800 miles away from the *Omaha*. This new cruiser's arc was copied by the Battleship *California*, which was 1800 miles distant, but it is reported that she could not pick up the *California's* replies.

Not only in code dispatches did the *Omaha* radio experts excell, but with her 300-watt tube set, spoken messages were transmitted to Pearl Harbor, Honolulu, 2300 nautical

Radio, loud and clear or radio "a la racket"

*The vital importance of using the proper
amplifying transformer in your radio set*

TENS of thousands of experienced radio owners throughout the United States, Canada and Cuba have adopted the Acme method to secure loud, clear broadcasting from stations five hundred to three thousand miles away.

The results have been marvelous. Loud, clear radio concerts are now heard with sets which once seemed capable of producing only weak or distorted, almost unintelligible sounds. If you are not already using that new method, this offers you a way to learn how.

Amplification not enough

Amplification, the very thing that eliminates distance and makes it possible for a roomful of people to be entertained at one time, is also the chief cause of distortion. For it is not enough merely to amplify sounds.

When you hear an opera singer's voice from New York sound like cat-calls, you have amplification, but you also have distortion.

The source is excellent but the energy of the voice goes through so many changes in form that unless proper apparatus is used, it reaches your ears garbled and almost unrecognizable. Distortion like static seems to have been taken for granted by most radio owners. Yet static is a natural, uncontrollable function of the elements while distortion is a controllable function of man-made apparatus.

How sound is distorted

With the vacuum tube, amplification can easily be obtained—but to amplify without howling and hissing requires a specially designed transformer which can eliminate resonance. For it is resonance or pathways in the ordinary transformer which makes it easier for some frequencies or sound waves to pass through than for the others. The sound waves overlap, causing blurring and other distortion. Each stage of such amplification added to the single tube set only serves to increase the distortion as the volume of sound is increased.

Overcoming distortion

Radio and sound engineers, after long research have at

last perfected two instruments which together insure maximum volume, clarity and distance. First they designed a special type of amplifying transformer which does not distort over the voice and musical range. This wonderful instrument with its 4.25 to 1 ratio allows its use with any vacuum tube now made, either dry or storage battery type.

This is called the Acme A-2 Audio Frequency Amplifying Transformer. When used with one stage of amplification (consisting of a vacuum tube, the Acme A-2 Transformer and certain minor apparatus) it produces strong, clear signals in any head set. When two Acme A-2 Audio Transformers are used, an Acme Klee-speaker or other loud speaking device may be hooked-up and clear, undistorted music received in volume.

Then these same engineers designed a second instrument which would add great distance to any set. This builds up the strength of the incoming radio waves before they are acted on by the detector. As a result signals from far distant stations (which had hitherto never been of sufficient strength to cause the detector to act) can now be secured and with the aid of Acme A-2 Audio Transformers turned into loud, clear, undistorted concerts. This second instrument is the Acme Radio Frequency Transformer, and is made in three types, R-2, R-3 and R-4, for more than one stage of radio frequency amplification.

How to get best results

In order to secure the best results with Acme Transformers, which are sold in practically all radio and electrical stores you should send for "Amplification without Distortion," an instructive and helpful book which not only explains exactly how to secure the best results with these two kinds of Acme Transformers on your own radio set (large or small), but also includes a number of wiring diagrams which will be helpful if you desire to build a set.

Send for booklet

Amplification and distortion are clearly explained, and methods of determining the causes of poor results with amplification are described. The book also explains how to get Audio and Radio Amplification in the same vacuum tube—the "REFLEX" System. Mail the coupon with ten cents now to secure your copy. Acme Apparatus Company, Dept 20, Cambridge, Mass., U. S. A.

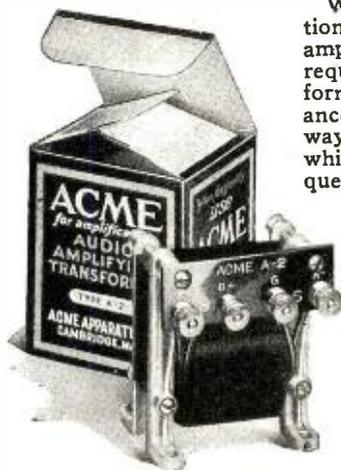

THE Acme A-2 Audio Transformer (shown) and Acme R-2, R-3 and R-4 radio frequency transformers sell for \$5 each. For prices on special transformers or coils, for any type of business, send specifications to factory.

ACME

for
amplification



A beginner on the trombone makes noise — but little music. Unless the proper transformer is used, radio sets do likewise.

ACME APPARATUS COMPANY, Dept. 20,
Cambridge, Mass., U. S. A.

Gentlemen:—Enclosed find ten cents (U. S. stamps) (U. S. Coin) for "Amplification without Distortion."

Name

Street

City State



The New Plug A Weston Product

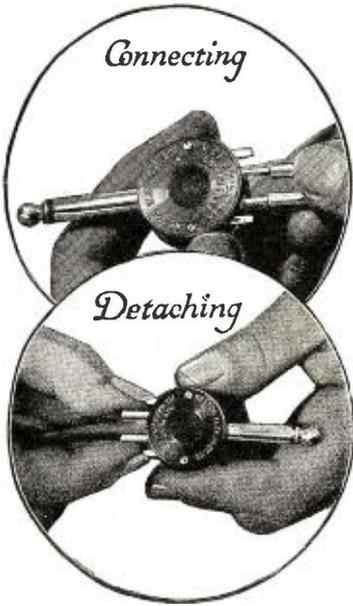

Unique—exceptionally handy—especially constructed for speed and perfect contact. Originally designed for our own use only—but the plug was so outstanding in its special features and merit it is now offered to the public.

So Convenient

will be your first exclamation. When you are in a hurry—just shove the terminals into a Weston plug—instant contact.

Or to disconnect with equal speed—press the triggers and pull out your terminals. No broken fingernails—no tools required. Requires but a fraction of a second to connect or disconnect it.

Looks as good as it works—typical of Weston workmanship. Try one and see if this plug is not infinitely superior to any plug you have ever used.

At All Dealers—Price \$1.00

If your dealer can't supply you, sent postpaid on receipt of price and name of your dealer.

WESTON ELECTRICAL INSTRUMENT COMPANY

173 WESTON AVENUE

NEWARK, N. J.

Makers of the World's Standard Electrical Instruments



STANDARD - The World Over



PATENT APPLIED FOR

THE FAVORITE Radio Cabinet

makes a high class Radio Instrument. It operates any good hook-up.

With one vacuum tube it operates a loud speaker. No loop, no aerial, no ground, or other attachments necessary. It fills all vacancies.

THE FAVORITE has won the heart of the nation. Everybody who sees it, want one and those who have the price, buy one.

It is a beautiful piece of household furniture and adds to the appearance of the finest home.

A FAVORITE in operation on the floor of a dealer attracts all the attention of his customers. Write for descriptive matter and prices.

Special discount to the trade.

Manufactured by

G. A. BARTHOLOMEW
409 Guardian Building, Cleveland, Ohio

Parts and Accessories for makers of radio apparatus



Details and Prices on request
GENERAL RADIO CORPORATION
Sole Distributors of
First Quality Radio Equipment
including *MUSIC MASTER RADIO Reproducer*
10th and Cherry Streets Philadelphia

AMPERITE
AUTOMATIC FILAMENT CURRENT ADJUSTER
FOR EVERY STANDARD TUBE
ELIMINATES RHEOSTATS
EXPELS ALL TUBE TROUBLES
FROM YOUR DEALER OR
RADIALL COMPANY \$1.10 WITH MOUNTING
558 GRAND AVE., NEW HAVEN, CONN.

miles distant. They were also heard at Key West, Fla., approximately 2100 miles over land and sea.

Part of the credit for the long-distance work is attributed to the 180' wooden masts, which carry the *Omaha's* aerials, almost 50' higher than the steel masts on Battleships. The mean effective height on the *Omaha* is better than 100', it is stated by Naval experts. Her radio equipment is also installed on the "top-side" and not below, eliminating long cable and wire leads.

LEVIATHAN ANSWERS TO WSN

When the Shipping Board's giant Leviathan sailed on her trial trip from Boston in the middle of June she kept in touch with the land radio stations by radio, and answered the call WSN. Radio operators Jack Irwin and E. N. Pickerill were in charge of the radio apparatus.

LONG DISTANCE

A wireless message from the naval station at Cavite, P. I., addressed to San Francisco for relay to Washington was picked up in the Washington Radio Central recently and copied before the San Francisco operator indicated its receipt. Needless to say, it was not relayed to Washington. This message was copied without error over 11,500 miles of sea and land.

NAVAL OFFICER OPERATORS

Very few naval officers assigned to communication duties are efficient radio operators according to naval records. An officer assigned to such duty should consider it his first duty to learn at once the code, and, after mastering it, a few hours "listening-in" each day with an experienced operator, will soon enable him to operate. Only by this method can an officer acquire first-hand information regarding the efficiency of his operators in transmitting and in the observance of procedure, communication officials say.

EXAMINATION FOR RADIO GUNNER

It is expected that the Naval Bureau of Navigation will hold an examination for Gunner (Radio) about the middle of August, 1923. The Bureau will notify the service at large as soon as it is definitely settled. In all probability, requirements for this examination will be the same as those incorporated in the Bureau's Manual. This is a step in advance for radio in the Navy as the Gunner is a Warrant officer and stands next to the commissioned personnel.

The Celebrated Pilkey Radio Case

(Continued from page 392)

often that it was on everybody's mind, and especially on Edbert's mind.

Edbert was a nice little fellow with a bald head and mild blue eyes. He worked in a bank and wore eyeglasses with a black ribbon with a white edge and white edging in the V of his vest, and he taught a Sunday School class and hoped some day to be Superintendent of the Sunday School. He was a sweet, gentle little man and at the bank had charge of the Ladies' Department.

Monday night, after the dress rehearsal of the wedding ceremony, Edbert and Anna May stole away to have a few minutes of love and kisses together, as lovers do. The ushers had cleared away the rugs in the big parlor and were dancing with the bridesmaids, so Edbert and Anna May went into the little back library, which Mr. Bunce had taken to calling the Radio Room, because his radio apparatus was there. Edbert pulled a large arm chair up to the radio table and

FIL-KO-STAT CONQUERS DISTANCE

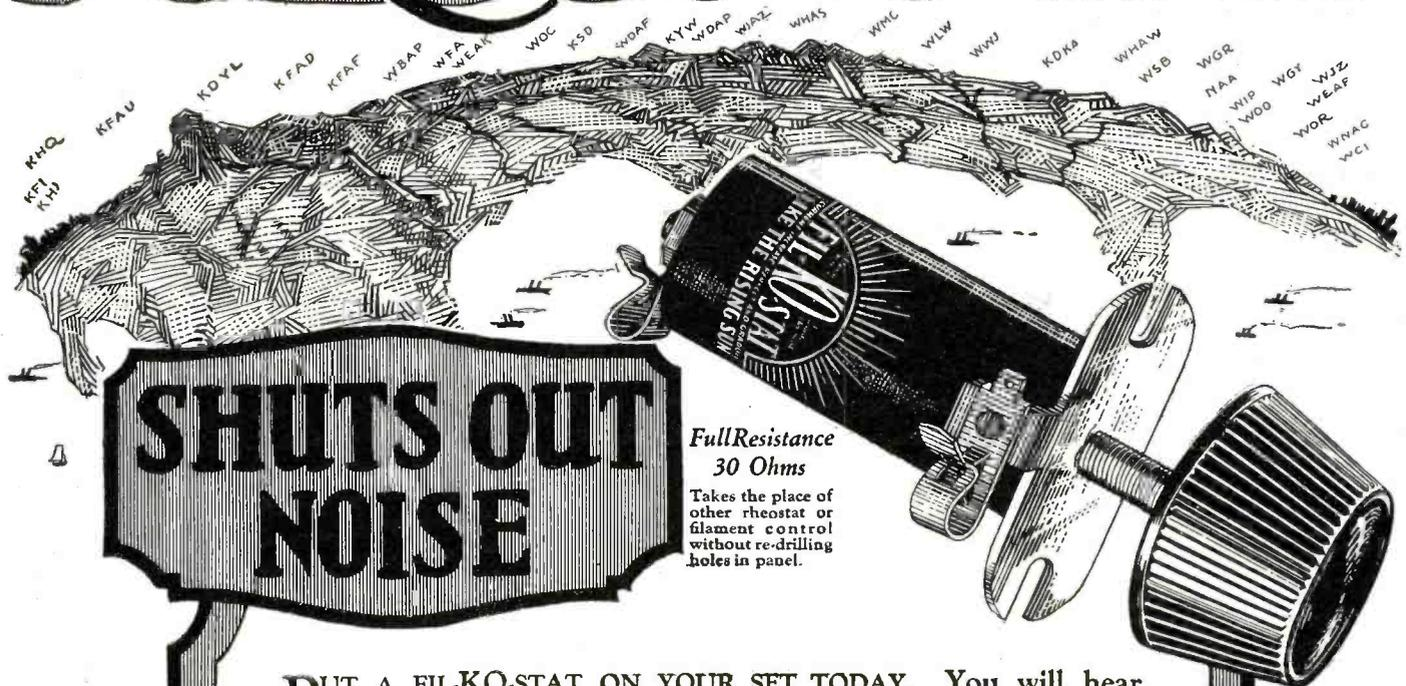

SHUTS OUT NOISE

**Full Resistance
30 Ohms**
Takes the place of other rheostat or filament control without re-drilling holes in panel.

PUT A FIL-KO-STAT ON YOUR SET TODAY. You will hear stations you believed to be far beyond its range. You will get greater distance! Louder signals! Finer adjustment! NOISELESS OPERATION! A. S. Allsup, of Kansas City, writes, "Since using my Fil-Ko-Stat I have picked up 5 stations I never heard before."

The FIL-KO-STAT is the filament control of INFINITE adjustment, with a fine adjustment area 18 times greater than a wire rheostat, and several times greater than the next best filament control.

There are no screws to tamper with on the FIL-KO-STAT. No wires! No discs to chip or break! No adjustments to puzzle! Triple tested and adjusted at the factory to the ideal "off" for UV200, 201, 201A, WD11, WD12, UV199, DV6A, W. E. Peanut and all other tubes including 5 watt transmitting tubes. Hailed by amateur and professional radio men as the greatest step forward in the development of the tuning possibilities of the vacuum tube.

FIL-KO-STAT supremacy is proven by every test!!

Price

\$2

Recommended and sold by dealers in high quality radio supplies.



MADE AND GUARANTEED BY **DX INSTRUMENT CO.**

RADIO STORES CORPORATION

SOLE INTERNATIONAL DISTRIBUTORS

Dept. RN10 218-222 West 34th Street New York

You Will Want This Book

Send 10c for "Radio Pocket Reference" by W. G. Merritt Garvey (of New York World Radio Staff), tables, 17 hook-ups, diagrams, etc. Reading this interesting book, we discovered that Mr. Garvey recommended the FIL-KO-STAT for fine filament control. We bought an edition of these books, and will send a copy anywhere at handling cost of 10c.

In Canada \$2.75



CONTINENTAL

"New York's Leading Radio House"

Radiola Loud Speaker

UZ-1320 reproduces broadcasted programs with clear and undistorted tones.

The magnetic system, the shape of the horn and the material of which it is made are of the very best. Mechanically this unit is very ruggedly built. The finish is of a dull black with a felt base. The bell is 12 1/4" in diameter and the height is 26 1/2".

One adjustment is provided for securing maximum efficiency on different values of signal strength.

UZ-1320 LIST PRICE, \$36.50.

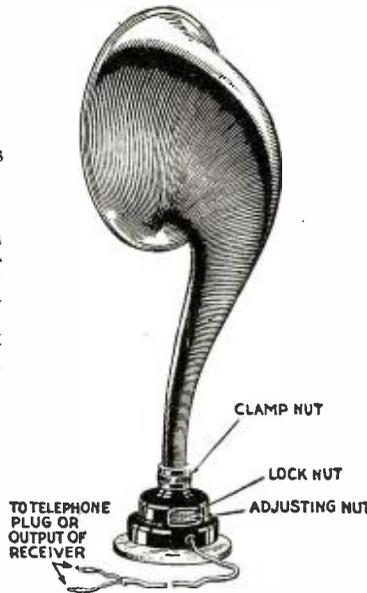

CONTINENTAL RADIO and ELECTRIC CORPORATION
SIX and FIFTEEN WARREN STREET, NEW YORK, U. S.

Confidence

These leading manufacturers of quality radio sets:

- Cutting & Washington
- Jones Radio
- Zenith (Chicago Radio Laboratory)
- Cleartone
- Midwest Radio Co.
- Audiola Radio Co.
- Illinois Radio Eng. Co.
- AND OTHERS USE

"ALL-AMERICAN" Amplifying Transformers

(Radio and Audio Frequency)

as standard equipment in their sets. This is reason enough why any man building his own set should use "All-American" Transformers.

The sales of these manufacturers depend on the efficiency of their apparatus. The confidence they place in "All-American" Transformers to function properly under all conditions is proof of the quality of these instruments.

Buy them, use them and you, too, will endorse them. Every live radio dealer carries them.

To help you get the best results from your radio set we offer FREE a book of 25 tested Hook-ups. Send 2 cent stamp to cover postage.

RAULAND MFG. Co.
200 No. Jefferson St., Chicago, Ill.



Radio Frequency Transformer



Audio Frequency Transformer

sat in it, and Anna May sat on his knee. They kissed each other ten or twelve times, and then—almost automatically, she was so accustomed to it—she slipped a pair of ear phones on Edbert's head and a pair on her own.

"Just think, Edbert dear," she said, "this will be the last time we will listen to radio together before we are married and in our own dear little home!"

So she put out a hand—Edbert was holding the other—and found Station WOW, and began to listen in. Now I don't say that Edbert was not in a somewhat bewildered frame of mind, what with love and staying up late and worry about whether he had bought the right sort of stick pins to give his ushers. I'll admit that he was, and I know he was a meek and easily controlled sort of young man, but what I do want to say is that folks should be careful how they broadcast this new stunt of hypnotizing folks by radio. I may be wrong, but that is my opinion.

I remember, for example, a hypnotist who used to come to my home town out in Iowa and give hypnotizing shows at the opera house. He used to get ten or twelve prominent citizens on the platform and hypnotize them and tell them they were a brass band. Then one would beat the drum and another would play the slide trombone and another would toot the fife, and it was a lot of fun for the audience. But what I want to say is that when folks begin to hypnotize by radio, and broadcast hypnotism, it is apt to be a nuisance. If the 20,000,000 radio listeners were all hypnotized into brass band players it would be altogether too much brass band, especially since the invention of the saxophone. Everybody would want to play the saxophone, and 20,000,000 more saxophone players in one country is altogether too many. Since I became a radio listener I am of the opinion that we already have too many saxophone players; we don't need 20,000,000 more. The 3,000,000 we have now are enough.

As I understand it, the man who was hypnotizing via wireless on the night before the wedding day of Edbert Pilkey and Anna May Bunce, was not trying to hypnotize every listener-in. He was only trying to hypnotize a man named Edbert Whiffenhoppel, of Skiutic, N. J., and to be properly subject to hypnosis Edbert Whiffenhoppel had to stick a pin in his arm. This pegged him, so to speak, as the right man. But the unfortunate thing was that Anna May Bunce had a pin in her sash when Edbert Pilkey put his arm around her waist, and he was so happy and loving that he did not notice it at all. And, doubly unfortunately, the hypnotist who was hypnotizing by radio spoke to his subject not as "Mr. Edbert Whiffenhoppel" but as "Edbert." So, as I may say, Edbert Pilkey was in every way properly "tuned-in" and "hooked-up" to be hypnotized.

Anna May Bunce had been kissing Edbert so industriously that she did not notice that he was gradually getting a glassy fixed stare as he sat there, and she was thinking so busily of love and how her veil would look that she did not notice what was coming via radio, but suddenly she happened to notice Edbert and that he was looking most disturbingly unusual.

"Edbert!" she cried, and then she remembered that this hypnotic stunt was being tried that evening, and she listened. What she heard was this:

"And now, Edbert, you are fully hypnotized, and you believe you are—"

Well, of course, Anna May was awfully shocked. She turned to the dial of the radio set and turned it quickly, but by some awful piece of bad luck she turned right to 360 meters, which was Station WUMP, where Orlando Biggs was broadcasting his bed-

RHAMSTINE ★

Victophone Loud Speakers, Amplifying Cabinets R. F. and A. F. Transformers, Rheostats, Potentiometers, etc., at attractive prices. Catalog on request.

J. THOS. RHAMSTINE★

2152 East Larned St. Detroit, Mich.
*Maker of Radio Products

ENGRAVING MACHINES

For

RADIO PANELS

And Other Radio Engraving

ENGRAVERS & PRINTERS MACHINERY CO.
Sag Harbor, N. Y.

Insure your copy reaching you each month. Subscribe to Radio News—\$2.50 a year. Experimenter Publishing Co., 53 Park Place, N. Y. C.



Why he couldn't hear XZBQ

HE could hear NEN and YST clearly enough on 360 meters. But the 550-meter XZBQ station, broadcasting particularly good programmes, he could hear only faintly.

His set had a radio-frequency transformer with an amplification factor that was good only for the 360-400 meter stations. That was why XZBQ and other 500 and 550 meter stations were almost inaudible.

It is this very difficulty that the Duratran, the new Dubilier radio-frequency transformer, overcomes. It has an amplification factor of over 20 for the entire wave-length band of 220 to 550 meters and amplifies well on an even wider band.

For this reason the Dubilier Duratran will give remarkably good amplification in any circuit requiring a radio-frequency transformer.

Dubilier Duratran
Price \$5.00

At all good dealers
Send for descriptive circular

Dubilier Condenser & Radio Corp.
48-50 West Fourth Street, New York

DUBILIER DEVICES

THE RADECO SAFETY FUSE

Patent Pending

makes it plumb impossible for you to "blowout" a tube

Goes directly on Filament terminals

50^c

Buy at your dealers or by mail

When ordering—state what kind of tube

RADIO EQUIPMENT CO.

630 Washington St.

Boston, Mass.

A LOUD SPEAKER and REPRODUCER IN ONE BRISTOL AUDIOPHONE

MORE THAN A LOUD SPEAKER the AUDIOPHONE is a real reproducer of the original broadcasting. It is easy to listen to the Audiophone reproduction, because they are so perfect. The speech, songs and instrumental music are not blurred or disguised by mechanical distortion. You get all the fine shadings and every inflection. In fact, the very personality of the artist seems to be present as you listen.

DEVELOPED in the laboratories of an engineering firm known the world over for recording instruments of precision.

COMPLETE in every way and ready to connect to the receiving set.

NO AUXILIARY BATTERIES are required for magnetizing.

ADAPTED for use on all types of two or three stage power amplifiers.



TRADE MARK
AUDIOPHONE
REG. U. S. PAT. OFFICE

THE BRISTOL SINGLE STAGE POWER AMPLIFIER for use with the usual two-stage amplifier can be furnished, which will greatly increase the range of the Audiophone where desirable. Price **\$25.00**

MADE IN TWO MODELS: BRISTOL AUDIOPHONE; SR. Loud Speaker, Size of Horn 15-inches Diameter, Price **\$32.50**

BRISTOL AUDIOPHONE JR. Loud Speaker, Size of Horn 11-inches Diameter, Price **\$22.50**

Write for Bulletin 3006-S.

THE BRISTOL COMPANY, WATERBURY, CONN.

Boston New York Philadelphia Pittsburgh Detroit
Chicago St. Louis San Francisco



☩ RADIO ☩

Complete Stock—Both Sets and Parts—All Makes
ROSE RADIO SUPPLY
129 Camp Street New Orleans, La.
Send 10c for latest catalog

CONNECTICUT RADIO

Panel and Portable type Variable Condensers, Audio-Frequency Transformers, Vacuum Tube Sockets, Rheostats, Head Phones, Jacks, Plugs and Switches. Send for Bulletin A-12
CONNECTICUT TELEPHONE COMPANY
Radio Division

time story, and she hit it just as Biggs was reading the words:

"—you are a rat hound."

For a moment Edbert Pilkey seemed to look surprised, but he had no control over himself, being hypnotized, and he had to believe what came to his ears. What he heard, beyond all doubt, was:

"And now, Edbert, you are fully hypnotized, and you believe you are—a rat hound."

For another instant dear Edbert held his head up, sniffing the air to right and to left, and then he pushed Anna May roughly from his knee and opened his mouth and let out one long howl at the ceiling, and the next instant he was down on his hands and knees and loping for the front door as fast as he could lope, barking eagerly and giving a sharp yelp now and then. Poor Anna May rushed to the door just in time to see Edbert make one leap down the veranda steps and land on all fours, and then she fainted into a large potted palm, damaging it so that her father had to pay the florist \$13.50 damages.

It was half an hour before anyone discovered Anna May, and when they had brought her to consciousness they could hardly believe what she told them. The six bridesmaids and the six ushers and Mr. and Mrs. Bunce, and three policemen from the Westcote Precinct, and eighteen assorted neighbors started out to find Edbert, and they found him three miles out in the country, down on his knees beside a corncrib digging a hole with his fingers so eagerly that the dirt went between his legs and fell in a pile six feet behind him. Every second scrape he would put his nose in the hole and sniff, and then utter four to six short yelps and begin digging eagerly.

Anna May immediately took him by the collar, but he turned and snarled and bit her on the wrist, and she fell back weeping, and when the others tried to argue with Edbert he only growled at first, but when they annoyed him too much he backed out of the hole and went loping across country and the next thing they saw of him he was two miles further out, digging under another corncrib, hunting another rat. And the worst of all was that Mr. Kaggerty came to join the hunt just then and had his rat hound with him, and the rat hound started in to help Edbert dig out that rat, and Edbert did not like it. Edbert evidently thought that was his rat, and he turned on Mr. Kaggerty's rat hound and snapped at him, and the rat hound snapped back, and in a minute there was the prettiest dog fight you ever saw—Edbert and the Kaggerty rat hound. First one was on top and then the other, and they growled and bit and scratched and snarled, and Anna May fainted again. Just after she fainted Edbert got a throat-grip on the Kaggerty hound and the Kaggerty hound yelped for mercy, and Mr. Bunce kicked Edbert in the ribs and loosened his jaws. The Kaggerty hound went yelping home, and Edbert shook himself once or twice and went back to the rat hole and began digging again.

Well, that was an awful condition for a fairly important part of a wedding to be in. From what Mr. Brunce knew of the Kaggerty rat hound he was aware that Edbert would never be satisfied until he had dug out every rat within sixteen square miles or more. Somebody suggested that they get a rope and take Edbert home and tie him up, so as to have him on hand for the wedding, but Mrs. Bunce would not have it. She said that if Edbert howled when he was tied as the Kaggerty hound howled when it was tied, he would be worse than useless at a swell wedding. She said Anna May was a girl with some of the finer feelings and she knew Anna May would never stand up to be married if her groom had to be tied to the piano leg and was howling like a lost soul all the time. She said that some of the



“What panel shall I use?”

ONE of the first questions you probably will ask yourself when you get ready to build your radio set will be about the choice of a good panel. Your answer will determine, to a large extent, the efficiency of your set.

Of course you want a panel that has superior insulating properties. Celoron Radio Panels are used by fans who appreciate the value of a good radio panel. They have high dielectric strength and great volume and surface resistivity. Celoron panels are uniform in quality, and do not warp or crack.

You will find Celoron panels easy to saw, drill, and tap. They engrave evenly without feathering, and enable you to build a set that is neat and attractive as well as efficient.

Approved by Uncle Sam

Celoron Radio Panels are approved by the U. S. Navy Department Bureau of Engineering and the U. S. Signal Corps. Many of the leading manufacturers of

radio equipment use Celoron in their standard parts.

Each panel is wrapped separately in glassine paper and carries complete instructions for working and finishing. Ask your dealer for one of the following sizes:

- | | |
|---------------------------|--------------------------|
| 1—6 x 7 x $\frac{1}{8}$ | 5—7 x 18 x $\frac{3}{8}$ |
| 2—7 x 9 x $\frac{1}{8}$ | 6—9 x 14 x $\frac{3}{8}$ |
| 3—7 x 12 x $\frac{1}{8}$ | 7—7 x 21 x $\frac{3}{8}$ |
| 4—7 x 14 x $\frac{3}{8}$ | 8—7 x 24 x $\frac{3}{8}$ |
| 9—12 x 14 x $\frac{3}{8}$ | |

We also furnish Celoron in full-sized sheets and can cut special sizes if desired. If your dealer has not yet stocked Celoron panels, ask him to order for you, or write direct to us. Indicate by number the size you want.

Send for free booklet

Our booklet, “Tuning in on a New World,” contains a list of the leading broadcasting stations in the United States and Canada, several efficient radio hook-ups, and an explanation of the symbols used in radio diagrams. Write at once and be sure of getting yours before the supply is exhausted.

To radio dealers: Send for special dealer price list showing standard assortments

Diamond State Fibre Company

BRIDGEPORT (near Philadelphia) PENNSYLVANIA

BRANCH FACTORIES AND WAREHOUSES
BOSTON CHICAGO SAN FRANCISCO

Offices in Principal Cities

In Canada: Diamond State Fibre Company of Canada, Limited, 245 Carlaw Ave., Toronto

CONDENSITE
CELORON
STANDARD RADIO PANEL



ANOTHER
TRUTONE
TRADE MARK
WINNER

Little Senior. A Marvel at the Price.

WITH this new model LITTLE SENIOR at the popular price of \$19.50 the line of TRUTONE LOUD SPEAKERS is complete. LITTLE SENIOR is a loud speaker complete with large mica diaphragm and wooden tone chamber in the base. Horn is made of beautiful non-metallic composition with crystalline finish and stands 24 inches high. Price includes 6 ft. of cord. TRUTONE SENIOR is supreme for all long-distance work, stands 32 inches high and price includes 6 ft. of cord. Types A and B are amplifying horns for use with any make of two and single phone receivers respectively. Price for either A or B, \$8.00. Horn only \$6.00. Base only \$2.00.

LITTLE SENIOR
\$19.50

Send for Illustrated Folder. They Speak for Themselves

We prepay parcels post charges to any point in the United States or Canada

SENIOR
\$25.00

SADLER MANUFACTURING CO.
86 FOURTH STREET, SAN FRANCISCO, CALIFORNIA

PIONEER" Instruments

HAVE WON ON THEIR MERITS

From a modest start, we have steadily advanced to a point where a factory many times its original size has been kept on the jump to supply the demand—winter and summer.

Pioneer Variometers and Variocouplers

possess such admirable radio-electric characteristics, and are so well made and beautifully finished, that they were awarded the Radio News Certificate of Approval, earning a high score on every count.

Shells are molded from genuine Bakelite, in a rich mahogany finish.

Winding of both rotor and stator of both devices is with heavy silk-bound copper wire.

Hardware is bronze, heavily nickeled.

Workmanship has no superior and few, if any, equals.

Design insures positive contacts and close coupling. Variocoupler is wound inside the shell the same as the variometer—a special feature exclusive with us.

Performance so satisfactory that every user becomes a consistent booster.

- "Pioneer" Variometer\$6.50
- "Pioneer" Variocoupler\$7.00

Order from your dealer or remit direct to us and give name and address of dealer you wish to favor.

PIONEER RADIO CORPORATION
GALESBURG, ILL. U. S. A.
European Branch Office: London, Eng., 27-28 Aning St.
Gaston E. Marbaix, European Mgr.

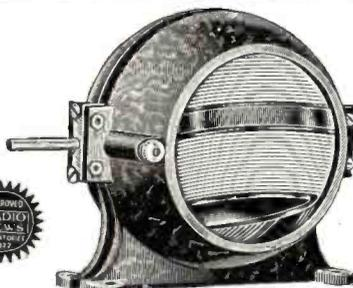

"Pioneer" Variometer—\$6.50

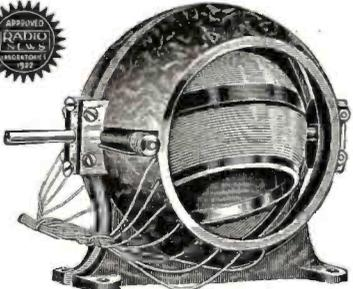

"Pioneer" Variocoupler—\$7.00

Branch Offices:
New York City..... 220 Fulton St.
Chicago, Ill..... 33 So. Clinton St.
Kansas City, Mo..... 208 Baltimore Bldg.
Minneapolis, Minn..... 705 Plymouth Bldg.
San Francisco, Calif..... 623 Larkin St.

neighbors who had not been invited might think Edbert was a reluctant marrier, and that—anyway—she did not know what the law was; perhaps they would have to get Edbert a dog license to be married, and no daughter of hers was going to be married with a dog license.

So they left Edbert digging rats and carried Anna May home on a green shutter. Every once in a while she would revive from her faint and sit up, and then she would remember Edbert and that he was now a mere rat hound, and she would faint again and flop back on the shutter. She revived and flopped so often on the way home that her head knocked eight slats out of the shutter, and that cost her father another \$4 for repairs—\$2 for new slats and \$2 for having them painted green to match the rest of the shutter. A wedding is an expensive thing when complicated with radio hypnotism. It is anyway.

When Mr. Bunce got Anna May home and his wife had put her to bed he had just got ready to telephone Radio Station WOW when the town marshal came to the house. He spoke to Mr. Bunce severely.

"I understand," the marshal said, "that your daughter claims this Edbert-hound that is running all over the county, and if that is so she'll have to get him a muzzle and a license and do it mighty quick. We've had a lot of complaints about unmuzzled dogs running loose, and this Edbert-hound of yours is liable to get hydrophobia and bite someone. So if he is not licensed and muzzled within twenty-four hours we'll fine you ten dollars and costs, and we'll take that human hound of yours down to the dog pound and chloroform him."

"Well, go ahead and do it!" cried Mr. Bunce, who was really becoming exasperated by all this nuisance.

"If I do," warned the marshal, "you'll be responsible for it, and that will amount to murder. Remember that, please. You'll probably be electrocuted for it. And don't forget that you'll have to settle the \$10 and costs before you are electrocuted, and not after. As a nuisance that Edbert is a dog, but as an individual he is a human being. Conniving at the death of anybody who pays a United States income tax is murder, and don't you forget it!"

As soon as the marshal left the house Mr. Bunce got in touch with Radio Station WOW by telephone, and he was lucky enough to get the radio hypnotizer on the wire, and the hypnotizer merely laughed and said it would be the easiest thing in the world to un hypnotize Edbert.

"Merely get him to listen in again," he said, "and I'll say three words that will un hypnotize him instantly."

And that was all right, too, except that it was impossible to get the human rat hound to listen in. When they tried to corral Edbert he gave one suspicious look and made off across country and nobody could catch him. When he was two or three miles ahead of all pursuers he would stop and look back and give a couple of barks and then scoot off faster than ever.

Well, I suppose no one would ever have caught Edbert without shooting him dead first if it had not been for Mr. Rondemere K. Plipp, our well known Westcote plutocrat. When Mr. Plipp heard of the trouble he telephoned to Mr. Bunce and asked him about it, and when Mr. Bunce had explained it all, Mr. Plipp said:

"See here, Bunce, I can help you. I have a limousine all fitted up with a radio set and a loud speaker. You just arrange with your un-hypnotizer to be ready at WOW and we'll get in my limousine and chase Edbert, and when we get within loud-speaking distance we'll tune in to WOW, and that'll fix him!"

And it did. Mr. Bunce and Mr. Plipp

A QUALITY BATTERY

Always Dependable

Marko Storage Battery Company
1494 Atlantic Ave.
Brooklyn N. Y.



MONTROSE CONDENSERS

- 11 Plate Vernier.....\$2.20
- 23 Plate Vernier..... 2.55
- 43 Plate Vernier..... 3.35
- 3 Plate Condenser..... 1.20
- 11 Plate Condenser..... 1.20
- 23 Plate Condenser..... 1.55
- 43 Plate Condenser..... 2.00
- .00025 mfd. Bal. Vernier 2.70
- .0005 mfd. Bal. Vernier 3.30
- .001 mfd. Bal. Vernier 4.00

MONTROSE MFG. CO.
1200 Bedford Ave. Brooklyn, N. Y.



SUPER-HETERODYNE RECEIVER NEW ADVANCED MODEL "C"

The Ideal Receiver for Long Distance Broadcast Reception

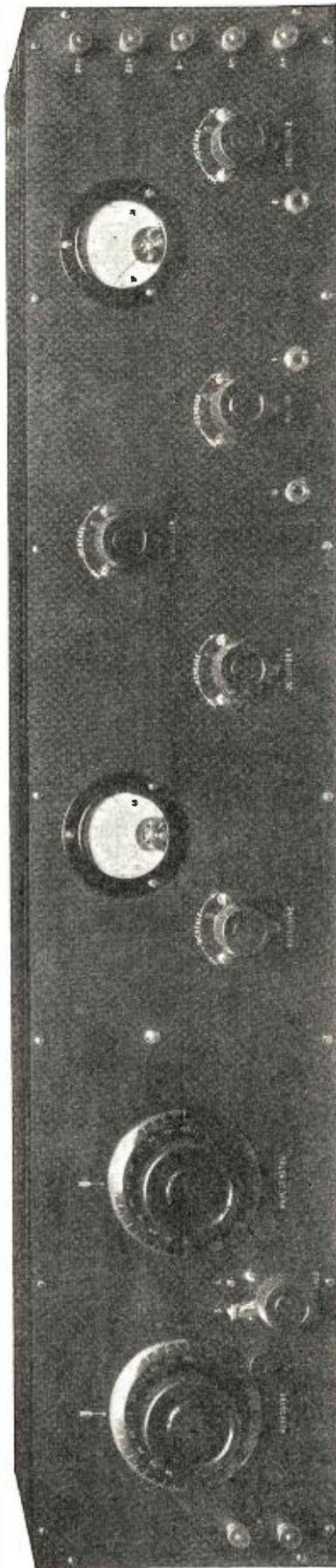

Model "C" Super-Heterodyne. Wave-length Range 160 to 850 Meters. Dimensions 40"x8"x7¾". Weight 42 lbs.

Simplicity—Only 2 variable dials for all wave-lengths between 160 and 850 meters

Efficiency—Uniform maximum radio frequency amplification over the entire wave-length range

Range—2000 mile night range using Radio Corp. loop, corresponding increase with good antenna

Selectivity—Most selective method of reception known, works completely through local broadcasters

Tubes—Use UV201A or UV199 throughout, 3 stages tuned radio, 2 stages audio, 2 detectors, oscillator

Learn More About This Remarkable Receiver. Write for Catalog 73

"Super-Heterodyne Receivers"—a complete book fully illustrated, covering this method of reception, is now ready for distribution. Written by Charles R. Leutz, one of America's foremost authorities on receivers."

Experimenters Information Service 531 WEST 46th STREET
NEW YORK CITY

Designers of the Highest Class Radio Apparatus in the World

TRADE "ESCO" MARK

Quality always has been, and always will be, The World's safest investment.

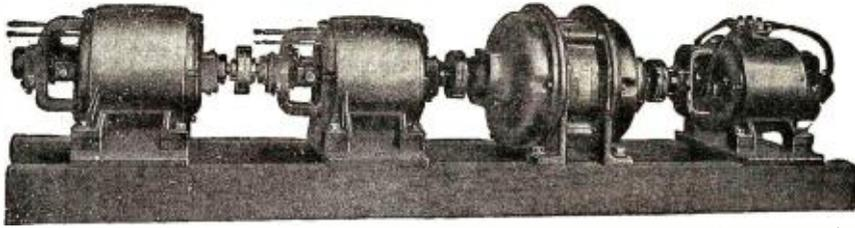

This is a Special 4 Unit Set for Wis. Dep't. of Markets—the largest broadcasting station in existence. A 10-h.p., 220-V., 60-cycle, 3-phase motor; two 1600 V., 2000 W. generators to operate in series, producing 2000 V. 4000 W. and one 12 V., 2000 W. Filament Current Generator.

These two, and many other types, used by most prominent Educational Institutions, various U. S. Government Departments, Research Laboratories, Newspapers, Department Stores.

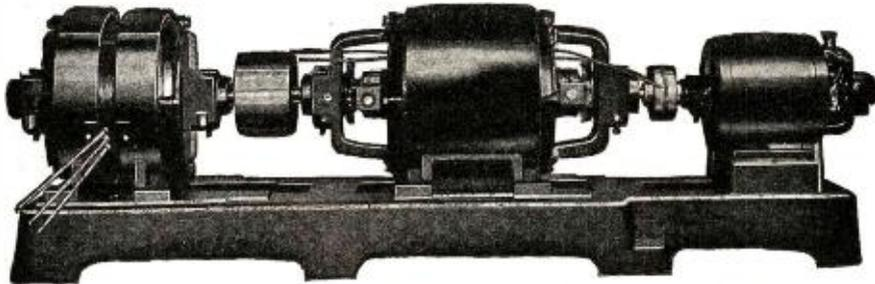

Sold by Principal dealers in U. S. and Abroad. Ask for Bulletin 248

ELECTRIC SPECIALTY CO.

211 SOUTH STREET STAMFORD, CONN., U. S. A.
PIONEERS IN DEVELOPING QUALITY WIRELESS APPARATUS.

Amplification Perfection

with an audio transformer means **PURE TONE QUALITY** with **MAXIMUM VOLUME**

The AMERTRAN AUDIO TRANSFORMER



PRICE \$7

Ask your electrical dealer, or sent carriage charges collect. (Wt. 1 lb.)

is acknowledged by professional radio engineers to be the **STANDARD OF EXCELLENCE** for audio amplification.

The reason for the popularity of the AmerTran among professional radio men is apparent in the Amplification Chart shown in our Circular No. 1005.

Turn ratio, 5:1. Amplification ratio, 30-40 times audibility in the flat part of the curve.

American Transformer Company

Designers and builders of radio transformers for over 20 years

177 Emmet St., Newark, N. J.

LET RADIO EXPERTS BUY FOR YOU

THIS SERVICE IS FREE

Why hunt from store to store? Save time, trouble and money—a group of Radio Experts in New York will act as your personal Representative, buy for you any standard make of radio equipment you want, from the smallest part to a complete set, either assembled or unassembled, and deliver it to you prepaid—all for less than if you did your own buying. Satisfaction guaranteed. Also disinterested advice on all radio problems—free. Write for plan. **PERSONAL SERVICE PURCHASING BUREAU** 505 Fifth Avenue Desk 15 New York

STAMMER

If you stammer attend no stammering school till you get my large **FREE** book entitled "STAMMERING, Its Origin and The Advanced Natural Method of Cure," bound in cloth and stamped in pure gold. Ask for special tuition rate and a **FREE** copy of "The Natural Speech Magazine." Largest, best equipped and most successful school in the world for the cure of stammering, stuttering, etc. No sing-song or time beat. Write today. **The North-Western School, 2366 Grand Ave., Milwaukee, Wis.**

Correspondence from Readers

(Continued from page 419)

chased the human rat hound with the loud-speaking limousine and the radio hypnotizer fifty miles away un-hypnotized Edbert instantly, and Edbert and Anna May were married on the dot, just as advertised, and all I say is that while no human being can doubt that radio is the greatest invention of all the ages, any invention may have its unpleasant sides.

As Edbert and Anna May drove away from the house on the first lap of their honeymoon Anna May put her head on Edbert's shoulder and looked up into his eyes and asked him one question.

"Edbert, my dearest love," she asked, "will you tell me just one thing? Did you catch any rats?"

But he could not tell her; he did not know; he had no memory of the incident whatever. But I will tell you the truth: Edbert did not catch a single rat.

How It Feels To Broadcast

(Continued from page 376)

Many flattering phrases the announcer tossed over the air in his introduction; I didn't know I was so good. I heard him say "famous, well known, distinguished." Then I thought he was talking about someone else. Finally I heard my name paged and then a nudge from him. I was to begin.

The perspiration began to pour in streams from my hand and forehead. It niled my eyes. At first I thought it was because of the heat of the room, but it wasn't. It was simply a good old nervous sweat, the sort you get when passing a country graveyard at midnight. The papers in my hand shook, for I had taken the precaution of writing my "talk" on foolscap. "Good evening ladies and gentlemen," I managed to blurt (having heard the announcer use that line as a stock phrase.) There was no response. Somehow or other one expected an answer. Instead, that mute disc just stared. It seemed so utterly stupid just to be talking into that thing-a-ma-jig at the other end of which there was no sign of life. Subconsciously the impression prevailed that I, of all radio broadcasters, was not being heard, that this was the one time the blooming thing was not working. Instead, I was simply chattering to myself. But I continued on, not daring to stop for fear it was working. How utterly cold and dead one's voice seemed in that heavily blanketed little room. But one can get used to anything in time, even hanging, and as I progressed I regained much of my normal composure. So much so in fact that I didn't want to cease. I was like a speaker who becomes so wrapped up in his subject that only an indignant snore appraises him that he was through long before. Glancing hastily at my watch I found that I had been talking 15 minutes. Outside in an ante room a jazz band was tuning up and waiting its turn. I concluded and for a second waited. No hisses, no applause greeted my weak efforts. I didn't know whether I had "gone over" or not; I still do not know. At any rate the experience has been mine. I shall put it down in the scrap book of thrills.

Good evening ladies and gentlemen.

no resistance to radio frequency currents. Certainly one can find no fault with the connections of such a set, so I cannot un-



THE "RICO" STRAIGHT LINE CONDENSER



HIS condenser marks a revolution in condenser building. It is the simplest and most practical type of condenser as yet developed for broadcast and amateur work. This condenser has been developed by our engineers after considerable research work and has been pronounced perfect by experts.

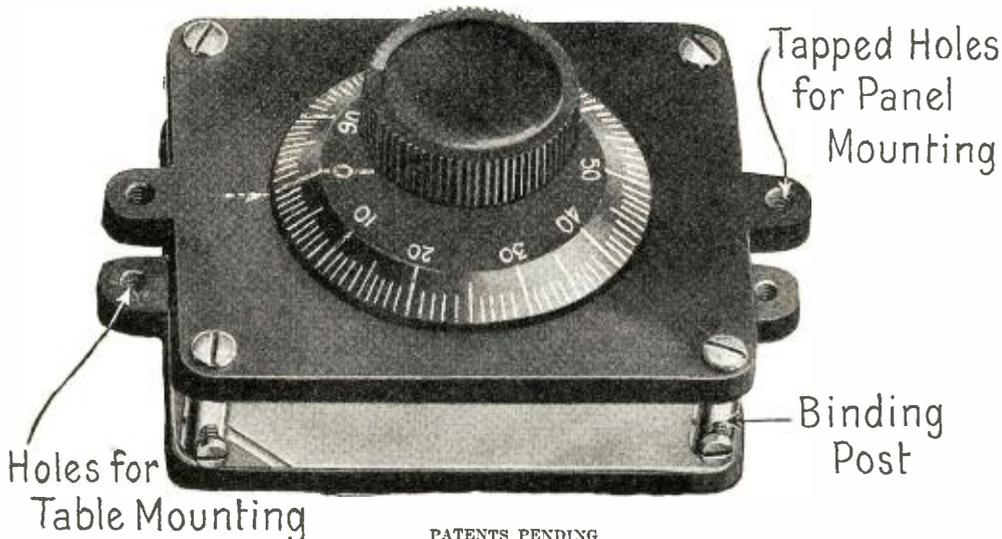

PATENTS PENDING

Here are Some of the Outstanding Points:

- 1—Large capacity (.000530 Mf.)
- 2—Replaces a 23-plate condenser.
- 3—Uses a minimum of space size, 3½" x 2½" x 1¾".
- 4.—For panel mounting or for table mounting—universal in its scope.
- 5—One complete revolution of dial adjusts condenser from minimum to maximum.
- 6—Vernier effect.
- 7—Absolute straight line curve.
- 8—Accumulates no dust between plates as is the case with air condensers.
- 9—Light weight. Condenser only weighs 3 oz.
- 10—Less than 1-10th amount of parts as used in old style mesh plate condenser.
- 11—Can never get out of order.
- 12—Impossible to short circuit.
- 13—Works in any position, vertical or horizontal. No counterweights needed.
- 14—Lowest in price for high class condenser.
- 15—Compactness. Size only 3½" x 2½" x 1¾" over all.

The Rico Straight Line Condenser must be seen to be appreciated. Made of the best materials that money can buy. Stands in a class by itself. All metal parts finished in nickel plate.

We will refund your money if this condenser is not all we claim for it.

Number 450 "Rico" Straight Line Condenser complete with moulded dial, **\$1.75.**

Number 451 the same condenser but without dial (shaft is for ¼ in.), **\$1.50.**

Send for free catalogs on "Rico" TUNED (adjustable) phones, and loud-speaker phones. "Rico" Phonoadapters, Fibre Ricohorns, "Rico" Melotone Loud Speakers.

RADIO INDUSTRIES CORPORATION
 131 Duane Street, New York City
 Cable Address: Ricotrade, New York.
 Chicago Distributor
 Triangle Electric Co., 160 W. Lake St., Chicago, Ill.
 Detroit Distributor
 Kopley & Ross, 1244 Randolph St., Detroit, Michigan

SEND NO MONEY
 COUPON R.N.10

Radio Industries Corp.,
 131 Duane Street,
 New York City.

Gentlemen:
 Please send me prepaid one Number "Rico" "Straight Line" Condenser, for which I enclose herewith \$

Name
 Street
 City State

MASTER Radio Products

"MASTER" Radio Products are bringing to dealers both the profit and prestige that comes from a national reputation for excellence

National recognition of the intrinsic quality of "MASTER" Radio Products is based upon uniformly good reception under all conditions. Increasing public confidence is making itself felt in the greater demand

and consequent greater turnover of "MASTER" Radio Products. Those who want to buy the best—as well as those dealers who want to sell the best—are choosing the "MASTER" line.

Bulletins RN-104 and RN-105 describe and illustrate the complete "MASTER" line

**RADIO DIVISION
UNION CONSTRUCTION COMPANY**

*Manufacturers "MASTER" Radio Products
OAKLAND, CALIFORNIA*

CHOICE JOBBING TERRITORY STILL OPEN. WRITE FOR PARTICULARS.

504

SIDBENEL--The Standard of Efficiency

The Improved Re-chargeable "B" Battery Insures Noiseless Radio Circuits



With the SIDBENEL Re-chargeable "B" Battery you can count on four or six months' service on one charge alone. Recharging costs you only a few cents and with ordinary care the battery will last 5 YEARS in normal service. That is one of the many reasons why

Sidbenel Storage "B" Batteries are universally recognized as "Perfect for Radio Work."

Its many SPECIAL NEW FEATURES include:

- Hard Rubber Container
- Separate sealed cover for each cell
- Extra large plates
- Brings signals in very loud

Complete illustrated directions for charging from your lamp socket or from your generator and how to assemble come with each battery.

Variable Type 201D	Assembled	Knocked Down
1 unit 22½ volts	\$ 5.00	\$ 4.00
2 units 45 volts	9.80	7.75
4 units 90 volts	18.00	14.75
5 units 115 volts	22.50	17.75
A. C. Rectifier	1.50	.85

Send for complete catalog of parts.



RADIO EQUIPMENT MANUFACTURING COMPANY
25 Mt. Eden Ave., New York City



"Read'em" Binding Posts

**With Knobs
That Won't Come Off**

Anyone can "read 'em." All popular styles—Antenna, Ground, Fones, A and B Battery plus and minus—abbreviations of different names engraved on knobs. Radio users—ask your dealer for "Read 'em." Dealers—write for our proposition on this big seller. Write Dept. A for liberal profit proposition.

**The Marshall-Gerken Co.
Manufacturers
Toledo, Ohio**



STYLE W RADIO KEY

A speed key designed for radio transmission and with which cramp is unknown. Other types carried in stock

Sample by mail,
\$4.00.

*Send stamp for catalog
No. 45-R.*

**J. H. BUNNELL & CO.,
32 Park Place, New York City.**

derstand his reason for saying that losses are considerable in a variometer-coupler set.

Another thing, we do admit that an A.C. C.W. transmitter using raw A.C. on the plate of the tube is a nuisance, that they are not C.W. transmitters at all, and that they do have a harmonic on twice the wave very often, BUT it certainly is the fault of the single-circuit tuner or any other tuner, if it cannot receive broadcasting through it, if it is not on the same wave-length. Moreover, Mr. Brackenridge says that "the waves emitted by broadcasting stations are very sharp and must be tuned to a hair, and that the average C.W. signal is much easier to get just right, as it can be read over a wider range of tuning." However, I do not agree with him; a broadcasting station covers a band of waves, or rather, a band of frequencies, due to the fact that it is a modulated wave. The carrier wave of a broadcasting station is just as sharp as a C.W. signal since they are both the same thing, but I have never yet heard a C.W. signal that covered a band of frequencies. I.C.W. and A.C.C.W. are not included in this because they emit modulated waves. I don't say that when hunting for DX broadcasting you don't have to tune sharply, I have learned that from experience; but you have to tune just as sharply when hunting for long distance C.W. stations.

It may seem to Mr. Brackenridge that "the new race of experimenters now coming along is more anxious to improve their sets, try new circuits than any of the old hams." Let me ask what circuits they try? The Reinartz, to be sure, but Mr. Reinartz, of IQP, is an old ham himself and not one of the "new race of experimenters." Perhaps they try the Neutrodyne, but the inventor of the Neutrodyne is also an old ham. The Flewelling? Mr. Flewelling is not one of the "new race" either. He's an old timer, too. The Old Timers are still carrying on; they are the ones who are controlling the broadcasting stations today, the very ones who provided a means for getting the "new race" started.

And last, I should like to question Mr. Brackenridge's statistics. He says that three-fourths of the cards hams receive from one another admit the use of a single circuit tuner. Now, I'm not trying to "razz" the single circuit tuner, but I'd bet my shirt on that statement, it sounds stuffed. I also doubt that nine-tenths of the real DX reception is done on single circuit tuners. The old three circuit tuner still speaks for itself and will continue to do so for some time to come. All that is necessary to do is find a QRA somewhere in the second district and listen in some night after 10:30 with an ordinary single circuit tuner, F.B., but try for some DX, and QRM will mean something entirely new. Of course, ham for ham, the second district only makes third place, but count the number of hams in every square mile, and then compare that with the other districts. Keep the window open, but be sure to take the tubes out first.

E. PEACOX,
Yonkers, N. Y.

ANOTHER HELPING HAND

Editor, RADIO NEWS:

I have just been reading the August edition of your magazine and in the "Correspondence from Readers" I came across the letter of J. T. Hanchett, of Antrim, N. H.

I feel the same as Mr. Hanchett does about the code problem, and I believe I have an idea that will help a little anyhow. I will have charge of the radio station at the University of Kentucky next year and I am making plans for educating the public to clear up the present misunderstandings as much as possible.

First I propose to start a little school at the station for the purpose of teaching code.

LOWEST RADIO PRICES

SAVE MONEY—no matter what you need for your Radio Outfit you will find you can save money if you buy from the Standard Radio Corporation.

VACUUM TUBES

We carry the standard tubes in stock. Radiotron and Cunningham and will ship which ever we have on hand.

- M-910 UV-200 Detector Tube \$4.30
- M-920 UV-201A Amplifier Tube 5.65
- M-921 UV-199 Tube.. 5.65
- M-922 WD-11 Tube.. 5.65
- M-923 WD-12 Tube.. 5.65
- M-924 DV-6 Deforest Tube 5.45

SOCKETS

- Bakelite WD-11 or Standard—each. . \$.50
- 199 Adaptor or Socket, each65
- High Grade VT Socket75
- Metal VT Socket.. .40

RHEOSTATS

Exceptionally high grade—6-25—or 40-Ohms. Your choice—specify which. \$.80

- Vernier Type—6-Ohms 1.35
- Potentiometer—200 or 400 Ohms—your choice 1.35
- Cheaper grade Rheostat50

VARIOCOUPLER

Exceptional vario coupler 180 degree bakelite tubes, wound with green silk wire, metal parts nickel plated.

- M-350 Premier Vario-coupler \$3.65
- Standard vario coupler, bakelite tube, wooden rotor, brass parts. M-325 Standard Vario-coupler \$1.95

VARIOMETERS

High grade variometer, mahogany forms, accurately wound, exceptional value.

- M-85 Mahogany variometer \$1.95
- Excellent moulded variometer, high di-electric can't warp, a real buy M-95 Moulded variometer \$3.50
- Highest grade moulded variometer, wave length 180 to 600 meters, exceptional bargain. M-105 Supreme Variometer \$4.95

RADIO CABINETS

Mahogany finished cabinets built sturdy adds to the appearance of any radio set, hinged top, takes panel of sizes listed below—

- M-1 6x7 \$2.40
- M-2 6x10 1/2 2.60
- M-3 6x14 2.95
- M-4 6x21 3.50
- M-3 1/2 7x18 3.50
- M-4 1/2 7x21 3.95

HOMECHARGER BATTERY CHARGING RECTIFIER

You can charge your battery at home for a few cents. Connects directly to 110 Volt 60 Cycle Light Circuit attached directly to your socket. Complete with cord, plug, battery clips and cords. Deluxe Type, \$18.50 Value.

- M-250 Homecharger \$13.65

PHONES



- Baldwin Head Set—Type C \$10.95
- Baldwin—Type C Unit with Cord.. 4.95
- Sraco Head Set—M-178—2000 Ohms.. 3.95
- Sraco Head Set—M-179—3000 Ohms.. 4.50
- Supreme head set—M-180 7.50
- Murdock Head Set—M-190—3000 ohms 4.50
- Murdock Head Set—M-189—2000 ohms 4.25
- Amateur's Head Set—M-174—2000 ohms 2.98

SWITCH LEVER

An excellent switch lever for a radio set, bushing lever with nickel plated switch arm.

- M-72 Switch Lever \$0.25
- M-74 Switch Lever (cheaper grade)19

VARIABLE CONDENSERS

These condensers are fully guaranteed and are of the highest grade workmanship. The vernier types are furnished with dial and knob.

- 43P—Vernier Condenser \$3.25
- 23P—Vernier Condenser 2.75
- 14P—Vernier Condenser 2.80
- 43P—Plain Condenser 1.65
- 23P—Plain Condenser 1.40
- 14P—Plain Condenser 1.30
- 5P—Plain Condenser 1.15
- 3P—Plain Condenser85

DIALS

High grade black dials, bushed for 3/4-inch shaft.

- M-729 2-inch dial \$0.25
- M-730 3-inch dial .25
- M-731 3 1/2-inch dial .35
- M-732 4-inch dial .45

Visit either of our two big stores at any time Our Experts will be glad to help you with your problems. This advice is absolutely FREE at any time.

MAGNAVOX

Genuine Magnavox, type R-3, has 14-inch horn, the ideal speaker for home, office, church, theatre, and etc. Sells everywhere for \$45.00 our special price \$29.50



Pathe Loudspeaker M-322 Value.. \$18.50
Music Master Loudspeaker-M-335 Value 29.00
Western Electric Loudspeaker M. No. 10D. \$55 Value 45.00

BINDING POSTS

Binding posts and contact points are brass nickel finished. Per doz.

- M-10 Nickel plated Binding Post, Large Size \$0.40
- M-20 Hard Rubber Binding Post, Large Size60
- M-30 Nickel plated Contact Point, 2 Nuts15
- M-40 Solder Lugs to fit Contact Points10

STORAGE BATTERIES

A high grade storage battery fully guaranteed for two years 100 ampere hour. This is an exceptional value.

- M-950 100 amp. hr. storage battery \$12.95

HONEYCOMB COILS

Honeycomb duo-lateral on coils completely mounted with plug and strap. Made by C. A. Branston.

Number of Turns	Wave Lengths	Price Mounted
M-25 25	125-250	\$.80
M-35 35	175-450	\$.85
M-50 50	240-720	.90
M-75 75	390-910	.95
M-100 100	500-1450	1.05

Any of the above sizes unmounted 45c each.

HONEYCOMB COIL MOUNTING

Can be used for panel or base mounting, connecting leads furnished. Constructed of Bakelite, metal parts nickel plated.

- M-140 3-coil mounting \$3.85
- M-150 2-coil mounting 2.85
- M-160 Single coil mounting 4.40

MISCELLANEOUS

- Spaghetti Tubing, per yd. \$0.10
- No. 14 Copper Tinned Connecting Wire, per ft.01
- Solder, per lb. roll.25
- Sliders, 3/4 or 3/1612
- Solder Paste, per can12
- Battery Clips, each10
- Galena Crystal (mounted and tested)25
- Galena Crystal (unmounted but tested)20
- Radiocite (unmounted but tested)25
- Radiocite (mounted and tested)25
- Silicon (unmounted but tested)25
- Grewol Permanent Crystal Detector.. 1.65
- BW Adjustable Detector 1.50
- B. Battery Voltmeter 0-50 V. 2.25
- Ammeter—0-35 2.25
- Combination 0-35A & 0-12V 2.65

Electric Soldering Iron

Every Radio fan and every electrician will find this the most handy article ever offered. Operates on AC or DC 110 Volts. Take advantage of this opportunity to buy one at a greatly reduced price.....

\$1.98

EXCEPTIONAL VALUE

THORDARSON AMPLIFYING TRANSFORMER

The genuine Thordarson Aluminum case transformers.

- M-710 3-1 Ratio Thordarson \$4.50 Value. \$3.50
- M-720 7-1 Ratio Thordarson \$5.00 Value. \$3.85

ALL AMERICAN TRANSFORMER

The genuine All American Shielded Transformer, latest type

- M-610 3-1 Ratio All American \$4.30
- M-820 5-1 Ratio All American 4.60
- M-630 10-1 Ratio All American 4.60

ERLA RADIO FREQUENCY TRANSFORMER

The genuine Erla Transformer nationally advertised, complete with pamphlet for instruction and hook ups, is furnished in three types for first, second and third stage.

- M-810 1st stage Erla Transformer \$3.65
- M-820 2nd stage Erla Transformer 3.65
- M-830 3rd stage Erla Transformer .. 3.65
- M-831 ERLA Reflex Transformer .. 4.75

B BATTERIES

High grade. Guaranteed long life. Large size 22 1/2 Volt. Regular \$3.00 sellers.

- M-400 22 1/2 Volts large battery \$1.75
- M-500 45 Volt large battery \$3.65
- M-600 22 1/2 Volt small battery..... 1.15
- Dry Cell Batteries 1 1/2 Volt..... 4.40

GRID LEAKS

Pencil Marked Variable Grid Leak \$0.15

Freshman Variable Grid Leak and Condenser75

Durham Variable Grid Leak and Mounting95

CRL Variable Grid Leak 1.25

AERIAL EQUIPMENT

- Stranded Antenna Wire No. 14 (7-22) per 100 ft. \$0.60
- No. 14 R. C. Lead-in Wire per 50 ft.75
- Porcelain Aerial Insulator each05
- Composition Insulator (Like cut) each10
- Ground Wire Insulator each10
- Lightning Protector for Radio set.. 1.50

FIXED CONDENSERS

- .0025 Mica Fixed Condenser \$0.35
- .005 Mica Fixed Condenser35
- .001 Mica Fixed Condenser40
- .002 Mica Fixed Condenser40
- .0025 Mica Fixed Condenser50
- .005 Mica Fixed Condenser75
- .008 Mica Fixed Condenser80
- .0025 Paper Condenser for Grid Leak15

RADIO PANELS

High grade panels for mounting your set. Nationally advertised.

- 6x9, 3/8 \$0.70
- 6x7, 3/850
- 6x10 1/2, 3/885
- 6x14, 3/8 1.00
- 7x9, 3/880
- 7x12, 3/8 1.05
- 7x18, 3/16 2.30
- 9x18, 3/8 2.35
- 9x14, 3/16 2.35
- 7x21, 3/16 2.60
- 6x21, 3/8 2.80
- 9x21, 3/8 2.80

Ten per cent must accompany all C.O.D. orders. Otherwise remit by personal check or P.O. Money Order. We guarantee your complete satisfaction on everything purchased from us. Write for Catalogue.

ORDERS PROMPTLY FILLED

STANDARD RADIO CORPORATION

227-229-231 W. MADISON ST. 410-412-414 SO. WABASH AV.

TWO BIG STORES CHICAGO ILL.



JOSEPH W. JONES

One of America's leading inventors, and who has been granted over 300 patents.

Inventor of the method now used for making Disc Phonograph records.

Inventor of the pioneer Speedometer and the Best.

Inventor of the Jones Victometer, or Aeroplane Tachometer, used by the U. S. Army and Navy.

Inventor of the Jones Motrola, which eliminates the need of phonograph winding.

DISTRIBUTED BY

- Triangle Radio Supply Co. New York City
- Wholesale Radio Equip. Co. Newark, N. J.
- W. T. Grant Stores All large cities
- General Radio Corporation Phila., Pa.
- Rumsey Electric Company Philadelphia
- James H. Jones Company Boston
- C. S. Tay Sales Co. Chicago, Ill.
- Avery & Loeb Electric Co. Columbus, Ohio
- Wright & Wilhemy Company Omaha, Neb.
- Robertson Cataract Elec. Co. Rochester, N. Y.
- Charles Goldfus Co. Minneapolis, Minn.
- Ludwig-Hommel & Company Pittsburgh, Penn.
- Radio Sales Company Pittsburgh, Penn.
- Electric Supply Co. Memphis, Tenn.
- Heard Company St. Louis, Mo.
- Havens Electric Co. Albany, N. Y.
- H. F. Sackett Electric Co. Buffalo, N. Y.
- McCarthy Bros. & Ford Buffalo, N. Y.
- Newman-Stern Co., Inc. Cleveland, O.
- Radio Engineering & Sales Co. Cleveland, O.
- M & M Company Cleveland, O.
- H. C. Tafel Louisville, Ky.
- American Radio Mfg. Co. Kansas City, Mo.
- Detroit Electric Co. Detroit, Mich.
- Stern & Co. Hartford, Conn.
- Blish, Mize & Stilliman Hdwe. Co., Atchison, Kansas
- Comers Electric Store Hutchison, Kansas
- Milnor Elec. Company Cincinnati, Ohio
- Joplin Radio Co. Joplin, Mo.
- W. A. L. Thompson Hdwe. Co. Topeka, Kan.
- The Varney Electric Supply Co. Indianapolis, Ind.

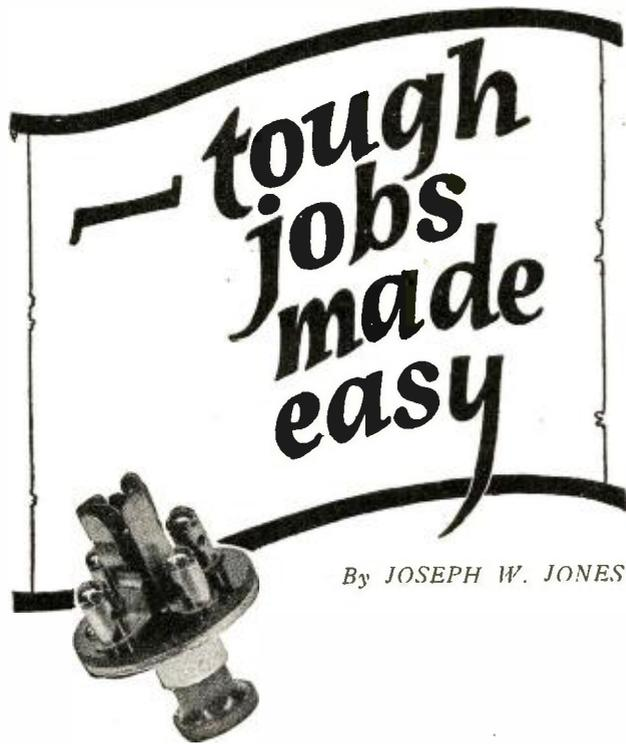

By JOSEPH W. JONES

Less Holes to Drill in Panel

NO SOLDERING

IMPROVED

ANTI-CAPACITY

RADIO JACKS and Switches

Improved Radio Jacks and switches are radically different in design and construction from other types of similar products. They are made especially for radio use and save money, time and labor in assembling a radio set. May be had from most dealers or direct on receipt of money order or bank draft.

Write for folder describing the entire line

Save Time

Save Money

Save Space



Double-throw, single pole anti-capacity switch. Price \$1.25



Open circuit Price, 70 cents



Double Circuit Jack. Price \$1.00



Closed Circuit Price 85 cents



Series Parallel Switch. Price \$1.50.



Single-throw A-battery switch. Price \$1.00

RADIO IMPROVEMENT CO., 29 W. 35th St., New York

RPM "Add-a-Unit" Line



The simple and inexpensive way of building your own radio set. Each RPM unit is complete in itself including a handsome individual Bakelite panel. No panels to drill; no dials, knobs, spaghetti wire or other things to buy. Just mount the units, one by one on a board, and connect up the binding posts. Hookup diagrams with every unit free.

A series of inexpensive RPM units, mounted side by side, make a fine looking set, and you'll get results.

You can start with the RPM Coupled Circuit Tuner, Variocoupler or Variometer with Detector. Then add RPM Amplifying units both audio and radio frequency as desired.

RPM Variometers, Variocouplers and Coupled Circuit Tuners also come without front panels to be used in any mounted set.

RPM Rotor and Stator Shells and individual panels are molded from genuine Bakelite in our own plant.

A mighty good line for both Jobbers and Retailers to tie to. Send for Circular and liberal discounts.

Radio Products Mfg. Co.
667 West 14th St. Chicago, Ill.

PEERLESS UNIVERSAL Double Range Tuning Coil

A Complete Tuning Coil—Three Units in One
Simple and Economical for Building Your Own Set

150-600 Meters



TAKES THE PLACE OF
Variometers
Vario-Couplers
Variable Condensers

THE PRICE is no more than any one of the above units.

Ask Your Dealer or Write Us

United Radio Corp.

ROCHESTER, N. Y.

Mfrs. of Peerless and Davis Headsets
Export Office: 50 Church St., New York

SALESMEN

Largest radio publishing organization in the world, wants salesmen, either whole or side line, to sell an assortment of 20 books to the trade.

Liberal commission to hustlers.

Box 233, RADIO NEWS
New York City.

SUN SET CRYSTALS

GUARANTEED

Granular Galena mounted in Woods metal. List price, 50c.

Pyrite mounted in a highly conductive alloy.

List Price, 25c.

Manufacturers, Jobbers and Dealers: Write for prices. The largest manufacturers of wireless sets are now using our crystals.

U. S. Mfg. & Distributing Co.
45 Clinton St., Newark, N. J.



GOLD tipped CATWHISKER, holds sensitive spot of CRYSTAL, 30c. Glass Cells for B. Batteries, 7"x1" each 7c. **RADIOKRAFT SHOP** New Canaan, Conn.

mfd. variable condensers in place of the .00052 mfd. capacity originally specified. No other change is necessary.

STOPPING CONDENSER

Considerable indecision seems to be apparent as to the necessity of a phone or stopping condenser in the circuit, inasmuch as one is called for in the material list, but not shown in the hook-up. This is a matter of experiment, as with some tubes a stopping condenser may be required, while with others it is superfluous. The writer found it of no advantage with the Radiotron type U.V.-201A tube or the Cunningham C-301A, but a necessity with either the U.V.-200 or C-300 tubes.

The matter of amplification seems to be next in order among the inquiries. The writer does not recommend radio frequency amplification with this set, although one correspondent tells of surprisingly excellent results with one stage.

In the majority of cases, however, audio frequency will be found most desirable and only A.F. will be discussed here. A suitable one- or two-stage A.F. amplifier for the set is identically the same as any typical A.F. amplifier with one exception.

Removing the telephones from the detector circuit takes their impedance from that circuit, which is not fully compensated for by the primary winding of the first amplifying transformer. It is therefore necessary, for good results, to insert a small impedance coil in series with the primary winding of the first amplifying transformer. A good coil for the purpose is one of the small telephone induction coils, or even a discarded telephone receiver winding. The best coil for the purpose can be readily found by experiment.

WONDERFUL RESULTS OBTAINED WITH THE REINARTZ TUNER

In conclusion, the writer wishes to suggest that if trouble is experienced in the construction or operation of the set, the builder carefully read over the article in the March issue of RADIO NEWS and also the above information, and re-check his hook-up as well as the constants called for. The set is capable of very excellent work, as proved by numerous letters reaching the writer reporting wonderful results.

The identical tuner described and pictured in the March issue of RADIO NEWS was used exclusively in the writer's amateur station, 8DAG, without amplification and up to the time of dismantling the station in April last, amateur and broadcast stations from every district were copied.

Radio News Laboratories

(Continued from page 417)

ally. It is provided with an adjustable air gap, thus adapting the instrument for use



under all conditions of service. The received concerts are reproduced very loudly and clearly, with a minimum of distortion. The instrument was found to be extremely sensitive and does not rattle on loud signals. The horn is so shaped as to give the instrument a pleasing and well-balanced appearance.

"BUILD YOUR OWN" WITH "RASCO" PARTS!

THE Radio Specialty Company—"RASCO" for short—now in its third year, is unquestionably the oldest and most unique radio parts supply house in the United States, if not in the whole world. This Company makes a specialty of small orders. No order is too small to get immediate and prompt attention. The reason is simple: 80% of our orders are small. The reputation of this house was built upon service. Ask any of your radio acquaintances what they think of "RASCO" service, "RASCO" promptness. Thousands of unsolicited testimonials are in our files, to prove that we serve the public as it has never been served in radio merchandise before. Be sure to get our great 84-page catalog, containing over 500 different parts. Catalog contains over 300 illustrations. "WE CAN ONLY DISAPPOINT YOU ONCE." Try us with a 50c. order and make us prove what we say. Prices include delivery to your door.

Order direct from this page. We pay all transportation charges. All goods sent prepaid in 24 hours.

NOTE BIG PRICE REDUCTIONS THIS MONTH

Money refunded if goods do not satisfy

LOOP AERIAL
The loop aerial you have been waiting for. Made entirely of well seasoned hard wood. Complete with all parts and base; No. 23 enameled wire used. Total height of loop 38", 2 feet on the side; loop is 10 convolutions. Can be put together by anyone in less than 5 minutes. Satisfaction guaranteed.

R-2600. Two foot loop aerial, complete... \$1.15

STORAGE BATTERIES
New! New! New!
Two volt, 40 ampere hour storage battery for use with WD11, 12, and U.V. 199 tubes. Don't keep on buying dry cells continuously. This storage battery will pay for itself in two months. Only best materials used. Guaranteed for 2 years. You can connect up to 6 dry cell tubes on a single one of these batteries. Can be recharged for a few cents. Hard rubber container encased in impregnated wood case. Due to low price and large weight of batteries, shipped express collect.

R-2400. Two volt, 40 ampere hour storage battery, size 2 1/2 x 8 x 9" \$4.25
R-640. Six volt, 40 ampere hour storage battery, size 4 1/2 x 7 1/2 x 9" 8.75
R-660. Six volt, 60 ampere hour storage battery, size 6 x 9 x 9 1/2" 11.00

WOOD CABINETS
Highest grade mahogany cabinets made. Best hand rubbed finish. Top is hinged. Front of cabinet rabbeted to fit panel. Price delivered to your door; no panel included in these prices. Entire cabinet made of 1/2" well seasoned stock.

R-714. Wood cabinets, panel size 7" x 14" \$3.35
R-718. Wood cabinets, panel size 7" x 18" 3.60
R-724. Wood cabinets, panel size 7" x 21" 4.40
R-710. Wood cabinets, panel size 7" x 10" 2.60
R-712. Wood cabinets, panel size 7" x 12" 3.00
R-721. Wood cabinets, panel size 7" x 21" 3.90

CARDBOARD TUBING
Only seamless tubing made in United States. Perfectly seasoned. Heavy wall. (I.D.—Inside Diameter. O.D.—Outside Diameter. L.—Length).

R-6600. 3" I.D., 3 1/4" O.D. x 7" L. \$3.30
R-6601. 3 1/2" I.D., 3 3/4" O.D. x 7" L.35
R-6602. 3 3/4" I.D., 3 3/4" O.D. x 10" L.25
R-6603. 3 3/4" I.D., 4" O.D. x 7" L.22
R-6604. 4" I.D., 4 1/4" O.D. x 5" L.35
R-6605. 2 1/2" I.D., 3" O.D. x 2 1/2" L.15

"RASCO" BEZELS
The finest Bezel on the market. Best brass mesh used. The bezel comes entirely nickel plated. Will improve looks of your panel 100 per cent. Outside diameter 1". Can be used on 3/8" or 3-16" panel.

R-1700. Rasco bezel..... \$1.15
R-1701. Bezel 1 1/2" diam. 20

FORMICA PANELS
Clearance Sale!
This sheeting is positively the best grade on the market. High finish on both sides. Too well known to require much explanation. Due to the fact that we are discontinuing these particular sizes, this material is now offered practically at cost. Prices are about 40 per cent lower than our catalogue list. Note also that we ship these panels prepaid. This alone amounts to a considerable saving.

R-350. 6" x 12" x 3-16" thick, each \$1.50
R-351. 6" x 18" x 3-16" thick, each 1.60
R-352. 9" x 12" x 3-16" thick, each 1.75
R-353. 12" x 18" x 3-16" thick, each 4.00
R-354. 6 1/2" x 19 1/2" x 3-16" thick, each 1.90
R-355. 6" x 7 1/2" x 3-16" thick, each85
R-356. 6" x 14" x 3-16" thick, each 1.60
R-357. 6" x 4" x 3-16" thick, each65

RASCO 180° VARIOCOUPLER
This Coupler while extremely low in price will do anything and everything that the more expensive ones accomplish. Silk Wire wound on bakelite tubes. There are six taps. Wave length of coupler is from 150 to 600 meters. Coupler is made for panel mounting, 1/4" shaft. Your money refunded if it does not do all that we claim for it.

R-3100 Variocoupler, prepaid..... \$1.50

MELOTONE LOUD SPEAKER
The best popular loud speaker on the market. Has tuned feature the same as all "Rico" phones. Fibre horn, heavy metal base, five foot cord. Nickel gooseneck. Greatest tuned loud talker. Compares favorably with most expensive speakers. Size overall 1 1/2", horn length 1 1/4", bell 5/8", total height 9".

R-255. Melotone Speaker..... \$4.90

RICO TUNED RECEIVERS
No better phones made. Super-sensitive. Awarded Radio News Laboratories Certificate of Merit. The only tuned phone on the market. Can be tuned for any intensity and sensitivity. Magnetic pole of phone is in mathematical center of diaphragm. "Turn the cap to tune."

R-2020. 2000 ohms, double head set \$4.45
R-3030. 3000 ohms, double head set \$5.50

"RASCO" VERNIER
Cleverest vernier made. Can be used with any dial. Soft rubber ring engages dial. Does away with vernier condenser. We guarantee results. All metal parts moulded in best black composition. Nothing to come apart. Biggest hit of the season.

R-1450. Vernier \$3.30

"RASCO" POSTS
R-650. Post made entirely of best black composition—3/32" screw—each \$0.08
R-202. Post has nickel-plated bottom part, each08
Dozen, each style90

"RASCO" SWITCH POINTS
Nickel-plated and polished. The following have been found the most popular.

R-301. 1/4" x 1/4", 6/32" thread, doz. \$1.18
R-302. 3/16" high, 1/4" dia., 6/32" thread doz.18
R-303. 3/16" x 3/16", 4-96" thread, doz.18
R-304. 1/4" dia., 1/4" thick; shank 8/32" .18
R-305. 1/4" dia., 3/16" thick; shank 4/36" .18
R-306. 3/16" dia., 3/16" thick; shank 4/36" .18
R-307. 3/16" dia., 1/4" thick; shank 4/36" .18
R-375. Switch Stop, 3/8" long, 4/36 thread, complete with nut, each18

"RASCO" SOCKETTES
Substitute for Vacuum Tube Socket. Four of these take one Vacuum Tube. Grasp tube firmly. Best contact possible. Take less room. Are better.

R-1550. Sockettes, nickleled, set of 4 \$2.25
R-1551. Sockettes, nickleled, set of 4 (to take WD-11 Tube)25
Note: Set of 4 sufficient to hold 1 Tube.

COPPER FOIL
Thinnest copper foil made. .001" thick. Comes 1/4" wide.

R-5025. Copper Foil, per ft. \$.10
10-ft. length80

PHONEHORN
Fills a new and distinct want. Base consists of R-1310 Phonodapter described on this page into which fits a fine enameled fibre horn. Size of horn 12"; bell 6 1/2". S111 Phonodapter end on a single telephone receiver and you have the lowest priced loud talker ever made. Mounted in your set or hung in corner of room it will bring sound all over the room. A most useful article! Welcome by all radio fans.

R-1321 Phonehorn, prepaid \$1.45

AUDIO FREQUENCY TRANSFORMERS
No better Transformer on the market. Highest class materials. Impregnated coils. Silicon steel stampings used. Save 50 per cent by assembling it yourself.

R-1100. A.F. Transformer, ratio 4% to 1 \$2.00
R-1150. A.F. Transformer, ratio 6 1/2% to 1 \$2.00

RADIO FREQUENCY TRANSFORMERS
The best Radio Frequency Transformer developed to date. Designed for us by Mr. R. E. LaCaul, Associate Editor of RADIO NEWS. Air core. Guaranteed to do the work. This Transformer brings in the long distances.

R-2800 Radio Frequency Transformer, size 1 1/2" x 2 1/2" \$1.50

RHEOSTATS AND POTENTIOMETERS
Highest grade Rheostat made. High tech dielectric composition base. Wound with best non-corrosive resistance wire. Comes with tapered, knurled knob. Diameter, 2 1/2". Complete with pointer.

R-4310—6 ohm, each \$.45
R-4311—30 ohms, for 301a and 201a tubes, each \$.65
R-4312—Potentiometer, 200 Ohms each. \$.85

SPIDER WEB FORMS
At last! Fine forms to wind your spider webs. Made from hard, well seasoned fibre, 1-16" thick, center and side holes for wiring. 3200 has 13 slots, 3201, 11 slots, both 5" diameter. 3201 has projection for mounting.

R-3200—Spider web form, each \$.25
R-3201—Spider web form, each \$.25

BRASS RODS
Sold in 6" lengths only

R-8032. Brass Rod, 5/32" thread, per length \$.08
R-6032. Brass Rod, 6/32" thread, per length06
R-1425. Brass Rod, plain 1/4" round, per length10
R-3616 Brass Rod, plain 3/16" round, per length06

"RASCO" NAME PLATES
The circular plate is our new Binding Post Name Plate. Diameter, 3/4". These denominations: PHONES, GROUND, OUTPUT, BATTERY, "A", BATTERY—LOUD SPEAKER, GRID, LOAD, "C" BATTERY—AERIAL, INPUT, "A", BATTERY+ "B" BATT +, LOOP, TICKLER, PLATE, "C" BATT +, FILAMENT.

R-6000 to 6019. Binding Post Name Plates, each denomination \$.15
Dozen \$ 30

REINARTZ SPIDERWEB COIL
Here is a very fine inductance for Reinartz circuit, 200-600 meters. 19 taps. Size 1 1/2" diameter; 1 1/2" center opening. Can be used in nearly all new circuits. Construction: duo-spider-web throughout. Coil is firm and will not fall apart as is case with many inferior makes. A few of these coils will work wonders in your set.

R-2650 Spider-web Reinartz coil \$1.15

PHONODAPTER
The Phonodapter will fit any phone. Metal tube fits any standard Phonograph. Make your Phonograph a loud talker. Phonocolumbia, Victor and Sonora Phonographs. Is made entirely of pure soft rubber with brass tube inserted.

R-1110 Phonodapter \$.56

DOUBLE PHONODAPTER
The Double Phonodapter fits all phonographs and will take any standard double head set, thereby making your phonograph a loud talker. Made of cast metal, nickel plated and highly polished. Has three generous soft rubber bushings.

R-1320 Double Phonodapter \$.65

RASCO Telephone Plug
This is the plug that is sold from 75c. to \$1.00 everywhere. Has hard rubber composition shell and patented cord tip holder. Must be seen to be appreciated. Finest workmanship throughout.

R-1030—Rasco Telephone Plug, each..... \$3.35

LITZ WIRE

R-323. equals No. 25 B&S, per foot \$.02
R-890. equals No. 28 B&S, per foot01
R-891. equals No. 21 B&S, per foot03
R-892. equals No. 20 B&S, per foot04
Discounts of 10 percent in 100-ft. lots.

UNIVERSAL BEARING
This bearing to hold variometer and variocoupler rotors. Total length of bearing 2 1/2". Outside shaft, 1 1/4". Length of threaded sleeve, 3/4".

R-1375. Bearing \$2.25

PANEL MOUNTING VARIABLE CONDENSERS
This condenser presents the latest word in precision mechanics. Plates, washers, and all other parts are accurately machined. Positively no better condenser on the market. Shafts 1/4". Save from 40% to 60% by assembling condenser yourself. A child can do it in a few minutes spare time. Capacities guaranteed.

R-1111 11 plate condenser, .00025 mfd. \$1.10
R-2121 21 plate condenser, .0005 mfd. 1.22
R-4343 43 plate condenser, .001 mfd. 1.50

The "Rasco" Catalog
CONTAINS 75 VACUUM TUBE HOOK-UPS. 350 ILLUSTRATIONS No. 10
550 ARTICLES, 84 PAGES

All Armstrong Circuits: These important circuits are explained clearly, all values having been given leaving out nothing that could puzzle you. Just to name a few of the Vacuum Tube circuits: The V.T. as a detector and one-step amplifier; Armstrong circuits; one-step radio frequency amplifier and detector; three stage audio frequency amplifier; short wave regenerative circuits; 4-stage radio frequency amplifiers; radio and audio frequency amplifier; inductively coupled amplifier; Armstrong superautodyne, etc. Catalog mailed only upon receipt of 15 Cents in Stamps or Coin.

Radio Specialty Co.
98 Park Place - New York City
Oldest and Original Exclusive Radio Parts House in U. S.
Factories: Brooklyn, N. Y. Elkridge, Md.

DEALERS
Get Our Special Proposition

"UNITED"
*Radio Instruments Will Multiply
the Joy of Your Radio Evenings*



Our new million dollar plant with its unequalled equipment of precision tools and our staff of trained radio experts have enabled us to develop condensers and transformers which offer

- 1—Finer tuning, under more perfect control.
- 2—Clearer reception, from any distance.
- 3—Welcome freedom from discordant noises.

"United" Audio-frequency Amplifying Transformer Magnetically shielded, Ratio 5 to 1. Price \$4.50.
"United" Variable Condensers, with new Vernier Dial Adjuster

43 plate \$6.50	11 plate \$5.50	3 plate \$4.75
23 plate 6.00	5 plate 5.00	Postpaid

Try your Dealer First. If he does not carry the line, remit to us and give us his name and address.

UNITED MFG. & DISTRIBUTING CO.
9705 COTTAGE GROVE AVENUE

New York Office:	CHICAGO,	San Francisco Office:
50 Church St.	ILL.	709 Mission St.
New York, N. Y.		San Francisco, Cal.



Arrived in excellent packing.
AWARDED THE RADIO NEWS
LABORATORIES CERTIFICATE OF
MERIT NO. 201.

**"ATLAS" AMPLITONE LOUD-
SPEAKER**

This loud-talker, which is manufactured by the Multiple Electric Products Co., Inc., 36 Spring street, Newark, N. J., is unique in that it employs two diaphragms of different sizes, one placed over the other and the two mechanically connected together at the centers. By this arrangement excellent quality



of the received concerts is obtained. The horn is designed to have good acoustic properties and also presents a pleasing appearance. Excellent results were obtained on this loud-talker with a two-step amplifier and a 45-volt "B" battery.

Arrived in excellent packing.
AWARDED THE RADIO NEWS
LABORATORIES CERTIFICATE OF
MERIT NO. 194.

The Story of Service

Before beginning the "Story of Service" let us study some of the definitions of the word "Service." Among them we find, "Act or means of supplying some general demand"—"That which promotes interest or happiness"—"Duty done."



Our goal is to make the above definitions synonymous with the SERVICE RADIO CO. Our "duty" is not "done" unless we "supply some general demand" and "promote interest or happiness."

The Story of Service begins next month

Dealers' list appearing soon. Write for
"The Story of Service."

This is a TELEFORCE product.

Service Radio Company
Dept. B

4727 Montgomery Ave., Cincinnati, O.

Service Radio

is establishing new records in loud, clear reception from distant stations; makes summer radio more dependable and winter radio a revelation; reception of distant stations through local stations—no outside wires. The Radio which combines beauty, ease of control, clarity of voice and music, distant reception and SERVICE. Compare with any on the market, then decide.

Make Your Aerial Safe!

It has all the dangerous possibilities of a lightning conductor—and it leads right into your house! Protect yourself from injury, your house from fire, and your instrument from damage by the use of a

H - C LIGHTNING ARRESTER

WITH GLASS COVER

90 CENTS
Postpaid

HOLTZER-CABOT ELECTRIC CO.
6161 South State Street, Chicago, Ill.

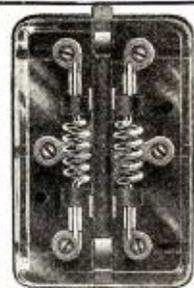

KILLOCH HEAD SET

2000 OHM \$3.25 POSTPAID IN U. S. A.
Baldwin Head Set \$8.75 Postpaid in U. S. A.
Send For Radio Catalogue

DAVID KILLOCH CO., 57 Murray St., N. Y. City

ARE YOU SELF-CONSCIOUS?

Embarrassed in company, lacking in self-control? Let me tell you how you can overcome these troubles.
M. VERITAS, 1400 Broadway, New York City

Electrons, Electric Waves and Wireless Telephony

(Continued from page 395)

make in order to avail himself, herself, or themselves of the facilities so offered, and to enable such listener-in to pick up from the ether wave energy thus sent out.

In the first place the intending listener

Get a Handy Binder for your RADIO NEWS. Holds and preserves six issues, each of which can be inserted or removed at will. Price 65c. Experimenter Pub. Co., Inc., Book Dept., 53 Park Place, New York.

Build Your Own Radio Apparatus

As Easily as a Woman Makes a Dress!

"CONSOLIDATED" PATTERNS

are designed by the foremost radio engineers and by our novel method of construction anyone can easily make efficient apparatus to receive all wave lengths. All Patterns are Full Size, printed on heavy Blue-Print paper and put up in attractive packet of heavy manila, 9x12'. Each one is fully illustrated by photographs.

Every packet contains complete instructions for the construction of these circuits including the tools required, parts needed, directions and pattern for drilling, mounting and wiring and most important of all, full instruction on how to tune the circuit. Sets constructed from these plans have been thoroughly tested and pronounced perfect.



A Cockaday Receiver

The Cockaday four-circuit tuner is one of the latest advancements in radio. Its main advantage lies in the fact that the set can be adjusted to the highest point of regeneration, and tuning accomplished over a wide band of wave-lengths without the necessity for readjusting the regeneration control. The set described in our folder was designed and built at our own shop. All dimensions, size of wire, number of turns, etc., are given, leaving nothing to the imagination.

50c.



A Reflex Receiver

The plans for the reflex receiver were gotten out only after considerable research work by our engineers. Most people have trouble with reflex receivers. It takes an expert to build one that will work satisfactorily. The trouble lies in the values of condensers, etc., in the circuits. If they are incorrect, the set is a dismal failure. The constructional details of a reflex receiver, contained in this folder, are the results of their successful efforts.

50c.



A Reinartz Receiver

The original Reinartz Receiver is the most popular type of set in existence today. It gained its popularity through its simplicity of operation and capability of long-distance reception. Full directions for building this receiver are given in this folder. The construction of the coil—the most difficult part—is made easy with the concise instructions we furnish. The connections of the set are shown plainly, so that the novice will have no trouble in following them.

50c.



Twenty Radio Phone Diagrams and Hook-Ups

These diagrams show how to get the best possible efficiency from the instruments you make or purchase. They cover hook-ups from the simplest to the most complicated, in a way that any amateur can understand and follow without difficulty. Printed on heavy paper, 8 1/2 x 11 1/2 inches, and together with KEY CHART OF SYMBOLS and pamphlet "HOW TO READ DIAGRAMS", are contained in a heavy two-color envelope.

50c.



All About Aerials and Their Construction

These blue prints were made after practical erection of each aerial, and point out how simple it is to erect not only the proper aerial for your particular need, but how to erect this aerial in the most practical manner and at the least expense.

Consists of 12 blue prints 8 1/2 x 11 inches and one four-page instruction pamphlet 8 1/2 x 11 inches.

50c.



14 Radio Formulae and Diagrams

With this packet of radio knowledge you need never worry about schematic wiring diagrams, measurements and radio tables. All formulas and diagrams are printed on heavy paper in black and blue; and contained in two-color printed envelope, 9x12 inches.

50c.

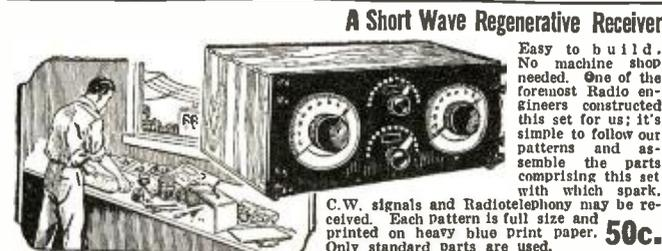

A Short Wave Regenerative Receiver

Easy to build. No machine shop needed. One of the foremost Radio engineers constructed this set for us; it's simple to follow our patterns and assemble the parts comprising this set with which spark.

C.W. signals and Radiotelephony may be received. Each Pattern is full size and printed on heavy blue print paper. Only standard parts are used.

50c.

Detector and Amplifier Units

Can be built anywhere in your house; no machine shop needed. May be used with any type of Regenerative Receiver or short wave set, with which spark, C. W. Signals and Radiotelephony may be received. We've tested these patterns by actually building the outfit — they're perfect! Only standard parts used in making the outfit.

50c.



Order from dealers whose names appear on page 494

If your dealer cannot supply you, order from us, giving his name and address

The Conrad Co

INC.

Formerly The Consolidated Radio Call Book Co.

233 Fulton Street, New York City

Publishers of Consolidated Patterns and Sales Agents for E. I. Co. Books

Picturetenna—The Antenna Supreme

MODEL A1

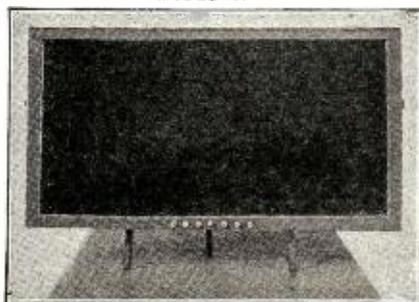

Patent Pending

Radio reception in your apartment, room, office, hotel, camp, auto, or anywhere that you can place a picture frame 16" x 30" either on a stand or on the wall. It will work any standard receiving set, one or more tubes. Reduces interference and static or atmospheric stray electrical discharges to a minimum.

Reproduces broadcasting faithfully without distortion, fading or other annoyances on all wave lengths now assigned to broadcasting.

It does away with the cost and inconvenience of having to install an outside aerial and is in many ways superior.

It is well manufactured, ornamental, and pleasing in appearance.

We will send either one post paid upon receipt of Money Order for \$7.50. Our Money Back Guarantee, if not satisfied is your protection.

MODEL A2

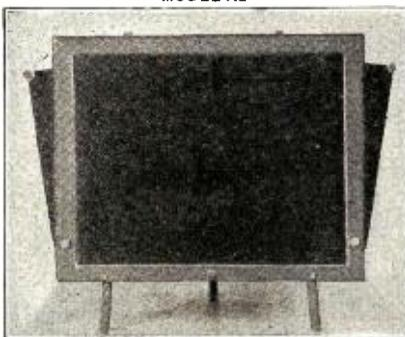

Patent Pending

The only antenna that can be used with the new Ingersoll Circuit. This circuit is one of the latest developments in radio.

It is beyond a doubt the simplest and most practical circuit yet devised for correct radio reception when used in connection with Picturetenna No. A2.

The only parts required for this circuit are one standard variometer, one standard 3-element vacuum detector tube, one socket and rheostat for same and one variable resistance leak.

It has large volume and is a distance wrecker. We will furnish working diagram and instructions for constructing this wonderful circuit free with antenna.

NATIONAL ELECTRICAL APPLIANCE CO., 177 N. State St., Chicago, Ill.

One Thousand Agents Wanted

WE want one thousand agents to sell subscriptions to RADIO NEWS, SCIENCE AND INVENTION and PRACTICAL ELECTRICS. We will pay a generous commission for this work and help you in every way. Our three publications are leaders in their fields, ready sellers and this is an offer well worth your while. A few spare hours a day will bring you a handsome return. Write regarding our proposition at once and be the first one to get started in your vicinity.

Experimenter Publishing Co.

HERBERT H. FOSTER, Sales Manager

53 Park Place

New York

(Patent Pending)



New Ideas In Radio

The Daniel Bearing and Mounting Assembly is only one of our NEW radio appliances enjoying marked success nationally. Our Merchandising Plan will prove of interest to Representatives and Dealers in open territory.

Write today for detailed information concerning the newest things in Radio.

R. W. DANIEL,
National Distributor

5232-38 Melrose Ave., Los Angeles, Calif.

THE RADIO AD LAMP



Here is the greatest business stimulator ever offered. The Radio Ad Lamp has your message painted on its transparent parchment shade. Light the lamp and the shade revolves, showing your ad on a background of illuminating colors. The shade rotates without the aid of springs or of any mechanism whatever. Everybody wonders what makes the shade revolve. It makes them guess. They speculate and talk. Put a Radio Ad Lamp in your window and stop the crowd. A Radio Ad Lamp with your ad on the shade will be sent upon receipt of \$6.00 or C.O.D. with our money-back guarantee. Send for interesting folder.

MR. SALESMAN: If you are a live wire, we can use you in some of our open territory. Write today.

CRYSTAL NOVELTY CO.

Manufacturers and Originators
9 W. Kinzie St., Chicago, Illinois.

before purchasing apparatus must provide himself or herself with a Post Office license for reception in Wireless Telephony. This is obtainable at all Post Offices where telegrams are received, and there will be no more trouble involved in purchasing a broadcasting license than in obtaining one for keeping a dog. The cost of the broadcasting reception license is 10s. Owners of home-made apparatus have to obtain an experimentalist's license after filling in a form giving particulars of their apparatus.

This license has to be renewed annually. Upon application the applicant has to give the address at which the receiving apparatus will be located and other particulars, and it is apparently part of the contract that the apparatus shall be open to inspection by duly authorized officials of the Post Office at convenient hours to see that no improper or unlicensed form of receivers are being used. The Post Office evidently contemplates a large demand for such receiving licenses, and a part of the fees taken for them will be handed over to the British Broadcasting Company to assist in meeting the expenses of upkeep of the broadcasting stations.

The public should clearly understand that the ordinary receiving license so obtained covers only the right to receive and not to transmit or speak.

The apparatus to be sold to the public for radio telephonic reception from the broadcasting stations has to comply with certain conditions and rules laid down by the Postmaster-General.

To appreciate the meaning and necessity for these rules the reader must understand that apparatus of this nature containing thermionic valves in which there is any inductive connection between the plate circuit and the grid circuit may become a source of high frequency current generation as already explained, and therefore if connected to an aerial wire it may produce violently disturbing electric waves radiated from it. Hence the necessity for Rule 4, as in the list of conditions announced, with which all such reception apparatus must comply before it can be stamped as an authorized or licensed type of receiving apparatus to be sold to the public.

The conditions now stated by the British Broadcasting Company, with which receivers must comply, are as follows:—

1. That all types of broadcast receivers may be constructed for the reception of signals of any wave-lengths.
2. That the apparatus shall be so constructed that it is difficult to change the arrangement of the circuits embodied in the design by means of external connections.
3. The following units, each of which must consist of apparatus assembled, connected and mounted in a single container, shall be approved:—

- (a) Combined tuner and rectifier.
- (b) Combined tuner, high frequency amplifier and rectifier.
- (c) Audio frequency amplifier (of valve or other type).

Any combination of two or three of the above separate units (a), (b) and (c) will be allowed.

4. No receiving apparatus for general broadcast purposes shall contain a valve or valves so connected as to be capable of causing the aerial to oscillate.

5. Where reaction is used onto the first receiving circuit it must not be adjustable, but must be fixed and incapable of causing oscillation.

6. Where regeneration is used between a second or subsequent valve on to the anode circuit of a valve connected to the aerial and there is no specific coupling provided between the first receiving circuit and the first anode circuit the reaction may be adjustable.

7. Tests of sets will be made on two

aerials, one 30 ft. long and the other 100 ft. long.

8. The sets will be tested for the production of oscillations in the aerial and for interference properties with a factor of safety, i.e., increasing the "B" battery by about 30 per cent., changing valves, etc., but not by altering any soldered connections.

9. The Postmaster-General must be satisfied that sets containing regeneration can be reasonably repeated with consistent conditions.

10. After approval the type will be given a Post Office registered number, and makers must see that the sets fulfill the non-interfering conditions before they are sold. All sets sold under the broadcast license shall bear the registered trade mark of the broadcasting company and the Post Office registered number.

11. The unit or set approved as the pattern instrument of a type shall be retained without alteration by the maker. The Postmaster-General shall have the right at any time to select any set of an approved type for test to see that the set is reasonably similar to the approved pattern. In the case of sets of an approved type employing regeneration being found to oscillate the aerial, the Post Office may cancel the authorization of the future sale of that type. No change in the design of any set or unit may be made after approval without the previous sanction of the Postmaster-General.

Having then obtained a Post Office license, the next precaution to be taken by the intending listener-in is to see that the apparatus he may decide to purchase is of an authorized type and is duly stamped to signify the same.

Unless the official mark B.B.C. is on the apparatus offered for sale, the intending purchaser should not buy it.

Another word of advice which may perhaps be offered, is that a purchaser who is possessed of very little or no technical experience in the matter of radio telephony and its apparatus would do well not to rely entirely on his own unaided judgment in the purchase, or on the assurances of shopkeepers, but should seek the advice either of a disinterested expert or some competent member of a local wireless society, or else, failing these, confine his choice to the productions of leading high-class firms with a reputation to lose, and who, for their own sake, therefore will not take advantage of his ignorance.

The next point for consideration is the type of receiving apparatus to be obtained.

This will be taken up in the next issue of RADIO NEWS.

(To be concluded in next issue)

A Reinartz Coil For A Quarter

(Continued from page 412)

sharp tool like the pointed end of a small file, and mark these, working the point into the wood about $\frac{1}{4}$ ". Get enough $\frac{3}{16}$ " diameter hard wood dowels, which come in 3' lengths and can be obtained in almost any hardware store for about one cent each. As you need 15 spokes about $2\frac{1}{2}$ " long, two lengths only are required. Drill the 15 holes in the core, but be sure your drill is of such a size that the spokes fit in tightly. Be very careful of this drilling, as it is the most tedious part of the entire coil. Start your drill at one of the center holes previously made and try to keep the center line of your drill straight with the lead pencil line previously drawn on the face of the core; at the same time your drill must be kept on a line parallel with the face of the

No Matter What Your Vocation

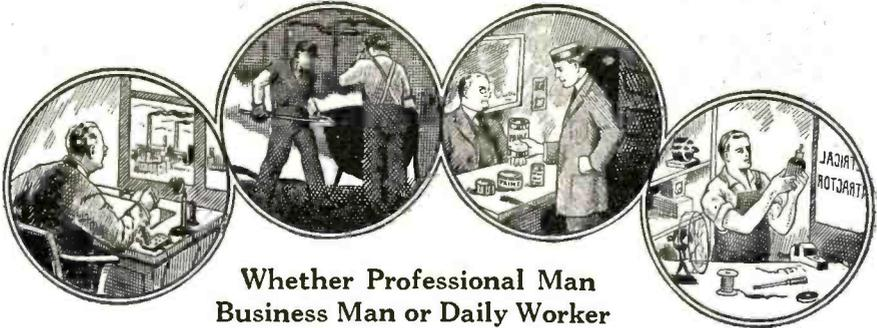

Whether Professional Man
Business Man or Daily Worker

A Thorough Training In CHEMISTRY Will Help You To Get Ahead

TO be successful today is to know Chemistry! Every line of business, every branch of industry depends upon Chemistry in some form. You may not realize it, but your own proficiency in whatever work you are doing would be increased by a knowledge of Chemistry. In many lines such knowledge is absolutely essential. In others it is a guarantee of promotion and more money.

The keen competition that exists in every commercial activity today requires that a man know all there is to know about his vocation. If you have something to sell—no matter what—Chemistry enters into its make-up. The salesman who knows the chemical composition of his article can talk about it more intelligently than the one who lacks this information, and his sales are proportionately larger. In the building trades Chemistry is of prime importance. The mason, electrician or painter who knows something about Chemistry can do better work and command more money than the one who does not. Through Chemistry a shop-keeper learns how to attract the most trade, and even in clerical positions one can capitalize his chemical skill.

Chemistry should be as much a part of your mental equipment as the ability to calculate or to write correct English. The world is paying a thousandfold more for ideas than for actual labor. The big rewards go to the man who can show how to turn out a little better product at a little lower cost. And Chemistry will give you the ideas that will save money for yourself or your firm in the very fundamentals of your business. There is nothing remarkable about this; it is going on every day. If you have not heard of it before, it is because the general public has been slow to recognize the tremendous value of chemical training. People have been content to leave Chemistry in the hands of a few trained chemists who could not possibly develop the subject to anywhere near its greatest extent.

Now we are on the eve of a great awakening. Our heritage from the World War has been an intense development of the chemical industries in the United States and a tremendous interest in all the applications of Chemistry. People are taking up the subject merely for the good it will do them in their own line of business.

It is no longer necessary to enter college in order to learn this fascinating science. Our Home Study Course trains you just as thoroughly, and with the same assurance of success, as those who took the longer way. And our methods are so simple that we can teach you no matter how little previous education you may have had. Many of our graduates now hold responsible positions or have materially increased their incomes from private enterprises as a result of taking our course. Hundreds of letters from students testifying to the benefits they have derived from our training are here for your inspection.

Remember that you do not need to study Chemistry with the idea of actually practicing as a chemist, although a great many of our students are taking our course with this object in view. If you want to know more about what Chemistry will do for you, if you want to know what our home study course offers, sign and mail the coupon today for FREE BOOK "Opportunities for Chemists."

Chemical Institute of New York, Inc.

Home Extension Division 10

66-R West Broadway, New York City

**DR. T. O'CONOR SLOANE Will
Teach You Chemistry In
Your Own Home**

The Chemical Institute of New York, of which Dr. T. O'Conor Sloane is Educational Director, was founded to fill the need of ambitious, far-sighted men who realize and recognize the splendid future Chemistry offers them, but who cannot spare either the time or the money to attend college. Dr. Sloane, a foremost authority on Chemistry, will teach you and will give you any individual help you may require. He will personally go over your papers, correct them, point out your faults, teaching you in a practical and interesting way. No special education required other than the ability to read and write English. One student has characterized our lessons as "The course that takes the mystery out of Chemistry."

Read What One of Our Recent Graduates Reports

"I thought I would let you know of my success. I finished your course about two months ago and now have a fine position as chemist at the DuPont Dye Works. I am getting along fine with my work and like it very much. It was through your course alone that I have been so successful. It is wonderful and I hope you have great success with it.

(Name and Address on request).

Easy Monthly Payments

You do not have to have even the small price of the course to start. You can pay for it in small monthly payments—so small that you won't feel them. The cost is very moderate, and includes everything, even the Laboratory Equipment—there are no extras to buy with our course. Our plan of monthly payments places a chemical education within the reach of everyone.

Laboratory Equipment Given To Every Student Without Additional Charge

We give to every student without additional charge his chemical equipment, including forty-two pieces of laboratory apparatus and supplies, and seventeen different chemicals and reagents. These comprise the apparatus and chemicals used for the experimental work of the course.

Special 30-Day Offer

For a short period we are making a special offer that will be worth your while to take advantage of. Write for particulars, using the coupon below or simply a postal card. This will not obligate you in the least. Do not wait until to-morrow. Send the coupon now while you think of it.

Sign and Mail the Coupon for FREE BOOK

CHEMICAL INSTITUTE OF NEW YORK, Inc.
Home Extension Division 10,
66-R—West Broadway, New York City.

Please send me at once without any obligation on my part, your Free Book "Opportunities for Chemists," and full particulars about the Laboratory Equipment furnished to every student. Also please tell me about your Plan of payment and your special 30 day offer.

NAME

ADDRESS

CITY

STATE

RN, 10-23.

VOL. XI. No. 5

SCIENCE AND INVENTION

OCTOBER, 1923

October

THE NEW

25 Cents

Science and Invention

IN PICTURES

\$ 12,000

IN PRIZES

FOR PICTURES

SEE PAGE 534

ELECTRIC FLAMING LOGS,
See Page 566

The NEW SCIENCE and INVENTION. On All Newsstands September 20th

The October issue of SCIENCE & INVENTION will witness an important and far-reaching innovation in the magazine field. In order to give our readers greater value for their money, the October issue, and subsequent issues of SCIENCE AND INVENTION, will contain almost three times as much matter as has been published in any previous issue.

Over Twice As Much Radio As Ever Before

INCIDENTALLY, SCIENCE AND INVENTION will appear in a new make-up which will make its reading far more fascinating and interesting than it has ever been in the past.

25c Per Copy - - \$2.50 Per Year

EXPERIMENTER PUBLISHING CO.

53 PARK PLACE, NEW YORK

core. After drilling is completed, sandpaper smooth, and the spokes can then be cut $2\frac{1}{2}$ " long and glued in. Leave it over night to dry. You will find some of your spokes projecting out farther than others on account of its being almost impossible to drill holes in the core of exactly the same depth. With a compass set at 3" and using the center of the core as a pivot, make a mark on each spoke and cut them all off. You now have a frame work which is 6" in diameter, which will look like the side and end views of the drawings. Erase all the lead pencil marks, sandpaper and give it two coats of shellac.

The mounting can be made with a piece of $\frac{3}{4}$ " x $\frac{1}{8}$ " brass, bent and drilled as shown; one screw is enough at the core and two small screws to fasten to base. This brace should not be put on until after the coil is wired. The method of winding is shown in the drawing. Always lay the wire on two spokes before carrying it through.

Use No. 22 or No. 24 D.C.C. wire and be sure it is *double covered*. The writer made a coil with single covered wire; most of the wires shorted at the crossings and the coil could not be used. The wire was removed and the frame rewound with double covered wire, which was found to be satisfactory.

If you mount the coil as shown, the taps can be taken off on both sides, and connections to switch points can be easily made.

I have found it a good plan in winding these coils to get some paper tabs and number each wire end and tap, starting at the inside with No. 1, next tap No. 2, and so on; and if you will mark your switch points at the back of the panel with corresponding numbers, the wiring will be much simplified.

A Five Watt C.W. Set For the Amateur

(Continued from page 405)

the current for two tubes very nicely. A switch for controlling the grid leak is situated between the two peep holes. This has a General Electric resistance of 5,000 ohms, having a center tap at 2,500 ohms. A .005 M. F. condenser is used in the grid circuit. This was made of 20 pieces of mica, 2" x 3", and 19 pieces of shim brass, $1\frac{1}{2}$ " x $2\frac{1}{2}$ ", each having a little lug projecting out, for means of connection. In operation the grid coil must be at the end of the inductance, opposite the ground. If there is no radiation at first, reverse the two connections of this coil.

For general information I might state that the panel of this set measures 12" x 18". A considerable amount of DX work has been accomplished with this transmitter and I feel confident that anyone who constructs an outfit similar to this one will never regret it.

Radio Can Be Sold On A Sane Basis

(Continued from page 379)

tions from inaudible to audible vibrations or frequencies so that they can be picked up by the human ear and the concerts enjoyed.

The vibrations in their original state, before they are converted by the detector, are known as "radio frequency" vibrations. After they have been converted by the detector into audible vibrations or frequencies they are known as "audio frequency" vibrations.

Heretofore, it was not possible to amplify the "radio frequency" currents before they



Raggedness Vs. Smoothness

Do you take pride in the *appearance* of the radio set you assemble? If you do, you'll use RADION panel. Besides having an incomparable finish in both Black and Mahoganite it is the easiest to saw, drill, countersink and engrave with simple tools at home.

Drill a piece of ordinary panel. The net result is usually a ragged, chipped hole—a disfigured panel. Then, too, it is difficult to saw such panels with a straight edge.

Radion is simple, easy, positive to work. With it you will always obtain a job in which you may take just pride. Combine these facts with the fact that Radion has been proved the supreme wireless insulation and you will understand why engineers, amateurs and fans, everywhere, find a truly satisfactory insulation material in RADION.

Write today for descriptive folder.

Panels, Dials, Knobs, Antenna, Insulators, Etc.

AMERICAN HARD RUBBER CO.

11 MERCER STREET, NEW YORK

RADION

"The Supreme Insulation"

The New "CLEARTONE" GOLDCREST Models

Embodying features of the so-called REFLEX circuit wherein the tubes can be made to function both as radio and audio frequency amplifiers, the new "CLEARTONE" GOLD-

CREST receivers make possible the reception of broadcasts over long distances at economical cost. The splendid quality and volume of reproduction over the entire broadcasting wave-range will agreeably surprise the user, who will also find the new GOLDCREST models to be "distinctively different" in general design.

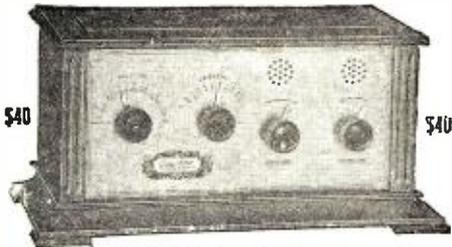

MODEL 2 REFLEX

a two-tube unit equal to one stage radio-frequency, detector and one-stage audio-frequency amplification, well mounted on panel finished in gold with lettering in black, the whole being housed in a beautiful solid mahogany cabinet.

Model 3 Reflex, similar in design to the above, but having three tubes which do the work of four. Price.....\$55.00

Model 4 Reflex, having four tubes which do the work of six. Price.....\$75.00



MODEL RFAA60.

Our standard radio frequency unit, comprising one-stage radio frequency, detector and two stages audio frequency amplification.

LITERATURE FREE ON REQUEST. Jobbers and Dealers, write for detailed proposition.

THE CLEARSTONE RADIO COMPANY
MCMILLAN & ESSEX PLACE, CINCINNATI, OHIO

LEARN THE CODE AT HOME

"Just Listen—The Omnigraph will do the teaching"

with the

OMNIGRAPH

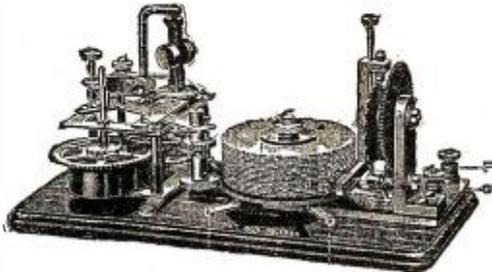

THE OMNIGRAPH Automatic Transmitter will teach you both the Wireless and Morse Codes—right in your own home—quickly, easily and inexpensively. Connected with Buzzer, Buzzer and Phone or to Sounder, it will send you unlimited messages, at any speed, from 5 to 50 words a minute.

—in fact, the Dept. of Commerce uses the OMNIGRAPH to test OMNIGRAPH has been successfully adopted by the leading Universities.

THE OMNIGRAPH is not an experiment. For more than 15 years, it has been sold all over the world with a money back guarantee. The OMNIGRAPH is used by several Depts. of the U.S. Govt. all applicants applying for a Radio license. The

Send for FREE Catalog describing three models, \$14 to \$30. DO IT TODAY.

The Omnigraph Mfg. Co., 20 Hudson St., New York City

If you own a Radio Phone set and don't know the code—you are missing most of the fun

RADIO FANS

OUR SPECIAL CATALOG AND HOOK UP—

Chock full of valuable radio information and complete list of standard radio apparatus at lowest prices in the United States.

SENT FREE

We Are New York's Largest Retailers

LIBERTY RADIO CO.

106 LIBERTY STREET
NEW YORK CITY

NEW GRIMES CIRCUIT DETAILS ARE DISCLOSED FOR THE FIRST TIME IN TWO SETS OF BLUE PRINTS EACH BEARING THE SIGNATURE OF MR. GRIMES. EACH SET HAS FULL SIZE PANEL PATTERNS, PICTURE WIRING DIAGRAMS, ALL CONSTANTS. TWO-TUBE SET CRYSTAL DETECTOR, FIVE SHEETS, \$1.25. FOUR-TUBE SET, AUDION DETECTOR, FOUR SHEETS, \$1.00.

Both Sets of Prints, TWO DOLLARS
This authoritative data is released by permission of the Sleeper Radio Corporation, licensed under the Grimes Inverse Duplex Inventions. Parts used in these sets are from Dubilier, Fada, Acme, Formica, Sleeper Radio, Stanley & Patterson, Eby, Connecticut, Pacent, and Eveready.
M. B. SLEEPER, INC.
TECHNICAL PUBLISHER
G-88 Park Place, NEW YORK CITY

WANTED—Back numbers of Radio News, Sept., Oct., Nov. and Dec., 1921, Jan. and Feb., 1922. Experimenter Publishing Co., 53 Park Place, New York City.

passed through the detector or frequency converter; however, it was common practice to amplify the "audio frequency" currents after they were released from the detector.

Today, "radio frequency" amplification is accomplished in a very simple way.

It is an easy matter to recognize the advantages of radio frequency amplification when it is realized that weak signals which will not operate the detector or frequency converter, are built up by the radio frequency amplifier to a value sufficient to operate it. This permits the reception of signals from distances which would not be possible without radio frequency amplification.

I do not believe that there is anything mysterious in this explanation, and I am quite sure that every explanation pertaining to radio can be done up in the same kind of non-technical package. The sooner the dealers recognize this and attempt to follow out such a plan, the better will be their chances of accomplishment in the field of radio merchandising.

An Experimental Radio Cabinet

(Continued from page 398)

In these and the other hook-ups the idea which is carried out is to give the technical data of the other hook-ups, while it must be left to the amateur to select for himself the connections from the ground plate of the cabinet.

The diagram Fig. 6 shows what is still a very simple arrangement for longer wave-lengths. Here we have the fixed condenser connected in parallel with the inductance coil. By this arrangement, a resonance circuit susceptible to tuning is formed, which in combination with the antenna, takes care of longer waves. This circuit can be made quite selective, so that the hook-up can satisfy tuning requirements up to a certain extent.

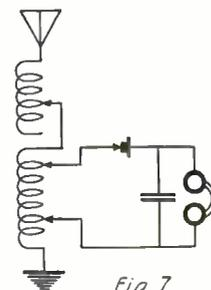

Fig. 7

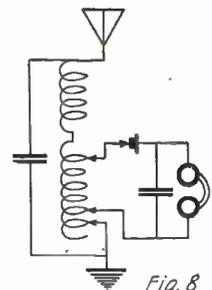

Fig. 8

With the Connections Shown In These Two Circuits, Stations On the Higher Wave-Lengths Can Be Received.

If one wants to take up still longer waves without using the parallel condenser, the coil arrangement shown in Fig. 7 is employed. Here all the available coils are put in series.

A similar arrangement which increases the capacity for receiving longer waves is given in Fig. 8. In this case the honey-comb coil is parallel to the fixed condenser,

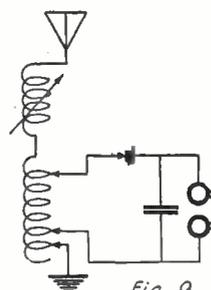

Fig. 9

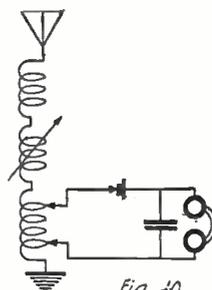

Fig. 10

Two Other Means of Connecting the Apparatus For Reception On the Longer Waves.

Perfect Radio Reception

With the Original **BALDWIN**

Only the original BALDWIN radio phone is manufactured under the personal supervision of the inventor and sold with the absolute guarantee of satisfaction after a fair trial, or your purchase price refunded, including transportation charges.



LOOK FOR THIS LABEL ON THE BOX

The BALDWIN is superior to all others because of its *distinct* construction—light weight, supersensitive mica diaphragm, permanently responsive; circular magnet with two U-shaped pole pieces, giving four points of magnetic contact; built like a fine watch. It gives perfect radio reception.

Ask your dealer for the original BALDWIN. If he cannot supply you write for circulars and price lists.

NATHANIEL BALDWIN, INC.

3474 South 23rd East Street

Salt Lake City, Utah

Attractive proposition open to distributors and dealers.



Mr. Punch says:
"The fun of having a radio is in making your own equipment. You'll find a bench lathe a good investment."



Bench Lathe
No. 494
Price \$40.00

Do real mechanic's work

With a good bench lathe, anyone who is handy with tools can do almost any kind of turning or boring job well.

The Goodell-Pratt Bench Lathe illustrated is just the right size for home use. Length over all, 31 inches. Height, 11½ inches. Swing, 7 inches. Extreme distance between centers, 18 inches.

With this lathe is included an adjustable tee rest, a slotted face plate, saw arbor,

and a drill chuck with a No. 1 Morse taper shank. The chuck holds round shanks of all sizes from 0 to ¼ inch.

Just One of 1500 Good Tools

If you are familiar with the Goodell-Pratt line, you know that there is a tool made for almost every conceivable kind of job.

Each of the 1500 Goodell-Pratt Tools is made for good workmen by good workmen—toolsmiths who have spent their lives in the business.

Write for Catalog No. 15. It's free.

GOODELL-PRATT COMPANY, Greenfield, Mass., U. S. A.

Toolsmiths

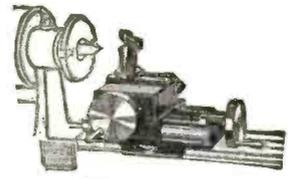

Slide Rest No. 132
Price, \$16.00



Countershaft No. 130
Price, \$11.00

Good tools for motor cars

Like all the Goodell-Pratt 1500 Good Tools, these are made for good workmen—the most exacting judges of good tools—by toolsmiths who have spent their lives in the business.

Write for complete details concerning the Goodell-Pratt Bench Lathe and other motor tools.

GOODELL-PRATT

1500 GOOD TOOLS

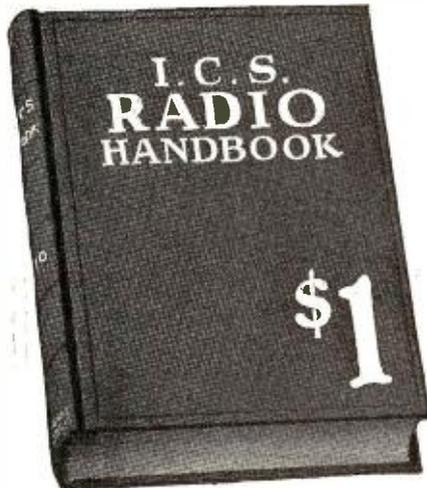

At last! A practical authoritative book on RADIO

562 pages. Price only \$1
 Compiled by HARRY F. DART, B.S.E.E.
 Formerly with the Western Electric Co., and
 U. S. Army Instructor of Radio
 Technically edited by F. H. DOANE

THE most complete book of its kind ever published. Written, compiled and edited by practical radio experts of national reputation. Packed with concise, sound information useful to every radio fan—from beginner to veteran hard-boiled owl. Hundreds of illustrations and diagrams to make every point clear. Note this partial list of contents:

Different types of receiving and sending hook-ups, electrical terms, condensers, oscillating circuits, coupled circuits, induction coils, antenna systems, electric batteries, generators and motors, protective devices, crystal detectors, arc generators, transmitters, filters, wavemeters, radio experiments, International and Morse codes, commercial receiving sets, tables and data, radio transmitting and broadcasting stations (with call letters), Radio License Regulations, etc.

Send \$1 to-day and get this 562-page I. C. S. Radio Handbook before you spend another cent on parts. Money back if not satisfied.

TEAR OUT HERE
 INTERNATIONAL CORRESPONDENCE SCHOOLS
 Box 8282, Scranton, Penna.

I enclose One Dollar. Please send me—post-paid—the 562-page I. C. S. Radio Handbook. It is understood that if I am not entirely satisfied I may return this book within five days and you will refund my money.

Name.....
 Address.....

LEARN ELECTRICITY IN 3 MONTHS

Make this the most profitable and enjoyable summer of your life. Come to Chicago, the electrical center and the country's greatest summer resort city. Learn Electricity in America's oldest, largest and best equipped school. Earn your way, free employment dept. If you come now we will pay your railroad fare and give you free a course in auto truck and tractor electricity, a course in radio, and a life scholarship in the great Coyne School. This is the greatest offer ever made by a school. Write at once for particulars. We cannot keep this offer open long.

Write Today **Coyne**

Trade and Engineering Schools
 1300-1310 W. Harrison St.,
 Dept. 59-47 Chicago, Ill.

which presents advantages similar to those of Fig. 6.

An actual improvement of the tuning idea is possible, if we connect the variometer in series with the honeycomb coil. This opens up a whole series of fundamental possibilities which are given in Figs. 9 to 12.

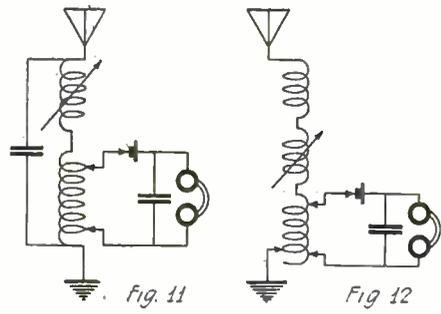

Showing How the Set Can Be Loaded By the Fixed Condenser Or the Loading Coil.

In Fig. 9 the variometer is connected in series definitely with the tapped coil. In Fig. 10 all the available honeycomb coils are connected in series with the variometer to increase the scope of wave-length. In

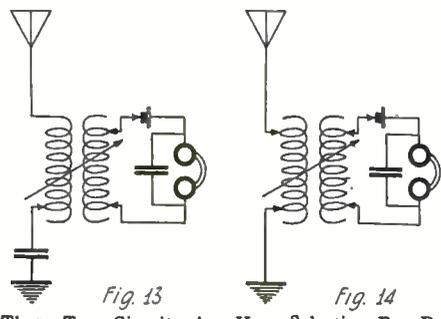

These Two Circuits Are Very Selective For Reception On the Lower Waves, Inductive Coupling Being Employed.

Fig. 11 the fixed condenser is in parallel with this combination, which provides again a considerably improved selectivity, outside of the increased scope of wave-length reception.

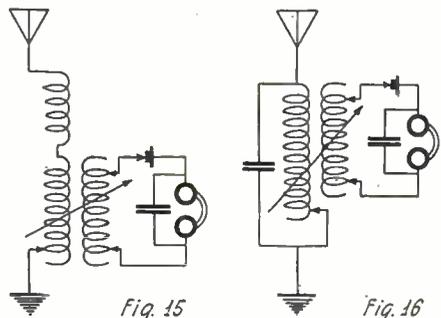

Two Selective Circuits For Reception On High Waves, Also Employing Inductive Coupling.

In Fig. 12 all the coils are used in combination with the variometer. In all the foregoing hook-ups, in a cer-

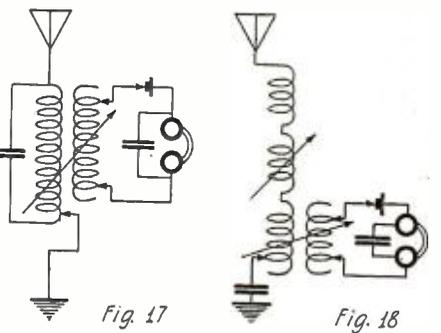

Two More Coupled Circuits Which Are Selective For Reception of Long-Wave Stations.

tain sense, a reasonably adjustable detector coupling is possible; no use has been made of a fine adjustment of this type. This is approached to a greater degree in the hook-

static?

John A. Burrichter, 207 E. Ohio St., Indianapolis, Ind., writes:

"My set is about ten blocks from one of the local stations and when they started broadcasting, it meant that ended everything for the evening. After your Wave Trap was installed, they were tuned out completely.

"Had expected with the approach of warm weather to take down my set until next fall, but while other local 'Listeners In' are almost entirely cut off by STATIC, I am enjoying the programs just as much as in the cold months.

"Have covered distances that heretofore have been impossible and really consider the Wave Trap the greatest invention since radio."

The Original \$8.50 Prepaid
 Wave Filter



25 E. SOUTH WATER ST.
 CHICAGO

STATIC and Interference is Reduced to a Minimum

Better Reception with the NASSAU

Pat. Pending
 Price \$35.00
 Jobbers and Dealers Write for Proposition
 Eliminates Aerial and Ground.

LOOPTUNER
 TRADE MARK

The Secret is in the Patented Winding
 1500 MILES ON LOUD SPEAKER
 With 2 stages radio and 2 stages audio frequency amplification.
 Write for Circular "R"
 Manufactured by

NASSAU RADIO CO., Inc.
 60 Court St., Brooklyn, N. Y.

Variable Grid Leaks	\$.45 each
Tubular Grid Leaks (all resistance)50 each
Tubular Grid Leaks mounting35 each
Single V. T. Sockets Type S-1090 each
Triple V. T. Sockets Type S-4	2.70 each
Bakelite WD-11 Sockets50 each

RADIO SERVICE & MFG. CO.
 (Established 1918)
 Factory—Lynbrook, L. I.
 We carry a Complete Line of Radio Apparatus

DENVER

COLORADO

9ZAF
REYNOLDS RADIO CO.
KLZ

1534 Glenarm St.

LARGE RADIO DISTRIBUTORS

DAY-FAN

Audio Frequency Transformers

Bakelite Variocouplers

Bakelite Variometers

Vernier Condensers

5, 10, 20, 30 Ohm Rheostats

Potentiometers

Knobs and Dials

Wave Length Adapters

Tuned Radio Frequency Transformer

FOR use in Standard Radio Frequency Circuits—Neutrodyne Circuits—Reflex Circuits. Tunes to any wave-length between 200 and 1000 meters.

Don't overlook the fact that many of our best broadcasting stations have been assigned new wave-lengths.

Every piece of Day-Fan Radio Apparatus is designed to operate over the entire public broadcasting range.

Write for 1923-1924 Catalog.

The Dayton Fan and Motor Company
Dayton, Ohio
Established 1889

DAY-FAN

Complete Detector Units

Complete Audio Frequency Amplifying Units

Complete Radio Frequency Amplifying Units

Mounted Variocouplers

Mounted Variometers

DAYTON FANS

DAYTON MOTORS

RADIO FOR ALL

By **H. GERNSBACK**
Editor "Radio News," "Science and Invention" and "Practical Electrics"

With over 130 illustrations and diagrams, and 12 photographs, 300 pages, size 8 1/4" x 5 1/2".

What the novice in radio needs is a book in which he can get all the information necessary for him to understand radio telephony and telegraphy, to make or buy a receiving set suitable to his means, to know how to operate his set, and after he has an understanding of the radio art, information that will enable him to advance and get the most out of his outfit. All this must ordinarily be dug out of text-books, pamphlets and government publications, but the aim of this book is to have all the data and information that the beginner will need from the time that he takes up radio. It is a permanent, comprehensive reference book for the dyed-in-the-wool dabbler in Radio.

What the Book Is.

A combination of a radio course for the novice in radio telegraphy and telephony with a reference book for the more experienced amateur. Half a dozen books in one.

For the Beginner.

The theory of radio carefully explained with drawings.
Description of and instruction for operating instruments of receiving and sending sets, with all picture diagrams of the wiring of the apparatus.
How to make your own receiving set, costing from \$3.00 to \$50.00.
How to read diagrams; for every picture diagram there is a corresponding technical diagram using the symbols instead of drawings.
How to tune sharply and eliminate interference from other stations.
How to protect your set from lightning and the laws regarding installation.
Explanation of time and weather signals.

For the More Experienced Amateur.

How to make a practical vacuum tube detector, two stage amplifier set costing less than \$50.00, that will work.
How the radio compass works.
All about underground aerials, loop aerials and directional aerials.
Formulae for finding wave length; miscellaneous formulae for finding capacity of condenser and other instruments. Tables of wire resistances, wave lengths and their corresponding frequencies, approximate wave lengths for different aerials, tuning coil data, and much more invaluable information.

Special Features.

Lists of all the broadcasting stations in the United States and Canada for concerts, time signals, weather reports, press, stock market reports, etc., with their call, wave length and time of sending.
Detailed description of Washington weather signals and their translation.
Description of a modern broadcasting station and its operation.
Large map showing location of all U. S. radio telephone broadcasting stations suitable for hanging up in radio room.
Collection of miscellaneous radio information for the amateur.

In Other Words.

The information that you ordinarily have to dig out of government publications, text-books, pamphlets, etc., is handily combined in this one book.

The Complete Book of
All Radio Information
PRICE POSTPAID

\$2.00

PRACTICAL ELECTRICS COMPANY :: :: **53 PARK PLACE, NEW YORK CITY**

FORMAN & Co.,
Broadcasting
To The Trade
The Merits of Our



RADIO ACCESSORIES



Mica Condensers of all capacities. TESTED and GUARANTEED accurate to rated capacity.

List price25c



TESTED AND GUARANTEED

GALENA PYRITES SILICON *I* there were any better we would *F* make them.

Packed in cotton in individual boxes. List Price10c

Paper Condensers, Mounted Crystals, Binding Posts, Switch Levers, Detectors, Sliders, Contact Points, Aluminum Sockets



Variable Grid Leak. 0-10 Meg. Specially formed tension contact. Permanent, impregnated Grid Line—with Composition, tapered knob.

List price25c

WHOLESALE ONLY

WRITE TO-DAY FOR TRADE DISCOUNTS.

FORMAN & CO.

Manufacturers

366 Greenwich Street, New York

RADIO PANEL SERVICE

Orders Shipped on First Train

1/8 in. Formica Panels, per sq. in.	1 3/4c.
3-16 in. Formica Panels per sq. in.	2 1/2c.
3-16 in. Hard Rubber Panels per sq. in.	1 1/2c.
1/4 in. Black Hard Fibre per sq. in.	1 1/4c.
No. 14 Tinned Copper Wire, per 100 ft.	\$1.00.
No. 16 Tinned Copper Wire, per 100 ft.60
No. 14 Square Tinned Bus Wire, per 100 ft.	\$2.00

Dealers—Write for illustrated catalog No. 4N

WESTERN RADIO CORPORATION
 CEDAR RAPIDS, IOWA.

PROTECT YOUR TUBES!



Trade "Vac-Shields" Mark

Stop Howling, Prevent Electro-Static Coupling. Make DX Tuning easy. Prevent tube damages. Shipped direct from our laboratories on receipt of \$1.00 or C.O.D., \$1.15

ORANGE RESEARCH LABORATORIES
 41 N. 16th. Dept. 10. East Orange, N. J.

ups shown in Figs. 13 to 19. In these arrangements the fine adjustment of the detector coupling is obtained by connecting the antenna circuit to one division of the variometer, while the detector circuit is connected to the other divisions.

For very short waves, the arrangement of Fig. 3 is to be used.

For somewhat longer waves, the hook-up Fig. 14 applies. Still longer waves can be received by hook-up No. 15. still longer ones by hook-up 16, and finally in Fig. 17 the connections for very long waves are shown using a resonance circuit in the antenna.

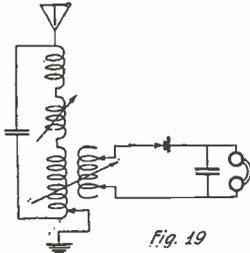

This Circuit is Adapted for Reception of Signals on Still Longer Waves. Inductive Coupling is Employed.

In Figs. 18 and 19 two possibilities in the way of hook-ups are shown for long and still longer waves, which uses everything contained in the simple erection cabinet.

The All-Purpose Receiver

(Continued from page 407)

A particularly interesting design for a two-step radio frequency amplifier will be described in the next article, and instructions will be given for using the All-Purpose Receiver with the radio frequency amplifier alone and with this audio frequency amplifier, too.

The Galena Loud Talker

(Continued from page 401)

of reproducing speech. It is the heating effect made by the electric current that causes expansion of the galena and carbon balls, and among many crystals and minerals tested, galena gave the best results. An ordinary carbon ball microphone will act as a telephone receiver to a certain extent; this fact was known as far back as 1878. Whether the galena loud talker, or loose contact thermophone, as it is technically termed, will ever be a success depends upon future developments.

Learn While You Sleep

(Continued from page 375)

"Kindly awaken," "Awaken," "Wake up," "Get up." He slept peacefully on, S.O.S. meant nothing to him. Later on another attempt failed and the following burned his head phones: "Helldamn, helldamn, helldamn." We all grew tired and still he signaled no response. What one word would arouse him? Finally, a consultation evolved the word "Doctor." It worked like a charm. He hit the key like a groggy prize fighter and the test had succeeded. We awoke him at will, thereafter, throughout the night and he always answered promptly with the key.

In the morning he was able to copy radio with much greater ease and, while no definite test was made to establish the exact amount of gain, he expressed himself as entirely convinced of the practicability of the idea and the result of his report, naturally, gained me the coveted opportunity to conduct further experiments with official sanction.

I was also assured that if further experi-

\$ 4.00



\$ 4.00

NATIONAL

AUDIO

TRANSFORMERS

Are Giving

PERFECT SATISFACTION

on thousands of sets. Use them on your set—with any type of tube. Better Transformers are not made. Highest grade materials and workmanship. Approved by experts everywhere. At your dealers. If not, order direct, mentioning his name. Dealers: Write for sales proposition.



NATIONAL TRANSFORMER MFG. CO.
 154 Whiting Street, Dept. 1014, Chicago, Illinois



A Twist of the Wrist **IT'S SET**

YELLOW TIP
 MICROMETER ADJUSTING
CRYSTAL DETECTOR

Any adjustment made in a moment—fixed instantly! Held indefinitely, until you wish a change, then—"A Twist of the Wrist—It's Set." Ideal for reflex and other circuits.

\$ 2

Write for folder and name of your nearest dealer.

WHOLESALE RADIO EQUIPMENT CO.

Exclusive Factory Representatives

38 WILLIAM ST., NEWARK, N. J.

Dealers and Jobbers write for attractive proposition.





Federal Radio Receiving Sets Bring Real Entertainment to Your Home



They embody the experience of twenty-five years in building high-class telephone equipment and fifteen years in producing radio parts and sets. They are built by radio engineers—not by experimenters. Each part and each set is guaranteed by the entire resources of the Federal Telephone and Telegraph Company.

Ask your dealer for a demonstration of the Federal 58 D. X. Receiver. If he doesn't stock them, a post card will bring a complete catalog of the 130 complete Federal units and the name and address of the nearest Federal dealer.

Federal Telephone and Telegraph Company

BUFFALO, N. Y.

Boston
San Francisco

New York

Bridgeburg, Canada

Philadelphia

Chicago
London, England

No More Leaks—

Solder Your Radio Connections This New Easy Way—

Every radio fan knows that loose, leaky connections will spoil even the best-built set.

With the Home Electric Soldering Iron, it is a simple and easy task to solder every connection and be sure of good, tight, leak-proof joints.

When assembling your set, building a loop, or installing an aerial, use the Home Electric Soldering Iron.

Extremely reasonable in cost, and almost negligible in current consumed, the Home Electric Soldering Iron will last a lifetime and pay for itself many times in convenience and utility.



Packed in a sturdy carton, with full instructions and a supply of flux and solder. Price \$3.00. If your dealer does not yet carry the Home Electric Soldering Iron, send us your order and we will ship you one by return mail, either C.O.D. parcel post or upon receipt of cash or money order.

THE A. MECKY COMPANY
1705 Allegheny Ave.
Philadelphia

KC RADIO

KUALITY SERVICE

Kilbourne & Clark Mfg. Co.

Head Office and Works: Seattle

BRANCH OFFICES

PORTLAND 305 Larrabee St.	SAN FRANCISCO, 591 Mission St.
LOS ANGELES, 1103 W. 10th St.	NEW YORK CITY, 80 Washington St.

For 10 years we have built radio apparatus for ships, shore stations, U. S. Navy, amateur and experimental use.

OUR MERCHANDISING LINE

- | | |
|----------------|-------------------|
| Receivers | Plugs |
| Amplifiers | Jacks |
| Head Phones | Adapters |
| Loud-Speakers | Sockets |
| Condensers | Amp. Transformers |
| Rheostats | Variometers |
| Potentiometers | Variocouplers |
| Switches | C. W. Apparatus |

COMPLETE LINE OF MOULDED PARTS

WATCH THIS SPACE FOR THE LATEST SPECIALTIES

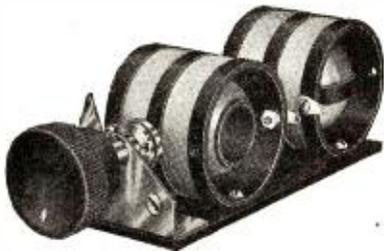

VARIABLE RADIO FREQUENCY AMPLIFYING TRANSFORMER (Midget Size)

Two Stage, 2"x2"x5½" \$10.00
Single Stage, 2"x2"x3" 5.50
Range 150-550 meters

CAN BE ACCURATELY TUNED TO ANY WAVE LENGTH BETWEEN THESE LIMITS (NOTE SMALL DIMENSIONS)

ELECTRIC SOLDERING IRON

EVERY RADIO FAN has been looking for this iron for both radio and home use. Operates on A. C. or D. C. current.

\$2.28

GUARANTEED one year. Sent anywhere in U.S. or Canada Parcel Post prepaid on receipt of money order for \$2.28.

Send 2c stamp for our list of FANS of RADIO BARGAINS

RADIO BARGAINS

17 N. LA SALLE ST. - CHICAGO

Ernest Electric Radio Headset
3000 OHMS SUPERSENSITIVE

Price **\$3.98**
Plus 20c postage—Total, \$4.18

Send 10c in Stamps for Radio Catalog
ERNEST ELECTRIC CO.
4847 Easton Ave., St. Louis, Mo.

ments were equally successful in demonstrating my claims, a request would be granted for the special automatic sending apparatus I had so long desired in order to incorporate my "Learn While You Sleep" method of instruction here.

A MATERIAL AID TO THE PRESENT SYSTEM OF INSTRUCTION

It is now proposed to develop my system as a very material aid to the present system.

Our prescribed syllabus of instruction covers a period of twenty-one weeks and the student is required to make a predetermined rate of progress week by week in order to remain in the class. Those students whose rate of progress had been consistently unsatisfactory for some time and who would therefore have been dropped from the class within the week, were told something of my successful experiences with my "Learn While You Sleep" system. Naturally, they jumped at the chance. Seventeen students volunteered for this experiment with the following results next day:

(1) One of the seventeen copied five words faster than he had ever been able to copy previously.

(2) Four copied three words faster and one nearly three words faster.

(3) Four copied two words faster, and one nearly two words faster.

(4) Three copied one word faster and one only half a word faster.

The instructors derive some amusement to compensate for their loss of time and sleep in watching the facial contortions, restlessness and mutterings caused by the induced dreams of the students. Errors and erratic sending cause restlessness and muttered protests. Stoppage of sending when changing operators will arouse them.

The system is now being tried out on officers of the class just started under much more favorable conditions, real beds replacing the wooden benches and tables. Students are no longer confined to last-chance tests.

Pioneer Work in Ether Waves

(Continued from page 377)

These experiments of Hertz were called attention to by FitzGerald in his Presidential Address to Section A of the British Association Meeting at Bath in 1888. And no wonder they interested him; for they showed that his method of utilizing the oscillatory discharge of a Leyden jar was effective; and, to the surprise of all of us, including Hertz himself, that the waves from an opened-out condenser had sufficient power to generate sparks in an insulated conductor upon which they impinged; the detecting conductor, as generally used by Hertz, being in the form of a nearly closed circle with a minute spark gap at which the scintilla appeared. The radiating power of even a small Hertz oscillator was calculated by me in a subsequent paper (*Phil. Mag.* for July, 1889, p. 54), and was found to be 100 horsepower, while it lasted. The duration was excessively short, for at that rate practically all the energy was expended in a single swing (about the 100 millionth of a second), but its power of producing little sparks was explained.

The work of Hertz was splendid. He was then Professor at Karlsruhe, still quite a young man. He had been trained under Helmholtz; and I had made his personal acquaintance in Berlin when I went to call on Helmholtz in 1881, on a tour of the universities of the continent. He was then Helmholtz's demonstrator, and was thought highly of by that great master. He could speak English, and was very friendly. I did not see him again till some time after the publication of his great discovery.

He was not at that time fully acquainted with Maxwell's Theory, though he knew

Pacent Adapter For U. V. 199 Tubes

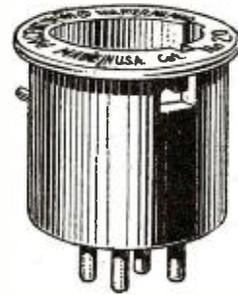

50c

A thorough quality Pacent product. Contact and insulation perfect. Cannot short circuit. Satisfactory for radio frequency circuits. At this price, the logical choice of all radio users. Catalog No. 20.

Send for Pacent Bulletins NC-10. Don't Improvise—"Pacentize"

PACENT ELECTRIC CO., INC.
22 Park Place New York, N. Y.

Pacent RADIO ESSENTIALS

Here It Is!

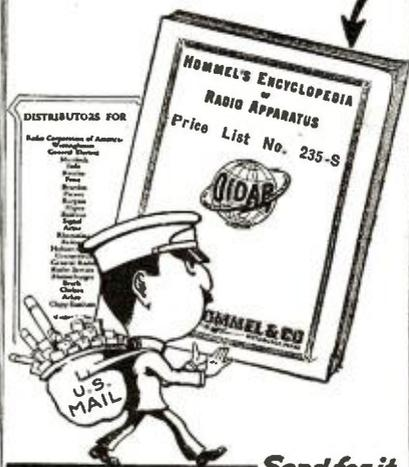

Send for it NOW

LUDWIG HOMMEL & CO
530-534 FERNANDO ST. PITTSBURGH, PENNA.

EISEMANN

RADIO UNITS
Made to the highest electrical and mechanical standards.
EISEMANN MAGNETO CORP'
Chicago BROOKLYN, N.Y. Detroit

PHONE SPECIALS

SIMPLEX SPECIAL 3000 OHM \$3.65

3000-Ohm Frost ... \$4.08	2000-Ohm Manhattan .. \$4.22
3000-Ohm Frost ... \$4.92	3000-Ohm Manhattan .. \$4.92
2000-Ohm Murdock \$4.12	3000-Ohm True-Tone .. \$3.92
3000-Ohm Murdock \$4.97	3000-Ohm Dictograph .. \$6.43
Western Electric . \$9.62	Brandes Superior \$4.76
2200-Ohm Federal. \$5.95	Baldwin Type "C" \$9.57
2000-Ohm Kellogg . \$5.92	American Elect. Special \$3.94
2400-Ohm Kellogg . \$7.89	Brandes Navy Type .. \$11.21

Send Stamp For Complete Price List.
SIMPLEX RADIO CO., 1806 Lafayette Ave., St. Louis, Mo.

his equations better than any other German except Helmholtz. Maxwell had not then made any serious impression on the Continent. Even Hertz does not seem at first to have realized what he was doing, and did not use the words "Electric Waves." That title was attached to his subsequently translated book at the suggestion of Lord Kelvin. He spoke about the out-spreading of electric force; somewhat as Joseph Henry had done. That was one title of his book. But he worked out the phenomena he observed with extraordinary skill, both experimentally and mathematically, rapidly perceiving that Maxwell's Theory could be applied to it and that it might be elaborated in detail so as to include the whole of his phenomena. He it was who drew those accurate diagrams of the genesis of the waves, showing what is happening near the oscillator at every phase—diagrams which now appear in most textbooks and of which the upper half is represented as scouring across the country. He knew that true waves were not emitted till beyond a quarter-wave length from the source. He knew how they were polarized, and how their intensity differed in the equatorial and polar directions and how it varied with what may be called latitude. In fact he rapidly came to know all about these waves. As to us, we knew not which to admire most—his experimental skill when working with a tiresome and irritating mode of detection; or his mathematical thoroughness in ascertaining the laws of their propagation. A synopsis of his equations will be found clearly cited in Preston's "Theory of Light," as well as in other books. I translated some of his papers into "Nature." And never was there the smallest iota of jealousy between us, or anything but cordial and frank appreciation. Maxwell and Hertz are the essential founders of the whole system of wireless. That is to say, they constructed the foundations solidly and well. Of the super-structure—splendid as it is now—we are as yet far from seeing the completion.

In March, 1889, I lectured to the Royal Institution on "The Oscillatory Discharge of a Leyden Jar," and incidentally exhibited many of the effects of waves, both on wires and in free space, with overflow and recoil effects. But there was nothing akin to *signalling* exhibited in this lecture, as there was in the subsequent 1894 one.

Nevertheless Sir William Crookes, on the strength of these experiments—which he mentions—wrote a brilliant article in the *Fortnightly Review* for February, 1892 (Vol. 51, page 173), in which he foreshadows actual telegraphic accomplishment by that means, and indicates also the possibility of tuning or selective telegraphy, which was not actually born till 1897. He is evidently impressed with the experiments both of Hertz and of myself, and he quotes from my *Phil. Mag. Paper* of August, 1888, in confirmation and illustration of his prevision. For he says—after speaking of choosing wave-length with which to signal to specific people—"This is no dream of a visionary philosopher. All the requisites needed to bring it within the grasp of daily life are well within the possibility of discovery, and are so reasonably and clearly in the path of researches now being actually prosecuted in every capital of Europe, that we may any day expect to hear they have emerged from the realm of speculation into that of sober fact." And then he goes on: "Even now indeed telegraphy without wires is possible within a restricted radius of a few hundred yards, and some years ago I assisted at experiments where messages were transmitted from one part of a house to another without any intervening wire, by almost the identical means here described."

That article appeared in 1892, and was an inspiration of genius. Too little appreciation is felt today for the brilliant surmises and careful and conscientious observations



One-piece glass case, including solid glass cell partitions and plate rests. Visible interior; liquid level easily watched. Rechargeable; lasts indefinitely.

New!

Westinghouse **CRYSTAL CASE** Radio Batteries

A Complete Line

Thousands of radio fans already know and enjoy the advantages of the glass-case Westinghouse "B" Batteries. Now the same advantages may also be had in Westinghouse **CRYSTAL CASE** "A" Batteries, in voltages and amperages, to meet various filament requirements. See your radio dealer, or the nearest Westinghouse Battery Service Station, at once. You're probably going to improve your set for this winter's big radio treats, and Westinghouse **CRYSTAL CASE** Batteries are a logical first step.

Westinghouse **CRYSTAL CASE** "B" Batteries

The 22-MG-2 (22 volts) is a marvel for steady, noiseless, full-powered service. Can be easily and repeatedly recharged. Larger types, too. Also single 2-volt "C" cells.

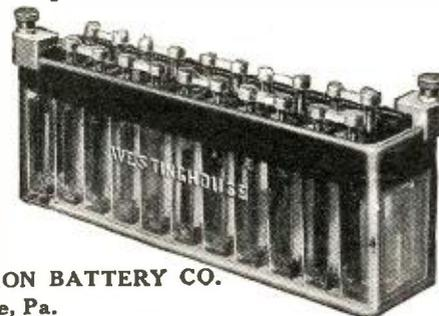

WESTINGHOUSE UNION BATTERY CO.
Swissvale, Pa.

WESTINGHOUSE

Radio "A" "B" and "C" BATTERIES



Reflex Superiority! Results Guaranteed!

Are You Getting the Best From Your Reflex Set?
M.P.M. (Million Point Mineral) Crystal

—tested and guaranteed—has proven itself the superior crystal for Reflex Reception. M.P.M. will not corrode or burn out; does not lose its sensitiveness; and clear, musical, economical reproduction is assured. Unsolicited testimonials show marvelous long-distance records, both with and without amplification. Ask your dealer for M.P.M., or send us 50c for two unmounted, or 70c for two mounted; and, in addition to crystals, we will send you diagram of a reflex circuit that we guarantee will give absolute satisfaction.

M. P. M. SALES CO., Dept. N., 247 So. Central Ave., Los Angeles, Calif.

JUST OFF THE PRESS

12th Edition

WIRELESS COURSE IN 20 LESSONS

By S. GERNSBACK, A. LESCARBOURA and H. W. SECOR

Very Greatly Enlarged

Price
\$2.00

Postpaid

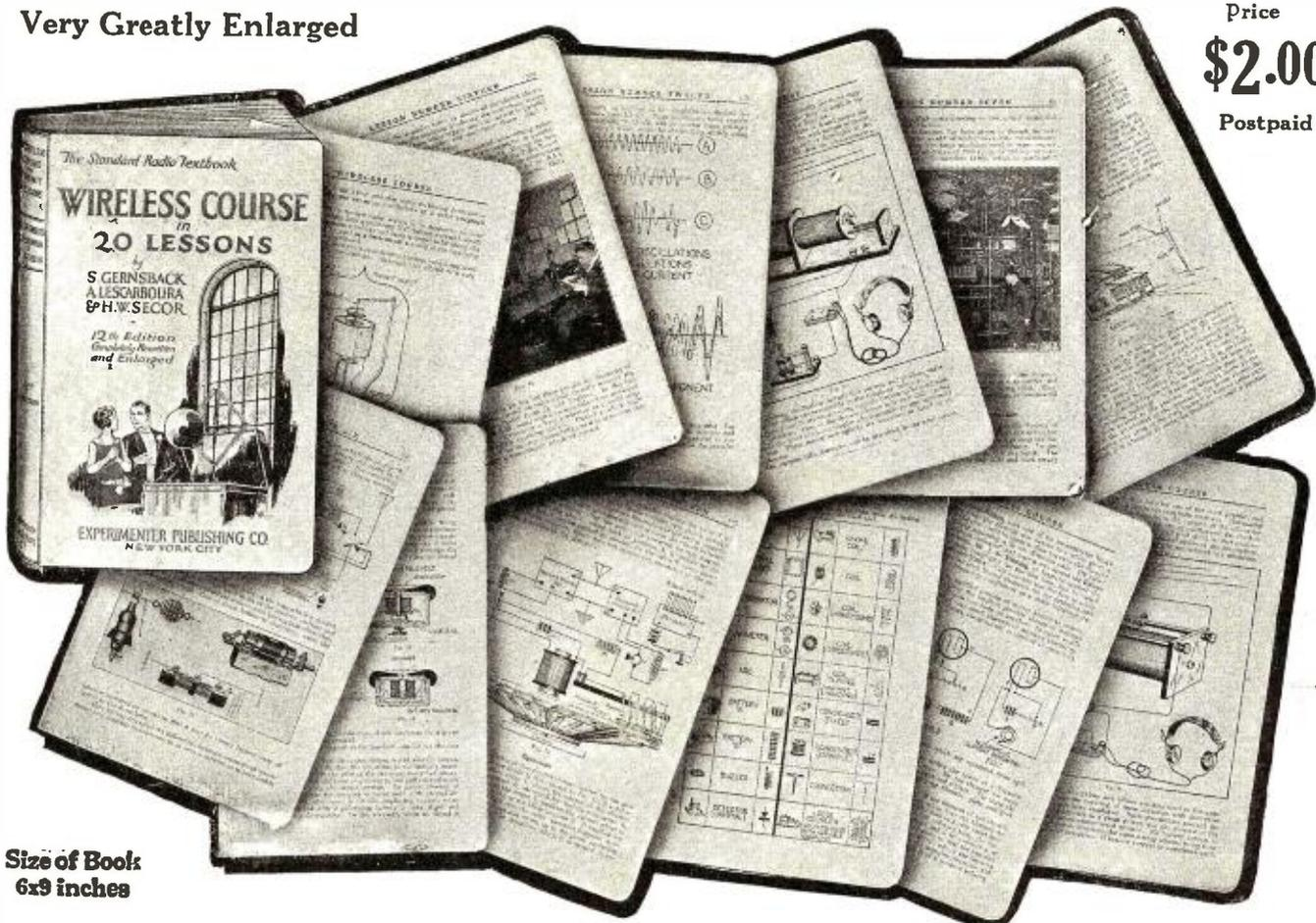

Size of Book
6x9 inches

264 pages. 500 illustrations, diagrams and photographs. Binding de luxe; black leatherette cover, genuine gold stamped; red edges; round corners; semi-flexible covers; multi-colored jacket.

This new edition contains over 100 pages more than the previous editions, of which over 100,000 were sold. It is printed in a larger type, on better paper and has better and more illustrations.

- Lesson No. 1: Principles of Electricity:
History and Explanation of Electricity, etc.
- Lesson No. 2: Principles of Magnetism:
The History and Explanation of Magnetism, etc.
- Lesson No. 3: Dynamos, Motors, Generators, and Wiring:
Explanation of Construction and Operation of each of the above, etc.
- Lesson No. 4: Principles of Wireless Telegraphy:
History and Explanation of the Wave Transmission and those concerned in the development of early radio, etc.
- Lesson No. 5: Amateur Transmitting Sets and Apparatus:
Apparatus and Circuits used by Amateurs in the early days of radio telegraphy, etc.
- Lesson No. 6: Transmitting Sets (Continued):
Apparatus and Circuits of Transmitting Apparatus, etc.
- Lesson No. 7: Commercial Transmitting Systems:
Apparatus and their operation, etc.
- Lesson No. 8: Aerials and Underwriters Installing Regulations:
Explanation of the Antenna System and Constructional details of the various types used. Official regulations, etc.

- Lesson No. 9: Radio Receiving Apparatus:
Description of the Various Types of Receiving Apparatus with an explanation of their operation, etc.
- Lesson No. 10: The Detector:
An explanation of the various types of detectors used for reception purposes, including circuits, etc.
- Lesson No. 11: The Vacuum Tube as a Detector:
Principles of operation of the vacuum tubes, etc.
- Lesson No. 12: Regenerative Receiving Set:
Description and explanation of various vacuum tube circuits, etc.
- Lesson No. 13: The Vacuum Tube as an Amplifier:
Operation of the types of amplifiers as in conjunction with tuners. Loud Speakers, etc.
- Lesson No. 14: Practical Vacuum Tube Circuits:
An explanation of various up-to-date Circuits used in Radio, etc.
- Lesson No. 15: Super-Regenerative Receiver:
Operation of the Super-Regenerative Receiver, etc.
- Lesson No. 16: Vacuum Tube Transmitter:
Vacuum Tube Transmission and Broadcasting Systems, etc.
- Lesson No. 17: Radio Compass—The Wavemeter—Radio Control:
The Radio Compass. Principles and operation of the Wavemeter and Radio Control, etc.
- Lesson No. 18: Learning to Operate—The Codes—The Wireless Law:
Methods of learning the International Code. Appendix: Detailed regulations of the wireless law, etc.
- Lesson No. 19: History of the Development of Radio:
A progressive history of radio and those concerned in its progress, etc.
- Lesson No. 20: Mathematics of Wireless Telegraphy and Appendix:
Formulas for the Calculation of Wave-length, Inductance, Capacity, and other measurements, etc.

Sent postpaid upon receipt of \$2.00

If your Dealer cannot supply you, order direct from us, giving Dealer's name and address

Experimenter Publishing Co., 53 Park Place, New York, N.Y.

of a great experimental worker like William Crookes. And on some of it orthodox science still turns its weighty and respectable back.

OTHER METHODS OF DETECTING WAVES

In 1889 I had come across the effect of cohesion under electric impetus, and employed it to ring a bell under the stimulus of the overflow of a Leyden-jar, as described in my paper to the Institution of Electrical Engineers in 1890.

In 1893 I heard of Branly's filings-tube—an independent discovery of M. Branly, which really constituted an improvement on the first rough coherer idea. I think I heard of it through a lecture and demonstration by Dr. Dawson Turner of Edinburgh. What I had called a coherer was not this, but a needle point arrangement, or the end of a spiral spring touching an aluminum plate, which was and is extremely sensitive, but rather unmanageable.

With a Branly's filings-tube I made many more experiments, developing the subject; and on the untimely death of Hertz I determined to raise a monument to his memory by a lecture at the Royal Institution on these experiments (Friday evening, June 1st, 1894), which I styled "The Work of Hertz,"—meaning that it was a direct outcome and development inspired by that work. I soon found that the title was misleading, so that in the next edition I changed it into "The Work of Hertz and some of his Successors," and subsequently changed it still further into "Signalling across Space without Wires"; for that of course is what was being done all the time. The depression of a key in one place produced a perceptible signal in another—usually the deflection of a spot of light—and, as I showed at Oxford, also in 1894, employing a Thomson marine speaking galvanometer lent me by Alexander Muirhead, a momentary depression of the key would produce a short signal, a continued depression a long signal—thus giving an equivalent for the dots and dashes of the Morse Code—if the filings-tube were associated with an automatic tapper-back. One form of such tapper-back was then and there exhibited—a trembler or vibrator being mounted on the stand of a receiving filings-tube. This was subsequently improved into a rotating steel wheel dipping into oiled mercury. Our aim was to get signals on tape with a siphon recorder, and not be satisfied with mere telephonic detection. We succeeded; but more rapid progress would have been made had we stuck to the telephone, as wiser people did.

TELEGRAPHY 1894 TO 1896

My Royal Institution (1894) lecture was heard by Dr. Muirhead, who immediately conceived the desire to apply it to practical telegraphy. And when my lecture was published—as it was in *The Electrician*, with diagrams roughly depicting the apparatus shown, drawn (some of them) skilfully but not always quite correctly, by the then editor of *The Electrician*, Mr. W. H. Snell, it excited a good deal of interest; stimulating, to the best of my belief, Captain, now Admiral Sir Henry Jackson, Professor Righi, and Admiral Popoff, to their various experimental successes which have been elsewhere described.

To show that my work of 1894, though published, and therefore unpatentable in this country, was recognized as of value and as patentable for telegraphic purposes in the United States, I appeal to my U. S. Patent (674,846, dated May 21st, 1901—application filed December 20th, 1897), which was granted, after long discussion, on the strength of work recorded in 1894, since it could be proved to have been introduced into the United States in that year—a year mentioned in the Specification, line 100.

I was too busy with teaching work to take up telegraphic or any other development; nor had I the foresight to perceive, what



**Ray-O-Vac "A's"
Fit Any One's Pocketbook**

Radio's on a basis where any one can have the best there is for a small sum, since these Ray-O-Vac "A" Dry Batteries came into use with WD-11 or WD-12 Dry Battery Tubes. Ray-O-Vac "A" Batteries cost very little, and last about 200 hours—100 nights or over 3 months of magic entertainment. The whole or any desired part of the United States is brought to your living room at a moment's notice.

Besides single cells, Ray-O-Vacs come in 2, 4 and 6-cell units. Our interesting free booklet "How to Get the Most Out of Radio" may be had by sending a card. It should be in the hands of every person with a radio set or who contemplates buying one. Ask your dealer for this battery.

FRENCH BATTERY & CARBON COMPANY
Madison Wisconsin
Atlanta Chicago New York Minneapolis Kansas City Dallas Denver



Use Ray-O-Vac "B" Batteries for sustained voltage, longer service, and elimination of noise

RAY-O-VAC
The Battery that Completes Radio

SUPER VALUES

N. & K.	German 6000 Ohms	\$5.50
BRANDES	Superior Matched Tone	\$5.25
STANDARD	3000 Ohms	\$3.50

CONDENSERS		
3	Plate Vernier\$.90
23	" " 2.50
43	" " 2.75
23	" Plain 1.50
43	" Plain 1.75

Send us a list of your requirements—anything in radio apparatus—and we will quote you special prices. Convince yourself that this is the

BEST WAY TO SAVE MONEY

All Mail Orders Shipped Promptly. Send Money Order, including Postage
Write for Our Catalogue

HANES-ZENER CO.

KNOWN FOR OUR LOW PRICES

3 West 29th Street

New York City



“Walnut” 10 Point Inductance Switch

Only one hole to drill in panel. Make all connections before inserting in panel. Contacts are smooth and positive. Base and knob genuine Bakelite, all metal parts nickel plated.

A time and money saver—and improves your set. Price complete, \$1.00.

“Walnut” Trouble Proof Variable Condensers.

Insure quick, accurate tuning. Plates are pressed and locked into supporting posts. Positive spring contact.

Plates	Plain	Vernier
3	\$1.50	—
5	1.65	—
13	2.25	\$4.25
23	3.00	5.00
43	3.50	6.00

WALNART FRICTION VERNIER ADJUSTER

Enables you to tune in the Elusive station that you always pass by. Fits any panel—only one hole to drill.

Price, 25c

All above will be sent postpaid on receipt of price; but ask your dealer first.

WALNART ELECTRIC MFG. CO.

DEPT. 602—1249 W. VAN BUREN STREET, CHICAGO, ILL.

RADIO FANS
Rejoice when using these pneumatic phone cushions. They gently hug the ears, shutting out all room noises. Fits any type headset. Money back guarantee if you are not satisfied.

FANS List of Bargains **FREE** SEND ANY AMOUNT POSTAGE FREE PER 100

RADIO BARGAINS
17 N. LA SALLE ST.—CHICAGO

W.T.501 DETECTOR TUBE

For tube sets, use our special Adaptor, 75c extra. To convert crystal sets into tube sets, use special socket, 40c extra.

\$2

Radio Research Guild
40 Clinton Street
Newark, N. J.

has turned out to be, its extraordinary importance to the navy, the merchant service, and indeed land and war service, too. But fortunately in Italy there was a man of sufficient insight to perceive much of this, and with leisure to devote himself to its practical development.

In 1896 Signor Marconi brought the subject to the notice of the British telegraphic authorities, and the subject began to assume practical and commercial importance. Its further progress during the present century is known to all. My patent of May, 1897, for tuned or selective telegraphy has been legally established by Lord Moulton as the fundamental tuning patent. It was extended in 1911 for another seven years by Lord Justice Parker, and was acquired by the Marconi Company.

The end

I Want to Know

(Continued from page 422)

will be seen, this will open the field of radio to a large number of persons to whom it is now more or less of a mystery.

Another great factor in the advancement of the radio art will be the retransmission of concerts, which have been broadcast by electric-light lines, it being done in a way similar to that discussed in the February issue of RADIO NEWS.

NOISE IN PHONES

(779) Mr. C. R. Doremus, c/o Ohla Electric Co., 23d & Market Sts., Philadelphia, Pa., writes:

Q. 1. When I use my radio receiving set I get a severe rattle in the phones, which sounds as if there is an open circuit somewhere in the set. However, I have not been able to locate any such condition and should like to know if you can assist me.

A. 1. From your description, we would strongly suspect the phone cords as being the source of your trouble. It may be that there is a broken strand in one of them, which makes contact as the cord is shifted by the movements of the wearer. Since you say that you have checked up all your connections, it would seem that this is the only possible place to look for such trouble.

ALTERNATING CURRENT ON VACUUM TUBES

(780) Mr. Walter Curtin, 1425 Broad Street, Hartford, Conn., asks:

Q. 1. How can I use alternating current for lighting the filament of my single-tube receiving set?

A. 1. Alternating current used on the filament of a single tube is very seldom satisfactory, due to the hum which will be produced in the receivers of such a set. Circuit diagrams for this circuit, which give a certain amount of satisfaction, have appeared in various past issues of the RADIO NEWS.

SHIELDING

(781) Mr. Edward E. Craven, 159 Lincoln Park Drive, Youngstown, O., writes:

Q. 1. When the back of the panel of a radio receiving set is covered with tin foil, is any connection made to this covering?

A. 1. The tin foil, when placed in the position you mention, is used to shield the instruments and is connected to the ground. This may be done by connecting it directly to the ground-post on the receiving set.

Enlarging the Classroom

(Continued from page 380)

RADIO CANNOT REPLACE THE TEACHER

“Radio can never replace the actual teacher in her classroom,” said Mr. Burnham, principal of the Haaren High School, “for after all, the most important thing about a teacher is her personality, and this is not obvious to a child who cannot see her. The idea of having pupils come up to the transmitter and talk in a regular class recitation is good, as the others can then hear the questions asked, corrections made, and instruction given.”

To this Dr. Gustave Straubenmuller, Associate Superintendent of Schools of New York City, agreed, adding, however, that a

The Pacent Rheostat

Price, \$1.00

Efficient, troubleproof, economical. Assembled with single set screw. When mounted on parts can loosen. Pointer cannot turn beyond its range. Silvered dial furnished with every rheostat. Resistances 6-10-20 or 30 ohms.

COMPLETE WITH DIAL.
Catalog No. 85—Price.....\$1.00
Cat. No. 88 Potentiometer, same design.....\$1.25

Don't Improvise—“PACENTIZE”
Send for Bulletins NA10

Pacent Electric Co., Inc.
22 Park Place
New York

Pacent RADIO ESSENTIALS

With drawer...\$15
With battery box \$17

A RADIO TABLE

Especially designed for the convenience and effectiveness of any radio set, and handsomely finished to harmonize with the furniture of the well appointed home.

Top 26 in. by 10½ in. Height 24½ in. Drawer for dry cell batteries with invisible connection at rear, or with roomy box for storage batteries.

Send money order and table will be expressed to you, or sent by express C. O. D. if you prefer. Write for photographs.

RADIO FURNITURE CO.

FLUSHING, N. Y.

\$9.00 Globe Phones for \$4.50

A purchase at a bankruptcy sale enables us to offer 300 pairs Globe Radio Head Phones, 2200 Ohms at \$4.50 per pair. Complete price list of radio parts sent upon request. Aitken Radio Co., 504 Superior Street, Toledo, Ohio.

MINERAL PRODUCTS SALES CORPORATION

Specialists in Radio Minerals,
GALENA—PYRITES—SILICON—
CADMIUM—TELLURIUM—BISMUTH.
H. P. BINSWANGER, Manager
No. 7 West 16th Street, New York

most important reason why it cannot ever replace the actual teacher is that questions arising in the minds of students must be answered immediately, or the opportunity for real service is lost. Furthermore, he said, no matter how clear an instructor may think he has made a subject there are always those who do not understand. The teacher standing before his class sees the bewilderment on the face before him, and immediately pausing, gets at the root of the trouble and clears it up. Unless he can do this the student is lost indeed, and radio lessons prevent this immediate help from being given.

This, then, is what the past year has done for the union of radio and education. It is only a start, to be sure, and it has brought to light difficulties as well as advantages, but it will be interesting to note the progress made in the new school year.

When Radio Clubs vie With Pig and Corn Clubs

(Continued from page 381)

report to the United States Department of Agriculture is enthusiastic about the benefits of this new medium for spreading, quickly and effectively, information concerning the prices of farm produce and live stock. This has been a promotion project which has centered the attention of the entire county upon our market and weather reports and the service rendered by our organization to the live stock industry, which is our main source of income. Again we cannot estimate the value of this service, nor can we determine the great benefits which will be derived in the future.

FARM BUREAU FURNISHES REPORTS

The Cedar County Farm Bureau was one of the first agencies in Iowa to install a wireless receiving set and furnish telegraphic market reports daily to farmers in that vicinity. The original radio instrument cost \$72.50, and the county agricultural agent donated an equal amount, which funds have combined to the end of acquiring efficient apparatus for the reception of crop and market reports. A blackboard is conspicuously placed, upon which to display the market reports, which are also conveyed by conventional telephone to the Bennet Savings Bank, at Bennet. Quotations on live stock and grain are received from Chicago, St. Louis, Omaha and Kansas City.

GET REPORTS BEFORE GOING TO MARKET

Instead of the "corn-husking bee" or "barn-raising frolic," where the farmers of a particular neighborhood pool their labor and husk their corn or build a new barn, the wireless instrument of the boys' radio club is likely to bring together neighboring farmers in the future. "We listen-in to reports before we start to market with our stock and quite often neighbors gather here to hear the markets," writes Lawrence Oberly of Humboldt, Nebraska.

The country bank, too, is becoming a meeting place or a radio club for farmers who read the bulletin board showing the latest news via radio. The Farmers' State Bank of Steel City, Nebraska, purchased and installed a \$125 wireless receiving outfit for the exclusive purpose of obtaining live stock and grain reports.

Eggs and poultry may be exchanged for currency in the market places on the strength of information borne on electro-magnetic waves, either tapped by boys' radio clubs or by individuals. A. C. Holfner of New Melle, Missouri, writes: "By waiting for the daily paper to bring us the market quotations, we are exactly 25 hours behind, as the market is set in St. Louis at 11:30 A. M. printed in the evening paper, which in turn, reaches us by mail at 1 P. M. the following day; whereas, we get the radio

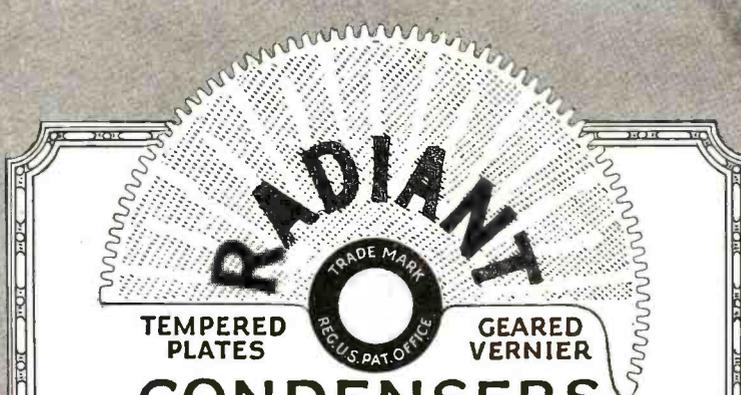

TEMPERED PLATES **GEARED VERNIER**

CONDENSERS

THE greatest condenser trouble — *warped plates* — is made IMPOSSIBLE in *Radiant Condensers*. No more readjusting, bending and makeshift supports. Both the rotating and stationary plates are PERMANENTLY FLAT as a straight edge. Flattened under powerful presses, and tempered by a new process, the plates of *Radiant Condensers* are unaffected by temperature changes. You can identify *Radiant Condensers* by the radiating rays design on rotary plates. Permanent alignment is "the best condenser buy."

Geared Vernier

Infinitely fine control of this delicate adjustment. Micrometer accuracy without special effort. Neat, smooth-working, trouble-proof gear. Another advantage for the price of just an ordinary condenser.

Write for illustrated booklet and the name of the nearest Radiant dealer.

Prices

VERNIER TYPE

13 Plate including 2 1/2" dial and knob....	\$5.00
25 Plate including 2 1/2" dial and knob....	\$5.50
45 Plate including 2 1/2" dial and knob....	\$6.50

Jobbers and Dealers
Write Immediately for Proposition.

HEATH RADIO & Electric Mfg. Co.

206 First St.
Newark, N. J., U. S. A.

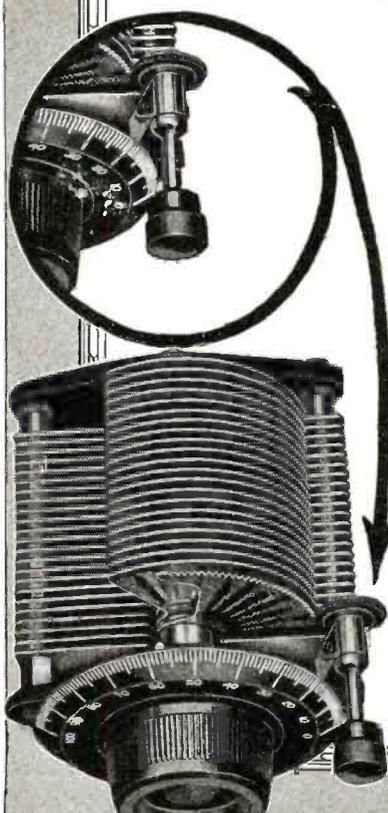



DUCK'S

Big 256 Page No. 16 Radio Catalog mailed for 25c. in coin. The largest radio catalog published. Special prices on many radio items. Prompt service, or money refunded. Ever since the year 1909 Duck's catalog has always occupied the foremost position among radio catalogs.

All radio books in catalog, except book on page 62 of our own publication, at half price, —actually less than jobber's cost. Duck Bakelite knob and dial, 30c.; Navy Type Transformer \$12.00; Jr. Loose Coupler \$4.00; 3 ft. lengths highest grade spaghetti, 18c.

Jobbers-Dealers. We have a most attractive proposition on Duck products,—well known everywhere.

NOTE.—Our new location and internal changes gives us admirable facilities to serve you promptly.

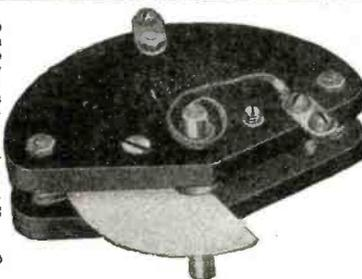

THE WILLIAM B. DUCK CO.

DEPT. A. 711-12 ADAMS ST. TOLEDO, O.

Leich Radio Parts and Accessories TIME TESTED

LEICH HEADPHONE
EUREKA HEADBAND.



Leich Headphone
1-B-2000 ohm, \$6.00

with SPECIAL No swivel adjustment required. Vertical adjustment made permanent by thumb lock nuts.

Most convenient to place in position and comfortable to wear.

Music, songs, and spoken word are reproduced in full natural tones that differentiates Radio programs from mechanical reproduction.

All phones have unbreakable cups and Bakelite caps, the strongest high quality insulating material known. Furnished with L'Radio plugs attached if ordered

PLUG



L'Radio Two Phone Series Plug, No. 61.

Price \$1.00

NEW STYLE RADIO PLUG. Two phones in series can be connected or plug used with single phone. Barrel held rigidly in position on center support by thumb lock nut. A plug made of the best of materials. Excellent finish.

You can make your home charging equipment as permanent as your Radio Set by installing Non Tune Radio Rectifiers. Secure the Non Tune firmly to a solid wall with permanent wiring to the "A" battery and recharging may be done with the least possible care. Patented Relay Lock positively prevents discharge of storage battery during power interruptions.

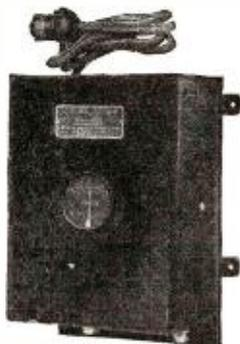

No. 16 Non Tune Radio Rectifier. Price, \$19.00.

It's Service That Counts
Write for Bulletin 101C

Leich Electric Co.
Genoa, Illinois

FREE write at once for ILLUSTRATED DRAWING of ONE TUBE-TRICOIL REFLEX CIRCUIT that will operate Loudspeaker.

The drawing is non-technical and is so arranged that anyone can build this wonderful inexpensive set.

Construction and Operating Instructions included. TRI-COIL R.F. TRANSFORMERS SOLD ON MONEY BACK GUARANTEE \$2.00 list at all dealers

BROOKLYN METAL STAMPING CO.
718-728 ATLANTIC AVE. BROOKLYN, N.Y.



KLOSNER RADIO PRODUCTS

Send for free literature.

KLOSNER IMPROVED APPARATUS CO.
2024 BOSTON ROAD New York City

market from the Post-Dispatch at St. Louis at 12:40, or one hour and twenty minutes after the market is set for the next twenty-four hours." This egg and poultry dealer resides in an inland town, eight miles from the nearest railroad.

The boys' radio clubs—or, "Farm Rad Clubs," if you will—offer possibilities both as a socializing influence and as organized agencies in the distribution of useful information; market reports, crop news, and weather forecasts, to be specific. Then, too, the glamour that is always present when tapping the ether for speech and music will rob rural life of some of its isolation and monotony. Of course, you cannot reasonably hope for a radio club to be as productive of dollars and cents as a pig club, with its increasing off-spring, yet if you measure the former project in terms of pleasure and not profit, then the benefits of the radio club may be truly appraised as one of the durable satisfactions of life in the countryside.

NAA Gets a New Voice

(Continued from page 391)

watch expert and had it checked. The result was a correction in gain or loss in seconds per day, and, as has been explained, necessitated daily corrections for exact time. To-day there is no reason for the skipper to carry his timepiece ashore for calibration, except about once a year, since he can correct it twice a day no matter where his ship is.

While the time is sent from NAA primarily for naval vessels, it is extended as a free service to all who sail the seas, besides all who listen in ashore. The new set will, it is believed, improve the time signals somewhat in audibility and in range.

Broadcasting Pays Song Writers

(Continued from page 390)

"In just four days after giving this program, we received orders for nearly two thousand copies of 'Hot Roasted Peanuts.' A majority of the orders were from sheet music dealers in the vicinity of New York, who reported that they had received numerous calls for it.

"The following week we broadcast the same program from Station WOR in Newark, New Jersey. We were again flooded with orders for 'Hot Roasted Peanuts.' As a result of the two broadcastings, nearly four thousand copies of 'Hot Roasted Peanuts' have been sold.

"So pleased are we with the result of our experiment that we are arranging to personally broadcast a program of our compositions from every principal station in the country. Already we have been booked to appear at fourteen different broadcasting stations between New York and Chicago during the month of September."

It is noteworthy that both Mr. Louis Breaux and Mr. Charles Tobias, as individuals, are members of the American Society of Authors, Publishers and Composers, which refuses to permit broadcasting stations to broadcast their copyrighted musical compositions. However, the Bee Tee Publishing Company, which owns all rights to their compositions, is a non-member. It is due to this fact that the composers of "Hot Roasted Peanuts" were able to obtain first hand and authoritative information concerning the advertising value of radio broadcasting without causing a breach between themselves personally and their society.



The Centricoupler

Approved by every Radio Fan from the Technical Wizard to the Woolworth Shopper

Approved because it is scientifically unique in construction, because it makes a 1,000 meters with ease, because it has a genuine bakelite stator and a kiln dried rotor because it is bank wound, because each tap eats up its 100 meters neatly, because—but why write history? See for yourself!

GET ONE FOR \$5

20 Diagrams with Each Instrument Free
For sale at your dealer—otherwise send the \$5 directly to the manufacturer and you will be supplied at once, postpaid.

G. H. FISCHER & CO.
123 LIBERTY ST. NEW YORK CITY

HERE'S YOUR CHANCE!!! READY FOR DELIVERY NOW!!! HAZELTINE NEUTRODYNE Circuit Complete

All Licensed Parts
Including drilled panels and complete instructions

\$28.60 Ready to Mount

CHICAGO SALVAGE STOCK STORE
Dept. RN 10
509 South State Street, Chicago



DX-PHANTOM-CIRCUIT

No Aerial-Ground-Loop required—just a piece of wire laid on floor or ground brings in near and far stations wonderfully free of static and interference. With one tube and 50 feet of wire laid on floor user writes: "I had Chicago, Minneapolis, Denver at 9 a.m. Night reception COAST to COAST. P. Ewing, Hardin, Montana." Vesco simplified circuit is easily operated, but one control for tuning in. Dry cell tube may be used for portable set. Inexpensive to make as few parts are needed. Quickly constructed by the inexperienced from our complete instructions sent postpaid for 25c, including hook-up of two-stage amplifier. Stamps accepted.
Box 117 VESCO RADIO SHOP, Oakland, Calif.

199 NECESSITIES

WIMCO 199 SOCKET95
WIMCO 199 C SOCKET 1.00
WIMCO 199 ADAPTER75

Send for free literature.
Jobbers' inquiries solicited.

THE WIRELESS MFG. CO., Canton, Ohio
MANUFACTURERS-DISTRIBUTORS

Paris Has Boulevard Radio Concerts

(Continued from page 378)

certs and statistics from 14 amplifying horns. The amplifiers are sufficiently loud to be heard over the terrific traffic noises, Consul Ives reports from Paris.

The public listening-in station was installed by the Societe Francaise Radio Electrique which broadcasts two concerts daily on 1780 meters. Other broadcasting is done by the Eiffel Tower on 2600 meters, and the Superior School of the Telegraph and Telephone Service of the Government on 450 meters.

No provision for a royalty to broadcasters has been made in France, beyond the payment of an annual fee of ten francs to the French Postal Service by owners of wireless receiving sets. The Eiffel Tower radiations are sent out for the general public, and the Superior School broadcasts are carried on in the interest of education and experimentation. The Societe Francaise Radio Electrique, however, states that it obtains its remuneration by the sale of the "Radiola" receiving sets adapted to the broadcasting system used by the Societe, explaining that in order to receive its wireless concerts properly it is essential that a "Radiola" set be used. The assertions of the company are borne out by owners of private sets who say that other receiving sets are unsuitable for the company's broadcasts, concerts being heard very indistinctly with other sets if at all.

Listening-in is becoming popular in France, it is reported, although not as extensively as in the United States. Anyone may own a receiving set there, but transmitting outfits must be licensed by the Government. French receiving sets are advertised for sale as low as 250 francs each. No specific import duties are prescribed for complete radio receiving sets, but the different parts are dutiable separately.

Most of the French broadcasts are on long wave-lengths, except those of the Superior School. It was learned recently, however, that the French Military authorities are experimenting in broadcasting on the 45-meter wave.

Calls Heard

ALVIN B. UNRUH, NEWTON, KAN. (ONE TUBE)

C.W.—5AGN, 5AHD, 5KO, 5KW, 5GA, 5LG, 5LL, 5MM, 5NN, 5ZAV, 5ZZ, 6ZZ, 7ZU, 9AAU, 9AIM, 9APW, 9ARJ, 9AWC, 9AEG, 9BAK, 9BOD, 9BRI, 9BXJ, 9CCS, 9CCV, 9CCZ, 9CWA, 9CWC, 9BK, 9BEZ, 9DHB, 9NR, 9NU, 9LA.

1 C.W.—9DEI.

Phone—5AHD, 5ZAV, 5XAJ, 5GA, 5MC, 7ZU, 9AIM, 9BEZ, 9BJN, 9CWC, 9EFV, 9DPI, 9DHB, 9EHV, 9EL, 9ZAC.

Spark—9ABV.

9DWT, ROCK ISLAND, ILL. (ONE TUBE)

C.W.—5BN, 5BW, 5FX, 5GA, 5MA, 5KW, 5PW, 5QI, 5XAJ, 5XBF, 5ZK, 8AAU, 8AGO, 8AQ, 8BAA, 8CGH, 8CEI, 8CTN, 8CWM, 8DCN, 8DDS, 8DFV, 8FU, 8JJ, 8TJ, 8VO, 9AAL, 9AAV, 9AEL, 9APV, 9ARB, 9AUD, 9AVU, 9AXB, 9DCR, 9DGA, 9DIS, 9DKW, 9DMH, 9DNF, 9DXO, 9DXN, 9BCD, 9BGT, 9BGW, 9BHD, 9BIZ, 9BSH, 9BVO, 9BZI, 9BZO, 9CDV, 9CEB, 9CVM, 9CYO, 9CXC, 9CXT, 9BK, 9HK, 9LI, 9MC, 9UR, 9ECZ, 9EIS, 9EKY.

Spark—8AYC, 9CS, 9LF.

CAN. 2HF, VERDUN, P. Q., CANADA

1CKI, 1CPN, 1BIE, 1CAZ, 1CMP, 1BLB, 1ANA, 1CPI, 1ASU, 1CCD, 1AJX, 1EMI, 1ASF, 1CDO, 1BTR, 1AMF, 1CSW, 1AJP, 1BKQ, 1ALI, 1CRE, 1MIE, 1CAB, 1AMC, 1CGR, 1BES, 1BFE, 1CIV, 1BNT, 1BQE, 1ATS, 1BQU, 1CPO, 1ASI, 1BSJ, 1ANX, 1CGS, 1BVR, 1CDR, 1CUZ, 1CLZ, 1CKI, 1XWR, 1ADN, 1CCZ, 1BLX, 1BSZ, 1BAC, 1CKP, 1ARF, 1BOK, 1AQI, 1KV, 1KC, 1ER, 1GL, 1FD, 1ZE, 1EZ, 1EE, 1KX, 1RD, 1RV, 1AR, 1VW, 1TL, 1DB, 1AF, 1IW, 1JV, 1AW, 1IL, 1XM, 1YB, 1WE, 2CLA, 2CNP, 2CEI, 2BYA, 2BYC, 2CBG, 2CUR, 2BSC, 2CKK, 2ADT, 2BBC, 2BQU, 2AGB, 2AJA, 2BRB, 2CVC, 2ATS, 2CTU, 2CBW, 2CTQ, 2CMP, 2AAV, 2AXF, 2CUI, 2CIM, 2CPA, 2AVV, 2AUZ, 2CVU, 2BKL.

Rainbow Multi-Plug & Cable

THE STANDARD SET CONNECTOR

Set end of type BP, short wires going to set



Cap end of cable used on both type B.P. and P. M.

Panel mounting type eliminates all binding posts. Type B.P. is used on sets with binding posts.



This end is the same as on the panel mounting only that a cap is over it and 18-in. wires run to the set.

Face of Panel Mounting



Showing Contacts

Here is shown the front of the one-inch button as panel mounting appears on the set. Note the key pin in center, which makes it impossible to make connections wrong.

Pull the Cable and Every Wire is dead. Push the Cable and Set is ready instantly.



Put this type on your new set; it is small and may be mounted anywhere with cord and plug, \$4.00 Type P.M.



Put your batteries on shelf in basement and run this 8 ft. cable through floor to set. 5A and B Battery wires in cable. Antenna and ground are separate leads from cap. Guaranteed not to impair efficiency of set. For sale by all Jobbers and Dealers.

JONES' "FIDDLESTICK" VERNIER



10c.

Tune with your hand away from your set. Used with or without pin. A small hole by each dial and you can split a whisker.

Dealers and Jobbers write for prices. Cuts are ready for your catalogue.

JONES' CONDENSER CLEANER



10c.

Clean those dirty condensers of dust that gathers moisture and weakens signals.

HOWARD B. JONES

612 S. Canal Street

Chicago, Ill.

VACUUM TUBE HOSPITAL

We Repair and Guarantee Them



Repairing the following tubes and many others

Vacubub Amplifiers and Detectors
Moorehead Amplifiers and Detectors
DeForest Amplifiers and Detectors
Cunningham C-299-C-300-C-301-C-301A-C-302
Radiotron U-V-199-200-201-201A-202-WD-11-WD-12.

Reasonable Prices

Mail orders solicited and promptly attended to.

Satisfaction Assured

GEORGE H. PORELL CO., Inc.
Telephone: 7931-R
SOMERVILLE (44) MASS.

BROWNLIE QUICK CONTACT

Reg. U. S. Pat. Off.
CRYSTAL

A NATURAL MINERAL FOR YOUR SET
Your catwhisker contact can move over the entire surface without loss of programme. Fourteen years of Crystal making now give you the World's best product for all uses, Reflex, Radio Frequency or Crystal Receivers.

Price Mounted and Guaranteed

30c each

Order from your dealer or sent Postpaid on receipt of coin.

ROLAND BROWNLIE, Manuf'r
22-24 Saunders Street Medford, Mass

MICHIGAN RADIO CORPORATION

GRAND RAPIDS, MICH.

Important Notice Next Month

RASLA SALES CORPORATION
10 East 43rd Street New York City.

Let an Experienced Newspaper Man Show You How to Break Into the Newspaper Field

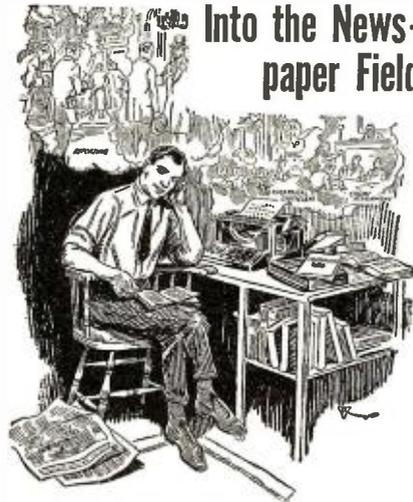

NEWSPAPER work offers countless opportunities for the young man or the young woman who really wants to amount to something. The history of Journalism shows innumerable instances where bright young Reporters have been graduated from newspaper staffs to high places in the industrial and political world. Ex-President Harding was an old newspaper man. Thomas W. Lamont, one of the senior partners of J. P. Morgan & Company, was a reporter on the New York Tribune. Senator Walter E. Edge of New Jersey was, and is, an editor; so is ex-Senator James K. Vardaman of Mississippi. Augustus Thomas, America's foremost playwright, was a reporter on the St. Louis Post Dispatch. Arthur Hopkins and Brock Pemberton, theatrical producers, were newspapermen. Arthur Woods, ex-police commissioner of New York, was a reporter. Newspaper work, in itself, is a field that offers unlimited opportunity—and it often leads to better things.

FASCINATING WORK

Salaries of \$40 to \$125 a week

There isn't any profession that offers the thrill that Journalism does and there is always room for a live, wide awake young fellow in this exciting field. Regular Reporters earn from \$40 to \$125 a week. Good deskmen on a daily paper are paid from \$60 to \$100 a week. A "Star" Reporter can command his own salary.

Part Time If You Prefer

Hundreds of ambitious men and women make extra money by corresponding for newspapers or writing for magazines in their spare time. Many of the most successful reporters of today started in this way. If you have the ability to write, there is always a market for your efforts.

We Will Teach You Journalism At Home

Henry J. Brockmeyer, Assistant City Editor of the New York Evening Post, will give you a thorough training in Journalism in six short, easy lessons. Mr. Brockmeyer is well qualified to teach you. He has trained hundreds of men and women, many of whom have, under his guidance, developed into front rank reporters or feature writers.

Mr. Brockmeyer's course in Practical Journalism will teach you what it would take months of actual newspaper work to learn. The course is complete, authoritative, easy to understand. In it Mr. Brockmeyer has incorporated everything that his long experience of over thirty years in the newspaper field has taught him. It shows not only the way a newspaper is run, giving a detailed explanation of the reportorial and administrative staffs, with the duties of each, but it trains the student in every phase of Journalism, instructing him how to develop a "nose for news," how to write, how to prepare his copy and edit it for publication and drills him in the development of style, with countless references and actual examples.

The complete course comprises six comprehensive lessons full of everything a reporter or correspondent must learn. And it's all interesting reading—more fascinating than any novel. You won't want to stop studying once you start.

Five Days Trial

To actually prove to you the merits of the course we will send it to you on five days' trial. If at the end of that time you do not feel that you have received more than your ten dollars' worth (the price of the complete course is only \$10) you may return it to us at our expense and your money will be immediately refunded. We won't even ask you for an explanation—we guarantee to refund your money in full within twenty-four hours after receiving the lessons back.

Just pin a check, money order or ten dollar bill to the coupon below and mail it to us. Then take five days after the course arrives to decide whether you want to keep it or not. You, alone, will be the judge. We know that you will find the course worth many times its price.

THE PRESS GUILD, Inc., 66-R-W, B'way, N. Y.

THE PRESS GUILD, Inc., 66-R-West Broadway, New York City.

Enclosed find \$10 for which you are to ship me at once, prepaid, Henry J. Brockmeyer's complete course in Practical Journalism with the distinct understanding that if I return the course in five days my full \$10 will be refunded and no questions asked.

(Name)
 (Address)
 (City) (State)

2HJ, 2WR, 2RB, 2JF, 2HW, 2SY, 2KF, 2VH, 3BU, 3CBM, 3BLA, 3ALA, 3ACV, 3ADB, 3ADQ, 3BOB, 3BER, 3BEI, 3BVA, 3JJ, 3HH, 3MK, 3AP, 3TJ, 3VW, 3FS, 3SU, 3AV, 3PZ, 3ME, 3BN, 3HE, 4FT, 8CQL, 8CMT, 8BFM, 8DAA, 8CUV, 8BOA, 8CEI, 8DEK, 8BDU, 8CTZ, 8CTP, 8ABA, 8DFI, 8AQO, 8BPN, 8AOI, 8ER, 8BF, 8HJ, 8FM, 8XW, 8HV, 8BT, 8ZZ, 9BN, 9BU.

Canada—1AR, 3AF, 3GE, 3XN, 3ADN.

9ZT, MINNEAPOLIS, MINN.

1FD, 1KC, (1YB), 1ALS, (1CPN), 1CPO, 2BN, (2TS), (2AA), (2AGB), 2BRB, 2BSC, (2CBW), 2CCD, (2CQZ), (2CUI), (2CUR), (3AB), 3HS, (3PZ), 3SI, 3SU, (3XN), 3ANZ, 3ARP, (3BFU), (3BGJ), (4EB), 4FG, (4FT), 4MY, (5EK), (5KW), (5LL), (5RL), (5ZB), (5AGN), (6EC), 6IV, 6KM, (6OD), (6RM), 6XE, (6ALK), (6AUU), (6AWT), (6BBC), 6BCL, 6BEO, (6BEZ), (6BJO), (6BPB), 6BOC, (6BUN), (6BVG), 6BVS, (6CBI), 6CGW, 7DH, 7IH, (7LA), 7ZA, (7ZU), 7ZV, (8GP), (8IJ), (8JY), (8QW), (8VQ), (8XH), (8ZV), (8ADA), (8AMP), (8AWP), (8BDR), (8BJV), (8BK), (8CAZ), (8CDD), (8CUR), (8CVG), (8DAT), (8DGE).

Canadian—(3DE), (3HE), 4CN.

Mexican—JH.
Bowdin—WNP.

E. L. LAMOUREUX, 3419 S. HOPE ST., LOS ANGELES, CAL. (On detector only)

5ADO, 5AKY, 5LG, 5NW, 5ZA, 5ZAV, 6ABS, 6AAJ, 6ACZ, 6ADP, 6AFA, 6AFY, 6AHX, 6ALD, 6ALQ, 6ALY, 6AME, 6AMB, 6AOI, 6AOJ, 6AOU, 6ARC, 6ATK, 6ATZ, 6AUP, 6AAU, 6AUY, 6AWT, 6BAR, 6BEH, 6BEZ, 6BFY, 6BDF, 6BFL, 6BGP, 6BIG, 6BIP, 6BIQ, 6BLY, 6BNC, 6BNT, 6BOE, 6BOP, 6BRI, 6BRU, 6BSD, 6BUA, 6BUY, 6CAS, 6CAY, 6CBU, 6CCU, 6CDC, 6CDG, 6CEI, 6CET, 6FY, 6GX, 6HP, 6HV, 6KM, 6LU, 6LV, 6RM, 6SG, 6SU, 6VF, 6WF, 6ZE, 6ZZ, 7ABS, 7AGE, 7AHW, 7KS, 7LR, 7QT, 9AMB, 9BXQ, 9BJK, 9CAA, 9CFY, 9CVC, 9ZT.

Anyone hearing my A.C. C.W. pse QSL. Also notice 60F new QRA.

5JY, DALLAS, TEXAS (1 STEP)

C.W.—4EB, 5AE, 5AJJ, 5AAR, 5AMJ, 5AKO, 5AHT, 5AIF, 5AEU, 5ADR, 5ACF, 5AHC, 5ALI, 5BE, 5CF, 5CY, 5DI, 5DT, 5EI, 5FA, 5FC, 5FX, 5GA, 5GF, 5GM, 5HY, 5JF, 5JJ, 5KC, 5KJ, 5KW, 5KO, 5LL, 5MC, 5MN, 5MR, 5NJ, 5NN, 5NW, 5NV, 5OV, 5PV, 5PX, 5PY, 5QI, 5RJ, 5RL, 5TI, 5VF, 5VK, 5VO, 5VY, 5WF, 5WY, 5XA, 5ZAV, 5ZBA, 5ZT, 8AMP, 8APN, 8FT, 8WX, 8ZZ, 9AAU, 9APE, 9AAL, 9APS, 9AEP, 9APW, 9AGY, 9AIM, 9AHZ, 9AWF, 9AOK, 9AUY, 9AVU, 9ADU, 9AYP, 9ATH, 9AMB, 9ARZ, 9AXX, 9BAK, 9BIK, 9BDS, 9BKO, 9BK, 9BRX, 9BTE, 9BTT, 9BZI, 9BSH, 9CAA, 9CAW, 9CIP, 9CCS, 9CKS, 9CKP, 9CVO, 9CFY, 9CUS, 9DFS, 9DAN, 9DFW, 9DOF, 9DMW, 9DQU, 9DVK, 9DX, 9DXN, 9DXC, 9EKF, 9EKY, 9ES, 9EJ, 9FG, 9HG, 9LZ, 9MC, 9NU, 9VB, 9VE, 9ZT.

Spark—5AKV, 5AL, 5ACO, 5AMP, 5AHW, 5AJJ, 5AJG, 5AIT, 5CT, 5JC, 5JH, 5JI (daylight), 5KO, 5KX, 5LR, 5OI, 5OS.

C.W.—FGM, QRA?

8DKC, KALAMAZOO, MICH. (4' Loop, Detector 2 Step)

(1BWJ), 1CKI, 2AJA, 2BRB, 3CI, 3HE, (3IW), 3JFA, 3BLP, 3BNU, 3BU, (3BVA), (3CEJ), 4 FT, 5XA, 5AG, (8CP), 8ER, 8FT, 8GA, 8HV, 8IJ, 8IO, 8JG (Phone), 8JJ, 8JU, (8ND), (8NZ), 8TE, 8TT, 8UK, 8VN, 8WX, 8ADO, 8AFT, 8AGP, 8APE, 8APT, 8AVD, 8AWL, (8AYJ), 8AZC, 8AZF, 8BBF, 8BDA, 8BDC, 8BDO, 8BFH, 8BFK, 8BFM, (8BGL), 8BHF, 8BJV, 8BNO, (8BPE), 8BRC, 8BSH, (8BTL), 8BVR, (8BVT), (8BWR), 8BXA, 8BZD, 8CAV, (8CED), 8CEI, 8CEJ, 8CEO, 8CES, 8CIE, 8CKO 8CPZ, (8COG), (8CQH), 8CQR, 8CRN, (8CUR), (8CVE), 8CWR, 8CXU, (8CZZ), 8DCG, (8DCY), (8DDK), 8DDT, 8DFP, (9OF), 9UR, 9WC, 9AOG, 9APS, 9APV, 9ATO, 9AWK, 9AWU, 9AZJ, 9BAK, 9BHR, (9BRY), 9BU, 9BVP, (9BWF), (9BWP), 9BZI, 9CGT, 9CHO, 9CIP, 9CNO, 9CNV, (9DDH), 9DFB, (9DHN), 9DHR, (9DSS), 9DYK, (9DWF), (9EFL), (9EGW), 9EHI, (9EIF).

Printed card to those who qsl for same. QRK, 8DKC, QRA same as 8CPY.

Club Gossip

AMATEUR RADIO CLUB

A new radio club has been formed in Erie, Pa., which has been given the name of the Amateur Radio Club. The officers elected were: Joseph E. Weber, president; Harold J. Sullivan, secretary and treasurer; Lawrence Howell, technical adviser. We shall be pleased to answer any questions from any amateur who wishes information. Just send a self-addressed stamped envelope with the query to Harold J. Sullivan, 521 Ash Street, Erie, Pa.

THE PROGRESSIVE RADIO CLUB OF RHODE ISLAND

At the first meeting of the Progressive Radio Club of Rhode Island, the following officers were elected: G. F. Aiken, president; E. J. Plummer,

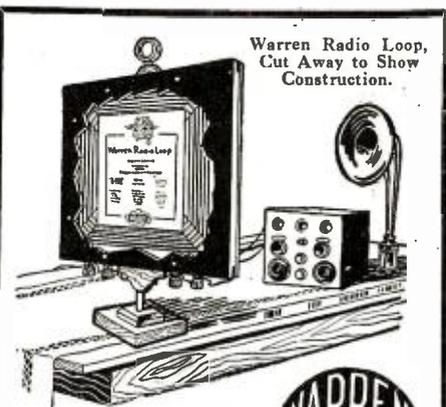

Warren Radio Loop, Cut Away to Show Construction.

Adds these Advantages to Your Set

These advantages that no ordinary aerial can give plus freedom from the danger and repairs—all incorporated in your set for the small cost of a Warren Radio Loop. Extremely accurate. Carefully made as the finest part of your set. Flat as an atlas. Completely enclosed—damp, dust and fool-proof. Use a modern aerial. Buy a Warren Radio Loop TODAY!

Send for Bulletin T102, containing hook-ups



Sharper Tuning One tuning adjustment — no others needed.

Directional Receives signals strongest.

Selective Picks out just the station you want to hear.

Portable Small, light, compact, ideal for portable or mobile sets.

Wider Range of Frequencies on single coil. Small re-radiative effect. Fine for regenerative circuit.

A Type For Every Set

- Type A-737 (300-700 meters) 6 inches square—non-directional \$10.00
- Type A-7236 (175-1000 meters) 6 inches square—non-directional 12.00
- Type B-2537 (300-700 meters) 18 inches square—directional 20.00
- Type BL-2520 (200-18,000 meters) with honeycomb coil mounting, 18 inches square—directional 25.00

V-DE-CO RADIO MFG. CO.

Dept. N ASBURY PARK, N. J.

KLAUS RADIO SERVICE

Makes Money for Dealers



Get Free Bulletin

Klaus Radio Dealers receive expert service in radio parts and in radio merchandising. Our dealers make more money. We want a dealer in every city and town. Some territory is still open. Write for our trade discount lists and the "Klaus Radio Bulletin."

KLAUS RADIO & ELECTRIC CO. Authorized Distributors Dept. 200 EUREKA, ILL.



"Built first to Last!" RADIO PRODUCTS Cotco-Coil Co. Providence, R. I.

vice-president; R. B. Perkins, secretary; G. Broster, treasurer. The chief object of this club is to promote the art of radio. We should like to get in touch with other radio clubs. Address all letters to the secretary, 46 Grove avenue, East Providence, R. I.

THE U. C. H. S. RADIO CLUB

The University City High School Radio Club of University City, Mo., was organized January 1, 1923, for the purpose of studying radio and electricity. There are 19 members. The following officers have been elected: President, Percival Barnes, 9NC; vice-president, Rea Chittenden; secretary, Frederick Schramm; treasurer, Granville Gloor; faculty advisors, Mr. Weber and Mr. Schultz.

The regular meetings are held every Wednesday after school hours. All communications to the club should be addressed to Secretary F. C. Schramm, 27 Emerson avenue, Overland, Mo.

MEN'S RADIO CLUB OF RICHMOND BOROUGH

A group of radio enthusiasts of Staten Island have recently organized a club known as the "Men's Radio Club of Richmond Borough."

The club, which is an outgrowth of the Castleton Community Council, meets every Friday evening at Public School No. 29.

A junior club, under the supervision of the Men's Club, is in the process of formation.

Membership in the club is restricted to residents of Staten Island, 18 years of age or over.

Much interesting work has been laid out for the future, in the form of lectures, experimentation and entertainment.

Non-technical talks of technical subjects have already been given by Mr. C. A. Stephen and Mr. H. Luyre.

The officers of the club are: President, Mr. C. A. Stephen; vice-president, Mr. Rudolph Neumann; secretary, Mr. F. H. Horenburger; treasurer, Mr. H. Luyre; librarian, Mr. T. Norton.

With all of Richmond Borough to draw from, a large membership is anticipated.

LYNNHURST RADIO CLUB

This club was formed in the early part of January, 1923, and has been meeting with much well earned success. Our officers are as follows: President, Mr. M. Adams; vice-president, Mr. G. Jacobs; treasurer, Mr. M. Carter; secretary, Mr. L. Mears; and corresponding secretary, Mr. E. Picklar.

The regular meetings are held every Wednesday night at 8 p. m. During the month of April we held a radio auction which proved very successful. Since that time we have been very busy fixing up our club room, which is located at the home of Mr. Mears. We have completed a single circuit tuner with two stages of amplification and a 50-watt C. W. transmitter is under construction. A radio dance is to be given in the very near future.

We should be pleased to have all interested drop us a line. Address all correspondence to Corresponding Secretary E. Picklar, 4225 Fremont avenue, South, Minneapolis, Minn.

MILWAUKEE RADIO AMATEURS' CLUB

The American Radio Relay League's Rochester Plan, which calls for no amateur transmission between the hours of 7:30 p. m. and 10:30 p. m., has been officially adopted in Milwaukee and approved by the membership of the Milwaukee Radio Amateurs' Club, Inc., and the society with the aid of A. R. R. L. City Manager, I. H. Strassman, 9AHO, and his staff is attempting to secure the utmost co-operation from the few local radio amateurs who are neither its own members nor those of the league. By such action the local amateur fraternity is sacrificing the use of the best hours of the evening in order that the broadcast listeners may be assured of no Milwaukee amateur interference whatsoever. Directly bearing upon this subject were the contents of a paper prepared by the A. R. R. L. entitled "The Status of the Amateur" which was read recently before the society by Business Manager L. S. Hillegas-Baird.

A full house turnout marked the visit of R. H. G. Mathews, 9ZN, central division manager for the A. R. R. L., and F. J. Marco, 9CD, "FJ" at 9ZN, and secretary of the Chicago Radio Traffic Organization. Mr. Mathews spoke under the title of "Construction and Operation of Radio Receivers," and Mr. Marco, "Some Recent Experiments with I. C. W." Following their talks at the club meeting, they were taken to Station 9AAP, where, among other things, Mr. Mathews listened with some surprise to his Chicago Radio Laboratory station, WJAZ.

E. T. Howell, Sc.M., technical committee chairman, has been very regular with his recent weekly reports, the subjects discussed in some of the more interesting ones being the new improved Reinartz receptor, synchronized grounds, aeriels, and University of Illinois stations 9XJ and WRM. Station 9AAP, owned by Marian Szukalski, Jr., one of the society's directors, was the only local station to be entered in the trans-Pacific tests.

The club's code class for fans and others is being conducted by H. F. Wareing, pre-war 9AEX and a former Marconi operator. Weekly meetings are continued to be held at 8 p. m., Thursdays, in the Public Museum trustees' room. The club's office, to which general correspondence should be addressed, is 601 Enterprise Bldg., Milwaukee, Wis.

RADIOGEM

The Dollar Radio Receiving Set
The Simplest Radio Outfit Made
—Yet as Practical as the Most Expensive!

You need know absolutely nothing about wireless to operate and enjoy the RADIOGEM. It is so sturdy, so simply constructed that it is small wonder radio engineers who have tested it have pronounced the RADIOGEM a brilliant achievement. The RADIOGEM is a crystal radio receiving set for everyone at a price anyone can afford.

Why The RADIOGEM Can Be Sold For Only \$1

Here's the secret: The RADIOGEM Construction eliminates all unnecessary trimmings, cabinets and the like, which do not play any part in the operation of a set. You receive the RADIOGEM unassembled, together with a clearly written instruction book, which shows you how to quickly and easily construct the set, using only your hands and a scissor. The outfit comprises all the necessary wire, contact points, detector mineral, tube on which to wind the coil, etc., etc. The instruction book explains simply and completely the principles of radio and its graphic illustrations make the assembling of the RADIOGEM real fun. Remember the RADIOGEM is a proven, practical radio receiving set and will do anything the most expensive crystal set will do.

The RADIOGEM is the Prize Winner of the Age

Out of hundreds of radio models submitted recently in a great nation-wide contest, radio engineers, the judges, unanimously chose the RADIOGEM as the winner—the simplest radio-receiving set made! And the RADIOGEM costs you nothing to operate; no form of local electricity is required.

Sent Postage Prepaid on receipt of \$1—stamps, money-order or check.

Order Your Radiogem To-day—
or send for Free Descriptive Circular

DEALERS

The RADIOGEM is the wonder item of the radio age. It is storming the country, for the RADIOGEM'S price is so low everyone is able to buy one. Write immediately for full particulars before that shop across the street beats you to it.



Hear the programs of the Broadcasting Stations on the RADIOGEM



\$1 without PHONE or AERIAL (Patent Pending)

What They Say About RADIOGEM

I am enclosing herewith \$1.00 to pay for the Radiogem. I had it carefully wound by our wireless operator and find that it works beautifully—fully as good as any crystal set we know of.

Radiogem received, which we assembled and were very much astonished at results obtained and the clearness and volume of tone produced.

The greatest distances I heard on one of your sets is 1000 miles, having heard WGY at Schenectady, N. Y. I think your set is the best I have ever sold at any price.

On an aerial 160 feet long and 20 high one of my customers has heard WOC and WEB, KBD, WMC on one of your sets using a Peerless headset.

Herewith P.O.M.O. amt. \$1.00 for another "RADIOGEM." The one received is O.K. Placed about 15 ft. of picture cord under front porch and grounded to a gas meter, and heard the Sacramento Bee and Sacramento Broadcasting Union much better than with my large crystal set.

Your RADIOGEM RECEIVER is a wonder. I have received every station in Philadelphia with it much louder than with a high-priced crystal set.

Your two Radiogem sets received last night, and one was wired up for testing. WOC is about 40 miles away, and their signals could be heard with headphones on table. After they quit KYW at Chicago about 170 miles east was heard. Every word could be plainly heard here. WMC at Memphis, Tenn., could also be easily heard and understood.

We find that this set does a great deal more than you claim for it. We took WEAR on our audion set last night; this being the Baltimore American Broadcasting station, and then cut in the Radiogem and got excellent results. After the Baltimore concert was over, we continued to use the audion set and about ten o'clock were listening to WVEAF—New York—and a little later we disconnected the audion set entirely and hooked up the Radiogem, very clearly hearing both piano music and announcement of name of station and its location.

You claim a radius of 20 miles over your "Radiogem" is sometimes a possibility. You should adhere to the truth. I constructed one for my mother, installed it with an aerial, and she listens not once in a while, but at her will, to Schenectady, Newark, New York, or Providence, R. I., and her home is Attleboro, Mass. I can't give your set too much praise.

(Names and Addresses on Request)

WOC--TRESKO

Licensed Armstrong U. S. Patent No. 1113149

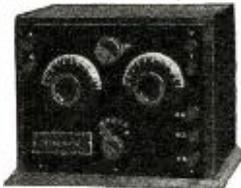

Two things that made Davenport famous. A complete 2000 mile Armstrong regenerative tuner for \$25.00. Use it with any make bulb W.D. 11 or 12, or dry battery operation as well as storage battery. Portable set to use at camp or in your machine. Complete with bulb, batteries and phones.

etc., \$37.50. Circulars free. This set received the Chicago American Regional Prize of \$350.00.

TRESKO

Tri City Radio Elec. Supply Co. Box 148 Davenport, Iowa

Why Pay More?

GENUINE R.C.A. TUBES

W.D. 11 \$5.95 UV-199
W.D. 12 \$5.95 UV-201A

ALL NEW, NO STAMPS, NO C.O.D. BALDWIN PHONES \$9.75

Send for our New Price List with many other items.

Save Money By Buying From Us

CUT RATE RADIO CO.

P. O. Box 472 Newark, N. J.

Insure your copy reaching you each month. Subscribe to Radio News—\$2.50 a year. Experimenter Publishing Co., 53 Park Place, N. Y. C.

Smart!

Handsomely finished a sleek, everlasting black, Bakelite - Dilecto (xx grade) makes the smartest, most "professional"-looking radio panels.

bakelite dilecto!

(A Laminated Phenolic Condensation Material)

It has no disadvantages for radio. And every advantage!

Strong, tough, durable; yet machinable. Warpless! Used in the U. S. Navy and Signal Corps over nine years!

Get Bakelite - Dilecto cut to size. Your electrical dealer knows how.

The Continental Fibre Co.,
Factory: Newark, Delaware.

Dealer Service From:
New York, 233 Broadway
Chicago, 332 S. Michigan Ave.
Pittsburgh, 301 Fifth Ave.
San Francisco, 75 Fremont St.
Seattle, 1041 Sixth Ave., South.
Los Angeles, 411 S. Main St.

How to Calibrate Your Receiver

By MERRILL C. ORSWELL (1TK)

With the recent allocation of the new wave-length limits for broadcasting stations, and the consequent wide variation in wave-lengths, a new and very useful advantage to the broadcast listener and amateur becomes evident. This is the calibration of the receiving set, and its possible use as a wave meter by tuning to a series of stations with such odd wave-lengths as 278-309-326-337-380-395-411 etc., up to 546 meters. A wave-length chart can then be plotted so that the tuning condenser can be set very accurately to any wave-length desired.

The following method for making such a chart is simple and effective, and is possible for every operator of the popular single circuit receiver, whether of the tickler or plate variometer type.

A standard sheet of coordinate paper, ruled off in squares, five to the inch, should be obtained to use in plotting the curves. The "A" battery should be up to its full voltage so that the curves will be accurate under normal operating conditions. The rheostat dial or pointer should first be adjusted to the point where, from the past experience of the operator, the filament of the tube is heated to get the best results. This point is usually where, with the antenna tuning condenser set at its maximum, the turning of the tickler or plate variometer

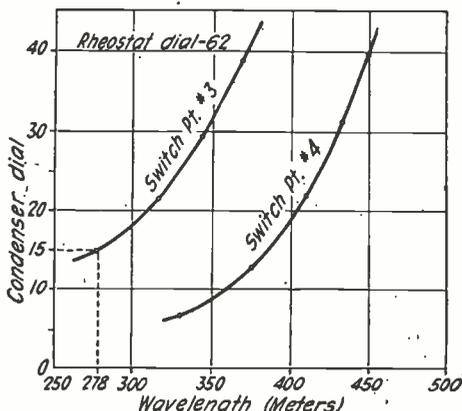

An Illustrative Chart Showing the Scale of the Condenser Dial Plotted Against the Wave-Lengths

dial will start the tube oscillating, or "mushing," just before this latter dial's maximum. This is only a suggestion; the operator should use his own judgment as to the proper point. This position of the rheostat should be indicated at the top of the paper as the standard position on which the curves are based, so that the rheostat may be set exactly at this point in using the curves. This is necessary because any change in the current to the filament causes a change in the grid and plate circuits, and consequently a resetting of the tuning controls would have to be made.

The antenna inductance switch should then be set on the switch point that will bring in near the zero point on the condenser dial, the lowest wave-length to be calibrated; for instance, 278 meters. When the first curve is completed, it should be labeled with the number of this switch point.

STATION ON A KNOWN WAVE-LENGTH SELECTED.

A station known to be transmitting on this low wave-length should now be tuned in the usual way, but care should be taken that the tuning is made sharp by using a minimum amount of the condenser and a maximum amount of the tickler or plate variometer, yet stopping at the critical point just before the circuit breaks into oscillation.

50¢

THE PACENT 40

A perfect plug for every radio requirement at a price which enables you to have one on every phone cord. Just one of the many PACENT Radio Essentials affording you more efficiency, convenience and enjoyment from your radio equipment.

Don't Improvise—"PACENTIZE"
Write for Descriptive Bulletins NB-10
PACENT ELECTRIC CO., Inc.
22 Park Place New York, N. Y.

Pacent

RADIO ESSENTIALS

Insist on the Genuine

Look for this Label

Coils and Mountings Licensed under De Forest Patents

They are Duo-Lateral We call them

BRANSTON LATERAL WOUND INDUCTANCE COILS

No other method of tuning has approached the wonderful flexibility of the Honeycomb Coil in changing to different wave lengths. If you are in doubt, ask your "Old Timer" radio friend why sets using Honeycomb Coils are better. With Branston Honeycomb Coils you can get closer tuning, greater selectivity, greater range. Two outstanding features of the Branston Coils are—no dead end losses and—distance records—clearness and loudness of reception. Send 2c in stamps for Series 1 "Hook-Up" Circular showing five good Honeycomb hook-ups and Catalog of material. Give dealer's name.

CHAS. A. BRANSTON, Inc.
817 Main St., Buffalo, N. Y.
In Canada Chas. A. Branston, Ltd., Toronto, Ont.

BRANSTON

RADIO

RADIO TUBE EXCHANGE

We Repair All Standard Makes of Tubes Including

W. D. 11 or W. D. 12	\$3.50
U. V. 200 or C. 300	\$2.75
U. V. 201 or C. 301	\$3.00
U. V. 201A or C. 301A	\$3.50
U. V. 199 or C. 299	\$3.50
U. V. 202 or C. 302	\$3.50
New 1 1/2 Volt Tubes	\$4.00

All tubes guaranteed to do the work.

RADIO TUBE EXCHANGE

200 BROADWAY NEW YORK CITY, N. Y.
All Mail Orders Given Prompt Attention
Orders sent Parcel Post C. O. D.

POSITIVE RESULTS

are being obtained by thousands of satisfied users of the

EASTERN COIL SETS

for the

COCKADAY CIRCUIT

The remarkable features which are making this circuit (4 circuit tuner) more popular each day are its simplicity of construction and control—wonderful selectivity and—distance records—clearness and loudness of reception, and the fact that all capacity squealing, interference, etc., are eliminated.

Made as per specifications of Mr. Cockaday, using No. 18 wire with D coil bank-wound.

COMPLETE ASSEMBLED SET OF B, C AND D COILS—PRICE..... **\$2.75**

Hook-up directions and material list furnished free with each set of coils.

Mail Orders Filled. Dealers Communicate.

EASTERN RADIO MFG. CO.
22 Warren Street, Dept. RN New York, N. Y.

RADISCO RADIO PRODUCTS

THE RADIO DISTRIBUTING COMPANY
Newark, New Jersey

This is the point where the station will come in the clearest and the loudest, and is the proper way to tune in. This suggestion is made, however, because many are in the habit of tuning by first getting the tube to oscillate, and then tuning the station by its whistling point on the condenser. If this is done, in this case, the calibration will not be accurate, for it is possible to get the zero beat point on several different places on the condenser dial. The exact number of the division on the condenser dial at this determined point should be read and plotted on the ruled paper as follows:

Referring to the chart, it is seen that the left and bottom edges of the paper have been used as a starting point for the graph, a heavy line having been drawn in ink over two of the ruled lines, one vertically, and one horizontally. The vertical line is labeled "Condenser Dial," and numbered as shown, each five squares corresponding to 10 divisions on the dial. The horizontal base line is labeled "Wave-length," and numbered so that each square corresponds to 10 meters in wave-length. Then, if a 278 meter station is tuned in at 15 on the dial, it is plotted by making a dot with a small circle around it directly opposite 15 on the vertical scale, and opposite 278 on the horizontal scale, as shown. Each square can be subdivided into tenths, by the eye, so that odd wave-lengths can be plotted. 278 meters will come, therefore, just two tenths or one fifth of a square less than 280 meters.

Other stations can now be tuned in, their wave-lengths determined from published lists, and plotted on the chart in the same way, until enough points are plotted so that a smooth curve can be drawn, first lightly in pencil, and then in red ink, and labeled with the number of the switch point, as illustrated. The next switch point can now be used for higher wave-lengths, and another curve plotted, and so on.

This calibration may require several days or evenings to complete the chart, but the reader will find that it is fascinating work, and when completed, and the chart posted near the receiver for reference, he will find that he has not only had lots of fun in making the curves, but that they are extremely useful in determining very accurately the wave-lengths of new stations, or in tuning in old stations on new wave-lengths. He need only tune in the station, note the switch point, and condenser dial number, follow this number horizontally across until it cuts the proper curve, and then drop vertically down and read the wave-length of the station on the horizontal scale. If the calibration has been done carefully, and the rheostat set at the proper point each time, the wave-length readings would be accurate within a few meters.

Another Way to Amplify Signals

By HOWARD C. WILEY

Experiments have demonstrated that two or more receiving sets can be operated simultaneously from the same antenna provided they are not tuned to the same wave-length or perhaps to the same station. With this idea in mind I decided to experiment with multiple antenna on a single receiving set. It has been understood that for receiving purposes alone, a single wire is nearly as good as a multiple wire antenna; if this be true then the results which I obtained will be of interest to readers and some may care to carry these experiments further than I could at the time. It is the purpose of this article to describe my experiment without attempting to guarantee results or to enter into theoretical discussion as to the why or wherefore, although I feel sure that anyone will be amply repaid



Nothing speaks so eloquently of HOMCHARGER satisfaction as the fact that thru sheer merit alone it has become the *standard* by which all other battery chargers are judged. Over 125,000 HOMCHARGERS already in use offer the most convincing proof that it is the most efficient, economical and fool-proof battery charger at any price.

A NEW TRADE-MARK FOR A TRIED AND PROVEN PRODUCT

Its phenomenal success has led to the introduction of many inferior and make-shift imitations. To insure our reputation and protect the buying public against substitution, the Radio De Luxe HOMCHARGER henceforth will be sold under a new Trade-Mark, viz.:



Retaining the same fundamentally correct operating principle and beautiful appearance of our Radio De Luxe model, it is a step nearer ultimate perfection through adoption of several construction refinements dictated by the policy of Progress.

HOMCHARGER'S 10 POINTS OF SUPERIORITY

1. Simple—Only one moving and wearing part, replaceable after thousands of hours use for \$1.00. Will last a lifetime.
2. Efficient—Uses less than one-half the current of any bulb or liquid type rectifier. Will charge any radio or automobile battery for a nickel.

3. Quick—Its high charging rate of 7 amperes eliminates long waiting for battery to become charged. Will charge any "A" or "B" battery over night, or three times as fast as a 2-ampere machine.
4. Clean—No expensive bulbs to break or acids to spill or replace. No acid fumes. Charges without muss, fuss or bother.
5. Dependable—Tungsten contacts insure continuous operation—prevent sticking and stopping.
6. Fool-Proof—Can be operated by anyone. Attach to lamp socket and connect battery either way, it will always charge. High-grade ammeter eliminates guess work.
7. Safe—No danger of shock or fire. Tested and approved by Fire Insurance Underwriters everywhere. Gives tapering charge—will not overheat or injure battery.
8. Beautiful—Mahogany and Gold Finish.
9. Unqualifiedly Guaranteed.
10. Popularly Priced—Retail at \$18.50 complete (\$22.00 Canada). No extras to buy. Sold by all dealers.

FREE BROADCASTING LIST. Send today for Free List of Broadcasting Stations, and Circular Describing the Gold Seal Homcharger.

DEALERS! JOBBERS!

GOLD SEAL HOMCHARGERS will outsell any other radio device this season. "GOLD SEAL Business Builders" illustrates many attractive sales helps and explains how we are prepared to cooperate with the Trade in making this a "HOMCHARGER Year." Send for your copy and Trade Discounts, TODAY.

Insist on the GOLD SEAL



It is your protection against substitution. When buying order by name and verify by the GOLD SEAL, which appears on the carton as well as the nameplate.

THE AUTOMATIC ELECTRICAL DEVICES CO., 118 West Third St., Cincinnati, O.
Largest Manufacturers of Vibrating Rectifiers in the World

TO THE RADIO DEALER.

Let us explain how you can make the sale of our publications a worth while, well paying part of your business. Every one that enters your store is a prospective buyer of RADIO NEWS. RADIO NEWS will sell with little effort on your part.

You may sell our publications on a single copy basis with a fine margin of profit or on a subscription basis with a generous commission allowance.

Write now and prepare for the Fall and Winter trade.

EXPERIMENTER PUBLISHING CO.,
53 Park Place, New York.

Morrison



Loud Speaker

Deep Notes Sweet Notes

both come equally true-toned and full-volumed over your Radio when your phonograph or horn has a Morrison Loud Speaker.

Perfect Reproduction

The real joy of radio is assured you. No rattle or vibration, no metallic harshness, even when the amplification is extreme.

Anyone can attach the Morrison Loud Speaker to the tone arm of a phonograph in a moment's time. A slight adjustment of the knob or dial on the rear adjusts the tone, soft or loud, just as you wish. There is nothing else to do—nothing to get out of order—you just begin to really enjoy radio when you use the Morrison Loud Speaker.

Adaptable for use on any bulb set with one or more stages of amplification.

Sold on a money-back guarantee. Price, complete with five-foot cord, nickel finish,

\$10.00

Order from your dealer or direct from us. Send today for beautifully illustrated catalogue—it is free.

Dealers

If you are interested in one of the fastest-selling Radio units on the market, wire or write at once for our proposition—it is interesting.

Morrison Laboratories, Inc.

339 Jefferson Avenue, East
Detroit, Mich.

The Boice Pony Bench Saw



A decidedly practical, extremely compact precision machine. Saws wood, bakelite, brass, copper, carbon, asbestos, etc., with remarkable ease and accuracy. Attachments for grinding, sanding, drilling and grooving. Top 10"x12" easily removed or elevated for grooving. Saws 1 1/2" stock. Driven by 1/4 or 1-3 h.p. motor. Sold on MONEY-BACK GUARANTEE.

Write for literature on this and other BOICE-BUILT Bench Machines and Motors

W. & J. BOICE Dept. 710 Toledo, Ohio

VULCANIZED FIBRE Be sure and specify "WILMINGTON FIBRE"

Sheets, Rods, Tubes, Washers, Etc., Specialties

Wilmington Fibre Specialty Co., Wilmington, Del.
Branch Offices "Everywhere"

for any trouble in trying out the same experiment and I am confident that far-reaching results will be obtained by refining the apparatus.

I had a home-made three-circuit tuner, with a detector and two-step amplifier. The hook-up for the detector and tuner is shown in Fig. 1. I removed the variocoupler and

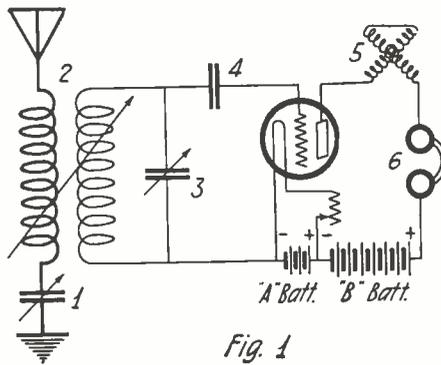

Fig. 1
A Standard Three Circuit Regenerative Receiver Was Used, with a Reconstructed Variocoupler

substituted another, which I constructed as follows: The rotor was the same as the old one, 40 turns of No. 28 wire. The stator was wound on a 4" cardboard tube. Instead of winding 100 turns of single wire, however, I made a four-wire cable by twisting four No. 28 D.C.C. wires together and wound 100 turns taking taps at every 10 turns. Each wire of the cable was attached to a separate binding post so that I had four primary coils acting on one secondary. Next I constructed a four-wire cage antenna with one-foot spreaders, taking care to keep all wires of the same length and insulated from each other. The antenna is 75' long, about 30' high and the leads are about 20' long. Each of the antenna wires was connected to a primary binding post and I was ready to tune. I tuned in a broadcasting station as loud and clear as possible with the four wires connected, and then disconnected one; the signal dropped perceptibly. I disconnected a second wire and the signal dropped again. When I disconnected the third wire. I could still hear the station but the signal was very faint compared to the first. The set in this condition should be working as the old set worked; I could not make any direct comparisons between the two, so am unable to state positively that the signal strength with one wire in use was equal to that using the old antenna and variocoupler. As I replaced the wires, the signal came back as strong as if I was plugging in on the first or second steps of amplification. Fig. 2 shows the hook-up and indicates the four antenna wires.

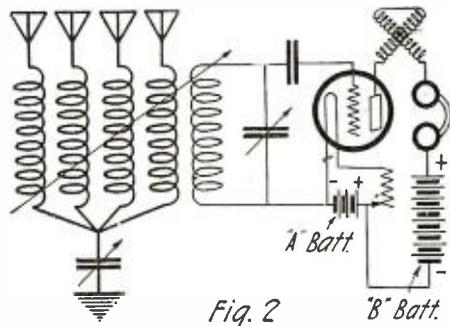

Fig. 2
By Using Four Aerials with Separate Primary Coils the Received Signal Energy Was Increased Considerably.

The primary induction switch was the same that I used on the old set, and as may be seen in the diagram shown in Fig. 3, the four wires are short-circuited at every tap and, beyond the first tap the same results might have been obtained by using a single wire, but I think that the four coils in

GUARANTEED Supreme To Any of Its Type



With You as a Judge

If not satisfied that it is Better than the Best, you can return within 10 days from purchase and receive full amount of purchase cost back.

A wonderful instrument of mechanical perfection. Endorsed by radio engineers, journals and fans, from all over the U. S. A trial will mean a most marvelous surprise to you in radio satisfaction.

"Certified" American Bell Condenser

Don't delay trial—Send at once You are absolutely guaranteed.

43 Plate Variable Condenser complete with Dust Proof Transparent Case **\$5.50**

23 Plate Variable Condenser complete with Dust Proof Transparent Case **\$5.00**

State if for Panel or Desk Set.

American Bell Radio Corporation
316 75th Street, Brooklyn, N. Y.

PATENTS

To the Man with an Idea

I offer a comprehensive, experienced, efficient service for his prompt, legal protection and the development of his proposition. Send sketch, or model and description, for advice as to cost, search through prior United States patents, etc. Preliminary advice gladly furnished without charge. My experience and familiarity with various arts frequently enable me to accurately advise clients as to probable patentability before they go to any expense.

Booklet of valuable information and form for properly disclosing your idea free on request.

Write today.

RICHARD B. OWEN
PATENT LAWYER

2 Owen Building, Washington, D. C.
2276A Woolworth Bldg., New York City

Standard Spanish ARMY



Used by French During World War

Buy direct from sole U. S. importers and SAVE 1/2 on this

GENUINE ASTRA AUTOMATIC

Your chance to have the finest European pistol—the equal of any similar American gun—at about 1/2 the price. Order direct at these special prices.

- \$7.75 25 calibre—7 shot—C. O. Q. Automatic.
- 8.95 25 calibre—7 shot—Astra Automatic.
- 9.95 25 calibre Astra with triple safety.
- 10.95 32 calibre—10 shot Astra, extra magazine.
- 16.95 32-20 and 38 cal. swing-out cyl. revolvers.

We guarantee every gun against defective workmanship; brand new; of Drop Forged Steel Throughout. Before buying any weapon INSIST on this guarantee. SEND NO MONEY unless you wish. State model desired—pay postman on delivery plus postage. Satisfaction guaranteed or money refunded. Write for new firearms catalogue.

CALIFORNIA TRADING CO.
Dept. 2310, Terminal Bldg., Los Angeles, Cal.

parallel tend to increase the inductance between the primary and secondary circuits.

So much for my experiment. I believe that superior results would be obtained by using an induction switch, as shown by the diagram in Fig. 4, which would keep the

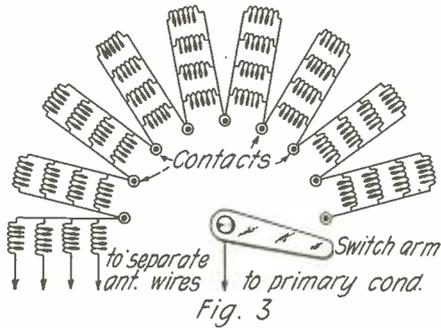

Fig. 3

The Primary Coil Switching Arrangement Used for Adjusting This Circuit.

four wires separated from the open end of the antenna clear to the switch arm. Of course care should be taken to keep the four wires of the same length, or inductance, so that the wave-length will be the same in each of the four primary windings. I used four wires for economical reasons, but I see no reason why six or more may not be used. Experiments with spider web or honeycomb coils could probably be worked out along the same lines.

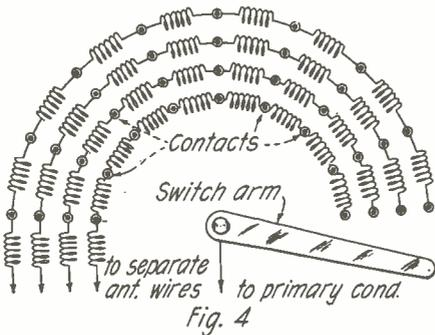

Fig. 4

A Suggested Switching Arrangement Wherein the Separate Antenna Wires Are Kept Well Apart.

I have discussed this experiment with a number of science teachers and practical radio men and all agree that the idea is good and none could see any reason why excellent results should not be obtained. If any readers are interested enough to try this out, I should be glad to answer any questions I can, and I should be very glad to hear from anyone who gets results as good as or better than I do.

PROTECTION OF VACUUM TUBE FILAMENTS

The radio fan is apt to experience disappointment when he finds that the high voltage leads from the "B" battery have been accidentally connected across the filament posts of his receiver and one or more tubes are burned out. Although the normal life of the average tube filament is considerably more than one thousand hours, it requires but an instant to destroy this delicate filament when excessive voltages are applied to its terminals.

When filaments are shorted across a 20-, 40- or 60-volt battery in new condition, the burnout requires but a fraction of a second and unless the user happens to be inspecting the tube at the instant of the flash, the damage would not be discovered until the set was used again. It is a very easy matter to protect tube filaments by either of the following means:

(a) Insert a 100-ohm (non-inductive) resistance for each 22-volt block of "B" battery in the circuit next to the positive termi-

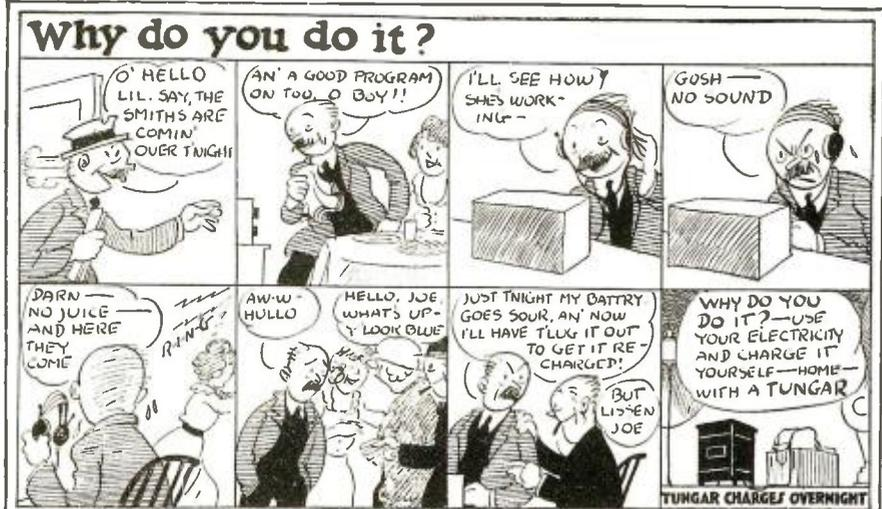

Is your battery always fully charged and fit?

Is it always toned up for best results, whenever friends happen in—throughout every concert?

Keep it at full strength and prolong its life—the simple, easy, inexpensive Tungar way.

Tungar—the go-between from house-lighting circuit to storage battery—attaches wherever there is a lamp or convenience outlet.

You don't have to move the battery. Just connect Tungar, and leave it—any time, day or night.

Tungar is certain, clean, quiet. No moving parts to get out of order or make noise.

Good for the auto battery too—the same Tungar.

See one at any good electrical store, or write for literature. Address Section RA10

Merchandise Department
General Electric Company
Bridgeport, Connecticut

Tungar Battery Charger. Operates on Alternating Current.
2 Ampere Outfits—\$18.00
5 Ampere Outfits—\$28.00
(Prices east of the Rockies)
Special attachment for charging 12 or 24 cell "B" Storage Battery—\$3.00—fits either size Tungar.



Charge 'em at Home, with

Tungar

BATTERY CHARGER

A GENERAL ELECTRIC PRODUCT

85A-0611

PATENTS. INVENTORS should write for List of Patent Buyers, Illustrated Guide Book and RECORD OF INVENTION BLANK before disclosing inventions. Send model or sketch and description of your invention for Examination and Instructions. Electrical cases a specialty.

No charge for the above information.

VICTOR J. EVANS & CO.
919 NINTH ST. WASHINGTON, D. C.

PATENTS

Send sketch or model today for examination and report. Record of Invention blank on which to disclose your invention and new guide book, "How to Obtain a Patent," sent free. Promptness assured. Highest references. WRITE TODAY. CLARENCE A. O'BRIEN, Registered Patent Lawyer, 1051 Southern Bldg., Washington, D. C.

PATENTS

DON'T LOSE YOUR RIGHTS Before disclosing your invention to anyone send for blank form "EVIDENCE OF CONCEPTION" to be signed and witnessed. Form and information concerning patents free. LANCASTER & ALLWINE 270 Ouray Bldg., Washington, D. C. Originators of the form "Evidence of Conception"

PATENTS

C. L. PARKER Formerly Member Examining Corps, U. S. Patent Office. PATENT - LAWYER McMillan Bldg., Wash., D. C.

Patents, Trade Marks, Copyrights, Patent Litigation Handbook for Inventors, "Protecting, Exploiting and Selling Inventions," sent upon request.

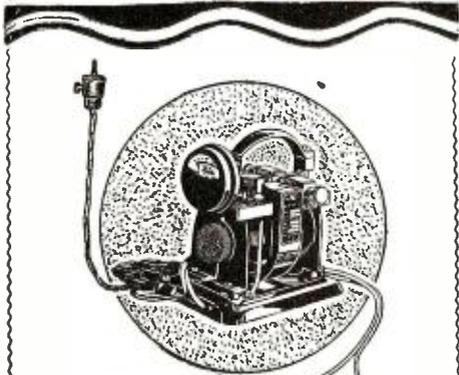

\$15.00

F.O.B. Cleveland.
Type 6 Charges 6 Volt
Storage Battery from
any 110 Volt 60 Cycle
lamp socket at average
rate of 6 Amperes.

**3,250 Hours' Service
From a \$15.00**

**F-F BATTERY
CHARGER**

"Dear Sir: Find enclosed fifty-four cents for which please send one set of carbon brushes for an F-F Battery Charger, Type 6.

"This charger has been in use on an average of 25 hours a week for about two and one-half years and the Carbons have never been renewed. The machine is giving very good service. Yours very truly,

(Signed) "Ralph C. Peters."
"1810 Pine St., Boulder, Colo."

This unsolicited report is but one of thousands. Every mail brings additional appreciation for the unusual reliability, and freedom from "grief", enjoyed by F-F owners.

This is the result of ten years' specialization, after making the first satisfactory mechanical battery charger years ago.

You, too, can benefit just as Mr. Peters above, by insisting on the F-F Charger.

There's a type for every need. Buy from your dealer. If he cannot supply you, write for literature or enclose remittance covering express or postal charges on 9 lbs.

It's Free
Write for Bulletin No. 32
Dealers get the F-F Proposition

The France Mfg. Co.
10432 Berea Road
Cleveland, Ohio

*Pioneer Manufacturers of
Patented Battery Chargers*

TWO SUPERSENSITIVE CIRCUITS

(Both Copyrighted)

My Highly Improved Reinartz brings in all important stations on both coasts and Mexican border, loud, clear and without distortion. We dance to music from Atlanta received on one loud Baldwin unit. Build one of these wonderful sets from my blueprints and specifications, price 50c, or with a perfect and complete double wound spiderweb coil, \$3.00 by mail. No other windings used. Photo of my set on a glass panel with every order.

My W. D. 1 Circuit is especially designed for use with the "Pickle" tube and brings out the full value of that little tube as no other circuit can. Stations 1000 miles away come in clearly on one tube. This set is small, complete, portable. For the man who wishes the highest efficiency this is the set to build. Price of blue print and specifications 50c. or with complete and perfect windings \$3.00. Photo of set with every order.

Either set is cheap and easy to build, easy to operate. Everything clearly shown.
S. A. Twitchell, 1927 Western Ave., Minneapolis, Minn.

TELEGRAPHY

BOTH MORSE AND WIRELESS taught thoroughly. Big salaries; tremendous demand. Oldest, largest school. Endorsed by Telegraph, Railway, Wireless and Government officials. Expense low—opportunities in every large nation. Catalog free.
DODGE'S INSTITUTE, Mora Street, Valparaiso, Ind.

nal of the "B" battery. This resistance may be left permanently in the circuit without any effects whatsoever in the normal life of the battery.

(b) Probably the most convenient form of resistance is a 25-watt, 110-volt tungsten lamp which will provide sufficient protection for plate voltages up to and including 100 volts. This resistance automatically increases current so as to act, in effect, as a protective ballast lamp.

**WHO'S WHO IN THE RADIO
INSPECTION SERVICE**

Every amateur and broadcaster should know the officials of the Radio Section of the Department of Commerce in his district, so that he can get advice, keep in touch with new regulations and not be imposed upon by bogus representatives.

At Headquarters in Washington, Chief Supervisor of Radio, W. D. Terrell, is in charge under Secretary Hoover and Commissioner Carson. Mr. Terrell is assisted by W. E. Downey, Supervisor of Radio. In the nine districts with headquarters as shown, the following men are in charge:

District	Headquarters	Supervisor of Radio.
1st	Boston	C. C. Kolster.
2nd	New York	Arthur Batcheller.
3d	Baltimore	R. Y. Cadmus.
4th	Atlanta	R. Y. Cadmus (until relieved by Van Nostrand.)
5th	New Orleans	Theodore G. Deiler.
6th	San Francisco	J. F. Dillon.
7th	Seattle	O. R. Redfern.
8th	Detroit	S. W. Edwards.
9th	Chicago	E. A. Beane.

Some recent changes in the personnel of the districts have been made: A. F. Parkhurst, Assistant Radio Inspector at Detroit, has been transferred to the 9th District at Chicago. Asst. Inspector H. S. Pyle has been appointed to work in the Detroit Office replacing Mr. Parkhurst. Assistant Inspector L. E. Richwien of the Baltimore Office has been detailed to the 7th District at Seattle. It is planned to open the office at Atlanta as the Headquarters of the 4th District soon, and Radio Inspector Wallis Van Nostrand, Jr., now at Norfolk, will probably be designated as Supervisor of this Division.

WGY HEARD IN CHILE

WGY was recently picked up by the steamship *Ebro* of the Pacific Steam Navigation Company when one day out from the Juan Fernandez Island, west of Valparaiso, Chile, about 5,400 miles from Schenectady, N. Y., the home of the General Electric Company broadcasting station.

Information of the long distance reception was contained in a letter from W. F. Robertson of Cincinnati, Ohio, who was a passenger on the boat. Mr. Robertson stated that the ship's radio operators were using his set and that the WGY concert was heard on the night of February 16.

WGY has been heard greater distances than Mr. Robertson reports, but reception has never been reported as far south as the Juan Fernandez Islands. The distance is remarkable because of the heavy static customarily encountered by operators when 10 to 20 degrees north or south of the equator.

LIGHTNING BOLT PROVES SAFETY OF RADIO

If any further evidence were necessary to prove the safety of radio there was plenty of it furnished during a severe electrical storm on July 28.

Lightning entered the broadcasting station at Medford Hillside, Mass., during the

**The Eztoon
2-in-1 Dial**



The necessity of fine tuning is recognized by every radio fan.

Here is a micrometer movement with a ratio of 40 to 1. It is two dials in one. The outer dial for finding the station, the center vernier dial tunes him in—clear and sharp—cutting out all interference.

When used on a condenser gives much closer tuning than a vernier plate. Attractive in appearance; it is easily attached to any variometer condenser, rheostat, variocoupler and tickler on all types of receivers. Fits either 1/4" or 3-16" shaft.

Sold under positive guarantee. Shipped parcel post, C.O.D., 3" dial \$2.00; 4" dial \$2.25.

Attractive discounts offered to recognized manufacturers, jobbers and dealers. Write today.

Butler Manufacturing Company
3235 W. Washington Street
Indianapolis, Indiana

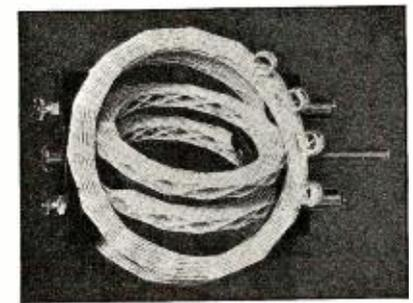

**R. M. C. Diamond Weave
Variocoupler and
Variometer**

Due to diamond weave construction and the fact that 3/4 of the total area of windings are supported in mid-air, capacity and dielectric losses are reduced to a minimum in R. M. C. Variometers and Variocouplers. The rotor is continuously variable.

These products may be used in any circuit where a high grade coupler or variometer is required. All metal parts are nickel-plated. Panel mounting requires very small space. Screw holes covered by 2" dial.

R. M. C. products are built for the finest sets that can be constructed.

Variocoupler\$4.25
Variometer\$4.25

Write for catalog of other diamond weave coils and Radio Frequency Transformers.

THE RADIO MANUFACTURING CO.
of Springfield, Massachusetts
Dept. A 97 Dwight St.

Frank D. Pearne RADIO AUTHORITY Says—

"the only reliable way to determine if 'B' Batteries are still capable of service is by testing with a Voltmeter." Thousands of radio fans are using the

**POCKET
VOLTMETER** \$1.49

Tests "B" Batteries up to 45 Volts. Guaranteed. Sent anywhere in U. S. or Canada, Parcel Post Prepaid, on receipt of money order for \$1.49.

Indian Head Pocket Ammeter at same price. Send 2c stamp for list of Radio Bargains.
Dept. 2, 417 S. Dearborn St., Chicago

INDIAN HEAD COMPANIES

Insure your copy reaching you each month.
Subscribe to Radio News—\$2.50 a year.
Experimenter Publishing Co.,
53 Park Place, N. Y. C.

worst of the storm, which was very severe locally. Investigation showed that it was attracted by the electric light wires, which it completely demolished. The electric light service was paralyzed. However, the 320-foot steel antenna tower used in connection with the broadcasting was not touched, nor was the broadcasting apparatus, thereby proving that a radio antenna does not attract lightning.

Time was when uninformed persons thought the installation of radio provided an extra fire hazard. This belief has been somewhat dispelled by the experts, who call the lightning hazard of radio a "childish hugaboo." No less authority than Dr. Steinmetz, the electrical wizard, the man who recently produced an electrical storm all his own, has said that the radio installation properly made was a protection rather than a source of danger from lightning. The truth of his statement was verified by the practical test on July 28.

(Abstract from N. Y. Tribune.)

STOLEN CAR LOCATED BY RADIO

By D. M. SCOTT

The thief who stole a new Essex cab from the Hollister-Miller Motor Co., at Emporia, Kansas, one night not long ago, chose a mighty poor time for the job, as the heavy rains in that part of the state had left many of the roads almost impassable. The man hid in a car in one corner of the big building some time during the day and, when the garage had been closed for the night, he unbolted the front door from the inside and drove the Essex out, leaving the imprint of his body on the dusty seat of the car where he had hidden.

Although the thief may not have taken the bad condition of the roads into consideration, he must have been wise to the possibilities of radio in locating criminals and stolen property, for he took part of the company's valuable radio apparatus with him.

The sheriffs of Lyon and other counties were immediately notified of the theft and they began a search, but neither the thief nor the car was found.

NEWS OF THEFT BROADCAST

The Hollister-Miller radio station, WAAZ, is one of the best radio stations in the state and it gives some delightful programs, and furnishes splendid broadcasting service to the community. After their radio apparatus had been stolen the company immediately sent for new parts and the night they were received a regular program was broadcast, the first since the theft. An important feature of the evening was the broadcasting of the news of the robbery the week before.

The news was broadcast at eight o'clock and those at the station waited anxiously for results. They did not have long to wait, for in less than ten minutes a long distance call from a farmer living near Walton, Kansas, a small town 75 miles west of Emporia, informed the Motor company that a car answering the description of the stolen Essex had been left in a ditch near Walton Wednesday morning nearly a week before and a neighboring farmer had pulled the car out and now had it in his yard. Further communication gave the information that the engine number on the car was the same as that of the stolen Essex.

The next morning the motor car dealers went to Walton with the sheriff and brought back the auto. They found it in good condition. The thief must have taken a roundabout way in search of better roads for the speedometer had registered 150 miles.

A reward of \$100 was divided evenly between the young man who heard the

BAKELITE Condensite REDMANOL

For Dials

Accuracy of dimension, beauty of color and finish, high dielectric and mechanical strength characterize Radio Dials molded of Bakelite — Condensite — Redmanol.

These properties are permanent; for this material is unaffected by extremes of temperature, does not absorb moisture; will not fade even when exposed to strong sunlight, and neither age nor use causes it to deteriorate.

All the leading makes of dials are molded of this material. Be sure those you buy are made of it.

BAKELITE CORPORATION

Address the Divisions

GENERAL BAKELITE COMPANY . 8 WEST 40th STREET, NEW YORK
CONDENSITE COMPANY OF AMERICA . BLOOMFIELD, NEW JERSEY
REDMANOL CHEMICAL PRODUCTS CO., 636 WEST 22d ST., CHICAGO



THE MATERIAL OF A THOUSAND USES

PATENTS If You Have an Invention and Desire to Learn How to Secure a Patent

Send for our Free Guide Book, HOW TO GET YOUR PATENT. Tells our terms and methods. Send model or sketch and description of your invention and we will give our opinion as to patentable nature. Our documentary **PROOF OF INVENTION** is intended for your protection and will be sent you without charge. Write for it.

RANDOLPH & CO.

Dept. 459 Washington, D. C.

NAME

STREET

CITYSTATE.....

WANTED—Back numbers of Radio News, Dec., 1921, Jan. and Feb., 1922. Experimenter Publishing Co., 53 Park Place, New York City.

THESE DEALERS CARRY

"Consolidated" E. I. Company

Patterns and 25c. Books

See Full Page Ads on Pages 435 and 467

Abilene, Kans. Union Elec. Co.
 Albany, Ga. Lonsbergs Book House
 Akron, O. Radioart Supply Co.
 Albany, N. Y. Havens Elec. Co.
 Ignition Service Supply Co
 Couper & Hotchkiss
 Kimball Bros.
 Peoples Radio Store
 Standard Elec. Co.
 Wanger Bros.
 Amsterdam, N. Y. Anderson Elec. Co.
 Allentown, Pa. Hess Bros.
 Buchman Book Store
 Altoona, Pa. Altoona Elec. Supply Co.
 Anthony, Kans. LeRoy Higibanks Rad. Co.
 Astoria, L. I. Astoria Radio Shop
 Atchison, Kans. Low & Blythe Co.
 Atlanta, Ga. Capital Elec. Co.
 Millers Book Store
 Atlantic City, N. J. Paramount Radio Co.
 Eastern Hdwe. & Sup. Co.
 Sport Shop
 Just Elec. Co.
 Sea Coast Radio Co.
 Auburn, Me. G. L. Ross
 Baltimore, Md. Jos. A. Becker
 Jos. M. Zamolski
 Wilbur Elec. Co.
 Bacharach Radio Co.
 W. W. Heitzwhel
 S. B. Berkovich
 Joel Outman
 Herdas Elec.
 Little Joes Dept. Store
 C. D. Kellert
 J. Meyer
 Murdock Co.
 E. I. Rosenfeld & Co.
 Batavia, N. Y. H. F. Smith
 Bethlehem, Pa. Lehigh Radio Co.
 Billings, Mont. Torrens Bros.
 Birmingham, Ala. Interstate Elec. Co.
 Bluefield, W. Va. Burgess Elec. Co.
 Boston, Mass. Atlantic Radio Co.
 Cutter & Wood Supply Co.
 Seth Fuller Co.
 International Radio Corp.
 Lewis Elec. Supply
 F. D. Pitts Co.
 New Eng. Elec. Spec. Co.
 Williams Book Stores
 J. B. Hunter & Co.
 James H. Jones, Inc.
 Samuel J. Beckwith
 Chandler & Parham Co.
 A. P. Merchant Co.
 Eugene Proctor Co., Inc.
 Radio Sales & Service Co.
 Farrington & Clark
 Berman Radio
 Bridgeport, Conn. Morrison Radiophone Parts
 Plym & Power
 Conn. Radio Supply Co.
 Brooklyn, N. Y. Arthor
 Brooklyn Radio Serv. Co.
 O. Olsen
 Toliner Elec. Co.
 Bklyn. Radio Center
 Bobs Radio Service
 Bklyn. Elec. Lamb & Nov.
 Globe Radio & Bat. Shop
 Haag & Vlyce Co.
 G. Kleinteich
 C. G. Rosewall
 J. Streiff
 Denmark American Phon. Exch.
 Arlington Radio Service
 Barnes Radio Shop
 Bengo Elec. Co.
 J. D. Cunningham
 Delta Elec. Co.
 H. A. Dietz
 Duchmans Music Store
 Kelley & Feitz
 Halborn Elec. Co.
 Kensington Radio

E. C. & H. B. Lagerholm
 G. Moskowitz
 G. Scharrf Sons
 H. Schur & Son
 Victor Radio Sport Shop
 Walker Elec. Co.
 Brener Bros.
 20th Century Radio Co.
 B. Ulrich
 B. Haupt
 David M. Isaac
 Starr Radio
 Buffalo, N. Y. McCarthy Bros. & Ford
 Robertson Cataract
 O. Ulrich Inc.
 Burlington, N. J. Burlington Elec. Co.
 Butte, Montana Montana Elec. Co.
 Cambridge, Mass. Clapp-Eastham Co.
 University Book Store
 Canton, Ill. Frank White & Bros.
 Camden, N. J. Neisner Bros.
 Carrollton, Mo. Carrollton Radio Shop
 Centerville, Ia. H. E. Luther
 Champagne, Ill. H. C. Swanell & Son
 Charlestown, W. Va. John R. Koch
 Charlestown, S. Car. S. C. Radio Shop
 Charlotte, N. C. Smith Novotny Elec. Co.
 Caroline Radio Co.
 Chester, Pa. Neisner Bros.
 Chicago, Ill. Harry Alter & Co.
 Karavik Co.
 Beckley-Ralston Co.
 Chicago Radio App. Co.
 Elec. Appliance Co.
 Inland Elec. Co.
 Marshall-Field & Co.
 A. C. McClurg & Co.
 Montgomery Ward & Co.
 Newark Elec. Co.
 Henry Paulson & Co.
 Sears-Robuck & Co.
 Chicago Cut Rate Book
 Community Book Store
 Jenzstark Radio Co.
 Follett Book Co.
 McArthur Elec. Co.
 P. O. News Co.
 Max Stern
 E. J. Stringas
 Fireside Radio Co.
 Cincinnati, O. Midwest Radio Co.
 Milnor Elec. Co.
 Reuter Elec. Co.
 Cleveland, O. Radio Electric Shop
 Radio Eng. & Sales Co.
 H. Lesser & Co.
 Oliver C. Schroeder
 Radio Sales & Rep. Co.
 Columbus, O. Hall Elec. Co.
 Coraopolis, Pa. T. O'Donovan
 Cumberland, Md. J. A. Fulton & Co.
 Dallas, Texas Huey & Phillip Hdwe. Co.
 Southwest Radio Sup. Co.
 Radio Equip. Co.
 Denton, Tex. Eves Hdwe. Co.
 Denver, Colo. Electrical Auto App. Co.
 Pratt Book Store
 Reynolds Radio Co.
 Des Moines, Ia. H. W. Kling
 Iowa Radio Co.
 Detroit, Mich. Federal Elec. Supply Co.
 Trentlith Century Radio Co.
 Crowley Milner Co.
 McCauley Bros.
 Detroit Elec. Co.
 Wolverine Radio Co.
 Northwestern Radio Co.
 Duluth, Minn. Kelley Duluth Co.
 Easton, Pa. P. & W. Grand Stores
 E. Orange, N. J. Essex Radio Shop
 United Radio & Sport Shop

Elizabeth, N. J. H. Richmond & Son
 Elizabeth Elec. Sup. Co.
 Eureka, Ill. Klaus Radio Co.
 Fergus Falls, Minn. Grande & Setzer
 Far Rockaway, L. I. Dunlap Spg. Goods Co.
 Scientific Radio Co., Inc.
 Fushing, L. I. The Electric Shop
 Ft. Worth, Tex. H. C. Meacham Co.
 Galveston, Tex. Galveston Wireless Sup. Co.
 Gardner, Mass. Gardner Hdwe. Co.
 Gloucester, N. J. Lemmy's Variety Store
 Granite City, Ill. Rosenberg Dept. Store
 Great Bend, Kans. Great Bend Radio Co.
 Greensburg, Pa. H. Hamilton
 Hamilton, O. Radio Co.
 Hartford, Conn. Elec. Sup. & Equip. Co.
 F. & W. Grand Stores
 G. Ross & Co.
 Havana, Cuba Diamond News Co.
 Liberia de Jose Albele
 Helena, Mont. Van Blaricom Co.
 Hoboken, N. J. International Book Store
 Kansas Radio Co.
 Holyoke, Mass. Haskell Elec. Co.
 Independence, Mo. The Melodian Co.
 Hackensack, N. J. Wurtz & Puchs
 Jacksonville, Fla. Southern Radio Co.
 Holt Elec. Co.
 Jamestown, N. Y. Willis Switch & Inst. Co.
 Jamaica Plain, Mass. Conrad Radio Co.
 Jamaica, L. I. Scientific Radio Co., Inc.
 Merrick Elec. Co.
 Jersey City, N. J. Arrow Elec. Co.
 M. Schein
 Guarantee Elec. Co.
 Johnson City, Tenn. Bishop Elec. Co.
 Johnstown, Pa. W. J. Grant Co.
 Joliet, Ill. Joliet Radio & Sta. Co.
 Kansas City, Mo. Vulcanizers Supply Co.
 Donaldson Radio Co.
 Lancaster, Pa. Radio Outfit & Sup. Co.
 Lawrence, Mass. Schwarzenberg, W.
 Los Angeles, Cal. Leo J. Meyberg
 S. California Elec. Co.
 West Radio Elec. Co.
 Radio Concert & Equip.
 Natick Book Store
 Brndle Elec. Co.
 Lewiston, Montana Chas. Lockman
 Lock Haven, Pa. Burkett Bros.
 Louisville, Ky. Sutcliffe Co.
 Lowell, Mass. G. A. Hill Co.
 Lyons, Kans. R. I. Case
 Macon, Ga. J. W. Burke Co.
 Memphis, Tenn. Street Elec. Co.
 McKeesport, Pa. F. C. Wampler & Son
 Milwaukee, Wis. Julius Andrae & Co.
 Deway Sport Goods Co.
 Badger Radio Co.
 Minneapolis, Minn. Jacob Andressen Co.
 Findlay Elec. Sup. Co.
 Nagell Hdwe. Co.
 Reinhold Bros. Co., Inc.
 Sterling Elec. Co.
 Peerless Elec. Co.
 Missoula, Mont. Missoula Elec. Sup. Co.

Montgomery, Ala. Alabama Radio Mfg. Co.
 R. P. Reeves
 Nashville, Tenn. Zibart Bros.
 Newark, N. J. Bamherter & Co.
 Bassett Radio Sup. Co.
 Paris Elec. Co.
 Eddies Wireless Ex.
 Bamister & Pollard
 Essex Mfg. Co.
 W. T. Grand Co.
 United Elec. Sub. Co.
 Friedmans Music Shop
 Mt. Vernon, N. Y. Stephens Shop
 New Brunswick, N. J. Schneider Bros.
 The Elec. Shop
 New Orleans, La. Interstate Elec. Co.
 Newport, R. I. Geo. H. Chase
 New Haven, Conn. W. W. Gale & Co.
 New York City Femo & Co.
 Frank Radio Co.
 Fremont Radio Co.
 J. J. Kelleher
 David Kilcho & Co.
 Liberty Radio Co.
 R. H. Macy & Co.
 Manhattan Elec. Sub.
 Overland Radio & Equip. Co.
 Peerless Light Co.
 Radio Specialty Co.
 Stanley & Patterson
 Viking Radio Co.
 The Winchester Store
 Army & Navy Dist. Co.
 Chamberlain Elec. Co.
 Economy Radio
 Elec. Service Eng. Co.
 Gaidinger Bros.
 Gimbel Bros.
 R. G. Haslinger
 Herbert & Hoegsen
 Allied Radio Co.
 J. Belmuth
 J. H. Bunnell & Co.
 Butler Bros.
 Camahan & Dalzell, Inc.
 Bray Radio Corp.
 P. M. Dreyfuss Co., Inc.
 Delta Elec. Co.
 Portland Radio Spec. Co.
 F. & W. Grand Stores
 J. L. Lewis & Co.
 Lowe Motor Sup. Co.
 Bora Radio Stores
 Live Wire Elec. Co.
 Marks Radio
 Model—S Stores
 Phillips Sport Shop
 Wehman Bros.
 A. & A. Elec. Co.
 Acme Radio Co.
 Am. Elec. Tech. App.
 Atlas Elec. Supply Co.
 Atlas Radio Co.
 Bergmiller Bros.
 Franklin Radio Shop
 J. Gabler
 Globe Radio Shop
 Hygrade Elec. Co.
 International Radio Store
 J. Kelleher
 Marlon Hdwe. Co.
 Nassau Radio Co.
 Times Sq. Auto Sup. Co.
 Trigeos
 Ace Elec. Co.
 A. & P. Radio Co.
 Baker & Taylor Co.
 Borough Elec. Co.
 Cambia Elec. Co.
 J. Edelson
 Keystone Battery Service
 S. S. Kresge & Co.
 Lankers Radio Store
 A. Marcus
 G. H. Masten & Co.
 Meutz Store
 Milbro Radio & Elec. Co.
 Radio & Mech. Trad. Corp.
 Radio Parlor
 Radiophone Equip. Co.
 Rialto Elec. Shop
 St. Marks Radio Co.
 K. R. Schultsman
 F. E. Silverman
 Woolfar
 M. Workman
 Perfection Radio
 Cortlandt Radio

James Gear
 A. J. Goldman
 T. Eaton & Co.
 Progressive Book Store
 S. Astor
 M. & T. Elec. Co.
 Borough Elec. Co.
 Marvel Elec. Sup. Co.
 O. R. B.
 A. E. Zimmerman
 Sun Astor
 Davidson Radio Co.
 Van Auto Supply Co.
 Mogul Elec. Co.
 Brunswick Supply Co.
 Stuyvesant Radio Co.
 Oscars Radio
 Fortham Sup. Co.
 M. H. Elec. Co.
 The Heights Radio Sun. Co.
 Eclipse Elec. Co.
 Fordham Radio Co.
 Crescent Radio Co.
 Terminal Rad. & Mus. Shop
 United Anchor Tire Co.
 Inter City Radio Co.
 Josephson
 Redlion Corp.
 Greenwirth Radio Co.
 H. Goldstein
 Isador Fajans, Inc.
 Grand Radio
 M. Rubin
 Hannes & Co.
 Madison Hdwe. Store
 American Radio Co.
 American Elec. Tech. Co.
 Electrical Eng. & Con. Co.
 Niagara Falls, N. Y. H. Messersmith & Sons
 Noristown, Pa. E. M. Law
 Oakland, Cal. Warner Bros.
 E. M. Sargent Co.
 Omaha, Neb. White Elec. Co.
 Onset, Mass. W. C. Spring
 Passaic, N. J. J. L. David
 Simon Bros.
 Pascaic Radio Shop
 Perth Amboy, N. J. Smerling, J.
 Amboy Lighting Co.
 Amboy Radio Co.
 Paterson, N. J. Federal Radio & Elec. Co.
 Pawtucket, R. I. Delancey Peleh & Co.
 Peoria, Ill. Peoria News Stand
 Philadelphia, Pa. Gimbel Bros.
 H. C. Roberts El. Sup. Co.
 Savoy Level Radio Co.
 Goetz Music Stores
 F. & W. Grand Stores
 E. P. Noll & Co.
 Trilling & Montague
 Neisner Bros.
 Schimmel Elec. Co.
 Radio Sales Co.
 John Wamamaker
 Phoenix, Ariz. Nielson Radio Sup. Co.
 Poughkeepsie, N. Y. C. P. Raymond
 Pittsburgh, Pa. Goldsmith & Son Co.
 Ludvig Hommel & Co.
 Gain-a-Day Elec. Co.
 Liberty Incan. Sup. Co.
 Pitts Radio & App. Co.
 W. S. Radio Co. of Pa.
 Doubleday Hill Co.
 Pittsfield, Mass. W. T. Grant Co.
 Plainfield, N. J. H. E. Gayle Hdwe. Co.
 Pittsburgh, N. Y. H. E. Atwater
 Portland, Me. Chisholm Bros.
 Portland, Oreg. E. L. Knight Co.
 Hynson Elec. Co.
 Highlands Old Book Store
 Pottstown, Pa. T. S. Reidenhour & Son
 Pottstown Radio Sup. Co.
 Princeton, N. J. Princeton Creta Shop
 Providence, R. I. R. & H. Supply Co.
 R. I. Elec. Equip.

The Shepard Co.
 The Outlet Co.
 Boston Store
 Reading, Pa. F. & W. Grand Stores
 Rochester, N. Y. Hickson Elec. Co.
 Rochester Elec. Sup. Co.
 Wheeler Green El. Sup. Co.
 Eastman Radio Co.
 H. Schmidt & Co.
 E. C. Sykes & Co.
 Neisner Bros.
 Miller Drug & Elec. Co.
 Ridgewood, L. I. Ridgewood Radio Shop
 Rock Island, Ill. H. E. Gelhart & Co.
 Berdsley Specialty Co.
 Vail Co.
 St. Joseph, Mo. Empire Elec. Co.
 Mammichrecks Book Stores
 St. Louis, Mo. The Benwood Co.
 Luize Elec. Supply Co.
 Foster Book & Cigar Co.
 St. Paul, Minn. North-West Elec. Eq. Co.
 Premier Radio Mfg. Co.
 Pioneer Elec. Co.
 St. Paul Book & Sta. Co.
 Crist Book Shop
 San Francisco, Cal. Richter, Conrad
 Schenectady, N. Y. Albany St. Radio Store
 Seattle, Wash. F. B. Wilson
 Stamford, Conn. Arthor
 Stillwater, Okla. Stillwater Elec. Shop
 Syracuse, N. Y. Grant's Alexander Sons
 Hughes Radio Corp.
 M. H. Salmon Elec. Co.
 Toledo, O. Kneuer Radio Co.
 W. J. Nadel Elec. Co.
 Toronto, Ont., Can. H. M. Kipp
 T. Eaton & Co.
 Trenton, N. J. Flevon & Son, Inc.
 Radio Chain Stores
 Troy, N. Y. L. H. Copper & Son
 Tyler, Tex. R. E. Brown
 Union Hill, N. J. N. W. Friedman
 Uniontown, Pa. Frederick Piano Co., W. E.
 Utica, N. Y. Dent, Co., M. F.
 Olds Book Store
 Utica Elec. App. Co.
 Utica Elec. Sup. Co., Inc.
 Waco, Tex. Jackson's Radio Eng. Lab.
 Washington, D. C. Continental Elec. & Sup. Co.
 Radio Auto Sup. Co.
 Waretown, Wis. D. & F. Kusel Co.
 Watertown, N. Y. F. A. Empsall & Co.
 W. Hoboken, N. J. The Heraco Exchange
 W. New York, N. J. W. N. Y. Heraco
 Wheeling, W. Va. Gee Electric Co.
 Wapakoneta, Ohio Helne & Nagel Elec. Co.
 Waupaca, Wis. Waupaca Radio Sales Co.
 Wausau, Wis. Janke, Kuth Co.
 Wilkes-Barre, Pa. Foster Radio & Elec. Co.
 Wilmington, Del. L. P. Moore
 Wilmington Elec. Spec. Co.
 Worcester, Mass. Neisner Bros.
 Williamsport, Pa. Wilhelm Book Store
 Yonkers, N. Y. Knepper, F.
 Westchester Elec. Eq. Co.
 York, Neb. Bullocks
 Youngstown, Ohio Robert P. Phillips



Order direct from these dealers. If your dealer cannot supply you, send us his name and address

233 Fulton Street, New York City

Publishers of Consolidated Patterns
 Sales Agents for E. I. Co. Books

radio message and telephoned the information leading to the recovery of the car and the farmer who had discovered the abandoned car in the ditch and taken it to his home. The thief has not yet been found.

Unfortunately, the stolen radio apparatus was not in the Essex when it was found. Mr. Hollister and Mr. Miller are still wondering if the fellow hid it, sold it, or if it were carried away by him and accomplices who may have helped him escape when the car had to be abandoned.

The Big Amateur Number

The November Issue of Radio News Is To Be the Amateur Number

THIS WILL CONTAIN ARTICLES BY SUCH WELL KNOWN AMATEURS AS JOHN L. REINARTZ, RALPH E. BATCHER, L. W. HATRY, A. L. GROVES, ETC.

SEE YOUR DEALER NOW AND RESERVE A COPY

BOOTLEG RADIO TUBES

The bootlegging of vacuum tubes used in radio receiving sets has grown to be one of the most widely-practiced and highly profitable by-products of prohibition. Its importance is second only to the business of rum-smuggling itself. With a potential market of nearly a million dollars worth of tubes per month, the radio bootlegger is playing a big game. His net profit is generally as large, if not larger, than that of the whisky runner and his danger of apprehension and punishment seems much less.

Beginning about a year ago, on a small scale, with the manufacture of various crude types of tubes which were easily spotted, the radio bootlegger has developed his business to the point of so skilfully and accurately counterfeiting the products of several prominent manufacturers that only an expert is able to detect the difference. In the course of examining the receiving sets of about 40 amateurs a day for the past year and a half, the "Sunday Call," of Newark, N. J., has been afforded an unusual opportunity of examining a large variety of vacuum tubes; and whereas it was formerly a very simple matter to detect a bootleg product because of its faulty construction, the job has now become one requiring the closest examination.

The manufacture of the so-called "standard" vacuum tubes is in the hands of a closely knit group comprising the General Electric Co., and the Westinghouse Electric and Manufacturing Co., from whose factories come the UV-200, UV-201, UV-201-A, UV-199, WD-11, WD-12 and, in addition, a series of tubes used largely in transmitting circuits. These tubes are sold through the Radio Corporation of America to the jobbers and dealers of the country. From the General Electric factories also come a series of tubes identically the same as listed above, but bearing the trade designation C-300, C-301, C-301A, C-299, C-11 and C-12 and the signature of E. T. Cunningham. These tubes are widely used on the Pacific coast and have recently been introduced into New Jersey through the State distributor, E. M. Wilson and Son, 11 Lafayette Street, this City.

Natural
Re-PRODUCTION
Atlas
AMPLITONE
LOUD SPEAKER

MIRRORS the naturalness of the original production. Actually re-Produces. New principles of acoustics introduced in the marvelous "double diaphragm." Sold by all up-to-the-minute dealers.

Letters from Users Requested

"Far superior in tone." "Surprisingly good results." "The best loud speaker before the radio public." "This most wonderful instrument"—these are typical phrases from letters written us unsolicited by enthusiastic users. What have you accomplished with your *Atlas Amplitone*? Tell us about it!

Multiple Electric Products Co. Inc.
ORANGE ST. RADIO DIVISION NEWARK, N. J.

TO THE RADIO DEALER.

Let us explain how you can make the sale of our publications a worth while, well paying part of your business. Every one that enters your store is a prospective buyer of RADIO NEWS. RADIO NEWS will sell with little effort on your part.

You may sell our publications on a single copy basis with a fine margin of profit or on a subscription basis with a generous commission allowance.

Write now and prepare for the Fall and Winter trade.

EXPERIMENTER PUBLISHING CO.,
53 Park Place, New York.

Are You Outfitting the Yachtsman?



IN the various harbors one sees aerials on more and more cruisers as the months pass. But the proportion is still small. The medium sized boat field has not yet been developed to any great extent, though the interest in radio amongst yachtsmen is coming along by leaps and bounds.

Don't neglect your big opportunity to get your share of this highly profitable new business.

Since the Department of Commerce regulations are making it so much easier for small yachts to install radio stations, there's an enormous number of new purchasers of radio supplies in the market—who will buy your goods if they are familiar with them.

You can reach your best customers through their own favorite magazine



119 West 40th Street
New York City, N. Y.

You can be quickly cured, if you

STAMMER

Send 10 cents for 288-page book on Stammering and Stuttering, "Its Cause and Cure." It tells how I cured myself after stammering 20 yrs. B. N. Bogue, 891 Bogue Bldg., 1147 N. Ill. St., Indianapolis

COPIES OF "PEANUT" TUBES

Another important manufacturer of standard tubes is the Western Electric Company, makers of the VT-1 and VT-2, used extensively by the Signal Corps of the United States Army, the 216-A used as a power amplifier and the "N" (peanut) tube employed as a detector, as well as a radio and audio amplifier. The latter tube, although not sold for amateur and experimental use in this country has attracted considerable attention here. The interest thus aroused has been capitalized by the bootleggers, who have placed copies of this tube on the market.

STEAL FRUITS OF RESEARCH

The development of "standard" vacuum tubes to their present high point of efficiency has been achieved only after the expenditure of hundreds of thousands of dollars by the companies mentioned above. The patents resulting from this costly experimentation represent a form of protection for the manufacturer against the pirates of industry who seek to profit by the fruits of another's labor and brains.

Patents mean nothing to the radio bootlegger, however. Not only does he steal the fundamental principle which has taken a legitimate firm years to develop, but he completes the job to the last detail by counterfeiting the tube in size, shape and even in the design of the trademark.

Newark is reported to be the biggest source of bootleg vacuum tubes in the country, but, strangely enough, fewer bootleg tubes are sold in this city than in any radio center of its size and importance in the United States. The local public is afforded a large measure of protection through the integrity of the dealers and through the medium of the personal service feature of the "Sunday Call's" Radio Department, which is available for testing tubes and apparatus every day except Monday, from 2 to 5 P.M. A constant watch over the radio market is maintained by the "Call's" staff for the protection and information of its readers. Because of this fact, radio bootleggers find it more profitable to seek other dumping grounds for their products.

SEVEN BOOTLEGGERS HERE

From a source believed to be very reliable the "Sunday Call" has learned that there are approximately seven "factories" engaged in the manufacture of bootleg tubes in Newark. The combined capacity of these plants is figured at 3,500 tubes a day. There are five additional factories in New York and Brooklyn, this latter group being capable of producing about 2,000 tubes a day.

The reason Newark is such a big manufacturing center for bootleg tubes is because this city and vicinity affords the greatest market for skilled labor and materials, vital necessities to the bootlegger. In Harrison, just across the Passaic River from Newark, is the General Electric plant, employing thousands of workers—mostly girls, on the various processes of vacuum tube construction. In Bloomfield, another suburban town, is the Westinghouse Lamp Works, also employing thousands of trained workers on radio tubes. In these factories inexperienced labor is taken and thoroughly trained in the delicate work of tube making. Once thoroughly trained and experienced, this labor is recruited by agents of the bootlegger who are known to have approached workers leaving the factories. Higher wages is the usual bait, but bonuses are offered to the girls skilled in the more delicate branches of the work.

With this labor at his command the bootlegger is better able to carry out the details of counterfeiting standard tubes. There has come to the attention of the "Sunday Call" some excellent copies of the UV-199. It is difficult to tell the copy from the original. Its weakness is in its extremely short filament life, the average bootleg lasting only a few hours as against 1,000 hours, the nor-

PORTENA

The Newest and Most Practical Development in Aerial Loops

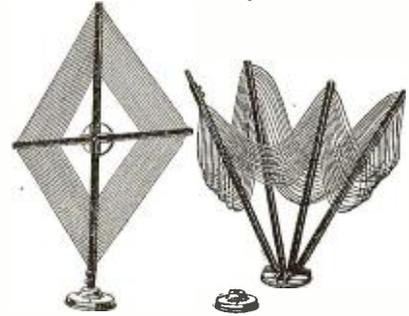

30 1/2 inches high, 28 inches wide
Collapsible and Portable
Patent Pending

PORTENA Loop Aerial has a natural period of 145 meters and when shunted by a 23-plate variable condenser will respond to a wave length range of from 190 to 650 meters. It is supersensitive and very selective, has correct electrical characteristics and its collapsible feature makes it an ideal Loop for all occasions.

PORTENA has been thoroughly tested and certificates of excellence have been issued by the Research Department of the New York Evening Mail, the Radio News, etc.

IT MAKES AN ATTRACTIVE ADDITION TO YOUR HOME SET

AVOIDING ALL LANDLORD INTERFERENCE
IDEAL FOR THE CAMP, MOTOR BOAT, AUTO, etc.
Automatically Opens and Closes
Instantly Set Up or Packed

The materials and workmanship of the PORTENA are of the very highest grade. It is guaranteed in every respect.

Complete with Morocco Finished Case

PRICE, \$6.50

Desirable Territory Open for Distributors

At All Reliable Radio Dealers
J. NAZELEY CO., Manufacturers
240 Broadway, New York City.

The choice of foremost
Engineers
for over 17 years.



Sold by
all dealers

BRACH VACUUM RADIO PROTECTOR

Approved by the National
Board of Fire Underwriters

Ask YOUR Insurance Agent

L. S. BRACH MFG. CO.,
Newark, New Jersey

SOLDERALL

Metal in Paste Form



Handy Tubes 25¢
Every Electrical
Connection Needs
Solderall for Perfect Reception
The Only Convenient Metal Solder

Starting a Company?

Save expenses and taxes by organizing on the popular, COMMON LAW plan under a pure DECLARATION OF TRUST. No experience required to fill in DEMAREE STANDARD FORMS, issue shares and begin doing business at once. Genuine DEMAREE FORMS are nationally known, approved by attorneys and utilized by successful concerns throughout the United States. Send for large, free pamphlet (D40) containing valuable information that you may need. C. S. DEMAREE, legal blank publisher, 708 Walnut, Kansas City, Missouri.

mal service of a standard tube. The bootleg 199's examined have a higher rate of current consumption than the genuine and a low percentage of electron emission, which means poorer service. This is largely because the bootlegger is unable to obtain the proper filament material and is obliged to substitute a flattened platinum wire, which, incidentally, is also obtainable locally.

EARMARKS OF FAKES

The counterfeit UV-199 is distinguished by the fact that the R.C.A., G.E. and W. trademarks impressed in white on the glass may be erased by rubbing a moistened finger over them. On the genuine, these trademarks are etched on the glass and cannot be removed. The printing on the base of the tube is frequently badly smudged on the bootleg, whereas on the genuine it is quite clear and readable.

In addition to the counterfeit UV-199, the "Sunday Call" has discovered fake Western Electric "N" tubes, UV-200 and UV-201, de Forest DV-6, WD-12 and UV-201-A.

—Abstract from the Newark Sunday Call.

BROADCASTING STATIONS SHUT DOWN TO HONOR THE MEMORY OF OUR LATE PRESIDENT

Befitting the Nation-wide mourning for the loss of our late President, Warren G. Harding, on Friday, August 10, all broadcasting stations throughout the United States ceased transmitting, with the exception of a few which broadcast services from local churches.

BUREAU OF MINES PLANS FURTHER RADIO EXPERIMENTS IN LIFE SAVING IN MINES

In connection with its efforts to keep pace with all safety and rescue developments, the Bureau of Mines of the Department of the Interior is planning to continue its investigations with radio communication underground. The development of radio has been rapid and officials of the Bureau feel that any application to mine rescue work must not be neglected.

Mr. J. J. Jakowsky, mechanical engineer, has been designated to undertake certain experiments in radio communication at the Bureau's experimental coal mine at Bruceton, Pa. Mr. Jakowsky was attached to the Signal Corps during the war, where he had considerable experience with radio work. The co-operation of the Radio Supervisor at Pittsburgh has been promised by the Department of Commerce in the new radio experiments.

Some months ago preliminary radio experiments in sending and receiving underground at the Bruceton mine were conducted with partial success. In reporting on the matter, the Bureau of Mines stated that the experiments consisted in receiving signals from without the mine by means of a receiver located inside the mine, and in sending and receiving messages underground through the strata. It was found that with a receiving instrument set at a point 100' underground, signals from station KDKA, East Pittsburgh, Pa., could be heard distinctly, at a distance of about 18 miles from the experimental mine. In sending waves underground, a Westinghouse 20-watt B.T. model T.F. transmitter was used in such a manner as to send out continuous waves of 200 to 300 meters in length. On account of the limited time, no attempt was made to modify the apparatus in such a manner as to produce waves of greater length. It was found that signals could be heard distinctly through 50' of coal strata, but that the audibility fell off rapidly as this distance was increased. In all experiments a vertical antenna was found to give the better results. The horizontal

Brandes



NEW PRICES

Superior

\$6.00

Navy Type

\$8.00

Grandpa joins the fans!

When Grandpa first "listened in" it was through a noisy, uncomfortable headset, and he wouldn't try it again till some one called him old fashioned. Then he heard a concert through a Brandes *Matched Tone* Radio Headset. Now his dinner grows cold when there is something good coming over!

He says the Brandes makes all the difference. It fits so comfortably and he gets real music or a clear message every time.

Grandpa may not appreciate what *Matched Tone* means, but he likes the result.

Made in Canada and England by

Canadian Brandes Limited, Toronto and London

C.Brandes, Inc. - 237 Lafayette St., N.Y.C.

Matched Tone

TRADE MARK REG. U.S. PAT. OFF.

Radio Headsets

© C. Brandes, Inc., 1923.



Radio Supplies at Cut Prices

Federal or Brandes Headsets\$4.95
Murdock 2000 ohm or Diamond Headsets 3.75
Murdock 3000 ohm Headsets 4.25
Federal Audio Transformers 4.95
Acme Audio Transformers 3.75
Acme Radio Transformers, Type R2-R3 3.95
Jefferson Star Transformers 2.95
Western Electric Peanut Tube 5.95
22½ Volt Variable B Battery 1.75
45 Volt Variable B Battery 2.50
22½ Volt Eveready Variable B Battery 1.25
45 Volt Eveready Variable B Battery 2.25
23 Plate Var. Condensers—Bakelite Ends 1.50
43 Plate Var. Condensers—Bakelite Ends 1.95
23 Plate Var. Condensers with Vernier 3.50
43 Plate Var. Condensers with Vernier 3.95
Sockets or Rheostats45

ALL MAIL ORDERS MUST INCLUDE POSTAGE
KENSINGTON RADIO SUPPLY CO.
4417 18th Ave., BROOKLYN, N. Y.

CATALOG **E19-112** PAGES **FREE**

EVERYTHING IN RADIO

One of the largest complete stocks in the world. 40 diagrams of latest Hookups.

DEALERS ALL OVER THE U.S.

Making big profits handling our supplies. 24-hour service. Goods shipped same day order received.



WHOLESALE RADIO DISTRIBUTORS
Dept. A 107 E. 13th St. Kansas City, Mo.

DUTHO

Rechargeable Storage "B" BATTERIES

**Cost You Less
Last Longer**



\$5
6" x 2 3/4" x 2 3/4"
Weight 2 1/2 lbs.

DUTHO 'B' Batteries eliminate all battery noise and internal action. This prevents distortion. Heavy, individual glass tubes permit visibility at all times and make surface discharge impossible. You can see when and how to "keep them up." Condensing chamber in each cell overcomes fumes and prevents spillage.



\$9
6" x 2 3/4" x 4 3/4"
Weight 4 1/2 lbs.

DUTHO Batteries are sold DRY CHARGED, with solution in separate container. Once filled your battery is fully charged, ready for immediate use. Ordinary care in following directions will make DUTHO 'B' Batteries last indefinitely. Thousands in use today.

DEALERS: Write for attractive proposition.

DURKEE-THOMAS PRODUCTS CO.
1228 Folsom Street
San Francisco

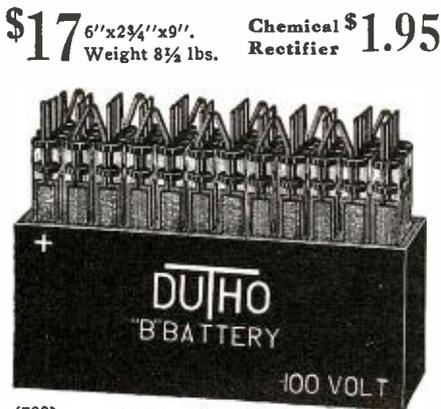

\$17
6" x 2 3/4" x 9"
Weight 8 1/2 lbs. **Chemical Rectifier \$1.95**

(700)

antenna gave practically no reception. A loop of a single turn was used with fair results. All these experiments were tried with a wave-length of 200 to 300 meters, except the reception from KDKA, which was 360 meters.

In conclusion the report stated:
"The present preliminary experiments, while unsuccessful in indicating any practical method of using wireless waves for underground communications, nevertheless indicate clearly that electromagnetic waves may be made to travel through solid strata. The absorption or loss of intensity with distance is very great for the short wave-lengths used in these experiments. Longer wave-lengths are known to suffer less absorption and may possibly be found practically effective under certain conditions."

USE RADIO SETS IN BALOON RACES

Reporting officially to the Chief of the Army Air Service on the use of radio in balloon races, Lieut. R. S. Olmstead, winner of the recent race says in part:

"The S-6 balloon radio installation complete with antenna and counterpoise weighed around 30 pounds, representing roughly one bag of sand ballast. Both Lt. Shoptaw and myself agreed that it was worth several times its weight in sand. It should always be remembered furthermore that the set could be used as ballast quite efficiently by the simple process of dissembly.

"Immediately upon taking off we dropped our antenna and (copper screen) ground and wired up to receive. The results were uniformly good from the first. Musical program after musical program with great clearness came in, and incidentally the Dempsey-Gibbons fight returns came from Detroit by rounds. There seemed always to be music in the air, and to anyone who has experienced the monotony, when everything is going well, of the hours of darkness in a balloon race flight, the value of such restful relief therefrom is very evident. There should always be two head-sets provided to a basket; we had but one. They do not interfere in the least with the work of the Pilots, and the tendency is to wear them at all times.

"From Detroit, Chicago and Schenectady, particularly from Schenectady, we received quite definitely the weather reports consisting of general flying conditions, wind directions and velocities, cloud conditions, and of great importance, the pressures recorded at various important cities. This information was quite conclusive in influenc-

PACENT

PLUG and JACK COMBINATIONS



The Pacent Multijack, Twinadapter and Duojack are the standard devices for making quick, convenient and dependable radio connections.

List Price now \$1.00

Write for Bulletins
ND10

The Pacent Multijack, three jacks in one moulded unit.

Don't Improvise—PACENTIZE
Pacent Electric Co., 22 Park Place
New York, N. Y.

Pacent

RADIO ESSENTIALS

Ideal Summer Vacations

BERMUDA

Only 2 Days from New York

8 Day Tours — \$83.00 and up
9 Day Tours — \$88.50 and up
Longer Tours in Proportion
Including all Expenses
All Outdoor Sports

Sailing, Bathing, Golf, Tennis, Crystal Caves, Sea Gardens, etc. Bermuda is Cool in Summer. Average Summer Temperature 77 deg.

No Passports Required
Sailings Twice Weekly
Via Palatial, Twin-Screw, Oil-Burning Transatlantic Liners

**S. S. "Fort Victoria" and
S. S. "Fort St. George"**

For Illustrated Booklets on Bermuda Tours write
FURNESS BERMUDA LINE
34 Whitehall St., N. Y., or any Local Tourist Agent

YOU MUST SEE . . .

The Greatest of all Radio Shows

Second Annual
American Radio Exposition
at the
Grand Central Palace, New York
Oct. 6-13, 1923
(Excepting Sunday)

Instructive and Entertaining

See for yourself the wonderful progress and achievements made during the past year. Hundreds of interesting exhibits will afford you a liberal Radio education.

Manufacturers—Only a few reservations still available.
Wire or write at once for particulars to

AMERICAN RADIO EXPOSITION CO.
J. C. Johnson, Gen. Mgr., 120 Broadway, N. Y.

WHOLESALE PRICES TO YOU STANDARD APPARATUS ONLY

Announcement: We are now in a position to supply the Radio Public with standard radio apparatus of the Highest Quality, at Wholesale Prices. 20 to 60% discount, on all radio merchandise. 12 Hour Service. SPECIAL OFFER 500 A. E.; 200 R. P. Unit Amplifiers, list \$12.00, ONLY \$3.75. Send money order or shipped C. O. D. All Apparatus GUARANTEED. Send for price list.

International Radio Sales & Service
12 Otis Street Medford, Mass.

FREE Price List containing hundreds of bargains of Radio equipment. Send stamp for Radio and Electrical catalog.
KALISH & MARTEN Box 183 Central Sta. Toledo, Ohio

ing our tactics to obtain a suitable direction of flight in order to obtain maximum endurance and distance. A feature which should be added and which we keenly felt the need of for several hours while out of sight of any land marks over Lake Erie is a direction finding attachment. A loop hung above the load ring with compass attached thereto it is believed would solve this problem.

"A point of vital importance in a race was the advice received by radio of the location of our various competitors from time to time. At the time of landing we knew that all but three of our competitors had been accounted for, and we were quite certain that we were in one of the three winning positions and eligible to go to Belgium. Had we not had this information, we might have tried to cross Lake Ontario without sufficient ballast, and failing in the attempt, would have disqualified ourselves.

"My recommendations are that a radio set should be installed in every racing balloon, directional attachment should be added and two head-sets should always be provided."

AUXILIARY RADIO EQUIPMENT SAVES PASSENGERS

An example of the value of auxiliary radio power in the form of batteries on sea-going vessels and the necessity of their frequent inspection, is found in the report of the total loss of the S.S. *Advance*.

When the *Advance* went aground off Halifax recently, the operator found that his power was cut off soon after, as it was feared there might be a boiler explosion. This made it necessary for him to shift to his emergency batteries for transmitting SOS calls to ships and shore stations. His batteries stood up for one and a half hours, when it became necessary to abandon the ship. All lives were saved, due to the bringing of aid by radio. Although the vessel itself was lost.

There would undoubtedly have been a loss of life if the batteries had not been in good shape, and it is understood that just before the vessel cleared from Boston for Halifax, a government radio inspector discovered that the old batteries were in very bad shape and condemned them. The owners immediately installed an entirely new unit of battery power supply, which insured radio communication when the regular power failed.

TELEPHONING OVER HIGH VOLTAGE LINES ACCOMPLISHED

Executives of large power plants from various sections of the United States, as well as officials of the Consumer's Power Company of Michigan recently witnessed the first demonstration of telephoning over power transmission lines over the company's system between Jackson and Battle Creek.

The celebration upon the occasion of the opening of the first new high frequency automatic telephone system, was in charge of B. E. Morrow and C. W. Tippy, officials of the Consumer's Power Company, who were the first to talk over the new system.

This system has just been installed by engineers of the Westinghouse Electric & Mfg. Co., who developed and designed the installation. Only two sets located at Jackson and Battle Creek are completed. Four other similar stations will be installed at various points along the 600 miles of transmission lines.

The installation on the Consumer's Power Company of Michigan is a long step in advance of anything yet attempted in experiments with so called "wired wireless."

This system provides for two-way communication, similar to an ordinary telephone line system. While the radio impulses are guided by the high voltage transmission lines along the entire system, in event of breaks in the power lines, communication



Licensed under Armstrong U. S. Pat. 1113149

RADAK — TYPE C23

THE BASIS OF RADAK SUPREMACY

lies in the fact that Radak sets are an engineered entity designed under the close supervision of a skilled expert, and fabricated by skilled craftsmen in the Radak factory. As a harmonious whole, they present a striking contrast to an assemblage of miscellaneous stock parts put together without one continuous line of reasoning.

Every wire, every coil and every part of each and every Radak set is the result of careful design and engineering thought directed to the end that each part may function at its greatest efficiency in conjunction with the rest.

Radak C23, for instance, combines the sharpness of radio frequency amplification with the volume obtained only by audio frequency amplification. Its control, already simple, is made a pleasure by Radak vernier dials, and places the realms of half a continent at your command on any normal night.

AS A MATTER OF COURSE, SUCH A MODERN ENGINEERED SET WILL OPERATE WITH ALL MAKES OF TUBES, DRY CELLS OR STORAGE BATTERY, and will surprise you with its extreme ability on a small indoor or loop antenna.

It is only through consistent, skillful engineering that all of these advantages can be combined in a set which can be thoroughly guaranteed and priced at \$125.

Radak

Radio Receiving Equipment

A complete line of guaranteed sets
from \$25.00 to \$300.00.

Manufactured by

CLAPP-EASTHAM COMPANY

107 MAIN STREET, CAMBRIDGE, MASS.

New York, N. Y.	Cleveland, Ohio	Chicago, Ills.	San Francisco, Cal.
395 Broadway	Caxton Building	154 West Lake St.	709 Mission St.

RADIO CATALOG

CONTAINING 14 HOOKUPS

SEND 10¢

To Cover Cost of Packing and Mailing

See Our Ad on Page 425

SERVICE and QUALITY

BUILT THIS HOUSE

GREAT LAKES RADIO Co.
136 W. LAKE ST., CHICAGO, ILL.

Would You Give \$1 to Qualify for a Transmitting License?

Thousands are qualifying for the Transmitting License largely through the help of the Radio Quiz Book. This book contains 260 questions and answers usually asked in examinations—detailed descriptions of radio equipment and how to take care of it, explanations of radio terms, symbols, diagrams, formulae, tables, laws, regulations—just the information you need to qualify for your license.

For a short time we are selling this Quiz Book for only \$1. Send for your Quiz Book today before this special offer is closed. Mail letter enclosing \$1 now.

NATIONAL RADIO INSTITUTE,
DEPT. 13-J, WASHINGTON, D. C.

Insure your copy reaching you each month. Subscribe to Radio News—\$2.50 a year. Experimenter Publishing Co., 53 Park Place, N. Y. C.

CIRCULATION 60,000 COPIES

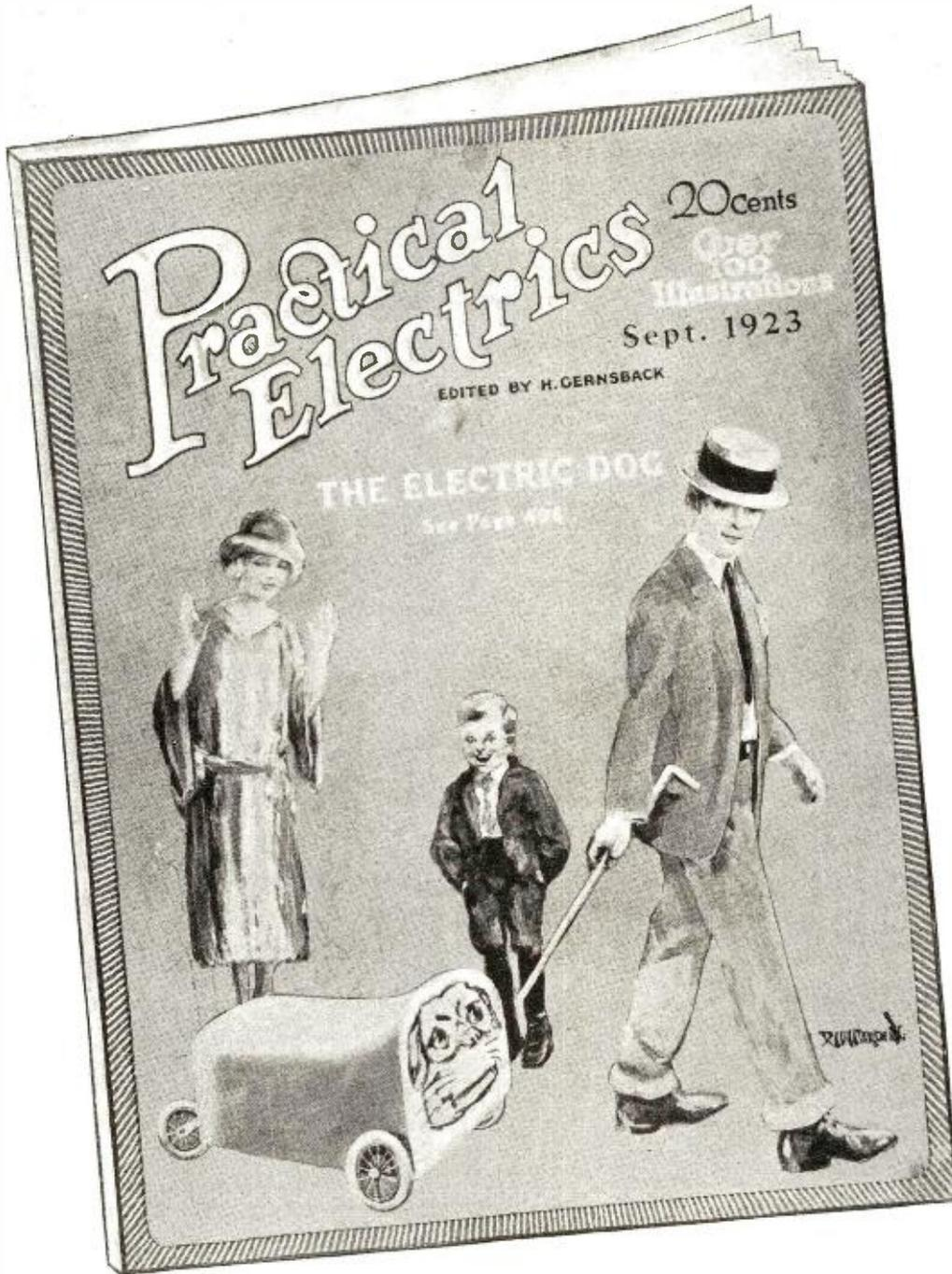

This magazine is edited by
H. GERNSBACK
 also Editor of
RADIO NEWS
 and
SCIENCE and INVENTION

100 Articles
 Over
 100 Illustrations

FOR SALE AT
 ALL NEWS STANDS

20c. the Copy
\$2.00 a Year
 Canada and Foreign
\$2.50 a Year

SEND FOR
FREE
 SAMPLE COPY
 TODAY

See Coupon Below
 for SPECIAL OFFER

"The Electrical Magazine for Everybody"

PRACTICAL ELECTRICS is probably the most novel magazine of its kind ever conceived. It is personally edited by H. Gernsback, editor of SCIENCE & INVENTION and RADIO NEWS. Mr. Gernsback, who founded the old "Modern Electrics," as well as the "Electrical Experimenter," knows thoroughly what his readers want and have wanted for many years. PRACTICAL ELECTRICS, the 100% electrical magazine eclipses the best that was in "Modern Electrics" and "Electrical Experimenter."

Electricity covers such a tremendous field that the man who does not keep abreast with it does himself a great injustice. PRACTICAL ELECTRICS covers that field from every angle. It is written in plain every-day language that all can understand. It portrays the entire electrical development of the month faithfully in non-technical language. It caters to everyone interested in electricity, be he a layman, an experimenter, an electrician or an engineer—each will find in this magazine a department for himself and plenty more.

The October issue now on the news-stands contains 48 pages and over 100 different articles and over 100 illustrations, with an artistic cover in three colors. Professor T. O'Connor Sjoane, Ph.D., is associate editor of the magazine.

INTERESTING ARTICLES IN OCTOBER
 "PRACTICAL ELECTRICS"

- Perpetual Motion? by H. Gernsback.
- Thermic Telephones—First installment of a remarkable paper on this interesting subject with numerous illustrations.
- Mammoth Electrodes, by Dr. Albert Gradenwitz, Berlin correspondent "Practical Electrics."
- Electric Bell Ringing, by Lucien Fournier, Paris Correspondent.
- A self-feeding Arc Light. Razor Blade Microphone. Electric Fish Net. Electric Coal Car Dumper.

PRIZES

This magazine offers a number of prizes, as follows:
 Our \$50.00 Prize Contest for Junior Electricians and Electrical Experimenters includes as its elements simplicity, as great a degree of novelty as possible, and practicality.
 An interesting \$100 prize contest is announced, for best new uses for old spark plugs.
 Also a new prize contest giving four prizes amounting to \$37.50 for the best account of an old electrical experience.
 \$3.00 for the best article on Elec-Tricks, the new department.
 \$3.00 for the best "short-circuit," the semi-humorous department.
 In addition to this, the magazine pays high prices for all electrical experiments, electrical articles, etc.
 See Current Issue for Full Details.

This issue also contains articles by some of the greatest electrical writers, workers and students. The magazine will prove a revelation to any one interested in electricity.

Every issue besides its many other features contains the following departments:

- "New Things Electric"
- "Experimental Electrics"
- "Electrical Digest"
- "Junior Electrician"
- "Elec-Tricks"
- "Motor Electrics"
- "Short Circuits"

"How and Why" (Questions and Answers.)

Make all checks payable to: "Practical Electrics Co."

R. N. 10-23

SPECIAL OFFER

Gentlemen:
 Although your regular price is \$2.00 per year, you will accept my subscription at \$1.75 per year (Canada and foreign \$2.25). I enclose the money herewith and I have written my name and address in margin below.

PRACTICAL ELECTRICS CO., 53 Park Place, New York

is not interrupted, as the radio impulses readily jump the gap. In fact, signals can be exchanged even if several miles of transmission lines are down. Even during lightning storms, which will interrupt ordinary line telephone momentarily, speech can be transmitted without difficulty over the system. This feature of the installation gives it a marked advantage over the conventional wire telephone circuits.

The high frequency apparatus, or the radio units of the system, are located at the various terminal stations. Two antenna wires are strung for a short distance on the towers which support high tension power lines. One of these is a sending antenna and one is used exclusively for receiving. The antenna wire is given a clearance of about 12' from the power line wire. The upper or transmitting antenna is connected to the transmitting set and the lower antenna to the receiving set.

High frequency currents are generated by a 250-watt vacuum tube similar to those used in broadcasting stations. This tube operates on a 2,000-volt direct current. This high frequency current flows into the transmitting antenna and instead of being broadcast through the air, it induces, by electrostatic and electro magnetic induction, corresponding high frequency current in the adjacent power line. This high frequency energy, superimposed upon the energy transmitted normally by the power line, is carried on the power line to the receiving station where, by induction, it is led into the receiving set through the receiving antenna. This unit is an ordinary long wave, coupled circuit radio receiver. It is equipped with a detector and one-step amplifier.

The high frequency currents are generated by the 250-watt vacuum tube type oscillator and modulated by a second 250-watt vacuum tube, to the grid of which the voice frequencies developed by the microphone are applied. A 50-watt vacuum tube is interposed between the relatively weak microphone circuit and the grid of the 250-watt modulator tube for the purpose of amplifying the voice frequencies.

MY RADIO RIVAL

By MADALON STEDMAN

My husband's radio is "certainly great." He's getting results from every state. From North and South, from East and West, He's "listening in" for what comes best.

He hears Havana, New York and Phil., Boston, Atlanta, Chicago, Ill. He learns what we have as weather in store, Quotations on market and football score.

He listens to lectures and stories they tell, He listens to music and singing, as well. In all of this the best part is "The Fireside Encore of the Artists."

Of distance he is no respecter, He gets them all with his detector. He's pleased as Punch and filled with flattery To find he's made a home-brew battery.

The many needs of a social wife, Seem to retain no place in life. He scarcely sleeps, and the midnight oil Burns cheerily on through hours of toil.

The man's absorbed! And I opine I no longer feel he's a husband of mine. To a jealous wife it's quite idiotic To have her mate go plumb "radiotic."

STAMPS ACCEPTED

In an effort to criticize a department in a radio magazine a certain reader wrote in that he did not want "any more free advice." To which the editor replied: "We have no objection if you want to pay for it."

F. A. D. ANDREA, Inc.
1581-A Jerome Ave.
N. Y. C.

Kindly send me.....books
"How to Build Hazeltine's
Neutrodyne Circuit Radio
Receivers" for which is en-
closed \$.....

Name

Address

CityState



Send For This
**FADA Neutrodyne
How-To-Build-It Book**

Gives complete assembly, wiring, adjusting and tuning instructions on both four and five-tube neutrodyne sets. Full size panel drilling template included. The special parts pictured above are needed. The combination package contains three neutroformers, three "Neutrodons" and the How to Build It book and sells for \$25.00. The book separate is 50 cents.



MAIL THE COUPON TO-DAY

F. A. D. ANDREA, INC.

1581-A Jerome Avenue
New York City

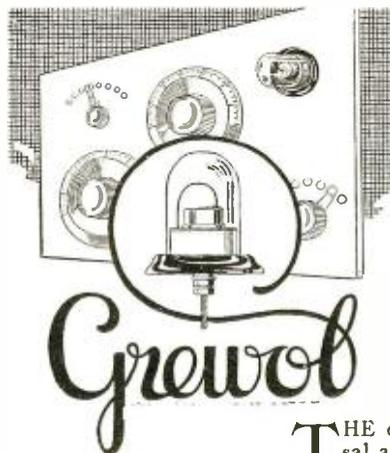

The
Crystal Detector
with a
**National
Reputation**
Fully Protected
by Patents

THE only crystal detector that has won such universal approval. Eliminates usual crystal detector difficulties. Most efficient adjustment found and fixed at the factory. Crystal protected from dust and moisture by glass enclosure. Re-adjustment seldom required—and then made in a moment. No complicated adjustments to get out of order. Needs no attention. Simplifies and improves the operation of your set. Unconditionally guaranteed.

Write for Booklet.

RANDEL WIRELESS CO.
9 CENTRAL AVE., NEWARK, N. J.

**PACKED
IN INDI-
VIDUAL
CARTONS**

At your dealer's or sent direct on receipt of price and dealer's name. **\$2**

OPPORTUNITY AD-LETS

Follow these advertisements every month. Reliable advertisers from all over the country offer their most attractive specials in these columns.

Classified advertising rate fifteen cents a word for each insertion. Ten per cent discount for 6 issues, 20 per cent discount for 12 issues. Name and address must be included at the above rate. Cash should accompany all classified advertisements unless placed by an accredited advertising agency. No advertisement for less than 10 words accepted.

Objectionable or misleading advertisements not accepted. Advertisements for the December issue must reach us not later than October 1st.

THE Net Paid CIRCULATION OF RADIO NEWS IS OVER 200,000
EXPERIMENTER PUBLISHING CO., INC., 53 Park Place, New York, N. Y.

Agents Wanted

Big Money and fast sales. Every owner buys gold initials for his auto. You charge \$1.50; make \$1.35. Ten orders daily easy. Write for particulars and free samples. American Monogram Co. Dept. 133, East Orange, N. J.

Men's Shirts. Easy to sell. Big demand everywhere. Make \$15.00 daily. Undersell stores. Complete line. Exclusive patterns. Free samples. Chicago Shirt Manufacturers, 241 W. Van Buren, Factory 120, Chicago.

Big Fast Profits for Agents. Repeater Six Fuse Plugs sell on sight wherever there is electricity. Do away with lighting troubles. Welcomed everywhere. Get details. Sample 25c. Moss-Schury Manufacturing Company, Inc., 16-A, Detroit, Mich.

We want Salesmen and Agents, either whole or side line, to sell our low priced radio books to the trade. Excellent proposition for live wires. The E. I. Company, Publishers, 233 Fulton Street, New York City.

Agents Wanted in every city and town to sell standard radio apparatus. Attractive discounts given. If interested, write us at once stating age and radio experience. Wilmington Electrical Specialty Co., Inc., 912 Orange St., Wilmington, Delaware.

Radio Salesmen or Distributors calling on Retailer can get profitable new side line. State territory covered. Investigate. Multivider Co., 3600 St. John, Kansas City, Mo.

American Made Toys

Manufacturers on Large Scale, also homeworkers, wanted to manufacture Metal Toys and Novelties. Millions needed of Barking Dogs, Wag Tail Pups, Wild Animals, Automobiles, Indians, Cowboys, Baseball Players, Cannons, Toy Soldiers, Crowing Roosters, Statues of Liberty, Miniature castings of Capitol, Bathing Girl Souvenirs and others. Unlimited possibilities. Guaranteed Casting forms furnished manufacturers at cost price from \$5.00 up, with complete outfit. No experience or tools necessary. Thousands made complete per hour. We buy goods all year and pay high prices for finished goods. Cash on delivery. Contract orders placed with manufacturers. Catalog and information free. Correspondence invited only if you mean business. Metal Cast Products Co., 1696 Boston Road, New York.

Automobiles

Automobile owners, garagemen, mechanics, send for free copy of America's popular motor magazine. Contains helpful, money-saving articles on repairing, overhauling, ignition, carburetors, batteries, etc. Automobile Digest, 528 Butler Bldg., Cincinnati.

Books

Radio Books Latest and Best. Catalog free. Ray Dubbins, 146 West 27th St., Indianapolis, Ind.

"Lights, Colors, Tones and Nature's Finer Forces", including Vibrations, colors; Electromagnetics; Odic-auras; Radio; Coldlights; Marvelous Opportunities. Illustrated; 270 pages, \$2.00. Table contents free. Stevens Publishers, 242 Powell, San Francisco, Calif.

Experimental Electricity Course in 20 Lessons. By S. Gernsback and H. W. Secor, E. E. A course of the theory and practice of Electricity for the Experimenter. Every phase of experimental electricity is treated comprehensively in plain English. New experiments are described and explained and nearly every application of Electricity in modern life is given. 160 pages—100 illustrations. Flexible cloth cover, 75c. postpaid. Stiff cloth cover, \$1.25 postpaid. Experimenter Publishing Co., Book Dept., 53 Park Place, New York City.

Wireless Course in 20 Lessons. By S. Gernsback, A. Lescaubour and H. W. Secor, E. E. Tells you everything you want to know about "Wireless"—theory, practice and history. A clear, concise course on every phase of this subject. 160 pages—50 illustrations, 30 tables. Stiff cloth cover, \$1.75, postpaid. Experimenter Publishing Co., Book Dept., 53 Park Place, New York.

Business Opportunities

Operate a Tire Repair Shop! Big Profits! Oldham made \$2200 in 4 months. Earnings averages \$100 week. We teach you and furnish full equipment for \$100 up. Write quick. Haywood's, 1331 South Oakley Ave., Chicago.

Sell us your spare time. You can earn Fifteen to Fifty dollars weekly writing showcards at home. No canvassing. Pleasant, profitable profession easily, quickly learned by our simple graphic block system, artistic ability unnecessary, we instruct you and supply work. Wilson Methods, Limited, Dept. J, Toronto, Canada.

Chemistry

Learn Chemistry at Home—Dr. T. O'Connor Sloane, noted educator and scientific authority, will teach you. Our home study correspondence course fits you to take a position as chemist. See our full page ad on page 486 of this issue. Chemical Institute of New York, 66 West Broadway, New York City.

"Popular Chemistry" magazine. "The Experimenter's Monthly." Six Months' Trial—45c. C. Wright Laboratory, Caldwell, N. J.

Correspondence Courses

Dollars Saved—Used correspondence courses of all kinds sold, rented and exchanged. List free. (Courses bought.) Lee Mountain, Plagah, Alabama.

Exchange

200-20,000 Meter Receiver including Itachotron \$35.00. Two Step Amplifier \$22.00. Smith, 4116 Market, Philadelphia, Pa.

1500 mile Vacuum tube receiver \$24.50. Radio, 4116 Market, Philadelphia.

Edison Elements for Storage B Batteries. Six to ten cents per pair postpaid. (Depending solely on size of order.) I handle strictly first-grade elements only. A. J. Hanks, 107 Highland Ave., Jersey City, N. J.

For Advertisers

I write letters, folders, booklets, complete follow-up for manufacturers, mail-order dealers. Long experience. Write for details. L. Taylor, Box 41N, Freeport, Illinois.

For Sale

\$250 DeForest three tube set, batteries, tubes, charger, Magnavox, etc. First \$150.00 takes all. Receives every state. R. C. Dodson, Masontown, Pa.

Health

Christians Red Food Salt. Greatest Natural Aid for Nutrition, \$1, \$2, sizes guaranteed. Vegetarian Food Co., St. Louis, Mo. Literature free.

Help Wanted

We want Salesmen and Agents, either whole or side line, to sell our low priced radio books to the trade. Excellent proposition for live wires. The E. I. Company, Publishers, 233 Fulton Street, New York City.

Detectives Needed Everywhere. Work home or travel. Experience unnecessary. Write, American Detective System, 1968 Broadway, N. Y.

Be a Mirror Expert. \$3-10 a day; spare time home at first; no capital; we train, start you making and silvering mirrors. French method. Free prospectus. W. H. Derr, Pres., 26 McKinley St., Baldwin, N. Y.

All men, women, boys, girls, 17 to 60, willing to accept Government Positions, \$17-\$190, traveling or stationary, write, Mr. Ozment, 251, St. Louis, Mo., immediately.

Earn \$25 Weekly, spare time, writing for newspapers, magazines. Experience unnecessary; details free. Press Syndicate, 5665, St. Louis, Mo.

Improved Made Toys

We show you how to earn big money easily with our casting forms making Whistling Birds, Wild Animals, Crowing Roosters, Automobiles, Baseball Players, Statue of Liberty, Indians, Toy Soldiers, Cowboys, Barking Dogs, Wag Tail Pups, Miniature castings of Capitol, Bathing Girl Souvenirs and others. No experience necessary. We furnish you with molds and necessary outfit from \$2.50 up. We buy large quantities of finished goods at highest prices. Spot cash. Send for catalogue and information free. The Improved Metal Casting Co., 342 East 145th Street, New York.

Languages

World-Romie System. Mastery to All Languages. Primers, 23 languages, \$1.94 each language: English, French, German, Italian, Portuguese, Spanish. Pronunciation-Tables, 192 languages, 30c each language. Languages Publishing Company, 8 West 40th Street, New York.

Instruction

Jazz-orchestra chording on tenor or regular banjo. Clary, 1521 E86, Cleveland, Ohio.

Learn Chemistry at Home—Dr. T. O'Connor Sloane, noted educator and scientific authority, will teach you. Our home study correspondence course fits you to take a position as chemist. See our full page ad on page 486 of this issue. Chemical Institute of New York, 66 West Broadway, New York City.

Used Correspondence Courses bought and sold. Bargain catalogue 1,000 courses free. Students' Exchange, Dept. 5, 47 West 42 St., New York.

Miscellaneous

Buy your cigars direct. 50 Aronor prepaid. \$1.50. Money back if dissatisfied. Agents wanted. Havana Smokehouse, Homeland, Ga.

Spark-Plug, cleans like a pipe; outright or royalty. Box 100, Worth, N. C.

Pecan-Orange Groves. Easy terms. Dept. R., Suburban Orchards Co., Ocean Springs, Miss.

Degrees earned by correspondence study in Engineering, science, law, theology medicine, etc. 700 courses. Catalog free. Oriental University, 1702 Oregon Ave., N. W. Washington, D. C.

Moon-O-Light radium paint shines in darkness; 25c. per bottle. Gray & Bretz Company, Dept. 45-146; St. Lawrence Ave., Bronx, New York.

Make money with your camera. Lancaster, Box 967, Los Angeles.

Radio World. Great national illustrated weekly; 15c copy. All newsdealers. Trial sub. \$1.00 seven issues. 1993 Broadway, N. Y.

Be a broker, buy and sell Currencies and Bonds, make 100 to 300 per cent profit. Write for interesting information. George Grigolet, 20 E. Jackson, Chicago.

Motorcycles—Bicycles

Don't buy a Bicycle Motor Attachment until you get our catalog and prices. Shaw Mfg. Co., Dept. 6, Galesburg, Kansas.

News Correspondents

Earn \$25 Weekly Spare Time writing for newspapers, magazines. Experience unnecessary; details free. Press Syndicate, 5665 St. Louis, Mo.

Office Devices

Save half on office machines, equipment, addressers, Multigraphs, Duplicators, Dictaphones. Pruitt Company, 172 North Wells, Chicago.

Personal

Lonesome—Join our club—make acquaintances everywhere. Big illustrated book with descriptions and photos, sent in plain wrapper for ten cents. Bonafide Co., Dept. 58, Kansas City, Mo.

Exchange interesting letters with new friends. Dolly G. Gray, Box 136, Denver, Colo.

Exchange cheery letters with new friends. Write Betty Lee, Inc., 4251 Broadway, New York City. Stamp appreciated.

Exchange letters with new friends everywhere. Pleasant pastime, particulars free—Smith, Box 1167Y, Denver, Colo.

Lonely Hearts—Exchange letters; make interesting new friends in our jolly club. Eva Moore, Box 903, Jacksonville, Florida. Enclose stamp.

Want to be Popular? Be a handuff expert! Send \$1. for instructions. J. Mello, 378 Central St., Lowell, Mass.

Radio Equipment

Edison Elements for making "B" Batteries 6c per pair; tubes 2c each. Nickel Wire, Insulators, and Cabinets, at reasonable prices. Todd Electric Co., 178 Lafayette St., New York City.

Patent Attorneys

Inventors: Protect your invention through A. M. Wilson, Inc., Washington, D. C. Over 25 years of efficient, expert, confidential service. Skilled in Radio-Electrical, Chemical and Mechanical fields. Our new illustrated Patent Book, giving much necessary and very useful information which every inventor should know, will be sent free upon request. Prompt and careful attention. Highest references. Moderate fees. Send sketch or model for our careful opinion and preliminary advice. Write today to A. M. Wilson, Inc., (Radio 3 ARH), 325 Victor Bldg., Washington, D. C.

Patents. Send drawing or model for examination and report as to patentability. Advice and booklet free. Highest references. Best results. Promptness assured. Watson E. Coleman, Patent Lawyer, 624 F Street, Washington, D. C.

Inventors: Record invention legally before disclosing to others. Our Invention-Record and Data Sheet shows how. Sent free and valuable information given on patent procedure, costs, etc. Report on patentability includes copies of patents nearest your idea. O'Connell & O'Connell, 402 Jenifer Bldg., Washington, D. C.

Patents Procured. Send sketch or model today for examination; prompt report and advice. No charge for preliminary advice. Write for free booklet and blank form on which to disclose your idea. Highest references. Promptness assured. Clarence A. O'Brien, Registered Patent Lawyer, 751 Southern Building, Washington, D. C.

H. F. Lowenstein, Registered Patent Attorney, Radio Expert. 825 McLachlen Building, Washington, D. C.

Patents—Send for form "Evidence of Conception" to be signed and witnessed. Form, fee schedule, information free. Lancaster & Allwine, 269 Ouray Bldg., Washington, D. C.

Patent Electrical cases a specialty. Pre-war charges. B. P. Fishburne, 340 McGill Bldg., Washington, D. C.

Millions Spent Annually for Ideas! Hundreds now wanted! Patent yours and profit! Write today for free books—tell how to protect yourself, how to invent, ideas wanted, how we help you sell, etc., 301 Kresge Bldg., American Industries, Inc., Washington, D. C.

Patents Secured. Prompt service. Avoid dangerous delays. Send for our "Record of Invention" form and Free Book telling how to obtain a patent. Send sketch or model for examination. Preliminary advice without charge. Highest Reference. Write today. Jacobl & Jacobi, 413 Ouray Bldg., Washington, D. C.

Patents—Inventors should write for Free Guide Books and Record of Invention Blank before disclosing invention. Send model or sketch of your invention for our Free opinion of its patentable nature. Radio, Electrical, Chemical, Mechanical and Trade-Mark experts. Victor J. Evans & Co., 922 Ninth, Washington, D. C.

Patents

Inventions Commercialized. Patented or unpatented. Write Adam Fisher Mfg. Co., 278, St. Louis, Mo.

Unpatented Ideas can be sold. I tell you how and help you make the sale. Particulars free. Write W. A. Greene, Jenifer Building, Washington, D. C.

Radio Supplies

Dealers—write for large illustrated catalog of radio supplies. Our discounts will interest you. Western Radio Corporation, Cedar Rapids Iowa.

Sales Agency Wanted

Manufacturer's Agent, located in Chicago Loop, now representing nationally known radio manufacturers, desires line of radio merchandise. Now covering jobbers in Missouri, Illinois, Wisconsin, and Iowa. Interested only in commission proposition. Address Box 135, care RADIO NEWS.

Salesmen Wanted

Lightning Strange Battery Compound. Charges uncharged batteries instantly. Eliminates old method entirely. Gallon free to agents. Lightning Co., St. Paul, Minn.

Scenery to Rent

Settings for Opera, Plays, Minstrels. Plush Drops. Address Amelia Grain, Philadelphia.

Telegraphy

Telegraphy in a Week. A fact pending patent. Medellin Code. Licensed only for amateur use. \$1.00 postpaid. A. U. Medellin, Mesilla Park, New Mexico.

Telegraphy—Both Morse and Wireless taught thoroughly and quickly. Tremendous demand. Big salaries. Wonderful opportunities. Expenses low; chance to earn part. School established fifty years. Catalog free. Dodge's Institute, Cour St., Valparaiso, Ind.

Learn Morse Telegraph. Expert telegraphers teach you at home. Individual instruction. Method recommended by railroad and commercial officials who have positions waiting for you. Experienced telegraphers use this automatic instructor to become experts. Booklet RN free. Wireless telegraphy free. Learn-O-Graph Company, Bogota, N. J.

Memorize Code in 45 Minutes. Radio Code Chart teaches both Wireless and Morse. Dollar complete. Particulars free. John Percival, 2115 York, Des Moines, Iowa.

Ventriloquism

Ventriloquism taught almost anyone at home. Small cost. Send 2c stamp today for particulars and proof. Geo. W. Smith, Room M-806, 125 N. Jefferson Ave., Peoria, Ill.

Wanted to Buy

Full Value Paid for Old Gold Jewelry, Watches, Diamonds, crowns, bridges, dental gold, silver, platinum, gold or silver ore, magneto points, old false teeth. Packages returned if our offer is not satisfactory. United States Smelting Works (The Old Reliable), 120 So. State St., Dept. 16, Chicago, Ill.

Wireless

Broadcasting Set for Sale. Formerly known as K F A C. Includes thousand volt M-G Set three fifty-watt tubes, panel etc. While on the air made wonderful record. Write for full description, and very attractive price. J. A. Newton Electric Co., Glendale, California.

Tested Recipes. Transmitter Button Hook-Ups. Amplification. Loud Speakers. Free Circular. K Electric Co., 15 Park Row, New York City.

Build your own electrolytic storage battery charger. Plates and complete instructions, \$1.00. Descriptive circular free. Peerless Electrical Parts Co., 105 Harris, Rochester, N. Y.

Boys! Don't Overlook This. The "Rasco" Baby Detector. Greatest detector ever brought out with molded base. Fully adjustable. See former advertisements in this publication, or our catalog. Detector with Galena Crystal, complete 50c, the same detector with Radiocite Crystal, 75c prepaid. Send for yours today. Radio Specialty Company, 96-98 Park Place, New York City.

Attention!—50 Vacuum tube hook-ups. The greatest collection of vacuum tube circuits ever brought under two covers at such insignificant cost. These diagrams will be found in the great "Rasco" catalog, which contains raw materials and parts in a greater profusion than any other catalog. 15c in stamps, or coin, will bring the catalog to you. Radio Specialty Co., 96-98 Park Place, N. Y.

Build your sets with quality parts and get sure results. Radio Parts Co., Box 56, Dunellen, N. J.

Blue Print Specifications and Plans. How to erect an outdoor single wire antenna. Price 10c. G. Reifsnnyder, P. O. Box No. 25, Easton, Pa.

Wonderful Radio Discovery, too loud for amplification on local stations. No expensive apparatus, simplest and most selective tuner known, regardless of price. Send \$1.00 for full details and wiring diagrams. J. W. Thetford, 571 Clinton St., Camden, N. J.

Pacific Coast Stations are heard in Pittsburgh with varicoupler and two Rogers Receiving Radiometers (Condensite molded variometers). Radiometers \$3.00 each, postage prepaid. Rogers Radio Company, 5133 Woodworth St., Pittsburgh, Pa.

Magnavox Type R 3. Latest nationally advertised improved reproducers in original factory sealed cartons. List, \$35. Introductory offer, \$25. Radio Central, Dept. R., Abilene, Kans.

Copper Braid—best conductor known for wiring radio sets. Fifteen feet for 50c. Radio Panel Shop, Junction City, Kansas.

Baldwin Headsets, Super sensitive. Standard in U. S. army and navy. List, \$12. Premium, one year's subscription or extension to Radio News. Radio Central, Abilene Kansas.

Protect Your Tubes with small fuse wire between rheostats and sockets. Three feet for 25c. Specify tube. Radio Panel Shop, Junction City, Kansas.

Western Electric Loud Speakers. Western Electric's reputation insures you of wonderful reproduction of music at all frequencies. List, \$55. Introductory, \$15. Radio Central, Abilene, Kansas.

Receiving Sets Overhauled, repaired, rebuilt and made to "percolate." Any circuit. Twelve years' experience and up-to-date. Radio Repair Shop, Junction City, Kansas.

Freed-Eisemann Neutrodyne Parts. Radio men the neutrodyne circuit holds a happy surprise for you. Per set, \$21. Introductory offer \$18. Radio Central, Abilene, Kan.

Westinghouse Tuner. UV200 tube, DeForest Audio transformer. .001 condensers, two-stage Radio and detector, two-stage amplifier, \$20. Raymond Schlerel, 1118 N. Negley, Pittsburgh, Pa.

Would You Like to Listen to Music from Europe? Try a Freed-Eisemann 5-tube Neutrodyne Receiver. List, \$150. Introductory, \$125. Complete with Magnavox, Tubes and Batteries, \$250. Introductory \$215. Radio Central, Abilene, Kansas.

Special Tubes UV201, UV201A, UV190, WD11, WD12, (301, (301A, (299 DV-1, DV-6, \$5.50, Radiola, (RC) or (V), \$120. Bradlevstats, \$1.60, Electric Soldering Iron \$2.00. Federal Sets, Type DX, 58, \$100. Type 57, \$88.00 Crystal Receiver, \$3.50, Amp. Transformers, \$2.50. Postpaid, Dealers Wanted. C. H. Anderson Lewistown, Mont.

Major Armstrong's New Epoch-Making Invention Will Solve Your Loop Antenna Problem. The New Armstrong Super-Regenerative Circuit is a means now that is made possible with two vacuum tubes and an indoor loop antenna to receive broadcasting music up to 100 miles distant. Our engineering department has compiled a pamphlet that gives an exposition of the theory of operation with full working directions, etc. A large blue-print is included with this pamphlet. Your dealer cannot supply you with these pamphlets. Send us 25c and we will mail to you this wonderful exposition prepaid. Tell your dealer to ask us for our proposition. The E. I. Company, 323 Fulton St., New York City.

NEW AND POPULAR BOOKS

DESIGN AND CONSTRUCTION OF AUDION AMPLIFYING TRANSFORMERS

Radio and Audio Frequency Type

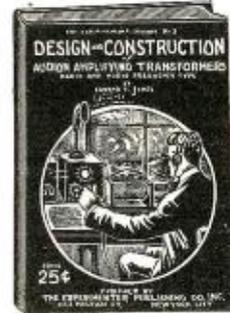

This latest and important book by Mr. Edward T. Jones, late Associate Editor of Radio News, will be of great interest to all radio amateurs throughout the land. The transformers shown in these books have never been described in print before, and have usually been considered a manufacturer's secret. Anyone who has several vacuum tubes cannot afford to do without this book because it will enable him to build the necessary amplifying transformers very readily. The designs are very simple and rugged, and anybody can make them without trouble.

The book is printed on good paper and has an attractive cover in two colors. Paper bound. Size 5x7 in. Contains many illustrations, diagrams and working data necessary to build the transformers.

Price, Postpaid 25c.

TWO REMARKABLE BOOKS

Book No. 1 contains 100 pages, size 7x5 in., and 88 illustrations. How to make Wireless Sending Apparatus 35c. Postpaid.

Book No. 2 contains 100 pages, size 7x5 in., and 90 illustrations. Written and published entirely for the wireless enthusiast who wants to make his own radio apparatus. Only strictly modern instruments are described and the illustrations and descriptions are so clear and simple that no trouble will be experienced in making the instruments.

Book No. 2—How to make Wireless Receiving Apparatus 35c. Postpaid.



THE EXPERIMENTER PUBLISHING CO.

Book Dept., 53 Park Place, New York

These Books Are For Sale Also At The Following Dealers

- Amer. Technical App. Co., 235 Fulton St., N. Y. C.
- Baker Taylor Co., 334 Fourth Ave., N. Y. C.
- Benwood Co. Inc., 3424 Olive St., St. Louis, Mo.
- Marconi Wireless Tel. Co., Montreal, Canada
- E. P. Noll Co., 21 N. 7th, Phila., Pa.
- Continental Radio Supply Corp., 6 Warren St., N. Y. C.
- F. S. Katzenback, 35 E. State St., Trenton, N. J.
- McDevitt & Wilson, 50 Church St., N. Y. C.
- R. H. Macy Co., New York City
- Manhattan Elec. Supply, 17 Park Place, N. Y. C.
- John Wanamaker, New York, N. Y.
- Geo. Parezo & Co., Washington, D. C.
- Southern Elec. Co., San Diego Calif.

CHIROPRACTIC and Smallpox

By JAMES G. GREGGERSON

National Lecturer for the Universal Chiropractors' Association

ALL RIGHTS RESERVED



TWENTY years ago compulsory vaccination was taken for granted, but in recent years the movement to abolish it has gone by leaps and bounds in every state in the Union. England, after testing the vaccination theory for more than a century, entirely abandoned it. Dr. Walter Hadwen, M. D., M. R. C. S., of Gloucester, England, speaking on this question at a public meeting in Los Angeles, Calif., June 16, 1922, said:

"Now, my friends, the whole of this wretched vaccination and inoculation system is based upon superstition! Thank God, we have carried a law in my country that no one need be vaccinated, and 75 per cent of the children born in the United Kingdom remain unvaccinated. We never had so little smallpox in all our history. It is practically non-existent."

This vaccination idea was tested in Kansas City, Missouri, during 1921, and here are the facts as published by the Advertisers' Protective Bureau of the Kansas City Advertising Club, George M. Husser, Sec'y, 801 Graphic Arts Bldg., Kansas City, Missouri:

"It is the policy of this bureau to deal only in facts. This policy underlies the bureau's work as a quasi-public institution in its mission of suppressing for the benefit of the public fraudulent and misleading advertising or publicity. . . ."

"The facts seem to be that health conditions just before the 'epidemic' were favorable, from the less than 50 per cent hospital attendance, the small list of contagious cases on record at the health office (see list) and the fact that E. H. Bullock, health officer, felt the time opportune to take his annual vacation. We learned also that medical practitioners had fewer cases, and were not overrun with calls.

"The sudden calling of the epidemic and the attendant publicity changed all this. Every medical practitioner in the city found his hands full with vaccinating patients, both at the office and in the homes. Unofficial estimates place the number of paid vaccinations (as distinguished from free vaccinations of school children and at health centers) at 200,000, for which it is alleged fees ranging from 25 cents up to \$5 each were charged. An estimated average fee of \$2.50 would yield an aggregate of one-half million dollars expended by the public of Kansas City during this period for vaccination alone. Besides the vaccination expenditure many people, suffered from the after-effects of vaccination, some of them severely. For these, medical attention was required, in some instances over a period of months, with added expenditure. Besides, there were numbers who, from reading of the epidemic, imagined they had the symptoms of smallpox and desired medical advice, which added to the cost. This phase need not be entered into at length, the above outline being, we believe, sufficient to emphasize our point."

The vaccination theory was also put to the test in the Philippine Islands for seven-

teen years, with the following results as given by the Masonic Observer of Minneapolis, Minn., issues of Dec. 17th, 1921, and of Jan. 14th, 1922. This paper is the publication of the Free Masons, a body of gentlemen than whom there is none greater.

"Sixty thousand, six hundred and twelve cases of smallpox, and 43,294 deaths from smallpox in the Philippines in 1919. . . ."

"We were unable to secure a 1919 report of the Philippine health service, and this is not surprising in view of a discovery made in the report of that organization for 1920, tucked away in one small paragraph on page 24 of the report, which discloses that the smallpox epidemic of 1918 continued during 1919 with a total of 60,612 additional cases and 43,294 deaths for 1919. . . ."

"The Philippines have experienced three smallpox epidemics since the U. S. first took over the islands, the first in 1905-1906, the second in 1907-1908, and the third, and worst of all, the recent epidemic of 1918-1919. Before 1905 (with no systematic general vaccination) the case mortality was about 10 per cent. In the 1905-1906 epidemic, with vaccination well started, the case mortality increased to over 16 per cent. In the epidemic of 1907-1908, with general systematic vaccination going strong, the case mortality ranged from 25 to 50 per cent in different parts of the islands. During the epidemic of 1918-1919, with the Philippine Islands, supposedly, almost universally immunized against smallpox by vaccination, the case mortality averaged over 65 per cent. These figures can be verified by reference to the report of the Philippine health service for 1919, see page 78. These figures are accompanied by the statement that the 'MORTALITY IS HARDLY EXPLAINABLE.' To anyone but a Philippine medical health commissioner it is plainly the result of vaccination."

Not only has smallpox become more deadly in the Philippines, but in addition,

"The statistics of the Philippine health service show that there has been a steady increase in recent years in the number of preventable diseases, especially typhoid, malaria and tuberculosis."

(Quoted from the 1921 Report of the special mission on investigation to the Philippine Islands, of which commission General Leonard Wood was the head.)

Just as a sort of condiment to this mass of facts, let us quote from Physical Culture of June, 1922. It places the facts very briefly as follows:

"IS THERE METHOD IN VACCINATION MADNESS?"

"Most vaccinated country, Philippine Islands, population 10,350,640, smallpox deaths, 1919, 44,408. Least vaccinated country, England and Wales, population 37,885,242, smallpox deaths, 1919, 28.

These facts admit of no contradiction. Kansas City can be reached with a one-

cent postal card, the report of the surgeon general of the Philippines is public property, and the authorities from which Physical Culture quotes are accessible to everyone. It is an established fact that the public has been victimized for over a hundred years by those whose science consisted of getting the cash by frightening the people with repulsive pictures. The injection into your body of the rotten tissue from the sores of a cow with cowpox to prevent smallpox, was a superstition when performed by those who knew no better. Its continuance with the facts established is a crime against humanity.

Chiropractic teaches that smallpox is the result of poisons accumulating in the body because the organs of elimination are not functioning properly. The poisons that ordinarily pass out through the kidneys, bowels, etc., are retained in the body and the "power within," that throws these poisons out, starts to expel them through the pores of the skin. These pores being closed permit the poisons to accumulate until they produce the eruption peculiar to smallpox.

We teach that the reason the bowels and kidneys do not work right, is because the functional impulse does not reach these organs, due to the fact that a vertebra in the spine is misaligned, thereby impinging the nerve and interrupting the normal flow of these functional impulses to bowels, kidneys, etc.

This adjustment of the vertebrae is the chiropractor's work, and this practice of ascertaining which vertebrae are misaligned by palpation, and adjusting them to normal alignment by hand, is all the chiropractor does. It is upon this simple practice of the palpation and adjustment of the vertebrae of the spinal column with the hands for the purpose of releasing the prisoned impulse, that Chiropractic has made the most astonishing growth of any profession in the history of the world.

Of course, Chiropractic is not the practice of medicine, and of course the real chiropractor is but a demonstrator of an idea. He is not a jack of all trades. Those who do other things beside palpating and adjusting the spine, in the name of Chiropractic, simply adopt the name chiropractor for business reasons. The denser the ignorance of these gentlemen, the more contraptions they use to conceal their ignorance. Those who wish to try Chiropractic should see that they secure a *competent* practitioner, and the service of directing you to the office of a competent practitioner will be performed by the



Universal Chiropractors' Association of Davenport, Iowa

Workrite Former

\$2.00

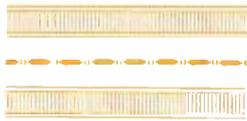

This aircore Transformer has been perfected for use in the Neutrodyne method of receiving. It should be used with .0004 mfd. variable condenser for tuning to all broadcasting wave lengths. It can also be used as a transformer for tuned radio frequency reception, or fixed coupler with condenser across secondary. It is made with tubes of moulded Bakelite and wound with green silk wire. Extreme care has been taken to see that the tubes are properly spaced and just the right number of turns of wire are used, insuring maximum efficiency. Like all WorkRite products it has been thoroughly tested by other laboratories as well as our own before being put on the market. It will measure up to the "WorkRite" standard of quality and efficiency.

Watch For The WorkRite Variable Condenser

WorkRite Super Vernier Rheostat



This improved WorkRite Vernier Rheostat is just the instrument you have been looking for, 50,000 possible adjustments. A turn of 1-32" will separate two stations or clear up one. Made in three different resistances so that there is a WorkRite Vernier Rheostat for every tube now on the market. 6 ohms, \$1.00; 15 ohms, \$1.15; 30 ohms, \$1.25.

WorkRite E-Z-Tune Dial
Snappiest Dial on the market. Has a knurled flange on the rim for delicate leverage. Price75c.

WorkRite Resistance Cartridge
Raises the resistance of your 5 or 6 ohm Rheostat to the 15 or 30 ohms required for UV 199, and similar tubes. Price, either 15 or 25 ohms, 40c.

WorkRite Neutralizing Condenser



Neat, Compact and very efficient. This instrument has a glass insulation on the outside which greatly expedites neutralizing the set. Price each 25c.

Work-Rite Tuner Team



WorkRite Super Variometer



WorkRite 180° Super Variocoupler

Tunes out local stations and gets the one you want. This famous Tuner Team is made up of two WorkRite Super Variometers and one WorkRite 180° Super Variocoupler. Variometer is made from polished mahogany. Variocoupler made from moulded Bakelite and wound with green silk. Range 150 to 705 meters. Shafts 3-16".

WorkRite Super Variometer, each\$3.50

WorkRite 180° Super Variocoupler, each\$3.50

**"WORKRITE RADIO PARTS
WORKRITE"**

WorkRite Nonmicrophonic Socket



Here is the right Socket for use with your UV 199 and C 299 Tubes. It is moulded with a sponge rubber base in one piece which is even better than the soft rubber recommended for use with these tubes. Very neat and attractive. Price 60c.

WorkRite Hydrometer

You need one for your storage "A" Battery. Full instructions with each instrument. Price75c.

WorkRite Head Set

Very Sensitive. Light and sanitary. Try one and see. Price\$6.00

Work-Rite Switch Set

Just what you want. Use the block for drilling panel. Arms and points made to work together. Price... 50c.

THE WORKRITE MANUFACTURING CO.

5531 EUCLID AVENUE

CLEVELAND, OHIO

(Branch Office, 536 Lake Shore Drive, Chicago)

**Radiotron
UV-201-A**
The super-amplifier tube \$6.50



**Radiotron
UV-199**
The little tube of big performance \$6.50



**Radiotron
UV-200**
The long distance detector \$5.00



**Radiotron
WD-11**
The ideal dry battery detector \$6.50



**Radiotron
WD-12**
The standard base dry cell tube \$6.50



This symbol of quality is your protection

Radiotrons

To Get Distance—and Get it Clearly

For quality of reception and length of service, every man wants a RADIOTRON. Experienced amateurs and broadcast listeners know the sensitivity and dependable performance of these tubes. UV-199 for portable sets because it operates on flashlight batteries. WD-11 and WD-12, the dry cell tubes, for use everywhere—especially on farms and at the summer bungalow. UV-200 and UV-201-A for use with a storage battery. There is a Radiotron for every need.

Look for the RCA trade mark, and the name RADIOTRON. Each is a guarantee of satisfaction.

Radio Corporation of America

Sales Dept., Suite 2065
233 Broadway
New York

District Sales Offices
10 So. LaSalle Street Chicago, Illinois
433 California Street San Francisco, California

Radiotrons

REG. U. S. PAT. OFF.